

Elias Safi

Comparative analysis of shear capacity in concrete structures: Eurocode 2 and its revised version

Master's thesis in Civil and Environmental Engineering

Supervisor: Jan Arve Øverli

December 2023

Elias Safi

Comparative analysis of shear capacity in concrete structures: Eurocode 2 and its revised version

Master's thesis in Civil and Environmental Engineering
Supervisor: Jan Arve Øverli
December 2023

Norwegian University of Science and Technology
Faculty of Engineering
Department of Structural Engineering





MASTER THESIS 2023

SUBJECT AREA: Concrete Structures	DATE: 14/12-2023	NO. OF PAGES: 71
--------------------------------------	------------------	------------------

TITLE:

**Comparative analysis of shear capacity in concrete structures:
Eurocode 2 and its revised version**

Komparativ analyse av skjærkapasitet i betongkonstruksjoner:
Eurokode 2 og dens reviderte versjon

BY:

Elias Safi



SUMMARY:

This study examines the transition from Eurocode 2 (EC2: NS-EN 1992-1-1:2004) to its revised version, FprEN (FprEN 1992-1-1:2022), with an emphasis on the shear capacity of concrete. Prompted by the need to update EC2 after nearly two decades, the revision incorporates significant contributions from various European countries and specialized teams. Key changes in FprEN include the integration of concrete bridges standards into liquid-retaining structures standards, along with advancements in understanding shear, cracking behaviour, and reinforcement in concrete structures.

A comprehensive analysis of shear guidelines based on both EC2 and FprEN is presented, examining structural components with and without requirements for design shear reinforcement, minimum shear reinforcement, shear between web and flange, and the analysis of shear at interfaces. The comparative study of these guidelines underscores the evolution, advancements, and the significant impact of these changes in the FprEN on structural engineering.

Overall, the findings of this study demonstrate a major advancement in structural engineering practices, moving towards more reliable methods that emphasize accuracy, safety, and efficiency in concrete design and construction. The study highlights the dynamic nature of engineering standards, adapting to new insights and technologies, and contributing to the development of safer and more efficient structural designs.

RESPONSIBLE TEACHER: Jan Arve Øverli

SUPERVISOR(S) Jan Arve Øverli

CARRIED OUT AT: Department of Structural Engineering NTNU

Preface

This thesis marks the culmination of my journey in the 5-year master's degree program at the Faculty of Engineering, Department of Structural Engineering at the Norwegian University of Science and Technology (NTNU).

The topic of this thesis was presented by the Department of Structural Engineering due to an ongoing revision of the European standard for the design of concrete structures, general rules, and rules for buildings: Eurocode 2: Part 1-1, EN 1992-1-2:2004. The assignment is limited to shear forces and includes a review of the current background literature, as well as a comparison of the calculation rules in the current and revised versions of Eurocode 2.

Writing this master's thesis has been a challenging yet enriching experience. It was inspiring to work on a topic that holds relevance and offers value to the future design of concrete structures.

I extend my heartfelt gratitude to my supervisor, Jan Arve Øverli, for his invaluable assistance and unwavering availability throughout the entirety of this project. I cannot thank him enough for his guidance and support during this process.

December 15, 2023, Trondheim
Elias Safi

Summary

This study examines the transition from Eurocode 2 (EC2: NS-EN 1992-1-1:2004) to its revised version, FprEN (FprEN 1992-1-1:2022), with an emphasis on the shear capacity of concrete. Prompted by the need to update EC2 after nearly two decades, the revision incorporates significant contributions from various European countries and specialized teams. Key changes in FprEN include the integration of concrete bridges standards into liquid-retaining structures standards, along with advancements in understanding shear, cracking behavior, and reinforcement in concrete structures.

The research focuses on the mechanical properties of concrete, comparing EC2 and FprEN standards. It investigates how FprEN refines the estimation of properties like compressive strength, tensile strength, and elastic modulus, considering factors such as concrete size, age, and the implications of these refined calculations on construction costs and procedures. This thesis also explores the complex aspects of concrete properties and shear capacity, revealing a shift towards more specific and detailed design methods. This shift is evident in the improved guidelines, indicating a stronger focus on precise structural design and adopting standards that prioritize safety and address the needs of modern construction.

A comprehensive analysis of shear guidelines based on both EC2 and FprEN is presented, examining structural components with and without requirements for design shear reinforcement, minimum shear reinforcement, shear between web and flange, and the analysis of shear at interfaces. The comparative study of these guidelines underscores the evolution, advancements, and the significant impact of these changes in the FprEN on structural engineering.

Overall, the findings of this study demonstrate a major advancement in structural engineering practices, moving towards more reliable methods that emphasize accuracy, safety, and efficiency in concrete design and construction. The study highlights the dynamic nature of engineering standards, adapting to new insights and technologies, and contributing to the development of safer and more efficient structural designs.

Contents

1	Introduction	1
2	Exploring: Eurocode 2, Concrete and Shear	3
2.1	Eurocode 2	3
2.1.1	Key changes presented in FprEN	4
2.2	Concrete	5
2.3	Importance of shear in concrete structures	7
2.4	Shear stress theory	8
2.4.1	Effect of shear force on reinforced concrete beam	8
2.4.2	Stresses between N.A and tensile reinforcement	10
2.4.3	Stresses above the N.A	10
2.4.4	Cracks due to shear forces	13
3	Analyzing Mechanical Properties of Concrete, EC2 vs. FprEN	15
3.1	The Design Compressive Strength, f_{cd}	15
3.2	Evaluation of Design Tensile Strength, f_{ctd}	17
3.3	Elastic Modulus	20
4	Shear, Eurocode 2 Guidelines	22
4.1	Members not requiring design shear force reinforcement	22
4.2	Members requiring design shear reinforcement	26
4.3	Minimum shear reinforcement	29
4.4	Shear between web and flanges	29
4.5	Shear at interfaces	31
5	Shear, FprEN Guidelines	35
5.1	Members not requiring design shear force reinforcement	35
5.2	Members requiring design shear reinforcement	39
5.3	In-plane shear and transverse bending	41
5.4	Minimum shear reinforcement	42
5.5	Shear between web and flanges	42
5.6	Shear at interfaces	43
6	Shear, EC2 vs. FprEN	46
6.1	Members not requiring design shear reinforcement	46
6.2	Members requiring design shear reinforcement	47
6.3	Minimum shear reinforcement	49
6.4	Shear between web and flanges	50
6.5	Shear at interfaces	51
7	Concluding Remarks	54

List of Figures

2.1	Different kinds of force acting on a beam [13].	7
2.2	Beam with shear force diagram [6].	8
2.3	Simply supported beam subjected to uniform distributed load with its shear force diagram, [18].	9
2.4	Stresses manifesting at a cross-section located at a distance X from the support .	9
2.5	Stress distribution above and below the neutral axis [18].	10
2.6	[18]	12
2.7	Types of cracks: [7]	13
2.8	Mohr's Circle: [18].	14
2.9	Mohr's circle in compression zone: [18].	14
3.1	Comparison of f_{cd} between EC2 and FprEN	17
3.2	Comparison of f_{ctd} between EC2 and FprEN	19
3.3	Stress-Strain curve for concrete in compression [14].	20
3.4	Comparison of E_{cm} between EC2 and FprEN	21
4.1	Illustration of tensile reinforcement, where d is the effective height, A_{sl} is the cross section area of the tensile reinforcement, V_{Ed} is the design shear force, and the l_x is the distance of section considered from the starting point of the transmission length.	23
4.2	Shear capacity ($V_{Rd,c}$) vs. reinforcement amount (ρ_l)	26
4.3	Truss model and notation for shear reinforced members [3].	27
4.4	$V_{Rd,s}$ and $V_{Rd,max}$ as a function of $\cot \theta$	28
4.5	Examples of shear reinforcement: [3].	29
4.6	Flange-web connection [3].	31
4.7	Examples of interfaces: [3].	32
4.8	Indented construction joint [3].	32
4.9	Shear diagram representing the required interface reinforcement: [3].	33
4.10	Design Shear Resistance at Interface	34
5.1	Regions where shear strength verification can be omitted [4].	35
5.2	A_{sl} : Source:[3].	36
5.3	Shear capacity ($v_{Rd,c}$) vs. reinforcement amount (ρ_l)	39
5.4	$\tau_{Rd,sy}$ vs. $\tau_{Rd,max}$	40
5.5	Interaction between shear and transverse bending: [4].	41
5.6	Design Shear Resistance at Interface	45
6.1	Shear capacity $V_{Rd,c}$ vs. reinforcement amount ρ_l (EC2 vs. FprEN)	47
6.2	EC2 vs FprEN	49
6.3	Shear diagram presenting a distributed stepped interface reinforcement: [3].	53

List of Tables

2.1	Overview of FprEN clauses and corresponding number of pages [9].	4
2.2	Overview of FprEN annexes and corresponding number of pages [9].	5
2.3	Classes of concrete, type of cement and their corresponding strengths [5, Table 3, pg.16].	6
5.1	Coefficients depending on the roughness of the surface [4].	44

Chapter 1

Introduction

Concrete is an essential construction material comprising aggregates (such as sand and gravel), cement, and water. By addition of water, a chemical reaction occurs that binds these aggregates together, resulting in the formation of concrete. This material is noted for its solidity, strength, and durability, making it a popular choice for building structures like buildings, bridges, and highways due to its widespread availability and versatility [19].

The European standard for the design of concrete structures, Eurocode 2 (EC2) [3], offers guidelines for calculations, dimensioning, and verifying structural elements. These guidelines ensure the safety, serviceability, and durability of structures. EC2 serves as an indispensable guide for engineers, both within the European Union and globally. It provides comprehensive directives on material selection, structural analysis, and intricate detailing of key structural components, including beams, columns, and slabs, making it an essential tool in the field of engineering.

In assessing the shear capacity of unreinforced concrete, EC2 integrates empirical data, experimental insights, and foundational structural mechanics principles. This intricate combination often culminates in sophisticated mathematical models that can pose significant challenges to those not deeply versed in the domain, potentially leading to suboptimal or even hazardous structural designs [3, 17].

The Technical Committee CEN/TC 250, responsible for Structural Eurocodes, is responsible for updating the Eurocode 2 (EC2) CEN/TC 250 - Structural Eurocodes. This revision process has been spurred by significant advancements in concrete technology since the original introduction of EC2 in 2004, as well as valuable feedback from its practical application. The overarching objectives of this update are to improve the clarity, safety, and efficiency of the code.

In line with these developments, the central aim of this thesis is to conduct a comprehensive comparison between the current version of EC2 and its upcoming revision, officially known as FprEN 1992-1-1:2022 (FprEN). This comparison was proposed by the Department Structural Engineering, with a particular emphasis on shear forces in concrete structures. The thesis includes literature review coupled with a detailed analytical assessment of the methodologies employed for calculating shear forces in both the existing and the revised versions of EC2.

This thesis addresses the limited tensile strength of concrete, exploring the theoretical basis of FprEN's revised model and its comparison with the current EC2, especially in terms of shear forces and their effects on concrete structures.

The thesis is structured into five parts. It starts with an overview of EC2 and the modifications introduced in FprEN, including discussions on different types of concrete and the foundational principles of shear stress theory. This is followed by a comparative study on the design compressive

strength, tensile strength, and elastic modulus of concrete as per both standards, aiming to understand the implications of FprEN's changes on structural design and construction.

Chapter 2 delves into the mechanical properties of concrete under both EC2 and FprEN, analyzing how FprEN refines property estimation and its impact on construction methodologies and costs.

The third and fourth parts focus on the Shear Guidelines based on EC2 and FprEN, examining structural components with varying shear reinforcement requirements and interface shear analysis.

The fifth part provides a comparative evaluation between EC2 and its revised version, FprEN. This segment highlights the significant advancements brought forth by FprEN and delineates its impact on the realm of structural engineering.

Furthermore, an in-depth analysis of shear in concrete structures is conducted under both EC2 (chapter 4) and FprEN (chapter 5), encompassing key aspects like in-plane shear and transverse bending (chapter 6). The thesis concludes with discussing the progressive evolution and the practical ramifications of these standards as they adapt and advance in response to emerging engineering challenges and innovations.

The decision to focus this master's thesis on shear in concrete was motivated by multiple factors, both academic and practical. Firstly, the subject offers a rich landscape for academic exploration, such as the impact of different factors like concrete quality, reinforcement details, and loading conditions on shear behavior. The complexity involved in studying shear provides an opportunity for analysis and interpretation. Secondly, the importance of understanding failures cannot be overstated; they often lead to consequences with limited options for remedial measures. Furthermore, the introduction of the revised code, FprEN, presents a timely opportunity to contribute to the understanding of any new or revised shear design provisions. This study attempts to bridge the gap between academic theory and practical application, providing engineers insights into the evolving landscape of shear design in concrete structures.

Chapter 2

Exploring: Eurocode 2, Concrete and Shear

This chapter begins with a brief overview of EC2 and changes introduced in FprEN, followed by an explanation of different types of concrete. Additionally, it aims to clarify the importance of shear forces in concrete structures. Moving forward, section 2.4 explores the shear stress theory, it examines the impact of shear force on a simply supported beam subjected to a uniformly distributed load. This examination includes evaluating stresses both below and above the neutral axis (N.A.) and an analysis of crack formation caused by these shear forces

2.1 Eurocode 2

EC2 is a set of European standards for the design of concrete structures. It was officially published in 2004 as EN 1992-1-1 [3], for general rules and rules for buildings and EN 1992-1-2 [2] for structural fire design. These codes aim to provide a unified approach for the design of concrete structures across European nations.

It was clear and evident that an update of EC2 was needed, due to the fact that the original version of the codes had not been significantly revised for nearly twenty years and had become increasingly outdated. The objective of the revision was to address specific problems and limitations identified in the EC2, as well as to include the new topics, in-plane shear and transverse bending. These new topics, discussed in section 5.3, were not covered in the previous version.

Plans to update EC2 started in 2010, as well as working on technical changes began in 2015. The European Committee for Standardization (CEN) started the revision process by conducting a systematic review, in which the CEN members were asked to provide comments on the current version. The revision of EC2 was an effort involving ten voluntary task groups, and three project teams worked on various aspects. Once the project team completed their task, the text was sent back to the European Standard Committee (CEN) for additional review, taking into account feedback from member nations.

A key technical advancement in the updated standards is the integration of the existing concrete bridge guidelines (EN 1992-2) into the primary document for liquid-retaining and containment structures (EN 1992-3). This strategic combination stems from the recognition that a significant portion of the principles and guidelines in these sections are relevant and applicable across a broader range of structures. Additionally, the revisions propose substantial enhancements in crucial areas, including shear resistance, crack control, and anchorage design, marking significant strides in structural engineering practices.

In July 2021, a draft for the revised EC2 was published for CEN examination and had been open for public feedback. Nearly 5000 comments were received and focus at that time was on addressing of these inputs. The draft of EC2 included topics like non-linear analysis procedures,

assessment for current structures, steel-fibre-reinforced concrete structures, and recycled aggregate concrete, among others [12].

The upcoming generation of Eurocode 2 presents a significant update from the existing code. It not only revises several areas, but it also has a much broader scope than the present code. It is expected that the next generation EC2 will be available after a formal vote, sometime between April 2024 and 2027 [12].

2.1.1 Key changes presented in FprEN

The changes in the main part of the standard is presented in Table 2.1.

Table 2.1: Overview of FprEN clauses and corresponding number of pages [9].

Clause	Title	Pages
	Title page, Table of contents, European foreword, Introduction	20
1; 2; 3	Scope; normative references; terms, definitions and symbols	
4	Basis of design	4
5	Materials	12 + Annex C
6	Durability	12
7	Structural analysis	19 + Annex O
8	Ultimate Limit State (ULS)	52
9	Serviceability Limit State (SLS)	14 + Annex S
10	Fatigue	4 + Annex E
11	Detailing of reinforcement and post-tensioning tendons	24
12	Detailing of members and particular rules	22
13	Additional rules for precast concrete elements and structures	12
14	Plain and lightly reinforced structures	6
Total main part		247

Similarly, the annex includes new additions as presented in Table 2.2.

Table 2.2: Overview of FprEN annexes and corresponding number of pages [9].

Clause	Title	Pages
A	Adjustment of partial factors for materials (Normative → Informative)	9
B	Time dependent behavior of materials (Normative)	11
C	Requirements to materials (Normative)	9
D	Evaluation of early-age and long-term cracking due to restraint (Informative)	5
E	Additional rules for fatigue verification (Normative)	5
F	Non-linear analyses procedures (Informative)	5
G	Design of membrane, shell and slab elements at ULS (Normative)	7
H	Guidance on design of concrete structures for water tightness (Informative)	3
I	Assessment of existing structures (Informative)	19
J	Strengthening of existing concrete structures with CFRP (Informative)	20
K	Bridges (Normative)	16
L	Steel fibre reinforced concrete structures (Informative)	14
M	Lightweight aggregate concrete structures (Normative)	3
N	Recycled aggregates concrete structures (Informative)	3
O	Simplified approaches for second order effects (Informative)	8
P	Alternative cover approach for durability (Informative)	4
Q	Stainless steel reinforcement (Normative)	4
R	Embedded FRP reinforcement (Informative)	11
S	Minimum reinforcement for crack control and simplified control of cracking (Informative)	4
	Bibliography	2
Total Annexes		162
Total FprEN 1992-1-1		409

In this thesis, a general discussion on shear forces, as addressed in Clause 8, is provided, along with a presentation of certain aspects of materials from Clause 5. The titles of these Clauses are listed in the table table 2.1.

2.2 Concrete

Concrete is one of the most widely used materials in modern infrastructure, has a rich history that dates back to ancient Egyptians, Greeks and Romans. Egyptians used calcined impure gypsum. Greeks and Romans used calcined limestone and later learned to add to lime and water, crushed stone and sand or brick and broken tiles [15].

Concrete is a composite material that is a mixture of pebble or coarse gravel, sand, water, cement, admixtures and mineral additives such as pozzolans¹. Fine and coarse aggregates forms about 70% of the volume, cement paste makes up approximately 30% of the volume and the volume fractions of the other components can be ignored [11]. Some of the concrete classes and their strength are presented in Table 2.3.

The description of some of the terms used above are as follows:[11, 15]:

Aggregates are categorized into two types: sand and coarse. Sand is natural particles smaller than 4 mm, and coarse aggregate is natural or crushed particles of natural rock with diameter greater than 4 mm.

¹Volcanic ash mined near the city of Pozzuoli, Italy.

Cement serves as binding agent in concrete mixture, and when mixed with water is often called cement paste. Cement is typically made from limestone, clay and other minerals. The cement goes through a chemical reaction known as hydration when mixed with water, this reaction leads to formation of hard mass, giving concrete its strength.

Admixtures are chemical agents added to concrete mix in small dosages to modify its properties. They are used less than 5% of cement weight but have a significant impact on concrete. There are different types of admixtures, such as accelerators, retarders, plasticizers and air-entraining agents.

Table 2.3: Classes of concrete, type of cement and their corresponding strengths [5, Table 3, pg.16].

Class*	Type of cement	Cement strength class [‡]	Composition and properties of the binder (cement and SCM [†])
CS	CEM III	32.5 N	Portland cement clinker and more than 65 %- of ground granulated blast furnace slag (ggbs) or more than 35 %- of fly ash (fa)
	CEM II/B	42.5 N	
CN	CEM II	42.5 N	Portland cement clinker and more than 35 %- but less than 65%- of ground granulated blast furnace slag (ggbs) or more than 20 %- but less than 35 %- of fly ash (fa)
	CEM I	32.5 R	
CR	CEM I	42.5 R	—
		52.5 N	
		52.5 R	

[‡] According to EN 197-1 [5]. The strength of cement is measured in MPa, and the letters “N” and “R” indicate normal early strength and high early strength, respectively.

[†] Secondary cementitious materials (SCM) considered as cement replacement for the water-binder-ratio according to EN 206 [1].

* The letters S, N, and R in the class column indicate the strength development of concrete with time, i.e. slow, normal, and rapid.

Cement types are grouped into five main categories:

CEM I Portland cement

CEM II Portland-composite cement

CEM III Blastfurnace cement

CEM IV Pozzolanic cement

CEM V Composite cement

For more detailed information on the composition of the 27 products in common cements and their respective groups, the reader is referred to EN 197-1 [5].

2.3 Importance of shear in concrete structures

Shear is usually a force that acts perpendicular to the longitudinal axis of structural members. Concrete structures must be able to carry shear force caused by own weight and external applied forces. In engineering terminology, shear force is often denoted by the variable V . For illustration, fig. 2.1 describes types of forces.

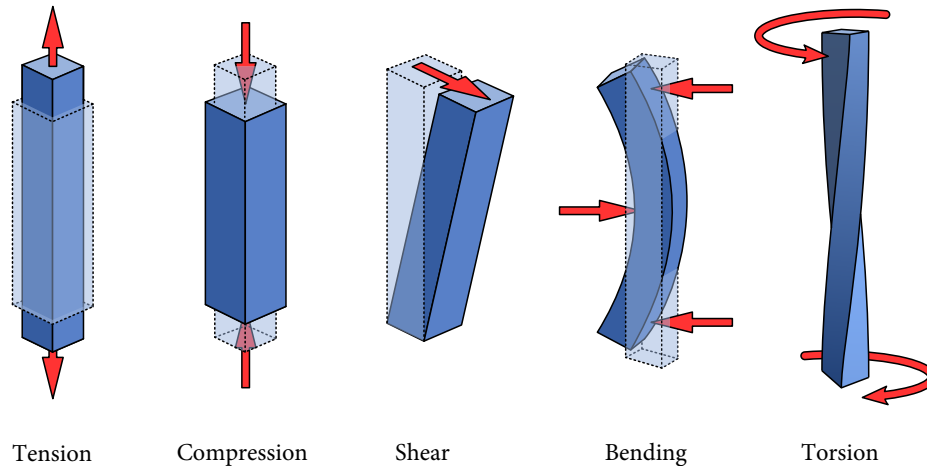

Figure 2.1: Different kinds of force acting on a beam [13].

It is important to understand the behavior of shear in structural engineering. Shear forces play a central role in determining the stability and durability of structures such as beams, slabs, and columns. Weak resistance to shear can lead to structural failures, making this property fundamental for the safety and integrity of buildings and infrastructures.

In beams, shear forces are not uniformly distributed, they are generally highest toward the supports, as shown in fig. 2.2, and are resisted by a combination of factors. To minimize the risk of potential diagonal cracks arising from shear forces, the use of shear reinforcement is generally required, except for beams subjected to minimal or negligible loads. Transverse reinforcement is also required in T-shaped beams to resist different shear forces between the web and the flange. Additionally, torsional moments on a beam can lead to shear stresses that attempt to induce diagonal cracks, necessitating reinforcement in addition to that required for bending and shear. Furthermore, both slabs and foundations can be exposed to concentrated loadings, leading to high localized “punching shear stresses” that may require reinforcement in these areas [14].

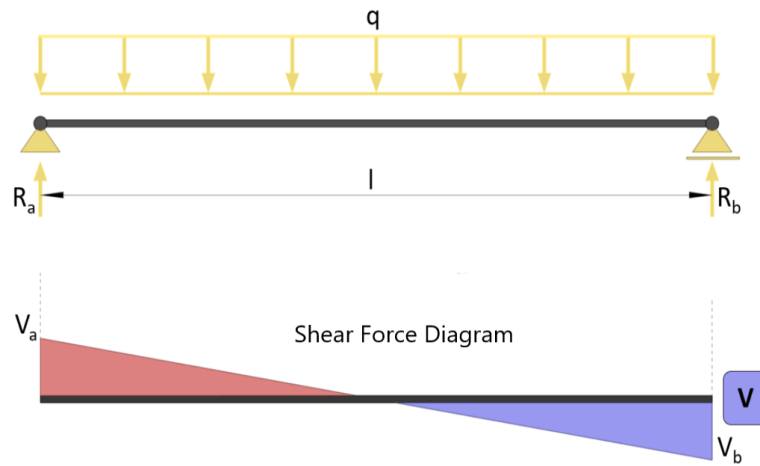

Figure 2.2: Beam with shear force diagram [6].

Figure 2.2 illustrates a simply supported beam subjected to a uniformly distributed load, denoted by q . The beam is supported by two reactions at each end, R_a and R_b . Below the beam is the shear force diagram, which is a graphical representation of the shear force variation along the length of the beam. In this case, the shear force starts at a maximum value (V_a) at left support, and decreases linearly along the length of the beam due to the uniform distribution of the force q . The shear force reaches zero at the center of the beam, and then becomes negative, reaching a minimum value (V_b) at the right support.

2.4 Shear stress theory

Shear stress plays a significant role in structural engineering, especially when analyzing beams under external loads. The way shear stress is distributed across the cross-section of a beam can have an impact on its behavior and entire performance [19].

2.4.1 Effect of shear force on reinforced concrete beam

To understand the concept of shear stress, consider a beam that is simply supported and subjected to a uniformly distributed load, as shown in fig. 2.3, where it will be the resulting shear force in the shear-force diagram. While the shear force theory applies to all homogeneous materials, it is necessary to know that the reinforced concrete is not homogeneous. As a consequence, the shear force capacity varies across the cross section of the beam. In this particular case the lower part of the beam is reinforced to handle large tensile loads. In the upper section of the cross section the tensile capacity of the concrete plays a key role in determining its ability to resist shear forces. Consequently it is necessary to conduct two calculations, for the upper and lower section of the cross-section [18].

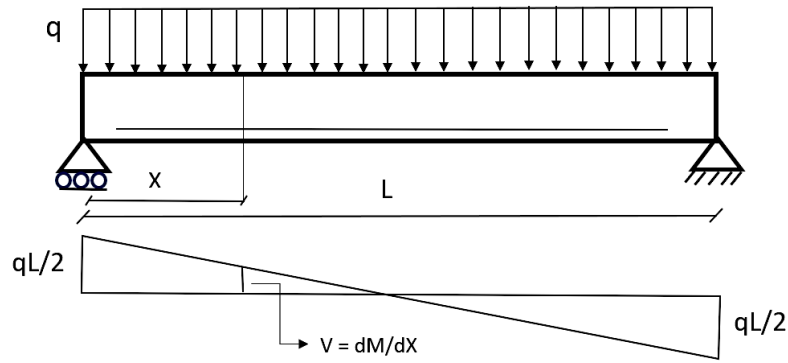

Figure 2.3: Simply supported beam subjected to uniform distributed load with its shear force diagram, [18].

Consider a section of the beam positioned at a distance X beginning from the left support, as shown in Figure 2.3. The resulting shear stress and normal stress on the left side of the section are shown in Figure 2.4. Note that the position of the natural axis (N.A.) shown here is for illustration purposes and may vary depending on how the beam is being utilized [18].

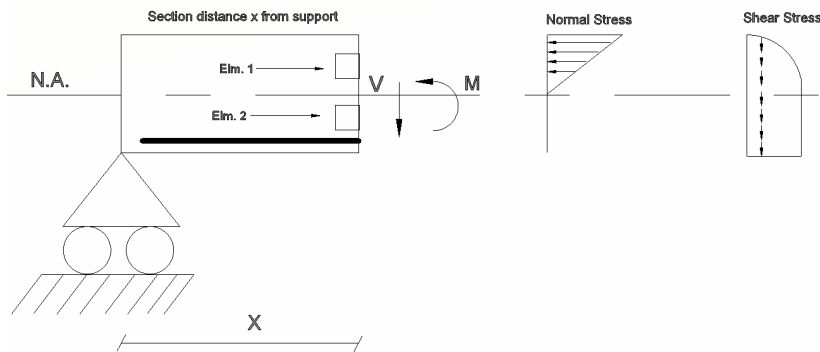

Figure 2.4: Stresses manifesting at a cross-section located at a distance X from the support

The neutral axis, as shown in fig. 2.4, represents the horizontal line within the cross-section of the beam where the normal stress is zero.

In Figure 2.4, it is shown that the normal stress conditions differ between above and below the neutral axis. It's crucial to take into account load conditions both over and under the neutral axis in order to identify which part has the largest load [18].

2.4.2 Consideration of stresses between the neutral axis and tensile reinforcement

In fig. 2.5, it is observed that shear stresses occur both vertically and horizontally. The eq. (2.1) represents the sum of the forces acting in the horizontal direction:

$$\tau \times b \times dx = ds = \frac{dM}{z} \quad (2.1)$$

The equation is solved:

$$\tau = \frac{dM}{dx \times b \times z} = \frac{V}{z \times b} \quad (2.2)$$

Between neutral axis and the longitudinal reinforcement, the shear stress (τ) doesn't change and remains constant. As a result the placement of the control section doesn't impact strongly on the results, and shear stresses in this area are as follows [19]:

$$\tau = \frac{V}{z \times b} \quad (2.3)$$

- where:
- τ = horizontal shear stress
 - z = internal moment arm (assumed to be $0.9d$, for prestressed concrete beams).
 - b = width of the cross section.
 - V = shear force.
 - dx = variation in length between each segment of the beam.
 - dM = difference in moment for each segment within the beam.

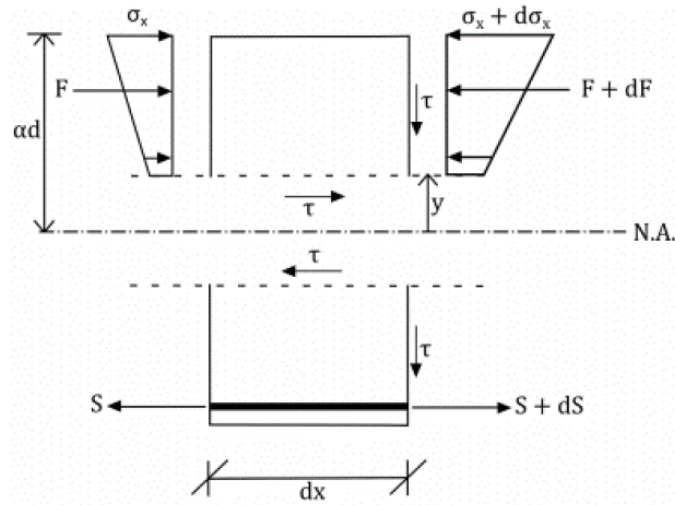

Figure 2.5: Stress distribution above and below the neutral axis [18].

2.4.3 Consideration of stresses above the neutral axis

Consider the stress distribution observed above the natural axis as illustrated in fig. 2.5. The total sum of forces in the horizontal direction can be represented by the following equations [19]:

$$\tau \times b \times dx = dF \quad (2.4)$$

where

$$dF = \int_{A_1}^{A_2} d\sigma dA = \int_{A_1}^{A_2} \frac{dM}{I_c} \times y dA = \frac{dM}{I_c} \int_{A_1}^{A_2} y dA \quad (2.5)$$

where: dF = differential force.

I_c = moment of inertia for the cross section around its natural-axis.

$\int_{A_1}^{A_2} y dA = S_M$ denotes the static moment of the cross section around the neutral axis. This is substituted into eq. (2.4) and gives:

$$\tau \times b \times dx = \frac{dM}{I_c} \times S_M \quad (2.6)$$

By solving eq. (2.6) with respect to τ , the following result is obtained:

$$\tau = \frac{dM \times S_M}{dx \times I_c \times b} = \frac{V \times S_M}{I_c \times b} \quad (2.7)$$

The static moment, S_M , can be expressed as:

$$S_M = \int_{A_1}^{A_2} y dA = y_{st} \times A \quad (2.8)$$

where: y_{st} = distance from the neutral-axis to the centroid of the area A.

In the case of a rectangular beam, y_{st} can be calculated as follows:

$$y_{st} = y + \frac{\alpha \times d - y}{2} = \frac{1}{2}(\alpha \times d + y) \quad (2.9)$$

$$A = b(\alpha \times d - y) \quad (2.10)$$

where: α = distance from neutral axis to the top edge of the beam divided by effective depth (d).

By substituting eqs. (2.9) and (2.10) into eq. (2.8), the following equation is obtained:

$$S_M = \frac{1}{2}(\alpha \times d + y)(\alpha \times d - y) \times b = \frac{1}{2}(\alpha^2 \times d^2 - y^2) \times b \quad (2.11)$$

Inserting eq. (2.11) into eq. (2.7) and solving it yields the following result:

$$\tau = \frac{V}{I_c} \times \frac{1}{2}(\alpha^2 \times d^2 - y^2) \quad (2.12)$$

The boundary conditions for the stress (τ) above the neutral axis are as follows: τ is zero at the edge of the compression zone, and at the neutral axis y is zero. The shear stress that occurs above the neutral axis will be largest there [18].

$$\tau = \frac{V \times \alpha^2 \times d^2}{2 \times I_c} \quad (2.13)$$

Equation (2.13) can be simplified, by deriving an expression for I_c , assuming that the beam has a rectangular shape and that the concrete behaves linear elastic under compression and without stress under tension [19]. Refer to fig. 2.6 to visualize how forces are distributed.

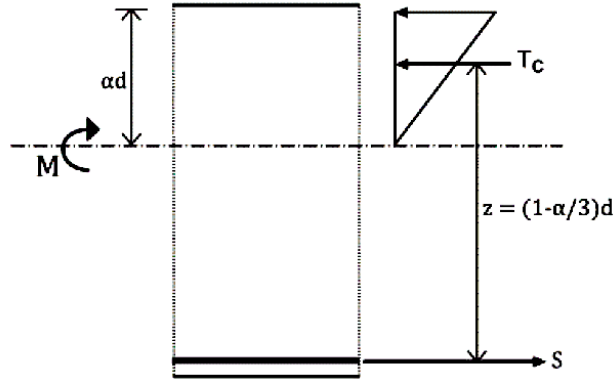

Figure 2.6: [18]

Equations (2.14) and (2.15) presented below are derived from principles in mechanics of materials and fig. 2.6.

$$\sigma_c = \frac{M}{I_c} \alpha \times d \quad (2.14)$$

$$M = T_c \times z = \frac{1}{2} \times \sigma_c b \alpha \left(1 - \frac{\alpha}{3}\right) d^2 \quad (2.15)$$

Substituting eq. (2.15) into eq. (2.14), results in:

$$\sigma_c = \frac{\frac{1}{2} \sigma_c \alpha \left(1 - \frac{\alpha}{3}\right) b d^2}{I_c} \times \alpha d \quad (2.16)$$

The moment of inertia (I_c) can be obtained from eq. (2.16), which is as follows:

$$I_c = \frac{1}{2} \alpha^2 \left(1 - \frac{\alpha}{3}\right) b d^3 \quad (2.17)$$

By inserting eq. (2.17) into eq. (2.13), the following equation is obtained:

$$\tau = \frac{V}{z \times b} \quad (2.18)$$

Where $z = \left(1 - \frac{\alpha}{3}\right) d$, as shown in fig. 2.6.

Equation (2.18) provides the shear stress on the compression side along the neutral axis. This equation is exactly the same as eq. (2.3) indicating that the distribution of stress aligns with what's shown in fig. 2.4. The maximum shear stress can be found between the neutral axis and the tensile reinforcement [18, 19].

2.4.4 Cracks due to shear forces

Cracks can develop in reinforced concrete structures for several reasons, for instance shear forces, tensile forces and flextural bending. It is particularly important to consider shear cracks in structural engineering as they can decrease the capacity of structure to bear weight and potentially result in failure.

The EC2 standard provides instructions and recommendations on how to design concrete structures to handle forces and deal with formation of cracks. Figure 2.7 shows a theoretical crack pattern, as derived from bending and shear stress.

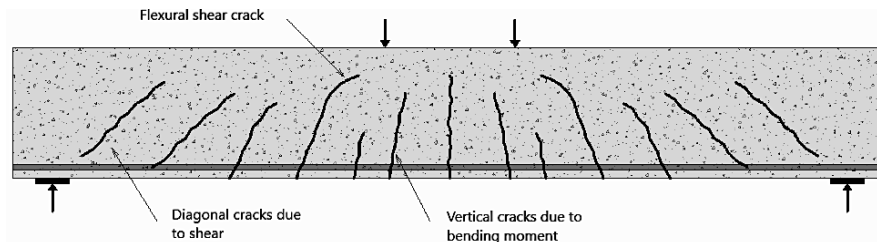

Figure 2.7: Types of cracks: [7]

Cracks occur when the maximum principal stress (σ_1) approaches the tensile capacity of concrete, That is, when $\sigma_1 = f_{ctk,0.05}$ [18]. The $f_{ctk,0.05}$ is the tensile strength of concrete at the 5th percentile.

Cracks in concrete structures typically develop perpendicular to the tensile stress. The direction of crack may be influenced by shear stress but also normal stress. In most cases, cracks form in a direction that's normal to the maximal principal stress [19, 10].

The crack direction is determined by finding the direction of σ_1 , dependent on shear τ and normal σ_x stresses. Mohr's circle is a useful tool for this [19]. Figure 2.8 illustrates a 2D plot of Mohr's circle with the normal stress (σ) on the horizontal axis and the shear stress (τ) on the vertical axis.

Generally, the normal stress, in both the x and y directions can be influenced by external forces, geometry and boundary conditions. The shear stress can be determined according to eq. (2.18).

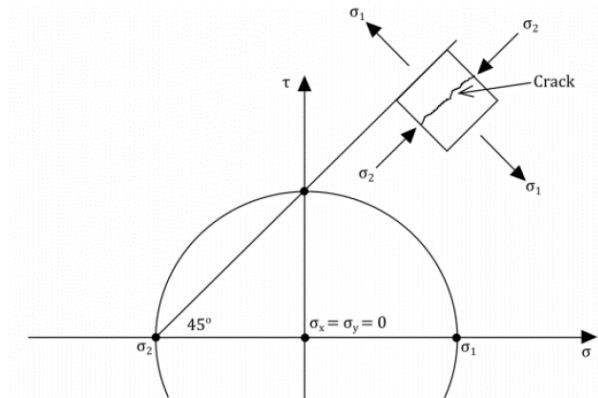

Figure 2.8: Mohr's Circle: [18].

In the concept of Mohr's circle, the center of the circle represents the average of the normal stresses on a specific point within a material.

As shown in fig. 2.4, element 2 is in the tension zone, so the normal stresses in both x and y directions are zero, leading to the stress state: $\sigma_x = \sigma_y = 0$ as shown in fig. 2.8. The principal tensile stress, σ_1 , is at 45 degrees to the beam axis in the tension zone [19].

As illustrated in fig. 2.4, element 1 is located in compression zone, experiences stress states: $\sigma_y = 0, \sigma_x \neq 0$ and $\tau \neq 0$ as shown in fig. 2.9.

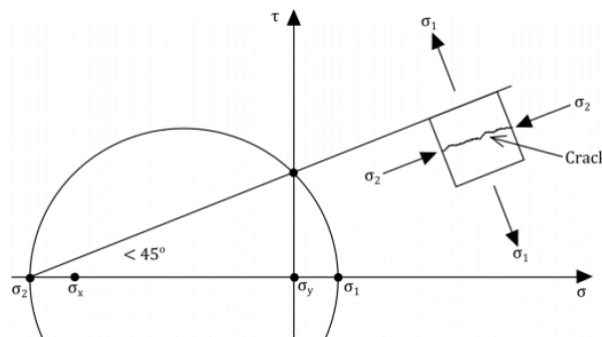

Figure 2.9: Mohr's circle in compression zone: [18].

Figure 2.9 shows principal stresses and directions, showing that cracks align more parallel to the beam axis and less than 45° to the σ_x -direction, especially as σ_x (compression) increases [19].

Chapter 3

Analyzing Mechanical Properties of Concrete, EC2 vs. FprEN

The recent updates made to EC2 have brought certain modifications in the properties of concrete, these changes have an impact on professionals involved in designing and constructing structures. In this chapter, the design compressive strength, tensile strength and elastic modulus of concrete as outlined in EC2 and its revised version, FprEN will be examined and compared. Furthermore, this chapter will explore how these changes influence the design and construction processes of structures.

3.1 The design compressive strength, f_{cd}

The compressive strength of concrete is its ability to resist uniaxial compression without crushing. The compressive strength of the concrete is significantly higher compared to its tension strength. The tensile strength is only about 10-12 % of its compressive strength for ordinary concrete and about 4-6 % of its compressive strength for high strength concrete [11].

When it comes to design it is crucial to have an understanding of various material characteristics particularly its ability to withstand compression. The compressive strength of concrete plays a role in determining the load bearing capacity of a structure.

According to EC2 [3], the design value of concrete compressive strength at 28 days is as follows:

$$f_{cd} = \alpha_{cc} \frac{f_{ck}}{\gamma_c} \quad (3.1)$$

where: f_{cd} = Design value of concrete compressive strength [MPa].
 α_{cc} = Coefficient for long-term effects on the concrete and any adverse effects caused by how weight is applied to the structure.
 f_{ck} = Characteristic compressive cylinder strength of concrete at 28 days [MPa].
 γ_c = Partial safety factor for concrete which considers variations, in material properties and uncertainties related to design and construction processes.

The value of α_{cc} varies between 0.80 for permanent loads, 1.00 for short-term loads, and potentially 0.85 for global loading combinations [20]. The recommended value for γ_c is 1.5 and it is empirically derived [14].

The concrete strength continues to develop beyond the standard 28-day evaluation period. Based on experimental results [20], the hardening law represents the following equation:

$$f_{cj} = e^{\beta(1-1/\sqrt{\tau})} f_{cd} \quad (3.2)$$

where: f_{cj} = Strength of concrete at a given day j
 β = coefficient depending on the type of cement (Fast, normal or slow setting)
 $\tau = t/2$ is the ageing time over the 28-day limit

For normal cements $\beta = 0.25$ can be assumed [20]. The factor in eq. (3.2) is calculated with β -value of 0.25 and t approaching infinity, resulting in $\approx 1.28 \times f_{cd}$, which is significantly higher than f_{cd} at 28 days.

The revised design value of concrete compressive strength according to FprEN [4] is given by:

$$f_{cd} = \eta_{cc} k_{tc} \frac{f_{ck}}{\gamma_c} \quad (3.3)$$

where: η_{cc} = is a factor to account for the difference between the undisturbed compressive strength of a cylinder and the effective compressive strength that can be developed in the structural member. It is taken as:

$$\eta_{cc} = \left(\frac{40}{f_{ck}} \right)^{\frac{1}{3}} \leq 1 \quad (3.4)$$

k_{tc} = is a factor considering the effect of high sustained loads and the time of loading on concrete compressive strength.

k_{tc} varies depending on the time being considered (t) and the specific class of concrete (CS, CN, CR). Classes CS, CN and CR refer to slow, normal and rapid strength development of concrete, respectively [4].

The concrete classes represents the compressive strength of concrete, which is obtained from direct tests on the material. For structural use, the minimum compressive strength is 8 MPa, while with modern technology, the maximum strength can exceed 70 MPa [20].

To account for the effect of size on the compressive strength of concrete, the factor η_{cc} has been introduced. It is well known that as the size of a specimen increases its compressive strength tends to decrease. Additionally, the factor k_{tc} takes into consideration how concrete strength develops over time.

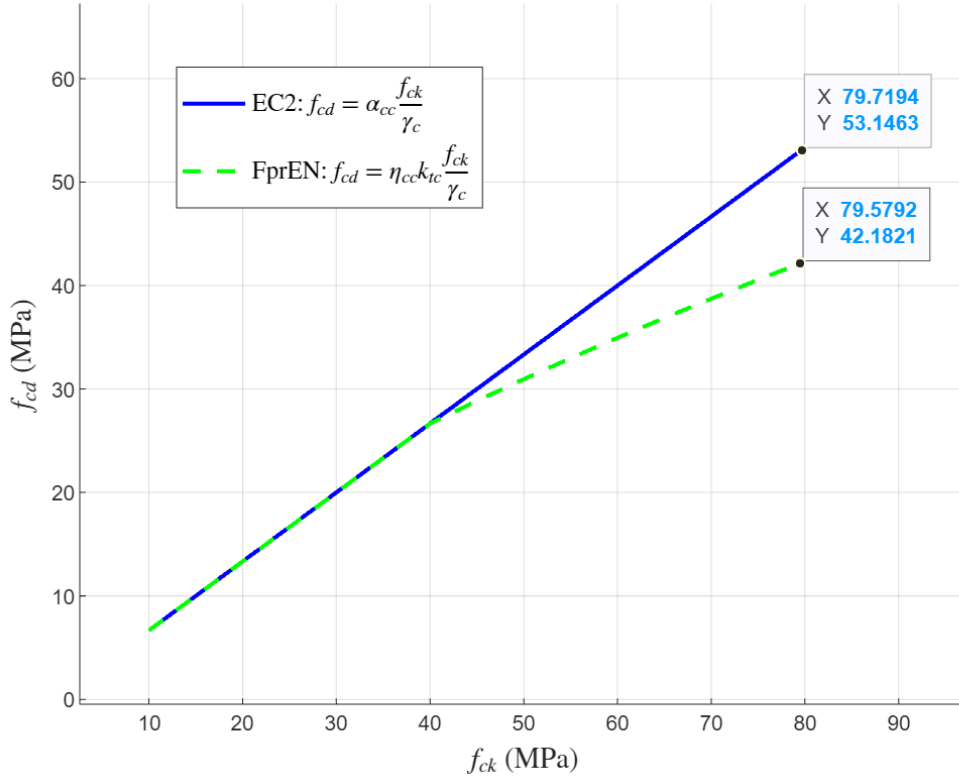

Figure 3.1: Comparison of f_{cd} between EC2 and FprEN

The fig. 3.1 illustrates comparison of design concrete strengths (f_{cd}) as defined by EC2 and FprEN. For simplification purposes, the constants α_{cc} , γ_c and k_{tc} were set to 1, 1.5 and 1, respectively.

As shown in fig. 3.1, the application of revised eq. (3.3) results in a lower f_{cd} compared to eq. (3.1), for value of f_{ck} greater than 40 MPa. This is due to the η_{cc} factor. As long the specified strength remains at or below 40 MPa, the value of η_{cc} is 1 and eqs. (3.1) and (3.3) are identical, based on the assumption that the k_{tc} equals 1. However, if the strength exceeds 40 MPa, then the value of η_{cc} gradually reduces to approximately 0.794 when the strength reaches 80 MPa. Thus, as f_{ck} increases, the two equations diverge, implying that the difference between the two design approaches is significant for high-strength concrete.

The revised equation specified in FprEN provides more accurate values for concrete compressive strength. This is achieved by considering both the size effect and the time dependent development of strength. However, it should be noted that this equation requires additional data and knowledge due to the introduction of new and unfamiliar parameters, such as η_{cc} and k_{tc} , and may pose challenges for practicing engineers.

3.2 Evaluation of design tensile strength, f_{ctd}

Tensile strength denoted as f_{ctd} , is a mechanical property of materials that measures their resistance to axial tension. It is commonly evaluated using standardized tensile tests where

rectangular or cylindrical specimens are subjected to tensile forces until failure. These tests apply longitudinal stresses along the axis of the specimen and measure the maximum stress that the material can sustain before necking or fracture occurs [20].

The design tensile strength of concrete is a factor in construction as it determines the durability and safety of concrete structures. It indicates the amount of tension that concrete can be expected to handle without cracking or failing.

In EC2 [3], the design tensile strength (f_{ctd}) is determined using following equation:

$$f_{ctd} = \alpha_{ct} \frac{f_{ctk,0.05}}{\gamma_c} \quad (3.5)$$

where: α_{ct} = a coefficient taking account of long-term effects on the tensile strength and of unfavorable effects, resulting from the way the load is applied.
 γ_c = the partial safety factor for concrete.
 $f_{ctk,0.05}$ = characteristic axial tensile strength of concrete (5% fractile¹), which is calculated as: $f_{ctk,0.05} = 0.7f_{ctm}$.

$$f_{ctm} = 0.3f_{ck}^{\frac{2}{3}} \leq C50 \quad (3.6)$$

$$f_{ctm} = 2.12 \ln \left(1 + \frac{f_{cm}}{10} \right) > C50 \quad (3.7)$$

According to EC2, f_{ctm} is the mean value of axial tensile strength of concrete, which can be calculated using equation (3.6) or (3.7), depending on the concrete strength class (C).

In eqs. (3.6) and (3.7), $C50^*$ is the concrete strength class, f_{ck} is the characteristic concrete cylinder strength at 28 days, and f_{cm} is the mean value of concrete cylinder compressive strength, calculated as $f_{cm} = f_{ck} + 8$ MPa.

On the other hand, the revised value of the design tensile strength (f_{ctd}) in the revised guidelines [4], is as follows:

$$f_{ctd} = k_{tt} \frac{f_{ctk,0.05}}{\gamma_c} \quad (3.8)$$

where: k_{tt} = a factor considering the effect of high sustained loads and the time of loading on concrete tensile strength.

In eq. (3.8), f_{ctm} is calculated same as eq. (3.6) for concrete classes $\leq C50$, but for concrete classes $> C50$, f_{ctm} is calculated as $f_{ctm} = 1.1f_{ck}^{\frac{1}{3}}$.

¹There is a 5% probability of not meeting the expected axial tensile strength of concrete.

*C stands for concrete followed by a numerical value which represents the compressive strength of the concrete, MPa.

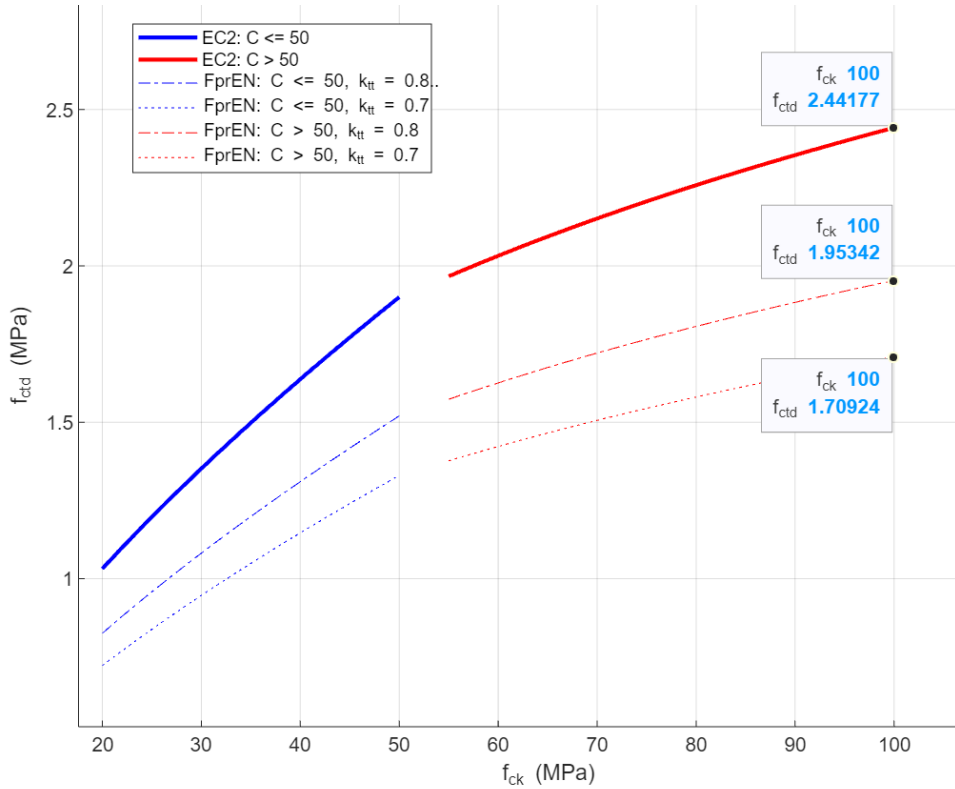

Figure 3.2: Comparison of f_{ctd} between EC2 and FprEN

Figure 3.2 compares the design tensile strength of concrete f_{ctd} as a function of the characteristic compressive strength f_{ck} according to both original and second generation of EC2. The lines represents eqs. (3.7) and (3.8) with different characteristic compressive strengths. There are two categories based on the concrete classes: Lines for $C \leq 50$ MPa, and lines for $C > 50$ MPa

The dashed and dotted lines represents the revised version, FprEN, with varying coefficients k_{tt} . The value of k_{tt} is 0.8 for $t_{ref}^* \leq 28$ days for concretes with classes CR and CN, and $t_{ref} \leq 56$ days for concretes with class CS. For other cases, including when $f_{ck}(t)$ is determined, $k_{tt} = 0.7$ [4].

As shown in fig. 3.2, the difference between the original and revised codes appears to be great, the FprEN indicate a lower f_{ctd} compared to EC2 for the same f_{ck} , and the difference increases and becomes significant as the compressive strength (f_{ck}) increases, suggesting that the revised version adopts a more conservative approach.

It seems reasonable to conclude that the updated equation (3.8) used for calculating the design tensile strength of concrete, provides an estimation of tensile strength in various loading scenarios and is particularly suitable for high strength concretes ($> C50$). This conclusion is based on the

*In EC2 [3], t_{ref} is the reference time in days from the casting of the concrete to the point at which a calculation or measurement is made.

fact that the revised equation considers factors such as the impact of heavy loads and timing of loading on concrete's tensile strength. By taking these factors into account it is expected that the updated equation provides an assessment of the design tensile strength under different load conditions. However, it does introduce some complexity due to the introduction of the new coefficient (k_{tt}) that has resulted in conservative designs based on the results from fig. 3.2, and may lead to higher construction costs.

3.3 Elastic Modulus

The elastic modulus of concrete, referred to as E_{cm} , plays a major role in the design and evaluation of concrete structures.

E_{cm} quantifies how well a material can deform elastically, meaning how it can recover its deformation after being subjected to a force.

The stress-strain curve for concrete in fig. 3.3 shows that the elastic behaviour may be considered for stresses less than approximately one-third of the compressive strength, this relation is not all linear. Therefore, it's important to define exactly which value should be used for the modulus of elasticity [14].

Moreover, precisely determining the elastic modulus of concrete is necessary as it directly impacts load deformation properties, cracking potential and the overall stability of concrete structures.

The equation for the elastic modulus (in MPa) of concrete according to EC2 [3], is defined as follows:

$$E_{cm} = 22000 \left(\frac{f_{cm}}{10} \right)^{0.3} \quad (3.9)$$

Variation in the modulus of elasticity over time can be determined from the following expression [20]:

$$E_{cj} = \left[e^{\beta(1-1/\tau)} \right]^{0.3} E_{cm} \quad (3.10)$$

In contrast, the revised version, FprEN [4], introduces a different equation for elastic modulus, which is as follows:

$$E_{cm} = k_E f_{cm}^{\frac{1}{3}} \text{ [MPa]} \quad (3.11)$$

The k_E , is a coefficient which depends on the type of aggregates used in concrete. When considering quartzite aggregates, one may assume that k_E equals 9500. However, for other types of aggregates k_E can range from 5000 to 13000 [4].

Equation (3.9) according to EC2 for calculating the elastic modulus doesn't account for the influence of aggregates, it assumes an approach that may not always yield accurate results for

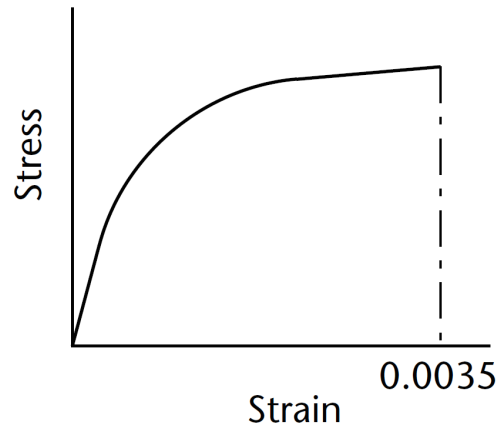

Figure 3.3: Stress-Strain curve for concrete in compression [14].

different types of concrete. In contrast, eq. (3.11) taken from FprEN, recognizes this influence by introducing the coefficient k_E that varies based on the type of aggregates used in concrete.

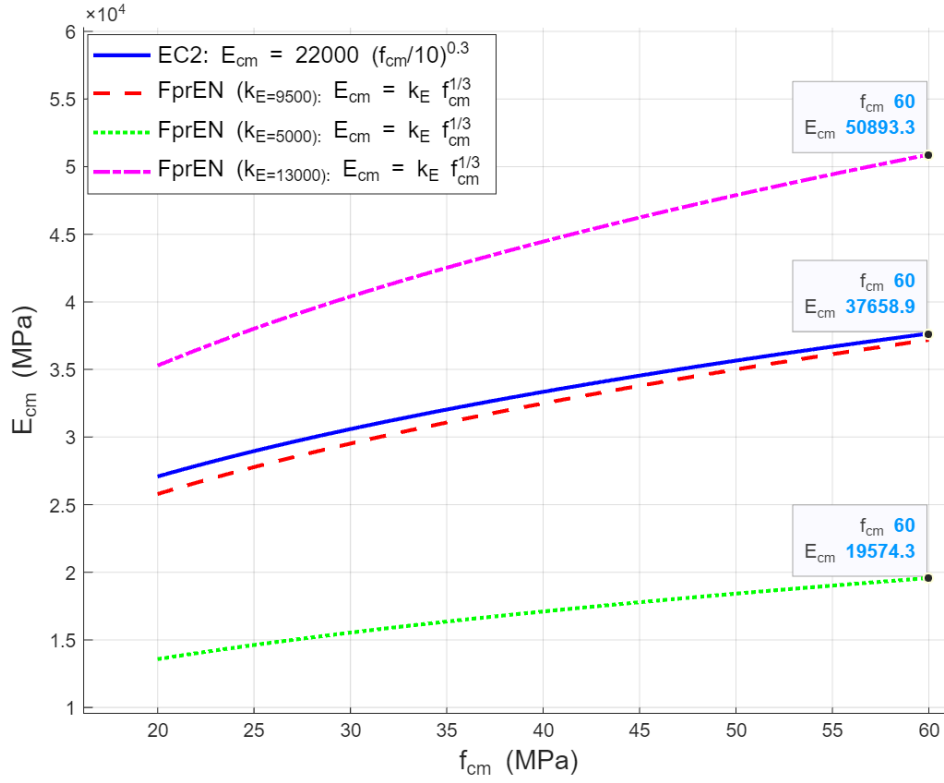

Figure 3.4: Comparison of E_{cm} between EC2 and FprEN

Figure 3.4 illustrates a comparison of the modulus of elasticity of concrete as a function of the mean compressive strength of concrete according to EC2 and FprEN. It shows the impact of k_E coefficient and illustrates how it can vary the calculation of the E_{cm} significantly.

This suggests that the choice of k_E can lead to considerable variations in the calculation of the elastic modulus. Such variations could have implications for design and structural analysis. Therefore, the revised equation has the potential to offer improved accuracy and precision in the calculation of elastic modulus of concrete.

Chapter 4

Shear, Eurocode 2 Guidelines

This chapter investigates shear in concrete structures guided by EC2. The chapter is designed to provide an understanding of various aspects of shear stress and its impact on structural integrity.

Section 4.1 examines concrete members not requiring design shear force reinforcement and presenting practical examples based on EC2 guidelines. In section 4.2, an analysis is conducted with respect to concrete members requiring design shear reinforcement and provides a thorough exploration of the shear reinforcement requirement. The discussion continues in section 4.3 with an evaluation of minimum shear reinforcement requirements. This evaluation focuses on explaining the rules and methods set by EC2 to ensure optimal reinforcement for concrete structures. Finally, sections 4.4 and 4.5 examine shear between the web and flange and shear at the interface, respectively.

As mentioned in chapter 1, EC2 considers the shear capacity of concrete based on a combination of observations, experimental tests and theoretical principles of structural mechanics. However, when dealing with members requiring design shear reinforcement, the design of members is based on a truss model (fig. 4.3) [3]. Despite this, certain parameter determinations still depend on empirical data [17, 19].

4.1 Members not requiring design shear force reinforcement

EC2 provides several methods for calculating the shear capacity of concrete elements, taking into account the effects of both the concrete itself and any reinforcement present. The two main methods used to calculate the shear capacity are as follows:

1. For structures without calculated need for shear reinforcement.
2. For structures with calculated need for shear reinforcement.

These methods apply only to the beams and slabs with a minimum span-to-height ratio of three when there are supports on both sides. For structures with cantilevers, this ratio should be no less than one and a half. Shear capacity control are conducted at a distance d from edge of the support [19, 3].

Shear forces have a significant impact in engineering and greatly influence the design of structural components. While some elements of a structure naturally resist shear due to their shape, material properties and how they are loaded. However, when on the basis of the design shear calculation, no shear reinforcement is required, minimum shear reinforcement according to [3] should still be provided.

Structural elements without calculations requirement for shear reinforcement are directed according to section 6.2.2 in EC2. As per EC2, for concrete members not requiring shear reinforcement, the design shear force (V_{Ed}) should be less than the shear resistance of the concrete section without reinforcement [3].

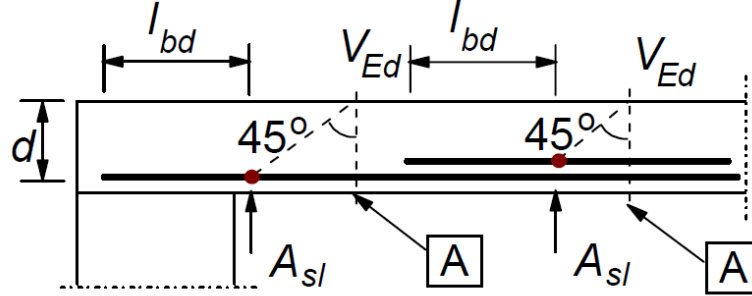

Figure 4.1: Illustration of tensile reinforcement, where d is the effective height, A_{sl} is the cross section area of the tensile reinforcement, V_{Ed} is the design shear force, and the l_x is the distance of section considered from the starting point of the transmission length.

The formula for the design shear resistance $V_{Rd,c}$ in [N] is as follows [3]:

$$V_{Rd,c} = \left[C_{Rd,c} K (100 \rho_l f_{ck})^{\frac{1}{3}} + K_1 \sigma_{cp} \right] b_w d \quad (4.1)$$

where: f_{ck} = characteristic compressive cylinder strength of concrete at 28 days in MPa
 K_1 = a factor of 0.15
 b_w = is the smallest width of the cross-section in the tensile zone
 d = effective height [3], see Fig. 4.1.

$$K = 1 + \sqrt{\frac{200}{d}} \leq 2 \quad \text{with } d \text{ in mm} \quad (4.2)$$

$$\rho_l = \frac{A_{sl}}{b_w d} \leq 0.02 \quad (4.3)$$

where: A_{sl} = cross section area of the tensile reinforcement, which extends beyond the given section by $\geq (l_{bd} + d)$ [3], see fig. 4.1.

$$\sigma_{cp} = \frac{N_{Ed}}{A_c} < 0.2 f_{cd} \quad (4.4)$$

where: N_{Ed} = axial force in the cross section caused by loading or prestressing measured in [N] ($N_{Ed} > 0$ for compression). The impact of applied deformations on N_{Ed} can be ignored [3].

A_c = area of concrete cross-section in mm^2

$$C_{Rd,c} = \frac{K_2}{\gamma_c} \quad (4.5)$$

The material factor for concrete represented by γ_c . Additionally K_2 is a factor that takes into account the type of aggregate and mix ratio utilized in the mixture.

The value of K_2 is set to 0.18 for concrete that has aggregate size (as specified in NS-EN 12620 [8]) of 16 mm or larger. This applies when the coarse aggregate makes up 50% or more of the total aggregate content and coarse aggregate of lime or stone with corresponding low strength is not used [19]. $K_2 = 0.15$ if the conditions for using K_2 equals 0.18 mentioned in paragraph above are not met [16].

Minimum design shear resistance according to EC2 is as follows:

$$V_{Rd,c} = (V_{min} + K_1 \sigma_{cp}) b_w d \quad (4.6)$$

$$V_{min} = 0.035 \cdot K^{\frac{3}{2}} \cdot f_{ck}^{\frac{1}{2}} \quad (4.7)$$

In eq. (4.7), K is as referenced in equation (4.2).

To ensure that the compressive stresses happening alongside the shear cracks are also investigated, it is important to confirm that these stresses not surpass the compressive capacity of concrete [3]:

$$V_{Ed} = 0.5 b_w d v f_{cd} \quad (4.8)$$

The factor v represents the reduction for concrete cracked in shear and the suggested value for v follows from [3]:

$$v = 0.6 \left(1 - \frac{f_{ck}}{250} \right) \quad (4.9)$$

In example below, the eq. (4.1) is used to show how it works in practice.

Example 4-1

Shear force calculation for concrete members without shear reinforcement according to EC.

Assumptions and Given Data

- A simply supported beam with a uniform distributed load.
- Axial force: $N_{Ed} = 400$ kN
- Effects of torsion area neglected.
- Concrete strength: $f_{ck} = 35$ MPa
- Dead load:^a $q_{dead} = 6$ kN/m
- Live load:^b $q_{live} = 10$ kN/m
- Partial factor for dead load: $\gamma_{dead} = 1.2$
- Partial factor for live load: $\gamma_{live} = 1.5$

- Partial factor for shear design based on FprEN Table 4.3 (NDP): $\gamma_v = 1.4$
- Partial factor for concrete: $\gamma_c = 1.5$
- Total height: $h = 412$ mm
- Effective depth: $d = 364$ mm
- Breadth: $b = 320$ mm
- Smallest value of the sieve size: $D_{\text{lower}} = 16$ mm

The necessary calculations for the assumed beam cross-section, including strength in bending, deflection and requirement for longitudinal reinforcement have been checked, and the result shown that it meets EC2 standard. All other requirements are assumed to be met.

Calculations

Ultimate Design Load

$$q_{Ed} = \gamma_{\text{dead}} \times q_{\text{dead}} + \gamma_{\text{live}} \times q_{\text{live}} = (1.2 \times 6) + (1.5 \times 10) \approx 22 \text{ kN/m}$$

Design shear force at control section

$$V_{Ed,\text{red}} = \frac{q_{Ed} \times (L - 2 \times d)}{2} = \frac{22.2 \times (8 - 2 \times 0.364)}{2} \approx 81 \text{ kN}$$

Required longitudinal Reinforcement

By using relevant equation for reinforcement requirement based on [19, eq. (4.26)], A_{sl} was calculated to be 1346.4 mm^2 . ($A_{sl} = 3\phi 25 = 1473 \text{ mm}^2$).

$$\rho_1 = \frac{A_{sl}}{b \times d} = \frac{1473}{320 \times 364} \approx 0.0127$$

$$K = 1 + \sqrt{\frac{200}{d}} = 1 + \sqrt{\frac{200}{364}} \leq 2 \implies K \approx 1.74$$

$$C_{Rd,c} = \frac{K_2}{\gamma_c} = \frac{0.18}{1.5} = 0.12$$

Calculating the design shear resistance value of concrete using equation (4.1)

$$V_{Rd,c} = \left[0.12 \times 1.741 \times (100 \times 0.01265 \times 35)^{\frac{1}{3}} + 0.15 \times \frac{400 \times 10^3}{412 \times 320} \right] \times 320 \times 364$$

$$V_{Rd,c} \approx 139 \text{ kN}$$

Based on the EC2 [3] and assumptions made, the concrete beam does not require shear reinforcement, as $V_{Rd,c} > V_{Ed}$.

Figure 4.2 illustrates the relationship between the shear capacity ($V_{Rd,c}$) of the beam and the longitudinal reinforcement ratio (ρ_l) for various grades of concrete strength (f_{ck}).

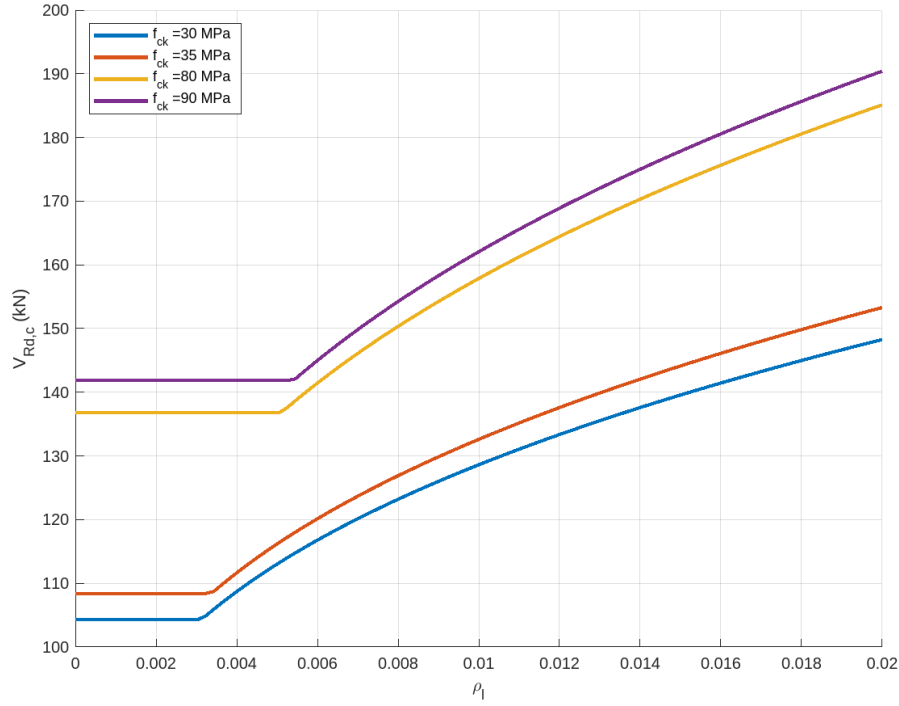

Figure 4.2: Shear capacity ($V_{Rd,c}$) vs. reinforcement amount (ρ_l)



^aDead load is the permanent and stationary weight of a structure and its static components.

^bLive load is a dynamic load that structure can experience, f.ex: weight of people, desks, chairs, and any other movable components.

4.2 Members requiring design shear reinforcement

Generally, shear reinforcement is required when the applied shear force (V_{Ed}) is greater than the shear capacity of concrete ($V_{Rd,c}$).

In EC2, the design of shear reinforcement in concrete is carried out using a method known as the inclination of struts, which is a truss model approach.

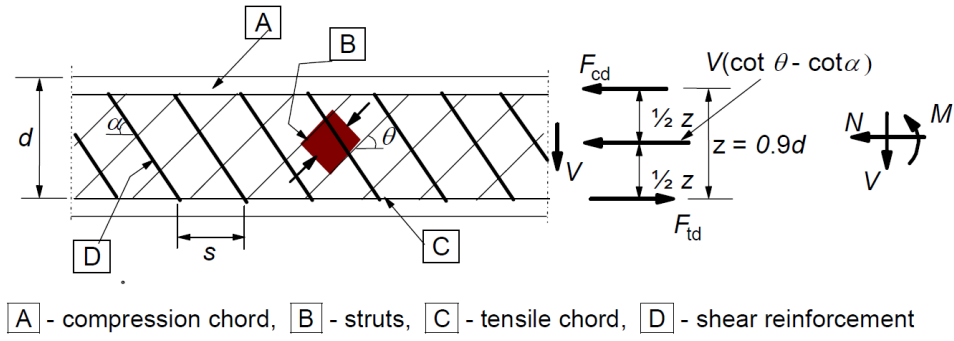

Figure 4.3: Truss model and notation for shear reinforced members [3].

The Figure 4.3 illustrates a cross-section of a concrete structure subjected to various forces: axial (N), moment (M), and shear (V). These forces break down into the tensile zone f_{td} , and the compressive zone f_{cd} . f_{td} is the design value of the tensile force in the longitudinal reinforcement and the f_{cd} is the design value of the concrete compression force in the direction of the longitudinal member axis.

The reinforcement handles the tension, while the concrete manages the compression. The angle α represents the orientation between the shear reinforcement and the beam's axis, and it should fall between 45 and 90 degrees. The angle θ is the angle between the concrete compression strut and the beam axis perpendicular to the shear force, the recommended limits for θ are $1 \leq \cot \theta \leq 2, 5$. d is the concrete's effective depth. Meanwhile, for a member of uniform depth, z represents the internal lever arm associated with the bending moment of the element being examined. When analyzing shear in reinforced concrete without axial force, one can typically use the estimated value $z = 0.9d$. Finally, s specifies the distance between shear reinforcements, determined by the bar design and the shear force's magnitude [3].

Based on the truss model, the following paragraphs calculated and present the equations and assumptions for the tensile capacity of concrete:

In the context of members with inclined shear reinforcement, the shear resistance is determined based on the smallest values of eqs. (4.10) and (4.11):

$$V_{Rd,s} = \frac{A_{sw}}{s} z f_{ywd} (\cot \theta + \cot \alpha) \sin \alpha \quad (4.10)$$

and

$$V_{Rd,max} = \alpha_{cw} b_w z v_1 f_{cd} \frac{(\cot \theta + \cot \alpha)}{(1 + \cot^2 \theta)} \quad (4.11)$$

where: A_{sw} = cross-sectional area of the shear reinforcement
 s = spacing of the stirrups
 f_{ywd} = design yield strength of the shear reinforcement
 v_1 = strength reduction factor for concrete cracked in shear
 α_{cw} = coefficient taking account of the state of the stress in the compression chord [3].

If the design stress of shear reinforcement is less than 80% of the characteristic yield stress (f_{yk}), the strength reduction factor (v) is 0.6 for f_{ck} below or equal 60 MPa. For values higher than 60 MPa, the v -factor calculates as follows:

$$v = 0.9 - \frac{f_{ck}}{200} \quad (4.12)$$

If the shear reinforcements characteristic yield strength (f_{yk}) exceeds 80%, then the equation (4.9) is used to calculate v -factor [3].

Positioning of reinforcement at a 90° angle to the beam axis is a widely accepted practice due to its efficiency in the construction process as well as minimizes the risk of errors. Moreover, it is common to use concrete with a compressive strength below 60 MPa in most standard construction projects. Considering these assumptions, one can further simplify eqs. (4.10) and (4.11) to [3]:

$$V_{Rd,s} = \frac{A_{sw}}{s} z f_{ywd} \cot \theta \quad (4.13)$$

$$V_{Rd,max} = \alpha_{cw} b_w z v_1 \frac{f_{cd}}{(\cot \theta + \tan \theta)} \quad (4.14)$$

The equations (4.13) and (4.14) are combined, and a following solution is then determined:

$$\frac{A_{sw}}{s} \geq \frac{v_1 \alpha_{cw} b_w f_{cd}}{f_{ywd} \cot \theta (\cot \theta + \tan \theta)} \quad (4.15)$$

Figure 4.4 illustrates the design shear resistance of reinforced concrete elements as a function of $\cot \theta$ for various values of f_{ck} in MPa. The curves represents the calculated shear resistance values using eqs. (4.13) and (4.14), with variable v_1 -factors applied. The v -factor is calculated based on guidelines explained in section 4.2 and assuming that the design stress of shear reinforcement is either below or exceeds 80 % of f_{yk} .

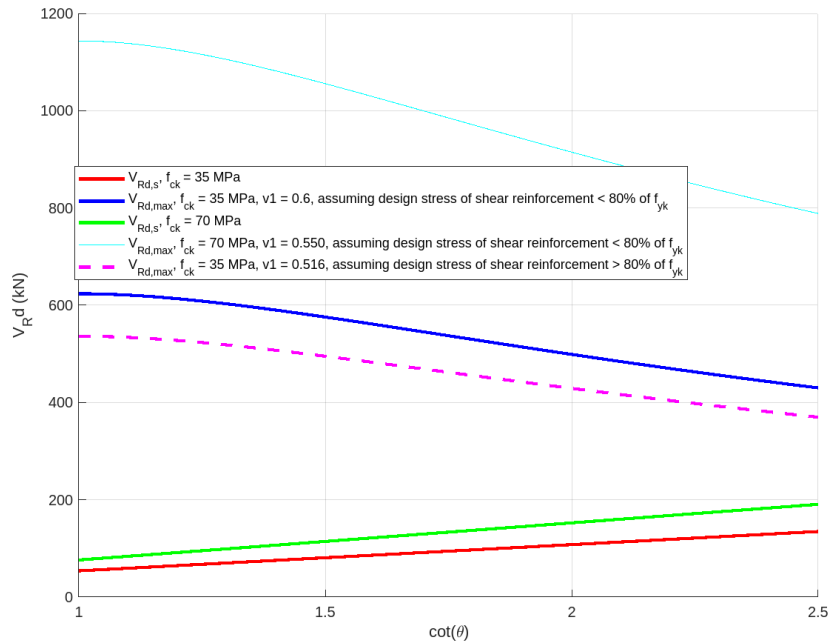

Figure 4.4: $V_{Rd,s}$ and $V_{Rd,max}$ as a function of $\cot \theta$

4.3 Minimum shear reinforcement

In cases where design shear calculations indicate that no shear reinforcement is required, minimum shear reinforcement should still be provided. However, the minimum shear reinforcement can be ignored in specific members like solid, ribbed, or hollow core slabs, in which transverse redistribution of loads is possible. Additionally, if a member is not essential for the structures resistance and stability, for example lintels with a span of 2 meters or less. You can also choose to omit the minimum reinforcement [3].

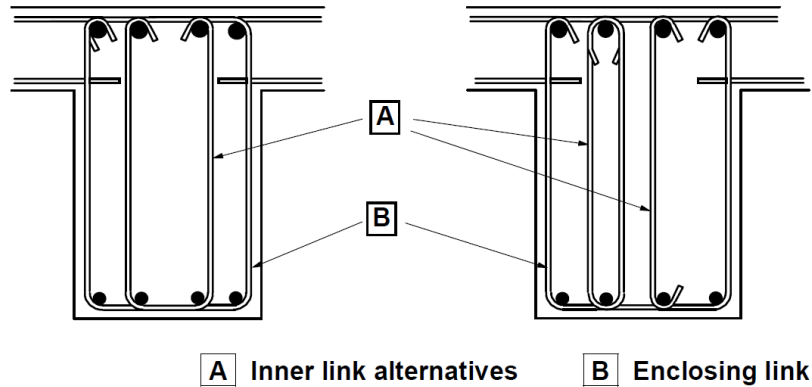

Figure 4.5: Examples of shear reinforcement: [3].

According to EC2 [3], the minimum shear reinforcement ratio is defined by:

$$\rho_{w,min} = \frac{A_{sw}}{sb_w \sin \alpha} \geq 0.08 \frac{\sqrt{f_{ck}}}{f_{yk}} \quad (4.16)$$

where: ρ_w = shear reinforcement ratio
 A_{sw} = area of shear reinforcement within the spacing s
 s = spacing of the shear reinforcement measured along the longitudinal axis of the member
 b_w = width of the web of the member
 α = angle between shear reinforcement and the longitudinal axis
 f_{ck} = characteristic concrete cylinder compressive strength at age t_{ref}
 f_{yk} = characteristic value of yield strength of reinforcement or, if yield phenomenon is not present, the characteristic value of 0.2% proof strength

4.4 Shear between web and flanges

The guidelines of shear between web and flange according to EC2 [3], is summarized as follows:

The shear strength of the flange can be calculated by considering the flange as a system of compressive struts combined with ties in the form of tensile reinforcement.

The shear strength of the flange is determined by evaluating the equilibrium between the applied

shear force V_{Ed} and the resistance provided by the concrete and reinforcement. EC2 introduces a crucial requirement as follows:

If the following condition is satisfied, no extra reinforcement is required over that for flexures is required:

$$V_{Ed} \leq k \cdot f_{ctd} \quad (4.17)$$

f_{ctd} is the design value of the tensile strength of concrete. The recommended value for the coefficient k is 0.4.

Longitudinal shear stress (V_{Ed}), at the flange-web junction is given by:

$$V_{Ed} = \frac{\Delta F_d}{h_f \cdot \Delta X} \quad (4.18)$$

where: h_f = flange thickness at the junction
 ΔX = length under consideration (see Fig. 4.6)
 ΔF_d = change of the normal force in the flange over ΔX

The transverse reinforcement per unit length (A_{sf}/S_f) can be defined as follows:

$$\frac{A_{sf} \cdot f_{yd}}{S_f} \geq \frac{V_{Ed} \cdot h_f}{\cot \theta_f} \quad (4.19)$$

To avoid crushing of the compression strut in the flange, the given condition should be fulfilled:

$$V_{Ed} \leq v f_{cd} \sin \theta_f \cos \theta_f \quad (4.20)$$

Recommended $\cot \theta_f$ range is as follows:

$$\begin{aligned} 1.0 \leq \cot \theta_f \leq 2.0 & \quad \text{for compression flanges.} \\ 1.0 \leq \cot \theta_f \leq 1.25 & \quad \text{for tension flanges.} \end{aligned}$$

In cases with both shear between the flange and web and transverse bending, the steel area should be greater than the equation (4.19) or half of the equation (4.19) plus that required for the transverse bending.

In the flange, the longitudinal tension must be anchored beyond the strut to transfer the force back to the web where needed.

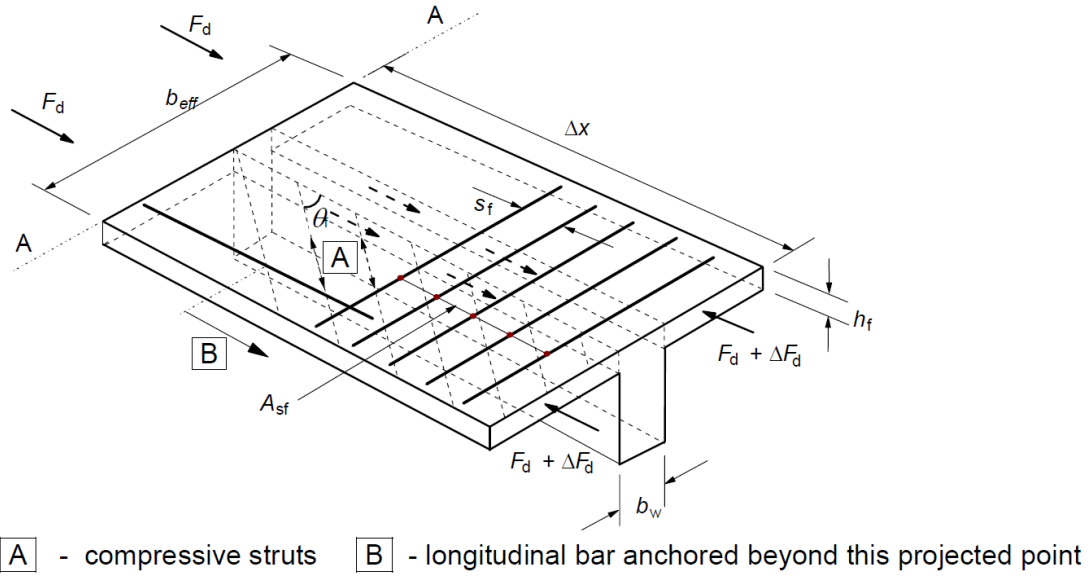

Figure 4.6: Flange-web connection [3].

4.5 Shear at interfaces

Having a thorough understanding of shear behavior at the interfaces between different concrete elements is important in managing concrete structures. This becomes especially important when concrete is cast at different times, creating a composite structure with interfaces that must effectively transfer shear and normal forces. In the following section, the guidelines and requirements for evaluating the shear capacity at interfaces, as specified in EC2 [3], are presented:

Shear stress and resistance

The first requirement to consider is the shear stress at the interface that must satisfy for safety design:

$$V_{Edi} \leq V_{Rdi} \quad (4.21)$$

where, V_{Edi} is the design value of the shear stress at the interface, calculated as:

$$V_{Edi} = \beta V_{Ed} / (z b_i) \quad (4.22)$$

where: β = ratio of the longitudinal force in the new concrete area and the total longitudinal force either in the compression or tension zone, both calculated for the section considered

V_{Ed} = transverse shear force

z = lever arm of composite section

b_i = width of the interface, as illustrated in Figure 4.7

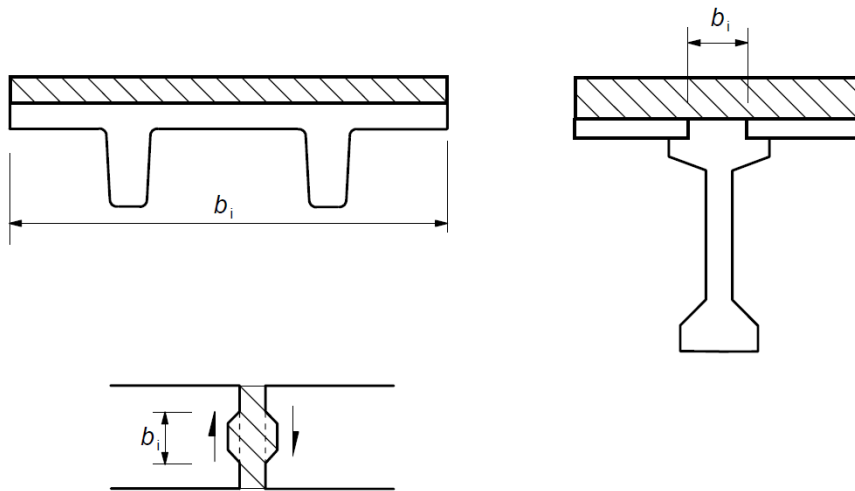

Figure 4.7: Examples of interfaces: [3].

The design shear resistance at interface, V_{Rdi} is given by:

$$V_{Rdi} = cf_{ctd} + \mu\sigma_n + \rho f_{yd}(\mu \sin \alpha + \cos \alpha) \leq 0.5v f_{cd} \quad (4.23)$$

where: c & μ = factors that depend on the roughness of the interface.

σ_n = stress per unit area due to the minimum external normal force across the interface.

$\rho = A_s/A_i$

A_s = area of reinforcement crossing the surface and A_i is the area of the joint.

α = defined in fig. 4.8, and should be limited by $45^\circ \leq \alpha \leq 90^\circ$

v = strength reduction factor. Refer to EC2 for additional detail.

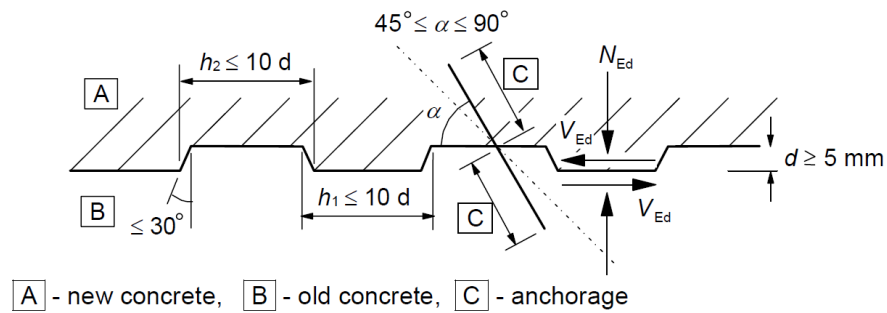

Figure 4.8: Indented construction joint [3].

Classification of interface surfaces

The values of c and μ are affected by the roughness of the concrete interface, and the EC2 suggests the following classifications:

- Very smooth: $c = 0.25, \mu = 0.5$
- Smooth: $c = 0.35, \mu = 0.6$
- Rough: $c = 0.45, \mu = 0.7$
- Indented: $c = 0.5, \mu = 0.9$

Transverse Reinforcement

Transverse reinforcement can be used (as indicated in Figure 4.9) to improve the shear resistance at the interface. If lattice girders are used, the steel contribution to V_{Rdi} can be calculated based on the resultant forces from each of the diagonals, provided that $45^\circ \leq \alpha \leq 135^\circ$.

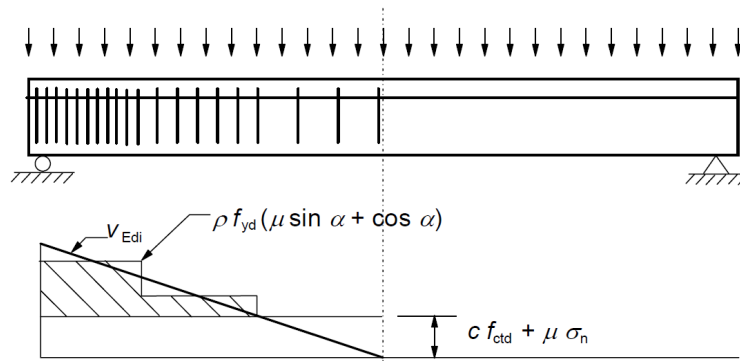

Figure 4.9: Shear diagram representing the required interface reinforcement: [3].

Special Cases

For grouted joints between slabs or wall elements, the value of c should be adjusted based on the likelihood of cracking at the joint. In other words, c should be taken as 0 for smooth and rough joints and 0.5 for indented joints. Additionally, under fatigue or dynamic loads the value of c should be halved [3].

Figure 4.10 illustrates the design shear resistance at the interface according to EC2 [3], as described in section 4.5 and eq. (4.23), focusing on a rough concrete interface with constants $c = 0.45$ and $\mu = 0.7$. It demonstrates how shear resistance varies as a function of the stress per unit area caused by the minimum external force across the interface. This variation is shown for different angles α , emphasizing the impact of angular orientation on the structural integrity.

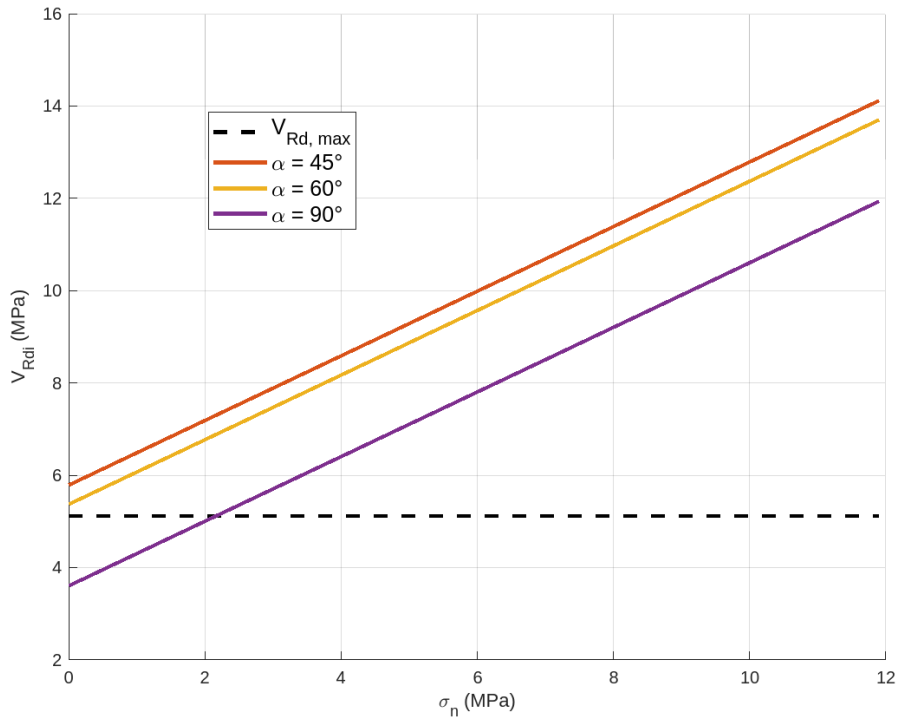

Figure 4.10: Design Shear Resistance at Interface

It should be noted that the representations in fig. 4.10 is based on key assumptions, including the stress σ_n acting in compression and a specified value of ρ . These factors are important in understanding the graph, as they influence the overall analysis of shear resistance.

Chapter 5

Shear, FprEN Guidelines

This chapter conducts a brief investigation of shear behavior in concrete structures, guided by FprEN [4]. The chapter is designed to provide an understanding of various aspects of shear stress and its impact on structural integrity.

Section 5.1 examines concrete members not requiring design shear force reinforcement and presenting practical examples based on FprEN guidelines. In section 5.2, an analysis is conducted on concrete members requiring design shear reinforcement and provides a thorough exploration of the shear reinforcement requirement. Furthermore, section 5.3 introduces a new direction presented by FprEN focusing on in-plane shear and transverse bending. The discussion continues in section 5.4 with an evaluation of minimum shear reinforcement requirements. This evaluation focuses on explaining the rules and methods set by FprEN to ensure optimal reinforcement for concrete structures. Finally, sections 5.5 and 5.6 examine shear between the web and flange and shear at the interface, respectively.

5.1 Members not requiring design shear force reinforcement

Unless there are concentrated loads applied at a distance less than d from the support, there is no need to perform a detailed verification of the shear resistance for control sections that are closer than d from the face of the support or from a significant concentrated load (as shown in fig. 5.1). However, if there are significant loads applied between d and $2d$ from the face of the support, a control section positioned at a distance of d from the support face needs to be verified [4].

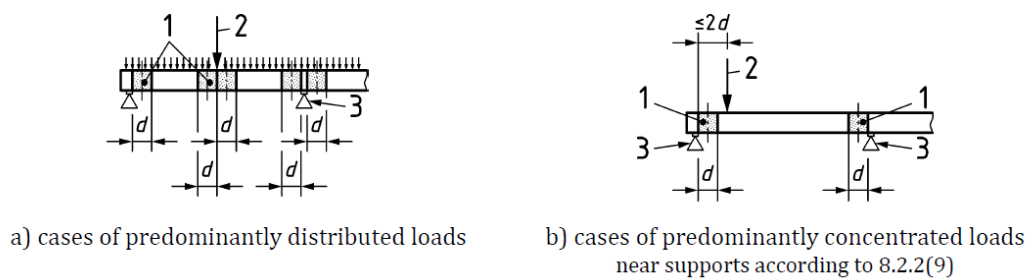

Key

- 1 regions where shear strength verification may be omitted
- 2 concentrated load
- 3 support

Figure 5.1: Regions where shear strength verification can be omitted [4].

The design value of shear resistance, $\tau_{Rd,c}$, is defined by:

$$\tau_{Rd,c} = \frac{0.66}{\gamma_v} \left(100 \rho_l f_{ck} \frac{d_{dg}}{d} \right)^{\frac{1}{3}} \quad (5.1)$$

With a minimum value of:

$$\tau_{Rd,c,min} = \frac{11}{\gamma_v} \times \sqrt{\frac{f_{ck}}{f_{yd}}} \times \frac{d_{dg}}{d} \quad (5.2)$$

where: $\tau_{Rd,c}$ = is the shear stress resistance of members without shear reinforcement.
 $\tau_{Rd,c,min}$ = is the minimum shear stress resistance allowing to avoid a detailed verification for shear.

Equation (5.2) provides a simple rule: If the design shear stress is equal to or lower than the value calculated by this equation, further consideration and verification for shear are not necessary. However, if the applied design shear stress exceeds this value, eq. (5.1) should be used to verify shear.

$$\rho_l = \frac{A_{sl}}{b_w d} \quad (5.3)$$

where: A_{sl} = tensile reinforcement effective area at the distance d beyond the given area, (see 5.2):

b_w = width of the cross-section of linear members.

d_{dg} = parameter describing the failure zone roughness, which depends on the concrete type and its aggregate properties.

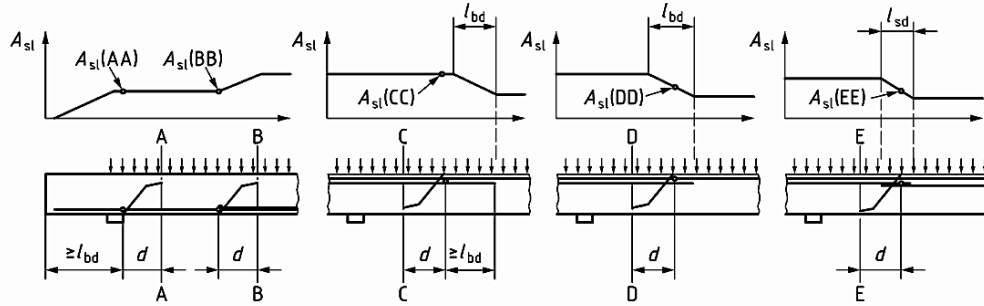

Key

- Control sections A-A and C-C: Cases where anchored and curtailed reinforcement may be fully accounted for
- Control section B-B: Case where curtailed reinforcement may not be accounted for
- Control sections D-D and E-E: Cases where curtailed or spliced reinforcement may be partially accounted for

Figure 5.2: A_{sl} : Source:[3].

d_{dg} [mm] may be taken as:

$$16 \text{ mm} + D_{lower} \leq 40 \text{ mm} \quad \text{for concrete with } f_{ck} \leq 60 \text{ MPa}$$

$$16 \text{ mm} + D_{lower} \left(\frac{60}{f_{ck}} \right)^2 \leq 40 \text{ mm} \quad \text{for concrete with } f_{ck} \geq 60 \text{ MPa}$$

D_{lower} is the smallest value of the upper sieve size D in an aggregate for the coarsest fraction of aggregates in the concrete permitted by the specification of concrete according to EN 206 [1].

In case D_{max} is known, D_{lower} can be replaced by D_{max} . f_{yd} is the design value of the yield strength which has been used to design the flexural reinforcement. γ_v is the partial factor for shear design according to tables 4.3, A.1 and A.2 [4].

The value of d in eq. (5.1) can be substituted by the mechanical shear span a_v , for members having an effective shear span a_{cs} less than 4 d :

$$a_v = \sqrt{\frac{a_{cd}}{4}} d \quad (5.4)$$

The effective shear span a_{cs} , is a function of internal forces at the control section for reinforced concrete members, it may be calculated as follows:

$$a_{cs} = \left| \frac{M_{Ed}}{V_{Ed}} \right| \geq d \quad (5.5)$$

Where: M_{Ed} and V_{Ed} include the effect of the prestressing [4].

$$k_{vp} = 1 + \frac{N_{Ed}}{|V_{Ed}|} \cdot \frac{d}{3a_{cs}} \geq 0.1 \quad (5.6)$$

When axial forces N_{Ed} act on the control section, a coefficient k_{vp} according to eq. (5.6) should be multiplied to the value of d in eq. (5.1) or a_v in eq. (5.4).

For prestressed members with bonded tendons, the effective depth d and the reinforcement ratio ρ_l can be computed as follows:

$$d = \frac{d_s^2 \cdot A_s + d_p^2 \cdot A_p}{d_s \cdot A_s + d_p \cdot A_p} \quad (5.7)$$

$$\rho_l = \frac{d_s \cdot A_s + d_p \cdot A_p}{b_w \cdot d^2} \quad (5.8)$$

In planar members with varying reinforcement ratios in both directions, ρ_l should be determined as a function of the ratio of the shear forces $v_{Ed,y}/v_{Ed,x}$:

$$\rho_l = \begin{cases} \rho_{l,x} & \text{for } \frac{v_{Ed,y}}{v_{Ed,x}} \leq 0.5, \\ \rho_{l,x} \cdot \cos^4(\alpha_v) + \rho_{l,y} \cdot \sin^4(\alpha_v) & \text{for } 0.5 < \frac{v_{Ed,y}}{v_{Ed,x}} < 2, \\ \rho_{l,y} & \text{for } \frac{v_{Ed,y}}{v_{Ed,x}} \geq 2. \end{cases}$$

Where the angle α_v between the principal shear force and x-axis is as follows:

$$\alpha_v = \arctan(V_{Ed,y}/V_{Ed,x}) \quad (5.9)$$

In example below, eqs. (5.1) and (5.2) are used to show how it works in a real situation:

Example 5-1

In this example, the assumptions and data from Example 4.1 are used to calculate shear force resistance for members without shear reinforcement requirement, following the guidelines of FprEN.

In presence of axial force N_{Ed} , acting at the control section, the value of d in eq. (5.1) should be

multiplied by coefficient k_{vp} according to following equation [4]:

$$k_{vp} = 1 + \frac{N_{Ed}}{|V_{Ed}|} \times \frac{d}{3 \cdot a_{cs}} \geq 0.1 \quad (5.10)$$

where:

$$a_{cs} = \left| \frac{M_{Ed}}{V_{Ed}} \right| \geq d \quad (5.11)$$

$$\Rightarrow V_{Ed} = \frac{q_{Ed} \times L}{2} = \frac{22.2 \times 8}{2} \approx 89 \text{ kN} \quad (5.12)$$

$$M_{Ed} = \frac{q_{Ed} \times L^2}{8} = \frac{22.2 \times 64}{8} \approx 178 \text{ kN m} \quad (5.13)$$

$$a_{cs} = \frac{177.6 \text{ kN m}}{88.8 \text{ kN}} = 2 \text{ m} \Rightarrow 2000 \text{ mm} \quad (5.14)$$

$$k_{vp} = 1 + \frac{-400}{88.8} \times \frac{364}{3 \times 2000} \approx 0.73 \quad (5.15)$$

Calculating the design shear resistance value of concrete using eq. (5.1)

$$v_{Rd,c} = \frac{0.6}{1.4} \left(100 \times 0.01265 \times 35 \times \frac{32}{364 \times 0.727} \right)^{\frac{1}{3}} \approx 0.75 \text{ MPa} \quad (5.16)$$

Calculating the minimum design shear resistance value of concrete using eq. (5.2)

$$v_{Rd,c,min} = \frac{11}{1.4} \sqrt{\frac{35 \times 32}{434 \times 364}} \approx 0.66 \text{ MPa} \quad (5.17)$$

Since $V_{Ed,red} > v_{Rd,c,min}$, it follows that $v_{Rd,c} \approx 0.75 \text{ MPa}$ (5.18)

$v_{Rd,c} > V_{Ed,red} \Rightarrow$ Shear reinforcement is not required. (5.19)

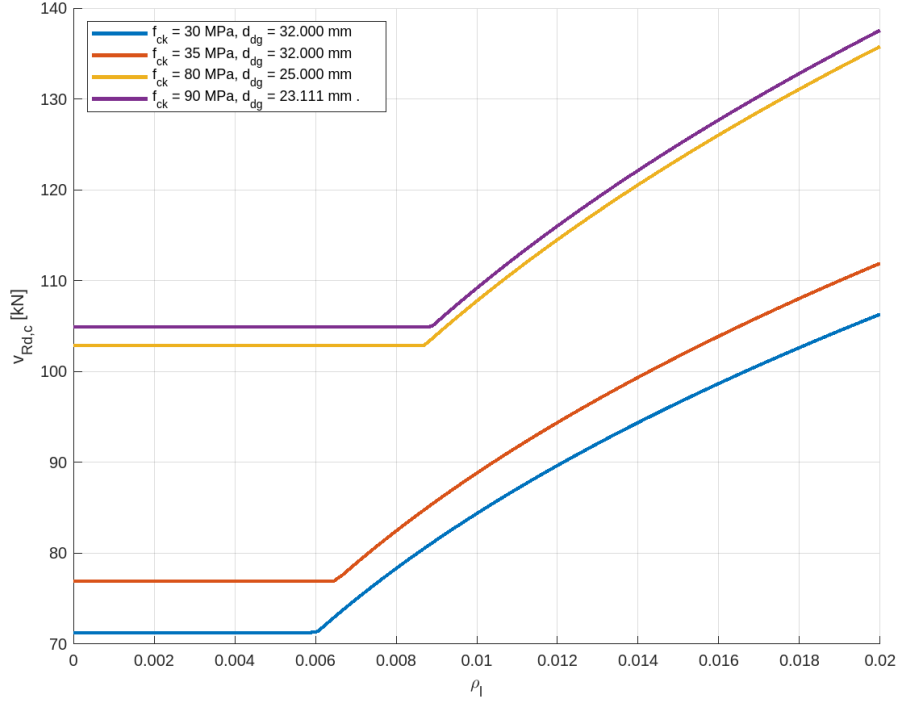

Figure 5.3: Shear capacity ($v_{Rd,c}$) vs. reinforcement amount (ρ_l)

Figure 5.3 illustrates the relationship between the shear capacity ($v_{Rd,c}$) of the beam and the longitudinal reinforcement ratio (ρ_l) for various grades of concrete strength (f_{ck}) and unique aggregate roughness parameters d_{dg} for each f_{ck} . To convert the unit of $v_{Rd,c}$ from MPa to kN, multiply it by the effective height (d) and the smallest width of the cross-section (b_w), and then divide the result by 1000. ■

5.2 Members requiring design shear reinforcement

The shear stress resistance perpendicular to the longitudinal member axis, in the case of yielding of the shear reinforcement, can be determined using the following equation [4]:

$$\tau_{Rd,sy} = \frac{A_{sw}}{b_w \cdot s} \cdot f_{ywd} \cdot \cot \theta \quad (5.20)$$

And, in all cross sections, the stress in the compression field shall be verified as follows:

$$\sigma_{cd} = \tau_{Ed}(\cot \theta + \tan \theta) \leq v \cdot f_{cd} \quad (5.21)$$

where τ_{Ed} is the design shear stress.

This requirement ensures that the stress in the compression field due to the design shear stress does not exceed a certain limit, which is dependent on the material properties and the angle θ (the angle between the compression strut and the longitudinal axis). This can impact the design and detailing of the members regarding how reinforcement is arranged to manage cracking and deformation caused by stress.

Furthermore, when shear reinforcement yields and the compression field fails simultaneously, the shear resistance is determined as follows:

$$\tau_{Rd} = \frac{A_{sw}}{b_w \cdot s} \cdot f_{ywd} \cdot \cot \theta \leq \frac{v \cdot f_{cd}}{2} \quad (5.22)$$

A value of $v = 0.5$ can be used under certain conditions related to angles (θ) of the compression field and cotangent of the minimum inclination [4]. Moreover, angles of the compression field inclination to the member axis lower than θ_{min} or values of factor v higher than 0.5 can be adopted given that the ductility class of the reinforcement falls within class B or C and the value of v is computed based on the state of strains of the member, which is as follows:

$$v = \frac{1}{1.0 + 110 \cdot (\varepsilon_x + (\varepsilon_x + 0.001) \cdot \cot^2 \theta)} \leq 1.0 \quad (5.23)$$

where: ε_x = average strain of the bottom and the top chords calculated at a cross-section not closer than $0.5z \cot \theta$ from the face of the support or a concentrated load [4].

The equation (5.23) is important as it allows for the determination of the strength reduction factor (v) by considering the strain conditions of the component, this is central to understand how the structure behaves under different load conditions. By taking strain into account, it makes the designs more accurate and reliable, improving safety and performance.

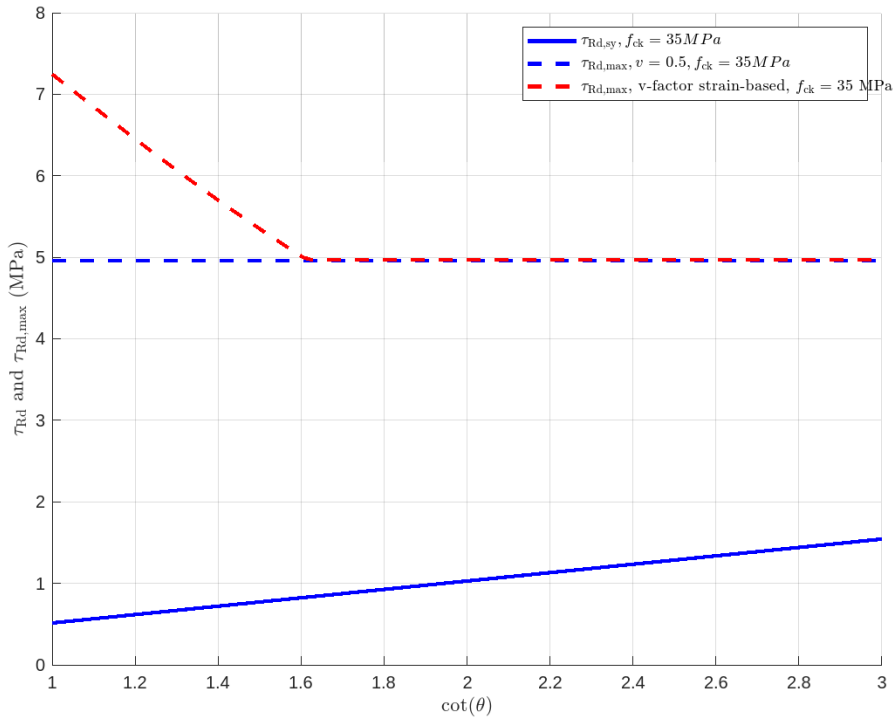

Figure 5.4: $\tau_{Rd,sy}$ vs. $\tau_{Rd,max}$

Figure 5.4 illustrates τ_{Rd} , and the maximum shear stress resistance $\tau_{Rd,max}$, as a function of the cotangent of $\cot \theta$. The top curve in the graph shows that $\tau_{Rd,max}$ decrease as $\cot \theta$ increases,

which can be associated to the variable influence of the v -factor according to eq. (5.23) on the shear capacity of concrete. Initially, the v -factor is ≈ 0.73 at $\cot \theta = 1$, indicating a higher maximum shear capacity. As $\cot \theta$ increases, the v -factor reduces, decreasing the shear resistance proportionally. The v -value reaches its minimum limit of 0.5 at $\cot \theta = 1.6$.

5.3 New directions in structural engineering: In-plane shear and transverse bending

The revised version (FprEN), introduces new rules, representing an important advancement in structural design. These regulations provide knowledge particularly regarding in-plane shear and transverse bending, making it easier to handle challenges in a more informed and accurate way. In the following section, this topic was examined to gain a better understanding of these new additions.

The interaction between shear stress, represented as τ_{Ed} and transverse bending, represented as m_{Ed} (Fig. 5.5), the interaction can be ignored if $\tau_{Ed}/\tau_{Rd} < 0.2$ or $m_{Ed}/m_{Rd} < 0.1$ [4].

Where:

τ_{Rd} is the shear resistance.

m_{Rd} is the bending resistance without interaction with shear.

In case where the shear reinforcement is perpendicular to the member's longitudinal axis and symmetric to the web middle plane, the shear stress resistance τ_{Rdm} reduced by the influence of transverse bending, can be calculated using the following equation:

$$\tau_{Rdm} = \tau_{Rd} \sqrt{1 - \frac{m_{Ed}}{m_{Rd}}} \quad (5.24)$$

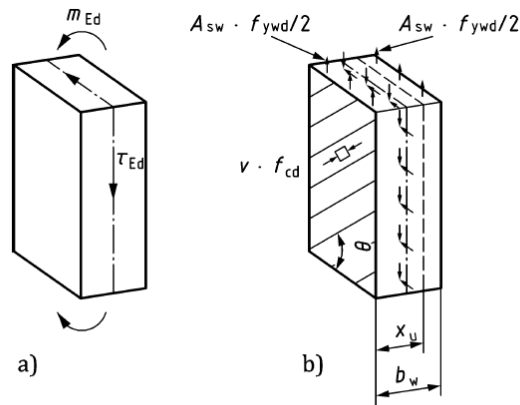

- a) web with shear stress τ_{Ed} and transverse bending moment m_{Ed}
- b) eccentric compression field carrying shear and transverse bending

Figure 5.5: Interaction between shear and transverse bending: [4].

These additional guidelines can optimize safety margins and increase the safety of buildings. The new rules also offer the possibility of simplifying design solutions by allowing for conditions where the interaction between shear stress and transverse bending can be disregarded. This can lead to potentially cost effective designs avoiding unnecessary materials or reinforcements that may have been overly conservative. Moreover these updated regulations expand the applicability of EC2 to types of structures and scenarios. They also promote consistency and clarity across projects facilitating comparisons between design approaches. In summary, these updates make it a lot better at dealing with many different aspects of how structures interact.

5.4 Minimum shear reinforcement

Similar to requirements in section 4.3, when design shear calculations indicate that no shear reinforcement is required, minimum shear reinforcement should still be provided.

The minimum shear reinforcement ratio ($\rho_{w,min}$) remains the same as in equation (4.16), but there are some differences in requirements, as following :

The value of $\rho_{w,min}$ given by the equation (4.16) can be reduced as follows:

- by 10 % for ductility class B reinforcement.
- by 20 % for ductility class C reinforcement.

According to FprEN [4], for linear members with an effective depth $d > 500$ mm, minimum shear reinforcement shall be provided. In exceptions where this were not possible, the approach described in [4, I.8.3.1(1)-(2)] should be used instead of the method according to [4, p. 8.2.2] or, alternatively, the eq. (5.1) should be multiplied with the following coefficient:

$$k_{vd} = 1.35 \left(100 \rho_l \frac{d_{dg}}{d} \right)^{\frac{1}{10}} \leq 1 \quad (5.25)$$

5.5 Shear between web and flanges

If the following condition is satisfied, no extra reinforcement is required over that for flexures is required and further verification of the shear between web and flange may be omitted:

$$\tau_{Ed} \leq \frac{A_{st,min}}{s_f \cdot h_f} \cdot f_{yd} \quad (5.26)$$

where: $A_{st,min}$ = is the minimum transverse reinforcement.
 s_f = is spacing of transverse reinforcement.

In case the condition of eq. (5.26) is not met, the shear strength of the flange can be computed by considering the flange as a system of compressive struts combined with ties in the form of tensile reinforcement [4].

The cotangent of the angle θ_f ($\cot \theta_f$) in eq. (5.26), which represents the inclination of compression field in the flanges with respect to the longitudinal axis, may be chosen within the following

range:

$$\begin{aligned} 1.0 \leq \cot \theta_f \leq 3.0 & \quad \text{for compression flanges.} \\ 1.0 \leq \cot \theta_f \leq 1.25 & \quad \text{for tension flanges.} \end{aligned}$$

To prevent crushing of compression struts in the flange, eq. (5.21) should be fulfilled.

A lower angle for the inclined compression field in the tensile flange may be adopted provided that the v -factor is computed on the basis of the state of strains of the member according to eq. (5.23). In this equation, ε_x is the longitudinal strain in the tension flange, which may be assumed as follows: [4]:

$$\varepsilon_x = \frac{F_{td}}{A_{st}E_s} \geq 0 \quad (5.27)$$

where: A_{st} = the area of the longitudinal reinforcement.

F_{td} = the force in the tension chord.

E_s = the modulus of elasticity of the reinforcement.

The requirement that ε_x must be greater than or equal to zero ($\varepsilon_x \geq 0$), makes sure that the tensile flange is in tension or neutral, which might be a safety consideration.

5.6 Shear at interfaces

The requirement to consider shear stress at the interface in the revised version is similar to EC2 as presented in section 4.5.

The design shear stress resistance at the interface according to FprEN [4], is as follows:

$$\tau_{Rdi} = c_{v1} \frac{\sqrt{f_{ck}}}{\gamma_c} + \mu_v \sigma_n + \rho_i f_{yd} (\mu_v \sin \alpha + \cos \alpha) \leq 0.3 f_{cd} + \rho_i f_{yd} \cos \alpha \quad (5.28)$$

Equation (5.28) can be applied when there is no reinforcement across the interface or if the required reinforcement is sufficiently anchored.

In other cases, $\tau_{Rd,i}$ should be calculated as follows:

$$\tau_{Rdi} = c_{v2} \frac{\sqrt{f_{ck}}}{\gamma_c} + \mu_v \sigma_n + k_v \rho_i f_{yd} \mu_v + k_{dowel} \rho_i \sqrt{f_{yd} \cdot f_{cd}} \leq 0.25 f_{cd} \quad (5.29)$$

where: f_{ck} = lowest compressive strength of concrete at the interface

α = limited to $35^\circ \leq \alpha \leq 135^\circ$; except for very smooth surfaces, where $35^\circ \leq \alpha \leq 90^\circ$

In both formulas, the factors c_{v1} , c_{v2} , μ_v , and k_{dowel} are dependent on the roughness of the surface, which can be categorized as very smooth, smooth, rough, very rough and indented as

shown in Table 5.1.

Table 5.1: Coefficients depending on the roughness of the surface [4].

Surface roughness	Equation (5.28)		Equation (5.29)		
	c_{v_1}	μ_v	c_{v_2}	k_v	k_{dowel}
Very smooth	0.01 ^a	0.5	0	0	1.5
Smooth	0.08 ^a	0.6	0	0.5	1.1
Rough	0.15 ^a	0.7	0.08 ^a	0.5	0.9
Very rough	0.19 ^a	0.9	0.15 ^a	0.5	0.9
Keyed ^d	0.37	0.9	-	-	-

^a When the interface is subjected to tensile stress caused by external axial force in perpendicular direction: $c_{v_1} = 0$ and $c_{v_2} = 0$.

^dThe factor for keyed interfaces shall be applied for the area of each key considering its concrete strength.

The design value of the shear stress at the interface is given by:

$$\tau_{Edi} = \frac{V_{Edi}}{A_i} \quad (5.30)$$

where: V_{Edi} = shear force acting parallel to the interface.
 A_i = area of the interface.

Moreover, the longitudinal shear stress at the interface as a result of composite action may be taken as:

$$\tau_{Edi} = \frac{\beta V_{Ed}}{z b_i} \quad (5.31)$$

When delamination is an issue, the minimum interface reinforcement along edges should be computed as follows:

$$a_{s,min} = t_{min} f_{ctm} / f_{yk} \quad (5.32)$$

where: t_{min} = smaller value of the thickness of new and old concrete layer.
 f_{ctm} = mean tensile strength of respective concrete layer.

Figure 5.6 illustrates the differences and applications of the two eqs. (5.28) and (5.29) as per the FprEN guidelines [4] for the design shear resistance at interfaces. The eq. (5.28) is represented by various curves corresponding to different angles of inclination (α) for the interface reinforcement. It highlights how shear resistance is influenced by the interface roughness, frictional properties, and the angle of reinforcement. This equation is particularly relevant when no reinforcement across the interface is needed or the reinforcement is sufficiently anchored. In contrast, the eq. (5.29), is plotted as a singular line, indicating a design approach where the yielding of the reinforcement across the interface is not ensured. This approach integrates factors like surface roughness and dowel action, which are critical in precast structures.

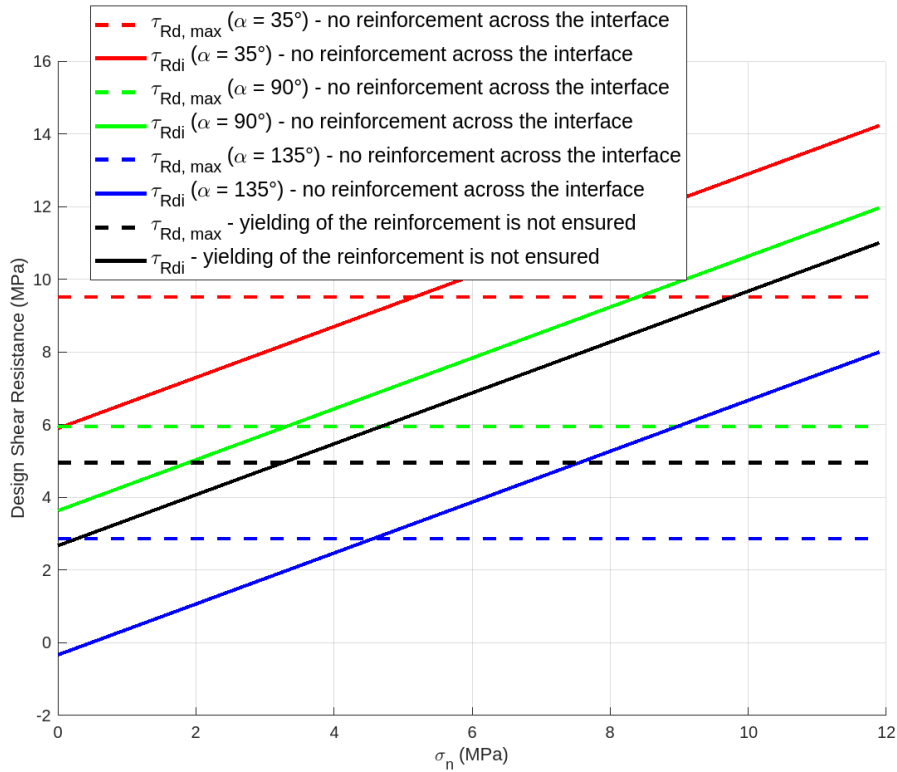

Figure 5.6: Design Shear Resistance at Interface

It should be noted that the representations in fig. 5.6 is based on key assumptions, including the stress σ_n acting in compression and a specified value of ρ . These factors are important in understanding the graph, as they influence the overall analysis of shear resistance.

Chapter 6

Shear, EC2 vs. FprEN

In this chapter, a brief comparison between EC2 and its revised version FprEN is carried out. This part of the thesis evaluates the shear guidelines discussed in chapters 4 and 5 offering a comparative analysis of the key changes and updates.

6.1 Members not requiring design shear reinforcement, EC2 vs. FprEN

The advancements in concrete members without shear reinforcement are significantly impacted by the introduction of the FprEN. A detailed investigation in Section section 5.1 reveals that the revised version is not merely an update but a considerable advancement over its predecessor.

This revision incorporates specific guidelines and rules for scenarios where concentrated loads are applied near supports. Such detailed attention ensures that potential design weaknesses around support areas are thoroughly addressed, thereby enhancing the safety and reliability of structures.

Furthermore, the incorporation of new equations like $\tau_{Rdc,min}$ and $\tau_{Rd,c}$ in the updated FprEN improves the accuracy and precision in calculating shear stress resistance for members without shear reinforcement. This advancement not only secures a higher margin of safety in shear but also streamlines the calculation process for engineers.

The updated equation for shear stress resistance, as seen in eq. (5.1), though similar in appearance to the equation according to EC2 (eq. (4.1)), but it is based on a different model. The flexibility of the document in allowing engineers to use parameters such as d_{dg} , k_{vp} , and a_v based on specific design scenarios demonstrates the adaptability of the standard. This ensures that the design process remains efficient and responsive to the unique requirements of each project.

A notable development in the revised FprEN is the detailed inclusion of prestressing effects into the design calculations. As construction methodologies evolve, it is crucial for standards to keep pace with these advancements. The emphasis on prestressing effects ensures that the FprEN remains suitable and relevant in modern construction practices.

Lastly, the updated standard's comprehensive approach to dealing with planar members, which have varying reinforcement ratios in different directions, highlights its meticulous focus. By taking into account the characteristics of shear forces, the standard sets the groundwork for more durable and well-informed design procedures.

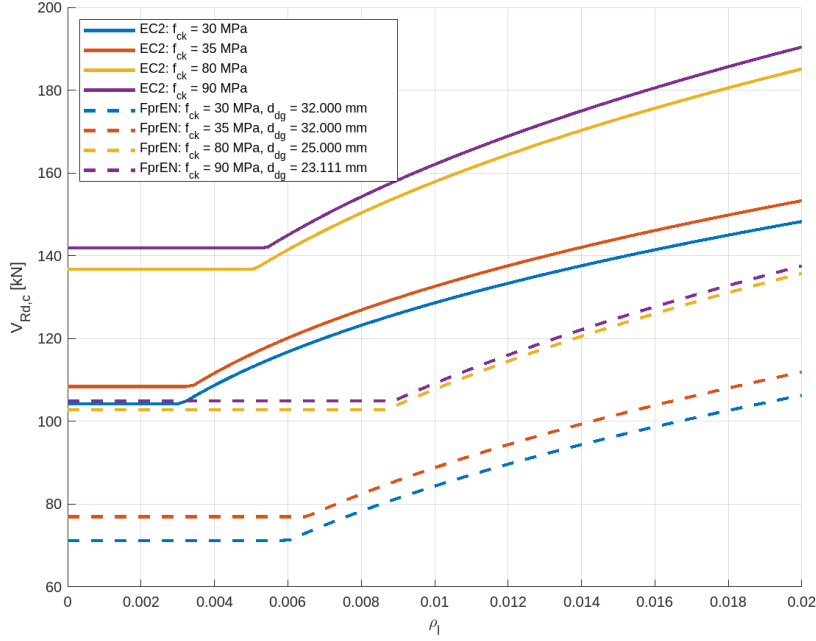

Figure 6.1: Shear capacity $V_{Rd,c}$ vs. reinforcement amount ρ_l (EC2 vs. FprEN)

Figure 6.1 illustrates a comparative analysis of design shear resistance ($V_{Rd,c}$) according to EC2 and FprEN for different f_{ck} values. The solid lines represent the EC2 while the dashed lines indicate FprEN predictions, highlighting the variations in shear resistance caused by the method and parameters used in each guideline. The analysis emphasizes that FprEN tends to be more conservative than the current standard.

6.2 Members requiring design shear reinforcement, EC2 vs. FprEN

In this section, a comparison is made between the guidelines defined in EC2 and FprEN, focusing on the changes and how they affect design methods.

In the revised version, the shear stress resistance perpendicular to the longitudinal member axis, in the case of yielding of the shear reinforcement, can be determined using eq. (5.20). This means that compared to the EC2 conditions, the shear stress resistance is now also influenced by the minimum width between tension and compression chord (b_w).

Based on FprEN [4], when shear reinforcement yields and the compression field fails simultaneously, the shear resistance is determined using equation eq. (5.22). This takes into account crucial situations such as when structural members experience both yielding and compression field failure and has the potential to improve safety and reliability level of structural member under various stress conditions.

According to the EC2 guidelines [3], the angle θ refers to the angle formed between the concrete compression strut and the beam axis that is perpendicular to the shear force. The recommended limits for $\cot \theta$ are as follows:

$$1 \leq \cot \theta \leq 2.5$$

The value of $\cot \theta$ in EC2 is independent of the forces acting on the structural element.

In the FprEN guidelines, the definition of the angle θ is retained, but there are some differences in the recommended limits for $\cot \theta$, as follows:

$$1 \leq \cot \theta \leq \cot \theta_{min}$$

The guidelines provide an explanation of how to determine the $\cot \theta_{min}$, based on different ductility classes, and the effects of axial compression and tension forces. There has been an improvement in defining the ranges for the minimum inclination of stress fields and the rules for very detailed verification. These improvements are believed to be most applicable to existing structures where strengthening is to be avoided if possible. This helps to better understand and consider the behavior of structures under different loads and boundary conditions leading to improve and safer design solutions.

As described in section 4.2, in EC2 for design stress of shear reinforcement less than 80% of f_{yk} , the strength reduction factor (v) is 0.6 for f_{ck} below or equal 60 MPa. For values higher than 60 MPa, the v -factor calculates as follows:

$$v = 0.9 - \frac{f_{ck}}{200}$$

If the design stress of shear reinforcement exceed 80% of f_{yk} , then v -factor can be calculated as:

$$v = 0.6(1 - f_{ck}/250)$$

In the revised version, a value of $v = 0.5$ can be used under certain conditions related to angles (θ) of the compression field and cotangent of the minimum inclination. This provides a level of detail compared to EC2. Furthermore, angles of the compression field inclination to the member axis lower than θ_{min} or values of factor v higher than 0.5 can be adopted given that the ductility class of the reinforcement falls within class B or C and the value of v is computed based on the state of strains as explained in section 5.2 by using eq. (5.23).

The equation (5.23) is important as it allows for the determination of the strength reduction factor (v) by considering the strain conditions of the component, this is central to understand how the structure behaves under different load conditions. By taking strain into account, it makes our designs more accurate and reliable, improving safety and performance.

The inclusion of additional formulas and specific guidelines in FprEN enables accurate calculations and ensure the reliability of the design. While EC2 offers a simplified approach, FprEN may be better suited for applications that require detailed analysis and consideration of multiple factors and conditions.

Furthermore, the FprEN focuses on the examination of how the effects of ducts should be considered when checking shear resistance without shear reinforcement, particularly in situations where ducts are not grouted or are injected with soft filling materials. This emphasis is important because it helps prevent structural problems by securing that the strength and stability of the structure are not weakened due to the overlook of important duct related factors, which might result in construction failures.

Considering the various duct materials and fillings, FprEN can make structural designs safer and more reliable compared to EC2. It deals with various construction situations and provides more detailed guidelines and requirements for checking shear stress resistance.

6.3 Minimum shear reinforcement, EC2 vs. FprEN

The design and construction of reinforced concrete structures have repeatedly improved due to progress in research and technology. In this section, the transformation from EC2 to FprEN will be compared looking at the rules for minimum reinforcement.

The transition from EC2 to FprEN marks an advancement in the field of minimum shear reinforcement. Notably, both versions highlight the requirement for minimum shear reinforcement. However, the current standard presents situations where reinforcement can in certain cases be neglected. In contrast the FprEN, introduces a new term that permits reductions based on ductility class, which was not present in the EC2.

Moreover, the updated standard provides guidance for designing elements with depth something that was not specifically addressed in the EC2. A key addition in the revised version is the inclusion of a parameter called d_{dg} , which highlights how aggregate size and properties impact design choices. This ensures that designs are more customized and precise based on materials used.

While the revised standard offers advantages like increased flexibility for designers and a detailed approach considering material specific behaviors, it also brings added complexity. This complexity may present challenges for those transitioning from the standard leading to potential challenges and risks of misinterpretation.

Figure 6.2 compares the minimum shear reinforcement ratios outlined in EC2 and FprEN. It shows requirements specified in EC2 and the adjusted requirements corresponding to ductility classes B and C in the FprEN. To make it easy to understand, the reinforcement ratios are expressed as percentages. As illustrated in figure, there is a decrease in the minimum shear reinforcement ratio when transitioning from EC2 to FprEN for both ductility classes. Class C experiences a reduction compared to class B. This visualization highlights the changes introduced in the FprEN standard, which allows for approaches based on the ductility class of reinforcement used. This shift indicates a trend towards material specific design considerations in modern structural engineering practices.

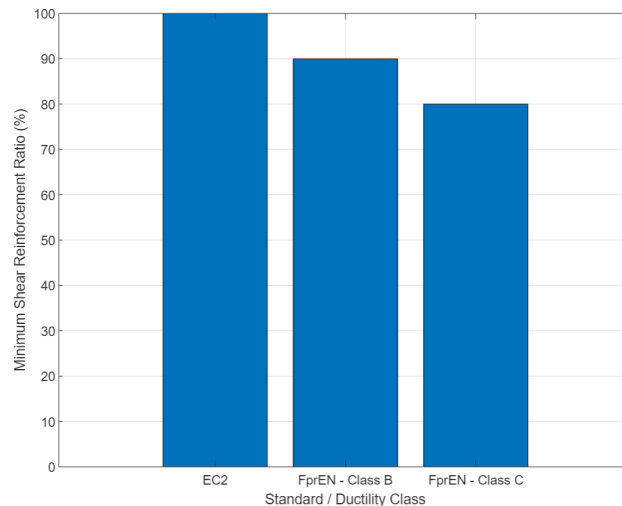

Figure 6.2: EC2 vs FprEN

6.4 Shear between web and flanges: EC2 vs. FprEN

After discussing the guidelines of shear between web and flange according to EC2 [3] and FprEN [4], in sections 4.4 and 6.4 respectively, this section aims to make a direct comparison between these codes.

Equation (4.17) according to EC2 has been revised to eq. (5.26) in revised guidelines. Comparing these two equations shows that condition for verification of shear between web and flange according EC2 is simpler, based on a coefficient k and the tensile strength of concrete f_{ctd} .

Furthermore, the revised standard introduces a requirement that considers factors such as: Minimum transverse reinforcement, spacing of reinforcement, thickness of the flange at the junctions, and the designed yield strength of the reinforcement, which were not considered in the previous standard. The revised condition seems to be more detailed, taking into account the geometric and reinforcement properties of the section and the inclusion of parameters related to transverse reinforcement.

Both the EC2 and FprEN versions mentions that the shear strength of the flange can be determined by considering the flange as a system of compressive struts combined with ties in the form of tensile reinforcement. This means that the basic method or approach to understand the shear strength remains consistent between the two versions. The EC2 version does not provide any formula or condition under which the mentioned method should be used. The FprEN version, on the other hand, introduces equation (5.26), this equation acts like a rule or limit. As stated in FprEN, if not complying with equation (5.26), then the method of considering the flange as a system of compression fields combined with tension reinforcement ties in the form of tensile reinforcement should be applied. This additional requirement provides a clear rule and makes it easier to use the method, allowing for more consistent application of the method across different projects and scenarios. This can lead to more uniform results and understandings.

The guidelines for selecting the cotangent of the angle, which represents the inclination of compression field in the flanges with respect to the longitudinal axis are identical, with the exception of compression flange where FprEN allows for a higher value (3 in FprEN and 2 in EC2). This might suggest that recent studies or practical observations have shown that steeper angles can be more effective and safer than the previous range. With the ability to use steeper inclination angles in compression flanges, there may be opportunities for cost savings in terms of materials, fabrication, or construction as components designed with these angles might be easier to assemble or require fewer additional supports during construction.

To prevent crushing of compression struts in the flange, equation (4.20) according to EC2 and equation (5.21) according to FprEN should be fulfilled.

Strength reduction factor v as stated in EC2 is as follows:

$$v = 0.6 \left(1 - \frac{f_{ck}}{250} \right)$$

However, according to FprEN, a strength reduction factor of 0.5 can be used.

The equation for v -factor according to EC2 indicates that as the characteristic concrete cylinder compression strength (f_{ck}) increases, the strength reduction factor (v) decreases. The EC2 adjusts

the strength reduction based on the concrete strength, however, the FprEN standard uses a fix value.

Moreover, FprEN introduces a new requirement regarding the angle of the inclined compression field in the tensile flange, this provides an updated approach to the shear between the web and flange compared to EC2. FprEN allows for choosing lower angle of the inclined compression in the tensile flange than given in EC2. This implies that there is room for flexibility in design, but this is only allowed if the value of factor v is calculated on the basis of the state of strains of the member. The provision permits the use of compression field inclination angles that are lower than θ_{min} or values of factor v that are greater than current standard. However, this is only allowed when the reinforcement being used is of ductility class B or C. This highlights the importance of ensuring ductile behavior particularly when deviating from recommendations.

To summarize this context, the additional requirement introduced by FprEN, provides more flexibility in design, particularly regarding the inclination of the compression field in the tensile flange. However, it associates this flexibility with conditions that ensure safety by considering the state of strains in the member and the ductility class of the reinforcement. This approach may lead to a nuanced design that ensures both safety and design efficiency.

6.5 Shear at Interfaces: EC2 vs. FprEN

In the revised standard, an additional requirement has been introduced, and this new provision states the following:

- For very rough interface with sufficiently anchored minimum reinforcement crossing the interface at an angle, the verification may be omitted [4].

This guideline specifies that when the surface of the interface is very rough, it can increase the shear resistance, this is probably because a rough surface improves the grip between the two layers of concrete due to the high level of friction. This, together with sufficiently anchored reinforcement is considered to provide enough shear resistance, thus potentially simplifying the design process and offering cost efficiencies. However, this provision should be applied with caution and thorough justification to ensure structural safety.

The equation (4.23) provided by EC2 serves as a general formula for calculating the design shear resistance at the interface (V_{Rdi}). There is no distinction made between situations that call for reinforcement or the specific conditions needed for anchoring. On the other hand, FprEN introduces eqs. (5.28) and (5.29) to calculate the design shear resistance at the interface.

Having these two scenarios adds a layer of complexity to the design due to needs for additional calculation effort and expertise to evaluate which case to apply for a given interface shear solution. Equation (5.28) may be more suitable for rough interface, based on the inclusion of terms that are highly dependent on the friction at the interface. While eq. (5.29) allows for inclusion of dowel action, making it proper ideal for precast structures.

As shown in eqs. (5.28) and (5.29), a new term $\sqrt{f_{ck}}/\gamma_c$ is introduced, which seems complicated compared to eq. (4.23), but may offer a more nuanced understanding of the concrete's shear behavior at interface, due to introduction of compressive strength f_{ck} , and safety factor γ_c .

There are also changes in the strength resistance limits. The limit according to eq. (4.23) is: $0.5v f_{cd}$. On the other hand, the limits based on FprEN version is $0.3f_{cd} + \rho_i f_{yd} \cos \alpha$ in case no reinforcement across the interface is required or if the reinforcement is adequately anchored, and $0.25f_{cd}$ in other cases [4]. These changes can lead to a more conservative or liberal design depending on specific conditions.

Furthermore, compared to EC2, the revised version allows for a broader range for the angle of inclination of interface reinforcement (α), as indicated in eq. (5.28): from 35° to 90° for very smooth surfaces and from 35° to 135° for other levels of surface roughness. This gives the designer more flexibility to optimize structural components, particularly in complex geometries or under specific conditions. However, it's worth mentioning that the freedom to choose from a broader range of angles can increase the likelihood of error and incorrect choice of design.

Moreover, FprEN introduces additional coefficients: k_v and k_{dowel} . The introduction of these coefficients may improve the accuracy of the structure, but it makes the design more conservative when the roughness of the concrete interface is classified as rough, very rough or keyed, resulting in an increase in material and costs.

In the EC2, the design value of shear stress at the interface (V_{Edi}) is given by eq. (4.22). This equation takes into consideration: the longitudinal force in the new concrete area, the transverse shear force, the lever arm and the width of the interface. It basically provides a method to the shear force by taking into account various factors, making it detailed.

In the FprEN version, the design value of the shear stress at the interface τ_{Edi} is given by:

$$\tau_{Edi} = \frac{V_{Edi}}{A_i}$$

Moreover, the longitudinal shear stress at the interface as a result of composite action may be taken as:

$$\tau_{Edi} = \frac{\beta V_{Ed}}{z b_i}$$

A new variable (A_i) for the design value of the shear at interface is introduced, which is the area of interface. It simplifies the equation by reducing the number of terms, but it also provides another equations that is identical to equation (4.22) presented in section 4.5.

The updated version now differentiates between shear forces that act parallel and perpendicular to the interface, a distinction not explicitly considered in EC2. This differentiation, together with the dual equations provided by FprEN, allows engineers greater flexibility in selection of the most appropriate situation and formula based on their project requirements.

The FpeEN guidelines identify limitations on the spacing between the reinforcing bars crossing the interface. This will lead to change in the design method, which may require designers to update their current plans and calculations. Moreover, the revised version introduce following equation:

$$a_{s,min} = t_{min} f_{ctm} / f_{yk}$$

This equation is used to calculate the minimum interface reinforcement along edges where delamination is an issue. This provision reduces the likelihood of delamination occurring, especially in parts of the composite slab that may be likely to experience it. It is worth mentioning that this additional requirement for shear at interface as presented by FprEN, were not part of the EC2.

Lastly, the FprEN version introduces additional condition that discusses the requirement under which reinforcements is needed across the interface. When reinforcement is required across the interface to satisfy eq. (5.28) or eq. (5.29), a simplified step approach may be used. This method allows for each step to have a maximum length of $2d$ for a linear members and $3d$ for a planar members, and the design effect within these step lengths is fully covered by the reinforcement. see Figure 6.3.

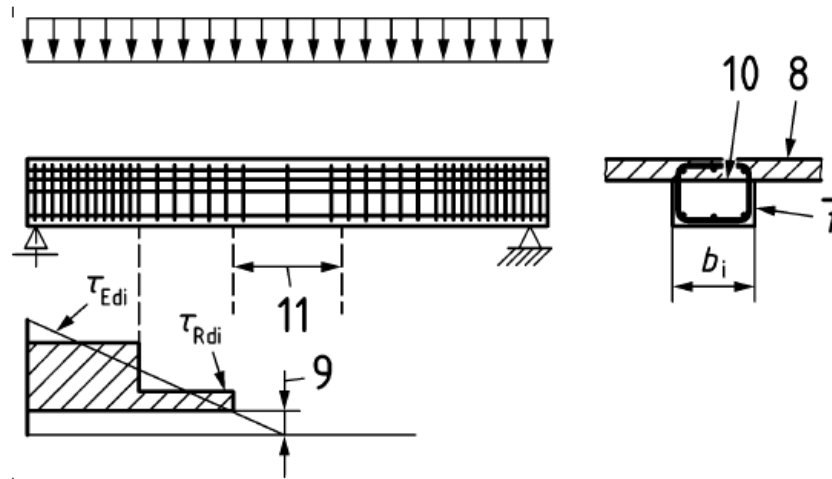

Figure 6.3: Shear diagram presenting a distributed stepped interface reinforcement: [3].

- where:
- 7 = first concrete pouring section
 - 8 = second concrete pouring section
 - 9 = interface shear resistance without interface reinforcement
 - 10 = Interface
 - 11 = Minimum shear reinforcement $A_{sw,min}$ (if needed)

Moreover, the spacing between the bares should be calculated to ensure τ_{Rdi} is greater than $\tau_{E di}$ at the central point of each steps.

The inclusion of this method makes it easier to design reinforcements at the interface of composite slabs. This approach may enhance efficiency, optimize material usage and improve the safety of the structures.

Chapter 7

Concluding Remarks

Conclusions

The transition from EC2 to the revised FprEN, highlighting key advancements and their implications for structural design. The revised FprEN introduces new coefficients and parameters, emphasizing a safety-focused, nuanced approach to the mechanical properties of concrete. These changes include considerations for high-strength concrete, long-term effects, loading conditions, and elastic modulus calculations.

The standard significantly improves shear capacity evaluation, introducing new parameters for concrete members without design shear reinforcement and enhancing guidelines for members requiring shear reinforcement. This includes detailed calculations for shear stress resistance, addressing factors like strain states, compression field inclination, and ductility classes of reinforcement.

Additionally, FprEN addresses the interaction between in-plane shear and transverse bending, offering clearer guidelines and cost-efficient solutions. It also revises the minimum shear reinforcement requirements, introducing flexibility for designers while maintaining safety and environmental considerations.

Updates in the guidelines for shear between web and flange include new specifications for transverse reinforcement and inclination angles in the compression field, reflecting an advanced understanding of structural behavior. Lastly, the standard introduces comprehensive guidelines for managing shear forces at interfaces, optimizing reinforcement efficiency, and ensuring structural integrity.

While the revisions in FprEN offer improved safety, accuracy, and adaptability, they also introduce complexity in calculations and may necessitate adjustments as construction methods progress. The revised guidelines, particularly in the design of concrete members with and without shear reinforcement, demonstrate a deeper understanding of the interaction between various forces and the impact of material properties on structural performance. However, it is crucial to recognize that these standards might require further refinement, especially as they represent a shift toward material-specific design, potentially affecting cost efficiency and environmental considerations.

Overall, the evolution from EC2 to FprEN reflects the adaptation to new insights and technological advancements. This transition offers a more flexible framework for addressing challenges in structural design, ensuring safety, efficiency, and the ongoing progression of civil engineering practices.

The transition from EC2 to FprEN, exemplifies the dynamic nature of structural engineering standards as they evolve in response to new insights and technological advancements. This evolution demonstrates EC2's ongoing commitment to adapt to emerging engineering challenges,

emphasizing a focus on modern and safety-oriented design principles. In essence, the findings from this study underscore the ongoing evolution of structural engineering standards, ensuring that they stay relevant and effective in an ever-changing landscape.

Critique and further work

This study is not without its limitations. The scope was limited to comparative shear analysis without experimental validation of the revised code's recommendations as well as without including the full breadth of concrete design challenges. In terms of method, using comparative static analysis might not completely show how concrete structures react dynamically to shear forces. Empirical studies and use of computational methods might shed some light on the new changes introduced.

Future investigations in this field could focus on empirically validating the recommendations of the revised code through experimental tests and studies of actual structures. Expanding research to include a wider range of structural elements, different concrete grades, and more varied loading conditions would be beneficial. Additionally, combining both theoretical and practical methods could provide a more robust verification of the updates to the Eurocode. Such studies would not only support the theoretical framework of shear design but also improve its practical application, ensuring more robust and optimized concrete structures.

References

- [1] CEN/TC 104. *Concrete — Specification, Performance, Production and Conformity*. Standard EN 206:2013+A2:2021. European Committee for Standardization, 2021.
- [2] CEN/TC 250 - Structural Eurocodes. *Eurocode 2: Design of concrete structures - Part 1-2: General rules - Structural fire design*. Standard EN 1992-1-2:2004. European Committee for Standardization, 2004.
- [3] CEN/TC 250 - Structural Eurocodes. *Eurocode 2: Design of concrete structures — Part 1-1: General rules and rules for buildings*. Standard EN 1992-1-1:2004. European Committee for Standardization, 2004.
- [4] CEN/TC 250 - Structural Eurocodes. *Eurocode 2: Design of concrete structures — Part 1-1: General rules and rules for buildings*. Standard EN 1992-1-1:2022. European Committee for Standardization, 2022.
- [5] CEN/TC 51. *Cement — Part 1: Composition, Specifications and Conformity Criteria for Common Cements*. Standard EN 197-1. European Committee for Standardization, 2011.
- [6] Laurin Donmik. *Understand Shear Forces [An Engineering Explanation]*. <https://www.structuralbasics.com/shear-force/>. Accessed: 2023.30.07. 2023.
- [7] Morten Fjeld Eriksen. “Verifikasjon av beregningsmetoder for skjærkapasitet av betongkonstruksjoner”. Accessed: 02.10.2023. Master’s thesis. 2018.
- [8] European Committee for Standardization (CEN). *Tilslag for betong*. Standard. 2016.
- [9] Hans Rudolf Ganz. “(7) DIBt Eurocode Conference 2023 - EN 1992 "Design of concrete structures"”. In: *Second generation of the Eurocodes: what is new?* May 24, 2023. URL: https://eurocodes.jrc.ec.europa.eu/sites/default/files/2023-06/7_EUROCODE_Conference_2023_Ganz_Eurocode_2-1.pdf (visited on 11/11/2023).
- [10] Russell C. Hibbeler. *Mechanics of Materials*. 8th ed. Boston [u.a.]: Prentice Hall, 2010. 862 pp. ISBN: 978-0136022305.
- [11] Stefan Jacobsen, ed. *Concrete technology*. Norwegian University of Science, Technology, Faculty of Engineering Science, and Technology, Department of Structural Engineering, 2016. ISBN: 82-7482-098-3.
- [12] Tony Jones. *Next Generation Eurocode 2*. Accessed: 11.10.2023. The Concrete Centre. June 2022. URL: [https://www.concretecentre.com/TCC/media/TCCMediaLibrary/News/2022/06_Concrete-Magazine_Next-Generation-Eurocode-2-\(TJ\).pdf](https://www.concretecentre.com/TCC/media/TCCMediaLibrary/News/2022/06_Concrete-Magazine_Next-Generation-Eurocode-2-(TJ).pdf).
- [13] MikeRun. *Different types of mechanical stress*. Wikimedia Commons. July 12, 2021. URL: https://commons.wikimedia.org/wiki/File:Different_types_of_mechanical_stress_EN.svg#mw-jump-to-license (visited on 11/11/2023).
- [14] Bill Mosley, John Bungey, and Ray Hulse. *Reinforced Concrete Design to Eurocode 2*. 7th ed. Printed in China. Houndmills, Basingstoke, Hampshire: Palgrave Macmillan, 2012. ISBN: 978-0-230-30285-3.
- [15] A. M. Neville. *Properties of Concrete*. 5th ed. Harlow: Pearson Education, 2012. 846 pp. ISBN: 9780273755807.

- [16] Standards Norway. *National Annex — Eurocode 2 Design of concrete structures Part 1-1: General rules and rules for buildings*. Accessed: 2023-08-25. 2021.
- [17] Jan Arve Øverli. *TKT4175 - Concrete Structures 1: Course Lectures*. Available on Blackboard, 2020.
- [18] Erik Lokreim Slapgard. “Beregningsmetoder for skjærkapasitet i betongdekker og -bjelker”. Accessed on 28.8.2023. MA thesis. 2016.
- [19] Svein Ivar Sørensen. *Betongkonstruksjoner: Beregning og dimensjonering etter Eurocode 2*. 2nd ed. Trondheim: Akademika, 2013. ISBN: 9788232102976.
- [20] Giandomenico Toniolo and Marco di Prisco. *Reinforced Concrete Design to Eurocode 2*. Springer International Publishing, 2017. DOI: [10.1007/978-3-319-52033-9](https://doi.org/10.1007/978-3-319-52033-9).

Appendix

The MATLAB codes included the data and assumptions from Example 4-1 whenever they were needed.

```
1
2 % Parameters and constants
3 b = 320; % width of the concrete section in mm
4 h = 412; % height of the concrete section in mm
5 d = 364; % effective depth of the concrete section in mm
6 C = 0.12;
7 k = 1.741; % factor
8 k1 = 0.15; % factor
9 N_Ed = 400e3; % axial force in N (400 kN)
10 A_c = b * h; % concrete cross-section area in mm^2
11
12 % Define the ranges for rho_l and f_ck
13 rho_l_range = linspace(0, 0.02, 100);
14 f_ck_range = [30, 35, 80, 90]; % Concrete strengths in MPa
15
16 V_Rd_c = zeros(length(f_ck_range), length(rho_l_range));
17 V_Rdc_min = zeros(length(f_ck_range), length(rho_l_range));
18
19 % Calculate shear capacity V_Rd_c for each combination of f_ck and rho_l
20 for i = 1:length(f_ck_range)
21     f_ck = f_ck_range(i);
22     V_Rdc_min(i, :) = (0.035 * k^(3/2) * f_ck^(1/2) + k1 * (N_Ed / A_c)) * b * d;
23     % Calculate V_Rdc_min
24     for j = 1:length(rho_l_range)
25         rho_l = rho_l_range(j);
26         V_Rd_c_temp = (C * k * (100 * rho_l * f_ck)^(1/3) + k1 * (N_Ed / A_c)) * b
27         * d;
28         V_Rd_c(i, j) = max(V_Rd_c_temp, V_Rdc_min(i, j)); % Apply the condition
29     end
30 end
31
32 % Convert the results from MPa*mm^2 to kN for plotting
33 V_Rd_c = V_Rd_c / 1e3;
34
35 % Plot the results
36 disp('Generating figure...');
37 figure; % Create a new figure window
38 hold on;
39 colors = lines(length(f_ck_range));
40 for i = 1:length(f_ck_range)
41     plot(rho_l_range, V_Rd_c(i, :), 'LineWidth', 2, 'Color', colors(i, :));
42     disp(['Plotting line for f_ck = ', num2str(f_ck_range(i)), ' MPa']);
43 end
44 hold off;
45
46 xlabel('\rho_l');
47 ylabel('V_{Rd,c} (kN)');
48
49 % Legend
50 legend(strcat('f_{ck} = ', string(f_ck_range), ' MPa'), 'Location', 'northwest');
51
52 % Add grid
53 grid on;
54 disp('Figure should now be visible...');
```

Listing 7.1: Matlab code for generating Figure 4.2

```

1
2 fywd = 435; % MPa
3 bw = 320; % mm
4 d = 364; % mm
5 z = 0.9 * d; % mm
6 fyk = 500; % MPa
7
8 % Define f_ck values for both cases
9 f_ck1 = 35; % MPa
10 f_ck2 = 70; % MPa
11
12 % cot(theta) range
13 cot_theta = linspace(1, 2.5, 100);
14
15 % Initialize matrices for V_Rd,s and V_Rd,max for both cases
16 V_Rd_s1 = zeros(size(cot_theta));
17 V_Rd_max1 = zeros(size(cot_theta));
18 V_Rd_s2 = zeros(size(cot_theta));
19 V_Rd_max2 = zeros(size(cot_theta));
20 V_Rd_max3 = zeros(size(cot_theta));
21
22 % Calculate v1 for both cases
23 v1_1 = 0.6; % For f_ck1 <= 60 MPa, assuming the design stress of shear
      reinforcement is less than 80% of fyk
24 v1_2 = 0.9 - f_ck2/200; % For f_ck2 >= 60 MPa, assuming the design stress of shear
      reinforcement is less than 80% of fyk
25 if v1_2 <= 0.5
26     v1_2 = 0.501;
27 end
28
29 % Calculate v1 for the additional assumption
30 v1_3 = 0.6*(1 - f_ck1/250); % Assuming the design stress of shear reinforcement
      exceeds 80% of fyk, according to EC2
31
32 % Calculate f_cd and Asw_per_s for both cases
33 f_cd1 = 0.85 * f_ck1 / 1.5; % MPa
34 f_cd2 = 0.85 * f_ck2 / 1.5; % MPa
35 Asw_per_s1 = 0.1 * sqrt(f_ck1) * bw / fyk; % mm
36 Asw_per_s2 = 0.1 * sqrt(f_ck2) * bw / fyk; % mm
37 %Asw_per_s3 = 0.1 * sqrt(f_ck1) * bw / fyk; % mm
38
39 % Calculate V_Rd,s and V_Rd,max for both cases (in kN)
40 V_Rd_s1 = Asw_per_s1 * z * fywd .* cot_theta / 1000; % Convert to kN
41 V_Rd_max1 = bw * z * v1_1 * f_cd1 ./ (cot_theta + 1./cot_theta) / 1000; % Convert
      to kN
42 V_Rd_s2 = Asw_per_s2 * z * fywd .* cot_theta / 1000; % Convert to kN
43 V_Rd_max2 = bw * z * v1_2 * f_cd2 ./ (cot_theta + 1./cot_theta) / 1000; % Convert
      to kN
44 %V_Rd_s3 = Asw_per_s2 * z * fywd .* cot_theta / 1000; % Convert to kN
45 V_Rd_max3 = bw * z * v1_3 * f_cd1 ./ (cot_theta + 1./cot_theta) / 1000; % Convert
      to kN
46
47 % Plotting
48 figure;
49 hold on;
50 plot(cot_theta, V_Rd_s1, 'r', 'DisplayName', sprintf('V_Rd,s, f_ck = %d MPa',
      f_ck1));
51 plot(cot_theta, V_Rd_max1, 'b', 'DisplayName', sprintf('V_Rd,max, f_ck = %d MPa,
      v1 = %.1f, assuming design stress of shear reinforcement < 80% of f_yk',
      f_ck1, v1_1));
52 plot(cot_theta, V_Rd_s2, 'g', 'DisplayName', sprintf('V_Rd,s, f_ck = %d MPa',
      f_ck2));

```

```

53 plot(cot_theta, V_Rd_max2, 'c', 'DisplayName', sprintf('V_Rd,max, f_ck = %d MPa,
    v1 = %.3f, assuming design stress of shear reinforcement < 80%% of f_yk',
    f_ck2, v1_2));
54 plot(cot_theta, V_Rd_max3, '--m', 'DisplayName', sprintf('V_Rd,max, f_ck = %d MPa,
    v1 = %.3f, assuming design stress of shear reinforcement > 80%% of f_yk',
    f_ck1, v1_3));
55 xlabel('cot(\theta)');
56 ylabel('V_Rd (kN)');
57 %title('V_Rd,s and V_Rd,max as Functions of cot(\theta) in kN for Different
    Assumptions');
58 legend('show');
59 grid on;

```

Listing 7.2: Matlab code for generating Figure 4.4

```

1 >> % Shear at interface according to EC2
2 % Constants and assumptions
3 c = 0.45; % Coefficient for rough surface
4 mu = 0.7; % Friction coefficient for rough surface
5 rho = 0.01; % Based on assumption
6 f_ck = 35; % Concrete compressive strength in MPa
7 f_cd = 0.85 * f_ck / 1.5; % Design concrete compressive strength in MPa
8 f_ctk_005 = 2.2; % Tensile strength of concrete in MPa
9 f_yk = 500; % Yield strength of steel in MPa
10 f_yd = f_yk / 1.15; % Design yield strength of steel in MPa
11 f_ctd = 0.85 * f_ctk_005 / 1.5; % Design tensile strength of concrete in MPa
12 v = 0.6 * (1 - f_ck / 250); % Reduction factor for shear capacity
13 V_Rd_max = 0.5 * v * f_cd; % Maximum shear resistance value
14
15 % Angles in degrees
16 alpha_degrees = [45, 60, 90];
17
18 % Range of sigma_n values from 0 to 0.6*f_cd
19 sigma_n_values = linspace(0, 0.6 * f_cd, 100);
20
21 % Calculations and plotting
22 figure;
23 hold on;
24
25 % Plot V_Rd,max line
26 plot(sigma_n_values, V_Rd_max * ones(size(sigma_n_values)), 'k--', 'LineWidth', 2,
    'DisplayName', 'V_{Rd, max}');
27
28 % Loop through each alpha value
29 for j = 1:length(alpha_degrees)
30     alpha_degree = alpha_degrees(j);
31     alpha_radian = deg2rad(alpha_degree); % Convert degrees to radians
32
33     % Calculating the design shear resistance for each alpha
34     V_Rdi = zeros(1, length(sigma_n_values));
35     for i = 1:length(sigma_n_values)
36         sigma_n = sigma_n_values(i);
37         V_Rdi(i) = c * f_ctd + mu * sigma_n + rho * f_yd * (mu * sin(alpha_radian)
            + cos(alpha_radian));
38     end
39
40     % Plotting the graph for each angle
41     plot(sigma_n_values, V_Rdi, 'LineWidth', 2, 'DisplayName', ['\alpha = ',
        num2str(alpha_degree), '\circ']);
42 end
43
44 % Add labels, title, and legend
45 xlabel('\sigma_n (MPa)');

```

```

46 ylabel('V_{Rdi} (MPa)');
47 %title('Design Shear Resistance at Interface for Different Angles');
48 legend('show');
49
50 % Increase the font size of the legend
51 lgd = legend;
52 set(lgd, 'FontSize', 12); % You can adjust the font size as needed
53
54 grid on;
55 hold off;

```

Listing 7.3: Matlab code for generating Figure 4.10

```

1 % Define constants common to both approaches
2 f_ck = 35; % MPa
3 bw = 320; % mm
4 d = 364; % mm
5 z = 0.9 * d; % mm
6 fyk = 500; % MPa
7 f_ywd = 500 / 1.15; % MPa
8 cot_theta = linspace(1, 3, 100);
9
10 % Calculate f_cd
11 f_cd = 0.85 * f_ck / 1.5; % MPa
12
13 % Approach 1: Using constant v1 = 0.5
14 v1_const = 0.5;
15 Asw_per_s_const = 0.1 * sqrt(f_ck) * bw / fyk; % mm^2
16 tau_Rd_sy_const = Asw_per_s_const / bw * f_ywd .* cot_theta; % MPa
17 tau_Rd_max_const = v1_const * f_cd / 2; % MPa
18
19 % Approach 2: Calculating v1 based on strain
20 M_Ed = 177.6e6; % Nmm
21 V_Ed = 88.8e3; % N
22 A_st = 1473; % mm*mm
23 E_s = 2e5; % MPa
24 E_cm = 22 * ((f_ck + 8) / 10)^0.3 * 1e3; % MPa
25 A_cc = M_Ed / (z * f_cd); % mm*mm
26 N_Ed = 400e3; % N (example value)
27 N_vd = abs(V_Ed) .* cot_theta; % N
28 F_td = M_Ed / z + (N_vd + N_Ed) / 2; % N
29 F_cd = M_Ed / z - (N_vd + N_Ed) / 2; % N
30 epsilon_xt = F_td / (A_st * E_s);
31 epsilon_xc = -F_cd / (A_cc * E_cm);
32 epsilon_x = (epsilon_xt + epsilon_xc) / 2;
33 v1_strain = 1 ./ (1.0 + 110 .* (epsilon_x + (epsilon_x + 0.001)) .* cot_theta.^2);
34 v1_strain(v1_strain < 0.5) = 0.501;
35 v1_strain(v1_strain > 1.0) = 1.0;
36 Asw_per_s_strain = 0.1 * sqrt(f_ck) * bw / fyk; % mm^2
37 %tau_Rd_sy_strain = Asw_per_s_strain / bw * f_ywd .* cot_theta; % MPa
38 tau_Rd_max_strain = v1_strain .* f_cd / 2; % MPa
39
40 % Plotting
41 figure;
42 hold on;
43
44 % Plot curves for constant v1 approach
45 plot(cot_theta, tau_Rd_sy_const, '-b', 'DisplayName', sprintf('\tau_{\mathrm{Rd}}
, sy}}, f_{\mathrm{ck}} = %d MPa$', f_ck));
46 plot(cot_theta, repmat(tau_Rd_max_const, length(cot_theta), 1), '--b', '
DisplayName', sprintf('\tau_{\mathrm{Rd,max}}, v = 0.5, f_{\mathrm{ck}} =
%d MPa$', f_ck));
47

```

```

48 % Plot curves for strain-based v1 approach
49 %plot(cot_theta, tau_Rd_sy_strain, '-r', 'DisplayName', sprintf('\tau_{\mathrm{
Rd,sy}} (strain-based, f_{\mathrm{ck}} = %d MPa)', f_ck));
50 plot(cot_theta, tau_Rd_max_strain, '--r', 'DisplayName', sprintf('\tau_{\mathrm
{Rd,max}}$, v-factor strain-based, $f_{\mathrm{ck}} = %d$ MPa', f_ck));
51
52
53
54 xlabel('\mathrm{cot}(\theta)', 'Interpreter', 'latex');
55 ylabel('\tau_{\mathrm{Rd}}$ and $\tau_{\mathrm{Rd,max}}$ (MPa)', 'Interpreter', '
latex');
56 legend('show', 'Interpreter', 'latex');
57 grid on;

```

Listing 7.4: Matlab code for generating Figure 5.4

```

1 % Parameters for the calculation
2 gamma_v = 1.4; % Partial safety factor for shear
3 f_yd = 435; % Design yield strength in MPa.
4 d = 364; % Effective depth in mm
5 b = 320; % Width of the concrete section in mm
6
7 % Define the range for rho_l values for f_ck
8 rho_l_range = linspace(0, 0.02, 100);
9 f_ck_range = [30, 35, 80, 90];
10
11 % Using the matrix to hold the values of V_Rd_c
12 v_Rd_c = zeros(length(f_ck_range), length(rho_l_range));
13 legend_info = strings(1, length(f_ck_range));
14
15 % Calculate V_Rd_c for each f_ck and rho_l, applying the minimum condition
16 for i = 1:length(f_ck_range)
17 f_ck = f_ck_range(i);
18 % Update d_g according to f_ck value
19 if f_ck > 60
20 d_dg = 16 + 16 * (60 / f_ck)^2;
21 d_dg = min(d_dg, 40); % Ensure that d_dg does not exceed 40 mm
22 else
23 d_dg = 32; % Original value if f_ck is 60 or less
24 end
25
26 % Calculate V_Rdc_min for the given f_ck and d_dg
27 v_Rdc_min = (11 / gamma_v) * sqrt((f_ck * d_dg) / (f_yd * d))*b*d;
28
29 % Store the legend information with three decimal places for d_dg
30 legend_info(i) = sprintf('f_{ck} = %d MPa, d_g = %.3f mm', f_ck, d_dg);
31
32 for j = 1:length(rho_l_range)
33 rho_l = rho_l_range(j);
34 v_Rd_c_value = (0.66 / gamma_v) * (100 * rho_l * f_ck * (d_dg / (d*0.727))
)^{(1/3)} * b * d;
35 % Apply the minimum condition
36 v_Rd_c(i, j) = max(v_Rd_c_value, v_Rdc_min);
37 end
38 end
39
40 % Convert the result to kN for plotting
41 v_Rd_c = v_Rd_c / 1e3;
42
43 % Plotting
44 figure;
45 hold on; % Hold on to plot multiple lines

```



```

46 colors = lines(length(f_ck_range)); % Colormap to distinguish different f_ck
    values
47
48 for i = 1:length(f_ck_range)
49     plot(rho_l_range, v_Rd_c(i, :), 'LineWidth', 2, 'Color', colors(i, :));
50 end
51
52 % Aesthetics
53 xlabel('\rho_l');
54 ylabel('v_{Rd,c} [kN]');
55 legend(legend_info, 'Location', 'northwest'); % Use the legend information with
    formatted d_dg values
56
57 grid on;
58 hold off;

```

Listing 7.5: Matlab code for generating Figure 5.3

```

1 % Constants and assumptions common to both codes:
2 f_ck = 35; % Concrete compressive strength in MPa
3 gamma_c = 1.5;
4 f_cd = 0.85 * f_ck / gamma_c; % Design concrete compressive strength in MPa
5 f_yk = 500; % Yield strength of steel in MPa
6 f_yd = f_yk / 1.15; % Design yield strength of steel in MPa
7 rho_i = 0.01;
8
9 % Constants specific to the first code:
10 cv1 = 0.15; % Coefficient for rough surface (first code)
11 mu_v = 0.7; % Friction coefficient for rough surface (first code)
12 alpha_degrees = [35, 90, 135]; % Angles in degrees
13
14 % Constants specific to the second code:
15 cv2 = 0.08; % Coefficient for rough surface (second code)
16 mu_v2 = 0.7; % Friction coefficient for rough surface (second code)
17 k_v = 0.5; % Coefficient for shear contribution of concrete
18 k_dowel = 0.9; % Dowel action coefficient
19
20 % Range of sigma_n values from 0 to 0.6*f_cd
21 sigma_n_values = linspace(0, 0.6 * f_cd, 100);
22
23 % Plotting setup
24 figure;
25 hold on;
26
27 % Colors for different curves
28 colors = ['r', 'g', 'b', 'm']; % Red, Green, Blue, Magenta
29
30 % Plotting for the first code:
31 for j = 1:length(alpha_degrees)
32     alpha_degree = alpha_degrees(j);
33     alpha_radian = deg2rad(alpha_degree); % Convert degrees to radians
34
35     % Calculate and plot tau_Rd,max line for each angle (first code)
36     tau_Rd_max = 0.3 * f_cd + rho_i * f_yd * cos(alpha_radian);
37     plot(sigma_n_values, tau_Rd_max * ones(size(sigma_n_values)), 'LineStyle', '--',
38         'Color', colors(j), 'LineWidth', 2, 'DisplayName', ['\tau_{Rd, max} (\alpha = ',
39         num2str(alpha_degree), '^\circ) - no reinforcement across the interface'
40         ]);
41
42     % Calculating and plotting tau_Rdi for each angle (first code)
43     tau_Rdi = cv1 * sqrt(f_ck) / gamma_c + mu_v * sigma_n_values + rho_i * f_yd *
44         (mu_v * sin(alpha_radian) + cos(alpha_radian));

```

```

41     plot(sigma_n_values, tau_Rdi, 'Color', colors(j), 'LineWidth', 2, 'DisplayName',
42         ['\tau_{Rdi} (\alpha = ', num2str(alpha_degree), '^\circ) - no
43         reinforcement across the interface']);
44 end
45 % Plotting for the second code:
46 tau_Rd_max_2 = 0.25 * f_cd;
47 plot(sigma_n_values, tau_Rd_max_2 * ones(size(sigma_n_values)), 'k--', 'LineWidth',
48     2, 'DisplayName', '\tau_{Rd, max} - yielding of the reinforcement is not
49     ensured');
50 % Calculating and plotting tau_Rdi (second code)
51 tau_Rdi_2 = cv2 * sqrt(f_ck) / gamma_c + mu_v2 * sigma_n_values + k_v * rho_i *
52     f_yd * mu_v2 + k_dowel * rho_i * sqrt(f_yd * f_cd);
53 plot(sigma_n_values, tau_Rdi_2, 'k', 'LineWidth', 2, 'DisplayName', '\tau_{Rdi} -
54     yielding of the reinforcement is not ensured');
55 % Add labels, title, and legend
56 xlabel('\sigma_n (MPa)');
57 ylabel('Design Shear Resistance (MPa)');
58 %title('Combined Design Shear Resistance at Interface');
59 % Create legend and increase the font size
60 lgd = legend;
61 set(lgd, 'FontSize', 12);
62 grid on;
63 hold off;

```

Listing 7.6: Matlab code for generating Figure 5.6

```

1
2 % Parameters and constants for EC2 calculation
3 b = 320; % width of the concrete section in mm
4 h = 412; % height of the concrete section in mm
5 d = 364; % effective depth in mm
6 C = 0.12;
7 k = 1.741; % factor for EC2
8 k1 = 0.15; % additional factor for EC2
9 N_Ed = 400e3; % axial force in N (400 kN)
10 A_c = b * h; % concrete cross-section area in mm^2
11
12 % Parameters for FprEN calculation
13 gamma_v = 1.4; % Partial safety factor for shear for FprEN
14 f_yd = 435; % Design yield strength in MPa for FprEN
15
16 % Define the ranges for rho_l and f_ck
17 rho_l_range = linspace(0, 0.02, 100);
18 f_ck_range = [30, 35, 80, 90]; % Concrete strengths in MPa
19
20 % matrices to hold the V_Rd_c values for EC2 and FprEN
21 V_Rd_c_EC2 = zeros(length(f_ck_range), length(rho_l_range));
22 V_Rd_c_FprEN = zeros(length(f_ck_range), length(rho_l_range));
23 legendInfoEC2 = cell(1, length(f_ck_range));
24 legendInfoFprEN = cell(1, length(f_ck_range));
25
26 % Calculate shear capacity V_Rd_c for EC2
27 for i = 1:length(f_ck_range)
28     f_ck = f_ck_range(i);
29     V_Rdc_min_EC2 = (0.035 * k^(3/2) * f_ck^(1/2) + k1 * (N_Ed / A_c)) * b * d;
30     for j = 1:length(rho_l_range)
31         rho_l = rho_l_range(j);

```

```

32     V_Rd_c_temp = (C * k * (100 * rho_l * f_ck)^(1/3) + k1 * (N_Ed / A_c)) * b
    * d;
33     V_Rd_c_EC2(i, j) = max(V_Rd_c_temp, V_Rdc_min_EC2);
34     end
35     legendInfoEC2{i} = sprintf('EC2: f_{ck} = %d MPa', f_ck);
36 end
37
38 % Calculate shear capacity V_Rd_c for FprEN
39 for i = 1:length(f_ck_range)
40     f_ck = f_ck_range(i);
41     % Update d_g according to f_ck value for FprEN
42     if f_ck > 60
43         d_dg = 16 + 16 * (60 / f_ck)^2;
44         d_dg = min(d_dg, 40); % Ensure that d_g does not exceed 40 mm
45     else
46         d_dg = 32; % Original value if f_ck is 60 or less
47     end
48
49     V_Rdc_min_FprEN = (11 / gamma_v) * sqrt((f_ck * d_dg) / (f_yd * d)) * b * d;
50
51     for j = 1:length(rho_l_range)
52         rho_l = rho_l_range(j);
53         V_Rd_c_value = (0.66 / gamma_v) * (100 * rho_l * f_ck * (d_dg / (d*0.727))
    )^(1/3) * b * d;
54         V_Rd_c_FprEN(i, j) = max(V_Rd_c_value, V_Rdc_min_FprEN);
55     end
56     legendInfoFprEN{i} = sprintf('FprEN: f_{ck} = %d MPa, d_g = %.3f mm', f_ck,
    d_dg);
57 end
58
59 % Convert the results from MPa*mm^2 to kN for plotting
60 V_Rd_c_EC2 = V_Rd_c_EC2 / 1e3;
61 V_Rd_c_FprEN = V_Rd_c_FprEN / 1e3;
62
63 % Plotting
64 figure;
65 hold on;
66 colors = lines(length(f_ck_range));
67
68 % Plotting EC2 results
69 for i = 1:length(f_ck_range)
70     plot(rho_l_range, V_Rd_c_EC2(i, :), 'LineWidth', 2, 'Color', colors(i, :));
71 end
72
73 % Plotting FprEN results
74 for i = 1:length(f_ck_range)
75     f_ck = f_ck_range(i);
76     % Recalculate d_g for the legend info
77     if f_ck > 60
78         d_dg = 16 + 16 * (60 / f_ck)^2;
79         d_dg = min(d_dg, 40);
80     else
81         d_dg = 32;
82     end
83     plot(rho_l_range, V_Rd_c_FprEN(i, :), 'LineWidth', 2, 'LineStyle', '--', '
    Color', colors(i, :));
84 end
85
86 % Add legends
87 legend([legendInfoEC2, legendInfoFprEN], 'Location', 'northwest');
88
89 xlabel('\rho_l');

```

```

90 ylabel('V_{Rd,c} [kN]');
91 %title('Comparison of Shear Capacity V_{Rd,c} according to EC2 and FprEN');
92 grid on;
93 hold off;

```

Listing 7.7: Matlab code for generating Figure 6.1

```

1 % MATLAB Script to Create a Bar Graph for Minimum Shear Reinforcement
  Comparison
2
3 % Data
4 reinforcement_types = {'EC2', 'FprEN - Class B', 'FprEN - Class C'};
5 min_shear_reinforcement = [1.0, 0.9, 0.8]; % Example values, replace with actual
  data
6
7 % Multiply the reinforcement ratios by 100 to convert to percentages
8 min_shear_reinforcement_percent = min_shear_reinforcement * 100;
9
10 % Create the bar graph
11 figure;
12 bar(min_shear_reinforcement_percent);
13
14 % Set the x-axis labels to the reinforcement types
15 set(gca, 'xticklabel', reinforcement_types);
16
17 % Adding titles and labels
18 %title('Minimum Shear Reinforcement Comparison: EC2 vs FprEN');
19 ylabel('Minimum Shear Reinforcement Ratio (%)');
20 xlabel('Standard / Ductility Class');
21
22 % Display the graph
23 grid on;
24
25 >>

```

Listing 7.8: Matlab code for generating Figure 6.2



 **NTNU**

Norwegian University of
Science and Technology