

Analysis of gray Box Modelling of Transformers^{☆☆☆}

Hans Kr. Høidalen^{a,*}, Angelica C.O. Rocha^b

^a Norwegian University of Science and Technology (NTNU), O. S. Bragstadspl. 2F, N7491-Trondheim, Norway

^b ATG Egenharia, Brazil

ARTICLE INFO

Keywords:

Transformers
Capacitance
Scaling factors
Gray-box
Black-box
TRV

ABSTRACT

Calculation of power system transients involving transformers require models that incorporate capacitive behavior. The paper outlines how classical low-frequency transformer models can be extended with capacitances and how to fit the parameters based on typical values, test report and frequency response measurements. Justified tuning factors are proposed. The responses of the models are compared to measurements in frequency domain, and with detailed black-box models in studies of transient recovery voltage and lightning. The models show reasonable agreement including the first resonance point, but with too low damping without proper adjustments.

1. Introduction

TRANSIENT overvoltages are one of the root causes for transformer dielectric failures [1]. CIGRE JWG A2/C4.39 "Electrical transient interaction between transformers and the power system" [2, 3] gave an overview of transient phenomena that can lead to insulation failures, such as steep-fronted waves and resonant voltage build-up. To perform transient simulations, transformer models with capacitance effects must be established. Such models can range from simple capacitance models, via classical low-frequency models with added terminal capacitances, to black-box models fitted to frequency response measurements or white-box models based on design parameters.

Gray-box transformer models are a compromise between white-box models made from design and black-box models made from measurements. The main idea is to establish a topological transformer model based on limited design-information and then tune its parameters to fit its response to (high frequency) terminal measurements. In literature, gray-box transformer models are mostly defined as RLCG ladder networks [4-7]. However, in this paper we analyze the class of gray-box models consisting of simpler engineering models extended with capacitance and damping. The aim is to discuss the impact of the available data on the transient response. Modeling guidelines can also be found in [8, 9].

This paper first outlines some simple transformer models, then presents scaling of capacitance and losses, details a specific model based on

measurements and typical values, and finally performs an analysis of transient recovery voltage and lightning compared to a black-box model.

2. Transformer modeling

Gray-box modeling of transformers is based on topological models fitted to measurements. This can both be simple lumped parameter model and sophisticated ladder network. In this paper the focus is on the simple, engineering models. Besides being based on limited and typically available data, these are (with exception of M2) also applicable for low-frequencies transients and are easily initialized.

2.1. Model topology

Figs. 1-4 show the four models analyzed in this paper.

2.2. Analysis of resonance frequency

The transformer model in Fig. 2(M3) will have resonance frequencies that can be determined analytically. Referred to the HV side, the first short circuit resonance frequency, as illustrated in Fig. 5, of the M3 model in Fig. 2 is:

$$f_{0,sc} = \frac{1}{2\pi\sqrt{L \cdot C}} \quad (1)$$

^{☆☆} The paper is based on the CIGRE WG A2/C4.52: Transformer and Reactor Models for Network Studies. ^{☆☆} Paper submitted to the International Conference on Power Systems Transients (IPST2021) in Belo Horizonte, Brazil June 6–10, 2021.

* Corresponding author.

E-mail address: hans.hoidalen@ntnu.no (H.Kr. Høidalen).

<https://doi.org/10.1016/j.epsr.2021.107266>

Received 27 November 2020; Received in revised form 17 March 2021; Accepted 8 April 2021

Available online 30 April 2021

0378-7796/© 2021 The Authors. Published by Elsevier B.V. This is an open access article under the CC BY license (<http://creativecommons.org/licenses/by/4.0/>).

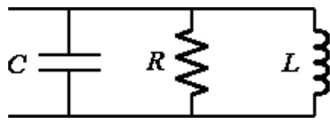

Fig. 1. M2- Artificial RLC-equivalent.

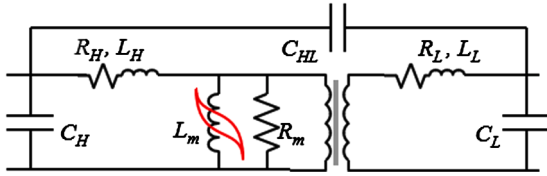

Fig. 2. M3- Simple LF-equivalent with concentrated shunt capacitances.

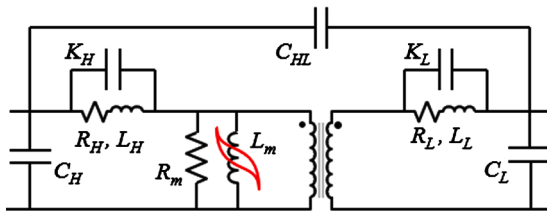

Fig. 3. M4- Simple LF-equivalent with concentrated shunt and series capacitances.

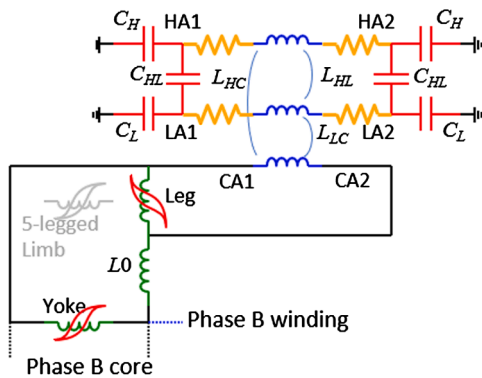

Fig. 4. M5- Three-phase model with capacitances concentrated on each side of the winding, shown for phase A.

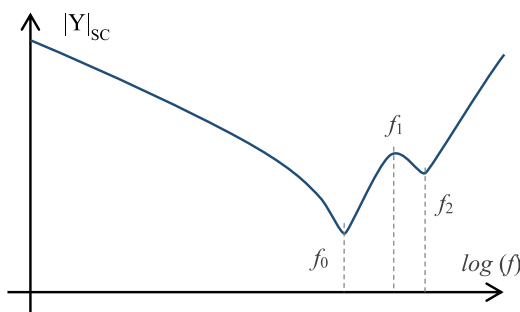

Fig. 5. Typical short circuit admittances and corresponding resonance frequencies.

with $L = L_H + n^2 \cdot L_L$ is the equivalent short circuit inductance and $C = C_H + C_{HL}$.

The transformer model in Fig. 3(M4) has a series capacitor

equivalent, and the short circuit resonance frequencies can also here be approximately determined analytically. If we ignore the contribution from the shorted secondary, we get:

$$f_{0\&2,M4} \approx \frac{1}{2\pi} \sqrt{\frac{2C + K_H \pm \sqrt{4C^2 + K_H^2}}{L \cdot C \cdot K_H}} \tag{2}$$

$$f_{1,M4} \approx \frac{1}{\pi \cdot \sqrt{L \cdot K_H}}$$

Based on this, the series capacitance can be estimated by utilizing the first maximum f_1 .

Estimation of series impedance based on frequency response measurements is discussed in [10, 11]. The authors fit a ladder network model the measurements on simple transformer windings with special focus on series capacitance.

3. Transformer model parameters

Gray-box transformer parameters can come from various sources categorized in typical values, test report and frequency response measurements. Some of these sources applies at power frequency others at very high frequency. Typical capacitance values found in textbook tables are usually high frequency values, while test report capacitances are given by low frequency measurements. Losses and short-circuit reactances are standardly given at power frequency. Consequently, it is necessary with a significant calibration of capacitance and losses in particular.

3.1. Capacitive scaling factors

The capacitances are measured at a low frequency and will contain the shunt elements only. At higher frequencies, the series capacitances become more important. The capacitance scaling factor K_S is defined as the ratio between the capacitance estimated from the first resonance frequency f_0 and the measured capacitance C_m .

$$K_S = \frac{1}{(2\pi f_0)^2 \cdot L \cdot C_m} \tag{3}$$

Horton et.al [12] suggest a scaling factor in the range of 0.3 to 0.8 with a first guess of 0.4 and state that this is well accepted. The value of the scaling factor will depend on the winding design influencing the series capacitances not measured in the standard tests.

With distributed capacitances and inductance shown in Fig. 6 the input admittance of a winding with grounded neutral becomes as shown in (4).

$$Y_{in} = \frac{\sqrt{y/z}}{\tanh(\sqrt{z \cdot y} \cdot l)} \tag{4}$$

with $y = j\omega C$ being the shunt element, $z = j\omega L / (1 - \omega^2 LK)$ the series element and l the length of the winding and ignoring all damping. This gives the first resonance (minimum) at

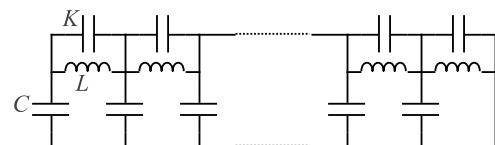

C -shunt capacitance [F/m]
 K -series capacitance [F·m]
 L -series inductance [H/m]

Fig. 6. Uniform single winding equivalent with distributed parameters.

$$\omega_0 = \frac{1}{\sqrt{L \cdot l \cdot (C \cdot l \cdot 4 / \pi^2 + K / l)}} \quad (5)$$

and a second minimum at

$$\omega_1 = \frac{1}{\sqrt{L \cdot l \cdot (C \cdot l \cdot 4 / (3\pi)^2 + K / l)}} \quad (6)$$

Requiring the same resonance frequency for a lumped circuit of a parallel inductor $L \bullet l$ and capacitor C_{eq} (model M2-M5) gives

$$C_{eq} = C \cdot l \cdot 4 / \pi^2 + K / l \approx C_{tot} \cdot 0.4 + K_{tot} \quad (7)$$

Cases with ignorable series capacitance K would give a scaling factor of $K_{S,K=0} = 4 / \pi^2 \approx 0.4$.

The second resonance frequency depends to a larger extent on the series capacitance. Requiring the same resonance frequency for a lumped circuit of a parallel inductor $L \bullet l$ and capacitor C_{eq} gives

$$C_{eq} = C \cdot l \cdot 4 / (3\pi)^2 + K / l \approx C_{tot} \cdot 0.045 + K_{tot} \quad (8)$$

The equivalent capacitance at very large frequencies:

$$C_{eq} = \lim_{\omega \rightarrow \infty} \frac{Y_{in}}{j\omega} = \frac{\sqrt{y/z}}{\tanh(\sqrt{z \cdot y} \cdot l) \cdot j\omega} = \frac{\sqrt{C \cdot K}}{\tanh(\sqrt{C/K} \cdot l)} \quad (9)$$

which is close to $C_{eq} \approx \sqrt{C \cdot K}$ in practical cases as in agreement with [13]. This capacitance should be chosen for a pure capacitance model.

Furthermore, 3-phase considerations must also be made to handle various winding connections. A first approach is to concentrate capacitances on each side of the winding as shown in Fig. 4. In [14] the capacitance location is analyzed and a method of calculating equivalent capacitances taking turn-ratio and phase-shift into considerations is proposed. The general idea is that the voltage distribution is not uniform but varies linearly along the winding, making the equal split approach inaccurate. Based on this, only 1/3 of the capacitance should be connected to the Y-side terminal. This is in agreement with [13]. The scaling for winding connection is called K_Y .

3.2. Damping factor

The winding and core loss resistances are typically given at power frequency but will generally increase with frequency to a considerable higher value at resonance. To obtain a model suitable for TRV studies this must be taken into account.

For the RLC model M2, the inductance is the short-circuit leakage value and the capacitance could come from measurements or typical values presented in textbooks. The resistance can be calculated by (10), considering a damping factor, DF in the range of 0.6–0.8 [15].

$$R = \frac{1}{2} \frac{\pi \sqrt{L/C}}{\ln(DF)} \quad (10)$$

4. Test object

This section compares measured frequency response of the test transformers T1 with the response of the transformer models M2-M5. The transformer models are based on test report data, typical values, and frequency response measurements. The comparison is somewhat complicated by the fact that the measured frequency responses were performed without oil and bushings, while test-report and typical values are always given with oil and bushings included.

4.1. Test report

The test reports for the two test transformers are shown in Tables 1 and 2.

Table 1

Test report for the 3-phase transformer, T1.

T1: 115/34.5/13.8 kV	YNyn0d	55 MVA (ONAN)
Open circuit @34.5 kV & 55 MVA	I_0 [%] 0.058	P_0 [kW] 30.362
Short circuit; winding seq. SPT	Z_{sc} [%]	P_{sc} [kW]
P-S @ 55 MVA	7.60	101.283
P-T @ 11 MVA	3.66	16.109
S-T @ 11 MVA	5.52	17.166
Capacitance (per phase)	C_s [nF] (winding to ground)	C_m [nF] (winding to winding)
P, S, T P-S, P-T, S-T	1.267, 1.033, 4.841	8.650, 3.337, 0.097

Table 2

Typical values for test transformers T1.

Quantity, M2-M5	T1: 115/34.5/13.8 kV, 55 MVA
Leakage, L [%→mH]	8.5% → 54.2 mH@115 kV
Winding resistance, R [%→Ω]	0.35% → 2.23 mΩ@115 kV
Capacitance C_p, C_s, C_T [nF]	0.75, 0.5, 1.5
Capacitance C_{ps}, C_{pt}, C_{st} [nF]	0.75, 0.5, 0.0
Series capacitance K_H [nF]	1.0
Damping (10), $DF=0.7$, $C=C_P+C_{PS}$	26.5 [kΩ]
Magnetization current→inductance	0.65% → 170 H @115 kV
Core loss resistance	764 kΩ @115 kV

The capacitance given in the test report are measured with floating terminals at low frequency and will only capture the shunt elements. The capacitance must thus be scaled by factors K_S and K_Y , with $K_S = 0.4$ and $K_Y = 0.5$ used in this paper.

4.2. Typical values

The typical quantities assumed for the two transformers are shown in Table 2. Values are obtained from [13, 16-18].

For typical capacitances in this 3-winding transformer, there is insufficient information to determine all quantities. From the test report it is seen that for T1 the winding sequence is S-P-T (tertiary is the outer winding) and for T2 the winding sequence is T-S-P (tertiary is the inner winding). Outer windings will have larger capacitance and capacitance between outer and inner will be small. It is further assumed a capacitive coupling factor of 0.5 which means that the mutual capacitance is similar to the capacitance to ground. Typical series capacitance is not available so a guess of a value in the same range as the shunt capacitance is assumed.

4.3. Frequency response measurements

The admittance matrix is measured in the frequency domain from 50 Hz to 10 MHz. The short circuit admittance is taken as the $Y_{sc}(\omega) = Y(1, 1)$ element directly, while the open circuit admittance is calculated as $Y_{oc}(\omega) = Y(1, 1) - Y(1, 2 : n)^T \cdot Y(2 : n, 2 : n)^{-1} \cdot Y(1, 2 : n)$.

The two admittances are shown in Fig. 7 for the transformers T1. For frequency above a few hundred kilohertz, the short- and open- circuit admittance are practically equal. In Fig. 7, the short circuit admittance shows several resonance frequencies above 20 kHz with two dominant zeros at 20 kHz and 40 kHz. The open circuit admittance has a dominant zero just above 1.5 kHz and then falls in with the poles and zeros of the short circuit admittance.

To compensate for the fact that the measurements were made without bushings, a diagonal element (representing the HV bushing) of 0.5 nF is added when post-processing the measurements. The measurements were also made without oil, but this is not compensated for here.

From Fig. 7 the basic RLC elements using in M2 can be identified:

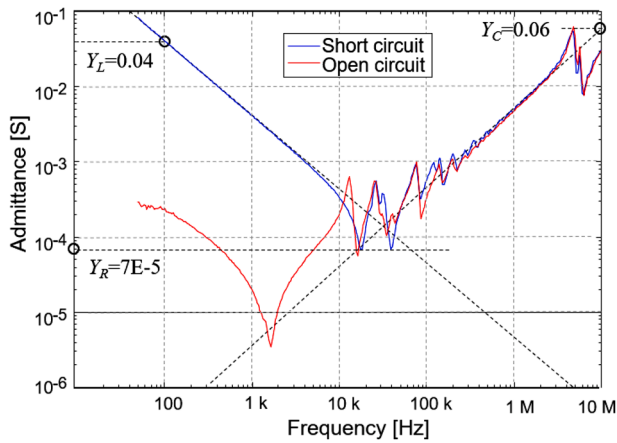

Fig. 7. Measured input admittance of phase 1 of the high-voltage winding of the 3-phase transformer, T1.

$$R = \frac{1}{Y_R} = 14.3k\Omega, L = \frac{1}{\omega_L \cdot Y_L} = 40mH, C = \frac{Y_C}{\omega_C} = 0.96nF$$

Based on (2) the series capacitance in M4 can be estimated from the second resonance. In Fig. 7 we estimate this frequency to 30 kHz and

$$K_H = \frac{1}{(\pi \cdot 30kHz)^2 \cdot 40mH} = 3nF$$

4.4. Transformer models

The models are based on the Transformer Test Report, Typical Values or FRA measurements with data given in Tabl. 1-2 as given in Table 3. In all cases the tertiary winding is ignored. Apparently, the capacitances of M5 are doubled, but this is due to the internal splitting of the capacitance according to Fig. 4. The capacitance on the secondary side is set qualitatively, and the same applies to typical and test-report series capacitance.

5. Results

In this section the models are compared to the measured frequency

Table 3
Transformer T1 model parameters.

Model	Test report	Typical	FRA fitted
M2	C = 1.98 nF Leakage inductance (7.6%): L = 48.5 mH Eq (10): R = 21.8 kΩ	C = 1.5 nF Leakage inductance (8.5%): L = 54.2 mH Eq (10): R = 26.5 kΩ	C = 0.96 nF L = 40 mH R = 14.3 kΩ
M3	C _p =0.253 nF C _{ps} =1.73 nF C _s =0.267 nF L = 48.5 mH R = 0.442 Ω R _m =436 kΩ L _m =1837 H	C _p =0.75 nF C _{ps} =0.75 nF C _s =0.5 nF L = 54.2 mH R = 0.805 Ω R _m =764 kΩ L _m =170 H	C _p =0.48 nF C _{ps} =0.48 nF C _s =0.5 nF L = 40 mH Damping added: R _d =14.3 kΩ
M4	Same as M3 with additional K _H =1 nF	Same as M3 with additional K _H =1 nF	Same as M3 with K _H =3 nF. Damping across K _H of 16 kΩ and R _d =20 kΩ.
M5	C _p =0.506 nF C _{ps} =3.46 nF C _s =0.534 nF Z _k =7.6%, P _k =101.283 kW I ₀ =0.058%, P ₀ =30.362 kW	C _p =1.5 nF C _{ps} =1.5 nF C _s =1.0 nF Z _k =8.5%, P _k =192.5 kW I ₀ =0.65%, P ₀ =0	C _p =0.96 nF C _{ps} =0.96 nF C _s =1.0 nF Z _k =6.27% P _k =100 kW P ₀ =0 Add damping R _d =14.3 kΩ

response, besides with an established black-box model for TRV and lightning time domain studies.

5.1. Short-circuit comparisons

Figs. 8-10 show the short-circuit admittance of the models M2-M5 compared to the measured black-box response.

5.2. TRV study

The purpose is to analyze how the differences observed in the frequency domain will show up in time domain in a transient recovery voltage study, according to Fig. 11. The reference (Black-box) BB-model is made from fitting the measured admittance matrix on the T1 matrix with a 120-pole model using matrix fitting toolbox [19, 20]. From Fig. 12 we see that the transformer models M2-M5 significantly overestimates the TRV peak. This is due to a far too low damping as also observed in Fig. 8. Fig. 13 shows that the over-estimated TRV-voltage is significantly reduced using fitted models with adjusted damping according to (10).

The models M2-M5 based on test report data cannot represent well the TRV and gives too high voltage with too low damping. The M2 model has added damping and is thus the best. When fitted to frequency response measurements, all models improve with M5 as the best.

5.3. Lightning study

This test compares the transformer T1 models in the case of lightning strikes, according to Fig. 14. This will primarily show the impact of the input impedance of the models at high frequencies (above resonance point). The lightning is assumed to hit directly in an overhead line here modelled as JMarti. The Model M2 is with the inductance disconnected.

For lightning studies, the models M2-M5 represent the behavior quite well, as seen in Figs. 15-16, especially with fitted quantities, in Fig. 16. In this case it is the high frequency capacitive characteristics that is important.

6. Discussion

The purpose of the paper is to discuss the consequence of the available parameter values both in frequency domain and in some transient responses. The black-box model accurately fitted to frequency response measurements is taken as a reference.

Referring to Fig. 8 (Test Report), the capacitance is too high for all the M2-M5 models. The inductance at low frequency is a bit low for the M2-M4 models. The resistive damping is good for the M2 model (always

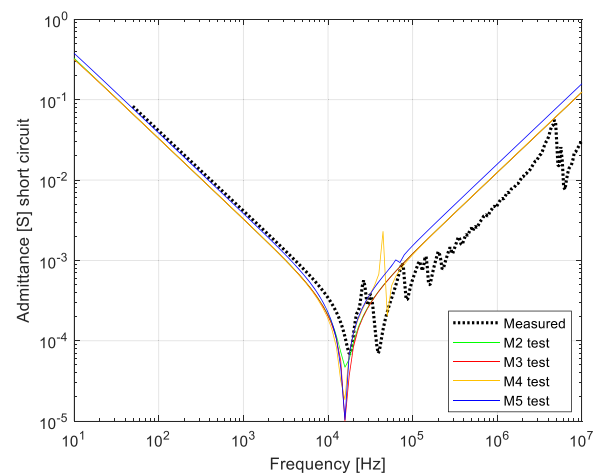

Fig. 8. T1 admittance measured and calculated, test report.

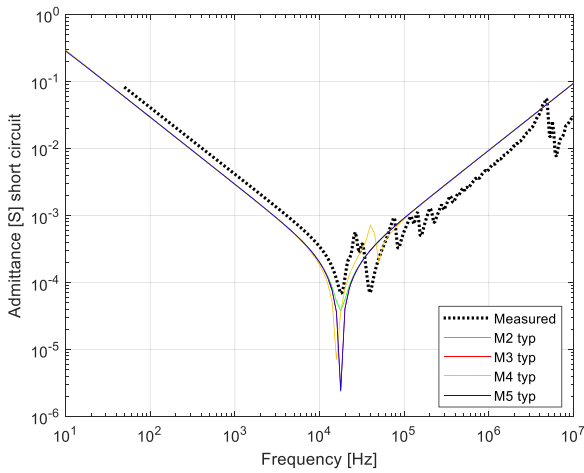

Fig. 9. T1 admittance measured and calculated, typical values.

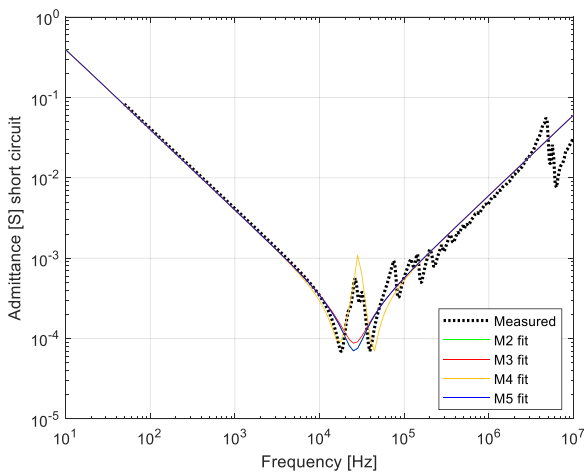

Fig. 10. T1 admittance measured and calculated, fitted parameters.

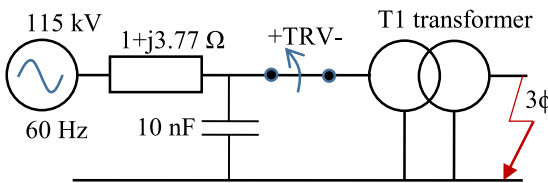

Fig. 11. Simulation of TRV with the models from Table 3.

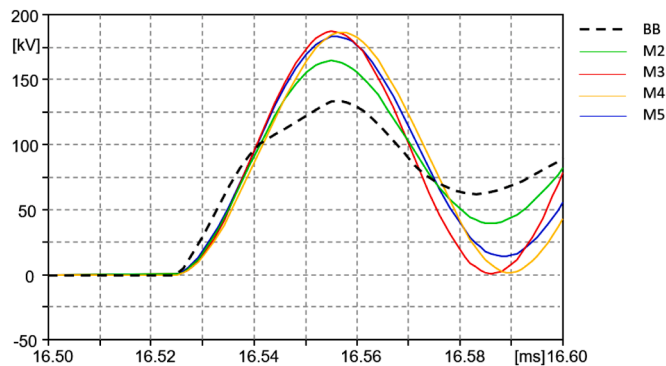

Fig. 12. Simulation result of TRV using the T1 test report transformer models from Fig. 8.

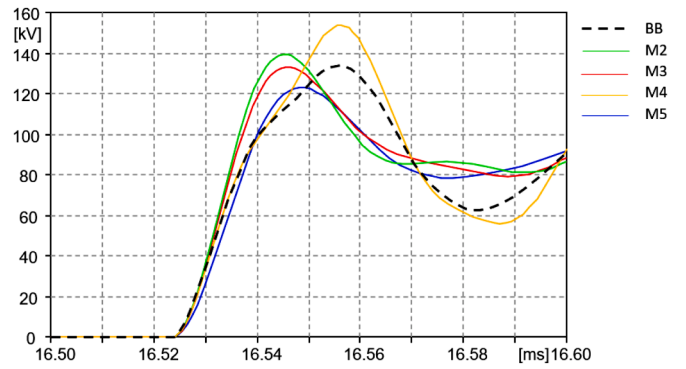

Fig. 13. Simulation result of TRV using the T1 FRA-fitted transformer models from Fig. 10.

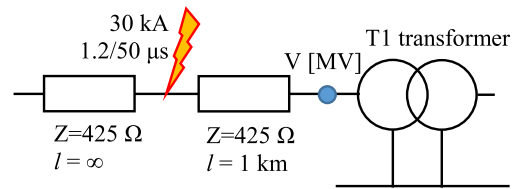

Fig. 14. Simulation of lightning overvoltages using the T1 transformer models. Open transformer secondary, M2 with disconnected inductance.

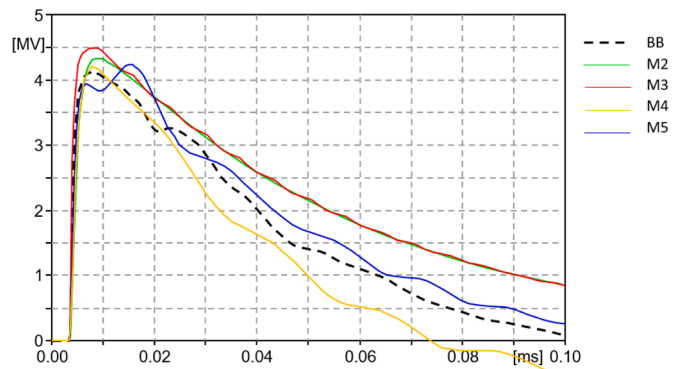

Fig. 15. Simulated lightning overvoltage at transformer terminal using the T1 test-report transformer models from Fig. 8.

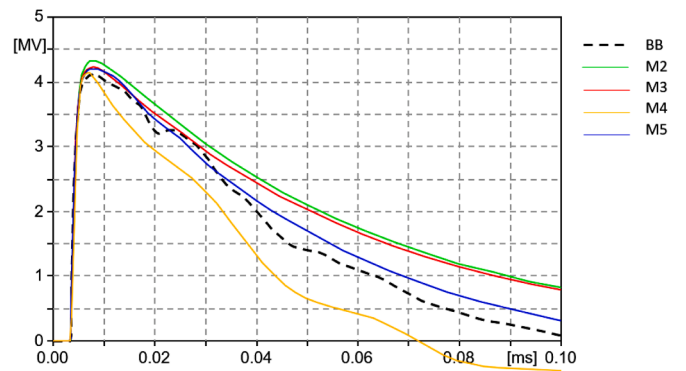

Fig. 16. Simulated lightning overvoltage at transformer terminal using the T1 fitted transformer models from Fig. 10.

based on (10)). Referring to Fig. 9 (Typical Values), the inductance at low frequency is too low and the capacitance at high frequency is too high for all models. In Fig. 10 it is possible to fit both inductance, capacitance and damping for all models. Only the M4 model manage to capture the double resonance in the measurements, but the overall qualitative agreement is reasonable.

The simple models M2-M5 cannot represent the complex resonance behavior of the test transformers T1. The model M4 gives a better representation around resonance, but the model suffers from difficulties in estimation of the series capacitance. The 1–3 nF series capacitance used for T1 gave generally an improved performance. The over-all characteristic with a low-frequency inductive behavior and a high frequency capacitive behavior is well represented by M2-M5. The scaling of the measured capacitance with a factor 0.4 seems reasonable.

Even if the fitting is reasonable in the frequency domain, there still might be severe deviations in the time domain. The simulation of TRV shows that damping is too low for the M2-M5 models (Fig. 12) and this applies also when fitting the model to measured damping at resonance (Fig. 13). The M4 model with added and fitted series capacitance agrees with the frequency of the TRV oscillations (Fig. 13). In lightning studies (without chopping) there are less differences between the models and the M5 models gave the best match to the black-box model.

7. Conclusions

For the transformer tested here, the qualitative agreement in the frequency domain seems reasonable matching the resonance frequency well. Still there are considerable deviations in time domain TEV studies.

- In general, the gray-box model for high frequency studies is an interesting option as it does not demand a great knowledge of the transformer design. One obvious advantage is that the models M3-M5 has a correct low-frequency behavior that make them easier to apply and initialize in general. The black-box model is in this paper used as a reference and, if available, will provide much more accurate results in transient studies.
- Depending on its structure, the simplified models can represent the behavior up to the first resonance frequency and at high frequencies. The often-complex behavior around and after the first resonance frequency is, however, not well represented by the simplified models (M2-M5). The M4 model can, in theory, represent some of the complexities at resonance but suffers from problems in estimation of the series capacitance. For a more detailed analysis of the transient behavior of the transformer, a black-box or white-box model should be considered.
- Capacitance values obtained from dielectric tests must be reduced when used in high frequency transient studies, because the series capacitances are not considered in such tests. A scaling factor in the range of 0.4 to 0.6 is recommended. The capacitances must in addition be scaled depending on the winding connections. A scaling of 1/3 to 1/2 is recommended for grounded wye.
- The consideration of damping is very important for cases where the behavior at resonance frequency dominates (for examples TRV-

studies). A shunt resistance can be calculated considering a typical damping factor, the terminal leakage inductance, and the effective capacitance. The transformer models M3-M5 will have too small damping as the winding resistance is based on power frequency measurements or estimates. The resistance calculated from damping factor in (10) has shown reasonable results for the all the models.

Declaration of Competing Interest

The authors declare that they have no known competing financial interests or personal relationships that could have appeared to influence the work reported in this paper.

References

- [1] W. A2.37, Transformer reliability survey, CIGRE TB 642 (2015).
- [2] J. A2/C4.39, Electrical transient interaction between transformers and the power system. Part 1 – Expertise, CIGRE TB 577A (2014).
- [3] J. A2/C4.39, Electrical transient interaction between transformers and the power system. Part 2 – Case studies, CIGRE TB 577B (2014).
- [4] S.D. Mitchell, J.S. Welsh, Initial parameter estimates and constraints to support gray box modeling of power transformers, IEEE T Power Del. 28 (4) (Oct 2013) 2411–2418.
- [5] B. Jurisic, P. Poujade, A. Xemard, I. Uglesic, F. Paladian, Application of wide band transformer models", in: IPST conference, Seoul, Republic of Korea, 2017.
- [6] R. Aghmasheh, V. Rashtchi, E. Rahimpour, Gray box modeling of power transformer windings based on design geometry and particle swarm optimization algorithm, IEEE T Power Del. 33 (5) (Oct 2018) 2384–2393.
- [7] A. Xemard, B. Jurisic, M. Rioual, A. Olivier, E. Sellin, Interruption of small, medium-voltage transformer current with a vacuum circuit breaker, Electric Power Syst. Res. 187 (2020), 1065020.
- [8] W. 33.02, Guidelines for representation of network elements when calculating transients, CIGRE TB39 (1990).
- [9] J.A. Martinez, B.A. Mork, Transformer modeling. for low- and mid-frequency transients - a review, IEEE T Power Del. 20 (2) (Apr 2005) 1625–1632.
- [10] S. Pramanik, L. Satish, Time-domain approach to estimate series capacitance of an isolated phase winding of a transformer, IEEE T Power Del. 29 (4) (Aug 2014) 1939–1945.
- [11] S. Pramanik, L. Satish, Estimation of series capacitance of a transformer winding based on frequency-response data: an indirect measurement approach (vol 26, pg 2870, 2011), IEEE T Power Del. 29 (1) (Feb 2014) 302–303.
- [12] R. Horton, R.C. Dugan, K. Wallace, D. Hallmark, Improved autotransformer model for transient recovery voltage (TRV) studies, IEEE T Power Del. 27 (2) (Apr 2012) 895–901.
- [13] A. Greenwood, Electrical Transients in Power Systems, 2nd ed., Wiley Interscience, New York, 1991, p. 751, pp. xvi.
- [14] A. Rezaei-Zare, Equivalent winding capacitance network for transformer transient analysis based on standard test data, IEEE T Power Del. 32 (4) (Aug 2017) 1899–1906.
- [15] A. Sabot, Transient recovery voltage behind transformer - calculation and measurement, IEEE T Power Ap Syst 104 (7) (1985) 1916–1921.
- [16] J. A2/C4.52, Transformer and reactor models for high frequency studies - Measurements/Design, CIGRE TBXXX (2019).
- [17] CRIEPI, Lightning protection design for power stations, substations and underground transmission lines, CRIEPI (1995) vol. Report T40.
- [18] IEC, Insulation co-ordination. Part 4: computational guide to insulation co-ordination and modelling of electrical networks, IEC 60071-4 (2004).
- [19] B. Gustavsen, A. Semlyen, Rational approximation of frequency domain responses by Vector Fitting, IEEE T Power Del. 14 (3) (July 1999) 1052–1061.
- [20] B. Gustavsen, Fast passivity enforcement for pole-residue models by perturbation of residue matrix eigenvalues, IEEE T Power Del. 23 (4) (October 2008) 2278–2285.