



Norwegian University of Science and Technology - NTNU

AAR4993 - MSc. Sustainable Architecture (DP) · May 26th, 2023

Supervisor: Pasi Aalto · Co-supervisor: Michael Gruner

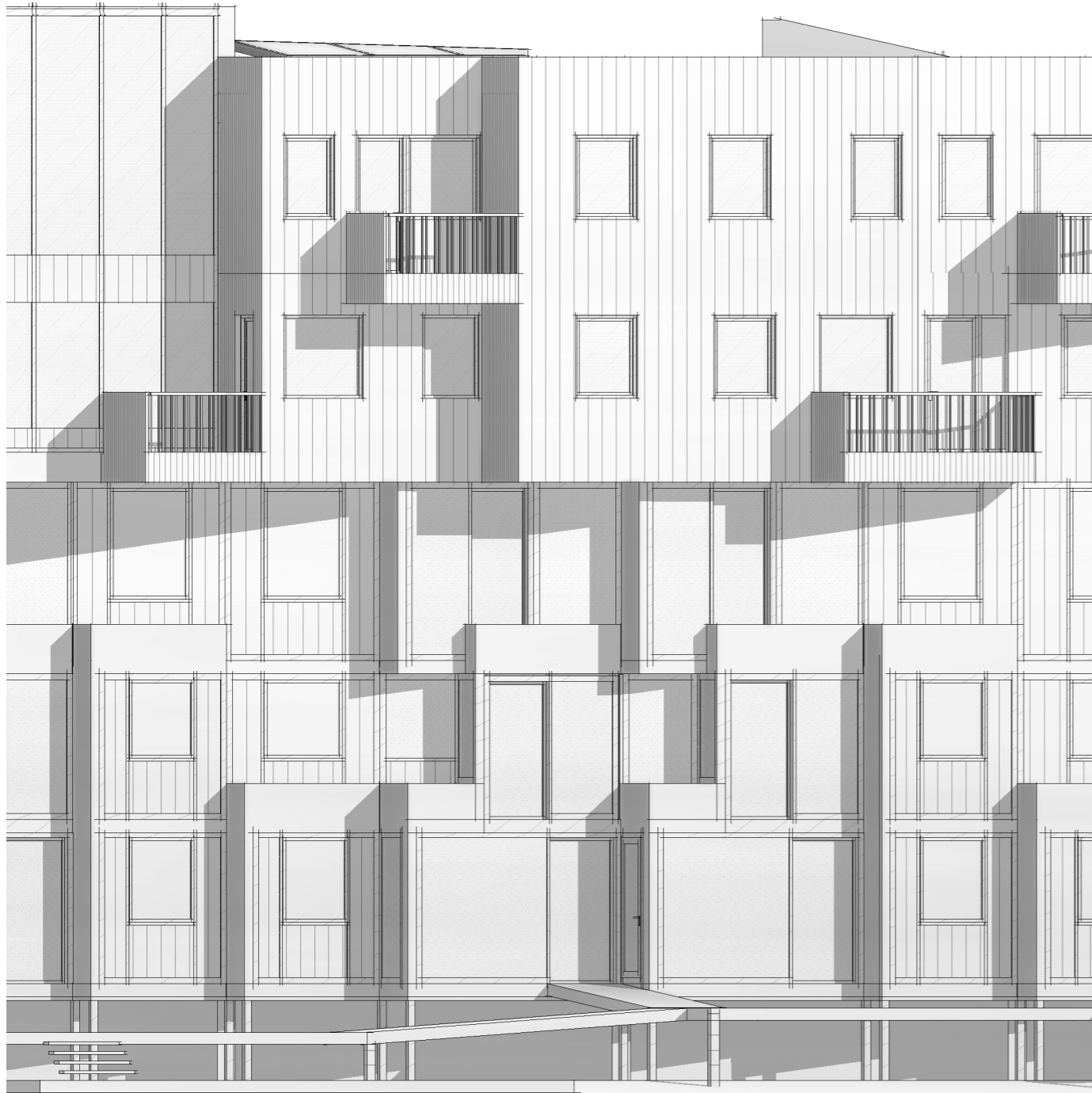
TRANSFORMATION

ELEMENT-BASED ENERGY UPGRADE

#refurbishment #life cycle assessment #energy upgrade #elements
#cohousing #social sustainability



ACKNOWLEDGEMENT



I would like to express my sincere appreciation to both of my supervisors for their guidance, knowledge, and inspiration. In particular, I thank my supervisor Pasi Aalto for inspiring me to choose this topic and learn more about wood construction. A special thank you to my co-supervisor Michael Gruner for his patience and helpful suggestions that have helped me complete this project.

Additionally, I thank Ola Lauve and the team at Overhalla Hus for showing us the production process of wooden building elements.

Finally, I would like to thank Sondre Andvik from ROJO Arkitekter and Kristian Stenerud Skeie from SINTEF for their responses that helped me resolve my questions about the project.

ABSTRACT

Vestlia Borettslag is a housing association consisting of 16 similar apartment blocks that were built in the 70s and went through numerous renovations since its completion. Based on a previous feasibility study from 2021 "Treindustrielle Muligheter for oppgradering og påbygg av eksisterende boligmasse", the goal is to transform the development by adding 2 new floors on top with prefabricated wood elements. In addition, a comprehensive renovation of the existing from both social and environmental standpoints is necessary.

To further explore the possibilities of the transformation, the project chose an apartment block with a different orientation compared to "Treindustrielle muligheter". Another difference from the former study is the project opted for compact apartments as one of the measures to reduce energy consumption per family. In addition to exploring design options, life cycle assessment and energy simulations are carried out to assist the process, for example, zoning the heated area for the new addition or choosing materials for the renovation.

After consideration for social and life cycle aspects, the renovation on the existing floors is modest but can be combined with voluntary upgrades for each apartment. This renovation is able to reduce at least 18% of the net energy demand for the existing apartments. The initial plan was to add new elevators to access the new rooftop apartments while making the existing apartments more accessible. However, after exploring numerous options, the least intrusive solution is to have a separate circulation system for the new floors on top while proposing wheelchair access for the apartments on the first floor.

On the other hand, the final proposal for the new addition on top includes 26 new compact apartments, which is 10 apartments more than the estimation from the former study, and new common areas which include a passive greenhouse for both the new and existing tenants. Due to their compact size and energy efficiency, new apartments require only one-third to nearly half of the energy needed for renovated apartments with the same number of bedrooms. The same rooftop apartments can potentially be applied to the remaining 11 out of 16 blocks with the same orientation. Because the difference in height varies for the blocks, the communal areas should be more customized to work well for each block.

In addition, the project proposed to have a combined heat and power (CHP) unit placed in the parking lot as the renewable energy source. The preliminary calculation shows that a 65 m² CHP unit can cover all the energy demand from both the new and existing floors of 3-4 similar blocks while still having surplus electricity to export to the grid. Considering the size of the development and the surrounding area, this renewable energy solution can potentially benefit not only the 16 blocks but also the nearby buildings.





SAMMENDRAG

Vestlia Borettslag er et borettslag som består av 16 like boligblokker som ble bygget på 70-tallet og som har gjennomgått en rekke renoveringer siden ferdigstillelsen. Basert på en tidligere mulighetsstudie fra 2021, "Treindustrielle muligheter for oppgradering og påbygg av eksisterende boligmasse", er målet å transformere utbyggingen ved å legge til to nye etasjer på toppen med prefabrikkerte treelementer. I tillegg er det nødvendig med en omfattende renovering fra både sosiale og miljømessige standpunkter.

For å utforske mulighetene for transformasjonen har prosjektet valgt en boligblokk med en annen orientering sammenlignet med "Treindustrielle muligheter". En annen forskjell fra den tidligere mulighetsstudien er at prosjektet har valgt kompakte leiligheter som et av tiltakene for å redusere energiforbruket per familie. I tillegg til å utforske designalternativer, utføres livssyklusvurdering og energisimuleringer for å hjelpe prosessen, som for eksempel sonering av det oppvarmede området for det nye tillegget eller valg av materialer for renoveringen.

Etter hensyn til sosiale og livsløpsaspekter er oppussingen i eksisterende etasjer beskjeden, men kan kombineres med frivillige oppgraderinger for hver leilighet. Denne renoveringen er i stand til å redusere minst 18% av netto energibehov for de eksisterende leilighetene. Den opprinnelige planen var å legge til nye heiser for å få tilgang til de nye takleilighetene og samtidig gjøre de eksisterende leilighetene mer tilgjengelige. Etter å ha undersøkt en rekke alternativer, er den minst påtrengende løsningen å ha et eget sirkulasjonssystem for de nye etasjene på toppen, samtidig som det foreslås rullestoltilgang for leilighetene i første etasje.

Det endelige forslaget til det nye tilbygget på toppen inneholder derimot 26 nye kompaktleiligheter, som er 10 leiligheter mer enn estimeringen fra tidligere utredning, og nye fellesarealer som inkluderer et passivt drivhus for både nye og eksisterende leietakere. På grunn av sin kompakte størrelse og energieffektivitet krever nye leiligheter bare en tredjedel til nesten halvparten av energien som trengs for renoverte leiligheter med samme antall soverom. De samme leilighetene kan potensielt brukes på de resterende 11 av 16 blokkene med samme orientering. Fordi forskjellen i høyde varierer for blokkene, bør fellesarealene tilpasses mer for å fungere godt for hver blokk.

I tillegg foreslo prosjektet å ha en kraftvarmeanhet (CHP) plassert på parkeringsplassen som fornybar energikilde. Den foreløpige beregningen viser at et kraftvarmeanlegg på 65 m² kan dekke hele energibehovet fra både nye og eksisterende etasjer i 3-4 like blokker samtidig som det fortsatt er overskuddsstrøm å eksportere til nettet. Med tanke på størrelsen på utbyggingen og området rundt, kan denne fornybare energiløsningen potensielt komme ikke bare de 16 blokkene til gode, men også de nærliggende bygningene.

CONTENTS

1 INTRODUCTION	1
2 METHOD	3
3 ANALYSIS	4
Urban context	5
Climate	6
Existing development	7
Existing building	8
Existing apartments	9
Renovation history	10
Current situation	11
Accessibility	12
4 CONCEPT	14
Existing	15
New addition	16
5 PROPOSAL	18
Plans	19
Greenhouse & energy	26
Greenhouse & emissions	28
Sections	30
Common area	32
Elements	34
Life cycle assessment	39
Energy demand	40
Renewable energy	41
6 CONCLUSION	43
7 REFERENCES	44

1 INTRODUCTION



The thesis is a transformation of a 1970s housing association achieved by adding a two-story extension on top and selectively renovating the existing part. The project not only proposes a design solution but also includes sustainable measures for the upgrade, which encompass social aspects, energy efficiency and life cycle assessment.

The basis for this thesis is a previous feasibility study from 2021, titled “Treindustrielle muligheter for oppgradering og påbygg av eksisterende boligmasse”, by TreFokus, Treteknisk, Treindustrien, NBBL and NTNU Wood. The study aims to achieve environmental and social goals by building new apartments on existing roofs and upgrading existing apartments. It assessed several locations in Norway with the goal of extending the lifespan and quality of existing building stock, reducing environmental impacts, improving energy efficiency, and allowing people to live longer in their homes instead of moving to specialized institutions. In addition, the project shows design studies for Vestlia borettslag from 3 different architectural firms to further illustrate the upgrade potential. The proposed material for the new rooftop addition is wood, due to its lightweight and potential to reduce construction time by using prefabricated elements. The study also described the current tenants’ expectations and hopes for the renovation, such as having a communal roof for socializing, area-efficient apartments, and new balconies and facades, which should be taken into account for the upgrade.

Furthermore, there is another SINTEF research from 2018, titled “Rehabilitering av borettslag til nesten nullenerginivå” (Skeie et al., 2018), which compared two energy upgrade options for Vestlia: a simple upgrade and an nZEB (nearly zero-energy building) upgrade. The simple upgrade is based on an actual upgrade with unspecified changes and can achieve a net annual energy demand of 168 kWh/m². On the other hand, the nZEB upgrade’s net energy demand is 89.4 kWh/m², which fulfills the current energy requirement of 95 kWh/m² per year from TEK17. The scope of the study did not include energy supplies, which can make further impacts on the delivered energy to the development.

In “Treindustrielle Muligheter”, the proposed architectural solutions for Vestlia chose a building with south-facing balconies. However, 12 out of 16 of the blocks have west-facing balconies, which is a less favorable solar condition because of the low sun altitude in Norway. Therefore, this thesis chooses one of the blocks with west-facing balconies as a case study to further assess the potential in terms of design. In addition to applying a selection of findings from previous studies, this thesis seeks to further explore the potential of this upgrade by considering different apartment typologies and sources of renewable energy. Social sustainability through thoughtful design is also an important aspect. Although it may not always align with energy efficiency and cannot always be expressed in numbers, it is still an important issue to address.

THE PROJECT



Fig. 2.1: VESTLIA BORETTSLAG - Google Earth

MOTIVATION

Building a completely new building would generate more emissions, particularly from its foundation. This means that building on top of existing buildings and utilizing their residual capacities can help reduce carbon footprints. Norway has 22,300+ apartment blocks built between 1950 and 2001 (SSB), all of which will eventually need upgrades. Considering that Trondheim is among the three Norwegian cities aiming for climate neutrality by 2030, this climate-conscious solution can help contribute to this goal.

In addition to the decrease in the quality of buildings in housing associations, some people cannot find affordable housing. Expanding and renovating existing housing developments can improve the living quality of current residents in terms of design and energy while providing more living spaces for others. However, housing associations consist of people with different backgrounds and needs, making it challenging to balance the social aspect, levels of intervention, and energy efficiency. While there is no perfect solution that fits all requirements, finding a proposal that balances these aspects is valuable.

CONSTRAINTS

The feasibility of adding floors has been discussed in the former study, "Treindustrielle Muligheter". While load-bearing and bracing capacities of the existing walls were assessed as sufficient, the load ability of the ground is uncertain. Treteknisk has suggested the feasibility of adding two floors until measurements are carried out. This estimation for two additional floors was also part of the call for three architecture offices whose proposals were presented in the report. In case measurements show that the condition is not sufficient, additional structural support is also an option. Therefore, this thesis will use the addition of two floors as the structural constraint.

Furthermore, "Treindustrielle Muligheter" provided conclusions for the economic aspect that can be used to establish the design brief for this thesis. For each 24-apartment block, which is the typical block type in the development, the profit from building one floor on top is 7.4 million NOK, and building two new floors doubles that amount to 14.7 million NOK. The estimated cost for a facade upgrade is 6.2 million NOK, and one elevator costs another 3.5 million NOK. Therefore, to maximize the building's capability and profit from selling new apartments, there should be two new floors with approximately 1000 sqm for apartments to cover the cost of refurbishment. Additionally, the report suggested that solutions with 4 new lifts are not profitable considering their cost, and it is preferable to have only 1 new lift for each block.

GOAL

The ultimate goal is to propose an efficient design solution for the new addition while allowing integration with the existing buildings. Therefore, balancing the social aspects, energy efficiency, and reducing carbon footprint is a priority. Although more comprehensive renovation can be more effective for energy upgrades, it requires drastic changes to people's homes and produces more emissions from materials. Therefore, the energy upgrade part of this project aims to reduce delivered electricity from the grid, which can be achieved by proposing renewable energy solutions and/or reducing the net energy demand.

SCOPE

Vestlia Borettslag has 16 apartment blocks with varying heights, lengths, and orientations, but all with the same depth and structural grids. This thesis focuses on only 1 building with balconies facing west, which is the orientation of 12 out of 16 blocks.

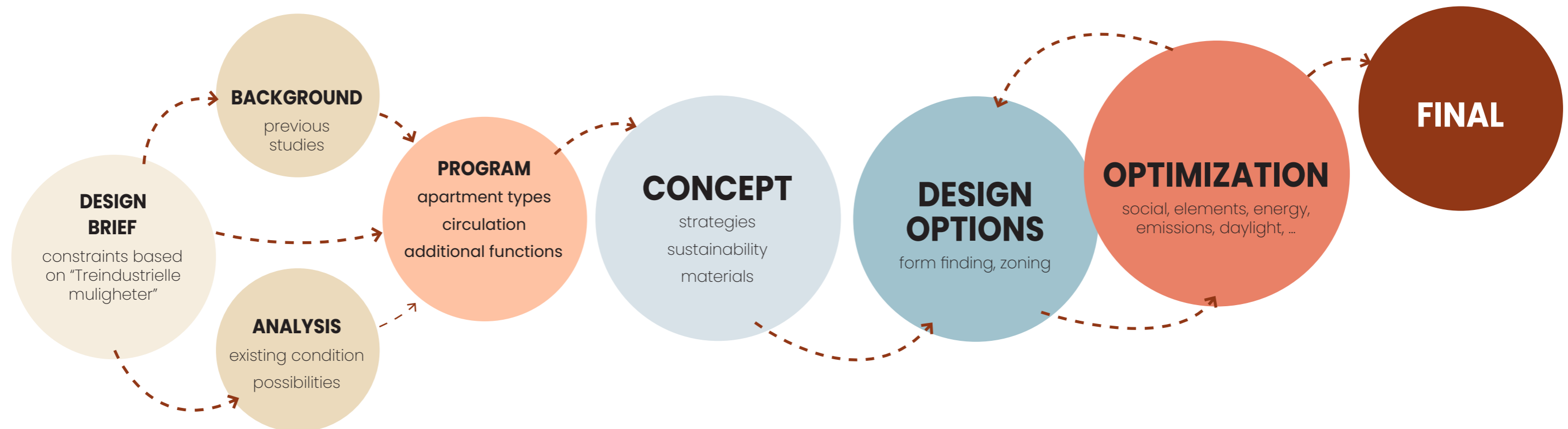
The project proposes a final design solution for new floors on top and renovation of existing floors through current condition assessment, life cycle assessment, and energy simulation.

This project uses the economic and structural constraints from "Treindustrielle muligheter", however, given the instability of the economic aspect and the lack of solid information on the existing structure and ground condition, they are not further discussed in this thesis.

2 METHOD

There are already previous studies on Vestlia borettslag, it is necessary to assess them to see what can be applied to this project. Additionally, it is challenging to know the exact details of the previous renovations since the completion of the buildings. Therefore, assumptions are made to establish the existing condition to determine what should be done to achieve the final goal.

Following preliminary analysis, the design concept, program, and sustainable strategies are established. Exploring design options and comparisons is vital to this project. Additionally, daylight analysis, energy simulations, and life cycle assessments inform the design revisions before arriving at the final proposal.



3 ANALYSIS

Vestlia is situated in a residential area, approximately 4 km from Trondheim's city center. It is located near the forest and hiking area on the east side of the city.

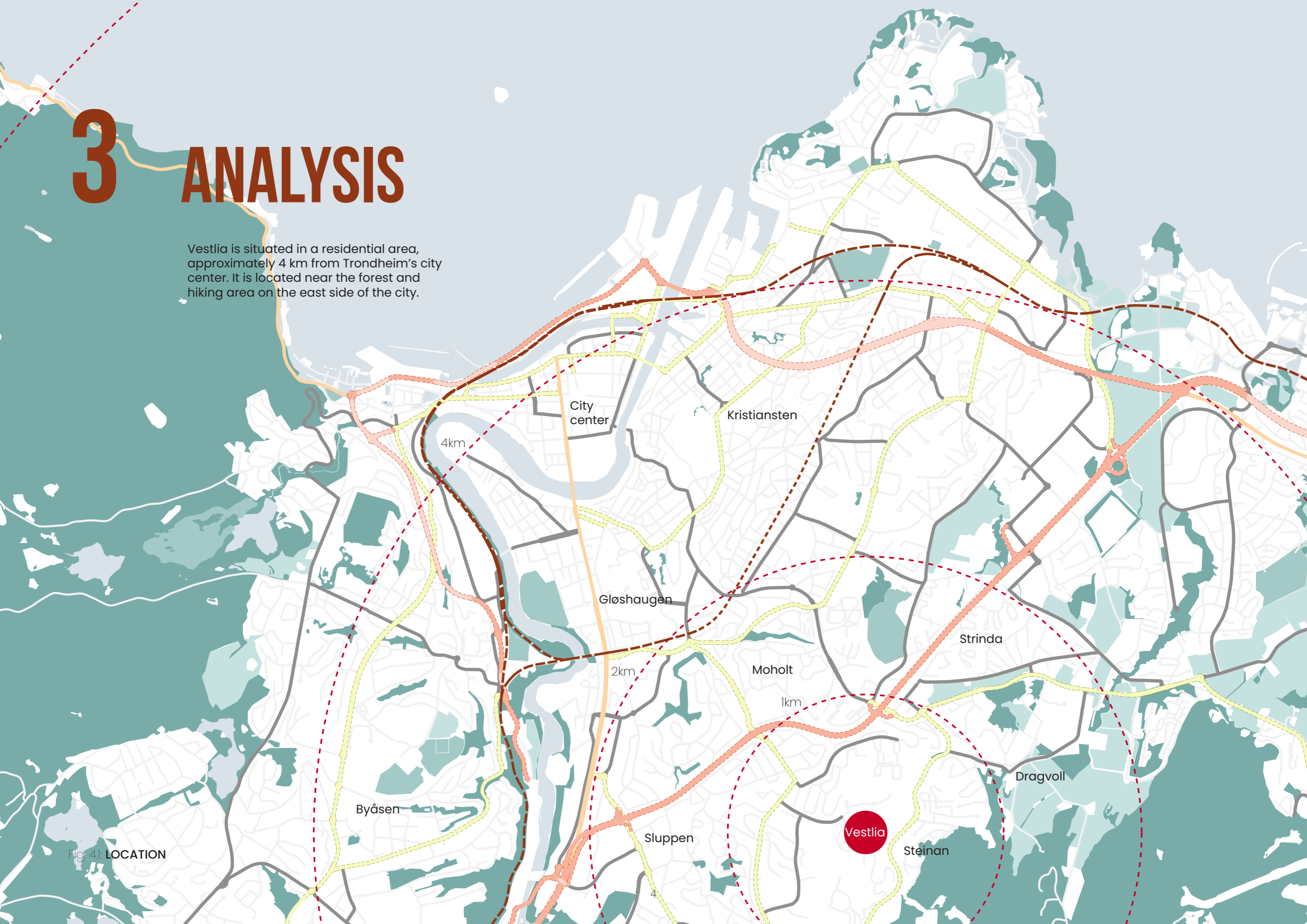


Fig. 4: LOCATION

URBAN CONTEXT

ACCESS



- Main roads
- Secondary roads
- Bicycle
- Power line

Fig. 51: ACCESS

NEARBY AMENITIES



- 1 Restaurants
- 2 Pharmacy
- 3 Education
- 4 Grocery
- 5 Library

Fig. 52: AMENITIES

CLIMATE

Trondheim's climate is classified as Dfc, with an average temperature that varies from -4 to 20°C throughout the year. January is the coldest month.

The prevailing wind direction is southwest, with the strongest winds occurring in the winter months.

The snow period lasts for six months, typically from the end of October to the end of April.

Due to the low sun altitude, the length of days varies from over 4.5 hours in December to 20.5 hours in June. This makes the summer the most efficient time period for solar energy production.

Therefore, the most important strategy is active heating. Other passive measures include internal heat gain, passive solar direct gain, and wind protection of outdoor space (Climate Consultant).

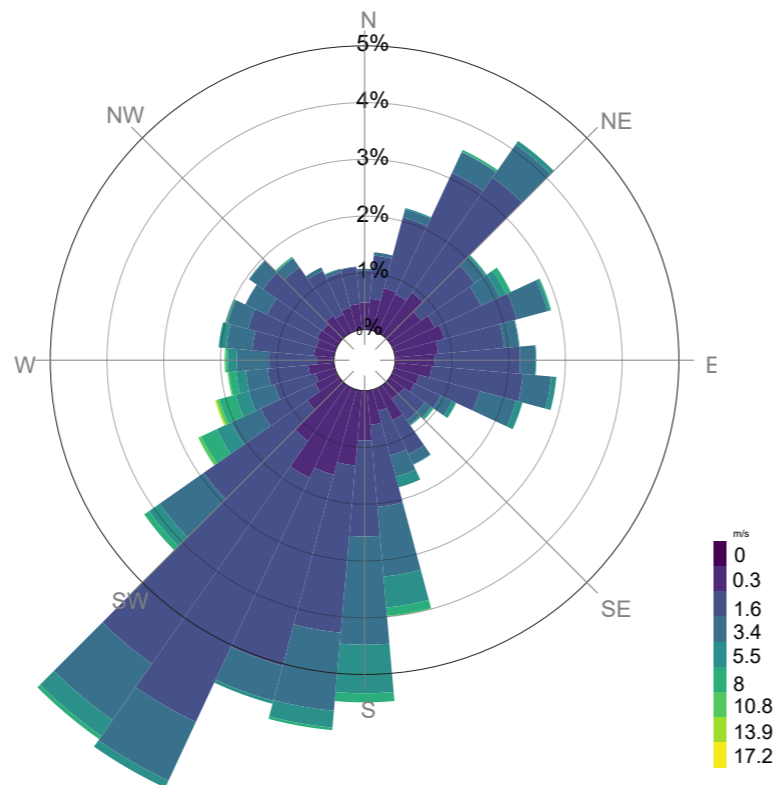


Fig. 6.1: WINDROSE

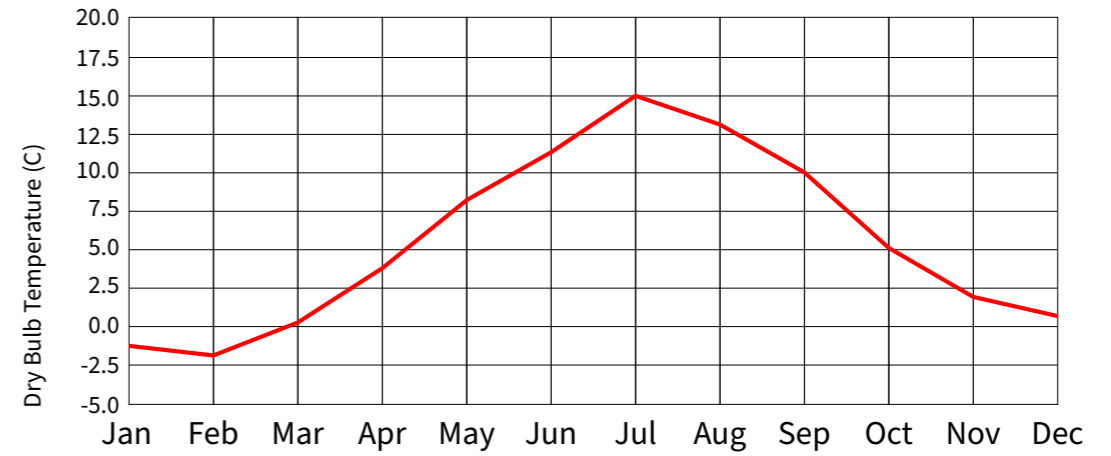
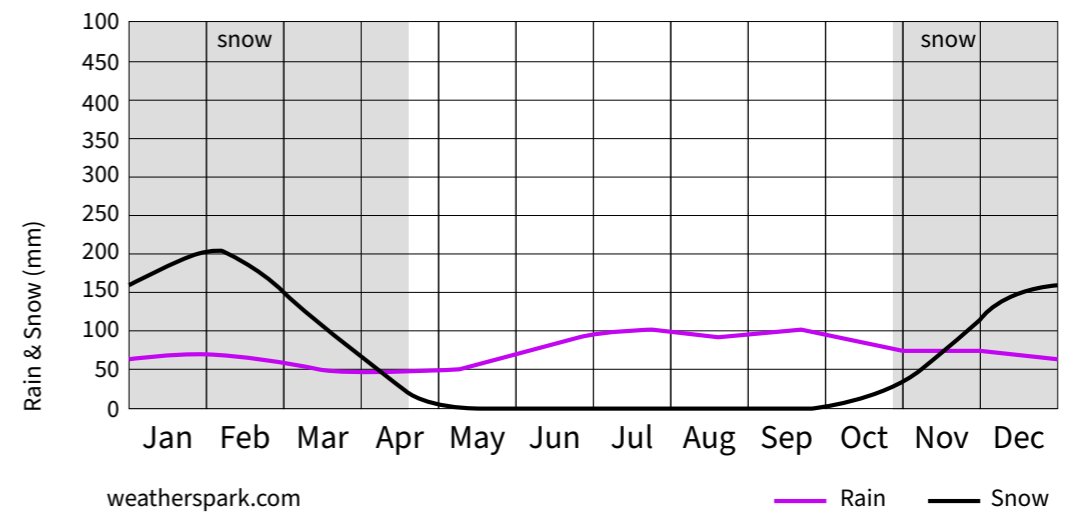


Fig. 6.2: DRY BULB TEMPERATURE



weatherspark.com

— Rain — Snow

Fig. 6.3: PRECIPITATION

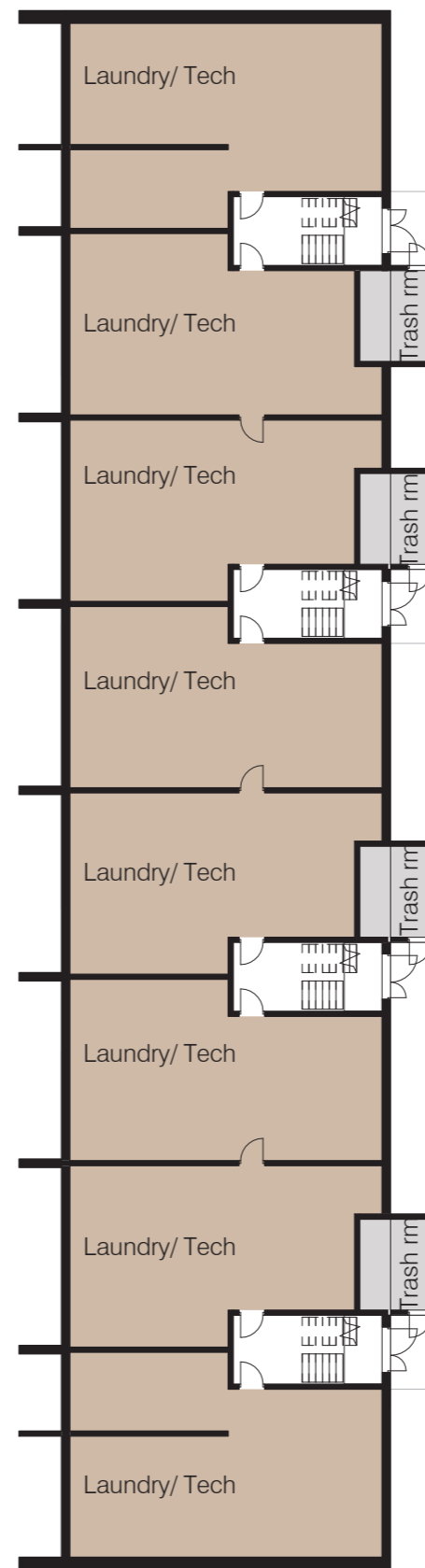
EXISTING DEVELOPMENT

The development has 16 apartment blocks, each with three stories and a basement. It includes 228 one-bedroom apartments, 72 two-bedroom apartments, and 24 three-bedroom apartments, which are only present in the south-facing balcony blocks. There are no elevators in any of the buildings. This project focuses on one of the west-facing balcony buildings, which makes up most of the development, unlike the "Treindustrielle muligheter" architecture proposals that focus on one of the south-facing balcony buildings.

CHOSEN BUILDING

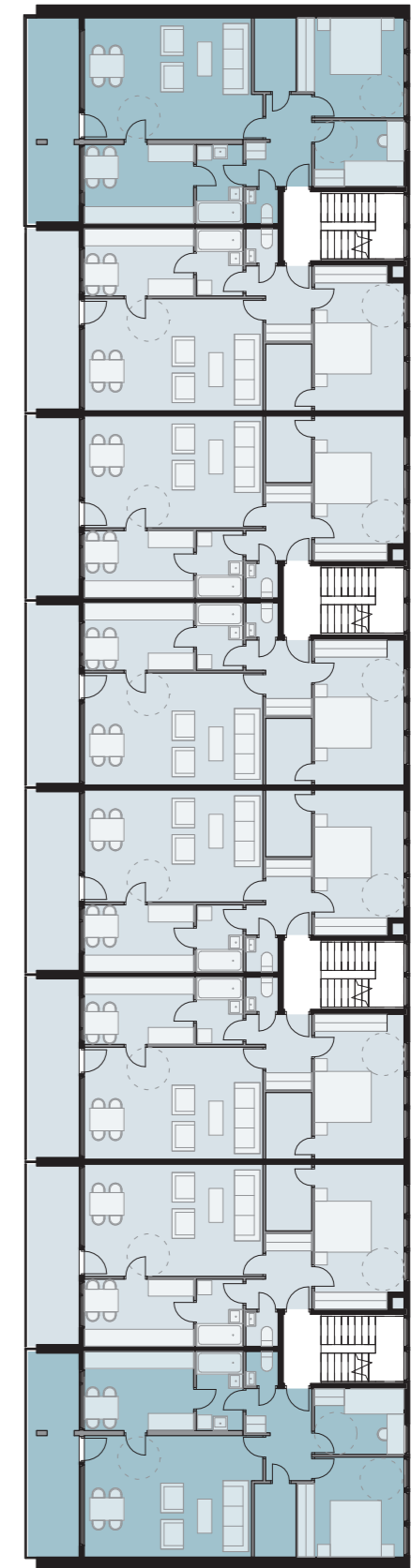
- 228 1-bedroom units
- 72 2-bedroom units
- 24 3-bedroom units
- staircases
- balconies

Fig. 7.1: APARTMENT BLOCKS IN THE DEVELOPMENT



- Laundry
- Trash room

Fig. 7.2: BASEMENT PLAN - 1:250



- 2 bedroom unit
- 1 bedroom unit

Fig. 7.3: 2F-3F PLANS - 1:250

EXISTING BUILDING

STRUCTURE

The existing apartment blocks are concrete structures with gable walls and partition walls between apartments serving as load-bearing elements. Assumptions for the load-bearing walls are shown in Fig.8.1.

The floor slabs and roof are also concrete, while the entrance and balcony walls are half-timber elements (Skeie et al., 2018).

To maintain the stability of the structure and take advantage of its residual loads, the new floors on top should also follow the same structural grids.

TECHNICAL SYSTEMS

The basement is unheated while the stairwells are partially heated because they are still sheltered from the outdoor area. Fig.8.2 shows the heated zone.

Current buildings use exhaust ventilation, with exhaust from the kitchen, bathroom, and WC. Most of the fresh air comes from the bedrooms (Skeie et al., 2018). Additionally, it can be assumed that there is no central system for heating and hot water. The apartments use direct electricity for heating.

To improve the existing system without causing inconvenience to current tenants, these upgrades can be carried out on a voluntary basis.

NATURAL DAYLIGHT

Fig.8.3 shows that the bedrooms receive a sufficient amount of daylight, while it is quite limited in the living room and kitchen due to the balconies covering the entire facade. Additionally, the balconies are not frequently used in the winter. Therefore, proposals to increase the usable area towards the balconies can take more advantage of the daylight condition.

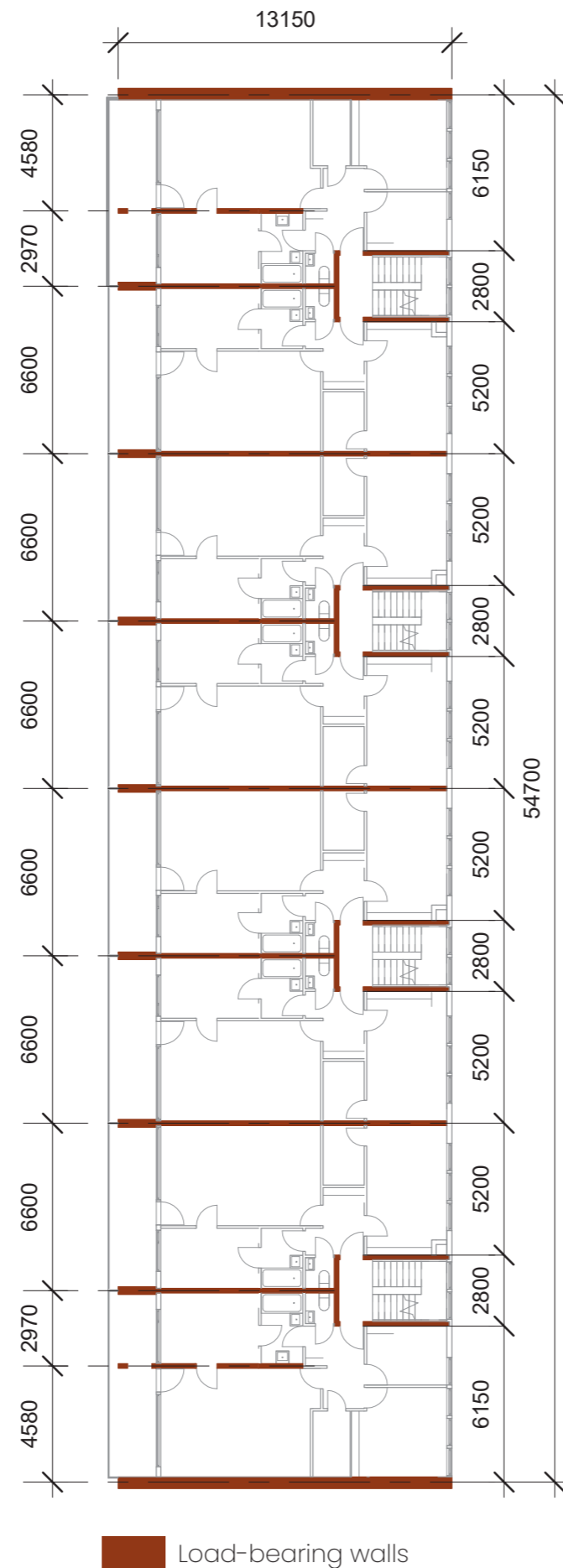


Fig. 8.1 LOAD BEARING WALLS - 1:250

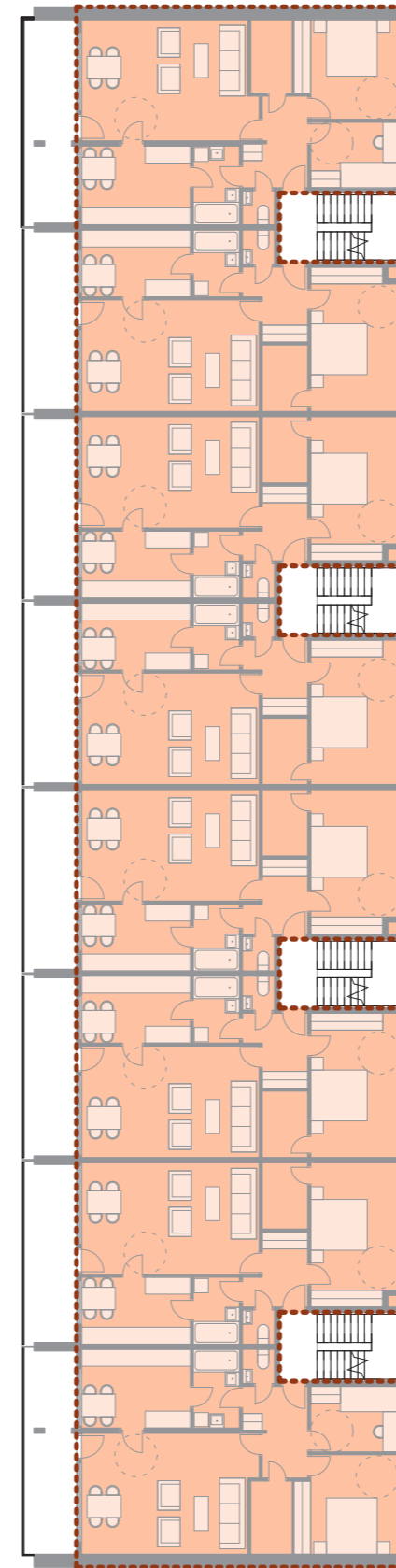


Fig. 8.2: HEATED AREA - 1:250

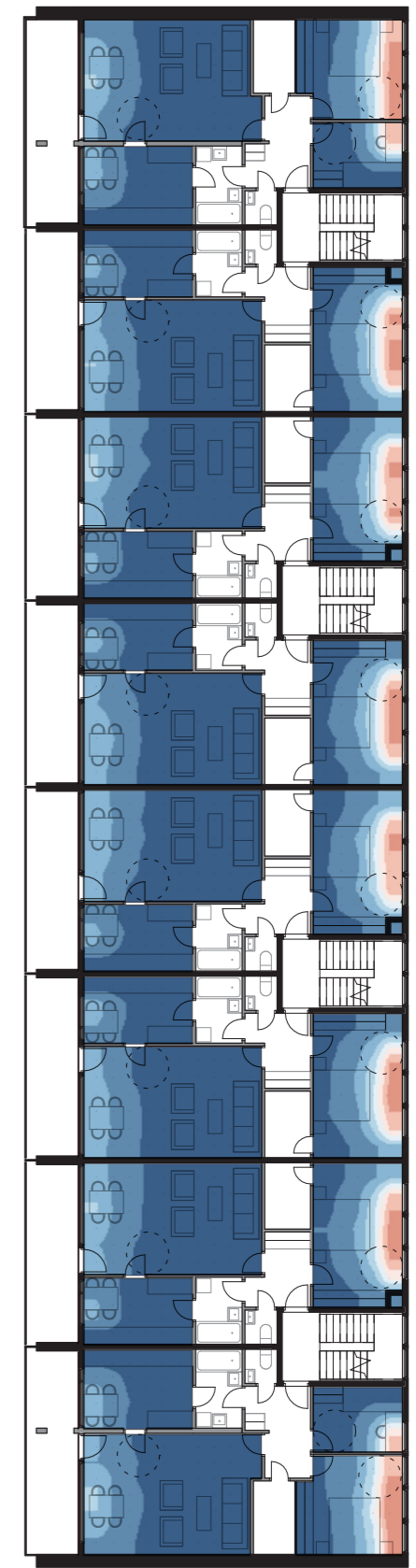


Fig. 8.3: DAYLIGHT FACTOR - 1:250

EXISTING APARTMENTS

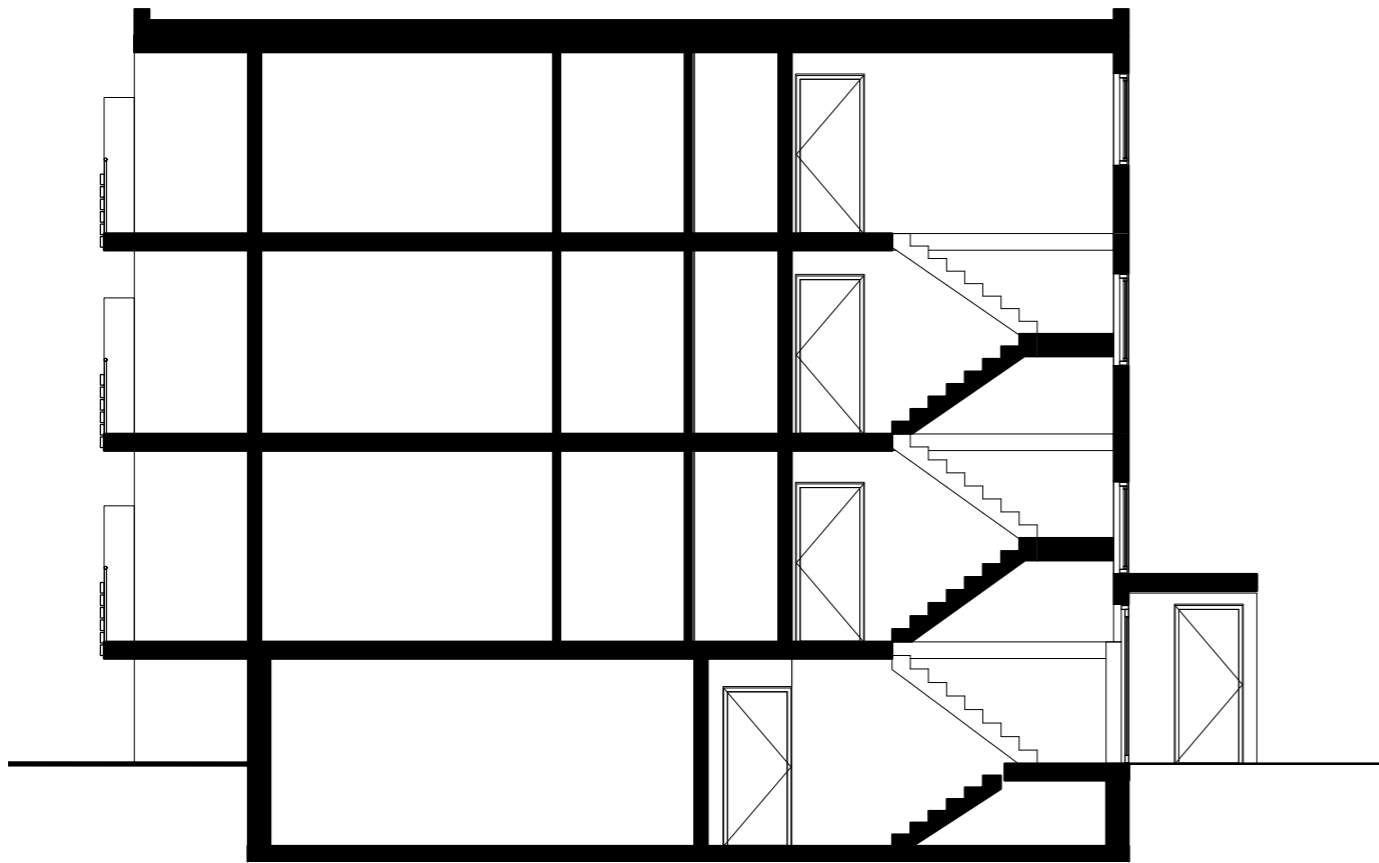


Fig. 9.1: SECTION - 1:100

The clear height of the apartments varies from 2.4 to 2.5 meters, and the basement is approximately half a story above the ground (Fig.9.1).

Fig.9.2, Fig.9.3 and Fig.9.4 shows the types of apartments available and their area. 3-bedroom apartments are not in the chosen building for this project. Compared to contemporary apartments, all of the existing apartment types have enough area to add 1 more bedroom. Additionally, it is possible to include voluntary renovations such as merging the bathroom and toilet into one room, and making the kitchen open to the living area.

To summarize the survey from "Treindustrielle muligheter," existing residents expressed a desire for new facades and balconies. Many also hoped for a reduction in electricity bills. As for the new floors on top, a large communal roof terrace with sunlight and the possibility to plant crops was a popular choice. Additionally, more space-efficient apartments and lifts for disabled individuals would be beneficial.

Apartment type	Area (m2)
1-bedroom	62
2-bedroom	71
3-bedroom	96

Fig. 9.2: TYPES OF APARTMENTS

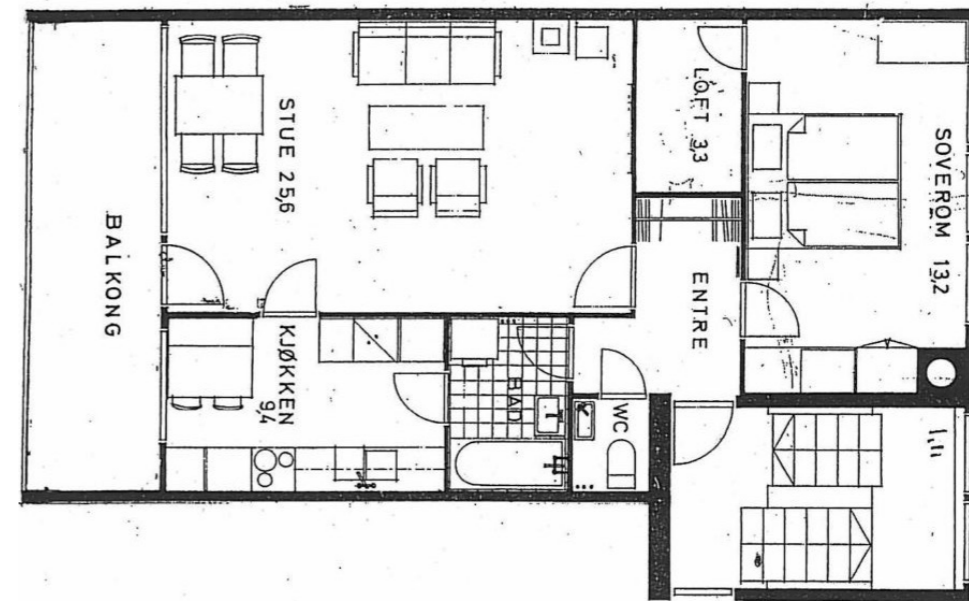


Fig. 9.3: 1-BEDROOM APARTMENT, 1:100 (vestliaborettslag.no)

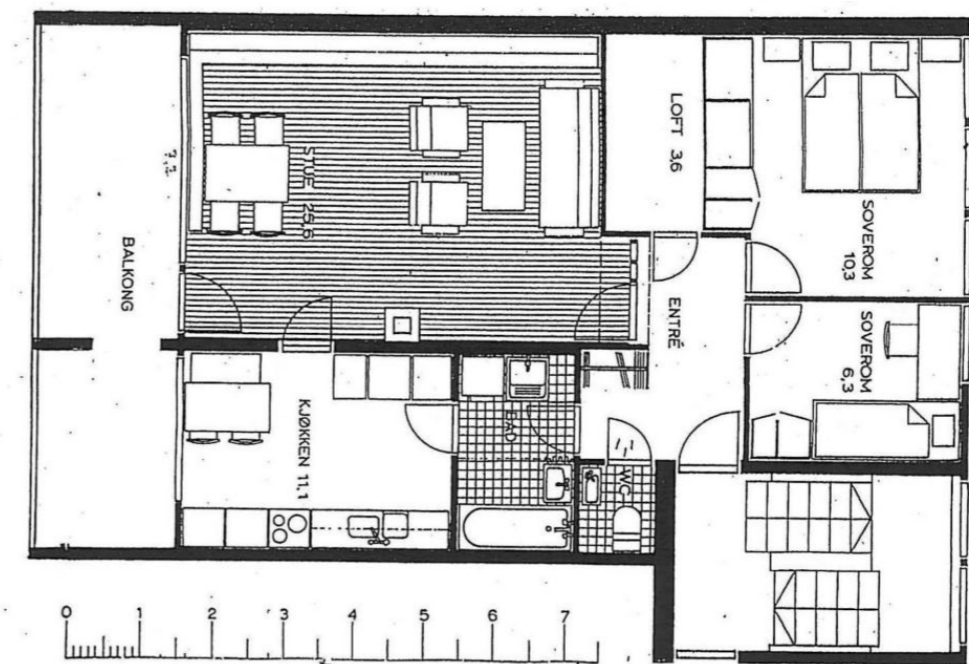


Fig. 9.4: 2-BEDROOM APARTMENT, 1:100 (vestliaborettslag.no)

RENOVATION HISTORY

The development of the buildings, which were completed between 1972 and 1975, utilized concrete structures that were typical for that time period.

The typical values and energy consumption of the original buildings are shown in Fig. 10.1, which provides a snapshot of the design and construction of the buildings at the time of their completion.

Since its completion in 1975, the buildings have undergone numerous maintenance procedures which involved the replacement of various components to meet the needs of their occupants and users. The renovations that have had a significant impact on the energy profile and service life of the buildings are included in Fig. 10.2.

	U-value (W/m ² K)	Total in- sulation thickness (mm)
Roof	0.42	100
Entrance facade	0.44	100
Balcony facade	0.44	100
Gable wall	0.39	100
Basement	1.1	50
Doors & windows	2.7	-
Floor to basement	0.49	60
Cold bridge	0.1 W/m ² K	
Heated area (BRA)	1833 m ²	
Heated volume	4575 m ³	
Specific energy budget	231.4 kWh/m ² /yr	
Annual energy budget	424,140 kWh/yr	

Fig. 10.1: CHARACTERISTICS OF THE ORIGINAL BUILDINGS (Skeie et al, 2018)

1972-1975

Completed the buildings

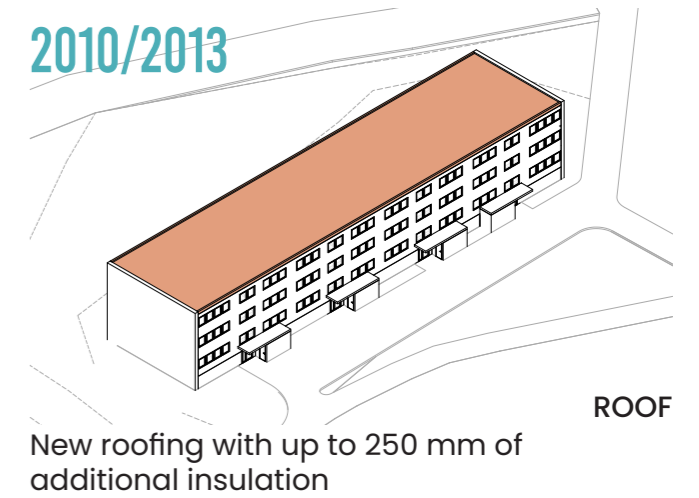
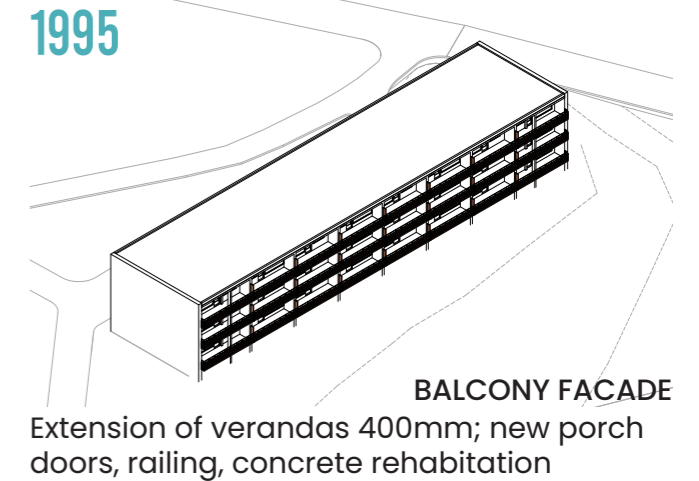
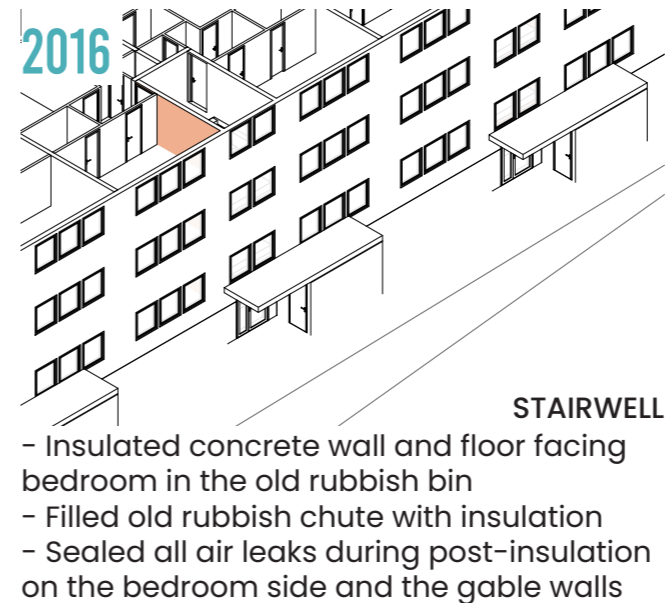
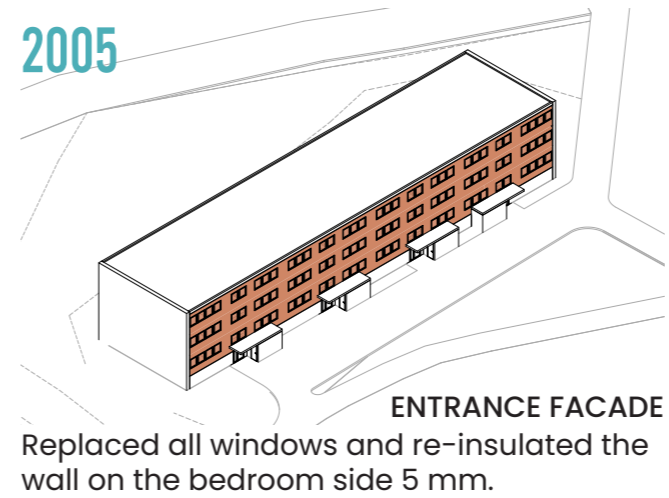
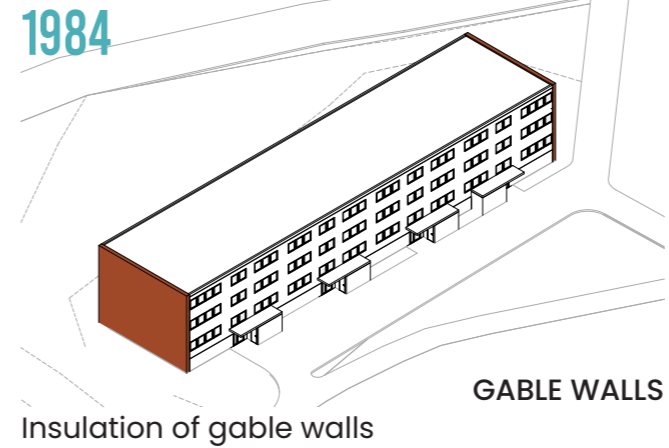
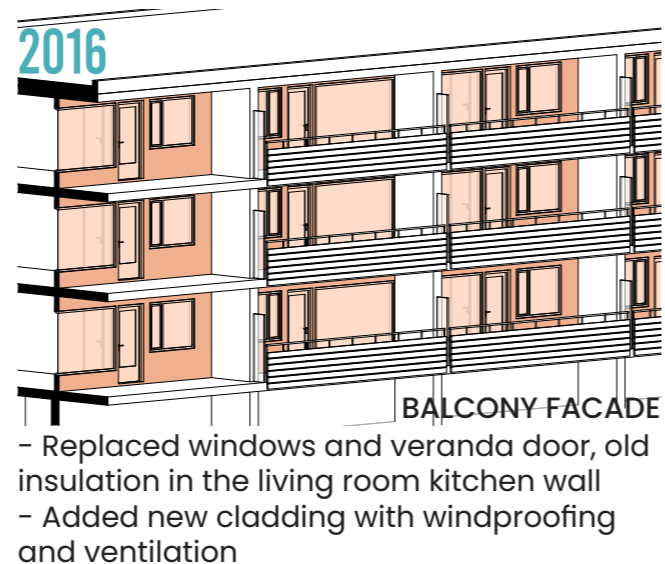


Fig. 10.2: RENOVATION FROM 1984 (vestliaborettslag.no)

CURRENT SITUATION

ASSUMPTIONS FOR CURRENT SITUATION

In 2018, SINTEF published a report titled “Rehabilitering av borettslag til nesten nullenerginivå” (Skeie et al., 2018), which aimed to upgrade Vestlia borettslag to nZEB level. The report compared two options for energy upgrades: a simple upgrade and an nZEB upgrade. Fig.11.1 shows the differences between the two proposals. In summary, the nZEB upgrade can reduce the energy budget by 47% compared to the simple upgrade. However, it also produces almost twice the amount of emissions from materials.

SINTEF’s “simple upgrade” is based on upgrades up until 2016, but the differences are not specified. A comparison with the renovation history suggests differences are likely in the balcony facade and gable walls. Vestlia’s website also mentions cleaning ventilation ducts and installing new ceiling

fans in communal facilities in 2016, but not in apartments for improved ventilation.

According to the “simple upgrade”, the windows on the balcony facade are double/triple-glazed with a U-value of 1.1 W/m²K, but were prescribed to be 0.8 W/m²K by Rojo Arkitekter as part of the renovation carried out in 2016. The old insulation layer of 100mm was also replaced.

The gable walls have 100mm of external insulation and were planned to have an additional 50mm internally but was not carried out (Skeie et al., 2018). The gable walls insulation in 1984 does not specify the thickness. So the worse scenario is assumed.

Fig.11.2 summarizes the assumptions for the characteristics of present-day buildings based on available information.

		Simple	nZEB
Roof	Post-insulation of roof	+100mm	+200mm
Main facades	Post-insulation of entrance facade	+50mm	+150mm
	Post-insulation/ renovation of balcony facade	new cladding, windows	+150mm
	Windows & doors’ U-value	1.1 W/m ² K	0.8 W/m ² K
	Post-insulation of partition walls on balcony side to reduce thermal bridge	-	+50mm
	Post insulation of balcony decks	-	+50mm
Gable walls	Post-insulation	+50mm internally	+150mm externally
Basement	Drainage & post insulation	-	+150mm
	Ceiling	-	+150mm
	Post-insulation of stairwell	-	+50mm
Technical systems	Solar system	-	140m ²
	Ventilation	existing, fans	balanced ventilation
	Alternative systems for heating & hot water	-	yes
Specific energy budget (kWh/m ² /yr)		168	89.4
Emissions from materials (ton kgCO ₂ e)		68.3	122.8

Fig. 11.1: SIMPLE & NZEB UPGRADES PROPOSED BY SINTEF (Skeie et al., 2018)

	U-value (W/m ² K)	Total insulation thickness (mm)
Roof	0.2	200
Entrance facade	0.3	150
Balcony facade	0.44	100
Gable wall	0.39	100
Basement wall	1.1	50
Door & window - entrance facade (solar factor = 0.55)	1.19	-
Door & window - balcony facade (solar factor = 0.55)	0.8	-
Floor to basement	0.49	60
Cold bridge	0.07 W/m ² K	
Heated area (BRA)	1833 m ²	
Heated volume	4575 m ³	

■ differences from SINTEF’s simple upgrade

Fig.11.2: ASSUMPTIONS FOR THE CURRENT BUILDINGS (based on Skeie et al., 2018; Rojo Arkitekter)

Similar to the architectural proposals in “Treindustrille muligheter,” SINTEF’s Simien simulations are also meant for buildings with south-facing balconies. To establish the present-day condition of the selected building in this thesis, an additional energy simulation using assumed values is carried out in Simien. Fig.11.3 shows the assumed energy budget for current situation. The reduction in solar gain from the balconies is also taken into account.

Specific energy budget	178.8 kWh/m ²
Annual energy budget	327,659 kWh
per 1-bedroom apartment*	11,085 kWh
per 2-bedroom apartment*	12,695 kWh

*estimation

Fig. 11.3: ASSUMED CURRENT ENERGY BUDGET

NEXT STEPS

For the next steps, the proposed solutions for the SINTEF’s “nZEB upgrade” are assessed to evaluate their suitability with the goals of this thesis, which can help determine the next course of action for the existing floors.

The proposals for nZEB upgrades for the roof, gable walls, and basement can be carried out without affecting any existing apartments. In addition, the roof renovation can be incorporated into the addition of 2 new floors on top.

The entrance facade underwent renovation in 2005 with new windows, cladding, and an additional 50mm of insulation. Adding an additional 150mm of insulation, as proposed in the “nZEB upgrade”, will likely require replacing the windows again. This is because simply adding insulation would result in the windows being placed at least 150mm away from the external wall, increasing the thermal bridge and low internal surface temperature at the transitions between frame and sash. Therefore, additional insulation should at least be added to the frame. Placing the windows on the new insulation layer is a better solution and provides better daylight. (Klinski, 2014, p.15) Given that the entrance facade was renovated 18 years ago and the goal is to avoid disturbing the existing, the renovation of this facade can be postponed until the end of its service life.

For the balcony facade, re-insulating can be difficult because it requires precise measurements of the existing balcony facades in order to make fitting elements. Additionally, this facade consists of a large area of doors and windows, which were replaced with new and more efficient ones (U-value = 0.8 W/m² K) only 8 years ago. Therefore, other options include leaving this facade until the end of its service life or proposing a less intrusive measure.

ACCESSIBILITY

INTERNAL SOLUTIONS

The thesis explores the possibility of enhancing accessibility to all existing apartments by adding new internal lifts.

Option 1 replaces the existing staircases with 4 lifts and adds new stairs. This solution creates minor changes to all apartments.

Option 2 involves 2 lifts replacing 2 staircases. However, it requires reducing the area of 4 apartments on each floor. In return, it can add 2 new small apartments while leaving 4 apartments unchanged.

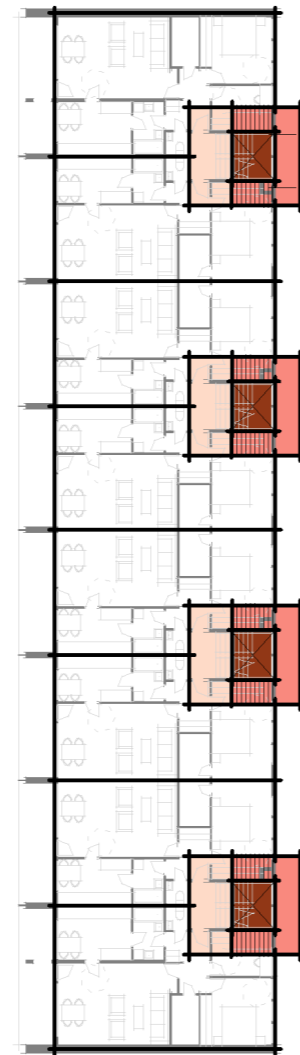
Option 3 proposes adding 1 new lift, resulting in a long and narrow corridor and significant changes to most apartments. While "Treindustrielle muligheter" prefers a solution with fewer lifts, this option requires too many changes.

Overall, option 2 requires the least change among the 3 internal options. However, all options are still challenging to implement because there are current tenants living there.

Elevator

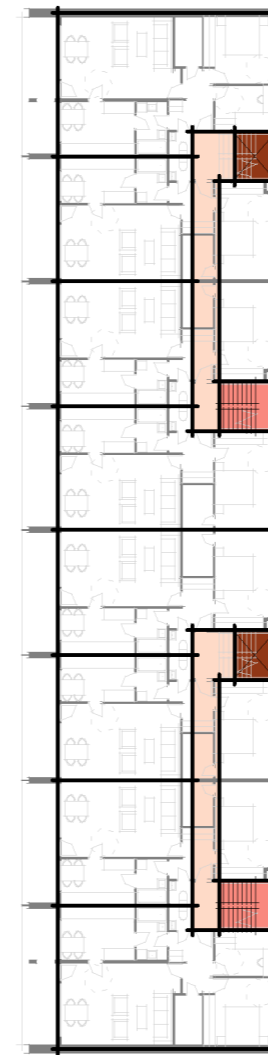
Staircase

Lobby/ corridor



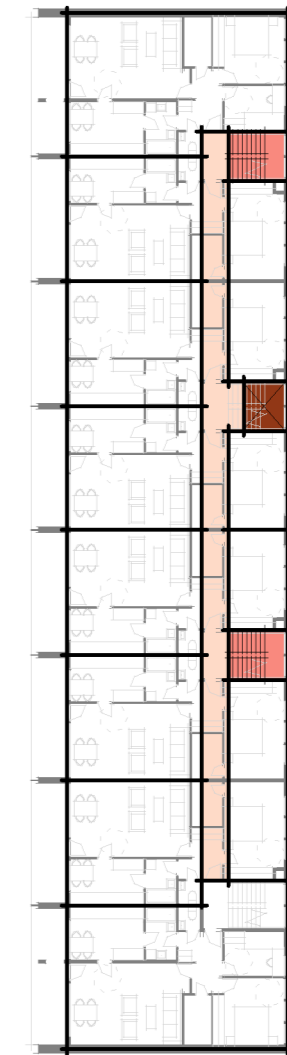
- Making all existing apartments accessible
- Too many lifts
- Changes to all apartments

Fig. 12.1: **OPTION 1: 4 LIFTS - PLAN - 1:400**



- Making all existing apartments accessible
- 6 new small apartments per block
- Opportunity to improve old apartments
- 12 unchanged apartments
- Moderate corridor
- Major changes to 12 apartments per block

Fig. 12.2: **OPTION 2: 2 LIFTS - PLAN - 1:400**



- Making all existing apartments accessible
- 9 new small apartments per block
- Opportunity to improve old apartments
- Long corridor
- Major changes to all apartments

Fig. 12.3: **OPTION 3: 1 LIFTS - PLAN - 1:400**

Elevator

Staircase

Lobby/ corridor



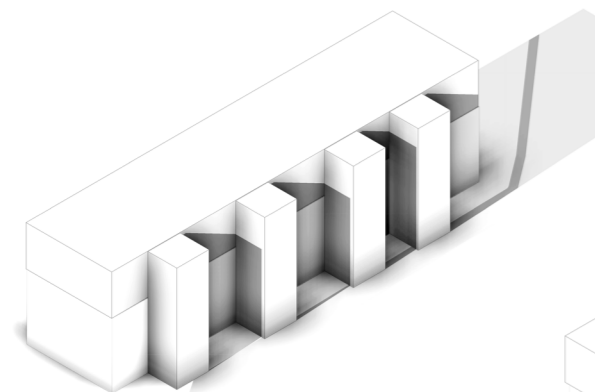
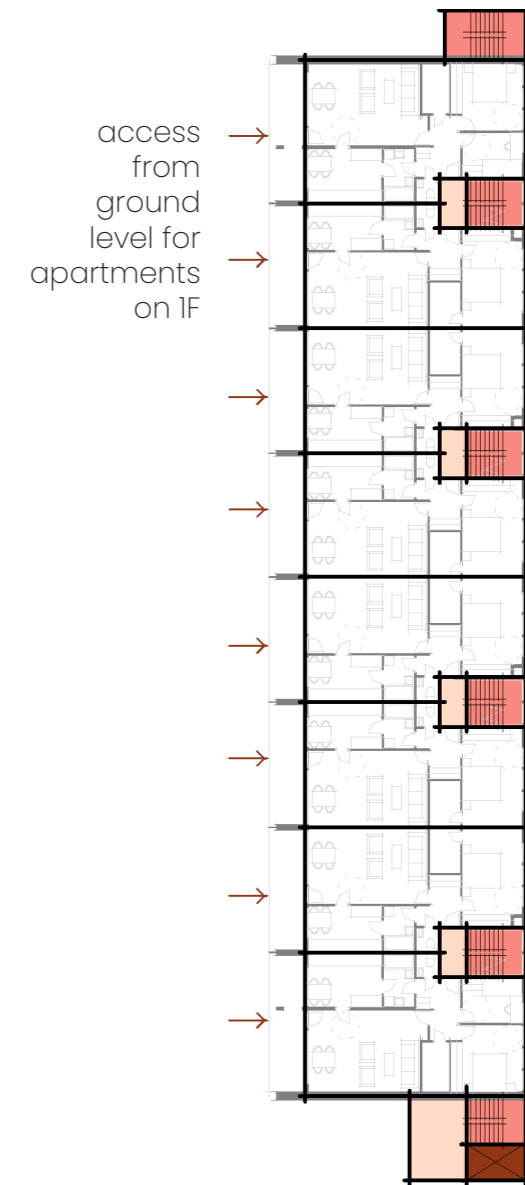
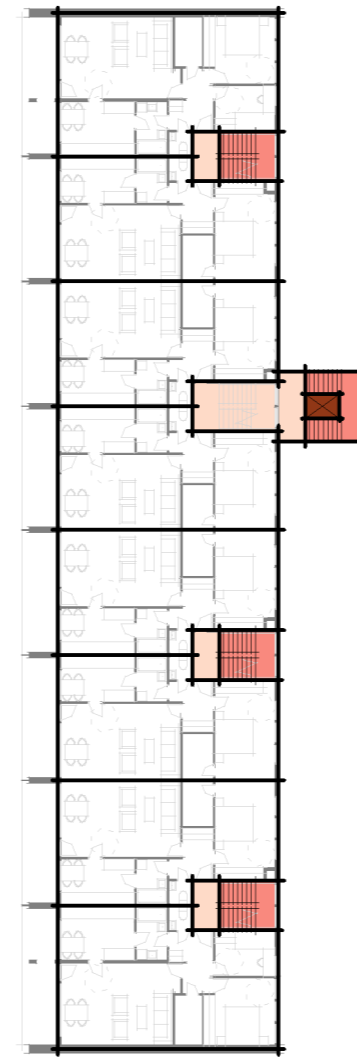
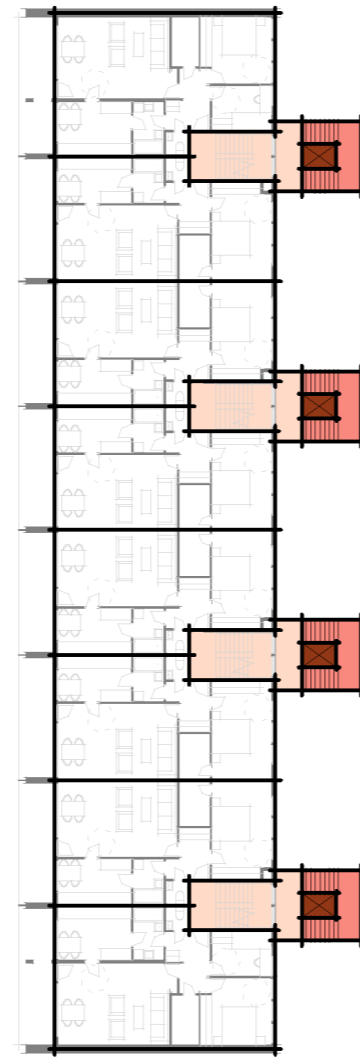
EXTERNAL SOLUTIONS

Option 4 is the proposal by Waugh Thistleton Architects for external staircases and lifts was designed for a block with a south-facing balcony. While the protruding stair cores do not have a significant impact on the north facade, they create more shadow on the east facade (Fig.13.1). In addition, having 4 new lifts is not ideal as suggested by "Treindustrielle muligheter".

Option 5 shows a partial upgrade solution is also possible by adding only one external stairwell. This option would make six apartments accessible while leaving the remaining 18 unchanged. A small intervention is required for the east facade if this option is chosen.

Option 6 proposes having the new stair core for the upper floors separately at the southern gable wall. The apartments on the first floor can become accessible by using ramps and platforms as part of the landscape on the west side of the building. This option can make eight apartments accessible without any major impact on the two main facades. Additionally, the new landscape has the potential to add new qualities to the entire development.

Therefore, option 6 is the chosen option for circulation.



- Making all existing apartments accessible
- No change to all apartments

- Too many lifts
- More shadows on the east facade
- Intervention to east facade

Fig. 13.2: OPTION 4: 4 LIFTS - PLAN - 1:400

- Making 6 existing apartments accessible
- No change to all apartments

- Intervention to east facade

Fig. 13.3: OPTION 5: 1 LIFT - PLAN - 1:400

- Making 8 existing apartment accessible
- No change to main facades
- Opportunity to improve the whole development with new landscape

- Separate circulation for the new floors on top

Fig. 13.4: OPTION 6: 1 LIFT - PLAN - 1:400

Fig. 13.1: OPTION 4: 4 LIFTS - 3D

4 CONCEPT

Based on the initial goals and analysis, the project's concept was developed. The strategy is to make the new addition benefit the existing while leaving options for the current residents.

SOCIAL SUSTAINABILITY

To achieve social sustainability, the project proposes solutions with minimal disturbance to existing tenants while increasing integration between the existing and the new.

The new addition on top aims for co-housing, which creates not only new apartments but also a community where both new and existing tenants can engage in different activities.

ENVIRONMENTAL IMPACT

From a life cycle perspective, the project will not replace materials that are not at the end of their service lives for the existing part. The renovation will use materials with low emissions.

To reduce energy consumption per family, the new apartments on top can be more compact compared to the existing apartments. This approach also provides options for tenants with different preferences for energy and/or living area.

Furthermore, renewable energy can be incorporated as part of the new addition to benefit both the new and the existing. A rain harvesting system can also be included as part of the new landscape.

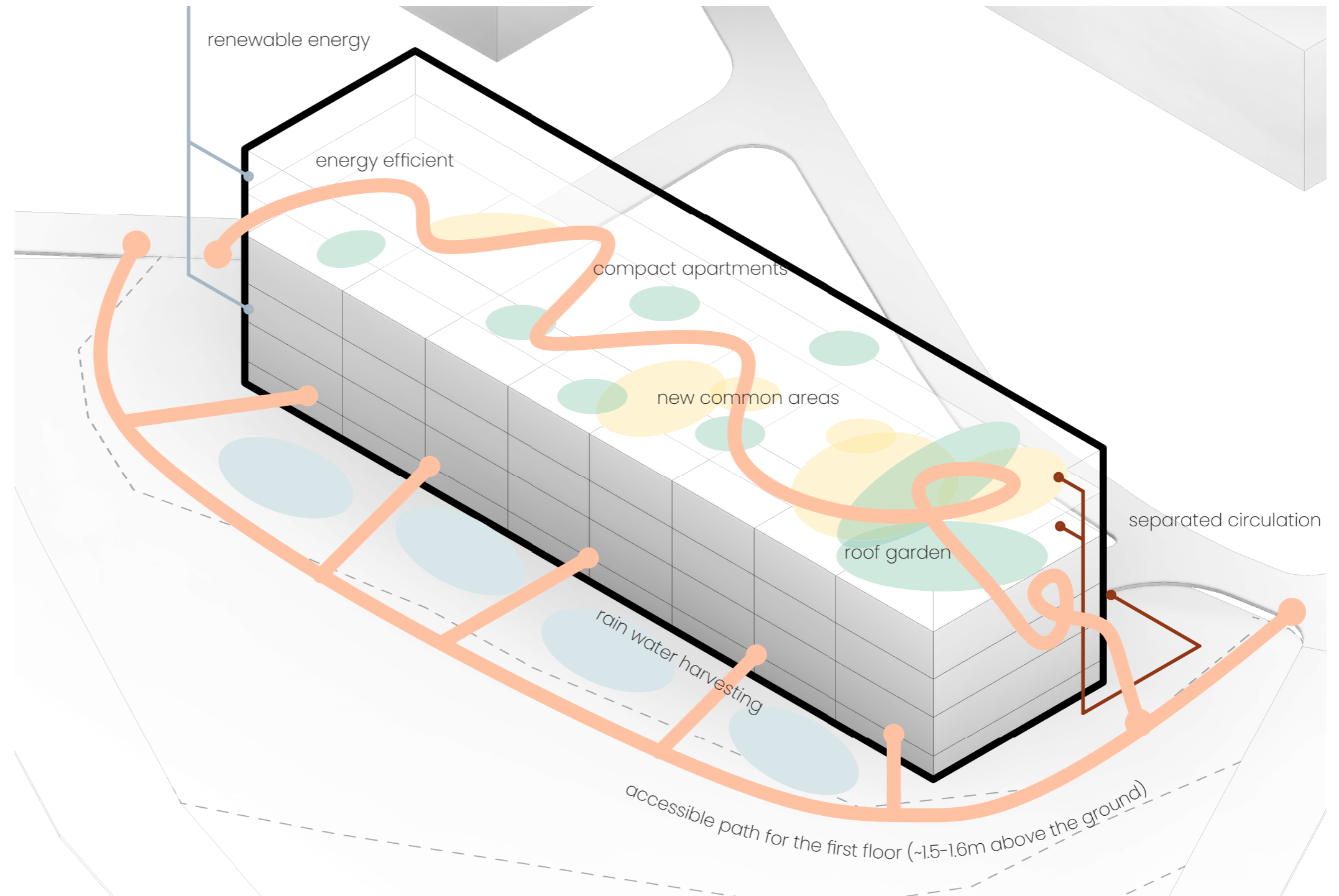
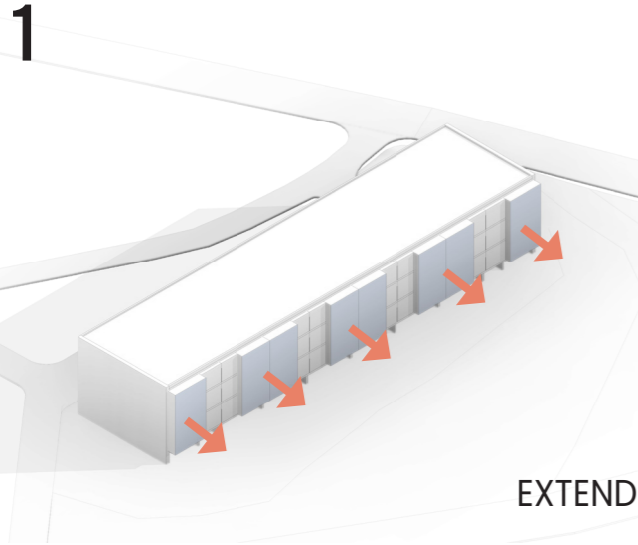


Fig. 14.1: CONCEPT

EXISTING

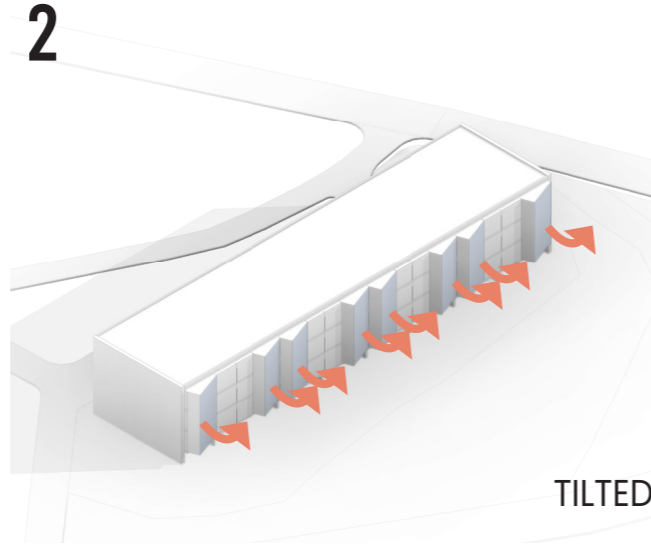


EXTEND

1- EXTEND

The balconies in front of the living rooms are partially extended, and the remaining area can be used for an optional extension of an extra bedroom.

This responds to a popular desire among existing residents for a new balcony, resulting in a new facade that can elevate the entire development. This aligns with survey responses described in "Beslutningsprosesser i borettslag" (Hauge et al., 2011), where residents typically prefer a larger balcony over better insulation, which does not result in a visible change to their home.



TILTED

2- TILTED

The balconies are glazed and tilted toward the southwest to receive more sunlight.

This is the proposed alternative to reinsulating and replacing the windows on this facade. While it is not as effective energy-wise, it is less intrusive to the existing residents. Byggforsk 726.608 shows glazing balconies as a solution for renovating existing buildings. Adding single glazing can turn the balconies into semi-climatized areas and extend the time period during which the balconies can be used.

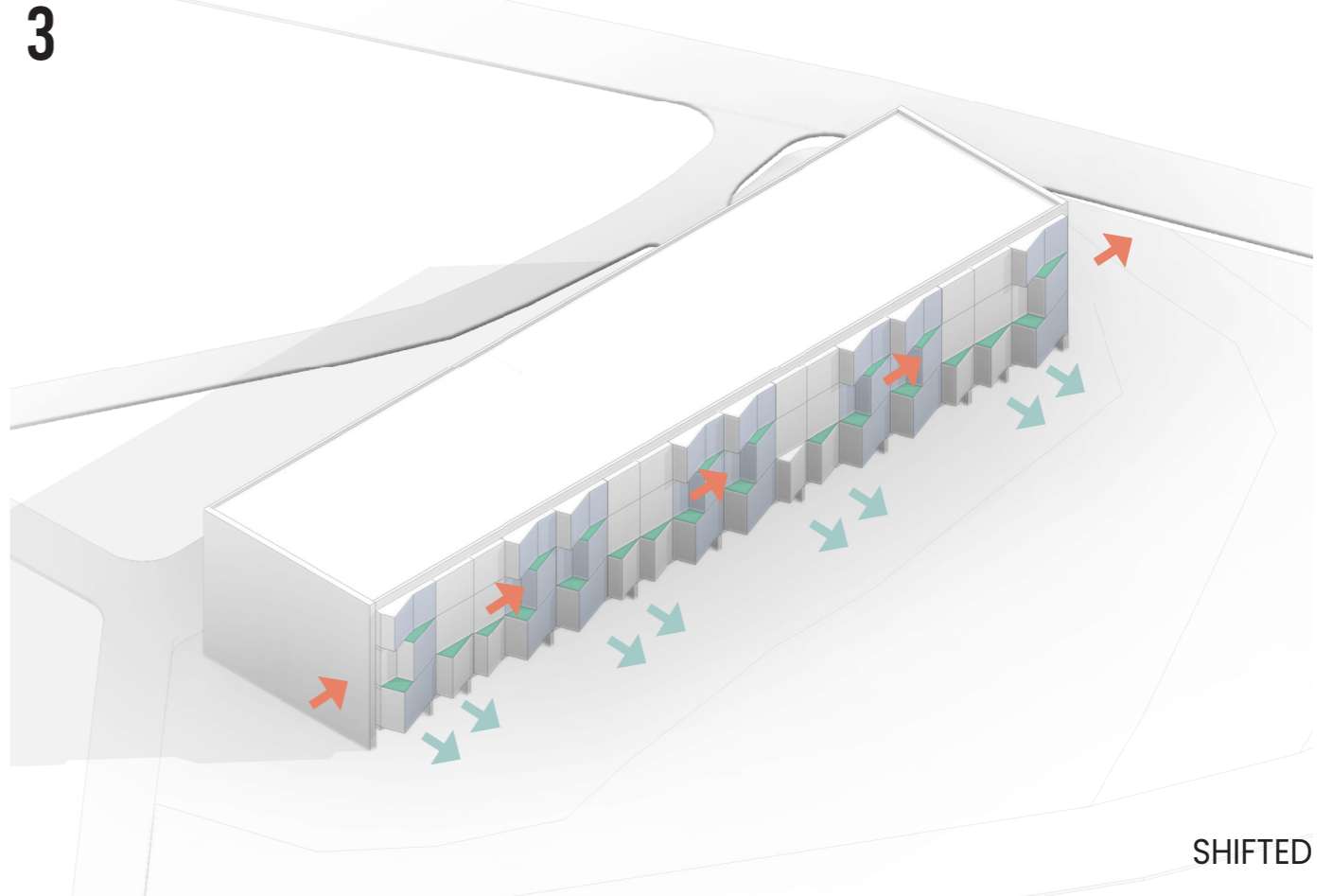
3- SHIFTED

Since the existing apartments can potentially be expanded with an extra bedroom, up to 5 people can live in each apartment. Byggforsk 361.501 proposes the following examples for the width of balconies:

- 2m for 5 people or 3 people with room for a wheelchair and a turning circle
- 2.6m to accommodate 7 people or 5 people with space for a wheelchair and a

turning circle

As the apartments on the first floor are renovated to be accessible, a width of 2.6m is chosen, while apartments on the second and third floors only require 2m. The angled balconies allow for a smooth transition between these changes, while also providing space for planting small vegetables for each apartment.



SHIFTED

NEW ADDITION

TPOLOGIES

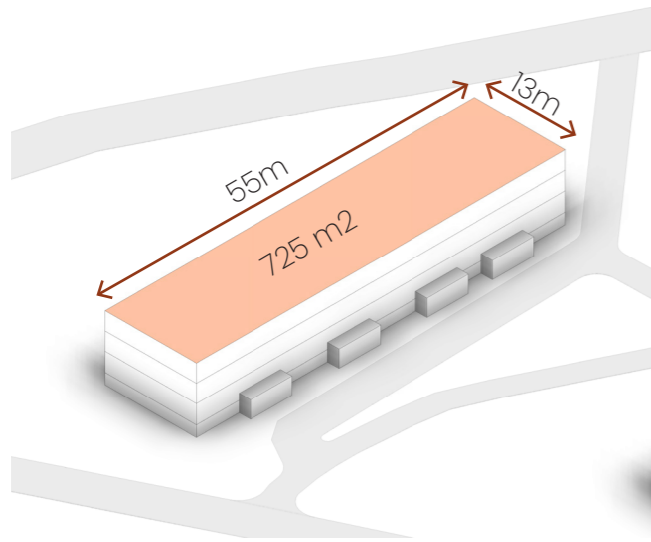


Fig. 16.1: ROOF AREA

SINGLE-LOADED CORRIDOR

Byggforsk 330.114 recommends a depth of 6–8m for one-sided apartments and 10–13m for two-sided apartments. Since the width of the building is 13m, if the new floors use a single-loaded corridor, it will likely result in one of the following scenarios:

- The apartments are two-sided, one of which has to open to the corridor (Fig.16.2). Additionally, compact apartments become long and narrow in this case.

- Apartments with a width of up to 8m will leave at least 5m for the corridor (Fig.16.3). While this corridor can be combined with social activities, there can only be a maximum of $8 \times 55 \times 2 = 880 \text{m}^2$ for apartments, as opposed to the approximate 1000m^2 proposed by “Treindustrielle Muligheter”

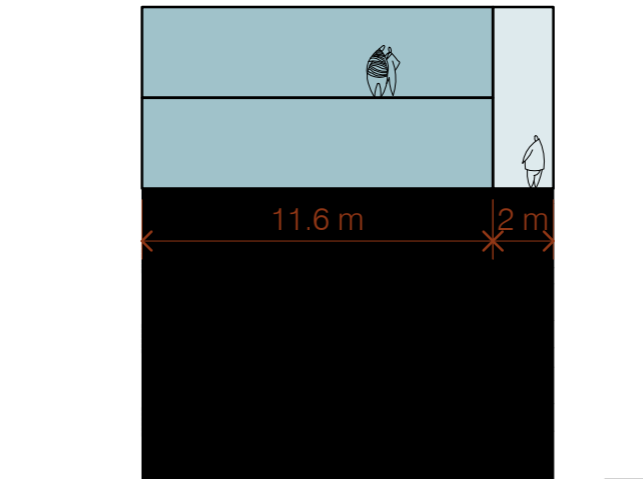


Fig. 16.2: SINGLE-LOADED CORRIDOR & TWO-SIDED APARTMENTS

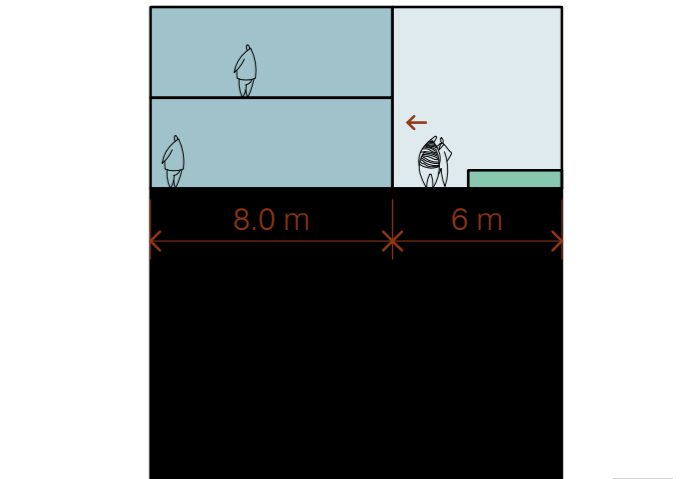


Fig. 16.3: SINGLE-LOADED CORRIDOR & ONE-SIDED APARTMENTS

One of the goals for the rooftop apartments at Vestlia is to reduce energy consumption per family by making them compact, while still leaving space for indoor social activities, which is currently lacking.

“Treindustrielle Muligheter” proposed having 8 apartments per floor, the same as the existing ones. If the new apartments are compact, there is potential to add more than 16 in total.

DOUBLE-LOADED CORRIDOR

Compared to the single-loaded corridor typology, the double-loaded corridor can accommodate more than 8 compact apartments per floor (Fig.16.4).

By overhanging the new units, the roof area can be maximized, and there is an increased potential to make use of the space in between (Fig.16.5). This is why the project has opted for this direction.

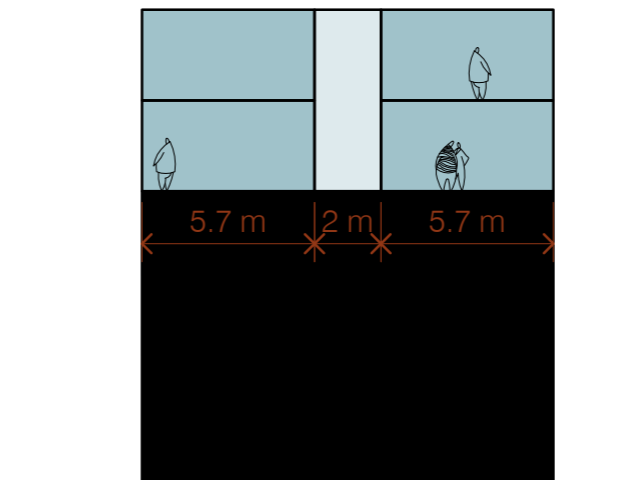


Fig. 16.4: DOUBLE-LOADED CORRIDOR & ONE-SIDED APARTMENTS

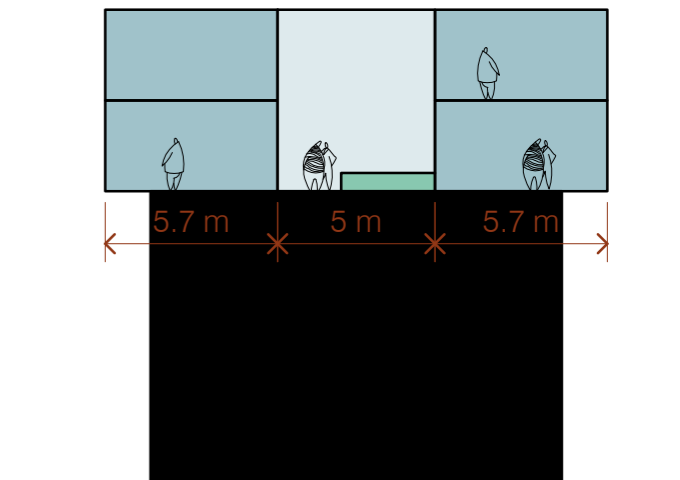
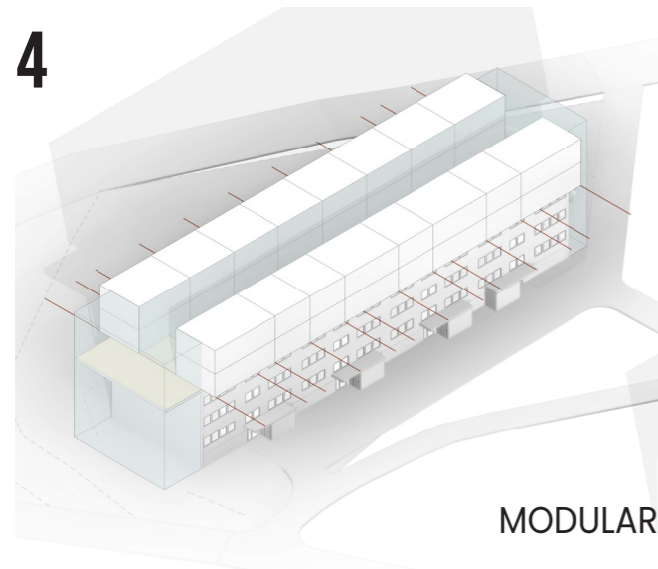


Fig. 16.5: DOUBLE-LOADED CORRIDOR & OVERHANG ONE-SIDED APARTMENTS

DEVELOPMENT

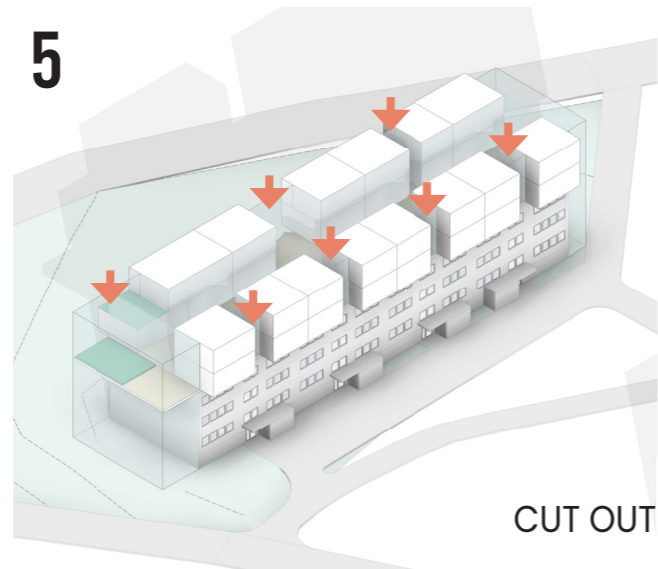
4



4- MODULAR

The new units on top are modular and compact while following the existing structural grids. To maximize the roof area, the new units are overhung, leaving more space for the corridor and common areas in between.

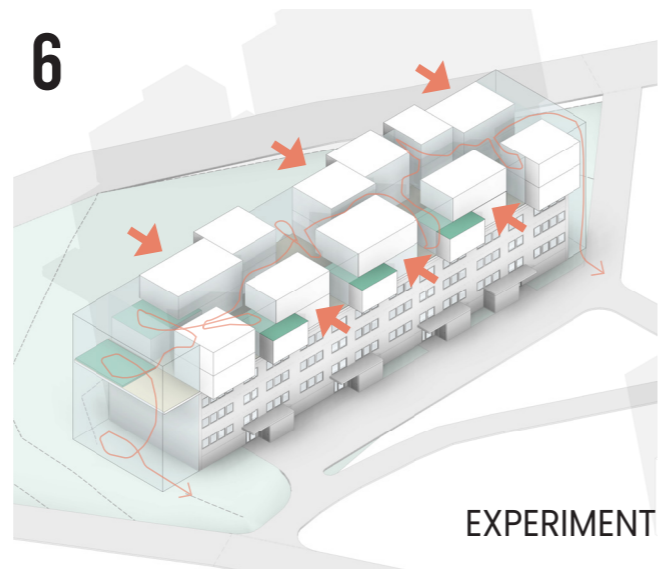
5



5- CUT OUT

To add roof gardens and bring more activities to the common space between the new apartments, small areas are cut out to allow for views and daylight.

6



6- EXPERIMENT

Next, the units are shifted to create a more seamless transition between the common space and the living space. This way, the space can also be subdivided while encouraging exploration.

7- REFINE

The entire rooftop is comprised of a greenhouse located on the south side next to the new lobby to maximize the amount of sunlight it receives, which can contribute to passive heating. An atrium space for activities with roof lights is located between the apartments. The new apartments have tilted balconies that match the renovated balconies on the existing floors.

7



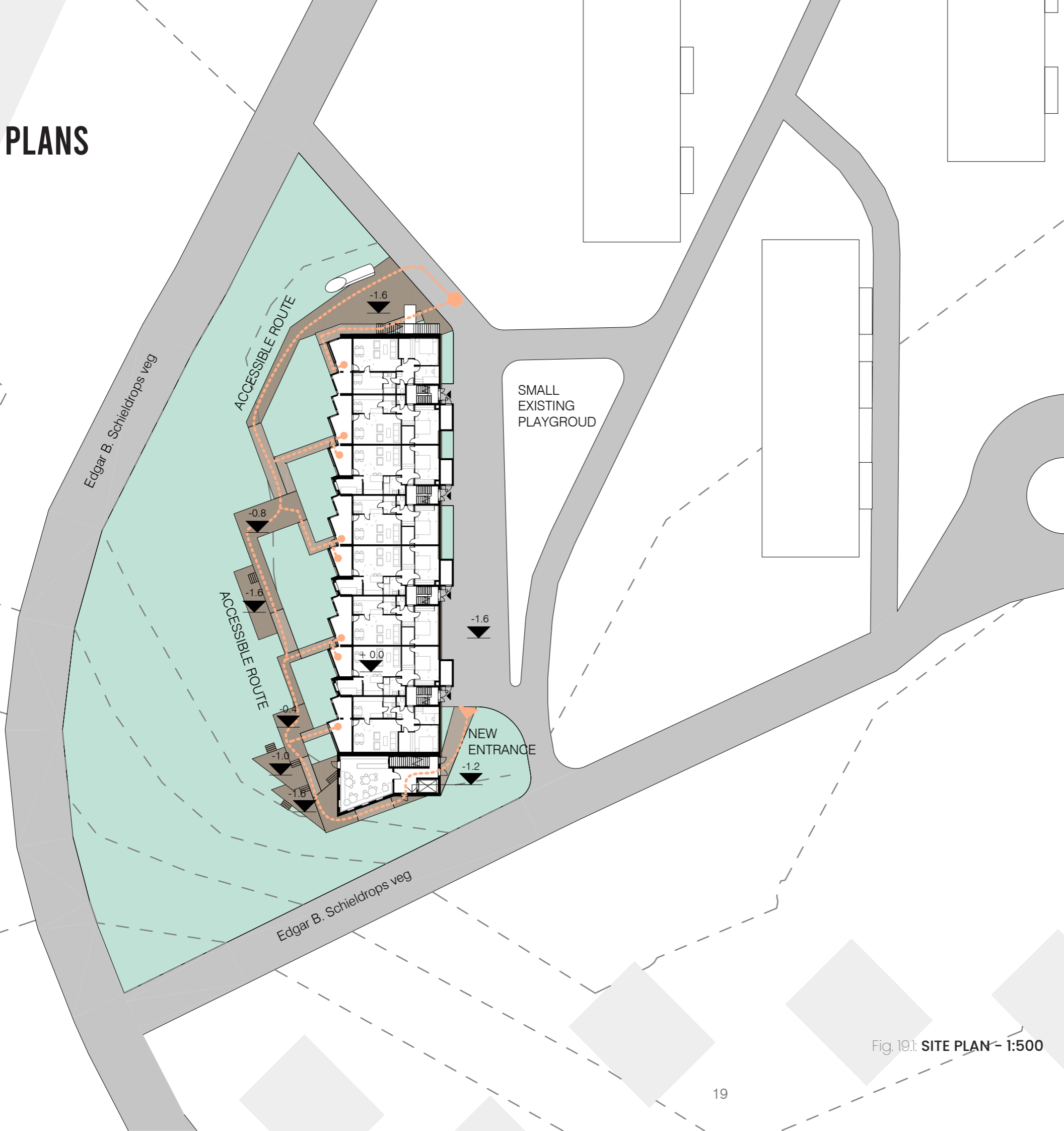
5 PROPOSAL



The proposed addition includes 26 new rooftop apartments with separate circulation located south of the existing building. Additionally, new functions such as a cafe, multipurpose room/party space, and a small workshop is added, with the central activities revolving around a gardening theme to complement the rooftop apartments. This space can also be shared with existing tenants.

PLANS

0 2 10m



The new entrance for the new addition can be accessed from the same route as the existing ones. It is linked to new shared amenities. There is an additional entrance/escape route on the north side combined with a slider to connect with the existing playground.

In addition, the wheelchair access route on the west side can be combined with platforms that can be used as a new outdoor hangout area.

Fig. 19: SITE PLAN - 1:500

0 1 5m

- 2-bedroom apartment
- Optional upgraded 2-bedroom apartment
- 1-bedroom apartment
- Optional upgraded 1-bedroom apartment
- Common area
- Garden



Fig. 20.1: 1F - 1:250



Fig. 20.2: 2F - 1:250



Fig. 20.3: 3F - 1:250

REGULAR APARTMENTS

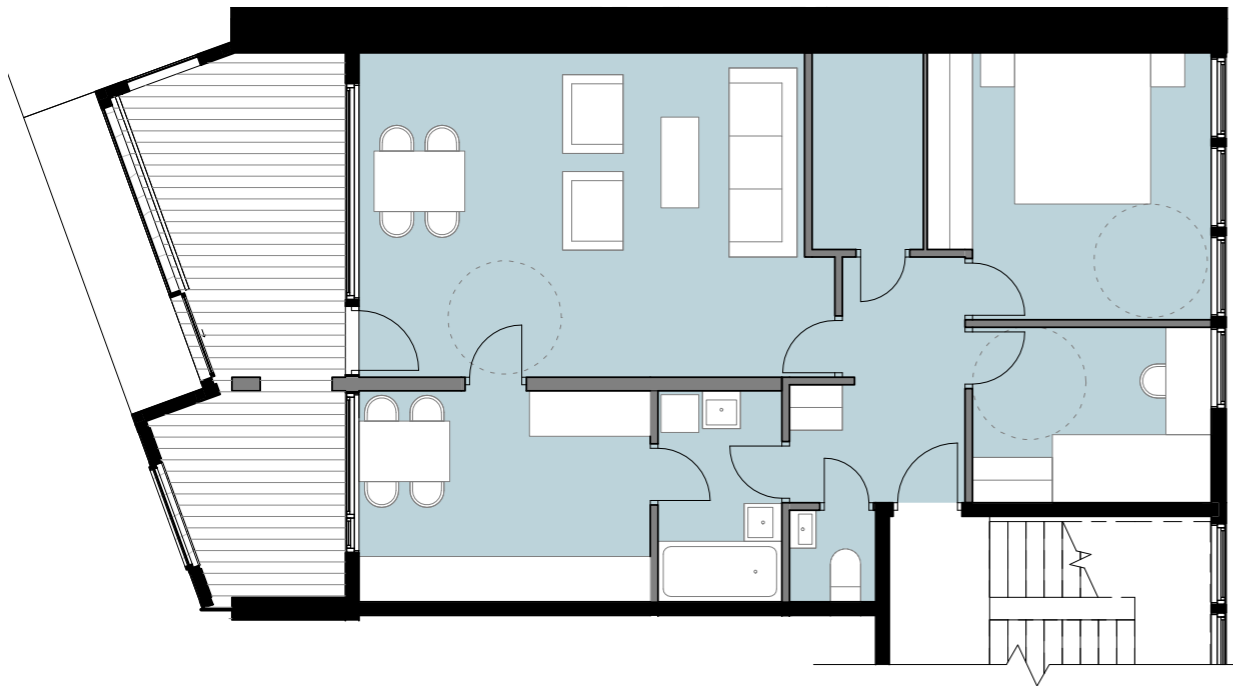


Fig. 211: RENOVATED 2-BEDROOM APARTMENT - 1:100

APARTMENTS WITH VOLUNTARY UPGRADES



Fig. 211: 3-BEDROOM APARTMENT - OPTIONAL UPGRADE - 1:100

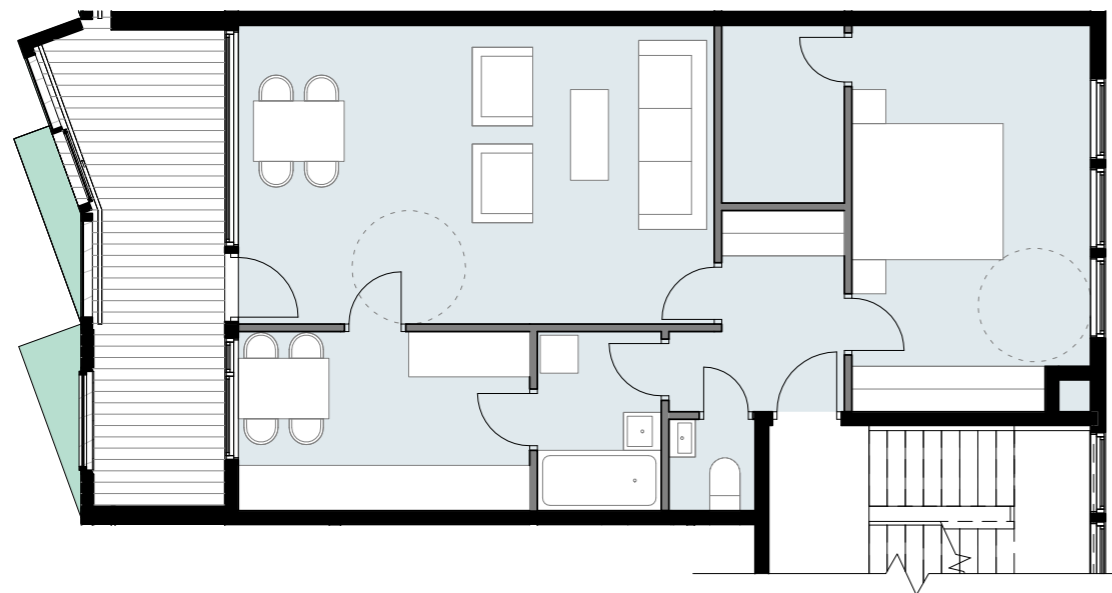


Fig. 211: RENOVATED 1-BEDROOM APARTMENT - 1:100

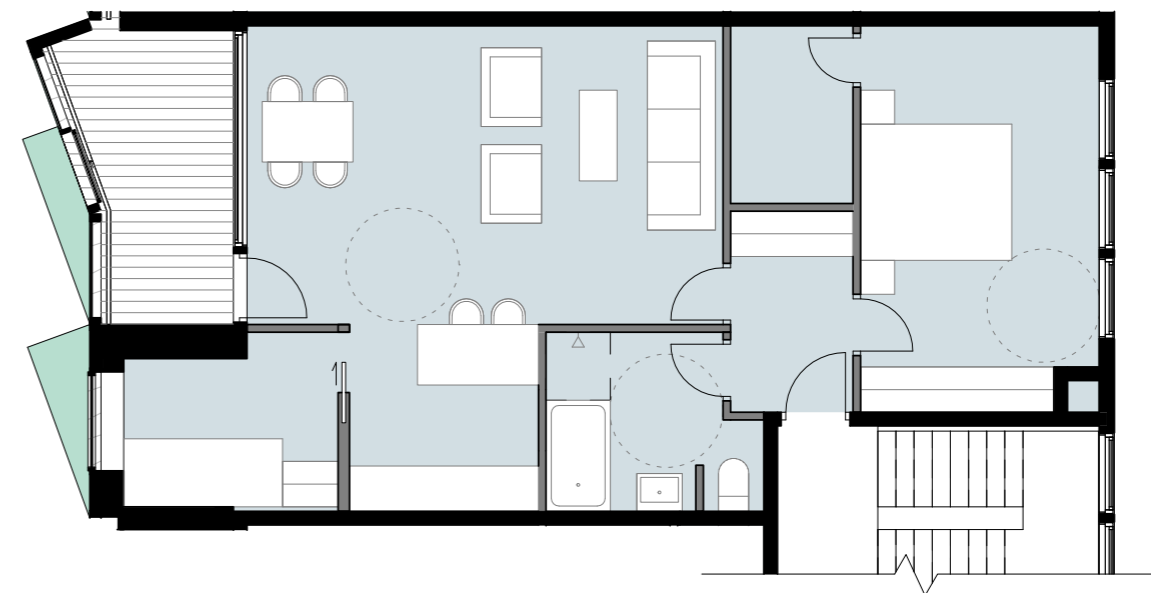


Fig. 212: 3-BEDROOM APARTMENT - OPTIONAL UPGRADE - 1:100

In addition to the larger balconies, tenants of the existing apartments can opt for voluntary upgrades. These upgrades include renovations to create a larger, combined bathroom, an open kitchen, and balanced ventilation, as well as the addition of an extra bedroom. Tenants can also extend their bedrooms on their own at a later stage.

0 1 5m

- 2-bedroom apartment
- 1-bedroom apartment
- Studio apartment
- Common area
- Garden

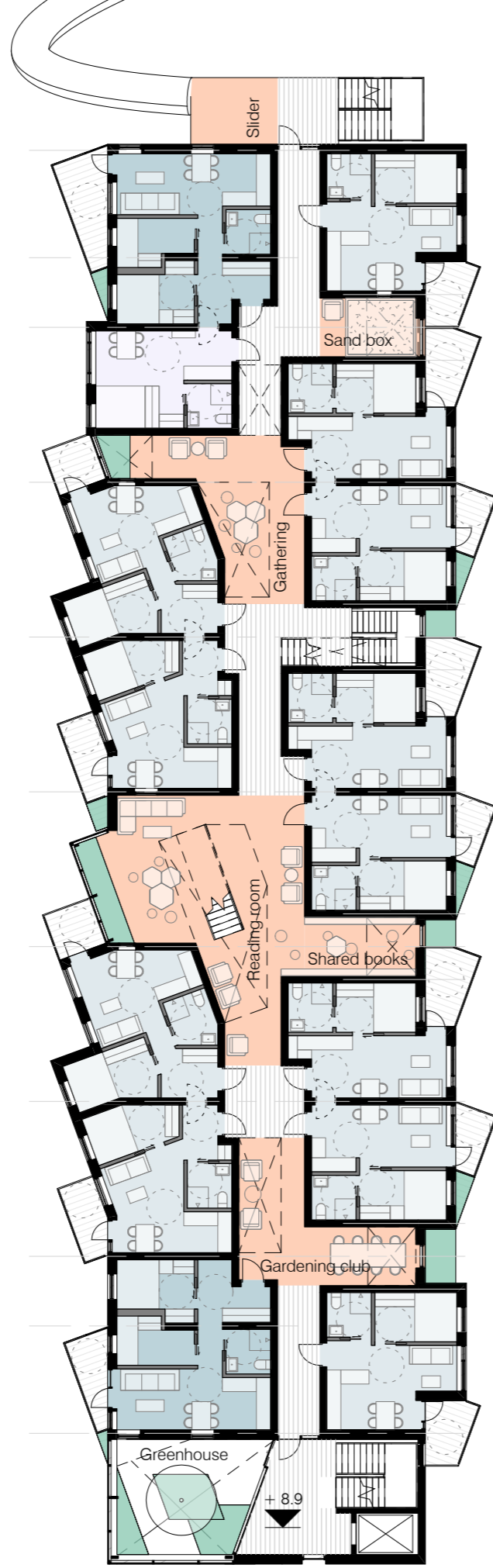


Fig. 221: 4F - 1:250

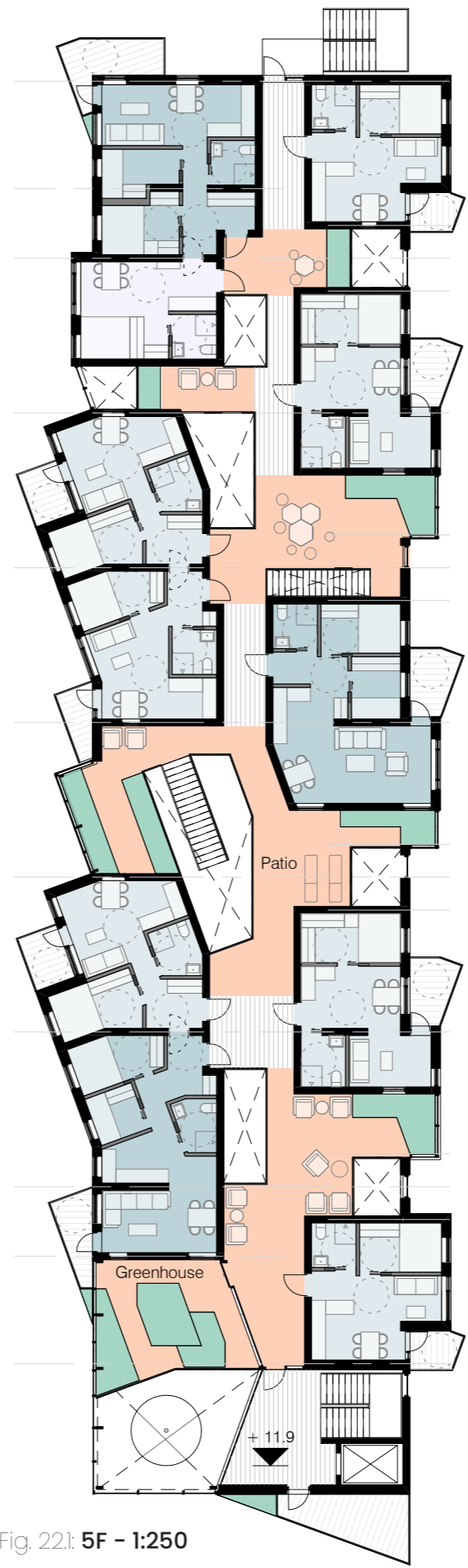


Fig. 221: 5F - 1:250

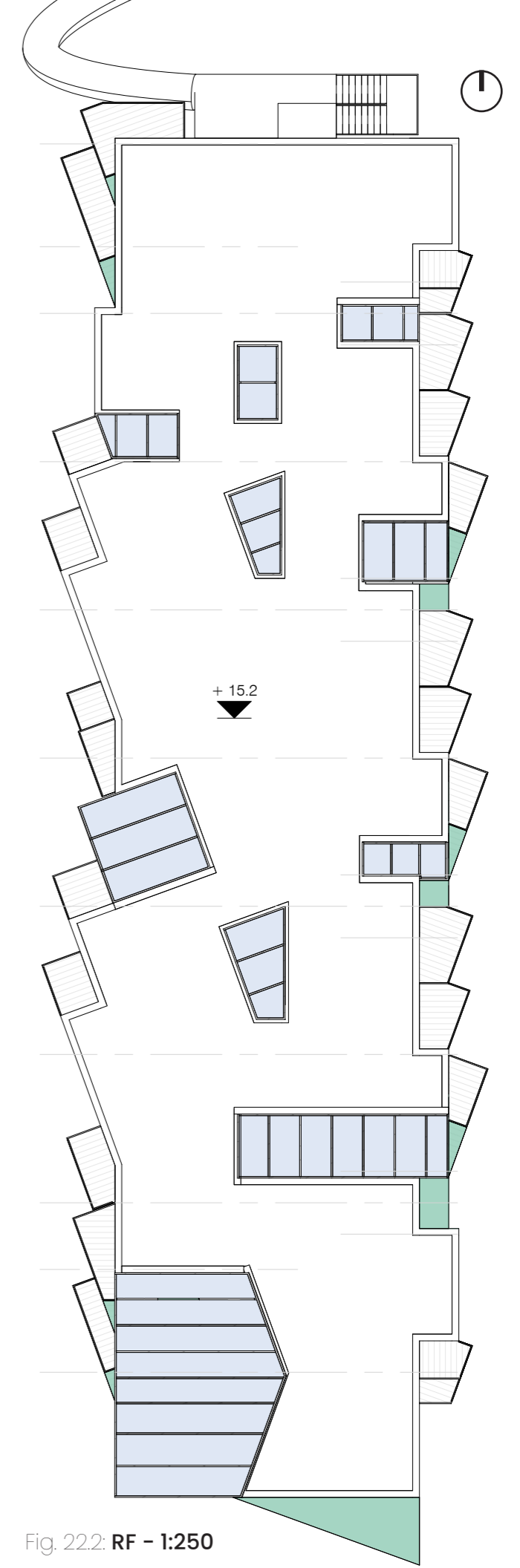
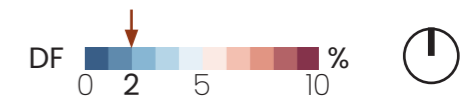


Fig. 222: RF - 1:250

The 4th and 5th floors of the building feature new, compact apartments. These units are separated by double-height common areas, which aim to bring the community together.

Most of the apartments have one or two bedrooms, but there is also an opportunity for future expansion.

The 5th floor has a more open area and offers more apartments with views of the gardens.



EXISTING

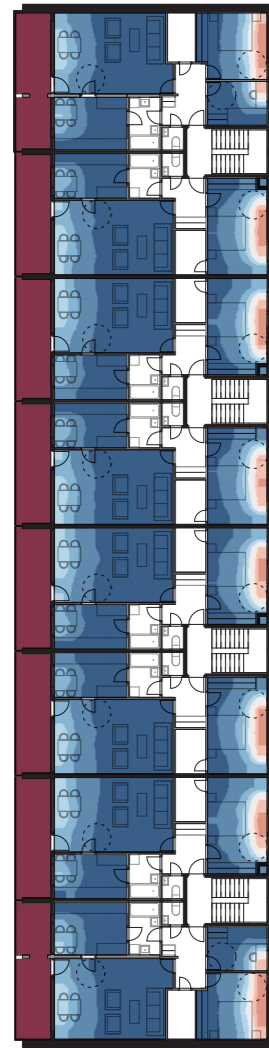


Fig. 23.1: DAYLIGHT FACTOR - EXISTING UNITS

Due to the long balconies covering the entire west facade, the daylight factor in most areas of the existing living rooms is below 2% (Fig.23.1). Expanding the usable area by adding an extra bedroom can make use of the large but not very frequently used balcony area. Although the newly expanded

RENOVATED

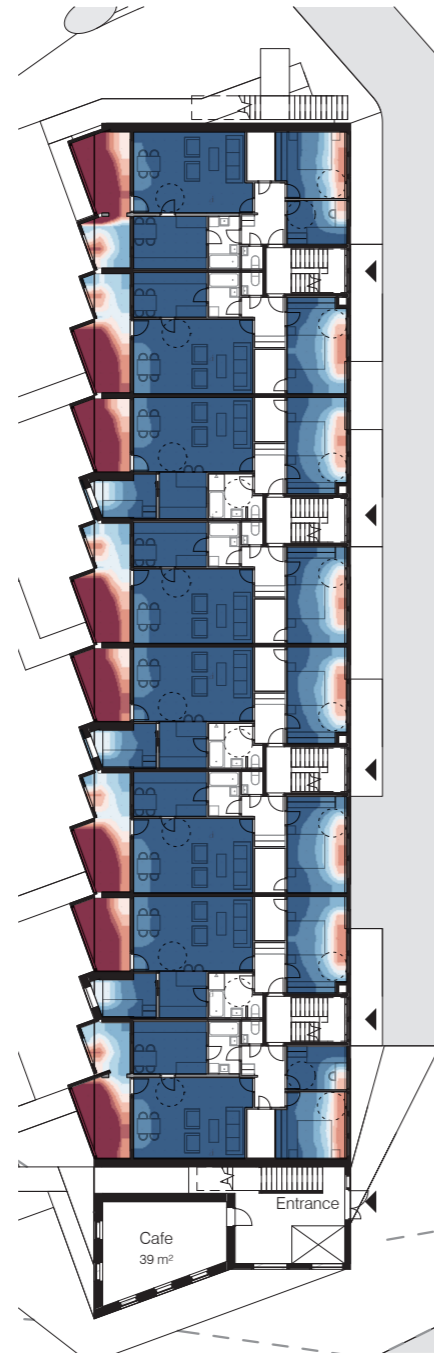


Fig. 23.2: DAYLIGHT FACTOR - RENOVATED UNITS - 1F

and single-glazed balcony reduces the daylight factor in the living room compared to the existing condition, it increases the usable area throughout the year (Fig.23.2, Fig.23.3, Fig.23.4). This suggests further study with finishing materials to improve the situation.

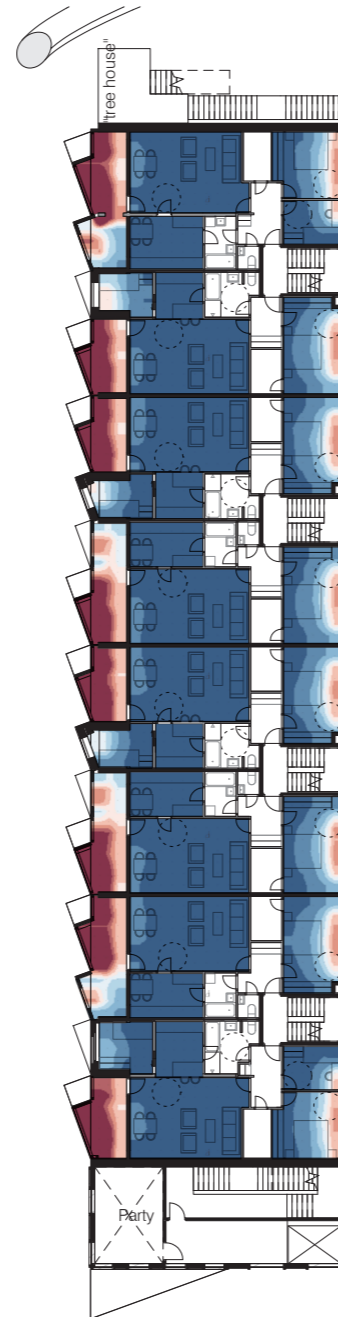


Fig. 23.3: DAYLIGHT FACTOR - RENOVATED UNITS - 2F

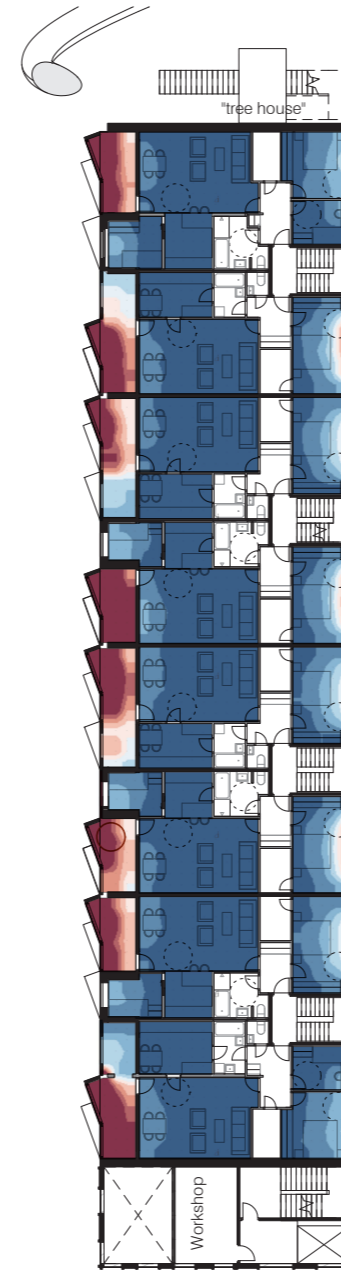


Fig. 23.4: DAYLIGHT FACTOR - RENOVATED UNITS - 3F

For the new apartments (Fig.23.5& Fig.23.6), the ratio between the total area of doors and windows to their heated area (BRA) is maintained at 28-30%. Because rooftop apartments already have access to common space, balcony sizes are minimized to allow more daylight into the apartments. Balcony

NEW ADDITION

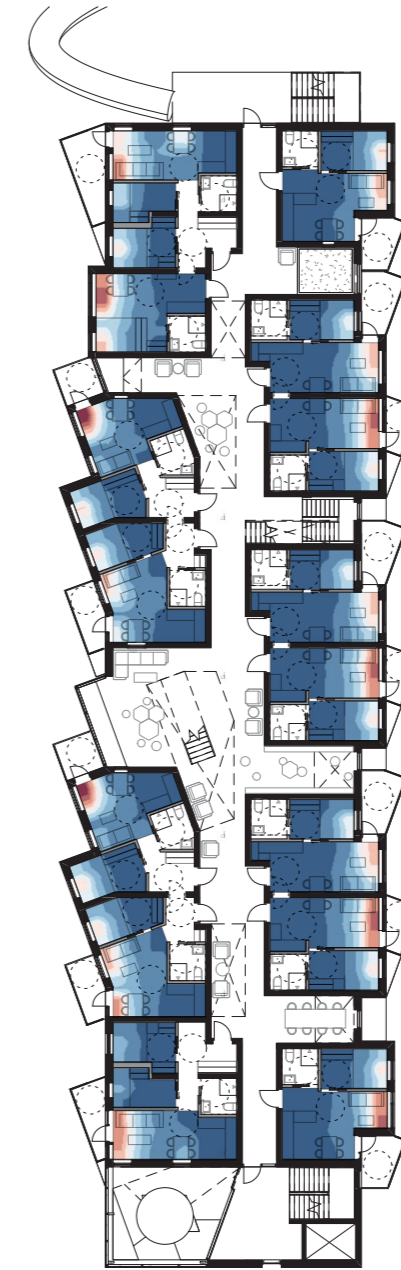


Fig. 23.5: DAYLIGHT FACTOR - NEW UNITS- 4F

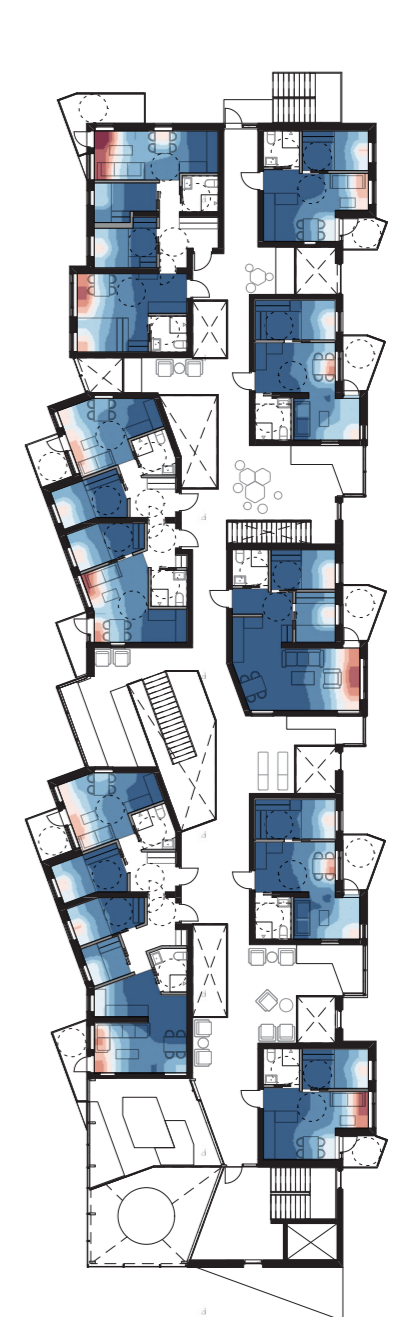


Fig. 23.6: DAYLIGHT FACTOR - NEW UNITS- 5F

locations on both floors are shifted to allow more sunlight into both the balconies and the interior spaces.

Overall, the new apartments have better natural daylight than the existing ones. This is partly because they are shallower than the existing apartments.

APARTMENTS THAT CAN BE EXPANDED

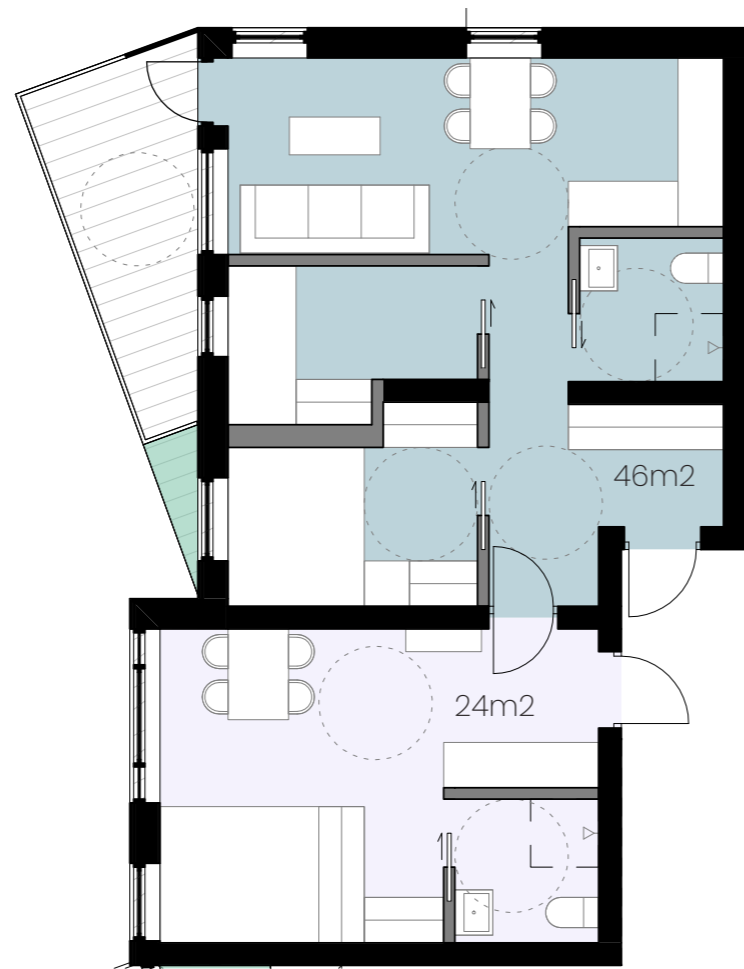


Fig. 24: 2B TYPE 1 + STUDIO - 1:100

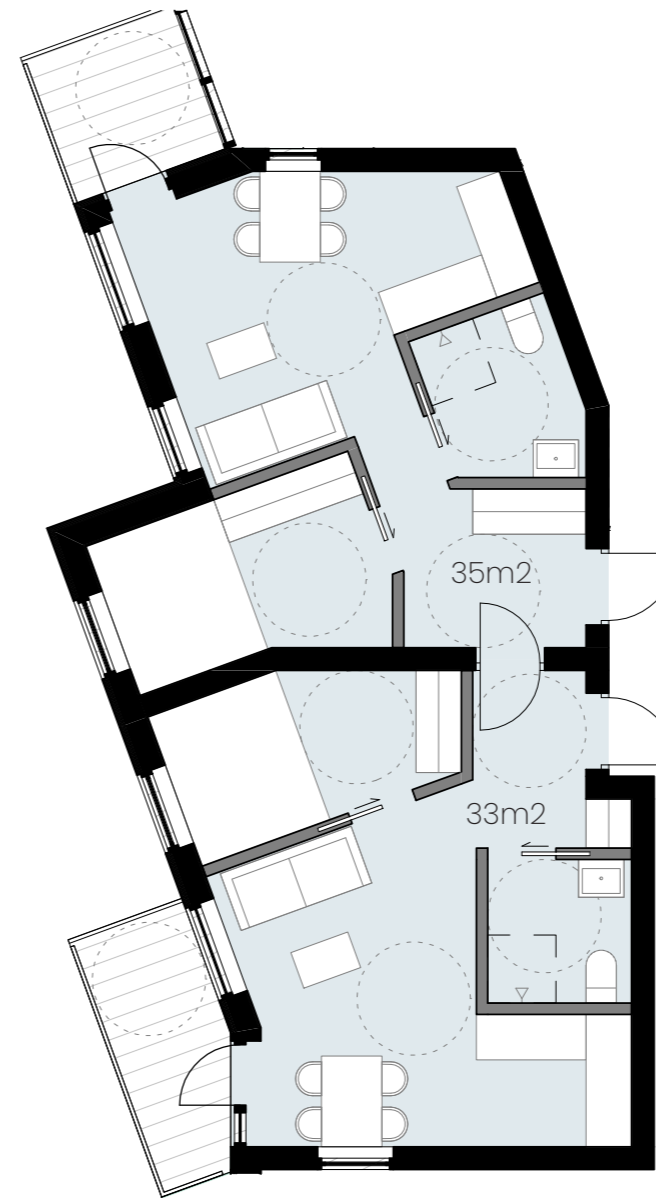


Fig. 24: 1B TYPE 1 FLEXIBLE - 1:100

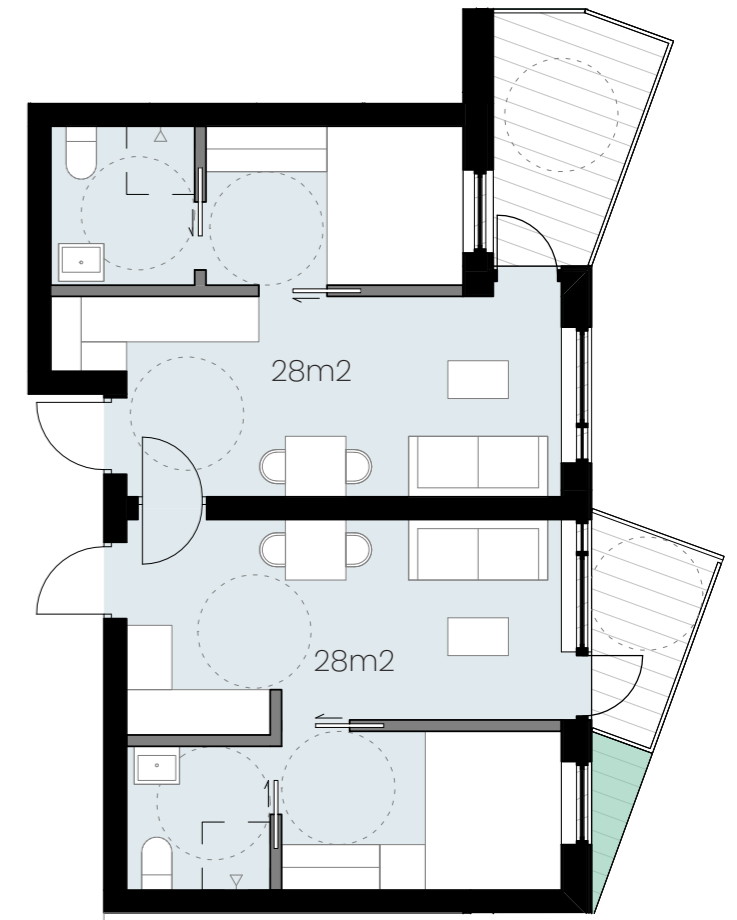


Fig. 24: 1B TYPE 2 FLEXIBLE - 1:100

APARTMENTS WITH VIEWS TO GARDENS

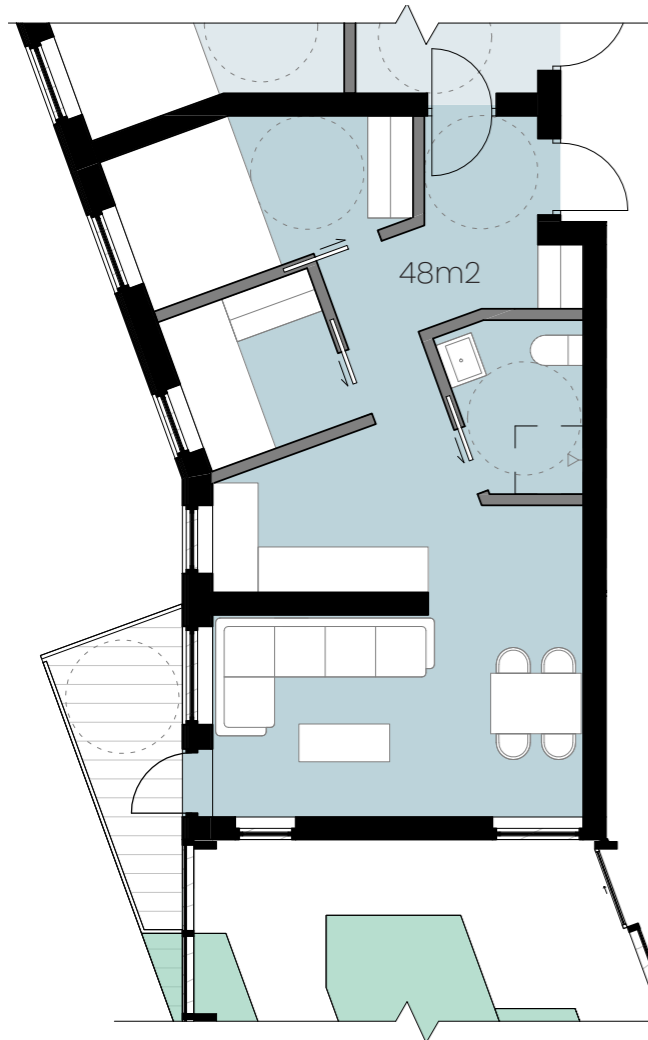


Fig. 25: 2B TYPE 2 - 1:100

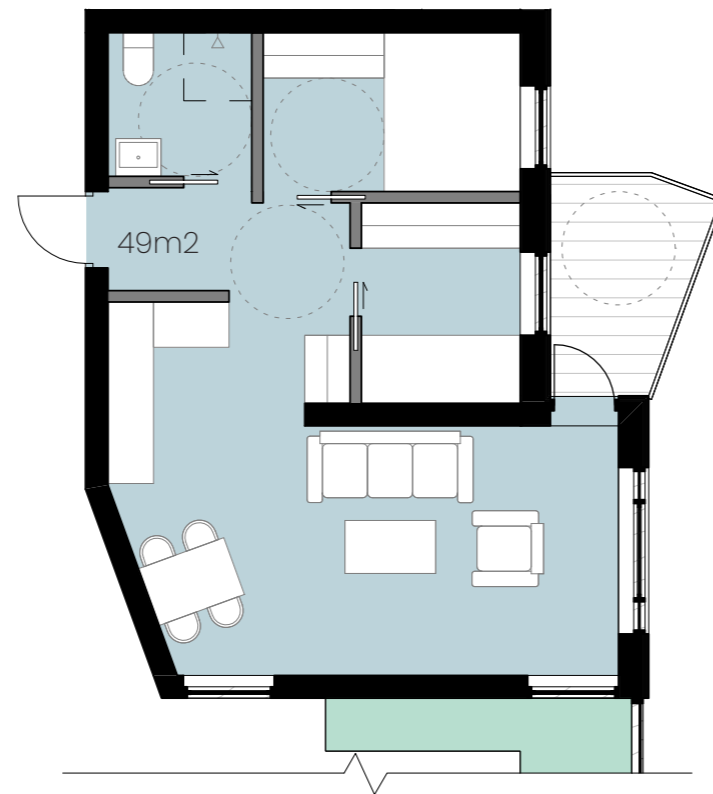


Fig. 25: 2B TYPE 3 - 1:100

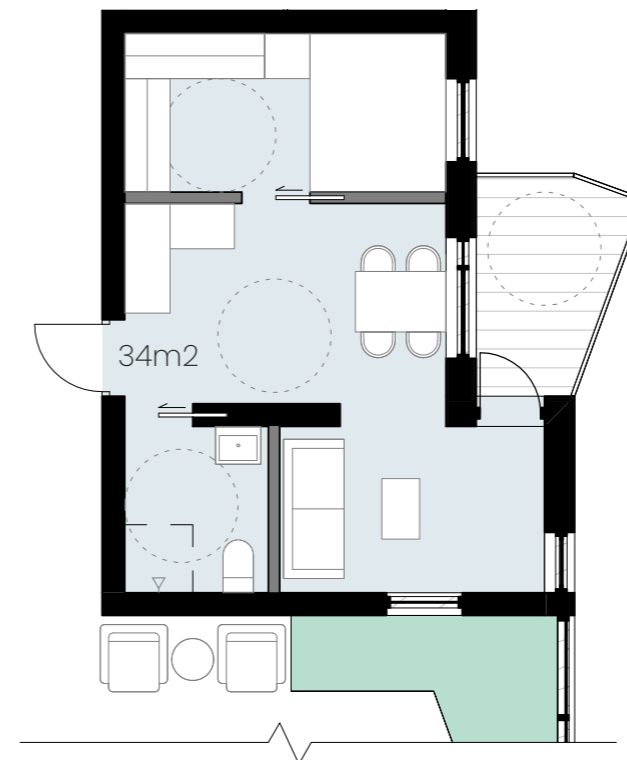


Fig. 25: 1B TYPE 3 - 1:100

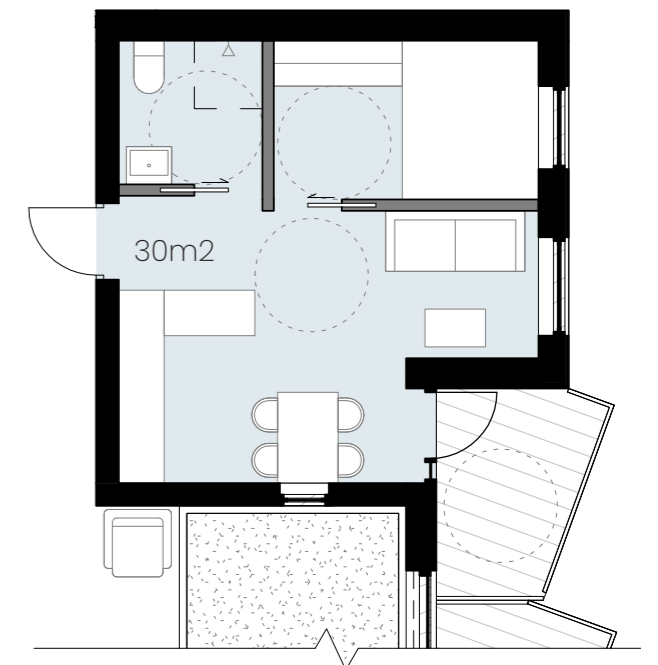


Fig. 25: 1B TYPE 4 - 1:100

GREENHOUSE & ENERGY

The initial plan was to create new rooftop apartments within an extended rooftop greenhouse, utilizing only passive strategies for the greenhouse. However, larger wall areas toward an unheated space can potentially increase heatloss and net energy demand. Therefore, two alternatives for the heated area are considered. In order to evaluate the environmental impact of this decision, energy calculations in Simien and emissions calculations in One Click LCA were performed.

ENERGY SIMULATION

The energy budget calculation in Simien compares the differences in the heated areas between two alternatives. While alternative 1 has an extended unheated greenhouse cover a large part of the top 2 floors, alternative 2 divides the common area into the unheated greenhouse at the south and the remaining area is a heated atrium space.

Both alternatives use the same U-value for exterior walls (0.14 W/m²K) and windows (0.8 W/m²K). The total area of windows and doors in both alternatives is the same; only their functions are treated differently. Therefore, for the total windows + doors/ BRA ratio, Alternative 1 includes the the windows and doors to the common area while Alternative 2 does not.

The walls, doors, and windows open to the unheated zone is calculated as elements open to ventilated winter garden/atrium.

In addition, underfloor waterborne heating system and balanced ventilation are applied in both cases.

For this comparison, both alternatives use air to water heat pump that covers 90% of space heating, hot water, heating battery and electricity and electricity covers the rest.

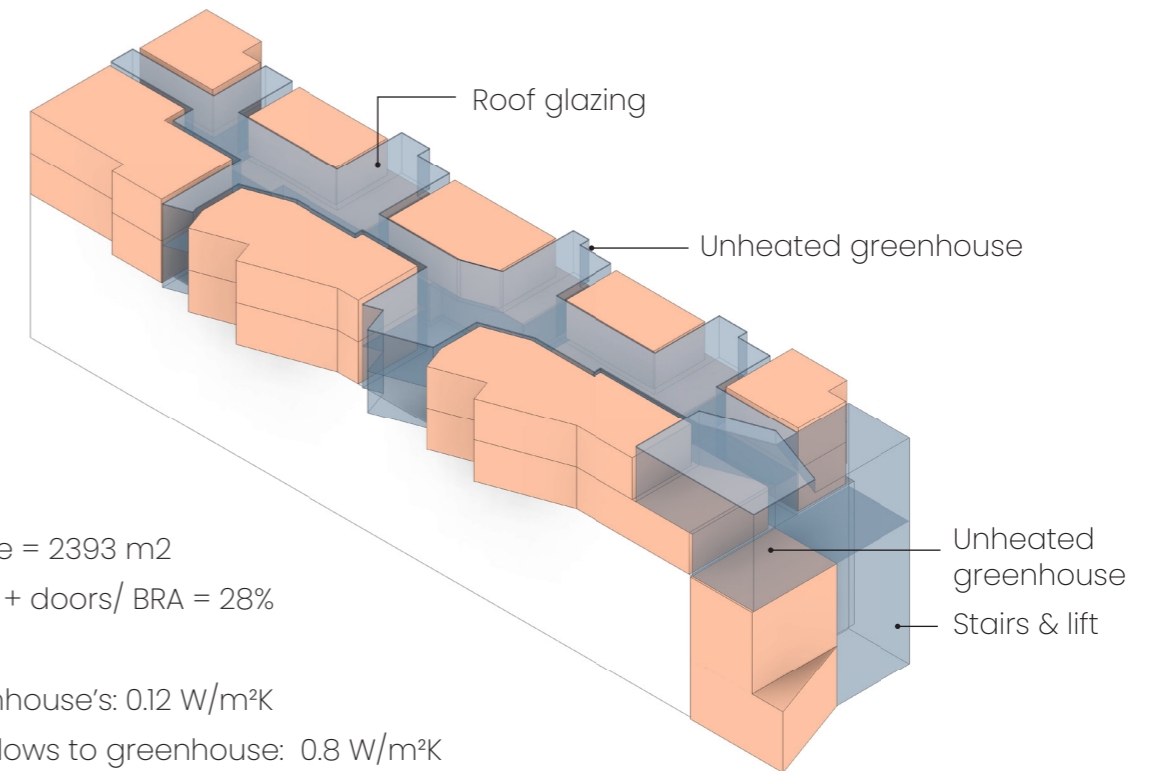
U-value	
Exterior walls	0.14 W/m ² K
Exterior doors, windows & glazing	0.8 W/m ² K
Roof	
Floor on ground	0.1 W/m ² K
Floor to outdoor air	0.09 W/m ² K
Solar factor	
	0.05
Cold bridge	
	0.03

Fig. 26.3: VALUES USED IN BOTH ALTERNATIVES

In Alternative 1 (Fig.26.1), the stair and lift lobby, the greenhouse, and the atrium are unheated and therefore not included in the Simien calculation. The goal is to create a climate-sheltered area that is still warmer than the outdoor space in the winter. This is a consideration for the total energy demand of the new addition. The entire roof is glazed to allow more sunlight into the shared space. The glazing used in this area can have a higher U-value because the common area is a semi-outdoor space and thinner glass has lower emissions.

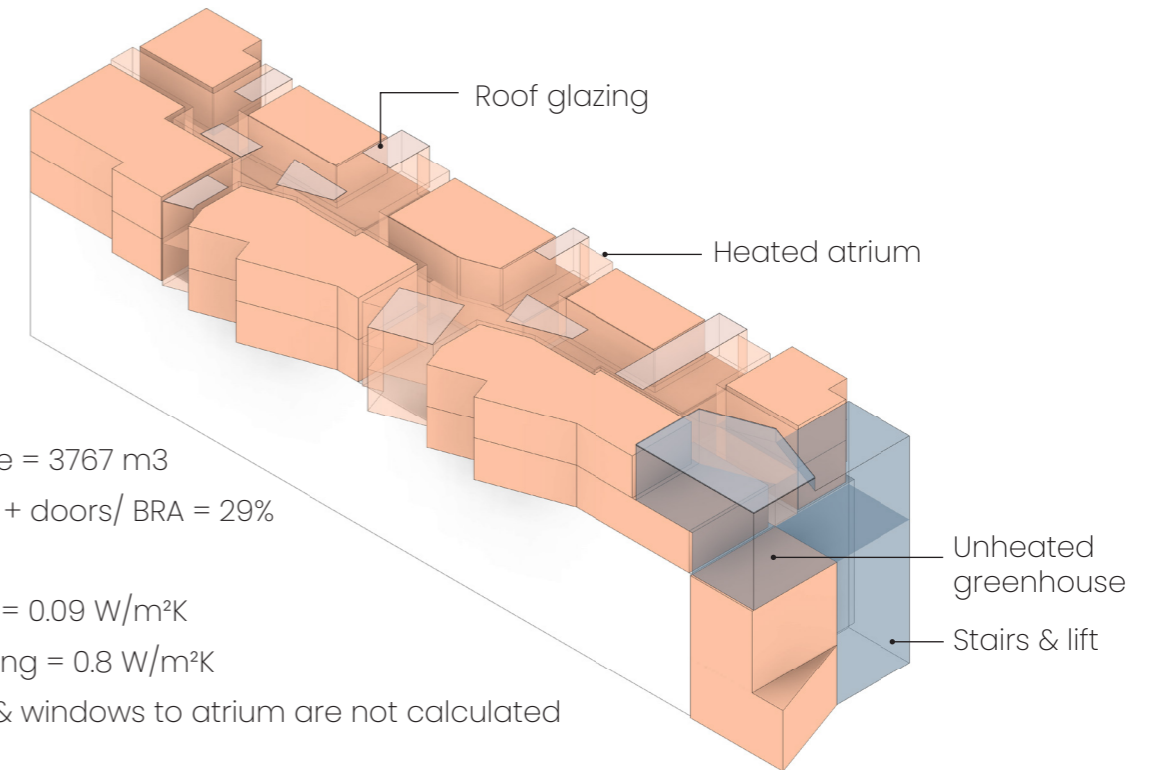
In Alternative 2 (Fig.26.2), the atrium is heated and therefore has smaller glazing area on the roof. The remaining areas have solid roofs with a U-value of 0.09 W/m²K. To reduce heat loss, the glazing in this alternative is triple glazed with a U-value of 0.8 W/m²K. The walls, doors, and windows to the atrium are interior elements. Although the operating hours and internal loads in the common area and the apartments are different, they are still unpredictable. Therefore, the simulations used the same standardized values of ventilation, heating and internal loads for both areas.

Heated Unheated



BRA = 963 m²
 Heated volume = 2393 m³
 Total windows + doors/ BRA = 28%
 U-value:
 - Wall to greenhouse's: 0.12 W/m²K
 - Doors & windows to greenhouse: 0.8 W/m²K
 - Unheated volume (including glazing) is not calculated

Fig. 26.1: ALTERNATIVE 1: EXTENDED & UNHEATED GREENHOUSE



BRA = 1421 m²
 Heated volume = 3767 m³
 Total windows + doors/ BRA = 29%
 U-value:
 - Atrium's roof = 0.09 W/m²K
 - Atrium's glazing = 0.8 W/m²K
 - Walls, doors & windows to atrium are not calculated

Fig. 26.2 ALTERNATIVE 2: SMALLER GREENHOUSE WITH HEATED ATRIUM

RESULTS

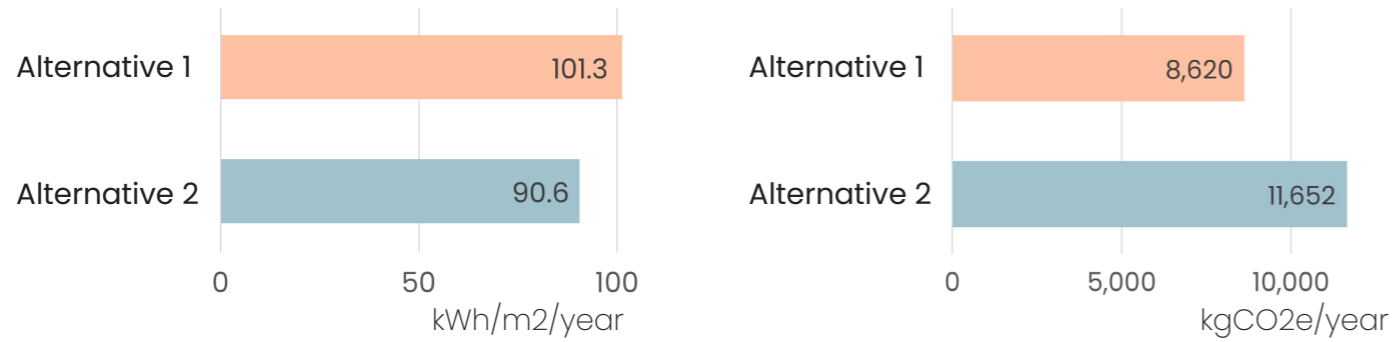


Fig. 27.1: SPECIFIC ENERGY BUDGET

Fig. 27.4: ANNUAL EMISSIONS FROM OPERATION (CO₂ factor = 130g/kWh)

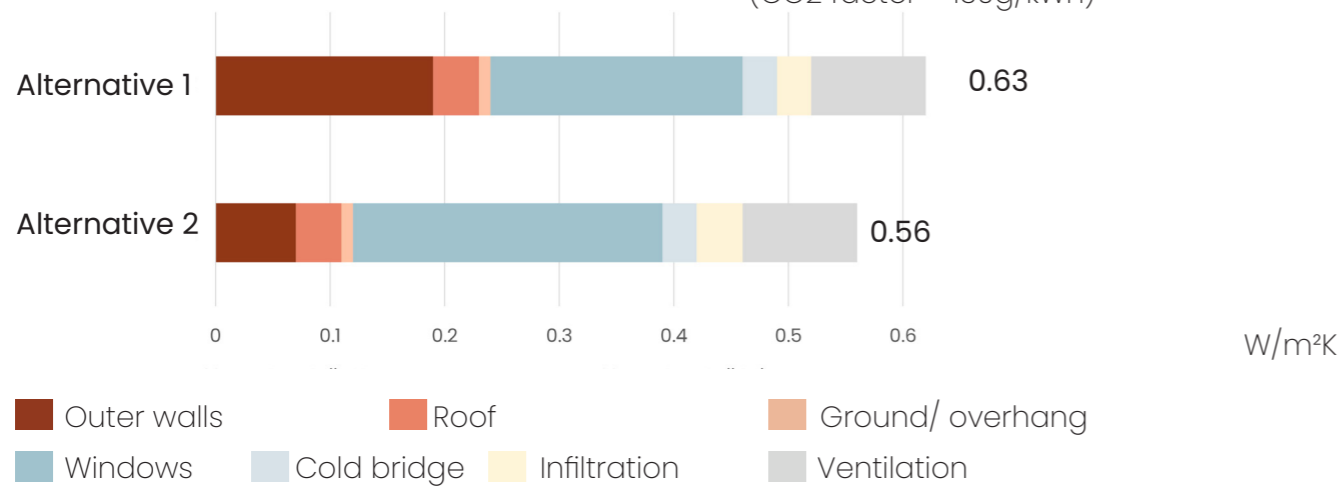


Fig. 27.2: HEATLOSS

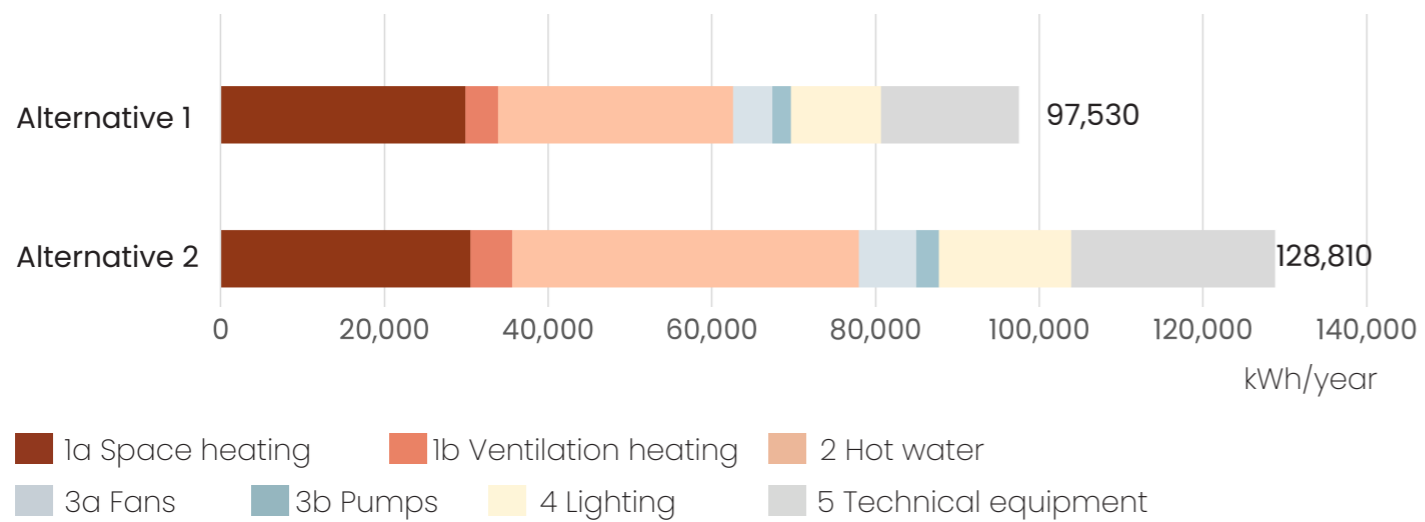


Fig. 27.3: ANNUAL ENERGY BUDGET

The specific energy budget (Fig. 27.1) shows that the average energy budget is lower in Alternative 2 (89.8 kWh/m²) compared to alternative 1 (101.3 kWh/m²). This is because there is more heat loss to the large unheated greenhouse in Alternative 1 (Fig. 27.2). Alternative 2 experiences greater heat loss through glazing/windows due to the larger glazing area in the atrium. However, the heat loss from walls in Alternative 1 is three times greater than that of Alternative 2, and is also the contributing factor for higher specific energy demand in this alternative.

This is also indicated in the annual energy budget (Fig. 27.1). Although Alternative 2 covers a 37% larger heating volume, the space heating demands for both alternatives are approximately equal. Overall, Alternative 2's energy budget is 24% higher than alternative 1.

Under the condition that there is no other source of renewable energy, annual emissions from Alternative 1 and 2 are 8,620 kgCO₂e and 11,567 kgCO₂e, respectively (Fig.27.4).

The results from Simien indicate that alternative 2 is more efficient in terms of energy usage. However, the increased energy budget from the larger heating volume should also be taken into account.

To have a more complete look at the emissions from the choice of materials to achieve the desired thermal quality in both options, life cycle assessment in One Click LCA is performed next.

GREENHOUSE & EMISSIONS

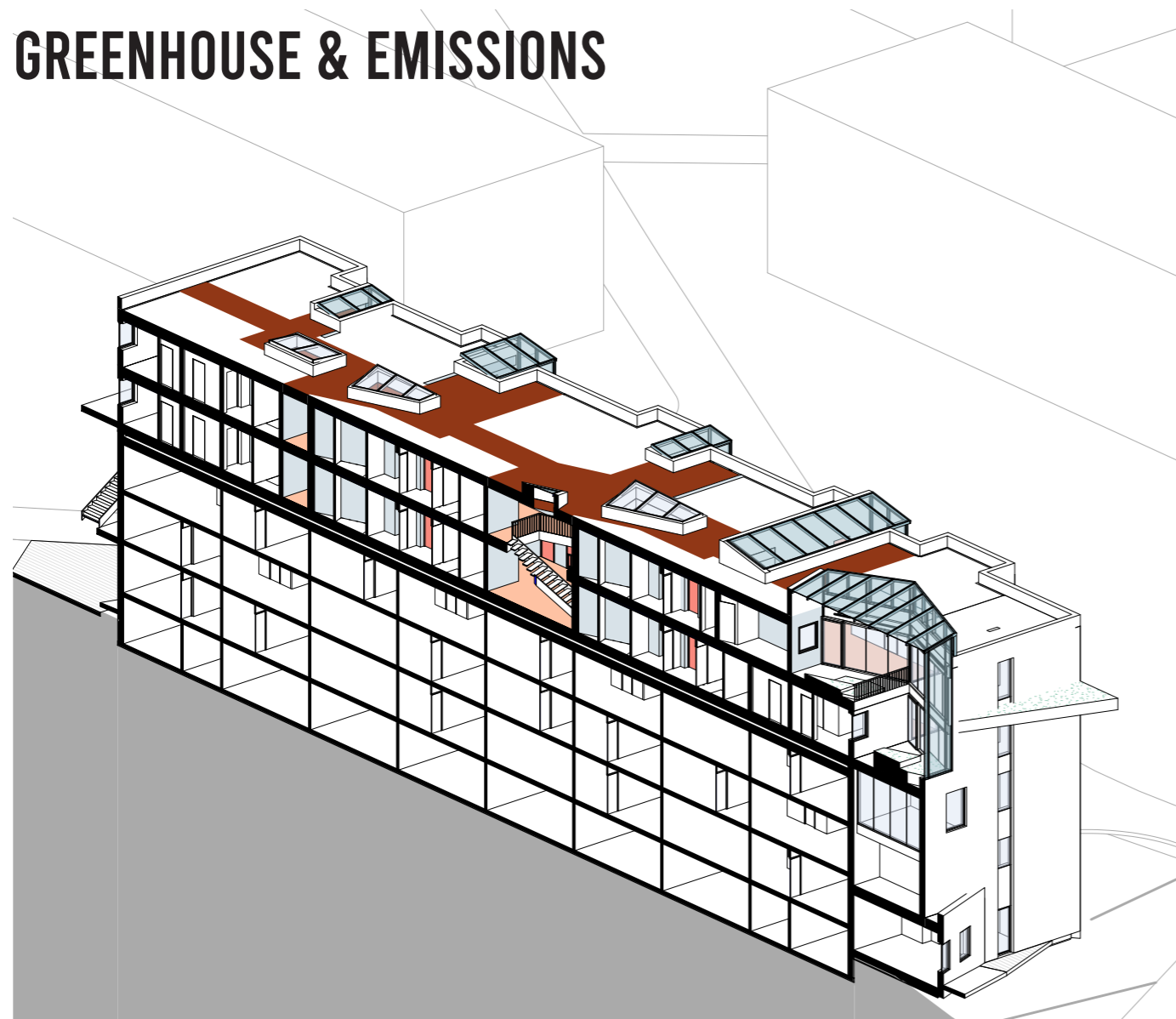


Fig. 28.1: COMPARED BUILDING ELEMENTS IN ALTERNATIVE 1 & 2

LIFE CYCLE ASSESSMENT

To simplify the comparison of embodied material emissions between alternatives, only the elements that differ are compared, as shown in Fig.28.1 & 28.2.

For Alternative 1, the roof of the extended greenhouse is glazed and an estimated volume for supporting structure is included. There are two variations for this alternative in this LCA calculation, 1a and 1b. The difference between them is the type of glazing used for the greenhouse. Because the common area is unheated, the walls, doors, and windows have U-values similar to exterior elements.

In Alternative 2, the walls, doors, and windows to the atrium are interior elements. This alternative uses triple glazing for both the greenhouse and the atrium. In addition, a fiberboard layer is added to the floor element to represent the underfloor heating system in the atrium.

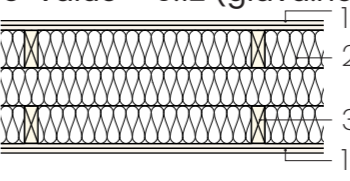
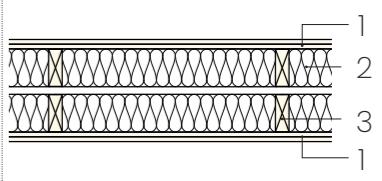
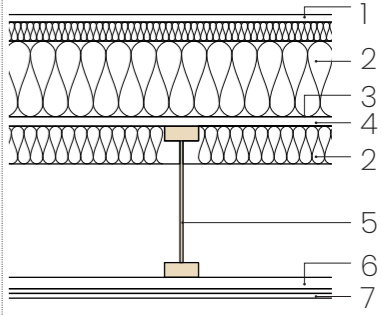
Element	Quantity	Alternative 1a	Alternative 1b	Alternative 2
Wall to greenhouse/atrium	735 m ²	Exterior wall U-value = 0.12 (glava.no)  1-Gypsum board x2 2-Insulation 3-Stud, approx. 16%		Interior wall  1-Gypsum board x2 2-Insulation 3-Stud, approx. 16%
Glazing (wall & roof)	345 m ²	Single glazing system Aluminium frame façade system with single safety glass, 10150 mm x 2670 mm, 946.2 kg/unit, Schüco FWS 50 W x H: 10150 mm x 2670 mm, for project: Felix (Schüco International KG)	Double glazing system Aluminium frame glass façade system, enamelled double glazing, 41.17 kg/m ² (Eiler Thomsen Alufacader)	Triple glazing system Aluminium frame glass façade system, triple glazing, 50.55 kg/m ² (Eiler Thomsen Alufacader)
Roof (common area)	210 m ²			Solid roof U-value = 0.09  1-roofing, 2-insulation, 3-water vapour barrier, 4-moisture resistant layer, 5-I-beams, 6-batten, 7-Gypsum board x2
Additional support for roof glazing	6.3 m ³	Beams to support roof glazing Glue laminated timber (Glulam), 468 kg/m ³ , 12% moisture content (Holmen Wood Products AB)		n/a
Doors to common area	54.6 m ²	Exterior doors Wooden exterior door for commercial buildings, per m ² , U= 0,76 W/m ² K, 1.23 x 2.18 m, 105 mm frame, 69 mm doorleaf, 22.77 kg/m ² , Bor Ytterdörr 801 Lejonet (NorDan AS)		Interior doors Wooden interior door, per m ² , 1.23m x 2.18m, 22.6 kg/m ² , fire class EI30 (Knudsen Dørfabrikk)
Windows to common area	15 m ²	Exterior windows Inward Opening Window, 798 W/m ² K, 69.1 kg, 1.23x1.48 m (Nordvestvinduet)		Interior windows 2 Way Inward Opening Window, Frame: 105 mm, 64.4 kg, 1.23x1.48 m (Lian Trevarrefabrikk)
Fiberboard represents heating	458 m ²	n/a		Fiberboard, sound absorbing, 36 mm, 9 kg/m ² , 250kg/m ³ , Silencio Thermo (Hunton Fiber AS)

Fig. 28.2: QUANTITY OF COMPARED ELEMENTS IN ONE CLICK LCA

RESULTS

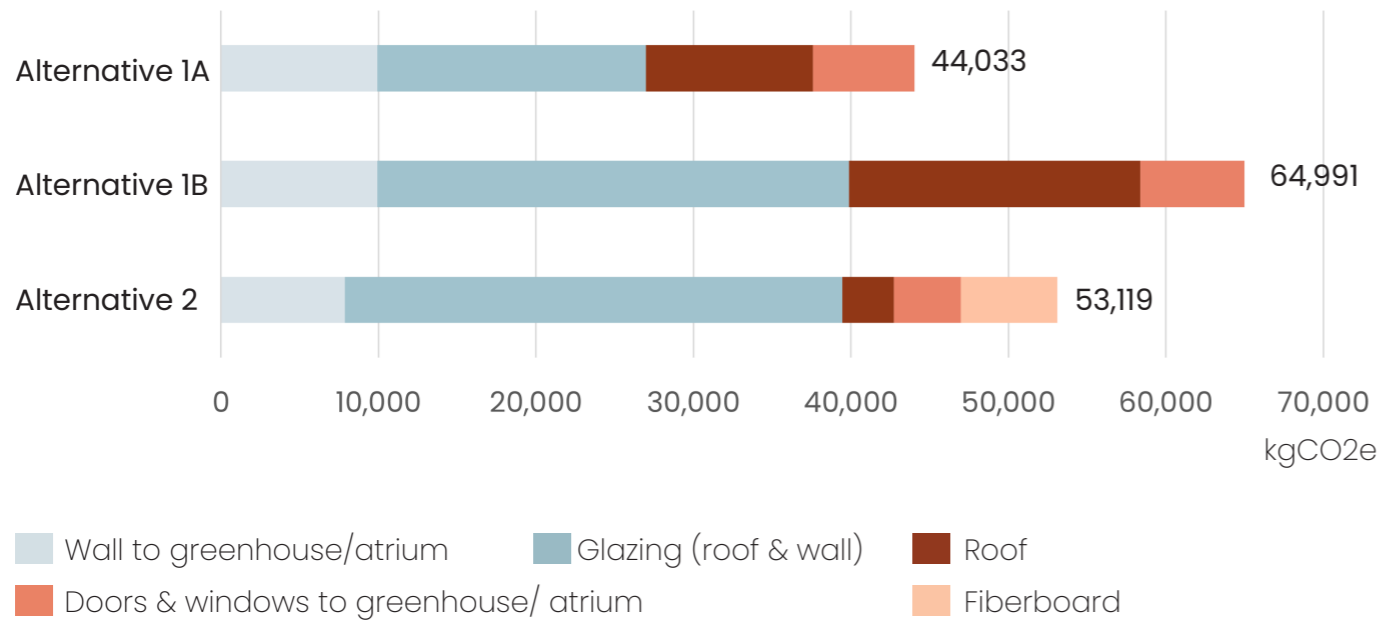


Fig. 29.1: EMISSIONS BY ELEMENTS IN 60 YEARS

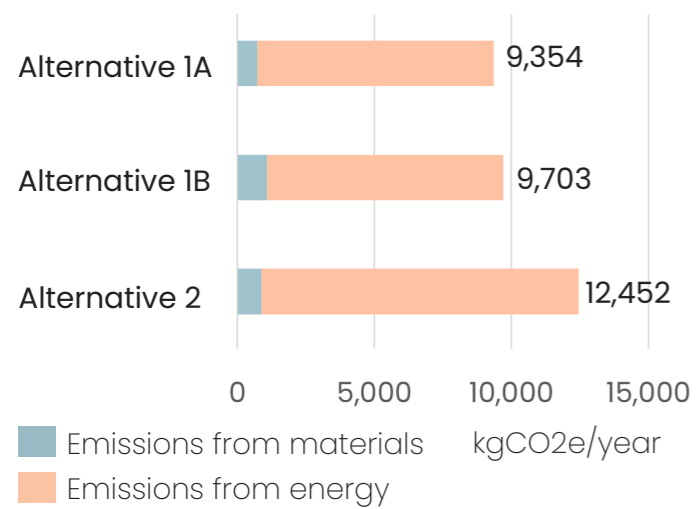


Fig. 29.2: ANNUAL EMISSIONS

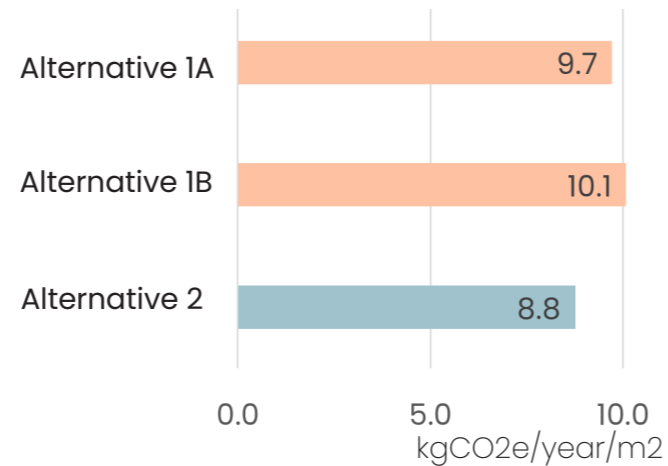


Fig. 29.3: ANNUAL EMISSIONS PER SQM BRA

The results of emissions by elements (Fig. 29.1) show that, throughout the entire life cycle, Alternative 1A has the lowest emissions, Alternative 1B has the highest, and Alternative 2 has an average amount.

In general, the interior walls, doors, and windows in Alternative 2 have lower emissions than the exterior ones in Alternative 1. Another advantage is that reducing the thickness of the walls in this area is possible if the atrium space is heated.

The glazing system is the most contributing element in all three alternatives. In Alternative 2, the emissions from a solid roof are significantly lower than those from the single and double-glazed roofs in the other two alternatives. Emissions from heating in Alternative 2 are quite significant, but overall, the embodied emissions from materials in this option are still lower than in Alternative 1B.

Combining the annual results from both embodied materials and energy, Alternative 2 still has the highest carbon footprint among all options (Fig. 29.2). However, it also has the lowest emissions per square meter of heated area (BRA) (Fig. 29.3). These results align with the previous energy comparison.

CHOSEN SOLUTION

In addition to energy consumption and embodied emissions from materials, other factors should also be considered.

While emissions from materials in Alternative 1A are the lowest, an uninsulated space can make it the least used communal space in cold climate conditions compared to the other two options.

Alternative 2's atrium space is more thermally comfortable in the winter compared to Alternative 1A and 1B. This encourages residents to use the common space more freely during the cold period. Although it increases the total energy demand, it also brings more savings for individual apartments while making the atrium space an extended part of their homes. This aligns with the project's social goals.

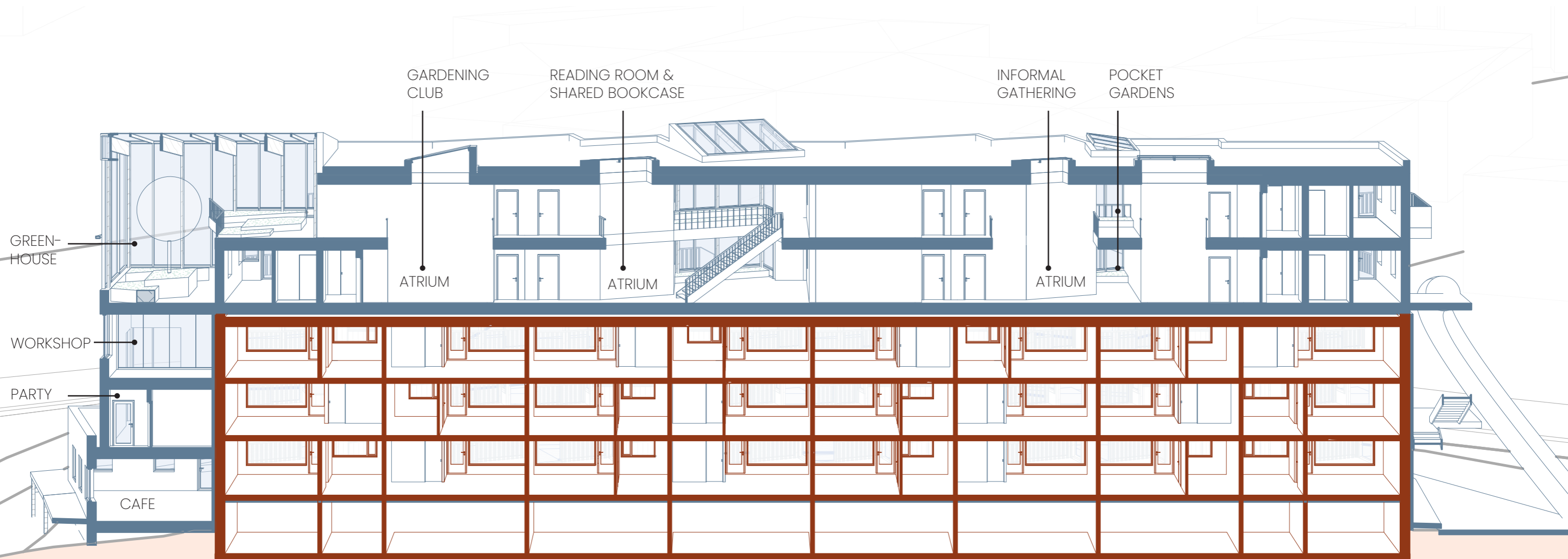
Considering the calculation results and the project's goals, Alternative 2 is the chosen option for further development.

SECTIONS

The new rooftop addition incorporates a greenhouse on the south facade and a glazed atrium for passive heating during colder months. With the heat gain during the daytime, the excess heat can be stored in the soil and concrete slabs at the south gable wall, and emitted during the nighttime, thereby allowing the building to stay warm during the winter.

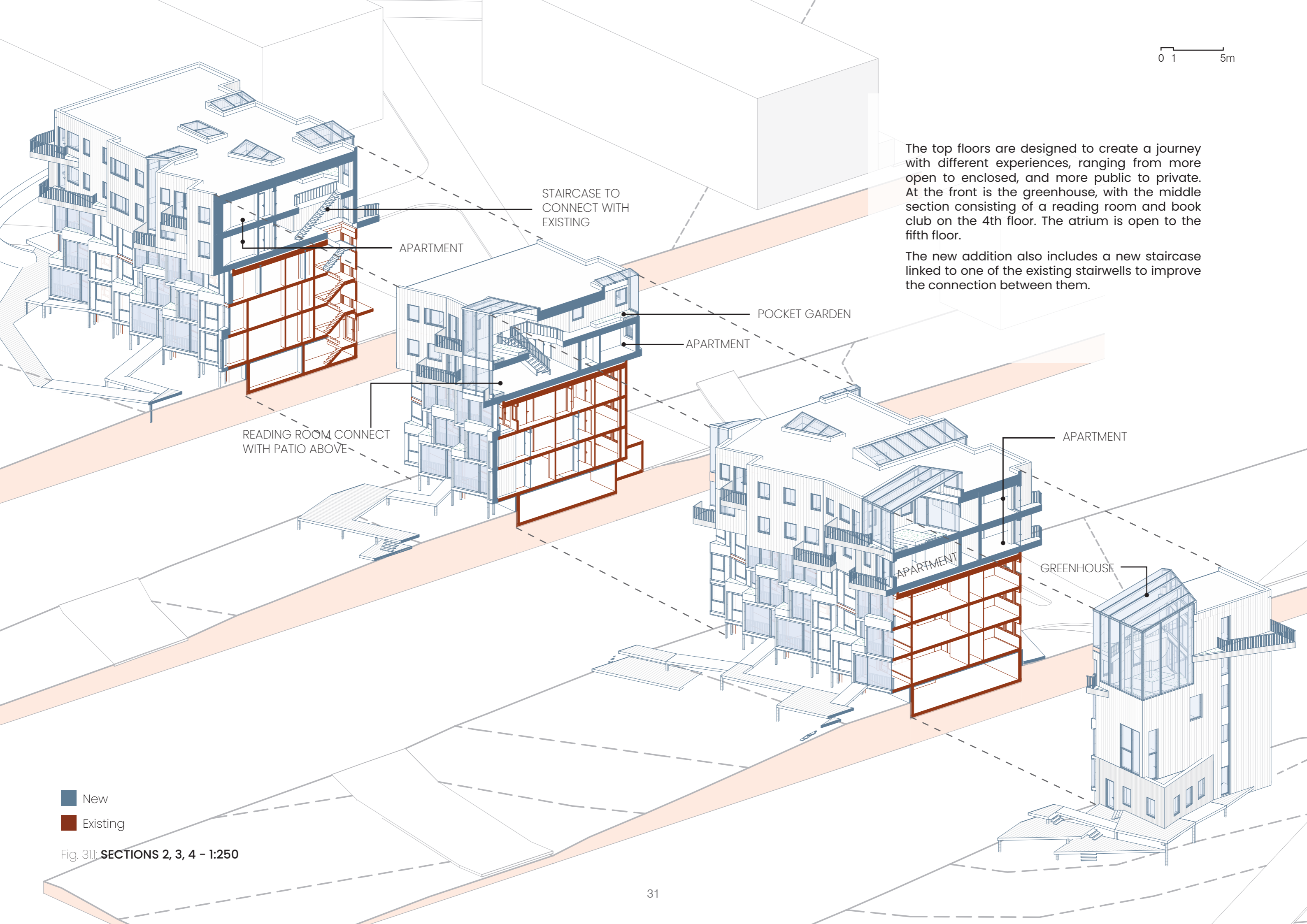
While the atrium space includes small raised gardens for crops like tomatoes and herbs, it may not have as strong of a passive heating effect as the greenhouse due to its orientation and different materials usage. Nevertheless, the glazed atrium still provides both daylight and aesthetic quality to the common area. This space serves as a social hub for both new and existing residents.

During the summer, both the greenhouse and atrium areas can be opened for natural ventilation, which will provide a cooling effect and promote air circulation. As the temperature in the greenhouse and atrium rises, the air can be accelerated to move from colder to warmer places, thereby enabling natural ventilation.



- New
- Existing

Fig. 30.1: SECTION 1



STAIRCASE TO CONNECT WITH EXISTING

APARTMENT

POCKET GARDEN

APARTMENT

READING ROOM CONNECT WITH PATIO ABOVE

APARTMENT

APARTMENT

GREENHOUSE

- New
- Existing

The top floors are designed to create a journey with different experiences, ranging from more open to enclosed, and more public to private. At the front is the greenhouse, with the middle section consisting of a reading room and book club on the 4th floor. The atrium is open to the fifth floor.

The new addition also includes a new staircase linked to one of the existing stairwells to improve the connection between them.

Fig. 31: SECTIONS 2, 3, 4 - 1:250

COMMON AREA

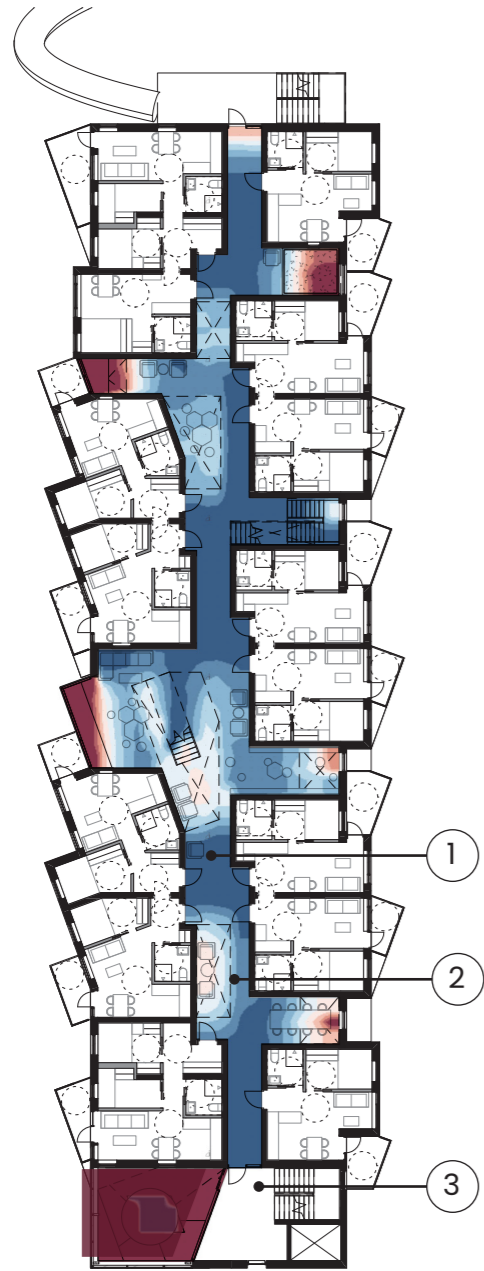
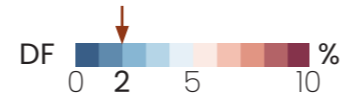


Fig. 32: DAYLIGHT FACTOR, 4F

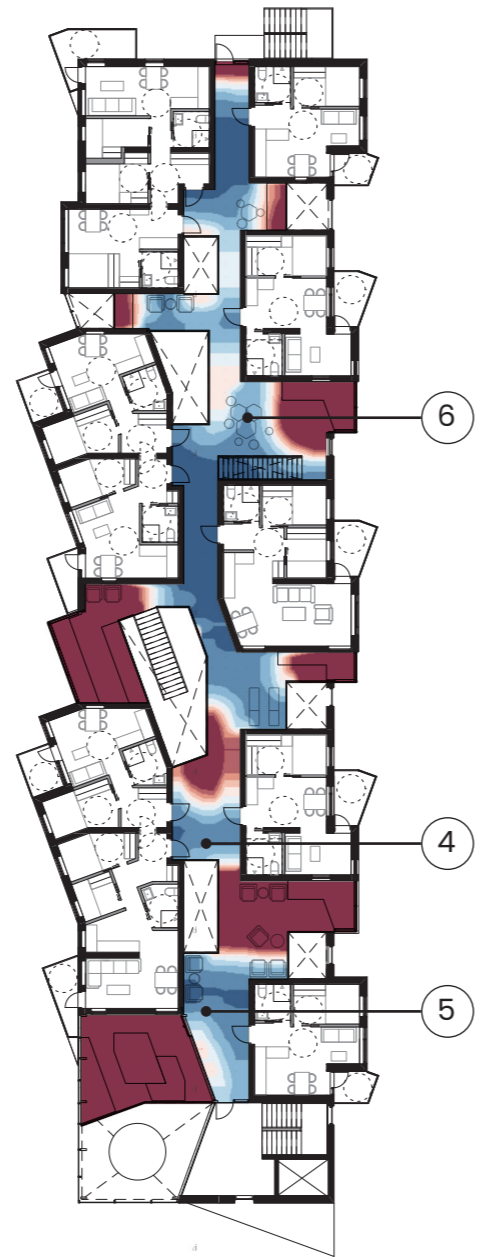
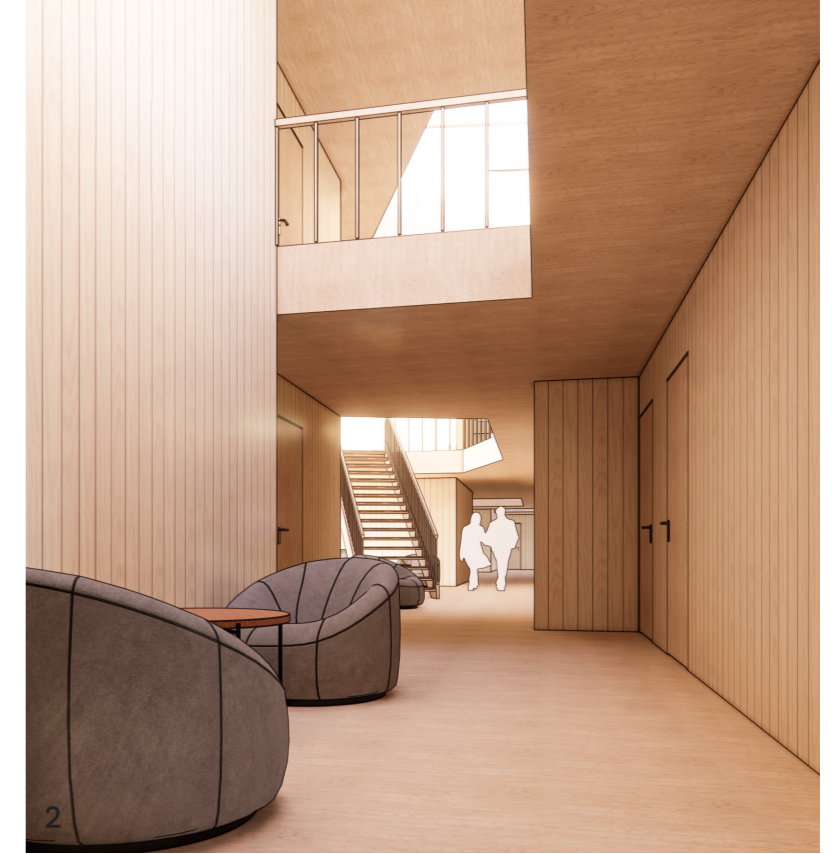


Fig. 32: DAYLIGHT FACTOR, 5F

Although having a sunlit common area is one of the goals, it is necessary to achieve a total area of approximately 1000m² for the apartments. While the fifth floor is directly under the roof glazing, making it easier to achieve a sunlit common space, the fourth floor presents more of a challenge, as previous tests have shown that there cannot be too much glazing area. To address this, different skylight locations in the atrium were tested using Climate Studio to ensure that the fourth floor also has a daylit common area.





4

In addition to the double height greenhouse, the strategy for 4F is to combine social zones with small planting areas throughout the atrium in locations that receive the most sunlight.



3



6

The atrium allows a smooth transition between the two new floors, making it not only circulation but also one big social zone that can be further subdivided.



5

ELEMENTS

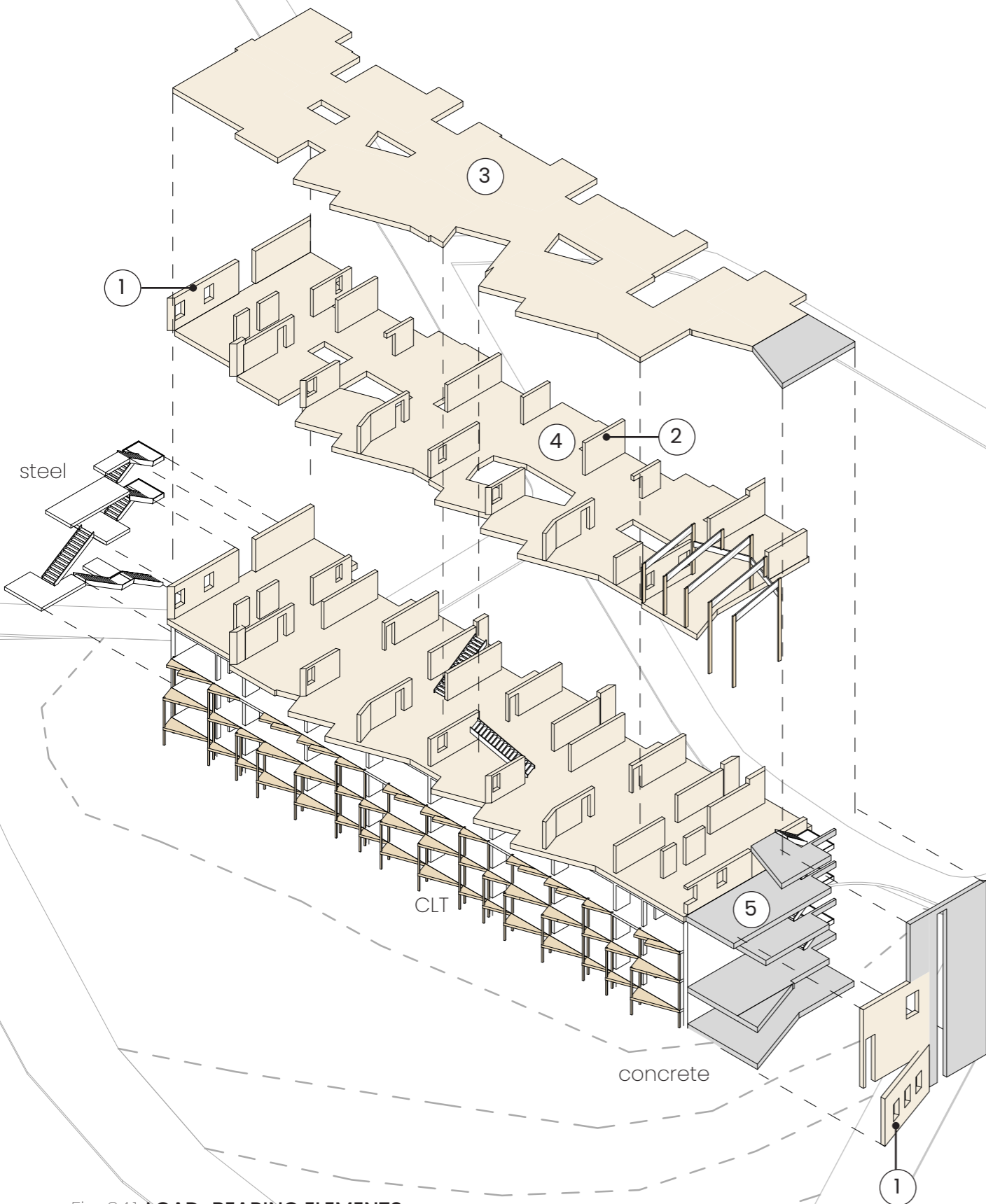


Fig. 34.1: LOAD-BEARING ELEMENTS

LOAD-BEARING ELEMENTS

Initial analysis using Carbon Designer for a two-story wooden apartment building of approximately 1600m² without a foundation or slab on the ground shows that, on average, the emissions from materials is 3.3 kg CO₂e/m² annually. Although this is already a reduced amount compared to a conventional building on the ground, the analysis suggests that the most significant contributors to the emissions are the floor and roof. Therefore, an efficient choice of materials for the slab elements is crucial to further reduce the overall embodied emissions.

To meet the demand for fire safety and acoustics in residential buildings, wooden floor elements need to be taller than concrete slabs. While CLT slabs were initially considered because of their strength and lower thickness, each square meter of a generic CLT slab with a thickness of 180mm already produces 28 kgCO₂e of emissions, so the project chose slabs with wooden I-beams instead, which have a lower carbon footprint and more lightweight. This choice is also more beneficial considering the limited information about the capacity of the existing structure and ground.

The south and north areas have exceptions. The northern addition has steel exterior escape staircases and a slider from the 4th floor. Meanwhile, the southern addition has new indoor staircases and an elevator for new floors on top. To ensure fire safety, the staircase and lift enclosures are made of concrete. The south also has only small remaining areas left by the stairs and lift, so all the slabs in this area are hollow concrete slabs for simple construction and better thermal mass for the greenhouse.

The extended balconies are CLT instead of the floor system with I-beams like the new addition. This choice is because the existing clear height is approximately 2.4-2.5m, and the thickness of the concrete slab is 180mm. To preserve the concrete slabs from the existing balconies, additional columns are added to support the extended area.

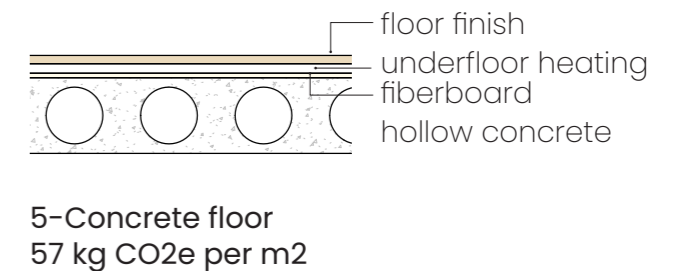
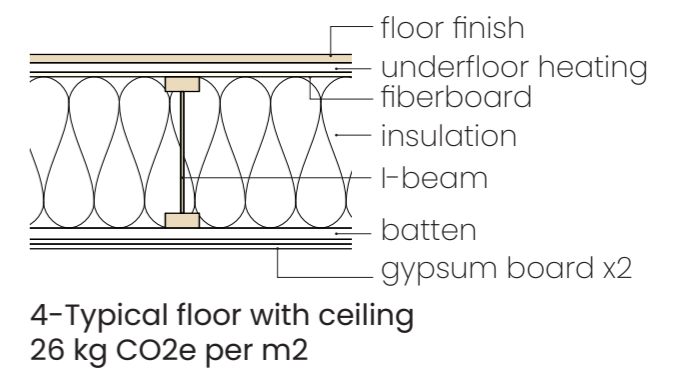
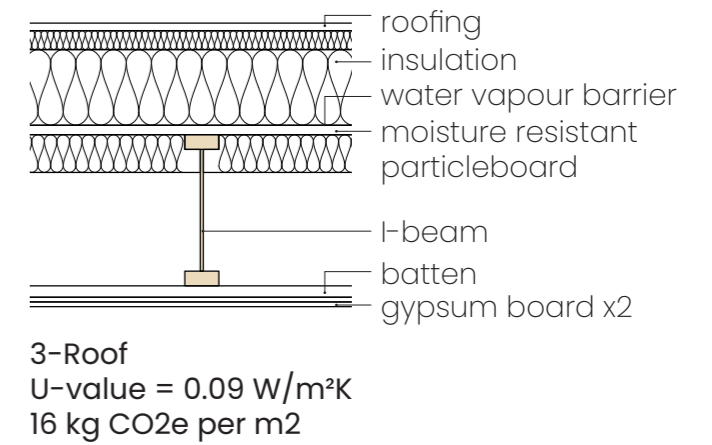
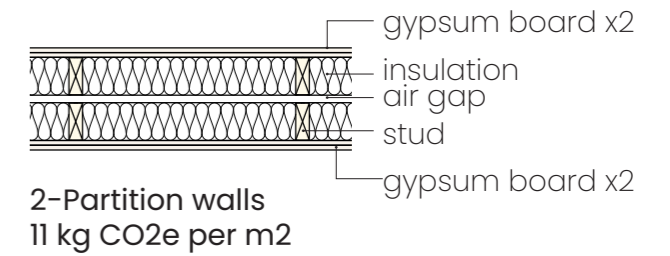
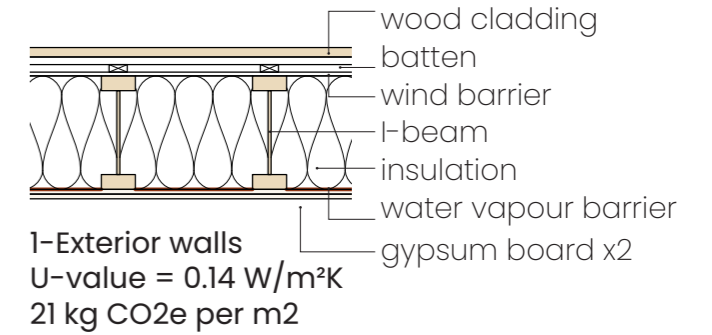


Fig. 34.1: TYPICAL NEW ELEMENTS

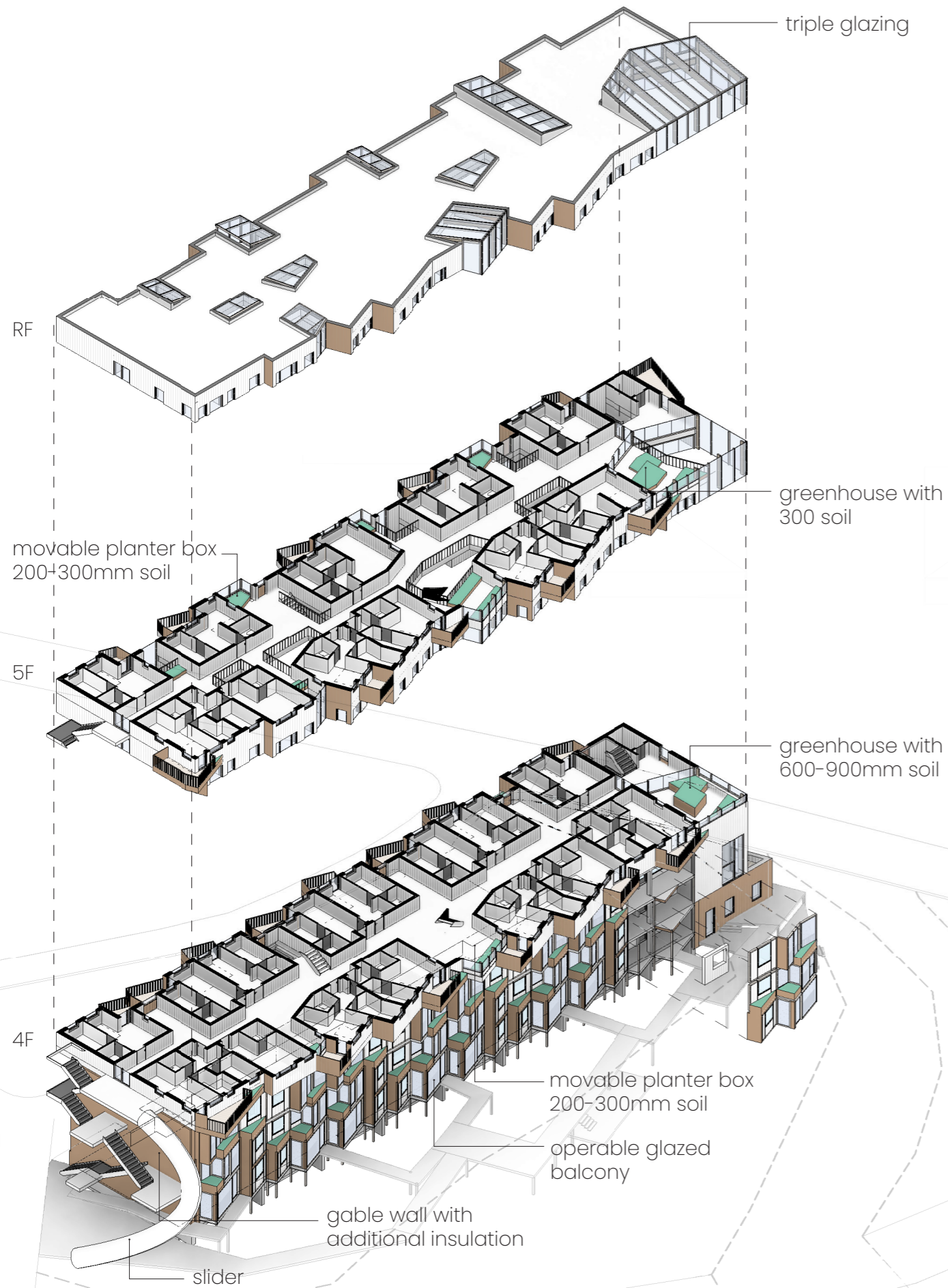


Fig. 35.1: ENVELOPE ELEMENTS

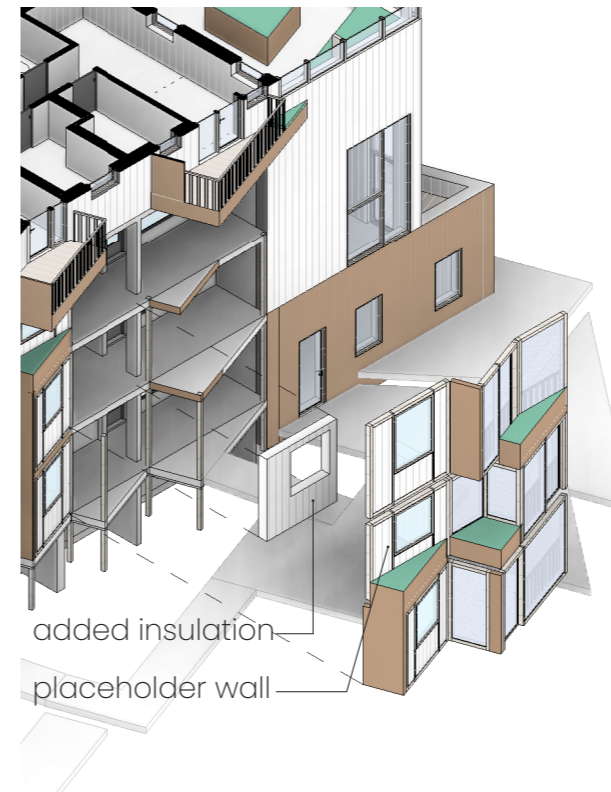
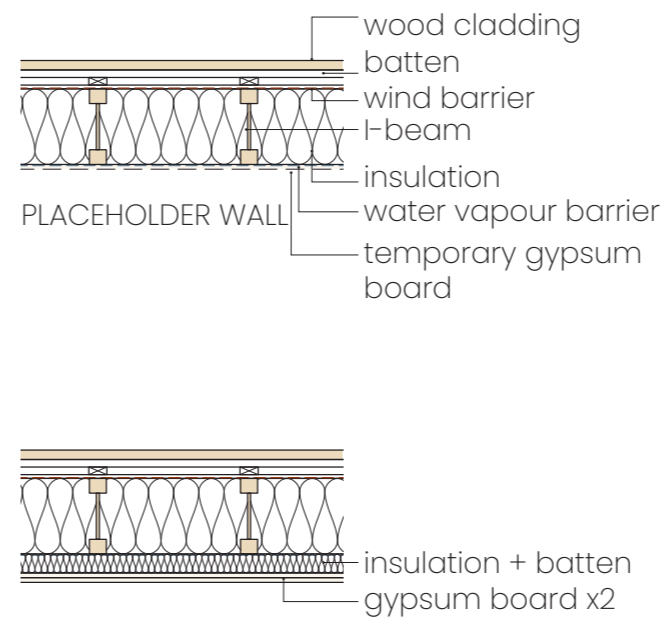


Fig. 35.2: TYPICAL FACADE RENOVATION



ADDED INSULATION

Fig. 35.3: BALCONY FACADE - PLACEHOLDER WALL, BEFORE & AFTER

NEW ROOF TOP APARTMENTS

The apartments have easy access to the atrium and indoor activities. The U-value of the exterior wall already meets $0.14 \text{ W/m}^2\text{K}$, so the balconies are entirely outdoor and not glazed like the existing balconies.

The design process takes the dimensions of the elements into account. Overhalla Hus recommends a typical length of 3.2m for more convenient transportation, while the maximum length can be up to 10m.

GREENHOUSE

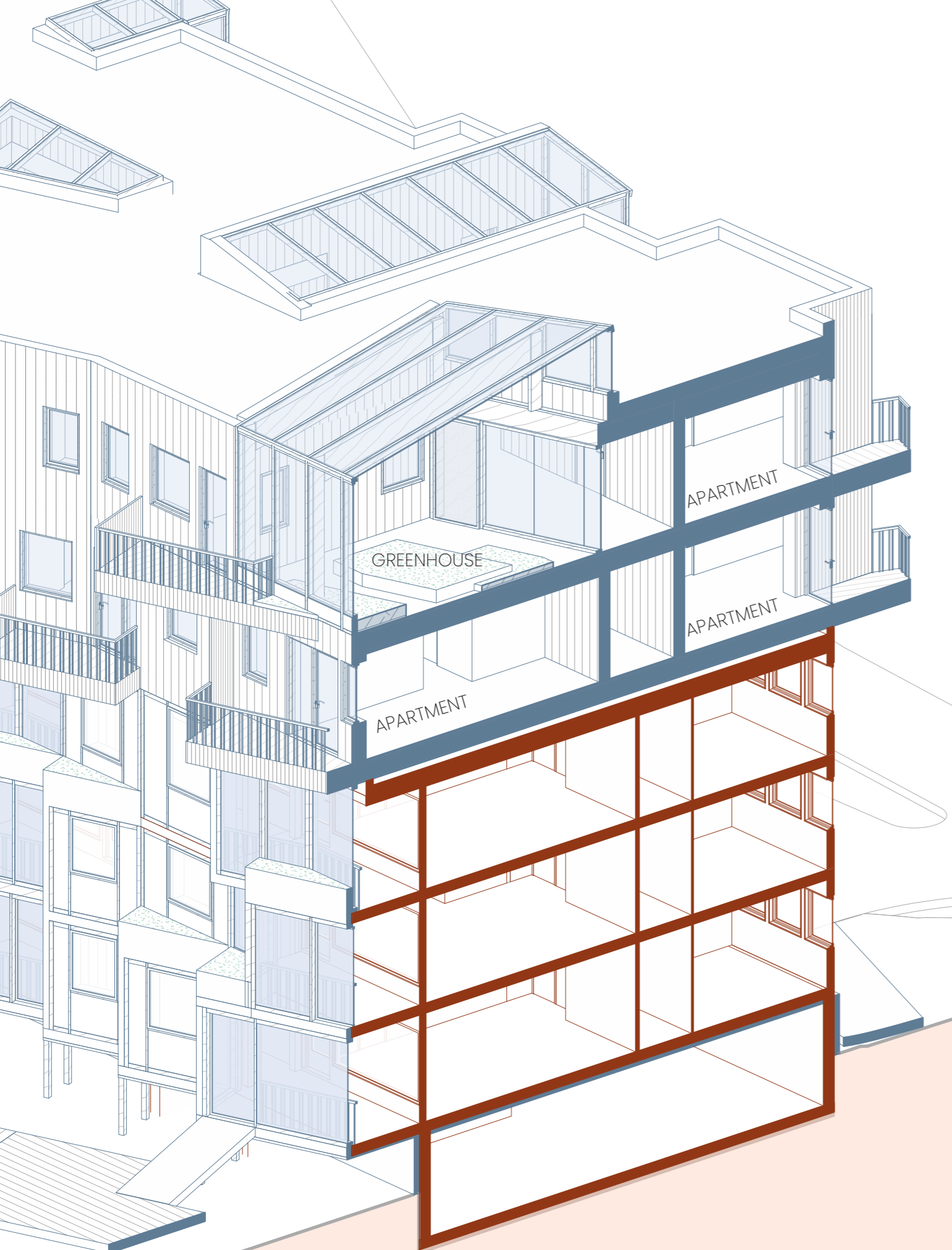
The greenhouse's glazing is triple-glazed with a U-value of $0.08 \text{ W/m}^2\text{K}$, providing insulation during the winter. Although other materials like polycarbonate are available, the triple-glazing system was chosen for its lower U-value and increased sunlight admission.

Furthermore, the greenhouse slab on the fourth floor is made of concrete, which has a high thermal mass value. This feature assists with the passive heating of the greenhouse during the winter. Since this part of the greenhouse is completely new, it can accommodate thicker soil of 600-900mm, allowing for a more diverse variety of plants than the greenhouse on the fifth floor. Additionally, the greenhouse features glass partitions to separate it from the atrium, preventing moisture from spreading to the rest of the atrium.

Inside the atrium are movable planter boxes, 300mm thick, are inside the atrium. This allows flexibility and is suitable for small plants like tomatoes and herbs.

EXISTING FACADE RENOVATION

The glazed balconies left placeholder walls to allow the future extension with one additional bedroom that the tenants can carry out by themselves with an additional layer of insulation and other internal changes (Fig.35.2 & Fig.35.3).



0 1 5m

GREEN HOUSE ENVELOPE
(U-value = 0.8)
Glass facade system
Glulam beams & columns

GREEN HOUSE

GREENHOUSE FLOOR
Sand
Draining layer
Water proofing membrane
Vapour countrol layer
I-beams & insulation (400mm)
Particleboard?
Batten
Gypsum plasterboard 12.5mm x2

PLANTING BED
Soil 300mm
Planter box

WINDOW (U-value = 0.8)

2450

BALCONY

APARTMENT

BALCONY FLOOR
Floor finish
Membrane
I-beams
Soffit

EXTERNAL WALL (U-value = 0.14)
Vertical wood cladding 20mm
Batten
Ventilated space
Wind barrier board
I-beams & insulation (300mm)
Water vapour barrier
Gypsum plasterboard 12.5mm x2

FLOOR (U-value = 0.09)
Wood flooring 20mm
Underfloor heating
Fiberboard
I-beams (400mm)
Water vapour barrier
Moisture resistance particle board

Fig. 36.1: FACADE SECTION 1 - 1:25

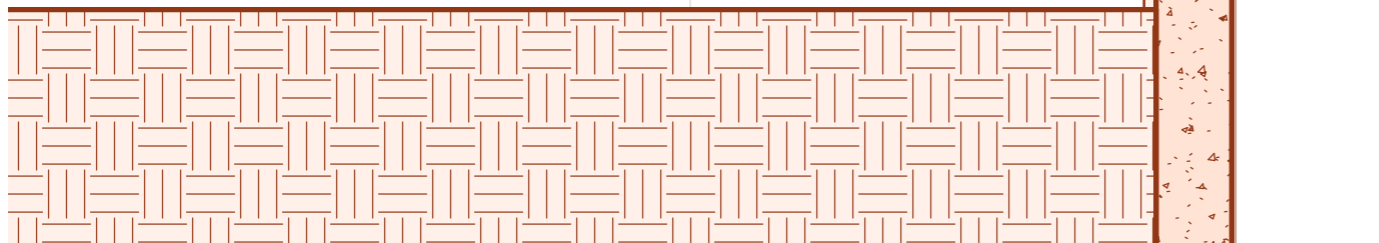
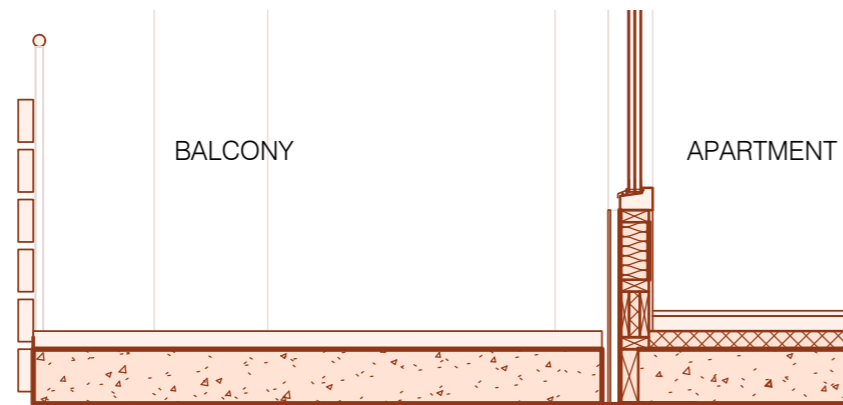
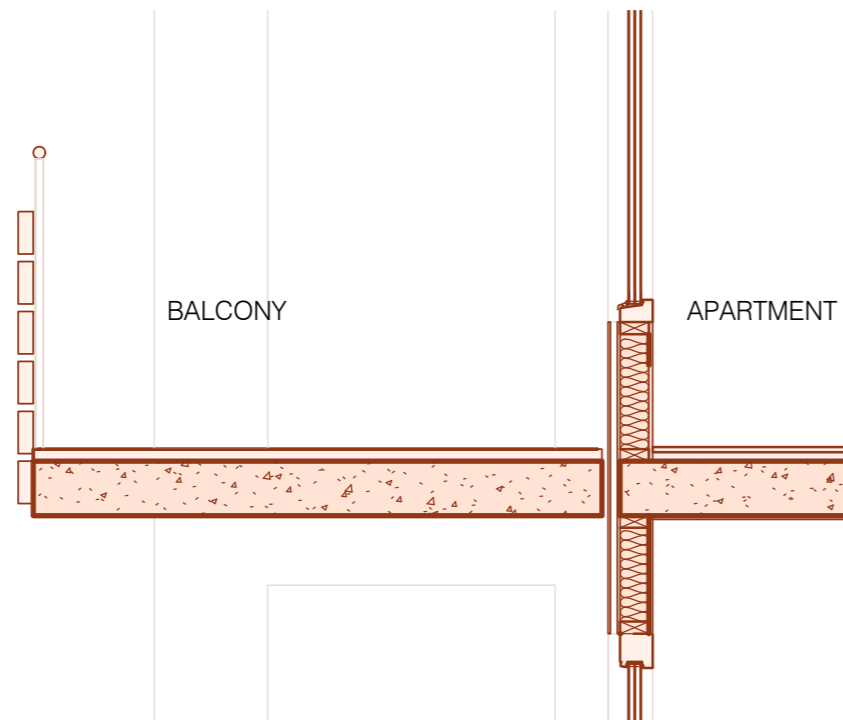


Fig. 37.1: FACADE SECTION 1 - 1:25

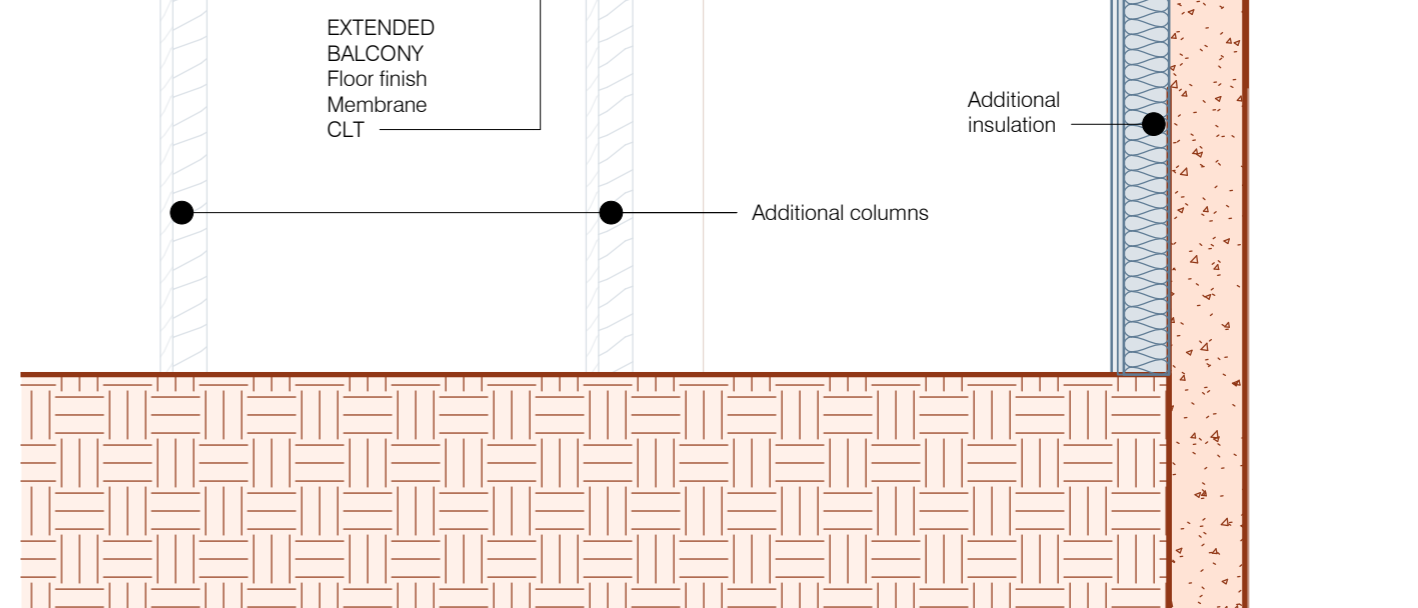
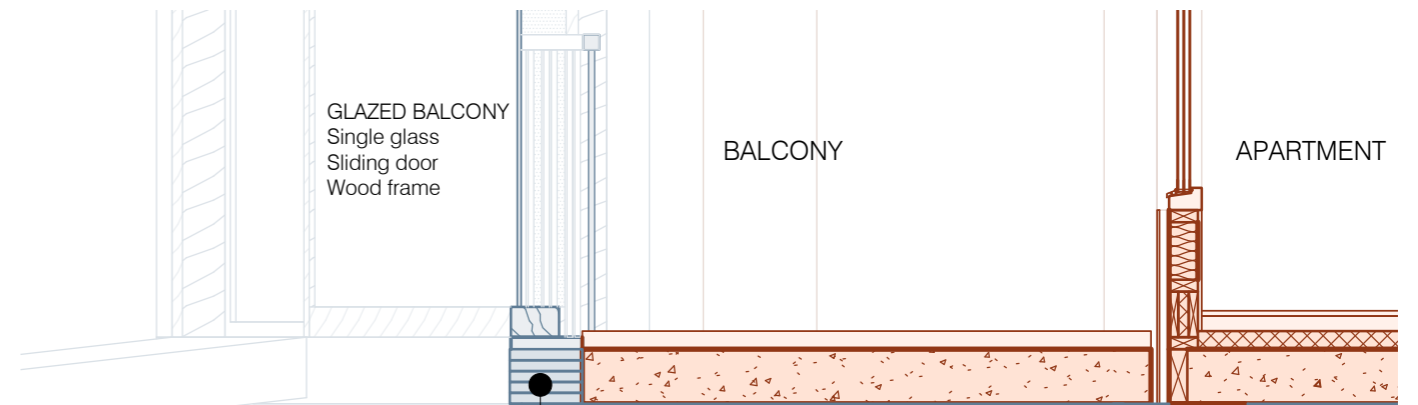
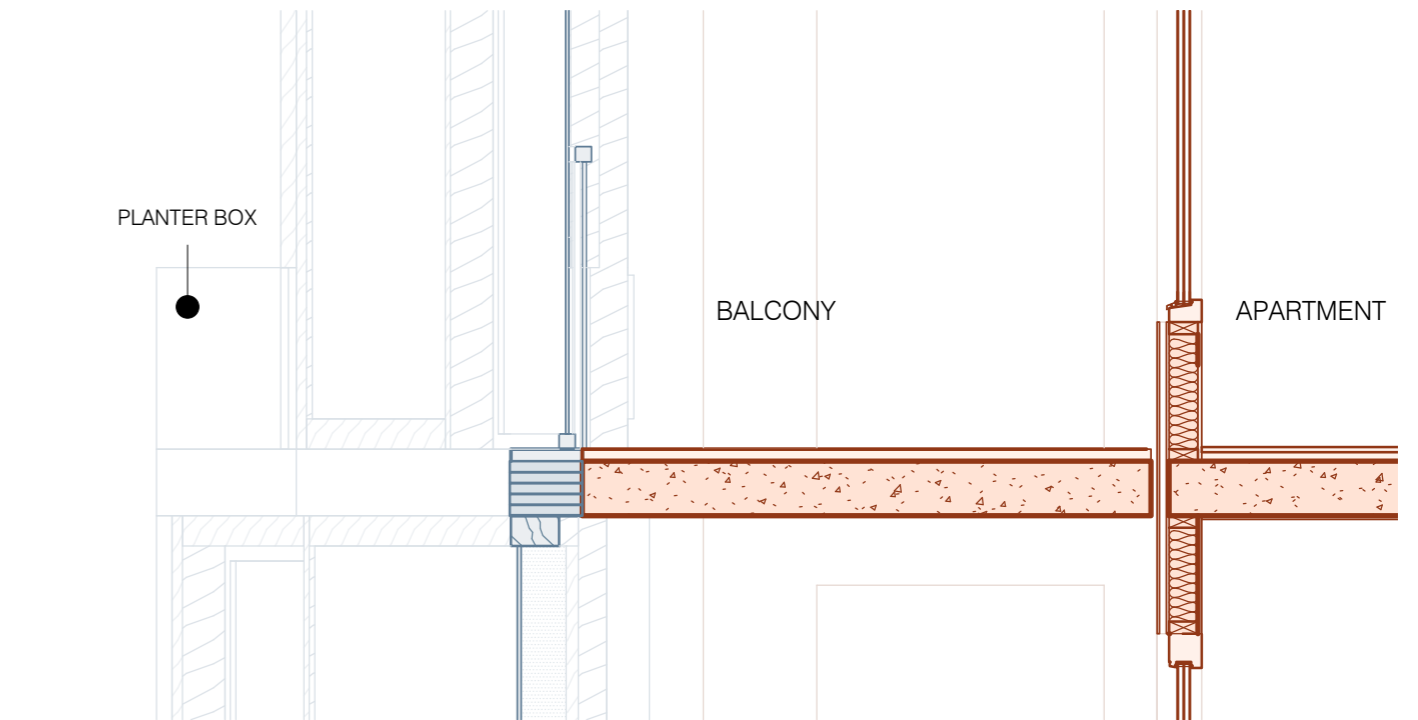


Fig. 37.1: FACADE SECTION 1 - 1:25



Fig. 38.1: **BEFORE**



Fig. 38.1: **AFTER**

LIFE CYCLE ASSESSMENT

The life cycle assessment of the project is divided into two parts: the new addition and the renovation of the existing building. Only architectural elements are included in the calculation, with a rough estimation of material volumes for structural elements. Technical systems and external works, including the slider, external staircases and the new landscape, are not factored in.

The renovation of the existing building includes a new balcony facade and added insulation for the gable walls, basement wall, ceiling, and stairwell. The additional insulation is based on SINTEF's nZEB upgrade proposal.

In total, the emissions from the renovation of the existing is 27,668 kgCO₂e and the new addition is 207,219 kgCO₂e in the entire service life of 60 years (Fig.39.1) making the total emissions from materials of the transformation 1.2 kgCO₂e/m²BRA/year.

The most contributing type of materials in both the new addition and the renovation is glass and glazing (Fig.39.2 & Fig.39.3). For the new addition, wooden doors, fiberboard, insulation and gypsum board are next by just a small margin.

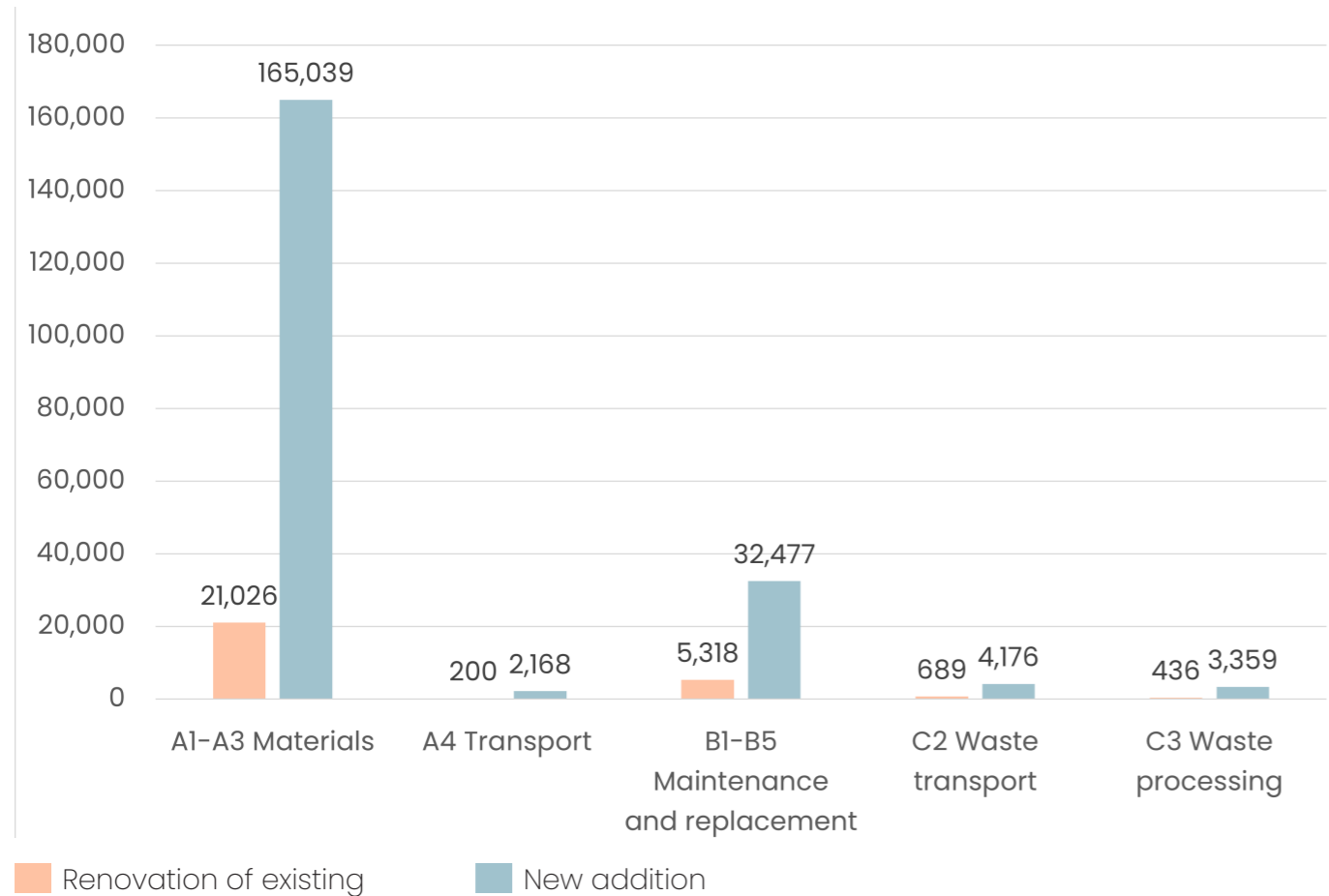


Fig. 39.1: GLOBAL WARMING (kg CO₂e)

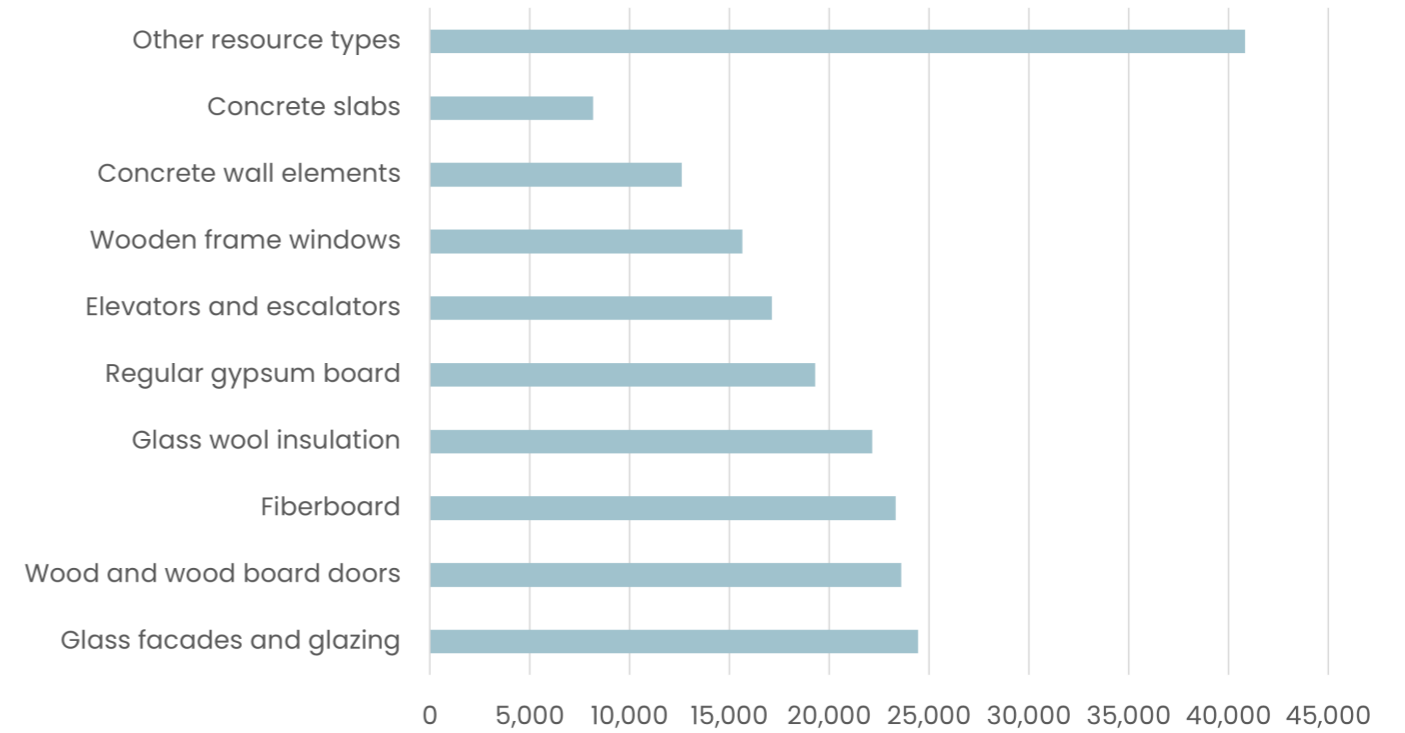


Fig. 39.12 NEW - MOST CONTRIBUTING TYPES OF MATERIALS (kg CO₂e)

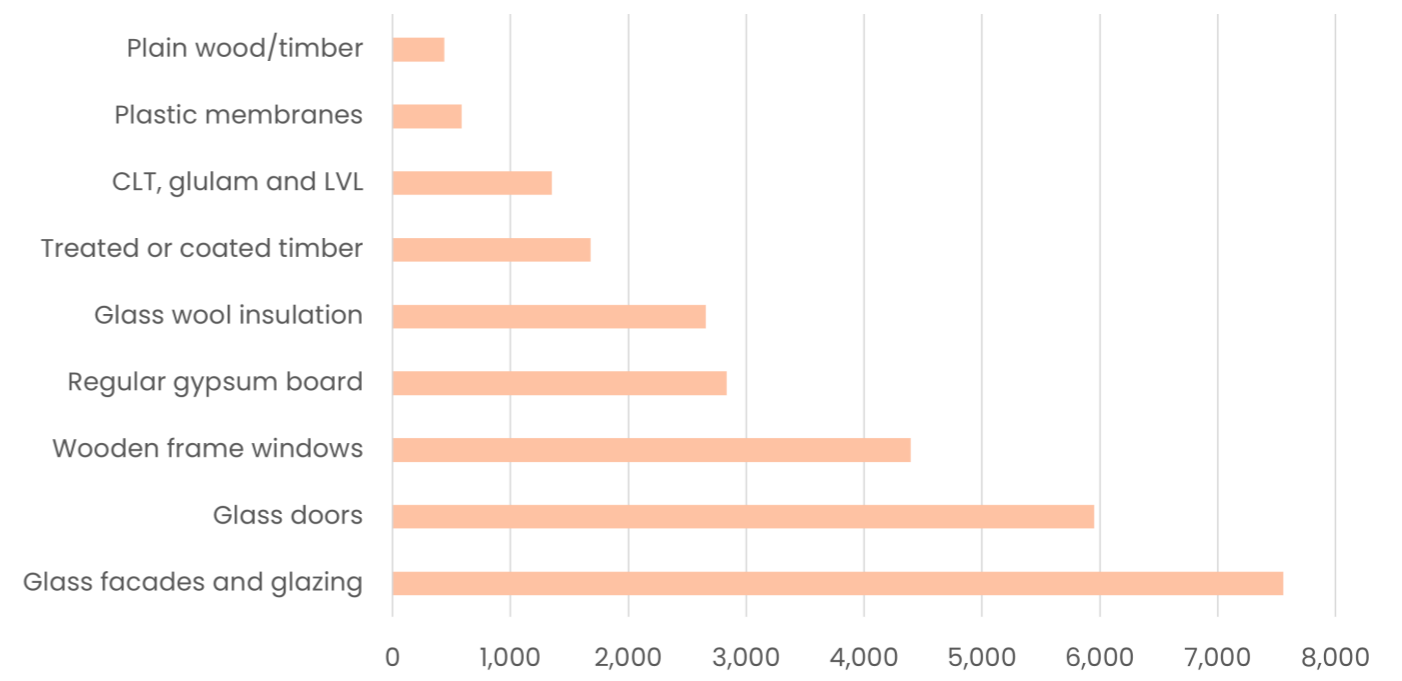


Fig. 39.3: RENOVATION OF EXISTING - MOST CONTRIBUTING TYPES OF MATERIALS (kgCO₂e)

ENERGY DEMAND

RENOVATION OF THE EXISTING

In addition to the suggestions from SINTEF's nZEB upgrade for the gable walls, basement walls, and the basement ceiling, additional measures include the existing roof, the southern gable wall, and the balcony facade.

In this project, the new top floors are heated, which makes the existing roof a building element towards a zone with the same temperature. Similarly, half of the southern gable wall now faces the heated common facilities, while the other half faces the unheated stairwell.

The impact of the newly added glazed balconies is included in the calculation by reducing the U-value of the existing balcony facade by 5% and the solar factor of the windows on this facade by 9%.

In addition, the voluntary measures which include optional new bedrooms, renovation of WCs, and balanced ventilation installation are voluntary measures. Therefore, the energy budget for the existing floors accounts for the worst-case scenario in which all apartments are keeping the existing floor plans and system: exhaust ventilation and heating from radiators.

The result shows that the new glazed balconies make a very small impact on the energy budget. In fact, it created a small increase of 0.01% in energy consumption according to this simplified calculation. However, they provide additional usable space and a sheltered outdoor area during the colder months, which lasts nearly half a year in Trondheim. In addition, changing the roof alone is responsible for a reduction of approximately 5%.

Fig.40.1 summarizes the changes made and the energy budget for the renovated floors. In total, this modest renovation reduces energy consumption in existing apartments by at least 18% compared to the current situation (Fig.40.2).

	U-value (W/m ² K)	Total insulation thickness (mm)
Roof	internal	
Entrance facade	0.3	150
Balcony facade	0.42 ⁽¹⁾	100
Gable wall	0.14	250
Basement wall	0.16	200
Door & window - entrance facade (solar factor = 0.55)	1.19	-
Door & window - balcony facade (solar factor = 0.5 ⁽²⁾)	0.76 ⁽¹⁾	-
Floor to basement	0.25	160
Cold bridge	0.07 W/m ² K	
Heated area (BRA)	1833 m ²	
Heated volume	4575 m ³	
Specific energy demand	146.9 kWh/m ² (114.2 kWh/m ² ⁽³⁾)	
Annual net energy demand	269,312 kWh (209,340 kWh/m ² ⁽³⁾)	
per 1-bedroom unit*	9,108 kWh	
per 2-bedroom unit*	10,430 kWh	

■ changes from the current condition

* estimation

(1) reduction to account for the new glazed balconies with heat loss factor = 0.95

(2) reduction to account for the extra layer of glazing with solar factor = 0.91

(3) with balanced ventilation

Fig. 40.1 RENOVATION OF THE EXISTING

WHOLE BUILDING

Fig.40.2 shows the specific demands for different zones and the building, which includes the new addition calculated in the previous comparison. The new addition meets the requirement of TEK17 for a net energy demand of 95 kWh/m² for apartment blocks, but the renovated floors do not.

Fig.40.3 shows the net energy demand of the different zones and the complete building. The existing floors demand twice as much energy as the new addition, mainly due to space heating. Effective solutions should be implemented to reduce the delivered energy to the building, particularly for thermal needs.

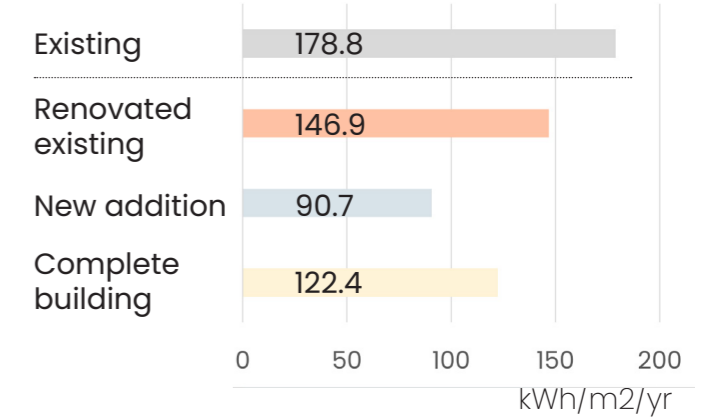


Fig. 40.2 SPECIFIC ENERGY DEMAND

kWh/yr	Renovated existing	New addition	Whole building
1a Space heating	154,429	30,543	184,972
1b Ventilation heat	0	5,109	5,109
2 Hot water	54,619	42,328	96,947
3a Fans	7,276	7,056	14,332
3b Pumps	0	2,729	2,729
4 Lighting	20,879	16,184	37,063
5 Technical equipment	32,108	24,901	57,009
6a Room cooling	0	0	0
6b Ventilation cooling	0	0	0
Total net energy demand, sum 1-6	269,312	128,850	398,161

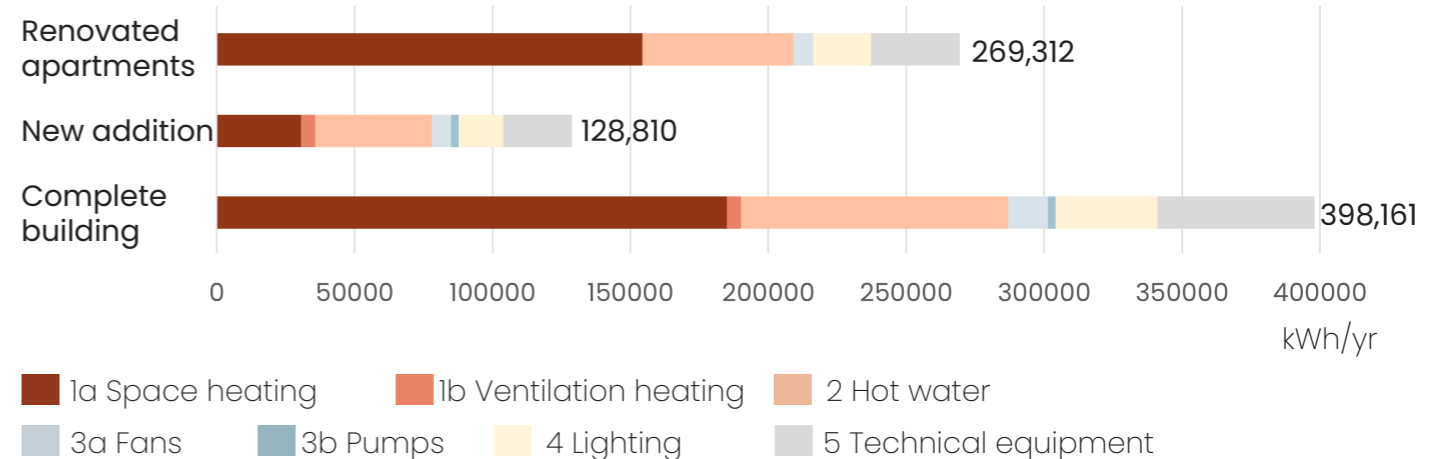


Fig. 40.3 ANNUAL NET ENERGY DEMAND

RENEWABLE ENERGY

SOLAR ENERGY + HEAT PUMP

In addition to the air-to-water heat pump that covers 90% of the space heating, hot water, and heating batteries ventilation, it is possible to use solar panels to cover the remaining electricity demands. The building has approximately 670 m² of roof, which is the most efficient area for solar panels in this project. To increase the potential, the total solar panels can include surfaces from the south facade and the tilted walls on the west facade of both the new and existing (Fig.41.1).

	Area m ²	Electricity	
		kWh/yr	kWh/m ² /yr
Roof (tilted 25°, south)	600	-84,639	-26.1
South	130	-12,331	-3.8
Southwest	140	-11,532	-3.5
Total	870	-108,503	-33.4

Fig. 41.1 SOLAR ENERGY PRODUCTION

However, solar energy is most efficient during the summer when there is little to no heating demand from the building (Fig.41.2). As a result, the building still relies on direct electricity during the winter. In total, solar panels can produce 108,503 kWh of electricity annually, and this solution can reduce the delivered direct electricity from the grid to 45.6 kWh/m² (Fig.41.5).

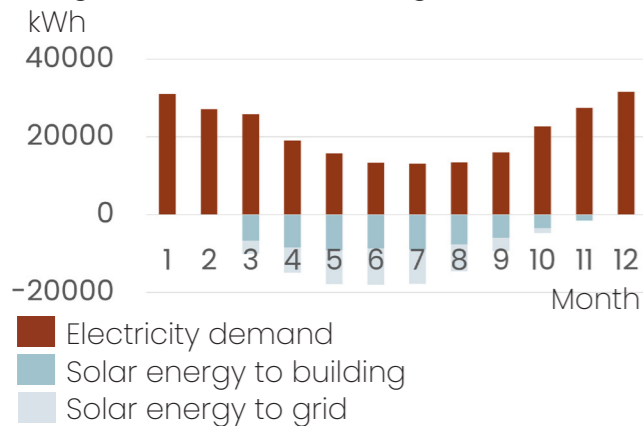


Fig. 41.2 MONTHLY ELECTRICITY DEMAND

CHP

Combined heat and power (CHP) is an alternative that can meet both the thermal and electricity needs of a building, regardless of the sun's availability. Fig.41.3 shows the CHP energy calculation, which divides the building's energy demand into two categories: heat and electricity. For this project, the heat demand includes space heating, ventilation heat, and hot water, while the remaining needs are electricity demand. The thermal demands are calculated separately due to the different heating and ventilation systems used in the new and existing buildings. A high-performance bio-based gas CHP unit with a total efficiency of 90% (55% for heat and 35% for electricity) (SN-NSPEK 3031:2021) that cover all the heat demand of 325,173 kWh can also deliver an additional 206,928 kWh of electricity, which is more than the demand of the building. This means that 89,290 kWh of surplus electricity can be exported to the grid. A reference CHP unit with the same efficiency, a thermal output of 270 kW and an electrical output of 180 kW, requires at least 63 m² (Burkhardt CHP ECO 180 HG). This thermal output is 3.5 times greater than the heat demand of a single building, allowing one CHP unit of this size to cover the demand for 3-4 similar buildings in the development. This CHP unit can potentially be located in the current parking lot (Fig. 41.4).

While solar panels can be integrated into the rooftops and facades of buildings, they cannot meet the heating demands during winter, which is important for the existing. A CHP unit may require a significant ground area, but it is feasible for a development of this size. Reducing the amount of delivered electricity is a top priority for this project, and CHP units can operate year-round, making them a more viable renewable energy solution than solar panels. Therefore, CHP is selected as the renewable energy solution for this project.

	New		Existing	
	kWh	kW	kWh	kW
Time (hour)	2452		6124	
Efficiency ⁽¹⁾	0.89		0.88	
Net heat demand	77,980	-	209,048	-
Heat demand the CHP unit covers (Q) ⁽²⁾	87,618	36	237,555	39
Net electricity demand	50,870	-	60,263	-
Electricity demand ⁽²⁾	57,157	-	68,480	-
Delivered electricity from the CHP unit (P) ⁽³⁾	55,757	23	151,171	25
Total heat demand the CHP unit covers	325,173 kWh		99.9 kWh/m²	75 kW
Total electricity demand the CHP unit covers	125,638 kWh		38.6 kWh/m²	
Total delivered electricity from the CHP unit	206,928 kWh		63.6 kWh/m²	48 kW

- (1) loss from distribution and space efficiency
- (2) Q = Net demand / Efficiency
- (3) P = Q x 35% / 55%

Fig. 41.3 ENERGY FROM CHP UNIT

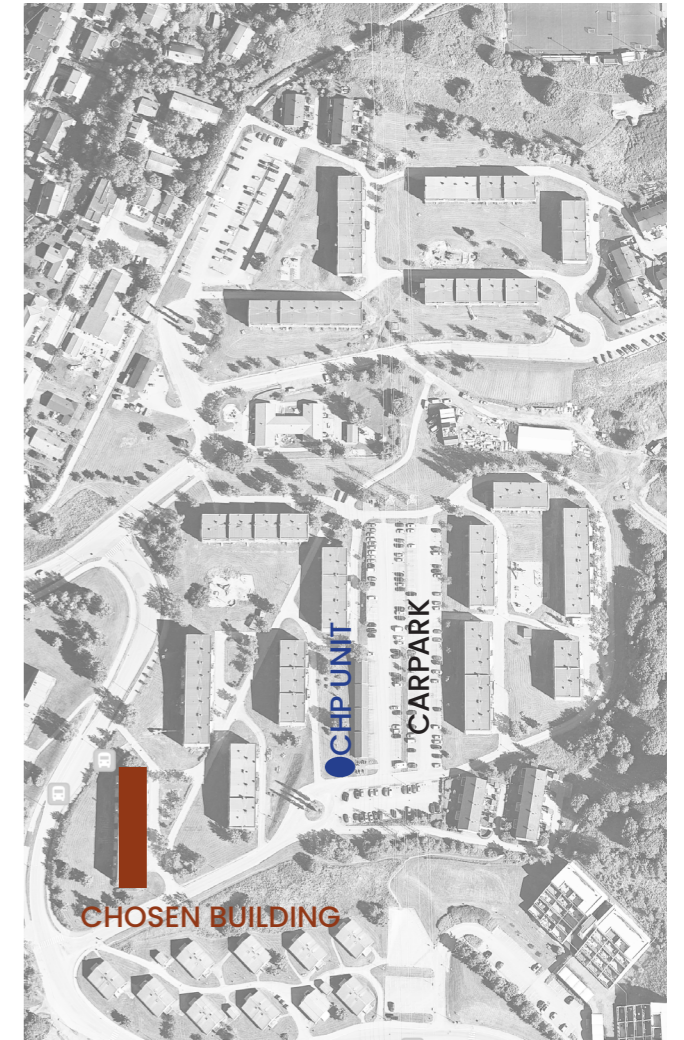


Fig. 41.4 POSSIBLE LOCATION FOR CHP UNIT

Resource	Delivered electricity to building		Renewable energy for own use		Renewable energy exported to grid	
	kWh/m ²	kgCO ₂ e/m ² ⁽¹⁾	kWh/m ²	kgCO ₂ e/m ² ⁽¹⁾	kWh/m ²	kgCO ₂ e/m ² ⁽¹⁾
Direct electricity	132.4	17.2	-	-	-	-
Heat pump	78.9	10.3	-	-	-	-
Solar energy + heat pump	45.6	5.9	-18.7	-2.4	-14.7	-1.9
CHP	0	0	-138.5⁽²⁾	-18	-25	-3.3

- (1) CO₂ factor = 130g/kWh (2) heat + electricity ■ chosen solution

Fig. 41.5 COMPARISON OF DIFFERENT ENERGY RESOURCES



6 CONCLUSION

Considering the social aspects, energy efficiency, and life cycle perspective, renovating this project proved to be quite challenging. It's difficult to propose a solution that can fulfill all requirements. Therefore, the thesis opted for a modest renovation of the existing floors and a more extensive proposal for the new addition on top.

In addition to transforming an old building to help solve the demand for housing, the project proposes three options to address the energy issue for existing residents from both social and environmental perspectives: voluntary upgrades of their homes as part of the building renovation, relocation to new apartments on the roof, and a proposal for renewable energy.

Modestly renovated existing apartments can reduce at least 18% of the energy budget compared to the previous condition. The energy calculation for the renovated apartments does not take into account any voluntary upgrades, but it is expected that these upgrades will further increase the reduction in energy usage.

The proposed new floors on top will include 26 new compact apartments: 2 studio apartments, 19 one-bedroom units, and 5 two-bedroom units. Moreover, 18 of the new units are flexible and can be merged into 9 larger units. Partly due to their compact size, the energy demand for each of the new rooftop apartments varies from 2200 to 4400 kWh annually, which is less than half the demand of the existing apartments, depending on the unit type. This provides alternatives for existing tenants who prefer smaller and more energy-efficient living spaces.

In addition, installing a CHP unit of 65m² can cover all the heat and electricity demands of approximately 3.5 buildings of the same size. This means that approximately 4 CHP units of this size can cover all the energy demand of the 16 apartment blocks and still have surplus electricity to export to the grid which can offset another 3.2 kgCO₂e/m². The amount of annual surplus electricity also exceeds the preliminary estimation for embodied materials (1.2 kCO₂e/m²BRA).

The project did not investigate the emissions resulting from additional site renovation, materials, and operation of combined heat and power (CHP) units. Furthermore, since the project proposes to use one CHP unit to cover the demand of multiple buildings, it would be more accurate to calculate the emissions for a group of buildings or the entire development. This would be valuable for future exploration.

7 REFERENCES

- TreFokus, Treteknisk, Treindustrien, NBBL and NTNU Wood (2021) *Treindustrielle muligheter for oppgradering og påbygg av eksisterende boligmasse*. Available at: <https://treindustriellekonsepter.no/images/Treindustrielle%20muligheter%20-%20Prosjektrapport.pdf>
- Skeie, K., Lien, A., Skaar, C., Olsen, E., Skippervik, R., Iversen, B. and Westermann, P. (2018) *Rehabilitering av borettslag til nesten nullenerginivå, en mulighetsstudie for boligbyggelaget TOBB*. Available at: https://sintef.brage.unit.no/sintef-xmliui/bitstream/handle/11250/2492684/1/organisasjon_Kunnskapsformidling_130122%2bSAF_Utgivelser_SINTEF%2bNotat%2b-%2bNotes_SNOTAT26_PDF%2btill%2bpublisering_SNotat26.pdf?sequence=2&isAllowed=y
- Klinski, M. (2014) *Ambisiøs energioppgradering med etterisolert fasade*. Available at: https://www.sintefbok.no/book/index/1036/ambisioes_energioppgradering_med_etterisolert_fasade
- Hauge, Å., Mellegård, S., Amundsen K. H. (2011) *Beslutningsprosesser i borettslag og sameiere, Hva fører til bærekraftige oppgraderingsprosjekter?* Available at: https://www.sintefbok.no/book/index/904/beslutningsprosesser_i_borettslag_og_sameier
- Byggteknisk forskrift (TEK17) med veiledning. Available at: <https://dibkno/regelverk/byggteknisk-forskrift-tek17>
- Byggforsk 330.114 (2020) *Utforming av leiligheter*. Available at: https://byggforsk.no/dokument/97/utforming_av_leiligheter
- Byggforsk 361.501 (2020) *Utforming av balkonger og terrasser i boliger*. Available at: https://byggforsk.no/dokument/149/utforming_av_balkonger_og_terrasser_i_boliger
- Byggforsk 726.608 (2017) *Innglassingssystemer for balkong*. Available at: https://byggforsk.no/dokument/696/innglassingssystemer_for_balkong
- Hunton (2018) Hunton I-bjelken. Available at: https://www.hunton.no/wp-content/uploads/2018/02/i-bjelken_teknisk_handbok_web.pdf
- SN-NSPEK 3031:2021 *Bygningers energiytelse – Beregning av energibehov og energiforsyning*. Available at: <https://www.standard.no/no/Nettbutikk/produktkatalogen/Produktpresentasjon/?ProductID=1393607>
- Bukhardt (n.d.) *Heat and power with wood pellets*. Available at: http://www.bioenergetika.si/images/Burkhardt_ENG.pdf
- Glava (n.d.) <https://www.glava.no/losninger>