

Magnus Lauritzen Holtet
Anh-Kha Nguyen Vo

Skillsprint - Gamifying Repetition in Mathematics

An Empirical Study Exploring How Various Factors Can Influence Perceived Motivation by a Gamified Application and Its Various Game Elements

Master's thesis in Informatics
Supervisor: Sofia Papavlasopoulou
June 2023



Norwegian University of
Science and Technology

Magnus Lauritzen Holtet
Anh-Kha Nguyen Vo

Skillsprint - Gamifying Repetition in Mathematics

An Empirical Study Exploring How Various Factors Can Influence Perceived Motivation by a Gamified Application and Its Various Game Elements

Master's thesis in Informatics
Supervisor: Sofia Papavlasopoulou
June 2023

Norwegian University of Science and Technology
Faculty of Information Technology and Electrical Engineering
Department of Computer Science



Norwegian University of
Science and Technology

Abstract

Building positive relationships with mathematics, particularly during secondary school, is crucial for future academic pursuits and being an informed citizen. Repetition is one of the most effective ways of learning mathematics, but traditional repetition methods often fail to engage students and may be perceived as boring. Additionally, the prevalent consumption of short-form content has significantly impacted students' attention spans, yielding a need for tailored educational approaches to meet their needs effectively. In this study, we developed SkillSprint, a sophisticated web application using gamification principles to enhance mathematics repetition. SkillSprint mirrors students' curriculum tasks and automatically validates their answers while providing a point system and various game elements to enhance motivation. This study aimed to investigate how students perceive the application and its game elements as motivating and examine factors influencing perceived motivation.

We collected data through application usage and pre- and post-questionnaires from 47 participants in 10th grade at Blussuvoll School. Descriptive statistics and statistical analyses were used to examine perceived motivation and what factors could influence how motivating the application and the game elements were perceived.

Overall, the students reported moderate motivation by SkillSprint, with mixed results for the game elements. Interestingly among the findings, interest and enjoyment by using SkillSprint emerged as the most influential factor in determining perceived motivation by the application and game elements. Simultaneously, results revealed no significant influence by gender and previous experiences, whereas certain user types from Marczewski's Hexad did show some influence.

This research contributes to the scarce literature on gamification in mathematics repetition by providing a thoroughly designed and developed application rather than a mere prototype. The results can serve as guidelines and a foundation for future gamification implementation of applications focused on enhancing motivation for tedious, repetitive academic tasks. Further studies can expand on our application and replicate the analyses with larger sample sizes in more controlled environments.

Sammenheng

Å utvikle et positivt forhold til matematikk helt fra tidlige skoleår, kan danne grunnlaget for å bedre forstå strukturer, orden og relasjoner, - samt kunne være avgjørende for fremtidige akademiske yrkesvalg. Repetisjon er en av de mest effektive metodene å lære matematikk på, men tradisjonelle repetisjonsmetoder er ofte lite engasjerende og kan oppleves som kjedelige. I tillegg har dagens utbredte forbruk av kortformatinnhold påvirket elevenes konsentrasjons- evner og oppmerksomhetsspenn i betydelig grad. Dette gir i dagens samfunn et behov for andre innlæringsmetoder og tilnærminger for å fremme og sikre matematiske ferdigheter og forståelse. I denne studien utviklet vi derfor SkillSprint, en sofistikert nettapplikasjon som bruker gamification-prinsipper for å motivere til repetisjon av matematikk. SkillSprint speiler elevenes pensumoppgaver og retter automatisk svarene deres. Korrekte svar gir poeng, samtidig som applikasjonen har en rekke andre spill-elementer for å bidra til motivasjon for å repetere matematikk. Denne studien hadde som mål å undersøke hvorvidt elevene oppfattet applikasjonen og dens spill-elementer som motiverende, samt undersøke faktorer som kunne påvirke hvordan det opplevdes motiverende.

Vi samlet inn data fra applikasjonen og spørreskjemaer fra 47 deltakere i 10. klasse ved Blussuvoll skole. Deskriptiv statistikk og statistiske analyser ble brukt for å undersøke den opplevde motivasjonen og hvilke faktorer som kunne påvirke hvor motiverende applikasjonen og spill-elementene ble oppfattet.

Samlet sett rapporterte elevene om moderat motivasjon ved bruk av SkillSprint, med blandede resultater for spill-elementene. Et interessant funn var at opplevd interesse og glede ved bruk av SkillSprint, var den mest innflytelsesrike faktoren for opplevd motivasjon av applikasjonen og spill-elementene. Samtidig viste resultatene ingen signifikant påvirkning av kjønn og tidligere erfaringer, mens enkelte brukertyper fra Marczewskis Hexad viste en viss innflytelse.

Denne forskningen er et bidrag til den knappe forskningslitteraturen om gamification av repetisjon i matematikk. I tillegg bidrar vi med en grundig designet og velutviklet applikasjon, i stedet for en enkel prototype slik mye annen forskning har benyttet seg av. Resultatene kan benyttes som retningslinjer for fremtidige utvikling, der gamification skal implementeres med fokus på å øke motivasjonen for kjedelige, repeterende akademiske oppgaver. Videre studier kan eksempelvis videreutvikle SkillSprint og replikere analysene med flere deltakere i mer kontrollerte miljøer.

Acknowledgements

We want to express our sincere gratitude to all those who have contributed to completing this thesis. Without your support, guidance, and encouragement, this research endeavor would not have been possible.

First and foremost, we are grateful to our supervisor, Sofia Papavlasopoulou, at the Norwegian University of Science and Technology (NTNU), for her support, guidance, and expert advice throughout the research process. Thank you for inspiring and guiding us throughout the preparatory project and the work with this thesis.

We would also like to extend our heartfelt appreciation to Oskar A. Olsen and his students at Blussuvoll School. Oskar's contribution was far beyond what we envisioned and expected, and it had an invaluable impact on the planning and execution of the application testing. We are also very grateful for the student's interest and willingness to partake in our study.

Thanks to our fellow students for their valuable social and academic input. The stimulating discussions, diverse perspectives, and shared experiences have contributed significantly. Additionally, we would like to express our profound gratitude to our friend, Kristine Larssen, for her invaluable support and knowledge sharing helping us overcome numerous obstacles.

Lastly, special thanks go to our friends and family for their unwavering love, moral support, and understanding throughout this academic journey. Their encouragement, patience, and belief in our abilities have been a constant source of inspiration.

Table of Contents

List of Figures	vii
List of Tables	ix
Thesis Outline and Reader's Guide	xii
1 Introduction	1
1.1 Problem Description	1
1.2 Research Process	3
2 Background	5
2.1 Literature Search Strategy	5
2.2 Repetition in Mathematics	5
2.3 Intrinsic and Extrinsic Motivation	5
2.4 Gamification	6
2.4.1 Game Flow	6
2.4.2 Game Elements	6
2.5 Marczewski's User Types Hexad	10
2.6 Existing Solutions	11
2.6.1 The King of Math series	11
2.6.2 Kahoot! and Quizalize	11
2.6.3 Duolingo Math	11
2.7 Summary	12
3 Design and Implementation	13
3.1 Design Process	13
3.1.1 Discover	14
3.1.2 Define	15
3.1.3 Develop and Deliver	18
3.2 The Application: SkillSprint	22
3.2.1 Homepage	22
3.2.2 Login Page	23
3.2.3 Task Page	23
3.2.4 Achievements Page	25
3.2.5 Leaderboard Page	26

3.2.6	Insight Page	26
3.3	Application Technologies and Development Tools	28
3.3.1	Development in TypeScript	28
3.3.2	Web Development With Next.js and React.js	28
3.3.3	Storing Data in Supabase	29
3.3.4	Hosting With Vercel	29
3.3.5	Analytics with PostHog	29
3.3.6	Embedding Nettskjema.no Into the Application	30
4	Methodology	31
4.1	Participants	31
4.2	Procedure	32
4.2.1	Preparation	32
4.3	Data Generation	33
4.3.1	Application Data	33
4.3.2	Instruments	33
4.3.3	Reliability	34
4.4	Data Analysis	36
5	Results	39
5.1	Descriptive Statistics	39
5.2	Correlation Analyses	41
5.3	Regression Analyses	41
5.4	t-tests	42
6	Discussion	45
6.1	Perceived Motivation by SkillSprint	45
6.2	Perceived Motivation by the Game Elements	48
6.2.1	Common Relationships and Predictors	51
6.3	The Study's Contributions	51
6.4	Limitations	52
7	Conclusion	53
7.1	Future Work	53
7.2	Conference Contribution	54
	References	55

Appendices	61
A Architectural Descriptions	61
A.1 Architectural Drivers / Architectural Significant Requirements (ASR's) . .	61
A.2 Stakeholders and Concerns	66
A.3 Architectural Views	66
B Application Usage Guide	74
C Response Options and Weights	75
D Wireframes	76
E User Interface Designs	79
F Participant Recruitment Email	82
G Attachment to the Participant Recruitment Email: Concept and Functionality . .	84
H Information Letter	89
I Introduction to SkillSprint	92
J Pre-questionnaire	102
K Post-questionnaire	107

List of Figures

1	Model of the Research Process, Adapted From Oates et al. [61].	4
2	Hexad by Marczewski [52].	10
3	The Double Diamond Process and It's Phases.	14
4	Some of the Wireframes.	19
5	The Mood Board in Figma.	20
6	SkillSprint's Color Palette.	20
7	Screenshot of Our Triage Queue System.	21
8	SkillSprint's Sitemap.	22
9	Home Page.	23
10	Login Page.	23
11	Task Page.	24
12	Task Page With Alternative Answer Types.	24
13	Achievements Page.	25
14	Leaderboard Page.	26
15	Activity Log Above, Performance Graph Below.	27
16	Task Statistics.	27
17	High Level Architecture Overview.	28
18	Questionnaire Embedded in SkillSprint.	30
19	Gender Distribution.	31
20	Student's Previous Experiences.	39
21	Students's Preference for Mathematics.	40
22	Bar Chart of Hexad User Types.	40
A.1	Logical View.	67
A.2	Activity Diagram of Task Solving.	69
A.3	Component Diagram.	70
A.4	Package Diagram.	72
A.5	Deployment Diagram.	73
D.1	Task Detail Wireframe.	76
D.2	Answered Task Detail wireframe.	76
D.3	Task Overview Wireframe.	77
D.4	Leaderboard Wireframe.	77
D.5	Insight Wireframe.	78
D.6	Achievement Wireframe.	78

E.1	Design of the Tasks Overview Page.	79
E.2	Design of the Task Page.	79
E.3	Design of the Leaderboard Page.	80
E.4	Design of the Achievement Page.	80
E.5	Design of the Insight Page.	81

List of Tables

1	The Research Questions and Their Corresponding Hypotheses.	3
2	Game Elements Classifications From Deterding et al. [16].	7
3	User Types Classifications by Marczewski [52].	10
4	The Selected Game Elements.	14
5	Overview Over the Computed Cronbach’s Alpha Coefficients.	35
6	Overview of the Variables.	35
7	Regression Variables Overview.	37
8	Descriptive Statistics.	41
9	Results from the Correlation Analyses.	41
10	Regression Results for Perceived Motivation by SkillSprint.	42
11	Regression Results for Perceived Motivation by the Game Elements.	43
12	t-test Results by Preference for Mathematics.	43
13	t-test Results by Gender.	44
A.1	Functional Requirements.	61
A.2	Stakeholders and Their Concerns.	66
A.3	Selection of Architectural Views.	66
A.4	Response Options and Weights for Pre- and Post-questionnaires.	75

Abbreviations

ICTMT 16 16th International Conference on Technology in Mathematics Teaching. 54

IMI Intrinsic Motivation Inventory. 34, 36, 37, 43

NSD Norwegian Center for Research Data. 31

NTNU Norwegian University of Science and Technology. iii, 15, 30

ORM Object Relational Mapper. 71

RPC Remote Procedure Calls. 29

SDT Self-Determination Theory. 5, 6, 47, 49

SUS System Usability Scale. 34, 36, 37

UI user interface. 28, 63, 68

Glossary

- Capture the Flag** A cybersecurity activity in which participants compete to locate and exploit vulnerabilities in a simulated system to retrieve a designated flag, testing their hacking and defensive skills. 15, 24
- design thinking** Design thinking is an analytical and creative process that involves experimentation, prototyping, feedback gathering, and iterative redesign, intending to promote problem-solving skills. 13
- double diamond** A design thinking framework that involves four phases—discover, define, develop, and deliver—to explore problems and generate innovative solutions [21]. 13, 18
- flag** In cybersecurity activities like “Capture The Flag,” a flag is a specific piece of digital information, typically represented as a string of characters or a file, that serves as tangible evidence of success, indicating the completion of an objective or marking progress and achievement within the game. 24, 61
- free practice session** A free practice session in a school setting is where students engage in independent work aligned with the relevant syllabus without direct instructional guidance. 1–3, 16, 17, 24, 31, 32, 34, 45–48, 51–53, 71
- Hexad** A Player Type Framework for Gamification Design that classifies individuals into six distinct player types (Socialiser, Philanthropist, Free Spirit, Achiever, Player, and Disruptor) based on their intrinsic motivations and preferred interaction styles, offering insights for designing personalized gamified experiences [52]. i, ii, vii, 10, 12, 14, 33, 34, 36, 37, 39, 40, 48–50
- high-fidelity design** A design approach that closely resembles the final product, incorporating realistic visual and interactive elements, providing a detailed and polished representation for user evaluation and implementation. 19
- low-fidelity design** A design approach that employs simple and basic representations, often using sketches, wireframes, or prototypes with minimal details and interactivity, facilitating quick iterations and exploration of design concepts and ideas. 18, 19, 21
- Nettskjema.no** An online form-building platform that enables users to create, customize, and distribute web-based forms for surveys, registrations, and feedback collection without the need for extensive technical knowledge [59]. v, 30
- Server-Side Rendering** A web rendering technique that consists of generating the HTML content of an application on the server before sending it to the client. 64
- SkillSprint** A gamified web platform created by the authors of the thesis. SkillSprint aims to motivate students in mathematics courses to solve and repeat math tasks. i, ii, v, vii, ix, xii, 2, 3, 13, 15–23, 26, 28–34, 36, 37, 39–43, 45–54, 61, 63–70, 73, 74
- Static-Site Generation** A web rendering technique that consists of pre-rendering the entire pages during the application build process. As a result, the pages are instantly served to the user as there’s no need for fetching data. 64
- STEM** A teaching approach that combines science, technology, engineering and mathematics. 15, 53
- triage queue system** A development workflow approach that organizes and prioritizes tasks based on urgency, severity, and impact, enabling efficient resource allocation and timely resolution of high-priority items. 21

Thesis Outline and Reader's Guide

Introduction

In the first section, we introduce the problem and motivation, the context, the research questions with their hypotheses, and the research process for the thesis.

This section (Section 1) is mostly based on work done in the preparatory project [30], with some changes.

Background

In the second section, we cover theories and definitions of repetition in mathematics, motivation, gamification, user types, as well as existing solutions.

This section (Section 2) is mostly based on work done in the preparatory project [30], with some changes.

Design and Implementation

In the third section, we first introduce the thorough design process with its phases, the concept, and our application SkillSprint. Further, we thoroughly cover the development process, SkillSprint's functional and non-functional requirements, and technologies and tools used.

Certain parts of this section (Section 3) are based on work done in the preparatory project [30], with some changes.

Methodology

In the fourth section, we present the systematic approach to the study. Further, the participants are introduced, and the procedure, the data generation methods with their respective instruments, and the data analyses are thoroughly described.

Certain parts of this section (Section 4) are based on work done in the preparatory project [30], with some changes.

Results

In the fifth section, we present the descriptive statistics from the gathered data and all results from the data analyses with relevant assumptions and caveats.

Discussion

The results are interpreted per our research questions and hypotheses in the sixth section and discussed with relevant literature. The study's limitations are also addressed, and its contributing factors are elaborated.

Conclusion

In the seventh and final section, we present a summarized conclusion of the findings and a description of possible future work.

1 Introduction

Children are taught basic mathematics as early as preschool through games and activities. In Norway, basic mathematics is mandatory and further elaborated in primary school (years 1-7) and secondary school (years 8-10) [23]. The mathematics taught in secondary school is particularly important, as it provides a foundation for concepts introduced in upper secondary school (years 11-13). Betz and Hackett [7] found that if one has an adverse affective reaction towards mathematics already in middle school, one might avoid future mathematical courses and thus career paths requiring mathematical skills. Therefore, one must have a good association with mathematics in secondary school so that potential career options are not limited early.

The mathematics taught in secondary school can also help students develop critical thinking, decision-making, and problem-solving skills [19]. Furthermore, understanding the basic mathematical principles taught at this educational level is, for instance, essential for being an informed citizen, as it allows individuals to make informed decisions about financial matters [27].

In short, being comfortable with mathematics in secondary school is vital as it provides a foundation for understanding more complex mathematical concepts introduced in upper secondary school and further education, enabling the possibility for a wide range of career paths and practical reasons in everyday life [33].

Studies show that one of the most effective ways of learning mathematics is through varied repetition [49], and is further elaborated in Section 2.2. Many find mathematics boring, and boredom can be fed with such a naturally repetitive task [45, 56].

We live in a digital age where entertainment is just a few clicks away, and pupils are used to scrolling social media and watching short-format videos on YouTube, TikTok, Instagram, and similar. According to Donaldson-Pressman et al. [18], *“research widely supports the theory that constant connectivity to media negatively affects one’s cognitive abilities to focus on academic tasks”*. Teachers back up this claim by mentioning that pupils need more breaks due to short-form content habits [24].

With the increased consumption of short-form content and constant connectivity, educators should look into ways to tailor education to a format that meets the pupils’ needs. A study by Buckley and Doyle [9] found that gamified learning interventions positively impact learning and participation, and a common approach is by many teachers to meet the pupils’ needs for external motivation by incorporating various game elements.

1.1 Problem Description

Studies show significant results in increased learning outcomes, participation, as well as an increment in motivation when game elements are introduced [9, 34, 35].

A study by Bernero [6] shows that many students find repetition in mathematics boring and unmotivating, leading to a negative feeling towards the subject. This is an interesting finding because repetition in mathematics has been proven to be very effective [13, 49, 46]. It is evident that a basic understanding of mathematics is essential for functioning in many areas of everyday life, and the math one learns in primary and secondary school lays a foundation for potential future studies and options.

Seaborn and Fels [76] point out that future research should aim to isolate the game elements in particular contexts for particular user types. In addition to thoroughly investigating game elements in particular contexts, Manzano-León et al. [51] propose a need for further research to examine the impact of demographics on gamification.

There is scarce existing research on the gamification of repetition, and it is a fact that many experience repetition in mathematics as boring. However, as repetition in mathematics is proven to be highly successful, we will investigate how game elements can be introduced to free practice sessions

for repetition of mathematics to make it more motivating. Additionally, we will explore various factors that can contribute to heightening the perceived motivation by a gamified application and its game elements. As a basis for the research, the proposed research questions are as follows:

RQ1 How do students perceive SkillSprint as motivating to repeat mathematics in a free practice session?

RQ1.1 How do specific factors influence the perception of motivation by SkillSprint to repeat mathematics in a free practice session?

RQ2 How do students perceive various game elements motivating to repeat mathematics in a free practice session?

RQ2.1 How do specific factors influence the perception of motivation by various game elements to repeat mathematics in a free practice session?

To answer the research questions in a structured manner, hypotheses have been developed to create boundaries and specify necessary factors:

H1 SkillSprint is perceived as more than neutrally motivating when repeating mathematics in a free practice session.

H2 A significant relationship exists between experience with similar applications and how motivating SkillSprint is perceived as.

H3 A significant relationship exists between video game experience and how motivating SkillSprint is perceived as.

H4 There is a significant difference in perceived motivation by SkillSprint between individuals who like and dislike mathematics.

H5 There is no significant difference in perceived motivation by SkillSprint by gender.

H6 The usability of SkillSprint has an influence on how it is perceived as motivating.

H7 Some game elements are perceived as motivating when repeating mathematics in a free practice session.

H7.1 *Leaderboards* are perceived as more than neutrally motivating.

H7.2 *Points* are perceived as more than neutrally motivating.

H7.3 *Achievements* are perceived as more than neutrally motivating.

H7.4 *Streaks* are neither perceived as motivating nor demotivating.

H7.5 *Performance graphs* are perceived as more than neutrally motivating.

H7.6 The *time pressure* aspect of free practice sessions is not perceived as motivating.

H7.7 *Animations* are neither perceived as motivating nor demotivating.

H8 A significant relationship exists between experiences with similar applications and how motivating the game elements are perceived as.

H9 A significant relationship exists between video game experiences and how motivating the game elements are perceived as.

H10 There is no significant difference in perceived motivation by the game elements between individuals who like and dislike mathematics.

H11 There is no significant difference in perceived motivation by the game elements by gender.

Table 1 presents an overview of the research questions and their corresponding hypotheses.

Table 1: The Research Questions and Their Corresponding Hypotheses.

RQ	Question	Corresponding Hypothesis
RQ1	How do students perceive SkillSprint as motivating to repeat mathematics in a free practice session?	H1
RQ1.1	How do specific factors influence the perception of motivation by SkillSprint to repeat mathematics in a free practice session?	H2, H3, H4, H5, H6
RQ2	How do students perceive various game elements motivating to repeat mathematics in a free practice session?	H7, H7.1, H7.2, H7.3, H7.4, H7.5, H7.6, H7.7
RQ2.1	How do specific factors influence the perception of motivation by various game elements to repeat mathematics in a free practice session?	H8, H9, H10, H11

1.2 Research Process

Extensive searches in the literature provided insight into the state-of-the-art techniques and studies regarding the implementation and effects of gamification in education, as well as gamification in general. Further, we explored existing research related to motivation and specific game elements. This exploration further enabled us to identify research gaps and frame our research questions [61]. Initially, the gamification and motivation papers we found conducted studies that lasted several days or longer. Therefore, we focused on how gamification may motivate students in the short term, such as within a single 45-90 minute class period. Papers suggest that gamification may increase task meaningfulness and motivate people to perform repetitive tasks [73], which is highly relevant as repetition is vital to education in various subjects, especially mathematics. Further examination of the literature revealed that repetition is quite effective in learning mathematics. Therefore, we decided to concentrate on using game elements in free practice sessions for repetition in mathematics and make the students perceive it as motivating as possible.

Based on a model by Oates et al. [61], Figure 1 shows our research process, with relevant subprocesses in green. The research strategies, data generation methods, and data analysis is further elaborated in Section 4.

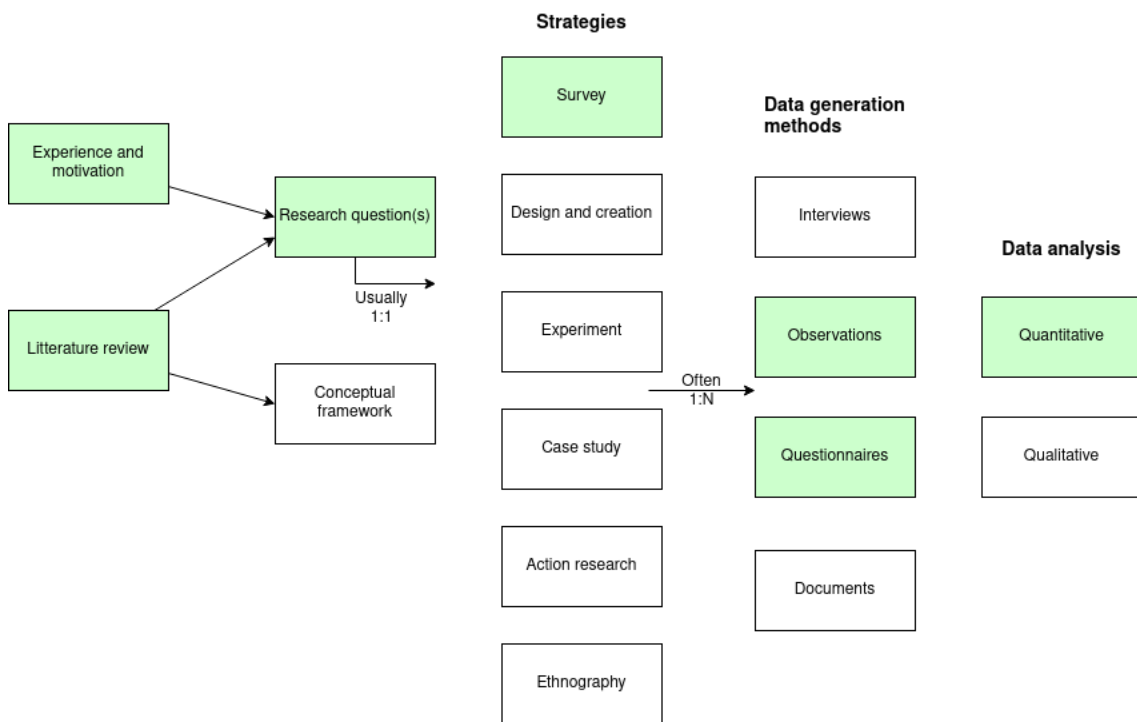

Figure 1: Model of the Research Process, Adapted From Oates et al. [61].

2 Background

2.1 Literature Search Strategy

As described in Section 1.2, we explored papers on the topics of *gamification*, *motivation*, *education*, and *science-activities* to gain knowledge related to the thesis. In Oria and Google Scholar, search strings like “gamification AND motivation”, “gamification AND education”, “motivation AND (education OR science-activities)”, and “gamification AND (education OR mathematics OR science-activities)” were used. Both the forward and backward snowballing methods were applied to the results from the various search strings. The backward snowballing method was applied to understand previous work better and identify key papers. The forward snowballing method was applied to view recent publications and find new uses for what had previously been found.

2.2 Repetition in Mathematics

Different cultures offer different views and belief systems in terms of mathematics education. For instance, in Western education, the focus is on understanding, while Asian education emphasizes repetition [49].

Western culture prioritizes a conceptual understanding of mathematical rules and symbols. Rather than memorizing what is being taught, pupils should prioritize understanding as it is believed to lead to better learning outcomes [13, 46]. A common way to create understanding is to make meaningful relations between the curriculum and the real world [63]. The Western view on repetition is that without a deep understanding, one is locked to a particular way of solving problems, thus unable to solve new, unpracticed challenges. Typically, repetitive learning is seen as the opposite of deep understanding.

In Asian education, on the other hand, repetition with variation is viewed as key to the development of understanding [54]. With systematic variations in mathematics education, students will develop a deep understanding of what is being taught. This claim is backed up by Dahlin and Watkins [13], who found that students focused on memorizing and understanding produced excellent results.

Even though there are two very different approaches, one is significantly more effective. Analyses conducted by Lomibao [49] found that “*students exposed to repetition with a variation approach had significantly higher achievement, conceptual understanding, and improved retention*”. The researchers recommended that teachers use repetition with variation as an approach for at least the four fundamental operations and that it could also be used as a basis for future studies.

2.3 Intrinsic and Extrinsic Motivation

Motivation can be defined as the reason(s) for acting or behaving in a particular way. In an educational context, one can interpret this as “*a student’s energy and drive to learn, work hard and achieve at school*” [53]. Edward Deci and Richard Ryan, two famous psychology professors at the University of Rochester, are known for developing the Self-Determination Theory (SDT). SDT concerns what motivates individuals to act until their goals are achieved. The amount of effort and commitment will impact the motivation for carrying out actions or performing activities to achieve a goal. Further, motivation is highly linked to persistence in the face of adversity [71]. Based on what gave rise to action, the SDT divides motivation into *intrinsic* and *extrinsic* motivation [14, 70].

Intrinsic motivation can be defined as “*the doing of an activity for its inherent satisfactions rather than for some separable consequence*” [70]. In other words, a person acts for the sake of the act and enjoyment of doing it instead of some external reward. On the other hand, extrinsic motivation can be defined as “*a construct that pertains whenever an activity is done to attain some separable outcome*” [70].

Intrinsic motivation is often seen as better than extrinsic motivation [14]. However, Ryan and Deci mention in the SDT that much school work is not designed to be intrinsically motivating, thus resulting in students benefiting from extrinsic motivation to push through [14]. Such extrinsic motivation might include grades, classmates' competition, fear of remarks, and similar. From a teacher's perspective, promoting active and voluntary forms of extrinsic motivation for boring activities can highly influence how successful the teaching is [70].

In order to influence both intrinsic and extrinsic motivation according to the SDT [14], the following psychological needs must be met.

- The need for competence
- The need for autonomy
- The need for social relatedness, often referred to as belonging

The aforementioned needs are considered motivational resources and can be developed and addressed through game elements [73].

2.4 Gamification

Gamification is using game principles and game design elements in non-game contexts. These contexts may, for instance, be regarding chores at home, in an educational situation, or for tracking specific habits. Adding game elements to such contexts aims to motivate and increase engagement [16], as it can encourage people to perform tasks they otherwise might not do or motivate them to engage more deeply in activities. Further, the gamified non-game context can promote learning and understanding through clear goals, feedback, and rewards [57].

2.4.1 Game Flow

Flow is a state of optimal experience in which individuals are completely immersed and intensely engaged with an activity [80]. Although flow and gamification are different concepts, research indicates that gamification can facilitate the attainment of flow state [78]. People in this state frequently lose track of time and have an intense sensation of concentration [80]. Furthermore, users in a flow state may find themselves more motivated as their attention becomes captured [94]. Designing an application with gamification elements that inherently motivate but also trigger flow experiences can improve the users' engagement and immersion. To achieve flow, one must finely balance difficulty and skill level [80]. Flow occurs when the amount of difficulty an activity provides corresponds to the user's skill level. Boredom might result if the challenge is too simple, and an excessively difficult assignment can cause anxiety and frustration. Finding the correct balance between the two is challenging but crucial so that an individual's talent may be used and developed at their own pace.

Goal setting and feedback are further paramount aspects of both flow and gamification [80]. Clear, attainable goals give users a sense of direction and allow them to focus their efforts. Furthermore, gamification includes various game elements that serve as feedback mechanisms and strategies for providing users with goals. Getting timely feedback enables users to understand how well they are progressing and how they can adapt their actions to reach their objective. Therefore, a clear goal, timely feedback, and a reasonable level of difficulty give users a sense of control over their activity, increasing total immersion [80].

2.4.2 Game Elements

Deterding et al. [16] define game elements as *"elements that are characteristic to games"*. In their context, gamification is reserved for game design, not game-based technologies. Different levels of abstraction can be used to classify game elements, as seen in Table 2.

Table 2: Game Elements Classifications From Deterding et al. [16].

Levels	Description	Example
Game interface design patterns	Common, successful interaction design components and design solutions for a known problem in a context, including prototypical implementations.	Badge, leaderboard, level
Game design patterns and mechanics	Commonly reoccurring parts of the design of a game that concern gameplay.	Time constraint, limited resources, turns
Game design principles and heuristics	Evaluative guidelines to approach a design problem or analyze a given design solution.	Enduring play, clear goals, variety of game styles
Game models	Conceptual models of the components of games or game experience.	MDA; challenge, fantasy, curiosity; game design atoms; CEGE
Game design methods	Game design-specific practices and processes.	Playtesting, playcentric design, conscious game design

The classification shows more gamification aspects than game elements, such as game mechanics, principles, and models. Furthermore, the classifications are evaluated by the degree of concreteness of the game elements. All of these aspects work together to provide a highly gamified experience. The thesis primarily focuses on game interface design patterns as we concentrate on how to gamify the repetition of mathematics. In addition, developing and testing a concrete product makes connecting outcomes to game elements easier. Therefore, restricting our research to the most concrete level of game aspects would be beneficial when gathering feedback from students.

Most of the game elements chosen for the research are based on the elements researched in the article “*How Gamification Motivates*” by Sailer et al. [73]. In this article, the focus lies on seven common game elements aiming at:

1. Direct visibility to the user.
2. How they address certain motivational factors.
3. Ease of implementation.

These game elements are *points*, *leaderboards*, *performance graphs*, *badges*, *avatars*, *meaningful stories* and *teammates*, which will be described in more detail below. Additionally *streaks*, *animation*, and *time pressure* will be described.

Points

Points are a game design element often used to numerically represent a user’s progress. There are many different points, such as experience points and redeemable points. They are frequently rewarded for doing certain activities and provide positive reinforcement by demonstrating which behaviors are good.

As a result, points provide granular feedback and measure a user’s in-game behaviors [73]. They can also adjust the difficulty by locking excessively difficult stages or tasks behind particular point thresholds. Hence, users possibly begin at an appropriate difficulty level and progress at their preferred rate, which is vital for achieving flow [80].

If the points are redeemable, they can be exchanged for various rewards. Depending on the type of reward, this mechanism can address extrinsic motivation and distinct intrinsic needs. For example, tradeable rewards encourage social interactions, whereas cosmetics may increase self-expression owing to additional customization options.

Leaderboards

A leaderboard is a game design element often associated with gamification [16]. In its most basic form, a leaderboard is a list of high scores and, therefore, a visual representation of a competition. The score should promote the correct metrics and align with the application's goals. In other words, leaderboards rank the users according to their relative success based on specific success criteria based on the application's goal.

As a result, a leaderboard provides a sense of competence, progress, and accomplishment because the user can compare their performance to that of others [73]. The leaderboard provides the user with cumulative feedback by evaluating a series of actions in a period. Due to this nature, users may utilize the leaderboard for goal-setting, an excellent incentive for self-improvement [44].

Furthermore, leaderboards can also be used to foster social relatedness. The leaderboard represents that the user is not alone in the activity and that others are also competing. This nature fosters social comparison and competitiveness[29]. On the other hand, Seaborn et al. [77] propose creating a prosocial leaderboard rather than a traditional one. This leaderboard can implement social mechanics like utilizing a shared team score or assigning points based on collaborative output to encourage social relatedness and promote collaboration.

On the other hand, the consensus on how motivating leaderboards are for users is mixed. The effects of leaderboards on motivation are not always positive. Leaderboards are effective motivators if users find themselves close in points to their peers, but can be demotivators if they are far behind [72]. The social pressure induced by the leaderboard also has the potential to harm a user's motivation and confidence [29, 73]. Therefore, there will likely be good benefits if the competitors possess similar performance levels but may serve adverse effects otherwise.

Performance Graphs

Performance graphs are a visual representation of how well a user is performing in a game. They are often used in gamification to show their progress over time visually. Performance graphs typically do not compare the user's performance to others but evaluate the user based on current and previous performance [73]. As a result, the performance graph provides sustained feedback and a sense of competence. Some performance graphs also showcase numerous metrics, which can help show which areas the user's performance lacks. Therefore, it may be a powerful motivator for those driven by mastery and self-improvement [74]. The game element encourages the user to engage in an activity for improvement and its own sake. Performance graphs benefit long-term motivation by providing a sense of competence and mastery over time. However, it can also show which specific areas the user should focus on to improve their performance quickly.

Avatars

Avatars are a game design element often used to visually represent the user in the game. In gamification, avatars may serve a variety of roles. For starters, they can provide the user a sense of identity by enabling them to create or choose a personalized character that matches their personality and interests. Therefore, avatars often provide a sense of autonomy through self-expression and freedom of choice [73]. Furthermore, the game element assists in distinguishing human users from other users or computer-controlled ones.

Sometimes avatars may depict a person's advancement since the user can see their avatar grow through time by unlocking new features, skills, or cosmetic options. As the avatar grows with the users, they can become emotionally attached to and motivated by the growth if done over a long period of time [74].

Badges

In gamification, badges are frequently used to represent progress or the completion of a specific task. Badges are commonly used as rewards to represent the fulfillment of specific milestones and are often characterized by a fitting visual image and a progression bar. However, they may also be given for less tangible achievements such as finishing a tutorial, demonstrating good sportsmanship, or contributing to the community [73]. As a result, badges can be used to encourage different

mechanics depending on their implementation. It should be noted that in gamification, the terms achievements, trophies, and badges are frequently used interchangeably. This thesis will primarily refer to this game element as *achievements*.

For starters, achievements can serve as goals if the user knows the achievements' prerequisites. The achievements may reflect their progress toward the goal and provide formative feedback [50]. Acquiring the achievements delivers a sense of competence and achievement. They can also be subdivided into different tiers, which serve as milestones to attain as they grow in difficulty. As a result, the achievement becomes a visual representation of the user's proficiency.

The significance of achievements can vary greatly depending on the type of achievement available to unlock. Macon [50] found that users may feel their autonomy is reduced if they perceive badges as an obligation. However, implementing achievements promoting play and exploration can increase users' sense of autonomy. Thus, it is crucial to strike a balance between various types of achievements in order to encourage desirable behaviors.

Meaningful Stories and Teammates

Two game design elements that are on the more abstract side are meaningful stories and teammates. These are concepts to consider while designing a game and not necessarily concrete elements to implement.

Meaningful stories provide a narrative to the game. The element involves the user in the game and provides a sense of purpose [74]. It is usually indifferent to the user's performance but does give additional meaning to the tasks and activities [73]. Therefore, the element offers task meaningfulness, which may motivate and inspire the user.

On the other hand, teammates is a game design element that frequently groups users into teams. This element promotes social relatedness as users collaborate and interact with one another [73]. When combined with meaningful stories, teammates grouped for a shared purpose could develop a sense of belonging. However, this element might create competition between the teams.

Streaks and Animation

Streaks are another common game element that refers to a method that rewards the user for repeated actions over a consecutive period. It is widely used to motivate people to push themselves by completing specific goals, such as a login streak several times without fail. When the streak lengthens, it gets more difficult for them to break it since they lose their progress when the streak resets. Overall, streaks can be seen as a variation of points, which resets on failure. As users want to maintain their streak, the element encourages consistency and thoughtfulness [69]. Therefore, streaks can motivate users to challenge themselves consistently, but they may also lead to a sense of obligation that can negatively impact their sense of autonomy.

Animation is a game element related to providing visually pleasing animations, often related to certain actions. These actions can be completing a particular goal, in which animations further emphasize the result by providing animations that give them a sense of accomplishment or progress. Therefore, animations provide visual feedback on a user's progress and may act as a reward. Animations could also increase the visual aesthetics of a gamified system. This could make an activity more visually appealing and engaging, contributing to a more enjoyable and immersive user experience.

Time Pressure

The time pressure element aims to limit a given activity. The element itself is not very visual, even if it could be represented as a countdown timer. According to Deterding et al. [16], time pressure is a game design pattern/mechanic, but Yildirim [92] suggests it could be utilized as a game design element. Time pressure can increase the challenge of the activity due to the limited time for decision-making. With a surplus of goals, users must manage their time efficiently to complete a certain amount. On the other hand, failing to complete the goals in time may reduce a user's sense of competence [92].

Without time pressure, the whole urgency aspect disappears from the activity and may lead to

boredom [84]. Users could then feel less motivated to achieve specific goals as they possibly procrastinate or become complacent. However, the absence could also increase autonomy and exploration, as users can take the time to explore or immerse themselves. Furthermore, adding time pressure to an activity may increase the challenge to the point of increasing stress and anxiety. As a result, the activity’s challenge does not match the user’s skill level, reducing their likelihood of flow [80].

2.5 Marczewski’s User Types Hexad

Figure 2 depicts Marczewski’s Hexad. This framework is valuable for analyzing how various people interact with gamified environments [52]. The six user types presented in the framework are philanthropists, achievers, socialisers, free spirits, disruptors, and players. Table 3 presents their key drivers for motivation, and by understanding these preferences, one can design a gamified application that caters to many people’s diverse needs and preferences.

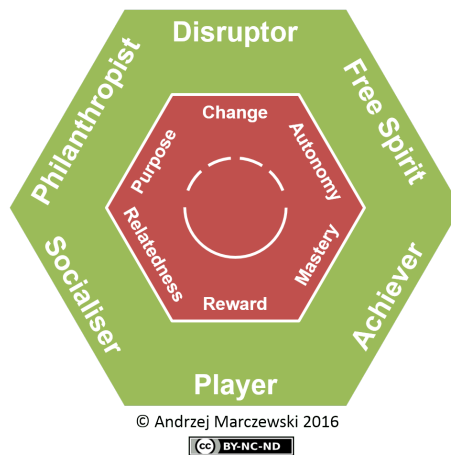

Figure 2: Hexad by Marczewski [52].

Table 3: User Types Classifications by Marczewski [52].

Player Type	Description	Key driver(s)
Achievers	These users are motivated by challenges and a sense of accomplishment. They enjoy games that are difficult and offer a sense of progress.	Mastery and competence
Socialisers	These users are motivated by interacting with other users. They enjoy games that offer opportunities to socialize and make new friends.	Relatedness
Free spirit	These users are motivated by curiosity and a sense of freedom. They enjoy games that offers new experiences with the freedom to express themselves.	Autonomy and self-expression
Philanthropists	These users are motivated by helping others and a sense of responsibility. They enjoy games that offer opportunities to help others and to make a difference. They are willing to give without expecting rewards.	Purpose
Players	These users are motivated by games that offer extrinsic rewards. They enjoy games that offers some sorts of competition or extrinsic rewards.	Extrinsic Rewards
Disruptors	Disruptors are motivated by triggering change, whether it is positive or negative. They enjoy games that offers them to trigger, either through the system or other users.	Change

2.6 Existing Solutions

Numerous applications are attempting to create an engaging learning environment in mathematics for pupils with the help of game elements. However, most existing solutions foster game-based learning or long-term engagement by the pupils. This is out of our scope as we sought to create an application and not a game, and our focus is on short-term interactions. In this section, we cover games and applications we consider relevant in terms of either how gamification is implemented or the nature of the application related to repetition.

2.6.1 The King of Math series

Oddbrobo Software has created several educational games and apps since 2011 [2]. Their most successful game series is the King of Math series, resulting in the games King of Math¹, King of Math 2², and King of Math Junior³, which have been downloaded over 10 million times and translated to numerous languages. The games are fast-paced mathematics games where the player plays as a farmer. In order to progress, the player has to solve various mathematical tasks and level up the farmer. One can compete against friends, collect stars and medals, and gradually climb the ladder to become the King of Math. The curriculum of the games targets pupils from primary school through secondary school, and the idea behind the game is to improve and refresh mathematical skills while having fun. The Junior edition naturally has more manageable tasks, and the application focuses more on awakening curiosity and putting mathematics in a fun context [40]. We have found no studies analyzing the game series. However, several papers have mentioned the games as good examples for gamification in education [50, 79].

2.6.2 Kahoot! and Quizalize

Many quiz applications are great at gamifying repetition. Applications that allow one to create custom quizzes can naturally be utilized to tailor quizzes for a particular curriculum. The applications Quizalize⁴ and Kahoot!⁵ are good examples of this. Teachers can use premade quizzes on the platforms or create tailored ones for a specific subject. Both Quizalize and Kahoot! use game elements like scores, streaks, accuracy trackers, and bonuses to engage and motivate. The applications have a variety of quiz modes, and they give great feedback to the players. Quizalize provides the teacher with detailed information regarding each player's performance and progression. Studies show that Kahoot! and Quizalize are deemed effective platforms for learning outcomes and motivation [47, 91].

2.6.3 Duolingo Math

Duolingo⁶ is by far most recognized as an application for learning languages. However, in the fall of 2022, they released their newest product, - Duolingo Math⁷. With its well-known design and recognized playing style, mathematics is now taught in the application. The application focuses on mathematical foundations and essential skills useable in everyday life. The player goes through various lessons before solving mathematical tasks. Learning by doing is the main idea, and with game elements like points, streaks, badges, progression, and similar rewards, the players are mentally challenged and engaged. Duolingo Math is brand new, so studies were not found addressing this application. However, there are several studies addressing gamification and the original Duolingo. Duolingo is considered an excellent example of the good use of gamification, and several studies show that it contributes to increased motivation among students [36, 48].

¹<http://oddrobo.com/kingofmath>

²<http://oddrobo.com/kingofmath2>

³<http://oddrobo.com/kingofmathjunior>

⁴<https://www.quizalize.com>

⁵<https://kahoot.com/>

⁶<https://www.duolingo.com>

⁷<https://www.duolingo.com/math>

2.7 Summary

The key aspects relevant to the thesis have been covered in this section. We defined motivation and narrowed the thesis's scope to a specific natural science area where the perceived motivation by introducing game elements is in focus. Furthermore, we have defined gamification and examined specific game elements relevant to our thesis. User types from Marczewski's Hexad have been examined, and the characteristics of each element have been elaborated on and linked to motivational factors. Several existing solutions have been reviewed to provide good insight into how game elements can be incorporated into an application for repetition to affect motivation.

3 Design and Implementation

As a part of the thesis, we created the web application SkillSprint. In this section, we describe the development and design of our application, and we start by addressing the thorough design process. Subsequently, the application technologies and development tools are elaborated, as well as encounter challenges and their solutions.

Throughout the section, we refer to Appendix A, which contains more detailed descriptions of the SkillSprint’s architecture, elaboration of technology choices and how they are linked to our application, functional requirements, quality attributes, and architectural tactics. SkillSprint’s source code is available under the GNU General Public License⁸ at <https://github.com/lekesoldat/skillsprint>. Appendix B provides additional information if one is interested in interacting with a live⁹ version of the application.

3.1 Design Process

SkillSprint was designed through the process of design thinking. This methodology is recognized as human-centered and problem-oriented, fostering creative thinking. At the same time, the participants work closely with one another in empathy-driven environments. Previously design thinking was primarily utilized within artistic disciplines such as architecture or design but is now often adopted across various disciplines such as education, software development, and engineering [66].

The most common use of design thinking is often among groups with diverse backgrounds and skill sets. There are no definite prerequisites for employing this approach, but some qualities might enhance its effectiveness. According to Razzouk and Shute [66], being empathetic, open-minded, and having an affinity for teamwork and communication are essential characteristics for someone practicing design thinking. Empathy and open-mindedness are vital as design thinking revolves around finding the most suitable solution for the user’s needs. When combined with teamwork and communication skills, design thinkers can effectively gather insight about users and convey it to their teammates, regardless of background. This approach often requires frequent changes during iterations with teammates and external collaborators. We, as a team was not that diverse, so we used external contacts with relevant experiences in education to fill out the gaps. Ultimately, we ended up with two primary external collaborators. One was the school teacher who assisted with the in-class testing, and the other was a teacher-student who provided additional valuable input. Further, we sparred with a graphic designer to ensure the overall appearance and experience of the application were on point.

To summarize, the design thinking approach allowed us to understand the students’ perspectives thoroughly, identify their pain points, and offer solutions to the identified problems. This aspect was highly beneficial as we didn’t know what we were about to produce at the very beginning and could develop in iterations. Through this human-centered approach, we could develop a user-friendly and intuitive application that met the students’ requirements and desires as we went.

To employ a design thinking approach, we employed the Double diamond framework, pictured in Figure 3, a widely recognized design thinking process for investigating problems and developing innovative solutions [21]. The British Design Council developed the framework to put design thinking in a more strategic context, and we found it especially beneficial for familiarizing ourselves with the thesis’s domain and understanding the type and shape of what was to be developed [82]. The Double diamond framework encompasses four distinct phases: *discover*, *define*, *develop*, and *deliver*. We engaged in divergent and convergent thinking cycles by embracing an iterative approach. However, this iterative process is dynamic, and we frequently visited previous phases as needed.

⁸<https://www.gnu.org/licenses/gpl-3.0.html>

⁹Available until 24.02.2024

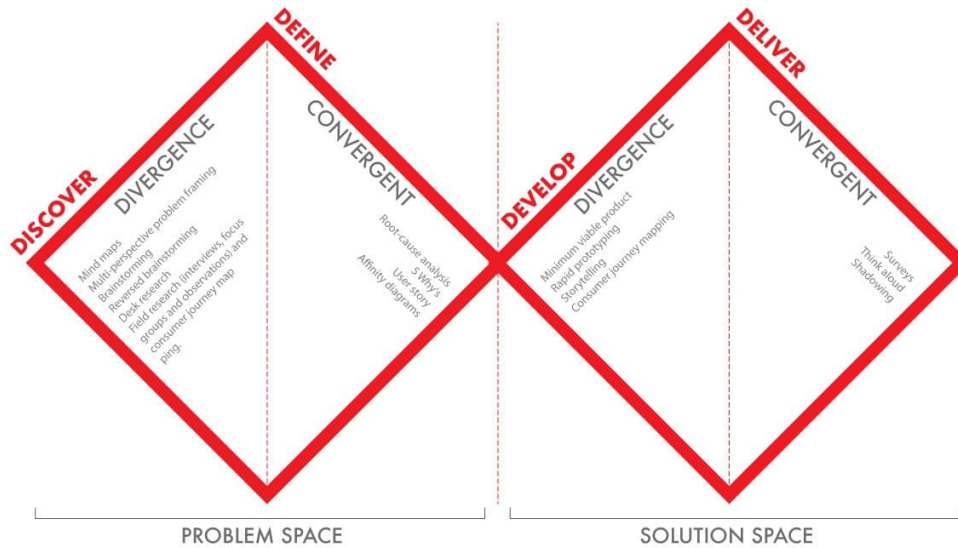

Source: <https://www.designorate.com>

Figure 3: The Double Diamond Process and It's Phases.

3.1.1 Discover

The discovery phase is characterized by divergent thinking. It serves as a means to delve into the problem space and gain valuable insights for developing the application. Based on the master's thesis' predefined framings, we knew we had to include gamification in education for youth and some app development. The discovery phase involved conducting a comprehensive investigation of current research regarding gamification concepts and techniques. Furthermore, we familiarized ourselves with prominent gamified applications and existing solutions to better understand the problem space and how existing solutions aim to solve such problems. By employing theory from Manzano-León et al. [51], we addressed that each student had various preferences for user types within the Hexad framework. Further, students have different educational needs and preferences, so it was essential to provide a variety of game elements [28]. Based on the students' differences, the success of each game element could vary. As a result, we aimed to offer a diverse selection of game elements to raise the possibility of including elements for everyone. Manzano-León et al. [51] highlight in their literature review that studies with less than two game elements had a less or even negative effect on student motivation than those with more. Table 4 showcases which elements we proceeded with and how they address various psychological needs related to motivation.

Table 4: The Selected Game Elements.

Game Element	Addressed Needs
Points	Competence
Streaks	Competence
Leaderboard	Social Relatedness
Achievement	Autonomy, Competence
Avatars	Autonomy
Performance Graph	Competence
Animation	Competence
Time Pressure	Competence

During this discovery phase, we also started to familiarize ourselves with common problems in education. One of the thesis authors previously worked with several schools, teaching coding to students between the ages of 11 to 15 through the programs “Kodeløypa”¹⁰ by NTNU, and “Kidsakoder”¹¹ during his free time. This unique experience gave us good initial insight into the problem space, which we further discussed with a fellow student studying the teacher program at NTNU. For instance, some relevant addressed problems were poor attention spans [24] and difficulties sustaining students’ motivation [17].

Before brainstorming a few ideas, several facts were certain. For instance, based on our limited school contacts, the students would attend secondary school (ages 13-16) or below. In upper secondary school, students gain much freedom in choosing courses. However, secondary school has primarily mandatory courses in all grades. Further, much gamification research targeting motivation uses performance as a measurement. Such an approach is imperfect as performance is an indirect measurement by many factors, including non-motivational related ones [17]. As a result, we decided to focus primarily on the motivation aspect and how students would perceive a gamified application as motivating.

After several concept iterations, we developed the idea that became SkillSprint. The idea behind SkillSprint is bringing the popular cybersecurity activity Capture the Flag into STEM education. Different styles of Capture the Flag exist, but we focused on Jeopardy Style Capture the Flag. This is an activity where participants compete, either in groups or individually, to solve a set of challenges in various cybersecurity areas. Each area often consists of tasks, with points representing the difficulty. Capture the Flag’s often contain game elements and tasks that participants report as challenging, fun, and educational [26]. Initially, our idea was to provide tasks, just like in Capture the Flag, but for areas in STEM courses. Such courses were preferred, as these courses often include concrete answers that are easy to validate in an application automatically. However, we decided to scope it down to only mathematics due to the time restrictions. Mathematics was deemed the most suitable for our application based on the mandatory courses, available online resources, and previous research addressed in Section 2.2.

By undertaking this rigorous discovery phase, we uncovered insights that provided a solid foundation in subsequent stages of the application’s design and development process.

3.1.2 Define

In the define phase, one identifies the core problems and challenges addressed in the discovery phase. The discovery phase led us toward a Jeopardy-style application, adapted and tailored for mathematics. With the Jeopardy-style format, the users can freely choose tasks befitting their current skill level. This freedom of choice is beneficial for learning and motivating as users can progress at their own pace [49, 80].

We established objectives and requirements early as providing a more precise direction in subsequent phases was important. Having a clear direction made it easier to communicate SkillSprint’s purpose with our stakeholders, primarily being the teacher. Overall, it facilitated collaboration and helped us to estimate the design and development process more accurately. By the start of the define phase, we contacted multiple schools, further covered in Section 4.1, to pitch the rough idea of SkillSprint and recruit participants for our research. Furthermore, we defined the objectives and requirements for our application.

¹⁰<https://www.ntnu.no/skolelab/kodeloypa>

¹¹<https://www.kidsakoder.no/>

Application Objectives

SkillSprint is primarily designed for usage during free practice sessions in the classroom by students in secondary school. During the define phase, it was established that all participants would be in the tenth grade, aged 15 to 16, as this would be the participating teacher’s class. A free practice session is a class period where the teacher has no specific lesson plan, and the students can work independently with the relevant curriculum. Even though it was intended to be used in the classroom, it could assist students in their self-studies. SkillSprint’s main objective is to facilitate the aforementioned free practice sessions by providing the students with a fun and engaging way to repeat and practice mathematics. Our application presents the students’ curriculum in a gamified environment with various game elements. Overall, SkillSprint is designed for students and teachers, and both are considered “end-users” in the stakeholder matrix in Appendix A.2. The objectives of SkillSprint can be summarized as follows:

- Make SkillSprint perceived as motivating for students to repeat mathematics
- Increase flow by providing sufficiently challenging tasks that match the students’ level
- Facilitate students to progress at their own pace
- Provide students with an environment for varied repetition
- Motivate different user types with a variety of game elements
 - Increase competition and social relatedness through a *leaderboard*
 - Foster competition by the *time pressure* aspect of the free practice session
 - Inspire and provide visually please *animations*
 - Provide self-mastery insight with *attempt statistics* and *performance graphs*
 - Progress tracking with *points* and *streaks*
 - Encourage students to explore and set goals with *achievements*
 - Increase self-expression with *avatars*

The objectives were further split into functional requirements.

Functional Requirements

Functional requirements are essential in defining the capabilities and functionalities that an application must have to satisfy its users’ needs and expectations. Such requirements are a blueprint detailing the application’s expected behavior, features, and interactions. They serve as the foundation for the application’s design and development, directing the development team to produce a product that fits the users’ needs. By mapping out the functional requirements for SkillSprint, we ensured that our application accurately addresses the correct problems.

Appendix A.1.1 thoroughly describes how we defined the functional requirements, summarized in Table A.1. Each requirement consists of an ID, title, description, and priority. These requirements were later used to create issues during the development phase. Our tracking tool of choice was Linear¹², as it fits our needs for rapid development and integrations with GitHub¹³.

Quality Attributes

Quality attributes, often referred to as non-functional requirements, pertain to software system requirements that are not directly associated with functional requirements but are nevertheless necessary for ensuring application quality. In the case of SkillSprint, several essential quality

¹²<https://linear.app>

¹³<https://github.com>

attributes were identified, such as *usability*, *performance*, *maintainability*, and *reliability*. Specific architectural tactics were employed to address these attributes, further elaborated in Appendix A.1.2.

Usability

Usability stands as an essential quality attribute in the realm of gamification design, particularly when it comes to creating compelling educational experiences for students. This quality attribute refers to the extent to which a software application or system is easy to use, achieve a desired task, learn, and navigate and its overall user-friendliness [5]. Therefore, increasing usability is an easy way to increase the quality of an application as it is directly related to the users.

Koivisto and Hamari [42] highlight in their literature review that most studies focus on developing a prototype or concept when testing on users. Consequently, these limited prototypes may raise questions regarding the validity of specific findings related to implementation and design. We, however, focused on providing a good user experience to ensure that students could effortlessly understand its mechanics, complete the tasks and interact with the game elements. SkillSprint was, to the best of our ability, designed as an intuitive and user-friendly application, facilitating motivating learning experiences rather than adding unnecessary complexity. If the application was poorly designed, leading to confusion, it could result in frustration, disengagement and reduced motivation for participation, ultimately affecting the interactions with the game elements.

In order to ensure high usability, we employed the following tactics, further elaborated in Appendix A.1.2: (1) Accessibility and responsiveness, (2) Maintain task model, (3) Prototyping and Usability tests, and (4) Support user initiative.

Performance

Performance emerged as a critical quality attribute during the planning of SkillSprint's development. This quality attribute refers to an application's ability to meet specific timing requirements, such as speed, responsiveness, throughput, and resource utilization under specific conditions [5]. Given the limited duration of the free practice sessions, the application had to operate seamlessly and minimize waiting time. Most of the application consists of static content, such as the tasks and their description. As the content rarely changes, these pages can be statically rendered. Navigating these static pages is nearly instantaneous, fostering a fluent user experience.

Additionally, SkillSprint had to handle the simultaneous participation of multiple students efficiently. Since the application has to store each student's answer attempts, it creates a substantial amount of data when used. Given that students may respond rapidly, the concurrent engagement of multiple students can impose a demanding workload on the application. This fact was particularly critical when certain game elements, such as the leaderboard, required real-time updates as users submitted their answers. Furthermore, providing feedback to users on their answers is vital. With timely validation of their responses, students can proceed to the next task or attempt it again.

In order to meet the performance demands, we employed the following tactics, further elaborated in Appendix A.1.2: (1) Reduce computational overhead, (2) Increase available resources and (3) Introduce concurrency.

Reliability

Reliability is a quality attribute that is usually a high priority. Most applications want to keep the error rate as low as possible, and SkillSprint is no different. Reliability refers to the consistency, stability, and dependability of the application. In an educational setting, reliability is vital for developing trust and confidence in students by ensuring that the program performs as intended without unexpected failures or problems. Students must trust that the application validates their task answers and provides consistent feedback. For instance, if a task fails, students should be confident that the provided mathematical answer is incorrect rather than an external reason or the application itself. A reliable application is one that students can invariably rely on to deliver a consistent and predictable user experience. On the other hand, an unreliable application might lead to frustration, disruption of learning activities, and a loss of confidence in the application.

High reliability was crucial so the students could engage more fully in solving tasks and focus on their learning goals.

In order to meet the reliability requirements, we attempted to prevent most faults, further elaborated in Appendix A.1.2.

Maintainability

Maintainability is a vital quality attribute that refers to the ease with which maintainers could update, modify, or sustain an application over time [5]. Because SkillSprint was built from scratch, the iterative process enabled a continuous cycle of rapid changes, ensuring the application could adapt, evolve, and remain relevant in response to changing needs.

Poor maintainability frequently results in long-term consequences as applications become progressively more challenging to update. This difficulty in resolving issues might harm the user experience and, thus, possibly students' perceived motivation by SkillSprint. As a result, prioritizing maintainability was vital to handle any technical issues, bugs, or critical challenges that could emerge.

Furthermore, maintainability is intrinsically linked to cost-effectiveness. A difficult-to-maintain application may necessitate considerable resources in terms of time and effort to implement updates or address technical issues. By emphasizing maintainability, we ensured maintenance and updates could be performed quickly and within a reasonable timeframe. This decision was vital given a minimal development time for SkillSprint. Maximizing available development time was critical to the success of our application.

Focusing on the deployability of SkillSprint played a significant role in its development by enabling fast deployments and early identification of technical issues or user experience problems, allowing us to address them rapidly.

In order to meet the requirements regarding maintainability, we employed the following tactics, further elaborated in Appendix A.1.2: (1) Split modules, (2) Increase cohesion, and (3) Code reusability.

3.1.3 Develop and Deliver

The development phase is the third phase of the double diamond approach and is an essential step in developing the solution space. This phase aims to identify and refine the most promising ideas into a design that can be implemented. During this phase, we designed and developed the user interface iteratively. We started by creating low-fidelity designs, gradually turning them into high-fidelity designs before we developed SkillSprint and were ready for deployment.

The delivery phase is the final phase of the double diamond approach, where the focus is on delivering a potential solution to the problem defined earlier. The goal of this phase is to ensure that the potential solution satisfies the requirements and objectives of the stakeholders. The development and delivery phases are closely related, as each iteration was delivered for feedback and evaluation. We revisited the previous phases several times with feedback and new insight from peers to further improve SkillSprint.

Low-Fidelity Design

For the low-fidelity design of the application, we utilized Excalidraw¹⁴ to create wireframes as seen in Figure 4 and Appendix D. Excalidraw is a virtual collaborative whiteboard known for its simplicity and hand-drawn style. The goal of low-fidelity design is to quickly iterate and visualize the application's design and layout without being slowed by details. The tool consists of different shapes, icons, and figures from public libraries, which we used to sketch the design first drafts. Excalidraw was perfect for the aforementioned goal of low-fidelity design, as it forced us to keep

¹⁴<https://plus.excalidraw.com>

the design simple. In a more advanced design tool, it is easy to spend too much time polishing the design or become discouraged by a preliminary design.

We sketched wireframes that fit the requirements based on the application objectives covered in Section 3.1.2. First, the application had to include all the game elements from Table 4. The initial sketches include a leaderboard page, an achievement page, and an insight page. The sketches also include pages for task overview and validation of task answers. When a user solves a task, the points and current streak are incremented in the header. Points and streaks are constantly shown since it is a metric that multiple other game elements use, such as the leaderboard being ranked by the users' points.

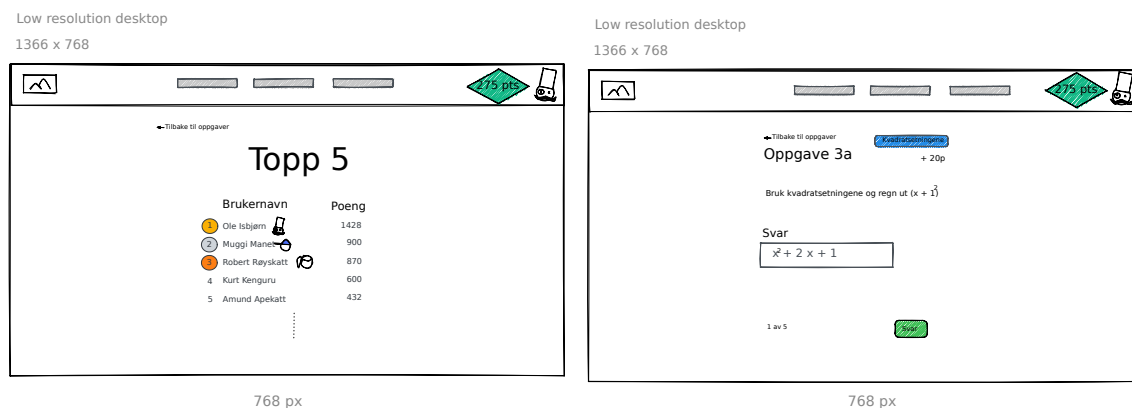

Figure 4: Some of the Wireframes.

High-Fidelity Design

The next step of the design process was to use the previous low-fidelity design as a base to create a high-fidelity design for the application. During this phase, the primary tool utilized was Figma¹⁵. Figma is a collaborative design tool that allows multiple users to design simultaneously on the same project. Professional designers commonly use Figma to create complex user interfaces, as it consists of many powerful design features, and Figma allowed us to iterate quickly and develop a direction for tSkillSprint's visual design.

Mood Board and Visual Identity

The first part of the high-fidelity design process consisted of creating a mood board, showcased in Figure 5. A mood board is a visual collage consisting of different images, typography, colors, and textures to capture the overall style and feel of the application. Mood boards are commonly used to ideate visual styles and direction, and most images in our mood board were taken from Dribbble¹⁶, a community for designers to share their work. As the application's primary goal was to engage and motivate the students, the mood board was playful, bold, colorful, and simplistic.

Manzano-León et al. [51] emphasize in their literature review that most studies do not describe why they utilized a particular aesthetic, but they say a shocking or well-known aesthetic could enhance students' commitment to gamification. As a result, the direction of SkillSprint's visual profile moved towards a more shocking unique style, namely neobrutalism. Neobrutalism is a design trend that especially gained popularity in 2022 [32]. It is a take on the classic brutalist trend, which is known for its raw and unpolished style. Bright colors, simple shapes, bold typography, and hard contrasts often characterize the neobrutalism trend. The unique style captures the users' attention and is memorable, particularly among educational applications. A playful design should, ideally, immerse the user in the action, allowing them to have fun. Fun in the learning process is supposed to create relaxation and motivation, which may facilitate the students' learning process [3]. As previously mentioned, we knew early in the process that SkillSprint had to target students

¹⁵<https://www.figma.com/>

¹⁶<https://dribbble.com/>

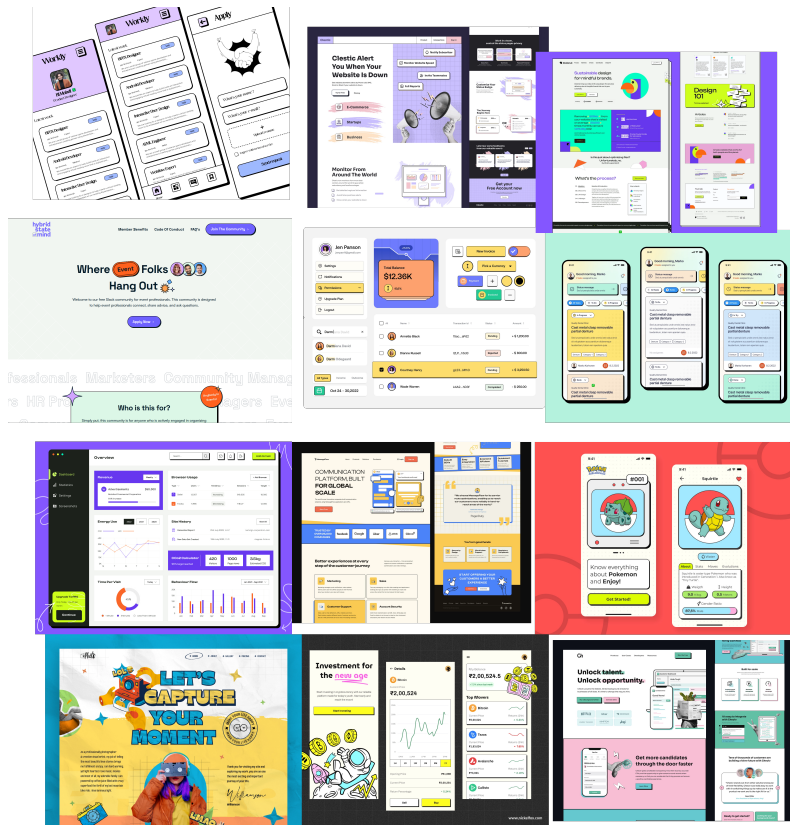

Figure 5: The Mood Board in Figma.

around 16 years old. We believe these may appreciate this playful design more than adults, who may deem it childish. Based on our target group and the desired theme of the application, the colors in Figure 6 were selected for our application.

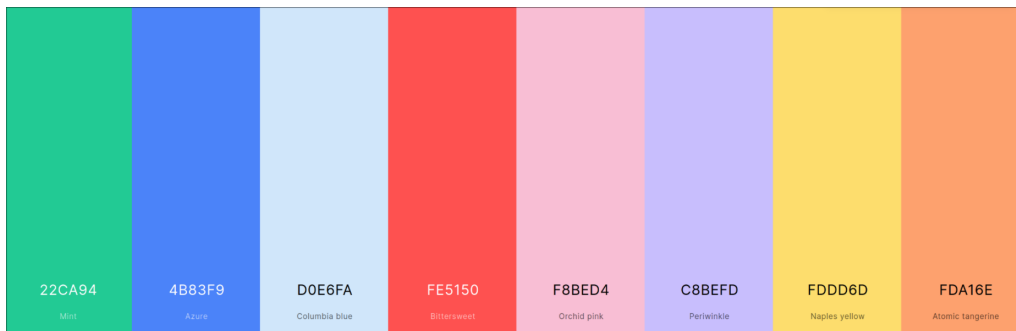

Figure 6: SkillSprint's Color Palette.

By early determining the visual approach, the design process of the user interface was rapid. We saved time and effort by not experimenting with various design styles that possibly did not align with our goals. Furthermore, Neobrutalism is often characterized by a minimalist style, which reduces visual clutter and allows users to concentrate on utilizing the application. Consequently, each page in SkillSprint needed to be simplistic and easy to design, resulting in less time spent designing. A defined visual style also assisted us in maintaining consistency throughout the design process, which is essential in producing a unified user experience and application brand.

User Interface Design

The user interface was created iteratively with significant feedback from peers, the supervisor, and, most importantly, the teacher. These user interfaces can be seen in Appendix E, and they were

created based on the previous low-fidelity design and the aforementioned requirements. From the previous design, wireframes for the task overview page, the task page, the leaderboard page, the insight page, and the achievement page were further improved. The new prototype design was presented to teachers and peers to receive feedback and further iterate. We made some changes to the design based on the feedback, such as removing a logo in the header and being more consistent with the typography. There was also a need for more consistency between using bold and italic text. Furthermore, some visual consistencies, such as rounded corners, had to be applied to all boxes in the design, depicted in Figure E.1. The insight page, shown in Figure E.5, was also quite cramped and required additional padding, while the achievement page layout was changed from a list layout to a grid layout. Even though the design was supposed to be playful, our doodles and hand-drawn, shown in Figure E.3, shapes were removed since they were regarded as distracting and too out of place. In addition to design changes, the prototyping and usability tests led to increased usability, especially regarding inputting task answers. However, as the design was well-received and easy to understand, we decided to start with the development implementation of the application after this.

Development Process

To ensure the progress and success of the implementation of SkillSprint, we would add and reprioritize tasks for the current week at the start of each week. Instead of a typical sprint-oriented development process, we used a triage queue system, visualized in Figure 7. In application development, a triage queue is a system that assesses, categorizes, and prioritizes issues based on urgency and relevance [90]. This process is done continuously throughout development as urgency and relevance may vary. Using a triage queue system, we could quickly identify and prioritize critical issues requiring immediate attention, such as major bugs, security vulnerabilities, or bigger feature requests. Lower-priority issues were also noticed since they remained in the queue and were treated when time allowed. Once higher-priority issues were resolved, we could move on to a lower-priority queue. Using the triage queue system, we worked more efficiently and effectively, resulting in faster issue resolution, a better overview of the project’s progress, and a more robust and reliable product. All queues were sorted by priority except for the unsorted triage queue in our system. However, this method required attention and time because we continuously had to sort the issues.

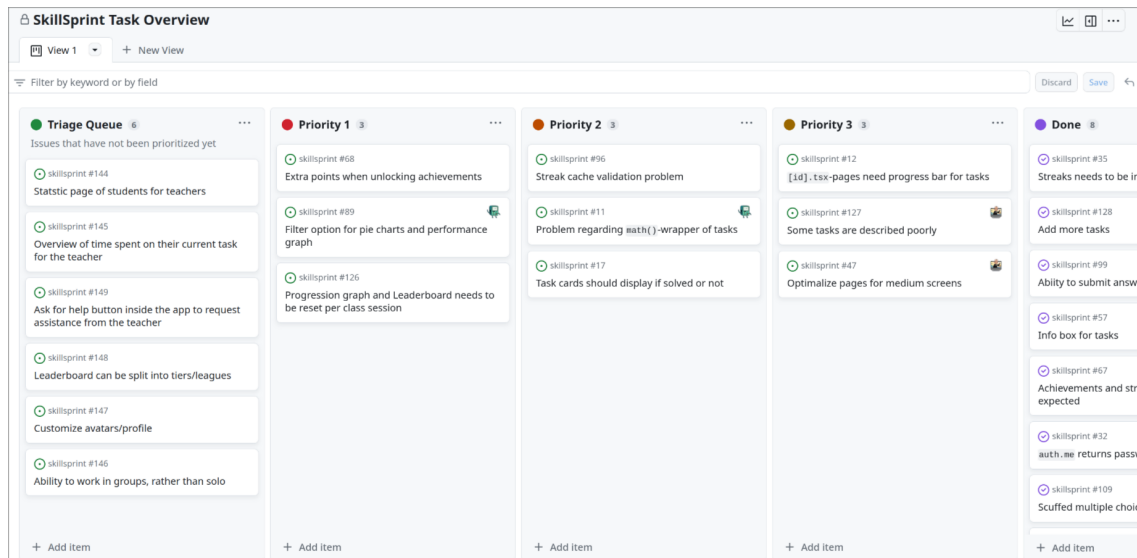

Figure 7: Screenshot of Our Triage Queue System.

Iterative Changes

We requested input from peers, the participating teacher, the designer, our supervisor, or peers each week, depending on who was available. Especially the feedback from the teacher and the designer

was valuable in improving the usability and functionality of our application. In SkillSprint, feedback unveiled that it was somewhat unintuitive and bothersome to move to subsequent mathematics tasks when one had yet to solve the current one. Initially, moving to the next task page with a “Next task” button was restricted until the learner completed the current task. If users intended to read the subsequent tasks, they had to return to the task overview page first. As a result, we removed this restriction, and the users could move freely between sub-tasks without going through the overview. Furthermore, we introduced a feature allowing users to redo tasks already solved. Answering a solved task does not reward the student with additional points; nonetheless, some users may prefer to utilize the application to repeat the same task multiple times. One feature that went through multiple iterations was hinting at the answer format. Initially, this was done with a description box below the input field. However, this still seemed to be quite tricky for some to understand. As a result, we moved towards a placeholder system, as seen in Figure 11, where the input has empty boxes the user would have to fill out. Additionally, the designer offered input on the user interface, recommending changes to improve application coherence and accessibility. SkillSprint initially displayed a popup below the input box on a successful answer. However, this was positioned atop the “Next page” button under certain circumstances, which many found bothersome. As a result, we removed the popup below the input field and replaced it with a toast, which is a popup at the top of the page.

3.2 The Application: SkillSprint

After a thorough design process, the final step was to develop SkillSprint. Figure 8 displays a sitemap over all the pages in our application, and Appendix A.3 details a complete overview of the application’s architecture, based on the 4+1 model by Kruchten [43]. The views serve as means for communicating relevant information about the application to the stakeholders defined in Appendix A.2. In the subsequent sections, we provide an exhaustive overview of the application’s interface, including relevant screenshots illustrating each view and a description of its associated features. The overview also contains additional issues related to the development process and how we handled them.

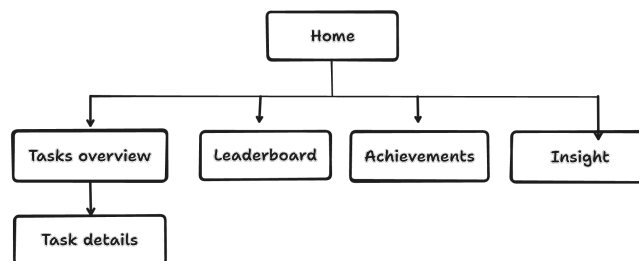

Figure 8: SkillSprint’s Sitemap.

3.2.1 Homepage

The homepage, pictured in Figure 9, is the initial page a user encounters using the application. The homepage’s primary goal is to describe the application and its features to the user and provide a link to the questionnaires detailed in Section 4.3.2. On the first assessment day, the students answered our pre-questionnaire. On the final assessment day, they answered the post-questionnaire.

The homepage varies in appearance based on the user’s authentication status. When the user is unauthenticated, as shown in Figure 9a, the homepage will show a login button, as it is vital for the students to log in so the application can track their progress and interactions. However, if the user is authenticated, shown in Figure 9b, the login button is hidden, a logout button appears in the footer, and the points and streaks are visible in the header. To access SkillSprint, authentication is required. If a user attempts to navigate to another page without being authenticated, they will be redirected to the login page.



(a) Unauthenticated.



(b) Authenticated.

Figure 9: Home Page.

3.2.2 Login Page

Compared to the other pages in this application, the login page was included and premade by a library named NextAuth¹⁷. As can be seen in Figure 10, this page does not match the design or visual direction of the other pages. As the user will only ever visit this page once, we decided that the effort spent designing and developing for login would be better spent elsewhere.

Instead of allowing students to sign up individually, each account was created beforehand and handed out on the day of the testing. The rationale behind this is further covered in Section 4.2.1. As a result, each student only had to log in using the provided username and password, saving time and keeping the students anonymous.

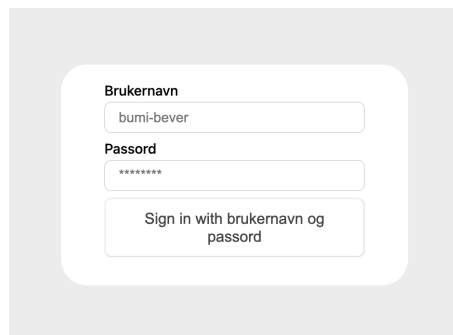

Figure 10: Login Page.

3.2.3 Task Page

The task page, depicted in Figure 11 is where users spend most of their time. This page contains the task description and an input field for the user's answer. In SkillsSprint, the task input field flawlessly handles fractions, exponents, and other arithmetic symbols. The users input their answers either with typical numerical input or using the provided virtual keyboard. Confetti appears on the screen as eye candy when a correct answer is entered and points are awarded. Furthermore, because the application utilizes a math engine to assess if two answers are equivalent, the input for mathematical solutions is quite fault-tolerant. This feature solved the challenge of students entering the same answer in different ways. I.e., if a user answers $f(x) = 2 - x$ or $f(x) = -x + 2$, their answer will still be correct. This validation is accomplished using the math library CortexJS¹⁸, which has a computing engine to validate such solutions.

¹⁷<https://next-auth.js.org>

¹⁸<https://cortexjs.io/>

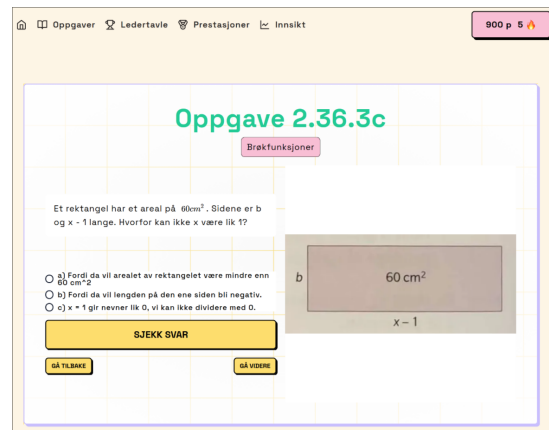

Figure 11: Task Page.

During the development weeks, challenges arose when we discussed the curriculum with the teacher. The relevant curriculum for the free practice sessions we would attend was quite different from what we had been provided with previously. The new curriculum featured several graphing tasks and discussion of various graphs. Such tasks would be challenging to evaluate, so we used a different strategy owing to time restrictions. Compared to previous tasks, these needed a more complex, non-numerical answer. As a result, the approaches employed for these sorts of tasks were multiple-choice and flag answers. Multiple-choice answers, visualized in Figure 12b, are ideal for testing students' reasoning or theoretical knowledge, and flag answers, visualized in Figure 12a, are ideal for tasks where the user must do something practical such as drawing a graph or explaining their reasoning. Inspired by Capture the Flag, flags refer to unique strings or phrases that teams or participants must find or extract as proof of solving a particular challenge or task. Instead of incorporating these flags into the application, the teacher examined the students' answers before awarding the flag. This approach allowed the teacher to offer feedback to the student and verify that the student has correctly comprehended the task.



(a) Flag Answer.



(b) Multiple Choice Answer.

Figure 12: Task Page With Alternative Answer Types.

3.2.4 Achievements Page

The achievement page in Figure 13 showcases the user's locked and unlocked achievements. For example, exploring different categories and attaining a high streak are possible achievements the users can pursue. When a user satisfies all of the prerequisites for the achievement, they can claim points for completing it. This feature was designed to encourage students to solve tasks in different categories with varying difficulties. Achievements can also be regarded as tiered because several achievements have the same type of prerequisite but differ in numbers. These various tiers provide different difficulty levels and ensure the user completes all achievements slowly.

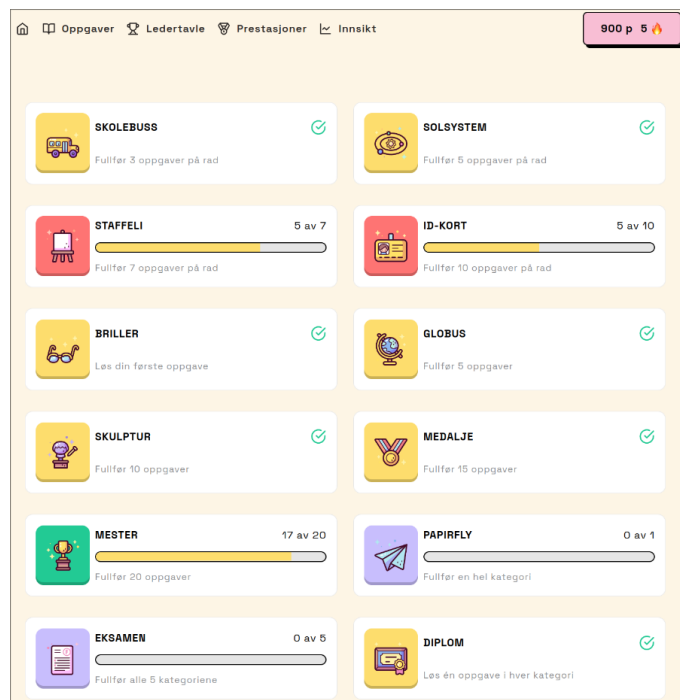

Figure 13: Achievements Page.

3.2.5 Leaderboard Page

Figure 14 visualizes SkillSprint’s leaderboard, a typical game element to encourage competitiveness. The leaderboard page displays the top five users for the daily session or all-time. Each row displays the user’s username, total points, and best streak. As stated in previous sections, ranking low on a leaderboard might demotivate poor performers, and we tackled this by only presenting the top five rated users. For the users to keep track of their placement, we privately display their placement if they are below the top five.

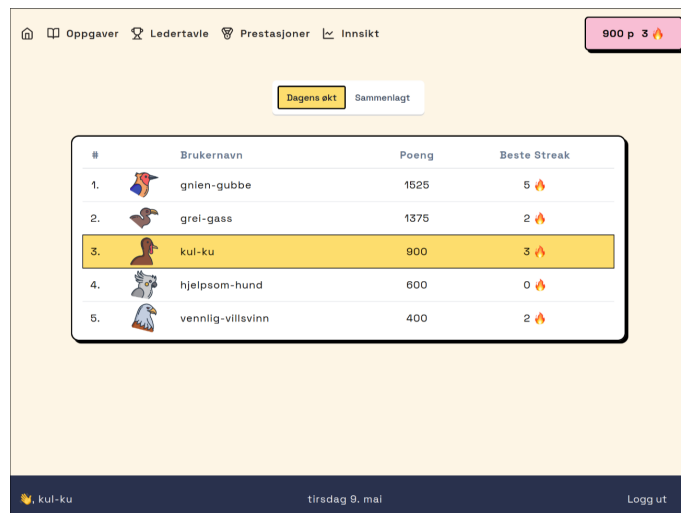

Figure 14: Leaderboard Page.

3.2.6 Insight Page

The insight page shown in Figure 15 gives insight into the user’s performance. In order to attain a private, secure, and personal space for reviewing performance and other personal statistics, the insights page is only available to the logged-in user.

The provided statistics ensure that users can focus on their self-mastery and use the insight to improve their performance. The page is divided into three sections: the user’s activity log, the performance graph, and task attempt statistics.

Activity Log and Performance Graph

Each task attempt by the user is logged in the activity log, sorted chronologically by the time of the attempt. Below the activity log is a performance graph that compares the user’s points over time to the average points of all users in the session. Initially, we hesitated to display the sessions’ average because the insight page should emphasize self-mastery rather than competitiveness. The performance graph was supposed to compare the user’s performance to their prior performance. This functionality, however, was removed owing to the students’ limited use of the application and the need for previous data for comparison. Therefore, we decided to compare the user’s performance to the session average instead, as it could be used to gauge their performance.

Task Statistics

Figure 16 visualizes the last portion of the insight page, namely statistics of the user’s task attempts. Self-insight can help students understand their behaviors, preferences, strengths, and weaknesses. The users may identify areas for improvement and focus on those lacking areas by reflecting on their data. For instance, the answer success rate and the number of solved tasks per topic are displayed. These charts allow the user to identify which topics require more practice and which they have practiced enough. Furthermore, the user can filter the statistics to specific topics to gain a more in-depth understanding of their performance on that topic or on a task-to-task basis.

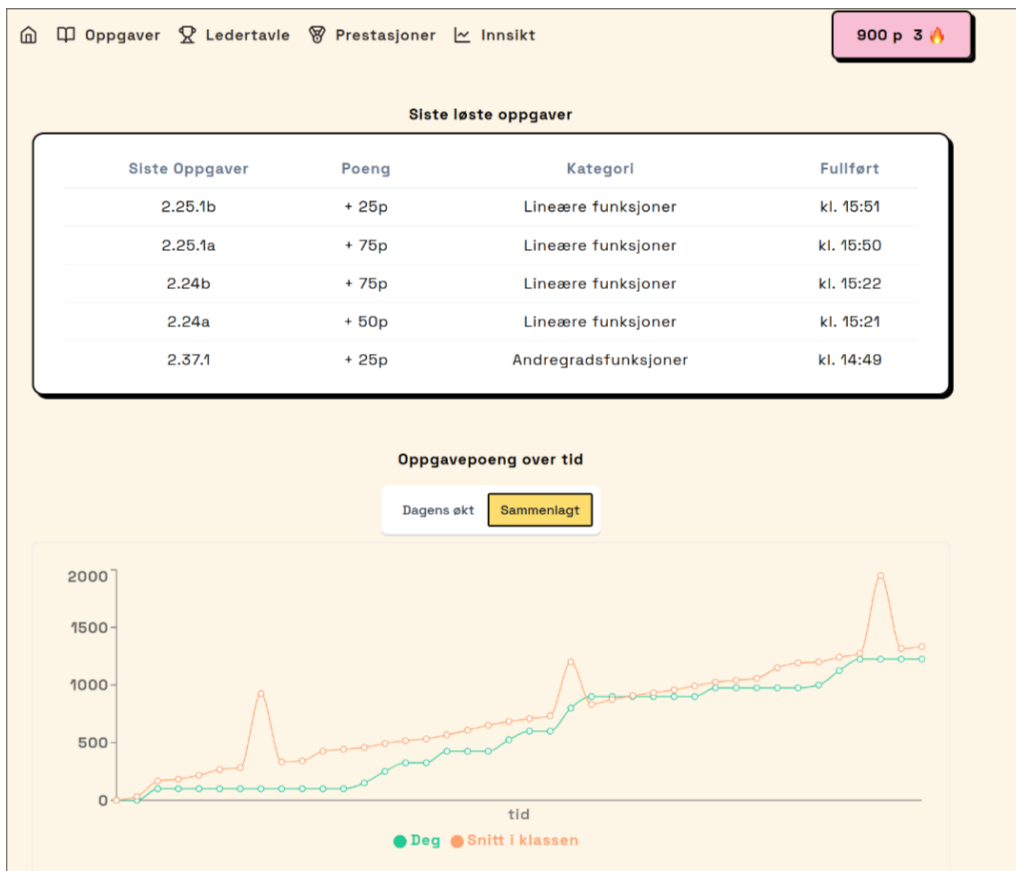

Figure 15: Activity Log Above, Performance Graph Below.

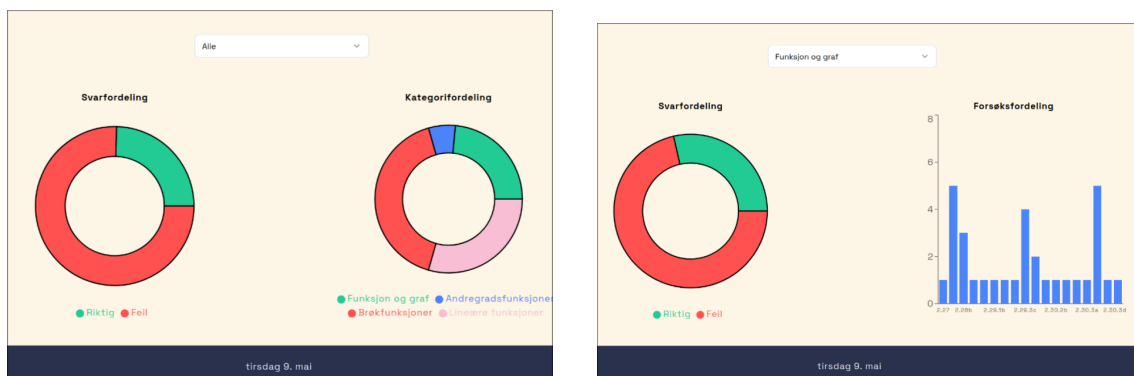

Figure 16: Task Statistics.

3.3 Application Technologies and Development Tools

The selection of suitable development tools and application technologies is critical to the success of any software development project. As a result, adopting appropriate technologies and tools can considerably streamline and save time throughout the development process. Each technology and tool was carefully evaluated according to the project's requirements and constraints. Figure 17 provides a simple overview of the technologies and tools and how they interact with each other.

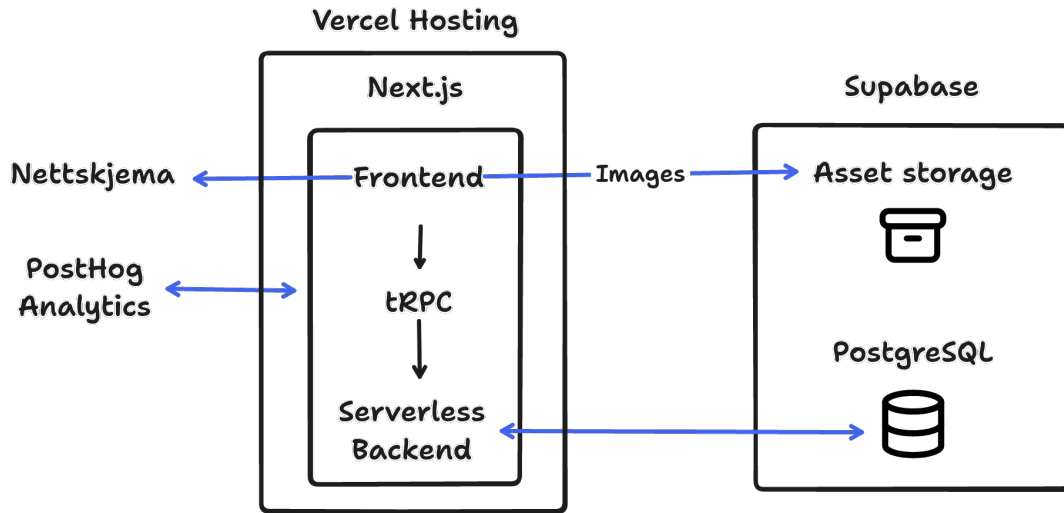

Figure 17: High Level Architecture Overview.

3.3.1 Development in TypeScript

TypeScript¹⁹ is a programming language, a typed superset of JavaScript²⁰, commonly used in web development. Compared to plain JavaScript, the static type checking of TypeScript improves the reliability and maintainability of the code [37]. TypeScript allowed us to catch type problems before running the code, which saved time and made it easier to identify and repair bugs. The typings functioned as a safety net, ensuring that the data flowing through SkillSprint was of the correct format, increasing reliability by preventing faults.

Furthermore, the TypeScript type system gave valuable insights and code completion suggestions. Both the frontend and backend of SkillSprint are written in TypeScript, which allowed us to share code between the client and server, reducing the amount of code written to save time.

3.3.2 Web Development With Next.js and React.js

React.js²¹ is a library developed by Meta for building complex and interactive user interfaces. It has features for quickly creating reusable user interface (UI) components and assembling them to build complicated user interfaces, reducing the amount of code written to save time [67]. Since each application part is divided into smaller components, it is easier to maintain and update the code, increasing maintainability. React.js is a battle-tested library with a large community known to be reliable and performant. It includes features for error handling and building fluent user flows.

Next.js²² is a full-stack web framework built on React.js. Compared to React.js, Next.js is a fully-

¹⁹<https://www.typescriptlang.org/>

²⁰<https://www.javascript.com/>

²¹<https://reactjs.org/>

²²<https://nextjs.org>

fledged framework with different rendering strategies, routing, and data-fetching features. Most of SkillSprint’s content is static pages, pre-rendered to HTML and CSS at build time. This allows our application to load faster and allows the user to instantly swap between pages with no loading time, improving the user experience and performance.

Typesafe APIs With tRPC

tRPC²³ is a library for building end-to-end typesafe APIs with TypeScript. Instead of REST or GraphQL, we used tRPC, which provides a simpler alternative using Remote Procedure Calls (RPC). It leverages the power of TypeScript inference to provide complete type safety from the back-end to the front-end. As we could guarantee that the data format would be respected throughout the application, we significantly reduced the amount of code written. Less code written and excellent developer experience with code completion increased SkillSprint’s maintainability. Lastly, due to the type-safety provided by tRPC, we could catch errors and force user inputs in the correct format, increasing the application’s reliability.

3.3.3 Storing Data in Supabase

Supabase advertises itself as an open-source Firebase²⁴ alternative that provides a range of backend services [83]. Compared to Firebase, Supabase uses PostgreSQL²⁵ as the database instead of NoSQL. For SkillSprint, it was essential to use a relational database as the data is heavily structured and relational. Supabase is free, easy to use, and has a great developer experience, making it a good choice for the application. In addition, it is also scalable and performant out of the box, which is essential as the application is expected to handle multiple users concurrently. Even if the application is not expected to have a large number of users, it is still vital that the response time is fast and the application is reliable. SkillSprint uses Supabase primarily for its database and file storage services.

PostgreSQL is a battle-tested object-relational database management system known for its reliability, performance, extensibility, and security [64]. For SkillSprint, PostgreSQL’s reliability and performance are crucial as the application is expected to handle multiple users concurrently. Its features include ACID compliance and transaction isolation features, ensuring the data is consistent and reliable [1].

3.3.4 Hosting With Vercel

Vercel²⁶ is a cloud platform known for deploying web applications. It includes a generous free tier and several features for deploying and hosting web applications, such as automatic deployment, preview deployments, and logging [88]. Vercel is also the creator of Next.js, the framework SkillSprint uses. Therefore, Vercel is excellent for deploying Next.js applications and became our preferred choice. Further, the simplicity of Vercel’s DevOps greatly reduced the time spent on deployment and maintenance, thus increasing our productivity by freeing time to rapidly iterate and deploy new features, further enhancing SkillSprint’s maintainability.

3.3.5 Analytics with PostHog

PostHog²⁷ is an open-source suite of product and data tools often used to improve the understanding of the user. For instance, it includes different types of analytics, such as funnels, retention, trends, and session replays. SkillSprint uses the managed version of PostHog for event capturing, such as page views, clicks, and form submissions. Most of the data is captured by enabling PostHog’s auto-capture feature, automatically capturing all user interactions on the page. These

²³<https://trpc.io/>

²⁴<https://firebase.google.com/>

²⁵<https://postgresql.org/>

²⁶<https://vercel.com/>

²⁷<https://posthog.com/>

interactions with game elements, page views, and achievement's redeeming were stored and used for further analyses.

PostHog strongly focuses on privacy compliance and complies with GDPR, HIPAA, and CCPA [65]. Our data was anonymized to ensure the user's privacy and contained no identifiable information. Instead, each user is assigned a unique identifier and a random username. They also provide extensive data collection controls if one wishes to opt out of certain features and minimize personal data collection.

3.3.6 Embedding Nettskjema.no Into the Application

To gather information from the students, we used Nettskjema.no²⁸. This service is a Norwegian online data collection tool often used for surveys and questionnaires by students at various universities [58]. It is commonly used in Norwegian research as it stores the data on Norwegian servers and complies with GDPR. NTNU, also has a data processing agreement with Nettskjema.no, which makes it easy to comply with data collection requirements for the thesis [59].

SkillSprint uses Nettskjema.no by embedding the questionnaires inside the web application, as shown in Figure 18. By embedding Nettskjema.no, the students could answer our pre- and post-questionnaires in the same environment without additional navigation. Further, Nettskjema.no let us code and label the questionnaire responses, making it very efficient to proceed with further analyses as we quickly could export the necessary data.

The image shows a screenshot of a web application interface. At the top, there is a navigation bar with icons and text: 'Oppgaver', 'Ledertavle', 'Prestasjoner', and 'Innsikt'. On the right side of the navigation bar, there is a pink box with the text '1375 p 2' and a flame icon. Below the navigation bar, the main content area is a questionnaire. The title of the questionnaire is 'I hvor stor grad er du enig i de følgende påstandene?'. Below the title, there are five columns of radio buttons representing the response scale: 'Svært uenig', 'Uenig', 'Nøytral', 'Enig', and 'Svært enig'. There are five questions, each with a corresponding row of radio buttons. The questions are: 'Det var gay å bruke SkillSprint *', 'Jeg likte å bruke SkillSprint veldig godt *', 'Jeg synes det var ganske underholdende å bruke SkillSprint *', 'Jeg vil beskrive å bruke SkillSprint som veldig interessant *', and 'Da jeg brukte SkillSprint, tenkte jeg på hvor mye jeg likte det *'. At the bottom of the interface, there is a dark blue footer with the text 'magnus', 'onsdag 7. juni', and 'Logg ut'.

Figure 18: Questionnaire Embedded in SkillSprint.

²⁸<https://nettskjema.no>

4 Methodology

Our approach recognized the significance of employing reliable research methods to ensure our findings' quality and validity as advised by Oates et al. [61]. We collected, analyzed, and interpreted the data using an objective and systematic methodology, minimizing potential biases and errors. In this section, we describe how the research methods were implemented and the rationales behind the choices.

4.1 Participants

To recruit participants for the study, we attempted to contact various secondary schools in Trondheim and Oslo. We contacted the schools by emailing relevant teachers and the school's public communication channels. In the initial contact (Appendix F), we briefly presented the thesis' goals and addressed what we were looking for and expected from participating schools. In addition, we attached a document (Appendix G) with more detailed descriptions of the concept and functionality of the application and low-fidelity mockups to visualize our idea. Several schools denied our requests immediately, but we eventually recruited a class of 10th graders at Blussuvoll School in Trondheim through connections. From 120 minutes of testing, spread over two free practice sessions, we received valid responses and data points from 24 boys and 23 girls, visualized in Figure 19.

SkillSprint was developed with ease of use in mind, and we wanted to limit potential external factors that might affect the research. Therefore, 10th graders (15-16 years old) were considered a good fit to participate in the study, as we viewed this as a group with sufficient technical skills. Further, this age group partakes in secondary education in Norway [23], which requires them to participate in a mandatory math course. Common to all math courses in Norwegian secondary schools is that they follow the same curriculum. Once we agreed with the specific class, we tailored SkillSprint to their situation regarding their curriculum and tasks.

According to the Norwegian Center for Research Data (NSD) [60], participation in research must be voluntary, and the children, parents, and teachers must consent and be informed. We were granted ethical approval for our data collection by submitting an application to the NSD, where we attached all questionnaires (Appendices J and K), the information letter, the declaration of consent, and additional information regarding data storage (Appendix H). However, we were able to structure the study and gather all necessary information without collecting any sensitive information, thus needing no consenting signatures from either parents or the students themselves.

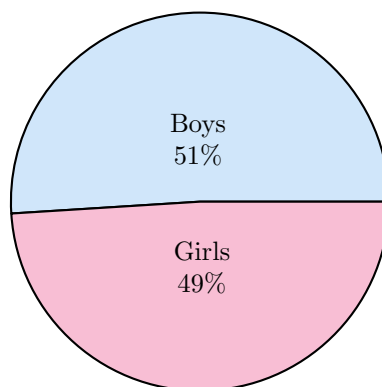

Figure 19: Gender Distribution.

4.2 Procedure

The students have weekly free practice sessions in mathematics where they can work freely with the relevant curriculum for homework, upcoming tests, exams, and similar. In two such sessions, we had the opportunity to test SkillSprint and thus collect necessary information for further analyses. Before the testing, SkillSprint was tailored to their particular curriculum and populated with all relevant tasks for the participating class. Initially, the plan was to have one test session. However, this could not be carried out as we only had 60 minutes available with the students, and the introduction and questionnaires would take up too much of the time. In consultation with the teacher, we agreed that the more robust solution was to come back to the following free practice session as well in order to give the students an accurate and fair impression of our application.

On the first day, we briefly introduced ourselves before demonstrating the application. After the introduction, the teacher distributed the login information to the students before they then answered the embedded self-administered pre-questionnaire inside our application. Once they were finished, some students worked independently with their tasks, and others collaborated. All students solved the tasks in their notebooks with the necessary tools before entering the answers into our application and having them automatically validated. Meanwhile, the teacher helped with any maths questions while we provided technical assistance if necessary. On the second day, we repeated close to the same procedure. However, instead of the students answering a pre-questionnaire, they immediately began working on the tasks before they answered the self-administered post-questionnaire at the end of the session.

4.2.1 Preparation

Ahead of the testing, there was a need for some preparation. These preparations were related to usernames distribution for the students without collecting sensitive information, implementing and adding math tasks from the curriculum, and creating a written demonstration of SkillSprint.

Usernames

Initially, we had not planned for the testing to take place over several sessions, so we had to find a way to ensure that the students were assigned the same user in SkillSprint both times. This was necessary to link the answers from the pre- and post-questionnaires to the same student and the application usage data. We wanted to carry out the entire data collection without collecting sensitive information such as names and email addresses, so the solution was to use the teacher as an intermediary. We sent the teacher many pre-generated users, which he, in turn, linked to each student and ensured that correct login information was provided in both sessions.

Tasks

An essential aspect of the application was that it should contain the same tasks as in the students' textbooks. We found no way to access these tasks online, but the teacher was accommodating and took pictures of a large selection of the tasks, sorted by the syllabus, and mailed them to us. We then manually added each task to our database. The tasks were ranked in the book by the degree of difficulty, so we assigned points to the tasks accordingly in our application as per our design.

Application Demonstration

The weekend before the first experiment day, we ensured the teacher and the students understood how things would occur. We maintained good communication with the teacher throughout the study, so he already had sufficiently good insight into what was required of him and the students. In order to reduce the time spent on presentation and guiding in the classroom, we sent the teacher a PDF (Appendix I) describing how the application works, which he forwarded to the class.

Pilot Test

With all the data added and the application close to complete, the teacher offered to carry out a pilot test on a student for whom he had private lessons. Although the pilot test could not be compared to a proper execution with an entire class, it gave us valuable feedback on when the

questionnaires should be filled in, specific answer input difficulties, and how we could best carry out the experiment with the students' regular schedule.

4.3 Data Generation

A survey-based research strategy was used, as it is considered suitable for collecting comparable standard data from a group of young students [61]. Observations and questionnaires were used as data-gathering techniques, and a complete overview of the computed variables from the collected data can be seen in Table 6.

4.3.1 Application Data

As covered in Section 3.3, we implemented event tracking and gathered log files in the application to observe and track how students interacted, progressed, and performed. The following data per student was obtained in order to be used in the data analysis:

- Total visits to the insight page
- Total visits to the leaderboard page
- Total visits to the achievements page
- Total tasks completed

4.3.2 Instruments

In addition to the application data, more quantitative data was generated through the self-administered pre- and post-questionnaires (Appendices J and K). As we could not ask additional questions after the sessions, the questionnaires were carefully constructed, as advised by Oates et al. [61]. To maintain consistency and minimize misunderstanding for the students, we employed a five-point Likert scale from “Strongly Disagree” to “Strongly Agree”, which meant that specific scales were changed. The weighting of the questionnaire items can be found in Table A.4. In addition, the questionnaires used in the study were translated into Norwegian to improve comprehension.

Pre-questionnaire

In the pre-questionnaire, we collected the students' username, gender, previous experience with similar applications, experience with video games, and preference for mathematics. Furthermore, we collected data that enabled us to give each user a separate score within Marczewski's Hexad [52], covered in Section 2.5, these being “philanthropist”, “free spirit”, “achiever”, “socialiser”, “player”, and “disruptor”.

The students' preference for mathematics was captured through their assessment of the following statement “I like mathematics” on the five-point Likert scale. The students' experience with previous similar applications was captured through their answer to the question “Have you previously used an application to repeat mathematics?” with the answer options “Never”, “1-5 times”, “6-9 times”, and “10 or more times”. The students' experience with computer games was captured through their answer of “How many hours do you spend playing in a week?” with the answer options “Never”, “1-5 hours”, “6-9 hours”, and “10 or more hours”.

The students' user types from Marczewski's Hexad were captured using the adapted scale and questionnaire items from Tondello et al. [85]. As recommended, the user type scores were calculated by separately adding the scores of the items corresponding to each subscale [85]. By collecting the user types of the participants, we could further examine its influence on the perceived motivation by SkillSprint and the game elements.

Post-questionnaire

As per RQ1 and RQ2, it was essential to capture how the students perceived SkillSprint and the game elements to repeat mathematics in a free practice session. We used a survey developed by Chapman and Rich [10] to capture this. With a five-point Likert scale, the students were to assess the following statement regarding (a) SkillSprint and (b) each game element:

(a) “Because of SkillSprint, I was in this free practice session in mathematics [Much Less, Less, Neutral, More, Much More] motivated to work and solve more tasks than I normally would in a free practice session.”

(b) “Because of [game element] in SkillSprint, I was in this free practice session in mathematics [Much Less, Less, Neutral, More, Much More] motivated to work and solve more tasks than I normally would in a free practice session.”

By wording the statement this way, we captured the essential part of our research questions, namely, the perceived motivation for repetition in mathematics. As the free practice sessions are used for working with the curriculum already taught, the wording regarding having solved more tasks than normally captured whether or not SkillSprint and the game elements motivated for effective repetition. We provided screenshots and explanations with each statement to increase the students’ comprehension of what was being assessed.

Regarding RQ1.1 and RQ2.1, we sought to understand which factors could influence the perceived motivation of the users engaging with SkillSprint and the various game elements. To gain this insight, in addition to a variety of data collected in the pre-questionnaire, we used a version of the Intrinsic Motivation Inventory (IMI) scale by Ostrow and Heffernan [62]. The IMI assesses intrinsic motivation using the dimensions “interest/enjoyment”, “competence”, “perceived autonomy”, and “belonging”, and links it to relationships with human behavior. Using this scale, we could understand what internal factors drove the students to use the application and to what extent these factors affected their perceived motivation. We adjusted the scale to a five-point Likert scale format to ensure comprehension.

While the survey adopted from Chapman and Rich [10] captured the students’ general perceived motivation by SkillSprint and the game elements to repeat mathematics, the use of the IMI scale by Ostrow and Heffernan [62] allowed for a deeper understanding of how different motivational factors influenced the students’ motivation for using the application.

In addition to capturing the perceived motivation by SkillSprint and which factors could possibly affect the motivation, we incorporated the System Usability Scale (SUS) [4, 8]. As it is a widely recognized and extensively used tool for measuring the usability of systems, it was also considered suitable for measuring SkillSprint’s usability.

4.3.3 Reliability

The reliability of the various questionnaire items was evaluated utilizing Cronbach’s Alpha coefficient, where a value higher than .70 is considered a high degree of validity [11].

For the System Usability Scale (SUS), we calculated a high validity for all items with $\alpha = .74$. Bangor et al. [4] found $\alpha = .91$, but we conclude that our α is acceptable. The score is likely lower as our study had significantly fewer participants.

For the IMI scale, we calculated a high validity for all items except for “belonging”. However, this was not a concern as Ostrow and Heffernan [62] reported the scales’ overall $\alpha = .78$, and other studies as well confirmed its validity and reliability [55, 87].

For the user type scale in Marczewski’s Hexad, we calculated a high validity for all items except for “disruptor”. This was also not a concern as Tondello et al. [85] verified the scale’s reliability.

In Table 5, a complete overview of the computed Cronbach’s Alpha coefficients can be seen.

Table 5: Overview Over the Computed Cronbach’s Alpha Coefficients.

Item	Cronbach’s Alpha	N of items
HEX_Philanthropist	.74	4
HEX_Socialiser	.74	4
HEX_Free_Spirit	.75	4
HEX_Achiever	.76	4
HEX_Disruptor	.68*	4
HEX_Player	.87	4
IMLIE	.89	5
IMLC	.87	5
IMLA	.86	6
IMLB	.43*	3
SUS_Final_Score	.74	10

* value below what is considered high validity

Table 6: Overview of the Variables.

Variable Name	Description	Source	Values
username	The student’s unique username		
gender	The student’s reported gender		[0,2]
experience	The student’s experience with similar applications		[0,3]
game.experience	The student’s weekly video game hours played		[0,3]
enjoy_math	The student’s reported enjoyment of mathematics		[1,5]
grouped.enjoy_math	The student’s preference for mathematics		[0,1]
HEX_Philanthropist	HEXAD score for <i>philanthropist</i>	Tondello et al. [85]	[0,20]
HEX_Socialiser	HEXAD score for <i>socialiser</i>	Tondello et al. [85]	[0,20]
HEX_Free_Spirit	HEXAD score for <i>free spirit</i>	Tondello et al. [85]	[0,20]
HEX_Achiever	HEXAD score for <i>achiever</i>	Tondello et al. [85]	[0,20]
HEX_Disruptor	HEXAD score for <i>disruptor</i>	Tondello et al. [85]	[0,20]
HEX_Player	HEXAD score for <i>player</i>	Tondello et al. [85]	[0,20]
MOT_SkillSprint	The student’s perceived motivation by the <i>entire application</i>	Chapman and Rich [10]	[1,5]
MOT_Leaderboard	The student’s perceived motivation by the <i>leaderboard</i>	Chapman and Rich [10]	[1,5]
MOT_Achievement	The student’s perceived motivation by the <i>achievements</i>	Chapman and Rich [10]	[1,5]
MOT_Points	The student’s perceived motivation by the <i>points</i>	Chapman and Rich [10]	[1,5]
MOT_Streaks	The student’s perceived motivation by the <i>streaks</i>	Chapman and Rich [10]	[1,5]
MOT_Performance_Graphs	The student’s perceived motivation by the <i>performance graphs</i>	Chapman and Rich [10]	[1,5]
MOT_Time_Pressure	The student’s perceived motivation by the <i>time pressure</i>	Chapman and Rich [10]	[1,5]
MOT_Animation	The student’s perceived motivation by the <i>animations</i>	Chapman and Rich [10]	[1,5]
total_tasks_completed	The student’s total mathematics tasks completed		[0,∞]
visits.insight	The student’s total visits to the <i>insight page</i>		[0,∞]
visits_leaderboard	The student’s total visits to the <i>leaderboard page</i>		[0,∞]
visits_achievements	The student’s total visits to the <i>achievements page</i>		[0,∞]
SUS_Final_Score	The student’s System Usability Score for skillsprint	Brooke et al. [8] and Sauro [75]	[1,100]
IMLIE	IMI <i>interest/enjoyment score for the application</i>	Ostrow and Heffernan [62]	[1,5]
IMLC	IMI <i>competence score for the application</i>	Ostrow and Heffernan [62]	[1,5]
IMLA	IMI <i>autonomy score for the application</i>	Ostrow and Heffernan [62]	[1,5]
IMLB	IMI <i>belonging score for the application</i>	Ostrow and Heffernan [62]	[1,5]

4.4 Data Analysis

Software and Data Processing

All statistical analyses were performed in IBM SPSS Statistics²⁹ v29.0.0.0. The significance level used was $p = .05$ unless stated otherwise.

Before the analyses, the data was processed in the following way in order to create a complete profile for each student:

- Merge pre- and post-questionnaire responses on the username of the student
- Merge application data and interaction data on the username
- Calculate the *IMI* scores for each dimension as advised by Ostrow and Heffernan [62]
 - i. Reversed score items marked (R)
 - ii. Calculated by taking the average of all items on each subscale
- Calculate the *Hexad* user type scores as advised by Tondello et al. [85]
 - i. Individually summarized scores for all items for each subscale
- Calculate the *SUS* scores as advised by Sauro [75]
 - i. For scores of odd items, one was subtracted
 - ii. For scores of even-numbered items, the score was subtracted from five
 - iii. Summarized the scores and multiplied the total by 2.5
- Calculate the *MOT_Performance_Graphs* score variable by calculating the average score from the three performance graphs on the insights page
 - i. The graphs were the category graph, average score graph, and answer distribution graph
- Divided students into groups based on whether they liked math or not
 - i. Based on the answers from the five-point Likert scale in the pre-questionnaire regarding math enjoyment, everyone who explicitly answered that they enjoyed mathematics (4-5) was placed in the group “likes math”
 - ii. Those who answered neutral or below (1-3) were placed in the group “dislike maths”

Some students were excluded from the study as they had yet to complete both questionnaires or deliberately answered all positive or negative to get it done. After the exclusion, we were left with 47 valid responses.

Correlation Analyses

We conducted correlation analyses to investigate potential relationships between students’ previous experience (with similar applications and video games) and their perceived motivation by using SkillSprint and by the game elements. This insight could be helpful for future works investigating previous experiences related to gamification and potential application redesigns.

For our correlation analysis, we chose to use the Pearson correlation coefficient. As the Pearson correlation is widely recognized and commonly used in statistical analyses, our results will be accessible and interpretable to a broad audience, increasing the impact and applicability of the study. The coefficient indicates the direction and strength of the relationships, which we deemed suitable for our study. Necessary requirements for analyses were considered [20]. However, it is worth noting that some of our data were not normally distributed, further elaborated in Section 4.4.

²⁹<https://www.ibm.com/products/spss-statistics>

Regression Analyses

In addition to the descriptive statistics and correlation analyses, we performed several regression analyses. These analyses offer predictive power, allowing us to investigate how changes in the independent variables affected the dependent variables. We used the perceived motivation by SkillSprint and the game elements as the dependent variables. The independent variables were the score of the dimensions from the IMI scale, the overall score from the SUS scale, the scores from the Hexad user types scale, as well as the application data “total tasks completed”. For the regression for perceived motivation by SkillSprint, “total visits” to the “insight,” “leaderboard,” and “achievement” pages were included as independent variables. By examining the results from the regression analyses, we got a more profound understanding of how the various independent variables collectively shaped the students’ perceived motivation. A complete overview of the dependent and independent variables can be seen in Table 7.

For our regression analysis, we chose the backward method. One of the main advantages of using this method over the standard enter method is reducing the number of predictors. By removing non-significant predictors, the model becomes more accurate and easier to interpret, and we reduce the possibility of overfitting and collinearity problems [20]. For the interpretation of variance, we used the adjusted R squared. We chose this, as adjusted R squared better accounts for several independent variables and therefore provides more precise measurements of model fit [20].

We refer to the approach by Keith [39] to interpreting the regressions’ beta values. He considers beta values lower than .05 too small, values above .05 to be small but meaningful, values above .10 to be moderate, and anything above .25 to be large.

Table 7: Regression Variables Overview.

		Dependent Variables						
		MOT_SkillSprint	MOT_Leaderboard	MOT_Achievement	MOT_Points	MOT_Performance_Graphs	MOT_Time_Pressure	MOT_Animation
SUS_Final_Score		✓	✓	✓	✓	✓	✓	✓
IMI								
IMLIE		✓	✓	✓	✓	✓	✓	✓
IMLC		✓	✓	✓	✓	✓	✓	✓
IMLA		✓	✓	✓	✓	✓	✓	✓
IMLB		✓	✓	✓	✓	✓	✓	✓
Independent Variables	Application Data							
	visits.insight	✓						
	visits.leaderboard	✓						
	visits.achievements	✓						
	total.tasks.completed	✓	✓	✓	✓	✓	✓	✓
Player Types								
HEX_Philanthropist		✓	✓	✓	✓	✓	✓	✓
HEX_Socialiser		✓	✓	✓	✓	✓	✓	✓
HEX_Free_spirit		✓	✓	✓	✓	✓	✓	✓
HEX_Achiever		✓	✓	✓	✓	✓	✓	✓
HEX_Disruptor		✓	✓	✓	✓	✓	✓	✓
HEX_Player		✓	✓	✓	✓	✓	✓	✓

t-tests

In addition to the analyses mentioned above, we wanted to investigate whether there was a significant difference between the means of those who report they like and dislike mathematics. We investigated differences in perceived motivation by SkillSprint and the game elements, the perceived competence in using SkillSprint, and the Hexad user types. Further, we investigated whether there was a significant difference between the reported genders. For the genders we investigated differences in the perceived motivation by SkillSprint and the game elements. By gaining this insight, we could investigate how to tailor a gamified application and game elements to fulfill the discovered necessities.

Assumptions of normality and homogeneity were taken into consideration, and to determine the magnitude of the effects, we use Cohen’s d as it provides a standardized representation of the

difference between the means of two groups [20]. Accordingly, we refer to Cohen's approach for interpreting the effect size with .10 as a small effect, .30 as a medium effect, and .50 as a large effect [12].

Assumptions for Analysis

For the statistical analyses conducted in the study, we aimed to explore the various relationships and predictors of our variables, and for all analyses, we assumed normal distribution. However, we observed that some of our data deviated from a perfect normal distribution, thus indicating non-normality. Some of the data not being normally distributed may impact the accuracy of the estimated coefficients in the regression models and the validity of the statistical deductions drawn from the correlations and t-tests. Further, these deviations from normality may restrict the generalizability of our findings. This deviation is worth keeping in mind when interpreting the results, and will be further elaborated in the study's limitations, Section 6.4.

5 Results

In this section we present the results and findings from the analyses of the data gathered through the testing of the application and the pre- and post-questionnaires. First we present the descriptive statistics, thereby previous experiences, preference for mathematics and the students Hexad user type preferences. Additionally we highlight the perceived motivation by SkillSprint and the game elements. Further, we present the results of the analyses, being correlation, regression and t-tests.

5.1 Descriptive Statistics

Demographics

Previous Experiences

Results show that 25 (53%) students report that they have zero experience with similar applications, 16 (34%) report that they have tried similar applications one to five times, two (4%) report that they have tried similar applications six to nine times and three (9%) students report that they have tried similar applications ten or more times.

Eighteen (38%) students report that they play video games one to five hours a week, 11 (23%) report that they play six to nine hours a week, ten (21%) students report that they play zero hours a week, and eight (17%) students report that they play ten or more hours a week.

The experience distributions are depicted in Figure 20.

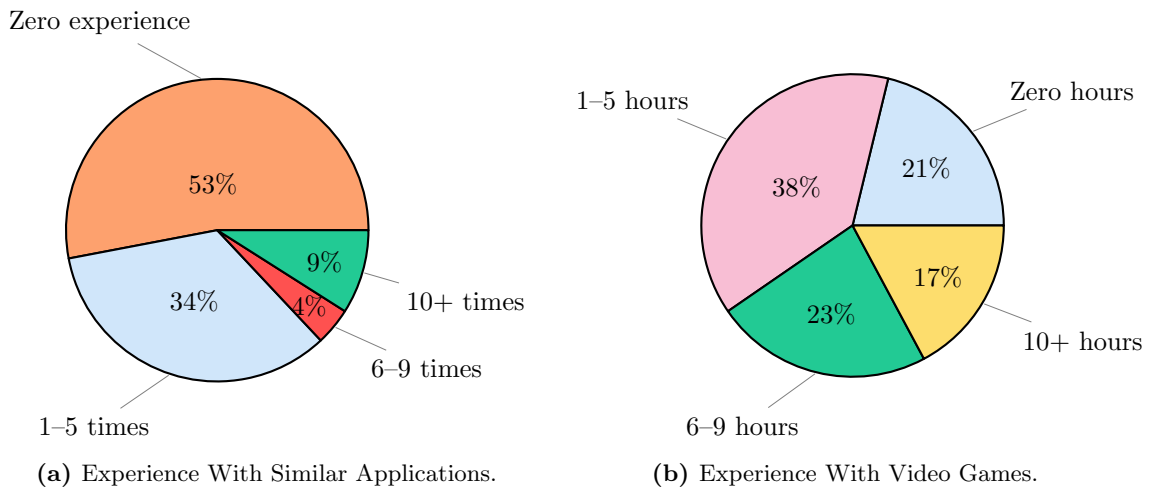

Figure 20: Student's Previous Experiences.

Preference for Mathematics

As visualized in Figure 21, 24 (51%) report that they like mathematics, and 23 (49%) report that they dislike mathematics.

Hexad User Types Distribution

The Hexad user type score is a score between 1 and 20, indicating the degree of relatedness to the user types defined in the framework by Marczewski [52]. In our selection, the user type “player” had the highest mean score ($M = 15.87$) and the highest standard deviation ($SD = 3.14$). In contrast, the user type “disruptor” demonstrated the lowest mean score ($M = 11.09$) and the second highest standard deviation ($SD = 2.84$), indicating that, on average, “disruptors” obtained lower scores compared to the other user types. The user types “philanthropist”, “achiever”, “free

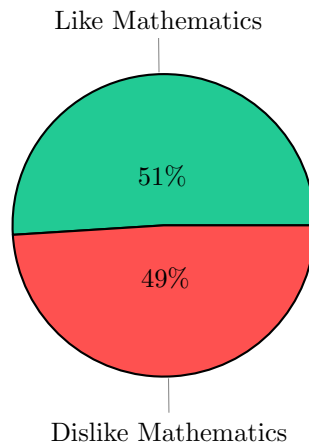

Figure 21: Students's Preference for Mathematics.

spirit”, and “socialiser” displayed similar mean scores (ranging from $M = 15.28$ to $M = 15.70$) and standard deviations (ranging from $SD = 2.39$ to $SD = 2.61$). Figure 22 shows the distribution of the user types in our sample, and additional information can be found in Table 8.

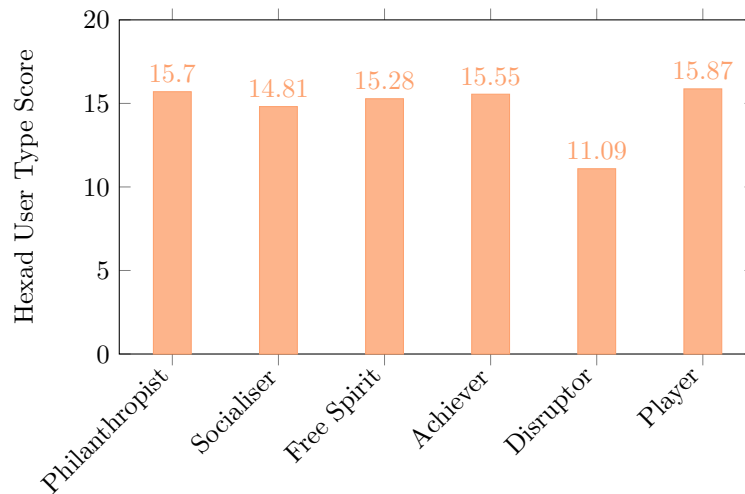

Figure 22: Bar Chart of Hexad User Types.

Perceived Motivation

SkillSprint

The participants reported a mean score of 3.85 ($SD = .81$) for *MOT_SkillSprint*, indicating that the students perceived SkillSprint as moderately motivating.

Game Elements

For all game elements, the participants reported a mean score above 3. *MOT_Points* had the highest mean of 4.09 ($SD = .72$) indicating that the students perceived the element as motivating. Further, *MOT_Achievements* had a mean of 3.91 ($SD = .75$), and *MOT_Animations* had a mean of 3.89 ($SD = .76$), indicating moderately perceived motivation.

An overview of all the descriptive statistics can be found in Table 8.

Table 8: Descriptive Statistics.

Variable	Values	Mean	Std. Deviation	Min	Max
experience	[0, 3]	.68	.91	0	3
game_experience	[0, 3]	1.36	1.01	0	3
enjoy_math	[1, 5]	3.51	.975	1	5
L1	[1, 5]	3.89	.814	1	5
SUS_Final_Score	[1, 100]	69.31	12.21	50	95
MOT_SkillSprint	[1, 5]	3.85	.81	3	5
MOT_Leaderboard	[1, 5]	3.87	.77	2	5
MOT_Achievements	[1, 5]	3.91	.75	3	5
MOT_Points	[1, 5]	4.09	.72	3	5
MOT_Streaks	[1, 5]	3.66	.84	2	5
MOT_Performance_Graphs	[1, 5]	3.46	.61	2.67	5
MOT_Time_Pressure	[1, 5]	3.62	.68	2	5
MOT_Animations	[1, 5]	3.89	.75	3	5
HEX_Player	[1,20]	15.87	3.14	9	20
HEX_Philanthropist	[1,20]	15.70	2.40	11	20
HEX_Achiever	[1,20]	15.55	2.53	10	20
HEX_Free_Spirit	[1,20]	15.28	2.39	10	20
HEX_Socialiser	[1,20]	14.81	2.61	9	20
HEX_Disruptor	[1,20]	11.11	2.84	5	17

5.2 Correlation Analyses

Results from the correlation analysis indicated no significant relationships between previous experience with similar applications or experience with video games and perceived motivation from SkillSprint and its various game elements. For *game_experience*, correlations ranged from $-.13$ to $.16$ ($p > .05$). Similarly, the correlations for *experience* ranged from $-.06$ to $.25$ ($p > .05$).

Table 9 shows a complete overview of the correlation results.

Table 9: Results from the Correlation Analyses.

	MOT_SkillSprint	MOT_Leaderboard	MOT_Achievements	MOT_Points	MOT_Streaks	MOT_Performance_Graphs	MOT_Time_Pressure	MOT_Animations
game_experience	.15	.03	.16	.02	-.13	-.15	-.11	.05
experience	.08	.25	.09	.01	-.06	.04	.15	-.05

Significance levels (2-tailed) ($p < .001$)***, ($p < .01$)**, ($p < .05$)*

5.3 Regression Analyses

Durbin-Watson was used to investigate independent errors, while the variance inflation factor (VIF) was used to examine collinearity. The Durbin-Watson scores ranged from 1.69 to 2.25, thus indicating weak correlations between the errors and the residuals as desired [20]. The VIF scores ranged from 1.00 to 2.66, thus showing a low degree of collinearity [20]. As the requirements for homoscedasticity and linearity were also satisfied, all prerequisites for the regression were met.

The independent variables explained a total of 53% (R_{adj}^2) of the variance in *MOT_SkillSprint*, 35% (R_{adj}^2) of the variance in *MOT_Points*, 34% (R_{adj}^2) of the variance in *MOT_Streaks*, 30% (R_{adj}^2)

of the variance in *MOT_Achievements*, 29% (R_{adj}^2) of the variance in the *MOT_Leaderboard*, 26% (R_{adj}^2) of the variance in *MOT_Time_Pressure*, and 16% (R_{adj}^2) of the variance in *MOT_Performance_Graphs*.

Results indicated that no independent variables could predict the dependent variable *MOT_Animations*. Further, the results indicated that the independent variables *SUS_Final_Score*, *IML_A*, *visits_insight*, *total_tasks_completed*, *HEX_Philanthropist*, *HEX_Socialiser*, *HEX_Free_Spirit*, *HEX_Achiever*, *HEX_Disruptor*, and *HEX_Player* failed to predict any dependent variable. However, results indicated that *IMLIE* had a large significant positive effect on *MOT_SkillSprint* ($\beta = .67, p < .001$), *MOT_Points* ($\beta = .60, p < .001$), *MOT_Streaks* ($\beta = .58, p < .001$), *MOT_Achievement* ($\beta = .55, p < .001$), *MOT_Performance_Graphs* ($\beta = .42, p < .01$) *MOT_Time_Pressure* ($\beta = .37, p < .01$) and *MOT_Leaderboard* ($\beta = .28, p < .05$). *IML_C* had a large significant negative effect on *MOT_SkillSprint* ($\beta = -.29, p < .05$), but failed to predict any other dependent variables. *IML_B* was a large significant positive predictor of *MOT_SkillSprint* ($\beta = .39, p < .05$) and *MOT_Leaderboard* ($\beta = .38, p < .05$), but failed to predict any other dependent variables. *visits_leaderboard* was a large significant negative predictor of *MOT_SkillSprint* ($\beta = -.41, p < .05$). *visits_achievements* was a large significant positive predictor of *MOT_SkillSprint* ($\beta = .32, p < .05$). *HEX_Free_Spirit* had a large significant positive effect on *MOT_Streaks* ($\beta = .47, p < .01$) and *MOT_Achievements* ($\beta = .33, p < .05$). *HEX_Achiever* was a large significant positive predictor of *MOT_Time_Pressure* ($\beta = .31, p < .05$).

The regression results for SkillSprint are presented in Table 10, while Table 11 displays the regression results for the game elements.

Table 10: Regression Results for Perceived Motivation by SkillSprint.

	MOT_SkillSprint	
	β	SE
SUS_Final_Score		
IMLIE	.67***	.16
IML_C	-.29*	.15
IML_A		
IML_B	.39**	.17
visits_insight	.21	.05
visits_leaderboard	-.41*	.02
visits_achievements	.32*	.03
total_tasks_completed		
HEX_Philanthropist		
HEX_Socialiser		
HEX_Free_spirit	.20	.04
HEX_Achiever		
HEX_Disruptor		
HEX_Player		
R_{adj}^2	.53	

$N = 47$. Significance levels ($p < .001$)***, ($p < .01$)**, ($p < .05$)*

5.4 t-tests

The t-test comparing the means of those reporting they dislike mathematics and those reporting they like mathematics revealed no significant differences for the dependent variables regarding perceived motivation, both by the application and the isolated game elements (prefixed *MOT_*). Further, the results showed no significant differences between the groups for *HEX_Philanthropist*, *HEX_Socialiser*, *HEX_Free_Spirit*, *HEX_Disruptor*, and *HEX_Player*. However, there was a significant difference between the groups in *HEX_Achiever* ($t(38) = -3.40, p < .001$). The group

Table 11: Regression Results for Perceived Motivation by the Game Elements.

	MOT_Leaderboard		MOT_Achievements		MOT_Points		MOT_Streaks		MOT_Performance_Graphs		MOT_Time_Pressure		MOT_Animations	
	β	SE	β	SE	β	SE	β	SE	β	SE	β	SE	β	SE
SUS_Final_Score														
IMLIE	.28*	.16	.55***	.14	.60***	.13	.58***	.17	.42**	.12	.37**	.13		
IML_C														
IML_A														
IML_B	.38*	.18												
total_tasks_completed														
HEX_Philanthropist														
HEX_Socialiser														
HEX_Free_spirit			.33*	.04			.47**	.05						
HEX_Achiever							-.25	.05			.31*	.04		
HEX_Disruptor							.25	.04						
HEX_Player														
R ² _{adj}	.29		.30		.35		.34		.16		.26			

$N = 47$. Significance levels ($p < .001$)***, ($p < .01$)**, ($p < .05$)*

reporting they like mathematics ($M = 16.67, SD = 1.79$) had a significantly higher *HEX_Achiever* score than those reporting they dislike mathematics ($M = 14.39, SD = 2.69$). Additionally, there was a significant difference between the groups in *IMI_C* ($t(45) = -1.71, p = .048$) from the Intrinsic Motivation Inventory (IMI). Those reporting they like mathematics ($M = 3.7, SD = .79$) scored significantly higher on the perceived competence in the use of SkillSprint, compared to those reporting they dislike mathematics ($M = 3.35, SD = .65$). A complete overview of the t-test results by the preference for mathematics can be seen in Table 12, and the distribution for the preference for mathematics can be seen in Figure 21.

Table 12: t-test Results by Preference for Mathematics.

Variable	t	df	p	Difference		95% Confidence Interval		<i>Cohen'sd</i>
				M	<i>Std.Error</i>	Lower	Upper	
MOT_SkillSprint	-1.30	45	.10	-.30	.23	-.78	.17	.38
MOT_Leaderboard	-1.57	45	.13	-.35	.22	-.79	.10	.46
MOT_Achievements	-.80	45	.43	-.17	.22	-.62	.27	.23
MOT_Points	-1.21	45	.23	-.25	.21	-.67	.17	.35
MOT_Streaks	-.06	45	.95	-.014	.25	-.51	.49	.02
MOT_Performance_Graphs	-.60	45	.55	-.11	.18	-.47	.25	.18
MOT_Time_Pressure	-1.39	45	.17	-.27	.20	-.67	.12	.41
MOT_Animations	-1.38	45	.17	-.30	.22	-.74	.14	.40
IMI_C	-1.71	45	.048*	-.36	.21	-.79	.07	.50
HEX_Philanthropist	-1.50	45	.070	-1.03	.69	-2.42	.35	.44
HEX_Socialiser	-.51	45	.31	-.39	.77	-1.94	1.16	.15
HEX_Free_Spirit	-1.53	45	.067	-1.05	.69	-2.44	.33	.45
HEX_Achiever	-3.40	38	.001***	-2.28	.67	-3.63	-.92	1.00
HEX_Disruptor	-.31	45	.38	.26	.84	-1.42	1.94	.09
HEX_Player	-.75	45	.23	-.69	.92	-2.55	1.18	.22

Significance levels ($p < .001$)***, ($p < .01$)**, ($p < .05$)*

The t-test comparing the means of reported gender revealed no significant differences for *MOT_SkillSprint*, nor *MOT_Leaderboard*, *MOT_Points*, *MOT_Streaks*, *MOT_Performance_Graphs*, *MOT_Time_Pressure*, or *MOT_Animations*. However, the results showed a significant difference between the groups in *MOT_Achievements* ($t(45) = 2.04, p = .048$). Boys ($M = 4.13, SD = .68$) reported significantly higher perceived motivation by achievements than girls ($M = 3.70, SD = .77$).

A complete overview of the t-tests by gender can be seen in Table 13, and the gender distribution can be seen in Figure 19.

Table 13: t-test Results by Gender.

Variable	<i>t</i>	<i>df</i>	<i>p</i>	Difference		95% Confidence Interval		<i>Cohen'sd</i>
				<i>M</i>	<i>Std.Error</i>	Lower	Upper	
MOT_SkillSprint	.93	45	.36	.22	.24	-.26	.69	.27
MOT_Leaderboard	1.17	45	.25	.26	.22	-.19	.71	.34
MOT_Achievements	2.04	45	.048*	.43	.21	.01	.85	.59
MOT_Points	1.62	36.71	.11	.34	.21	-.08	.76	.48
MOT_Streaks	.06	45	.95	.01	.25	-.49	.51	.02
MOT_Performance_Graphs	-1.15	45	.26	-.20	.18	-.56	.15	.34
MOT_Time_Pressure	.51	45	.61	.10	.20	-.30	.50	.15
MOT_Animations	.59	45	.56	.13	.22	-.32	.58	.17

Significance levels ($p < .001$)***, ($p < .01$)**, ($p < .05$)*

6 Discussion

In this section, we provide an interpretation and discussion of the results and findings from the empirical study. The section is structured into four subsections to provide a comprehensive structure and presentation. In the first subsection, we focus on SkillSprint, specifically addressing the research questions RQ1 and RQ1.1. In the subsequent subsection, we focus on each game element, addressing research questions RQ2 and RQ2.1. Finally, we discuss the thesis’s contributions and critically evaluate its limitations.

6.1 Perceived Motivation by SkillSprint

In this study, we examine how the students perceived SkillSprint as motivating when repeating mathematics in a free practice session. Furthermore, we explore how specific factors influence the perception of motivation by our gamified application. In the following section, we present our interpretation of the results from the analyses, answer the related research questions with their hypotheses, and discuss relationships with relevant studies. We first discuss the descriptive statistics concerning RQ1 before investigating the relationships with and predictors of the perceived motivation concerning RQ1.1.

The research question for this part, introduced in Section 1.1, is as follows:

RQ1 How do students perceive SkillSprint as motivating to repeat mathematics in a free practice session?

Based on the results from our analyses, we found evidence to support the first hypothesis, **H1**. The findings suggest that the students perceived SkillSprint as *moderately motivating* when repeating mathematics in a free practice session. Even though it may not have been motivating to all, it was not perceived as demotivating by anyone. This is an exciting find, as the participants’ demographics are very diverse. Boys and girls were well mixed, and there was an excellent variety of previous experiences, preferences for mathematics, and user types the individuals identify with.

Hamari et al. [28] point out in their literature review that gamification of learning activities can positively affect motivation. Our study addresses the learning activity of solving and repeating mathematics tasks in free practice sessions, and the perceived motivation reported by the participants is consistent with their findings. Furthermore, Hamari et al. [28] argue that the effect of gamification depends on its implementation and design. The thorough design and development process for SkillSprint attempted to incorporate these critical criteria, and the reported positive perceptions suggest that we successfully integrated gamification with these prerequisites.

On the other hand, our findings regarding SkillSprint differ from those of Hanus and Fox [29], who found that gamification could have a significantly adverse effect on students’ intrinsic motivation. A reason for that none of our participants reported SkillSprint as demotivating may be related to the time perspective in which they interacted with our application. The study of Hanus and Fox [29] lasted 16 weeks, while our participants only interacted with SkillSprint for 120 minutes spread over two sessions. Due to this time perspective, it is reasonable to believe that their participants experienced a weakened feeling of autonomy compared to ours. Hanus and Fox [29] even addressed this, as they found that students experiencing a diminishing sense of autonomy also report significantly lower motivation. This is further supported by Alsawaier [3], who promote the 80-20 rule. Instead of fully gamifying a course, he advocates for a 20 percent course quota that can utilize gamification, with the rest being traditional teaching methods. As described by Deci and Ryan [14, 70], autonomy is an essential factor for motivation. However, our findings suggest that autonomy does not impact the perceived motivation by SkillSprint. The absence of significant results aligning with their studies in our research, may indicate that autonomy does not play a significant role in our specific context.

Exploring Relationships and Predictors of Perceived Motivation by SkillSprint

The research question for this part, introduced in Section 1.1, is as follows:

RQ1.1 How do specific factors influence the perception of motivation by SkillSprint to repeat mathematics in a free practice session?

Previous Experiences

Our results indicated no significant relationships between experience with similar applications and the perceived motivation by SkillSprint, suggesting that **H2** can be incorrect. This may be because SkillSprint is so different from applications the students have previously used or that the functionality and gamification were implemented so that previous experience was irrelevant to the perception of motivation. Tahir et al. [81] found that in their study, students with prior experience with gamification interacted with their application for a significantly longer time when exposed to certain game elements compared to those without experience. We interpret this as increased interaction implies an increased motivation to work with the gamified application. However, our study does not align with this finding, as we found no significant relationships. The findings may differ due to dissimilar gamified contexts and game elements. Further, the results indicated that experience with video games neither had any relationship with the perceived motivation by SkillSprint, thus indicating that **H3** is also incorrect. Denden et al. [15] found that gaming frequency did not significantly affect learners' perception of gamification. Our findings are consistent with theirs, suggesting that previous gaming experience does not necessarily translate into higher motivation or perception of gamified elements in educational contexts.

Interest and Enjoyment

The students' intrinsic motivation played a significant role in how they experienced our application as motivating and is seen in our most significant results regarding the effect on perceived motivation by SkillSprint. The results suggest that the more enjoyable and interesting the students find SkillSprint, the more motivating it is perceived. These findings align well with Deci and Ryan [14], who point out that by being intrinsically motivated, individuals are more likely to engage in activities willingly and experience greater satisfaction and well-being. From a gamification perspective, we can view the enjoyability and interest in SkillSprint as a result of factors such as fun game mechanics (e.g., points and achievements), the actual game dynamics (e.g., competition, cooperation), or the actual design of the application (e.g., animations, graphics). This further aligns with findings from Alsawaier [3], who found that *fun* elements, being elements promoting feelings of achievement, sense of exploration, and rewards for accomplishments, had an essential effect on the user's motivation.

Perceived Competence by Using SkillSprint

Furthermore, results indicate that perceived competence using SkillSprint negatively influences the perceived motivation. This suggests that the more competent one feels in using SkillSprint, the less motivating the application is perceived to be. One reason for this may be overqualification. Students who perceived themselves as competent in using SkillSprint may have felt that using the application slowed down their practice. Furthermore, it is conceivable that people who found the app straightforward did not enjoy the challenges it offered, such as streaks, achievements, and points, and therefore reported a lower level of perceived motivation. This aligns well with the theory of flow, where Rose et al. [69] suggests that if an activity's challenge level is too low compared to the user's skill level, it can cause boredom or apathy. These interpretations can further be complemented by our results indicating that those who like mathematics report significantly higher perceived competence in using SkillSprint. One could argue that those who already like mathematics did not need further motivation to do more tasks in free practice sessions and thus felt limited by using an extra tool.

Sense of Belonging

Our findings indicate that the sense of belonging by SkillSprint positively influences how it is perceived as motivating. These results suggest that the higher the sense of belonging by use of

our application, the more motivational it is perceived. The principles of Deci and Ryan’s SDT propose that fulfilling the need for relatedness is crucial for intrinsic motivation, and our findings align with these [14]. The results further propose that we successfully created an application that promotes a sense of belonging for the users, conceivably due to the easy navigation of tasks making it simple to collaborate. This aligns well with the findings of Sailer et al. [73], where collaboration with teammates was one of the elements that led to increased social relatedness. We also believe the students felt a sense of belonging as they could physically see other students participating in the activity. The teacher stated that students were more willing to sit together and collaborate on tasks than in the free practice sessions without the application. He argued that some students would typically move to different rooms to work alone, but the way SkillSprint presented the tasks made solving them a shared goal and fostered collaboration. According to Sailer et al. [73], a shared goal is a mechanism that may induce feelings of relevance and social relatedness, thus aligning well with our findings.

Preference for Mathematics

We further examined the potential impact of participants’ preference for mathematics on their reported perceived motivation by SkillSprint. However, our results indicated that the preference for mathematics yielded no significant effect, thus not aligning with **H4**. This may indicate that the application is designed in a way that not only motivates a wide range of students but also that one’s attitude towards the context in which the gamification is used does not necessarily matter. In our specific case, the results can be attributed to the fundamental nature of mathematics itself. Students who already like mathematics would likely be motivated to repeat mathematics, regardless of the gamified application. In contrast, those who dislike mathematics may perceive the gamified application as unappealing, akin to “chocolate-covered broccoli.” Consequently, the gamified application would not matter, as their underlying attitudes toward mathematics remain relatively unchanged.

Gender Bias

Gender bias was also examined regarding the perceived motivation by SkillSprint, and our results revealed no significant differences based on gender, thereby indicating that **H5** may be correct. This finding somewhat aligns with the findings of Denden et al. [15], who found that gender did not significantly affect students’ perception of gamification. We consider their findings relevant, as how students perceive an application can significantly impact their motivation. However, our findings differ from those of Seaborn and Fels [76], who reported that girls were more engaged by gamification than boys. While motivation and engagement are not synonymous, they are still strongly intertwined. Motivation may be regarded as a precursor to engagement because motivation is frequently regarded as the driving factor behind performing and engaging in activities [3].

Application Usability

Our results showed that the application’s usability did not influence perceived motivation by SkillSprint, thus indicating that **H6** may be incorrect. This suggests that whether the students found the application user-friendly or not, it did not influence how motivating SkillSprint was perceived. Our findings indicate that all students found SkillSprint to be either motivating or neutrally motivating. This aligns with the hygiene factors analogy from Zhang and von Dran [93]’s “*two-factor model for website design and evaluation*”. A part of this analogy is factors contributing to dissatisfaction but not satisfaction. Application usability can be seen as such a hygiene factor as an application is expected to be good. If the usability is bad, it can demotivate, but if it is good, it will not necessarily be a motivating factor [93]. However, it may increase their enjoyment and perception of the application.

Total Tasks Completed and User Types

Further, our results revealed that the total tasks completed did not significantly predict perceived motivation by SkillSprint. This may suggest that it does not influence motivation regardless of how many tasks a student solves. However, measuring performance might be a poor metric as gamification is a psychologically driven approach targeting motivation [17]. Dichev and Dicheva [17] note that performance as a metric is an indirect measure of various factors, including non-motivational

ones, such as aptitude, prior knowledge, and ease of usage, thus not being comparable, nor relevant for our study. Lastly, our results showed that none of the Hexad user types were significant predictors of the perceived motivation by the application. This may suggest that SkillSprint does not favor a particular type of student with their respective preferences, as advised by Manzano-León et al. [51].

6.2 Perceived Motivation by the Game Elements

In addition to examining how SkillSprint was perceived as motivating when repeating mathematics in free practice sessions, we also examined how each game element was perceived as motivating. In this subsection, we present an interpretation of the results from the analyses, answer the related research questions with their hypotheses and discuss its relationships with other studies. Each game element will be covered in its own subsection to present the interpretations of the results in a structured manner. For each game element, we discuss the descriptive statistics concerning RQ2.1 before investigating the influence on perceived motivation concerning RQ2.1. Our analyses revealed several common relationships and predictors for the game elements, and we examine these at the very end.

The research questions for this subsection, introduced in Section 1.1, are as follows:

RQ2 How do students perceive various game elements motivating to repeat mathematics in a free practice session?

RQ2.1 How do specific factors influence the perception of motivation by various game elements to repeat mathematics in a free practice session?

Leaderboard

Our findings suggest that isolated, the leaderboard was perceived as *moderately motivating* when repeating mathematics in a free practice sessions, thus indicating that **H7** and **H7.1** may be correct. However, results revealed that when incorporating the leaderboard in SkillSprint, exposure to this element had a significant negative influence on the perceived motivation by the application. In other words, the more the students visited the leaderboard, the less motivating they perceived SkillSprint. A possible explanation is that the best-performing students focused more on solving tasks and getting points than visiting the leaderboard. On the other hand, the weaker students may more frequently have checked how they were doing and thus became further demotivated. This explanation aligns well with studies by Furdu et al. [22], who found that such upward comparison could lead to lower academic self-concept, possibly related and comparable to perceived motivation by SkillSprint. Our findings indicating that leaderboards can have positive and negative effects are further consistent with the findings of Werbach et al. [89], who emphasized that this game element may be motivating to those close to advancing positions and demotivating to those finding themselves at the bottom. Kalogiannakis et al. [38] support that leaderboards have mixed results, highlighting that creating a competitive environment might be controversial.

When examining specific factors that could influence the perception of motivation by the leaderboard, we found that the students' sense of belonging when using SkillSprint had a positive influence. Although the users were anonymized and the leaderboard only showed the top five performing students, we observed in the classroom that the students asked for each other's usernames to compare themselves and openly competed. These internal competitions, comparisons, and general interactions implied that the students collaborated significantly, possibly contributing to a sense of belonging. The observations align well with the findings from Hanus and Fox [29], who found that the classroom naturally facilitates comparison by the constant exposure to peers' performance, and Alsawaier [3], who found that those engaging with the leaderboard experience significant relatedness.

Points

Our results showed that the students perceived the game element points as *motivating*, thus supporting **H7.2**. Although all students did not perceive it as motivating, none perceived it as demotivating. Points was also the game element with the highest reported mean value on perceived motivation. We believe this game element has a high score because it is a fundamental element of a multitude of games. Additionally, it is a comprehensive measure of progress and is often used as a competitive element. Further, the points can be seen as an extrinsic reward, which Ryan and Deci [70] pointed out could be the most beneficial motivation in an academic context over a short time period. It is also worth noting that in our context, many points communicated that one had either completed many tasks or solved challenging tasks. According to Gomes Fernandes Matsubara and Lima Corrêa Da Silva [25], points should be distributed relatively based on the activity's difficulty level. Their study showed that users prefer engaging in many easy activities rather than time-consuming ones offering higher rewards. However, we found that total tasks completed did not influence the perceived motivation by points, indicating that the motivational aspects of points did not come from the students communicating many tasks solved, but possibly challenging tasks solved.

Achievements

Our findings indicate that the students perceived the game element achievements as *moderately motivating*, supporting that **H7.3** may be correct. Even though some students reported it as motivating and neutrally motivating, no one reported it as demotivating. Compared to the other game elements, achievements were perceived as the second most motivating element by the students, and we believe this is tightly coupled with how we implemented it. We implemented the achievements as progress towards a goal with redeemable points upon completion. As points was perceived as the most motivating element, we interpret the high achievement ranking with the perceived motivation by points.

We found that the Hexad user type “free spirit” positively influenced the perceived motivation by achievements. According to the Hexad user type framework, the key drivers for “free spirits” are autonomy and self-expression [52]. SkillSprint aimed to target such user types by having a variety of potential achievements present in which the student could progress freely. Furthermore, our application has achievements that encourage users to explore different categories of tasks. These achievements can serve as exploratory tasks as Tondello et al. [85] recommended for free-spirited users. Similarly, Macon [50] highlight that badge designs promoting play and exploration, can positively impact curiosity, a common characteristic of free-spirited individuals. Our findings suggest that one can positively influence different user types by focusing on achievement design and implementing a balanced assortment of achievements.

Another interesting finding was not only that achievements were considered motivating, but we also found that the number of visits to the achievement page, and thus exposure to the element itself, positively influenced the perceived motivation by SkillSprint. In other words, students who frequently were exposed to the achievements reported higher perceived motivation by SkillSprint. This finding aligns well with the SDT by Ryan and Deci [71], emphasizing competence as a key driver of intrinsic motivation. Our findings indicate that application features that highlight users' achievements and progress can positively influence the perceived motivation by gamified applications.

Denden et al. [15] found that girls had a higher perception of achievements than boys, and Toda et al. [84] found that girls would make more use of elements communicating rewards. Further Klock et al. [41] highlighted in their literature review that many studies suggest badges to girls. These findings differ from our results, as ours indicate that boys perceived achievements as more motivating than girls. The aforementioned differences may result from how we implemented the achievements, aligning well with Klock et al. [41] highlighting that studies often suggest competition to boys. As our achievements rewarded points upon completion, the achievements may have been utilized to gain a competitive advantage. The students would rapidly climb the leaderboard by strategically solving tasks that also progressed specific achievements.

Streaks

We found that students perceived the game element streaks as *moderately motivating*. However, some students reported the element as demotivating, and we suspect this is due to user error. When we assisted with technical assistance during the experiment, several people complained that their streak disappeared when they entered the task answer incorrectly. We believe that frustration linked to this failure, and that the streak did not give it an appreciably good advantage resulted in some students perceiving it as a demotivating element. Due to inconclusive results and likely application design flaws, we refrain from giving any indications regarding **H7.4**.

Results indicate that the Hexad user type “free spirit” positively influenced the perceived motivation by streaks. This finding is interesting, as “free spirits” are often driven by a desire for exploration and freedom [52, 85], but on the other hand, pursuing streaks often leads users to prioritize consistency over exploration due to the fear of failure [69]. As we found that the more the students’ identified as “free spirits”, the more motivating they perceived streaks, our findings do not align with these assertions. One could argue that “free spirits” got an outlet for their desire for exploration by finding creative ways to maintain the streak. However, this has to be further investigated to conclude confidently.

Performance Graphs

Our findings indicate that the students perceived the performance graphs as *moderately motivating*. However, we lack conclusive evidence to give any indications regarding **H7.5**. To create a variable that considered all performance graphs simultaneously, we combined the scores from the three different performance graphs and calculated the average without specific support from the literature. Furthermore, we observed during the execution of the experiment that several people questioned what the graphs showed and what kind of benefit they added to the application. The idea was that the students should use the graphs to get an overview of their progression in the subject and how they were compared to the class average. However, the results and observations indicate that this was not communicated sufficiently and that we would need further qualitative research to conclude confidently.

We found that total visits to the insight page, and thus exposure to the *performance graphs*, had no influence on the perceived motivation by SkillSprint. This adds to the idea that the implementation was poor, and the lack of results is in line with Hamari et al. [28]’s findings when looking at what must be in place for gamification to affect motivation. As covered in Section 3.2.6, the performance graph displays where the students align with the average points in the class, which might have fostered competitiveness. However, the literature points out that performance graphs should focus on the student’s past performance rather than using it for comparison to others [73]. Performance graphs could then be used for self-improvement, but we chose otherwise as we had no previous data on the students. We believe that the leaderboard element became the preferred way to engage in competition, thus resulting in the performance graphs not playing a significant role. On the other hand, since the performance graph may have adopted the competitive aspect of leaderboards, it could also promote similar negatives.

Time Pressure

Our findings indicate that the students experienced the time pressure as *moderately motivating*, thus indicating that **H7.6** may be incorrect. The time pressure in SkillSprint was experienced through the very limited time of interaction with the application and process of solving tasks, thus, the opportunity to assert themselves. The results align with the research of Toda et al. [84], which emphasizes that the absence of time pressure may lead to students not feeling challenged or pressured to complete tasks.

Furthermore, the results revealed that Hexad user type “achiever” was a significantly positive predictor for the motivation of the time pressure element. “Achievers” are largely motivated by

challenges [52], and our findings align well with the study by Toda et al. [84], as the time pressure offered by SkillSprint indeed may be perceived as challenging.

Animations

Our findings show that the students perceived animations as *moderately motivating*, thus indicating that **H7.7** may be incorrect. The animated elements in SkillSprint were confetti popups when one received points, animated page transitions, and animated indicators symbolizing loading states.

Manzano-León et al. [51] highlight that a balanced design of different game elements can increase students' motivation, which is also supported by Hamari et al. [28]. As they point out that aesthetics is one of those elements, our findings align with theirs. Visually pleasing aesthetics, e.g., animations, naturally introduce novelty and fun to the application, and the visual feedback we introduce to the application can be thought to be perceived as motivating and pleasing.

6.2.1 Common Relationships and Predictors

Common to all game elements examined is that neither experience with similar applications nor video games influenced perceived motivation, indicating that **H8** and **H9** may be incorrect. We likely found no relationships due to the context being so unique compared to previous experiences and possible differences in which game elements were used. Further, we did not explicitly investigate experiences with each game element, thereby possibly not capturing essential data for other outcomes.

Further, we found that the usability of the context in which the game elements were incorporated did not influence how they were perceived as motivating. In the same way, as for SkillSprint, we believe that the context in which the game elements are used is expected to be satisfactory, and thus the results align with the analogy of the hygiene factors from Zhang and von Dran [93]. In other words, if the usability of the context was bad, the game elements could be experienced as demotivating. However, when it was adequate, it did not necessarily affect the perceived motivation by the game elements.

Apart from animations, the students' intrinsic motivation positively influenced the students' perceived motivation by the game elements. The more enjoyable and interesting the students found SkillSprint, the more motivating they found the game elements. However, emphasis should be placed on the fact that we selected appropriate game elements for educational purposes and the nature of the application based on the guidelines of Manzano-León et al. [51]. Some elements, such as Meaningful stories, were deemed inappropriate for SkillSprint's theme and therefore excluded from our study.

The students' preference for mathematics revealed no differences in perceived motivation by the game elements either, thereby indicating that **H10** may be correct. This may indicate that regardless of the mathematics preferences, the students already had established attitudes related to the game elements, and that the mathematics repetition context did not lead to any deviations from these.

Lastly, our results revealed no significant differences in perceived motivation by the game elements by gender, except for achievements addressed in Section 6.2, thereby indicating that **H11** may be correct. This aligns well with the findings of Denden et al. [15], as they also found that gender did not affect students' perception of gamification, a precursor to engagement and thus motivation.

6.3 The Study's Contributions

The study's results indicate that using a well-implemented and carefully designed gamified application can be experienced as motivating in free practice sessions for the repetition of mathematics. Furthermore, the results indicate that all the game elements covered in the analysis, in isolation,

can be experienced as motivating in the same context. We have carefully considered how the application and its game elements can be implemented and tailored so that they are experienced and as motivating as possible. Other researchers can use the combination of these results as inspiration and guidance on implementing similar solutions for further studies of repetition and work in free practice sessions. Furthermore, it can inspire the development of other gamified solutions where potentially tedious tasks are to be completed or there are difficulties related to keeping users focused and motivated. Last, the application, SkillSprint, is a valuable contribution. All code is available open-source³⁰ and can be freely used, modified, and further developed for further gamification studies.

6.4 Limitations

While the study provides valuable insights into the gamification of mathematics free practice sessions, it is essential to acknowledge various limitations that should be considered when interpreting the findings. Some contextual factors, measurement errors, and methodical errors are likely, and common to all is that they are forsaken mainly by time constraints and limited resources.

We had a relatively small sample size of 47 valid responses. With a smaller sample size, there is an increased risk of sampling error, and as addressed in Section 4.4, we discovered non-normality in some of our data. The most probable cause is due to the small sample size, but we also acknowledge it may be caused by the respondents giving socially desired responses [86]. I.e., that the young students responded with what they believed we wanted to hear. By some of the data being non-normally distributed, our findings and the statistical power of the analyses are limited [20].

Several parts of the study relied on descriptive statistics from self-reported data derived from various Likert scale statements regarding perceived motivation in the questionnaires. Such data-gathering techniques are prone to response biases, and our questions regarding perceived motivation could not capture the various aspects of and deeper insight into the students' motivation [68]. Further, we may have failed to capture the full complexity of other measured constructs, possibly affecting our results.

The questionnaire administration and timing could have been better. Considering the respondents were 15-16 years old, their responses may also be subject to errors due to comprehension or fatigue. Additionally, the students were to answer the questionnaires within a limited time frame. As their recess was the following activity for the day, we observed that many answered rapidly to be released.

We did not experiment in a laboratory, and by not doing so, we had no control over which participants participated in the experiments. Additionally, we could not follow up that the students did what they were supposed to do. Our log data showed that some students used SkillSprint at home, resulting in more experience than the rest of the sample. For the analyses, we eliminated data points outside the desired time frame. However, some students still had more experience and exposure to the application.

We had no control group. By having a control group, we could have compared the effects of the gamified application to a group without this exposure to increase the robustness of our findings. Without this control group, our findings are less reliable as we have no evidence for the results being due to the game elements or other factors.

The implementation of certain game elements had its shortcomings. As addressed in Section 2.4.2, the streaks and performance graphs could be improved. With proper implementation of these elements, the students might perceive and rate them otherwise.

³⁰<https://github.com/Lekesoldat/skillsprint>

7 Conclusion

In this study, we have explored how students perceived SkillSprint as motivating to repeat mathematics in a free practice session. Within the same context, we also investigated the perceived motivation by various game elements. Furthermore, this study examined how various factors could influence the perception of motivation by SkillSprint and the game elements. Having examined these factors, we provide valuable insights into how one can implement a gamified application and game elements individually to be perceived as motivating when repeating mathematics. In light of our findings, we argue that a gamified application and all the examined game elements can be perceived as motivating when repeating mathematics in free practice sessions. Looking at the game elements individually, we found that points, achievements, and animations were solely perceived as neutrally or moderately motivating, as opposed to leaderboards, streaks, time pressure, and performance graphs, which requires caution and thorough evaluation when used, as some experienced them as demotivating.

The findings in the study are based on a carefully carried out comprehensive process. Relevant literature in the field has been examined to form a solid picture of current findings, methods, and research gaps. Furthermore, we have developed a well-functioning application with modern technologies where design and user experience for our context have been central to the development process. The application, SkillSprint, has collected interaction and user data that complemented the data collected from the pre- and post-questionnaires. The collected data has been carefully structured and analyzed before being interpreted and contextualized with existing relevant literature.

The study contributes to the limited literature on the gamification of repetition in mathematics. In addition, the application itself is a solid contribution, as many studies often only develop a prototype while we provide a full-fledged service. From a broader perspective, further research can use our findings as a basis for implementation choices where motivation is the focus. Furthermore, the application can be further developed and adapted as researchers consider it useful for their studies.

7.1 Future Work

As a starting point for future work, we would like to refer to the limitations described in Section 6.4.

First, further studies can aim for a larger sample size. For one, the larger sample could better tackle the problem of the non-normality of the data. Further, the larger sample size could better represent a more general sample while increasing the statistical analyses' robustness.

Further studies can examine motivation and what can influence this with more in-depth data collection methods and statistical analyses. By gaining deeper and broader perspectives, one can better understand how gamification can influence motivation and how this can be optimized in an educational context, possibly with a particular focus on repetition.

Future work can be performing the experiments in a more controlled environment. By ensuring that the sample is not influenced by external factors while answering the questionnaires, that everyone is equally exposed to the application, and does what they should, a more precise data foundation can be obtained for a more robust analysis. Additionally, we recommend further studies with a control group. This will make it easier to identify whether the results are due to external factors beyond what one tries to test.

Lastly, further studies can examine how SkillSprint is perceived and functions in other STEM courses. If this is successful, one can investigate how to make the application optimal to motivate repetition across the subjects. Further studies can consider expanding the application with other game elements or improving those already implemented.

7.2 Conference Contribution

An exciting remark is that alongside the work on the master's thesis, we submitted a poster that was accepted to the 16th International Conference on Technology in Mathematics Teaching (ICTMT 16)³¹ in Greece. The poster focused primarily on SkillSprint and its functionality concerning mathematics repetition [31], and the data had yet to be thoroughly analyzed by the time of the poster submission. However, we provided a summary of preliminary findings and highlighted interesting indications from the study, as some were quite evident.

³¹<https://conferences.uoa.gr/event/47/>

References

- [1] 30.1. *Reliability*. Feb. 2023. URL: <https://www.postgresql.org/docs/15/wal-reliability.html> (visited on 24th Apr. 2023).
- [2] *About* \ll *Oddrobo*. URL: <http://oddrobo.com/about> (visited on 26th Nov. 2022).
- [3] Raed S. Alsawaier. “The Effect of Gamification on Motivation and Engagement”. In: *The International Journal of Information and Learning Technology* 35.1 (Jan. 2018), pp. 56–79. ISSN: 2056-4880. DOI: 10.1108/IJILT-02-2017-0009. URL: <https://www.emerald.com/insight/content/doi/10.1108/IJILT-02-2017-0009/full/html> (visited on 19th May 2023).
- [4] Aaron Bangor, Philip T. Kortum and James T. Miller. “An Empirical Evaluation of the System Usability Scale”. In: *International Journal of Human-Computer Interaction* 24.6 (July 2008), pp. 574–594. ISSN: 1044-7318, 1532-7590. DOI: 10.1080/10447310802205776. URL: <http://www.tandfonline.com/doi/abs/10.1080/10447310802205776> (visited on 9th May 2023).
- [5] Len Bass, Paul Clements and Rick Kazman. *Software Architecture in Practice*. Fourth edition. Sei Series in Software Engineering. Boston: Addison-Wesley, 2021. ISBN: 978-0-13-688609-9.
- [6] Jacqueline Bernero. “Motivating Students in Math Using Cooperative Learning”. PhD thesis. May 2000. URL: <https://eric.ed.gov/?id=ED446999> (visited on 9th Nov. 2022).
- [7] Nancy E Betz and Gail Hackett. “The Relationship of Mathematics Self-Efficacy Expectations to the Selection of Science-Based College Majors”. In: *Journal of Vocational Behavior* 23.3 (Dec. 1983), pp. 329–345. ISSN: 0001-8791. DOI: 10.1016/0001-8791(83)90046-5. URL: <https://www.sciencedirect.com/science/article/pii/0001879183900465> (visited on 8th Dec. 2022).
- [8] John Brooke et al. “SUS-A Quick and Dirty Usability Scale”. In: *Usability evaluation in industry* 189.194 (1996), pp. 4–7.
- [9] Patrick Buckley and Elaine Doyle. “Gamification and Student Motivation”. In: *Interactive Learning Environments* 24.6 (Aug. 2016), pp. 1162–1175. ISSN: 1049-4820. DOI: 10.1080/10494820.2014.964263. URL: <https://doi.org/10.1080/10494820.2014.964263> (visited on 29th Sept. 2022).
- [10] Jared Chapman and Peter Rich. “Does Educational Gamification Improve Students’ Motivation? If so, Which Game Elements Work Best?”. In: *Journal of Education for Business* 93 (Oct. 2018), pp. 314–321. DOI: 10.1080/08832323.2018.1490687.
- [11] Clinical Research Centre, Sarawak General Hospital, Ministry of Health, Sarawak, Malaysia et al. “A Review on Sample Size Determination for Cronbach’s Alpha Test: A Simple Guide for Researchers”. In: *Malaysian Journal of Medical Sciences* 25.6 (2018), pp. 85–99. ISSN: 1394195X, 21804303. DOI: 10.21315/mjms2018.25.6.9. URL: <http://www.mjms.usm.my/MJMS25062018/09MJMS25062018.OA6.pdf> (visited on 9th May 2023).
- [12] J. Cohen. “A Power Primer”. In: *Psychological Bulletin* 112.1 (July 1992), pp. 155–159. ISSN: 0033-2909. DOI: 10.1037//0033-2909.112.1.155.
- [13] Bo Dahlin and David Watkins. “The Role of Repetition in the Processes of Memorising and Understanding: A Comparison of the Views of German and Chinese Secondary School Students in Hong Kong”. In: *British Journal of Educational Psychology* 70.1 (2000), pp. 65–84. ISSN: 2044-8279. DOI: 10.1348/000709900157976. URL: <https://onlinelibrary.wiley.com/doi/abs/10.1348/000709900157976> (visited on 15th Nov. 2022).
- [14] Edward L. Deci and Richard M. Ryan. *Intrinsic Motivation and Self-Determination in Human Behavior*. Springer Science & Business Media, June 2013. ISBN: 978-1-4899-2271-7.
- [15] Mouna Denden et al. “An Investigation of the Factors Affecting the Perception of Gamification and Game Elements”. In: *2017 6th International Conference on Information and Communication Technology and Accessibility (ICTA)*. Dec. 2017, pp. 1–6. DOI: 10.1109/ICTA.2017.8336019.

-
- [16] Sebastian Deterding et al. “From Game Design Elements to Gamefulness: Defining Gamification”. In: *Proceedings of the 15th International Academic MindTrek Conference: Envisioning Future Media Environments, MindTrek 2011*. Vol. 11. Sept. 2011, pp. 9–15. DOI: 10.1145/2181037.2181040.
- [17] Christo Dichev and Darina Dicheva. “Gamifying Education: What Is Known, What Is Believed and What Remains Uncertain: A Critical Review”. In: *International Journal of Educational Technology in Higher Education* 14.1 (Feb. 2017), p. 9. ISSN: 2365-9440. DOI: 10.1186/s41239-017-0042-5. URL: <https://doi.org/10.1186/s41239-017-0042-5> (visited on 16th May 2023).
- [18] Stephanie Donaldson-Pressman, Rebecca Jackson and Robert Pressman. *The Learning Habit: A Groundbreaking Approach to Homework and Parenting That Helps Our Children Succeed in School and Life*. Penguin, Sept. 2014. ISBN: 978-0-698-13925-1.
- [19] Tanya M. Evans et al. “Brain Structural Integrity and Intrinsic Functional Connectivity Forecast 6 Year Longitudinal Growth in Children’s Numerical Abilities”. In: *Journal of Neuroscience* 35.33 (Aug. 2015), pp. 11743–11750. ISSN: 0270-6474, 1529-2401. DOI: 10.1523/JNEUROSCI.0216-15.2015. URL: <https://www.jneurosci.org/content/35/33/11743> (visited on 31st Oct. 2022).
- [20] Andy P. Field. *Discovering Statistics Using SPSS: And Sex, Drugs and Rock ‘n’ Roll*. 3rd ed. Los Angeles: SAGE Publications, 2009. ISBN: 978-1-84787-906-6.
- [21] *Framework for Innovation - Design Council*. URL: <https://www.designcouncil.org.uk/our-resources/framework-for-innovation/> (visited on 12th May 2023).
- [22] Iulian Furdu, Cosmin Tomozei and Utku Kose. *Pros and Cons Gamification and Gaming in Classroom*. Aug. 2017. DOI: 10.48550/arXiv.1708.09337. arXiv: 1708.09337 [cs]. URL: <http://arxiv.org/abs/1708.09337> (visited on 30th May 2023).
- [23] *Generelt om norsk utdanning*. URL: <https://www.nokut.no/norsk-utdanning/generelt-om-norsk-utdanning/> (visited on 27th Nov. 2022).
- [24] Mitchell Gillick. *Competing Against Outside Distractions in Online Classrooms for Grade-School Students*. Nov. 2020. DOI: 10.13140/RG.2.2.25181.13285.
- [25] Patrícia Gomes Fernandes Matsubara and Caroline Lima Corrêa Da Silva. “Game Elements in a Software Engineering Study Group: A Case Study”. In: *2017 IEEE/ACM 39th International Conference on Software Engineering: Software Engineering Education and Training Track (ICSE-SEET)*. May 2017, pp. 160–169. DOI: 10.1109/ICSE-SEET.2017.8.
- [26] Hugo Gonzalez, Rafael Llamas and Omar Montaña. “Using a CTF Tournament for Reinforcing Learned Skills in Cybersecurity Course”. In: *Research in Computing Science* 148.5 (Dec. 2019), pp. 133–141. ISSN: 1870-4069. DOI: 10.13053/rcs-148-5-15. URL: http://rcs.cic.ipn.mx/2019_148.5/Using%20a%20CTF%20Tournament%20for%20Reinforcing%20Learned%20Skills%20in%20Cybersecurity%20Course.pdf (visited on 15th Sept. 2022).
- [27] Koeno Gravemeijer et al. “What Mathematics Education May Prepare Students for the Society of the Future?” In: *International Journal of Science and Mathematics Education* 15.1 (May 2017), pp. 105–123. ISSN: 1573-1774. DOI: 10.1007/s10763-017-9814-6. URL: <https://doi.org/10.1007/s10763-017-9814-6> (visited on 21st Nov. 2022).
- [28] Juho Hamari, Jonna Koivisto and Harri Sarsa. “Does Gamification Work? – A Literature Review of Empirical Studies on Gamification”. In: *2014 47th Hawaii International Conference on System Sciences*. Jan. 2014, pp. 3025–3034. DOI: 10.1109/HICSS.2014.377.
- [29] Michael D. Hanus and Jesse Fox. “Assessing the Effects of Gamification in the Classroom: A Longitudinal Study on Intrinsic Motivation, Social Comparison, Satisfaction, Effort, and Academic Performance”. In: *Computers & Education* 80 (Jan. 2015), pp. 152–161. ISSN: 0360-1315. DOI: 10.1016/j.compedu.2014.08.019. URL: <https://www.sciencedirect.com/science/article/pii/S0360131514002000> (visited on 15th Nov. 2022).
- [30] Magnus Lauritzen Holtet and Anh-Kha Nguyen Vo. “IT3915 - Master in Informatics, Preparatory Project”. In: *Department of Computer Science, Norwegian University of Science and Technology* (Dec. 2022). URL: unpublished.
-

-
- [31] Magnus Lauritzen Holtet, Anh-Kha Nguyen Vo and Sofia Papavlasopoulou. “SkillSprint: Gamifying Mathematics Repetition”. In: *16th International Conference on Technology in Mathematics Teaching (ICTMT)*. National and Kapodistrian University of Athens, June 2023. URL: <https://conferences.uoa.gr/event/47/>.
- [32] Elvis Hsiao. *The Neubrutalism or Neo Brutalism UI Design Trend*. June 2023. URL: <https://bootcamp.uxdesign.cc/the-neubrutalism-or-neo-brutalism-ui-design-trend-641714825fed> (visited on 10th June 2023).
- [33] Xiaoxia Huang, Jie Zhang and Laura Hudson. “Impact of Math Self-Efficacy, Math Anxiety, and Growth Mindset on Math and Science Career Interest for Middle School Students: The Gender Moderating Effect”. In: *European Journal of Psychology of Education* 34.3 (July 2019), pp. 621–640. ISSN: 1878-5174. DOI: 10.1007/s10212-018-0403-z. URL: <https://doi.org/10.1007/s10212-018-0403-z> (visited on 8th Dec. 2022).
- [34] Cigdem Hursen and Cizem Bas. “Use of Gamification Applications in Science Education”. In: *International Journal of Emerging Technologies in Learning (iJET)* 14.01 (Jan. 2019), pp. 4–23. ISSN: 1863-0383. DOI: 10.3991/ijet.v14i01.8894. URL: <https://online-journals.org/index.php/i-jet/article/view/8894> (visited on 29th Sept. 2022).
- [35] María-Blanca Ibáñez, Ángela Di-Serio and Carlos Delgado-Kloos. “Gamification for Engaging Computer Science Students in Learning Activities: A Case Study”. In: *IEEE Transactions on Learning Technologies* 7.3 (July 2014), pp. 291–301. ISSN: 1939-1382. DOI: 10.1109/TLT.2014.2329293.
- [36] *JAIST Repository: An Analysis of Winning Streak’s Effects in Language Course of ”Duolingo”*. URL: <https://dspace.jaist.ac.jp/dspace/handle/10119/15292> (visited on 27th Nov. 2022).
- [37] *JavaScript With Syntax For Types*. URL: <https://www.typescriptlang.org/> (visited on 4th Dec. 2022).
- [38] Michail Kalogiannakis, Stamatios Papadakis and Alkinoos-Ioannis Zourmpakis. “Gamification in Science Education. A Systematic Review of the Literature”. In: *Education Sciences* 11.1 (Jan. 2021), p. 22. ISSN: 2227-7102. DOI: 10.3390/educsci11010022. URL: <https://www.mdpi.com/2227-7102/11/1/22> (visited on 9th Sept. 2022).
- [39] Timothy Z. Keith. *Multiple Regression and beyond: An Introduction to Multiple Regression and Structural Equation Modeling*. Third Edition. New York: Routledge, 2019. ISBN: 978-1-315-16234-8.
- [40] *King of Math Junior* < *Oddrobo*. URL: <http://oddrobo.com/kingofmathjunior> (visited on 26th Nov. 2022).
- [41] Ana Carolina Tomé Klock et al. “Tailored Gamification: A Review of Literature”. In: *International Journal of Human-Computer Studies* 144 (Dec. 2020), p. 102495. ISSN: 1071-5819. DOI: 10.1016/j.ijhcs.2020.102495. URL: <https://www.sciencedirect.com/science/article/pii/S1071581920300975> (visited on 4th June 2023).
- [42] Jonna Koivisto and Juho Hamari. “The Rise of Motivational Information Systems: A Review of Gamification Research”. In: *International Journal of Information Management* 45 (Apr. 2019), pp. 191–210. ISSN: 0268-4012. DOI: 10.1016/j.ijinfomgt.2018.10.013. URL: <https://www.sciencedirect.com/science/article/pii/S0268401217305169> (visited on 13th Apr. 2023).
- [43] Philippe Kruchten. “The 4+1 View Model of Architecture”. In: *IEEE Software* 12 (Nov. 1995), pp. 45–50. DOI: 10.1109/52.469759.
- [44] Richard N. Landers, Kristina N. Bauer and Rachel C. Callan. “Gamification of Task Performance with Leaderboards: A Goal Setting Experiment”. In: *Computers in Human Behavior* 71 (2017), pp. 508–515. ISSN: 0747-5632. DOI: 10.1016/j.chb.2015.08.008. URL: <https://www.sciencedirect.com/science/article/pii/S0747563215300868>.
- [45] Joey Lee and Jessica Hammer. “Gamification in Education: What, How, Why Bother?” In: *Academic Exchange Quarterly* 15 (Jan. 2011), pp. 1–5.
-

-
- [46] Shiqi Li. “Practice Makes Perfect: A Key Belief in China”. In: *Mathematics Education in Different Cultural Traditions-A Comparative Study of East Asia and the West: The 13th ICMI Study*. Ed. by Frederick K. S. Leung, Klaus-D. Graf and Francis J. Lopez-Real. New ICMI Study Series. Boston, MA: Springer US, 2006, pp. 129–138. ISBN: 978-0-387-29723-1. DOI: 10.1007/0-387-29723-5_8. URL: https://doi.org/10.1007/0-387-29723-5_8 (visited on 11th June 2023).
- [47] Debbita Tan Ai Lin and Manjet Kaur. “Kahoot! It: Gamification in Higher Education”. In: (2018), p. 18.
- [48] Shawn Loewen et al. “Mobile-Assisted Language Learning: A Duolingo Case Study”. In: *RECALL* 31.3 (Sept. 2019), pp. 293–311. ISSN: 0958-3440, 1474-0109. DOI: 10.1017/S0958344019000065. URL: <https://www.cambridge.org/core/journals/recall/article/mobileassisted-language-learning-a-duolingo-case-study/A4D7C8F71782A37D258C19F357DDBCBE> (visited on 27th Nov. 2022).
- [49] Laila Lomibao. *Does Repetition with Variation Improve Students’ Mathematics Conceptual Understanding and Retention?* Tech. rep. June 2017. DOI: 10.21275/ART20174479.
- [50] Brian Macon. “Gamification: Badges and Feedback”. In: *Electronic Theses and Dissertations* (May 2019). URL: <https://stars.library.ucf.edu/etd/6340>.
- [51] Ana Manzano-León et al. “Between Level Up and Game Over: A Systematic Literature Review of Gamification in Education”. In: *Sustainability* 13.4 (Feb. 2021), p. 2247. ISSN: 2071-1050. DOI: 10.3390/su13042247. URL: <https://www.mdpi.com/2071-1050/13/4/2247> (visited on 15th May 2023).
- [52] Andrzej Marczewski. *Even Ninja Monkeys like to Play: Gamification, Game Thinking & Motivational Design*. United Kingdom: Gamified UK, 2015. ISBN: 978-1-5147-4566-3 978-1-364-95552-6.
- [53] Andrew Martin. “The Student Motivation Scale: A Tool for Measuring and Enhancing Motivation”. In: *Australian Journal of Guidance and Counselling* 11 (Nov. 2001), pp. 1–20. DOI: 10.1017/S1037291100004301.
- [54] Ference Marton, Qiufang Wen and Kam Cheung Wong. “‘Read a Hundred Times and the Meaning Will Appear ...’ Changes in Chinese University Students’ Views of the Temporal Structure of Learning”. In: *Higher Education* 49.3 (Apr. 2005), pp. 291–318. ISSN: 1573-174X. DOI: 10.1007/s10734-004-6667-z. URL: <https://doi.org/10.1007/s10734-004-6667-z> (visited on 15th Nov. 2022).
- [55] Edward McAuley, Terry Duncan and Vance V. Tammen. “Psychometric Properties of the Intrinsic Motivation Inventory in a Competitive Sport Setting: A Confirmatory Factor Analysis”. In: *Research Quarterly for Exercise and Sport* 60.1 (Mar. 1989), pp. 48–58. ISSN: 0270-1367, 2168-3824. DOI: 10.1080/02701367.1989.10607413. URL: <http://www.tandfonline.com/doi/abs/10.1080/02701367.1989.10607413> (visited on 11th May 2023).
- [56] Jürgen Maasz and Wolfgang Schlöglmann. *Beliefs and Attitudes in Mathematics Education: New Research Results*. BRILL, Feb. 2019. ISBN: 978-90-8790-723-5.
- [57] Lennart E. Nacke and Sebastian Deterding. “The Maturing of Gamification Research”. In: *Computers in Human Behavior* 71 (2017), pp. 450–454. ISSN: 0747-5632. DOI: 10.1016/j.chb.2016.11.062. URL: <https://www.sciencedirect.com/science/article/pii/S0747563216308111>.
- [58] *Nettskjema*. URL: <https://nettskjema.no> (visited on 21st Apr. 2023).
- [59] *Nettskjema - Kunnskapsbasen - NTNU*. URL: <https://i.ntnu.no/wiki/-/wiki/Norsk/nettskjema> (visited on 21st Apr. 2023).
- [60] NSD. *Barnehage- Og Skoleforskning*. URL: <https://nsd.no/personverntjenester/oppslagsverk-for-personvern-i-forskning/barnehage-og-skoleforskning> (visited on 9th Dec. 2022).
- [61] Briony J. Oates, Marie Griffiths and Rachel McLean. *Researching Information Systems and Computing*. SAGE, Jan. 2022. ISBN: 978-1-5297-8493-0.
- [62] Korinn Ostrow and Neil Heffernan. “Testing the Validity and Reliability of Intrinsic Motivation Inventory Subscales Within ASSISTments”. In: June 2018, pp. 381–394. ISBN: 978-3-319-93842-4. DOI: 10.1007/978-3-319-93843-1_28.
-

-
- [63] Judith Polman, Lisette Hornstra and Monique Volman. “The Meaning of Meaningful Learning in Mathematics in Upper-Primary Education”. In: *Learning Environments Research* 24.3 (Oct. 2021), pp. 469–486. ISSN: 1573-1855. DOI: 10.1007/s10984-020-09337-8. URL: <https://doi.org/10.1007/s10984-020-09337-8> (visited on 15th Nov. 2022).
- [64] *PostgreSQL: About*. URL: <https://www.postgresql.org/about/> (visited on 24th Apr. 2023).
- [65] *Privacy Compliance - Docs - PostHog*. URL: <https://posthog.com/docs/privacy> (visited on 21st Apr. 2023).
- [66] Rim Razzouk and Valerie Shute. “What Is Design Thinking and Why Is It Important?” In: *Review of Educational Research* 82.3 (Sept. 2012), pp. 330–348. ISSN: 0034-6543, 1935-1046. DOI: 10.3102/0034654312457429. URL: <http://journals.sagepub.com/doi/10.3102/0034654312457429> (visited on 12th May 2023).
- [67] *React – A JavaScript Library for Building User Interfaces*. URL: <https://reactjs.org/> (visited on 4th Dec. 2022).
- [68] Lance J. Rips, Kenneth Rasinski and Roger Tourangeau. *The Psychology of Survey Response*. Cambridge University Press, Mar. 2000. ISBN: 978-0-521-57629-1.
- [69] J. A. Rose et al. “Gamification: Using Elements of Video Games to Improve Engagement in an Undergraduate Physics Class”. In: *Physics Education* 51.5 (July 2016), p. 055007. ISSN: 0031-9120. DOI: 10.1088/0031-9120/51/5/055007. URL: <https://dx.doi.org/10.1088/0031-9120/51/5/055007> (visited on 9th June 2023).
- [70] Richard M. Ryan and Edward L. Deci. “Intrinsic and Extrinsic Motivations: Classic Definitions and New Directions”. In: *Contemporary Educational Psychology* 25.1 (Jan. 2000), pp. 54–67. ISSN: 0361-476X. DOI: 10.1006/ceps.1999.1020. URL: <https://www.sciencedirect.com/science/article/pii/S0361476X99910202> (visited on 17th Nov. 2022).
- [71] Richard M. Ryan and Edward L. Deci. *Self-Determination Theory: Basic Psychological Needs in Motivation, Development, and Wellness*. Guilford Publications, Feb. 2017. ISBN: 978-1-4625-2876-9.
- [72] Michael Sailer and Lisa Homner. “The Gamification of Learning: A Meta-analysis”. In: *Educational Psychology Review* 32.1 (Mar. 2020), pp. 77–112. ISSN: 1573-336X. DOI: 10.1007/s10648-019-09498-w. URL: <https://doi.org/10.1007/s10648-019-09498-w> (visited on 3rd Dec. 2022).
- [73] Michael Sailer et al. “How Gamification Motivates: An Experimental Study of the Effects of Specific Game Design Elements on Psychological Need Satisfaction”. In: *Computers in Human Behavior* 69 (Apr. 2017), pp. 371–380. DOI: 10.1016/j.chb.2016.12.033.
- [74] Michael Sailer et al. “Psychological Perspectives on Motivation through Gamification”. In: *Interaction Design and Architecture(s)* 19 (Dec. 2013), pp. 28–37. ISSN: 22832998. DOI: 10.55612/s-5002-019-002. URL: https://ixdea.org/19_2/ (visited on 10th June 2023).
- [75] Jeff Sauro. *Measuring Usability with the System Usability Scale (SUS) – MeasuringU*. URL: <https://measuringu.com/sus/> (visited on 28th May 2023).
- [76] Katie Seaborn and Deborah Fels. “Gamification in Theory and Action: A Survey”. In: *International Journal of Human-Computer Studies* 74 (Feb. 2015), pp. 14–31. DOI: 10.1016/j.ijhcs.2014.09.006.
- [77] Katie Seaborn, Peter Pennefather and Deborah I. Fels. “Reimagining Leaderboards: Towards Gamifying Competency Models through Social Game Mechanics”. In: *Proceedings of the First International Conference on Gameful Design, Research, and Applications*. Toronto Ontario Canada: ACM, Oct. 2013, pp. 107–110. ISBN: 978-1-4503-2815-9. DOI: 10.1145/2583008.2583026. URL: <https://dl.acm.org/doi/10.1145/2583008.2583026> (visited on 10th June 2023).
- [78] Martin Sillaots. “Achieving Flow Through Gamification: A Study on Re-Designing Research Methods Courses”. In: *European Conference on Games Based Learning*. Vol. 2. Reading, United Kingdom: Academic Conferences International Limited, Oct. 2014, pp. 538–545. URL: <https://www.proquest.com/docview/1674245409/abstract/A063F7E5C5DA458CPQ/1> (visited on 10th June 2023).
- [79] Lori Soule. “Math Apps for Students of All Ages”. In: *Louisiana Association of Teachers of Mathematics* 9 (2013), pp. 33–40.
-

-
- [80] Penelope Sweetser and Peta Wyeth. “GameFlow: A Model for Evaluating Player Enjoyment in Games”. In: *Computers in Entertainment* 3.3 (July 2005), p. 3. DOI: 10.1145/1077246.1077253. URL: <https://doi.org/10.1145/1077246.1077253> (visited on 12th Sept. 2022).
- [81] Faiza Tahir, Valerie Sotardi and Antonija Mitrovic. “Do Gaming Experience and Prior Knowledge Matter When Learning with a Gamified ITS?” In: (2021). DOI: 10.1109/icalt52272.2021.00030. URL: <https://ir.canterbury.ac.nz/handle/10092/102521> (visited on 13th Apr. 2023).
- [82] *The Double Diamond: A Universally Accepted Depiction of the Design Process*. URL: <https://www.designcouncil.org.uk/our-resources/archive/articles/double-diamond-universally-accepted-depiction-design-process/> (visited on 12th May 2023).
- [83] *The Open Source Firebase Alternative*. URL: <https://supabase.com/> (visited on 24th Apr. 2023).
- [84] Armando M. Toda et al. “Analysing Gamification Elements in Educational Environments Using an Existing Gamification Taxonomy”. In: *Smart Learning Environments* 6.1 (Dec. 2019), p. 16. ISSN: 2196-7091. DOI: 10.1186/s40561-019-0106-1. URL: <https://doi.org/10.1186/s40561-019-0106-1> (visited on 19th Sept. 2022).
- [85] Gustavo F. Tondello et al. “The Gamification User Types Hexad Scale”. In: *Proceedings of the 2016 Annual Symposium on Computer-Human Interaction in Play*. Austin Texas USA: ACM, Oct. 2016, pp. 229–243. ISBN: 978-1-4503-4456-2. DOI: 10.1145/2967934.2968082. URL: <https://dl.acm.org/doi/10.1145/2967934.2968082> (visited on 21st Nov. 2022).
- [86] Roger Tourangeau and Ting Yan. “Sensitive Questions in Surveys.” In: *Psychological Bulletin* 133.5 (2007), pp. 859–883. ISSN: 1939-1455, 0033-2909. DOI: 10.1037/0033-2909.133.5.859. URL: <http://doi.apa.org/getdoi.cfm?doi=10.1037/0033-2909.133.5.859> (visited on 4th June 2023).
- [87] Nikolaos Tsigilis and Argiris Theodosiou. “Temporal Stability of the Intrinsic Motivation Inventory”. In: *Perceptual and Motor Skills* 97.1 (Aug. 2003), pp. 271–280. ISSN: 0031-5125, 1558-688X. DOI: 10.2466/pms.2003.97.1.271. URL: <http://journals.sagepub.com/doi/10.2466/pms.2003.97.1.271> (visited on 11th May 2023).
- [88] *Vercel: Develop. Preview. Ship. For the Best Frontend Teams*. URL: <https://vercel.com/> (visited on 24th Apr. 2023).
- [89] Kevin Werbach, Dan Hunter and Walter Dixon. *For the Win: How Game Thinking Can Revolutionize Your Business*. Vol. 1. Wharton digital press Philadelphia, 2012.
- [90] *What Is Triage In IT? — Definition from TechTarget*. URL: <https://www.techtarget.com/whatis/definition/triage> (visited on 10th June 2023).
- [91] Brigita Linda Wulandari and Meilani Hartono. “The Effectiveness of Using Quizizz and Quizalize Media on Mathematics Learning Outcomes of Grade IV Students”. In: *2021 7th International Conference on Education and Technology (ICET)*. Sept. 2021, pp. 320–325. DOI: 10.1109/ICET53279.2021.9575113.
- [92] Irem Gökçe Yildirim. “Time Pressure as Video Game Design Element and Basic Need Satisfaction”. In: *Proceedings of the 2016 CHI Conference Extended Abstracts on Human Factors in Computing Systems*. CHI EA ’16. New York, NY, USA: Association for Computing Machinery, May 2016, pp. 2005–2011. ISBN: 978-1-4503-4082-3. DOI: 10.1145/2851581.2892298. URL: <https://dl.acm.org/doi/10.1145/2851581.2892298> (visited on 30th May 2023).
- [93] Ping Zhang and Gisela M. von Dran. “Satisfiers and Dissatisfiers: A Two-Factor Model for Website Design and Evaluation”. In: *Journal of the American Society for Information Science* 51.14 (2000), pp. 1253–1268. ISSN: 1097-4571. DOI: 10.1002/1097-4571(2000)9999:9999::AID-ASI1039)3.0.CO;2-O. URL: <https://onlinelibrary.wiley.com/doi/abs/10.1002/1097-4571%282000%299999%3A9999%3C%3A%3AAID-ASI1039%3E3.0.CO%3B2-O> (visited on 22nd May 2023).
- [94] Şeyma Çağlar Özhan and Selay Arkün Kocadere. “The Effects of Flow, Emotional Engagement, and Motivation on Success in a Gamified Online Learning Environment”. In: *Journal of Educational Computing Research* 57.8 (Jan. 2020), pp. 2006–2031. ISSN: 0735-6331, 1541-4140. DOI: 10.1177/0735633118823159. URL: <http://journals.sagepub.com/doi/10.1177/0735633118823159> (visited on 10th June 2023).
-

Appendices

A Architectural Descriptions

In this appendix, we present the architecture behind SkillSprint in detail. We start by presenting the architectural drivers, followed up by the identified stakeholders, and conclude with the architectural design.

A.1 Architectural Drivers / Architectural Significant Requirements (ASR's)

The primary architectural drivers underlying the system architecture are described in this section. Functional requirements and qualitative attributes were the main drivers considered.

A.1.1 Functional Requirements

Functional requirements represent the foundation for the core features of SkillSprint. The functional requirements are presented in Table A.1, which comprises an ID, requirement title, description, and priority for each requirement. These requirements were formulated through a comprehensive analysis of relevant literature in Section 2, the objectives specified in Section 3.1.2, and a compilation of desired features noted by the teacher through meetings.

The functional requirements, FR1 and FR2, pertain to the capability of answering, categorizing, and navigating tasks and supporting different task types. Conversely, FR3 to FR9 is based on incorporating specific game elements and their suitability for SkillSprint, as per the literature. The final set of requirements, FR10-FR12, includes features requested by the teacher or those related to the quality of life. Prioritizing high-priority requirements for the minimum viable prototype is crucial, while lower priorities are implemented if time permits. Due to time constraints, not all requirements were met, such as FR3.3, FR5.1, FR9.1, FR11, and FR12.

Table A.1: Functional Requirements.

ID	Requirements	Description	Priority
FR1	Application nput	The user can input an answer for a task	High
FR1.1	Multiple choice answers	The application should support multiple-choice tasks	Medium
FR1.2	Flag answers	The application should support flag-type tasks	High
FR1.3	Placeholder answer	The application should provide hints or placeholders to show the correct answer format.	Medium
FR1.4	Task images	The application should support tasks with images/figures	High
FR2	Task navigation	The user should be able to select a task from an overview	High
FR2.1	Subtask navigation	The user can navigate between sub-tasks directly	Medium
FR2.2	Task grouping	The application should group related tasks using the same problem description	High

Continued on next page

Table A.1: Functional Requirements. (Continued)

FR2.3	Overview categories	The overview should categorize tasks related to the same topic	Medium
FR3	Leaderboard	The leaderboard shows the best-performing users	High
FR3.1	Leaderboard placement	The user can see their placement	Medium
FR3.2	Restricted public leaderboard	The leaderboard only shows users in the top 5 and hides the rest	High
FR3.3	Leaderboard divisions	The leaderboard is split into divisions, each with its own sub-ladder	Low
FR3.4	Leaderboard period	The user can switch between the leaderboard today and all time.	Low
FR4	Achievement	The user can unlock achievements when satisfying the requirements	High
FR4.1	Achievement gives points	Once the user unlocks an achievement, they can claim points	Medium
FR4.2	Group and filter achievements	The user can filter or group achievements based on their type, difficulty, etc.	Low
FR4.3	Achievement notification	The user has a notification if the user has unlocked a new achievement	Medium
FR4.4	Achievement current progress	The user is shown the achievements they are the closest to unlocking	Low
FR4.5	Achievement tiers	Achievements have different tiers that grow in difficulty	Low
FR5	Avatars	The user can select their avatar, shown on their profile and leaderboard	Low
FR5.1	Cosmetic rewards	The user can customize their avatar with cosmetic rewards for doing tasks	Low
FR6	Activity log	The user can see a log of their task attempts	Medium
FR7	Points	The user is given points for successfully answering tasks	High
FR8	Streaks	The user gains a streak for each successive answer	High
FR9	Performance graph	The user can see the performance graph over time of their points	High
FR9.1	Performance graph of own performance	The user can compare their previous performance with their current one on the performance graph	Low
FR9.2	Performance graph of class average	The user can see their performance compared with the average	Medium
FR9.3	Performance graph period	The user can filter the performance graph with a custom period	Low
FR10	Attempt statistics	The user can see statistics about their task attempt performance	High

Continued on next page

Table A.1: Functional Requirements. (Continued)

FR10.1	Answer distribution	The user can see the percentage of correct/work answers	High
FR10.2	Category distribution	The user can choose which categories they have solved the most tasks in	High
FR11	Admin view	The admin can view an overview over each user’s stats	Low
FR11.1	User time on task	The admin can see how long a user is stuck in their current task	Low
FR12	Call for help	A user can press a button to call for assistance from a teacher	Low
FR13	User login	A user log in to the application with a user	High

A.1.2 Quality Attributes and Architectural Tactics

This section delves into the architectural tactics that aim to enhance SkillSprint’s overall quality focusing primarily on usability, performance, reliability, and maintainability. Among these attributes, usability and performance hold the highest significance. Specific architectural tactics have been utilized to address the quality attributes, whereas most are taken from “Software Architecture in Practice” by Bass et al. [5].

Bass et al. [5] have recommended the majority of these architectural tactics to address certain quality attributes.

Usability

Accessibility and Responsiveness

Making sure that our application is accessible is vital to ensure that everyone can use it regardless of their capabilities. Specific measures must be taken to achieve this, such as using proper semantics, implementing strong color contrasts, and enabling keyboard accessibility.

Certain user interface elements, such as links and buttons, must appear distinct to be easily recognized. The element’s appearance may alter upon user interactions like hovers and clicks to make it easier for users with visual impairments or color blindness to recognize it. Overall, this feature improves usability by increasing our application’s clarity while considering a spectrum of users.

The neo-brutalism aesthetic employed in SkillSprint is especially beneficial for creating strong color contrast. This design decision is especially advantageous for visually impaired users, as it guarantees that the text and the background have adequate contrast. We conducted color blindness tests by utilizing Mozilla Firefox’s color vision simulation tool³².

Various accessible user interface (UI) components have been utilized throughout SkillSprint. Most of these components were developed utilizing the Radix UI³³, which provides unstyled, accessible user interface (UI) components. These components meet accessibility standards, including keyboard accessibility, allowing users to navigate and input information using their keyboard easily. As a result, users can, if desired, fully utilize SkillSprint without needing a mouse.

SkillSprint is primarily designed to be responsive on tablets and laptops, the primary devices used by students in school. To accommodate the variety of devices that may be utilized, we ensured a responsive design across an extensive range of devices.

³²https://firefox-source-docs.mozilla.org/devtools-user/accessibility_inspector/simulation/index.html

³³<https://www.radix-ui.com/>

Maintain Task Model

The task model tactic is related to providing the application context of what the user is attempting to accomplish so that it can assist the user in various ways. For example, SkillSprint provides different types of placeholder answers to assist the users in answering in a valid format. Furthermore, our application provides feedback during the activity, such as disallowing blank answers and giving notifications for unclaimed achievements.

Prototyping and Usability Tests

One of the most straightforward approaches to creating an excellent user interface is through an iterative development process and incorporating feedback from usability tests. Incorporating user feedback ensures that the resulting interface meets their needs, while early detection of issues allows for improvements during each iteration. When combined with a high degree of modifiability, this approach offers a time-efficient solution to enhancing usability.

Support User Initiative

SkillSprint may enhance usability by providing feedback to the user during their usage. For instance, SkillSprint provides feedback on when elements are loading or whether or not a submission is correct. Furthermore, gamification contains various aspects that provide feedback, such as points, and as a result, promote usability.

Performance

Reduce Computational Overhead

This performance tactic refers to minimizing the amount of unnecessary or excessive computational work in an application, increasing performance. The processing requirements are also minimized by reducing the frequency of resource requests. To achieve this, SkillSprint utilizes various techniques, including Server-Side Rendering (SSR) and Static-Site Generation (SSG), to prerender or cache specific pages.

With Server-Side Rendering, the server takes on the heavy task of rendering web pages, providing clients with fully rendered pages. As a result, the client's processing requirements have been significantly reduced as fewer network requests are performed. This technique significantly reduces round-trip latency because the back-end and the server performing Server-Side Rendering are either the same or closely located.

Static-Site Generation renders certain pages fully during our application's build process. This approach is best suited for pages with static content, as modifying the content after rendering can be challenging. When a client requests a page, the server can deliver the generated page without additional server computation, as the generation happened during the build process. As a result, this technique reduces both server and client computation. However, Static-Site Generation is limited to only pages with static content and, thus, cannot be applied to the entire application.

Increase Available Resources

Scalability is another crucial, closely related quality attribute that an application should possess, indicating its ability to accommodate growing demands or increased user traffic without affecting performance. Traditionally, an application distributes its available resources among incoming traffic. Vertical scaling by increasing the server's computational power is one way to meet this need. However, this application uses horizontal scaling through short-lived serverless functions provided by Vercel, which relies on AWS Lambda³⁴. In a serverless Lambda environment, computing resources are allocated on demand and automatically scaled based on SkillSprint's needs, ensuring optimal performance without bottlenecking clients due to auto-scaling.

Introduce Concurrency

Concurrency allows SkillSprint to perform multiple actions simultaneously, leading to faster response times and higher throughput. To improve efficiency, instead of loading data from the server

³⁴<https://aws.amazon.com/lambda/>

sequentially, it would be more effective to load it all simultaneously. This results in better overall performance because data is loaded concurrently, avoiding potential delays caused by slow requests during a sequential load. The upcoming requests often cause this delay since the requests depending on when the current request is processed. Some requests are asynchronous, meaning multiple ones can be initiated and completed independently.

Maintainability

Split Modules

Splitting larger modules into several smaller ones is a usual method to improve maintainability. Large and complex modules need extensive modifications compared to smaller ones. SkillSprint is divided into smaller modules that serve a specific purpose, such as managing database communication or API requests. Furthermore, larger packages, such as the API router, are broken down even further to ensure the main package is manageable. By having smaller packages, discoverability increased as we could easier locate specific codes based on the parent module as they're divided by responsibility.

Increase Cohesion

While splitting the modules, one should make sure to group related elements. Cohesion represents the degree to which the responsibilities and functionality within a module are related and focused. By increasing cohesion, so does discoverability, as related elements are close in the code base. Furthermore, an increase in cohesion also improves maintainability and modifiability.

Code Reusability

Code reusability improves an application's maintainability by reducing duplication and encouraging consistency. Furthermore, minimizing the code produced leaves less room for making mistakes. Developers can modify the reusable module while ensuring that any dependent code does not break by encapsulating specific code. This decreases the number of unwanted side effects, improving maintainability. Finally, reusable code boosts developer productivity by minimizing the complexity and scope of what must be maintained.

We use user interface components and shared types between the front-end and back-end to achieve high code reusability.

Reliability

Prevent Faults

The primary approach for increasing application reliability is using various tools and technologies to prevent faults. This can be accomplished by employing technologies that enforce consistent data formats throughout the application or by employing good engineering practices. As a result of these measures, the likelihood of us introducing faults into the application was reduced.

A.2 Stakeholders and Concerns

The following table describes the identified stakeholders and their main concerns about SkillSprint’s architecture.

Table A.2: Stakeholders and Their Concerns.

Stakeholders	Concerns
Developers	The developer’s primary concern is to develop a good application and user experience for end users, as well as quality documentation and maintainable code.
End-users	The end-users primary concerns are whether the application is interesting and easy to use. SkillSprint should also be intuitive and enjoyable to use. This group consists of both students and teachers.
Researchers	The researcher’s concern is to examine the thesis’s quality and potentially extend the work done. To make these tasks easier, the documentation should be of excellent quality and provide a complete architectural overview.

A.3 Architectural Views

Architectural views refer to describing the application’s architecture from different perspectives. The selected views are based on Kruchten’s 4+1 model [43], which are the following views: (1) logical, (2) process, (3) physical and (4) development. Each view can be visualized through various diagrams and is summarized in Table A.3.

Table A.3: Selection of Architectural Views.

View	Purpose	Stakeholder	Notation
Logical	Showcases what an application offers regarding features and the structure that supports them. The view emphasizes the system’s functionality and high-level architecture without getting hung up by implementation details.	End-users, Developers, Researchers	UML,
Process	Showcases the application’s dynamic behavior and internal procedures, including their communication. The view emphasizes information flow, synchronization, and concurrency, insight into the application’s performance.	Developers Researchers	UML, Activity diagram
Physical	Displays the subsystems of the application and how they are deployed in each of their respective environments. This view highlights software distribution across infrastructure and communication between them.	Developers Researchers	UML, Deployment diagram
Development	Shows how the application is separated into modules and how these modules communicate with one another as well as with other services/libraries. This view focuses on the codebase’s organization and structure.	Developers Researchers	UML, Package and Component diagram

Logical View

Figure A.1 depicts the logical view, showcasing SkillSprint’s features and supporting underlying structure. This view highlights the system’s features and high-level architecture without delving into implementation details. This view did not employ a class diagram, as the code base did not adhere to an object-oriented paradigm. Consequently, translating the current architecture into a class diagram would prove challenging and non-representative.

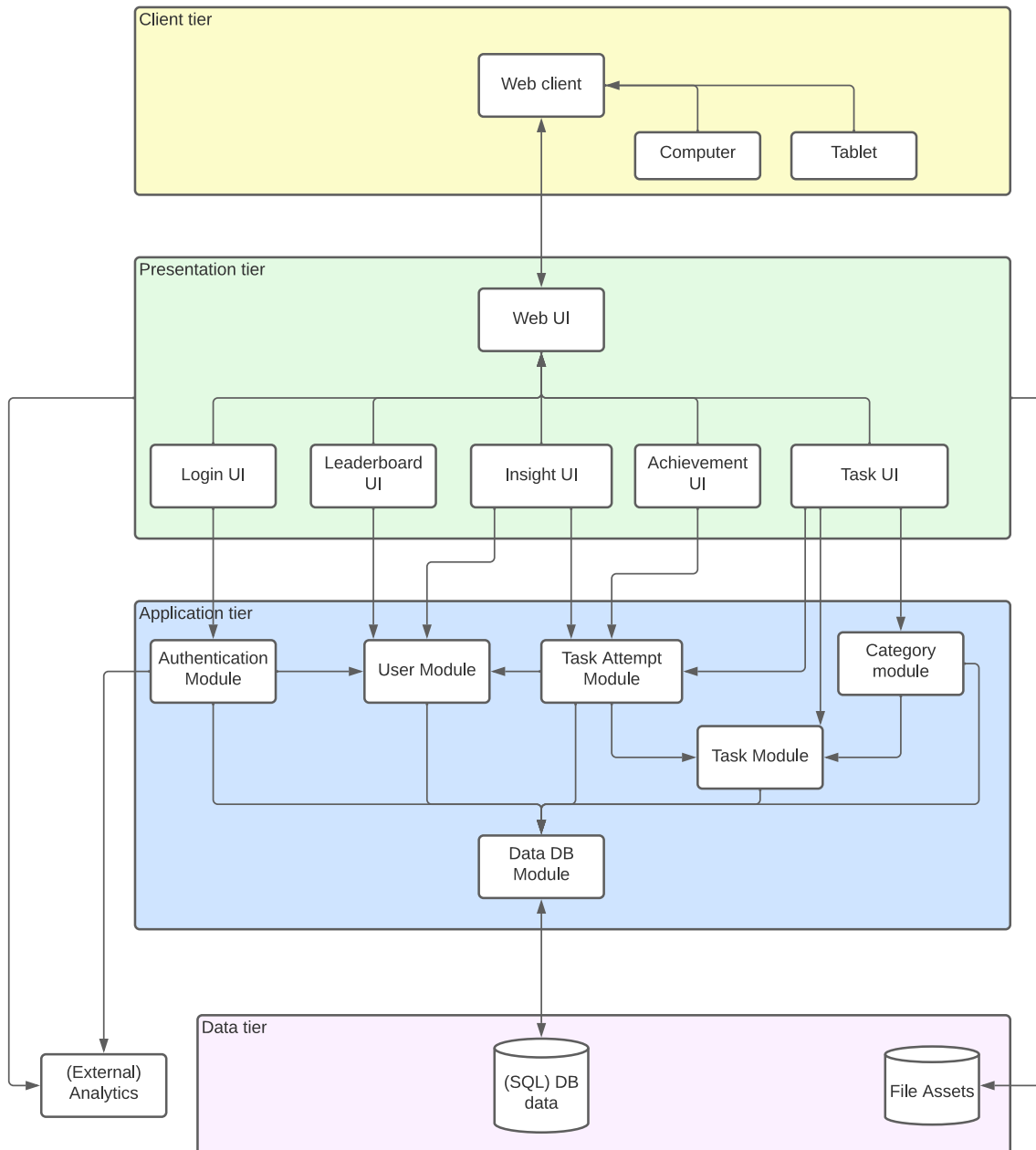

Figure A.1: Logical View.

By presenting a high-level overview of the primary components of an application, this view enables stakeholders to comprehend and reason about the system’s capabilities and how it satisfies the functional requirements. This overview allows stakeholders to think about how different elements of functionality interact to achieve the intended behavior.

SkillSprint follows a multi-tier architecture that includes the client, presentation, application, and data tiers. The client tier primarily supports two devices: computers and tablets. Our application was not developed for mobile devices, as the end-users mainly use laptops. These clients can access

SkillSprint's user interface through a web browser.

SkillSprint's user interface (UI) is divided into various user interfaces, each with its purpose: (1) Login, (2) Leaderboard, (3) Insight, (4) Achievement, and (5) Task. While most user interfaces consist of a single page, the Task UI has a task overview page and a separate page for each solvable task. These user interfaces communicate with various modules within the application tier.

One detail to notice is how both the Insight UI and Achievement UI communicate with the Task Attempt module. The task attempt are stored regardless of success or failure on a task. On failure, a new attempt is started. This detail lets us compute which achievements have been unlocked based on a user's task attempts. From the task attempt module, we can compute lots of information such as the number of tasks solved in a row without failure, which tasks have been solved, amount of tasks solved, and so on. Furthermore, these task attempts can also be processed in the Insight UI to present different statistics to the user.

Lastly, all the core system modules communicate with a module that handles all the database communication. This module abstracts the database specifics and ensures proper management of connections. This feature also increases modifiability by increasing code reusability across our application.

Process View

Figure A.2 depicts the process view utilizing an activity diagram. This diagram showcases a crucial core functionality of SkillSprint, specifically the process of solving tasks. This view provides an overview of the procedural flow involved in task solving.

This depicted flow loops itself as users continue to use SkillSprint until the session has ended. While using our application, users have the flexibility to visit other pages, such as the leaderboard and insight page, in between solving tasks. Overall, there are two possible methods of accumulating points, either through solving tasks or as a bonus for unlocking an achievement.

Lastly, it is worth noting that the activity diagram contains a loop if a user is not logged in. This emphasizes our application's reliance on an authenticated user to store essential data. Thus, authentication is a prerequisite for utilizing SkillSprint, ensuring data integrity and personalized user experiences.

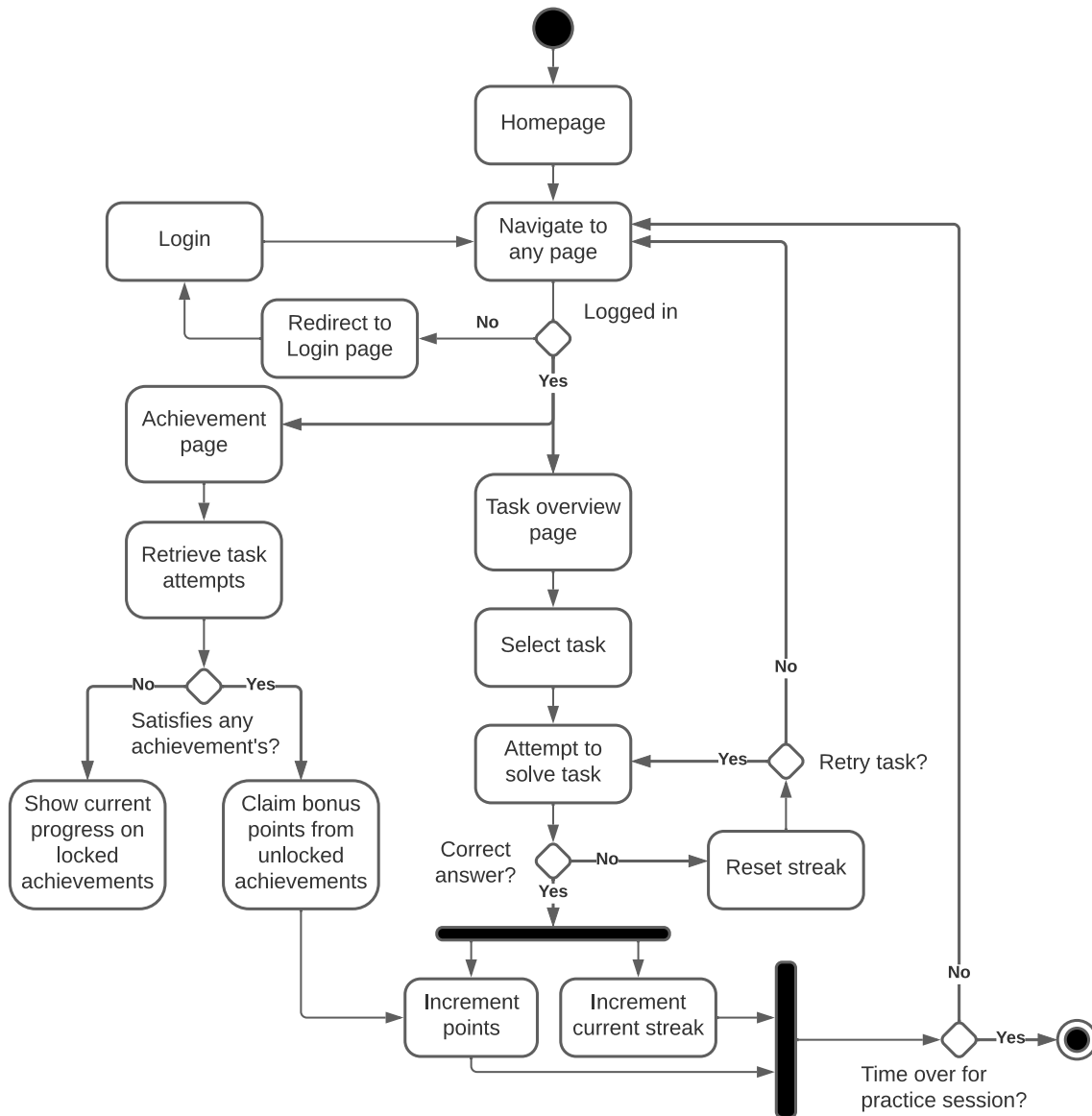

Figure A.2: Activity Diagram of Task Solving.

Development View

Two diagrams have been utilized to depict the development view. Figure A.3 shows a component diagram of SkillSprint, illustrating how components can be connected to produce larger components or interconnected systems. Moreover, Figure A.4 shows the inner relations inside the API module between the different sub-routers.

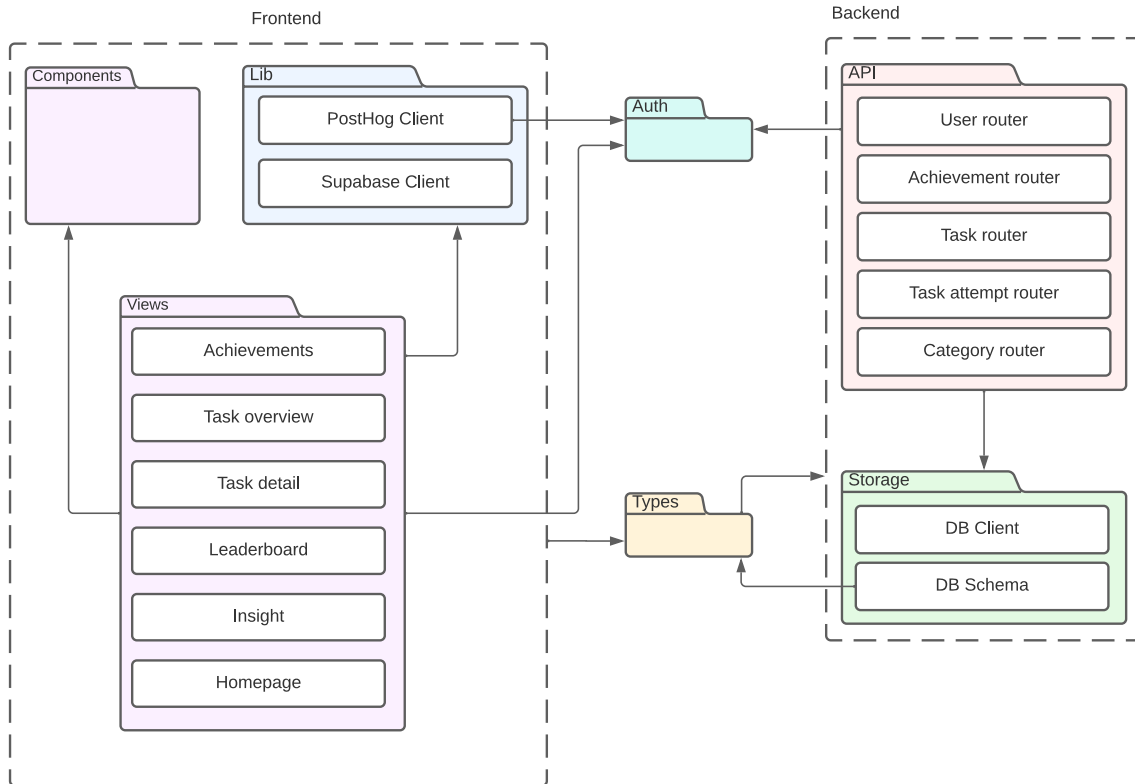

Figure A.3: Component Diagram.

Components

The large components module consists of reusable user interface components utilized across different pages. These user interface components can then be wired together to create larger components or complete pages.

Views

This module represents the different views and pages a user can navigate to. These pages are built with elements from the components module.

Lib

The Lib module consists primarily of utility methods or exporting a single instance of an API client. Since Supabase and PostHog are external services, these can be communicated through these clients. These clients have been organized in their modules for code re-usability and sharing client configuration.

API

The API module is responsible for providing communication between the front-end and back-end. The primary responsibility of this module is to allow the user interface to exchange data or perform actions from the server.

The module is also responsible for communicating with other modules, such as the *storage* and *auth* modules. One could say that the API module's role is to provide an interface for public

communication, also what actions are available for the client. The API would then forward requests to the appropriate modules based on the request.

An API router is a component that matches the incoming requests with the corresponding actions on the server. This API router is split into multiple sub routers, each encompassing methods under the same domain. For instance, the user router would include all user-related methods.

Storage

The storage module is responsible for communicating between the back-end and the database. This module handles all responsibilities, including connection pooling, migrations, etc. The migrations are done through an Object Relational Mapper (ORM) (Object Relational Mapper) named Prisma³⁵, which syncs the database tables with a schema.

Types

The *Types* module features a system allowing the front and back-end to share TypeScript types. The types used are generated by the ORM, such as the database tables matching the types used in the application. These types are then used by tRPC, a library for building end-to-end typesafe APIs, allowing the front and back-end to share the TypeScript types.

Auth

The authentication module is responsible for ensuring that users are logged in validly. This module is a part of both the front and back-end, as the application has utilized a library named NextAuth³⁶. This library provides a user interface and backend logic for persisting user information. Furthermore, authentication is done through JWT³⁷ tokens with an expiration duration of 90 minutes, fitting the duration of a free practice session.

³⁵<https://www.prisma.io/>

³⁶<https://next-auth.js.org/>

³⁷<https://jwt.io>

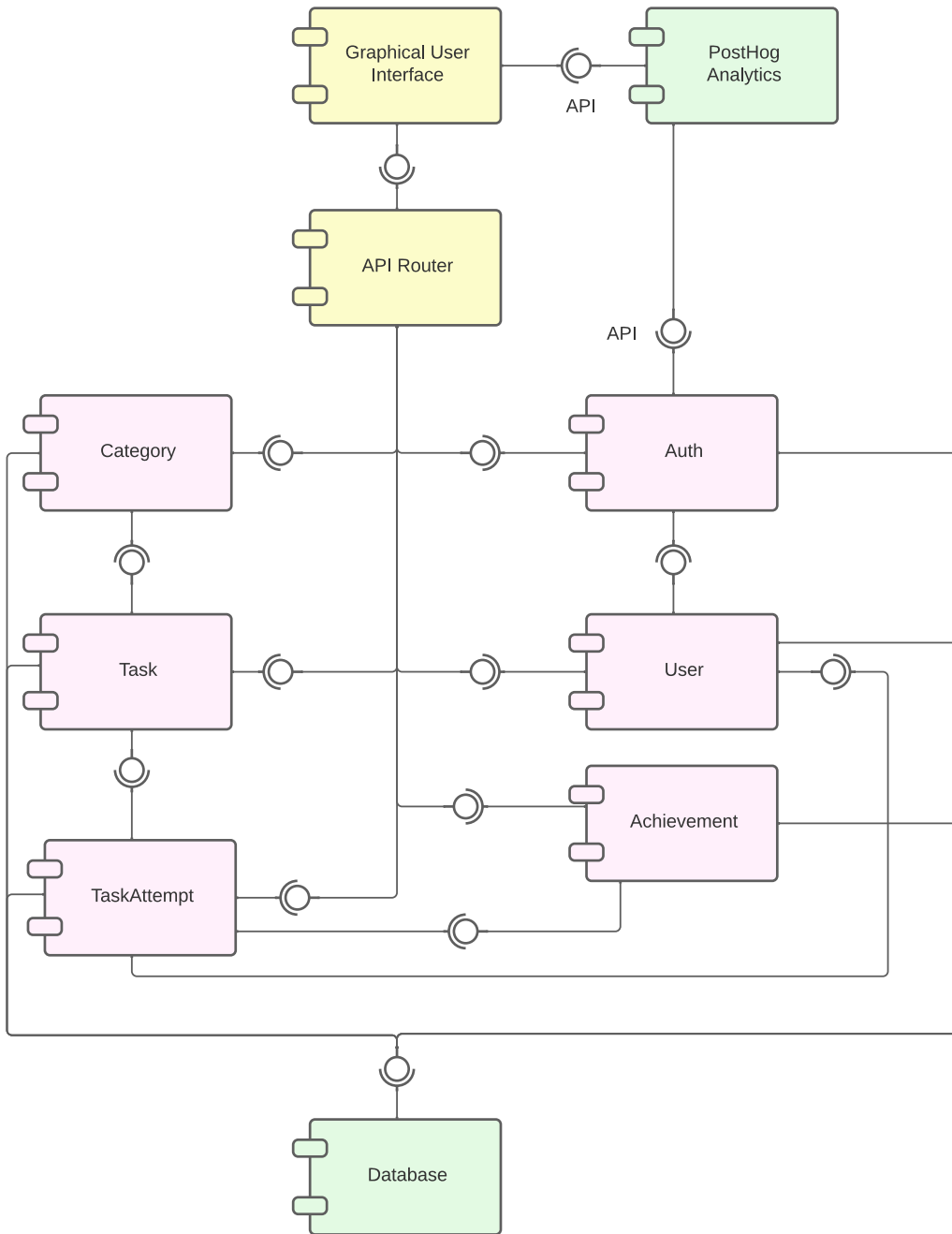

Figure A.4: Package Diagram.

Physical View

Figure A.5 depicts the physical view utilizing a deployment diagram. This view showcases that the software has been distributed to different environments. SkillSprint consists of a front-end and back-end, both hosted on Vercel³⁸, a web hosting platform. Additionally, the data tier, depicted in Figure A.1, is hosted on Supabase³⁹. By utilizing external platforms for managing the infrastructure, we could focus our time on the development of our application. These platforms address scalability through automatic scaling based on traffic. However, this may require selecting an appropriate tier for our application's needs, for which we opted for the free tier. The free tier fits SkillSprint's intended traffic and data requirements as the number of end-users was relatively low. Lastly, SkillSprint utilized an analytics service named PostHog⁴⁰, which was embedded into our application through their library.

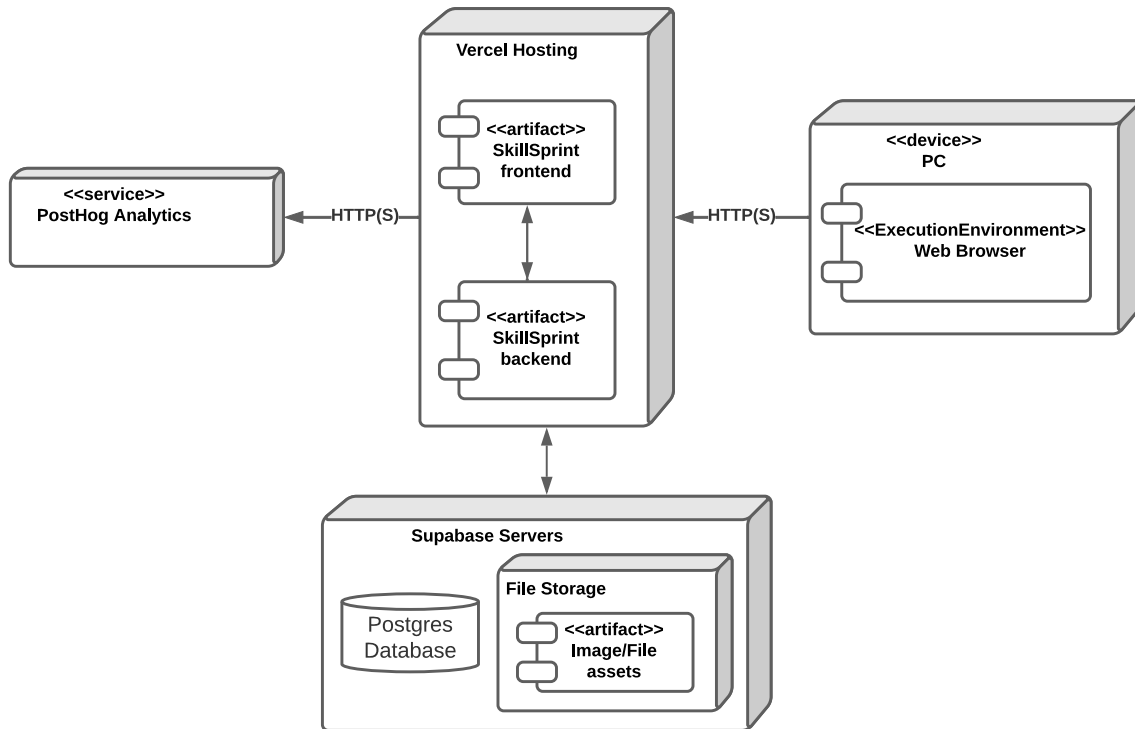

Figure A.5: Deployment Diagram.

³⁸<https://vercel.com>

³⁹<https://supabase.com>

⁴⁰<https://posthog.com>

B Application Usage Guide

To test a live version of SkillSprint, open a web browser and follow these steps:

1. Navigate to <https://www.skillsprint.no/>
2. Login with the following credentials:
 - Username: skillsprint
 - Password: sensor
3. Navigate by using the links in the header

From here on, an overview of the tasks can be seen in under the “oppgaver” tab. For further information on usage and the application’s features, see Appendix I.

C Response Options and Weights

Table A.4: Response Options and Weights for Pre- and Post-questionnaires.

Item	Response Options and Weights
“Hvilket kjønn identifiserer du deg med?”	0 = gutt, 1 = jente, 2 = annet
“Har du tidligere brukt en applikasjon med spill-elementer for å repetere matematikk?”	0 = aldri, 1 = 1-5 ganger, 2 = 6-9 ganger, 3 = 10 eller flere ganger
“Hvor mange timer bruker du på å spille i løpet av en uke?”	0 = timer, 1 = 1-5 timer, 2 = 6-9 timer, 3 = 10 timer eller mer
All items regarding assessment of statements with a five-point Likert scale	1 = Svært uenig, 2 = Uenig, 3 = Nøytral, 4 = Enig, 5 = Svært enig

D Wireframes

Low resolution desktop

1366 x 768

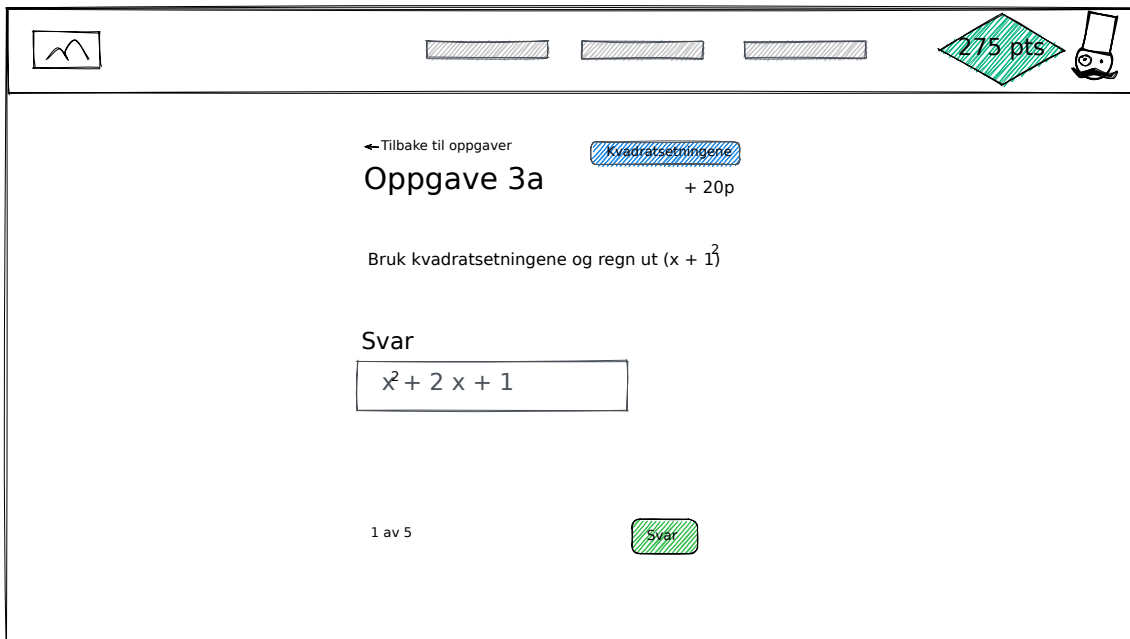

768 px

Figure D.1: Task Detail Wireframe.

Low resolution desktop

1366 x 768

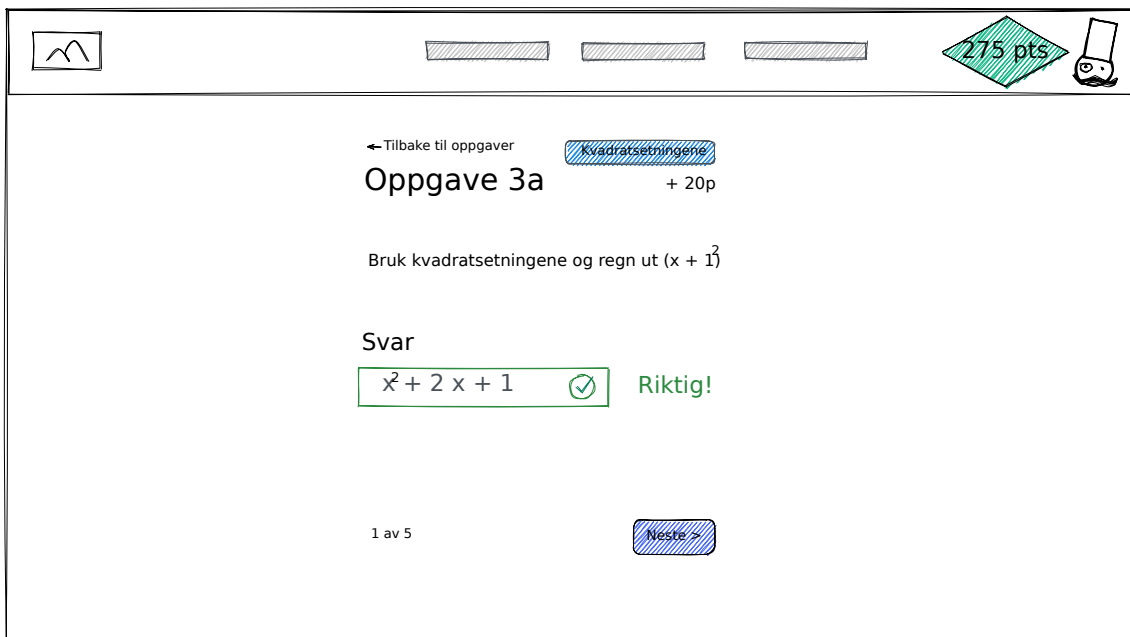

768 px

Figure D.2: Answered Task Detail wireframe.

Low resolution desktop

1366 x 768

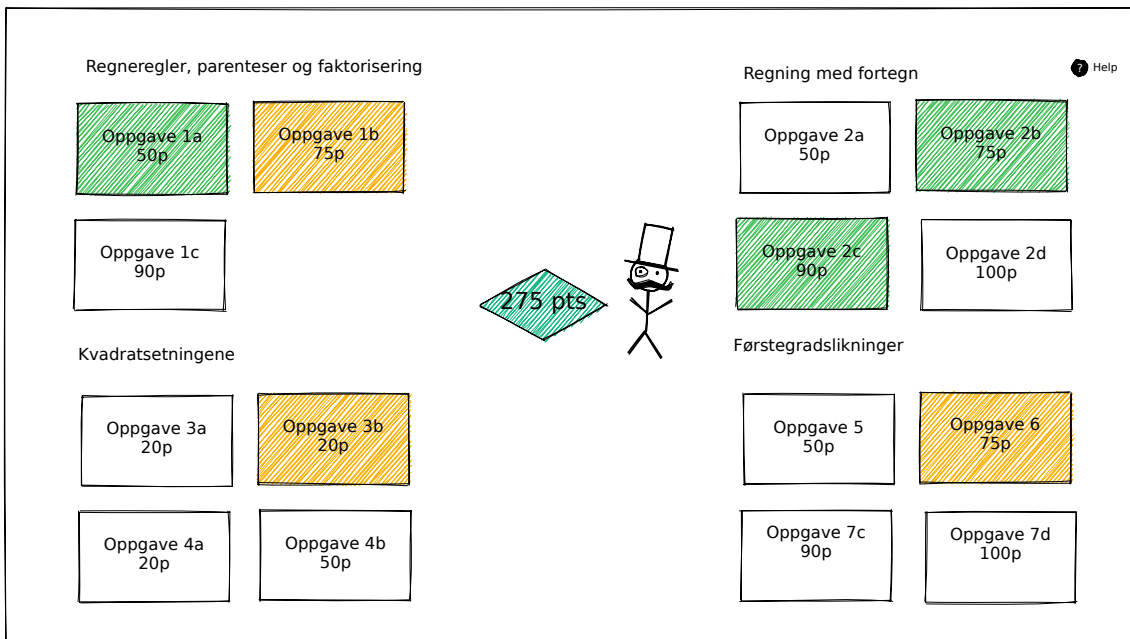

768 px

Figure D.3: Task Overview Wireframe.

Low resolution desktop

1366 x 768

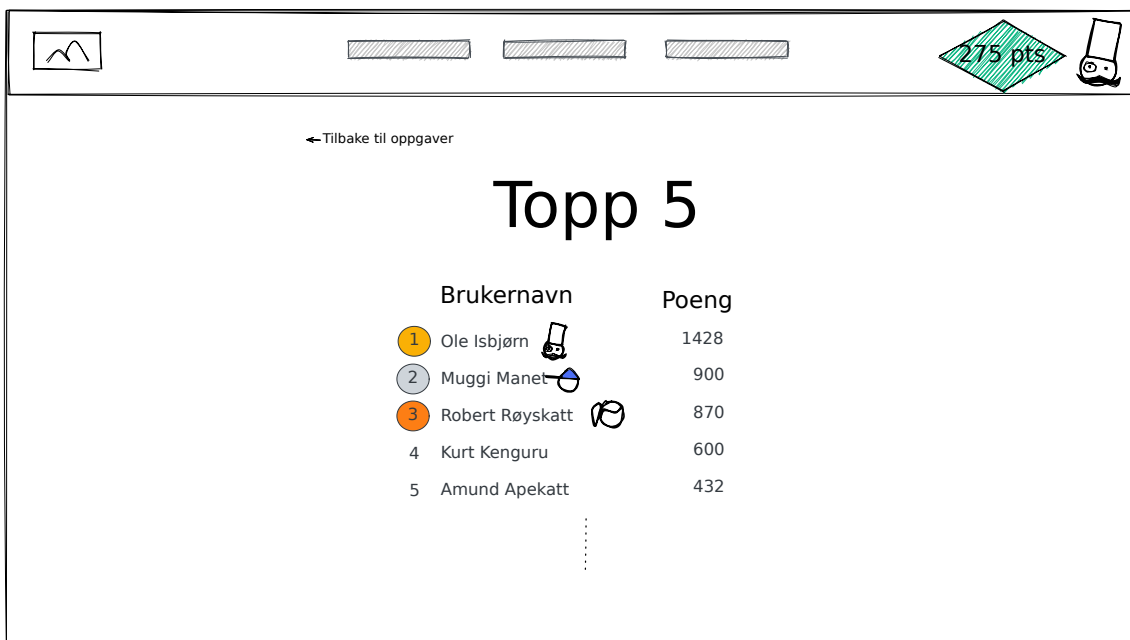

768 px

Figure D.4: Leaderboard Wireframe.

Low resolution desktop

1366 x 768

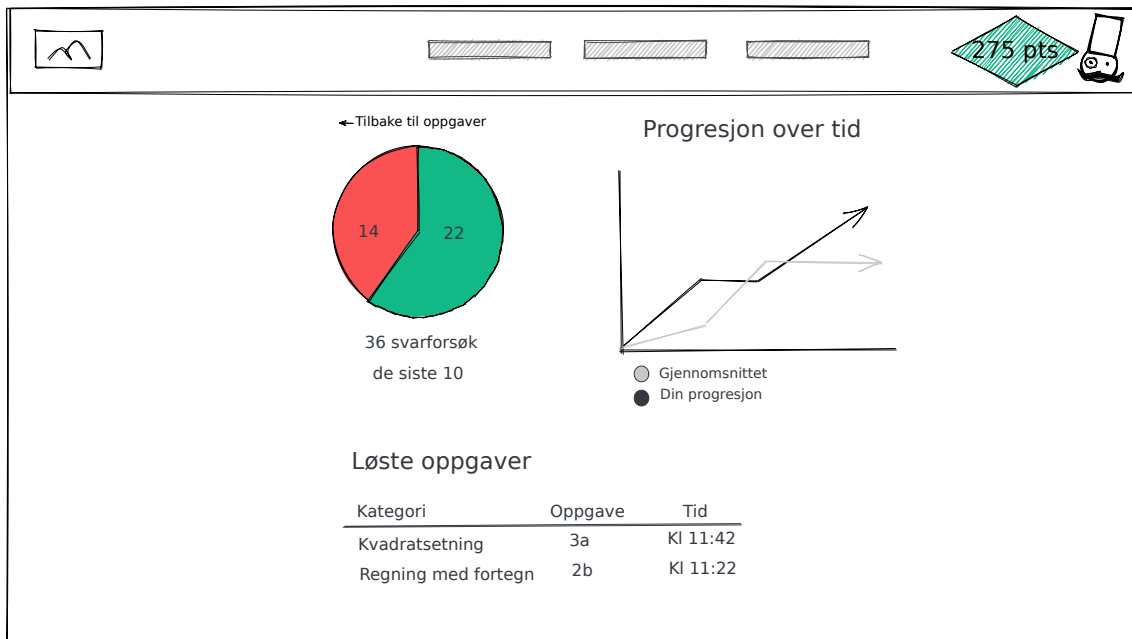

768 px

Figure D.5: Insight Wireframe.

Low resolution desktop

1366 x 768

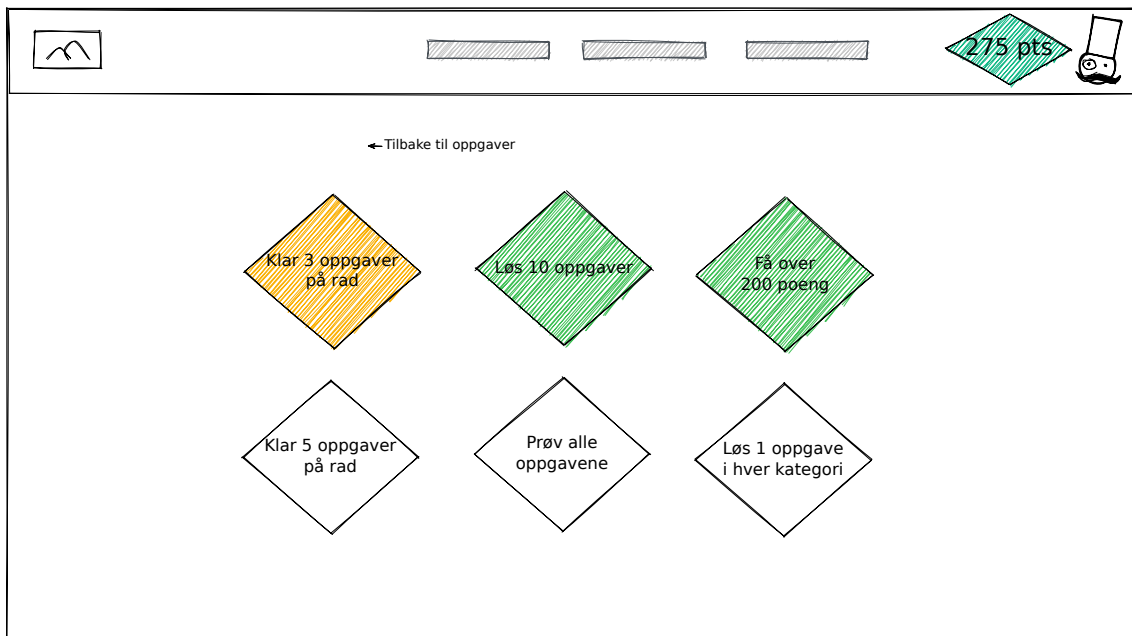

768 px

Figure D.6: Achievement Wireframe.

E User Interface Designs

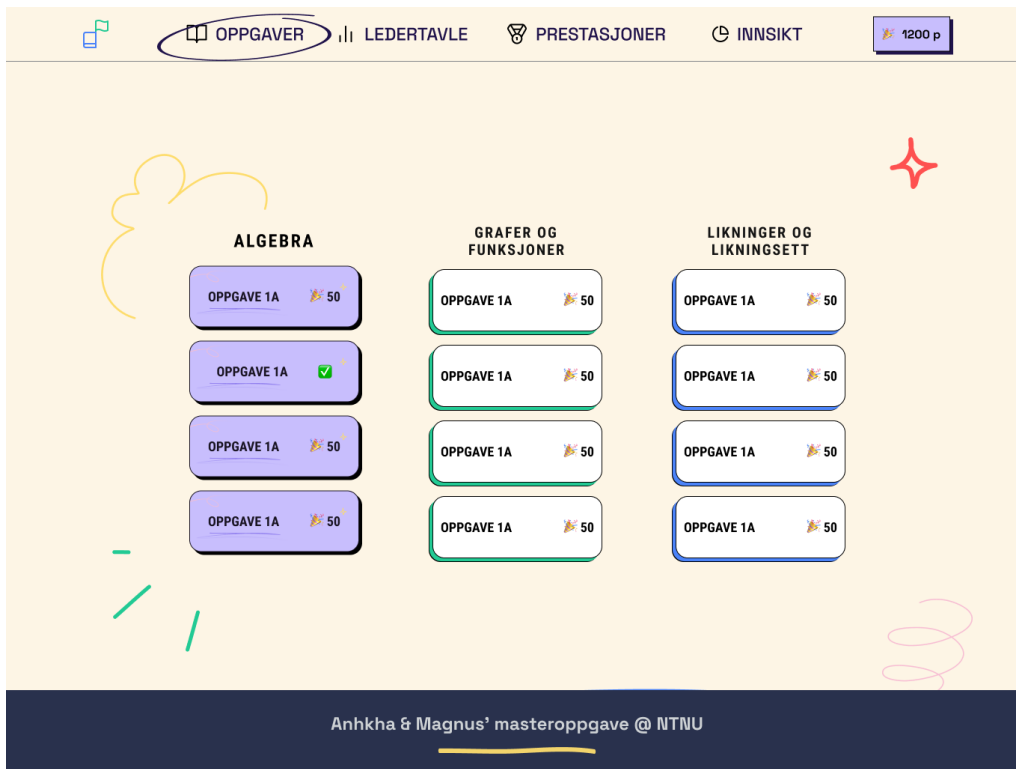

Figure E.1: Design of the Tasks Overview Page.

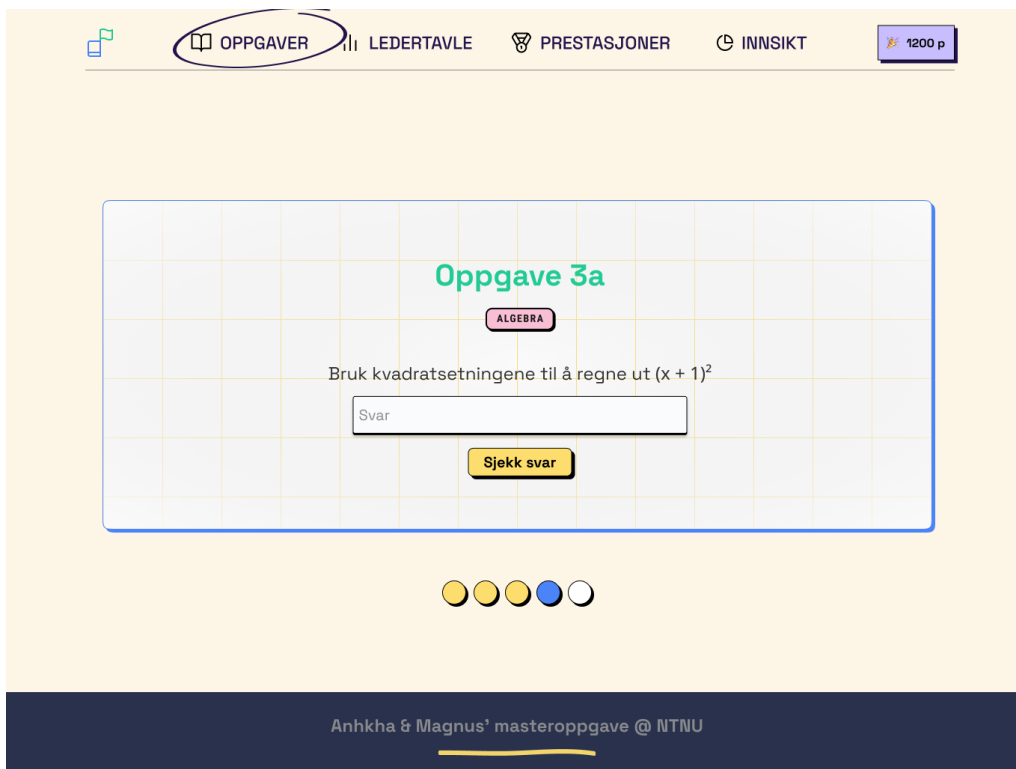

Figure E.2: Design of the Task Page.

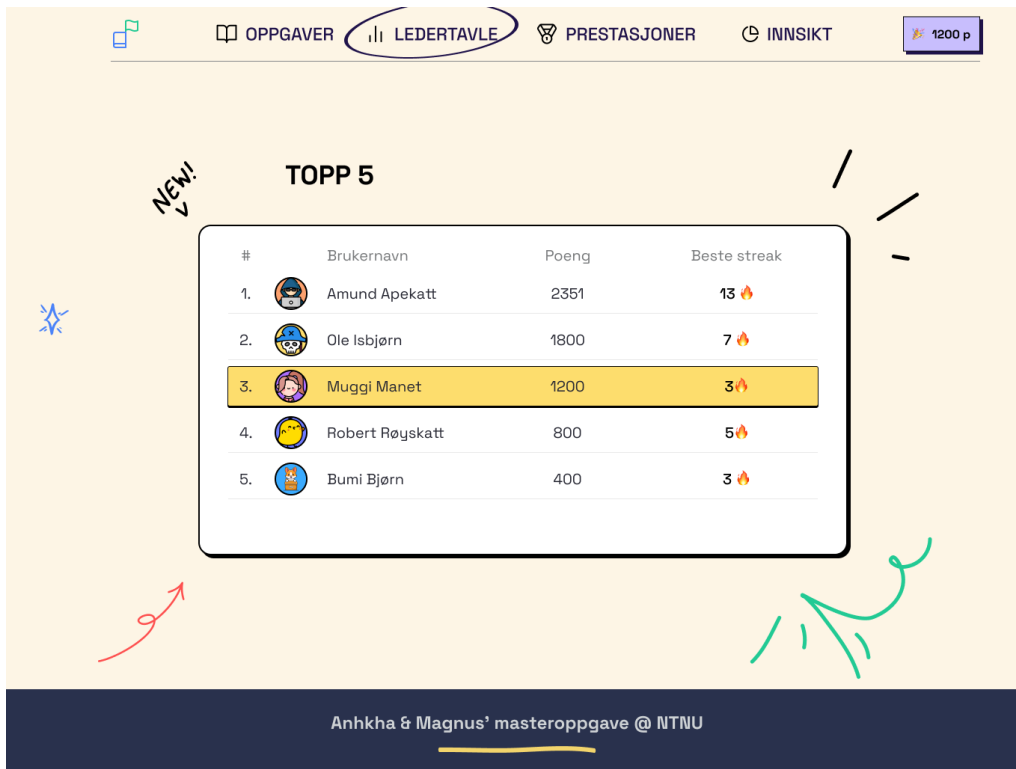

Figure E.3: Design of the Leaderboard Page.

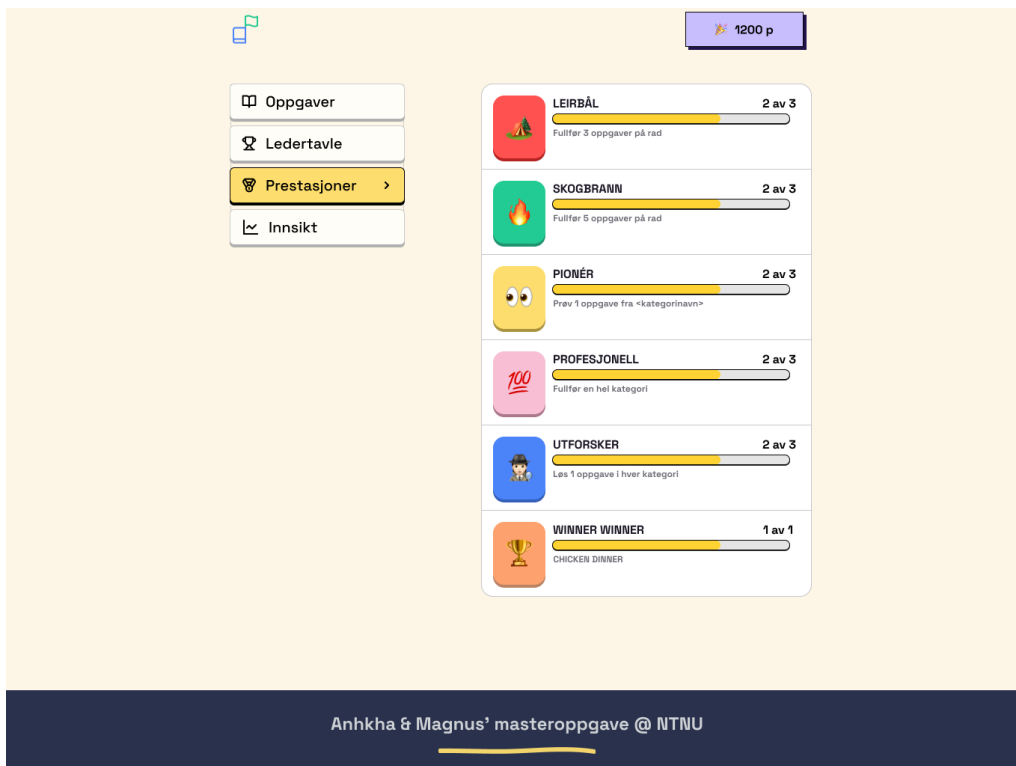

Figure E.4: Design of the Achievement Page.



Figure E.5: Design of the Insight Page.

F Participant Recruitment Email

Hei!

Jeg heter Magnus, og sammen med arbeidspartneren min, Anh-Kha, er vi godt i gang med masteroppgaven vår i Informatikk ved NTNU, Trondheim. I korte trekk skal vi utvikle en applikasjon som bidrar til å øke elevens motivasjon i repetisjons-timer i matematikk, - gjerne i forkant av en prøve eller tentamen/eksamen. I den anledning er vi avhengige av testpersoner/klasser som kan teste applikasjonen.

Vedlagt ligger en beskrivelse av kontekst, hva som trengs av ulike parter samt annen relevant informasjon. I tillegg legges det ved en PDF med videre beskrivelser og enkle skisser av konseptet.

I motsetning til mange eksisterende løsninger der all læring, oppgaveløsning og div. foregår i applikasjoner, tar vi utgangspunkt i at elevene bruker sine egne skrivebøker, sitt eget pensum og liknende. Løsningen vi ønsker å teste ut er kun en motivator til den vanlige arbeidssituasjonen. Vi hadde satt stor pris på om dette var noe dere kunne vært behjelpelige med å la seg gjennomføre!

Spørsmål, oppklaringer eller lignende kan gjerne tas i denne mailtråden, eller på sms/telefon til meg, Magnus, på **+47 977 70 865**.

Med vennlig hilsen,
Magnus L. Holtet og Anh-Kha Vo

Kontekst:

En arbeidsøkt, gjerne 45-90 minutter, der elevene kan jobbe fritt med oppgaver fra matematikk-pensum. Pensumet skal være undervist, og oppgaveløsningen er ment som repetisjon/mengdetrening. Oppgavene er hentet fra elevenes egne mattekøker og ressurser, og vil bli presentert og anvendt i vår applikasjon (i praksis vil dette være en nettside).

Anh-Kha og jeg vil innledningsvis introdusere applikasjonens virkemåte for elevene, før de får anledning til å bruke den og jobbe fritt med matteoppgavene resten av timen. Mot slutten gjennomføres en anonym spørreundersøkelse.

Hva forventes av lærere som skal bidra?

Et (gjærne digitalt) møte i forkant der vi avklarer hvilket pensum som er gjennomgått og hvilke oppgaver fra boken som er relevant for øvingstimen. De relevante oppgavene kan vi så sammen tildele en vanskelighetsgrad.

Vi registrerer så oppgavene og legger det inn i applikasjonen god tid i forveien før vi sender tilbake en kjapp demonstrasjon av hvordan alt ser ut.

Hva er tidsrammen for prosjektet?

Masteroppgaven fullføres i juni, og er forventet sensurert etter 3 måneder. Alt av data som er samlet inn behandles konfidensielt og anonymisert hele veien, og vil naturligvis bli slettet så fort sensur foreligger.

Selve gjennomføringen i klassen vil vare i omkring 2 timer. Dette er medregnet tid til oppstart, gjennomføring og en *anonym* spørreundersøkelse på slutten.

Hvilket klassetrinn og hvor mange elever bør delta?

Helst 10. trinn, - minimum én klasse, men gjerne flere.

Hva forventes av skolen?

Elevene trenger egen datamaskin, mobiltelefon eller nettbrett, samt internettilgang. Det trengs ikke å installere noe programvare da alt vil foregå i nettleseren.

Er det behov for å innhente samtykke fra foreldre?

Dersom eleven er 15 år eller eldre kan de samtykke selv. Er vedkommende yngre trengs samtykke fra foresatte. Det er verdt å nevne at det ikke vil samles inn informasjon som kan identifisere eleven eller er av sensitiv karakter. Dataen som skal samles inn er bruksdata i applikasjonen samt et anonymt skjema knyttet til elevens oppfattelse av hvordan applikasjonen påvirket motivasjonen i mattetimen.

G Attachment to the Participant Recruitment Email: Concept and Functionality

Applikasjonens funksjonalitet

NB! De vedlagte skissene er kun ment å gi et bilde av applikasjonens virkemåte, og reflekterer ikke ferdig utseende.

Vi (Magnus, Anh-Kha og lærer) er i klasserommet, og det er satt av 45-90 minutter for fritt arbeid med relevant matematikk-pensum. I forkant av økten har vi i samråd med faglærer gått igjennom hvilke oppgaver som er relevante for økten (sett i lys av hva som er undervist og hva som kommer på en prøve i nærmeste fremtid). Oppgavene fra elevenes bok/pensum presenteres i applikasjonen vår, der de er delt inn i kapitler og gitt poeng ut i fra vanskelighetsgrad. Elevene kan løse oppgavene i eget rolig temp og velge rekkefølge helt selv.

På slutten av økten vil det bli satt av tid til å svare på en rask, anonym, spørreundersøkelse om applikasjonen knyttet opp mot motivasjon. Hvordan de ulike spillelementene (poeng, ledertavle, streaks ol.) isolert sett påvirket motivasjonen til å løse oppgaver samt hvordan applikasjonen som en helhet bidro/eller ikke bidro til motivasjonen.

Hovedside

Til enhver tid vil eleven ha oversikt over hvilke oppgaver som er løst (grønn), hvilke oppgaver som er forsøkt løst (gul) og hvilke som ikke enda er prøvd (hvit).

Low resolution desktop

1366 x 768

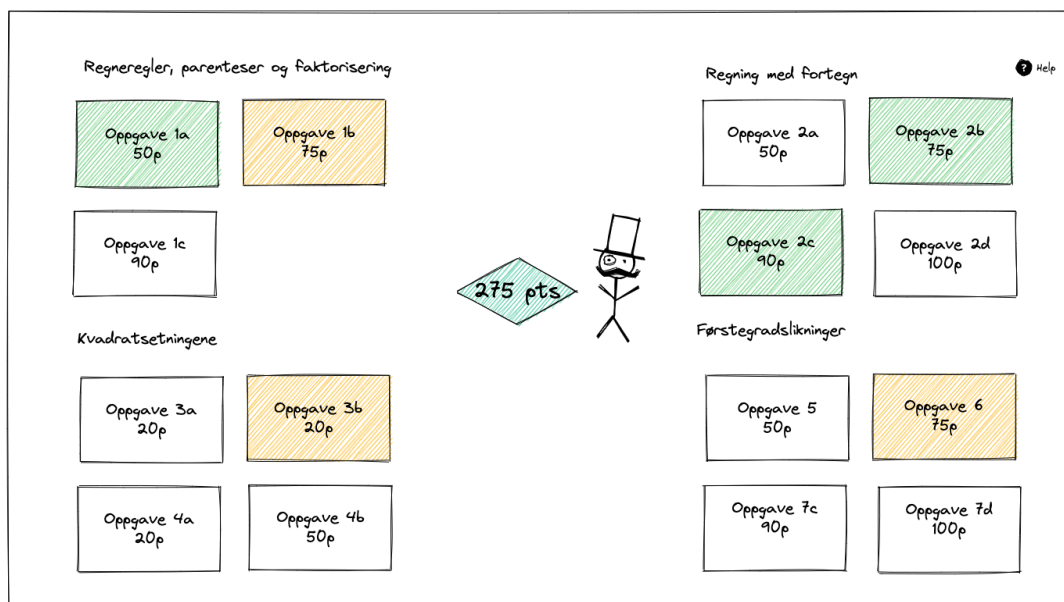

768 px

Oppgaveside

Ved å klikke på oppgavene på hovedsiden, vil elevene få opp samme oppgave som i boken/pensum. Eleven skal så løse oppgaven selvstendig før svaret skrives inn i applikasjonen. Er svaret riktig, får eleven de tilhørende poengene. Er det oppgitte svaret feil, får eleven mulighet til å prøve på nytt eller hoppe over til en annen oppgave.

Low resolution desktop

1366 x 768

← Tilbake til oppgaver 275 pts 

Kvadratsetningene + 20p

Oppgave 3a

Bruk kvadratsetningene og regn ut $(x + 1)^2$

Svar

$x^2 + 2x + 1$ ✔ Riktig!

1 av 5 Neste >

768 px

Ledertavle

Etterhvert som man opparbeider seg poeng vil de fem elevene med flest poeng vises på en automatisk oppdatert ledertavle.

NB! Det er verdt å nevne at elevenes brukernavn er generert anonymt på forhånd. Dette gjøres for å ivareta anonymiteten til eleven inntil de eventuelt selv forteller hvilket navn de ble tildelt.

Low resolution desktop

1366 x 768

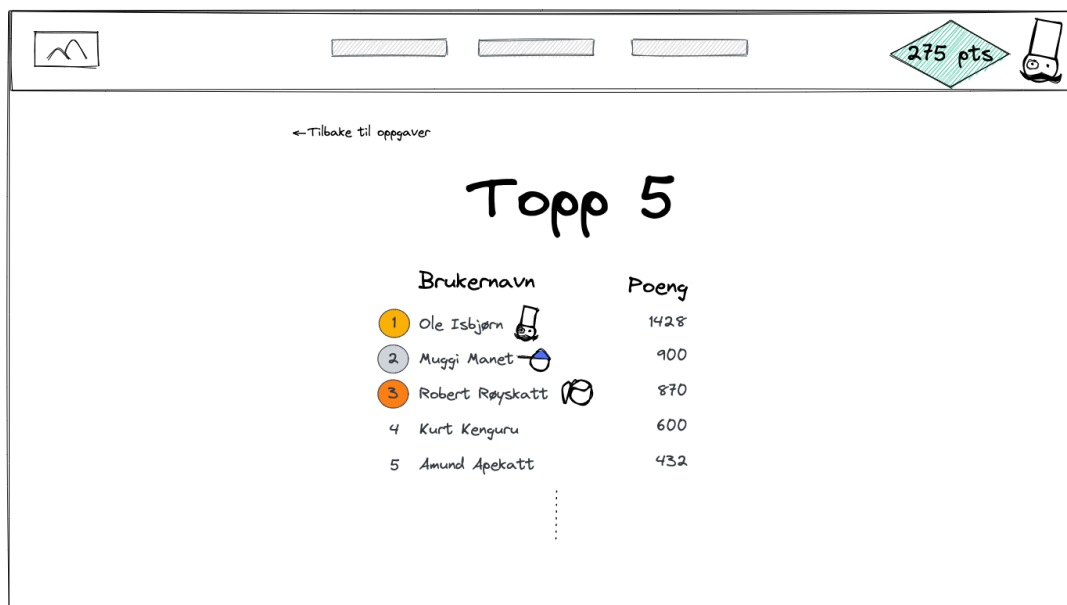

768 px

Innsikt-side

På innsikt-siden vil eleven få oversikt over sin egen progresjon. Hen vil kunne se hvor mange ganger hen har svart rett/galt, progresjon over tid sammenlignet med klassens snitt samt en oversikt over hvilke oppgaver som er løst.

Denne oversikten er ment å gi eleven et inntrykk av hvilke deler av pensum som er under kontroll, og hvilke deler som kanskje trenger litt mer øving.

Low resolution desktop

1366 x 768

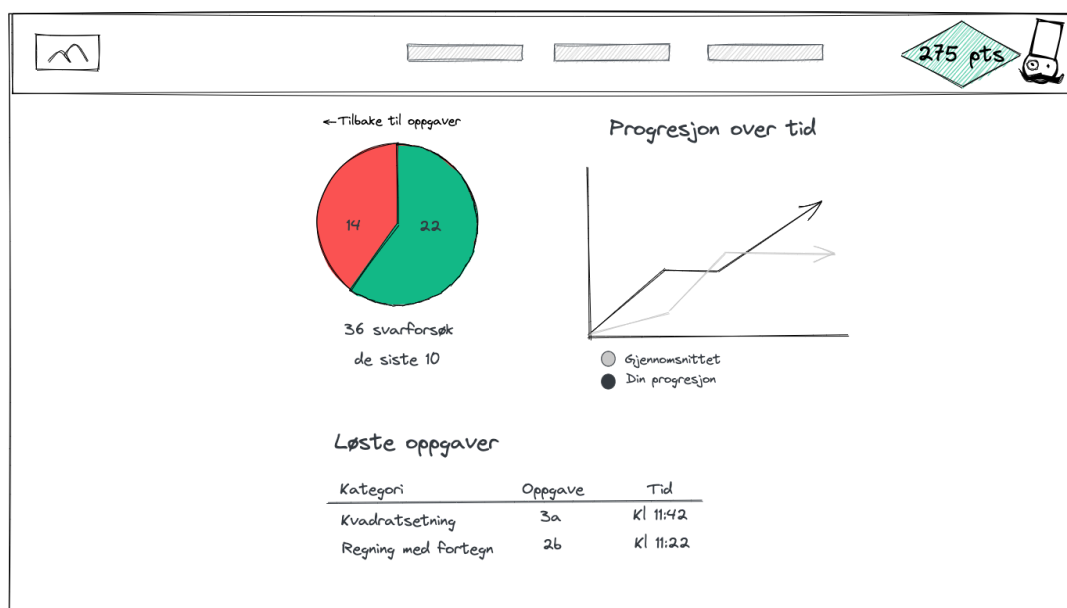

768 px

Bragder/måloppnåelser

I tillegg til at man får poeng ved å løse oppgaver, vil man kunne få personlige "badges/utmerkelse" for å oppnå en rekke mål. Dette kan være alt fra å klare x antall oppgaver på rad, opparbeide seg over en viss mengde poeng osv.

Low resolution desktop

1366 x 768

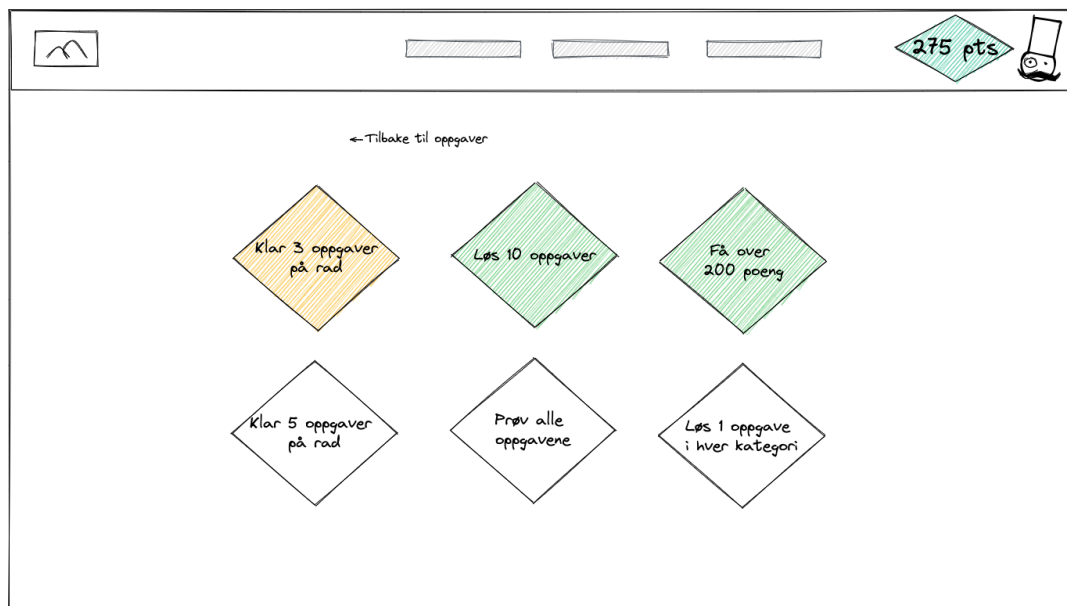

768 px

Vil du delta i forskningsprosjektet

«App development with gamification elements for learning activities»?

Dette er et spørsmål til deg om å delta i et forskningsprosjekt hvor formålet er å utforske om en applikasjon, med fokus på spill-elementer, motiverer elever til å gjøre repetisjonsoppgaver i matematikk. I dette skrevet gir vi deg informasjon om målene for prosjektet og hva deltakelse vil innebære for deg.

Formål

Som en del av masteroppgaven har vi laget en applikasjon for repetisjon i matematikk, der spill-elementer (poeng, streaks, ledertavler mm.) står sentralt. Gjennom studien ønsker vi å kartlegge om en slik applikasjon i det hele tatt oppleves motiverende av elevene, samt i hvilken grad de ulike spill-elementene påvirker dette.

Hvem er ansvarlig for forskningsprosjektet?

Forskningsprosjektet er en del av masteroppgaven vår i Informatikk ved Norges teknisk-naturvitenskapelige universitet.

Forskningsprosjektet og masteroppgaven skrives og gjennomføres av:

Magnus Lauritzen Holtet

- magnus.holtet@gmail.com
- +47 97 77 08 65

Anh-Kha Nguyen Vo

- hey@akvo.no
- +47 467 85 755

Førsteamanuensis Sofia Papavlasopoulou er veileder for masteroppgaven og kan kontaktes på:

- spapav@ntnu.no
- Sem Sælands vei 9, IT-bygget 146
- +47 45786588

Hvorfor får du spørsmål om å delta?

En rekke skoler er kontaktet, og du er relevant fordi vi søker elever på 10. trinn som deltar i matematikkopplæring. Vi ønsker at 10.klasse-elever skal teste applikasjonen vi har utviklet, for så å svare på en del spørsmål knyttet til hvordan elevene oppfattet motivasjonen for repetisjon i matematikk, ved bruk av applikasjonen. Det kreves ingen tidligere erfaring med dataspill eller liknende.

Hva innebærer det for deg å delta?

Studien vil ta plass i klasserommet i en repetisjonstime i matematikk. Pensum vil være undervist på forhånd, og tanken er at elevene jobber fritt med relevant pensum og bruker den utviklede applikasjonen ved siden av. Elevene er anonyme seg imellom og hele gjennomføringen vil ta 1-2 skoletimer.

Dersom du deltar i studien, vil du:

1. Få en introduksjon av applikasjonens virkemåte og funksjoner. Dette tar 5-10 minutter.
2. Jobbe selvstendig med relevante matteoppgaver i ditt eget tempo der du bruker applikasjonen. Dette tar 60-90 minutter.
3. Svare på et digitalt spørreskjema om din oppfattelse av applikasjonens påvirkning på motivasjon, samt rangere hvordan de ulike spill-elementene bidro til dette. Dette tar 10-15 minutter.
4. Potensielt delta i et kort intervju der lyd tas opp. Her vil du kunne komme med tilbakemeldinger og meninger om applikasjonen og spill-elementer i forbindelse med motivasjon for repetisjon i matematikk. Dette tar 10-15 minutter.

Om ønskelig kan foresatte få se spørreskjema / intervjuguide på forhånd ved å ta kontakt.

Det er frivillig å delta

Det er frivillig å delta i prosjektet. Hvis du velger å delta, kan du når som helst trekke samtykket tilbake uten å oppgi noen grunn. Alle dine personopplysninger vil da bli slettet. Det vil ikke ha noen negative konsekvenser for deg hvis du ikke vil delta eller senere velger å trekke deg.

Deltakelsen din vil ikke påvirke karakterer, ditt forhold til skolen/lærer eller liknende.

Ditt personvern – hvordan vi oppbevarer og bruker dine opplysninger

Vi vil bare bruke opplysningene om deg til formålene vi har fortalt om i dette skrevet. Vi behandler opplysningene konfidensielt og i samsvar med personvernregelverket.

- Det er kun masterstudentene Magnus og Anh-Kha, samt deres veileder Sofia, som vil ha tilgang til den personlige dataen.
- Dataen vil lagres på masterstudentenes maskiner der dataen er passord-beskyttet. Navnet og kontaktopplysningene dine vil vi erstatte med en kode som lagres på egen navneliste adskilt fra øvrige data.
- Deltakere vil ikke kunne identifiseres i noen publikasjoner.

Hva skjer med personopplysningene dine når forskningsprosjektet avsluttes?

Prosjektet vil etter planen avsluttes i løpet av høsten 2023 når sensur for masteroppgaven foreligger. Etter prosjektslutt vil datamaterialet med dine personopplysninger anonymiseres.

Hva gir oss rett til å behandle personopplysninger om deg?

Vi behandler opplysninger om deg basert på ditt samtykke.

På oppdrag fra Institutt for datateknologi og informatikk v/ NTNU har Sikt – Kunnskapssektorens tjenesteleverandør vurdert at behandlingen av personopplysninger i dette prosjektet er i samsvar med personvernregelverket.

Dine rettigheter

Så lenge du kan identifiseres i datamaterialet, har du rett til:

- innsyn i hvilke opplysninger vi behandler om deg, og å få utlevert en kopi av opplysningene
- å få rettet opplysninger om deg som er feil eller misvisende
- å få slettet personopplysninger om deg
- å sende klage til Datatilsynet om behandlingen av dine personopplysninger

Hvis du har spørsmål til studien, eller ønsker å vite mer om eller benytte deg av dine rettigheter, ta kontakt med:

- Norges teknisk-naturvitenskapelige universitet via:
 - o Magnus Lauritzen Holtet på e-post: magnus.holtetx@gmail.com.
 - o Anh-Kha Nguyen Vo på e-post: hey@akvo.no.
 - o Veileder Sofia Papavlasopoulou på e-post: spapav@ntnu.no.
- Vårt personvernombud: Tomas Helgesen på e-post: thomas.helgesen@ntnu.no, eller på telefon: +47 93 07 90 38.

Hvis du har spørsmål knyttet til vurderingen som er gjort av personverntjenestene fra Sikt, kan du ta kontakt via:

- Epost: personverntjenester@sikt.no eller telefon: 73 98 40 40.

Med vennlig hilsen

Prosjektansvarlig

Eventuelt student

(Forsker/veileder)

Samtykkeerklæring

Jeg har mottatt og forstått informasjon om prosjektet [*sett inn tittel*], og har fått anledning til å stille spørsmål. Jeg samtykker til:

- å delta i bruk av applikasjon
- å delta i en digital spørreundersøkelse
- å delta i et kort intervju

Jeg samtykker til at mine opplysninger behandles frem til prosjektet er avsluttet.

(Signert av prosjektdeltaker, dato)

For foresatt/verge dersom prosjektdeltaker er under 16 år:

Jeg samtykker til at opplysninger om prosjektdeltakeren behandles frem til prosjektet er avsluttet.

(Navn på prosjektdeltaker)

(Signert av foresatt/verge, dato)



Introduksjon til SkillSprint

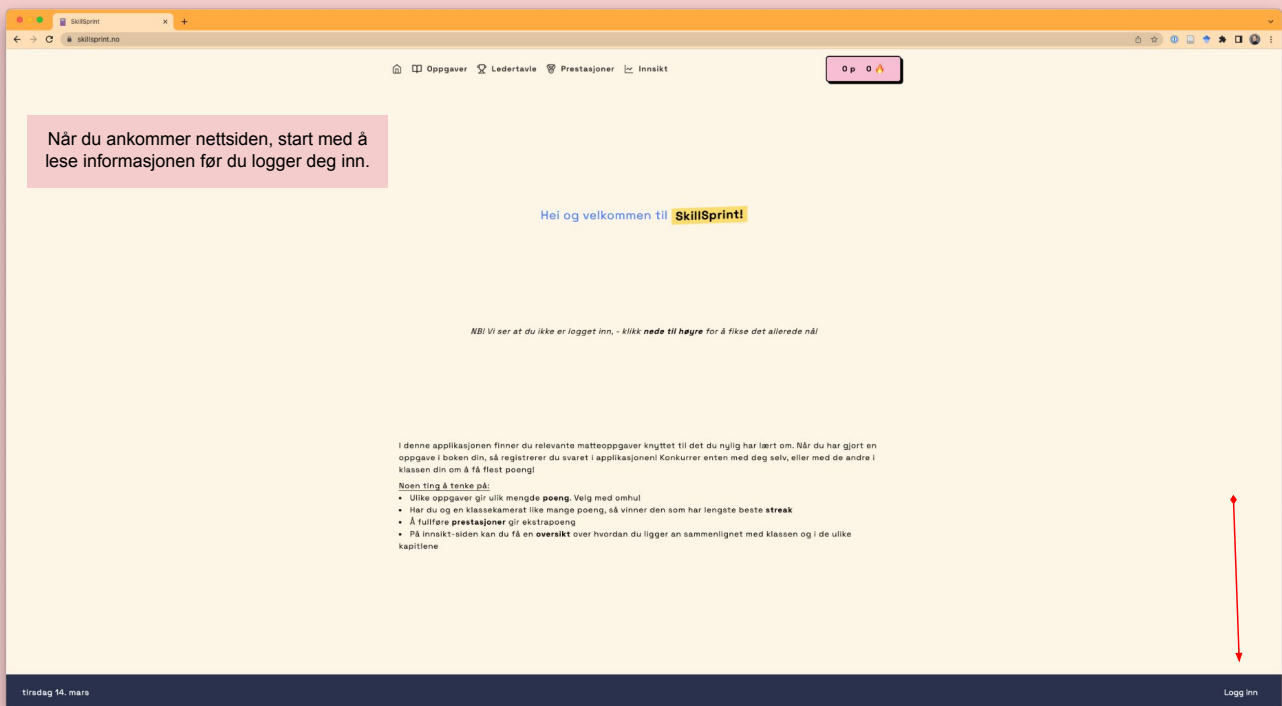

Logg inn med brukernavnet og passordet du mottok av læreren din eller oss. Ta vare på lappen!

Brukernavn

Passord

Sign in with brukernavn og passord

Oppgaver
Her er oppgavene sortert etter tema i pensum, og de er gitt ulik mengde poeng basert på vanskelighetsgrad.

Grønne oppgaver er løst.

Blå oppgaver består av en rekke deloppgaver du ikke har løst. Klikk på dem for å utvide menyen og velge deloppgavene.

Rosa oppgaver er oppgaver du enda ikke har løst.

Oppgaver Ledertavle Prestasjoner Innsikt
250 p 1

FUNKSJON OG GRAF	LINEÆRE FUNKSJONER	BRØKFUNKSJONER
Oppgave 2.27 +100p	Oppgave 2.23 +100p	Oppgave 2.31 0/300
Oppgave 2.28 0/325	Oppgave 2.24 0/125	Oppgave 2.32.1 +50p
Oppgave 2.29.1 0/150	Oppgave 2.25.1 0/100	Oppgave 2.32.2 75p
Oppgave 2.29.2 0/225	Oppgave 2.25.2 0/150	Oppgave 2.32.3 100p
Oppgave 2.29.3 0/375	Oppgave 2.26.3 0/150	Oppgave 2.33 0/200
Oppgave 2.30.1 0/250	Oppgave 2.26.1 0/100	Oppgave 2.34 0/200
Oppgave 2.30.2 0/300	Oppgave 2.26.2 0/150	Oppgave 2.35.1 100p
Oppgave 2.30.3 0/300	Oppgave 2.26.3 0/250	Oppgave 2.35.2 0/175
		Oppgave 2.35.3 0/300
		Oppgave 2.36.1 0/100
		Oppgave 2.36.2 0/225
		Oppgave 2.36.3 0/500
ANDREGRADSFUNKSJONER	EKSPONENTIALFUNKSJONER	
Oppgave 2.37.1 25p	Oppgave 2.48 50p	
Oppgave 2.37.2 25p	Oppgave 2.49 0/125	
Oppgave 2.37.3 25p	Oppgave 2.50 0/175	

Det finnes en rekke forskjellige oppgavetyper. Her kommer en forklaring på hvordan svare på dem.

NB! Ofte står det også int under oppgavene om hvilket format vi ønsker svaret på.

The image displays three examples of math problems from a digital learning platform. Each problem is shown in a separate window with a yellow background and a grid pattern. The first problem, 'Oppgave 2.29.3c', is a multiple-choice question about a car's average speed. The second, 'Oppgave 2.31a2', is a word problem about a class's average score, featuring a table for 'Klassens resultat' and a text input field. The third, 'Oppgave 2.36.3a', is a geometry problem about a rectangle's area, with a diagram and a text input field. Each problem window includes a 'SJEKK SVAR' button and a 'Svaralternativer' button.

Multiple choice. Klikk på rett svar.

Bildeoppgave. Les oppgaveteksten alltid nøye. Oftest skriver du *ikke* inn mengdeord som *meter, timer, liter* osv.

Opgaver med bokser for utfylling. Her er det kun nødvendig å fylle inn svaret i boksen. Forsvinner det som er ferdig utfyllt fra før, kan du klikke på lilla reset-knapp.

Oppgave 2.28a

Funksjon Og Graf

Sammenhengen mellom celsiusgrader og fahrenheitgrader kan beskrives med funksjonen $F(C) = 1.8C + 32$ der F er fahrenheitgrader og C er celsiusgrader. Tegn grafen til funksjonen $F(C) = 1.8C + 32$.

NB! Løsningsordet på denne oppgaven får du av læreren din når du har gjort oppgaven.

SJEKK SVAR

SÅ VIDERE

Løsningsord. Noen oppgaver er det vanskelig å få rettet automatisk. Her løser du oppgaven for deg selv, rekker opp hånden og venter på at læreren din eller en av oss kommer bort og gir deg løsningsordet. Dette skrives så inn i svarfeltet. Et et løsningsord kan f.eks være *silten-bajas*

Oppgave 2.39b

Andregradsfunksjoner

Grafen $y = -2x^2 + 4.5$ kan du se i koordinatsystemet. Omtrent hvilke verdier har x når $y = 2.5$?

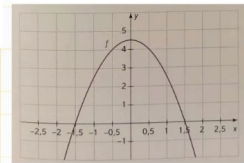

$x = \square$ v $x = \square$

SJEKK SVAR

SÅ TILBAKE

SÅ VIDERE

Flere svar. Noen oppgaver har gjerne flere svar, skriv her inn svaret i boksene.

Ettersprøve

skilspriint_n0tasks/ctewppczm02010311dpozhev3v

Oppgaver Ledertavle Prestasjoner Innsikt 250 p 1

Oppgave 2.36.3a

Brøkfunksjoner

Et rektangel har et areal på 60 cm^2 . Siden er b og $x - 1$ lange. Finn et uttrykk $b(x)$ der bredden er b cm, arealet er 60 cm^2 og lengden er $(x - 1)$ cm.

$b(x) =$

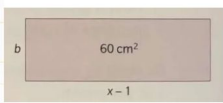

123	f()	∞#€	ABC	αβγ				
$\frac{1}{x}$	n	7	8	9	+	e	i	π
<	>	4	5	6	*	\square^2	x^{\square}	$\sqrt{\square}$
()	1	2	3	-	\int_{\square}^{\square}	$\sqrt{\square}$	\square
\circ	\bullet	0	.	=	+	<	>	\leftarrow

skilspriest.no/leaderboard

Oppgaver Ledertavle Prestasjoner Innsikt 250 p 1 🔥

Ledertavle.
På ledertavlen får du oversikt over topp 5 i klassen og deres poeng samt beste streak. Her kan du også se din egen plassering.

NB! Alle elever har forhånds-genererte brukernavn, så man er anonym seg i mellom.

#	Brukernavn	Poeng	Beste Streak
1.	oskar	750	8 🔥
2.	magnus	250	2 🔥
3.	ankha	100	1 🔥
4.	synne	0	0 🔥
5.	hilde	0	0 🔥

magnus tirsdag 14. mars Logg ut

skilspriint

Oppgaver Ledertavle Prestasjoner Innsikt 250 p 1

Prestasjoner.
Fullfør ulike prestasjoner og oppnå ekstrapoeng på veien.

SKOLEBUSS 2 av 3 Fullfør 3 oppgaver på rad	SOLSYSTEM 2 av 5 Fullfør 5 oppgaver på rad
ATOM 2 av 5 Fullfør 5 oppgaver på rad	STAFFELI 2 av 7 Fullfør 7 oppgaver på rad
ID-KORT 2 av 10 Fullfør 10 oppgaver på rad	BRILLER 1 av 1 Les din første oppgave
GLOBUS 3 av 5 Fullfør 5 oppgaver	SKULPTUR 3 av 10 Fullfør 10 oppgaver
MEDALJE 3 av 15 Fullfør 15 oppgaver	MESTER 3 av 20 Fullfør 20 oppgaver
PAPIRFLY 0 av 1 Fullfør en hel kategori	EKSAMEN 0 av 5 Fullfør alle 5 kategoriene
DIPLOM 3 av 4 Les en oppgave i hver kategori	

magnus tirsdag 14. mars Logg ut



J Pre-questionnaire



Skjemaet skal være anonymt. [Vis mer](#) ▾

SkillSprint: Pre-test

0 %

Obligatoriske felter er merket med stjerne *

SkillSprint: Pre-test

Estimert tid på å fullføre undersøkelsen: **5 minutter**.

Som en del av masteroppgaven vår, undersøker vi hvordan ulike spillelementer og en applikasjon vi har utviklet, påvirker ungdoms motivasjon knyttet til repetisjon i matematikk.

Dersom du har spørsmål knyttet til studien, spørreskjemaet eller annet, kan du ta kontakt med Magnus på magnulho@stud.ntnu.no.

[Neste side](#)

 **NTNU** Ansvarlig for skjemaet: magnulho@stud.ntnu.no

 **Nettskjema** VILKÅR NETTSKJEMA ER UTVIKLET OG DESIGNET AV
[Personvern og vilkår for bruk](#) [Universitetet i Oslo](#)
[Informasjonskapsler](#)
[Tilgjengelighetserklæring](#)

Skillsprint: Pre-test

50 %

Obligatoriske felter er merket med stjerne *

Personopplysninger

Her ønsker vi å vite litt om din erfaring med liknende applikasjoner, dataspill og generelle holdning til matematikk og repetisjon. NB! Du er anonym til enhver tid.

Hva var brukernavnet ditt? *

Brukernavnet du fikk utdelt og logget inn med på skillsprint.no står også nede til venstre i footeren på nettsiden.

Hvilket kjønn identifiserer du deg med? *

Gutt

Jente

Annet

Har du tidligere brukt en applikasjon med spill-elementer for å repetere matematikk? *

Velg det som er mest presist.

Eksempler kan være Khan Academy, Prodigy, Euclidean, SplashLearn, DreamBox

Aldri

1 - 5 ganger

6 - 9 ganger

10 eller flere ganger

Hvor mange timer bruker du på å spille i løpet av en uke? *

Mobilspill, PC-spill, PlayStation, X-Box osv.

0 timer

1 - 5 timer

6 - 9 timer

10 timer eller mer

I hvor stor grad er du enig i de følgende påstandene?

Om repetisjon, matematikk og repetisjon i matematikk.

	Svært uenig	Uenig	Nøytral	Enig	Svært enig
Jeg liker matematikk *	<input type="radio"/>	<input type="radio"/>	<input type="radio"/>	<input type="radio"/>	<input type="radio"/>
Jeg liker øvingstimer i matematikk der jeg kan jobbe fritt med relevante oppgaver *	<input type="radio"/>	<input type="radio"/>	<input type="radio"/>	<input type="radio"/>	<input type="radio"/>
Jeg lærer mye av repetisjon *	<input type="radio"/>	<input type="radio"/>	<input type="radio"/>	<input type="radio"/>	<input type="radio"/>
Jeg liker å jobbe med repetisjonsoppgaver i matematikk *	<input type="radio"/>	<input type="radio"/>	<input type="radio"/>	<input type="radio"/>	<input type="radio"/>

Spiller-typer

Nå kommer det en del påstander som skal kartlegge hvilken spiller-type du er. Svar så ærlig som mulig.

I hvor stor grad er du enig i de følgende påstandene?

	Svært uenig	Uenig	Nøytral	Enig	Svært enig
Jeg blir glad hvis jeg kan hjelpe andre *	<input type="radio"/>	<input type="radio"/>	<input type="radio"/>	<input type="radio"/>	<input type="radio"/>
Jeg liker å hjelpe andre til å orientere seg i nye situasjoner *	<input type="radio"/>	<input type="radio"/>	<input type="radio"/>	<input type="radio"/>	<input type="radio"/>
Jeg liker å dele egen kunnskap *	<input type="radio"/>	<input type="radio"/>	<input type="radio"/>	<input type="radio"/>	<input type="radio"/>
Andres velvære er viktig for meg *	<input type="radio"/>	<input type="radio"/>	<input type="radio"/>	<input type="radio"/>	<input type="radio"/>

I hvor stor grad er du enig i de følgende påstandene?

	Svært uenig	Uenig	Nøytral	Enig	Svært enig
Å interagere med andre er viktig for meg *	<input type="radio"/>	<input type="radio"/>	<input type="radio"/>	<input type="radio"/>	<input type="radio"/>
Jeg liker å være en del av laget *	<input type="radio"/>	<input type="radio"/>	<input type="radio"/>	<input type="radio"/>	<input type="radio"/>
Det er viktig for meg å føle at jeg er en del av samfunnet *	<input type="radio"/>	<input type="radio"/>	<input type="radio"/>	<input type="radio"/>	<input type="radio"/>
Jeg liker gruppeaktiviteter *	<input type="radio"/>	<input type="radio"/>	<input type="radio"/>	<input type="radio"/>	<input type="radio"/>

I hvor stor grad er du enig i de følgende påstandene?

	Svært uenig	Uenig	Nøytral	Enig	Svært enig
Det er viktig for meg å gå min egen vei *	<input type="radio"/>	<input type="radio"/>	<input type="radio"/>	<input type="radio"/>	<input type="radio"/>
Jeg lar ofte nysgjerrigheten min lede meg *	<input type="radio"/>	<input type="radio"/>	<input type="radio"/>	<input type="radio"/>	<input type="radio"/>
Jeg liker å prøve nye ting *	<input type="radio"/>	<input type="radio"/>	<input type="radio"/>	<input type="radio"/>	<input type="radio"/>
Å være selvstendig er viktig for meg *	<input type="radio"/>	<input type="radio"/>	<input type="radio"/>	<input type="radio"/>	<input type="radio"/>

I hvor stor grad er du enig i de følgende påstandene?

	Svært uenig	Uenig	Nøytral	Enig	Svært enig
Jeg liker å overkomme hindringer *	<input type="radio"/>	<input type="radio"/>	<input type="radio"/>	<input type="radio"/>	<input type="radio"/>
Det er viktig for meg å alltid fullføre ting jeg har begynt på *	<input type="radio"/>	<input type="radio"/>	<input type="radio"/>	<input type="radio"/>	<input type="radio"/>
Det er vanskelig for meg å gi slipp på noe før jeg har funnet en løsning *	<input type="radio"/>	<input type="radio"/>	<input type="radio"/>	<input type="radio"/>	<input type="radio"/>
Jeg liker å mestre vanskelige oppgaver *	<input type="radio"/>	<input type="radio"/>	<input type="radio"/>	<input type="radio"/>	<input type="radio"/>

I hvor stor grad er du enig i de følgende påstandene?

	Svært uenig	Uenig	Nøytral	Enig	Svært enig
Jeg liker å provosere *	<input type="radio"/>	<input type="radio"/>	<input type="radio"/>	<input type="radio"/>	<input type="radio"/>
Jeg liker å utfordre hvorfor ting er som de er *	<input type="radio"/>	<input type="radio"/>	<input type="radio"/>	<input type="radio"/>	<input type="radio"/>
Jeg ser på meg selv som en rebell *	<input type="radio"/>	<input type="radio"/>	<input type="radio"/>	<input type="radio"/>	<input type="radio"/>
Jeg misliker å følge regler *	<input type="radio"/>	<input type="radio"/>	<input type="radio"/>	<input type="radio"/>	<input type="radio"/>

I hvor stor grad er du enig i de følgende påstandene?

	Svært uenig	Uenig	Nøytral	Enig	Svært enig
Jeg liker konkurranser der det er en belønning *	<input type="radio"/>	<input type="radio"/>	<input type="radio"/>	<input type="radio"/>	<input type="radio"/>
Belønninger er en god måte å motivere meg på *	<input type="radio"/>	<input type="radio"/>	<input type="radio"/>	<input type="radio"/>	<input type="radio"/>
Å få tilbake for noe jeg har gjort er viktig for meg *	<input type="radio"/>	<input type="radio"/>	<input type="radio"/>	<input type="radio"/>	<input type="radio"/>
Om belønningen er tilstrekkelig god, vil jeg legge inn innsatsen *	<input type="radio"/>	<input type="radio"/>	<input type="radio"/>	<input type="radio"/>	<input type="radio"/>

Forrige side

Send



Ansvarlig for skjemaet: magnulho@stud.ntnu.no



VILKÅR

[Personvern og vilkår for bruk](#)
[Informasjonskapsler](#)
[Tilgjengelighetserklæring](#)

NETTSKJEMA ER UTVIKLET OG DESIGNET AV

[Universitetet i Oslo](#)

K Post-questionnaire



Skjemaet skal være anonymt. [Vis mer](#) ▾

SkillSprint: Post-test

0 %

Obligatoriske felter er merket med stjerne *

SkillSprint: Post-test

Estimert tid på å fullføre undersøkelsen: **10 minutter**.

Som en del av masteroppgaven vår, undersøker vi hvordan ulike spillelementer og en applikasjon vi har utviklet, påvirker ungdoms motivasjon knyttet til repetisjon i matematikk.

Dersom du har spørsmål knyttet til studien, spørreskjemaet eller annet, kan du ta kontakt med Magnus på magnulho@stud.ntnu.no.

[Neste side](#)

 **NTNU** Ansvarlig for skjemaet: magnulho@stud.ntnu.no

 **Nettskjema** VILKÅR NETTSKJEMA ER UTVIKLET OG DESIGNET AV
[Personvern og vilkår for bruk](#) [Universitetet i Oslo](#)
[Informasjonskapsler](#)
[Tilgjengelighetserklæring](#)

Skjemaet skal være anonymt. [Vis mer](#) ▾

SkillSprint: Post-test

20 %

Obligatoriske felter er merket med stjerne *

Hva var brukernavnet ditt? *

Brukernavnet du fikk utdelt og logget inn med på skillsprint.no står også nede til venstre i footeren på nettsiden.

[Forrige side](#)

[Neste side](#)

Skillsprint: Post-test

40 %

Obligatoriske felter er merket med stjerne *

Interesse for Skillsprint.no

I denne delen av undersøkelsen kommer det en rekke spørsmål om Skillsprint.no som en helhet.

I hvor stor grad er du enig i de følgende påstandene?

	Svært uenig	Uenig	Nøytral	Enig	Svært enig
Det var gøy å bruke Skillsprint *	<input type="radio"/>	<input type="radio"/>	<input type="radio"/>	<input type="radio"/>	<input type="radio"/>
Jeg likte å bruke Skillsprint veldig godt *	<input type="radio"/>	<input type="radio"/>	<input type="radio"/>	<input type="radio"/>	<input type="radio"/>
Jeg synes det var ganske underholdende å bruke Skillsprint *	<input type="radio"/>	<input type="radio"/>	<input type="radio"/>	<input type="radio"/>	<input type="radio"/>
Jeg vil beskrive å bruke Skillsprint som veldig interessant *	<input type="radio"/>	<input type="radio"/>	<input type="radio"/>	<input type="radio"/>	<input type="radio"/>
Da jeg brukte Skillsprint, tenkte jeg på hvor mye jeg likte det *	<input type="radio"/>	<input type="radio"/>	<input type="radio"/>	<input type="radio"/>	<input type="radio"/>

I hvor stor grad er du enig i de følgende påstandene?

	Svært uenig	Uenig	Nøytral	Enig	Svært enig
Jeg er tilfreds med min prestasjon på Skillsprint *	<input type="radio"/>	<input type="radio"/>	<input type="radio"/>	<input type="radio"/>	<input type="radio"/>
Jeg var ganske dyktig i bruken av Skillsprint *	<input type="radio"/>	<input type="radio"/>	<input type="radio"/>	<input type="radio"/>	<input type="radio"/>
Jeg synes jeg var ganske flink til å bruke Skillsprint *	<input type="radio"/>	<input type="radio"/>	<input type="radio"/>	<input type="radio"/>	<input type="radio"/>
Etter å ha brukt Skillsprint en stund, så følte jeg meg kompetent *	<input type="radio"/>	<input type="radio"/>	<input type="radio"/>	<input type="radio"/>	<input type="radio"/>

I hvor stor grad er du enig i de følgende påstandene?

	Svært uenig	Uenig	Nøytral	Enig	Svært enig
Jeg brukte SkillSprint fordi jeg ikke hadde noe valg. *	<input type="radio"/>	<input type="radio"/>	<input type="radio"/>	<input type="radio"/>	<input type="radio"/>
Jeg hadde ikke noe valg når det kom til å bruke SkillSprint *	<input type="radio"/>	<input type="radio"/>	<input type="radio"/>	<input type="radio"/>	<input type="radio"/>
Jeg brukte SkillSprint fordi jeg måtte *	<input type="radio"/>	<input type="radio"/>	<input type="radio"/>	<input type="radio"/>	<input type="radio"/>
Jeg følte at jeg måtte bruke SkillSprint *	<input type="radio"/>	<input type="radio"/>	<input type="radio"/>	<input type="radio"/>	<input type="radio"/>
Jeg følte at det ikke var mitt valg å bruke SkillSprint *	<input type="radio"/>	<input type="radio"/>	<input type="radio"/>	<input type="radio"/>	<input type="radio"/>
Jeg tror jeg hadde et valg angående å bruke SkillSprint *	<input type="radio"/>	<input type="radio"/>	<input type="radio"/>	<input type="radio"/>	<input type="radio"/>

I hvor stor grad er du enig i de følgende påstandene?

	Svært uenig	Uenig	Nøytral	Enig	Svært enig
Jeg hadde foretrukket å ikke sammenligne med meg klassekamerater på SkillSprint i fremtiden *	<input type="radio"/>	<input type="radio"/>	<input type="radio"/>	<input type="radio"/>	<input type="radio"/>
Jeg følte på avstand til klassekameratene mine da jeg brukte SkillSprint *	<input type="radio"/>	<input type="radio"/>	<input type="radio"/>	<input type="radio"/>	<input type="radio"/>
Det er sannsynlig at gjennom bruk av SkillSprint kan klassekameratene mine og jeg bli bedre venner om vi samarbeidet mye *	<input type="radio"/>	<input type="radio"/>	<input type="radio"/>	<input type="radio"/>	<input type="radio"/>

Forrige side

Neste side

Skjemaet skal være anonymt. [Vis mer](#) ▾

SkillSprint: Post-test

60 %

Obligatoriske felter er merket med stjerne *

Motivasjon

I denne delen av spørreundersøkelsen ønsker vi å finne ut av hvordan du opplevde at de ulike spill-elementene påvirket motivasjonen din i denne øvingstimen.

Med tanke på SkillSprint som en helhet, ta utgangspunkt i utsagnet under og svar det som passer best.

På grunn av SkillSprint, ble jeg i denne øvingstimen i matematikk [Mye mindre, Mindre, Nøytral, Mer, Mye Mer] motivert til å jobbe og løse flere oppgaver enn jeg vanligvis ville vært i en øvingstime.

	Mye Mindre	Mindre	Verken Mindre eller Mer	Mer	Mye Mer
SkillSprint *	<input type="radio"/>	<input type="radio"/>	<input type="radio"/>	<input type="radio"/>	<input type="radio"/>

Ta utgangspunkt i utsagnet under og svar det som passer best.

På grunn av Ledertavlen i SkillSprint, ble jeg i denne øvingstimen i matematikk [Mye mindre, Mindre, Nøytral, Mer, Mye Mer] motivert til å jobbe og løse flere oppgaver enn jeg vanligvis ville vært i en øvingstime.

Dagens økt **Sammenlagt**

#	Brukernavn	Poeng	Beste Streak
1.	magnus	1275	7 🔥
2.	annika	975	4 🔥
3.	oskar	875	9 🔥
4.	synne	0	0 🔥
5.	Nlde	0	0 🔥

	Mye Mindre	Mindre	Verken Mindre eller Mer	Mer	Mye Mer
Ledertavle *	<input type="radio"/>	<input type="radio"/>	<input type="radio"/>	<input type="radio"/>	<input type="radio"/>

På grunn av **Prestasjoner** i SkillSprint, ble jeg i denne øvingstimen i matematikk [Mye mindre, Mindre, Nøytral, Mer, Mye Mer] motivert til å jobbe og løse flere oppgaver enn jeg vanligvis ville vært i en øvingstime.



Verken Mindre eller Mer

Mye Mindre Mindre Verken Mindre eller Mer Mer Mye Mer

Prestasjoner *

På grunn av **Poeng** i SkillSprint, ble jeg i denne øvingstimen i matematikk [Mye mindre, Mindre, Nøytral, Mer, Mye Mer] motivert til å jobbe og løse flere oppgaver enn jeg vanligvis ville vært i en øvingstime.



Verken Mindre eller Mer

Mye Mindre Mindre Verken Mindre eller Mer Mer Mye Mer

Poeng *

På grunn av **Streaks** i SkillSprint, ble jeg i denne øvingstimen i matematikk [Mye mindre, Mindre, Nøytral, Mer, Mye Mer] motivert til å jobbe og løse flere oppgaver enn jeg vanligvis ville vært i en øvingstime.



Verken Mindre eller Mer

Mye Mindre Mindre Verken Mindre eller Mer Mer Mye Mer

Streaks *

På grunn av **Grafen for sammenlikning av poeng** i SkillSprint, ble jeg i denne øvingstimen i matematikk [Mye mindre, Mindre, Nøytral, Mer, Mye Mer] motivert til å jobbe og løse flere oppgaver enn jeg vanligvis ville vært i en øvingstime.

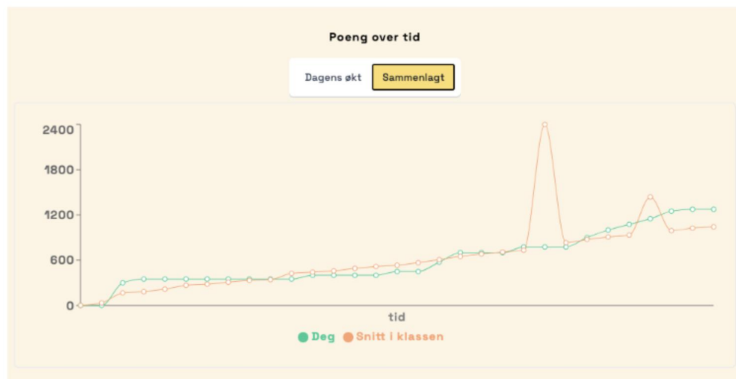

Verken
Mindre eller
Mer

Mye Mindre Mindre Mer Mye Mer

Graf for sammenlikning av poeng *

På grunn av **Grafen for svar og antall forsøk per oppgave** i SkillSprint, ble jeg i denne øvingstimen i matematikk [Mye mindre, Mindre, Nøytral, Mer, Mye Mer] motivert til å jobbe og løse flere oppgaver enn jeg vanligvis ville vært i en øvingstime.

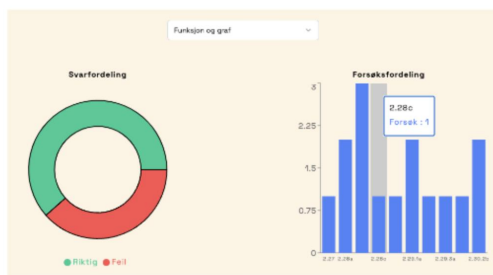

Verken
Mindre eller
Mer

Mye Mindre Mindre Mer Mye Mer

Grafen for svar *

Grafen for antall forsøk per oppgave *

På grunn av **Graf for fordeling av kategorier** i SkillSprint, ble jeg i denne øvingstimen i matematikk [Mye mindre, Mindre, Nøytral, Mer, Mye Mer] motivert til å jobbe og løse flere oppgaver enn jeg vanligvis ville vært i en øvingstime.

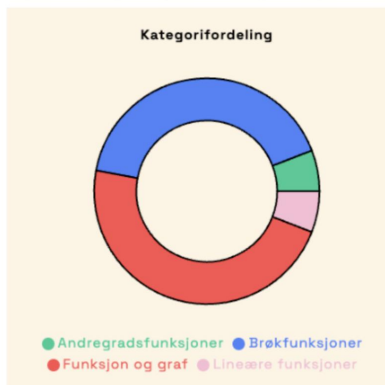

	Mye Mindre	Mindre	Verken Mindre eller Mer	Mer	Mye Mer
Grafen for fordeling av kategorier *	<input type="radio"/>	<input type="radio"/>	<input type="radio"/>	<input type="radio"/>	<input type="radio"/>

På grunn av **Tidspresset ved å bare kunne jobbe en kort periode for å få poeng** i SkillSprint, ble jeg i denne øvingstimen i matematikk [Mye mindre, Mindre, Nøytral, Mer, Mye Mer] motivert til å jobbe og løse flere oppgaver enn jeg vanligvis ville vært i en øvingstime.

	Mye Mindre	Mindre	Verken Mindre eller Mer	Mer	Mye Mer
Tidspress *	<input type="radio"/>	<input type="radio"/>	<input type="radio"/>	<input type="radio"/>	<input type="radio"/>

På grunn av **Animasjoner (konfetti på korrekt svar, grafer som beveger seg når de laster inn etc.)** i SkillSprint, ble jeg i denne øvingstimen i matematikk [Mye mindre, Mindre, Nøytral, Mer, Mye Mer] motivert til å jobbe og løse flere oppgaver enn jeg vanligvis ville vært i en øvingstime.

	Mye Mindre	Mindre	Verken Mindre eller Mer	Mer	Mye Mer
Animasjoner *	<input type="radio"/>	<input type="radio"/>	<input type="radio"/>	<input type="radio"/>	<input type="radio"/>

Forrige side

Neste side

SkillSprint: Post-test

80 %

Obligatoriske felter er merket med stjerne *

Systemets brukervennlighet

I hvor stor grad er du enig i de følgende påstandene?

	Svært uenig	Uenig	Nøytral	Enig	Svært enig
Jeg kunne tenkt meg å bruke SkillSprint oftere *	<input type="radio"/>	<input type="radio"/>	<input type="radio"/>	<input type="radio"/>	<input type="radio"/>
Jeg synes SkillSprint er unødvendig komplisert *	<input type="radio"/>	<input type="radio"/>	<input type="radio"/>	<input type="radio"/>	<input type="radio"/>
Jeg synes SkillSprint var lett å bruke *	<input type="radio"/>	<input type="radio"/>	<input type="radio"/>	<input type="radio"/>	<input type="radio"/>
Jeg tror jeg ville måtte trenge hjelp fra en person med teknisk kunnskap for å kunne bruke SkillSprint *	<input type="radio"/>	<input type="radio"/>	<input type="radio"/>	<input type="radio"/>	<input type="radio"/>
Jeg synes de forskjellige delene i SkillSprint hang godt sammen *	<input type="radio"/>	<input type="radio"/>	<input type="radio"/>	<input type="radio"/>	<input type="radio"/>
Jeg syntes det var for mye inkonsistens i SkillSprint, jeg opplevde det ulogisk *	<input type="radio"/>	<input type="radio"/>	<input type="radio"/>	<input type="radio"/>	<input type="radio"/>
Jeg innbiller meg at folk flest kan lære seg SkillSprint veldig raskt *	<input type="radio"/>	<input type="radio"/>	<input type="radio"/>	<input type="radio"/>	<input type="radio"/>
Jeg synes SkillSprint er veldig tungvint å bruke *	<input type="radio"/>	<input type="radio"/>	<input type="radio"/>	<input type="radio"/>	<input type="radio"/>
Jeg føler meg sikker når jeg bruker SkillSprint *	<input type="radio"/>	<input type="radio"/>	<input type="radio"/>	<input type="radio"/>	<input type="radio"/>
Jeg trenger å lære meg mye før jeg kan komme i gang med SkillSprint *	<input type="radio"/>	<input type="radio"/>	<input type="radio"/>	<input type="radio"/>	<input type="radio"/>

