

Vemund Hjertvik Lenes

# Optimal performance of a housing cooperative with PV and smart use of electric water heaters

Master's thesis in Energy and Environmental Engineering

Supervisor: Karen Byskov Lindberg

June 2023



Vemund Hjertvik Lenes

# **Optimal performance of a housing cooperative with PV and smart use of electric water heaters**

Master's thesis in Energy and Environmental Engineering  
Supervisor: Karen Byskov Lindberg  
June 2023

Norwegian University of Science and Technology  
Faculty of Information Technology and Electrical Engineering  
Department of Electric Power Engineering





---

# Abstract

Norway is projected to experience a substantial increase in electricity consumption by 2050, along with a potential peak power capacity deficit in the near future. The building sector is identified to have significant potential for reducing the peak power by using electricity flexibly. In addition, solar power presents an opportunity to meet future electricity demands while aligning with Norway's emission reduction goals. One promising solution involves combining solar power with water heaters to optimize energy consumption, reducing the operating cost as well as the stress on the grid. This study investigates the technical viability and profitability of this solution within the Norwegian power market context.

To quantify and assess the benefit of optimal electric water heater (EWH) control and solar panels, a linear optimization model was developed to analyze the heating strategy of hot water and evaluate its profitability. The model considered scenarios with and without local solar power production to evaluate the benefits of integrating these technologies. The model considers electricity consumption data gathered in the GreenCharge project, as well as simulated hot water consumption and solar panel power generation profiles.

The results indicate that smart control of EWHs can effectively reduce operational costs and peak power imports. The optimization analysis reveals potential cost savings of 6.7% through operational optimization and 26.4% by lowering the hot water temperature. Furthermore, the incorporation of solar power generation enhances the flexibility of the water heaters, leading to additional cost savings of 12.5% to 38%, depending on the hot water temperature and the presence of a fixed load. These savings primarily arise from reduced peak power tariffs rather than operational costs. However, it should be noted that the model assumes perfect information, which may not be attainable in practice, affecting the achievable savings.

In addition to cost reduction, the study also examines the potential for reducing peak power imports. The peak power import reduction is a result of the cost-optimal solution which considers the peak power tariff. The results demonstrate a significant decrease in peak power imports, ranging from 15% to 64% when considering EWHs in isolation. Incorporating solar power generation and a fixed load further enhances the reduction potential. The water heater can be completely turned off during peak fixed power import hours, thus reducing its contribution to the peak by 100%. The analysis highlights the complexity of heating strategies, which are highly dependent on specific scenarios and access to accurate information. Naive strategies can lead to increased costs and peak power usage. Therefore, it is crucial to tailor the heating approach to the unique circumstances of each case.

When evaluating the profitability of the technologies, it becomes evident that there is greater potential for cost savings through solar power integration than through smart control of EWHs alone. The study shows maximum savings of 25,000 NOK per year (4.3% of the total power bill) through optimal control, including a reduction in hot water temperature. This revenue is also highly uncertain and relies on perfect information. Contrary, solar power investments can yield savings of up to 36,000 NOK per year with higher certainty. The profitability of solar power investment is dependent on the ability to increase self-consumption rates by virtually sharing power. At low self-consumption rates, solar power investment may not be financially viable, considering the assumed spot prices, tariffs, and investment costs.

Overall, the findings emphasize the potential benefits of optimal control of EWHs and the integration of solar power in the Norwegian power market. The results underscore the importance of considering specific use cases and available information when designing heating strategies. Moreover, while cost reduction in operation is feasible, the majority of savings are derived from reduced peak power tariffs which depend on the perfect knowledge about the monthly peak load. This study provides insights into the technological and economic aspects of solar power and smart water heater control.

---

# Sammendrag

Det forventes en betydelig økning i elektrisitetsforbruket i Norge innen 2050 og en mulig kraftmangel i nær fremtid. Byggesektoren er identifisert som et område med betydelig potensial for å redusere strømforbruket i topper ved å bruke elektrisitet fleksibelt. I tillegg gir solenergi en mulighet til å møte fremtidige krav til elektrisitet samtidig som man oppfyller Norges mål om utslippsreduksjon. En lovende løsning innebærer å kombinere solenergi med varmtvannsberedere for å optimalisere energiforbruket, redusere driftskostnader og belastningen på strømmettet. Denne studien undersøker den tekniske gjennomførbarheten og lønnsomheten av disse teknologiene.

For å kvantifisere og vurdere fordelene med optimal styring av elektriske varmtvannsberedere og solcellepaneler, er det utviklet en lineær optimaliseringsmodell for å analysere oppvarmingsstrategien for varmtvann og evaluere lønnsomheten. Modellen vurderer scenarier med og uten lokal solenergiproduksjon og en inelastisk last for å evaluere ulike scenarier. Modellen tar hensyn til elektrisitetsforbruksdata samlet inn i GreenCharge-prosjektet, samt simulerte data for varmtvannsforbruk og solcellepanelers kraftgenerasjon.

Resultatene indikerer at smart styring av elektriske varmtvannsberedere kan redusere driftskostnader og import av strøm under strømtopper. Optimeringsanalysen viser mulige kostnadsbesparelser på 6,7% gjennom driftsoptimalisering og opp til 26,4% ved å senke varmtvannstemperaturen. Videre bidrar solenergiproduksjon til økt fleksibilitet i varmtvannsberederne, noe som gir ytterligere kostnadsbesparelser på 12,5% til 38%, avhengig av varmtvannstemperaturen og inkluderingen av en inelastisk last. Disse besparelsene skyldes primært redusert effekttariff. Det bør imidlertid bemerkes at modellen antar perfekt informasjon, noe som kanskje ikke er oppnåelig i praksis og kan påvirke de oppnåelige besparelsene.

I tillegg til kostnadsreduksjon, undersøker studien potensialet for å redusere importen av strøm under effekttopper. Reduksjonen i import av strøm under strømtopper er et resultat av den kostnadsoptimale løsningen som tar hensyn til effekttariffen. Resultatene viser en betydelig reduksjon i importen av strøm under strømtopper, som varierer fra 15% til 64% når kun varmtvannsberedere vurderes isolert. Ved å inkludere solenergiproduksjon og en inelastisk last blir potensialet for å redusere effekttoppene enda høyere. Varmtvannsberederen kan slås helt av under timer med høy inelastisk import av strøm, noe som reduserer varmtvannsberederens bidrag til effekttoppen med 100%. Analysen forklarer kompleksiteten i oppvarmingsstrategier, som er sterkt avhengig av spesifikke scenarier og tilgangen til nøyaktig informasjon. Simple strategier kan føre til økte kostnader og bruk av strøm under strømtopper. Derfor er det avgjørende å tilpasse oppvarmingsmetoden til brukeren.

Ved vurdering av lønnsomheten til teknologiene blir det tydelig at det er større potensial for kostnadsbesparelser gjennom investering i solcellepaneler enn med smart styring av varmtvannsberedere. Studien viser maksimale besparelser på 25 000 NOK per år (4,3% av den totale strømregningen) gjennom optimal styring, inkludert en reduksjon i varmtvannstemperaturen. Denne inntekten er også svært usikker og avhenger av perfekt informasjon. Til sammenligning kan solenergiinvesteringer uten optimering gi besparelser på opptil 36 000 NOK per år med høyere grad av sikkerhet. Lønnsomheten av solenergiinvesteringen avhenger av høyt selvforbruk som oppnås ved virtuell strømdeling. Ved lavt selvforbruk blir solenergi ikke lønnsomhet med de antatte spotprisene, tariffene og investeringskostnad.

Resultatene viser mulige fordeler med optimal styring av varmtvannsberedere og integrasjon av solenergi i det norske kraftmarkedet. Resultatene understreker viktigheten av å vurdere spesifikke bruk og tilgjengelig informasjon ved utformingen av oppvarmingsstrategier. Selv om det er noe kostnadsreduksjon ved å styre varmtvannsberederne best mulig, så kommer mesteparten av besparelsen fra reduksjon i effekttariffen, som er avhengig av den perfekte informasjonen om månedlig maks effekt.

---

# Preface

I am grateful to my main supervisor, Karen Byskov Lindberg, for her valuable guidance, discussions, and engagement throughout this master's thesis. I also want to express my thanks to Kjersti Berg at SINTEF for being an excellent discussion partner. Special appreciation goes to Mari Lauglo and Martin Høydal from Norconsult for sharing their knowledge and providing valuable input. I would like to acknowledge the contribution of Røverkollen housing cooperative for providing the necessary data.

Lastly, I want to extend my appreciation to all my family and friends for their constant encouragement and inspiration. Without the support and contributions of these individuals, this thesis would not have been possible.

Trondheim, June 2021

Vemund Hjertvik Lenes

---

# Table of Contents

<b>Abstract</b>	<b>i</b>
<b>Sammendrag</b>	<b>ii</b>
<b>Preface</b>	<b>iii</b>
<b>List of Figures</b>	<b>vi</b>
<b>List of Tables</b>	<b>ix</b>
<b>Abbreviations</b>	<b>x</b>
<b>1 Introduction</b>	<b>1</b>
1.1 Motivation . . . . .	1
1.2 Scope . . . . .	1
1.3 Limitations . . . . .	2
1.4 Structure . . . . .	2
<b>2 Background</b>	<b>3</b>
2.1 Flexibility . . . . .	3
2.1.1 Flexibility in building energy usage . . . . .	3
2.2 Air-source heat pump water heater . . . . .	4
2.2.1 Legionella . . . . .	5
2.2.2 Water heater flexibility . . . . .	5
2.3 Solar power - Norway . . . . .	7
2.3.1 Impact on power market . . . . .	7
2.3.2 Power grid considerations . . . . .	9
2.3.3 Solar power regulation . . . . .	10
2.3.4 PV investment . . . . .	11
2.4 Solar power and water heating . . . . .	11
2.5 Norwegian grid tariffs and taxes . . . . .	12
2.5.1 Elvia - grid tariffs . . . . .	13
2.6 Linear optimization . . . . .	13
2.7 Summary PV and water heater flexibility . . . . .	14
<b>3 Røverkollen data</b>	<b>15</b>
3.1 Data overview . . . . .	15



---

3.2	EWH . . . . .	15
3.2.1	EWH and HCC . . . . .	18
3.3	Apartments . . . . .	19
3.4	Solar power . . . . .	19
<b>4</b>	<b>Data simulation</b>	<b>21</b>
4.1	Solar power . . . . .	21
4.2	Synthetic hot water consumption profiles . . . . .	23
4.2.1	Modelled and measured EWH power consumption . . . . .	24
4.3	Spotprices . . . . .	25
<b>5</b>	<b>Optimization model</b>	<b>27</b>
5.1	EWH . . . . .	27
5.1.1	Heat pump modelling . . . . .	27
5.2	Optimization time-horizon . . . . .	28
5.3	Sets . . . . .	28
5.4	Parameters . . . . .	29
5.5	Variables . . . . .	29
5.6	System limit . . . . .	29
5.7	Objective function . . . . .	30
5.8	Constraints . . . . .	31
<b>6</b>	<b>Results</b>	<b>33</b>
6.1	Comparison to measured data . . . . .	33
6.1.1	HP heating capacity . . . . .	35
6.2	EWH alone . . . . .	36
6.3	EWH alone and PV included . . . . .	37
6.4	Apartments' electric consumption included . . . . .	41
6.5	Apartments' electricity consumption and PV included . . . . .	42
6.6	Strategy comparison - apartment power consumption included and excluded . . . . .	44
6.7	Strategy comparison - PV included and excluded . . . . .	45
6.7.1	EWH alone . . . . .	45
6.7.2	EWH and apartment electricity consumption . . . . .	49
6.8	KPI summary . . . . .	49
6.9	Maximum grid export . . . . .	50
6.10	Sensitivity analysis - volume . . . . .	51

---

---

<b>7</b>	<b>Discussion</b>	<b>52</b>
7.1	Financial benefits of optimal control . . . . .	52
7.2	Grid benefits of optimal control . . . . .	52
7.3	Water heating strategy . . . . .	53
7.3.1	Heating during hot water consumption . . . . .	53
7.3.2	PV . . . . .	53
7.3.3	Heating element power limitation . . . . .	54
7.3.4	Lower temperature limit . . . . .	54
7.4	Solar power investment . . . . .	54
7.4.1	Model simplifications . . . . .	55
7.5	Viability of results . . . . .	55
<b>8</b>	<b>Conclusion</b>	<b>57</b>
<b>9</b>	<b>Further work</b>	<b>58</b>
9.1	Flexible and uncertain load . . . . .	58
9.2	More detailed EWH simulation . . . . .	58
	<b>Bibliography</b>	<b>59</b>
	<b>Appendix</b>	<b>63</b>
A	EWH typical power consumption profiles . . . . .	63
B	Røverkollen measured data . . . . .	65
C	HP heat capacity . . . . .	65
D	PV and no-PV . . . . .	66
E	Apartments and PV . . . . .	67
E.1	SSR and SCR . . . . .	67
F	Apt vs no apt . . . . .	68
G	EWH losses . . . . .	68
H	Code . . . . .	68
H.1	Optimization model . . . . .	68
H.2	Parameters . . . . .	74
	<b>List of Figures</b>	
1	Flexibility strategies [29] . . . . .	3
2	COP plotted against temperature difference [4] . . . . .	4

---

---

3	COP and water temperature relationship [21] . . . . .	6
4	Example of rebound peaks[27] . . . . .	7
5	Merit order effect illustration . . . . .	8
6	Solar power market value[57] . . . . .	9
7	Solar power market price and LCOE[22] . . . . .	9
8	Solar power - customer and market relation . . . . .	10
9	Example EWH power consumption and PV generation [12] . . . . .	12
10	Røverkollen data overview . . . . .	15
11	EWH power consumption 2021[28] . . . . .	16
12	EWH power consumption August 2021[28] . . . . .	16
13	EWH and HCC usage 2021 . . . . .	18
14	HWT and HCC electricity usage - hourly average April 2021 . . . . .	18
15	HWT, HCC and APT electricity usage Hourly average April 202 . . . . .	19
16	Apartments' measured monthly max import during 2021 . . . . .	19
17	Measured PV power generation 2021 [28] . . . . .	20
18	Shading model for PV generation . . . . .	21
19	Horizon at Røverkollen . . . . .	22
20	Simulated and measured power profile Annual to the right and example days in April to the left . . . . .	23
21	Modelled and measured (HW-MDH-2006) EWH power consumption in [60] . . . . .	24
22	Modelled and measured (EL-SEA-2007) EWH power consumption in [60] . . . . .	25
23	Synthetic and measured profiles from April [27] . . . . .	25
24	Sketch of a KWSmart system [17] . . . . .	28
25	Power flow and notation . . . . .	30
26	Measured and optimized HE and HP power consumption - hourly average in April . . . . .	34
27	Measured and optimized HE and HP power consumption - example days April . . . . .	35
28	Yearly cost breakdown at different flexibility levels . . . . .	36
29	EWH - Monthly max import . . . . .	37
30	EWH_PV - Yearly cost breakdown . . . . .	38
31	EWH_PV - Monthly maximum import . . . . .	39
32	EWH_PV - Monthly SSR . . . . .	40
33	EWH_PV - Monthly SCR . . . . .	40
34	APT - Cost breakdown at different flexibility levels . . . . .	41
35	APT - Monthly max import, case comparison . . . . .	42
36	APT_PV - Cost at different flexibility levels . . . . .	43

---

---

37	APT_PV - Monthly max import, case comparison . . . . .	43
38	EWH cf APT - HWT heating strategy April $T_{min} = 75^{\circ}C$ . . . . .	44
39	EWH cf APT - HWT heating strategy comparison April $T_{min} = 55^{\circ}C$ . . . . .	45
40	EWH cf EWH_PV Optimal strategy at $55^{\circ}C$ in January . . . . .	46
41	EWH cf EWH_PV Optimal strategy at $75^{\circ}C$ in April . . . . .	47
42	EWH cf EWH_PV Optimal strategy comparison at $65^{\circ}C$ in April . . . . .	47
43	EWH cf EWH_PV Optimal strategy comparison at $55^{\circ}C$ in April . . . . .	48
44	EWH cf EWH_PV Optimal strategy comparison at $75^{\circ}C$ in July . . . . .	49
45	Maximum exported power during the year . . . . .	51
46	Reference type and explanation . . . . .	63
47	Volume to energy of different activities [60] . . . . .	64
48	EWH power consumption profiles [52] . . . . .	64
49	EWH power consumption profiles [52] . . . . .	64
50	EWH power consumption profiles [52] . . . . .	65
51	Measured HP and HE power consumption [kWh/h] in April 2021 . . . . .	65
52	Optimal strategy comparison at $65^{\circ}C$ . . . . .	66
53	Optimal strategy comparison at $55^{\circ}C$ . . . . .	66
54	apt_pv - Monthly self sufficiency . . . . .	67
55	apt_pv - Monthly self consumption . . . . .	67
56	HWT heating strategy ewh and apt comparison - April $T_{min} = 65^{\circ}C$ . . . . .	68
57	EWH losses for all scenarios and all cases . . . . .	68

---

## List of Tables

1	Lower HWT temperature limit - regulations and literature . . . . .	5
2	Power taxes in 2023 [34] [6] . . . . .	13
3	Elvia grid tariffs - 2023 [34] . . . . .	13
4	Optimal EWH control benefits . . . . .	14
5	Term distinction . . . . .	15
6	EWH key measurements . . . . .	17
7	Solar power simulation parameters . . . . .	22
8	PV investment annuity and LCOE . . . . .	23
9	Hot water usage profile generation parameters . . . . .	23
10	400l HWT Parameters . . . . .	27
11	HP COP datasheet and estimated values . . . . .	27
12	Sets . . . . .	28
13	Parameters . . . . .	29
14	Variables . . . . .	29
15	Abbreviations . . . . .	33
16	EWH key measurement - EWH base case . . . . .	35
17	Results summary . . . . .	50
18	Sensitivity analysis . . . . .	51
19	EWH key measurement - ewh $T_{min} = 55$ . . . . .	65

---

# Abbreviations

ASHP	Air source heat pump
COP	Coefficient of performance
DHW	District hot water
EWH	Electric water heater
FiT	Feed in tariff
HE	Heating element
HP	Heat pump
HWD	Hot water demand
HWT	Hot water tank
LCOE	Levelized cost of energy
PV	Photovoltaic
SC	Self consumption
SCR	Self consumption rate
SS	Self sufficiency
SSR	Self sufficiency rate

---

# 1 Introduction

## 1.1 Motivation

Norway's estimated electricity consumption in 2050 is between 200 and 250 TWh, a 42-78% increase in just 27 years [11]. Peak power use will also increase in the coming years, and Norway may reach a peak power capacity deficit already in 2027, which will impact all end-users [57]. The building sector is identified to have a lot of potential to reduce total electricity used and power peaks [11]. Buildings accounted for 29% of the total electricity used in 2021 [1], and the Norwegian residential sector consumes the most electricity per building in Europe [8].

Solar power in the residential sector can contribute to meeting the future electricity demand while aligning with Norway's goal to reduce carbon emissions by at least 50% by 2030. However, solar power poses challenges to the grid, which can result in power outages and damage to equipment. By consuming more of the electricity where it is produced, less power will meet the grid. It is also more beneficial to cover own demand than selling it to the grid [28]. One way to reduce power to the grid is to use flexible resources in buildings, which consume power when generated.

Water heaters store a lot of energy and have shown potential as a flexible energy resource without compromising user comfort [43]. By combining PV systems' uncertain power production with the flexibility of water heaters, a study found that electricity imported from the grid to heat water can be reduced by 80%. Furthermore, by including a heat pump the imported electricity was reduced by 90% [12].

The combination of water heaters and solar power shows excellent promise, aiding in meeting increased power demand and possibly reducing power peaks. However, it must be investigated whether or not the solution is technologically viable and profitable in the Norwegian power market context.

## 1.2 Scope

There is a need to develop electricity production in Norway to meet the coming demand, and solar is one of the possible solutions. In addition to increased electricity production, the grid has to be dimensioned to accommodate higher power flow. To keep the grid investment low, a high degree of self-consumption of locally produced power is beneficial [47]. It may be possible to reduce the power exported to the grid by controlling flexible resources.

In 2022, 760 thousand of 2.6 million buildings in Norway were apartment buildings [9]. Since it is possible to reach many end-users with one large-scale investment, these may have a lot of potential to reduce peak power use. As part of the EU's greencharge project, the apartment buildings located in Røverkollen housing cooperative in Oslo gathered energy data related to the electricity consumption of their appliances and heating systems, as well as data on the power usage of their solar panels and air-source heat pump (ASHP) electric water heaters (EWH). Røverkollen housing cooperative has provided the necessary data for the preliminary work of this thesis and has also supplied the data used as input in this study.

So what would a solar power export profile look like if combined with an optimally controlled water heating system? And what is the optimal control of the water heaters at Røverkollen housing cooperative?

It also has to be profitable to stimulate investment in solar power and smart control. Given the current policies in Norway, are Røverkollen housing cooperative's savings substantial enough to justify an investment into solar power and smart control of its water heaters? If not, what factors hinder profitability?

The problem statements can be summarized in 3 research questions:

1. What is the potential for cost reduction and decreasing peak power consumption by con-

---

trolling an ASHP EWH optimally?

2. What is the optimal water heating strategy for an ASHP EWH?
3. How would on-site solar power affect the answer in questions 1 and 2?

### 1.3 Limitations

Røverkollen has collected data on different energy parameters as a part of the H2020 EU project GreenCharge. The data was structured and analyzed as a part of the pre-work to this master thesis and are used as a foundation in the case. However, the data quality was poor for certain meters which led to the following limitations:

- PV power generation was simulated in PVSyst.
- Hot water (HW) power consumption was simulated based on the stochastic load profile model generator developed in [60] and [58].

Due to poor data quality, the apartment block's common electricity consumption is not used in the optimization. These measurements include EWH energy use in addition to lighting, heating, and elevators. They are however analyzed and used for discussion.

The master thesis is written in the context of the Norwegian power market and grid tariff structure.

### 1.4 Structure

**Chapter 2** provides a literature review as well as background theory.

**Chapter 3** presents the data collected by Røverkollen housing cooperative

**Chapter 4** describes the simulated input data used in the modeling

**Chapter 5** shows and explains the optimization model

**Chapter 6** presents the results of selected cases

**Chapter 7** discusses the results based on the research question and literature presented in chapter 2.

**Chapter 8** provides a conclusion to the results and discussion

**Chapter 9** recommends further work based on results and experiences from this thesis.



---

## 2 Background

### 2.1 Flexibility

Flexibility is defined as the ability to change or be changed easily according to the situation. The following section will try to define what this means in the context of building energy usage and give examples of flexibility measures.

The motivation behind introducing flexibility to the grid and buildings is the transition to inflexible energy sources like wind and solar. They are highly weather dependent, and there is no guarantee that power is available when needed [32]. Supply and demand must always be balanced in the power system [46][10], meaning that the demand side might have to adapt in a system where generation is uncertain. The grid will also benefit from flattened load curves due to less power loss and avoided expensive grid investments. Furthermore, reducing peaks would prevent the use of high-cost peak power generators, thereby reducing end-user electricity cost[44].

#### 2.1.1 Flexibility in building energy usage

IEA's "Energy in Buildings and Communities" program describes building flexibility as "the ability to manage its demand and generation according to local climate conditions, user needs, and grid requirements." [23]. The building demand is the sum of all power consumption from all technologies in the building. Some are controllable by the end user, like lighting and heaters, and some are less controllable, like hot water heating, especially in housing cooperatives. In a power system with high penetration of renewable energy, power generation depends on the local climate conditions like wind and sun intensity.

Changing the building's energy behavior to reduce the stress on the grid without compromising user comfort is no easy task. Three main flexibility strategies are illustrated in Figure 1.

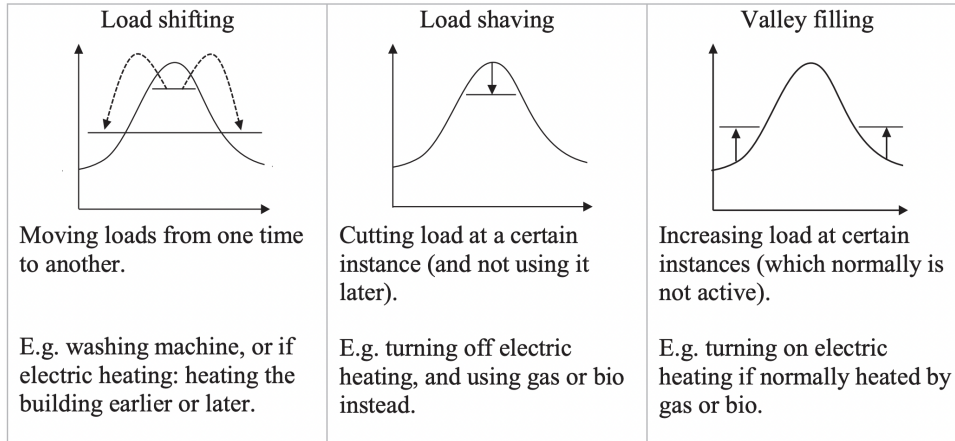

Figure 1: Flexibility strategies [29]

Heating water and EV charging can be examples of load shifting as they can be delayed but still has to be heated or charged within a time limit to avoid user discomfort. Shifting loads can avoid high peaks, which benefits the user as the power grid tariff is reduced.

Investing in more insulation and heat pump (HP) water heaters can reduce general energy consumption and power peaks. However, in poorly isolated buildings, using an HP can increase the power peaks [40]. According to a study about introducing HPs to traditionally bio-heated Finnish residential buildings, the added electricity use and power peaks are significantly decreased or even mitigated by using higher performance insulation [18]. Heat pump water heaters have also proven to be efficient in reducing power peaks according to energy.gov, reducing the evening peak power

---

by 90% [45]. Both of these measures are already done at Røverkollen, however, there is currently no smart control over the EWHs.

The strategies illustrated and flexibility solutions may seem simple, but as further discussed in Section 2.2.2, implementing some of them can have unexpected consequences.

## 2.2 Air-source heat pump water heater

Heat pumps (HPs) use electricity to move heat from one area to another. Since the heat is transferred instead of generated, HPs are highly efficient compared to electric heaters and boilers. An air source heat pump uses the air outside to heat a refrigerant which then transfers the heat energy to the desired location[19]. In this case, it is used as an air source heat pump water heater (ASHPWH).

The heat output of an HP depends on the heat difference between the two areas,  $\Delta T$ , and operates optimally when  $\Delta T = 0$ . According to IEA, the average energy output is four times higher than the input[19], however, this is highly dependent on the type of heat pump and the temperature difference. The amount of heat energy a HP provides divided by the energy in form of electricity put in is called the coefficient of performance (COP). A COP vs temperature difference curve from over 100 investigated heat pumps is shown in Figure 2[4]. At too high  $\Delta T$ s the HP will not be able to transfer heat at all [3].

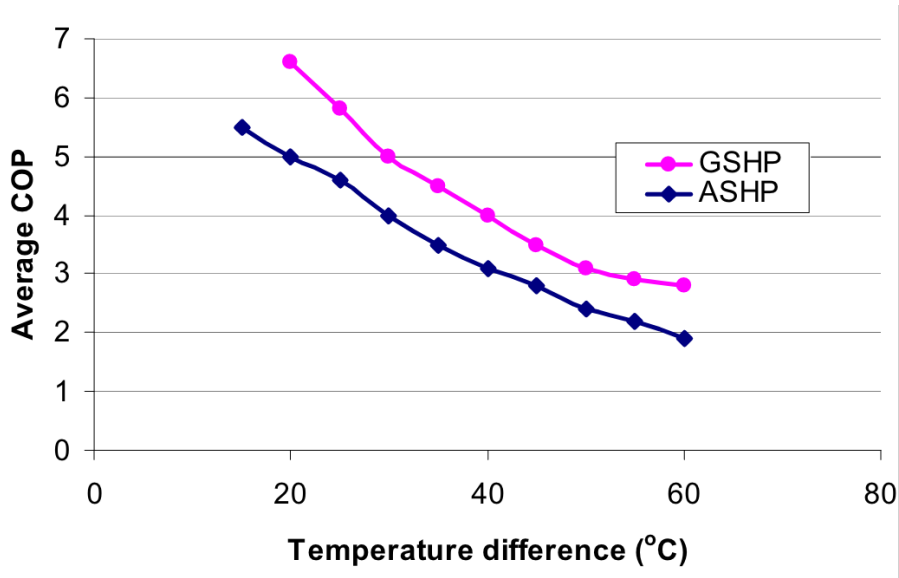

Figure 2: COP plotted against temperature difference [4]

A heating element is also included since HPs cannot always heat the water to the desired temperature. It raises the water delivered from the HP to the temperature needed [2].

There are several ways to model an EWH. The simplest is a single-zone model, where the hot water tank is considered energy storage with a uniform temperature. In reality, the water will have different temperatures inside the tank because of the difference in density. This is called stratification [62]. According to [62], a single-zone model is used for demand side management. However, [13] claims that a multi-zone model is needed for accuracy when co. The demand response potential of a single-zone model is calculated to be 34% lower and increase costs by 21% [13].

---

### 2.2.1 Legionella

Legionella is a type of bacteria that can cause pneumonia if inhaled and thrives in water systems. To prevent the growth and spread of Legionella, it is important to follow specific guidelines and regulations. According to FHI, one way to avoid Legionella is to keep the temperature of hot water tanks above  $70^{\circ}\text{C}$  and to ensure proper circulation in the water system to prevent stagnant water pockets where the bacteria can thrive. Additionally, it is essential to avoid temperatures between 20-55 degrees, as these temperatures encourage the growth of Legionella [16].

FHI also reports that Legionella bacteria die quickly at  $70^{\circ}\text{C}$  and that the temperature should not drop below  $55^{\circ}\text{C}$  degrees for periods longer than 20 minutes daily[16].

FHI has strict guidelines regarding HWT temperatures compared to the literature, which uses lower temperatures. An overview of HWT temperatures is shown in Table 1, which includes regulations by country and temperatures in the relevant literature.

Table 1: Lower HWT temperature limit - regulations and literature

Country	HWT temp [ $^{\circ}\text{C}$ ]	Comment
Regulation		
FHI - Norway	70	
Norway	65 in circulating system	
ETG*	60 once per day	
Switzerland	Outlet 60	
Denmark	Outlet 55	
Germany	50 if DHW	
Literature		
[56]	60/55	Two scenarios
[38]	43	
[24]	30	Temperatures below 40 punished
[45]	55	Temperature delivered by HP
[21]	45	
[14]	45	
[15]	55	
[13]	50	Always heated above 60 once daily

### 2.2.2 Water heater flexibility

EWHs are proven to be a flexible resource according to multiple sources [53][15][44][48]. However, the results whether financial or physical vary greatly, see Table 4. EWHs are used because they store a lot of energy, and the hot water heating can be shifted without discomfort to the user, largely without loss of efficiency and without degradation to the EWH. If EWHs are not controlled, they will typically heat up during the morning and afternoon due to consumer behavior. This is unfortunate as these are the peak power consumption hours with the highest electricity prices [53][43].

For simplicity, the following strategies are defined:

- **Thermostatically** - No control other than the EWH internal thermostat. Temperature band can be varied
- **Timer** - EWH only operates within a given time window
- **Power control** - The power of the heating element is controlled
- **Smart control** - Similar to timer control, but turns the EWH on and off based on forecasted signals. Eg. price, weather

---

A paper from Libanon concluded that 41% of the energy bill from an ASHPWH could be achieved by moving the heating cycle (HC) from the night to noon or afternoon. The air outside reached the highest temperature during these hours, leading to a higher coefficient of performance (COP). The COP describes how much heat energy an HP delivers compared to its electricity consumption as defined by Equation 1 [21].

$$COP = \frac{Q}{W} \quad (1)$$

However, it is noted that areas that are generally colder have less to gain by moving their HC to the time with the lowest  $\Delta T$ . This is illustrated in Figure 3, where it is evident that the loss of COP per increase in water temperature decreases at high temperatures.

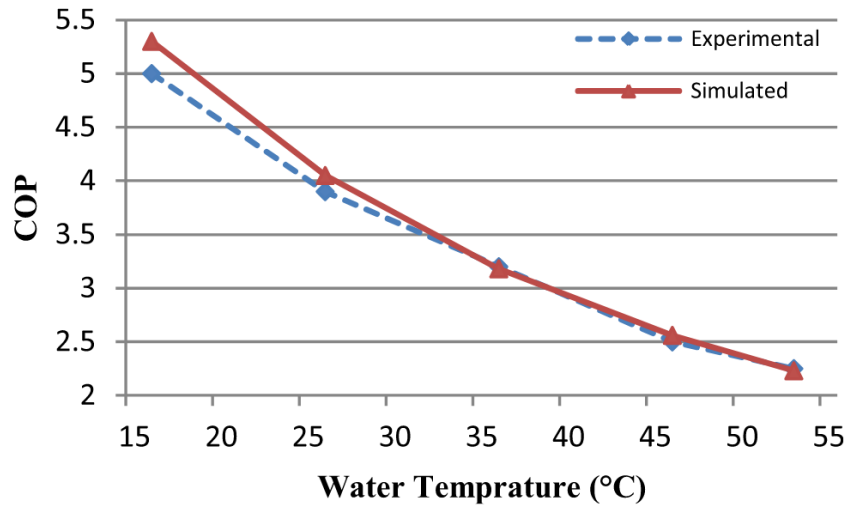

Figure 3: COP and water temperature relationship [21]

A Norwegian case study showed a 47% average reduction in cost, or 2028 euros when using simple power limitation in a building consisting of 55 apartments. In this paper, power limitation, with or without the combination with PV, was the best alternative and more profitable than spot price control. However, this only applies to customers with peak power tariffs [48].

Even though the motivation to introduce flexibility in EWH is to keep the grid stable, there may be consequences of flexible control. Since the HWD has to be met within a specific timeframe, suddenly disconnecting and reconnecting many EWHs can lead to rebound peaks. These may be higher than the original peak, causing problems for both the grid and end-user[27]. An example is shown in Figure 4, where the deactivation of EWHs between hours 8 and 9 causes a higher peak power at hour 9 than not using EWHs flexibly at all. The peak power in the evening (16:00-20:00) is also higher than in the original case. This rebound is found to be up to a 60% increase in peak power [27].

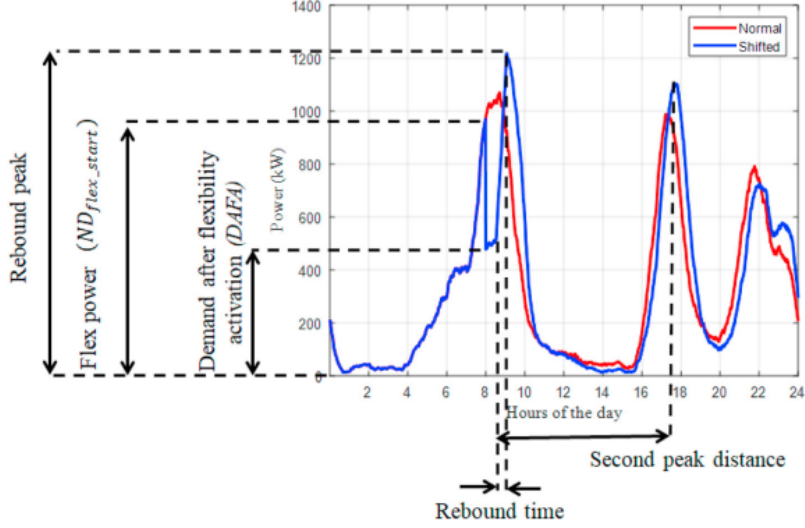

Figure 4: Example of rebound peaks[27]

There are many ways to increase the flexibility of an HWT. Increasing the volume increases the total energy available for storage. The amount of energy in the tank can be formulated as the volume of the tank at the current water temperature multiplied by the specific heat capacity ( $c_p$ ):

$$Q = c_p V \Delta T \quad (2)$$

However, increasing the volume of the HWT increases the surface area. This will lead to higher system losses according to the heat loss function presented in [42] and [20], shown in Equation 3.  $U$  is the thermal transmittance,  $A^{HWT}$  is the area,  $T^{HWT}$  is the water temperature, and  $T^{amb}$  is the ambient temperature outside the tank.

$$q^{loss} = U A^{HWT} (T^{HWT} - T^{amb}) \quad (3)$$

HWTs are typically controlled between two temperature limits, and increasing the difference between these limits allows for more load shifting. Increasing the upper-temperature limit leads to more energy storage as per the energy storage Equation 2, [24] showed a 25% cost reduction by increasing the upper-temperature limit from 45-90°C. By increasing from 80-90°C, the reduction was lower at 4%. The lower limit was fixed at 30°C, showing an expanded temperature band increases flexibility. The heating element can be delayed by allowing a lower temperature limit, enabling more renewable energy use and load shifting to off-peak hours.

## 2.3 Solar power - Norway

Solar power is the fastest-growing power generation technology in Europe and has experienced a 90% drop in levelized cost of energy since 2010 [50]. PV has also gained traction in the Norwegian market, which has seen a 136% increase in total installed capacity during 2021 and 2022[39].

There are, however, challenges regarding solar power investment due to the uncertainty of power prices, power grid limitations, and regulations [63][57][47].

### 2.3.1 Impact on power market

Due to the merit order effect, the increased power production from renewable energy leads to reduced wholesale electricity prices. This is a lowering in overall power prices due to the marginal

cost of energy production from renewable energy being zero [31]. As illustrated in Figure 5, the cheapest power generators are used first to meet demand. If demand is constant and more cheap generators enter the system, the power price will be lower.

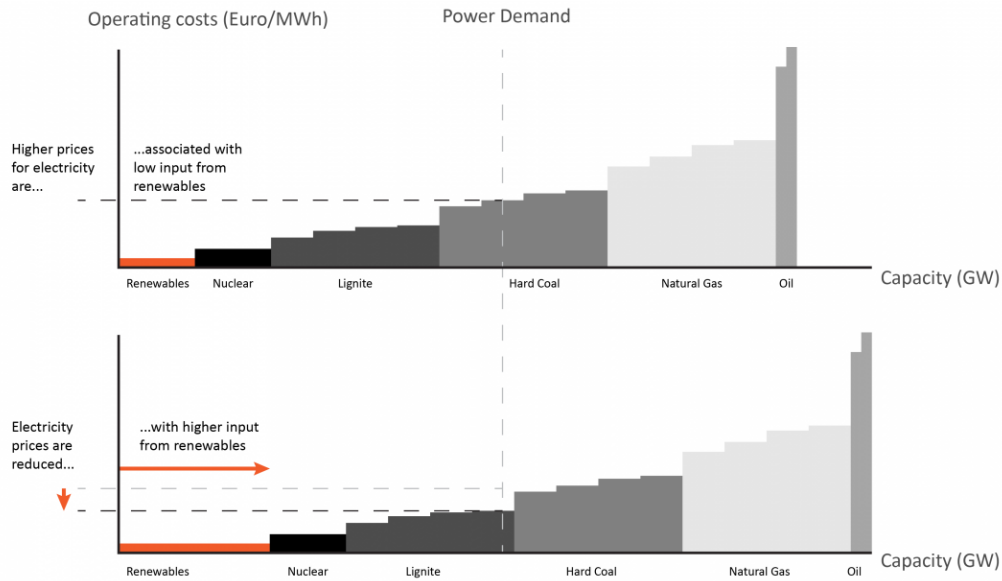

Figure 5: Merit order effect illustration

The increased presence of renewable energy in a perfect market will decrease the frequency of high price spikes when demand is high and increase the frequency of low price valleys when demand is low[5]. However, according to [5], the lowered average power price is only a transitional phase, and the long-term effect is minimal.

Even though [5] found the long-term average power price to remain similar, [57] expects there to be an increase in hours where the price is 0. [50] concludes that the power price is 30 in 30% of the hours in Germany by 2030 due to renewable energy. This is due to the stochastic nature of renewable energy and the lack of storage alternatives. Contrary to [5], [50] expects an increase in peak demand power prices due to increased  $CO_2$  tax.

When the power from solar systems increases, the power price may decrease, leading to a lower market value for the sold energy. The estimated market value of different renewable alternatives for selected European countries is shown in Figure 6. Solar power market value is expected to decrease by 50-70% from 2022 to 2027 in displayed countries [57].

In addition to the decreased market value of sold energy, the LCOE of solar panels is assumed to increase due to high demand and expensive raw materials [57].

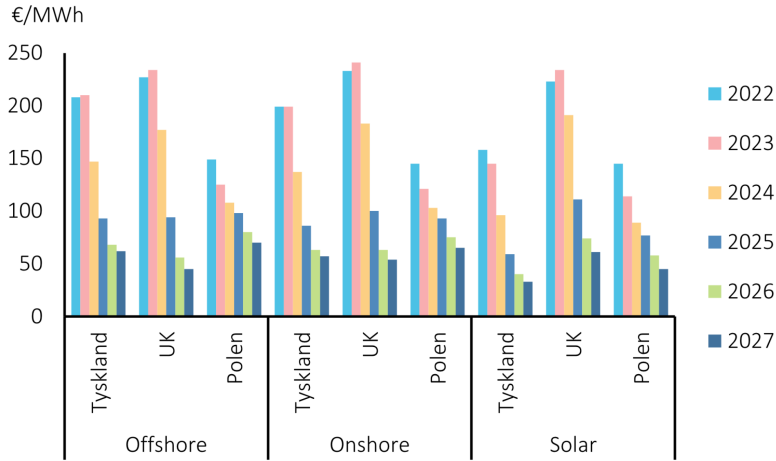

Figure 6: Solar power market value[57]

[22] have similar results in their long-term analysis of the renewable energy market in Norway. They estimate that there is <1% probability that the LCOE will be lower than the market value of solar power. The simulated LCOE and market value is illustrated in Figure 7.

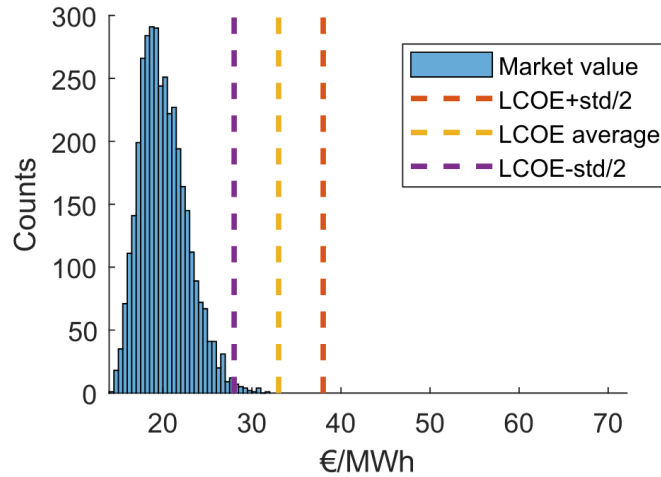

Figure 7: Solar power market price and LCOE[22]

Norway's long-term power average power prices are expected to be 45-50€/MWh in 2030/2035 and 40€/MWh in 2040/2050[50]. This is substantially higher than the estimated 20€/MWh market value of solar power.

### 2.3.2 Power grid considerations

According to a report by The Norwegian Solar Energy Cluster. (Solenergiklyngen) and Multiconsult, an increasing share of solar power in the energy system can lead to capacity issues in the power grid if local power generation exceeds local consumption to a greater extent. This primarily applies to areas with a high density of solar panel installations or large-scale solar power plants. Small-scale solar panel installations, where most of the annually produced electricity is consumed behind the meter, and medium-scale solar panel installations, where the maximum solar power production coincides with electricity consumption, will generally not contribute to capacity issues. In cases where maximum consumption coincides with solar power production, solar power can help reduce the power demand and potentially postpone the need for local grid capacity reinforcement. The situation in Norway is characterized by a low density of solar power plants and relatively few

---

capacity challenges in the grid. However, the challenges will increase with an increasing share of solar power in the energy supply. Suppose a significant number of buildings in a specific area adopt solar power. In that case, it will amplify overproduction, especially during the summer months, with surplus energy being injected into the power grid [47].

There have already been instances where PV installations pose grid challenges in Norway, resulting in the need for solar panels to be deactivated during specific hours. These challenges stem from the grid being inadequately sized to accommodate the power generated. Consequently, the financial advantages of solar power are compromised, as the surplus energy cannot be sold. Furthermore, if the solar panels were not deactivated, a substantial power export could damage equipment and even trigger a blackout [25].

### 2.3.3 Solar power regulation

The Norwegian Energy Regulatory Authority (NVE-RME) regulates the electricity and power markets to promote socioeconomic development and an environmentally sound energy system. NVE-RME areas of responsibility include efficient and reliable transmission, distribution, trade, and energy use. Because of the increased interest in and construction of solar power in Norway in the last few years, NVE-RME has proposed a new regulatory scheme regarding PV systems connected to buildings [54].

The current scheme lets buildings with one metering point cover the building's demand with solar power [54]. This benefits the end user because it is more expensive to buy power than the revenue of selling it [7]. However, buildings with more than one metering point cannot cover their demand with solar power because each end-user has an individual customer relationship with the power provider. Connecting solar panels to every apartment is also technically complex and expensive. This is typical for housing co-operations. Even though the power is generated on the property, the power must first be sold to the grid and then bought back by the end user with added taxes and tariffs. This is illustrated in Figure 8, the PV-generated power in single meter households is available for consumption before the meter, and in multiple metering properties, the power is measured before it is available for consumption [54].

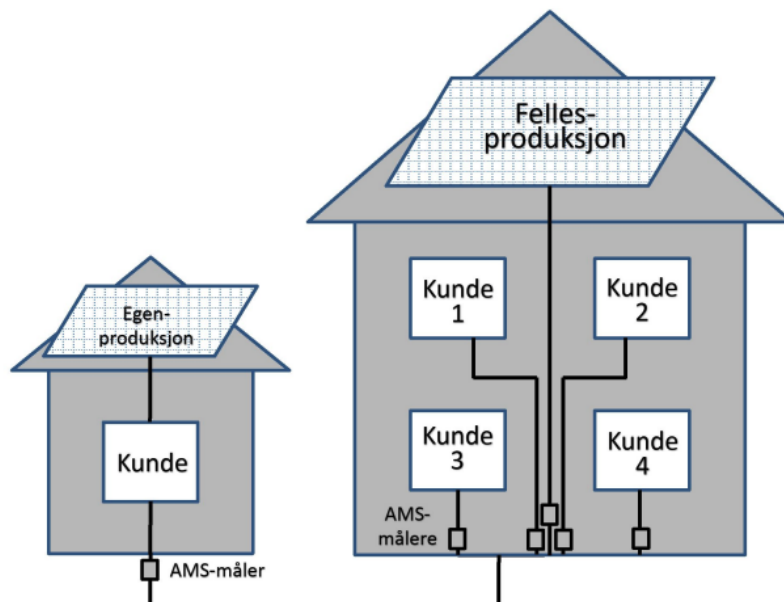

Figure 8: Solar power - customer and market relation



---

The new regulation scheme suggests solving this problem by allowing 500kW shared power between multiple metering points on the same property. The power producer on the property has the right to decide with whom the power is shared. Every apartment that is a part of the shared power scheme will receive an amount of the power produced. However, it is not allowed to combine its own PV generation and be a part of a shared solution simultaneously. Since the meters measure physical power transfer, the final consumption value has to be virtual to include the shared PV generation [54].

This is shown with the following equation with an hourly resolution:

$$P_t^{virtualconsumption} = P_t^{Measuredconsumption} - P_t^{PVgeneration} \cdot \sigma_{customershare} \quad (4)$$

The end user can have one of three positions in each hour:

- Virtual consumer of power
- Net zero
- Virtual producer of power

The downside of this implementation is that the grid costs will stay the same. The end-users will always cover this cost, causing the group without PV investments paying a higher share of the total grid tariff sum [54].

### 2.3.4 PV investment

The annual investment cost, calculated using the annuity formula presented in Equation 5, takes into account the annual expenses associated with an investment over a specified duration and the prevailing interest rate. In order for an investment to be financially viable, the generated revenue must exceed the annual payment or required return. The annuity factor ( $a$ ), shown in Equation 5, is multiplied by the investment cost to determine the total investment expenditure at the given discount rate ( $r$ ) over the specified time period ( $t$ ).

$$a = \frac{r}{1 - (1 + r)^{-t}} \quad (5)$$

Choosing a discount rate will impact the potential profitability of an investment. The state's recommended discount rate for investment is 4% [26], which is also used as a default by the industry unless other requirements are made. During 2018, the average discount rate on PV investment was 6% according to [55], whereas Irena used 5% in their report "Renewable Power Generation Costs in 2021" [41]

## 2.4 Solar power and water heating

Flexible use of water heaters in combination with the stochastic power production of PV systems has been proven to increase self-consumption in several papers [12][14][38]. It may also be more attractive than residential battery systems, as they are not economically viable for most households [63].

The self-consumption rate (SCR) is the share of power produced that the consumer uses. It is defined by Equation 6 as the share that is not exported. Self-sufficiency rate (SSR) is how much of the total consumption PV generated power covers and is defined by Equation 7.

$$SCR = 1 - \frac{P_{Export}}{P_{Generated}} \quad (6)$$

$$SSR = 1 - \frac{P^{Import}}{P^{Demand}} \quad (7)$$

EWHs are often power intensive, consuming large amounts of energy in a short period, while PV-system produces power over an extended period on an average day. This is illustrated in Figure 9 for a thermostatically controlled EWH. As a result, the EWH's power exceeds the power generation of the PV system, while the PV-system-generated energy may be enough to cover all demand. To combat this, it is possible to reduce the power of the HE. However, the hot water may not reach the desired temperature for consumption [12].

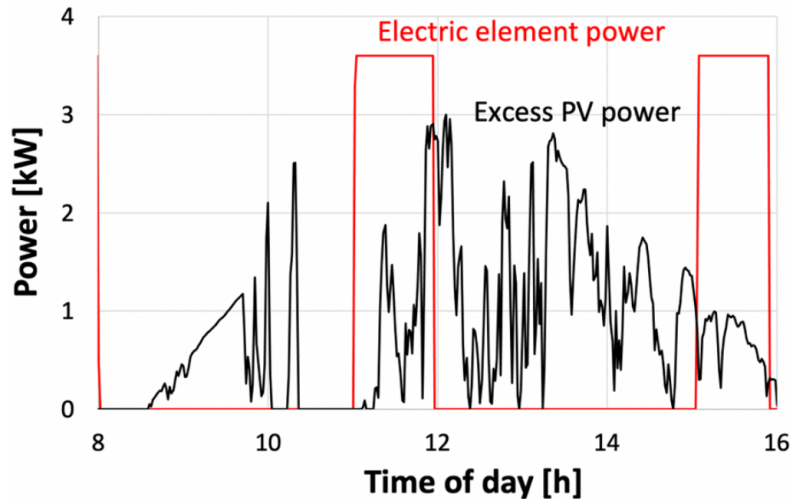

Figure 9: Example EWH power consumption and PV generation [12]

According to [12], the self-consumption of a 3.6 kW EWH and a 3.6kWp solar panel was 13% before any smart control. By adding smart control, the SCR increased to 80%. Further reductions were found by including an HP in the system, 90% of the power imported from the grid was replaced by locally generated power. To achieve these results, they used advanced control of the EWH by controlling the power to the HE [12], but in most cases, a variable power draw is impossible. However, this also depends on the size of the solar panel, geographical location, seasonal changes, etc. By analyzing a combination of 3.6 and 4 kWp PV systems with a 3.6 kW water heater, [63] found very similar results to [12] and achieved a maximum SSR of 90% for the water heater. However, on average 48% of the HWD was supplied by excess PV power.

According to THEMA Consulting group, self-consumption can be increased up to 60% by storing energy. However, it is not specified how much each technology group contributes [53]. SINTEF has slightly lower estimates for self-consumption at 40% when using smart control, however, this also includes using the HP for space heating. They also saved 20% of the final electricity bill when optimizing for cost saving. Optimizing for self-consumption and cost reduction led to opposite strategies. The cost optimizer shifts the load to nighttime, leading to a higher peak power draw and worse self-consumption. Optimizing for self-consumption naturally shifts the load to the daytime [14].

## 2.5 Norwegian grid tariffs and taxes

The following section is an extended version of the pre-work to this thesis[28]. Values have also been updated.

In addition to paying a spot price for electrical power, a grid tariff is paid to cover the costs of the grid operator. Norway has different grid tariff systems based on the type of customer and the grid

operators' contracts. However, there are some general guidelines set by NVE.

According to NVE, Norwegian grid tariffs are divided into two parts. The first part is a variable cost based on the energy [kWh] consumed by the customer, usually measured in øre/kWh. The second part is a power-dependent charge based on the maximum grid capacity each user claims. Most grid operators use a table divided into power ranges and a respective cost to decide the final fixed cost. To calculate where each customer belongs in the table, NVE suggests using the average of the three highest consumption hours during a month. However, each grid operator is free to choose its calculation method [37]. See Table 3 for an example of a commercial customer's grid tariff model.

In addition to the variable and fixed cost, there is a public tax consisting of three parts, summed up in Table 2. Firstly, the value-added tax of 25%, which affects both grid tariffs and the spot price. Secondly, an electrical power fee is calculated as a variable cost [øre/kWh], and thirdly a contribution to the energy investment fund ENOVA. Elvia estimates that taxes account for almost half of the total grid tariff fee [49].

Finally, there is possible revenue if the customer has solar power that exports into the grid. The "consumer" is then considered a power producer and is paid the current spot price for the power.

Table 2: Power taxes in 2023 [34] [6]

Tax	Cost
VAT	25%
Electrical power fee, Jan-Mar	9.16 øre/kWh
Electrical power fee, Apr-Dec	15.84 øre/kWh
ENOVA fee	800 NOK/year

### 2.5.1 Elvia - grid tariffs

Røverkollen housing cooperative is located in the grid operator Elvia's area and is qualified for the "company over 100.000 kWh deal". As Table 3 shows, Elvia operates with a fixed tariff in addition to the tariffs described in Section 2.5. The power tariff depends on the season. The peak power-dependent cost is calculated based on the highest power drawn from the grid during a month and is not step-based as NVE's proposed solution.

Table 3: Elvia grid tariffs - 2023 [34]

Grid tariff	Low voltage
Fixed tariff	1225 NOK/month
Power tariff, Oct-Mar	72 NOK/kW/month
Power tariff, Apr-Sep	32 NOK/kW/month
Energy tariff	5 øre/kWh
Remuneration from the grid company for loss reduction	5 øre/kWh

## 2.6 Linear optimization

Linear optimization is a mathematical formulation to maximize or minimize an objective function while satisfying a set of constraints. It involves finding the values for decision variables within defined bounds, the problem's constraints, to optimize the objective. Linear optimization is widely used in various fields, from engineering to business planning[30]. However, not all problems are linear, meaning the system's physical limits must be simplified. The thermodynamics behind EWH's operation is an example of a nonlinear system, necessitating model simplifications to be able to solve the problem with linear optimization. There are other optimization methods such as heuristic, but these often have long run times and can result in sub-optimal solutions [61]

A typical linear optimization problem can be expressed as follows:

$$\min/\max z = \sum_n^N c_n x_n \quad (8)$$

Subject to:

$$\sum_{n,m}^{N,M} a_{n,m} x_n \leq b_n \quad (9)$$

where  $x_n$  is decision variables,  $c_n$  is the objective function coefficient,  $a_n$  is the constraint coefficient and  $b_n$  is the constraints' bound.

In a deterministic model, all parameter values, such as the coefficients and bounds, are assumed to be fixed and known exactly. The model then has perfect information and disregards any uncertainty. On the other hand, in a stochastic model, certain parameters are allowed to vary within specified probability distributions, reflecting the inherent uncertainty. This provides a more realistic representation of real-world systems and allows decision-makers to assess the robustness of their solutions under different scenarios. A stochastic model is however more complex in formulation and requires stochastic input data.

The disadvantage of relying on a model with perfect information is that it assumes complete knowledge and ignores the uncertainties in real-world systems, for example, solar power generation. Given perfect information, a linear optimization will find the upper or lower bound of the system, meaning the absolute minimum or maximum, which yields unrealistic results. Disregarding uncertainties can lead also lead to sub-optimal or impractical solutions.

## 2.7 Summary PV and water heater flexibility

Table 4: Optimal EWH control benefits

Study	Location	Result	Incentives	Comments
[38]	UK Germany	22% reduced cost 16% SSR, 100% increase 20% reduced cost 15% SSR, 138% increase	Power tariff	Non-linear optimization
[40]	Switzerland	30-39% SCR 13-26% cost reduction		Both space heating (SH) and DHW Only thermostat control 2-6% SCR if SH only
[48]	Norway	47% cost reduction	Power tariff	Power draw limitation
[12]	Australia	90% SSR		Variable power draw
[44]	Finland	5.4% peak load reduction 24.4% increased valley load 4.5% increased load factor		50% of EWH were used flexibly
[53]	Norway	60% SCR		Includes all storage systems
[14]	Norway	40% SCR 20% cost reduction 30% reduction in peak load hours		SCR and cost reduction have opposite strategies. Multi zone simulation
[24]	Greece	29.9% cost reduction 33.5% cost reduction 23.6% cost reduction		Compared to Temperature control at 60°C Temperature control at 70°C Price sensitive control 30-70°C Single zone optimization
[15]		20% cost reduction up to 40% cost reduction		Optimal compared to base case HWT temperature reduction
[13]	Australia	113-217% cost reduction 92% energy consumption during DR	DR	EWH profitable due to DR scheme Multi zone model

### 3 Røverkollen data

The data collected about Røverkollen housing cooperative in the Greencharge project was processed and analyzed as a part of the pre-work to this thesis. Relevant data is presented and discussed in the light of this master thesis.

#### 3.1 Data overview

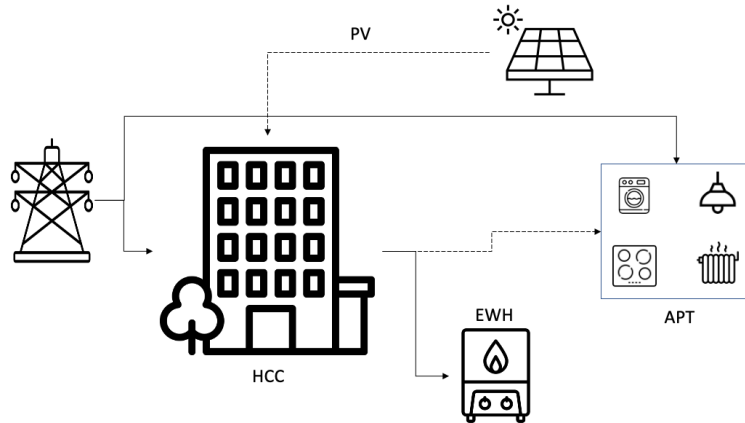

Figure 10: Røverkollen data overview

Table 5: Term distinction

Term	Description	Power consumption	Source
HCC	The power consumption by the apartment block excluding individual apartments	Hot water, lighting, hall and pavement heating	Elhub
APT	The electricity consumed by all individual apartments in a block	Appliances, space heating, lighting	Elvia
PV	Solar power generation		Greencharge
	Measured, simulated		GreenCharge, PVSyst
EWH	EWH HP and HE power consumption		Greencharge, [60]

Figure 10 shows all power flows and the data source for one apartment block. There are a total of 6 blocks, however, only one is analyzed in this project. Table 5 explains the terms used for the power flows, what type of power consumption they include, and their source.

The apartments' electricity consumption was measured as an aggregated series by Elvia. During GreenCharge some specific apartments were chosen to be metered in higher detail.

#### 3.2 EWH

The power consumption of EWHs in apartment blocks was measured as a part of the GreenCharge project. To safeguard resident privacy, all data was encoded to prevent identifying individual addresses. The dataset presented in this paper pertains to block P1D3L14, which corresponds to Sverre Iversen Veg 3, 17, or 23, inferred from the EWH system size. These three blocks comprise a total of 52, 54, and 52 apartments, respectively. From this point, it is assumed that P1D3L14 corresponds to Sverre Iversen veg 23.

---

Each EWH system comprises a series of HWTs containing heating elements and HP. The system at P1D3L14 has six tanks, two heating elements, and three heat pumps.

In this study, the power consumption data of the EWH at L14 for the year 2021 is presented in Figure 11. For a more detailed view of the data, a higher resolution graph specifically for August 2021 in Figure 12 is provided [28]. It is important to note that the dataset is incomplete, with approximately half of the time period missing. Moreover, there are instances where only a subset of the meters are functional, as demonstrated by the beginning of August when only one heating element meter was collecting data.

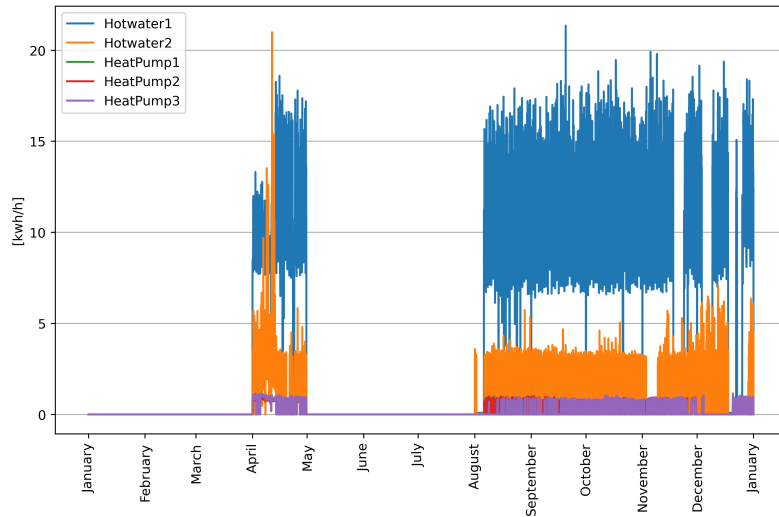

Figure 11: EWH power consumption 2021[28]

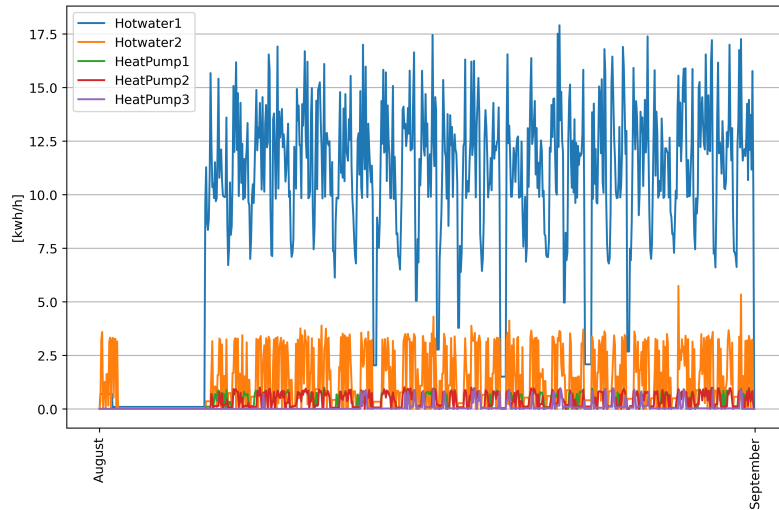

Figure 12: EWH power consumption August 2021[28]

---

Some key measurement data are summarized in Table 6. The missing months have no data. Both the heating element and HP power consumption vary, but in the months with less missing data, the total imported power seems to be in the 9 000-11 000kWh/year range. The HP covers between 7-14% of the imported power, but it is difficult to determine the accuracy of this estimate. For example, faulty heating element measurements with high-quality HPs measurements in months will spike the share covered by the HPs. However, the share HP covers in most months is between 10 and 14%. There is no clear connection between HP share and months, but this is difficult to assess due to missing measurements.

Table 6: EWH key measurements

Measured data [kWh]				
<b>2021</b>	<b>Heating element</b>	<b>Heat pump</b>	<b>Total</b>	<b>Share</b>
Apr	9 468	1 529	10 998	14%
Aug	7 997	623	8 619	7%
Sep	9 338	757	10 094	7%
Oct	9 833	883	10 716	8%
Nov	8 008	927	8 935	10%
Dec	6 501	485	6 986	7%
<b>2022</b>				
Jan	10 888	1 245	12 133	10%
Sep	7 622	822	8 443	10%
Oct	4 653	522	5 175	10%
Nov	8 946	1 108	10 054	11%
Dec	10 007	1 429	11 437	12%
<b>2023</b>				
Jan	10 268	1 287	11 556	11%
Feb	6 996	1 121	8 117	14%
<b>All</b>				
Average	8 502	980	9 482	10%

Due to the incomplete dataset and poor quality, the data cannot be used in a simulation or optimization model. New data is simulated based on the building resident parameters in Section 4.2

Ideally, the EWH consumption data would be subtracted from the total electricity consumed by the apartment block to find lighting, elevator, and heating energy use. However, as seen in Figure 13 it is impossible to get a complete time series of common electricity usage. There are a lot of faulty measurement points in addition to the months that have not been measured. Spikes in the difference between the apartment block and HWT electricity consumption identify this. By excluding all zero values and HWT power consumption of less than 50% of building energy use, the HWT makes up for 72% of the electricity consumption. This share is probably higher since the spikes are more prevalent when multiple measurement points are faulty.

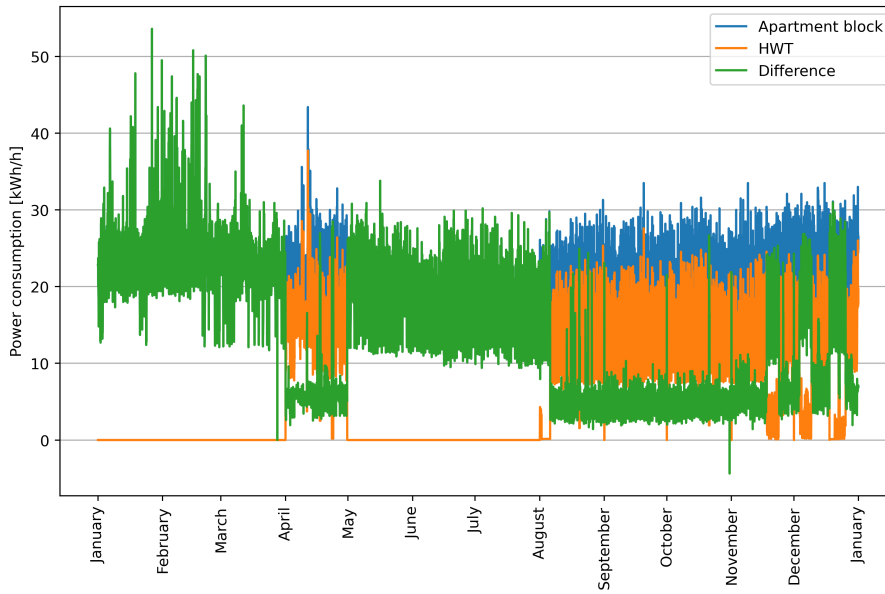

Figure 13: EWH and HCC usage 2021

### 3.2.1 EWH and HCC

Figure 14 shows the hourly average power consumption during April 2021. The shapes of the graphs are similar, meaning that the peak in common electricity usage corresponds to the peak in EWH electric consumption. This is positive because moving the EWH load from peak to valley will not affect the total peak power negatively. However, by not considering common electricity usage, the EWH will not compensate for the valleys created by this consumption.

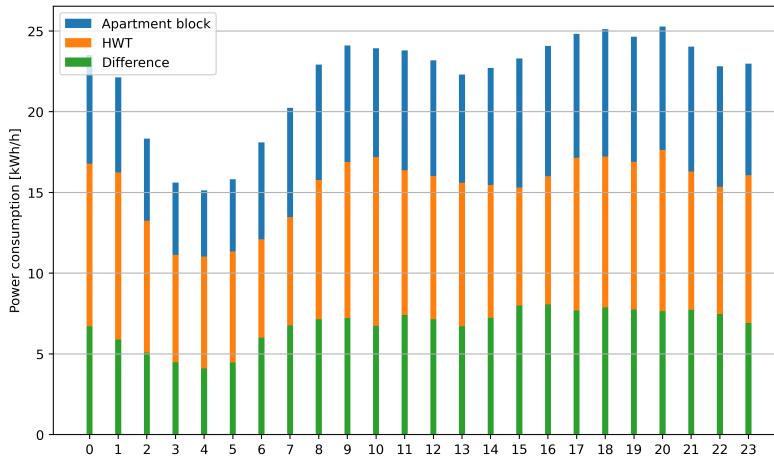

Figure 14: HWT and HCC electricity usage - hourly average April 2021

Figure 3.2.1 shows the average difference between peak and valley in April 2021. By completely evening out the peak/valley difference for the EWH, 3.3kWh/h would be moved. However, the potential for the entire block is 5kWh/h. Thus, by only considering the EWH, there is less total flexibility potential.

- Apartment block: 10.1 kWh/h
- EWH: 6.6 kWh/h
- Difference: 4 kWh/h



---

### 3.3 Apartments

Elvia provided data from individual apartments. All apartments' electricity data are aggregated into one profile to safeguard privacy.

Figure 15 illustrated the hourly average power consumption during April 2021. The consumption from individual apartments is now included, and the total toll on the grid is calculated as the impact from individual apartments and the apartment block. All power profiles are again similar in shape, with a valley around 02:00 and peaks in the morning and afternoon. The peak/valley difference is increased to 16.7kWh/h when considering apartments, which is further increased to 22.7kWh/h when including EWH. It is possible to negate the effect of not including apartment block energy usage by considering apartments. The valley and peaks correspond and the total potential is higher.

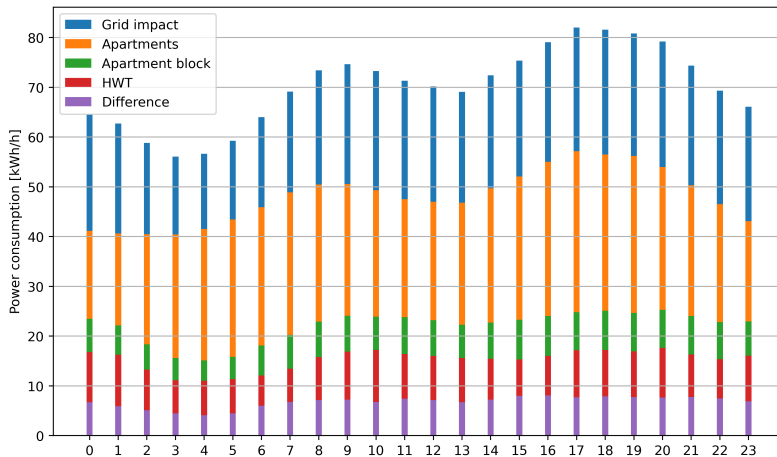

Figure 15: HWT, HCC and APT electricity usage  
Hourly average April 202

The maximum monthly import during 2021 is shown in Figure 16. The top import peaks during the winter due to high heating requirements and decreases when the temperature increases, as shown in the preliminary work to this thesis [28]. In this case, the maximum import is 122 kWh/h in January.

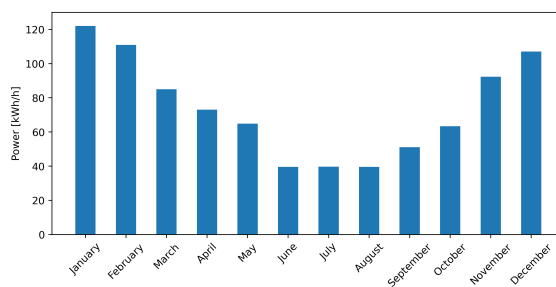

Figure 16: Apartments' measured monthly max import during 2021

### 3.4 Solar power

The solar power at Røverkollen is connected to the garage, not an apartment block. However, when considering the new solar power-sharing scheme, it does not matter where the solar power is connected as long as Røverkollen can share the energy virtually.

Figure 17 shows the measured solar power generation at Røverkollen housing cooperative [28].

---

The data quality is poor, and it is observable that the measured data is faulty due to PV power production during the night. This can be seen as the elevated power production in May, July, September, and October, where the production never reaches 0. There are also several timespans where the power generation is unexpectedly 0.

Due to poor data, new datasets were simulated with PVSyst, further described in Section 4.1.

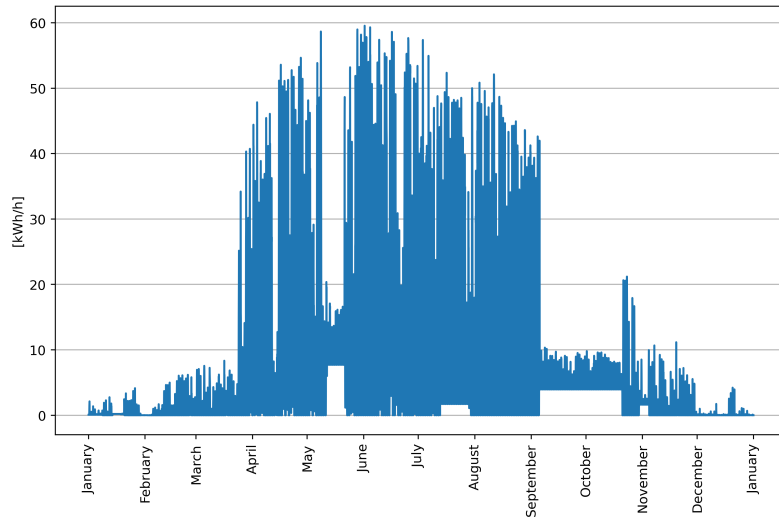

Figure 17: Measured PV power generation 2021 [28]

---

## 4 Data simulation

Due to the poor data quality of some meters at Røverkollen housing cooperative, the solar power generation and hot water consumption had to be simulated. In addition, spot prices estimating the future power market are calculated.

### 4.1 Solar power

Estimating solar power generation potential is necessary due to the poor data quality of the metered data. In this case, the available roof area of the building is considered as a parameter in determining the size of a solar panel installation.

To simulate the annual, hourly PV power generation curve, a widely used software tool called PVsyst is utilized. This software tool offers a comprehensive approach to modeling the behavior of PV systems under various environmental conditions. By inputting data such as location, orientation, tilt, and panel specifications, PVsyst can generate a detailed analysis of the system's performance over time.

In addition to the basic input data, PVsyst can consider more complex factors that may influence the solar power generation potential. For instance, the simulation can consider the shading caused by nearby trees, buildings, and other obstructions. The software also considers the effects of local climate conditions, such as temperature, humidity, and solar radiation, on the system's performance. A synthetic, local climate file is generated from Meteonorm 8.1 data.

Figure 18 provides an example of the shading input simulation for Røverkollen housing cooperative. This helps to account for any potential shading, which can significantly affect the power generation potential of the system.

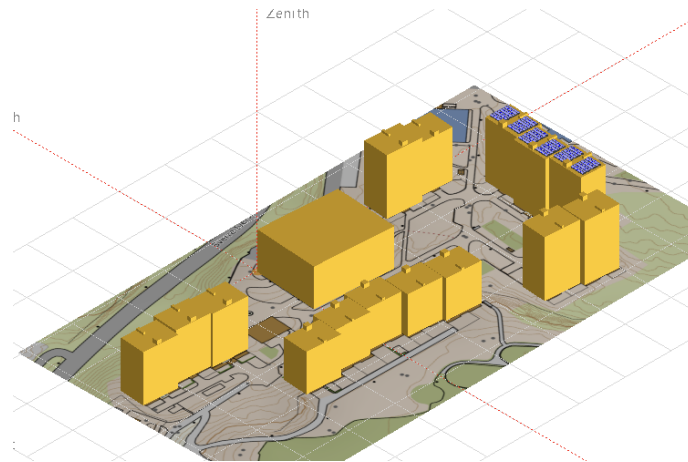

Figure 18: Shading model for PV generation

Finally, Figure 19 illustrates the horizon used in the simulation, which shows the areas where shading is expected to occur during different times of the day. This information is critical in determining the optimal placement of solar panels to maximize the power generation potential. Considering all these factors, obtaining a more accurate estimate of each address's solar power generation potential is possible.

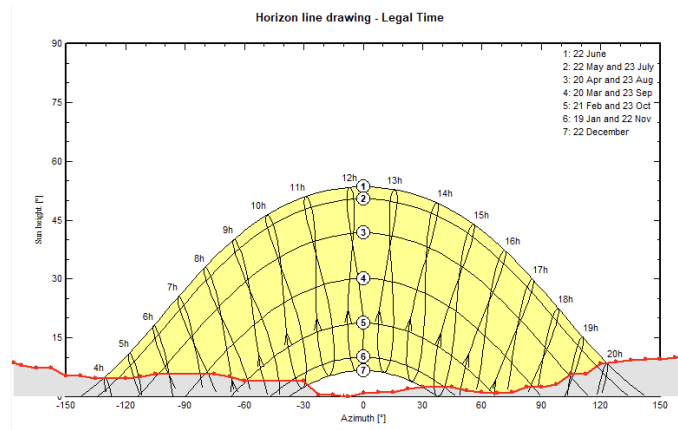

Figure 19: Horizon at Røverkollen

The parameters used in the simulation are shown in Table 7 and are set based on the existing solar system and available roof area of the apartment blocks. T

Table 7: Solar power simulation parameters

Parameter	Value
kWp	50.4
Orientation	east/west
Tilt	10°

The simulated and measured PV power generation is shown in Figure 20. The annual power production profile is shown to the left, and three days from April are shown to the right. The real PV system has a 70 kWp installed capacity, and its generation is on the right y-axis to compare the overall profiles.

As expected, the generation is low in the winter and increases as the solar irradiation increases. The production is especially low in the winter months due to expected snowfall. The peak power produced is 40 kWh/h, significantly lower than the 50.4 kWp simulated. However, 40 kWh/h is an hourly average value, meaning the maximum instantaneous power generation might be higher. The simulated and real data are very close in profile as expected. Since the simulated profile is based on a typical weather year and the measured data is from 2021, the profiles will not overlap exactly. Overall it seems like the measured data is slightly higher in generation than the simulated, except in late March.

The example days provided demonstrate that the PVSyst model generates daily profiles that reflect typical variations rather than average profiles. The power generation data for the specific days indicates distinct weather conditions: the first day (23.04) represents an overcast day, followed by a clear day, and the subsequent two days represent partially cloudy conditions. These varied weather conditions offer insights into the dynamic nature of power generation and emphasize the ability of the PVSyst model to capture these fluctuations in its daily profiles.

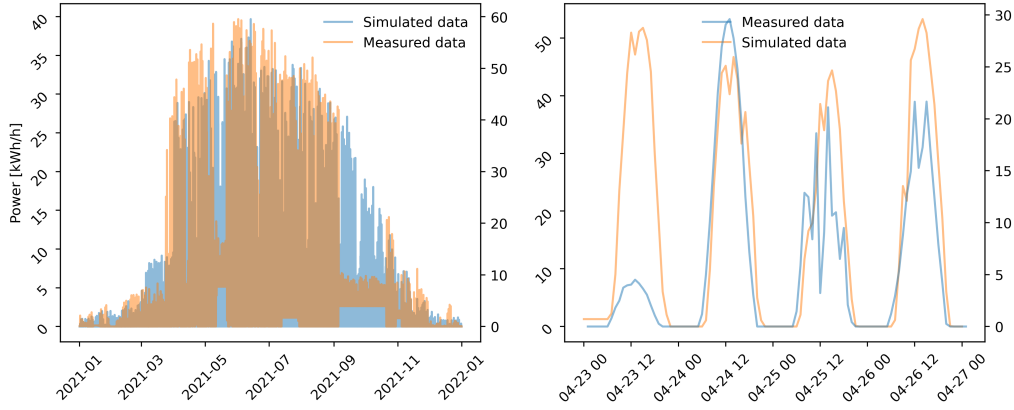

Figure 20: Simulated and measured power profile  
Annual to the right and example days in April to the left

The total estimated annual solar power generation is 37 146 kWh. Based on discussions with industry professionals, it is assumed that the cost of PV installation is 10 000 NOK/kWp.

In this case, the levelized cost of energy (LCOE) is calculated as the required yearly revenue divided by the estimated annual power production. The annuity and LCOE are calculated at different discount rates in Table 8. Given the yearly simulated power production, investment cost, and discount rate, the LCOE is substantially higher than the suggested 35€/MWh (0.35 NOK/kWh) by [22].

Table 8: PV investment annuity and LCOE

Discount rate	Required revenue [NOK/year]	LCOE [NOK/kWh]
4%	29 146	0.78
5%	32 786	0.88
6%	36 615	0.99

## 4.2 Synthetic hot water consumption profiles

Synthetic, stochastic hot water consumption profiles are based on an extension of the model presented in [59] and [58]. It creates typical hot water consumption profiles based on Markov chains. The HWD is based on time of use data of showering and bathing for apartments. In addition to shower and bath, a miscellaneous water draw is added with a constant probability of occurring at each time-step, except at night.

To increase the accuracy of the profiles, the number of residents in each apartment is taken as input. The data used is based on [33], which reports that 52% live alone and 22% live with children. Due to the size of the apartments, the following assumption is made: 50% live alone, 30% two-person, and 20% three-person apartments.

The model uses a constant flow rate for all data and has a per-minute resolution. The flow rates and times were chosen to comply with the DHW profiles developed by IEA SHC Task 44 [59] and are shown in Table 9. The output data from the profile generator is given in liters per minute (L/min), which is aggregated to an hourly resolution (L/hour)

Table 9: Hot water usage profile generation parameters

Type	Value
Shower	10 l/min, 4 min tapping
Bath	16 l/min, 6 min tapping
Misc	4 l/min, 2 min tapping

To simplify the model, hot water usage is converted to energy usage. It is assumed that the cold water added to the tank is  $9^{\circ}\text{C}$  and that all hot water usage is  $40^{\circ}\text{C}$ .  $9^{\circ}\text{C}$  is chosen as inlet temperature because it is used in the KWsmart system documentation[3]. It is also very close to the  $10^{\circ}\text{C}$  seen in [24] supporting the decision.  $9^{\circ}\text{C}$  is used as the reference point when converting temperature and volume to energy with Equation 10.

$$Q^{stored} = mc_p\Delta T \quad (10)$$

When the water input to the tank is at the same temperature as the reference temperature  $\Delta T$  becomes zero, the power flow does not have to be considered.

#### 4.2.1 Modelled and measured EWH power consumption

Since the EWHs power consumption is simulated, there are deviations from the measured consumption. There are also significant differences in the measured data in [60]. The modeled data and the measured from projects EL-SEA-2007 and HW-MDH-2006 are shown in Figure 21 and Figure 22. Please note that the left and right axes in Figure 22 correspond to modeled and measured data respectively. The model provides liter per minute, but this is converted to power/hour by using a liter-to-energy coefficient for different sources, shown in Figure 47 in the appendix [60].

The general trend fits well between simulated data and HW-MDH-2006, with morning and evening peaks. Since the model is based on time-of-use data, it differs between weekends and weekdays. On weekdays, the measured peak consumption in the morning comes earlier than in the simulated, but they are of similar magnitude. The measured power consumption profile during the afternoon peaks more than the simulated data.

During the weekend, the measured power consumption curve is flatter than the simulated, with lower peaks and higher midday valleys. The measured morning peak also occurs earlier than the modeled.

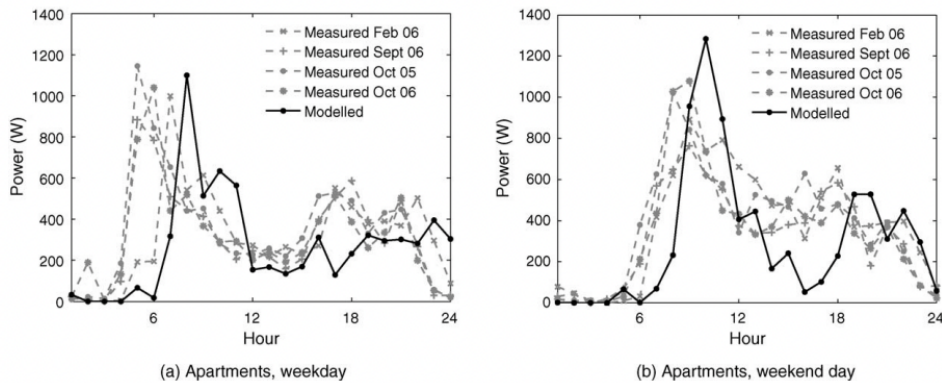

Figure 21: Modelled and measured (HW-MDH-2006) EWH power consumption in [60]

The simulated data compared to EL-SEA-2007 varies greatly in magnitude as seen from the axis values in Figure 22. However, the profile fits relatively well during the weekdays, whereas the weekend consumption seems more sporadic. The ratio between the peaks and the valleys is higher in the simulated data than in the measured data, especially during the weekdays. As discussed in Section 3.2.1, a higher ratio has a higher potential for load-shifting and more flexibility. It should be noted that the figure shows a water consumption curve for detached houses, whereas Røverkollen housing cooperative consists of apartments.

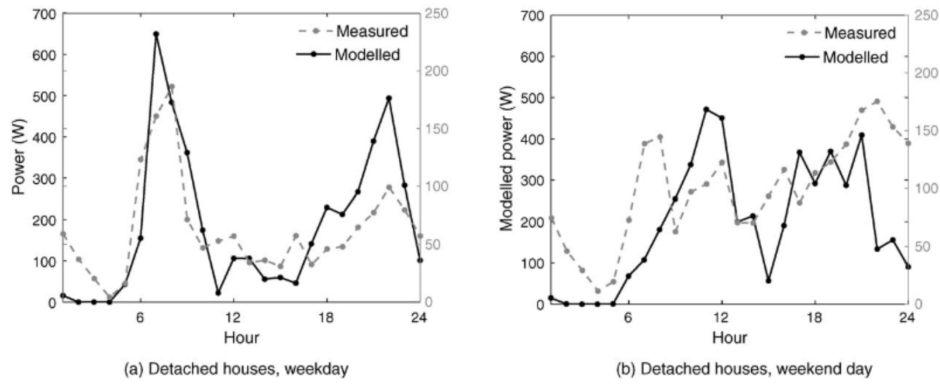

Figure 22: Modelled and measured (EL-SEA-2007) EWH power consumption in [60]

Compared to an average day of hot water consumption at Røvekrollen during April 2021, see Figure 14, the simulated EWH power profiles shown has higher peaks and lower valleys. Figure 23 shows the measured power consumption of Røverkollens EWH and the synthetic liter/hour profiles generated. Comparing liter/hour and kWh/hour does not consider the thermal inertia of the HWT. Nevertheless, the power consumption profile is much flatter than the synthetic liter consumption generated. Due to this inertia, it is difficult to conclude whether there are significant differences in the liter consumption between the synthetic profiles and Røverkollens consumption. Røverkollens EWH draws power is relatively stable compared to the profiles previously shown, and several measured cases are shown in Figure 48, Figure 49 and Figure 50 in the appendix [52]. Figure 46 provides references for the previously mentioned figures' data.

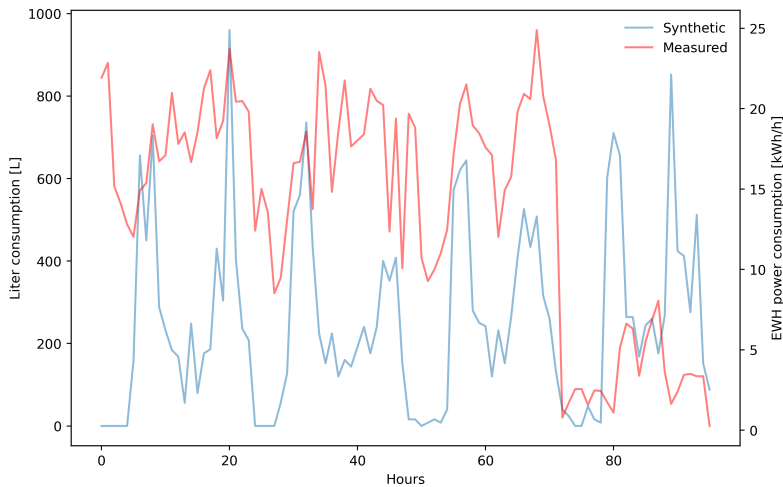

Figure 23: Synthetic and measured profiles from April [27]

### 4.3 Spotprices

Historic spot price time series were provided by Nordpool for this master thesis, however, to reflect the future power market better, they have been altered. To capture the seasonal and daily fluctuation in the spot prices, the 2019 prices were used as a base. These have been adjusted to have a higher average value due to the current estimates of the future power prices in Norway. By taking the average of the estimated short- and long-term power prices, an average spot price of 0.58 NOK/kWh is found. In the short term, the power prices are expected to be higher on average than historic prices but settle to normal levels by 2027 [51].

The value chosen is higher than the estimated 45-55€/MWh (0.52-0.64 NOK/kWh) by 2030/2035

---

and 40€/MWh (0.46 NOK/kWh) 2040/2050[50] to capture the effect of high power prices the coming years.



---

## 5 Optimization model

### 5.1 EWH

There are many ways to model an EWH, as briefly discussed in Section 2.2.2. A multi-zone model is the most accurate because it divides the EWH into multiple layers with individual temperature and heat exchanges to its surrounding layers. However, this model is not linear, as it depends on the temperature in the tank and the volume of water used.

The EWH is modeled as a single zone with energy flows in and out. This simplification keeps the model linear, a necessity in linear optimization. It has an upper and lower temperature limit, where the upper is fixed to  $80^{\circ}\text{C}$ , and the lower is variable to increase flexibility. The HWT will always raise the temperature to  $70^{\circ}\text{C}$  at 05:00 on weekdays and 07:00 on weekends to avoid legionella growth. The specific times are chosen based on the estimated peak HWD during the days, where the peak HWD is around 6-8 on weekdays and 8-10 on weekends.

The datasheet does not provide the dimensions or the thermal transmittance value of the HWT. However, they estimate a loss of 100W/h in a 200L tank with  $T^{\text{HWT}} = 65^{\circ}\text{C}$  [2]. To find the U-value of the 200L tank, the dimension of a similar tank is used [35]. The losses from a 400L tank are then found by using the dimensions of a 400L tank [36] and the estimated thermal transmittance.

HWT losses are calculated per hour to incorporate the effect of increased loss at high temperatures. The parameters used are summarized in Table 10.

To estimate the thermal transmittance Equation 3 is used.

Table 10: 400l HWT Parameters

Parameter	Value
Radius	0.589 m
Height	2.093 m
Ambient temperature	$20^{\circ}\text{C}$
U - calculated	$0.00091 \frac{\text{W}}{\text{m}^2 \text{K}}$

#### 5.1.1 Heat pump modelling

The datasheet for the DHW system at Røverkollen provides limited information about the HPs COP. The example information given about the rated power and heat capacity is for a tank at  $65^{\circ}\text{C}$ , whereas the actual tank keeps  $80^{\circ}\text{C}$ . Table 11 presents the available information from the datasheet and assumed values [3].

Table 11: HP COP datasheet and estimated values

Outside temperature	HW temperature	Temperature difference	COP
Reported values			
$7^{\circ}\text{C}$	$65^{\circ}\text{C}$	$58^{\circ}\text{C}$	3.3
$-15^{\circ}\text{C}$	$65^{\circ}\text{C}$	$80^{\circ}\text{C}$	1.1
Assumed values			
$22^{\circ}\text{C}$	$80^{\circ}\text{C}$	$58^{\circ}\text{C}$	3.3
$0^{\circ}\text{C}$	$80^{\circ}\text{C}$	$80^{\circ}\text{C}$	1.1

In order to determine the COP of Røverkollen's system, the COP at specific temperature differences is employed. It is reasonable to assume that the COP follows a linear trend between the operating points, as supported by the data presented in Figure 2 and Figure 3. Below  $0^{\circ}\text{C}$  it is assumed that the COP is 1.1 as the lowest rated heat capacity of the HP is 2, and the rated power draw is 1.82.  $-15^{\circ}\text{C}$  is the lower operating limit of the HP.

$$COP = \begin{cases} 0, & \Delta T > 95^\circ C \\ 1.1, & 95^\circ C > \Delta T > 80^\circ C \\ 1.1 + 0.1\Delta T, & 58^\circ C < \Delta T < 80^\circ C \\ 3.3, & \Delta T < 58^\circ C \end{cases} \quad (11)$$

There are also other technical parameters to the HP. These are difficult to simulate but presented for discussion. An example system is illustrated in Figure 24, showing the cascading tanks with flow from the HP, intake, and outtake. One of the HWT system technical parameters states that the HPs are only used if the water at the temperature sensor T2\_H is  $40^\circ C$ . This is the upper sensor in the tank to the left with the cold water intake. The heating elements in the tanks to the right are turned on if the temperature at T2\_H is under  $76^\circ C$ . The heating element is also turned on if the water out of the HP is below  $80^\circ C$

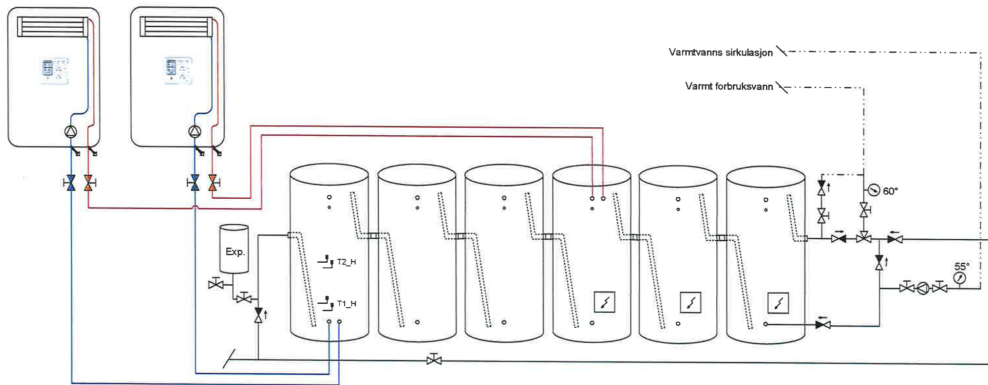

Figure 24: Sketch of a KWSmart system [17]

## 5.2 Optimization time-horizon

The time horizon of the optimization is set for a year with an hourly resolution to capture the effects of varying spot prices, tariffs, temperature, and consumption patterns.

## 5.3 Sets

Table 12: Sets

Type	Set	Indicator	Value	Comment
Time	$T$	$t$	$[0,8759]$	
Month	$M$	$m$	$[0,11]$	
Hour in a month	$K$	$k$	-	Sets of hours corresponding to months
05:00 weekday	$WD$	$h$	-	Set of weekday hours with time 05:00
07:00 weekend	$WE$	$h$	-	Set of weekend hours with time 07:00

## 5.4 Parameters

Table 13: Parameters

Parameter	Value	Unit	Description
$Z^{start}$	$Z^{max}$	kWh	Energy in tank before simulation
$Z^{min}$	-	kWh	Minimum energy in tank
$Z^{max}$	-	kWh	Maximum energy in tank
$Q^{HP,max}$	-	kWh/h	Max heat delivered by HP
$Q^{El,max}$	28	kWh/h	Max heat delivered by HE
$V$	2400	L	Volume of the EWH
$T^{null}$	9	°C	Reference temperature
$T^{amb}$	20	°C	Ambient temperature
$C_t^s$	-	NOK/kWh	Spotprice cost of electricity
$C^{ET}$	0.05	NOK/kWh	Grid tariff per kWh consumed
$C^{EPT}$	0.1584	NOK/kWh	Electrical power tax
$C^{Rem}$	0.05	NOK/kWh	Remuneration from DSO for loss reduction
$C^{VAT}$	1.25	-	25% VAT
$C_m^{PPT}$	72/32	$NOK/kW^{max}$	Monthly peak power tariff 72 from October to March 32 from April to September
$Q_t^{dem}$	-	kWh/h	Hot water demand
$COP_t$	-	-	COP calculated from outside temperature
$Y_t^{PV}$	-	kWh/h	Power generated by PV
$Y_t^{apt}$	-	kWh/h	Apartments' electricity demand
$M$	-	-	Used to increase the penalty of certain variables

The HE efficiency is set to 1, supported by [24], and is therefore not included as a parameter. The COP is calculated based on the outside temperature.

## 5.5 Variables

Table 14: Variables

Variable	Description
$z_t$	Energy stored in HWT
$q_t^{HP}$	Heat energy out of HP
$q_t^{HE}$	Heat energy from HE
$s_t^{Forced}$	Forced slack for HWT heat balance
$q^{loss}$	Energy loss to environment
$\alpha_m$	Monthly peak power demand
$y_t^{imp}$	Imported electricity
$y_t^{exp}$	Exported electricity to grid

## 5.6 System limit

The power flows and system limit are shown in Figure 25. There has to be energy balance in and out of the box at all times, but the HWT is outside of this system limit and is able to reduce or increase power import by affecting its power draw. It can operate freely within its temperature bounds to provide flexibility to the rest of the system. The energy balance of the HWT is not strict because of its ability to store energy.

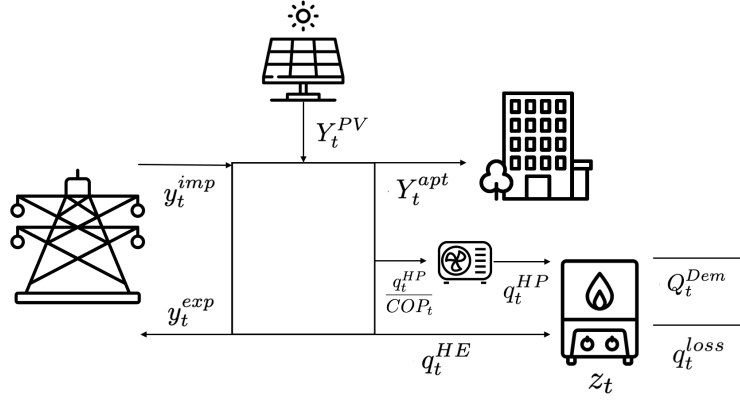

Figure 25: Power flow and notation

## 5.7 Objective function

Three objective functions have been formulated to evaluate the flexibility potential of the EWH.

Firstly, a base case was formulated that does not include any cost parameters. It is considered a baseline without optimization necessary as a comparison to see the benefits gained by optimization. The objective is to minimize temperature differences in the HWT between two timesteps while maximizing the amount of energy from the HP. A minimization of temperature difference was chosen to simulate how the HWT would operate without any optimization, purely reacting to HW consumption. Using the HP for HW production is also prioritized in the objective function to reflect decisions made in the literature and make the optimized HW heating strategies more comparable to the base case. If the base case covers all load with the HE, the gain from optimizing and moving all load over to the HP would be unreasonably high.

An even HWT temperature was chosen because solar power would interfere with the minimizing power import difference. It would also be possible to minimize the HE and HP power consumption difference, but then it would be difficult to prioritize HP over HE as no costs are included.

This is implemented by Equation 12, which minimizes the difference in stored energy between two timesteps. By only looking at two timesteps the optimal solution would be to keep the temperature low in hour 0 and high in hour 1. However, when increasing the horizon, high temperature in hour 1 would be penalized in hour 2.

$$\min z = \sum_{t \in T} z_t - z_{t-1} - q_t^{HP} + Ms_t^{Forced} \quad (12)$$

Secondly, a cost-minimizing objective function was formulated based on all relevant prices and tariffs, Equation 13. This is used as the main objective function, as it evaluates the cost for Røverkollen and reveals how the consumer can operate optimally according to the current tariff system. It is then also possible to assess whether the tariff system serves its intended purpose.

---

$$elCost = C^{VAT} \sum_{t \in T} y_t^{imp} (C_t^s + C^{ET} + C^{EPT})$$

$$pptCost = C^{VAT} \sum_{m \in M} \alpha_m C_m^{ppt}$$

$$elRev = \sum_{t \in T} y_t^{exp} (C_t^s + C^{Rem})$$

$$min z = elCost + pptCost - elRev \quad (13)$$

Thirdly, a solar power export minimizing function was formulated, Equation 14. This simply minimizes export to the grid and thereby increases self-consumption. This is interesting because [14] reported that optimizing SCR and cost when having a PV panel and smart control of EWH resulted in different water heating strategies. It also allows us to assess EWHs' potential to reduce power export.

$$min z = \sum_{t \in T} y_t^{exp} + Ms_t^{Forced} \quad (14)$$

## 5.8 Constraints

Equation 15 is the heat balance in the HWT in kWh/h. The current stored energy is found as the energy stored in the previous timestep with hot water usage and losses subtracted. The added energy is divided into power delivered by the heat pump and the electric HE.

$$Z_t = Z_{t-1} - Q_t^{Dem} - q_t^{loss} + q_t^{HP} + q_t^{HE} \quad (15)$$

Equation 16 describes the electric power balance. Note that PV power generation and apartment power consumption are turned off in many of the cases and are then 0. Since  $q^{hp}$  is the heat the HP delivers, it is divided by its COP in each timestep as the imported power is lower than the delivered heat energy.

$$y_t^{imp} - y_t^{exp} = \frac{q_t^{HP}}{COP_t} + q_t^{HE} - Y_t^{PV} + Y_t^{apt} \quad (16)$$

The upper-temperature limit of the tank is fixed at  $Z_{max}$ . There is no flexibility introduced in the up-regulation of temperature due to the safety limits of the tank, where the pressure might reach a critical level at high temperatures.

$$Z_t \leq Z^{max} \quad (17)$$

The lower temperature of the tank is regulated by setting a minimum energy content.  $Z^{min}$  can be varied to explore different flexibility levels. Since  $Z^{max}$  is fixed, lowering  $Z^{min}$  will increase the temperature band the HWT can operate in.  $s_t^{Forced}$  is used in cases where the HWD is too high to be covered by the HE and HP, forcing a lower temperature limit. It is necessary to get a feasible solution to the optimization problem.

$$Z_t \geq Z^{min} - s_t^{Forced} \quad (18)$$

---

The legionella constraint is implemented by Equation 19, ensuring the temperature stays above the set limit at the given times.

$$Z_h \geq c_p V (70 - T^{null}), h \in WD, h \in WE \quad (19)$$

The losses in the EWH are based on Equation 3 and included in the optimization by Equation 21. Since the EWH is modeled as an energy storage with  $9^\circ C$  as a reference point,  $\Delta t$  is first found with Equation 20.

$$\Delta T = \frac{Z_t}{lc_p} + T^{null} - T^{amb} \quad (20)$$

$$q_t^{loss} = UA\Delta T \quad (21)$$

The HP and HE are modeled to operate between 0 and the upper power limit.

$$q_t^{HE} \leq Q^{HE,max}, q_t^{HE} \in \mathbb{R}^{\geq 0} \quad (22)$$

$$q_t^{HP} \leq Q^{HP,max}, q_t^{HP} \in \mathbb{R}^{\geq 0} \quad (23)$$

---

## 6 Results

Four scenarios are chosen to investigate different EWH operation strategies, summarized in Table 15. The first scenario focuses on the EWH as an isolated system, aiming to determine its optimal strategy independent of solar energy or other electricity consumption factors. In the second scenario, PV-generated power is introduced as an additional resource for the isolated EWH, allowing for an assessment of potential changes in strategy and cost.

The third scenario incorporates the EWH as part of a more extensive system, considering the apartment's electricity consumption as a fixed load and the EWH as a flexible resource. This scenario explores how the EWH can be utilized to reduce costs and peak power import of an external fixed load. Finally, the fourth scenario combines fixed load and PV power generation, enabling further evaluation of strategy variations and associated costs.

These scenarios are divided further into different cases based on the minimum temperature ( $T_{min}$ ) allowed in the tank and one base case. The base case is simply the regular operation of the tank, simulated by keeping the temperature difference to a minimum and prioritizing the HP for better comparison to the optimization cases. Without prioritization, the use of HP and the HE would be arbitrary, and the model might get unreasonably high usage of the HE. The other case simulates an increase in flexibility as the minimum temperature decreases.

The temperature ranges chosen are from the current actual minimum limit of  $75^{\circ}C$  to  $55^{\circ}C$  with  $5^{\circ}C$  intervals. A lower limit of  $55^{\circ}C$  is chosen based on regulations in different countries and the current literature shown in Table 1. Though the literature has temperatures down to  $30^{\circ}C$ , FHI claims that legionella growth happens in the  $20-55^{\circ}C$  range. In all cases, the upper limit is  $80^{\circ}C$ .

The key performance indexes (KPI) chosen are; cost, monthly max power import, self-sufficiency (SSR), and self-consumption (SCR).

The final cost comprises five elements described in Section 2.5. A cost breakdown is made for every scenario and case to show what parts of the power bill impact the final cost to the consumer. This is important to evaluate how the consumer should invest correctly and if the tariffs set by grid operators have the intended impact.

The monthly peak power import is important to the consumer as it is a part of the final power bill. The winter months have increased peak power tariff are the most important, but the summer months will also affect the final annual cost. Additionally, peak power is essential to the power grid operators as the grid is dimensioned based on the maximum capacity. Since the peak power demand from the grid is expected to increase, it is, as discussed, beneficial to look to consumer flexibility to decrease investment costs in the grid. Flexibility during winter when demand is high is most important. Reducing peak power in other months may also be beneficial because it allows power consumption by other sources to utilize the grid better.

SSR is used to investigate how much of the building's demand is covered by solar panels, thereby reducing its reliance on the grid. SCR is important as an investment decision, as the self-consumption of power is more profitable than exporting to the grid.

Table 15: Abbreviations

Scenario abbreviation	Description
EWH	EWH alone
EWH_PV	EWH alone and PV
APT	EWH and apartments' electricity consumption
APT_PV	EWH, apartments' electricity consumption and PV

### 6.1 Comparison to measured data

Figure 26 shows the measured daily average HE and HP power consumption during 09.-30. April compared to selected optimized cases. Using the average minimizes the impact of any day-specific

heating strategies, and the selected days in April were chosen because of the relatively good measured data quality, shown in Figure 51 in the appendix.

In the base case, the HE has much higher peaks and lower valleys than the measured data, and the HPs are used significantly more. On average, the base case has considerably more potential to shift load than reality. In the modeled case, the difference between the peaks and valleys is almost 17 kWh/h but only 6 kWh/h in reality. This will affect all results, making them more optimistic than reality.

In the optimized EWH scenario at a temperature limit of  $T_{lim} = 55^\circ C$ , the utilization of the HE is significantly reduced compared to the measured data. Furthermore, the timing of the HE's power usage is reversed between the two cases. In the optimized scenario, the HE power peaks between 02:00 and 06:00, whereas in reality, the lowest power usage occurs during the same period. The HP use is further increased in this scenario.

Incorporating the electricity consumption of the apartments alters the optimal heating strategy for the HWT. The HP remains a dominant priority, and the contrast in strategy between the base case and optimization period of 02:00-06:00 becomes more pronounced. Furthermore, there is another change compared to the EWH scenario, where the HE is used at higher power during the evening.

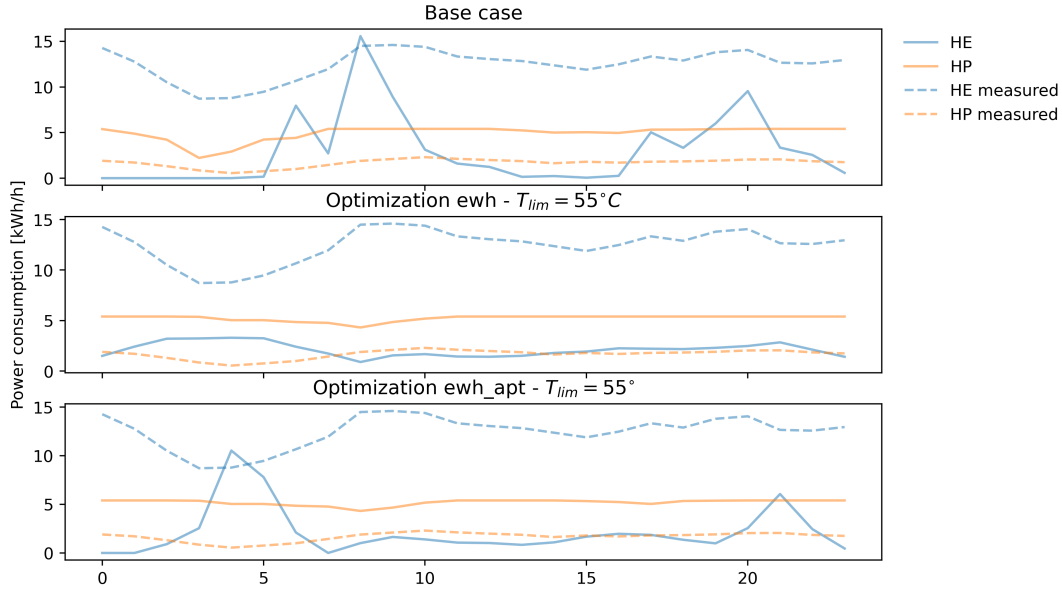

Figure 26: Measured and optimized HE and HP power consumption - hourly average in April

Figure 26 shows example days during April to investigate the differences in greater detail. It confirms the previous results, where the HE is utilized far more in reality than in the simulation. The difference between peak and valley during the selected days is 12 kWh/h, showing more potential load shift than the average values. The base case increases from 17 kWh/h to 28 kWh/h, but only on selected days. On other days it may be as low as 11 kWh/h.

If the measurements made on the HP during these days are correct, the difference between measured and simulated HP usage is even greater. The HP is barely used in reality, only operating during the peak load hours when the HE is also in use. This is disadvantageous because the HP adds to the HE already high load.

The optimization scenarios also show the same results as in the average case. Optimizing EWH operation isolated decreases the peak power the HE uses significantly, from 28 kWh/h to 4 kWh/h. When adding the apartments' power consumption, the HE is used at high capacity at night and early morning.



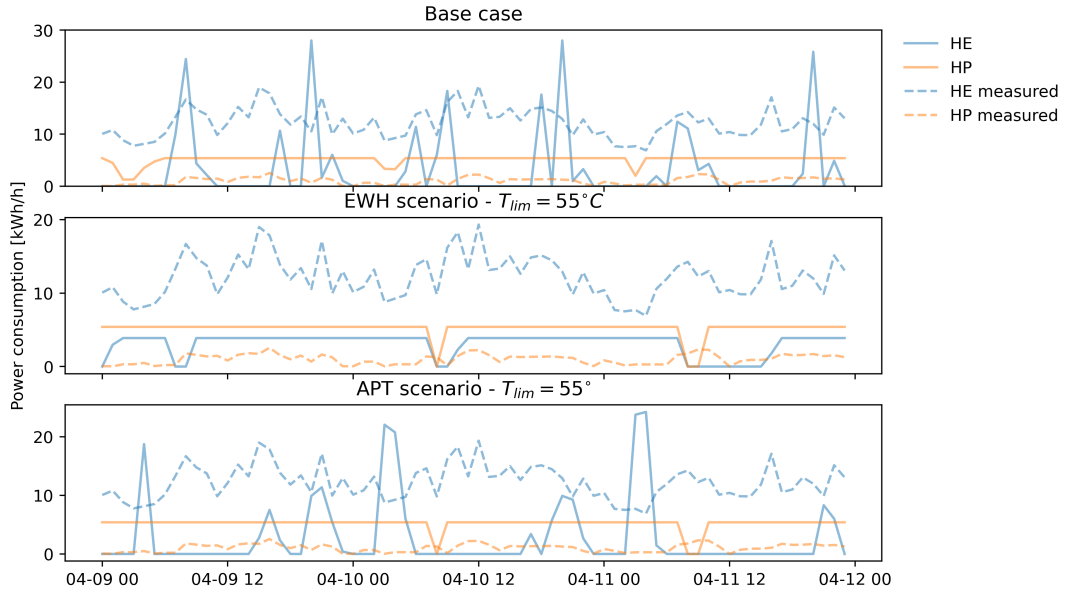

Figure 27: Measured and optimized HE and HP power consumption - example days April

By comparing the base case and the cost-optimized cases, it is observed that all three kinds of flexibility introduced in Section 2.2.2 is present. There is load shaving due to higher HP usage, reducing the total import because of the COP. There is valley filling in the EWH\_APT scenario, where water is heated before the morning peak. additionally, there are load shifting as a result of moving the load from peak hours to the valley.

### 6.1.1 HP heating capacity

The measured power delivered to the HE and HP was presented in Table 6. Table 16 shows the EWH key measurement in the simulated case. The HE is far less utilized, and the HP consumes more power than the measured data. Due to the HP delivering more heat than the power it uses, a one-unit increase in HP will decrease the use of the HE by the COP. This is due to the model's prioritization of the HP to cover the load. For example, when optimizing and reducing  $T_{min}$  to 55°C, more load is covered by the HP, from 55% in January to 100% in the summer months, see Table 19.

Table 16: EWH key measurement - EWH base case

Modeled data [kWh]	Modeled data [kWh]			
	HE	HP	Total	Share
Jan	3 738	3 729	7 468	50%
Feb	3 324	3 315	6 638	50%
Mar	3 011	3 763	6 774	56%
Apr	2 168	3 554	5 722	62%
May	1 309	3 312	4 621	72%
Jun	383	2 678	3 061	87%
Jul	208	2 622	2 830	93%
Aug	534	2 873	3 407	84%
Sep	850	2 971	3 821	78%
Oct	1 595	3 419	5 014	68%
Nov	2 792	3 563	6 354	56%
Dec	3 655	3 803	7 458	51%

## 6.2 EWH alone

Figure 28 shows the yearly cost breakdown of the EWH operation on the left axes and the cost saving compared to the base on the right axis. By optimizing under perfect information without decreasing HWT minimum temperature, the operation cost is reduced by 6000 NOK/year. Most of the savings, 5400 NOK, come from a reduction in the peak power cost. In addition, 400 NOK comes from shifting power usage to hours with lower spot prices. The rest is divided into power tax and energy tariff.

The extra flexibility gained by reducing the minimum HWT temperature provides a further cost saving. By setting the lower limit to 70°C, Røverkollen can save up to 14 600 NOK yearly. Again, most of the savings come from peak power reduction, but the increased flexibility also allows for more load shifting based on the spot price. Additionally, there is a reduction in the energy tariff and the power tax due to lower losses from the tank. The lower losses also affect the spot price cost, however, it is difficult to quantify the saving from power consumption reduction and load shifting based on the spot price. The amount of decrease in loss is shown in Figure 57 in the appendix. A clear trend shows that reducing the temperature reduces losses, supporting the previous claim.

Reducing the temperature from 75 to 70 °C gives the highest marginal saving. There are diminishing returns by further reducing the temperature. The additional saving by lowering the temperature further at 5°C intervals is approximately 5500, 2000, and 1300 NOK. Even though the spot price, energy tariff, and power tax get lower, there are expected diminishing returns from the peak power tariff as the power consumption becomes more even during the day.

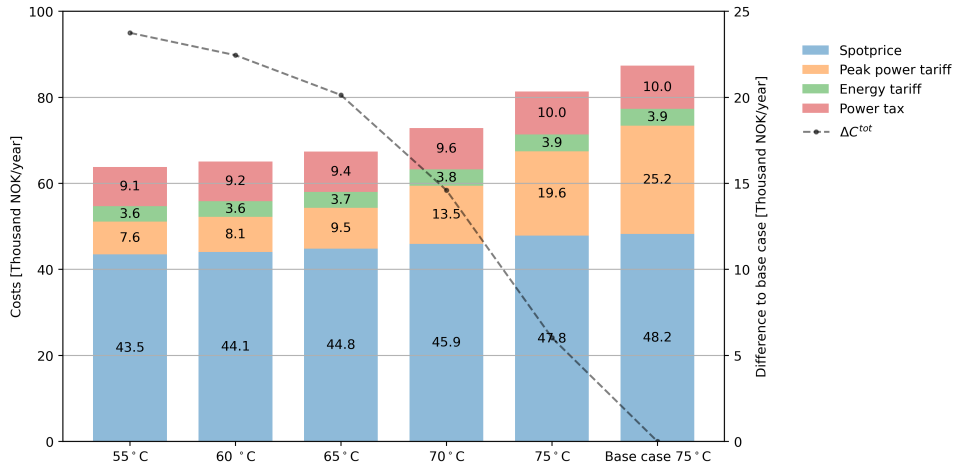

Figure 28: Yearly cost breakdown at different flexibility levels

As illustrated in Figure 29, the maximum import is reduced drastically when reducing the temperature and optimizing under perfect information. Simply by optimizing, the peak power in January is reduced from 33.4 kWh/h to 28.4 kWh/h or 15%. January is chosen as a representative month because it has the highest apartment peak power import. By reducing  $T_{min}$  to 55°C, the peak import is reduced to 12.5kWh/h, or by 64%.

The import in the months with the highest power peaks is most relevant from a power grid perspective. These are typically the winter months, confirmed by the apartments' maximum imports during January in this case. There are similar results in decreased maximum import in all winter months. However, confirming the results in the previous section, there are diminishing returns when reducing the minimum temperature limit.

In November, there is one outlier value when comparing the base case to the optimization under 75°C case. There is almost no peak power reduction because the maximum HWD during the year occurred on 2021-11-04 at 09:00, resulting in a forced high import value. This illustrated the difficulty with optimizing the peak power consumption of HWT under hard constraints as an arbitrary, high hot water outtake during a month sets the overall maximum import. Multiple

solutions may solve this issue. One is by reducing the temperature, as shown in this case. This gives enough flexibility to reduce the peak power even in high HWD hours. Extending the model to allow for reduced temperature in a certain number of hours during a day will also capture outliers like this. A third solution is to limit the maximum power available. According to the results presented in Figure 29, 28.4 KW is sufficient to cover all optimization scenarios except the outlier in November. However, the solution is further discussed in Section 7.3 as it may interact poorly in a larger system and with the inclusion of PV.

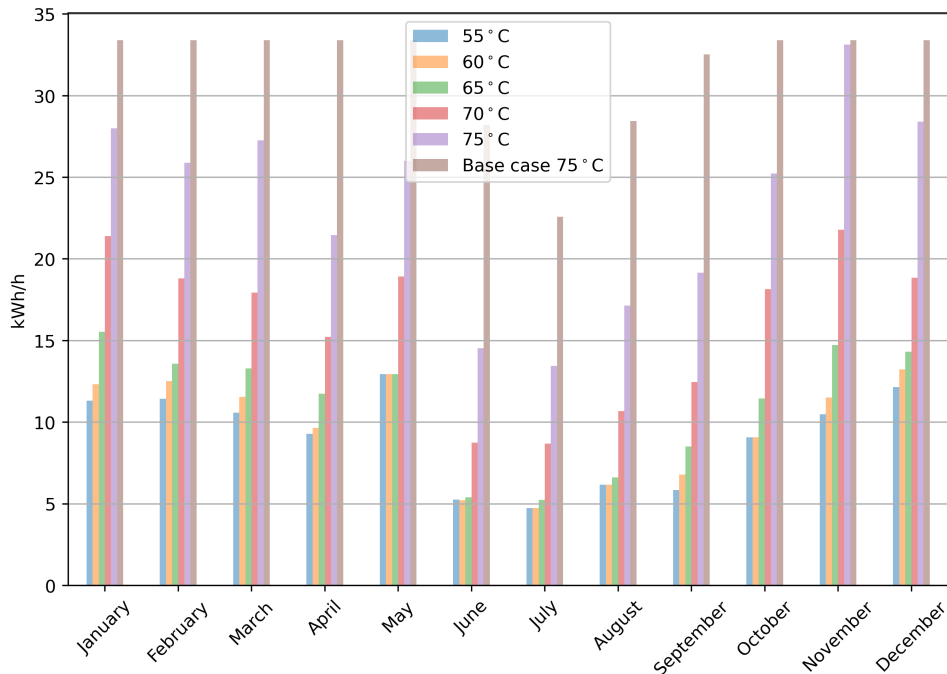

Figure 29: EWH - Monthly max import

### 6.3 EWH alone and PV included

When introducing local PV power generation, the imported power demand goes down. The cost in the base case is reduced by 27 500 NOK/year compared to the no PV case. That gives a marginal revenue of 0.74 NOK/kWh. PV investment is not profitable under any discount rate and the estimated spot prices. The marginal revenue is still significantly higher than the market value of 0.2 NOK/kWh estimated in [5]

PV power also adds another layer of optimization by shifting the load to when there is solar power generation. When optimizing at 75 °C, there is a cost reduction of 7 800 NOK, Figure 30. Similar to the scenario without PV, most of the benefit comes from reducing the peak power tariff. However, the spot price, energy tariff, and power tax are also reduced more than in the case without PV because the load shifts to the hours with PV generation. This is also seen in the decrease in revenue from the grid company.

Similar to the case without PV, there are diminishing returns in this case too. The largest savings happen when optimizing and reducing the temperature to 70°C.

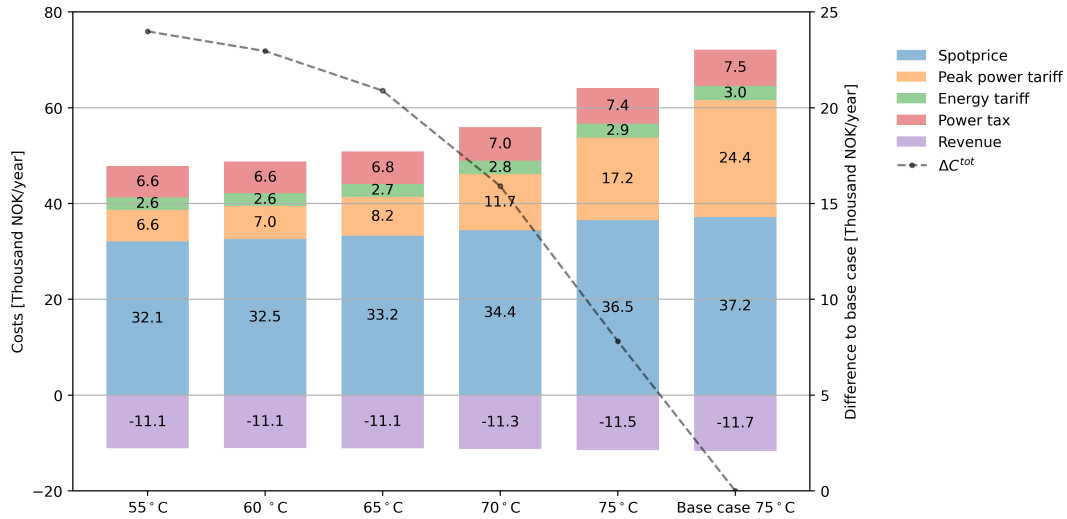

Figure 30: EWH\_PV - Yearly cost breakdown

Compared to the EWH scenario, peak power import is reduced in all months with sufficient solar power generation, and this applies to almost every case, Figure 31. The effect of solar power on import during the winter months is mostly negligible, however, the peak HWD in November which causes high peak import even in the 75°C optimization case is slightly reduced.

The change in peak power reflects the seasonal properties of solar power, making it difficult to quantify how much the max import is reduced. The peak power reduction ranges from 0 to 50%, however, the highest yield is seen in the summer months, where the need for peak power reduction is at its lowest.

By comparing the base case scenarios with and without pv, there is little to no change. The only notable months are July and August. Although the base case sees little gain from solar power, optimizing under the same temperature constraint at 75 °C reduces peak import almost monthly. This highlights the importance of smart control when considering the peak power import of an HWT with solar power.

May is a good example of the extra flexibility provided by solar power. In the case without PV, the import is quite high at above 25 kWh/h with  $T_{min}$  at 75°, which is reduced to only 15 kWh/h when solar is added. During May, there are also quick diminishing returns by reducing  $T_{min}$ , where the peak power import is the same for 55, 60, and 65°C cases. By adding solar power, the extra flexibility reduces the peak power from 13kWh/h to 5kWh/h at 55 and 60 °C and 7.5kWh/h at 65 °C. This illustrates that solar power gives the HWT more flexibility when introduced and allows the extra flexibility when reducing  $T_{min}$  to be utilized at a higher capacity.

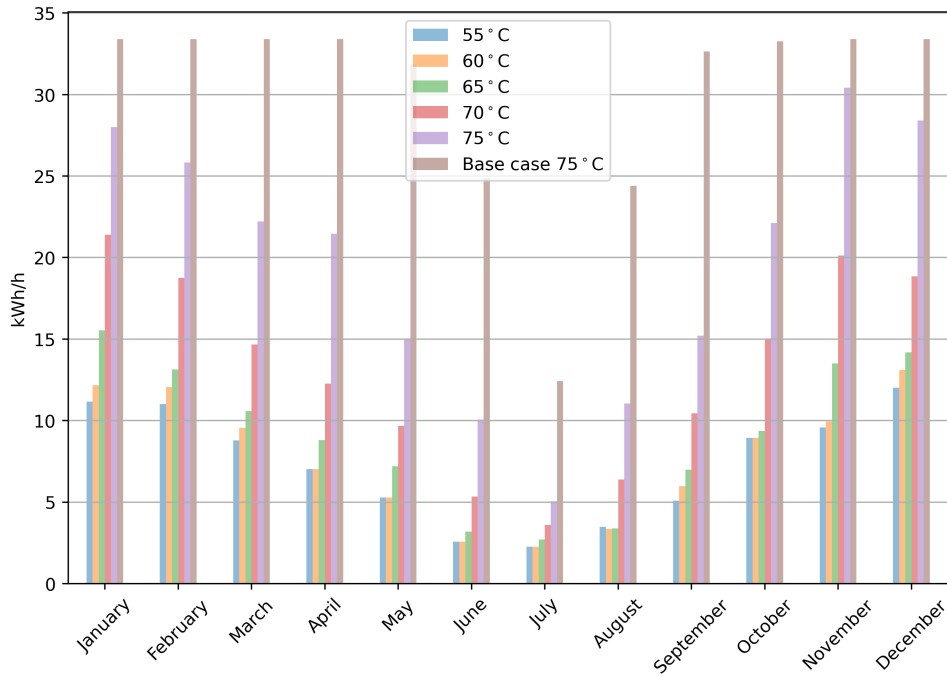

Figure 31: EWH\_PV - Monthly maximum import

The increase in HWT SSR is also season dependent, seen in Figure 32. During the winter months, it is very low, at 1-3% with a negligible difference with solar. Otherwise, the SSR increases as the generated power increases and  $T_{min}$  is reduced. The largest increase is seen in April, where the SSR increases from 44% in the base case to 61% in the 55°C case.

There are also cases where the SSR decreases as  $T_{min}$  decreases. In May the heating strategy at 55°C causes the SSR to decrease slightly from the peak SSR at 65°C. However, the change is only 1 percentage point. This may happen because lower temperature allows the HP to be utilized more, or the HE is used at high capacity during one hour causing more exported power in the next.

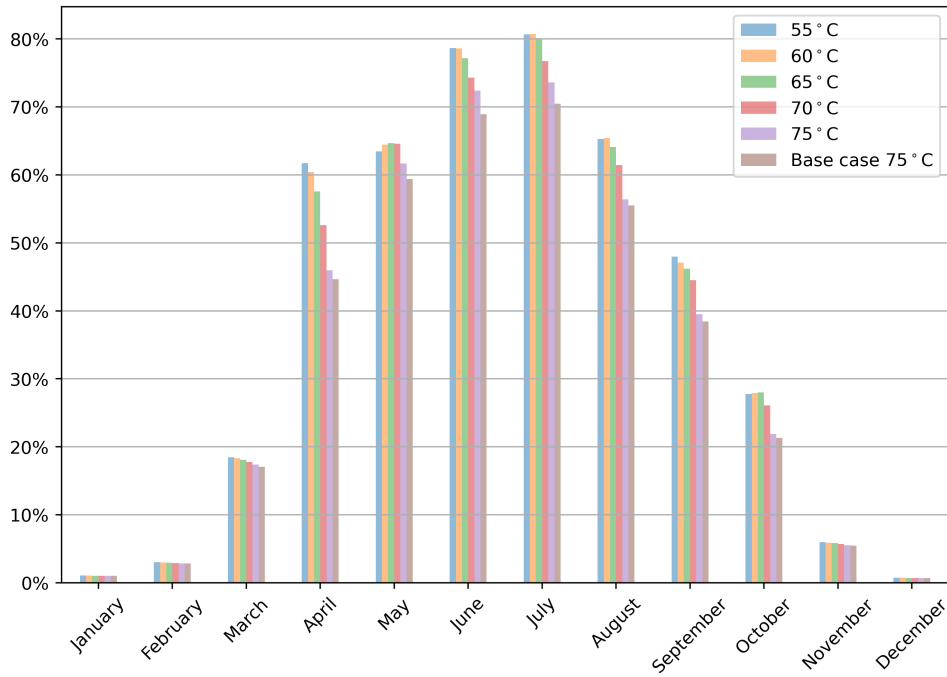

Figure 32: EWH.PV - Monthly SSR

The SCR is more complex than the SSR. It follows the main trends as SSR, but the opposite, as seen in Figure 33. The SCR is very high in months with low power production and decreases when power generation increases. During April the expected results of increased SCR when  $T_{min}$  is illustrated. However, in May the opposite is seen - as more flexibility is introduced, the SCR goes down. There are several reasons for this. When  $T_{min}$  is reduced the total electricity needed is also reduced due to fewer losses and higher HP usage. Since the HP delivers more heat energy than the electricity it consumes, it is possible for the SSR to go up while the SCR goes down. Other effects such as the spot price and peak power tariff might also impact the SCR.

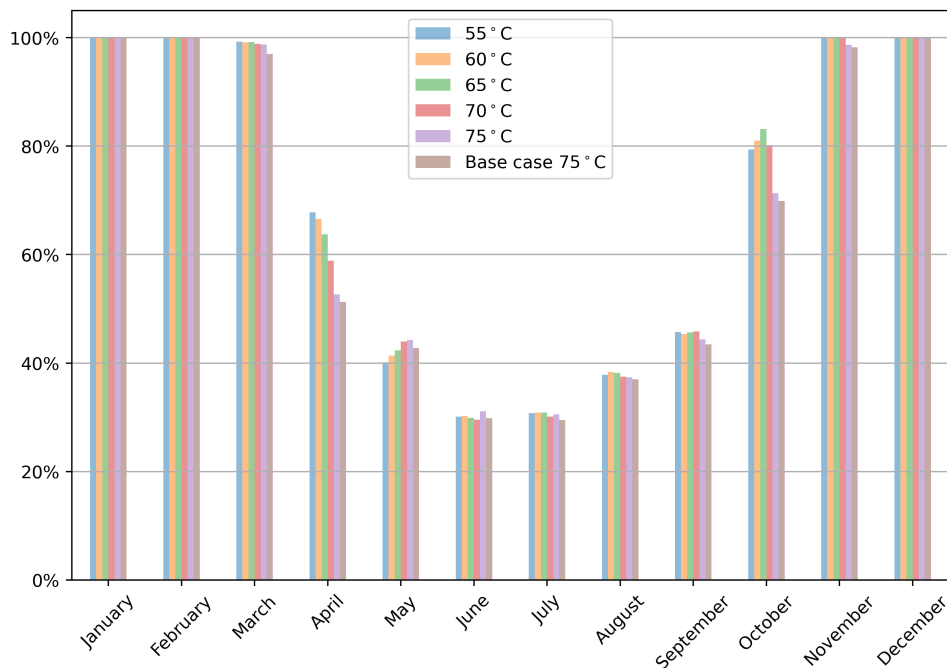

Figure 33: EWH.PV - Monthly SCR

## 6.4 Apartments' electric consumption included

The cost breakdown with apartments' electricity consumption added as an inelastic load, shown in Figure 34, sees mostly the same changes as HWT alone. The change in reduced power tax and energy tariff remains the same as the EWH alone, but the spot price is difficult to assess because of the large proportion of apartment usage. Peak power tariff reduction is the main difference between the cases. Optimizing at  $75^{\circ}\text{C}$   $T_{min}$  gives drastically higher cost savings, 12 800 NOK compared to 5 400 NOK. By reducing  $T_{min}$  to  $70^{\circ}\text{C}$ , the total saving is 18 500 NOK compared to 14 600 NOK without apartments included.

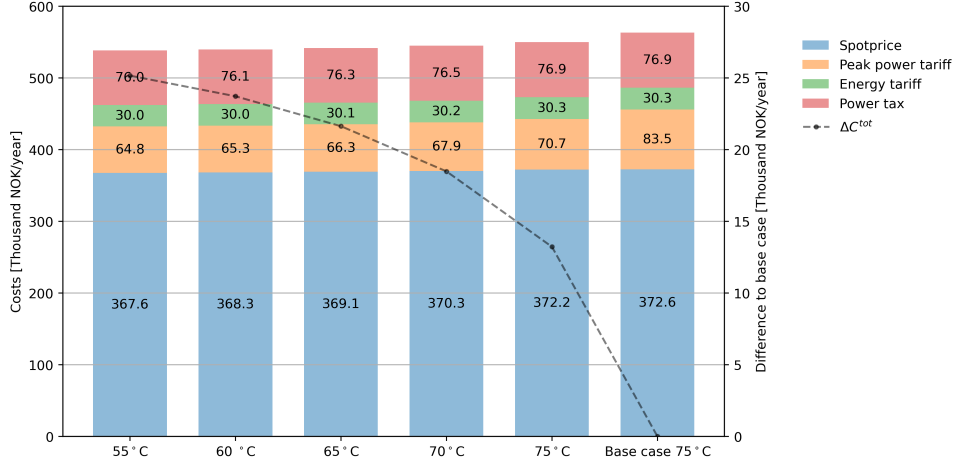

Figure 34: APT - Cost breakdown at different flexibility levels

The optimization process results in a reduction of maximum power import for all months, as depicted in Figure 35. The highest peak demand is observed in January, reaching 140 kWh/h. When optimizing with a temperature limit of  $T_{min} = 75^{\circ}\text{C}$ , a reduction of 11 kWh/h is achieved, corresponding to an 8% decrease. Although this reduction appears lower in percentage compared to the "EWH" scenario, the absolute reduction in kWh/h is significantly increased by over 100%. This substantial increase is attributed to the fact that power can be significantly reduced during periods of high apartment consumption.

As  $T_{min}$  is decreased, the peak power import experiences further reduction. However, it reaches the fixed load minimum limit of 122 kWh/h relatively quickly, specifically at  $65^{\circ}\text{C}$ . At this point, the HWT is turned off, completely eliminating its contribution to the peak power import. Similar results can be observed across multiple months and scenarios where the peak power import is solely driven by fixed demand.

Despite reaching the fixed load minimum limit in some months, there are still notable benefits to reducing  $T_{min}$  in others. For instance, in March, the largest decrease in maximum import is achieved by introducing optimization, reducing the peak import from 117 kWh/h to 95 kWh/h. Then there is a diminishing return of reducing the temperature further. Nevertheless, the cumulative reduction difference between  $T_{min}$  values of  $75^{\circ}\text{C}$  and  $55^{\circ}\text{C}$  amounts to 9 kWh/h or approximately 10% reduction in peak import.

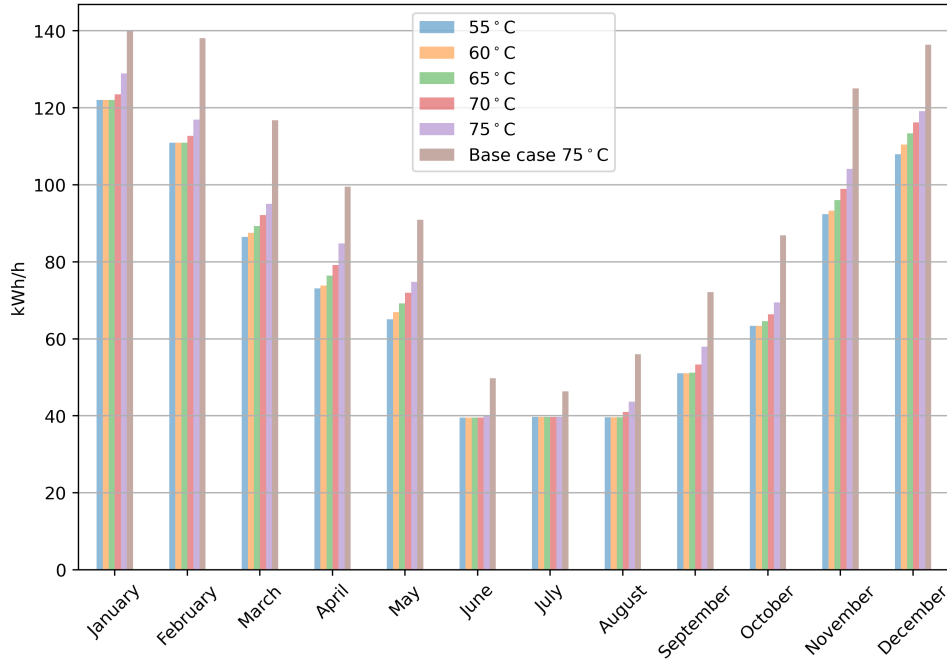

Figure 35: APT - Monthly max import, case comparison

## 6.5 Apartments' electricity consumption and PV included

The base case with PV compared to no PV results in 36 304 NOK/year saved. This is higher than the required revenue calculated with 4 and 5% discount rates but is barely not profitable with a discount rate of 6%. The marginal revenue of solar investment is 0.98 NOK/kWh, whereas the LCOE with 6% discount rate is 0.99 NOK/kWh.

The change in operating cost of the APT\_PV scenario is almost identical to the APT scenario, shown in Figure 36.

Compared to the base case, the main gain comes from optimization at  $T_{min} = 75^{\circ}C$  at 12 800 NOK. Optimizing at  $T_{min} = 70^{\circ}C$  saves 300 NOK/year less than the case without PV. The other cases experience diminishing returns as expected and reach a maximum cost reduction of 25 000 NOK at  $T_{min} = 70^{\circ}C$ .

There is barely any revenue due to power sales because of high SCR.



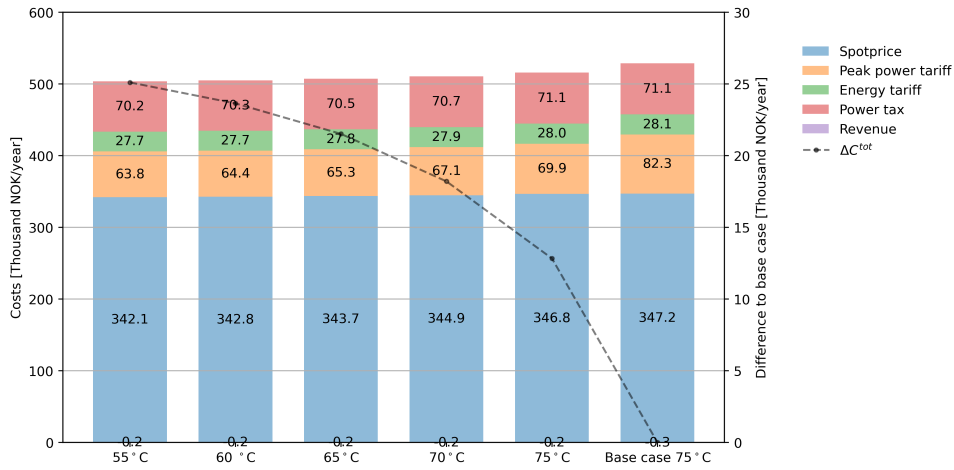

Figure 36: APT\_PV - Cost at different flexibility levels

The peak import is mostly unaffected by adding solar power because the fixed peak import occurs when there is little solar power, typically during the morning or afternoon. In most cases, there is a slight reduction in peak import from May to August, shown in Figure 37, but this is not a result of the optimization but a reduction in the fixed apartment power import due to solar power.

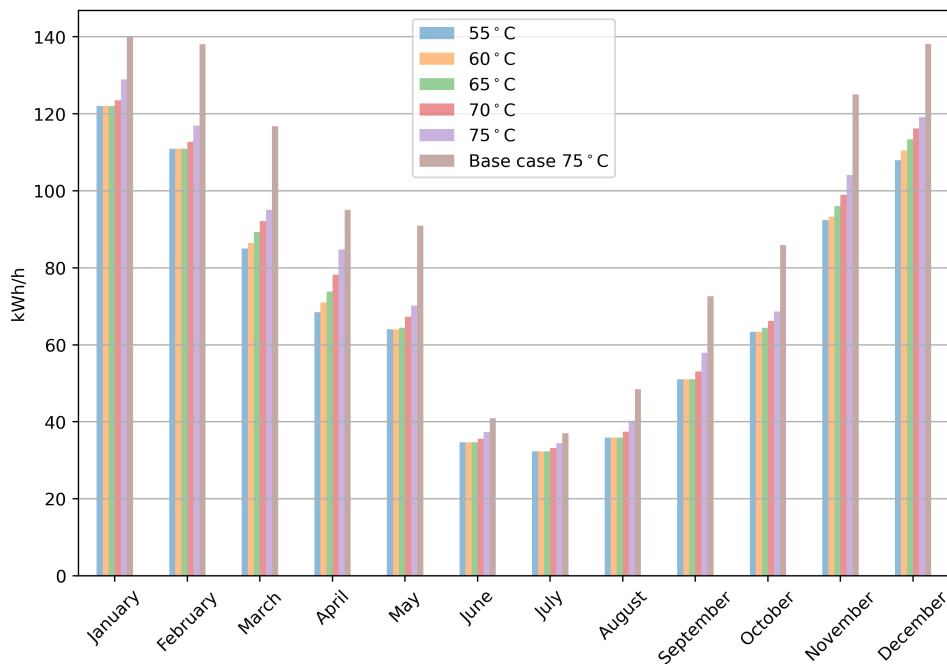

Figure 37: APT\_PV - Monthly max import, case comparison

The SSR and the SCR, shown in Figure 54 and Figure 55, are mostly unaffected by reducing  $T_{min}$  because the power consumption is considerably larger than the power production. There is a slight increase in both SSR and SCR during June and July at one percentage point. The SCR is mostly at 100% in all months except June and July where it drops to approximately 95%. The SSR reaches a maximum value of around 35% in June and July due to high PV power generation and lower power consumption during the summer.

## 6.6 Strategy comparison - apartment power consumption included and excluded

The heating strategy, depicted in Figure 38, changes when introducing the apartments as a fixed load because the peak import is not only dependent on HWT electricity consumption. HP's strategy in the days shown remains the same because it covers the base load in both scenarios. The HE peak power usage is higher in EWH\_APT than in the EWH alone scenario for all  $T_{min}$ .

It is important to note that even though the HWT power peak happens simultaneously with the apartments' fixed demand, it is still below the maximum forced import during the month. This can be seen in the import and HE use in Figure 38 between 01.04 00:00 and 01.04 12:00. The maximum forced import is the fixed import and the minimum import to the HWT to fulfill restrictions. As long as the peak import is below the forced import, there is no penalty for increasing the peak power draw.

It is noteworthy that while the power peak of the HWT coincides with the fixed demand of the apartments, it remains lower than the maximum forced import for the month. This observation is evident from "HE APT" and "imp APT" shown in Figure 38 between 01.04 00:00 and 01.04 12:00. The maximum forced import represents the fixed import requirement and the minimum import necessary for the HWT to meet the imposed restrictions. As long as the peak import remains below the monthly maximum forced import, there are no penalties for increasing the power draw during peak periods.

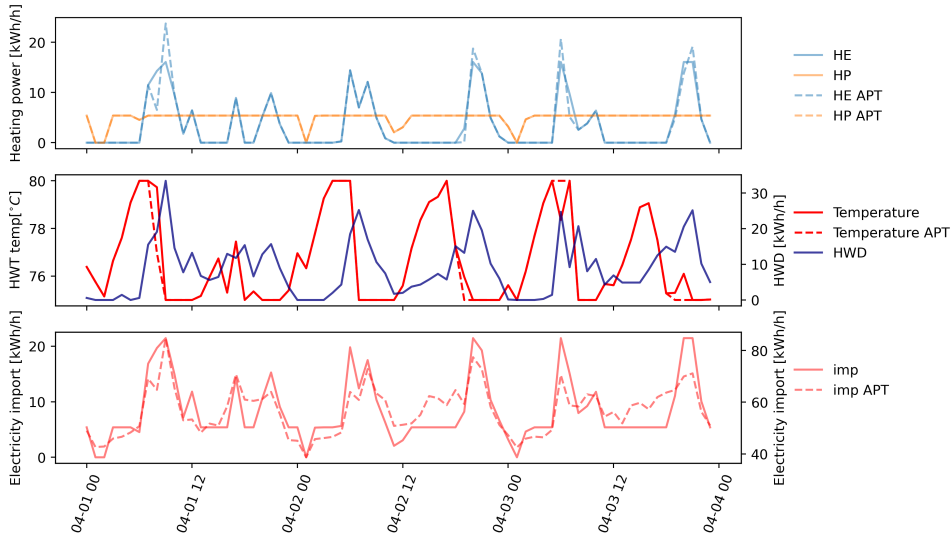

Figure 38: EWH cf APT - HWT heating strategy  
April  $T_{min} = 75^{\circ}C$

In the  $T_{min} = 55^{\circ}C$  case, Figure 39, the peak power import used by the HE increases in magnitude and frequency. Peak power import by the HE coincides with the peak apartment import. However, at  $55^{\circ}C$  during April, the fixed peak load is 73.5kWh/h. The HWT does not contribute to increasing the monthly peak load when  $T_{min}$  provides sufficient flexibility. At  $55^{\circ}C$ , the peak fixed import sets the monthly maximum import for all months except March, where the HWT increases the peak marginally by 1.5kWh/h.

The occurrence of earlier morning power peaks can be attributed to the presence of a legionella constraint, which ensures that the water temperature remains at or above  $70^{\circ}C$  at specific times during the week. On weekdays, the constraint requires the water to reach this temperature by 05:00. During weekends it must be achieved by 07:00. This condition applies to all scenarios where the minimum water temperature, denoted as  $T_{min}$ , falls below  $70^{\circ}C$ . An illustrative example of this scenario, with  $T_{min}$  set to  $65^{\circ}C$ , is presented in Figure 56.

As anticipated, the water is heated to 70°C before the peak HWD, as demonstrated in the figure. This preemptive heating can prove advantageous, allowing sufficient time for the water temperature to reach the desired level. In the absence of the legionella constraint, where heating occurs simultaneously with withdrawal, achieving a temperature of 70°C becomes challenging without significantly increasing power consumption.

By comparing the morning peak with the evening peak, this effect becomes noticeable. During the evening peak, the HE is activated simultaneously with the withdrawal of power.

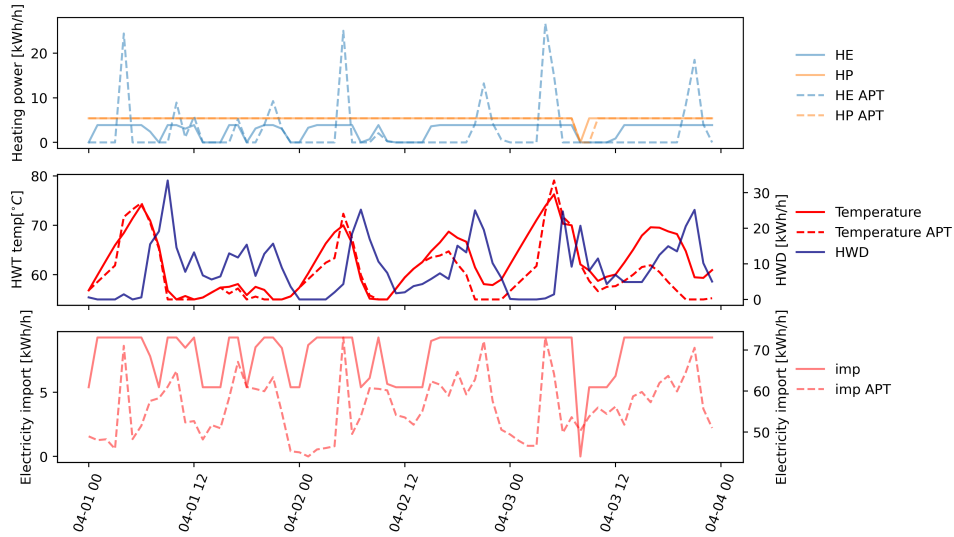

Figure 39: EWH of APT - HWT heating strategy comparison  
April  $T_{min} = 55^{\circ}C$

## 6.7 Strategy comparison - PV included and excluded

Three different seasons are investigated, winter, spring, and summer, to consider different solar irradiation levels. The months chosen are January, April, and July because they represent low, medium, and high power production months at a respective average of 0.1 kWh/hour, 6.9 kWh/hour, and 9.8 kWh/hour. Three days are chosen each month to show patterns in strategy with and without PV in the different seasons. To assess the strategy, the power used by the heating element and HP is presented along with imported power and the HWT temperature. The strategy where only EWH is present and when apartment electricity use is included are separated.

### 6.7.1 EWH alone

As expected in the months with little PV power production, the HWT heating strategy is nearly identical. Since the strategy is identical for every case except  $T_{min} = 55^{\circ}C$ , only this case is shown in Figure 40. The only notable difference in strategy is the peak import by the heating element between 10:00 and 14:00 on January third, where the heating element power draw is slightly higher than in the case without PV. Still, the imported power from the grid stays the same. The difference is however negligible when looking at the temperature in the tank, as there is barely any change. The power import only drops between 10:00 and 14:00 due to PV power production, and there is no exported power at any time.

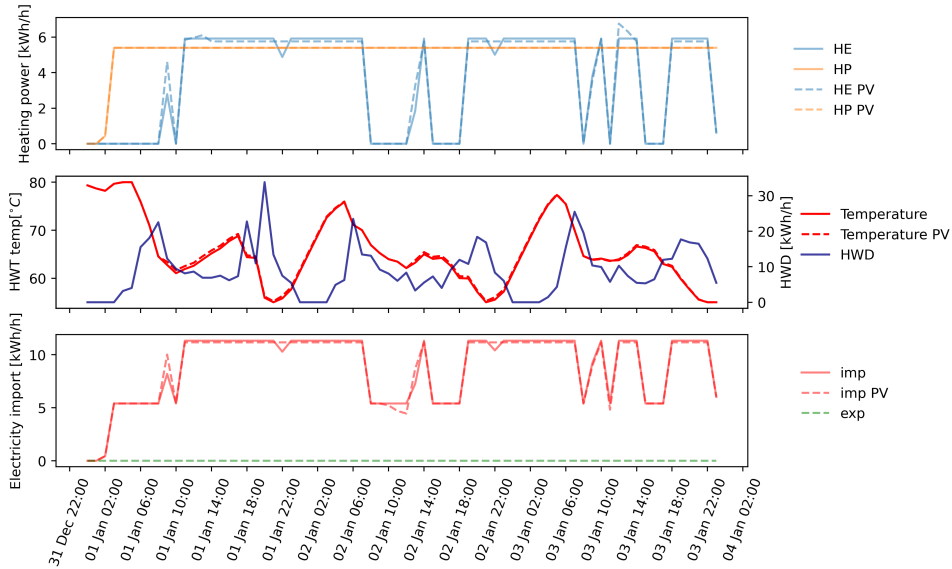

Figure 40: EWH of EWH.PV  
Optimal strategy at 55°C in January

During April, notable differences in heating strategies for solar power utilization can be observed, particularly when optimizing and decreasing the HWT temperature.

Optimizing the HWT temperature at 75°C results in a distinct change in the heating element strategy, see Figure 41, exhibiting similarities to the peak seen in January but with more pronounced effects. Specifically, between 06:00 and 10:00 on April 1st, the power consumption in the scenario with PV input is significantly higher compared to the scenario without PV, while the imported grid power remains lower.

Another notable distinction is observed in the temperature profile between 14:00 and 18:00 on April 1st. In the PV scenario, the heating element's power usage is slightly shifted closer to 14:00 to optimize solar power utilization. As a result, the water is heated before consumption, causing the increased HWT temperature. Conversely, in the no PV scenario, the water is heated while being consumed, thus not increasing the temperature. The optimization process considers the act of heating water during consumption as advantageous, as it reduces losses within the tank.

Since the spot price remains constant at 0.57 NOK during the relevant hours, it does not affect this scenario. This leaves the effect of self-consumption and shows that the benefits of increasing outweigh the additional losses incurred within the tank. This finding emphasizes the higher value placed on the self-consumption of solar power compared to the associated tank losses by the optimization algorithm.

These findings highlight the substantial impact of heating strategies on solar power utilization and tank temperature dynamics. Understanding and considering these factors are essential for optimizing energy consumption in residential settings, particularly in relation to solar power integration.

There is significant export to the grid even though some load is shifted to increase self-consumption. The export peaks at approximately 20 kWh/h at midday.

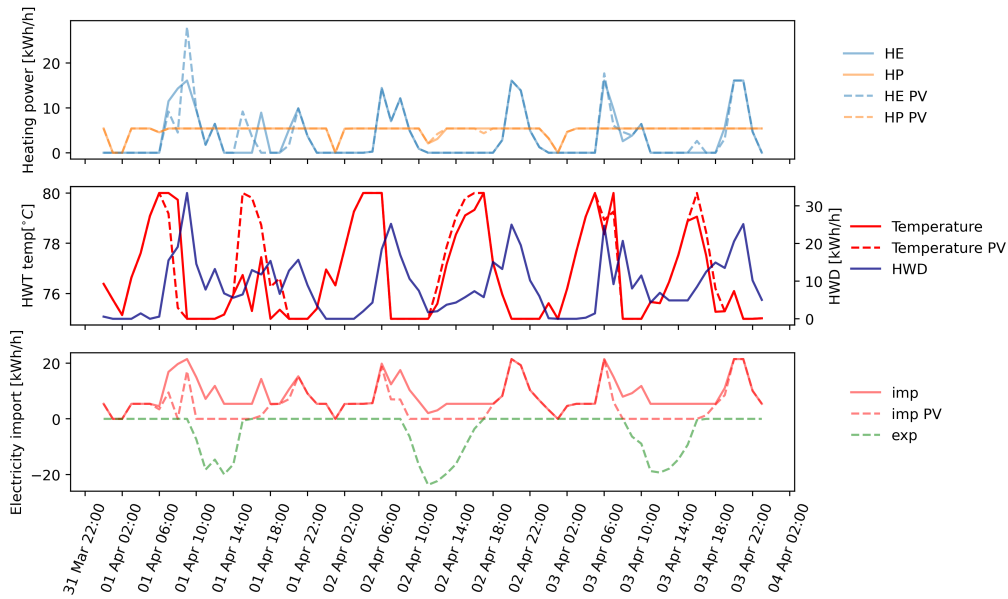

Figure 41: EWH of EWH.PV  
Optimal strategy at 75°C in April

As mentioned, reducing the minimum temperature increases the flexibility because it allows the temperature to drop further before the heating element is turned on. This effect is illustrated in Figure 42, where the HWT temperature drops to 65°C at regular intervals and is only heated due to legionella constraints or to cover high demand. The preheating strategy seen in Figure 41 is present, where the HWT temperature regularly increases to 80°C during the day. Without PV, temperature increase during the day is markedly decreased. To achieve higher HWT temperatures, the heating element uses higher peak power, and is frequently higher with PV present than without, while maintaining lower maximum grid power import. The peak power the heating element uses increases from 6 kW to 15.5 kW when introducing PV. Compared to a minimum temperature of 75°C, the exported power is reduced by 72 kWh over the three days showcased.

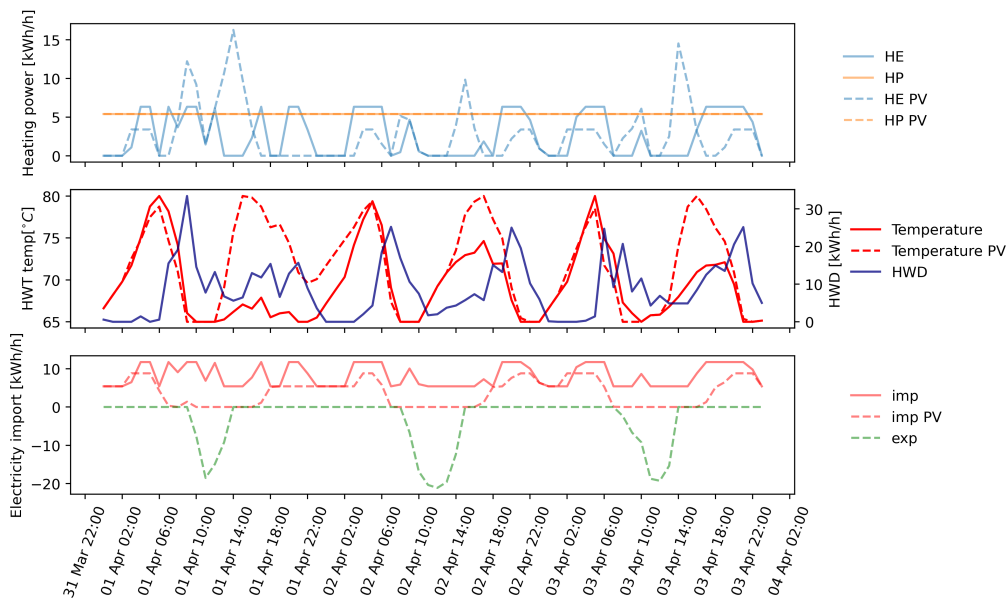

Figure 42: EWH of EWH.PV  
Optimal strategy comparison at 65°C in April

In the scenario where the minimum temperature is lowered to 55°C, refer to Figure 43, several notable effects emerge. The temperature is dropped down to 55°C at times to decrease losses and increase the heating energy needed when solar power is available. As a result, the heating element is frequently used at high capacity without penalty to the peak power tariff. Moreover, strategic measures are implemented to optimize energy consumption, including occasional HP shutdowns to minimize HWT losses and facilitate a load shift to periods when solar power is available. Consequently, the HWT is utilized more dynamically, functioning as a medium for energy storage. Ultimately, this leads to a reduction of 123 kWh in power exported to the grid over a three-day duration when compared to the scenario where the minimum temperature was maintained at 75°C.

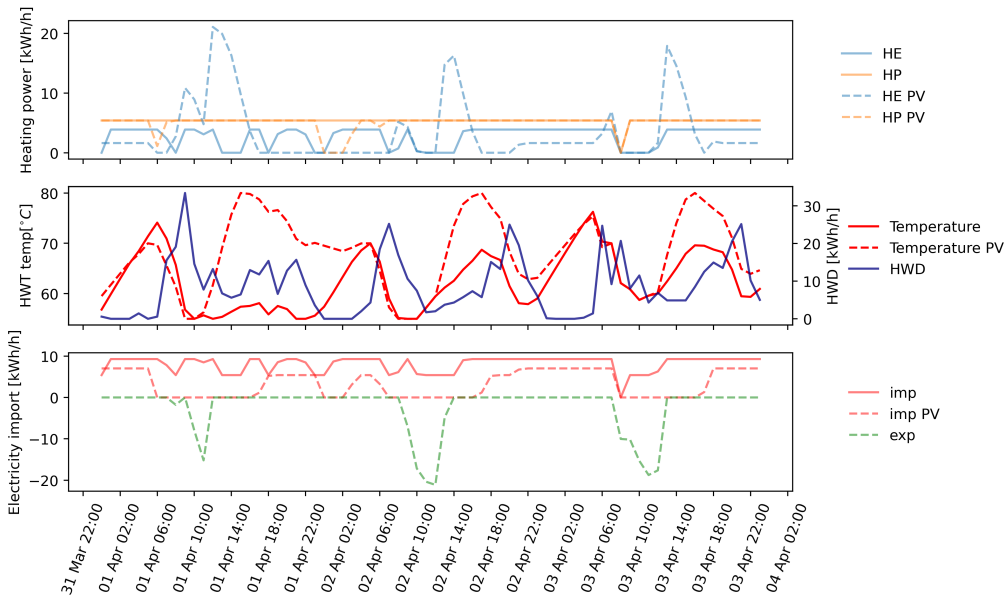

Figure 43: EWH of EWH\_PV  
Optimal strategy comparison at 55°C in April

The HP assumes a greater portion of the energy load during summer owing to its higher COP. The increased energy delivery by the HP enables the sufficient heating of water during the daytime to meet the demand. The HP heating strategy illustrated in Figure 44, with and without PV power, shows minimal disparity. However, there is a shift of load from nighttime to daytime to utilize the available PV power. This similarity in the HP strategy can be attributed to the elevated COP during the daytime, making it the optimal strategy regardless of local energy or not.

In the scenario with a temperature limit of 75°C, the heating element strategy closely resembles that observed in April. During hot water consumption, the heating element operates at a heightened capacity without necessitating an increase in imported power due to the presence of locally generated power.

The power imported is generally minimal in both scenarios, but its magnitude decreases notably when incorporating PV power. In the majority of hours, the power input is zero, and when power import does occur, it is solely attributable to the HP. Given the minimal power import, there is significant exported power during the day.

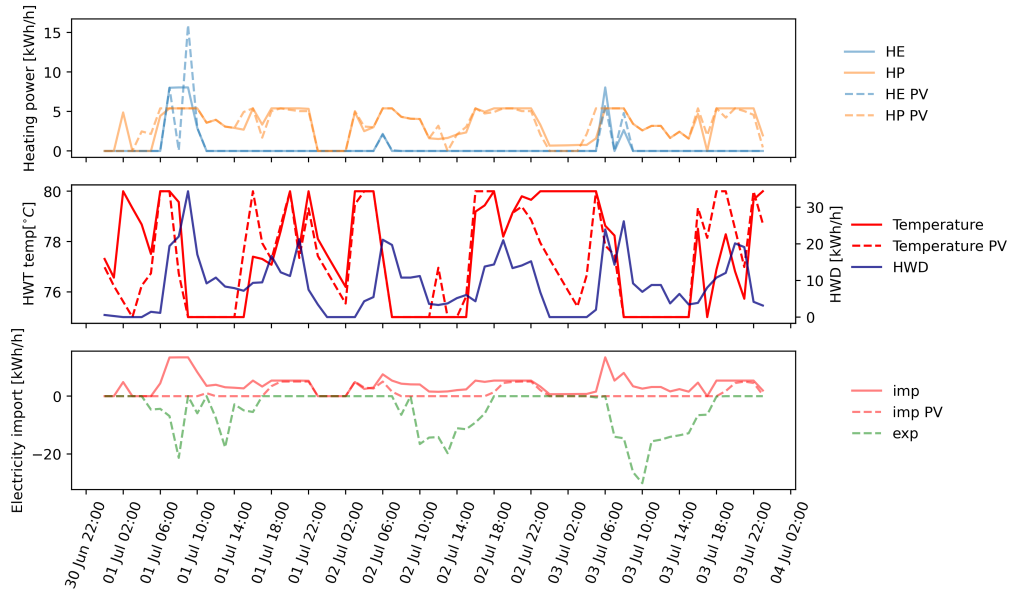

Figure 44: EWH of EWH\_PV  
Optimal strategy comparison at 75°C in July

At a temperature limit of 65°C, as illustrated in Figure 52 in the appendix, there is a notable decrease in the peak power utilized by the HWT since the entire load is handled by the heat pump HP. The primary distinction in the heating process is that in the EWH\_PV scenario, the HP starts operating slightly earlier in the morning and is utilized less during the night and evening, thereby maximizing the utilization of locally generated power. In the scenario without PV, the HWT temperature remains higher than in the PV case from approximately 18:00 to 06:00, as the HP continues to operate until midnight. The peak power used by the HPs is slightly higher with PV than the scenario without PV, as no penalty is associated since the PVs cover the extra electricity usage.

Similar outcomes are observed when the temperature is reduced to 55°C, Figure 53. The peak power utilized by the HPs further decreases in the absence of PV, while it remains unchanged in the presence of PV.

### 6.7.2 EWH and apartment electricity consumption

The HWT heating strategy is mostly unaffected when including the apartment electricity consumption because the power consumption is significantly higher than the power generation. Since the SSR is very high in general, as seen in Figure 54 in the appendix, the benefit of shifting load to increase it further is negligible. By reducing the temperature from 75 to 55°C, the increase in SC is only 103kWh during the year.

In some cases, the heating element is used at a higher peak power to reduce losses from the tank by heating while water is consumed. However, the financial gain from this is negligible, and it is only present under one case in April where the temperature limit is 70°C.

## 6.8 KPI summary

The cost reduction and max import reduction are compared to the scenarios base case in Table 17. The added benefit from solar investment is not included. The SCR and SSR are also excluded because the annual increase is marginal, and other effects like load reduction overshadow the effect of SCR. Showing SCR and SSR without understanding the factors that affect them might be misleading in a table summary.

---

The yearly peak power reduction is compared to January.

Table 17: Results summary

Scenario	Case	Cost reduction	Yearly peak import reduction
EWH	75°C	6 027 NOK, 6.7%	5 kWh, 15%
	55°C	23 747 NOK, 26.4%	20.9 kWh, 64%
EWH_pv	75°C	7 800 NOK, 12.5%	5 kWh, 15%
	55°C	24 000 NOK, 38%	21.4 kWh, 64%
apt	75°C	13 200 NOK, 2%	11kWh/h, 8%
	55°C	25 000 NOK, 4.3%	18kWh/h, 13%
apt_pv	75°C	12 800 NOK, 2%	11kWh/h, 8%
	55°C	25 000 NOK, 4.3%	18kWh/h, 13%

By investigating these diverse scenarios, this study provides valuable insights into different EWH operation strategies. It sheds light on the potential benefits and considerations associated with each scenario, including the impact of solar energy availability and the role of EWH in reducing overall power peaks. The findings contribute to an enhanced understanding of optimizing EWH utilization in various contexts and its integration with renewable energy sources.

## 6.9 Maximum grid export

The power exported to the distribution grid is important to avoid damage to the grid, as discussed in Section 2.3.2. Again, it is important to note that all the values presented are hourly averages and might be higher in reality. The values in EWH isolated scenario are not presented here because they do not represent the power exported to the power grid.

To showcase how the EWH can be used flexibly, the objective function of reducing power export is used. Figure 45 illustrates the peak power export day for the base case during the year, cost optimization at 55°C, and export minimization at 55°C. The base case peaks at 14 kWh/h, cost optimization at 12 kWh/h, and the export minimization have no export. This is due to using the heating element when there is a surplus of solar power. The cost and SC optimization have almost opposite strategies, as shown by the HE being used at higher capacity and the HP being turned on from 03:00 to 06:00 and turned off otherwise. That supports the results found in [14] where cost reduction and SCR maximization have opposite heating strategies.

However, with a naive optimization that minimizes export, the total cost increases from 546 215 in the base case to 549 781. The decreased use of HP outweighs the increased revenue from higher SC-



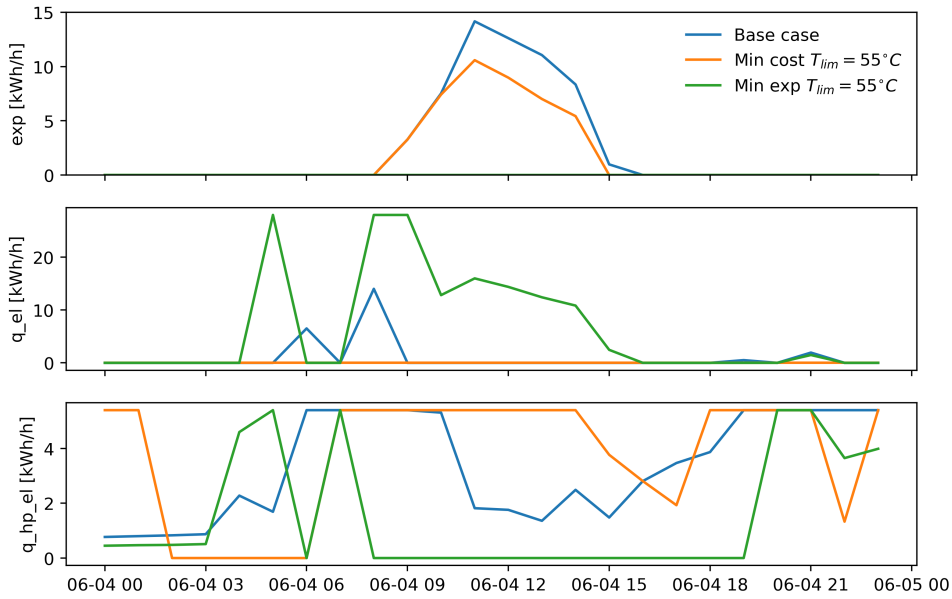

Figure 45: Maximum exported power during the year

## 6.10 Sensitivity analysis - volume

A sensitivity analysis on the HWT volume was done on the ewh\_pv scenarios to investigate potential increased flexibility and losses. This scenario was chosen because the SCR in the apt\_pv scenario is too high to achieve any benefit of increased temperatures. The maximum import also achieves a minimum value in most of the cases.

The results presented in Table 18 display the outcomes of the base case and the cost-optimal solution at temperatures of 55°C and 75°C. The size of the hot HWT system is doubled, with a transition from 6 HWTs at a volume of 400L to 12 HWTs at the same volume. It is observed that the total cost rises across all cases when expanding the volume due to an increase in heat losses from the tank. Since the number of tanks were doubled rather than increasing their volume, the losses are exaggerated as the surface area of a tank does not increase linearly with the volume. Despite the increase in the SCR in all scenarios, the additional benefits do not counteract the approximately doubled heat losses. Furthermore, the peak power is lower at high volume when the temperature is set at 75°C, but it rises when the temperature is reduced to 55°C due to the losses.

These findings indicate that increasing the tank size offers certain advantages but also entails drawbacks. The enhanced flexibility must be carefully evaluated against the increased heat losses from the tank.

Table 18: Sensitivity analysis

Scenario/case	Description	Total cost [NOK/year]	Max import [kWh/h]	SCR	Heat loss [kwh/h]
ewh_pv/Base	2400L	62 319	33.4	42.4%	15 855
ewh_pv/75°C	2400L	54 502, 12.5% reduction	28	43.3%	15 529
ewh_pv/55°C	2400L	38 336, 38% reduction	11.16	45%	12 427
ewh_pv/Base	4800L	87 883	33.4	47.4%	31 048
ewh_pv/75°C	4800L	60 085, 31.6% reduction	23	49.6%	31 017
ewh_pv/55°C	4800L	48 414, 44.9% reduction	13	51.4%	25 887

---

## 7 Discussion

Firstly it should be noted that perfect information heavily affects the heating strategy and its benefits. The energy tariff and power tax are known and, according to the results presented, not affected by strategy but by HWT losses. Modeling the spot price as perfect information is reasonable because the hourly spot prices are known a day ahead, allowing a smart controller to make decisions ahead of time. However, each month's peak power may set a potentially unreasonable limit to how accurately an HWT can be controlled. During a month, the forced peak power import is found and sets the upper limit for heating element operation. As long as the total import stays below the limit, no further penalty is received by the peak power tariff. If the peak import occurs on the last day of the month, all decisions are based on that day. Knowing the peak power import possible 30 days ahead of time is impossible. Optimizing such that every day is penalized by peak power import may be possible but would affect the strategy based on unrealistic economic parameters. Another possibility is to set a maximum allowed power import for each day or month, taking into account the COP of the HP and predicted HWD.

Secondly, it is important to consider the larger system and not the EWH alone as the HWT heating strategy varies greatly. The scale of a PV system compared to the power of the HWT system also affects the optimal heating strategy.

### 7.1 Financial benefits of optimal control

There are financial benefits to controlling HWT heating optimally in all scenarios, mostly due to reduced peak power tariffs. This may indicate that the power tariff is well-suited to provide incentives to investment into flexibility measures. However, it is still dependent on perfect information modeling. In reality, there will be uncertainty and a smart controller cannot operate perfectly. Even though a smart controller could potentially reduce the average peak power import, one hour out of well above 700 a month would still be the deciding factor in setting the peak power tariff. This may set unrealistic expectations of how accurately an EWH can be controlled.

Considering the ewh scenario, the total cost reduction is 6 026 NOK, a 6.7% decrease in EWH operation cost. This is more than doubled to 13 800 NOK in apt scenario where the apartments are added as a fixed load. This highlights the importance of considering all factors relevant to the final power bill. None of the scenarios will represent Røverkollen's final power bill as they are based on the apartments' electricity consumption and not the housing cooperative common electricity consumption. Since there are large differences in the strategies when adding a fixed load or PV, an analysis that includes all specific factors would have to be done to assess the case correctly.

In the highest flexibility cases, 23 747 - 25 000 NOK is saved. With the apartment blocks 50 residents, this amount to a 120-500 NOK yearly cost reduction for each resident, making the revenue very uncertain. Especially considering that it is unknown how reducing the HWT temperature to 55°C would affect the consumers' hot water. The saving presented is also given perfect information - meaning the savings would be lower in real applications.

Most of the financial benefit comes from decreased power tariffs, which may be unfortunate due to the complexity of controlling it. When only considering the EWH, a simple strategy such as reducing the power of the heating element might work, but this may interact poorly with PV and apartment consumption, further discussed in Section 7.3.

### 7.2 Grid benefits of optimal control

When considering the EWH benefit to the grid, it is important to differentiate between the scenarios where the apartments' consumption is included and excluded. By only considering the EWH operation, the peak power import is reduced by 5 kWh/h (15%) when the minimum HWT temperature is at 75°C. When a lower temperature limit of 55°C is allowed, the peak power import can be reduced by 20.9 kWh/h (64%), illustrating the greatly increased flexibility achieved by

---

increasing the temperature band. Reducing the temperature limit of EWHs might be desirable for grid operators because of the flexibility increase.

However, the grid is not heavily affected by one EWH alone, but rather the larger system. Luckily the peak power reduction potential is increased when also considering a fixed load because the HE can be used more flexibly. It is no longer restricted to operate at a fixed maximum limit due to the peak power tariff constraint and can operate more freely as long as its own peak power does not coincide with the fixed load peak power. This increased flexibility gives a more than double potential for peak power reduction than when considering the EWH alone.

It is also beneficial to include PV to reduce the peak power tariff cost, but this benefit may show a discrepancy in the peak power tariff system. The peak power when adding PV is only reduced in the months with sufficient solar irradiation, resulting in the yearly peak import being unaffected. Though it is a benefit to the user, the grid still has to be dimensioned from the yearly peak power. Nevertheless, reducing peak power in all months can be beneficial since it frees up capacity to be used by others which may require higher power during the summer, such as data centers or storage units with a large need for cooling.

The potential of using an EWH flexibly to shift load from peaks to valleys is greater when also considering the fixed, reducing the EWHs contribution to the max power peak by 100%. However, in this scenario, the maximum grid import reduction depends on the models' perfect knowledge as it knows exactly when to turn off the HP. In reality, it is difficult to predict exactly when the maximum import will happen during a year, meaning that the results presented here are the absolute upper limit to peak power reduction. In the "ewh" scenario, the strategy has less potential for peak reduction but is not as dependent on perfect information.

## 7.3 Water heating strategy

### 7.3.1 Heating during hot water consumption

In the apt scenario, the optimal strategy is often to keep the water temperature low and heat it as it is used to minimize losses. This is identical to the strategy in the base case scenario, where water is heated as it is used to minimize temperature differences. Although the general strategies are very similar, the cost of operation is very different. Due to the optimization having perfect information about the fixed load, the model can avoid high HWT power consumption in exactly the right hours to minimize the peak power tariff. Heating at high power simultaneously as hot water consumption is especially prioritized in the low  $T_{min}$  cases because keeping the temperature low decreases losses. Still, high heating is required to meet HWD without breaking constraints. Having a naive control, instructed to start heating as water is withdrawn, may seem beneficial, but can, in reality, worsen the peak power import due to HWD and general electricity demand coinciding. Without perfect information regarding the fixed load, this strategy may prove disadvantageous.

### 7.3.2 PV

The opposite strategy to heating during consumption is seen when including locally generated power in the ewh\_pv case. Preheating the water to high temperatures during the day is now more beneficial. Analyzing ewh\_pv reveals that there are slightly higher losses from the HWT than in the ewh scenario, but this is at most 5%. Increasing the SCR is therefore more beneficial than increasing tank losses in this case. This will however not always be the case, as shown in the sensitivity analysis on tank size, where the losses and SCR are significantly increased, but the added cost exceeds the benefit.

When comparing the apt and apt\_ov scenarios, the difference in losses is insignificant, reaching a maximum of 0.4%. This can be attributed to the nearly identical heating strategies employed in these scenarios, as demonstrated.

In order to accurately assess the impact of solar panels on the power bill of Røverkollen housing

---

cooperative and the HWT heating strategy, electricity consumption of the apartment common areas should be included instead of the apartments' consumption. In the apt\_pv scenario, the advantages of preheating are largely nullified due to the high SCR, regardless of the heating strategy employed. By incorporating the apartments' consumption, the HE can operate at a higher capacity, similar to the interaction between the EWH and PV system. Because the electricity usage of the apartment block is lower than that of the individual apartments, preheating may be the optimal strategy during PV generation.

### 7.3.3 Heating element power limitation

As seen by comparing the EWH-only scenario with PV and apartments-included scenarios, reducing the HE capacity may be disadvantageous as it decreases flexibility.

Reducing HE capacity hinders flexibility when introducing a fixed load because a high-capacity HE can reduce power peaks by utilizing valleys in the fixed load rather than causing peaks. This may be difficult to control as the fixed load is unknown in most cases. It does however follow some trends, where.

In reality, a high-capacity HE might be turned on simultaneously as the general consumption is high. A low-capacity element will also be on simultaneously as other consumption and probably more frequently because it is used for longer periods. Still, in return, the peak power import is increased less. A high-capacity HE might increase the flexibility under smart control, with arguably unreasonable accuracy, but may also worsen peak power import when not used with smart control.

The strategy when including solar power becomes even more complex because solar power generation is highly uncertain. Delaying water heating for hours with forecasted high PV power production may increase the power peak if the forecast is incorrect because the HE has to draw high power from the grid to compensate. Thus controlling based on PV alone may have a disadvantageous effect.

It is also shown that having a HE can mitigate peak power export to the grid and potentially increase its load to decrease the load on the grid. By turning off the HP, more power is needed due to not utilizing the COP, allowing the HP to act as an extra load for the grid. However, this presumes that the temperature in the HWT is not too high in the relevant hours. Turning off the HP frequently can also reduce its life expectancy. The total cost, when only minimizing the export increases, showing that naive optimization only focused on one parameter will act poorly.

### 7.3.4 Lower temperature limit

Reducing the tank temperature benefits both the grid and the consumer because it reduces the overall losses from the tank and provides more flexibility thus reducing peak power import. Although it is beneficial under optimality, HWT at lower temperatures may be more difficult to manage. It requires higher levels of prediction as water heating has to occur the moment before or while consuming water to maintain enough hot water reserves. While a lower minimum temperature limit keeps the average temperature lower, the water is often heated up to 80 degrees regardless to have enough reserves to cover HWD peaks and reduce peak power import in the future. Predicting when to heat water simultaneously as consumption and when to preheat may prove difficult. Reducing the lower temperature limit will not work because an optimal model requires a dynamic stopping point. Heating water to a fixed stopping point will result in the HE working over a long time at high capacity, increasing potential import power peaks.

## 7.4 Solar power investment

Solar power investment is simpler than smart control because the investment cost is known, and the financial benefits are more predictable. However, solar power is only profitable when apartment electricity consumption is added because of significantly higher self-consumption at almost 100%.

---

A high self-consumption increases the accuracy of the estimated benefits because the user power consumption pattern will not affect profitability unless it changes dramatically. It also makes the investment slightly less dependent on spot prices because there is a fixed revenue from decreased energy tariffs and power tax. These are also expected to increase in the future. However, most of the cost reduction comes from spot price cost reduction, meaning that future spot prices are the dominant factor when considering PV investment. The investment profitability also depends on the new regulation proposal where PV-generated power can be shared locally.

Solar power investment would be very profitable when comparing the estimated marginal revenue of 0.98 NOK/kWh to the LCOE of 0.3 NOK/kWh presented by [22]. The market value of PV is estimated to be approximately 20€/MWh (0.2 NOK/kWh) in the same paper. This considers spot price sales only and the possible cannibalization effect solar power can have on the power market. Considering that the energy tariff and power tax, with sales tax added, amount to 0.26 NOK/kWh, the value of PV power for self-consumption may be significantly higher than the long-term estimated market value.

Most of the cost reduction comes from the spot price, followed by the power tax, energy tariff, and peak power tariff. If the cannibalization effect reduces the market value of solar to the 0.2 NOK/kWh reported in [22], the investment may not be profitable.

#### 7.4.1 Model simplifications

The primary simplification that appears to impact the results significantly is the assumption that the HP can be used at any time. In reality, it is only employed when the HWT temperature is exceptionally low, which contradicts the optimized strategy and the general approach in the literature for modeling HP HWTs. The model must incorporate stratification to account for this constraint, considering that the temperature sensor is located at the bottom of the tank. Additionally, the model would have to consider hot water circulation since hot water can re-enter the system at the sensor point. Optimizing these factors would be impractical, necessitating the use of simulations based on the recommendations provided in this paper to investigate the system further and assess the viability of the strategies in greater detail.

The results reveal a potential flaw in the optimization model concerning the implementation of peak power tariffs. While the model is based on real-life tariff implementation, it is based on perfect information regarding future fixed power demand. This constraint may need to be revised to obtain more realistic results by for example introducing stochasticity, minimizing daily peak power usage, or establishing a maximum power usage based on the month.

### 7.5 Viability of results

The exact strategies presented here are not viable to be implemented by Røverkollen in their current HW system because of the significant differences in measured and simulated data. Furthermore, the base case differs significantly from the measured data with higher peaks, lower valleys, higher HP use, and lower HE use. Since the HP was used more, decreasing the total imported power, the real cost of EWH operation will likely be higher than the results presented.

As discussed, having even power import to the HWT during the day is not optimal in most cases, suggesting that Røverkollen's HWT has a suboptimal heating strategy. However, there are many factors to consider. In reality, the HWT is controlled at a high resolution, has cascading HWTs, and has low HP usage. Actual water usage may also differ in magnitude and timing of synthetic profiles.

Røverkollen's HWT does not operate under perfect information, so a generally lower peak power consumption may be beneficial. Although Røverkollen's average peak power consumption is lower, it still reaches high values, which may increase the monthly peak power tariff. Moving more of the needed heating capacity from the HE to the HP may decrease these power spikes, as the HP delivers energy at lower power consumption over a longer time.

---

Using the heat pump was heavily prioritized in all optimal cases. A lower  $T_{min}$  allowed the HP to operate more frequently, often constantly, except in the summer months because HWT temperature reached the upper limit.

Since the HP in Røverkollen's system operates less than in the simulated case, a technical investigation might help determine why this is the case. The simplifications made in the modeling might also be too rough. In practice, the HE is activated once the HWT thermostat detects a temperature of 76°C to maintain the desired HWT temperature. Conversely, the HP only operates when the temperature falls below 40°C. This operational discrepancy likely explains why, in reality, the HE accounts for 90% of the load, as it is activated before the HP. It is also shown that the HE is regularly on during the day and is never turned off for an entire hour. This contrasts with the optimized results, where HPs are primarily utilized to meet the base load. At the same time, the HE is employed to address peak demand, minimize tank heat loss, take advantage of lower spot prices, or utilize surplus solar energy. Increasing the HP's operational range from 40°C could potentially raise its contribution to hot water heating. Removing the use of HE at 76°C may also increase HP usage, but further considerations must be made before making changes to an existing technical solution.

Based on the model, it is feasible to increase the usage of the HP without violating the minimum temperature requirement of 75°C. This suggests the potential for greater utilization of the HP, albeit certain factors might impede its effectiveness. For instance, if the COP is lower in practice, the HE would need to be activated more frequently to compensate for the reduced heating capacity of the HP. Røverkollen's hot water usage might also be different from the synthetic profiles. Considering the variation observed between synthetic and measured temperatures as illustrated in Figure 21, it is plausible that this discrepancy arises from the measured data exhibiting a greater peak HWD during the evening hours. Conversely, the modeled data displays a higher peak in the morning and a relatively higher peak in the afternoon. In Figure 22, it can be observed that the synthetic HWD exhibits a greater magnitude compared to the measured data. This suggests that, in the optimization process, the HE needs to be employed more frequently to meet the heightened load. Due to the inadequate quality of the measured EWH data obtained from Røverkollen and the substantial variations observed in the measured data reported in [60], it becomes challenging to derive any conclusive findings regarding the impact of HWD on the results.

---

## 8 Conclusion

The optimization analysis demonstrates that smart control of EWHs has the potential to reduce operational costs and reduce peak power import from the grid. Isolating the operation of EWHs reveals that a 6.7% reduction in costs can be achieved through operational optimization, and 26.4% can be saved by reducing the HWT minimum temperature from 75°C to 55°C. Incorporating PV power generation enhances the flexibility of EWHs, enabling cost savings of 12.5% at 75°C and 38% at 55°C compared to a base case with PV. When optimizing EWHs operation in conjunction with a fixed load, the potential savings from smart control at 75°C are doubled because the EWHs can operate at reduced loads or be completely turned off during peak load hours, thereby avoiding increased peak power tariffs. While cost reduction in operation is possible, the majority of savings stem from reduced peak power tariffs. It should be noted that the optimization model assumes perfect information regarding future hot water demand and fixed loads, which may be challenging to predict accurately in reality. Consequently, the achievable savings are highly uncertain and likely lower than presented.

Peak power import also exhibits reduction potential. Isolating the operation of EWHs reveals a 15% reduction (5 kWh/h) at 75°C and a 64% reduction (20.9 kWh/h) at 55°C. The results remain consistent when PV is included since PV power generation in January when peak power import occurs, is 0. When a fixed load is added, the reduction in peak import increases from 5 kWh/h to 11 kWh/h at 75°C due to an increased potential for load shaving and valley filling. At 55°C, the peak import is reduced by 18 kWh/h compared to the base case. Although seemingly lower than the isolated EWH base case, during the fixed load peak import hour, the EWH only operates at 18 kWh/h, resulting in a 100% decrease in EWH peak power contribution.

The strategies identified for heating are complex and heavily dependent on the scenario and access to perfect information. Analyzing the operation of EWHs in isolation, the heating element's peak power is reduced to reduce peak power import. Incorporating PV into the scenario introduces strategies such as pre-heating water before consumption and heating water during power generation. The heating element can operate at higher power without increasing the power import because it is offset by PV power generation. However, this depends on good forecasting as planning heating at high capacity is risking a high import or cold water if the forecast is incorrect. When a fixed load is added, the EWH is utilized more dynamically, taking advantage of pre-heating during load valleys, turning off during fixed peak load hours, and heating water at high power during usage. These results highlight that there is no universally applicable heating strategy, and the approach must be tailored to the specific use case. Employing naive heating strategies that overlook certain factors may increase costs and the peak power usage rather than reduce them.

Analyzing PV investments without considering optimization reveals more significant potential for cost savings than through smart control of EWHs. The maximum savings achieved through optimal control is 25,000 NOK per year, which includes reducing the hot water temperature by 20°C. On the other hand, solar power investments can save 36,000 NOK per year. However, the profitability of solar power investment depends on the ability to virtually share power to increase self-consumption rates. Given the spot prices, tariffs, and investment costs assumed in this study, PV investment is not profitable at low self-consumption rates.

---

## 9 Further work

### 9.1 Flexible and uncertain load

To get a better understanding of how the HWT should be operating in a flexible consumer market, the apartments' electricity consumption should also be considered as a flexible resource. Controlling apartment heating and appliances will affect the optimal operation of the HWT. By moving both space heating and hot water heating to the same hour based on either naive algorithms or based on spotprice may cause increased peak power draw.

In practice, the HWT would have to be controlled based on uncertain input data. An extension of the model considering uncertainty in PV power production and fixed load should be conducted to get a better understanding of the real-life application of smart control.

### 9.2 More detailed EWH simulation

More detailed simulations considering stratification and uncertainty should be done to check the viability of the suggested water heating strategies.

The large differences between synthetic HWD profiles and real HWD should be investigated, and preferably real hot water consumption data should be used in a future optimization/simulation.

The COP of the HP and its otherwise technical limitations should also be found more accurately and simulated as it may impact the results greatly.



---

## Bibliography

- [1] Thomas Aanesen. *Rekordhøyt strømforbruk i fjor*. June 2022. URL: <https://www.ssb.no/energi-og-industri/energi/statistikk/elektrisitet/artikler/rekordhoyt-stromforbruk-i-fjor> (visited on 20th Jan. 2023).
- [2] ABK. *kWsmart MasterDoc 16.05.2007*. (Visited on 2nd Dec. 2023).
- [3] ABK. *kWsmartUserGuide.pdf*. 2007.
- [4] Muhammad Akmal and Brendan Fox. ‘Modelling and Simulation of Underfloor Heating System Supplied from Heat Pump’. en. In: *International Journal of Simulation: Systems, Science & Technology* (Jan. 2017). ISSN: 1473-804X. DOI: 10.5013/IJSSST.a.17.35.28. URL: <https://edas.info/doi/10.5013/IJSSST.a.17.35.28> (visited on 21st Feb. 2023).
- [5] Werner Antweiler and Felix Muesgens. ‘On the long-term merit order effect of renewable energies’. en. In: *Energy Economics* 99 (July 2021), p. 105275. ISSN: 0140-9883. DOI: 10.1016/j.eneco.2021.105275. URL: <https://www.sciencedirect.com/science/article/pii/S0140988321001808> (visited on 7th Feb. 2023).
- [6] *Avgift på elektrisk kraft - Skatteetaten*. URL: <https://www.skatteetaten.no/bedrift-og-organisasjon/avgifter/saravgifter/om/elektrisk-kraft/> (visited on 21st Mar. 2023).
- [7] Stian Backe. *Derfor lønner det seg å bruke strømmen fra solcellene selv*. nb-NO. Nov. 2021. URL: <https://blogg.sintef.no/sintefenergy-nb/derfor-lonner-det-seg-a-bruke-strommen-fra-solcellene-selv/> (visited on 12th Feb. 2023).
- [8] Ann Christin Bøeng. *På verdenstoppen i bruk av strøm*. Apr. 2012.
- [9] *Boliger*. nb. URL: <https://www.ssb.no/bygg-bolig-og-eiendom/bolig-og-boforhold/statistikk/boliger> (visited on 1st Mar. 2023).
- [10] Yongbao Chen et al. ‘Measures to improve energy demand flexibility in buildings for demand response (DR): A review’. en. In: *Energy and Buildings* 177 (Oct. 2018), pp. 125–139. ISSN: 0378-7788. DOI: 10.1016/j.enbuild.2018.08.003. URL: <https://www.sciencedirect.com/science/article/pii/S0378778818310387> (visited on 8th June 2023).
- [11] Lasse Christiansen et al. *Forbruksutvikling i Norge 2022-2050*. Tech. rep. 2023. (Visited on 20th Jan. 2023).
- [12] Dean Holland Clift and Harry Suehrcke. ‘Control optimization of PV powered electric storage and heat pump water heaters’. In: *Solar Energy* 226 (Sept. 2021). Publisher: Pergamon, pp. 489–500. ISSN: 0038-092X. DOI: 10.1016/J.SOLENER.2021.08.059. (Visited on 4th Dec. 2022).
- [13] Dean Holland Clift et al. ‘Assessment of advanced demand response value streams for water heaters in renewable-rich electricity markets’. en. In: *Energy* 267 (Mar. 2023), p. 126577. ISSN: 0360-5442. DOI: 10.1016/j.energy.2022.126577. URL: <https://www.sciencedirect.com/science/article/pii/S0360544222034648> (visited on 22nd Feb. 2023).
- [14] Usman Ijaz Dar et al. ‘Advanced control of heat pumps for improved flexibility of Net-ZEB towards the grid’. en. In: *Energy and Buildings* 69 (Feb. 2014), pp. 74–84. ISSN: 0378-7788. DOI: 10.1016/j.enbuild.2013.10.019. URL: <https://www.sciencedirect.com/science/article/pii/S0378778813006658> (visited on 7th Feb. 2023).
- [15] Pengwei Du and Ning Lu. ‘Appliance Commitment for Household Load Scheduling’. en. In: *IEEE Transactions on Smart Grid* 2.2 (June 2011), pp. 411–419. ISSN: 1949-3053, 1949-3061. DOI: 10.1109/TSG.2011.2140344. URL: <http://ieeexplore.ieee.org/document/5765461/> (visited on 16th Feb. 2023).
- [16] FHI. *Råd for forebygging av legionellasmitte i hjemmet*. no. July 2012. URL: <https://www.fhi.no/sv/smittsomme-sykdommer/legionella/legionellasmitte-hjemme-kan-forebyg/> (visited on 26th May 2023).
- [17] Hassan Youssef. *varmtvannsberederDatablad.pdf*. Feb. 2014.
- [18] *Heat Pump Water Heaters Achieve Significant Peak Reduction and Energy Savings — Department of Energy*. URL: <https://www.energy.gov/eere/buildings/articles/heat-pump-water-heaters-achieve-significant-peak-reduction-and-energy> (visited on 21st Mar. 2023).

- 
- [19] *How a heat pump works – The Future of Heat Pumps – Analysis*. en-GB. URL: <https://www.iea.org/reports/the-future-of-heat-pumps/how-a-heat-pump-works> (visited on 21st Feb. 2023).
- [20] Fayaz Hussain et al. ‘Chapter 6 - Energy storage technologies’. en. In: *Energy for Sustainable Development*. Ed. by MD. Hasanuzzaman and Nasrudin Abd Rahim. Academic Press, Jan. 2020, pp. 125–165. ISBN: 978-0-12-814645-3. DOI: 10.1016/B978-0-12-814645-3.00006-7. URL: <https://www.sciencedirect.com/science/article/pii/B9780128146453000067> (visited on 21st Mar. 2023).
- [21] Oussama Ibrahim et al. ‘Air source heat pump water heater: Dynamic modeling, optimal energy management and mini-tubes condensers’. en. In: *Energy* 64 (Jan. 2014), pp. 1102–1116. ISSN: 03605442. DOI: 10.1016/j.energy.2013.11.017. URL: <https://linkinghub.elsevier.com/retrieve/pii/S0360544213009791> (visited on 16th Feb. 2023).
- [22] Eirik Ogner Jåstad, Ian M. Trotter and Torjus Folsland Bolkesjø. ‘Long term power prices and renewable energy market values in Norway – A probabilistic approach’. en. In: *Energy Economics* 112 (Aug. 2022), p. 106182. ISSN: 0140-9883. DOI: 10.1016/j.eneco.2022.106182. URL: <https://www.sciencedirect.com/science/article/pii/S0140988322003346> (visited on 22nd Feb. 2023).
- [23] Søren Østergaard Jensen et al. ‘IEA EBC Annex 67 Energy Flexible Buildings’. en. In: *Energy and Buildings* 155 (Nov. 2017), pp. 25–34. ISSN: 0378-7788. DOI: 10.1016/j.enbuild.2017.08.044. URL: <https://www.sciencedirect.com/science/article/pii/S0378778817317024> (visited on 5th June 2023).
- [24] Vassilis Kapsalis and Loukas Hadellis. ‘Optimal operation scheduling of electric water heaters under dynamic pricing’. en. In: *Sustainable Cities and Society* 31 (May 2017), pp. 109–121. ISSN: 2210-6707. DOI: 10.1016/j.scs.2017.02.013. URL: <https://www.sciencedirect.com/science/article/pii/S2210670716304383> (visited on 11th May 2023).
- [25] Knut Bjørheim. *Solcellene til Øyvind kobler seg ut når det er mye sol: – Et økende problem*. May 2023. URL: <https://www.tu.no/artikler/solcellene-til-oyvind-kobler-seg-ut-nar-det-er-mye-sol-et-okende-problem/530033> (visited on 27th May 2023).
- [26] Statsministerens kontor. ‘Prinsipper og krav ved utarbeidelse av samfunnsøkonomiske analyser’. no. In: *25.06.2021* ().
- [27] Venkatachalam Lakshmanan, Hanne Sæle and Merkebu Zenebe Degefa. ‘Electric water heater flexibility potential and activation impact in system operator perspective – Norwegian scenario case study’. In: *Energy* 236 (Dec. 2021). Publisher: Elsevier Ltd. ISSN: 03605442. DOI: 10.1016/J.ENERGY.2021.121490. (Visited on 10th Oct. 2022).
- [28] Vemund Lenæs. ‘Optimal performance of a housing cooperative with PV and electric vehicles’. en. PhD thesis. NTNU, 2022.
- [29] Karen Lindberg. (PDF) *Impact of Zero Energy Buildings on the Power System: A study of load profiles, flexibility and system investments*. 2017. URL: [https://www.researchgate.net/publication/320706014\\_Impact\\_of\\_Zero\\_Energy\\_Buildings\\_on\\_the\\_Power\\_System\\_A\\_study\\_of\\_load\\_profiles\\_flexibility\\_and\\_system\\_investments](https://www.researchgate.net/publication/320706014_Impact_of_Zero_Energy_Buildings_on_the_Power_System_A_study_of_load_profiles_flexibility_and_system_investments) (visited on 3rd Dec. 2022).
- [30] *Linear programming — Definition & Facts — Britannica*. en. URL: <https://www.britannica.com/science/linear-programming-mathematics> (visited on 29th May 2023).
- [31] Javier López Prol, Karl W. Steininger and David Zilberman. ‘The cannibalization effect of wind and solar in the California wholesale electricity market’. en. In: *Energy Economics* 85 (Jan. 2020), p. 104552. ISSN: 0140-9883. DOI: 10.1016/j.eneco.2019.104552. URL: <https://www.sciencedirect.com/science/article/pii/S0140988319303470> (visited on 13th Mar. 2023).
- [32] Jun Lu et al. ‘Robust day-ahead coordinated scheduling of multi-energy systems with integrated heat-electricity demand response and high penetration of renewable energy’. en. In: *Renewable Energy* 178 (Nov. 2021), pp. 466–482. ISSN: 0960-1481. DOI: 10.1016/j.renene.2021.05.164. URL: <https://www.sciencedirect.com/science/article/pii/S0960148121008533> (visited on 22nd Feb. 2023).
- [33] NBBL. *Borettslag statistikk*. URL: [https://www.nbbl.no/media/4619/2005-01-01-hvem\\_bor\\_i-borettslag.pdf](https://www.nbbl.no/media/4619/2005-01-01-hvem_bor_i-borettslag.pdf) (visited on 14th Mar. 2023).
-

- 
- [34] *Nettleiepriser og effekttariff for bedrifter med årsforbruk over 100.000 kWh*. no. URL: <https://www.elvia.no/nettleie/alt-om-nettleiepriser/nettleiepriser-og-effekttariff-for-bedrifter-med-arsforbruk-over-100000-kwh/> (visited on 21st Mar. 2023).
- [35] Iht Ns. *TEKNISK DOKUMENT Iht. NS 5820:1994 FOR PRODUKTER I SERIEN: SRS ECO 400*. no. URL: <https://www.hoiax.no/produkter/varmtvannsberedere/storberedere/srs-eco-400> (visited on 24th Apr. 2023).
- [36] Iht Ns. *TEKNISK DOKUMENT Iht. NS 5820:1994 FOR PRODUKTER I SERIEN: Titanium ECO*. no. URL: [https://webservice.hoiax.no/WebService/Attachments/Article/pdf/4945-TD\\_2022\\_Titanium%20Eco-9.pdf](https://webservice.hoiax.no/WebService/Attachments/Article/pdf/4945-TD_2022_Titanium%20Eco-9.pdf) (visited on 24th Apr. 2023).
- [37] *Ny nettleie (fra 1. juli 2022) - NVE*. no. URL: <https://www.nve.no/reguleringsmyndigheten/kunde/nett/ny-nettleie-fra-1-juli-2022/> (visited on 21st Mar. 2023).
- [38] Andreas V. Olympios et al. ‘Operational optimisation of an air-source heat pump system with thermal energy storage for domestic applications’. en. In: *Energy Conversion and Management* 273 (Dec. 2022), p. 116426. ISSN: 0196-8904. DOI: 10.1016/j.enconman.2022.116426. URL: <https://www.sciencedirect.com/science/article/pii/S0196890422012043> (visited on 22nd Feb. 2023).
- [39] Olav A. Øvrebø. *Solenergi: Grafene som viser hvordan det norske markedet nå virkelig tar av*. no. Section: nyhet. Sept. 2022. URL: <https://energiogklima.no/nyhet/solenergi-grafene-som-viser-hvordan-det-norske-markedet-na-virkelig-tar-av/> (visited on 21st Mar. 2023).
- [40] Alejandro Pena-Bello et al. ‘Decarbonizing heat with PV-coupled heat pumps supported by electricity and heat storage: Impacts and trade-offs for prosumers and the grid’. en. In: *Energy Conversion and Management* 240 (July 2021), p. 114220. ISSN: 0196-8904. DOI: 10.1016/j.enconman.2021.114220. URL: <https://www.sciencedirect.com/science/article/pii/S0196890421003964> (visited on 8th June 2023).
- [41] International Renewable Energy Agency. *Renewable power generation costs in 2021*. 2022. ISBN: 978-92-9260-452-3. URL: [www.irena.org](http://www.irena.org).
- [42] Dmytro Romanchenko et al. ‘Thermal energy storage in district heating: Centralised storage vs. storage in thermal inertia of buildings’. en. In: *Energy Conversion and Management* 162 (Apr. 2018), pp. 26–38. ISSN: 0196-8904. DOI: 10.1016/j.enconman.2018.01.068. URL: <https://www.sciencedirect.com/science/article/pii/S0196890418300803> (visited on 20th Mar. 2023).
- [43] Hanne Saele and Ove S. Grande. ‘Demand response from household customers: Experiences from a pilot study in Norway’. In: *IEEE Transactions on Smart Grid* 2.1 (2011). Publisher: Institute of Electrical and Electronics Engineers Inc., pp. 102–109. ISSN: 19493053. DOI: 10.1109/TSG.2010.2104165. (Visited on 11th Nov. 2022).
- [44] Amir Safdarian et al. ‘Domestic EWH and HVAC management in smart grids: Potential benefits and realization’. en. In: *Electric Power Systems Research* 134 (May 2016), pp. 38–46. ISSN: 0378-7796. DOI: 10.1016/j.epsr.2015.12.021. URL: <https://www.sciencedirect.com/science/article/pii/S0378779615003983> (visited on 8th June 2023).
- [45] Henri Sarevet et al. ‘Residential buildings with heat pumps peak power reduction with high performance insulation’. In: *E3S Web of Conferences* 172 (Jan. 2020), p. 12008. DOI: 10.1051/e3sconf/202017212008.
- [46] *Slik fungerer kraftsystemet*. no. Jan. 2023. URL: <https://www.statnett.no/om-statnett/blibedre-kjent-med-statnett/slik-fungerer-kraftsystemet/> (visited on 13th Feb. 2023).
- [47] Solenergyklyngen and Multiconsult. *Norsk solkraft 2022 – innenlands og eksport*.
- [48] Åse Lekang Sørensen et al. ‘Energy flexibility potential of domestic hot water systems in apartment buildings’. en. In: *E3S Web of Conferences* 246 (2021). Ed. by J. Kurnitski and M. Thalfeldt, p. 11005. ISSN: 2267-1242. DOI: 10.1051/e3sconf/202124611005. URL: <https://www.e3s-conferences.org/10.1051/e3sconf/202124611005> (visited on 6th Feb. 2023).
- [49] *Statlige avgifter inngår i nettleien*. no. URL: <https://www.elvia.no/nettleie/alt-om-nettleie/statlige-avgifter-inngar-i-nettleien/> (visited on 21st Mar. 2023).
- [50] Statnett. *Langsiktig Markedsanalyse 2022-2050*. Norwegian. Mar. 2023. URL: <https://www.statnett.no/for-aktorer-i-kraftbransjen/planer-og-analyser/publiserte-rapporter-og-utredninger/> (visited on 21st Mar. 2023).
-

- 
- [51] *Statnetts Kortsiktige markedsanalyse*. no. Mar. 2023. URL: <https://www.statnett.no/for-aktorer-i-kraftbransjen/planer-og-analyser/kortsiktig-markedsanalyse/> (visited on 21st Mar. 2023).
- [52] Synne Krekling Lien, Igor Sartori1 and Dmytro Ivanko. ‘Domestic hot water decomposition from measured total heat load in Norwegian buildings’. In: Oct. 2020. URL: <https://ntnuopen.ntnu.no/ntnu-xmlui/bitstream/handle/11250/2684373/Pages%2bfrom%2bSPceedings%2bno%2b5-244.pdf?sequence=1&isAllowed=y> (visited on 29th May 2023).
- [53] Berit Tennbakk, Mina B. Ryssdal and Kristine Fiksen. ‘NVE Ekstern rapport’. en. In: ().
- [54] *The Norwegian Energy Regulatory Authority - NVE*. no. URL: <https://www.nve.no/norwegian-energy-regulatory-authority/the-norwegian-energy-regulatory-authority/> (visited on 12th Feb. 2023).
- [55] Grant UK Thornton LLP. ‘Renewable energy discount rate survey results-2018’. In: (2019). URL: <https://www.grantthornton.co.uk/insights/renewable-energy-discount-rate-survey/>.
- [56] Riccardo Toffanin, Vinicio Curti and Maurizio C. Barbato. ‘Impact of Legionella regulation on a 4th generation district heating substation energy use and cost: the case of a Swiss single-family household’. en. In: *Energy* 228 (Aug. 2021), p. 120473. ISSN: 0360-5442. DOI: 10.1016/j.energy.2021.120473. URL: <https://www.sciencedirect.com/science/article/pii/S0360544221007222> (visited on 11th May 2023).
- [57] Dalibor Vagner et al. *Kortsiktig Markedsanalyse 2022-27*. Tech. rep. 2022. URL: <https://www.statnett.no/for-aktorer-i-kraftbransjen/planer-og-analyser/kortsiktig-markedsanalyse/> (visited on 20th Jan. 2023).
- [58] Joakim Widén, Annica Nilsson and Ewa Wäckelgård. ‘A combined Markov-chain and bottom-up approach to modelling of domestic lighting demand’. In: *Energy and Buildings - ENERGBLDG* 41 (Oct. 2009), pp. 1001–1012. DOI: 10.1016/j.enbuild.2009.05.002.
- [59] Joakim Widén and Ewa Wäckelgård. ‘A high-resolution stochastic model of domestic activity patterns and electricity demand’. en. In: *Applied Energy* 87.6 (June 2010), pp. 1880–1892. ISSN: 0306-2619. DOI: 10.1016/j.apenergy.2009.11.006. URL: <https://www.sciencedirect.com/science/article/pii/S0306261909004930> (visited on 14th Mar. 2023).
- [60] Joakim Widén et al. ‘Constructing load profiles for household electricity and hot water from time-use data—Modelling approach and validation’. en. In: *Energy and Buildings* 41.7 (July 2009), pp. 753–768. ISSN: 0378-7788. DOI: 10.1016/j.enbuild.2009.02.013. URL: <https://www.sciencedirect.com/science/article/pii/S0378778809000413> (visited on 12th May 2023).
- [61] Mei WU et al. ‘Multi-objective optimization for electric water heater using mixed integer linear programming’. en. In: *Journal of Modern Power Systems and Clean Energy* 7.5 (Sept. 2019), pp. 1256–1266. ISSN: 2196-5420. DOI: 10.1007/s40565-019-0542-5. URL: <https://doi.org/10.1007/s40565-019-0542-5> (visited on 31st May 2023).
- [62] Yu-Chieh J. Yen, Ken J. Nixon and Willie A. Cronje. ‘Volume Segmentation in a Stratified Vertical EWH Tank Using Steady-State Element Cycles for Energy Balance’. en. In: *Transition Towards 100% Renewable Energy: Selected Papers from the World Renewable Energy Congress WREC 2017*. Ed. by Ali Sayigh. Innovative Renewable Energy. Cham: Springer International Publishing, 2018, pp. 481–490. ISBN: 978-3-319-69844-1. DOI: 10.1007/978-3-319-69844-1\_44. URL: [https://doi.org/10.1007/978-3-319-69844-1\\_44](https://doi.org/10.1007/978-3-319-69844-1_44) (visited on 22nd Feb. 2023).
- [63] Baran Yildiz et al. ‘Analysis of electricity consumption and thermal storage of domestic electric water heating systems to utilize excess PV generation’. en. In: *Energy* 235 (Nov. 2021), p. 121325. ISSN: 0360-5442. DOI: 10.1016/j.energy.2021.121325. URL: <https://www.sciencedirect.com/science/article/pii/S0360544221015735> (visited on 8th June 2023).
-

## Appendix

### A EWH typical power consumption profiles

		Description	#	Sirc. losses	Energy supply
Test data	SM-1	Seasonal method without (1) and with marking (2) of holidays.	58 apartment blocks, 20 Htl	Yes	DH
	SM-2				
	Hybrid SM-ES 18	Seasonal method with linear regression at 18°C			
	ES-1	Energy signature 1			
References	ES-2	Reference Energy signature values for apartments (Pedersen, 2007) and for hotels (Lindberg et al., 2019).	53 dwellings, 7 hotels	Yes	DH
	REF-1	Reference 1 from measurements. Flow and energy measurements on pipes in Norwegian hotels and apartments. (Walnum et al., 2019)	2 Apt. blocks 3 hotels.	Yes	DH and EL
				No	
	REF-2	Reference 2 from measurements. Flow measurements on pipes in Swedish apartments, later converted into energy with a fix conversion factor. Individual metering for each unit. (Bagge et al., 2015)	4 apt. blocks with 1000 units.	No	NA
	REF-3	Reference 3, measurements of DHW energy use in single family houses. Energy measurement on socket (EIDek, 2020)	Unknown.	Yes	EL
NORM	SN-NSPEK 3031:2020. Normative values of net energy demand for heating of DHW used in building modelling	-	No	-	

Figure 46: Reference type and explanation

Activity	Volume	Energy
Shower	40 l/5 min	2.1 kWh/5 min
Bath	100 l	5.2 kWh
Wash hands/go to toilet	0.67 l	0.035 kWh
Dishes, by hand, in tub	16 l	0.8 kWh
Dishes, cross between tub and running water	39 l	2.0 kWh
Dishes after baking or preservation	7.8 l/5 min	0.41 kWh
Hand wash	0.7 l	0.04 kWh
Cooking/baking	0.45 l/5 min	0.02 kWh/5 min
Cleaning, scrubbing	3.3 l/5 min	0.2 kWh/5 min
Wash clothes by hand	6.7 l/5 min	0.35 kWh/5 min
Brush teeth	0.27 l	0.014 kWh
Wash oneself	0.37 l	0.019 kWh
Wash hair	10 l	0.52 kWh
Shaving	4 l	0.21 kWh
Wash face	1.3 l	0.068 kWh
Wash feet	2 l	0.10 kWh
Change napkin, clean chamber pot	0.67 l	0.35 kWh
Complementary work, bath	10 l	0.52 kWh
Foot bath	7.8 l	0.41 kWh
Wash up things (not food)	6.7 l	0.35 kWh
Dust	1.7 l/5 min	0.89 kWh/5 min
Clean windows	1.1 l/5 min	0.057 kWh/5 min
Car wash	2.2 l	0.11 kWh
Work on the car	3.3 l	0.17 kWh
Wash bike or moped	6.6 l	0.34 kWh

Figure 47: Volume to energy of different activities [60]

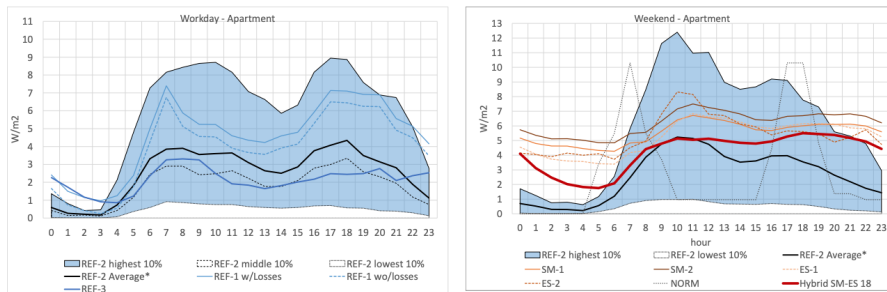

Figure 48: EWH power consumption profiles [52]

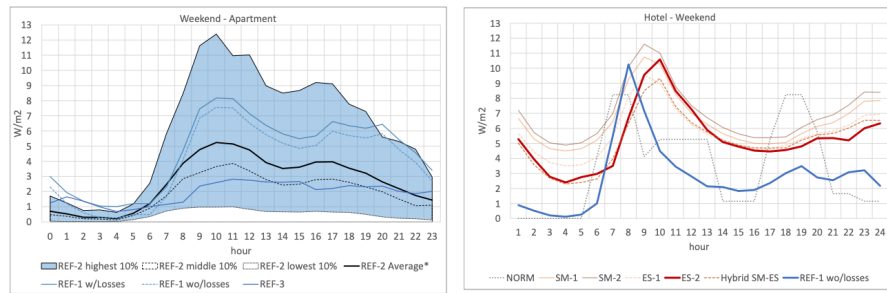

Figure 49: EWH power consumption profiles [52]

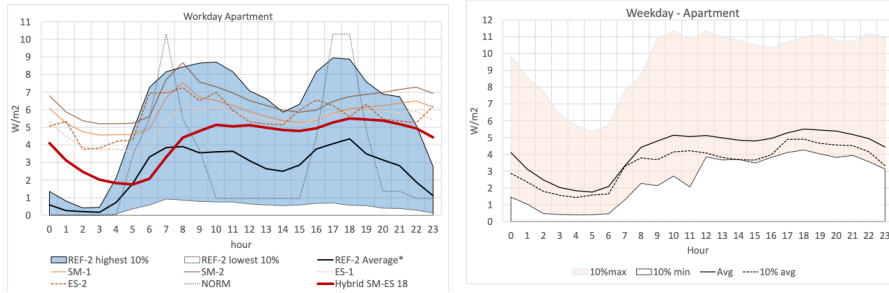

Figure 50: EWH power consumption profiles [52]

## B Røverkollen measured data

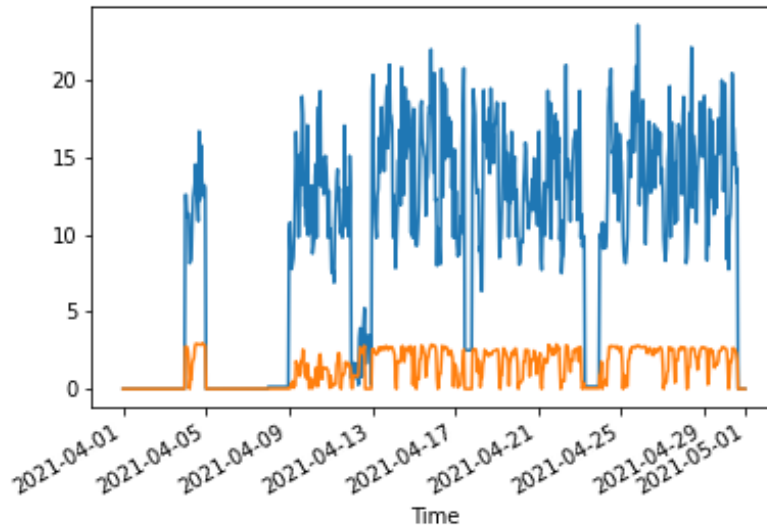

Figure 51: Measured HP and HE power consumption [kWh/h] in April 2021

## C HP heat capacity

Table 19: EWH key measurement - ewh  $T_{min} = 55$

Modeled data [kWh]	Heating element	HP	Total	Share
Jan	3 205	3 857	7 063	55%
Feb	2 770	3 514	6 284	56%
Mar	2 392	3 974	6 366	62%
Apr	1 534	3 776	5 310	71%
May	378	3 650	4 028	91%
Jun	0	2 651	2 651	100%
Jul	0	2 516	2 516	100%
Aug	2	2 907	2 909	100%
Sep	27	3 147	3 175	99%
Oct	540	3 809	4 349	88%
Nov	2 025	3 871	5 896	66%
Dec	3 073	3 982	7 054	56%

## D PV and no-PV

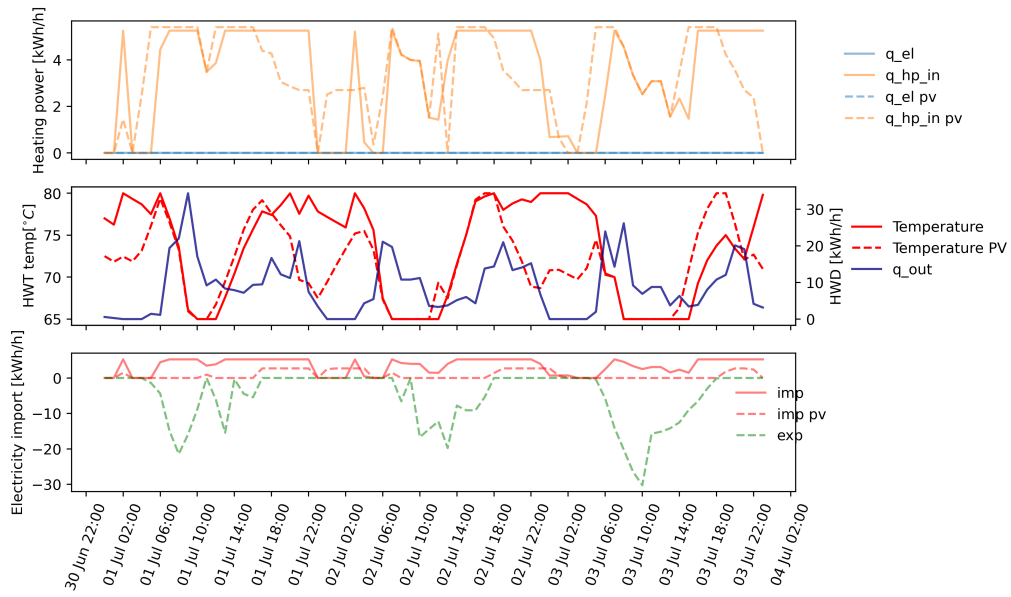

Figure 52: Optimal strategy comparison at 65°C

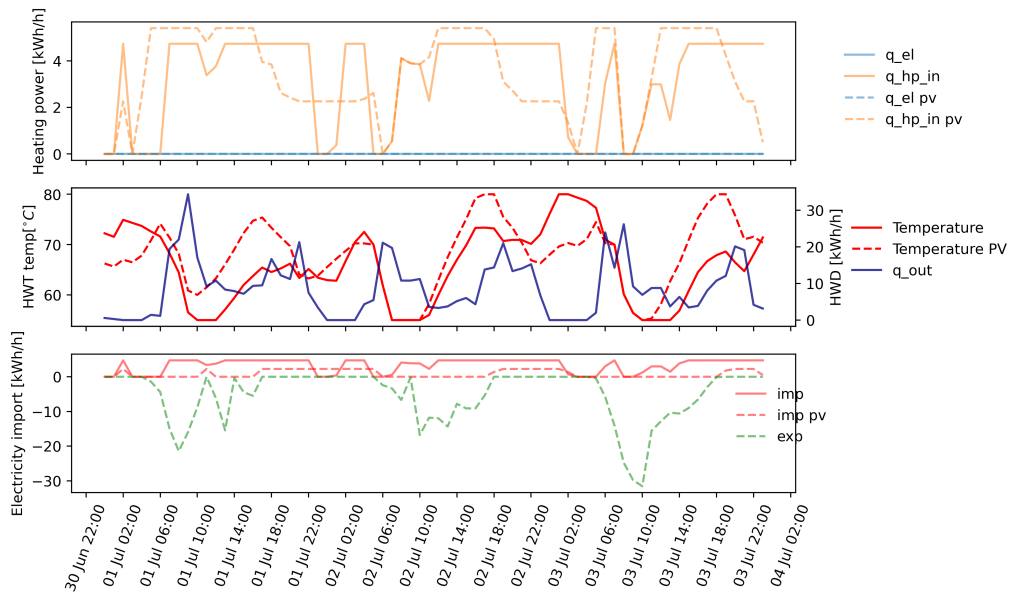

Figure 53: Optimal strategy comparison at 55°C



---

## E Apartments and PV

### E.1 SSR and SCR

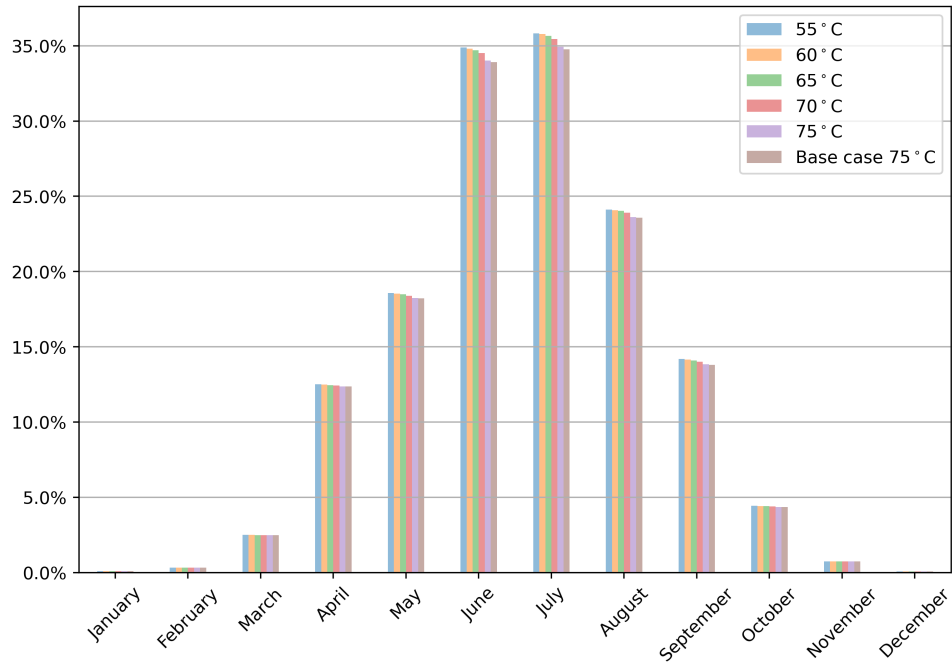

Figure 54: apt\_pv - Monthly self sufficiency

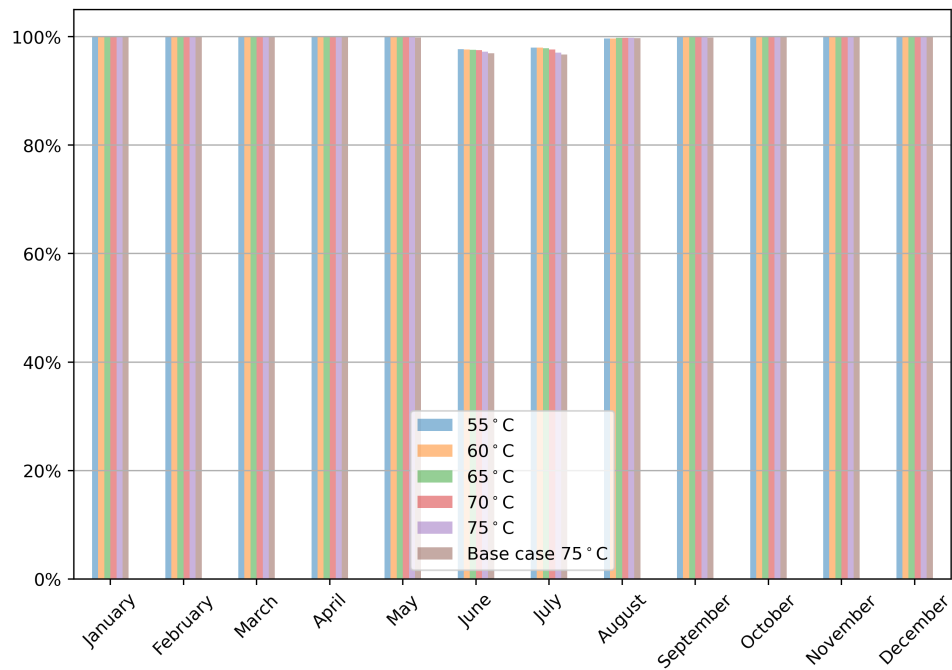

Figure 55: apt\_pv - Monthly self consumption

## F Apt vs no apt

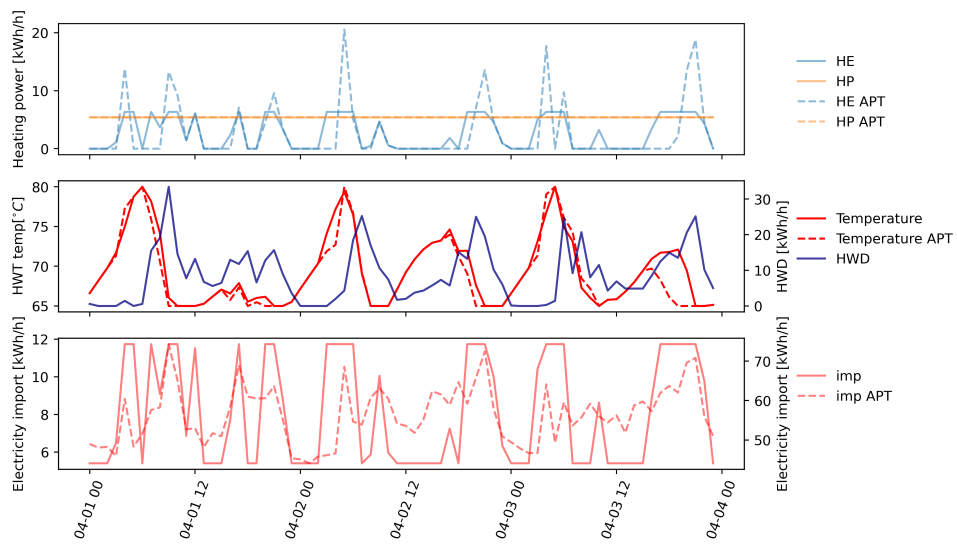

Figure 56: HWT heating strategy ewh and apt comparison  
- April  $T_{min} = 65^{\circ}C$

## G EWH losses

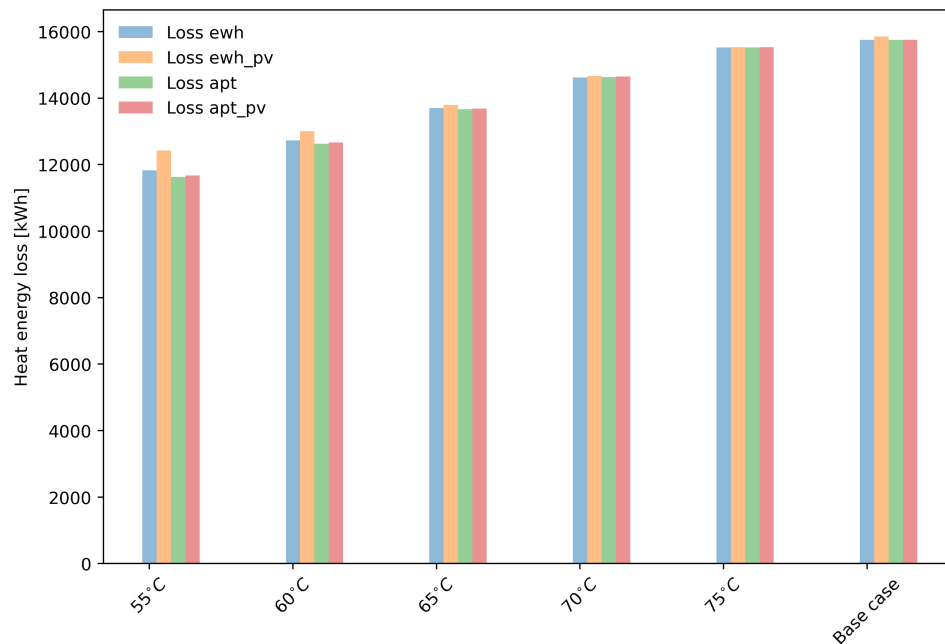

Figure 57: EWH losses for all scenarios and all cases

## H Code

### H.1 Optimization model

```
#!/usr/bin/env python3
# -*- coding: utf-8 -*-
```

---

```

"""
Created on Sun May 28 11:23:58 2023

@author: vemund
"""

import pyomo.environ as pyo
from pyomo.opt import SolverFactory
import pandas as pd

def run_opt(tank_par, bat_par, tar_par, ewh, temp, spotprice, pv, apt, no_hours,
↳ ob = None):

    if ob['pv_on'] == 0:
        pv = [0]*8760

    if ob['apt_on'] == 0:
        apt = [0]*8760
    def cop_of_t(temp):
        # cop =1.1
        if temp > 0 and temp <22:
            cop = (2 + 0.181818182*temp)/1.818
        elif temp >= 22:
            cop = 3.3
        elif temp <=0 and temp >-15:
            cop = 1.1
        else:
            cop = 1
        return cop

    datetime_series = pd.Series(pd.date_range('2021-01-01 00:00', '2021-12-31
↳ 23:00', freq='h'))

    ''' Model '''
    m = pyo.ConcreteModel()

    ''' Sets '''
    m.time = pyo.Set(initialize=range(no_hours)) # dette er nå antall timer i et
↳ år
    m.time_minus1 =pyo.Set(initialize=range(no_hours-1))
    m.months = pyo.Set(initialize = range(12)) # dette er antall måneder
    m.weekdays = [datetime_series[t].weekday() for t in range(0, no_hours)]
    m.hour_of_day = [datetime_series[t].hour for t in range(0, no_hours)]

    ''' Parameters '''
    # tank parameter
    m.u = tank_par['u']
    m.t_amb = tank_par['t_amb']
    m.t_null = tank_par['t_null']
    m.t_legionella = tank_par['t_legionella']
    m.liter = tank_par['liter']
    m.surface_area = tank_par['surface_area']
    m.cap = tank_par['cap']

```

---

```

# Parameters in kWh. Energy in heat
m.Q_min =
↳ tank_par['cap']*tank_par['liter]*(tank_par['t_lower']-tank_par['t_null'])
m.Q_max =
↳ tank_par['cap']*tank_par['liter]*(tank_par['t_upper']-tank_par['t_null'])
m.Q_start = m.Q_max
# m.Q_loss = Q_loss
m.El_max = tank_par['El_max']

m.num_hp = tank_par['num_hp']
m.hp_power = tank_par['hp_power']

m.energy_tariff = tar_par['energy_tariff']
m.plusskunde_energy = tar_par['plusskunde_energy']
m.pp_tariff = tar_par['pp_tariff']
m.mva = tar_par['mva']
m.power_fee = tar_par['power_fee']

m.f_slack = tank_par['forced_slack']

m.max_battery = bat_par['max_battery']
m.battery_start = bat_par['battery_start']
m.bat_eff = bat_par['bat_eff']
m.max_charge_rate = bat_par['max_charge_rate']
m.max_discharge_rate = bat_par['max_discharge_rate']
ewh_d = ewh * tank_par['cap'] * (tank_par['t_out'] - tank_par['t_in'])

''' Variables '''
m.alpha = pyo.Var(m.months, within=pyo.NonNegativeReals) # peak power usage
↳ during month [kWh/h]
m.leg = pyo.Var(m.time, within=pyo.Binary) # peak power usage during month
↳ [kWh/h]

m.y_imp = pyo.Var(m.time, within=pyo.NonNegativeReals) # Power import
↳ [kWh/h]
m.y_exp = pyo.Var(m.time, within=pyo.NonNegativeReals) # Power export
↳ [kWh/h]

" hot water tank variables "
m.q_hp = pyo.Var(m.time, within = pyo.NonNegativeReals) # hp on or off,
↳ real because binary is
# computation heavy
m.q_el = pyo.Var(m.time, within = pyo.NonNegativeReals) # electric heating
↳ element [kWh/h]
m.Q = pyo.Var(m.time, within = pyo.NonNegativeReals) # energy stored
↳ in tank at time t [kWh]
m.forced_slack = pyo.Var(m.time, within = pyo.NonNegativeReals) # slack
↳ variable in case there is no solution (
# too little hot water or something)
m.q_loss = pyo.Var(m.time) # energy loss from
↳ tank [kWh]

" battery variables "
m.b_soc = pyo.Var(m.time, within = pyo.NonNegativeReals) # stateofcharge
m.y_b_ch = pyo.Var(m.time, within = pyo.NonNegativeReals) # charge
m.y_b_disch = pyo.Var(m.time, within = pyo.NonNegativeReals) # discharge

''' Objective '''

```

---

---

```

#
def ObjRule(m): # TODO hvorfor straffes ikke energy_slack
    elCost = sum(m.y_imp[j] * (spotprice[j] * m.mva + m.energy_tariff*m.mva +
    ↪ m.power_fee*m.mva) for j in
        m.time) #
    demCost = m.mva * sum(m.alpha[i] * m.pp_tariff[i] for i in m.months)
    elRev = sum(m.y_exp[j] * (spotprice[j] + m.plusskunde_energy) for j in
    ↪ m.time)
    flexCost = sum(1000 * m.forced_slack[j] for j in m.time)

    if ob['cost_optimize'] and ob['power_tariff_on']:
        return elCost + demCost - elRev + flexCost
    elif ob['cost_optimize'] and not ob['power_tariff_on']:
        return elCost - elRev + flexCost
    elif not ob['cost_optimize'] and not ob['ss_opt'] and not ob['grid_opt']:
        return sum(m.Q[i] - m.Q[i+1] + 1000* m.forced_slack[i] for i in
    ↪ m.time_minus1)

    #
    # elif not ob['cost_optimize'] and not ob['ss_opt'] and not
    ↪ ob['grid_opt']:
    #     return sum(m.Q[i] - m.Q[i+1] - m.q_hp[i] + 1000* m.forced_slack[i]
    ↪ for i in m.time_minus1)
    # #
    elif ob['ss_opt']:
        return sum(m.y_imp[j] for j in m.time) + flexCost
    elif ob['sc_opt']:
        return sum(m.y_exp[j] for j in m.time) + flexCost
    elif ob['grid_opt']:
        return sum(1000 * m.forced_slack[j] for j in m.time_minus1) \
            + sum(m.pp_tariff[i] * m.alpha[i] for i in m.months)
m.OBJ = pyo.Objective(rule=ObjRule, sense=pyo.minimize)

''' Constraints '''

# MAX power HP
def max_power_hp(m, j):
    if temp[j] <= -15:
        return m.q_hp[j] ==0
    else:
        return m.q_hp[j] <= m.num_hp * cop_of_t(temp[j])*m.hp_power
m.max_power_hp = pyo.Constraint(m.time, rule=max_power_hp)

" battery constraints "
def battery_level(m, j):
    if j == 0:
        return m.b_soc[j] == m.battery_start
    else:
        return m.b_soc[j] == m.b_soc[j-1] + m.bat_eff*m.y_b_ch[j] -
    ↪ m.y_b_disch[j]
m.battery_level = pyo.Constraint(m.time, rule=battery_level)

def max_bat_charge(m, j):
    return m.y_b_ch[j] <= m.max_charge_rate
m.max_bat_charge = pyo.Constraint(m.time, rule=max_bat_charge)

def max_bat_discharge(m, j):
    return m.y_b_disch[j] <= m.max_discharge_rate
m.max_bat_discharge = pyo.Constraint(m.time, rule=max_bat_discharge)

```

---

---

```

def max_bat_lvl(m, j):
    return m.b_soc[j] <= m.max_battery
m.max_bat_lvl = pyo.Constraint(m.time, rule=max_bat_lvl)

" Hot water tank constraints "
# MAX power electric heating element of tank, 28kW
def max_power_el(m, j):
    return m.q_el[j] <= m.El_max
m.max_power_el = pyo.Constraint(m.time, rule=max_power_el)

def heat_loss(m, j): # heat loss in hot water tank
    return m.q_loss[j] == m.u*m.surface_area*(m.Q[j]/m.liter/m.cap + m.t_null
        ↪ - m.t_amb)*tank_par['num_VVB']
m.heat_loss = pyo.Constraint(m.time, rule=heat_loss)

#Heat balance
def heat_balance(m, j):
    if j==0:
        return m.Q[j] == m.Q_start+ m.q_hp[j] + m.q_el[j] - ewh_d[j] -
            ↪ m.q_loss[j] # TODO KB: dobbeltsjekk timer
    else:
        return m.Q[j] == m.Q[j-1] + m.q_hp[j] + m.q_el[j] - ewh_d[j] -
            ↪ m.q_loss[j]
m.heat_balance = pyo.Constraint(m.time, rule=heat_balance)

# Upper temperature/energy stored in hot water tank
def max_store(m, j):
    return m.Q[j] <= m.Q_max
m.max_store = pyo.Constraint(m.time, rule=max_store)

def min_store(m, j):
    if j == 0:
        return m.Q[j] >= m.Q_min
    elif j == 1:
        return m.Q[j] >= m.Q_min - m.forced_slack[j]
    else:
        return m.Q[j] >= m.Q_min -m.forced_slack[j]
m.min_store = pyo.Constraint(m.time, rule=min_store)

def power_balance(m, j):
    return m.y_imp[j] - m.y_exp[j] == apt[j] + m.q_hp[j] / cop_of_t(temp[j])
        ↪ - pv[j]+\
            m.q_el[j] + m.y_b_ch[j] - m.bat_eff*m.y_b_disch[j]
m.power_balance = pyo.Constraint(m.time, rule = power_balance)

def max_forced_slack(m, j):
    if j >= no_hours-3:
        return m.forced_slack[j] <= 0
    else:
        return m.forced_slack[j] <= m.f_slack
m.max_forced_slack = pyo.Constraint(m.time, rule=max_forced_slack)

if ob['power_tariff_on']:
    def power_tariff_cons(m, j):
        i = datetime_series[j].month - 1

```

---

---

```

        return m.alpha[i] >= m.y_imp[j]
    m.power_tariff_cons = pyo.Constraint(m.time, rule=power_tariff_cons)

def legionella_cons(m,i):

    if m.weekdays[i] in [5,6] and m.hour_of_day[i] == 7 :
        return m.Q[i] /(m.cap*m.liter)+m.t_null >= m.t_legionella

    elif m.weekdays[i] not in [5,6] and m.hour_of_day[i] == 5:
        return m.Q[i] /(m.cap*m.liter)+m.t_null >= m.t_legionella
    else:
        return m.Q[i] <= m.Q_max
m.legionella_cons = pyo.Constraint(m.time, rule = legionella_cons)

''' Running optimization model '''
# m.dual = pyo.Suffix(direction=pyo.Suffix.IMPORT)
opt = SolverFactory("glpk")
results = opt.solve(m, load_solutions=True)
m.solutions.load_from(results)
objVal = pyo.value(m.OBJ)
print(objVal)

###
" Getting results "

res_dict = {
    'spotprice' : [spotprice[j] for j in m.time],
    'q_hp'      : [m.q_hp[j].value for j in m.time],
    'q_hp_in'   : [(m.q_hp[j].value / cop_of_t(temp[j])) for j in m.time],
    'q_el'      : [(m.q_el[j].value) for j in m.time],
    'Q'         : [m.Q[j].value for j in m.time],
    'q_out'     : [ewh_d[j] for j in m.time],
    'imp'       : [m.y_imp[j].value for j in m.time],
    'exp'       : [m.y_exp[j].value for j in m.time],
    'cop'       : [cop_of_t(temp[j]) for j in m.time],
    'f_slack'   : [m.forced_slack[j].value for j in m.time],
    'apt'       : [apt[j] for j in m.time],
    'hwt_imp'   : [(m.q_hp[j].value / cop_of_t(temp[j]) + m.q_el[j].value) for
    → j in
        m.time],
    'Q_loss'    : [m.q_loss[j].value for j in m.time],
    # 'battery_level' : [m.b_soc[j].value for j in m.time],
    # 'battery_charge' : [m.y_b_ch[j].value for j in m.time],
    # 'battery_discharge' : [m.y_b_disch[j].value for j in m.time],
    'temp hwt' : [1/(m.cap*m.liter)*m.Q[j].value+m.t_null for j in m.time],
}
if ob['power_tariff_on']:
    res_dict['alpha'] = [m.alpha[i].value for i in m.months] # max import
    → per month

return res_dict,m

```

---

---

## H.2 Parameters

```
#!/usr/bin/env python3
# -*- coding: utf-8 -*-
"""
Created on Wed Apr 26 09:58:10 2023

@author: vemund + kjersti
"""

# import pyomo.environ as pyo
import matplotlib.pyplot as plt
# from pyomo.opt import SolverFactory
import data_formatter_kjersti as d_for
import pandas as pd
import numpy as np
# import plot_results as pr
from opt_model_kjersti import run_opt

no_hours = 8760
building = 1 # can be 0, 1, 2, 3, 4 (0 is two buildings)
building_map= ['rk_11_13', ' rk_21_23_25', ' rk_1_3_5_7_9', ' rk_31_33', '
→ rk_15_17_19']
no_people = [40, 52, 52+18, 30, 54]

ewh, temp, spotprice, pv, apt = d_for.get_data(building, no_hours)

VVB_power = [28, 28, 28+14, 28, 28]
no_VVB = [4, 6, 6+3, 4, 6]
no_HP = [2, 3, 1+3, 2, 3]

write_to_file_on = 1 # 1 to write results to file
folder = 'results/' # The file saved here contains all cost and max power
→ import data
df_folder = 'results_dataframes/' # The file saved here is a dataframe with all
→ results
write_to_file = 'results_opt_sc_apt_pv_75.xlsx'

''' Options '''
ob = {
    'apt_on' : 1, # always on 1 to include electricity consumption by
→ apartments, 0 otherwise
    'pv_on' : 1, # 1 to include 50kwp solar power generation, 0
→ otherwise
    'battery_on' : 0,

    'cost_optimize' :0, # Minimizes cost
    'ss_opt' : 0,
    'sc_opt' :1, # Optimize self consumption of pv power
    'grid_opt' : 0, # Minimizes max grid import
    'power_tariff_on' :0 # turns peak power tariff on and off (always on)
}

''' Parameters '''
tank_par = {
```

---



---

```

'surface_area' : 5.72,      # hot water tank surface area for a 400 l tank
'u'            : 0.00091,  # Thermal transmittance W/(m2 · K)]
't_amb'        : 20,      # celsius
'hp_power'     : 1.8,      # heat pump power [kW] TODO må settes til en verdi
↳ (f.eks. 0.9), må bestemmes
't_null'       : 9,       # celsius
'liter'        : 400*no_VVB[building], # l for whole building
't_upper'      : 80,      # celsius
't_lower'      : 75,      # celsius
'cap'          : 1.16*10**(-3), # specific heat capacity water
'El_max'       : VVB_power[building], # max el consumption heating
↳ element
'num_hp'       : no_HP[building], # number of heat pumps
't_out'        : 40,      # temperature of water out, celsius,
't_in'         : 9,       # temperature of water in, celsius
't_legionella' : 70,
# 'temp_slack_val' : 70, # the new lower value in celsius TODO sjekk
↳ hvordan det funker i optimisering
'num_VVB'      : no_VVB[building]
}
# hp_power = 1.818 (original number)

tank_par['forced_slack'] = 100

###
bat_par = {
    'bat_eff' : 0.9
}
if ob['battery_on'] == 1:
    bat_par['max_battery'] = 100 # this is capacity in kWh
else:
    bat_par['max_battery'] = 0
bat_par['max_charge_rate'] = bat_par['max_battery']*0.5
bat_par['max_discharge_rate'] = bat_par['max_battery']*0.5
bat_par['battery_start'] = bat_par['max_battery']

if ob['pv_on'] == 0:
    pv = [0]*8760

if ob['apt_on'] == 0:
    apt = [0]*8760

tar_par = { #
↳ https://www.elvia.no/nettleie/alt-om-nettleiepriser/nettleiepriser-og-effekttariff-for-bedrif
    'energy_tariff' : 0.05, # NOK/kWh
    'plusskunde_energy' : 0.05, # tapsreduksjon NOK/kWh
    'pp_tariff' : [72,72,72,32,32,32,32,32,32,72,72,72], # NOK/kW
    'power_fee' : 15.84/100, # NOK/kWh
    'mva' : 1.25
}

''' Errors on wrong input '''

if ob['ss_opt'] + ob['cost_optimize'] + ob['grid_opt'] > 1:
    raise Exception('Multiple obj optimering')

```

---

---

```
if ob['battery_on']:
    print('battery on')

res_dict,m = run_opt(tank_par, bat_par, tar_par, ewh, temp, spotprice, pv, apt,
    → no_hours, ob = ob)

#%%
exclude_keys = ['alpha']
new_d = {k: res_dict[k] for k in set(list(res_dict.keys())) - set(exclude_keys)}
yearly_df = pd.DataFrame(new_d)
yearly_df.index = pd.date_range("2021-01-01", periods=no_hours, freq="H")
yearly_df['apt fixed'] = apt

writer = pd.ExcelWriter(df_folder+write_to_file, engine='xlsxwriter')
yearly_df.to_excel(writer, sheet_name='results', float_format='%.2f')
pd.DataFrame(ob, index=[0]).T.to_excel(writer, sheet_name='objective')
pd.DataFrame(tank_par, index=[0]).T.to_excel(writer, sheet_name='tank_par')
writer.close()

#
```

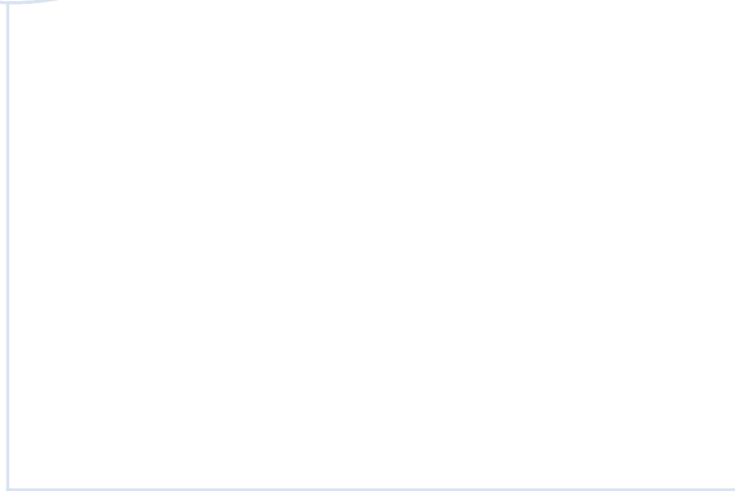

 **NTNU**

Norwegian University of  
Science and Technology