

## Article

# Rain Intrusion through Horizontal Joints in Façade Panel Systems—Experimental Investigation

Eva Armstrong Støver <sup>1,†</sup>, Marte Haugen Sundsøy <sup>1,†</sup>, Erlend Andenæs <sup>1,\*</sup> , Stig Geving <sup>2</sup> and Tore Kvande <sup>1</sup> 

<sup>1</sup> Department of Civil and Environmental Engineering, Norwegian University of Science and Technology (NTNU), 7491 Trondheim, Norway

<sup>2</sup> Department of Architecture, Materials and Structures, SINTEF Community, 7465 Trondheim, Norway

\* Correspondence: erlend.andenas@ntnu.no

† These authors contributed equally to this work.

**Abstract:** Façade panel systems with horizontal open joints are commonly used on larger buildings in Nordic countries. Excessive water intrusion through open joints may cause deterioration of the façade, a concern exacerbated by climate change. Previous studies have shown that current design recommendations for open-joint façade panel systems may not be optimal to prevent water intrusion. It is therefore of interest to investigate the watertightness of different design solutions for horizontal joints to inform recommendations for more durable façades. Large-scale measurements are conducted in a driving rain apparatus. Façade panel systems with different joint solutions are tested according to NS-EN 1027:2016. In total, 72 unique tests are conducted, investigating the impact of the four parameters: panel types, joint widths, joint profiles, and bevelled joint designs. All designs performed differently for the different types of panels, making it difficult to draw general conclusions. Smooth panels consistently exhibit higher water intrusion rates than rough panels, because runoff concentrates in streams on a smooth surface, causing localized, great intrusion in the horizontal joints. Modifications of the joints or the insertion of aluminium profiles may reduce or increase water intrusion. The most watertight among the investigated solutions involves an h-shaped profile. Bevelled joints improve overall watertightness but may direct more water towards the wind barrier. For open joints, a narrower joint width was found to decrease water intrusion to the wind barrier. In general, a barrier is needed to protect the joints against water intrusion. However, the effectiveness of protection measures depends on their design and mounting. Some protection measures led to greater water intrusion than no barrier at all.

**Keywords:** water intrusion; rain intrusion; open joint; laboratory measurements; façade panel systems; watertightness



**Citation:** Støver, E.A.; Sundsøy, M.H.; Andenæs, E.; Geving, S.; Kvande, T. Rain Intrusion through Horizontal Joints in Façade Panel Systems—Experimental Investigation. *Buildings* **2022**, *12*, 1497. <https://doi.org/10.3390/buildings12101497>

Academic Editor: Emilio Bastidas-Arteaga

Received: 31 August 2022

Accepted: 18 September 2022

Published: 21 September 2022

**Publisher's Note:** MDPI stays neutral with regard to jurisdictional claims in published maps and institutional affiliations.



**Copyright:** © 2022 by the authors. Licensee MDPI, Basel, Switzerland. This article is an open access article distributed under the terms and conditions of the Creative Commons Attribution (CC BY) license (<https://creativecommons.org/licenses/by/4.0/>).

## 1. Introduction

The main objective of a building façade is to shield the building envelope from the exterior climate and ensure the longtime integrity of the building [1]. Façades serve as the primary weather barrier for buildings and therefore need to withstand climatic loads for many years without requiring excessive maintenance or repairs [2]. Following decades of carbon emissions, the climate is now changing globally [3,4]. Among the predicted consequences of climate change in the Nordic countries are more extreme weather, including more frequent and intense precipitation [5]. Climate change requires buildings and infrastructure to be adapted for future climatic stresses [6,7]. Notably, building façades will be subjected to increased moisture loads, which may cause moisture defects [8]. A façade typically consists of several layers, with a ventilated cladding forming the exterior layer. Claddings are in many cases not entirely air- or watertight. Water intrusion through the façade cladding may cause moisture damage to the interior layers [9–11]. The consequences of water intrusion are an issue for façades today, with several defects occurring in wood

materials [12,13]. Therefore, it is important to know how much water infiltrates the façade cladding to understand the moisture loads imposed on the interior layers and ensure the long-term integrity of the façade.

In Nordic countries, façades are typically designed according to the principle of two-stage weatherproofing [1]. The principle is thoroughly presented in [14]. An outer layer, the cladding, acts as a weather barrier while a wind barrier is located behind an air cavity, as illustrated in Figure 1. The wind barrier is raintight and vapor permeable to allow outwards drying. The principle of two-stage weatherproofing is used to reduce the risk of moisture damage in joints, roof or outer walls [1,15]. However, while the principle is considered to provide adequate weatherproofing, it is unknown to what degree its performance is affected by the intrusion of rain water through joints or gaps in the cladding [14].

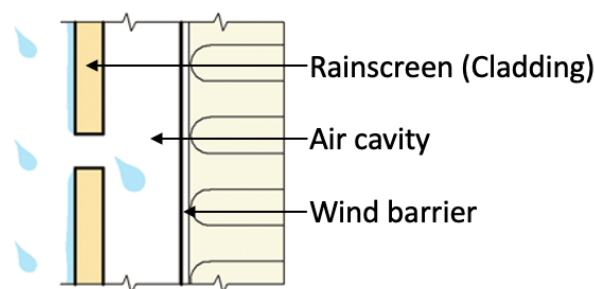

**Figure 1.** Principle of two-stage weatherproofing for an exterior wall with façade panels. The principle is not used for the horizontal open joint. Figure adapted from [15].

Façade panel systems are commonly used as exterior cladding on larger buildings in Norway [16]. The façade panels are often made of polymer composite, fiber cement, or high-pressure-laminate (HPL) [17,18]. The panels are typically mounted, following the principle of two-stage weatherproofing, to vertical wood or metal battens, creating a ventilated air cavity between the interior side of the panels and the wall's wind barrier. It is recommended to mount façade panels with a joint width ranging between 5 and 10 mm to account for expansion of the panels due to moisture and heat. For definitions of the dimensions of joints and façade panels, see Figure 2. The vertical joints are kept relatively watertight by mounting a rubber gasket between the panels and vertical battens. The horizontal joints are, on the other hand, often kept open, thus deviating from the principle of two-stage weatherproofing. Laboratory experiments show that more than 98% of water infiltration through façade panel systems with open horizontal and vertical joints occurs through the horizontal joint [9].

In Norway, building design guidelines for outer walls with façade panel systems are issued by SINTEF [17]. The recommendations suggest that horizontal open joints without any form of protection should be avoided [17], since SINTEF's archive of building defects show that moisture damage often occurs behind these types of cladding [19]. However, horizontal open joints are often preferred by architects for esthetic reasons. It is also faster and less expensive to mount façade panels without weatherproofing in the horizontal joints. Consequently, horizontal joints are often left open regardless of Norwegian recommendations. Previous studies show that horizontal open joints facilitate water intrusion both to the interior side of the panels and the wind barrier [20].

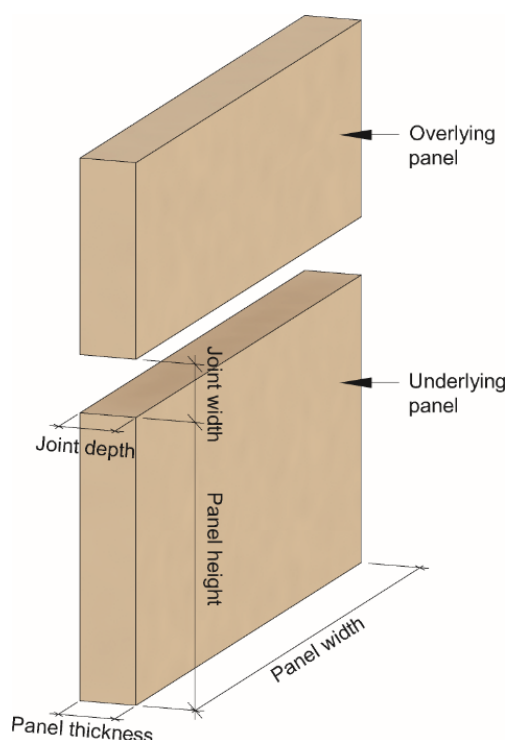

**Figure 2.** Definition of terms used to describe attributes of the panels and horizontal joints.

On impact with the façade cladding, rain will either splash off, flow down the façade, evaporate, be absorbed, or remain on the cladding [21–23]. Parameters that can affect rain runoff include surface tension, façade roughness, wind forces, the type of cladding material, the degree of wet condition, protruding wall elements, dirt, and the size of droplets, among others [22,24–26]. Water intrusion through joints, or openings, can occur due to kinetic energy, gravity, wind pressure, pressure differences, local air currents, hydrostatic pressure, and capillary forces [19,27–30]. In cases with highly concentrated streams on the exterior side of the panels, the streams can infiltrate the joint and hit the wind barrier directly due to the ejection effect [20]. The ejection effect is a concentrated stream with a horizontal velocity component forming when water flows into a joint, thereby easily leading water to the wind barrier. Water that passes directly through openings without hitting the façade panels is referred to as direct spray.

Joint profiles are extruded elements, often made from aluminium, that are inserted longitudinally into joints to form a protection against water intrusion and UV radiation [17]. It is recommended to use joint profiles to weatherproof horizontal open joints. Common types include the T1-, T2-, and h-profiles illustrated in Figure 3 [17]. The h-profiles have proven to be very effective protection against water intrusion [20,31]. However, profiles that very visibly protrude the joints to the exterior of the panels, such as, for instance, the h-profile, are not popular among architects for esthetic reasons [20]. “Hidden” profiles are preferred, such as the two T-profiles in Figure 3. However, these profiles have been shown to sometimes direct more water behind the façade instead of increasing the watertightness [20]. This is because the profiles do not adhere to the principle of dedicated dripping edges. Furthermore, they are not completely pressed against the panels, creating a sufficient gap to lead water onto the interior side of the panels.

Joint width recommendations in Norway are based on a study by [32], where 5 mm joint widths were found to be optimal. In general, larger joint widths lead to more water intrusion [20,32–35]. Smaller joint widths increase the risk of static water in the joints, which may foster microbial or algae growth. Joint design that differs from rectangular joints has proven effective against water intrusion [20,35]. For 40 mm joint depths, it is very effective to create vertical drainage grooves or quirks [35]. In joints with depths of 6 mm, overhangs and bevelled edges might prevent water intrusion [20]. The impact of

different joint designs on water intrusion through horizontal open joints has not yet been sufficiently documented.

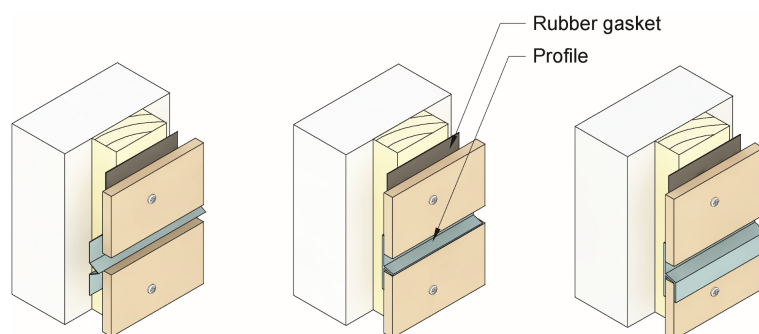

**Figure 3.** Joint profiles within the joint. From the left: T1-profile, T2-profile, and h-profile.

The study presented in this article aims to enhance the knowledge about the watertightness of horizontal open joints, and how different joint solutions affect watertightness. Previous studies on rain runoff or intrusion on façade panel systems have varied in their methodology, including computational fluid dynamics (CFD) simulations [24,36,37], field studies [10,22,33,38] and laboratory studies [10,20,31–33,35,39]. However, few laboratory measurements have been conducted on façade panel systems with horizontal open joints [9,20,32–35,40]. In addition, a previous study shows that some of the current Norwegian recommended solutions involving joint profiles lead to substantial amounts of water infiltrating the façade cladding [20]. However, the parameters of the study were limited, highlighting the need for this follow-up study. To address these general concerns, the following research questions are formulated:

1. What is known from existing scientific literature about the raintightness of horizontal joints in façade panel systems?
2. How do different joint solutions affect rain intrusion through the horizontal joints in façade panel systems?

A scoping literature study and a laboratory study are conducted. Findings from previous studies are compared to the laboratory results of the present study to obtain a more holistic view of the water intrusion through horizontal open joints.

To test the watertightness of horizontal open joints for façade panel systems, laboratory tests are conducted in a driving rain apparatus set up according to NS-EN 1027:2016. The quantity of applied water is determined by NS-EN 1027:2016. Since the test rig is built according to the principle of two-stage weatherproofing, it is considered pressure-equalized across the cladding, and air pressure is therefore not of interest.

Certain limitations are acknowledged. Five different types of façade panels are included in this study. The scope of the study is also limited to investigating water intrusion through horizontal open joints in façade panel systems. Additionally, only experimental laboratory studies investigating façade panel systems with similarities to this study are of interest in the literary review.

## 2. Methods

### 2.1. Literature Review

In order to map the current state of the research field, a scoping literature review has been conducted. This method is useful to get an overview of available research within a topic of interest and to uncover knowledge gaps [41]. The research questions determine the premises for relevant keywords and phrases. The scoping method used is based on the five-step procedure described by [42]. These are: identify and define the research questions; identify relevant research; select the most relevant research; map the data; and gather, summarize and report the results.

To identify and collect the most relevant research, the scientific databases Scopus, Science Direct, and Oria were used. Oria is a Norwegian research library database. It is used because a large extent of the research within this field is conducted at Norwegian research institutions and published in Norwegian. To widen the search, synonyms to words and phrases used in the research questions were also included. The keywords are primarily English, except some Norwegian searches in Oria. Boolean operators were used to combine keywords and -phrases, as shown in Table 1, thereby excluding irrelevant findings and narrowing the results. The 50 first results for every search were examined for relevance.

**Table 1.** Keywords and -phrases and Boolean operators used in the literature review.

Keyword or Phrase	AND	NOT
Façade OR	"Rain penetration" OR	CFD
"Façade cladding" OR	"Driving rain" OR	
"Panel cladding" OR	"Water penetration" OR	
"Panel façade" OR	"Water intrusion" OR	
Laboratory OR	"Wind-driven rain" OR	
Walls OR	WDR OR	
"Panel frame façade" OR	Laboratory OR	
"Exterior walls" OR	"Laboratory test" OR	
"External cladding" OR	"Open joint" OR	
	Junction	

The selection of the most relevant research for further study was carried out using a four-step procedure. The exclusion criteria were based on the articles' relevance in answering the research questions. The first step examined the articles' title. Only titles in English, Norwegian, Swedish, or Danish were considered. The articles considered relevant were gathered in a spreadsheet with information such as author, country, name of journal, year of publishing, keywords and abstract. The second step was to select articles for further study based on relevant keywords. In the third step, the abstract and conclusion of each remaining article were read, subsequently excluding those found irrelevant from further study. The fourth step included a quick read-through of the entire article. Finally, the references of the remaining articles were reviewed to identify articles that were not found through the database searches. In addition, the "cited by" function in Google Scholar was used to find literature citing the collected articles. This method is called snowballing or citation chaining [43]. Relevant information gathered outside of the literature review includes Norwegian construction guidelines and information from textbooks in building physics and encyclopedias.

## 2.2. Laboratory Measurements

### 2.2.1. Test Set-Up

A vertical test rig, 2645 × 2645 mm, was built with two separate test sections. Each test section was 1196 mm wide and 2573 mm tall, which allowed three panels to be tested in each section, creating two horizontal joints. The test rig was built into a metal frame that was installed in a driving rain apparatus, as shown in Figure 4. The outer wooden frame was fastened to the metal frame, and then the perimeter was sealed with an elastic sealant. The test rig was built by first fastening two battens to the outer frame and then fastening the studs to both the battens and the outer frame. Instead of a wind barrier, a transparent polycarbonate board (Lexan) was used so that the experiment could be observed.





**Figure 4.** The test rig seen from the interior side. The water-collecting system consists of buckets and tubes. The left side of the rig is test section 1, and the right side is test section 2.

To measure the amount of water that hits the wind barrier, a gutter system was constructed using aluminum foil, tape, plastic tubes, and sleeves. The aluminium gutter was taped to the Lexan board and not connected to the interior side of the panels. Tubes led the collected water from the aluminium gutter to buckets, as seen in the foreground of Figure 4. A separate gutter system, using plastic foil, was constructed after the panels were mounted to measure the amount of water infiltrating to the interior side of the panels. The plastic gutters were taped to the bottom of the lowest panel. Plastic tubes were used to lead the collected water to buckets placed outside the driving rain apparatus.

Vertical battens were mounted to the Lexan board and underlying studs. The façade panels were mounted on the vertical battens with the plastic gutters fastened. The battens,  $30 \times 48$  mm, created a 30 mm wide air cavity. A 70 mm wide ethylene propylene diene monomer (EPDM) gasket was placed between the vertical battens and façade panels. Two types of EPDM gaskets were used according to recommendations from the façade panel suppliers; one plain and one with grooves. Each panel is approximately  $1200 \times 800$  mm. Three panels were used for each test section, thus creating two horizontal joints in each section.

### 2.2.2. Rain Testing

The driving rain apparatus was set up and tests carried out according to NS-EN 1027:2016 [44]. The test rig was built as a pressure equalized cladding. The apparatus was equipped with eight nozzles with a distance of 400 mm between them. However, only six nozzles spray water onto the test rig, meaning there are three nozzles spraying on each test section. The nozzles were placed with a horizontal distance of 150 mm from the panels and a vertical distance of 100 mm above the top joint with an inclination of  $24^\circ$  to the azimuth. An acknowledged source of potential uncertainty is the row of nozzles in the apparatus, which can only be moved manually. The nozzles had to be moved between tests and have a positioning accuracy of approximately  $\pm 15$  mm. Each nozzle sprays 2 L/min. The majority of the applied water hits above the top horizontal joint, and some water hits the joint directly. The slightly different spray profile for each test may impact the precision and reliability of the wind barrier measurements. The lower horizontal joint will mainly be exposed to runoff water from the overlying panels.

Four different parameters were the focus of the testing: different façade panels, joint widths, joint profiles, and bevelled joint designs. The different combinations of parameters and an overview of the test program are presented in Table 2. Additionally, tests with the top joint sealed (hindering water intrusion due to direct spray and increased water runoff) and tests without any panels was conducted. All the parameters were tested with open joints. Unless otherwise specified, the joint widths are those given in Table 3. Protection measures are defined as anything used to alter the joint, in this instance different profiles, gasket, and bevelled joint designs. The joints with protection measures are hereby referred to as protected joints. The five panels tested and their characteristics are presented in Table 3. Whenever the present article refers to *the standard recommendation* from the suppliers for the different panels, it is defined as an open joint without any protection measures, and recommended joint widths as stated in Table 3.

**Table 2.** Overview of combination of test parameters conducted during the laboratory measurements. (FP is an abbreviation of “fastening points”).

	HPL			Glass Fiber Smooth			Glass Fiber Rough			Fiber Cement White			Fiber Cement Grey		
	3 mm	5 mm	8 mm	3 mm	5 mm	8 mm	3 mm	5 mm	8 mm	3 mm	5 mm	8 mm	3 mm	5 mm	8 mm
Open joint		X	X	X	X	X	X	X	X	X	X	X	X	X	X
T1-profile		X	X		X			X			X			X	
T2-profile		X	X		X			X			X			X	
h-profile					X			X							
Sealed top joint		X	X		X			X			X			X	
Gasket											X			X	
U-batten					X			X			X			X	
U-batten with extra FP					X			X			X			X	
U-batten with gasket					X			X			X			X	
U with gasket and extra FP					X			X			X			X	
Bevelled top 15°		X	X		X			X							
Bevelled top 30°		X	X		X			X							
Bevelled top 45°		X	X												
Bevelled both 15°		X	X		X			X							
Bevelled both 30°		X	X		X			X							
Bevelled both 45°		X	X												

**Table 3.** Overview of different panels used in laboratory measurements and the supplier’s recommended joint widths (without protection measures) (fourth column), referred to as “standard recommendations” throughout this article.

Material/Name	Surface Characteristics	Dimensions [mm × mm × mm]	Recommended Joint Width [mm]
Glass Fiber Smooth	Painted and very smooth	1195 × 840 × 6	5
Glass Fiber Rough	Crushed stone and very rough	1195 × 840 × 6	5
Fiber Cement Grey	Painted and smooth	1192 × 800 × 8	5
Fiber Cement White	Sandblasted and rough	1192 × 800 × 8	5
HPL	Painted and very smooth	1200 × 800 × 8	8

Five different panels were tested. The contact angles were obtained by taking pictures of droplets on the panels (lying horizontally) and thereupon measuring the angles of the droplets. Three different joint widths were tested: 3, 5, and 8 mm. The different joint widths were achieved using spacers. The three aluminium joint profiles tested, referred to as profiles within the joint, are shown in Figure 3. The three profiles’ dimensions are given in Figure 5. Additionally, a gasket and a ventilated U-batten were tested in different combinations, referred to as profiles behind the joint. Figure 6 illustrates three of the combinations. A 70 mm wide gasket with no grooves was used. The U-batten was made of steel with a depth of 15 mm and a height of 70 mm. The U-batten was mounted to the vertical battens; in common practice, vertical battens are not used. Additionally,

variants were tested wherein extra fastening points for the panels were placed between the previously existing fastening points in the joint, creating a distance of 275 mm instead of 550 mm. Bevelled joint designs, top-bevelled and top-and-bottom bevelled, as shown in Figure 7, with angles of  $15^\circ$ ,  $30^\circ$ , and  $45^\circ$ , were constructed using a circular saw.

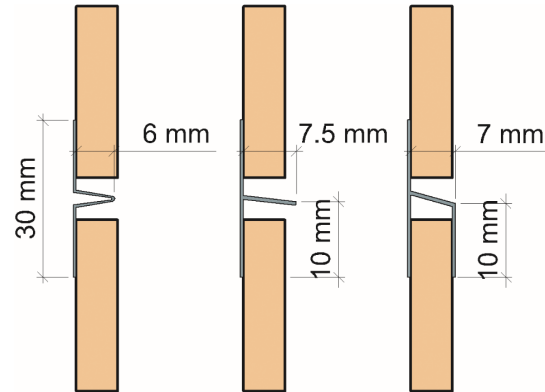

**Figure 5.** Joint profile dimensions. From the left: T1-profile, T2-profile and h-profile. Left side of panels is the interior side, and right side is the exterior. Altered from [12].

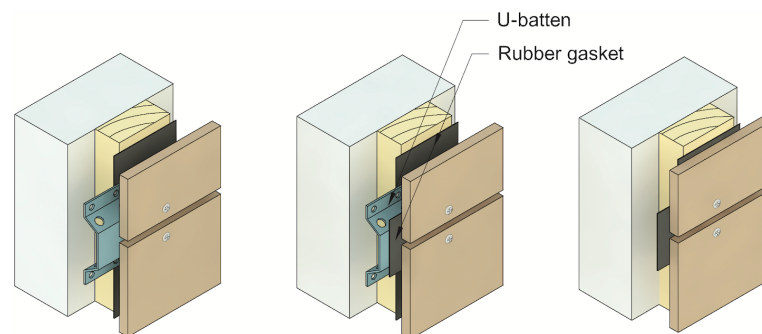

**Figure 6.** Profiles behind the joint, U-battens. From left: U-batten without a gasket, U-batten with a gasket, and with only a gasket. Normally, a vertical batten is not used in combination with an U-batten.

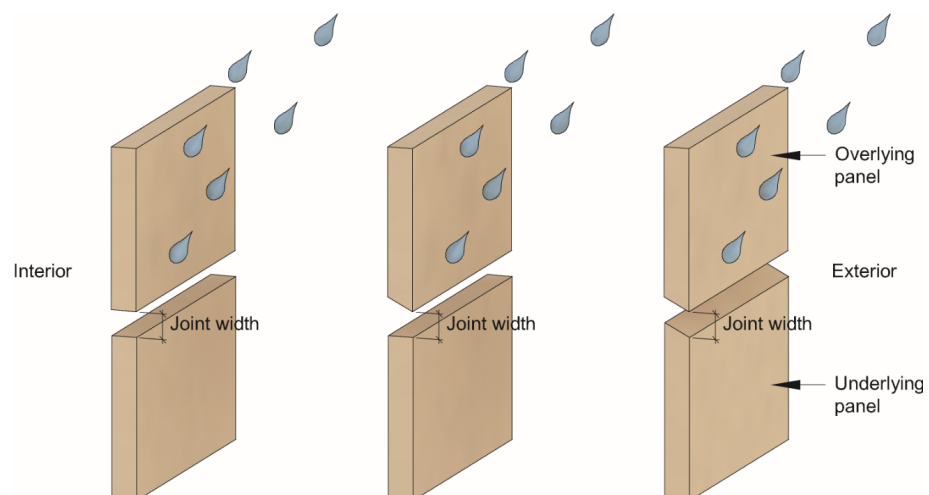

**Figure 7.** Different bevelled joint designs. From left: A rectangular joint, a top-bevelled joint, and a top-and-bottom bevelled joint.

For every parameter tested, water was applied to the test rig for ten minutes before water collection and measurement commenced. The application of water before the measurements started normalized the water runoff conditions and ensured more consistent results. For each measurement, the water was applied for two minutes. Collected water



runoff was measured shortly after the nozzles were turned off, but allowing some time for the water in the gutters to empty into the buckets. The two-minute water application and subsequent measurement was repeated at least three times for every parameter. If a measured result varied considerably from the others, the result was discarded and water applied for an additional two-minute measurement. The water from the gutter systems was collected in buckets and measured using measuring jugs and cups. The three measurements were averaged, with single outliers excluded. The presented output of every parameter test is the averaged collected runoff quantities from the interior side of the panels and from the wind barrier.

### 3. Results

#### 3.1. Review of Previous Research

The literature review revealed eight previous studies featuring a thorough discussion of water intrusion in horizontal open joints. Additionally, a recent state-of-the-art review article by van Linden and van den Bossche [45] summarized the scientific literature on water infiltration in several types of wall assemblies. The following paragraphs are structured around each parameter found to be of relevance for rainwater intrusion.

##### 3.1.1. Water Distribution

A limited number of studies have investigated how rain water distributes between the exterior and interior sides of the panels, and the wind barrier [9,20,32,33]. The majority of studies only investigated the amount of water that infiltrates the open joints. However, it is concluded that most of the water that infiltrates the open joints flows on the interior side of the panels, approximately 25–35% of the total water applied [9,20,33], and only approximately 0.5–2% flows down the wind barrier [9,20]. Isaksen [33] states that with horizontal open joints, there will always be some water intrusion to the wind barrier; however, the quantity is often too small to measure. It is uncertain how much water will flow down the wind barrier, since the quantities are so small that measurement errors will have a large impact [20]. Water will either hit the wind barrier directly through the joint or due to splashing [9]. In laboratory tests, water intrusion due to direct spray from the nozzles will be greater than for runoff on the façade panels. Additionally, the water will often flow down in smaller streams, both on the façade panels and the wind barrier [9,20].

##### 3.1.2. Joint Width

Joint width can have substantial impact on water intrusion through horizontal open joints. Several studies have used joint widths as a test parameter [20,32–34]. Isaksen [33] concluded that joint widths  $\geq 7$  mm will direct too much water to the wind barrier, even with an air cavity width of 40 mm. Isaksen's later experiments came to the same conclusion, while adding that a 5 mm joint width would be satisfactory [32]. The current Norwegian recommendations are based on this conclusion [17]. A joint width  $\leq 5$  mm increases the risk of static water in the joint, which can lead to algae and microbiological growth. Mo and Lid [20] found in their study that there was a positive correlation between the joint width and water intrusion. In addition, they stated that the panels should be mounted with a 5–10 mm joint width to allow for temperature and moisture movement, based on recommendations from product suppliers.

##### 3.1.3. Joint Profiles

Earlier studies have investigated the effect of joint profiles on water intrusion [20,31,39]. Herbert and Harrison [39] found labyrinth joint profiles to be relatively watertight. The water intrusion in their study was caused by runoff on the exterior side of the panels, being forced through joints by air pressure. However, the studied profiles were quite complex and are not available on the Norwegian market, making the present study unable to replicate the experiment. The Norwegian recommendations advise using joint profiles in open joints to protect the wind barrier from driving rain and UV radiation [17]. Two of the recommended

profiles are the T1-profile and the h-profile, illustrated in Figure 3. Earlier studies indicate that the h-profile is a watertight solution [20]. The degree of watertightness will depend on the design of the h-profile [31]. So-called “hidden profiles” have received the greatest industry attention, since they cannot be seen from the exterior [20]. Examples of these are the T1- and T2-profiles. A study by Mo and Lid [20] found neither of the T-profiles to be watertight, and in some cases, they directed more water to the interior side of the façade panels than when no profile was used. They stated difficulties in tightening the profiles against the panels as a possible explanation for the increased water intrusion.

#### 3.1.4. Joint Design

Studies indicate that non-rectangular joints may reduce water intrusion compared to rectangular joints [20,35]. Mas et al. [35] tested joints with a vertical drainage groove running along the top edge of panels, and joints featuring a quirk edge along the overlying panels. Both designs reduced rainwater intrusion considerably compared to rectangular joints. These results were obtained using panels with a joint depth of 40 mm. Rainwater was drained by the grooves before the water reached the air cavity. However, this drainage design can be difficult to carry out in panels with smaller joint depths and different panel materials. Utilizing quirk-edged joints reduces water intrusion in smaller joints of 4–6 mm. Although no tests were performed on bevelled joint designs, Mas et al. [35] recommended their use. The effectiveness of bevelled joints was confirmed by Mo and Lid [20], where joints bevelled at 45° were proven to be quite watertight.

#### 3.1.5. Air Cavity

The size of the air cavity has varied in different experiments. However, few have discussed its impact on rain intrusion. Experiments by Isaksen [32,33] indicated that an increase in the air cavity width led to an increase in the water amount on the interior side of the façade panels. In addition, for greater joint widths, the air cavity width should be made greater correspondingly [32]. An increase in the air cavity width might decrease the amount of water on the wind barrier [32], but this assumption is not backed by any identified studies.

#### 3.1.6. Joint Depth

Studies have shown a negative correlation between the joint depth and water intrusion [20,32,34,35,39]. In most of these studies, the joint depth was  $\geq 20$  mm [33–35]. Mas et al. [35] state that it is common to increase the joint depth in order to reduce water intrusion. This conclusion is valid for a number of different façade panels. Conversely, Mas et al. claim the influence of joint depth is insignificant for larger joint widths. Admittedly, the panels used in the studies varied in terms of size and texture, which could have an impact on the results. However, all studies concluded that larger joint depths provide better watertightness.

#### 3.1.7. Air Pressure

Air pressure on the exterior side of the joints has been used as a parameter in most of the investigated studies [9,20,32,33,39,40]. The studies are in disagreement about the effect of air pressure on water intrusion. Isaksen conducted three experiments with air pressure that indicate that air pressure had no impact on water intrusion [33]. Several other studies came to the same conclusion using static pressure [9,20]. The test rigs in these studies were built as pressure-equalized rain screens, which implies that the applied pressure should be equalized across the joints. However, for joint widths  $\geq 5$  mm, wind gusts are more critical for water intrusion [32]. Later experiments confirmed these results [9]. A study on water intrusion through joints featuring labyrinth profiles concluded that air pressure, whether dynamic or static, only had an impact after water had infiltrated into the joint profile [39]. The study indicates that an increase in air pressure causes more water intrusion by pressing the water that is lying static in the joint. Earlier studies show the same effect

with larger joint widths [32]. Mo and Lid [20] assessed whether applied pressure had an impact on water intrusion and found no qualitative indication that it did but conducted no quantitative measurements.

### 3.1.8. Applied Water

Recatala et al. [9] studied the correlation between spray rate and water intrusion. The study shows that there is a positive logarithmic correlation between spray rate and water intrusion [9]. This correlation is valid for both the interior side of the panels and the wind barrier. The same study concluded that 49.7% of rain on façade panels would splash off.

## 3.2. Laboratory Results

In total, 72 unique tests of water intrusion were conducted using the test rig. The tests were conducted for the following test parameters: joint widths, joint profiles, and bevelled joint designs. Additionally, two further tests were performed: one with the top joint sealed, and one test where the panels were removed and water was allowed to spray freely to the wind barrier, measuring the maximum amount of water that could theoretically reach behind the panels. In this section, the performance of the protected joints are expressed as percentage change from the measured runoff for 5 and 8 mm open joints, the standard recommendation for the respective panels (given in Table 3).

### 3.2.1. Water Distribution between the Wind Barrier and the Interior Side of the Panels

The results display the water intrusion as measured from the runoff collected at the wind barrier and at the interior side of the panels. There was often too little water on the wind barrier to measure any runoff, for instance with a 3 mm joint width. With joint widths of 5 mm and 8 mm in an open joint, every test yielded measurable runoff. The water distribution can be expressed based on the measured runoff from a 5 and 8 mm joint width for a horizontal open joint. The average water intrusion to the wind barrier and interior side of the panels is 0.5–2% and 19–20%, respectively, of the total water sprayed on the panels (6000 mL/min).

### 3.2.2. Panel Surfaces

In every test, the measured infiltration rates varied substantially between the five different types of panels, with other parameters being equal. On smoother panels (see Table 3), runoff water tended to concentrate in streams that caused substantial water intrusion when intersecting the horizontal joints. Rougher panels dispersed the runoff more evenly across the panel, leaving the joints without areas of water concentration that could cause localized, intense leakage.

All the panels can be considered moderately hydrophilic, as their contact angles were visually assessed to range from approximately 50° to 85°.

### 3.2.3. Joint Widths

For water intrusion to the wind barrier, the same trend is observed for all the panels, as shown in Figure 8. With a 3 mm joint width there was too little water intrusion to create a measurable quantity of runoff. The amount of infiltrated water increased when the joint width was increased from 3 mm to 5 mm, and again up to 8 mm. Glass Fiber Smooth with an 8 mm joint is an outlier, yielding double the water intrusion compared to the other panels. An ejection effect was observed in every measurement with an 8 mm joint width and the Glass Fiber Smooth panels.

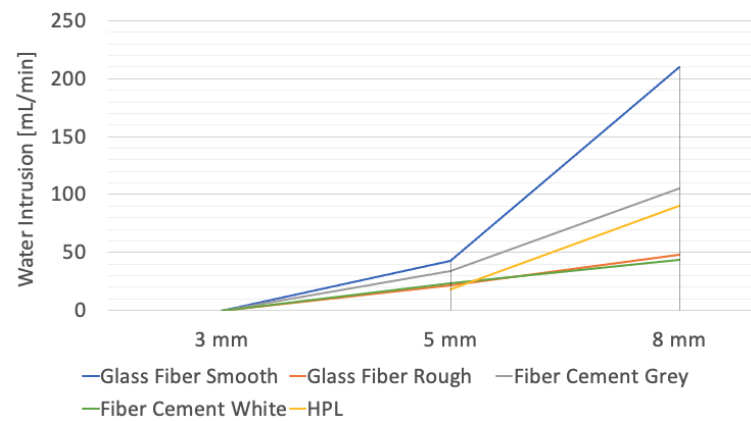

**Figure 8.** Water intrusion to the wind barrier for five different panels with 3, 5, and 8 mm joint widths.

The water intrusion to the interior side of the panels varies greatly, as shown in Figure 9. The same trend is evident for all the panels, except for Glass Fiber Rough, with an increase in water intrusion when joint widths are increased from 3 mm to 5 mm and a smaller decrease from 5 mm to 8 mm. Note that there is no measurement combining the HPL panels with a 3 mm joint width because the recommended joint width for these panels is  $\geq 8$  mm, larger than the others, as shown in Table 3.

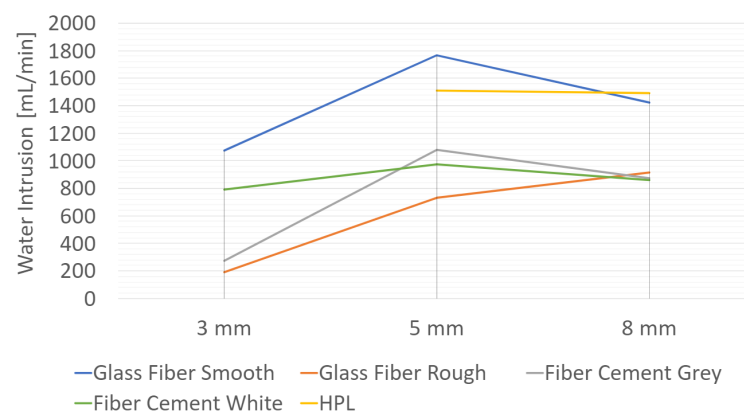
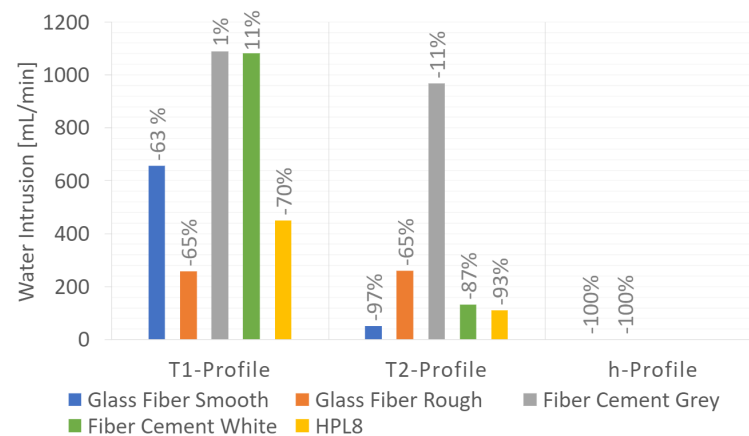

**Figure 9.** Water intrusion to the interior side of the panels for five different panels with 3, 5, and 8 mm joint widths.

As the joint width increases, different water behaviours were observed. For the 3 mm joint, a continuous water bridge was formed along the entirety of the joint, whereas only partial water bridges were observed in the 5 mm joint. Dripping occurred in both the 5 and 8 mm joints. However, for greater joint widths the water droplets were larger and had a higher dripping frequency. The horizontal ejection effect was only observed for the smooth panels and 5 and 8 mm joint widths.

### 3.2.4. Joint Profiles

Figure 10 shows the water intrusion to the interior side of the panels when joint profiles within the joint were used. The amount of water intrusion with both the T1- and T2-profiles varied greatly for the different panels. For the most part, the profiles let in less water than the standard recommended solution did. However, the infiltrated water amounts are still substantial. The h-profile let in the least water with no water intrusion, followed by the T2-profile. All the joint profiles protected the wind barrier from water; hence, no water was measured or observed on the wind barrier in any of the tests.



**Figure 10.** Water intrusion to the interior side of the panels when profiles within the joint were used: T1-, T2-, and h-profiles. The percentage change from the water intrusion measured with the standard recommendations in Table 3 is shown.

Figure 11 shows the water intrusion to the interior side of the panels when joint profiles behind the joint were used. The most effective protected joint solution against water intrusion, in this instance, was an U-batten combined with both a gasket and extra fastening points. An U-batten combined with only a gasket also yielded less water intrusion than the standard recommendations. A U-batten or gasket alone resulted in increased water intrusion, with measurable amounts of water on the wind barrier in some cases. Similarly, a U-batten combined with extra fastening points resulted in increased water intrusion, even compared to a U-batten alone in several cases. Most tests did not yield measurable amounts of water intrusion on the wind barrier. However, water that had infiltrated the joint would hang on the edges of the U-batten and drip, causing substantial splashing to the wind barrier at the bottom of the air cavity. However, the splashing mostly occurred below the gutters that measured the water intrusion to the wind barrier, rendering quantification impossible. In an instance where water was observed dripping from the top U-batten and splashing off the lower U-batten, almost 3.3% of the total water sprayed was measured on the wind barrier.

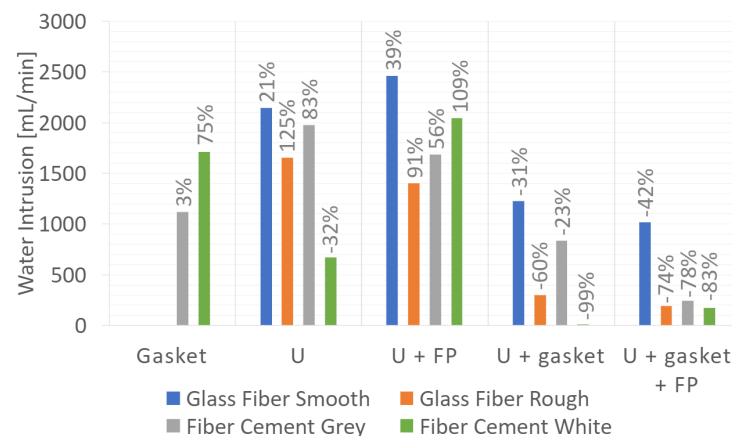
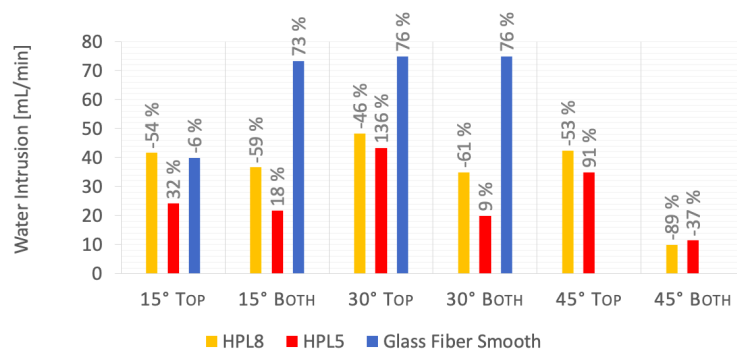

**Figure 11.** Water intrusion to the wind barrier when profiles behind the joint were used. Gasket, U-batten, U-batten + extra fastening points, U-batten + gasket, and U-batten + gasket + extra fastening points. The percentage change from the water intrusion measured with the standard recommendations in Table 3 is shown.

### 3.2.5. Bevelled Joint Designs

Water intrusion to the wind barrier when the joints were bevelled to different angles (see Figure 7) is shown in Figure 12. The peak water intrusion to the wind barrier occurred

mostly with a 30° bevelment. Water intrusion increased on average by 58% from a 15° to a 30° top-bevelled joint and decreased by 1% for a top-and-bottom-bevelled joint. The least water intrusion occurred with a 45° bevelled joint. Water intrusion decreased on average by 30% from a 30° to a 45° top-bevelled joint and decreased on average by 75% from a 30° to 45° top-and-bottom-bevelled joint. Interestingly, with a 5 mm joint width, the HPL panel exhibits a higher rate of water intrusion to the wind barrier for all different types of bevelment, except 45° top-and-bottom. Counter-intuitively, Glass Fiber Smooth exhibits higher rates of leakage to the wind barrier when the top and bottom panel edges are both bevelled than when only the top edge is. The concentration of runoff water into streams on the smooth panel surface may have influenced these measurements. Large variations in the results make it unfeasible to draw any general conclusions from this study alone.



**Figure 12.** Water intrusion to the wind barrier for HPL and Glass Fiber Smooth with different bevelled joint designs. HPL8 has a joint width of 8 mm, while HPL5 has a joint width of 5 mm. Bevelment degrees are 15°, 30°, and 45°. The percentage change from the water intrusion measured with the standard recommendations in Table 3 is shown.

The amount of water intrusion to the interior side of the panels varied for the top-bevelled and top-and-bottom-bevelled joint designs, as shown in Figure 13. A top-and-bottom-bevelled joint exhibited substantially less water intrusion than a top-bevelled joint. For top-bevelled joints, there was little to no correlation between the bevelment angle and water intrusion. Results indicate that top-and-bottom-bevelled joints substantially reduce water intrusion to the wind barrier and that 45° bevelment is more effective than 30°.

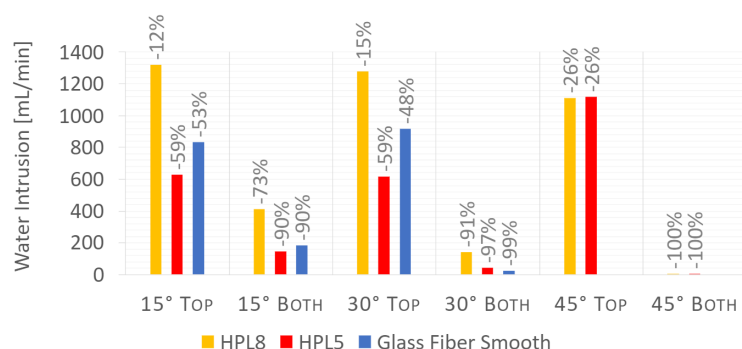

**Figure 13.** Water intrusion to the interior side of the HPL and Glass Fiber Smooth panels with different bevelled joint designs. HPL8 has a joint width of 8 mm, while HPL5 has a joint width of 5 mm. Bevelment degrees are 15°, 30°, and 45°. The percentage change from the water intrusion measured with the standard recommendations in Table 3 is shown.



### 3.2.6. Sealed Top Joint and Water Runoff without Panels

When the top joint was sealed, larger amounts of water entered behind the panels than when both joints were open. Of the total water sprayed on the the panels, an average of 27% infiltrated to the interior side of the panels. Additionally, due to splashing, more water also hit the wind barrier, and an average of 0.4% of the total water sprayed on the panels. One test was conducted with the panels entirely removed from the test rig, leaving only the wind barrier and its collection gutter. Approximately 64% of the water sprayed by the nozzles was collected by the collection apparatus in this test, indicating the theoretical upper bound for the total water intrusion using this equipment.

## 4. Discussion

### 4.1. Water Distribution between the Wind Barrier and the Interior Side of the Panels

The measured water distribution to both the wind barrier and interior side of the panels is very similar to earlier studies [9,20,32,33]. The majority of the infiltrated water is observed and measured on the interior side of the panels. If the infiltrated water is not properly drained out of the air cavity, it can facilitate fungal growth on the battens, eventually leading to rot. Water can be led from the interior side of the panels to the wind barrier along the vertical battens. Additionally, in reality, for taller buildings, more water will infiltrate to the wind barrier via the vertical battens. The majority of water infiltrating to the wind barrier is due to direct spray, however, by sealing the top joint, it was confirmed that water intrusion also occurred due to splashing and the ejection effect. There is some uncertainty relating to the reliability of the water intrusion measurements on the wind barrier. The row of nozzles was moved manually and with a low degree of accuracy ( $\pm 15$  mm). As direct spray from the nozzles is observed to be the main factor for water intrusion to the wind barrier, the exact placement of the nozzles relative to the joint openings has a substantial impact. By moving the row of nozzles slightly, the amount of direct spray on the wind barrier would vary greatly, while only slightly affecting the water intrusion to the interior side of the panels. Another factor that led to larger amounts of water intrusion to the wind barrier was the ejection effect. This was observed to happen sporadically when concentrated streams of water intersected a joint. The effect caused outlier results, as recorded for Glass Fiber Smooth with 8 mm joint width. Due to these inconsistent factors, the measurements of wind barrier runoff are considered more unreliable than water intrusion measurements from the interior side of the panels.

### 4.2. Panels

With regards to the contact angles and water intrusion, no clear trend could be determined. However, all the panels are categorized as hydrophilic. Therefore, the variation in this parameter is not considered great enough to substantially influence the runoff or water intrusion. However, the degree of roughness or smoothness was observed to be paramount to the water intrusion. The smoother panels exhibited more concentrated streams which often led to considerable water intrusion where the stream intersected a joint. The rougher panels had a more dispersed runoff, and the water intrusion distributed more evenly over the joint. In earlier studies, the material of the panels have been mentioned, whereas the surfaces' and their impact on water distribution is not as clear. However, for a façade exposed to actual weather, the rain and wind will differ all the time, and consequently, so will the runoff and distribution of water. The results of this study indicate that panels with a smoother surface are more prone to rain intrusion; there should therefore be stricter recommendations when using smoother panels in regards to the robustness of the back wall and the rain-tightness of the joints.

### 4.3. Joint Widths

Previous studies have all concluded that there is a positive correlation between joint width and water intrusion [20,32–34]. In the present study, this conclusion only holds for water intrusion to the wind barrier. Water intrusion to the interior side of the panels

diverges from this conclusion. On average, peak water intrusion to the interior side of the panels occurred with a 5 mm joint width. From previous research, this is the recommended joint width [20,32,33]. Based on the results of the present study, this should not be the recommended joint width, and a joint width of 3 mm seems to be the most desirable as it directs the least amount of water to both the wind barrier and the interior side of the panels. Previous studies have not recommended a 3 mm joint because microbial growth and algae is considered a risk due to static water remaining in the joint [20,32,33]. However, static water was not observed to be an issue in the present study. As soon as the nozzles were turned off, the water would drain from the joints. In addition, water bridges appear to direct the water runoff across the joints and thus prevent water intrusion. The conclusion is therefore that a 3 mm joint is the most watertight, but in reality, water may still be directed to both the wind barrier and the interior side of the panels due to wind. However, not all panels can be mounted with small joint widths, since the joint must allow for temperature and moisture expansion. On average, the water intrusion to the interior side of the panels are less for an 8 mm joint width than a 5 mm. However, the opposite is the case for water intrusion to the wind barrier, which could put a greater strain on the wind barrier.

#### 4.4. Joint Profiles

In general, joint profiles are solutions that decrease water intrusion compared to an open joint. The h-profile is found to be completely watertight, in agreement with a previous study examining the same profile [20]. Contrary to previous results [20], the T-profiles do not (on average) direct more water behind the cladding than the standard recommendations. Additionally, they completely prevent water from entering to the wind barrier. The discrepancy between the present study and earlier studies is likely caused by differences in the placements of the profiles within the joints. In Mo and Lid's [20] study, the profiles were centered in the joints, as illustrated in Figure 14. In the present study, the profiles were pressed down towards the underlying panel as much as possible, as illustrated in Figure 15. The profiles being pressed downward likely caused less water to enter underneath the protruding part, and the water was more easily led across the joints, thereby ensuring a more watertight solution. The T-profiles' watertightness seems to be sensitive to how they are mounted and to the top edge of the panels being even. Minor unevenness may lead to capillary suction, which could cause increased water intrusion. The results indicate that it is difficult to ensure complete watertightness, especially with the T1-profile. The T1-profile's protruding part can not be completely pressed down to the underlying panel due to its design. Moreover, observations indicate that the majority of water intrusion occurs between the profile and the underlying panel. As a result, profiles should be designed in a way that hinders water from entering underneath them. An idea that needs further investigation is to use a small rubber gasket underneath the protruding part of the T-profiles to make it less sensitive to mounting and more watertight.

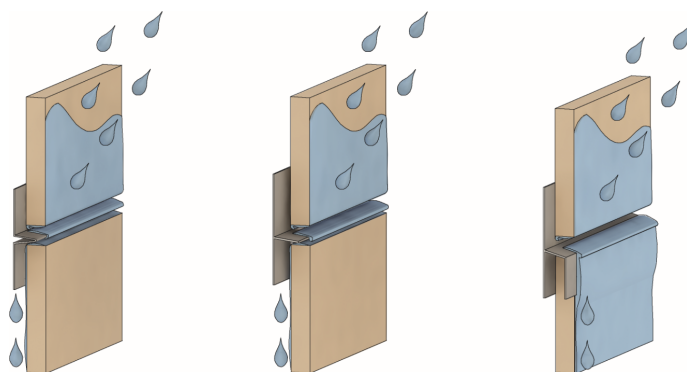

**Figure 14.** Assumed water intrusion when profiles centered in the joint.

The U-batten reduced water intrusion considerably when combined with a gasket, even more so when this was combined with extra fastening points securing the batten to

the panel. Other combinations, surprisingly, directed more water to the interior than an open joint. A reason for this could be capillary suction due to small gaps between the panels and gaskets or battens. Due to the stiffness of both the panels and the U-batten, the extra fastening points could have increased the gaps between the panels and battens. Additionally, the U-batten causes a risk of water intrusion to the wind barrier. When water drips from the U-batten (which protrudes from the air cavity), the droplets impact the underlying U-batten and subsequently splash to the wind barrier. In instances where this happened, a large amount of water was observed on the wind barrier. Dripping from the lower U-batten fell below the gutter on the wind barrier, and this effect could therefore not be quantified. Although some of the solutions were efficient protective measures, the risk of large water amounts on the wind barrier may be unacceptably high. The results indicate that protruding parts in the air cavity, for instance, horizontal battens, creates an extra risk for water intrusion to the wind barrier if there is water intrusion to the interior side of the panels. Additionally, the U-battens are not supposed to be mounted with vertical battens, as conducted in the present study. Therefore it is likely that the water intrusion to the wind barrier in reality is higher than in the laboratory experiments, since the U-batten and the wind barrier would be in direct contact.

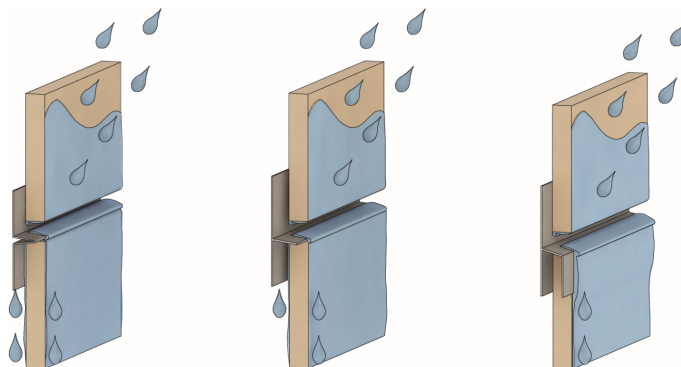

**Figure 15.** Water intrusion when the profiles are pressed downward in the joint.

#### 4.5. Bevelled Joint Designs

The tests of different bevelled joint designs yielded similar results to previous experiments: a non-rectangular joint design is better than a rectangular joint [20,35]. A bevelled joint reduces water intrusion through the joint and also leads infiltrated water out of the façade. The results with a top-and-bottom-bevelled joint indicate a positive correlation between the angle of bevelment and reduction in water intrusion to both the interior side of the panels and the wind barrier. With a top-bevelled joint, the increase in angles led to less consistent trend in regards to water intrusion. Angles  $\geq 45^\circ$  were not tested, but it is assumed that the positive correlation will uphold for larger angles. However, the handling of the panels could be difficult with larger bevelled angles, and the panels would be more vulnerable to damage. Top-and-bottom-bevelled joints are found to be considerably more watertight than top-bevelled joints. A notable improvement is the reduction in water intrusion due to splashing, since the water is led out of the joint by gravity.

#### 4.6. Sealed Top Joints and Water Runoff without Panels

By sealing the top joint, water could only infiltrate the cladding through the lower joint. As the water intrusion was substantial, it proves that direct spray is not the only reason for water intrusion. The increase in water intrusion, when compared to open joints, could be due to an increased velocity in water flow. This indicates that panels with larger heights could cause an increase in water intrusion, and thereby, more open joints are actually preferable to less. This, however, needs further investigation. Additionally, direct spray is not the only cause of water intrusion to the wind barrier since water infiltrated due to splashing in the joints.

The amount of water measured without any panels coincides with previous results. In the present study, less water splashed off compared to earlier studies; however, there is still a substantial amount that splashes off. Consequently, the water intrusion, when compared to the theoretically maximum intrusion, would be substantially greater than when compared with the total applied water.

#### 4.7. Other Parameters

Previous studies have mentioned certain parameters that may affect water intrusion but which have not been investigated in the present study. These include: air cavity depth, joint depth, air pressure, and spray rate.

The air cavity depth is not varied in these tests because the width is determined by the dimensions of the battens. Standard dimensions are used throughout the industry, and in practice, cavities thus tend to always conform to approximately the same size. The cavity width was increased slightly by the U-battens, but this was not considered to affect the water intrusion.

The joint depth investigation was limited by the available panels which had thicknesses of 6 and 8 mm. Additionally, the effect of joint depth has been thoroughly tested by previous studies and is therefore not as interesting [20,32,34,35,39].

Air pressure was not applied as a driving force due to the test rig being a pressure-equalized façade, and therefore, pressure differences should not occur. Additionally, the effect of air pressure is not clear from previous studies [9,20,32,33,39,40]. The previous tests by Mo and Lid [20] observed no effect of applied air pressure.

Recatala et al. [9] stated that there is a positive correlation between the spray rate and infiltrated water. The present study did not vary the spray rate but tested water intrusion with a sealed top joint to increase the amount of water impinging on the bottom joint. The observations are in accordance with those of Recatala et al.

## 5. Conclusions

The present study carried out an experimental investigation of water intrusion through horizontal joints in façade panel systems. The effectiveness of different joint solutions was tested. Out of a total of 6000 mL/min sprayed on the test sections, the water intrusion to the wind barrier and interior side of the panels with a 5–8 mm joint width is 0.5–2% and 19–20%, respectively. Panels with surface characteristics that ensure a dispersed water runoff, in general, exhibit less water intrusion through the joints than smooth panels where concentrated streams occur. Out of the three tested joint widths, a 3 mm joint width yields the least amount of water to both the wind barrier and the interior side of the panels. However, due to uncertainties related to whether a 3 mm joint width can be used due to expansions of the panels, it is not an unconditionally recommended solution. Contrary to both Norwegian recommendations and previous studies, a 5 mm joint is found to lead in the most water to the interior side of the panels. The only tested joint solution that yielded no water intrusion is the h-profile, which is therefore suggested to be the optimal solution. The T2-profile yielded less water intrusion than the T1-profile, but the performance of T-profiles is highly dependent on their mounting and placement within the joints. U-battens as a protection measure are not recommended due to the high risk of water intrusion to the wind barrier caused by splashing droplets. Gaskets as a protection measure cause increased water intrusion compared to solutions without a gasket. Bevelled joints are a recommendable solution if profiles cannot be used. The larger the angle, the more watertight the joint, but fragility may become a practical challenge. A top-and-bottom-bevelled joint was found to be the most watertight joint solution, second only to the h-profile. In practical terms, the results of the research indicate that recommendations should be changed to recommend using joint profiles, instead of using open joints as the base case. If no joint profiles can be used, panels with a rough surface should be selected as they yield less water intrusion than smooth panels. Gaskets should be discouraged unless accompanied by a joint profile. Beveled panel joints are found to be advantageous,

but beveling panels on-site may be costly and carry the risk of breakage. Future work on the subject should aim to investigate a broader selection of panel types and quantitatively determine the impact of surface characteristics on water intrusion and runoff. The present research has shown that surface characteristics are a very important parameter that should be subject to more thorough investigation.

**Author Contributions:** Conceptualization, S.G. and T.K.; methodology, E.A.S., M.H.S., S.G. and T.K.; validation, T.K.; formal analysis, E.A.S. and M.H.S.; investigation, E.A.S. and M.H.S.; resources, T.K.; data curation, E.A.S. and M.H.S.; writing—original draft preparation, E.A.S. and M.H.S.; writing—review and editing, E.A.S., M.H.S. and E.A.; visualization, E.A.S. and M.H.S.; supervision, E.A. and T.K.; project administration, T.K.; funding acquisition, T.K. All authors have read and agreed to the published version of the manuscript.

**Funding:** This study was funded by the Research Council of Norway (Grant No 237859) and several partners through the Centre for Research-based Innovation “Klima 2050”.

**Data Availability Statement:** Not applicable.

**Acknowledgments:** The authors would like to extend special thanks to CAD operator Remy Eik for assisting with illustrations and to Egil Rognvik, Stig Roar Rudolfsen, Øystein Holmberget and Ole Aunrønning for support with the laboratory work. Additionally, a thank you is extended to professor Claire Armstrong at UiT for extensive proofreading.

**Conflicts of Interest:** The authors declare no conflict of interest. The funders had no role in the design of the study; in the collection, analyses, or interpretation of data; in the writing of the manuscript, or in the decision to publish the results.

## References

1. Edvardsen, I.E.; Ramstad, K.I. *Trehus*, 4th ed.; SINTEF Akademiske Forlag: Oslo, Norway, 2018; ISBN 978-82-536-0919.
2. Lisø, K.R. Building Envelope Performance Assessments in Harsh Climates: Methods for Geographically Dependent Design. Ph.D. Thesis, Norwegian University of Science and Technology, Trondheim, Norway, 2006; p. 185.
3. Pachauri, R.K.; Mayer, L. *Climate Change 2014: Synthesis Report. Contribution of Working Groups I, II and III to the Fifth Assessment Report of the Intergovernmental Panel on Climate Change*; Intergovernmental Panel on Climate Change: Geneva, Switzerland, 2015; ISBN 978-92-9169-143-2.
4. IPCC. *Climate Change 2021: The Physical Science Basis. Contribution of Working Group I to the Sixth Assessment Report of the Intergovernmental Panel on Climate Change*; Masson-Delmotte, V., Zhai, P., Pirani, A., Connors, S.L., Péan, C., Berger, S., Caud, N., Chen, Y., Goldfarb, L., Gomis, M.I., et al., Eds.; Cambridge University Press: Cambridge, UK; New York, NY, USA, 2021. [[CrossRef](#)]
5. Hanssen-Bauer, I.; Drange, H.; Førland, E.J.; Roald, L.A.; Børsheim, K.Y.; Hisdal, H.; Lawrence, D.; Nesje, A.; Sandven, S.; Sorteberg, A. *Klima i Norge 2100—Kunnskapsgrunnlag for Klimatilpasning Oppdatert i 2015*; Norwegian Environmental Agency/Norwegian Climate Service Center: Oslo, Norway, 2015.
6. Grynning, S.; Gradeci, K.; Gaarder, J.E.; Time, B.; Lohne, J.; Kvande, T. Climate Adaptation in Maintenance Operation and Management of Buildings. *Buildings* **2020**, *10*, 107. [[CrossRef](#)]
7. Flæte, O.; Bardalen, A.; Gjørsum, I.; Nyeggen, E.; Petkovic, G.; Aanestad, J. *Adapting to a Changing Climate—Norway’s Vulnerability and the Need to Adapt to the Impacts of Climate Change*; Official Norwegian Reports NOU 2010:10; Norwegian Ministry of the Environment: Oslo, Norway, 2010. (In Norwegian)
8. Lisø, K.R.; Kvande, T.; Time, B. Climate Adaptation Framework for Moisture-Resilient Buildings in Norway. *Energy Procedia* **2017**, *132*, 628–633. [[CrossRef](#)]
9. Recatala, M.A.; Morales, S.G.; Van Den Bossche, N. Experimental Assessment of Rainwater Management of a Ventilated Façade. *J. Build. Phys.* **2018**, *42*, 38–67. [[CrossRef](#)]
10. Recatala, M.A.; Morales, S.; Van den Bossche, N. Rain infiltration mechanisms in ventilated façades: Literature review, case studies, understanding common practice flaws. In Proceedings of the 1st International Symposium on Building Pathology (ISBP 2015), Porto, Portugal, 24–27 March 2015; p. 659.
11. Bøhlerengen, T.; Rolstad, A.N.; Gustavsen, A.; Einstabland, H.; Meløysund, V. Tightening Against Rain and Wind for Façades—Experience from Practice. In Proceedings of the 7th Symposium on Building Physics in the Nordic Countries, Reykjavik, Iceland, 13–15 June 2008.
12. Geving, S. Kledningsplater til besvær. *Byggfakta* **2022**, *2*, 52–54.
13. Ulvnes, K.; Cadamarteri, F. Må Fjerne Opptil 50 Plater Etter Funn av Råte. *adressa.no* 2020. Available online: <https://www.adressa.no/nyheter/i/28dr1r/ma-fjerne-opptil-50-plater-etter-funn-av-rate> (accessed on 27 May 2022).



14. Ingebretsen, S.B.; Andenæs, E.; Kvande, T. Microclimate of Air Cavities in Ventilated Roof and Façade Systems in Nordic Climates. *Buildings* **2022**, *12*, 683. [[CrossRef](#)]
15. Kvande, T. *Totrinnetning mot Slagregn på Fasader. Luftede Kledninger og Fuger*; Byggeforskserien 542.003; SINTEF Community: Trondheim, Norway, 2013.
16. Geving, S. *Praktisk Bygningsfysikk*, 1st ed.; Fagbokforlaget: Bergen, Norway, 2021; ISBN 978-82-450-2801-0.
17. Gaarder, J.E. *Utvendig Kledning Med Plane Plater*; Byggeforskserien 542.502; SINTEF Community: Trondheim, Norway, 2019.
18. Gaarder, J.E. *Fasadekledning av Metall*; Byggeforskserien 542.201; SINTEF Community: Trondheim, Norway, 2019.
19. Bunkholt, N.S.; Time, B.; Kvande, T. *Luftede Kledninger. Anbefalinger for Klimatilpasning*; SINTEF Community: Trondheim, Norway, 2021.
20. Mo, B.H.; Lid, H.S. Slagregninntrenging i Horisontale Fuger på Fasader Med Plane Plater. Master's Thesis, Norwegian University of Science and Technology, Trondheim, Norway, 2020.
21. Blocken, B.; Derome, D.; Carmeliet, J. Rainwater runoff from building facades: A review. *Build. Environ.* **2013**, *60*, 339–361. [[CrossRef](#)]
22. Blocken, B.; Carmeliet, J. On the accuracy of wind-driven rain measurements on buildings. *Build. Environ.* **2006**, *41*, 1798–1810. [[CrossRef](#)]
23. Abuku, M.; Janssen, H.; Poesen, J.; Roels, S. Impact, absorption and evaporation of raindrops on building facades. *Build. Environ.* **2009**, *44*, 113–124. [[CrossRef](#)]
24. Park, C.; Park, J.; Kim, N.; Kim, Y. Modeling Water Flow on Façade. *Autom. Constr.* **2018**, *93*, 265–279. j.autcon.2018.05.021. [[CrossRef](#)]
25. Bielek, M. The main principles of water movement on the wall surfaces of building of various roughnesses. In Proceedings of the RILEM/ASTM/CIB Symposium on Evaluation of the Performance of External Vertical Surfaces of Buildings, Espoo, Finland, 28 August–2 September 1977; Volume 1, pp. 77–96.
26. Robinson, G.; Baker, M.C. *Wind-Driven Rain and Buildings*; Technical Paper No. 445; Division of Building Research, National Research Council; Ottawa, ON, Canada, 1975.
27. Birkeland. *General Report on Rain Penetration*; Norwegian Building Research Institute: Oslo, Norway, 1966; p. 14.
28. Van den Bossche, N. Watertightness of Building Components: Principles, Testing and Design Guidelines. Ph.D. Thesis, University of Gent, Gent, Belgium, 2013.
29. Garden, G.K. Rain Penetration and its Control. In *Canadian Building Digest*; Division of Building Research, National Research Council of Canada: Ottawa, ON, Canada, 1963; pp. 401–404. [[CrossRef](#)]
30. Chew, M.Y.L. A modified on-site water chamber tester for masonry walls. *Constr. Build. Mater.* **2001**, *15*, 329–337. [[CrossRef](#)]
31. Bassett, M.; Overton, G. Measuring the Weathertight Performance of Flashings. *Buildings* **2015**, *5*, 130–148. buildings5010130. [[CrossRef](#)]
32. Isaksen, T. *Åpne Fuger i Utvendige Kledninger?*; Norges Byggeforskningsinstitutt: Oslo, Norway, 1966.
33. Isaksen, T. *Fugeutforming og Slagregn-Gjennomgang*; Norges Byggeforskningsinstitutt: Oslo, Norway, 1964.
34. Dordá, P.H.; Pitarch, A.M.R.; Escrig, A.C.; Gurrea, L.M. *Water Penetration into Ventilated Façade Joints*; Universitat Jaume I: Castellón, Spain, 2010.
35. Mas, Á.; Gutiérrez, J.; Gil, E.; Gil, A.; Galvañ, V. Design and construction recommendations to improve impermeability in rain-screen walls built with natural stone coverings. *Constr. Build. Mater.* **2011**, *25*, 1753–1761. j.conbuildmat.2010.11.091. [[CrossRef](#)]
36. Blocken, B.; Carmeliet, J. A simplified numerical model for rainwater runoff on building facades: Possibilities and limitations. *Build. Environ.* **2012**, *53*, 59–73. [[CrossRef](#)]
37. Blocken, B.; Carmeliet, J. A review of wind-driven rain research in building science. *J. Wind Eng. Ind. Aerodyn.* **2004**, *92*, 1079–1130. [[CrossRef](#)]
38. Bishop, D.; Webster, C.J.D.; Herbert, M.R.M. The Performance of Drained Joints. In Proceedings of the International Symposium on Weathertight Joints for Walls, Oslo, Norway, 25 September 1967; pp. 349–354.
39. Herbert, M.R.M.; Harrison, H.W. *New Ways with Weatherproof Joints*; Building Research Establishment: Watford, UK, 1974.
40. Fernández, M.J. Study of influence of wind pressure and rain conditions in rain screen walls. *Struct. Surv.* **2010**, *28*, 46–52. [[CrossRef](#)]
41. Stagrum, A.E.; Andenæs, E.; Kvande, T.; Lohne, J. Climate Change Adaptation Measures for Buildings—A Scoping Review. *Sustainability* **2020**, *12*, 1721. [[CrossRef](#)]
42. Arksey, H.; O'Malley, L. Scoping studies: Towards a methodological framework. *Int. J. Soc. Res. Methodol.* **2005**, *8*, 19–32. [[CrossRef](#)]
43. Wohlin, C. Guidelines for Snowballing in Systematic Literature Studies and a Replication in Software Engineering. In Proceedings of the 18th International Conference on Evaluation and Assessment in Software Engineering—EASE'14, London, UK, 13–14 May 2014; ACM Press: London, UK, 2014; pp. 1–10.
44. *NS-EN 1027:2016*; Windows and Doors—Water Tightness—Test Method. Standards Norway: Oslo, Norway, 2016.
45. Van Linden, S.; Van Den Bossche, N. Review of Rainwater Infiltration Rates in Wall Assemblies. *Build. Environ.* **2022**, *219*, 109213. [[CrossRef](#)]