

Paloma Romero Hernández

# Design and evaluation of a method to produce hydrogen via water electrolysis at large scale

Master's thesis in Hydrogen technology

Supervisor: Lars Olof Nord, EPT

Co-supervisor: Rubén Mocholí Montañés, SINTEF Energy Research

June 2022



Paloma Romero Hernández

# **Design and evaluation of a method to produce hydrogen via water electrolysis at large scale**

Master's thesis in Hydrogen technology

Supervisor: Lars Olof Nord, EPT

Co-supervisor: Rubén Mocholí Montañés, SINTEF Energy Research

June 2022

Norwegian University of Science and Technology

Faculty of Engineering

Department of Energy and Process Engineering



Norwegian University of  
Science and Technology



# Abstract

Hydrogen has unique properties that can transform our fossil-fuel dependent economy into an hydrogen one. This element is the lightest and most abundant in the universe and its many industrial applications make it be a promising alternative to build clean path-ways. Nowadays, it can be produced from several sources such as steam reforming of natural gas, which is a widely used hydrogen production technology, but environmentally friendly production is a pressing issue. Therefore, it is important to switch to cleaner, more sustainable primary energy sources such as water electrolysis. Furthermore, clean hydrogen is currently in unprecedented political and commercial momentum, with policies and projects growing rapidly worldwide. However, due to the low density of hydrogen, its storage and transport are subjects of intense research.

The sustainability of hydrogen production technology lies in the way it is produced, so this work is focused on comparing two different approaches of producing hydrogen through seawater electrolysis at large scale. The aim is to provide 50 MW of energy to a refinery, using 5 electrolyzers of 10 MW each one. Nowadays, each electrolyser's stack has its own balance of plant, so the first approach consists on simulating 5 electrolyzers with 5 different equipment of each type. However, it is believed that a shared balance of plant can lead to lower costs with a better or similar efficiency, so the second approach is focused on simulating a model with 5 electrolyzers as well, but sharing the rest of the equipment needed. Both models have been simulated using Aspen HYSYS. To compare the results, different scenarios are being considered using costs' correlations and the Aspen Capital Cost Estimated tool of AspenTech. For this tool, three scenarios are analysed: compression at different pressures without considering the storage, compression at different pressures considering one-day of storage, and compression at different pressures considering the necessary storage to provide three different periods of autonomy to the refinery (5, 10 and 15 days). The pressure of compression range considered varies between 350 and 800 bar.

At large, results show that the common balance of plant reduces the total final costs, specially when the pressure of compression is low. Considering different pressures of compression shows that the price is lower when the pressure is low because less energy input is needed to compress the stream. However, due to the low density of hydrogen, compressing up to the lowest value of the pressure's range means that a smaller amount of hydrogen can be stored. The second scenario of considering the storage corroborates that the higher the pressure of compression is, the higher the amount of hydrogen is. Nevertheless, when increasing this pressure the thickness of the walls of the tanks also increases since more material is needed, which causes higher costs. Finally, the last scenario shows a very hypothetical case in which the final cost increases considerably when larger periods are considered. There is a clear uptrend when increasing the days of autonomy depending on the number of tanks needed, which is different in each case, and on the capacities and prices of these tanks depending on the pressure considered. The results will vary depending on the project and on the boundary conditions that are considered, so it is up to each one the decision of compressing up to a certain pressure and for how long storing the product according to the necessities. However, for this case study in particular, a shared balance of plant will provide better profits.

# Acknowledgements

I have been very involved in order to write a good thesis to finish my master's studies, but I do know that nothing of this project could have been done without the support of my people.

Firstly, I would like to begin by thanking my supervisor, Professor Lars O. Nord, for having welcomed me with open arms and having offered me a topic to work in his department. Not everybody is willing to accept an exchange student, and you have given me the opportunity to go deeper into an important issue in the context of energy transition. I am extremely grateful for your effort and the time you have dedicated to me.

Thanks should also go to my co-supervisor Rubén Mocholí Montañés for his help since the very first day. You have been the one who have guided me in the right path, I truly know that I could not have done almost nothing without our weekly meetings. It is popularly said that there is nobody who is going to read your thesis more than yourself, but I would say you are the next one in the list of reading mine and I could not be happier. Thank you so much for all your feedback and for sharing your knowledge with me. Finally, I do not want to pass up the opportunity to express my deep gratitude to your advice, not only in aspects related to my thesis but also in those regarding my near professional future as engineer.

I would also like to extend my sincere thanks to my parents, who have cheering me up when I was not capable of seeing clarity along my way. Thank you for giving me the chance to experience the student life abroad not only once, but twice, and thank you for your unconditional support, even stronger in the distance. Many thanks also to my sisters, for being a model to emulate and for showing me that family will always be there, no matter what and no matter where. Lastly, to my grandparents, for being proud of me in every single step and for helping me grow as a person.

I would be remiss in not mentioning my lifelong friends and the friends I have made throughout my stay in Trondheim. To my crew from Jesús-María, specially Carmen, for demonstrating me that real friendship need little to endure over time. To my engineers from UPCT, particularly María Dolores, Marta and Juan Miguel, we have grown together and I do know that we will continue doing it as a team. And last but not least, to María, Irene, Javi and Víctor, you have been my discoveries of this Nordic Erasmus. Thank you very much for making this experience better in all aspects, and for making me realised that people like you are the ones I want in my life. I feel very lucky to count on your friendship.

To all of you for believing in me even when I did not, I am forever in your debt.

# Contents

<b>List of Figures</b>	<b>5</b>
<b>1 Introduction</b>	<b>8</b>
1.1 Project background . . . . .	8
1.2 Motivation . . . . .	8
1.3 Objectives of the project and research question . . . . .	10
1.4 Risk Assessment . . . . .	10
1.5 Organization . . . . .	10
1.6 Limitations . . . . .	10
<b>2 The Hydrogen</b>	<b>12</b>
2.1 The Hydrogen Economy . . . . .	12
2.2 Hydrogen: characteristics and applications . . . . .	13
2.2.1 Repsol refinery . . . . .	15
2.3 Ways to produce hydrogen via water electrolysis . . . . .	17
2.3.1 Alkaline electrolyzers (AEL) . . . . .	19
2.3.2 Polymer electrolyte membrane electrolyzers (PEM) . . . . .	20
2.3.3 Solid oxide electrolyzers (SOEC) . . . . .	21
2.3.4 Anion exchange membrane electrolyzers (AEM) . . . . .	23
<b>3 Methodology</b>	<b>26</b>
3.1 Case study: Repsol refinery in Cartagena, Spain . . . . .	26
3.1.1 Description of the plant . . . . .	26
3.1.2 Two different approaches for the plant design . . . . .	26
3.1.3 Key performance indicators . . . . .	27
3.2 Plant model development . . . . .	30
3.2.1 Water treatment system . . . . .	30
3.2.2 Polymer electrolyte membrane (PEM) electrolyser . . . . .	34
3.2.3 Compression system . . . . .	35
3.3 Cost methods . . . . .	38
3.3.1 Cost analysis via correlations . . . . .	38
3.3.2 Aspen Process Economic Analyzer (CAPEX and OPEX) . . . . .	39
3.4 Sensitivity analysis . . . . .	40
3.4.1 Hydrogen compression system . . . . .	40
3.4.2 Hydrogen storage system . . . . .	41
<b>4 Costs analysis</b>	<b>46</b>
4.1 Correlations . . . . .	46
4.1.1 Capital investment for the water treatment system . . . . .	46
4.1.2 Capital investment for the compressors . . . . .	47
4.1.3 Capital investment for the heat exchangers . . . . .	47
4.1.4 Capital investment for the air coolers . . . . .	48
4.1.5 Analysis of the operating expenses . . . . .	49
4.2 Aspen Process Economic Analyzer . . . . .	49

<b>5</b>	<b>Results and discussions</b>	<b>51</b>
5.1	Validation of the model . . . . .	51
5.1.1	Validation challenges . . . . .	51
5.1.2	Conclusions for the validation of the model . . . . .	52
5.2	Results of the correlations . . . . .	53
5.3	Results of Aspen HYSYS . . . . .	57
5.3.1	Analysis without considering the storage at different pressures . . . . .	57
5.3.2	Analysis considering one day of storage at different pressures . . . . .	62
5.3.3	Analysis considering storage to provide different days of autonomy . . . . .	65
<b>6</b>	<b>Conclusions</b>	<b>67</b>
6.1	Modular vs common BoP conclusions . . . . .	67
6.2	Evaluation of objectives . . . . .	68
6.3	Further work . . . . .	69
	<b>Appendices</b>	<b>70</b>
<b>A</b>	<b>Demonstration of the condition for minimum work-done by a two-stage compressor</b>	<b>71</b>
<b>B</b>	<b>Price breakdown of the equipment to provide autonomy to the refinery</b>	<b>72</b>
	<b>Bibliography</b>	<b>75</b>



# List of Figures

2.1	Hydrogen production processes. Own figure based on Figure 1 from [7]	13
2.2	Sketch of the applications of hydrogen produced via electrolyzers. Own figure based on [9]	14
2.3	Main products generated in Repsol refinery [11]	15
2.4	Applications of hydrogen in refinery processes [12]	16
2.5	Industrial complexes of Repsol [11]	16
2.6	Simple sketch of the production of hydrogen that is being studied in this thesis	17
2.7	Electrochemical cell sketch of a water electrolysis unit [16]	18
2.8	Classification of possible metals for the electrodes according to its reactivity level [17]	18
2.9	Alkaline electrolysis process sketch [18]	19
2.10	Generic BoP for an alkaline electrolysis process [18]	20
2.11	Proton exchange membrane electrolysis process sketch [18]	20
2.12	Generic BoP of a PEM electrolysis process [18]	21
2.13	Solid oxide electrolysis process sketch [18]	22
2.14	Generic BoP of SOEC process [18]	23
2.15	Anion exchange electrolysis process sketch [18]	23
2.16	Generic BoP of AEM process [18]	24
2.17	Comparison among the three main electrolyzers [25]	24
3.1	Modular BoP flowsheet	27
3.2	Common BoP flowsheet	27
3.3	Scope of the techno-economic analysis. Proprietary development based on [27]	28
3.4	Levelized cost of hydrogen for grid connected electrolysis according the Fuel Cells and Hydrogen Observatory [28]	28
3.5	CO <sub>2</sub> equivalent emission factor and greenhouse gas emission factor regarding non-renewable generation ( $tCO_{2eq} - tCO_{2eq}/MWh$ ) [30]	30
3.6	Water desalination processes classification [32]	31
3.7	Multi-effect distillation plant [38]	33
3.8	Multi-stage flash distillation plant [38]	33
3.9	Flow-sheet of the simulation of the PEM electrolyser system in Aspen HYSYS	34
3.10	Cell specific parameters in the PEM HYSYS model [40]	34
3.11	Flow-sheet of the simulation of the compression system in Aspen HYSYS	35
3.12	Energy density comparison among some fuels [44]	36
3.13	P-V diagram for compression processes	36
3.14	P-V and T-S diagram for a two-stage steady-flow compression process	37
3.15	Cost estimates classification matrix for process industries [51]	39
3.16	Storing hydrogen tank sketch (left) and compressed gas vessel structure (right)	41
3.17	Comparison among the main hydrogen storage technologies [47]	42
4.1	Centrifugal compressor cost against power for different models [52]	47
4.2	Shell-and-tube heat exchanger cost against the area 1	48
4.3	Shell-and-tube heat exchanger cost against the area 2	48
4.4	Air cooler cost against area 1	48
4.5	Air cooler cost against area 2	48
5.1	Comparison of the prices involved in a modular BoP versus in a common BoP	53

5.2	Case 1. Cost of the compressors depending on the configuration at 350 bar . . . . .	55
5.3	Case 2. Cost of the compressors depending on the configuration at 350 bar . . . . .	55
5.4	Case 3. Cost of the compressors depending on the configuration at 350 bar . . . . .	55
5.5	Case 4. Cost of the compressors depending on the configuration at 350 bar . . . . .	55
5.6	Efficiency in terms of energy needed at 350 bar in the four different scenarios . . . . .	56
5.7	Comparison of the price between modular and common BoP for a final compression of 350 bar . . . . .	57
5.8	Comparison of the price between modular and common BoP for the four different scenarios	58
5.9	Total costs of the compression of 350 bar as a function of percentages . . . . .	58
5.10	Comparison of the compressors' prices at 350 bar between modular and common BoP . .	58
5.11	Compressors price at different levels of final pressure in the modular BoP . . . . .	59
5.12	Compressors price at different levels of final pressure in the common BoP . . . . .	59
5.13	LCOH depending on the connection to the grid and the configuration of the plant . . . .	60
5.14	CO <sub>2</sub> intensity of H <sub>2</sub> depending on the connection to the grid at 350 bar . . . . .	61
5.15	Comparison among the prices of storing hydrogen depending on the configuration and the pressure . . . . .	64
5.16	Comparison of the storing price between modular and common BoP . . . . .	64
5.17	Comparison of the total price of storing hydrogen between modular and common BoP . .	65
5.18	Comparison of the final price to provide different days of autonomy to the refinery . . . .	66
5.19	Comparison of the levelized cost of hydrogen depending on the configuration of the plant and on the days of autonomy . . . . .	66

# Nomenclature

## Abbreviations

<i>ACCE</i>	Aspen capital cost estimation
<i>AEL</i>	Alkaline electrolyser
<i>AEM</i>	Anion exchange membrane
<i>BoP</i>	Balance of plant
<i>BWRO</i>	Brackish water reverse osmosis
<i>C1</i>	Compressor one
<i>C2</i>	Compressor two
<i>C3</i>	Compressor three
<i>CAPEX</i>	Capital expenditures
<i>ED</i>	Electro dialysis
<i>KPIs</i>	Key performance indicators
<i>MD</i>	Membrane distillation
<i>MEB</i>	Multiple-effect boiling
<i>MED</i>	Multi-effect distillation
<i>MSF</i>	Multi-stage flash
<i>MSLV</i>	Multi-functional stationary layered vessel
<i>NRTL</i>	Non-random two liquids
<i>OPEX</i>	Operating expenditures
<i>PEM</i>	Polymer electrolyte membrane
<i>RO</i>	Reverse osmosis
<i>SOEC</i>	Solid oxide electrolyser cell
<i>SOEL</i>	Solid oxide electrolyser
<i>SWRO</i>	Seawater reverse osmosis
<i>VC</i>	Vapour compression

## Parameters

<i>r</i>	Rate of return (%)
<i>t</i>	Time (years)

# Chapter 1

## Introduction

### 1.1 Project background

Since the Kyoto Protocol (2005) and the Paris Agreement (2015) came into force, lot of policies and strategies have been established to fight against climate change and to preserve the environment. By the end of 2019, the European Commission presented the European Green Deal and the Europe's green energy transition (European Commission 2020e) to become a modern economy, efficient in the use of the resources and competitive.

On the one hand, in June 2020, the Norwegian Government's hydrogen strategy was presented. It must be produced with no or very low emissions such as by electrolysis of water with pure power [1], so further technology development is crucial. On 29 May, NOK 120 million were allocated to the ENERGIX program in the Research Council of Norway with the aim of finding solutions for the today key barriers to increase use of hydrogen. Through the Zero Emission Fund, the company ENOVA contributes to introduce hydrogen solutions in commercial vehicles and vessels in the market. NOK 20 million were allocated for the speedboat investment as part of the green restructuring package.

On the other hand, in October 2020, the Spanish government's Council of Ministers (the "Government"), at the proposal of the Ministry for Ecological Transition and the Demographic Challenge ("MITECO"), approved the "Hydrogen Roadmap: a commitment to renewable hydrogen" (the "Hydrogen Roadmap"). The Hydrogen Roadmap was subject to prior public consultation and received contributions from a total of 78 entities, organizations, associations and individuals. It follows the momentum of the EU Hydrogen Strategy for a climate-neutral Europe (the "EU Hydrogen Strategy"), with a core objective of achieving climate neutrality, with a 100% of net-zero emissions by 2050.

To achieve important environment objectives by 2030 and 2050, it has been necessary to put forward new lines of action in many economic sectors. When talking about the energy sector, the aim is to decarbonize it and to give a higher role to the renewable energies, reducing in this way the use of fossil fuels. Among all the components to make it possible it is important to emphasized the low CO<sub>2</sub> emission that hydrogen has as an energetic vector [2].

Following this premise, green hydrogen provides a path to achieve a clean, affordable and secure energy future. "Hydrogen is today enjoying unprecedented momentum. The world should not miss this unique chance to make hydrogen an important part of our clean and secure energy future" [3].

### 1.2 Motivation

The Hydrogen Roadmap [4] relies on the Spain's potential to position itself as a technological leader in the production and use of green hydrogen, given the advantageous climate and large areas available for the installation of renewable energy projects (solar or wind).

In this regard, the Hydrogen Roadmap defines ambitious targets that can be framed (and contrasted) within the three phases defined in the EU Hydrogen Strategy:

	EU Hydrogen Strategy	Spanish Hydrogen Roadmap
First phase (2020 – 2024)	Installation of 6 GW of electrolyzers and production of 1m tonnes of renewable hydrogen in the EU.	Installation of 300 – 600 MW of electrolyser plants.
Second phase (2025 – 2030)	Installation of 40 GW of electrolyzers and production of up to 10m tonnes of renewable hydrogen in the EU.	Installation of at least 4 GW of electrolyser plants <u>Industry</u> : minimum renewable hydrogen contribution of 25% of the total hydrogen consumed in 2030 in all industries. <u>Transport</u> : 150 – 200 fuel cell buses in 2030. 5,000 – 7,500 light and heavy-duty fuel cell vehicles for freight transport in 2030. 100 – 150 public access hydrogen stations by 2030. <u>Power sector/energy storage</u> : commercial hydrogen projects operational by 2030 for electricity storage and/or use of surplus renewable energy.
Third phase (2030 – 2050)	Maturity and large-scale development of renewable hydrogen technologies.	Economy based on the production and application of renewable hydrogen. Competitiveness of hydrogen production using renewable energy compared to other production technologies. Decarbonisation of society by 2050. Increased manageability of renewable energies. Quality, sustainable and competitively priced energy supply.

Table 1.1: Spanish targets with regard to the EU Hydrogen Strategy

Basically, the EU intends to achieve a renewable hydrogen economy in the three phases summarized in Table 1.1 [5]:

- In the first phase (2020-24), the production of 6 GW of power capacity from renewable hydrogen should be promoted. To permit a large-scale production, each of the electrolyzers shall reach a size of up to 100 MW, which would allow production of 1 million tonnes of renewable hydrogen by 2024. Moreover, existing hydrogen plants shall be decarbonised and the incorporation of hydrogen applications into end-uses should be promoted.
- In the second phase (2025-2030), the EU aims to produce 10 million tonnes of renewable hydrogen in Europe by 2030. To achieve this, the EU will install 40 GW of electrolyzers by 2030. Solar and wind power will help reduce the price of renewable hydrogen, making it more competitive. This phase also envisages building an EU-wide logistics infrastructure, building larger storage facilities and planning a pan-European hydrogen network, possibly including retrofitting existing gas infrastructure.
- The third phase (2030-50) refers to the market growth period. Renewable hydrogen will be mature and widely used in hard-to-decarbonize sectors. The EU Hydrogen Strategy does not specify the capacity needed to produce renewable hydrogen in the EU, but it is expected that a quarter of the EU’s renewable electricity generation may be required.

There is no doubt that renewable hydrogen is a key factor to convert the 2050 zero emissions target into a reality, but a proper regulation and a boost to develop its technologies and knowledge are required. Scaling-up the production of hydrogen or improving the efficiency of the electrolyser and the whole BoP are some of the possibilities to overcome today’s limitations. Because of all the previous reasons this thesis will analyse the positive effects of substituting a modular BoP for a common one, which contributes to the scaled-up of the hydrogen production.

## 1.3 Objectives of the project and research question

The objectives this project will cover are:

1. Perform a literature review on electrolysis technologies, BoP design and components, and scale-up.
2. Define a case study.
3. Evaluate and select possible electrolysis processes and configurations.
4. Design the systems based on modular and large-scale approaches and simulate a model of the BoP to enable in-depth analysis.
5. Perform analysis based on the simulation of the chemical model and evaluate key performance indicators at different levels of pressure.
6. Perform a sensitivity analysis to evaluate other storage options.

All the bullet points above-mentioned will be develop to come to a conclusion at the end of the thesis, being the following research question answered: Does a common balance of plant provide lower costs than a modular one?

## 1.4 Risk Assessment

After having checked the required risk assessment sheet, it concludes that this project is purely theoretical, so no risk assessment is necessary.

## 1.5 Organization

To answer the research question, this thesis is structured in seven chapters:

1. Introduction. The first one will provide a reason why this thesis is being developed. The main policies that have been worldwide implemented to achieve the 2050's targets, as well as some of the national politics of Norway and Spain, will be presented.
2. The Hydrogen. This chapter will contain the literature review necessary to place the reader in the industrial context of the topic. The case study of the thesis will be also presented, followed by a comparison among the main technologies of electrolysers. Also, the two sensitivity analysis of this project will be explained. An important part for the industrial application of hydrogen is its storing, so one of the sensitivity analysis will evaluate different scenarios for the storage.
3. Methodology. The core of the thesis will be presented in this chapter. The case study will be defined in detail, as well as the two different approaches that this study will analyse based on the KPIs. The simulation done in Aspen HYSYS will be also presented, explaining all the assumptions considered.
4. Costs analysis. Once the simulation is finished, the costs analysis will provide the necessary values to compare both configurations of the plant. To do so, some correlations and the economic tool of Aspen HYSYS will be used.
5. Results and discussions. Starting with the validation of the model, this section will contain all the results of the different proposed scenarios. Relevant graphs will be presented as well as the three KPIs.
6. Conclusions. The final ideas of the study will be presented in this last section, as well as the answer of the research question.

## 1.6 Limitations

The validation challenges will be further treated in Section 5.1.1, however, some limitations that have appeared during the development of the thesis are presented:

- This study has tried to define a case study as close to reality as possible in the context of hydrogen. It is focused on one of the Repsol refineries (Cartagena, Spain). However, since it is not possible to obtain real data from the company, lot of assumptions have been considered.
- PEM electrolyzers in Aspen HYSYS are currently being investigated, so it has been necessary adapting the model in order to produce the necessary amount of hydrogen using a black box model that scales it up.
- Seawater is used to cool the stream of hydrogen after each compression stage. The specific requirements to return this water to the sea after its use is determined individually depending on the project by the regional government, so it has been necessary to assume a value for the simulation ( $\Delta T=10^{\circ}\text{C}$  between the seawater that goes inside the equipment and the seawater that goes outside).
- The streams of seawater have been simulated using the hypothetical components tool, since not all the versions of Aspen HYSYS are capable of introducing components with electrolytes (NaCl in case of salt water).
- Simulating a water treatment system in detail takes too long and it is outside the scope of this thesis, so considering the fact that this section has no big impact in the final cost of the whole plant, it has been simulated as a black box. To do so, Jaime Lora García, professor of the department of chemical and nuclear engineering of the Polytechnic University of Valencia, suggests an efficiency for this type of technology of 45%.

# Chapter 2

## The Hydrogen

### 2.1 The Hydrogen Economy

Besides the fact that the chemical industry uses the hydrogen at large scale as a basic component, the Economy of Hydrogen is referred to the use of this gas as an energy carrier, that is, as a means to store and transport energy. In 1766 hydrogen was recognised as chemical element, but it was not until 1800 that water electrolysis was discovered. In 1920 the firsts hydrogen combustion engines are developed and, since then, many engineers started to suggest the use of hydrogen as a substitute to natural gas. On this basis, Iceland was the first country in establishing a strategy to have its own Hydrogen Economy. Shortly after, it was followed by the rest of the world [6].

To take advantage of its potential, hydrogen has been under continuous investigations and it has been generated from many different energy sources (see Figure 2.1), giving rise to the following classification [7]:

1. Green hydrogen: it is the one generated via water electrolysis using renewable sources. During its process no  $\text{CO}_2$  is released to the atmosphere, so it results in a good way to decarbonize industrial sectors.
2. Gray hydrogen: it is generated by hydrocarbons, in particular, by natural gas. It has a tendency to be less and less used because of the emissions it releases.
3. Blue hydrogen: its production generates  $\text{CO}_2$  emissions that are captured to be stored or reused. It is, therefore, a low emissions' hydrogen that also helps to decarbonize the industry.
4. Brown hydrogen: it is also generated by hydrocarbons, but in this case by coal. Coal contains a greater ratio of carbon to hydrogen than natural gas, so its use is expected to reduce as soon as possible.
5. White hydrogen: it is the one present in the nature in gas state. Sometimes it can be found in underground reservoirs, and its emissions depends on the mix of electricity sources that have been used to generate it.

The main ways of obtaining hydrogen can be seen in Table 2.1 and in Figure 2.1.

Source	Process
Natural gas	Steam Methane Reforming Autothermal Reforming Partial Oxidation
Water/Electricity	Electrolysis
Coal	Coal Gasification
Biomass	Biomass Gasification

Table 2.1: Processing to produce hydrogen from different sources



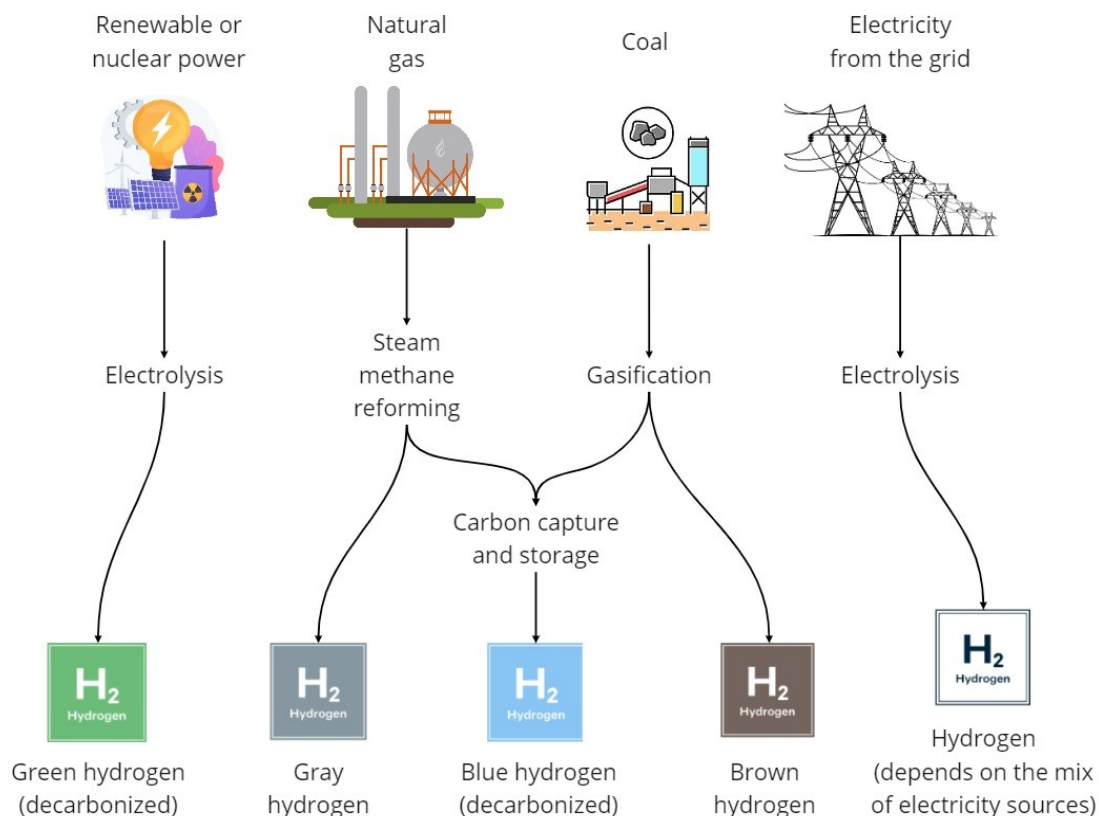

Figure 2.1: Hydrogen production processes. Own figure based on Figure 1 from [7]

Unfortunately, green hydrogen has many drawbacks that are necessary to overcome. The use of renewable sources makes the electrolysis process more expensive, specially nowadays that the price of electricity is strongly increasing. Furthermore, the production of hydrogen requires way much energy than other fuels. It is also noteworthy its volatility and flammability, so it has to be carefully checked during all the process.

Finally, the cost of hydrogen depends on three main factors:

1. The cost of the electricity used in the electrolysis.
2. The cost of the electrolysis' plant. The higher the power of the plant is, the lower the ratio €/MW will be.
3. Operating hours of the plant. On this basis, the higher the number of operating hours is, the higher the quantity of hydrogen produced will be, so the selling price of hydrogen will decrease. A refinery is an industrial complex that works 24 hours per day, 365 days per year.

Taking the above-mentioned factors into account, the current selling price of hydrogen oscillates from 3-4€/kg to 10€/kg. However, taking the selling price of hydrogen generation plants in other countries as a reference point, the current selling price can be established between 8-10 €/kg. This price is expected to decrease in the incoming years, but nowadays it is still high.

## 2.2 Hydrogen: characteristics and applications

Hydrogen, due to its simply structure (one proton and one electron), is the most abundant element on earth. However, it is always present as part of other molecules such as water (H<sub>2</sub>O) or other organic molecules such as glucose (C<sub>6</sub>H<sub>12</sub>O<sub>6</sub>), so technologies capable of separating it from those compounds are needed. Among its chemical characteristics it is worthy to name its high energy mass density and its

low energy volume density, that is, it allows to storage an important amount of mass into an affordable volume. The aim to build an economy based on renewable hydrogen is because of the following reasons:

- Hydrogen, apart from ammonia, is the only fuel that does not generate carbon dioxide during its use, since its combination with oxygen only produces water.
- Its reserves are inexhaustible since it is a renewable resource.
- It could be stored in a relatively simple manner, such as pressurized gas or liquid.

For a better understanding of its characteristics, a comparison with natural gas is shown down below.

Chemical property	Hydrogen	In respect of natural gas
Density (gas)	0.089 kg/m <sup>3</sup> (0°C, 1bar)	1/10
Density (liquid)	70.79 kg/m <sup>3</sup> (-253°C, 1bar)	1/6
Boiling point	-253°C (1bar)	-90°C
Energy density (mass)	120MJ/kg 33.33kWh/kg	x2
Energy density (volume)	10.8MJ/Nm <sup>3</sup>	1/3
Wobbe's index	11.29kWh/Nm <sup>3</sup>	5/6

Table 2.2: Comparison between the main chemical characteristics of hydrogen and natural gas [8]

Hydrogen has a density between 6 to 10 times smaller than natural gas, which means that to obtain the same quantity of mass it is required more volume of storage. However, hydrogen provides twice energy as natural gas with the same mass quantity. Hydrogen also requires three times more volume than natural gas, so if liquefaction is needed for its storage, its boiling point is too low (-253°C). Finally, Wobbe's index represents the combustion degree in a burner, which is slightly minor than natural gas. Taking everything into consideration, hydrogen cannot substitute actual fuels without modifications in its applications and without further deep investigations, however, this is often overlooked.

When talking about the applications of green hydrogen, it links renewable electricity such as solar and wind with a wide range of end-used applications. Transport, off grid, grid balancing and industry are the principal areas in which hydrogen can be used.

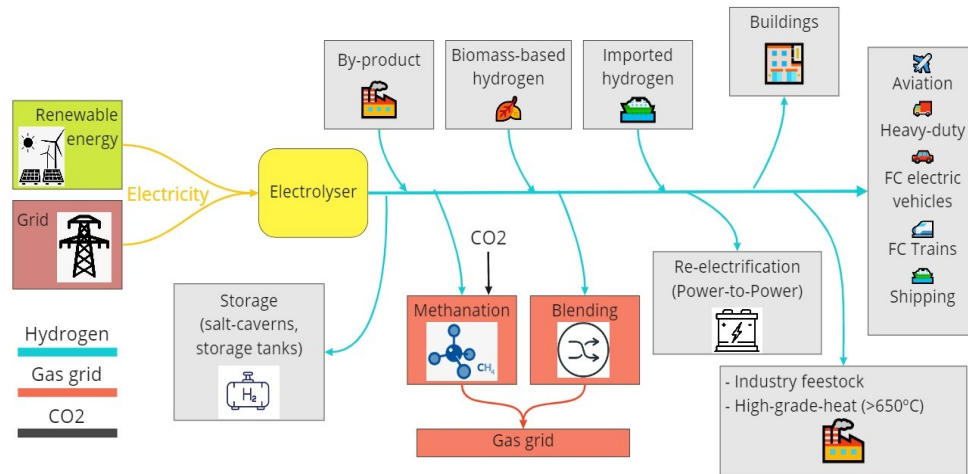

Figure 2.2: Sketch of the applications of hydrogen produced via electrolyzers. Own figure based on [9]

Focusing on industry, Spain is the main consumer of hydrogen representing more than the 90% of global consumption, but it is mostly grey hydrogen. On this basis, 500.000 tons/year of hydrogen (mainly grey) is consumed in Spain. The 70% of it is used as raw material in refineries, and the 25% is used to fabricate chemical products. For this reason, a refinery has been chosen as case study for this thesis.

### 2.2.1 Repsol refinery

Among all the refineries that exist currently, Repsol was the more contaminant company in Spain during 2021 [10]. Moreover, they want to be one of the pioneers in working with renewable hydrogen, so they are carrying out many projects about it. For this reason, one of the refineries of the Repsol company has been selected as case study.

They use chemical and physical processes to transform crude and other raw materials into higher quality products:

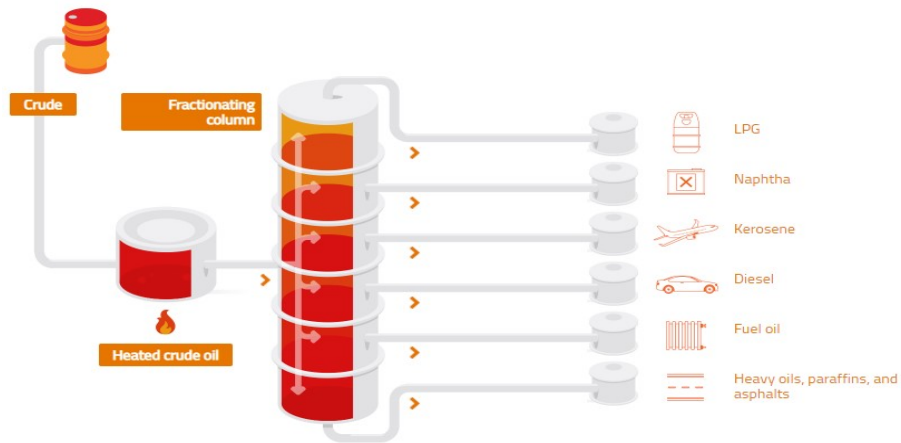

Figure 2.3: Main products generated in Repsol refinery [11]

The hydrogenation processes that take place in a refinery have as main goal obtaining light fractions of crude from heavy ones, increasing its content of hydrogen and reducing its molecular weight. Simultaneously, undesired products as sulphur, nitrogen or metals can be removed. Among these processes, hydrodesulphurization, isomerization or hydrocracking can be mentioned. Hydrogen used in these processes represent around 28% of the worldwide consumption. In the picture below, it can be seen that hydrogen is totally integrated in refinery processes.

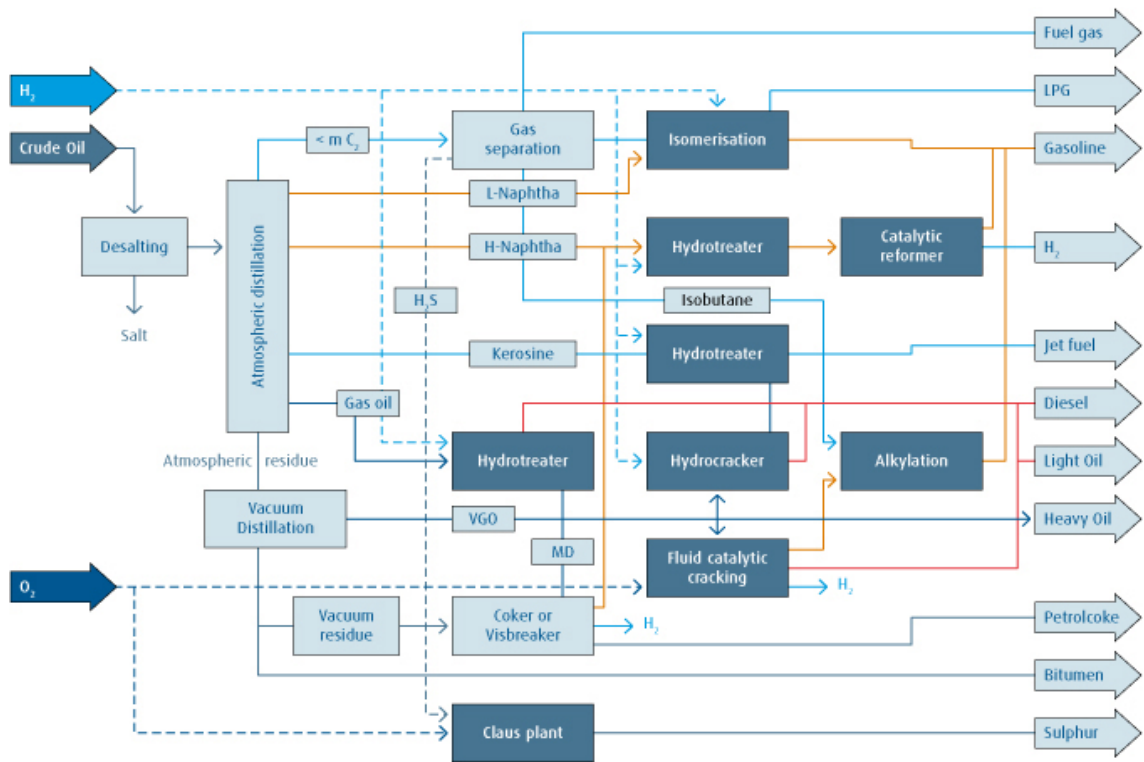

Figure 2.4: Applications of hydrogen in refinery processes [12]

Repsol has seven industrial complexes operating during the whole year. Its production capacity is higher than 1 million of barrels per day and they are planning to invest around 400 million of euros by 2025 in improving the energy efficient transition [13].



Figure 2.5: Industrial complexes of Repsol [11]

As part of the Basque Hydrogen Corridor, Repsol will install the first electrolyser to produce renewable hydrogen in 2022. Using also green hydrogen, one of the biggest synthetic fuels plants will be installed in Bilbao by 2024. They are planning also to install at least 12 hydrogen generators by 2025. An agreement with Talgo's railway company has been signed to boost the hydrogen train in the Iberian Peninsula. They are one of the drivers of the Hydrogen Valley of Murcia and Castilla la Mancha. Furthermore, they have produced in Cartagena 10 tons of renewable hydrogen using bio-methane [14]. All these initiatives make drawing attention to Repsol as main character of this thesis possible.

Two different applications will have the hydrogen produced in the plant:

1. A part will be introduced in the chemical separation process of the refinery known as hydrodesul-

phurisation, one of the main hydrotreating processes, in which hydrogen is already indispensable. In this reaction, hydrogen bonds with sulphur to form hydrogen sulphide, which is captured and further processed in another treatment step. This process is important because the quality of the crude oil depends on its sulphur content and, furthermore, fuels for vehicles has been restricted to 10 ppm of sulphur in many countries.

2. Another part will be storage so as to take advantage of periods in which the availability of energy from renewable sources is high (i.e. solar radiation in summertime or wind power during thunderstorms) and to sell it when this availability is low or nonexistent. In case it can not be sold, it will be sent also to the refinery in order to participate in the hydrodesulphurisation process.

## 2.3 Ways to produce hydrogen via water electrolysis

First of all, a very simple sketch of the process is shown in the figure 2.6 to have a general idea of the whole system.

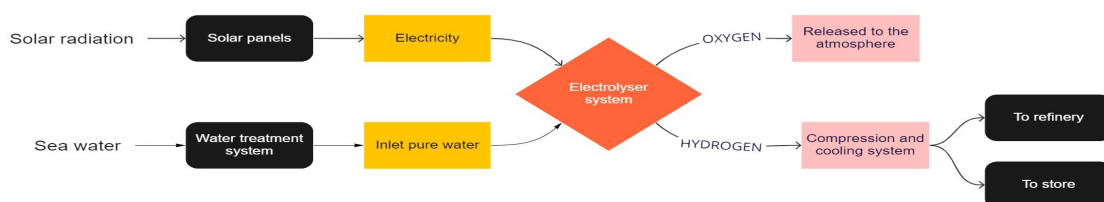

Figure 2.6: Simple sketch of the production of hydrogen that is being studied in this thesis

### Source of electricity

The electrolyser needs a direct current to split the water, and it is provided by the power supply stack (solar panels in this case). The system is composed by a transformer, in charge of adjusting the voltage, and a rectifier, who converts the alternating current into direct current.

### Inlet water system

The water is directly introduced in the system from a tank, and an injection pump is needed to ensure an adequate input flow. Once in the system, it must be purified to get the appropriate conductivity level in order not to harm the electrolyser stack. In this case seawater will be used, and since the water needed must have a very high quality it is required a complete treatment to have a very low level of salts.

### Electrolyser stack

Pure water is introduced into the electrolyser stack, where water electrolysis process takes place. The aim of this process is to split the water molecule to obtain hydrogen and oxygen in gaseous state. Due to de fact that water is a thermal insulator, it is combined with an electrolyte to make it be a conductive medium. The phenomenon takes place in the electrochemical cell of the electrolysis unit, which consists of the electrolyte with two electrodes connected to a power supply. When the cell is filled with pure water and the critical voltage value is reached, these electrodes start to produce oxygen in the anode side and hydrogen in the cathode one. The higher the current that passes through the cell is, the higher the quantity of gases produced are [15].

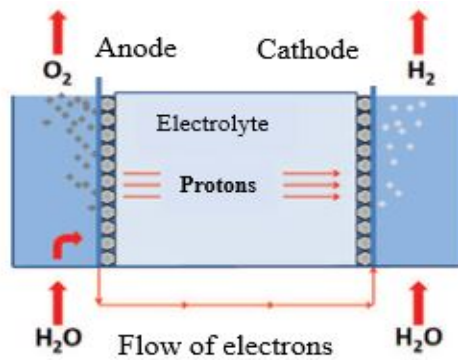

Figure 2.7: Electrochemical cell sketch of a water electrolysis unit [16]

The reactions that take place on each part are:

Cathode:



Anode:

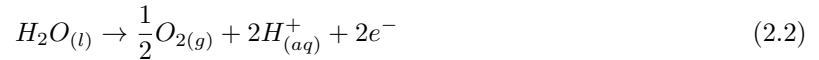

Overall reaction:

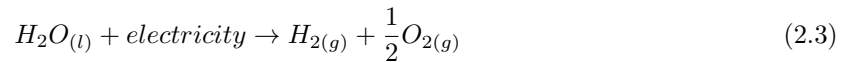

Once oxygen and hydrogen are obtained, both are introduced into its respective gas separator tanks to remove the water it may contain. This water will be introduced again into the purification system. One important parameter is the reactivity of the metal that compounds the electrodes. If the electrolyte is more reactive than the hydrogen, then hydrogen will be produced at the cathode. Otherwise, the metal will be produced in the cathode. In the Figure 2.8 it is a classification of the main metals that can compound the electrolyte (hydrogen and carbon are also included to a better comparison, but there are not metals). Those who are more reactive than hydrogen can be used as electrolyte material.

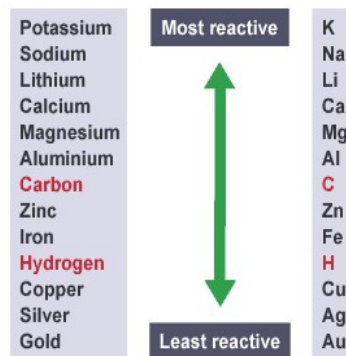

Figure 2.8: Classification of possible metals for the electrodes according to its reactivity level [17]

### Hydrogen subsystem

Hydrogen flow must be carefully treated since, in order to store it, its humidity has to be removed. To do that, a tank that controls the humidity gradient is installed. When certain value of humidity is reached, the flow will go to a “dirty” hydrogen separator. The hydrogen that can be mixed into the atmosphere is released, and the water goes to the purification system to be subsequently used in the electrolysis process. On the other hand, the dry hydrogen flows to the drying stage to remove impurities from the

gas. Finally, the hydrogen stream is sent to the compressor stage to get the necessary pressure for its storage.

The history of water electrolysis started as early as the first industrial revolution (1800) and, since then, lot of investigations are being carried out in order to find suitable technologies at a feasible cost and as less harmful to the environment as possible. The following is a description of the main technologies that exist currently.

### 2.3.1 Alkaline electrolysers (AEL)

The alkaline electrolysis process is shown in Figure 3. When the water molecule reaches the cathode side, gives rise to one molecule of hydrogen and two hydroxyl ions. The hydrogen ascends towards the surface in gaseous form and the hydroxyl ions go through the porous diaphragm under the influence of the electrical field between cathode and anode. The encounter between ions and anode result in 1/2 molecule of oxygen and one molecule of water. Finally, the oxygen molecules escape to the surface in gaseous state as hydrogen did.

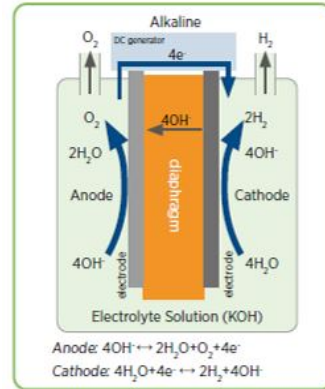

Figure 2.9: Alkaline electrolysis process sketch [18]

Its main characteristics are summarized in Table 2.3.

Efficiency	60-70%
Electricity consumption	4.6–5.2 kWh <sub>e</sub> /Nm <sup>3</sup> H <sub>2</sub>
Current density	200-600 mA/cm <sup>2</sup>
Operating temperature	70-90°C
Operating pressure	<30 bar
Cost	1000-1500 €/kW
Cell area	>4m <sup>2</sup>
Lifetime system	20-30 years
Degradation rate	0.13%/1000 h [8]

Table 2.3: Main characteristics of an alkaline electrolysis process [19]

The main advantage of this type of electrolysis is the fact that is the more mature technology with the lower costs in the actual market, whereas its main disadvantage is the use of a liquid electrolyte, usually potassium hydroxide (KOH) or sodium hydroxide (NaOH). The liquid electrolyte is a bottleneck to have a compact design and operate at high pressure, furthermore, it does not have a rapid answer to the power variation so it is not appropriate to combine with renewable energies. Another drawback is the low current density achievable due to the high ohmic losses across the liquid electrolyte and the diaphragm [20].

When talking about the BoP of an alkaline electrolyser, it requires the recirculation of the electrolyte into and out the stack components. This causes a pressure drop that needs specific pumping characteristics resulting in losing a bit of the efficiency [18].

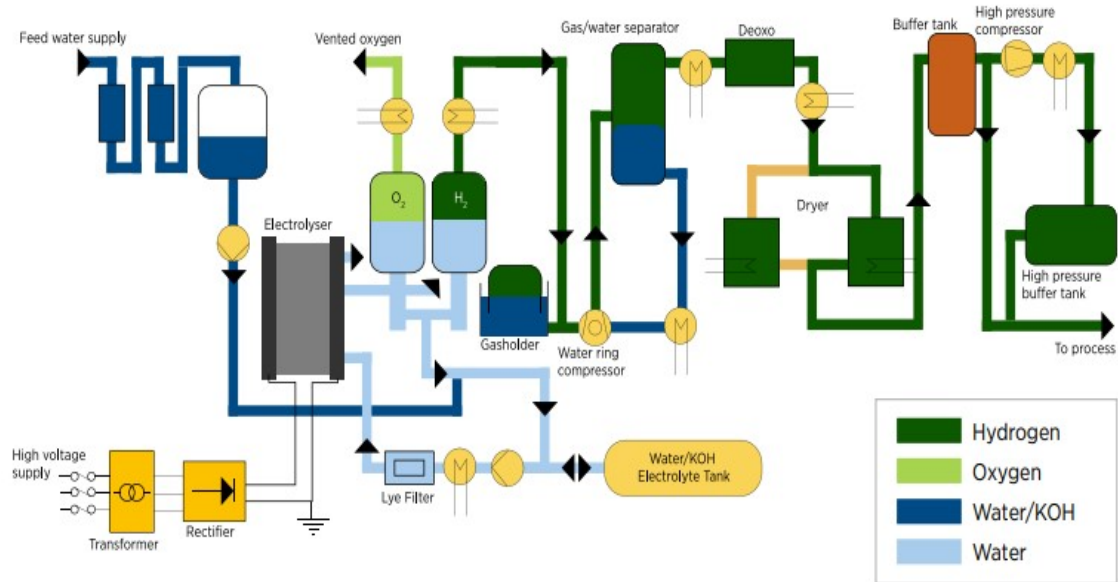

Figure 2.10: Generic BoP for an alkaline electrolysis process [18]

### 2.3.2 Polymer electrolyte membrane electrolysers (PEM)

Many experiments took place to overcome the drawbacks of alkaline electrolysers, but it was not until 1960s that the solution arrive. General Electric company was the first one in creating a successful water electrolyser based on a solid polymer. It provides a high proton conductivity, low gas crossover, compact system design and high-pressure operation [20].

This electrolyser consists of a polymeric membrane with two electrodes on its sides connected to a power supply as shown in 2.11. The ion-conducting polymer materials that forms the membrane have two purposes: carrying the hydrated protons generated on the anode side to the cathode one, and separating the products formed on each electrode ( $H_2$  and  $O_2$ ) to avoid its spontaneous recombination.

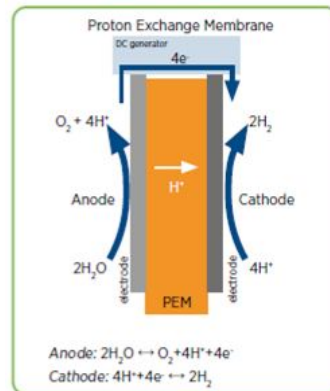

Figure 2.11: Proton exchange membrane electrolysis process sketch [18]

A summary of its main characteristics is shown in Table 2.4.



Efficiency	70-80%
Electricity consumption	4.5–4.8 kWh <sub>e</sub> /Nm <sup>3</sup> H <sub>2</sub>
Current density	600-2000 mA/cm <sup>2</sup>
Operating temperature	50-80°C
Operating pressure	<60 bar
Cost	1500-2000 €/kW
Cell area	<0.03m <sup>2</sup>
Lifetime system	50000 h
Degradation rate	0.25%/1000 h [8]

Table 2.4: Main characteristics of a PEM electrolysis process [19]

PEM electrolyzers can operate at much higher current density (up to 2 A/cm<sup>2</sup>); therefore, a higher amount of hydrogen can be generated if compared with alkaline one. One relevant advantage is the high pressure at which it can work, which not only serves to avoid the first compression stage after leaving the electrolyser (it is very expensive) but also minimizes the degradation of the membrane. Another advantage is the capability of the solid electrolyte to responding quickly to power variations, which provides the possibility to mating with renewable energies. When talking about its drawbacks, the main issue is that the corrosive acid regime of the membrane requires scarce and expensive materials and components [20].

The BoP of a PEM electrolyser is much simpler than the alkaline one. Only the anode side require the use of circulation pumps, heat exchangers, pressure control and monitoring. The cathode side typically has a gas-separator, a de-oxygenation component, a gas dryer and a compressor [18].

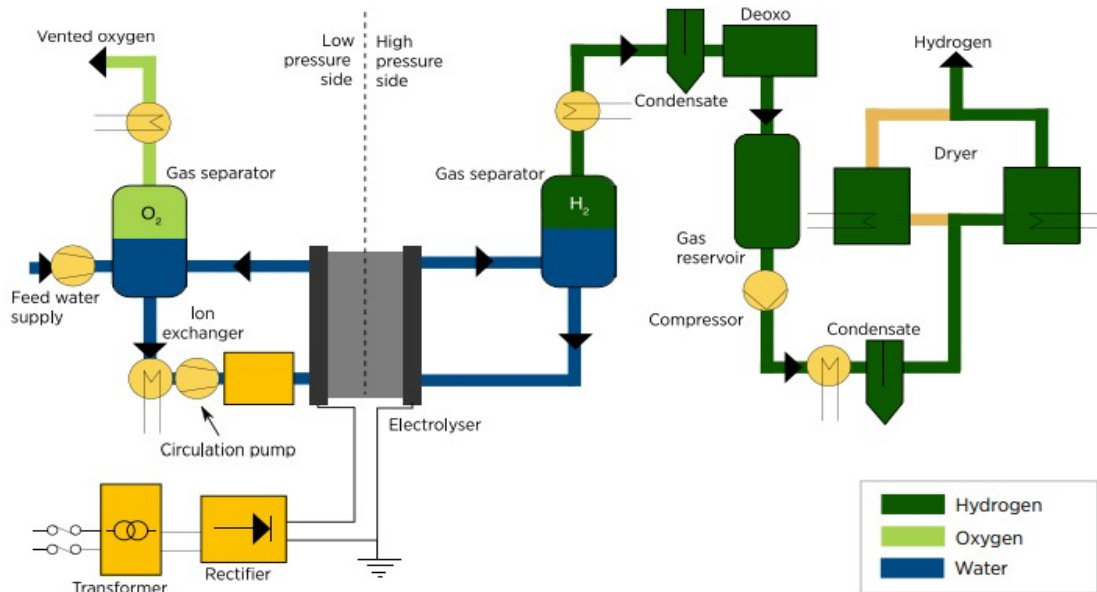

Figure 2.12: Generic BoP of a PEM electrolysis process [18]

### 2.3.3 Solid oxide electrolyzers (SOEC)

Apart from the two technologies that are already in commercialize stage (AEL and PEM), there are other options in laboratory stage as SOEC. The main characteristic of this type is its high operating temperature. The possibility to operate between a range of 500-1000°C appears to be a promising technique since it offers the capability of consuming less energy per unit of hydrogen produced in comparison with low temperature electrolyzers [21].

This technology is known as high temperature electrolysis (HTE) or vapour technology, and it uses a ceramic material as solid electrolyte. The process is the following: the electrons of the external circuit

combine in the cathode side with water to generate hydrogen and negative ions charge. Oxygen flows through the ceramic membrane and reacts with the anode producing oxygen gas and electrons for the external circuit [22].

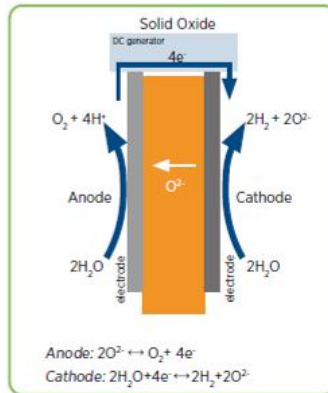

Figure 2.13: Solid oxide electrolysis process sketch [18]

Its main characteristics are summarized in Table 2.5

Efficiency	85-95%
Electricity consumption	3.2–3.5 kWh <sub>e</sub> /Nm <sup>3</sup> H <sub>2</sub>
Current density	<2000 mA/cm <sup>2</sup>
Operating temperature	500-1000°C
Operating pression	1-5 bar
Cost	prototype
Cell area	<85cm <sup>2</sup> [23]
Lifetime system	20000 h [18]
Degradation rate	2.8-1.9%/1000 h [8]

Table 2.5: Main characteristics of a SOEC electrolysis process [19]

As shown before, a very appealing characteristic of SOECs is the high efficiency it provides. They are still being under research, especially for the design of a novel, improved, low cost, and highly durable materials. Another interesting thing is its chemical flexibility and high temperature operation, which serves to CO<sub>2</sub> electrolysis to CO and also for the co-electrolysis of H<sub>2</sub> O/CO<sub>2</sub> to H<sub>2</sub>/CO syngas [20]. All in all, this technology is a promising alternative to the mass production of hydrogen, but its drawbacks related to the ceramic membrane resistance has to be solved.

Talking about the BoP of a SOEC system, the electrolyzers can be coupled with heat-producing technologies. It provides a higher efficiency due to the fact that water electrolysis is a very endothermic process, so it increases the temperature of the stack. As shown below, the overall system is simpler than the AEL and PEM ones.

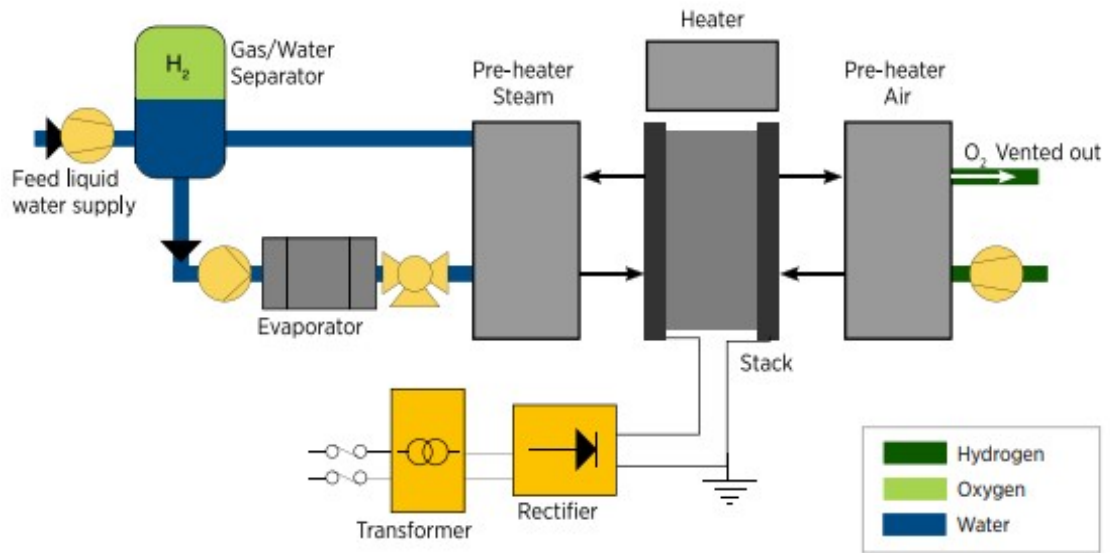

Figure 2.14: Generic BoP of SOEC process [18]

### 2.3.4 Anion exchange membrane electrolyzers (AEM)

The second electrolysis technology that is still in laboratory stage is the anion exchange membrane. It has been developed for electrochemical applications since it offers some benefits for PEM and AEL technologies, especially its low cost and high performance. However, just a few researches have been carried out on this topic so it requires further investigations.

During the process, water flows through the cathode side forming hydrogen and hydroxyl anions by the addition of two electrons. Hydroxyl anions flows to the anode side where it is recombined as water and oxygen by losing electrons. Finally, gas state oxygen is released in bubble form [24].

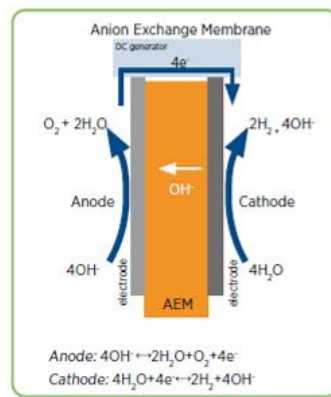

Figure 2.15: Anion exchange electrolysis process sketch [18]

Since this technology has too few publications, some of the characteristics mentioned in Tables 2.3, 2.4 and 2.5 are still unknown. However, in Table 2.6 there is a summary of what it is known so far.

Efficiency	$\approx 50\%$
Electricity consumption	$4.5-4.8 \text{ kWh}_e/\text{Nm}^3 \text{ H}_2$
Current density	$200-1000 \text{ mA}/\text{cm}^2$
Operating temperature	$50-70^\circ\text{C}$ [24]
Operating pressure	$<30 \text{ bar}$
Cost	prototype

Table 2.6: Main characteristics of an AEM electrolysis process [19]

As it can be seen, its efficiency and its current density are very low in comparison with the other technologies. When talking about its BoP, it is very similar to a PEM system.

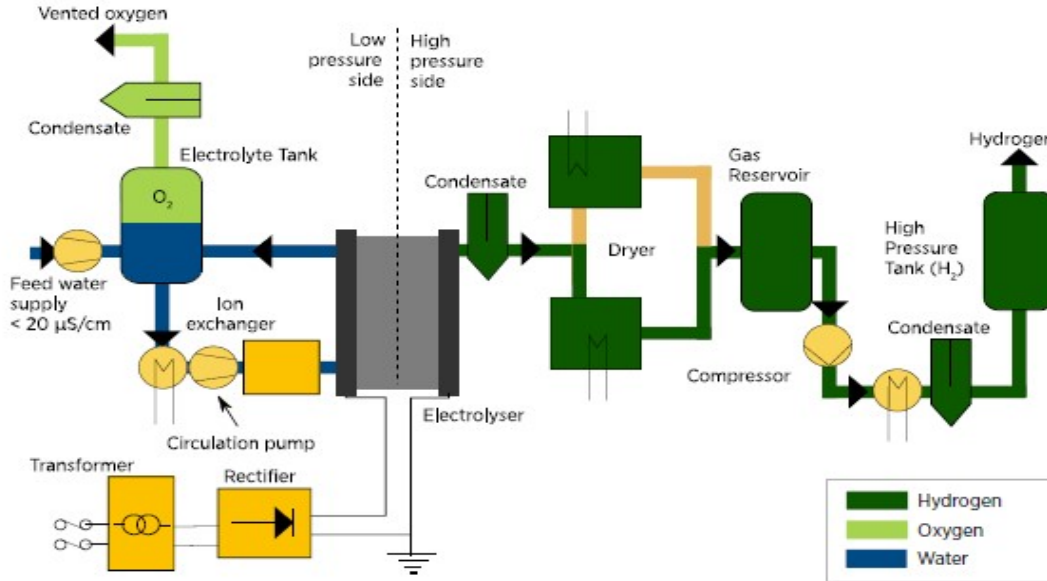

Figure 2.16: Generic BoP of AEM process [18]

Finally, a graphic to see the differences among AEL, PEM and SOEC electrolyzers is shown in relation to cell voltage and current density:

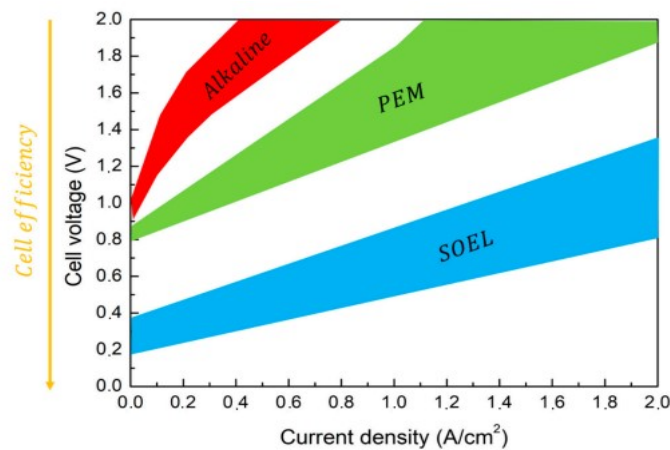

Figure 2.17: Comparison among the three main electrolyzers [25]

The efficiency decreases when decreasing the cell voltage, that is, AEL would be more efficient than

PEM, which is more efficient than SOEL. However, as stated before, the higher the current density is, the higher the quantity of hydrogen produced will be. This explains why lot of research is being carried out to utilize PEM or SOEL instead of AEL.

Since SOEL is still a prototype that has not been commercialised nor simulated in the main softwares of chemical processes, a PEM electrolyser will be used for this study.

# Chapter 3

## Methodology

Starting with the presentation of the case study, this section contains the explanation of the main systems that are part of the plant. Each one includes some literature review to explain the reason of the selected parameters and technologies.

### 3.1 Case study: Repsol refinery in Cartagena, Spain

#### 3.1.1 Description of the plant

Part of the hydrogen produced will be used in the industrial complex of Repsol in Cartagena, that is, in the hydrodesulphurization process. Some of the projects that Repsol is planning related to hydrogen have been stated before, but talking now about the green hydrogen projects in terms of official figures, an electrolyser with 2.5MW of capacity is going to be installed in the Basque Country-region during this year. For 2024 it is scheduled the putting into service of an electrolyser plant with 10MW of capacity. Furthermore, the company is also considering the installation of two plants of electrolysers with 100MW of capacity each one in Petronor (Basque Country-region) and Cartagena (Murcia) [11].

Since a very large scale is needed not only to reduce costs as much as possible but also to compare a common BoP versus an individual one, which is the scope of this thesis, 50MW of capacity for the electrolyser plant is going to be considered for this study.

Once decided the capacity of the plant, it is time to look for commercial electrolysers that are being selling currently to now the number of stacks. One of the largest developers of PEM electrolysers is the British company called ITM Power, which fabricates a model named 3MEP CUBE that results perfect for modular approaches with a power range between 10-50MW [26]. Considering 10MW per electrolyser, the case study will be based on 5 stacks.

#### 3.1.2 Two different approaches for the plant design

In this case study two approaches are going to be considered. Until now, many small modular stacks, each one with its own rectifier and equipment (see Figure 3.1), are the most used technology because of the following reasons:

- It leads to standardization that could reduce costs. When considering to add another electrolyser stack, it is only necessary to replicate the same engineering, fabrication, installation and commissioning of those already installed.
- More availability of commercial equipment. Medium or small size equipment are more likely to be offered in the market rather than bigger ones, since them should be designed especially for each application.
- It provides more stability in case of failure of some equipment. If something goes wrong in one electrolyser's chain production (leakages along the pipes, deconfiguration of operating conditions in the compressor, bad performance of the rectifier...), it will not affect the rest of stacks.

- When maintenance is necessary, the productive process can go on for the same reason given before: each electrolyser works independently of the rest, so a stop in one of them will not stop the whole production of hydrogen.

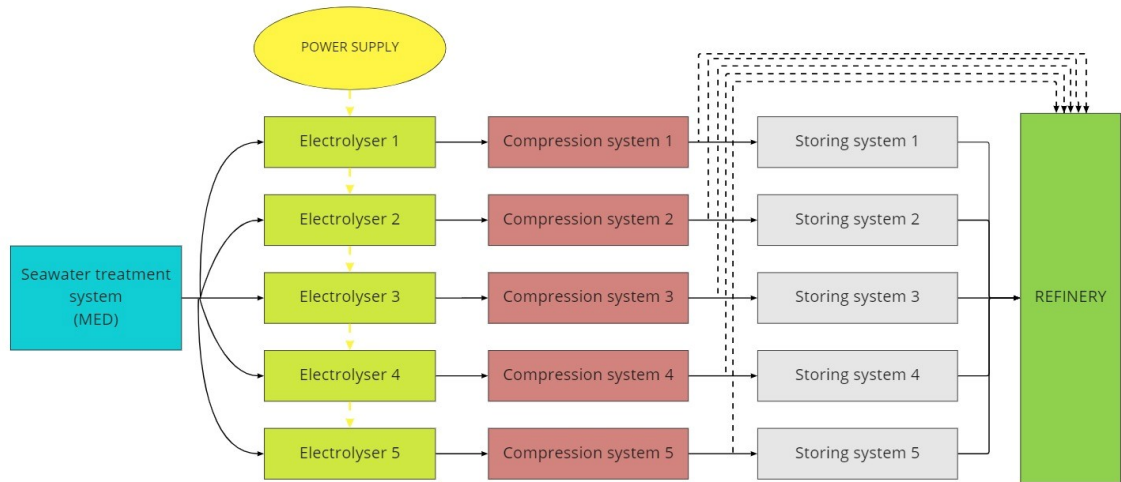

Figure 3.1: Modular BoP flowsheet

However, sharing a BoP for all the electrolysers (see Figure 3.2) seem to be a very promising alternative, because a bigger shared BoP allow to scale-up the hydrogen production not only with affordable costs but with a good global efficiency as well.

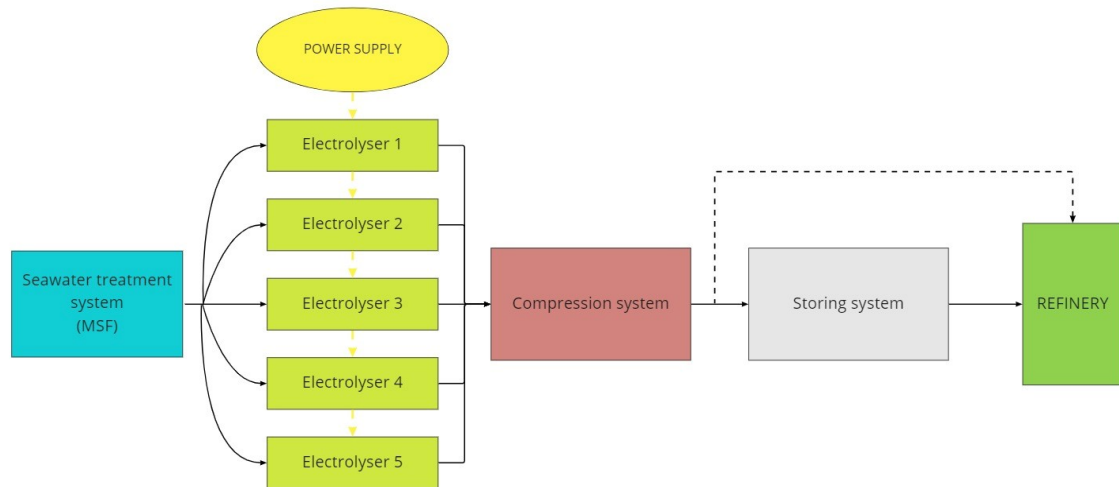

Figure 3.2: Common BoP flowsheet

### 3.1.3 Key performance indicators

The scope of this study is to investigate and compare both approaches basing on several key parameters.

#### 1. Levelized cost of hydrogen

When comparing different options for an industrial process, the final cost is the main indicator of feasibility. This cost can be subdivided into CAPEX and OPEX. On the one hand, the CAPEX mostly consists of the investment needed for the plant, that is, the price of each equipment adding its price of installation. To this should be added some indirect costs that could appear. The equipment of this plant that will be considered for the economic assessment are compressors, air coolers, pumps, separator vessels, heat exchangers and the storage tanks. The approximate price

of the electrolyser has been mentioned in Table 2.4, however, it will not be added to the analysis since it is the same for both approaches. On the other hand, the OPEX represents the operating expenditures that will arise from the normal operation of the plant. In this case, it is composed of the cost of energy that the equipment need to work and those costs related to the periodic maintenance.

$$c_{H_2} = \frac{\sum_{t=1}^n (CAPEX_t + OPEX_t)}{\sum_{t=1}^n P_{H_2} (1+r)^{-t}} [\text{euros}/\text{kg}H_2] \quad (3.1)$$

Where  $CAPEX_t$  is the total initial investment,  $OPEX_t$  is the total operating expenses,  $r=10\%$  is the rate of return,  $t$  is the horizon of transaction of the analysis and  $P_{H_2}$  is the quantity of hydrogen produced.

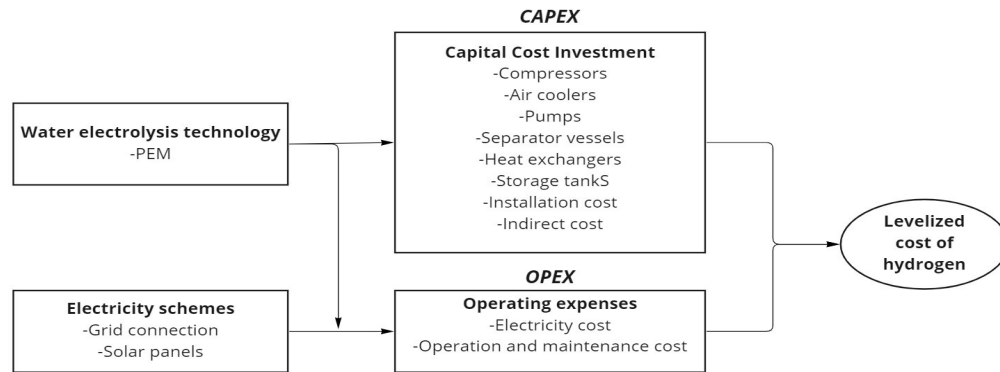

Figure 3.3: Scope of the techno-economic analysis. Proprietary development based on [27]

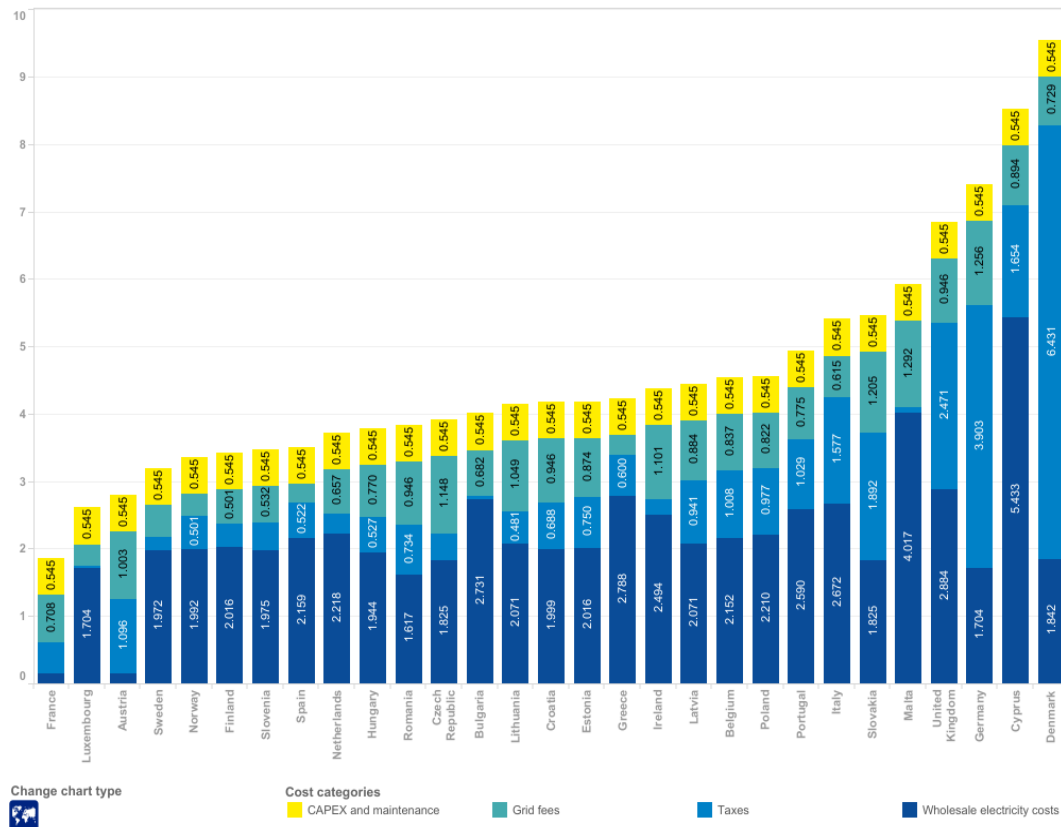

Figure 3.4: Levelized cost of hydrogen for grid connected electrolysis according the Fuel Cells and Hydrogen Observatory [28]



According to existing data such as the provided by the Fuel Cells and Hydrogen observatory (FCHO), the current LCOH in Spain is approximately 3.226 €/kg H<sub>2</sub> (see Figure 3.4). Considering that the largest share of electrolysis plants that are currently operating have a modular balance of plant, the LCOH for the case of modular configuration is expected to be close to that value.

2. Efficiency in terms of energy needed to produce the H<sub>2</sub>

$$\varepsilon_{H_2} = \frac{\sum \dot{W}_i}{m_{H_2}} [kWh/kgH_2] \quad (3.2)$$

Where  $\sum \dot{W}_i$  is the sum of the whole work required in each configuration of the plant and  $m_{H_2}$  is the quantity of hydrogen produced.

3. CO<sub>2</sub> intensity of H<sub>2</sub>

$$e_{H_2} = \frac{m_{CO_2} + P_{el} \cdot e_{el}}{m_{H_2}} [kgCO_2/kgH_2] \quad (3.3)$$

Where  $m_{CO_2}$  is the quantity of CO<sub>2</sub> generated,  $P_{el}$  is the emission factor of using electricity,  $e_{el}$  is the amount of energy required and  $m_{H_2}$  is the quantity of hydrogen produced.

Since water electrolysis does not emit CO<sub>2</sub>,  $m_{CO_2}$  will be zero. The value of  $P_{el}$  can be extracted from the data provided by the Spanish Institute for Diversification and Energy Saving (IDAE). Each type of power source has a CO<sub>2</sub> emission factor associated as a function of the final energy generated (kWh) as shown in Table 3.1. When considering the electricity as power source, it depends on the electric energetic mix, that is, on those technologies that have been used to produce it. The national conventional electricity has been calculated considering all the generation in Spain, including Ceuta, Melilla and the islands. The peninsular conventional electricity is only for locations placed in the peninsula, and the extra peninsular serves for Canary Islands, Balear Islands, Ceuta and Melilla. However, for these locations it is preferable to use the specific factor that has also been calculated for each one (fourth, fifth and sixth row in Table 3.1). Since Cartagena is located in the peninsula, the emission factor 0.331 will be used.

Power source type	CO <sub>2</sub> emission factor (kg CO <sub>2</sub> /kWh final energy)
National conventional electricity	0.357
Peninsular conventional electricity	0.331
Extra-Peninsular conventional electricity	0.833
Balear Islands conventional electricity	0.932
Canary Islands conventional electricity	0.776
Ceuta and Melilla conventional electricity	0.721
Heating diesel	0.331
Liquefied petroleum gas	0.254
Natural gas	0.252
Coal	0.472
Non-densified biomass	0.018
Densified biomass (pellets)	0.018

Table 3.1: CO<sub>2</sub> emission factors provided by the Spanish Institute for Diversification and Energy Saving [29]

These values came into force the 14th January 2016. As said before, they have been calculated according to the technologies that were used to generate the electricity. Going to the official web page of the electric grid of Spain [30], the values of the different power sources can be observed. For example, in the case of the peninsular conventional electricity of 2016 the energetic mix was the one shown in Figure 3.5. As it can be observed in the ordinate axis at the right, the blue curve is around 0.331 tCO<sub>2eq</sub>/MWh.

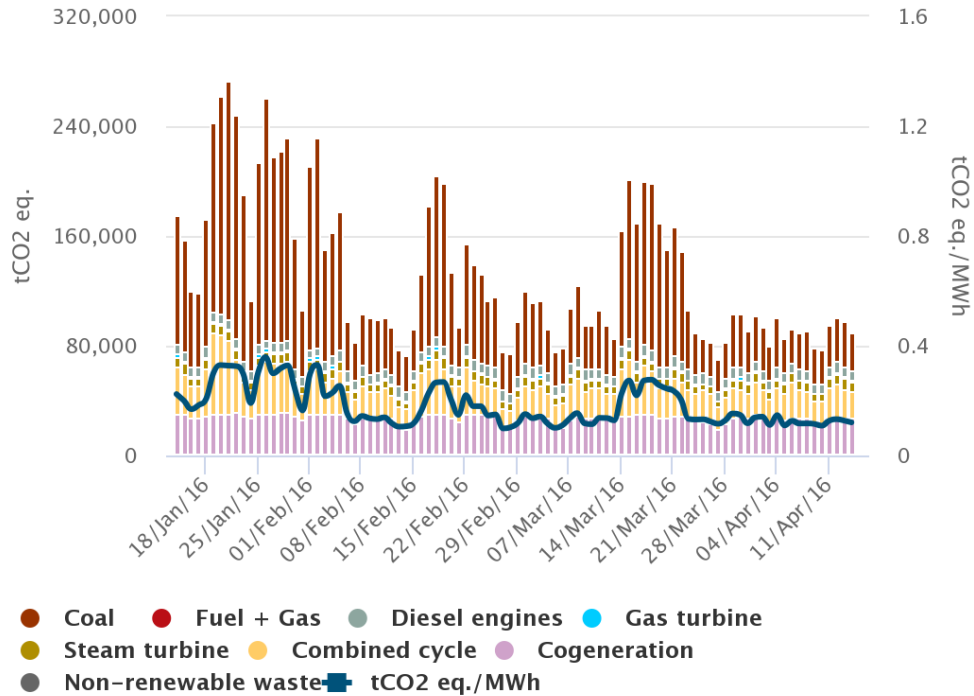

Source: www.ree.es

Figure 3.5: CO<sub>2</sub> equivalent emission factor and greenhouse gas emission factor regarding non-renewable generation ( $tCO_{2eq}$  —  $tCO_{2eq}/MWh$ ) [30].

For this KPI five different scenarios will be considered:

- Full Grid. The 100% of the electricity is provided by the grid.
- High Grid. The 75% of the electricity is provided by the grid and the other 25% by the solar panels.
- Medium Grid. The 50% of the electricity is provided by the grid and the other 50% by the solar panels.
- Low Grid. The 25% of the electricity is provided by the grid and the other 75% by the solar panels.
- No grid. All the electricity is provided by the solar panels.

## 3.2 Plant model development

### 3.2.1 Water treatment system

Around two thirds of the surface of the planet is covered by water, but only the 2.5% is freshwater and the 0.3% is suitable for human consumption [31]. Taking this fact into account and considering the proximity of the refinery to the sea, seawater will be used for the electrolysis process.

Several methods are used currently to desalinate seawater, which can be defined as the process to remove excess of salt and minerals of the water to changing seawater into potable one. The main desalination processes are classified in thermal and membrane technologies as shown in 3.6:

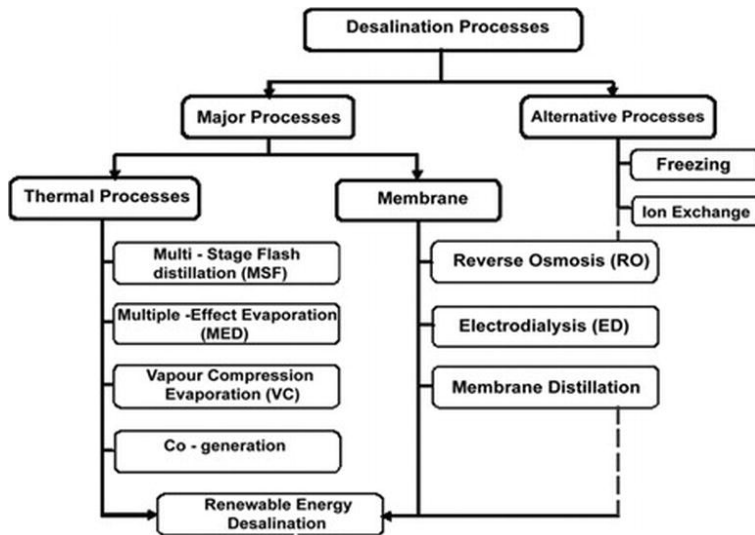

Figure 3.6: Water desalination processes classification [32]

Thermal desalination, often known as distillation, is one of the most ancient technologies ways to purify salt waters. It is based on boiling the water, evaporate it and then condense it to obtain freshwater. Thermal processes are subdivided into the following types:

- Multi-stage flash distillation (MSF). It is currently producing around 64% of the worldwide desalinated water. Besides the fact of being the most reliable way to obtain potable water, it is considered as energy demanding because its requirement of thermal and mechanical energy. Operating temperatures over  $115^{\circ}\text{C}$  improves the efficiency, but it causes scaling problems because the precipitation of salts may cause tube clogging. Furthermore, adding more stages improve its efficiency and increases water production, but it results in higher capital costs and operational complexity [33].
- Multi-effect distillation (MED). With a production of 3.5% of desalted water, it is the oldest large scale desalination method, which is characterised by high quality distilled water, high unit capacity and high heat efficiency [34]. The quality of the feed water is not a key factor, so it provides lower costs in the pre-treatment process. Moreover, the power consumption is lower than MSF and the efficiency is higher, therefore MED can be considered as cost effective and more efficient than MSF [32].
- Vapour compression evaporation (VC). It is used in combination with other processes. Its operating temperature ( $70^{\circ}\text{C}$ ) not only reduces the scale formation and tube corrosion but also make it simpler and more efficient in terms of power requirements. Its simplicity and reliability of plant operation make it appealing to small-scale production (usually around  $3000\text{ m}^3/\text{day}$ ) [32].
- Cogeneration. In combination with other methods, it is possible to generate electric power and desalinate water at the same time. The main advantage is that it uses much less fuel than each plant operating separately, and energy cost is crucial when desalinating water. However, problems can occur since the coupling between the desalination plant and the power plant is permanent, which can create a problem for the water production when the need for electricity is reduced or when the turbine or generator fail. Besides the strides of VC and MED processes, MSF is still considered the more reliable and flexible one because its success over almost 50 years in plant designing and operation. For large desalination capacity, the MSF process can be considered as the only candidate commercially.
- Solar water desalination. It is generally used for small-scale operations and in arid regions where freshwater is not available.

From 1980s on, synthetic membranes started playing an important role in water desalination processes. In its early phase, it was limited to municipal water treatment but with the development of membrane types it has been expanded to water industry and to high return processes such as chemical separations.

It is basically based on the difference of concentrations between the two zones that the permeable membrane is separating. These technologies are categorised into:

- Reverse osmosis (RO). It is relatively new in comparison to other methods and it became commercially used in the early 1970s. Material corrosion problems are much lower than MSF and MED and its operating costs are being reduced thanks to the development of high durability of the membranes and the use of devices connected to the concentrated zone to recover energy. Water feed needs to be pre-treated to avoid harming the membrane, then it flows against the membrane thanks to a pump and finally it is post-treated to stabilise the water (pH adjustments, removal of dissolved gases. . . ) [32].
- Electro dialysis (ED). It arrived 10 years after the RO, and it consists of reducing the salinity by transferring ions from the feed water zone through membranes under the influence of an electrical potential difference. Its capability of freshwater recovery is very high; however, it is not economically viable for seawater treatments [35].
- Membrane distillation (MD). Commercially developed on a small scale in the 1980s, it consists of using hydrophobic membranes only permeable by vapour, thus excluding the transition of liquid phase and particles. Then, the vapour phase is condensed to produce freshwater. Its simplicity and low operating temperatures and pressures are its main advantages. By contrast, it consumes as much energy as MSF and MED methods and it requires a feed free of organic pollutants, which limits a lot its use [32].

Item	MSF	MED	VC	RO	Solar still
Scale of application	Medium-Large	Small-Medium	Small	Small-Large	Small
Seawater treatment	Scale inhibitor antifoam chemical	Scale inhibitor	Scale inhibitor	Sterilizer coagulant acid deoxidiser	-
Equipment price (€/m <sup>3</sup> )	950-1,900	900-1,700	1,500-2,500	900-2,500 and membrane replacement every 4/5 years	800-1,000
Prime energy consumption (kJ/kg of product)	338.4	149.4	192	120	2,333.6

Table 3.2: Comparison of desalination plants. The prime energy consumption assumes 30% of electric conversion efficiency [35]

From 3.2 it can be seen that RO requires the smallest energy, but it is expensive and requires a complex seawater treatment. It is followed by MED, which requires the simplest water treatment system. In [36] these two technologies are compared when using photovoltaic cells as power to desalinate the water, and the conclusions were the following ones:

1. The total cost of fresh water produced by MED is less than RO.
2. The plant reliability of MED is so high that makes its installation possible in countries with high insolation levels but with lack of personnel with experience. In contrast, any mistake in RO plant can ruin the membrane so high skilled workers are needed.

Additionally, distillation processes are preferred in polluted countries because water is boiled, ensuring the absence of micro-organisms. What is more, it is believed that solar energy is cheaply harnessed with thermal-energy systems, so MSF and MEB are the two systems that could be used. MEB plants are more flexible to operate at partial load, less sensible to scaling, cheaper and more suitable for limited capacity than MSF plants, which energy consumption is higher because of the recirculation pump. However, MED has failed in the past to compete with MSF due to large scaling problems [37], so MED will be used for the modular BoP and MSF for the common one. Taking everything into consideration, this case study will consist of:

- Multi-effect distillation for the individual BoP.

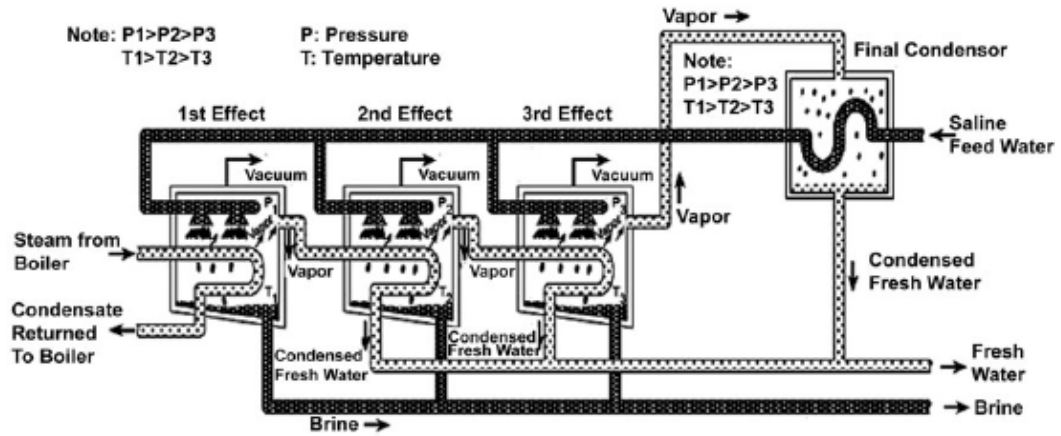

Figure 3.7: Multi-effect distillation plant [38]

The process takes place in a series of vessels called ‘effects’, which use the principle of evaporation and condensation by reducing the pressure. This leads to undergo the boiling stages without the neediness of supplying more heat after the first stage. The saline feed water enters the first effect after being pre-heated along the tubes. When the stream reaches the evaporator, it is sprayed onto its surface, which is externally heated, provoking the quick evaporation of the water. The steam is condensed on the opposite side of the tubes, in which the steam of the last effect is sent to pre-heat the feed water as shown in 3.7. Typically, this process contains from 4 to 21 effects and between 10 and 18 is found to be suitable in large plants [32].

- Multi-stage flash distillation for the common BoP.

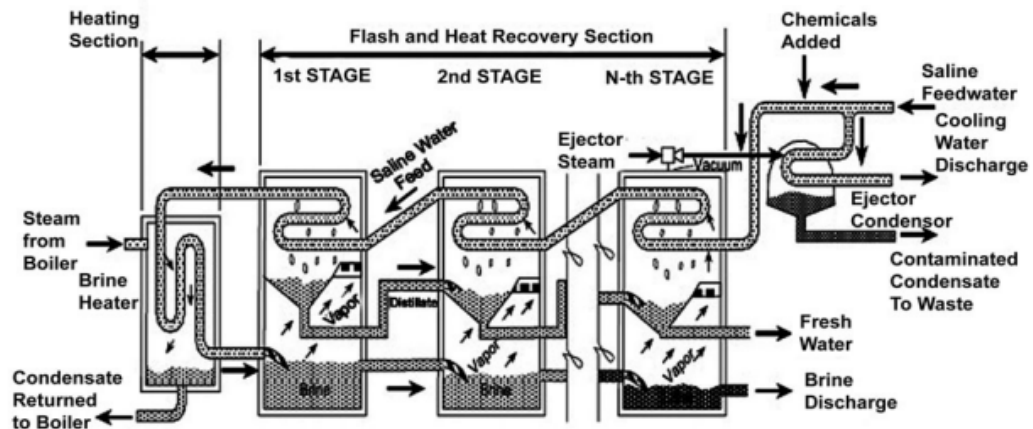

Figure 3.8: Multi-stage flash distillation plant [38]

The saline water is heated in the brine heater until it reaches a temperature below the boiling point. This water flows through some vessels in sequence, where the lower ambient temperature causes the water to rapidly boil and vaporize. This introduction of heated water into a chamber with lower pressure is called the ‘flashing effect’, because the water almost flashes into steam. Depending on the pressure inside the stage, a small percentage of this water become vapour, which is converted to freshwater by being condensed on the tubes of the heat exchanger. The incoming saline feed water going to the brine heats cools the tubes. In turn, it heats up the feed water reducing the amount of thermal energy required in the brine to rise the temperature of the salt water. Typically, between 15-25 stages compounds an MSF plant.

### 3.2.2 Polymer electrolyte membrane (PEM) electrolyser

A flow-sheet of the PEM model that has been used in Aspen HYSYS is shown in Figure 3.9.

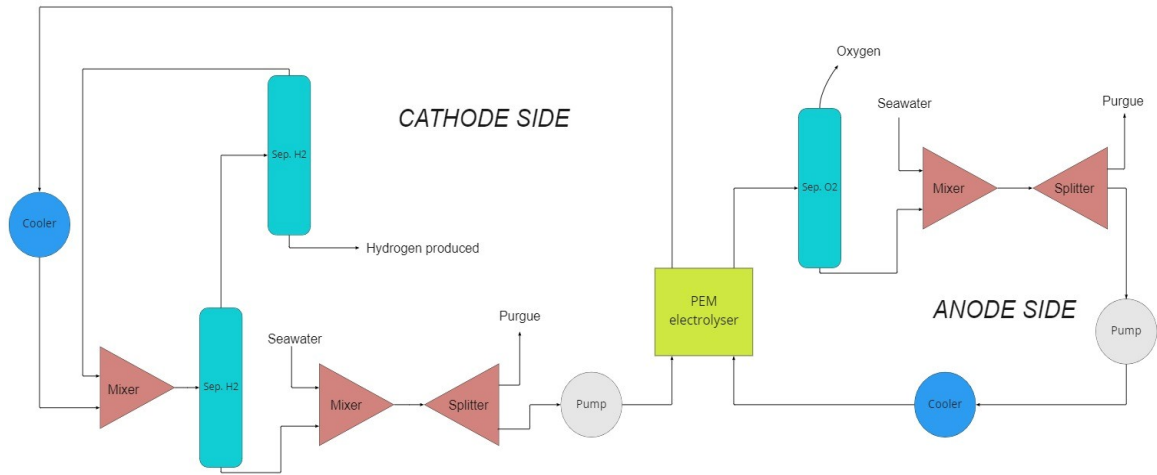

Figure 3.9: Flow-sheet of the simulation of the PEM electrolyser system in Aspen HYSYS

The PEM model used is the one present in the AspenTech web, in which Aspen Custom Modeller has been used to introduced all the equations that form the electrolyser. The thermodynamic model used is the NRTL (Non-Random Two Liquids model), which is the one recommended for organic mixtures in presence of water.

This model also contains the gas separator equipment to release the oxygen produced to the atmosphere and to send the hydrogen produced to the following stage (compression and storage).

The operating pressure in the anode is set at 2.5 bar while the cathodic level pressure can vary between 2 and 50 bar, so 30 bar has been chosen. The optimal temperature for the electrolyser stack is found to be at low temperature and greater than 25°C [39]. While this optimizes the overall system efficiency, the safety problem that arises from hydrogen permeation across the membrane, resulting in the generation of explosive gases on the oxygen side, is also diminished due to a slower permeation process. In addition to these two factors, there is a third advantage in that the lower stack temperature also increases stack durability.

Parameter description	Value
Exchange current density (anode)	$i_{0,an}=1\times 10^{-10} \text{ A/cm}^2$
Exchange current density (cathode)	$i_{0,cat}=1\times 10^{-3} \text{ A/cm}^2$
Charge transfer coefficient (anode)	$\alpha_{an}=0.5$
Charge transfer coefficient (cathode)	$\alpha_{cat}=0.5$
Faraday efficiency	$\eta_f=0.99$
Active cell area	$A_{cell}=160 \text{ cm}^2$
Number of cells	$N_{cells}=12$
Electrode resistivity	$\rho_{el}=7.5 \text{ m}\Omega\text{-cm}$
Electrode thickness	$t_{el}=1.3 \text{ mm}$
Membrane thickness	$t_{mem}=127 \mu\text{m}$
Membrane hydration	$\lambda=22$
Membrane porosity	$\epsilon=0.3$
Membrane permeability	$K_{Darcy}=1.58\times 10^{-18} \text{ m}^2$

Figure 3.10: Cell specific parameters in the PEM HYSYS model [40]

The number of cells must be adjusted to this case since it is thought to serve for large scale production, but the rest of the constant parameters above-shown are totally valid for this case study as it is explained

down below:

- $i_{0,an} = 10^{-10} \text{ A/cm}^2$  and  $i_{0,cath} = 10^{-3} \text{ A/cm}^2$  [41]

For Pt based electrodes, the exchange current densities for the oxygen reduction (anode) and hydrogen oxidation (cathode) reactions are reported to be in the range  $10^{-9}$ - $10^{-12}$  and  $10^{-4}$ - $10^{-3}$  respectively.

- $\alpha_{an} = \alpha_{cath} = 0.5$  [41]

Typical experimental values reported for the charge transfer coefficients at the anode and cathode. Since the conceptual basis of the charge transfer coefficient requires  $\alpha$  less than 1, values greater than one obtained from experiments suggest a faulty analysis model.

- $\rho_{el} = 7.5 \text{ m}\Omega \cdot \text{cm}$  [20]

The normal values of the thickness of current collectors are between 5-10  $\text{m}\Omega \cdot \text{cm}$

- $t_{el} = 1.3 \text{ mm}$  [20]

The normal values of the specific electric resistance of current electrodes are between 0.8–2  $\text{m}\Omega \cdot \text{cm}$ .

- $t_{mem} = 127 \mu\text{m}$  [42]

The low membrane thickness (approximately 20-300  $\mu\text{m}$  thick) is in part the reason for many of the advantages of the solid polymer electrolyte. After the introduction of Nafion, the great majority of studies used the 115 version ( $\frac{1}{1000}$ -inch  $\times 5 = 127 \mu\text{m}$  thickness) or the 117 version ( $\frac{1}{1000}$ -inch  $\times 7 = 177 \mu\text{m}$  thickness) of Nafion membranes.

- $\lambda = 22$  [43]

While in fuel cells it is quite important to evaluate this parameter since the membrane hydration can vary in a large interval, in the case of this PEM electrolyser the whole membrane can be considered fully hydrated, since water is present in huge quantities in the anodic chambers (and also on the cathodic side due to transport phenomena). Usually in such cases the range is assumed to be 14 – 21, but values up to 25 can be assumed.

- $\varepsilon = 0.3$  [42]

A normal range for the current porosity parameter for PEM electrolyzers is 20 – 50%.

### 3.2.3 Compression system

A flow-sheet of the compression model that has been simulated in Aspen HYSYS is shown in Figure 3.11.

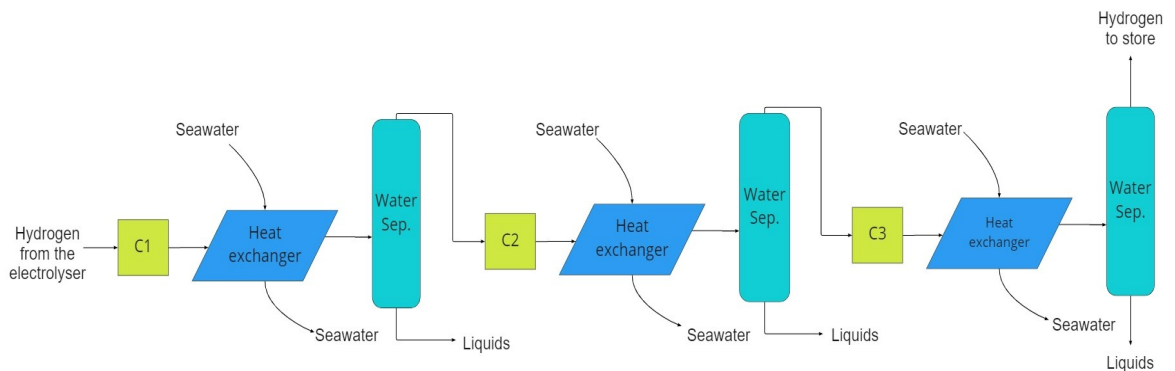

Figure 3.11: Flow-sheet of the simulation of the compression system in Aspen HYSYS

As stated before, in mass basis hydrogen has almost three times the energy content of the gasoline (120 MJ/kg versus 40 MJ/kg). However, hydrogen has lower energy per volume than gasoline, which means that it is needed a higher amount of hydrogen to store the same energy than gasoline. Because of this,

the compression of hydrogen is needed to use it as energy carrier. Another important reason for its compression is the possibility of storing it with the aim of using hydrogen for a later use.

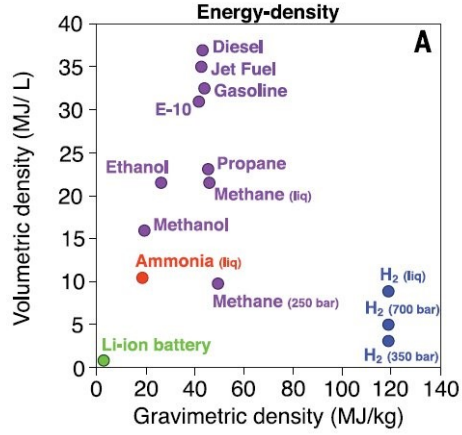

Figure 3.12: Energy density comparison among some fuels [44]

Hydrogen is typically produced at relatively low pressures (20–30 bar or lower) and must be compressed prior to transport. This is why compressors play a critical role in both hydrogen compression and transport. Most compressors used today for gaseous hydrogen compression are either positive displacement compressors (reciprocating) or centrifugal compressors.

According to the national laboratory of the energy department of the United States, after lot of researches and after consulting lot of manufacturers and suppliers of compressors, they came to the conclusion that the most efficient way of compression is done in various stages even if more than one compressor is needed. As stated in Parks et al. review [45], compressor manufacturers expressed concern about the difficulty and undesirability of using one single compressor capable of taking hydrogen from the exit pressure of the electrolyser (around 30 bar) to the storage pressure (around 700 bar). Therefore, they recommend to use separate compressors to reach firstly intermediate pressures and finally the storage one.

For maximum efficiency in multi-stage compression:

1. Air should be cooled to initial temperature after each stage [46]. That is, the closer the process is to isothermal conditions, the lesser is the work required to compress hydrogen [47] and to understand this, the P-V diagram for compression processes can be observed (3.13). In the isothermal process the area is minimum, so less work is required (Equation 3.4).

$$W_{i,i+1} = - \int_i^{i+1} v dP \quad (3.4)$$

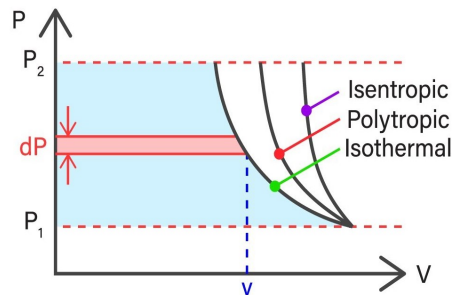

Figure 3.13: P-V diagram for compression processes



- Pressure ratio in each stage should be the same. A multi-stage compressor based on two stages will be used to demonstrate this condition.

In general, the compression processes follow polytropic trajectories in the state space, represented by Equation 3.5.

$$Pv^n = P_1v_1^n \rightarrow v = \left(\frac{P_1v_1^n}{P}\right)^{\frac{1}{n}} \quad (3.5)$$

The specific work required to be done by a two-stage compressor can be formulated parting from Equations 3.4 and 3.5 as shown in Equation 3.6.

$$W = \frac{n}{n-1} \cdot p_1 \cdot v_1 \left[ \frac{p_2^{\frac{n-1}{n}}}{p_1^{\frac{n-1}{n}}} + \frac{p_3^{\frac{n-1}{n}}}{p_2^{\frac{n-1}{n}}} - 2 \right] \quad (3.6)$$

If the intake pressure and the delivery pressure are constant, then the least value of the intermediate or intercooler pressure may be obtained by differentiating the above equation with respect to intercooler pressure. At this value of intercooler pressure, the work required to drive the compressor is minimum.

$$\frac{\delta W}{\delta p_2} = 0 \rightarrow \frac{\delta}{\delta p_2} \left[ \frac{n}{n-1} \cdot p_1 \cdot v_1 \left[ \frac{p_2^{\frac{n-1}{n}}}{p_1^{\frac{n-1}{n}}} + \frac{p_3^{\frac{n-1}{n}}}{p_2^{\frac{n-1}{n}}} - 2 \right] \right] = 0 \quad (3.7)$$

Proceeding as shown in the appendix *Demonstration of the condition for minimum work-done by a two-stage compressor*, the condition for minimum work is given by designing the compressors with the same pressure ratio:

$$p_2 = \sqrt{p_3 \cdot p_1} \quad (3.8)$$

Or, in other words,

$$\frac{p_2}{p_1} = \frac{p_3}{p_2} = \frac{p_3}{p_1}^{\frac{1}{2}} \quad (3.9)$$

- Work done for each stage should be the same. If the pressure ratio should be the same in all the compressors to ensure the minimum work condition, so it happens with the work done for each stage.

Whereas a compressor that can compress gas isothermally does not exist under real conditions, it is possible to use multi-stage compression and cool down the compressed gas after each stage using cooling devices to make the compression as close as possible to the isothermal performance [48], so a heat exchanger will be used after each compression stage as shown in 3.14, which represents a two-stage steady-flow compression with inter-cooling.

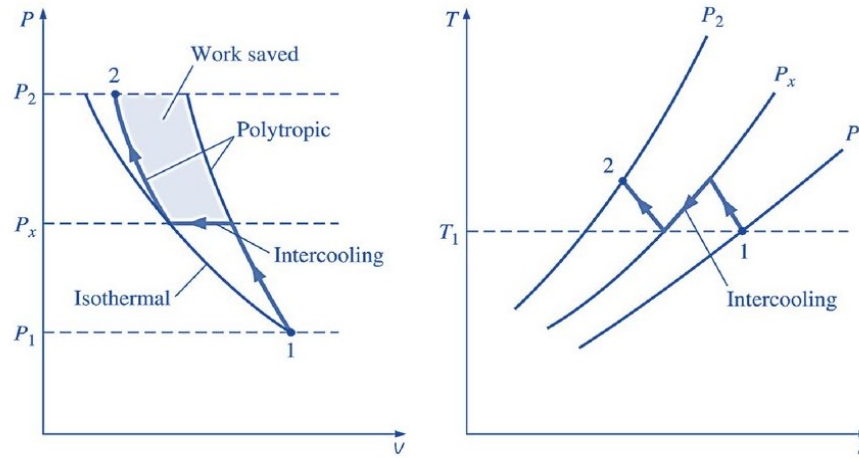

Figure 3.14: P-V and T-S diagram for a two-stage steady-flow compression process

To cool this stream, water from the sea will be used. Once cooled the hydrogen, the water will return to the sea so the maximum temperature that water can reach is limited by an authorization given by the regional government, in which each case is evaluated individually and has now specific maximum values to be used in general. It is known that the energy consumption for water cooling reaches 10-20% of the total energy consumed by the compressor

One important aspect to keep in mind is the fact that liquids must be avoided inside the compressor, so a flash separator vessel will be also used after each heat exchanger to remove the condensates and do not harm the next compressor.

To decide the number of compressors to install, the pressure ratio has to be defined. If all the compressions have the same isentropic efficiency, there exists a formula in engineering that defines the optimal compression ratio [49]:

$$R = \frac{P_2}{P_1}^{\frac{1}{n}} \quad (3.10)$$

Being R the pressure ratio, which is normally between 1.2 and 5,  $P_2$  the required discharge pressure,  $P_1$  the required suction pressure and n the number of stages.

A first approximation can be made assuming a value per stage of 3.5 so as to limit the discharge temperature due to the following temperature limitations:

- Packing life: 121°C to 135°C
- Lube oil degradation: 149°C
- Ignition if oxygen present: 149°C
- Maximum: 177°C to 204°C

$$3.5 = \frac{700}{30}^{\frac{1}{n}} \rightarrow n = 2.51 \quad (3.11)$$

Once obtained the preliminary pressure ratio, that value can be rounded upwards to 3 compressors by reducing the assumed pressure ratio, or down to 2 by increasing it. Taking into account that the lower efficiency for centrifugal compressors is usually associated with pressure ratios of 3 and higher [50], it is preferable to reduce the compression ratio by installing three compressors with a pressure ratio of 2.9.

### 3.3 Cost methods

One of the main factors to decide whether or not to start up an industrial plant is the capital cost estimation, that is, the investment needed to build or expand that plant. During the designing stage of the project, it is very difficult to know the exact quantity of the investment. That is why a cost analysis to get as close to the real value as possible is important to project managers and engineers.

To compare both approaches according to the KPIs explained above, two different methods will be carried out. The first one is analysing the costs by using correlations. Its results will serve to calculate the key performance indicator 'efficiency in terms of energy needed'. The second method is the use of Aspen Process Economic Analyzer tool, which is part of Aspen HYSYS. Its results will serve to calculate the other two KPI, that is, the LCOH and the CO<sub>2</sub> intensity of H<sub>2</sub>.

#### 3.3.1 Cost analysis via correlations

In most cases, authors propose methods that are based on correlations of vendor's commercial data. Some scatter in price data exists due to the possible variations among manufacturers, so the accuracy of the correlations can not be better than 25%. There are five classifications with different level of information needed to classify correlations: detailed estimates, definitive estimates, preliminary estimates, study estimates and order-of-magnitude estimates. In [51] report an example of this classification is shown in matrix form 3.15.

Estimate Class	Primary Characteristic	Secondary Characteristic		
	Percent of project Completion	Purpose of estimate	Methodology	Expected Accuracy range
Class 5	0% to 2%	Concept Screening	Capacity factored, parametric models, judgement, or analogy	L: -20% to 50% H: +30% to +100%
Class 4	1% to 15%	Study or feasibility	Equipment factored or parametric models	L: -15% to 30% H: +20% to +50%
Class 3	10% to 40%	Budget authorization or control	Semi-detailed unit costs with assembly level line items	L: -10% to 20% H: +10% to +30%
Class 2	30% to 75%	Control or bid/tender	Detailed unit cost with forced detailed take-off	L: -5% to 15% H: +5% to +20%
Class 1	65% to 100%	Check estimate or bid/tender	Detailed unit cost with detailed take-off	L: -3% to 10% H: +3% to +15%

Figure 3.15: Cost estimates classification matrix for process industries [51]

Some graphs and correlations are available to calculate power plant equipment cost, however, most are not recent. What is more, manufacturers rarely share their prices, leading to some scatter in the cost value for each equipment. The selected correlations are extracted from a comprehensive cost correlation for BoP equipment conducted by [52]. The database of IHS Markit QUE\$TOR software they have used has been updated in 2020, and their correlations are for various types of equipment such as pumps, heat exchangers, tanks, compressors, air coolers and pressure vessels. Hence, the results of their proposed models will take into account the state-of-the-art technology. On the other hand, the correlations used for the water treatment system has been extracted from [53], who proposed correlations based on a very complete cost database methodology. They collected information from a wide variety of sources such as surveys, reports and published journals. Furthermore, the data collected include information about the plants including location, the technology being used, plant capacity, operating life, availability and water being treated.

The main equipment used in this thesis is shown in Table 3.3. The pumps, the electrolyzers and the air coolers will have the same impact in the costs of both configurations since they are part of the electrolyser system, which is the same in both cases. However, to corroborate this, the air coolers will be also included in the analysis.

Equipment	Modular BoP	Common BoP
MED	1	0
MSF	0	1
Pump	11	11
Electrolyser	5	5
Compressor	15	3
Heat Exchanger	15	3
Air cooler	10	10
Flash separator	25	17

Table 3.3: Quantity of equipment required in the model depending on the approach

### 3.3.2 Aspen Process Economic Analyzer (CAPEX and OPEX)

It is expected that the final cost is mostly increased because of the compressors and the storage tank. A first approach will be analyse without considering the storing system.

In the research developed by [51], they compare the capital cost estimation software ACCE available in AspenTech (Aspen Capital Cost Estimation) with methods proposed by Turton and also Towler and Sinott. The study compares ten types of equipment, including various types of mixers, pumps, heat exchangers, compressors and pressure vessels.

When comparing the results to ACCE, the cost trend of Towler and Sinott's method was the highest of the other two methods. This may be due to different contributors to cost and also how these contributors are accounted for. However, in some equipment analysis the cost trend obtained in ACCE is the highest one, so it can be assumed the three methods are balanced. It is also worth noticing that stainless steel is four times more expensive than steel according to MEPS International (an independent supplier of steel market information and trends [54]), so it is expected to see an increase in price from carbon steel to stainless steel.

Looking at the cost capacity per unit graphs in [51], it should be noted that as capacity increases, the price per unit decreases, and in some cases the cost per unit capacity starts to increase again.

When the design pressure increases (compressor number three of the simulations), some adjustments must be done, especially for wall thickness. This will lead to an increase of price, because the thicker is the wall the higher is the amount of material needed to fabricate the vessels. For this reason, a sensitivity analysis will be developed to observe the variation of the cost when varying the final pressure.

All in all, the trend of the three methods is very similar, so the use of any of them will provide similar results. Hence, Aspen Process Economic Analyser (predecessor of ACCE) is selected to study the capital investment, which is designed to generate both conceptual and detailed estimates. Economics in Aspen involves two software systems: The process simulator (Aspen HYSYS) and the economic evaluation software (Aspen Capital Cost Estimator). According to AspenTech, ACCE is a model-based estimator which employs a "sophisticated volumetric" model to prepare detailed lists of costs of process equipment and bulk materials. They ensure that their models have been tested and improved over the time taking into account feedback of some organizations that have used the software.

### 3.4 Sensitivity analysis

There is a part of the hydrogen stream produced that will be directly sent to the refinery and the rest will be stored. However, both streams are being compressed for this analysis, even though the storing of the stream that goes to the refinery is not being taken into account.

Hence, part of the hydrogen produced will be directly sent to the desulphurization process of the refinery and the hydrogen left will be stored in tanks for a certain period with the aim of providing autonomy to the refinery during some days. Three different scenarios will be considered as a function of the days of autonomy provided to the plant: 5 days, 10 days or 15 days of autonomy. After this period, it will be sent to the refinery.

Now an analysis to study how does the cost vary at different levels of polytropic efficiency and at different pressures of storing hydrogen will be developed. The storage of hydrogen is calculated depending of the days of autonomy required in each scenario as shown later on.

#### 3.4.1 Hydrogen compression system

The same energy will be needed if the polytropic efficiency of the compressors of both approaches is the same, so the second KPI proposed, that is, the efficiency in terms of energy required, would be the same. Since the compressors in both approaches are designed using the parameters mentioned in Section 3.2.3, different polytropic efficiencies will be selected to analyse the costs involved for the case of the correlations.

There are several parameters that affect the polytropic efficiency of the compressor, being the most important the pressure ratio. It also depends on the gas that is being compressed, because it changes the polytropic exponent and the engine running speed. However, it is reasonable to choose a range between 70% and 90% as it is stated in [55].

Thanks to the scale up factor, it is expected that the compressors of the common BoP will have a better performance than the ones of the modular BoP, so the analysis will be carried out considering a 5%

higher efficiency for the common configuration in each case. The four different scenarios that will be analysed are shown in Table 3.4.

	Case 1 (%)	Case 2 (%)	Case 3 (%)	Case 4 (%)
Modular BoP	70	75	80	85
Common BoP	75	80	85	90

Table 3.4: Different scenarios for the polytropic efficiency of the compressors depending on the configuration of the plant

The previous scenarios will be analysed for the four different pressures of compression.

### 3.4.2 Hydrogen storage system

There are several methods to store hydrogen, being the most widespread one the gas under pressure. It consists of tanks with operating pressure range from 150 to 800 bar (see 3.16).

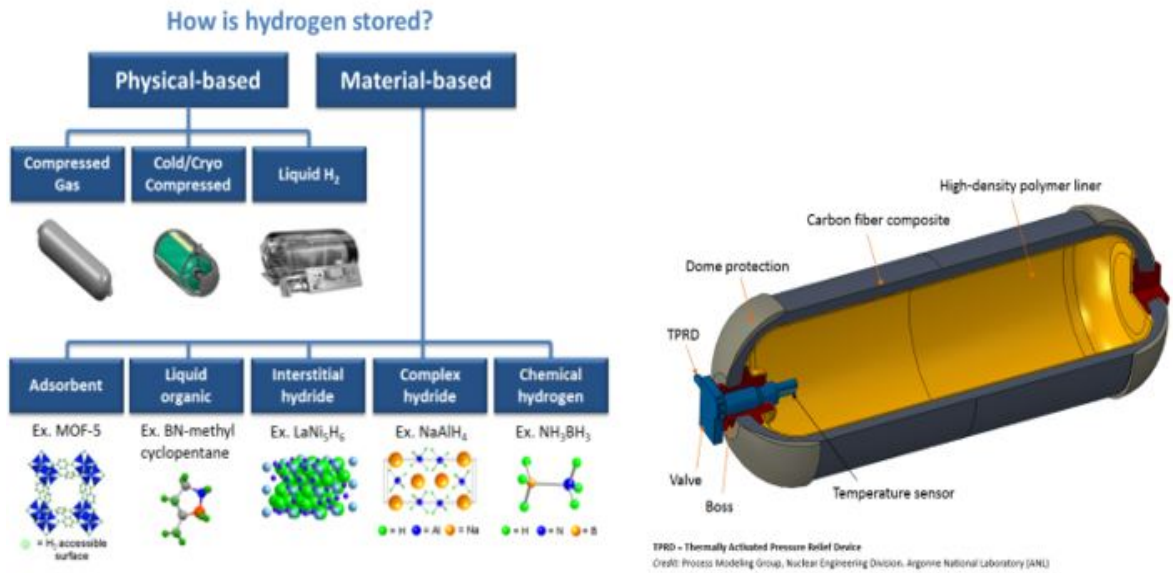

Figure 3.16: Storing hydrogen tank sketch (left) and compressed gas vessel structure (right)

Even though the pressure vessels are the most expensive option among the compressing technologies available in the market, they are the ones that better fit in this case as shown in Figure 3.17.





Criteria	Compressed			
	Storage vessels			Geological storage
	Wind turbine tower	Pressure vessels	Underground pipes	
Storage size (GWh)	Up to 0,031 per 82 m tall WT	0,034	2,15	>10-100 Depends on the site nature
Cost				
Technology maturity For NG	N/A	✓	✓	✓
Technology maturity For H <sub>2</sub>	×	✓	Exist but not on large scale	×
				

Figure 3.17: Comparison among the main hydrogen storage technologies [47]

Hydrogen is normally compressed at ambient temperature and the storage vessels are classified depending on its fabrication materials and the maximum pressure allowed as shown in the following table:

Tank type	Allowed pressure (bar)	Characteristics
Type I. Steel or Aluminium (seamlessly and without coating)	150-300	Very heavy and with thicker walls. Used mainly in vehicles of natural gas compressed and in stationary industrial applications
Type II. Metallics seamlessly wrapped up in fiberglass and resin	450-800	Very heavy. Used mainly as intermediate tanks for stationary applications
Type III. Seamlessly aluminium coating wrapped up in fiberglass and resin composites	350-700	Lighter and with thinner walls. Used mainly in mobility applications and to transport hydrogen in trailers
Type IV. Non-metallic coating wrapped up in polymer fibre and coating		

Table 3.5: Different types of tanks to store hydrogen

Type II is selected for this case, since it is the one that fits better the scope of the thesis (integrating the hydrogen in the chemical processes of the refinery). Hence, four different pressures will be considered to see the variation in the costs: 350, 575, 700 and 800 bar.

The next step is sizing the tank. To do that, the subsystem after the three compression stages must be explained. When the hydrogen leaves the compression stage, it will be split into two streams: the main one who goes directly to the desulphurization process of the refinery (around the 70% of the hydrogen produced) and the secondary one who goes to the tank (around the 30% left).

The products produced in the Repsol refinery of Cartagena depends on the demand, prioritizing one product or another as a function of the requirements. Altogether the complex provides 11 million of tons per year, that is 31.000 kg per day approximately. Taking crude petroleum as reference, it can be considered a weight percentage of 0.31% of sulfur, that is, 930 kg of sulfur have to be removed per day.

When looking at the storage tanks that are commercially available, the multi-functional layered stationary hydrogen storage vessels (MSLV) is the more suitable for this case. Its basis structure is based on two main components: a flat steel ribbon wound cylindrical shell and two double-layered hemispherical heads where the cylinder shell is composed of three shells (inner, layered, and a protective shell). The configuration is systematized in order to keep the high pressure hydrogen in direct contact with austenitic stainless steel. One of the main advantages of the MSLV is the feasibility for manufacturing large-scale hydrogen storage vessels at high pressure without restrictions on size. Furthermore, as the inner diameter increases, the manufacturing process results more manageable, which leads to a better efficiency in the manufacture [47]. Another advantage is that it is not prone to hydrogen embrittlement. The cladding layer material of the steel used in the inner shell is 316L stainless steel, which is compatible with hydrogen at ambient temperature and high pressure.

Even though theoretically there are no restrictions in the design parameters, the manufacturing of MSLV is restricted by the available winding machines capacities [56]. The following design specifications were identified by the Chinese National Standard: maximum operating temperature of 100 MPa, inner diameter up to 15m, and maximum length of 30m. According to some authors, MSLVs can be manufactured with design pressures between 200-980 bar and with volumes between 0.5-25 m<sup>3</sup> [57]. Considering the maximum volume available for this type of tanks (25 m<sup>3</sup>) for the common BoP and the fifth part (5 m<sup>3</sup>) for the modular BoP, and knowing that the density of hydrogen varies as a function of its pressure as shown in Equation 3.12 the four densities for the study are shown in Table 3.6.

$$\text{Density of } H_2 = 0.08707 \cdot P \text{ (kg/m}^3\text{)} \quad (3.12)$$

Multiplying each pressure by the constant of Equation 3.12 the density of hydrogen is obtained, which multiplied by the volume of the tank (25 m<sup>3</sup>) provide the quantity of hydrogen that can be stored in each scenario (see **Capacity of the tank** in Table 3.6).

Pressure (bar)	Density (kg/m <sup>3</sup> )	Capacity of the tank (kg of H <sub>2</sub> in 25 m <sup>3</sup> )	Capacity of the tank (kg of H <sub>2</sub> in 5 m <sup>3</sup> )
350	30.47	762	153
575	50.07	1,252	251
700	60.95	1,524	305
800	69.66	1,742	349

Table 3.6: Capacity of each tank as a function of the density of hydrogen depending on the pressure

The approximate costs for storing hydrogen at 860, 430 and 160 bar are 600, 450 and 350 \$/kg of H<sub>2</sub>, respectively [57]. Considering that values and the capacity of the tanks, the price of each one can be obtained as shown in Table 3.7.

Pressure (bar)	Price (\$/kg of H <sub>2</sub> )	Capacity in 25 m <sup>3</sup> (kg of H <sub>2</sub> )	Final price (\$)	Capacity in 5 m <sup>3</sup> (kg of H <sub>2</sub> )	Final price (\$)
350	420.37	762	320,321.94	153	64,316.61
575	500.58	1,252	626,726.16	251	125,645.58
700	544.18	1,524	829,330.32	305	165,974.90
800	579.07	1,742	1,008,739.94	349	202,095.43

Table 3.7: Final cost of each tank depending on the pressure and the capacity

Considering the three periods of autonomy and the different pressures, the number of tanks needed for each case can be calculated by dividing the quantity of hydrogen (see **Quantity of hydrogen needed** in Table 3.8) by the capacity of each tank depending on the pressure (see **Capacity of the tank** in Table 3.6). The results are shown in Table 3.8.

Days of autonomy	Quantity of hydrogen needed (kg of H <sub>2</sub> )	Pressure (bar)	Number of tanks (common BoP)	Number of tanks (modular BoP)
5	4,650	350	7	30
		575	4	18
		700	4	15
		800	3	14
10	9,300	350	13	60
		575	8	38
		700	7	31
		800	6	27
15	13,950	350	19	92
		575	12	56
		700	10	46
		800	8	40

Table 3.8: Number of tanks needed depending on the pressure of storing

By changing the storing pressure, different pressure ratios for the compression system are required as shown in Table 3.9. As stated in Section 3.2.3, it is preferable having the same pressure ratio for all the compressors since it provides the minimum specific work required. Again, considering three stages and an initial pressure of 30 bar, the pressure ratio will be calculated as shown in Equation 3.13.

$$R_i = \frac{P_2^{\frac{1}{3}}}{P_1} \quad (3.13)$$

Storing pressure (bar)	Pressure ratio
350	2.27
575	2.68
700	2.90
800	2.99

Table 3.9: Pressure ratios of the compressors depending on the storing pressure

Before proceeding with the analysis, it is necessary to verify the reliability of the costs obtained. To do so, the storage system cost analysis developed by Ahluwalia et. al (2012) [58] and the lower heating value of hydrogen will be used. As stated in Ahluwalia's analysis, for a 350 bar compressed hydrogen system, it is expected to have a storing cost of 16 \$/kWh for approximately a week of storing. Considering that the lower heating value of hydrogen is 33.6 kWh/kg, and that for 5 days (a bit less than a week) of autonomy at 350 bar (that is, 4,650 kg of H<sub>2</sub>) there are needed 7 tanks for the common BoP and 30 tanks for the modular one as shown in Table 3.8, the reliability of the costs obtained can be checked as follow in Equations 3.14, 3.15, 3.16, 3.17 and 3.18.

#### Specific power of hydrogen

$$4,650 \text{ kg of H}_2 \cdot 33.6 \text{ kWh/kg of H}_2 = 156,240 \text{ kWh} \quad (3.14)$$

#### Costs depending on the configuration

- Common BoP (7 tanks)

$$\frac{320,321.94\$}{156,240 \text{ kWh}} = 2.05 \text{ \$/kWh} \quad (3.15)$$

$$2.05 \text{ \$/kWh} \cdot 7 \text{ tanks} = 14,35 \text{ \$/kWh} \quad (3.16)$$



- Modular BoP (30 tanks)

$$\frac{64,316.61\$}{156,240kWh} = 0.42 \$/kWh \quad (3.17)$$

$$0.42 \$/kWh \cdot 30 \text{ tanks} = 12,35 \$/kWh \quad (3.18)$$

As it is observed, both values are very close to the reference one (16 \$/kWh), so the reliability of the results can be approved.

# Chapter 4

## Costs analysis

### 4.1 Correlations

The correlations will be used to compare both approaches based on the second KPI explained in Sub-section 3.1.3, that is, efficiency in terms of energy needed by the compressors to produce the necessary pressure to compress hydrogen.

#### 4.1.1 Capital investment for the water treatment system

The equipment to treat the water before being introduced into the electrolyser is different depending on the approach. In [53] they developed the Equation 4.1, that is, a power law model which shows the relation between capital cost and plant capacity for water treatment.

$$\ln(CapitalCost) = m \times \ln(Capacity) + Constant \quad (4.1)$$

Where the m exponent and the constant depend on the technology as shown in Table 4.1.

Technology	Exponent, m	Constant, C	R <sup>2</sup>
ED	0.75	3.88	0.655
SWRO	0.81	4.07	0.907
BWRO	0.74	3.95	0.814
MSF	0.70	4.86	0.718
MED	0.83	4.13	0.880

Table 4.1: Water treatment correlation's parameters depending on the technology based on [53]

#### Multi-effect distillation (MED)

In the first approach, that is, the individual BoP for each electrolyser's stack, a MED technology is used whose correlation is shown in Equation 4.2.

$$\ln(CapitalCost) = 0.83 \times \ln(Capacity) + 4.13 \quad (4.2)$$

#### Multi-stage flash distillation (MFS)

In the second approach, that is, a common BoP for all the electrolyser's stack, a MSF technology is used, whose correlation is shown in Equation 4.3.

$$\ln(CapitalCost) = 0.70 \times \ln(Capacity) + 4.86 \quad (4.3)$$

### 4.1.2 Capital investment for the compressors

For the compressors equipment, they have also evaluated and compared several models to find the most suitable one (blue curve in Figure 4.1).

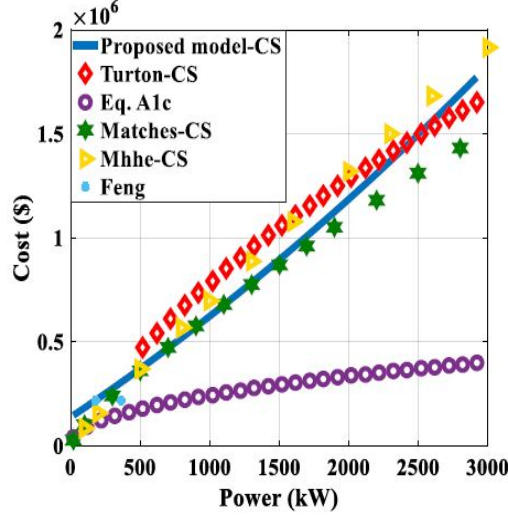

Figure 4.1: Centrifugal compressor cost against power for different models [52]

The general form for the compressor cost correlation is shown in Equation 4.4.

$$C = \log(\dot{W}_{comp}) + a \cdot (\dot{W}_{comp})^2 + b \cdot \dot{W}_{comp} + c \quad (4.4)$$

Where a,b and c coefficients depend on the compressor type as shown in Table 4.2.

Compressor type	a	b	c	R <sup>2</sup>
Centrifugal	0.03867	446.7	$1.378 \cdot 10^5$	0.99
Reciprocating	0.04147	454.8	$1.81 \cdot 10^5$	0.96

Table 4.2: The coefficients of Equation 4.4 for both compressor types based on [53]

Since the centrifugal compressor is used, the corresponding correlation is shown in Equation 4.5.

$$C = \log(\dot{W}_{comp}) + 0.03867 \cdot (\dot{W}_{comp})^2 + 446.7 \cdot \dot{W}_{comp} + 1.378 \cdot 10^5 \quad (4.5)$$

### 4.1.3 Capital investment for the heat exchangers

The heat exchanger could have two configurations: Shell-and-Tube or Flat Plate. The simulation has been modeled using the shell-and-Tube configuration since many additional correlations has been compared in [52] to find the proposed model (blue curves in Figures 4.2 and 4.3).

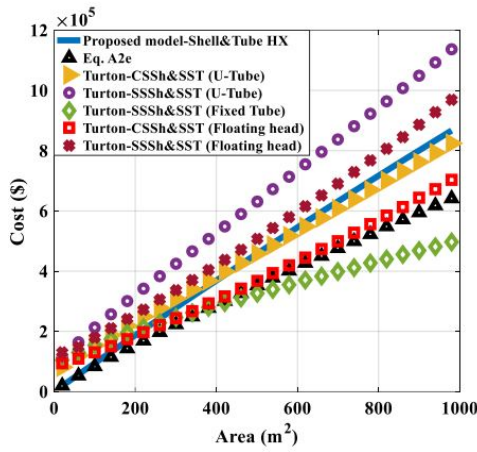

Figure 4.2: Shell-and-tube heat exchanger cost against the area 1

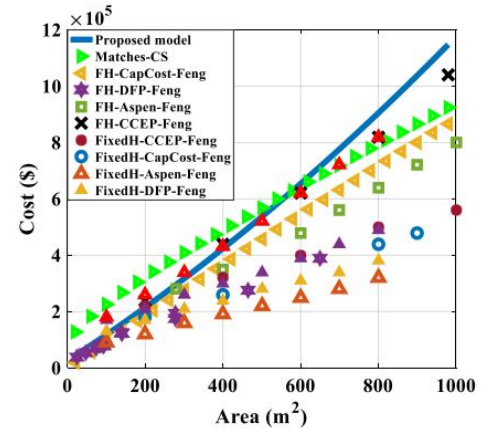

Figure 4.3: Shell-and-tube heat exchanger cost against the area 2

The general correlation for the proposed model is shown in Equation 4.6.

$$C = \log(A) + a \cdot (A)^2 + b \cdot A + c \quad (4.6)$$

Being  $A$  the heat exchanger area in  $m^2$  and  $C$  the cost in \$, and the values for the parameters  $a$ ,  $b$  and  $c$  depending on the configuration are shown in Table 4.3.

Heat exchanger Type	$a$	$b$	$c$	$R^2$
Shell & Tube	-0.06395	947.2	227.9	0.98
Flat plate	0.2581	891.7	$2.605 \cdot 10^4$	0.96

Table 4.3: The coefficients of Equation 4.6 for both configurations based on [53]

Hence, the proposed correlation is shown in Equation 4.7.

$$C = \log(A) - 0.06395 \cdot (A)^2 + 947.2 \cdot A + 227.9 \quad (4.7)$$

#### 4.1.4 Capital investment for the air coolers

Basing on the comparison among several correlations, the proposed model by [52] follows the growing trend of Eq. A2e and Eq. A3f, being the Turton correlation model. On the other side, Matche's correlations are slightly higher due to the fact that they include stainless steel. As before, the proposed model is shown in blue curves in Figures 4.4 and 4.5.

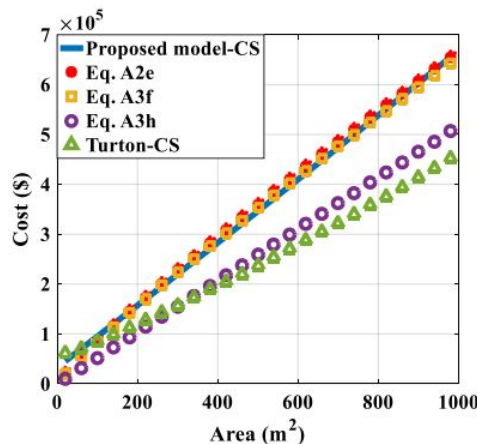

Figure 4.4: Air cooler cost against area 1

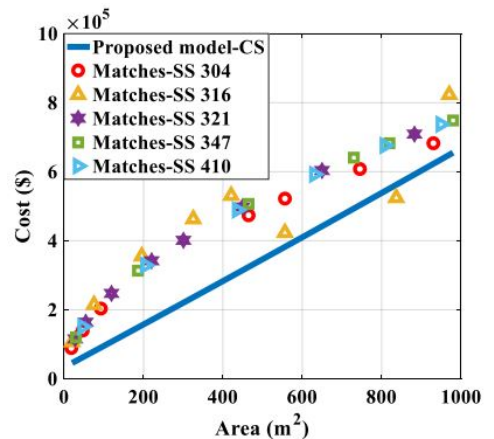

Figure 4.5: Air cooler cost against area 2

The general form of the generated cost correlation is the same for the heat exchanger based on the area of the air cooler Equation 4.8.

$$C = \log(A) + a \cdot (A)^2 + b \cdot A + c \quad (4.8)$$

Being A the air cooler area in m<sup>2</sup> and C the cost in \$, and the values for the parameters a, b and c are shown in Figure 4.4.

Equipment	a	b	c	R <sup>2</sup>
Air cooler	0.01764	617.4	$3.31 \cdot 10^4$	0.95

Table 4.4: The coefficients of Equation 4.8 for both configurations based on [53]

Hence, the proposed correlation is shown in Equation 4.9.

$$C = \log(A) + 0.01764 \cdot (A)^2 + 617.4 \cdot A + 3.31 \cdot 10^4 \quad (4.9)$$

The total cost of storing hydrogen is expected to be quite high, so to reduce the costs involved an amount of hydrogen will be fixed as the maximum one to store and the rest will be sold. In this way, the selling cost of the hydrogen should be subtracted to the storage tank price.

#### 4.1.5 Analysis of the operating expenses

The operating expenses include all those expenses that a business incurs through its normal business operation. They often include rent, inventory costs, marketing, payroll, insurance, step costs and fund allocated for research and development among others.

The indirect costs and the costs related to the maintenance and operation have to be estimated based on previous research as shown in Tables 4.5 and

Indirect costs	Value (% of total capital investment)	Reference
Site preparation	5%	[59]
Engineering design	10%	[59]
Project contingency	5%	[59]
On-time licensing fee	0.1%	[59]
Up-front permitting cost	3%	[59]
Install factor	1.2-1.3%	[59]

Table 4.5: Install factor and other indirect costs based on [27]

Operation and maintenance costs	Value (% of total capital investment)	Reference
Labor cost	5%	[60]
Electrolyser maintenance cost	1%	[59]
Compressor maintenance cost	4%	[59]
Storage maintenance cost fee	1%	[59]
Electrical maintenance cost	1%	[59]
Insurance	1%	[59]
Property tax	1%	[59]
Licensing and permits	0.1%	[59]

Table 4.6: Estimation of the operation and maintenance costs of the hydrogen production system based on [27]

## 4.2 Aspen Process Economic Analyzer

The tool to analyse the costs in Aspen HYSYS will be used in order to compare both approaches basing on the LCOH and in the CO<sub>2</sub> intensity of H<sub>2</sub>. As stated in Section 3.3.2, the software contains the

data of state-of-the-art technology and it is only necessary to introduce the parameters for the hydrogen production application that have been explained in the Section 3.

# Chapter 5

## Results and discussions

Results are presented for the different scenarios above to assess the feasibility of a common BoP instead of a modular one. The storage of hydrogen is expected to be the most expensive part of the plant, so for the first analysis it is not taken into account.

Firstly, an analysis using correlations will be carried out. The sensitivity analysis regarding the polytropic efficiency of the compressors will be developed in this section, as well as the comparison of the results according the efficiency in terms of energy needed. In this case, the storage will not be considered.

Secondly, an analysis based on different scenarios using Aspen HYSYS will be carried out so as to obtain conclusions in terms of the CO<sub>2</sub> intensity of H<sub>2</sub> and in the levelized cost of hydrogen. For this case, the storage will be considered in the last studies.

### 5.1 Validation of the model

The validation of the Aspen HYSYS model has been one of the main limitations. In spite of having done an effort to design the model as realistic as possible and having carried out a consistent literature review, the lack of experience using this software and the very low availability of PEM electrolyzers' models, which are still in an early stage of development, have been an hindrance to validate the results.

In this section, the challenges that had to be faced during the development of the thesis are going to be presented.

#### 5.1.1 Validation challenges

The chemical process that has been simulated requires the use of many parameters and properties that have to be carefully chosen according to the application, and not all of them have enough information in reliable scientific articles to be pretty sure about the choice. This has led to the assumption of some values that may provoke some scatter in the results.

The unavailability of equipment prices has also been a big limitation to contrast the results of ACCE in HYSYS. That is why some correlations are being utilized before proceeding with the results of the software, so as to have an overall idea of the orders of magnitude.

- PEM electrolyser stack

A model for PEM electrolyzers was found in AspenTech web page, however, it only serves to produce an small amount of hydrogen. The AspenTech support has been contacted to corroborate that there are not other models more suitable for this thesis, and they said they are currently working on a more general one. All in all, that model is the only one available so far, so it has been used in this simulation. On this note, to adapt it in order to produce the necessary amount of hydrogen it has been necessary to include a black box that scales it up until the desired flow rate. The problem of this solution is that the equipment that are part of the electrolyser system are designed as if they treat those streams to produced the small amount of hydrogen and not the

desired one, so it will lead to a non-realistic result. However, since the stacks will be exactly the same in both configurations, the scope of the thesis can also be achieved in this way. In case of having more time to develop the thesis, a PEM model would have been simulated from scratch using some tool such as MATLAB or HYSYS.

- Seawater simulation

Since seawater has been chosen not only for the electrolysers' stacks but for the refrigeration of the stream of hydrogen as well, it has to be necessary to simulate it in Aspen HYSYS. Some versions of the software do not allow to introduce components with electrolytes (NaCl in case of salt water), so the streams of seawater has been simulated using the hypothetical components tool. To do so, an average density and molecular weight have been assumed taking the surface of the sea as reference (that is, 0 m of depth) since the closer to the surface is the suction of the water, the lesser the costs will be.

- Simulation of the water treatment system

Since the water treatment system does not considerably affect to the final price, a black box has been used to model it following the suggestions of the professor Jaime García Lora<sup>1</sup>.

- Choice of the cost correlations

During the research, many different correlations were found to estimate the costs for the BoP equipment. However, in the majority of cases the data used to propose the models was old, and considering that the application of PEM electrolysers at large scale is an idea that came up recently, the aim was to find the more recent correlations. It has also been considered important to use models proposed by the same author so as to have all of them done according to the same assumptions. On this basis, the article that has been eventually selected is not only because it compares a lot of correlations from previous works but also because it has been published in 2021. This article does not have a correlation for all the equipment used in this simulation, however, it does have correlation for those that are relevant for the study (i.e. compressors).

- Results of the costs analysis

The results of HYSYS and correlations' analysis will differ because different equipment are being considered depending on the method used (compressors, coolers, pumps, heat exchangers and separator vessels in ACCE analysis; and compressors, water treatment system, heat exchangers and coolers in the correlations). As stated before, the reason is that not all the equipment have a correlation model proposed in the selected article. However, the compressors are included in both analysis, which is the most important equipment for the storing of hydrogen.

Also, in the correlations' analysis, as it has been stated in Section 3.3.1, there are only being considered those equipment that differ considerably between modular and common BoP. The pumps, the electrolysers and the air coolers will have the same impact in the costs of both configurations since they are part of the electrolyser system, which is the same in both cases. However, to corroborate this, the air coolers will be also included in the analysis. Finally, for the study using the correlations, a pressure of compression of 700 bar is being considered. The rest of scenarios will be analysed utilizing HYSYS.

- Accuracy of the costs analysis

In Figure 3.15 of Chapter 3 it has been shown a classification matrix of the methodology used, providing a level of accuracy depending on the characteristics. This work could be classified as Class 4 or Class 5, which means that it has a completion around 0-15% and the level of accuracy can be classified from -20% to 50%. An effort has been done to create a case study as realistic as possible, but it is still an hypothetical scenario which possible uncertainties.

### 5.1.2 Conclusions for the validation of the model

Considering all the reasons given, it can be concluded that the validation of the model is not possible. However, a huge effort was made to design all the equipment according to the scientific research done

---

<sup>1</sup>An efficiency of 45% has been considered to know the amount of water needed to treat



previously. Also, all the assumptions that ACCE considers to provide a cost of each equipment have been carefully studied and adapted to guarantee the highest reliability of the results. As stated before, the results of the correlations will be used as a reference to compare the ones obtained with Aspen HYSYS, and the KPIs will be also compared to other research so as to ensure the truthfulness of the outcomes.

## 5.2 Results of the correlations

When using the correlations only the equipment cost (CAPEX) is being considered, that is, the electrical connection, the installation cost and the indirect costs are not taken into account. For that reason the operating expenses (OPEX) have to be estimated as shown in Tables 4.2 and 4.3.

In the Figure 5.1 it is corroborated how using a common BoP can reduce the costs involved. In particular, the CAPEX of the electrolysis plant without considering the storage and the compressors is dominated by the water treatment system, which can represent approximately the 39% of the total investment costs. For this equipment, there is a reduction in the cost of around 112.000 € in the case of the common BoP. As stated in [53], MSF is usually slightly more expensive than MED, however, for large scale plants the cost approaches one another. For this case, the results of MSF are more economically feasible than MED.

In the case of the heat exchangers the price is slightly lower in the common configuration. The common plant has three big heat exchangers, whereas the modular one has fifteen small ones. The reason of the cost reduction is that the manufacturing of three heat exchangers with a heat transfer area of 47.59 m<sup>2</sup> each one, that is, a total heat transfer area of 142.78 m<sup>2</sup> when considering the three of them, is cheaper than the manufacturing of fifteen small heat exchangers with an individual heat transfer area of 10.17 m<sup>2</sup> and a total one of 152.58 m<sup>2</sup> approximately. Despite the advantage of standardization when manufacturing lot of small equal devices, the total material that has to be used is less in the case of the common configuration, and that is the main reason of requiring a lower investment.

As stated before, the air cooler system remains exactly in both approaches because it is only being used in the electrolyser system, which is the same.

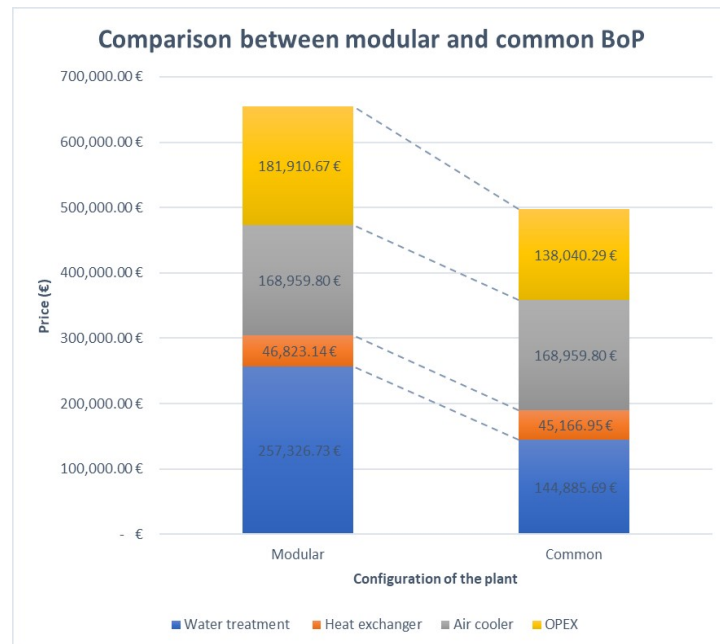

Figure 5.1: Comparison of the prices involved in a modular BoP versus in a common BoP

For the case of the compressors, the sensitivity analysis changing the polytropic efficiency was carried out. Depending on the efficiency and the pressure of compression, different specific energy is required as shown in Table 5.1. One of the main reasons of analysing a common configuration is that the performance

of the whole plant is expected to increase. On this note, the efficiency of the compressors is supposed to be higher in the common BoP than in the modular because of the scaling up factor, so a difference of 5% is considered in each study.

	70 %	75 %	80 %	85 %	75 %	80 %	85 %	90 %
350 bar	2205 kW	2025 kW	1875 kW	1755 kW	2034 kW	1887 kW	1761 kW	1650 kW
575 bar	2745 kW	2520 kW	2340 kW	2175 kW	2529 kW	2343 kW	2181 kW	2040 kW
700 bar	3015 kW	2775 kW	2565 kW	2385 kW	2775 kW	2568 kW	2388 kW	2232 kW
800 bar	3120 kW	2865 kW	2655 kW	2460 kW	2874 kW	2655 kW	3469 kW	2307 kW

Table 5.1: Specific energy required for each configuration (modular BoP in the left side and common BoP in the right side) depending on the pressure of compression and the polytropic efficiency

The utilization of three big compressors rather than multiple smaller ones results not only in lower specific energy needed but also in a saving in costs as shown in Figures 5.2, 5.3, 5.4 and 5.5. Many people wrongly assume that the most expensive part of buying a compressor is the purchase of the equipment. However, when time goes by, the electricity to make the compressor work is way more expensive. Orders of magnitude can be found in many different articles such as in [61], which gives the following costs percentages:

- Equipment and installation: 12%
- Maintenance: 12%
- Electricity to work: 76%

Since more energy is needed for the modular approach, that is one of the reasons that makes the cost higher for this configuration. Also, using a common compressor requires less space than many smaller ones, which could be an important factor depending on the industrial complex. Another important factor that increases the cost of a compressor are the losses. There are many different efficiencies to evaluate these losses and that provide more reasons why the common BoP is more efficient:

1. Mechanical efficiency. This parameter considers losses such as the intern friction one. The lower the stream is in contact with the walls of the compressor, the lower the losses because of friction stream-wall will be. Indeed, that is what happens in a common configuration, in which the largest share of the hydrogen is kept in the core of the compressor instead of in the boundaries.
2. Volumetric efficiency. Losses such as leakages through the valves or re-expansion of the refrigerant gas inside the compressor make up this group. These losses depends on the pressure ratio and on the operating temperature, and that is one of the reasons why the price in the compressor increases when increasing the pressure of compression.
3. Electric efficiency. These losses take place in the electric engines, being the largest share of them losses in the copper due to the Joule effect. More efficient designs use electrical conductors with higher diameters, which requires more space inside the compressor.
4. Thermal efficiency. The high temperature of compression causes the dissipation of heat through the body and the walls of the compressor. The admission temperature determine the density of the stream, and the cold stream requires less energy to compress. Because of this, a multi-stage compressor with inter-cooling after each compression was chosen. However, these losses still exist to a greater or lesser extent, and that is another plus for the common configuration.

All in all, and as it has been previously stated, it has been assumed an increase of 5% in the efficiency of the common compressors since they will be specifically designed for this electrolyser plant (scaling up advantage), unlike the modular compressors that will be directly selected from the industrial market. That is, the bigger compressors have to be tailored-made and the smaller ones are already available in the market, and this implies that the common configuration provides a better performance with lower

costs involved. Furthermore, it is also preferable to consume as less energy as possible due to the current fluctuations in the price of electricity, that has been considerably increasing lately.

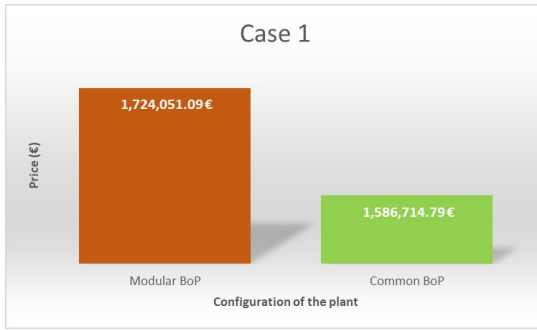

Figure 5.2: Case 1. Cost of the compressors depending on the configuration at 350 bar

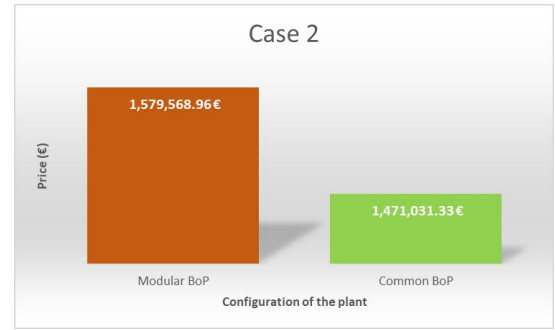

Figure 5.3: Case 2. Cost of the compressors depending on the configuration at 350 bar

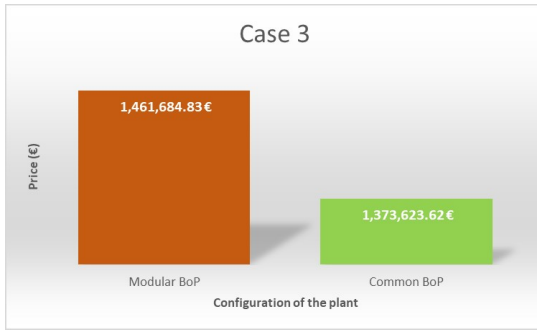

Figure 5.4: Case 3. Cost of the compressors depending on the configuration at 350 bar

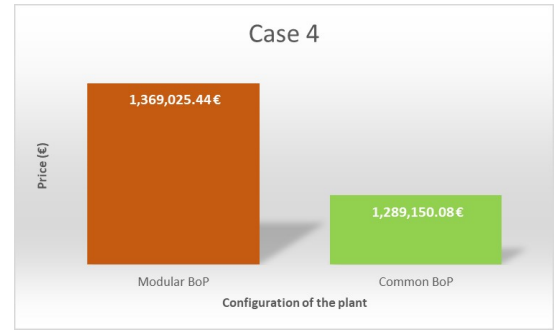

Figure 5.5: Case 4. Cost of the compressors depending on the configuration at 350 bar

The representation of the KPI number two, that is, the efficiency in terms of energy needed in the compressors is shown in Figure 5.6. As it is expected, there is a decreasing trend in the graphic because the higher the efficiency is, the lower the energy needed will be to get the same results. Among the four scenarios, there is not a big difference because only 5% of difference has been considered between the efficiency of the modular and common configuration. These results can not be compared with existing data since the energy that has been taken into account is only the one needed by the compressors, and the largest share of research usually consider the whole energy of the plant. However, even though these values are too small, it serves to visualize how it decreases when increasing the efficiency, which is the aim of the sensitivity analysis.

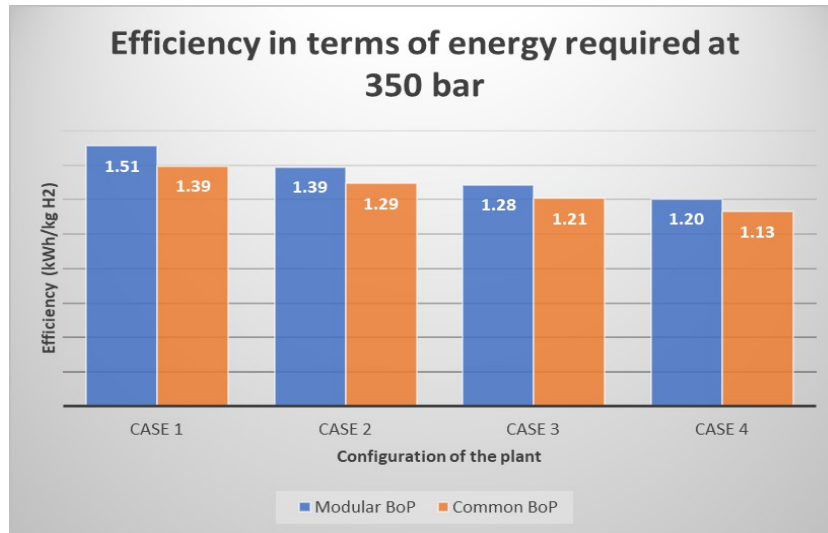

Figure 5.6: Efficiency in terms of energy needed at 350 bar in the four different scenarios

The trend is the same for the different pressures of compression, that is, the common configuration provides lower costs, so the results of the other scenarios will be shown in Tables 5.2, 5.3 and 5.4.

	Modular BoP €	$\varepsilon_{H_2}$ (kWh/kgH <sub>2</sub> )	Common BoP €	$\varepsilon_{H_2}$ (kWh/kgH <sub>2</sub> )
Case 1	2,177,272.51	1.88	1,992,424.44	1.73
Case 2	1,984,825.43	1.73	1,837,052.74	1.60
Case 3	1,834,575.59	1.60	1,704,596.38	1.49
Case 4	1,699,741.86	1.49	1,591,483.25	1.40

Table 5.2: Cost of the compressors depending on the configuration for the four different scenarios at 575 bar

	Modular BoP €	$\varepsilon_{H_2}$ (kWh/kgH <sub>2</sub> )	Common BoP €	$\varepsilon_{H_2}$ (kWh/kgH <sub>2</sub> )
Case 1	2,415,006.65	2.07	2,203,321.21	1.90
Case 2	2,203,321.21	1.90	2,025,448.69	1.76
Case 3	2,022,902.87	1.76	1,874,319.95	1.64
Case 4	1,871,829.06	1.63	1,746,007.68	1.53

Table 5.3: Cost of the compressors depending on the configuration for the four different scenarios at 700 bar

	Modular BoP €	$\varepsilon_{H_2}$ (kWh/kgH <sub>2</sub> )	Common BoP €	$\varepsilon_{H_2}$ (kWh/kgH <sub>2</sub> )
Case 1	2,509,461.50	2.14	2,289,931.48	1.97
Case 2	2,282,016.62	1.96	2,099,675.71	1.82
Case 3	2,099,675.71	1.82	1,941,920.02	1.69
Case 4	1,934,375.95	1.68	1,807,387.29	1.58

Table 5.4: Cost of the compressors depending on the configuration for the four different scenarios at 800 bar

Taking these results into consideration, the higher the efficiency is, the lower the energy required will be, which leads to a reduction in the costs. Considering that impact of the compressors in the final cost

is the highest of the whole system, it is interesting to evaluate different pressures of storage to reduce the power required in the compressor's chain as stated before.

### 5.3 Results of Aspen HYSYS

For this part of the study three different scenarios will be considered. The first one will not include the storage so as to carry out an analysis focused on the compressors. The LCOH and the CO<sub>2</sub> intensity of H<sub>2</sub> for different percentages of connection to the grid is assessed in this first subsection. In the second scenario the storage come into play, and both approaches are compared according to the LCOH. Finally, a third scenario to analyse different periods of storage will be develop. In particular, the study will consider the amount of tanks required to provide 5, 10 and 15 days of autonomy to the refinery. These results will be compared according to the LCOH obtained in each case.

#### 5.3.1 Analysis without considering the storage at different pressures

As it can be seen in Figures 5.7 and 5.8, the tendency of the four cases is the same as the one obtained in Section 5.2: the costs in the common configuration are lower. Again, the percentages of the compressors are the highest of the system, which represents the 63% of the total investment in the case of 350 bar, so it is interesting to focus on this equipment.

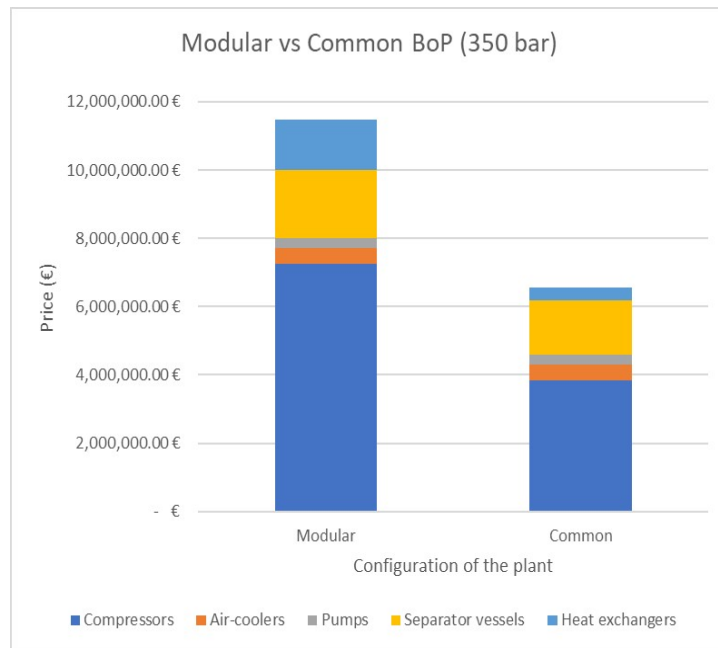

Figure 5.7: Comparison of the price between modular and common BoP for a final compression of 350 bar

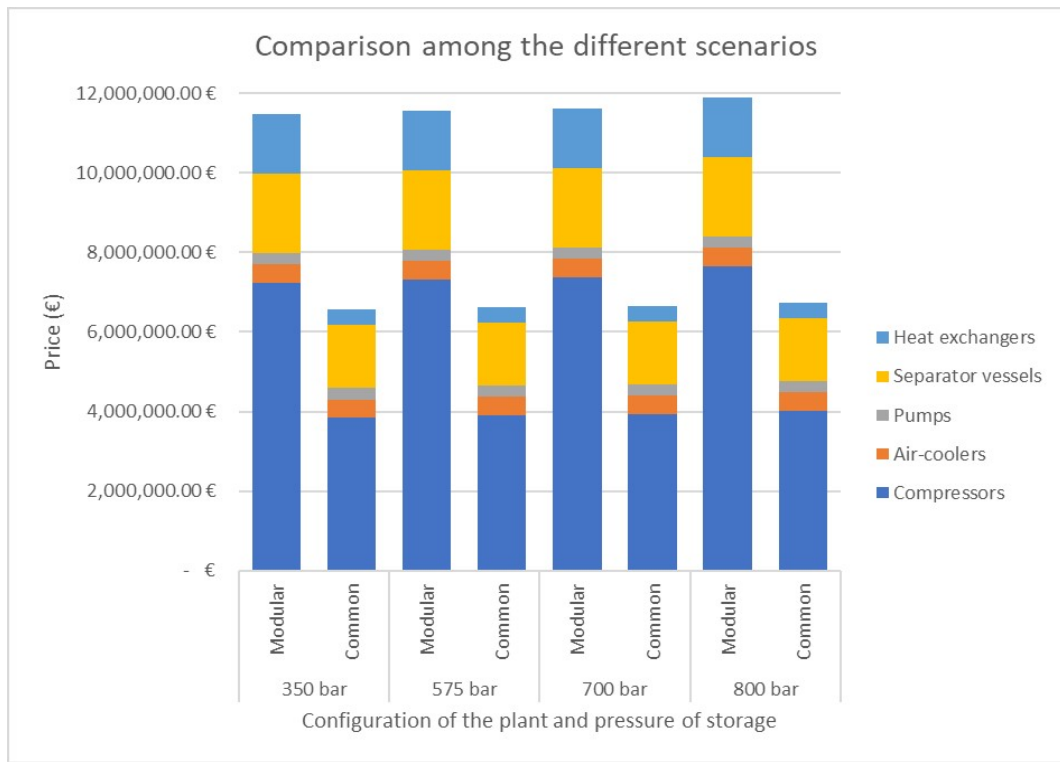

Figure 5.8: Comparison of the price between modular and common BoP for the four different scenarios

As it can also be seen in the figures above, when increasing the pressure of compression the price also slightly increases. However, it has to be kept in mind that a bigger amount of hydrogen can be stored if the pressure is higher, and considering that the difference of the final costs among the four cases is not significant, it is interesting the option of compressing up to higher pressures. When comparing between modular and common BoP, the reduction in the costs is clear, even though three bigger compressors require more material to withstand the high pressure and the higher flow rate rather than lot of smaller ones. The reason is the fact that scaling up the equipment provides a better performance due to higher efficiencies and lower losses. All the cases follow the same trend (see Figure 5.8). If the compression up to 350 bar is represented, in Figure 5.9 it can be seen how the compressors affect the most to the final cost with a percentage of 63% as it has been stated before. Also, in Figure 5.10 it is observed that utilizing a common compressors' chain provides a saving of 3 M€ approximately.

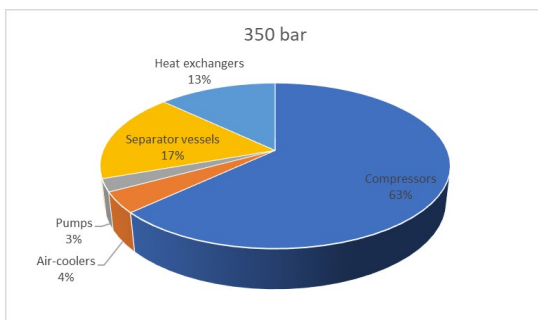

Figure 5.9: Total costs of the compression of 350 bar as a function of percentages

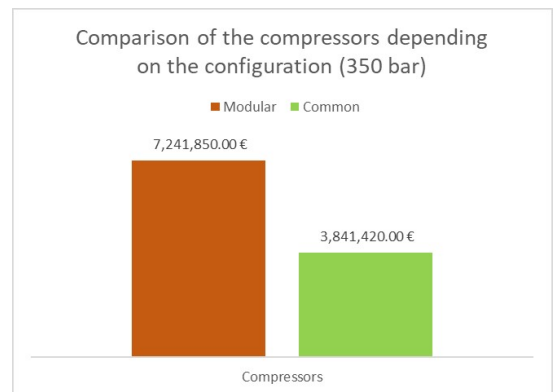

Figure 5.10: Comparison of the compressors' prices at 350 bar between modular and common BoP

As shown previously, the equipment that affects the final price the most is the compressor chain. If the final price of each scenario is represented, it can be seen how does the price increase when increasing the pressure of storage with a clear upward trend whose coefficient of variation result very reliable (higher than 80%) as shown in Figures 5.11 and 5.12. When the pressure inside the equipment increases, the material used to build the compressor has to be capable of tackling it. Furthermore, the high pressure results in thicker walls that leads to use more material, which results in greater investments. However, as it has been stated in previous sections, if the pressure of compression is higher it means that more quantity of hydrogen can be stored in the final tank. For big industrial applications this is an appealing factor since more energy will be available to use in the industrial complex or to sell in the current markets.

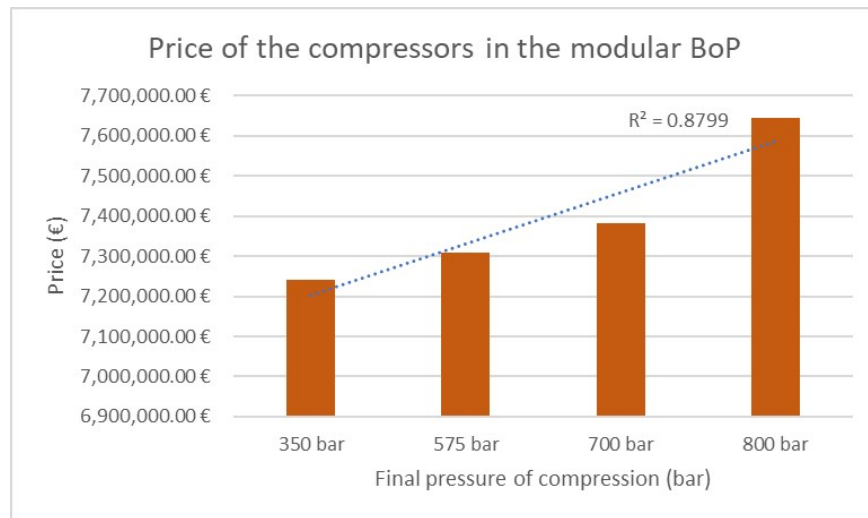

Figure 5.11: Compressors price at different levels of final pressure in the modular BoP

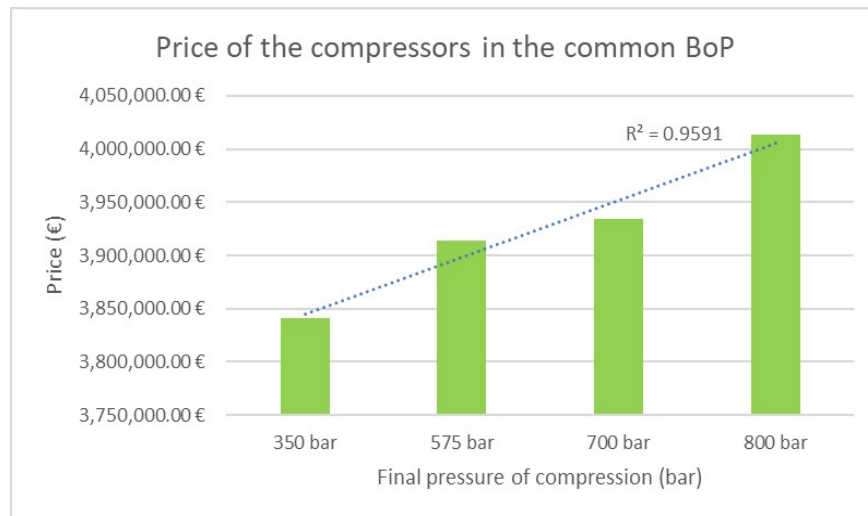

Figure 5.12: Compressors price at different levels of final pressure in the common BoP

As it can be seen in Table 5.5 and in Figure 5.13, the LCOH varies between modular and common BoP but it slightly increases when increasing the pressure of compression. This means that the use of a common configuration leads to a lower investment per kilogram of hydrogen produced, which is a very important factor when scaling up the generation of this energy carrier. Unlike the efficiency in terms of energy needed represented in the previous section, this results can be compared with existing research. As stated in Chapter 3, the Fuel Cells and Hydrogen Observatory (FCHO) [28], whose data

was compiled in March 2022, shows that the LCOH in Spain considering CAPEX, OPEX, grid fees and taxes has a value of 3.226 €/kg H<sub>2</sub> approximately (see Figure 3.4). Currently, the modular configuration is the principal way of producing hydrogen, and this means that the value obtained for the modular BoP should varies around the reference value of the FCHO. Indeed, that is what happens, and the common configuration provides lower cost.

Pressure (bar)	LCOH (€/kg H <sub>2</sub> ) in Modular BoP	LCOH (€/kg H <sub>2</sub> ) in Common BoP
350	3.34	1.91
575	3.36	1.93
700	3.38	1.94
800	3.46	1.96

Table 5.5: Comparison of the levelized cost of hydrogen LCOH (€/kg H<sub>2</sub>) between modular and common BoP at different pressures of compression

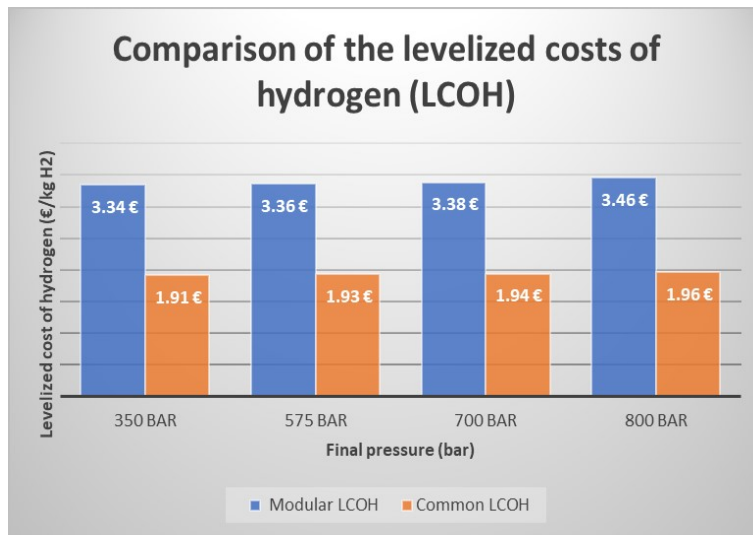

Figure 5.13: LCOH depending on the connection to the grid and the configuration of the plant

Focusing now on the second KPI and considering that the peninsular conventional electricity is being used, that is, the CO<sub>2</sub> emission factor is 0.331 (kg CO<sub>2</sub>/kWh final energy), the CO<sub>2</sub> intensity of H<sub>2</sub> can be calculated using Equation 3.3 as shown in Table 5.6.

Grid connection at 350 bar	Modular BoP	Common BoP
Full grid (100%)	0.4602	0.4589
High grid (75%)	0.3451	0.3441
Medium grid (50%)	0.2301	0.2294
Low grid (25%)	0.1151	0.1147
No grid (0%)	0	0

Table 5.6: Comparison of the CO<sub>2</sub> intensity of H<sub>2</sub> between the modular and common BoP at 350 bar in different scenarios of grid connection

It is observed that with a lower dependency of the grid, the emission of CO<sub>2</sub> to the atmosphere is smaller. In Figure 5.14 it is represented the case of compressing up to 350 bar. There is not a big difference between common and modular BoP. What's more, at first sight, as it can be observed in the ordinate axis of Figure 5.13, the difference among the kilograms of CO<sub>2</sub> per kg of H<sub>2</sub> is small, but when considering



the production of larger quantities of hydrogen, this factor will become crucial because of the current policies to tackle climate change.

However, it has to be taken into consideration that the investment needed to install the solar panels has not been calculated, so it would be necessary a higher investment for the cases of percentage of grid connection that are not 100%.

Finally, this KPI can also be compared to existing research. In particular, the Rystad Energy web [62] shows average values of carbon intensity in 2021 when producing hydrogen being connected to the European grid. It shows that the hydrogen produced via electrolysis would yield a value of 14 kilograms of CO<sub>2</sub> per kilogram of H<sub>2</sub> because the 35% of all the electricity was produced using fossil fuels. By comparison, a value of 1.7 kilograms of CO<sub>2</sub> per kilogram of H<sub>2</sub> was obtained in case of blue hydrogen, which was produced via natural gas reformation. In this study, the electricity is expected to come mostly from renewable sources, so the results should be similar to the one obtained for the blue hydrogen. Furthermore, since this value is expected to decrease due to the near future decarbonisation, the results of this KPI can be approved.

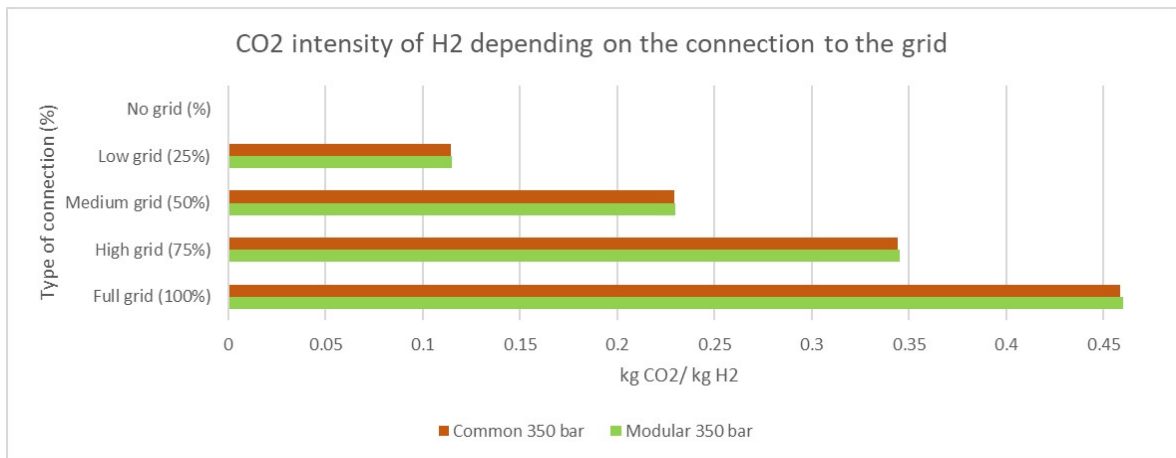

Figure 5.14: CO<sub>2</sub> intensity of H<sub>2</sub> depending on the connection to the grid at 350 bar

The other pressures of compression follow the same trend, and its results are shown in Tables 5.7, 5.8 and 5.9.

Grid connection at 575 bar	Modular BoP	Common BoP
Full grid (100%)	0.5721	0.5705
High grid (75%)	0.4291	0.4278
Medium grid (50%)	0.2860	0.2852
Low grid (25%)	0.1430	0.1426
No grid (0%)	0	0

Table 5.7: Comparison of the CO<sub>2</sub> intensity of H<sub>2</sub> between the modular and common BoP at 575 bar in different scenarios of grid connection

Grid connection at 700 bar	Modular BoP	Common BoP
Full grid (100%)	0.6277	0.6259
High grid (75%)	0.4708	0.4695
Medium grid (50%)	0.3139	0.3129
Low grid (25%)	0.1569	0.1565
No grid (0%)	0	0

Table 5.8: Comparison of the CO<sub>2</sub> intensity of H<sub>2</sub> between the modular and common BoP at 700 bar in different scenarios of grid connection

Grid connection at 800 bar	Modular BoP	Common BoP
Full grid (100%)	0.6498	0.6479
High grid (75%)	0.4873	0.4859
Medium grid (50%)	0.3249	0.3239
Low grid (25%)	0.1624	0.1619
No grid (0%)	0	0

Table 5.9: Comparison of the CO<sub>2</sub> intensity of H<sub>2</sub> between the modular and common BoP at 800 bar in different scenarios of grid connection

### 5.3.2 Analysis considering one day of storage at different pressures

For one day of storage, that is, 930 kg of H<sub>2</sub> stored, the number of tanks needed are shown in Table 5.10.

Pressure (bar)	Number of tanks in modular BoP	Number of tanks in common BoP	Expected price
350	7	2	↑
575	4	1	↑↑
700	4	1	↑↑↑
800	3	1	↑↑↑↑

Table 5.10: Number of tanks depending on the configuration and on the pressure for one day of storage

On the one hand, as it is represented in the fourth column, the price is expected to increase while increasing the pressure since more material is needed for the walls of the tanks to withstand those conditions. On the other hand, the price also depends on the number of installed tanks, which is higher in the modular configuration. Taking the above-mentioned and the prices of the tanks (see Table 3.7) into consideration, the final cost between the modular and the common type is not expected to considerably differ, because they are balanced thanks to the material needed and the number on tanks. Indeed, in columns fourth and sixth of Table 5.11, which shows the prices of each equipment differentiating between modular and common BoP at the different levels of pressure, it can be seen that the difference in price between both approaches varies only from 2 M€ to 5 M€.

Pressure of storage (bar)	Equipment	Modular BoP	Final price (€)	Common BoP	Final price (€)
350	Compressors	6,698,400	13,596,100	3,838,200	10,660,054
	Air coolers	607,400		607,500.00	
	Pumps	299,400		299,500	
	Separator vessels	2,147,500		1,673,500	
	Storage	2,393,900		3,725,654	
Heat exchangers	1,449,500	515,700			
575	Compressors	7,693,800	15,703,687	4,119,800	12,147,599
	Air coolers	607,400		607,500	
	Pumps	299,400		299,500	
	Separator vessels	2,154,500		1,674,900	
	Storage	3,399,587		4,818,899	
Heat exchangers	1,549,000	627,000			
700	Compressors	7,771,100	17,270,600	4,141,500	12,948,987
	Air coolers	607,600		607,500	
	Pumps	299,400		299,500	
	Separator vessels	2,102,500		1,664,500	
	Storage	4,033,200		5,825,887	
Heat exchangers	2,456,800	410,100			
800	Compressors	8,048,000	19,051,189	4,224,200	14,083,652
	Air coolers	607,600		607,500	
	Pumps	299,400		299,500	
	Separator vessels	2,102,500		1,664,500	
	Storage	5,536,889		6,876,252	
Heat exchangers	2,456,800	411,700			

Table 5.11: Prices of the equipment for one day of storage at different levels of storing pressures

For storing only one day at 350 bar, the most expensive equipment is still the compressor chain. As it is observed, while increasing the pressure of storage the price of the tank highly increases if it is compared to the price of the compressors. In the case of common configuration, the final cost of the tank overcome the one of the compressors as early as 575 bar. The reason is that the costs of the common tanks are way higher than the ones in the modular type because all the extra material that is required to manufacture them (see Table 3.7). On the other hand, in the case of modular configuration the price of the compressors are always higher than the storage tank because for storing 930 kg of H<sub>2</sub> the price of the tanks are still affordable.

Looking at Figure 5.15 it is observed that the storage in modular form results in lower prices in this scenario. However, considering all the equipment of the electrolysis plant, the final cost is still lower in the common configuration.

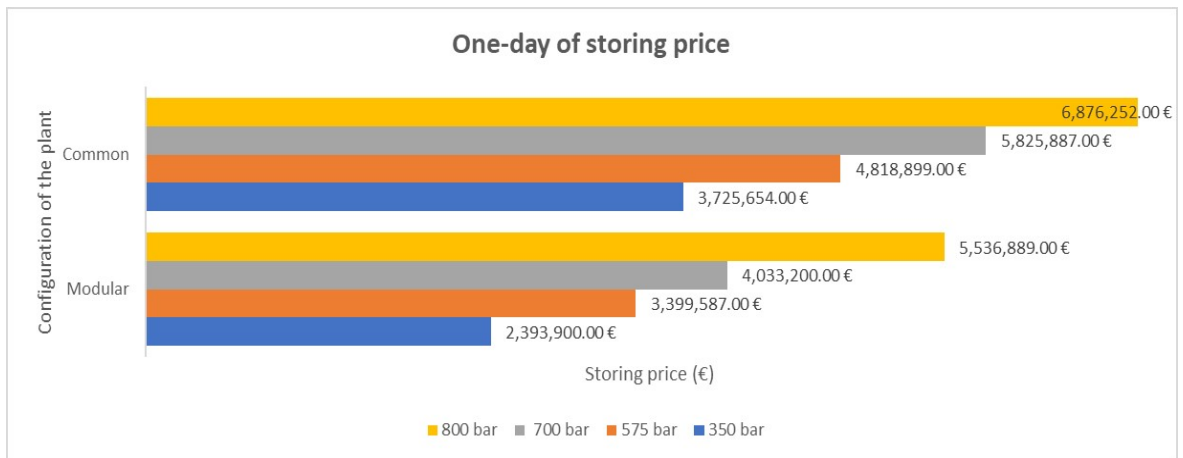

Figure 5.15: Comparison among the prices of storing hydrogen depending on the configuration and the pressure

Considering these results, the following conclusions can be drawn:

- The total price increases with the pressure, because thicker walls are needed.
- In the modular configuration the more expensive equipment is still the compressor chain since 930 kg of H<sub>2</sub> can be stored in small tanks at an affordable price.
- As shown in Figure 5.16, the price of storing in the common configuration results slightly higher than the modular one. As stated in Table 3.7, the tanks for the common BoP are more expensive since it depends on the capacity of the tank, that is, on the kilograms of H<sub>2</sub> that can be stored per tank, and the common configuration has a larger inner compartment available.

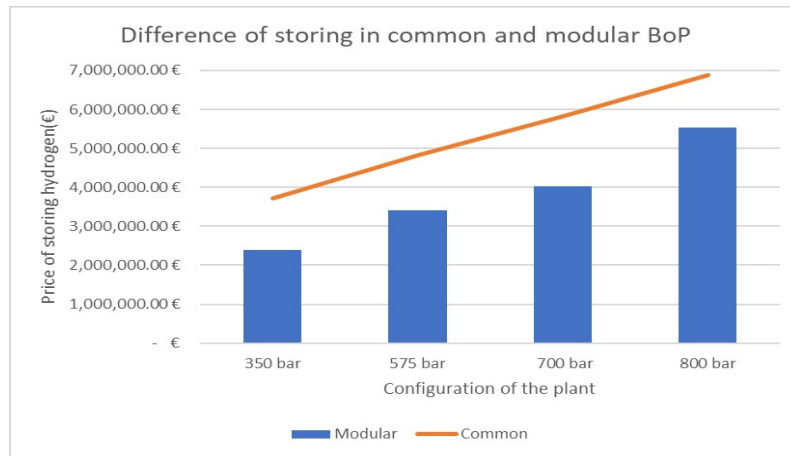

Figure 5.16: Comparison of the storing price between modular and common BoP

- As shown in Figure 5.17, even though storing in a common tank results in a higher price, the total cost is still lower for this configuration.

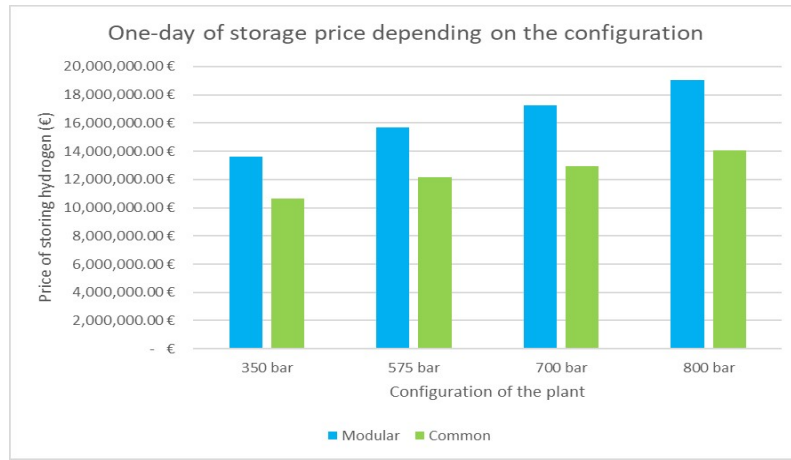

Figure 5.17: Comparison of the total price of storing hydrogen between modular and common BoP

If the LCOH is calculated, it can be seen that the production of hydrogen require a higher investment due to the storage tank. When comparing Tables 5.5 and 5.12 it can be observed that the price in the common configuration increases in larger quantities than the modular type. Indeed, the LCOH at 350 bar in the modular configuration is almost the exact value in both cases, that is, with and without considering the storage. Considering this, despite the fast increase of the common BoP compared to the modular one, the LCOH shows that a common configuration is cheaper.

Pressure (bar)	LCOH (€/kg H <sub>2</sub> ) in Modular BoP	LCOH (€/kg H <sub>2</sub> ) in Common BoP
350	3.96	3.10
575	4.57	3.53
700	5.02	3.77
800	5.54	4.10

Table 5.12: Comparison of the levelized cost of hydrogen LCOH (€/kg H<sub>2</sub>) between modular and common BoP at different pressures of compression for one day of storage

### 5.3.3 Analysis considering storage to provide different days of autonomy

Finally, this section will consider the scenario of providing autonomy to the refinery. As stated in previous sections, there are many ways of storing hydrogen depending on the storing time and its volume. In particular, the pressurized hydrogen in vessels serves for applications planning to store it from days to weeks, that is, this storage provides the lower storing time. The reason is that it is very expensive for longer periods as it can be seen in Figure 5.18, in which the total cost of the plant is approximately 50 M€ for 800 bar. For example, in this case the storage represents the 76% of the total cost. That is why this section serves merely to analyse a very hypothetical case.

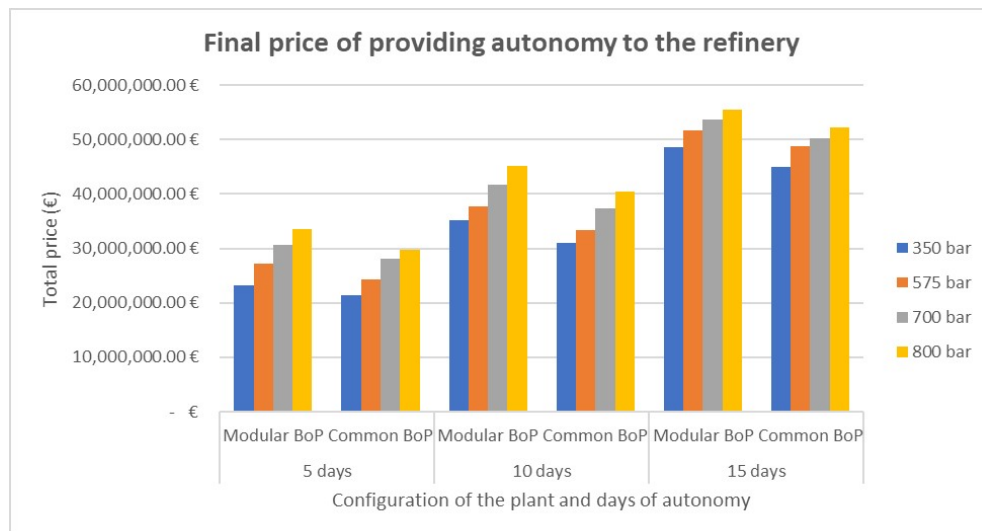

Figure 5.18: Comparison of the final price to provide different days of autonomy to the refinery

Again, when comparing modular and common configuration, it can be observed that the common one is the best option for a lower investment. The trend is the same as in previous sections, and the breakdown price of each pressure case for each scenario is shown in Appendix B.

Calculating the LCOH it is clear the uptrend of the price of obtaining hydrogen (see Figure 5.19). For 5 days of storage the total cost is still affordable if the aim is to be totally disconnected to the grid during a temporary period in which the electricity price is very high, as the ones that there are currently in the market. For larger storing periods it would be necessary a deep analysis to prove its feasibility.

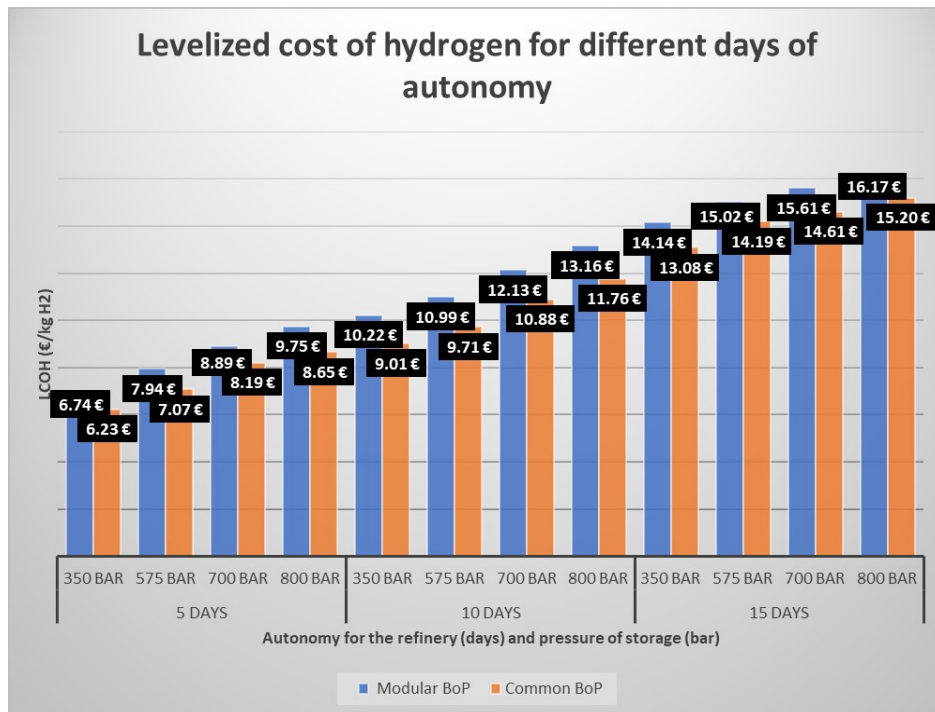

Figure 5.19: Comparison of the levelized cost of hydrogen depending on the configuration of the plant and on the days of autonomy

# Chapter 6

## Conclusions

From the discussed results, the following conclusions are extracted:

### 6.1 Modular vs common BoP conclusions

As it has been shown throughout the project, the design of an electrolysis plant has been analyzed and two different approaches have been compared: a common BoP versus a modular BoP.

- The flow-sheet layout of a separate BoP for each electrolyser stack requires higher investments. However, it has the advantage of operational flexibility in case of failure of one of the equipment (leakages along the pipes, deconfiguration of operating conditions of the compressor, bad performance of the rectifier...) or of the electrolyser stack itself because of the degradation phenomenon. This configuration also leads to standardization since it would be only necessary to replicate the same engineering, fabrication, installation and commissioning of the equipment already installed. On the other hand, it has been proved that the flow-sheet layout of a common BoP for the five electrolysers require a lower investment with a better performance according to the LCOH, carbon intensity and efficiency in terms of energy needed in the compressors.
- Focusing on the water treatment system and according to several studies, both MSF and MED systems are the more suitable ones to connect to solar energy. The MSF technology is usually more expensive than MED, nevertheless, for large scale plants the cost of both technologies approaches one another. In this case it has been shown that the MSF results in a lower cost, because the quantity of water needed to treat is high enough to get more benefits from MSF than from MED.
- Without considering the storage, the most expensive equipment in the BoP is the compressor. It needs to be carefully designed according specially to the polytropic efficiency, which as has been shown, leads to a lower electrical consumption when increasing its value. Another important design parameter is the pressure ratio. If possible, it is important that its design does not overcome a pressure ratio of 3 since lower efficiencies for centrifugal compressors are usually associated with values of 3 and higher. Also, it is preferable using the same pressure ratio for all the compressors installed so as to need the minimum work-done. This simulation has been conducted considering a size of compressors that fit with the stream of hydrogen to compress, that is, the compressors will work at full-load. If the demand decreases and the compressor works at part-load, a big common compressor could become more inefficient than many smaller ones, so it is important to ensure that the size is optimal for the treated stream. The fact of using a common compressor' chain is suitable when working at full load, it is important that Finally, it is outstanding to remark that also been demonstrated that an isothermal compression requires the lower specific work of all the possible processes. However, this is not possible under real conditions, and that is why a multi-stage compression and a cool down using heat exchangers have been used.
- The idea of designing the heat exchangers to cool down the hydrogen stream using seawater is a very promising alternative, specially for those areas that are close to the sea as happens in this case study. The larger heat transfer area allows for more cooling capacity and also allows the

electrolyser to operate at the maximum temperature at higher current density. For this case study, it has been shown that the common configuration for this equipment provides also lower costs rather than the modular configuration, with an approximate total heat transfer area needed of 143 m<sup>2</sup> versus 153 m<sup>2</sup> respectively.

- When adding the storage tanks, the price increases considerably. Storing hydrogen in pressurized vessels is a good option when the aim is store it during a short period. If larger periods are needed it is necessary to turn to other storing technologies such as geological storage or underground pipes. The price of this system is increased by the number of tanks, the material needed, the pressure of compression and the days of autonomy to the refinery. If more hydrogen is stored there are three options: tanks with higher capacities, larger number of tanks or compressors with higher pressure ratios. In all the scenarios proposed in this study, the common configuration needs a higher investment. This is because the walls of these tanks must be designed to withstand not only the high pressure conditions but the high quantities of hydrogen stored as well. However, even though the price for the common storing system is higher, the final cost considering the whole electrolysis plant is lower than the modular configuration.
- The three KPIs chosen for this study show that the common BoP is better in every single case. There are some equipment that are more expensive for the common plant, but the system as a whole results more economically feasible for this configuration. The results of LCOH obtained are similar to the current average ones, however, it is expected to decrease in the future years. The efficiency in terms of energy needed by the compressors allows to draw a simple conclusion: the higher the polytropic efficiency of the compressors is, the better the performance of the system will be. Finally, the carbon intensity shows the necessity of depending as less as possible on the grid. The kilograms of CO<sub>2</sub> released to the atmosphere per kilogram of H<sub>2</sub> produced are not very high in this study, however, when considering the production of larger quantities of hydrogen, the fact that this value is low will become a crucial factor, specially with the current policies to tackle climate change.

Taking everything into consideration, the research question can be confidently answered: a common balance of plant does imply a lower investment to produce hydrogen than the one in a modular balance of plant.

## 6.2 Evaluation of objectives

In this section the accomplishment of the objectives of the work are stated.

1. According to the first goal set, an extensive literature review was presented in Chapter 2 with the aim of explaining the role of hydrogen, as well as its characteristics, applications and ways of producing it.
2. A case study focused on the Repsol refinery located in Cartagena has been defined in Chapter 3. Firstly, the description of the plant was presented basing not only on existing industrial complexes but also in projects that are being planned to implement in the following years. Secondly, the two different approaches of the plant were presented, showing advantages and disadvantages and explaining the three KPIs that have been used to compare them.
3. Different electrolysis processes were explained in Chapter 2, with a final comparison to select the PEM technology. Also, throughout the Chapter 3, the possible configurations for the rest of the equipment were explained thanks to the conducting of a comprehensive literature review.
4. According to the fourth goal set, all the equipment of the electrolysis plant have been designed. To do so, the necessary parameters selected for each case have been explained in Chapter 3. After it, both approaches have been simulated using the software Aspen HYSYS to enable in-depth analysis. As stated in the validation challenges, the final validation of the model could not be carried out since there are only few research of PEM electrolysis plants. However, a great effort was made to design all the equipment basing on scientific research previously done. Also, the KPIs have served to compare these results with existing data.
5. The simulation of the chemical model was conducted. After that, a set of correlations as well



as the Aspen Process Economic Analyzer tool presented in Chapter 4 were used to perform the techno-economic analysis. Given the results presented in Chapter 5, the KPIs were represented and discussed.

6. Finally, two sensitivity analysis were presented in Chapter 3 and discussed in Chapter 5. The first of them has been focused on the polytropic efficiency of the compressors. The second one has studied the storage system, proposing different scenarios to compare the results.

### 6.3 Further work

The development of this master thesis has been useful to show the benefits that producing hydrogen using a common balance of plant instead of a modular one can provide. During the short period available to develop this thesis, a simple techno-economic analysis has been conducted to find answers to the objectives of the work. However, there is still much to contribute to this field of study, such as analyzing these suggestions:

1. First of all, one of the most important limitations of this work has been the unavailability of PEM models in Aspen HYSYS that are able to generate high amounts of hydrogen. According to AspenTech support, they are currently working on the simulation of a more generic model, it is therefore proposed as future work the simulation of a PEM electrolyser capable of producing a large amount of hydrogen.
2. All the correlations that have been chosen to conduct the cost analysis in the Chapter 4 have been selected according to two main reasons: the collected data was done considering state-of-the-art technology; and the selected author proposed correlations for all the equipment of the electrolysis plant, with no necessity of using many different correlations in which the authors used different assumptions. However, there might be other correlations more suitable for this case study, so it is proposed the implementation of some cost correlations so as to substantiate the results.
3. For ease of study, the solar panels have not been calculated nor simulated. It could be interesting performing a study of the power source so as to carry out a sensitivity analysis considering different levels of power to provide to the electrolyser stack. In this way, the performance of both systems (power source and electrolysis plant) could be analysed at the same time.
4. According to the results of this project and contrary to what might be reasonable expected, storing the hydrogen in a common tank does not result more economically feasible than in many smaller tanks. At first sight, the type of tank selected (MSLV) has the necessary characteristics (capacity and maximum temperature) to store hydrogen in this case study. However, in the light of the results obtained, the selection of other tanks could make the common configuration more suitable than the modular one. It is proposed the use of other type of storage to determine whether the common configuration can provide lower costs also for the storing system. It would be also interesting the analysis of a new scenario considering a common BoP for all the stacks of the electrolysis plant with a final storage in many different tanks.
5. The economic results obtained from HYSYS have considered the engineering design from scratch of the equipment and its installation cost. Unlike the common BoP that has to be specifically designed for the case study, the modular BoP has the advantage of standardization thanks to the availability in the market of all the equipment that will be used as stated in Chapter 3. That is why it is proposed for future work a cost analysis of a modular plant considering the use of prefabricated equipment so as to check if its decrease in costs make the modular configuration be cheaper than the common one.

# Appendices

## Appendix A

# Demonstration of the condition for minimum work-done by a two-stage compressor

$$K = \frac{n}{n-1}; k = \frac{1}{K}$$

$$\frac{\delta}{\delta p_2} [K \cdot p_1 \cdot v_1 [\frac{p_2^k}{p_1} + \frac{p_3^k}{p_2} - 2]] = 0$$

$$K \cdot p_1 \cdot v_1 [\frac{1}{p_1} \cdot k \cdot p_2^{k-1} + p_3^k \cdot (-k) \cdot p_2^{-k-1}] = 0$$

$$k \cdot p_1^{-k} \cdot p_2^{k-1} - k \cdot p_3^k \cdot p_2^{-k-1} = 0$$

$$k \cdot p_1^{-k} \cdot p_2^{k-1} = k \cdot p_3^k \cdot p_2^{-k-1}$$

$$p_1^{-k} \cdot p_2^{k-1} = p_3^k \cdot p_2^{-k-1}$$

$$p_1^{-k} \cdot p_2^k \cdot p_2^{-1} = p_3^k \cdot p_2^{-k} \cdot p_2^{-1}$$

$$\frac{1}{p_1^k} \cdot p_2^k = p_3^k \cdot \frac{1}{p_2^k}$$

$$p_2^{2k} = p_3^k \cdot p_1^k$$

$$p_2^2 = p_3 \cdot p_1$$

$$p_2 = \sqrt{p_3 \cdot p_1}$$

Or, in other words,

$$\frac{p_2}{p_1} = \frac{p_3}{p_2} = \frac{p_3}{p_1}^{\frac{1}{2}}$$

## Appendix B

# Price breakdown of the equipment to provide autonomy to the refinery

1. For 5 days of autonomy

Pressure of storage (bar)	Equipment	Modular BoP	Final price (€)	Common BoP	Final price (€)
350	Compressors	6,698,400	23,171,500	3,838,200	21,404,068
	Air coolers	607,400		607,500.00	
	Pumps	299,400		299,500	
	Separator vessels	2,147,500		1,673,500	
	Storage	11,969,300		14,469,668	
	Heat exchangers	1,449,500		515,700	
575	Compressors	7,693,800	27,279,023	4,119,800	24,310,497
	Air coolers	607,400		607,500	
	Pumps	299,400		299,500	
	Separator vessels	2,154,500		1,674,900	
	Storage	14,974,923		16,981,797	
	Heat exchangers	1,549,000		627,000	
700	Compressors	7,771,100	30,568,611	4,141,500	28,139,090
	Air coolers	607,600		607,500	
	Pumps	299,400		299,500	
	Separator vessels	2,102,500		1,664,500	
	Storage	17,331,411		21,015,990	
	Heat exchangers	2,456,800		410,100	
800	Compressors	8,048,000	33,500,500	4,224,200	29,740,587
	Air coolers	607,600		607,500	
	Pumps	299,400		299,500	
	Separator vessels	2,102,500		1,664,500	
	Storage	19,986,200		22,533,187	
	Heat exchangers	2,456,800		411,700	

Table B.1: Prices of the equipment for 5 days of storage at different levels of storing pressures

2. For 10 days of autonomy

Pressure of storage (bar)	Equipment	Modular BoP	Final price (€)	Common BoP	Final price (€)
350	Compressors	6,698,400	35,140,900	3,838,200	21,404,068
	Air coolers	607,400		607,500.00	
	Pumps	299,400		299,500	
	Separator vessels	2,147,500		1,673,500	
	Storage	23,938,700		14,469,668	
	Heat exchangers	1,449,500		515,700	
575	Compressors	7,693,800	37,774,945	4,119,800	33,382,710
	Air coolers	607,400		607,500	
	Pumps	299,400		299,500	
	Separator vessels	2,154,500		1,674,900	
	Storage	25,470,845		26,054,010	
	Heat exchangers	1,549,000		627,000	
700	Compressors	7,771,100	41,710,385	4,141,500	37,398,450
	Air coolers	607,600		607,500	
	Pumps	299,400		299,500	
	Separator vessels	2,102,500		1,664,500	
	Storage	28,472,985		30,275,350	
	Heat exchangers	2,456,800		410,100	
800	Compressors	8,048,000	45,241,895	4,224,200	40,438,210
	Air coolers	607,600		607,500	
	Pumps	299,400		299,500	
	Separator vessels	2,102,500		1,664,500	
	Storage	31,727,595		33,230,810	
	Heat exchangers	2,456,800		411,700	

Table B.2: Prices of the equipment for 10 days of storage at different levels of storing pressures

3. For 15 days of autonomy

Pressure of storage (bar)	Equipment	Modular BoP	Final price (€)	Common BoP	Final price (€)
350	Compressors	6,698,400	48,617,600	3,838,200	44,961,956
	Air coolers	607,400		607,500.00	
	Pumps	299,400		299,500	
	Separator vessels	2,147,500		1,673,500	
	Storage	36,706,000		37,729,656	
	Heat exchangers	1,449,500		515,700	
575	Compressors	7,693,800	51,613,325	4,119,800	48,766,357
	Air coolers	607,400		607,500	
	Pumps	299,400		299,500	
	Separator vessels	2,154,500		1,674,900	
	Storage	38,706,325		41,252,457	
	Heat exchangers	1,549,000		627,000	
700	Compressors	7,771,100	53,643,190	4,141,500	50,207,942
	Air coolers	607,600		607,500	
	Pumps	299,400		299,500	
	Separator vessels	2,102,500		1,664,500	
	Storage	40,658,690		42,672,342	
	Heat exchangers	2,456,800		410,100	
800	Compressors	8,048,000	55,574,217	4,224,200	52,246,740
	Air coolers	607,600		607,500	
	Pumps	299,400		299,500	
	Separator vessels	2,102,500		1,664,500	
	Storage	42,312,817		44,628,440	
	Heat exchangers	2,456,800		411,700	

Table B.3: Prices of the equipment for 15 days of storage at different levels of storing pressures

# Bibliography

- [1] SINTEF. “The Government’s hydrogen strategy”. In: *SINTEF blog* (2020). DOI: <https://www.regjeringen.no/no/dokumentarkiv/regjeringen-solberg/aktuelt-regjeringen-solberg/oed/pressemeldinger/2020/regjeringen-legger-frem-hydrogenstrategi/id2704774/>.
- [2] Juan Ramón et al. “35 Hidrógeno Vector energético de una economía descarbonizada”. In: *Fundación Naturgy* (2019).
- [3] Dr. Fatih Birol. “The future of hydrogen”. In: *Hidrógeno. Vector energético de una economía descarbonizada* (2019). DOI: [url{https://www.iea.org/reports/the-future-of-hydrogen}](https://www.iea.org/reports/the-future-of-hydrogen).
- [4] “A SUSTAINABLE PATHWAY FOR THE EUROPEAN ENERGY TRANSITION HYDROGEN ROADMAP EUROPE”. In: (). DOI: 10.2843/249013.
- [5] Eprs. *The potential of hydrogen for decarbonising EU industry*. Tech. rep. European Parliamentary Research Service, 2021.
- [6] Felipe Benjumea Llorente. “Breve historia de la economía del hidrógeno”. In: *Felipe Benjumea Llorente* (2019). URL: <https://felipebenjumeallorete.com/breve-historia-de-la-economia-del-hidrogeno/> (visited on 2021).
- [7] Resources for the future. “Decarbonized Hydrogen in the US Power and Industrial Sectors: Identifying and Incentivizing Opportunities to Lower Emissions”. In: *RFF official web page* (2022). DOI: <https://www.rff.org/publications/reports/decarbonizing-hydrogen-us-power-and-industrial-sectors/>.
- [8] Juan Ramón et al. *35 Hidrógeno Vector energético de una economía descarbonizada*. Tech. rep. Fundación Naturgy, 2021.
- [9] The International Renewable Energy Agency. *GREEN HYDROGEN COST REDUCTION SCALING UP ELECTROLYSERS TO MEET THE 1.5° C CLIMATE GOAL H 2 O 2*. 2020. ISBN: 9789292602956. URL: [www.irena.org/publications](http://www.irena.org/publications).
- [10] ElBoletín. “Repsol y Endesa: las empresas mas contaminantes de España”. In: *ElBoletín* (2021). URL: <https://www.elboletin.com/repsol-y-endesa-las-empresas-mas-contaminantes-de-espana/#:~:text=Repsol%20habr%C3%ADa%20sido%20la%20m%C3%A1s,las%20emisiones%20totales%20del%20pa%C3%ADs> (visited on 2021).
- [11] Repsol company. “Leaders in efficiency and value creation in Europe”. In: *Repsol web page* (2022). URL: <https://www.repsol.com/en/about-us/what-we-do/refining/index.cshtml> (visited on 2021).
- [12] Linde-gas. “Hydrogen in Refining”. In: *Linde web page* (2022). DOI: [https://www.linde-gas.com/en/processes/petrochemical-processing-and-refining/hydrogen\\_applications\\_refineries/index.html](https://www.linde-gas.com/en/processes/petrochemical-processing-and-refining/hydrogen_applications_refineries/index.html).
- [13] Repsol. “Leaders in efficiency and value creation in Europe”. In: *Repsol web page* (2022). DOI: <https://www.repsol.com/en/about-us/what-we-do/refining/index.cshtml>.
- [14] Repsol. “Repsol produce por primera vez hidrógeno renovable a partir de biometano”. In: *Repsol web page* (2022). DOI: <https://www.repsol.com/es/sala-prensa/notas-prensa/2021/repsol-produce-por--primera-vez-hidrogeno-renovable-a-partir-de-/index.cshtml#:~:text=Repsol%20ha%20producido%20por%20primera,gas%C3%B3leo%20y%20queroseno%20para%20aviaci%C3%B3n..>
- [15] Esi Arian and Calin Zamfirescu. *A REVIEW ON WATER ELECTROLYSIS Related papers Hydrogen and Fuel Cell Syst ems*. Tech. rep. ACADEMIA, 2019.

- [16] MDPI. “CFD Modeling and Experimental Validation of an Alkaline Water Electrolysis Cell for Hydrogen Production”. In: *MDPI* (2022). DOI: <https://www.mdpi.com/2227-9717/8/12/1634/htm>.
- [17] Combined Science. *What are electrolytes and what happens in electrolysis?* Tech. rep. BBC, 2022.
- [18] The International Renewable Energy Agency. *GREEN HYDROGEN COST REDUCTION SCALING UP ELECTROLYSERS TO MEET THE 1.5°C CLIMATE GOAL H 2 O 2*. IRENA, 2020. ISBN: 9789292602956. URL: [www.irena.org/publications](http://www.irena.org/publications).
- [19] Tekniker Sharing Events. *Webinar “Producción de hidrógeno: Retos tecnológicos en electrolizadores de membranas poliméricas”*. Youtube, 2022. URL: <https://www.youtube.com/watch?v=DUhiXiPEJlk>.
- [20] Marcelo Carmo et al. *A comprehensive review on PEM water electrolysis*. Apr. 2013. DOI: 10.1016/j.ijhydene.2013.01.151.
- [21] Qiong Cai, Claire S. Adjiman, and Nigel P. Brandon. “Optimal control strategies for hydrogen production when coupling solid oxide electrolyzers with intermittent renewable energies”. In: *Journal of Power Sources* 268 (Dec. 2014), pp. 212–224. ISSN: 03787753. DOI: 10.1016/j.jpowsour.2014.06.028.
- [22] Iberdrola company. “¿Qué es un electrolizador y por qué es clave para el suministro de hidrógeno verde?” In: *Iberdrola web page* (2022). URL: [https://www.iberdrola.com/sostenibilidad/electrolizador#:~:text=Electrolizador%20de%20C3%B3xido%20s%20C3%B3lido%20\(SOEC,material%20cer%20C3%A1mico%20s%20C3%B3lido%20como%20electrolito](https://www.iberdrola.com/sostenibilidad/electrolizador#:~:text=Electrolizador%20de%20C3%B3xido%20s%20C3%B3lido%20(SOEC,material%20cer%20C3%A1mico%20s%20C3%B3lido%20como%20electrolito). (visited on 2022).
- [23] Eric Tang et al. *Solid Oxide Based Electrolysis and Stack Technology with Ultra-High Electrolysis Current Density ( $\geq 3A/cm^2$ ) and Efficiency*. Tech. rep. Science Direct, 2018.
- [24] Immanuel Vincent and Dmitri Bessarabov. *Low cost hydrogen production by anion exchange membrane electrolysis: A review*. Jan. 2018. DOI: 10.1016/j.rser.2017.05.258.
- [25] Pasquale Daniele Cavaliere, Angelo Perrone, and Alessio Silvello. *Water electrolysis for the production of hydrogen to be employed in the ironmaking and steelmaking industry*. Nov. 2021. DOI: 10.3390/met11111816.
- [26] ITM Power. “3MEP CUBE”. In: *ITM Power web page* (2022). URL: <https://itm-power.com/products/3-mep-cube> (visited on 2021).
- [27] T. Nguyen et al. “Grid-connected hydrogen production via large-scale water electrolysis”. In: *Energy Conversion and Management* 200 (Nov. 2019). ISSN: 01968904. DOI: 10.1016/j.enconman.2019.112108.
- [28] Fuel Cells and Hydrogen Observatory. “Levelized Cost of Hydrogen”. In: *FCHO web page* (2022). DOI: <https://www.fchobservatory.eu/observatory/technology-and-market/levelised-cost-of-hydrogen-grid-connected-electrolysis>.
- [29] Instituto para la diversificación y ahorro de energía. *FACTORES DE EMISION DE CO2 y COEFICIENTES DE PASO A ENERGIA PRIMARIA DE DIFERENTES FUENTES DE ENERGIA FINAL CONSUMIDAS EN EL SECTOR DE EDIFICIOS EN ESPAÑA*. Tech. rep.
- [30] Red Eléctrica de España. “Emisiones y factor de emisión de CO2 equivalente en la generación”. In: *Red Eléctrica official web page* (2022). DOI: <https://www.ree.es/es/datos/generacion/no-renovables-detalle-emisiones-CO2>.
- [31] ACCIONA. “Tratamiento de agua - Desalación”. In: *ACCIONA* (2021). URL: [https://www.acciona.com/es/tratamiento-de-agua/desalacion/?\\_adin=02021864894/](https://www.acciona.com/es/tratamiento-de-agua/desalacion/?_adin=02021864894/) (visited on 2021).
- [32] Mahmoud Shatat and Saffa B. Riffat. “Water desalination technologies utilizing conventional and renewable energy sources”. In: *International Journal of Low-Carbon Technologies* 9.1 (Mar. 2014), pp. 1–19. ISSN: 17481317. DOI: 10.1093/ijlct/cts025.
- [33] O K Buros. *The ABCs of Desalting*. Tech. rep. International Desalination Association, 2019.
- [34] Manish Thimmaraju et al. “Desalination of Water”. In: *Desalination and Water Treatment*. InTech, Sept. 2018. DOI: 10.5772/intechopen.78659.
- [35] Soteris A. Kalogirou. “Seawater desalination using renewable energy sources”. In: *Progress in Energy and Combustion Science* 31.3 (2005), pp. 242–281. ISSN: 03601285. DOI: 10.1016/j.pecc.2005.03.001.
- [36] A Gregorzewski et al. *THE SOLAR THERMAL DESALINATION RESEARCH PROJECT AT THE PLATAFORMA SOLAR DE ALMERIA*. Tech. rep. Technical University of Munich, 1991.
- [37] Muhammad W Shahzad and Kim C Ng. *Multiple Effect Distillation MED-AD is the hybrid of the multieffect desalination (MED) system and the adsorption desalination (AD) cycle*. From: *Emerg-*



- ing Technologies for Sustainable Desalination Handbook, 2018 Adsorption desalination-Principles, process design, and its hybrids for future sustainable desalination.* Tech. rep. Science Direct, 2018.
- [38] Peter H Gleick et al. *The World's Water The Biennial Report on Freshwater Resources • Hydraulic Fracturing • Corporate Water Engagement • Water Footprints • Sustainable Water Jobs • Global Water Governance • Desalination Financing • Zombie Water Projects • Water and Conflict.* Tech. rep. The world's water, 2019. URL: [www.worldwater.org](http://www.worldwater.org).
- [39] Fabian Scheepers et al. "Temperature optimization for improving polymer electrolyte membrane-water electrolysis system efficiency". In: *Applied Energy* 283 (Feb. 2021). ISSN: 03062619. DOI: 10.1016/j.apenergy.2020.116270.
- [40] Aspen Technology. *Water Electrolysis with PEM 1.* Tech. rep. AspenTech, 2021.
- [41] Z. Abdin, C. J. Webb, and E. Maca Gray. "Modelling and simulation of a proton exchange membrane (PEM) electrolyser cell". In: *International Journal of Hydrogen Energy* 40.39 (Oct. 2015), pp. 13243–13257. ISSN: 03603199. DOI: 10.1016/j.ijhydene.2015.07.129.
- [42] P. Medina and M. Santarelli. "Analysis of water transport in a high pressure PEM electrolyzer". In: *International Journal of Hydrogen Energy* 35.11 (June 2010), pp. 5173–5186. ISSN: 03603199. DOI: 10.1016/j.ijhydene.2010.02.130.
- [43] F. Marangio, M. Santarelli, and M. Cali. "Theoretical model and experimental analysis of a high pressure PEM water electrolyser for hydrogen production". In: *International Journal of Hydrogen Energy* 34.3 (Feb. 2009), pp. 1143–1158. ISSN: 03603199. DOI: 10.1016/j.ijhydene.2008.11.083.
- [44] Energy efficiency and renewable energy. "Hydrogen storage". In: *Department of energy official web* (2022). DOI: <https://www.energy.gov/eere/fuelcells/hydrogen-storage>.
- [45] George Parks et al. *Hydrogen Station Compression, Storage, and Dispensing Technical Status and Costs: Systems Integration.* Tech. rep. U.S. Department of Energy Office of Scientific and Technical Information, 2020. URL: <http://www.osti.gov/bridge>.
- [46] Ignacio López-Paniagua et al. "Step by step derivation of the optimum multistage compression ratio and an application case". In: *Entropy* 22.6 (June 2020). ISSN: 10994300. DOI: 10.3390/E22060678.
- [47] Ahmed M. Elberry et al. *Large-scale compressed hydrogen storage as part of renewable electricity storage systems.* Apr. 2021. DOI: 10.1016/j.ijhydene.2021.02.080.
- [48] Maurice Stewart. "Compressor fundamentals". In: *Surface Production Operations.* Elsevier, 2019, pp. 457–525. DOI: 10.1016/b978-0-12-809895-0.00007-7.
- [49] D. L. Karelin, A. V. Boldyrev, and A. M. Belousov. "Design Features of Multistage Centrifugal Compressor of Vapor Refrigerating Machine with Complete Working Fluid Intercooling". In: *Procedia Engineering.* Vol. 206. Elsevier Ltd, 2017, pp. 1488–1496. DOI: 10.1016/j.proeng.2017.10.666.
- [50] Saeid Mokhatab and William A. Poe. "Natural Gas Compression". In: *Handbook of Natural Gas Transmission and Processing.* Elsevier, 2012, pp. 393–423. DOI: 10.1016/b978-0-12-386914-2.00011-x.
- [51] Omar Joel Symister. *An Analysis of Capital Cost Estimation Techniques for Chemical Processing.* Tech. rep. 2016.
- [52] Moein Shamoushaki et al. "Development of cost correlations for the economic assessment of power plant equipment". In: *Energies* 14.9 (May 2021). ISSN: 19961073. DOI: 10.3390/en14092665.
- [53] Michelle K. Wittholz et al. "Estimating the cost of desalination plants using a cost database". In: *Desalination* 229.1-3 (Sept. 2008), pp. 10–20. ISSN: 00119164. DOI: 10.1016/j.desal.2007.07.023.
- [54] MEPS International. "Steel Price Index". In: *MEPS web page* (2022).
- [55] Petro Skills. John M. Campbell. "How to Estimate Compressor Efficiency?" In: *Petro Skills official web page* (2022). DOI: <http://www.jmcampbell.com/tip-of-the-month/2015/07/how-to-estimate-compressor-efficiency/>.
- [56] Jinyang Zheng et al. *HIGH PRESSURE 98 MPa MULTIFUNCTIONAL STEEL LAYERED VESSELS FOR STATIONARY HYDROGEN STORAGE.* Tech. rep. 2016.
- [57] Jinyang Zheng. *Research State of the Art and Knowledge Gaps in High Pressure Hydrogen Storage.* Tech. rep.
- [58] R. K. Ahluwalia, T. Q. Hua, and J. K. Peng. "On-board and Off-board performance of hydrogen storage options for light-duty vehicles". In: *International Journal of Hydrogen Energy.* Vol. 37. 3. Feb. 2012, pp. 2891–2910. DOI: 10.1016/j.ijhydene.2011.05.040.
- [59] *H2A Hydrogen Delivery Infrastructure Analysis Models and Conventional Pathway Options Analysis Results.* Tech. rep. 2008.

- [60] Babatunde Olateju and Amit Kumar. “Hydrogen production from wind energy in Western Canada for upgrading bitumen from oil sands”. In: *Energy* 36.11 (2011), pp. 6326–6339. ISSN: 03605442. DOI: 10.1016/j.energy.2011.09.045.
- [61] MR Perú. “Conoce sobre el consumo de energía de un compresor de aire”. In: *MR Perú official web* (2022). DOI: <https://www.mrperu.com.pe/blog/consumo-energia-compresor-aire/>.
- [62] Rystad Energy. “3rd Energy Transition report: Hydrogen’s CO2 intensity, vehicles cost, refinery demand, growth markets, production costs and energy needs”. In: *Rystad Energy web page* (2022). DOI: <https://www.rystadenergy.com/newsevents/news/press-releases/3rd-energy-transition-report-hydrogens-co2-intensity-vehicles-cost-refinery-demand-growth-markets-production-costs-and-energy-needs/>.

