

Andrea Viken Strand

Optimizing the phosphorus resource use and emissions in a growing Norwegian aquaculture industry

A multi-scale multi-level Substance Flow analysis approach

Master's thesis in Industrial Ecology

Supervisor: Daniel Müller

June 2021

Andrea Viken Strand

Optimizing the phosphorus resource use and emissions in a growing Norwegian aquaculture industry

A multi-scale multi-level Substance Flow analysis approach

Master's thesis in Industrial Ecology
Supervisor: Daniel Müller
June 2021

Norwegian University of Science and Technology
Faculty of Engineering
Department of Energy and Process Engineering



Kunnskap for en bedre verden

Preface

This thesis was carried out during the spring semester 2021 and concludes my Master of Science in Industrial Ecology at the Norwegian University of Science and Technology (NTNU). The thesis is a continuation of the project thesis performed in the autumn semester 2020.

I would like to give my sincere thanks to Helen Hamilton from BioMar, Klemet Steen from Lerøy and Anders Fossmark from LiftUP who have given me useful insights and contributed with data for different approaches to reduce phosphorus emissions from salmon and rainbow trout production. Moreover, I would like to thank my co-supervisor Kjell Inge Reitan for invaluable insight in the aquaculture industry.

I would also like to thank my family and friends, and especially my father, Gisle Strand and my dear friend Aurora Grefsrud for taking of their time to read and give me valuable feedback on the thesis. This period would not have been the same without my wonderful classmates, who have in spite covid-19 made this challenging semester joyful. A special thanks goes to my boyfriend Didrik Ulleberg who has given me constant support throughout the last year as well as giving me lots of feedback on the thesis.

Finally, I would like to thank my supervisor Daniel Müller and my co-supervisors Avijit Pandit and Thomas Galea for all the guidance, feedback and inspiration they have given me throughout the work of the thesis.

Trondheim, June 2021



Andrea Viken Strand

algal bloom
the ocean flushes
with waste

- Robin Anna Smith

Abstract

Phosphorus (P) is a limited resource that can contribute to marine and freshwater eutrophication. This study has with the use of a multi-scale multi-layer substance flow analysis (SFA), quantified the annual emissions of P, N and C from Norwegian salmon and rainbow trout aquaculture. The Norwegian salmon and trout aquaculture emits more than 12 kt P/yr, dissolved 64 kt N/ yr and 572 kt C/ yr.

Several strategies to reduce P emissions from salmon and rainbow trout aquaculture have been assessed in this study. They include sludge collection in open net sea cages, production of fish in closed systems at sea or on land, offsetting emissions with cultivation of integrated multi-trophic aquaculture (IMTA) species as well as using a feed with low P concentration. The maximum potential they have to reduce P emissions have been quantified in this study, by implementing each strategy at 2019's production data and comparing the results with emission levels for 2019. Shifting today's production volume to a closed land-based system could decrease P emissions with 87 %. This would allow for an increase of production volume up to 11.3 million tons without exceeding 2019's emission level of P.

Three scenarios for aquaculture production in 2050 have been developed, with the aim of investigating potential approaches to a sustainable P management in this growing industry. In these scenarios a combination of the strategies previously mentioned has been used. The results show that production can reach 3.7 million tons without exceeding 2019's emission level and at the same time recover up to 50 % of input P as fish sludge or IMTA products.

There are no regulations on emissions from sea-based aquaculture today, where the majority of salmon and rainbow trout takes place. Stricter regulations on emissions from sea-based aquaculture as well as more knowledge about the global P challenge, especially might be the missing drivers for a more optimized use of P in the aquaculture sector in Norway. This could increase the demand and use for feed with lower P concentration, cultivating of IMTA species and sludge collection.

Sammendrag

Fosfor (P) er en begrenset ressurs som også forårsaker eutrofiering. Denne studien har ved bruk av en substansflytanalyse kvantifisert utslippene av fosfor (P), nitrogen (N) og karbon (C) fra norsk oppdrett av laks og regnbueørret. Det slippes årlig ut mer enn 12 000 tonn P, 64 000 tonn N og 572 000 tonn C fra denne industrien. Den nåværende håndteringen av fosfor i denne industrien er dermed ikke bærekraftig. Ifølge Sjømatbarometeret 2021, er det forventet en vekst på opptil 3.7 millioner tonn produsert laks og regnbueørret innen 2050.

Denne oppgaven tar for seg ulike strategier for å optimere bruken av P i denne industrien. Disse strategiene inkluderer slamoppsamling ved sjømerder, integrert multi-trofisk havbruk (IMTA), fôr med lavere fosforinnhold og produksjon i lukkede anlegg til sjøs og på land. Resultatene viser at ved å flytte hele produksjon til lukkede land-baserte anlegg kan P-utslippene reduseres med 87 % og produksjonen kan økes til 11.3 millioner tonn uten at P-utslippene overskrider utslippsnivået i 2019.

Videre er det utviklet tre forskjellige scenarier for produksjon av 3.7 millioner laks og regnbueørret i 2050. Her er en kombinasjon av de ulike nevnte strategiene brukt for å undersøke ulike tilnærminger for å oppnå en bærekraftig forvaltning av P innen havbruk. Resultatene viser at en slik produksjonsvekst er mulig, samtidig som utslippene holdes på dagens nivå og opptil 50 % av fosforet som strømmer inn i systemet kan samles opp igjen som slam, børstemark eller tare.

Denne utviklingen kommer ikke til å skje uten press fra politisk hold eller fra konsumentene. Et av de viktigste tiltakene fra politisk hold vil være å få på plass krav til oppsamling av utslipp, fiskeslam, fra havbruk. Det er viktig at både konsumentene og industrien blir opplyst om den globale fosforutfordringen for å øke behovet og interessen for oppsamling av slam, fôr med lavere P-innhold og IMTA.

Table of contents

PREFACE	I
ABSTRACT	III
SAMMENDRAG	V
TABLE OF CONTENTS	VII
LIST OF FIGURES	IX
LIST OF TABLES	XI
LIST OF ABBREVIATIONS AND DEFINITIONS	XII
1. INTRODUCTION	1
1.1 BACKGROUND AND MOTIVATION	1
1.2 SALMON AND RAINBOW TROUT AQUACULTURE SECTOR IN NORWAY	2
1.3 NUTRIENT CYCLE AND EMISSIONS IN AQUACULTURE	2
1.3.1 <i>Current approaches to estimate and manage emissions from aquaculture</i>	3
1.3.2 <i>Main findings from the project thesis</i>	4
1.3.3 <i>Potential of reducing nutrient emissions from aquaculture</i>	4
1.4 SCOPE AND RESEARCH QUESTIONS	6
1.5 OUTLINE	7
2 METHODS	9
2.1 SYSTEM DEFINITION	9
2.1.1 <i>System boundaries, processes and flows</i>	9
2.2 SYSTEM QUANTIFICATION	15
2.2.1 <i>Multi-scale multi-layer substance flow analysis</i>	15
2.2.2 <i>Data Sources</i>	15
2.2.3 <i>Model coefficients</i>	16
2.2.4 <i>Quantification of flows for 2019</i>	19
2.3 UNCERTAINTY ANALYSIS	21
2.4 TESTING OF INDIVIDUAL TECHNOLOGIES	23
2.4.1 <i>Low P feed</i>	23
2.4.2 <i>IMTA</i>	23
2.4.3 <i>LiftUP</i>	23
2.4.4 <i>Closed containment system (CCS) at sea</i>	24
2.4.5 <i>Land-based production with RAS</i>	24
2.5 SCENARIOS	25
2.5.1 <i>Scenario 1: Basecase scenario</i>	25
2.5.2 <i>Scenario 2: Production growth at SEA</i>	25
2.5.3 <i>Scenario 3: Production growth at LAND</i>	25
2.6 P EFFICIENCY INDICATORS	26
2.7 VISUALIZATION	27
2.8 MODEL REPRESENTATION	27
3. RESULTS	29
3.1 NUTRIENT EMISSIONS FROM THE AQUACULTURE SECTOR IN NORWAY 2019	29
3.1.1 <i>P flows for sea-based salmon and rainbow trout production on a locality level in 2019</i>	29
3.1.2 <i>P flows for sea-based salmon and rainbow trout production on a national level in 2019</i>	31
3.1.3 <i>Nitrogen and carbon flows 2019</i>	32
3.1.4 <i>Overview over emissions and sludge production in 2019</i>	32
3.2 TESTING OF INDIVIDUAL STRATEGIES	32
3.2.1 <i>LiftUP and IMTA</i>	33
3.2.2 <i>Low P feed</i>	33
3.2.3 <i>CCS</i>	34

3.2.4 RAS	34
3.2.5 P Emission comparison of the different systems	35
3.3 SCENARIOS	36
3.3.1 Scenario 1: Basecase	36
3.3.2 Scenario 2: Production growth at SEA	37
3.3.3 Scenario 3: Production growth at LAND	38
3.3.4 Comparison of scenarios	39
3.3.4 Overview over P efficiency indicators	39
4. DISCUSSION	41
4.1 DATA QUALITY AND MODEL ROBUSTNESS	41
4.2 LEVEL OF NUTRIENT EMISSIONS FROM AQUACULTURE IN 2019	42
4.2.1 Emissions on locality level	42
4.2.2 Emissions on a national level	43
4.3 TESTING OF INDIVIDUAL STRATEGIES TO REDUCE P EMISSIONS AND RESOURCE USE	43
4.3.1 Potential and barriers of each strategy	44
4.5 SCENARIOS FOR P EMISSIONS AND RECOVERY IN THE FUTURE	47
4.6 A NOTE ON SLUDGE AND IMTA APPLICATIONS	49
4.6.1 Sludge applications	49
4.6.2 IMTA applications	49
4.7 MISSING REGULATIONS ON EMISSIONS FROM SEA-BASED AQUACULTURE	49
4.8 FURTHER WORK FOR AN OPTIMIZED P MANAGEMENT IN THE AQUACULTURE INDUSTRY	50
5. CONCLUSION	51
6. BIBLIOGRAPHY	53
APPENDIX	1
APPENDIX A: LIST OF CONTACTS	1
APPENDIX B: DETAILED EQUATIONS OF QUANTIFICATION OF FLOWS	2
APPENDIX C: MASS BALANCE INCONSISTENCES	4
APPENDIX D: REGULATION OF THE AQUACULTURE SECTOR	5
APPENDIX E: OVERVIEW OF THE PRODUCTION AREAS AND THE TRAFFIC LIGHT SYSTEM	6

List of Figures

Figure 1: Nutrient cycle in sea-based aquaculture. Adapted from Wang et al. 2012. 3

Figure 2: System description of the salmonid aquaculture production in Norway 2019. Each process is represented as a bow and flows are represented as arrows. The dotted line represents the system boundaries. Boxes within a process represent a stock. 10

Figure 3: System description of smolt production of salmonid species in Norway 2019. 11

Figure 4: System description of grow-out fish production in open net sea cages of salmonid species in Norway. 12

Figure 5: System description of grow-out fish production of salmonid species in a sea-based system with sludge collection and production of IMTA species. 13

Figure 6: System description of grow-out fish production of salmonid species in a closed containment system at sea. 14

Figure 7: System description of grow-out fish production of salmonid species at land based facilities with RAS. 14

Figure 8: Data availability and quantification of grow-out fish production. 15

Figure 9: Data availability and quantification of smolt production. 15

Figure 10: Systematic overview of data management and approach and model used in this project. 27

Figure 11: Phosphorus flows in sea-based grow-out fish production for two different localities in 2019. 29

Figure 12: Wet weight sludge produced in the Frøya and Hitra area in Trøndelag in 2019. 30

Figure 13: P, N and C emissions in tons from aquaculture in the Frøya and Hitra area in Trøndelag in 2019. 30

Figure 14: Phosphorus emissions in tons from aquaculture in the Frøya and Hitra area in Trøndelag in 2019. 31

Figure 15: Phosphorus flows in sea-based grow-out fish production (left) and smolt production in Norway 2019. 31

Figure 16: Nitrogen (left) and carbon (right) flows in sea-based grow-out fish production in Norway 2019. 32

Figure 17: Phosphorus flows in sea-based grow-out fish production in Norway 2019 with implemented sludge collection at open sea cages and P-offset in seaweed production. 33

Figure 18: Phosphorus flows in sea-based grow-out fish production in Norway 2019 when the feed has a lower P concentration. 33

Figure 19: Phosphorus flows in closed sea-based grow-out fish production in Norway 2019. 34

Figure 20: Phosphorus flows in closed sea-based grow-out fish production in Norway 2019. 34

Figure 21: Total emissions based on 2019 data of grow-out fish production of salmon and rainbow trout from the different systems with a 100% implementation of the strategies. 35

Figure 22: Theoretic maximum production in the different system when the P emission levels for 2019 are not exceeded. The blue line shows the baseline estimation of 3.7 million tons produced fish in 2050. 35

Figure 23: Phosphorus flows in scenario 2 Production growth at SEA, where production is increased to 3.7 million tons in 2050. All production of grow-out fish is sea-based in open net cages.	36
Figure 24: Phosphorus flows in scenario 2 Production growth at SEA, where production is increased to 3.7 million tons in 2050. All production of grow-out fish is sea-based in open net cages.	37
Figure 25: Phosphorus flows in scenario 3 Production growth at LAND, where production is increased to 3.7 million tons in 2050. Production of grow-out fish is divided between land-based facilities with RAS and sea-based open net cages.	38
Figure 26: P inflow, P emissions and recovered P as sludge, seaweed and ragworms in the different scenarios.	39
Figure 27: Regulation of the aquaculture sector in Norway. Adapted from Miljødirektoratet (2019).	5
Figure 28: Production areas with their current light in the Traffic Light System. Figure is created with the mapping tools from the Directorate of Fisheries.....	6

List of Tables

Table 1: Production data for salmon and rainbow trout in Norway 2019.....	16
Table 2: Model coefficients	18
Table 3: Quantification of flows. The X stands for either P, N or C.	20
Table 4: Qualitative estimation of uncertainty	21
Table 5: Uncertainty levels flows. Geographic level is not distinguished. For Grow-out production uncertainty levels are the same for locality and national level, for smolt production, uncertainty is higher on a locality level. X stands for P, N and C.....	21
Table 6: Equations for flows in strategies. Flows that have the same value as Grow-out fish production without any strategies have not been repeated. Equations for these flows can be found in Table 3.	24
Table 7: Overview over key factors in scenarios	26
Table 8: Estimated amount of sludge and nutrient emissions in tons from Norwegian aquaculture in 2019.	32
Table 9: P indicators for emitted and recovered P in the scenarios.....	39
Table 10: Equations for WW layer.....	2
Table 11: Equations for DW layer.....	2
Table 12: Equations for P, C and N layer .X stands for P, N or C. If the flow name contains P rather than X the flow has only been quantified for P.....	3
Table 13: Mass balance inconsistencies.	4

List of abbreviations and definitions

C = Carbon

CCS = Closed containment system

DIC = Dissolved inorganic carbon

DIN = Dissolved inorganic nitrogen

DIP = Dissolved inorganic phosphorus

DM = Dry matter

DOC = Dissolved organic carbon

DON = Dissolved organic nitrogen

DOP = Dissolved organic phosphorus

DW = Dry weight

IMTA = Integrated multi-trophic aquaculture

N = Nitrogen

P = Phosphorus

POC = Particulate organic carbon

PON = Particulate organic nitrogen

POP = Particulate organic phosphorus

RAS = Recirculating Aquaculture System

SFA = Substance Flow Analysis

WW = Wet weight

Sludge = fish faeces and feed loss.

1. Introduction

1.1 Background and motivation

Global mineral phosphorus stocks are driven towards depletion caused by the increased use of inorganic fertilizer (Cordell et al., 2009). Phosphorus (P) is an essential mineral for all living organisms as it plays a key role in several biochemical reactions (Ruttenberg, 2003). Global phosphorus flows to the ocean from freshwater sources (22 Mt P /yr) have already passed the planetary boundary of 11 Mt P / yr (Howarth et al., 1996, Smil, 2000, Bennett et al., 2001, Carpenter and Bennett, 2011, Steffen et al., 2015). Aquaculture is the world's fastest growing food production sector. With most of the global fisheries already exploited to the maximum or beyond, aquaculture has the potential to meet the rapid growing demand for seafood (Moffitt and Cajas-Cano, 2014, Huang et al., 2020).

The MINeral Phosphorus INDependence (MIND-P) project is a collaboration between The Norwegian University of Science and Technology (NTNU), Norwegian Institute of Bioeconomy Research (NIBIO) and The Technical University of Denmark (DTU). The purpose of this project is to map and identify the phosphorus flows in the agriculture and aquaculture sector in Norway and identify possible synergies in which phosphorus can become a circular resource in these industries, with the aim of becoming independent of mineral phosphorus. Phosphorus in fertilizer is mainly from mineral sources, which are not renewable in human timescales (Hamilton et al., 2017). Fish sludge (feed loss and faeces) and manure from agriculture are sources of secondary P which could replace mineral P in fertilizer. If not collected, these secondary P resources can contribute to both marine and freshwater eutrophication. Consequences of eutrophication include excessive plant and algal growth due to the increased availability of limiting nutrients, such as phosphorus or nitrogen (N).

In Norway, aquaculture is responsible for emitting 9-11 kt/yr to coastal waters (Hamilton et al., 2016, Miljødirektoratet, 2020). It has been a goal by the Norwegian governments to fivefold increase the production of Atlantic salmon (*Salmo salar L.*) and rainbow trout (*Oncorhynchus mykiss*) by 2050 (Fiskeridepartementet, 2014). However, challenges related to sea lice and escapes have limited the growth, and neither the industry nor researchers believe this is a likely scenario (PwC, 2021, Tveterås et al., 2019). Compared to other sources of protein such as cattle, poultry and pork, salmonid species have much lower carbon footprint, and salmonid species as a source of sustainable protein has now been identified as the main driver of growth in the industry (Tveterås et al., 2019, PwC, 2021).

Several new applications to reuse the fish sludge have been identified and developed on a commercial scale. These include fertilizer for plants, soil improver, biogas production and feed ingredient for ragworms (Aspaas et al., 2016, Blytt et al., 2011, Cabell et al., 2019, Lundberg and Larsen, 2019, Rosten et al., 2013b). As the aquaculture industry is projected to increase, both on a national level and on a global level, this will lead to an even higher

demand for phosphorus. Simultaneously, more secondary P will become available through fish sludge. A systematic understanding is necessary to identify what options exists for effectively collecting and reusing P as well as reducing the P emissions.

1.2 Salmon and rainbow trout aquaculture sector in Norway

Production of salmonid species, namely Atlantic salmon and rainbow trout, is divided into a land-based phase and a sea-based phase. The land-based phase, referred to as smolt production, lasts from 8-18 months, until the fish weighs approximately 100g. This production takes place in facilities that use either flow-through or Recirculating Aquaculture Systems (RAS) or a combination of the two systems (Lomnes et al., 2019). The main difference between these two technologies is that almost all of the water in a RAS facility is recycled and the particulate emissions are collected as sludge. However, regulations have become more strict, and now most flow-through systems also have a form of sludge collection on-site.

The sea-based phase, the production of grow-out fish, usually takes place in open net cages in the sea. The fish stays in the open net cages for 18-24 months, before it is slaughtered. Between each production cycle there is a fallowing period of minimum two months to disinfect the cages (Mattilsynet). The coast is divided into 13 production areas for salmon and rainbow trout. The level of sea lice determines the allowed production growth in the Traffic Light System, which allows for maximum 6 % growth every second year (Havforskningsinstituttet, 2020). There is one facility that produces grow-out fish in a land-based facility with RAS, Fredrikstad Seafood, and at least one producer that has started producing salmon in closed containment systems (CCS) at sea in Norway, AkvaFuture AS (Rosten et al., 2011, Staalstrøm and Johnsen, 2015).

1.3 Nutrient cycle and emissions in aquaculture

Phosphorus (P), nitrogen (N) and carbon (C), as illustrated in Figure 1, is given to the fish in the feed. Only a fraction of this is retained as biomass. The rest is emitted to surrounding waters as feed loss, fecal matter or excretion. The emissions are divided into particulate organic matter (POP, PON and POC), dissolved organic matter (DOP, DON and DOC) and dissolved inorganic matter (DIP, DIN and DIC). The particulate emissions settle on the seafloor and can be consumed by deposit feeders. The dissolved organic nutrients are consumed in bacterial activities and dissolved inorganic nutrients are taken up by primary producers.

Land-based facilities are required by law to collect at least 50 % of particulate matter from the waste water (Rosten et al., 2013a). No such regulation exists for the sea-based production, but there are examinations of the conditions on the seafloor under the open net sea cages, and of the nearby ecosystem. These are called MOM-B and MOM-C examinations and happens every second year if conditions are satisfactory (Fiskeridirektoratet, 2019, Fiskeridirektoratet, 2017). If emissions from aquaculture have

led to negative impacts on the local environment, the following period might be extended and production levels decreased.

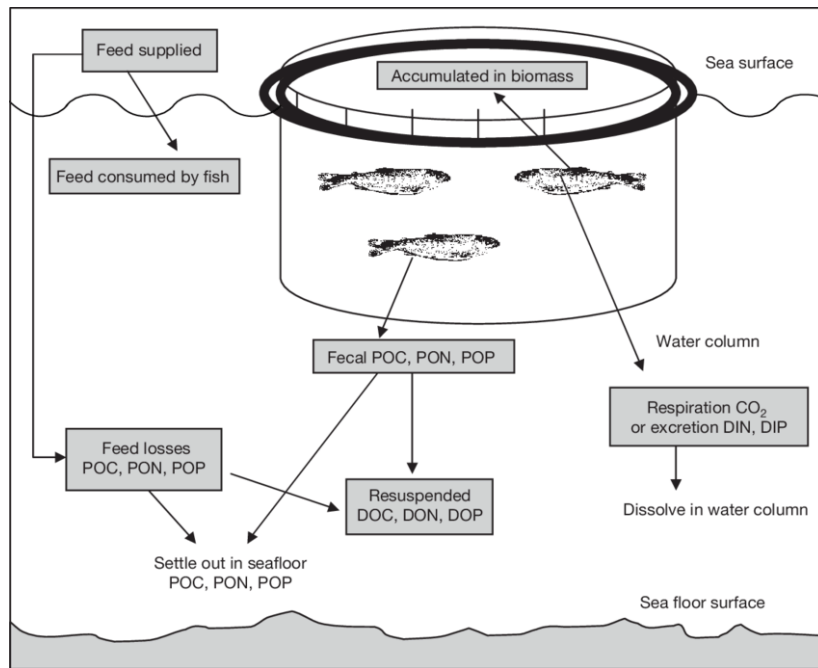

Figure 1: Nutrient cycle in sea-based aquaculture. Adapted from Wang et al. 2012.

1.3.1 Current approaches to estimate and manage emissions from aquaculture

Havforskningsinstituttet have stated that emissions from aquaculture does not pose a risk towards eutrophication in Norwegian coastal waters, even though some areas such as fjords with low water exchange, are more vulnerable than production sites with high oxygen levels and currents that spread the emissions to the surrounding waters (Boxaspen and Husa, 2019, Husa, 2018, Fredriksen et al., 2011). Several studies have estimated the nutrient emissions from the aquaculture sector in Norway on a national level. Guerrero and Sample (2021) estimates that aquaculture emitted 10 928 tons P and 63 379 tons N in 2019. Grefsrud et al. (2021) estimates that aquaculture is the source of 52 111 tons DIN and 6886 tons DIP in 2018-2019. Wang et al. (2012) developed a mass balance model of P, N and C emissions from aquaculture, based directly on the feed consumption. This model was used to quantify emissions from a single salmon farm in 2009 in Wang et al. (2013) and for all production areas in 2019 by Broch and Ellingsen (2020). There is a good understanding of nutrient emissions from aquaculture, even though these results are based on model estimations rather than experimental field data.

Hamilton et al. (2016) conducted a national substance flow analysis (SFA) of the P balance for Norway, where the P emission from aquaculture was found to be 9000 tons/yr. Huang et al. (2019) quantified the phosphorus flows in a Chinese city with a rapid growing aquaculture industry with the use of a SFA over the course of 10 years. They discovered that the phosphorus loss from the aquaculture industry increased more than for any other sector, due to the rapid growth of aquaculture. The P-use efficiency (PUE), defined as the ratio of harvested P to the input P, was used as a P efficiency indicator in the study. They

found that PUE was decreasing over the ten years. In other words, P use in the aquaculture sector was becoming less efficient. In the aquaculture sector in China, PUE was found to be ranging from 8.7 - 21.2 % (Huang et al., 2020, Zhang et al., 2015). They concluded that for a balanced anthropogenic P flow, global PUE should be increased from 20 % to at least 48% by 2050.

1.3.2 Main findings from the project thesis

This thesis is the continuation of the project thesis *Modelling the phosphorus cycle in Norwegian sea-based salmon aquaculture* (Strand, 2020). In this work the phosphorus flows for sea-based salmon aquaculture was mapped and quantified on a monthly resolution on locality level. The main finding from that work was the development of model that could capture both the temporal and spatial dimension of P emissions in aquaculture. These are important points to include when developing strategies for a sustainable P management. Emissions from aquaculture are not constant, as they depend on the feed input to the system. In following periods, there are no emissions, and there is usually a peak in emissions when the fish is at its largest size. National emission level estimations lacks the both the spatial and temporal resolution to capture both when and where nutrient emission happens.

1.3.3 Potential of reducing nutrient emissions from aquaculture

In order to reduce emissions from sea-based aquaculture, many farms have implemented feed control with cameras and sensors to limit feed waste and opted for a high energy feed which reduces the feed conversion ratio (FCR) (Braaten et al., 2010). Collection and reuse of the sludge from fish farming have been identified as one of the most important measures to reduce the impacts of emissions from aquaculture (Kraugrud, 2021). However, sludge collection, per today, is only implemented at smolt production facilities. Sludge from grow-out fish production is 25 times larger than from smolt production, (Hilmarsen et al., 2018). For this option to reach its full potential, sludge collection from sea-based localities is necessary. Sludge collection can only collect the particulate emissions and is therefore inadequate to reduce the emission levels of N and C, which are mostly in a dissolved inorganic form. A holistic approach is necessary to optimize the whole system and avoid potential problem shifts. An optimization of each individual farm does not necessarily mean that the upscaled system will be sustainable in terms of nutrient management.

Other known strategies to reduce nutrient emissions, that have not yet been implemented at large scale in Norway are i) phytase added to fish feed, ii) nutrient offset in species cultivated in integrated multitrophic aquaculture (IMTA), iii) sludge collection in open net sea cages or iv) production of grow-out fish in CCS either on land or at sea. The potential these strategies have to optimize both P, N and C resource use and emissions in aquaculture, both individually and combined, has yet to be quantified and analyzed both on a locality level and on a national level.

1.3.2.1 Phytase added feed

Due to overexploited fish stocks, commercial salmonid feed ingredients has become dominated by plant based ingredients (Winther et al., 2020). In plants, the main storage form of phosphorus is phytate, which is indigestible for salmonid species (Ytrestøyl et al., 2015, Cao et al., 2007). Therefore, mineral P is added to the feed to sustain the required level of P for the fish. In 2012, only 29 % of P was retained in the fish, leaving 71 % of the P in feed as emissions to the waterbody. Phytase is an enzyme that breaks the phytic bonds and it has been shown that adding this enzyme to the feed can increase the digestibility of P and N compared to feeds that did not contain phytase (Cao et al., 2007, Carter and Sajjadi, 2011, Storebakken et al., 1998, Denstadli et al., 2007). The use of phytase can decrease the amount of mineral P required in fish feed, as well as reducing P emissions. Phytase has been increasingly added to fish feed over the last two decades, but is still not a standard ingredient in fish feed (Cao et al., 2007, Hamilton, 2021).

1.3.2.2 Integrated multi-trophic aquaculture (IMTA)

Integrated multi-trophic aquaculture (IMTA) is based on the principle where one species feeds on the waste products of another (Buck et al., 2018). In sea-based production of salmonid species, dissolved inorganic emissions such as DIP, DIC and DIN can be taken up by primary producers such as seaweed. Particulate organic matter such as PON, POC and POP can be consumed by filter feeding organisms such as mussels and scallops or deposit feeders such as ragworms and sea-cucumbers. Several studies have assessed the potential of nutrient recycling through cultivating IMTA species in Norway (Bergvik et al., 2019, Handå et al., 2013, Wang et al., 2013). They have found that especially seaweed play an important role in taking up CO₂ and dissolved inorganic nutrients, making seaweed cultivation an efficient way to carbon offset the fish production (Duarte et al., 2017, Krause-Jensen and Duarte, 2016). Several producers in Norway, such as Seaweed Solutions, are cultivating seaweed separately from a fish farm. Some pilot projects for IMTA farms exist, such as Ocean Forest, a collaboration between the salmon producer Lerøy and the research institution Bellona. It focuses on cultivating several species of seaweed and blue mussels in proximity of salmon farms, with the aim of using the IMTA products as ingredients in fish feed. The potential of growing seaweed in Norway is huge, and production volumes may reach 20 million tons in 2050 compared to 178 tons produced in 2018 (Olafsen et al., 2012).

IMTA in sea-based systems have mostly focused on cultivating seaweed and bivalves such as mussels and scallops in proximity to fish farms. A group of species that has been mostly overlooked as a potential IMTA species until a few years ago, are ragworms (Jansen et al., 2019). Ragworms are rich in lipids and proteins, and can therefore be a valuable source of n-3 fatty acids that can be used in fish feed (Nederlof et al., 2019). They also have a great bioremediation potential and can convert the daily flux of organic nutrient waste deposited under the net sea cages (Nederlof et al., 2020).

1.3.2.3 Sludge collection options for grow-out fish production

LiftUP is a Norwegian company that specializes in a technology which pumps up dead fish from open sea cages. They have, after demand from a fish producer in Hordaland, developed a similar technology that pumps up sludge from open net cages in sea-based localities. The technology is now commercially available at the market (Fossmark, 2021). Collection of sludge is also possible if the fish is produced in closed sea-based or land-based systems. Many producers of closed containment systems (CCS) claims to have the possibility of collecting sludge up to a rate of 90% (Clarke et al., 2018). The production, cost and risks of implementing closed cages for sea based aquaculture in Norway has been analyzed by Bjørndal et al. (2018). They estimated that a full transition towards land-based production of grow-out fish would require an area of 11 700 000 m². Production in closed systems is also more expensive than in open sea cages. Rosten et al. (2011) estimated that the investment cost of closed sea-based system is approximately 1000-3000 NOK/m³, and 20 000 NOK/m³ for land-based system with RAS, compared to only 100 NOK/m³ for open net sea cages.

1.4 Scope and research questions

In the project thesis leading up to this work, *Modelling the phosphorus cycle in Norwegian sea-based salmon aquaculture*, a substance flow analysis (SFA) of P was implemented at locality level for the sea-phase of salmon production in Norway (Strand, 2020). This model employed a monthly resolution and was able to capture both the temporal and spatial dimension of the P flows in aquaculture. In this study, a multi-scale, multi-layer SFA has been further developed to quantify the flows of wet weight (WW), dry weight (DW), phosphorus (P), nitrogen (N) and carbon (C) flows of Norwegian production of salmon and rainbow trout at a production site level as well as an aggregated national level, for both the land- and sea-phase of the production in 2019.

Five strategies to optimize P emissions and resource use, have been added to the model and assessed. These include on-site sludge collection in open net pens, IMTA, low P concentration feed, CCS at sea and land-based production in RAS. The quantification of P flows in 2019 as well as estimates on production volume in 2050 by PwC (2021), have been used to develop three scenarios for the P flows for grow-out fish production in 2050 on a production area level and national level. 2019 has been used as a reference year. The processing and end-uses of sludge and IMTA products have not been mapped and quantified in this thesis.

The aim of this thesis is to investigate how phosphorus resource use and emissions can be optimized in the Norwegian aquaculture sector. This will be done by analyzing the performance of individual strategies as well as a combination of several strategies, in scenarios for the future of aquaculture in Norway by addressing the following research questions:

- What were the annual emissions of P, N and C from Norwegian aquaculture farms on a locality level and a national level in 2019?
- How much can sludge collection at open net sea cages, low P feed or production in CCS at sea or in RAS facilities reduce the P emissions individually? How much can production increase with the implementation of these strategies without increasing the 2019 P emission level?
- What options exists to optimize P emissions and resource use in the aquaculture sector in Norway while simultaneously allowing for production growth in the industry?

1.5 Outline

This thesis is structured as follows: chapter two presents the SFA system defined with system boundaries, processes and flows. All data and methods used to quantify the flows for 2019 as well as assumptions made to test individual strategies and to develop scenarios are presented. Chapter three presents the results. Chapter four discusses the data quality, results and findings. Chapter five presents a summary of the main findings and concludes.

2 Methods

2.1 System definition

2.1.1 System boundaries, processes and flows

The system includes production of Atlantic salmon (*Salmo salar* L.) and rainbow trout (*Onchorhynchus mykiss*). Both the land-based phase, smolt production, and the grow-out fish production is included. Cleaner fish such as Lump sucker (*Cyclopterus lumpus*) and Ballan wrasse (*Labris bergylta*), was omitted even though they are placed in the same open net cages as the salmonid species. Production of other fish species in Norway such as Turbot (*Scophthalmus maximus*) and Atlantic halibut (*Hippoglossus hippoglossus*), were also omitted.

The system has two individual system boundaries as shown in Figure 2, one for smolt production (Figure 3) in land-based facilities and one for grow-out fish production (Figure 4) in either open net cages at sea, CCS at sea or land-based production in land-based facilities with RAS. It is further assumed that all grow-out fish is produced in open net sea cages in 2019 without on-site sludge collection and IMTA production. The subsystems, that also includes production in open net sea-cages with sludge collection and IMTA, production (Figure 5) in CCS at sea (Figure 6) and production of grow-out fish in RAS (Figure 7) are presented in detailed versions in Figure 3-7.

In the overall system for salmonid aquaculture in Norway, fish feed is imported from the fish feed market to 1. *Smolt production* and production of grow-out fish. The smolt is transferred to the production of grow-out fish. This is either 2. *Grow-out fish production in open net sea cages*, 3. *Grow-out fish production in closed sea cages* or 4. *Grow-out fish production in RAS facilities*, via the process *Smolt market*. Fully grown fish is sent to *Slaughterhouses*. The collected sludge from smolt production grow-out fish production is sent to *Sludge treatment*, and the emissions from smolt production are treated in *Waste water treatment*. The emissions from grow-out fish production at sea, either in open or closed cages, are emitted directly to the *Surrounding waters*.

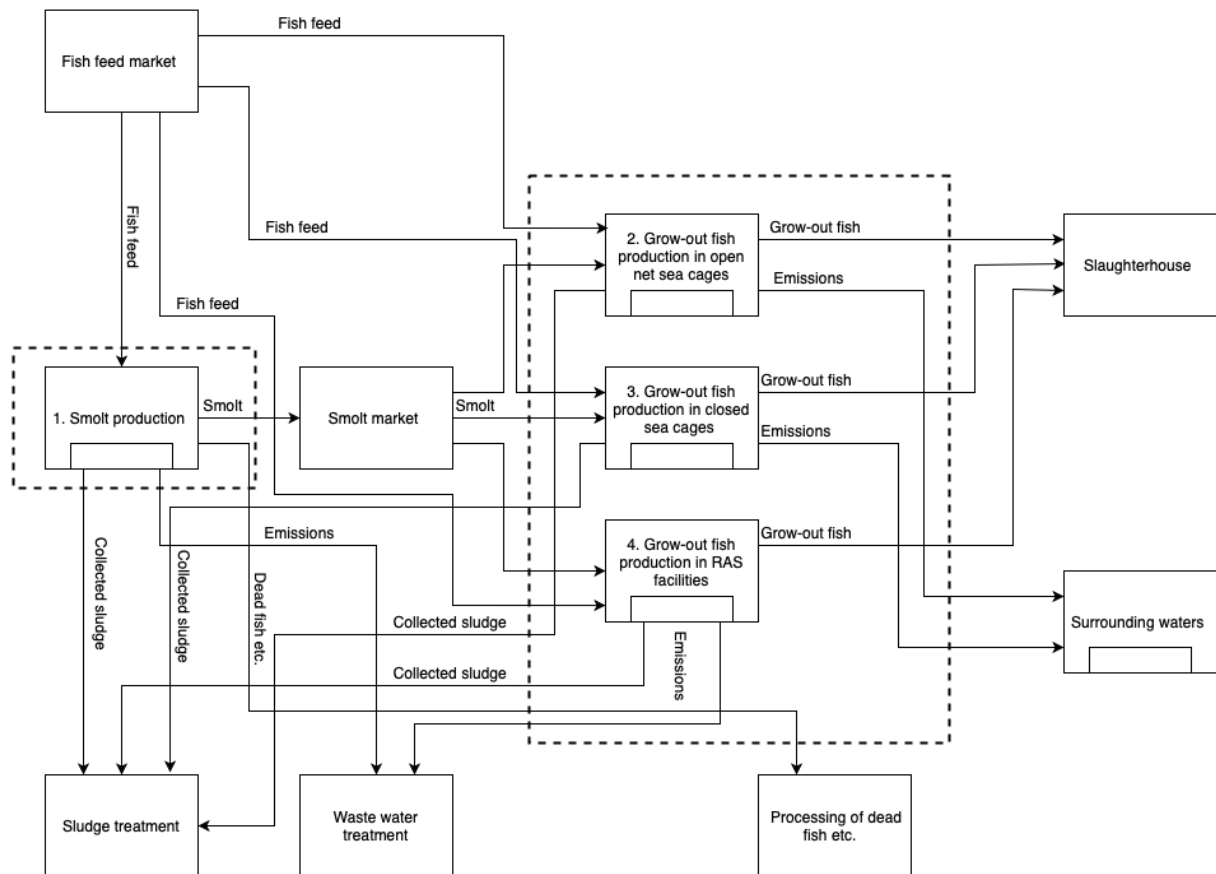

Figure 2: System description of the salmonid aquaculture production in Norway 2019. Each process is represented as a box and flows are represented as arrows. The dotted line represents the system boundaries. Boxes within a process represent a stock.

2.1.1.1 Smolt production

For the smolt production, presented in Figure 3, it is assumed the smolt is produced in a RAS facility, even though flow through system is also common. The reason for this simplification is that compared to the grow-out fish production, the smolt production is relatively small and RAS is predicted to be the main production form of land-based production (Mota, 2020). In RAS, the waste water is filtered, and toxic compounds are either removed or converted into non-toxic compounds, before the purified water is reused in the production (Lomnes et al., 2019). A RAS system usually consists of a fish tank, a mechanical filter, a biological filter and a pump tank. Particulate waste, mainly feces and feed loss, is filtered out with the mechanical filter. The waste water passes through a biological filter where ammonia is transformed into nitrite and then into nitrate by bacteria decomposition. Some of the phosphorus is also decomposed here, and it is assumed that this is in the form of DOP (Steen, 2021).

The system has four processes within the system boundaries, *1. Tanks*, *2. Fish biomass*, *3. Mechanical filter* and *4. Biofilter*. Feed is supplied to the system from *Fish feed market* to *1. Tanks*. Some of the feed is eaten by *2. Fish biomass*, while the rest of the feed is lost as feed loss. The emissions of P, N and C from *2. Fish biomass* to *1. Tanks* are divided in to dissolved inorganic emissions (DIX), dissolved organic emissions (DOX) and particulate

organic emissions (POX). DIX is excreted through the gills or through urine. POX comes from the fecal matter. DOX is the fraction of POX which is immediately dissolved. From 1. Tanks to 3. Mechanical Filter, the P, N or C in the feed loss is also included as POX and DOX. Particulate emissions (POX) are filtered out in the 3. Mechanical filter and collected as sludge going to Sludge treatment. The filtered water flows are transferred to the 4. Biofilter. It is assumed that the purified water flow going from 4. Biofilter to 1. Tanks do not contain any phosphorus. From 4. Biofilter there is a flow of waste water going to Waste water treatment. It is assumed that P in the waste water will be in the form of DIP.

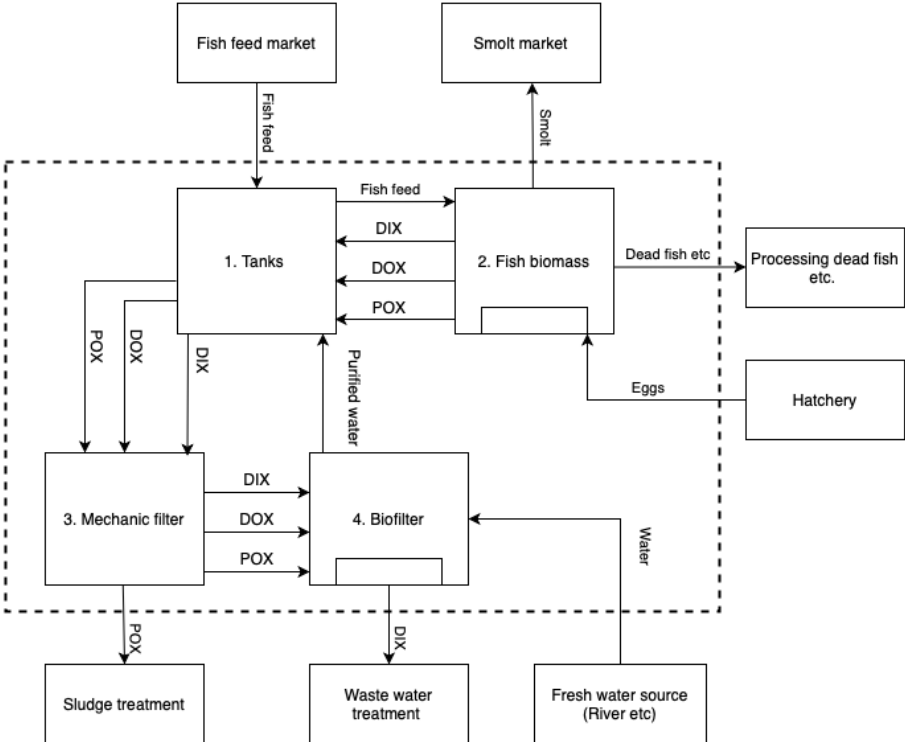

Figure 3: System description of smolt production of salmonid species in Norway 2019.

2.1.1.2 Grow-out fish production in open net sea cages

In Grow-out fish production, Figure 4, smolt is imported from the process *Smolt market* to the process 2. *Fish biomass*, which represents the grow-out fish that are produced in 1. *Open net cages*, where they stay until they go to *Slaughterhouse* for slaughtering. Some fish might also be transferred to or from other localities as well, presented as the process *Grow-out fish production – other locality*. This is done to maximize the allowed production per permit. *Grow-out fish production – other locality* is only included at a locality level, and not in the aggregated systems to production area or national level, because all localities are considered as one process in the aggregated system.

Some fish also manage to escape from the open net cages, mostly due to holes in the net caused by structural flaws or that the fish simply swims over the fence if it is submerged due to high waves. It is assumed that escaped fish goes directly from 2. *Fish biomass* to the *Surrounding waters*. Fish that dies in the pen or does not have the required quality for the fish fillet market is categorized as production loss at the site, and in this system, it is assumed that they will go to *Processing of dead fish etc.* Fish feed from *Fish feed market* is

released in the water column in the 1. *Open net cages* where the 2. *Fish biomass* can consume it. The emission flows of P, N and C are the same as in smolt production, but here they are emitted from 2. *Fish biomass* to 1. *Open net cages* before being transferred to *Surrounding waters*.

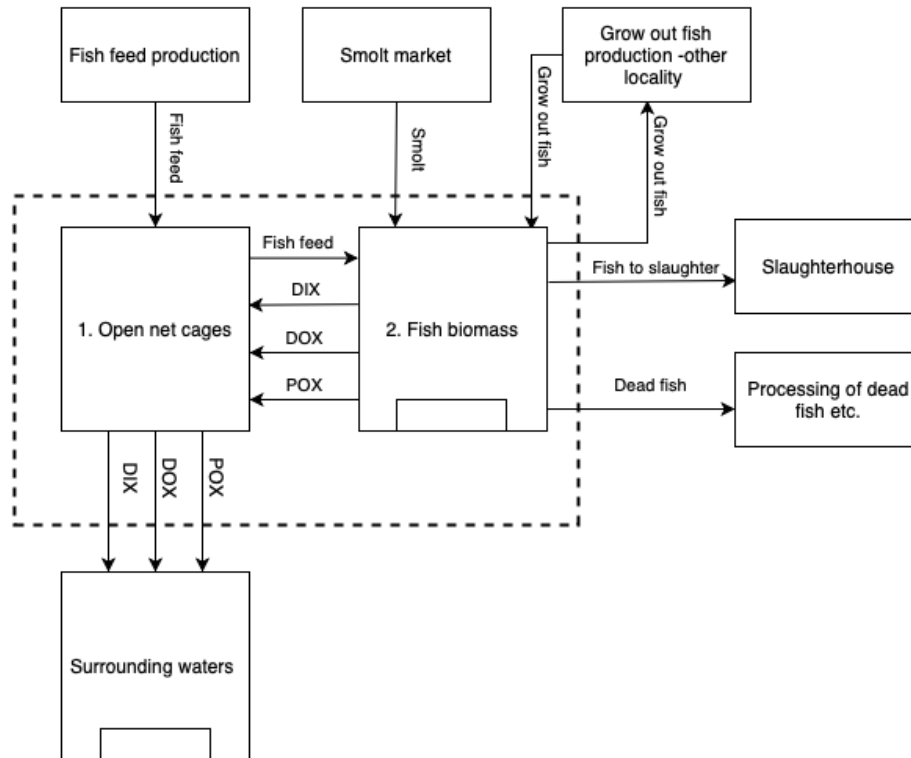

Figure 4: System description of grow-out fish production in open net sea cages of salmonid species in Norway.

2.1.1.3 Grow-out fish production open net cages with IMTA and LiftUP

This system, Figure 5, is quite like the standard production of grow-out fish in open sea cages. However, within the system boundaries, the process 3. *Sludge Collection* is included. This process represents an on-site sludge collection technology, like the one produced by LiftUP, that pumps up sludge from the open sea cages. It is assumed that the P collected in this pump is in the form of POP.

Nutrient offset by *Seaweed production* or *Ragworm production* have also been included. IMTA systems are normally divided into either coupled or de-coupled IMTA systems. The difference between the two system is that in coupled IMTA, the species are cultivated in proximity of each other and in decoupled IMTA they are cultivated at different geographical positions (Goddek et al., 2016). In this system, coupled and de-coupled IMTA have not been differentiated. *Seaweed production* or *Ragworm production* are therefore outside the system boundaries. A production loss of IMTA species has been omitted. The seaweed production is based on data for the production of Sugar kelp (*Saccharina Latissima*). This is the most commonly cultivated seaweed species in Norway, even though several other species are already cultivated on a commercial scale. Ragworm production is still at a research phase and data for this has been based on recent studies on the species *Hediste Diversicolor*, *Capitella sp.* and *O. craigsmithi*.

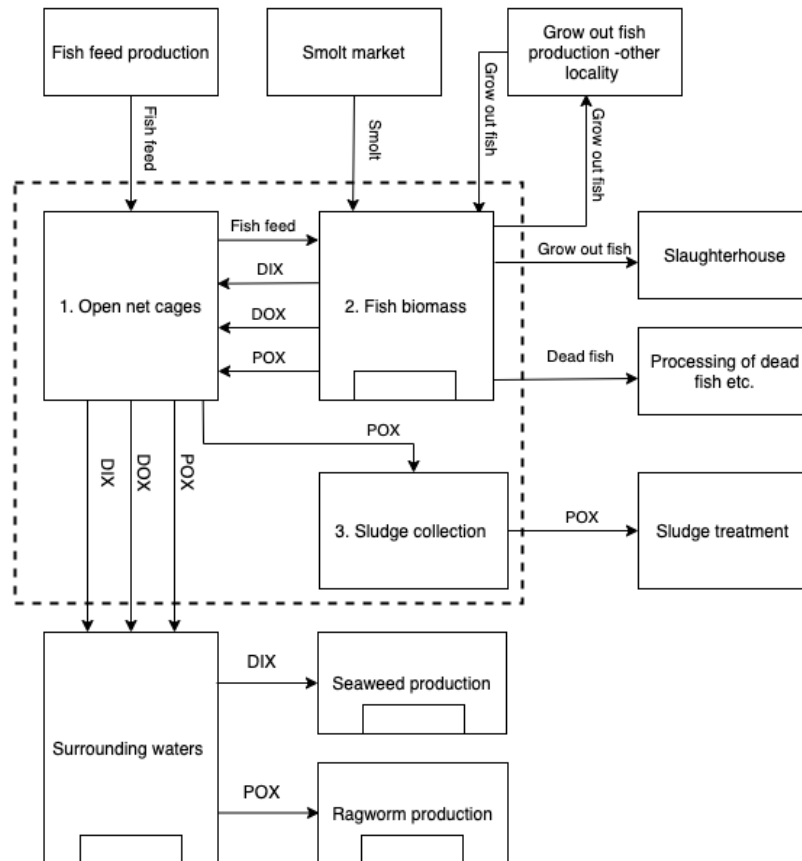

Figure 5: System description of grow-out fish production of salmonid species in a sea-based system with sludge collection and production of IMTA species.

2.1.1.4 Grow-out fish in closed sea cages

Production of grow-out fish in CCS (Figure 6) is like the system of production in open net sea cages, but the *2. Fish biomass* is here placed inside *1. Closed tanks*. Feed is coming to the system to the *1. Closed tanks* and eaten by the *2. Fish biomass*. Emissions including excreted DIP, fecal POP and DOP and feed loss are filtered with a mechanical filter that collects particulate matter, POP, before being emitted to the surrounding waters. The collected sludge is transferred to *Sludge treatment*. A N and C layer was not included for this subsystem.

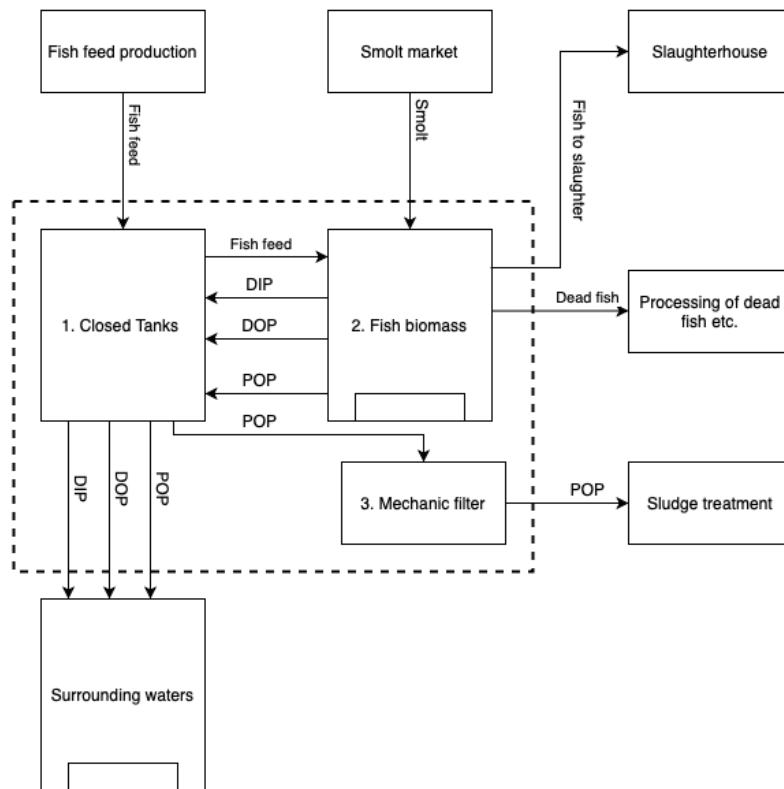

Figure 6: System description of grow-out fish production of salmonid species in a closed containment system at sea.

2.1.1.5 Grow-out fish in RAS systems

The system description for producing grow-out fish in RAS facilities (Figure 7) is similar to that of smolt production in RAS facilities, but differs in the fact that the fish leaving the system in this case goes to *Slaughterhouse* rather than to the *Smolt market*. A N and C layer was not included for this subsystem.

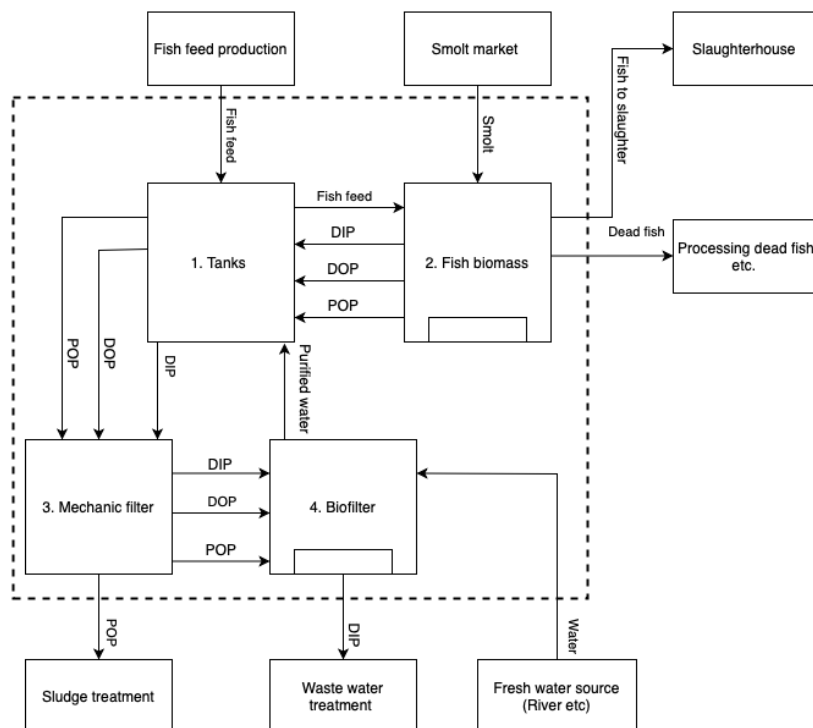

Figure 7: System description of grow-out fish production of salmonid species at land based facilities with RAS.

2.2 System quantification

2.2.1 Multi-scale multi-layer substance flow analysis

A multi-scale multi-layer substance flow analysis (SFA) was performed on a locality level and on a national level for grow-out fish and smolt production. The layers include a wet weight (WW) layer, a dry weight (DW) layer, and a P, N and C layer. SFA is an excellent tool for analyzing resource efficiency with a system's approach developed by Brunner and Rechberger (2004). A mass balance model developed by Wang et al. (2012) was used for quantifying the P, N and C emissions flows from salmon and rainbow trout production. This model has also been applied in Wang et al. (2013) and Broch and Ellingsen (2020).

2.2.2 Data Sources

Available data including unit, production stage and geographical level is summarized in Table 1. Data on a locality level per month was retrieved from Fiskeridirektoratet for sea-based grow-out fish production for biomass, feed consumption, escapes, production losses and fish to slaughter. The flows were quantified on a locality level and aggregated to a production area level and to a national level as shown in Figure 8.

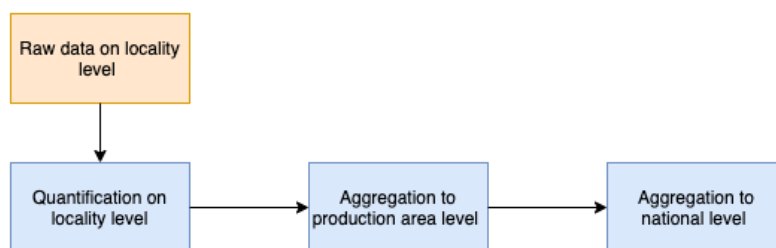

Figure 8: Data availability and quantification of grow-out fish production.

Smolt producers are not required to report data on feed consumption to Fiskeridirektoratet. They report to the County Governor and there is no official register where all this data is collected. Data on sold smolt on a county level as well as number of facilities per county is available from Fiskeridirektoratet. Therefore, the flows for smolt production were quantified on a county level and divided to a locality level. The results were coupled to localities coordinates from Akvakulturregisteret (Fiskeridirektoratet, 2020). The county level flows were aggregated to a national level for 2019.

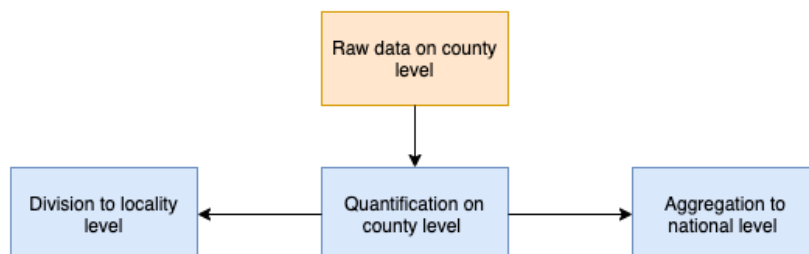

Figure 9: Data availability and quantification of smolt production.

Relevant stakeholders and experts in the industry were contacted to retrieve useful insights and estimations regarding feed composition (Hamilton, 2021), IMTA production (Sveier, 2021, Reitan, 2021, Strand, 2021, Kristensen, 2021), RAS facilities (Steen, 2021, Attramadal, 2021) and sludge collection in open sea cages (Fossmark, 2021).

Table 1: Production data for salmon and rainbow trout in Norway 2019.

Parameter name	Unit	Production stage	Geographical level	Source
Current biomass in net pens	kg	Grow-out	Locality	1
Current biomass in net pens	pc	Grow-out	Locality	1
Feed consumption	kg	Grow-out	Locality	1
Smolt input	pc	Grow-out	Locality	1
Total input	pc	Grow-out	Locality	1
Slaughtered fish	kg	Grow-out	Locality	1
Slaughtered fish	pc	Grow-out	Locality	1
Escaped fish	pc	Grow-out	Locality	1
Production loss at farm	pc	Grow-out	Locality	1
Production loss at slaughter	pc	Grow-out	Locality	1
Production loss other	pc	Grow-out	Locality	1
Fish transferred to other locality	pc	Grow-out	Locality	1
Average weight smolt	kg	Smolt	-	1
Smolt sale per county	pc	Smolt	County	1
Seaweed produced per locality	tons	Grow-out	Locality	2
Average area per locality	m ²	Grow-out	-	3
Nb of localities	pc	Grow-out	Production area	1

¹(Fiskeridirektoratet); ²(Sveier, 2021); ³(Barentswatch)

2.2.3 Model coefficients

All coefficients used in the quantification of the WW, DW, P, N and C layer for the grow-out and smolt production in 2019 are summarized in Table 2 with the numerical range and the value used.

2.2.3.1 Feed loss

The feed loss is reported by Wang et al. (2012) is 3 %, an estimate that originated from Corner et al. (2006) and Reid et al. (2009). Other estimates of feed loss are 3-5% made by Broch et al. (2017) and 7.42 % (Torrissen et al., 2016).

2.2.3.2 Dry matter in feed

Wang et al. (2013) estimated that the dry matter in fish feed is between 97-99% with an average of 98%. Aas et al. (2019) reports a dry matter content of 93.4% in fish feed. Aas et al. (2020) found a dry matter content of 92.8 – 93.9%.

2.2.2.3 Dry matter in salmonid species

Wang et al. (2013) found that the dry matter in salmon varies from 31% to 40% of the total wet weight with a mean of 36%. and Aas et al. (2019) reports a dry matter content of 40.9% in slaughtered salmon.

2.2.2.4 Soluble fraction of particulate waste

The soluble fraction of particulate waste is estimated to be 15% by (Wang et al., 2012). An interval of 10-20% has also been reported by Aas and Åsgård (2017).

2.2.2.5 Feed Composition

The P concentration in fish feed is estimated to be 0.83-0.9.3%, with an average of 0.88% according to Wang et al. (2013). Other studies report a higher content of 1.3%(Aas et al., 2019) and 0.9%(Ytrestøyl et al., 2015). BioMar has also launched a new low phosphorus feed, Blue IMPACT™, with a P concentration of 0.6%. In their standard feed the P concentration is 0.7% (BioMar, 2020). The nitrogen content of feed was reported to be 5.5-7.2% by Wang et al. (2013). Torrissen et al. (2016), found a content of 5.68% and Aas et al. (2019) found an average of 5.69% nitrogen in the feed, when the conversion *protein* = $N \times 6.25$ was used. (Aas et al., 2020) used values from 6.2 -6.7% for N in feed. Wang et al. (2013) reports a carbon content of the feed of 51.5-55.5%.

2.2.2.6 Chemical composition in salmonid species

The concentration of phosphorus in the dry matter of salmon is reported to be between 0.61-0.67 % with an average of 0.64 %(Wang et al., 2013). Ytrestøyl et al. (2015) estimated a P concentration in whole wet weight salmon to 0.35 % and the updated study for salmon production in 2016 reported a decrease to 0.31 % (Aas et al., 2019). This is equivalent to a P dry matter content of 0.85 % and 0.76 %, respectively. Wang et al. (2013) reports a N content of 6.2-8.8 % in salmon and 57.4-63.5 % C in DM salmon. Aas et al. (2019) found that the nitrogen content of slaughtered fish was 2.7 % and a value of 2.8 % N was reported by Ytrestøyl et al. (2015), this indicates a dry matter content of 6.6 % and 6.8% N.

2.2.2.7 Assimilation efficiency

The assimilation efficiency of P in fish feed for salmon is estimated to range from 24 % (Torrissen et al., 2016) to 50 % (Wang et al., 2012). Ytrestøyl et al. (2011) found a retention efficiency of 27 % for P. For nitrogen the assimilation efficiency is estimated to be between 85-89% (Wang et al., 2013) and 89-90 % in (Ytrestøyl et al., 2015). For carbon the assimilation efficiency is found to be 80 % Wang et al. (2012).

2.2.2.8 Retention efficiency

The retention efficiency of P in fish feed for salmon is reported by Wang et al. (2013) to be 24-26 %, and (Torrissen et al., 2016) reports 21 %. (Ytrestøyl et al., 2015) estimated a retention of 29 % for salmon production in 2012, while the updated study that assessed feed use for 2016 reported a retention of 18 % for P (Aas et al., 2019). The latter study does not take feed spill and dead fish into account, making this number lower than it realistically should be. Aas et al. (2020) found that the retention of P ranged from 22.8-41.9% when the salmon was fed three different types of pellet quality and Hatlen et al. (2015) found the retention of P to vary between 15.3-35.3 %. The retention efficiency of N ranged from 47.1-50.8 % in Aas et al. (2020). Wang et al. (2013) uses a range of 43-46 % for nitrogen and Torrissen et al. (2016) used a value of 49 % for nitrogen. In Hatlen et

al. (2015) the retention efficiency of N ranged from 50.1 - 53.1 %. Torrissen et al. (2016) reported a retention efficiency of 46% for carbon and Wang et al. (2013) found it to be 40% for carbon.

Table 2: Model coefficients

Name	Symbol	Range	Value used	Unit	Source
Feed loss	F _L	1-10	3	%	1, 2, 3, 4, 5
Dry matter in feed	DM _{Feed}	97-99	98	%	1
Dry matter in fish	DM _{Fish}	31-40	36	%	1
Soluble fraction of particulate waste	S	10-20	15	%	1, 6
P in feed	P _C	0.6-1.3	0.88	%	1,7,8
P in fish	P _C	0.61-0.76	0.64	%	1, 7, 8
P in faeces	P _C	1.4-3	2.3	%	1
Assimilation efficiency P	P _A	24-50	37	%	1, 5
Retention efficiency P	P _R	21-26	23.5	%	1, 5, 7, 8
N in feed	N _C	5.5-7.2	6.35	%	1,4
N in fish	N _C	6.2-8.8	7.4	%	1,4
N in faeces	N _C	2.2-3.7	2.7	%	1
Assimilation efficiency N	N _A	85-89	87	%	1,4
Retention efficiency N	N _R	43-50.8	46	%	1,4
C in feed	C _C	51.9-55.5	54	%	1,4
C in fish	C _C	57.4-63.5	60.6	%	1,4
C in faeces	C _C	31.2-44.8	36.5	%	1,4
Assimilation efficiency C	C _A	75-89	82	%	1,4
Retention efficiency C	C _R	40-46	43	%	1,4
WW Faeces per feed	WW _{faeces}	-	1.96	kg/kg	6
WW Sludge per feed	WW _{sludge}	1.5-2.0	1.7	kg /kg	9
Dry matter faeces	DM _{faeces}	11-25	15	%	1
Dry matter sludge	DM _{sludge}	-	10	%	1
FCR smolt	FCR	-	1	kg /kg	9
Production loss smolt	-	-	15	%	10
Lift Up collection rate	-	0.3-0.6	0.44	kg/kg	11
Cleansing criteria RAS	-	-	50	%	12
P collection in RAS	-	30-85	65	%	12, 13
Dissolved P consumed in biofilter	-	71-74	72.5	%	13
Sludge collection in CCS	-	60-90	75	%	14
DM in sugar kelp	DM _{seaweed}	6.3-16.8	10	%	15, 16
P in sugar kelp	P _{seaweed}	0.11-0.34	0.195	%	15, 16, 17
N in sugar kelp	N _{seaweed}	2.4-4.5	4.0	%	15, 16,17
C in sugar kelp	C _{seaweed}	25.2-33.4	29.3	%	16,17
P in <i>H. diversicolor</i>	P _{ragworm}	-	0.008	g/100g TS	18
Individuals of ragworms per m ² for daily uptake of nutrient fluxes	-	65 -194	130	1000 ind/m ²	19
AFDW ragworms	DW _{ragworm}	73-90.1	81.55	%	20

Sources : ¹(Wang et al., 2013) ; ²(Corner et al., 2006); ³(Reid et al., 2009); ⁴(Broch et al., 2017); ⁵(Torrissen et al., 2016); ⁶(Aas and Åsgård, 2017); ⁷(Aas et al., 2019); ⁸(Ytrestøyl et al., 2015); ⁹(Hilmarsen et al., 2018); ¹⁰ (Fiskeridirektoratet) ; ¹¹ (Fossmark, 2021); ¹² (Rosten et al., 2013a); ¹³ (Steen, 2021); ¹⁴(Clarke et al., 2018); ¹⁵ (Sveier, 2021); ¹⁶(Bruhn et al., 2016); ¹⁷(Reid et al., 2013); ¹⁸ (Kristensen, 2021); ¹⁹(Nederlof et al., 2020); ²⁰(Nederlof et al., 2019);

2.2.2.9 Sludge and faeces

Several studies have estimated that the sludge produced is between 0.7-2.0 kg per kg feed. A converter used by Hilmarsen et al. (2018) is 1.5 kg sludge with 10 % TS per kg feed. In this study, sludge is considered the sum of feed loss and faeces. A converter of 1.96 kg faeces/kg feed is derived from Aas and Åsgård (2017). The DM content of faeces is reported to be 15 % (Aas and Åsgård, 2017, Wang et al., 2013).

2.2.2.10 Grow-out fish

It has been assumed that the same model coefficients are valid for both salmon and rainbow trout as well as for smolt. An approximation of an average weight of the fish is used where the data is only given in number of fish and not biomass. This average weight is calculated based the average weight of *slaughtered fish (kg)/slaughtered fish (pc)*. This means that the flows Escaped fish and Dead fish etc. are probably higher than what they should be. However, these flows are relatively small compared to the flows Fish to slaughter and Fish Feed and the nutrient emission flows.

2.2.2.11 Smolt production

The weight of the smolt when transferred to grow-out fish production is normally estimated to be 100 g (Havforskningsinstituttet, 2019). However, some producers have the fish longer in land-based facilities, not transferring the post-smolt to the sea until it is 600 g (NOFIMA, 2018). It is further assumed that smolt and grow-out fish has the same chemical composition, retention and assimilation efficiency. An economic feed conversion ratio (EFCR) of 1 is assumed for smolt production. Included in this is the 30% feed loss, resulting in a biological FCR of 0.7. A production loss of 15 % is assumed based on data on total amount of sold smolt compared the total amount of bought eggs (Fiskeridirektoratet).

2.2.2.12 Smolt production in land-based production with RAS

In RAS a 50 % removal of particulate matter is required, but the overall efficiency is ranging from 60-84% for removal of P (Rosten et al., 2013a). P in waste water flows and P consumed by bacteria are based on yearly average data from a smolt production facility in Norway. It is assumed that these transfer coefficients are valid for grow-out fish production in RAS systems as well. It is further assumed that only POP can be filtered out in the *Mechanical filter* and that DOP and POP will be consumed by bacteria. What is left will then be emitted in the waste water flows as DIP.

2.2.4 Quantification of flows for 2019

The general equations of all the flows for grow-out fish production and smolt production in 2019 are presented in Table 3. It is assumed that all grow-out fish is produced in open net sea cages in 2019 without on-site sludge collection and IMTA production and that all smolt production takes place in RAS. The general equation shows the wet weight layer amount multiplied with the concentration of P, N or C from the dry matter content in each wet weight flow. Detailed equations for each layer can be found in Appendix B.

Table 3: Quantification of flows. The X stands for either P, N or C.

Subsystem	Flow name	General Equation
Grow-out fish at sea	Feed consumption	Feed consumption $\times X_c$
Grow-out fish at sea	Feed intake	Feed consumption $\times (1 - F_L) \times X_c$
Grow-out fish at sea	Feed loss	Feed consumption $\times F_L \times X_c$
Grow-out fish at sea	DIX to water column (pen)	(Feed consumption - Feed loss) $\times X_c \times (A_x \times E_x)$
Grow-out fish at sea	DOX to water column (pen)	$S \times (1 - A_x) \times (\text{Feed consumption} - \text{Feed loss}) \times X_c$
Grow-out fish at sea	POX to water column (pen)	$(1 - S) \times (1 - A_x) \times (\text{Feed consumption} - \text{Feed loss}) \times X_c$
Grow-out fish at sea	DIX to surrounding waters	DIX to water column (pen)
Grow-out fish at sea	DOX to surrounding waters	DOX to water column (pen) + $S \times (1 - A_x) \times \text{Feed loss} \times X_c$
Grow-out fish at sea	POX to surrounding waters	POX to water column (pen) + $(1 - S) \times (1 - A_x) \times \text{Feed loss} \times X_c$
Grow-out fish at sea	Escapes	Escaped fish $\times X_c$
Grow-out fish at sea	Fish to slaughter	Fish to slaughter $\times X_c$
Grow-out fish at sea	Dead fish etc.	(Production loss at farm + Production loss at slaughter + Production loss other) $\times X_c$
Grow-out fish at sea	Smolt	Smolt input $\times X_c$
Grow-out fish at sea	Grow-out fish from other locality	(Total input - Smolt input) $\times X_c$
Grow-out fish at sea	Grow-out fish to other locality	Fish transferred to other locality $\times X_c$
Grow-out fish at sea	Feces	Feed Consumption $\times WW$ Feces per feed
Grow-out fish at sea	Sludge	Faeces + Feed loss
Grow-out fish at sea	X in faeces	DOX to water column (pen) + POX to water column (pen)
Grow-out fish at sea	X in sludge	X in faeces + Feed loss
Smolt in RAS	Fish to smolt market	Smolt sale per county
Smolt in RAS	Feed consumption	Fish to smolt market $\times FCR \times X_c$
Smolt in RAS	Feed intake	Feed consumption $\times (1 - F_{L,smolt}) \times X_c$
Smolt in RAS	Feed loss	Feed consumption $\times F_{L,smolt} \times X_c$
Smolt in RAS	Production loss	Smolt sale per county \times Production loss smolt $\times X_c$
Smolt in RAS	Eggs	-
Smolt in RAS	DIX to RAS tanks	(Feed consumption - Feed loss) $\times X_c \times (A_x \times E_x)$
Smolt in RAS	DOX to RAS tanks	$S \times (1 - A_x) \times (\text{Feed consumption} - \text{Feed loss}) \times X_c$
Smolt in RAS	POX to RAS tanks	$(1 - S) \times (1 - A_x) \times (\text{Feed consumption} - \text{Feed loss}) \times X_c$
Smolt in RAS	DIX to mechanical filter	DIP to RAS tanks
Smolt in RAS	DOX to mechanical filter	DOX to RAS tanks + $S \times (1 - A_x) \times \text{Feed loss} \times X_c$
Smolt in RAS	POX to mechanical filter	POX to RAS tanks + $(1 - S) \times (1 - A_x) \times \text{Feed loss} \times X_c$
Smolt in RAS	X in faeces	DOX to RAS tanks + POX to RAS tanks
Smolt in RAS	X in sludge	X in faeces + Feed loss $\times X_c$
Smolt in RAS	Collected P in RAS	P in sludge \times P collection in RAS
Smolt in RAS	DIP to biofilter	DIP to mechanical filter
Smolt in RAS	DOP to biofilter	DOP to mechanical filter
Smolt in RAS	POP to biofilter	POP to mechanical filter - Collected P_c in RAS
Smolt in RAS	Total P consumed by bacteria	(DIX to biofilter + DOX to biofilter+ POX to biofilter) \times Dissolved P consumed in biofilter
Smolt in RAS	DOP consumed by bacteria	DOP to biofilter
Smolt in RAS	POP consumed by bacteria	POP to biofilter
Smolt in RAS	DIP consumed by bacteria	Total X_c consumed by bacteria - DOP to biofilter - POP to biofilter
Smolt in RAS	DIP in waste water	DIP to biofilter - DIP consumed by bacteria
Smolt in RAS	DOP in waste water	DOP to biofilter - DOP consumed by bacteria
Smolt in RAS	POP in waste water	POP to biofilter - POP consumed by bacteria

2.3 Uncertainty analysis

The quantified flows have been given a qualitative measure of uncertainty divided into four levels. The levels are based on the data quality of the raw data and the model coefficients. Uncertainty levels and their explanation is summarized in Table 4 and each flow with their qualitative level of uncertainty is shown in Table 5. It is important to note that uncertainties at the level of feed composition, assimilation and retention efficiency can have great impacts on the nutrient emission flows. Therefore, a quantitative uncertainty analysis with an error propagation should be conducted to estimate the standard deviation of these flows. WW Sludge and emissions of P and have been compared to values found by other studies. A mass balance check was calculated for the P, N and C layer for grow-out fish production. This was done by subtracting all output flows from the sum of all input flows in the processes *Open net pens* and *Fish biomass*. The results of this mass balance check can be found in Appendix C.

Table 4: Qualitative estimation of uncertainty

Uncertainty levels	Explanation
Low	Based on only raw data
Medium	Values/estimations are similar in different sources
High	Values/estimation varies significantly in different sources
Very high	Uncertain estimates -cannot be validated

Table 5: Uncertainty levels flows. Geographic level is not distinguished. For Grow-out production uncertainty levels are the same for locality and national level, for smolt production, uncertainty is higher on a locality level. X stands for P, N and C.

Subsystem	Flow name	Uncertainty	Sources of error
Grow-out fish	Fish feed to open sea cages	Low	Chemical composition in feed
Grow-out fish	Feed intake	Medium	Feed loss convertor
Grow-out fish	DOP to water column	Very high	P concentration in feed and assimilation efficiency
Grow-out fish	DIP to water column	Very high	P concentration in feed and assimilation efficiency
Grow-out fish	POP to water column	Very high	P concentration in feed and assimilation efficiency
Grow-out fish	DOP to surrounding waters	Very high	P concentration in feed and assimilation efficiency
Grow-out fish	DIP to surrounding waters	Very high	P concentration in feed and assimilation efficiency
Grow-out fish	POP to surrounding waters	Very high	P concentration in feed and assimilation efficiency
Grow-out fish	DON to water column	High	N concentration in feed
Grow-out fish	DIN to water column	High	N concentration in feed
Grow-out fish	PON to water column	High	N concentration in feed
Grow-out fish	DON to surrounding waters	High	N concentration in feed
Grow-out fish	DIN to surrounding waters	High	N concentration in feed
Grow-out fish	POC to surrounding waters	High	C concentration in feed
Grow-out fish	DOC to water column	High	C concentration in feed
Grow-out fish	DIC to water column	High	C concentration in feed
Grow-out fish	POC to water column	High	C concentration in feed
Grow-out fish	DOC to surrounding waters	High	C concentration in feed

Grow-out fish	DIC to surrounding waters	High	C concentration in feed
Grow-out fish	POC to surrounding waters	High	C concentration in feed
Grow-out fish	Escapes	Medium	Avg. weight per fish
Grow-out fish	Fish to slaughter	Low	Chemical composition of fish
Grow-out fish	Dead fish etc.	Medium	Avg. weight per fish
Grow-out fish	Smolt	Medium	Avg. weight per fish
Grow-out fish	X in feces	High	Amount of feces
Grow-out fish	X in sludge	High	Amount of sludge
Smolt in RAS	Fish to smolt market	Medium	Avg. weight per fish
Smolt in RAS	Feed consumption	High	Based on FCR
Smolt in RAS	Feed intake	High	Based on FCR and feed loss convertor
Smolt in RAS	Feed loss	High	Based on FCR and feed loss convertor
Smolt in RAS	Production loss	High	Estimations on loss
Smolt in RAS	Eggs	-	Not quantified
Smolt in RAS	DIX to RAS tanks	High	X concentration in feed and assimilation efficiency
Smolt in RAS	DOX to RAS tanks	High	X concentration in feed and assimilation efficiency
Smolt in RAS	POX to RAS tanks	High	X concentration in feed and assimilation efficiency
Smolt in RAS	DIX to mechanical filter	High	X concentration in feed and assimilation efficiency
Smolt in RAS	DOX to mechanical filter	High	X concentration in feed and assimilation efficiency
Smolt in RAS	POX to mechanical filter	High	X concentration in feed and assimilation efficiency
Smolt in RAS	X in faeces	High	Amount of faeces
Smolt in RAS	X in sludge	High	Amount of sludge
Smolt in RAS	Collected P in Ras	High	Amount of sludge and fraction collected
Smolt in RAS	DIP to biofilter	High	Amount of P emissions and fraction collected
Smolt in RAS	DOP to biofilter	High	Amount of P emissions and fraction collected in RAS
Smolt in RAS	POP to biofilter	High	Amount of P emissions and fraction collected in RAS
Smolt in RAS	Total P consumed by bacteria	High	Amount of P emissions and fraction collected in RAS
Smolt in RAS	DIP consumed by bacteria	High	Amount of P emissions and fraction consumed by bacteria
Smolt in RAS	DIP consumed by bacteria	High	Amount of P emissions and fraction consumed by bacteria
Smolt in RAS	DIP consumed by bacteria	High	Amount of P emissions and fraction consumed by bacteria
Smolt in RAS	DIP in waste water flows	High	Amount of P emissions and fraction consumed by bacteria
Smolt in RAS	DOP in waste water flows	High	Amount of P emissions and fraction consumed by bacteria
Smolt in RAS	POP in waste water flows	High	Amount of P emissions and fraction consumed by bacteria

2.4 Testing of individual technologies

A 100% implementation of the following strategies was added to the model. In the first strategy, IMTA and LiftUP, every production site have an on-site sludge collection system from LiftUP and a P offset by producing 150 tons seaweed per locality. In the second strategy, Low P feed, the concentration of P in feed was decreased to 0.6%. In the third strategy, CCS, it is imagined that all production takes place in closed containment systems at sea with sludge collection. The fourth strategy, RAS, the grow-out production takes place in land-based facilities with RAS. The following section includes important assumptions made for every strategy. The model presented in 2.2 serves as a basis for estimating the strategy specific flows presented in this section. Equations for the strategy specific flows are summarized in Table 6, flows that are similar in all cases such as Fish to slaughter, Smolt etc. have not been repeated in this table. They can be found in Table 3.

2.4.1 Low P feed

The P concentration in the feed is decreased to 0.6 % and it is assumed that the fish has the same assimilation and retention efficiency as with the standard feed (P concentration 0.88%).

2.4.2 IMTA

Nutrient uptake in seaweed is based on measurements on chemical composition in dry weight tissue of sugar kelp. Sveier (2021) reports that the seaweed from Ocean Forest, no species specified, has a DW content of approximately 10%, a P content of 0.34% and a N content of 2.4% in DM seaweed. It is assumed that every locality cultivates 150 tons seaweed. Bruhn et al. (2016) reports a DM content 6.3-16.8% for sugar kelp. The P content ranged from 0.11-0.28% , the N content ranged from 3.5-4.5 % and the C content ranged from 25.8 -33.4 %. Reid et al. (2013) measured a P content of 0.31 %, a N content of 2.4 % and a C content of 25.2 %.

Nederlof et al. (2019) found an ash free dry weight of (AFDW) *O. craigsmithi* to be 73 % and 90.2% of *Capitella sp.* When fed fresh salmon feces. Nederlof et al. (2020) found that cultivating 65 000 – 95 000 ind. m⁻² of *Capitella sp.* or 36 000 - 194 000 ind. m⁻² of *O. craigsmithi* was the amount of ragworms required to convert the daily flux of particulate nutrient waste from an average salmon farm. Only one unpublished master thesis has investigated the P contents of ragworms (*H. Diversicolor*), 0.008 g/ 100g, and therefore this tissue concentration has not been validated with other sources (Kristensen, 2021). He also reports that ragworms only retain approximately 1 % of P in diet.

2.4.3 LiftUP

An average efficiency of 44% is assumed based on estimates of sludge collection efficiency of 0.6-0.9 kg collected sludge per kg feed input and the estimated amount of sludge is 1.5 -2.1 kg sludge per kg feed input (Fossmark, 2021, Hilmarsen et al., 2018).

2.4.4 Closed containment system (CCS) at sea

Most CCS systems are still under development, and only a few reports the efficiency to filter out particulate waste. Amongst them, the efficiency is reported to be around 60% up to 90% of particulate matter in the most efficient systems (Clarke et al., 2018).

2.4.5 Land-based production with RAS

It is assumed that the assumptions made for smolt production in RAS in 2.2.2.12 are valid for the production of grow-out fish in RAS too.

Table 6: Equations for flows in strategies. Flows that have the same value as Grow-out fish production without any strategies have not been repeated. Equations for these flows can be found in Table 3.

Subsystem	Flow name	Equation
IMTA+LiftUP	Collected sludge LiftUp	Sludge \times X_c
IMTA+LiftUP	POP to surrounding waters	POP to surrounding waters- Collected sludge LiftUp
IMTA+LiftUP	DIX uptake in seaweed	Seaweed production \times X_c
IMTA+LiftUP	X uptake in ragworms	Individuals of ragworms per m ² for daily uptake \times Nb of localities \times Average area per locality \times X_c
Low P feed	All flows	Same as Grow-out sea, but $P_c=0.6\%$
RAS	DIX to RAS tanks	(Feed consumption - Feed loss) \times $X_c \times (A_x \times E_x)$
RAS	DOX to RAS tanks	$S \times (1 - A_x) \times (\text{Feed consumption} - \text{Feed loss}) \times X_c$
RAS	POX to RAS tanks	$(1 - S) \times (1 - A_x) \times (\text{Feed consumption} - \text{Feed loss}) \times X_c$
RAS	DIX to mechanical filter	DIP to RAS tanks
RAS	DOX to mechanical filter	DOX to RAS tanks + $S \times (1 - A_x) \times \text{Feed loss} \times X_c$
RAS	POX to mechanical filter	POX to RAS tanks + $(1 - S) \times (1 - A_x) \times \text{Feed loss} \times X_c$
RAS	X in faeces	DOX to RAS tanks + POX to RAS tanks
RAS	X in sludge	X_c in faeces + Feed loss \times X_c
RAS	Collected X in RAS	X_c in sludge \times X_c collection in RAS
RAS	DIX to biofilter	DIX to mechanical filter
RAS	DOX to biofilter	DOX to mechanical filter
RAS	POX to biofilter	POX to mechanical filter - Collected X_c in RAS
RAS	Total X consumed by bacteria	(DIX to biofilter + DOX to biofilter+ POX to biofilter) \times Dissolved p consumed in biofilter
RAS	DOX consumed by bacteria	DOX to biofilter
RAS	POX consumed by bacteria	POX to biofilter
RAS	DIX consumed by bacteria	Total X_c consumed by bacteria - DOX to biofilter - POX to biofilter
RAS	DIX in waste water	DIX to biofilter - DIX consumed by bacteria
RAS	DOX in waste water	DOX to biofilter - DOX consumed by bacteria
RAS	POX in waste water	POX to biofilter - POX consumed by bacteria
CCS	DIX to closed tank	(Feed consumption - Feed loss) \times $X_c \times (A_x \times E_x)$
CCS	DOX to closed tank	$S \times (1 - A_x) \times (\text{Feed consumption} - \text{Feed loss}) \times X_c$
CCS	POX to closed tank	$(1 - S) \times (1 - A_x) \times (\text{Feed consumption} - \text{Feed loss}) \times X_c$
CCS	DIX to filter	DIP to closed tanks
CCS	DOX to filter	DOX to closed tanks + $S \times (1 - A_x) \times \text{Feed loss} \times X_c$
CCS	POX to filter	POX to closed tanks + $(1 - S) \times (1 - A_x) \times \text{Feed loss} \times X_c$
CCS	Collected POX in closed systems	POX to filter \times Closed sea collection
CCS	DIX to surrounding waters	DIX to filter
CCS	DOX to surrounding waters	DOX to filter
CCS	POX to surrounding waters	POX to filter

2.5 Scenarios

Three different scenarios have been developed with the aim to investigate how much P is emitted and how much P can be recovered when different approaches to reduce P emissions and resource use are combined. In all the scenarios it is assumed that the production of salmon and trout is 3.7 million tons in 2050 (PwC, 2021). A FCR of 1.2 and a production loss of 20% are assumed for all scenarios. The scenarios are developed on a production area level and aggregated to a national level. This is because it is difficult to predict exactly where the production growth will happen, and at which geographic coordinates new production sites will be situated. An overview over key differences of the different scenarios is presented in Table 7.

2.5.1 Scenario 1: Basecase scenario

An average of 50% green lights will allow for 1.5% annual growth of open net sea cages at sea. Salmon as a source of sustainable protein is the key driver of the growth. Every open net sea cage is required to collect particulate waste on site to reduce nutrient emissions. 10 million tons wet weight seaweed is included in the system to P, N and C-offset the production. To further reduce emissions, the producers have invested in a low P feed. The rest of the production growth will then happen either on land in RAS facilities in Norway, or in CCS at sea. CCS farms will have a criterion to collect 75 % of particulate emissions. Due to high investment costs only 10 % of the production will happen in land-based facilities with RAS, 30 % in CCS and 60 % in open net sea cages.

2.5.2 Scenario 2: Production growth at SEA

The challenges with sea lice and escapes are solved and an average of 100 % green lights will allow for 3 % annual production growth in open net sea cages at sea. Salmon as a source of sustainable protein is the key driver of the growth. Every open net sea cage is required to collect particulate waste on site to reduce nutrient emissions. 20 million tons wet weight seaweed is included in the system to P, N and C-offset the production. To further reduce the emissions, producers have invested in a low P feed. Every production site cultivates ragworms under the net sea cages. There are no production sites either on land in RAS systems or in CCS as the investment costs are much higher than open net sea cages with on-site sludge collection.

2.5.3 Scenario 3: Production growth at LAND

Due to increased problems with sea lice, genetic pollution and area conflicts, no new licenses for increased production at sea are given. The producers are allowed to keep producing at existing localities, but new sites have to be situated on land. In 2050, 60% of Norwegian production of salmonid species is estimated to take place in land-based RAS systems. The sea-based farms are not required to collect sludge or reduce nutrient emissions. There is no production of IMTA species to offset nutrient and C emissions from the production.

Table 7: Overview over key factors in scenarios

Factors	Base case	Sea-based growth	Land based growth
Production in 2050	3.7 million tons	3.7 million tons	3.7 million tons
FCR	1.2	1.2	1.2
Production loss	20 %	20 %	20 %
Fraction of production at sea	60 %	100 %	40 %
Fraction of CCS at sea	30 %	0 %	0 %
Fraction of RAS systems	10 %	0 %	60 %
P in feed concentration	0.6 %	0.6 %	0.88 %
Fraction of open sea cages with sludge collection	100 %	100 %	0 %
IMTA Seaweed production	10 millions tons WW	20 millions tons WW	No offset in seaweed
IMTA Ragworm production	No offset in ragworms	Every locality cultivates ragworms	No offset in ragworms

2.6 P efficiency indicators

Several indicators have been used to estimate the P efficiency in the overall systems presented in each scenario as well as the emission level of each scenario. The first indicator is based on the amount of P emitted in each scenario compared to the P input to the system:

$$\text{P emitted per input} = \frac{\text{P emissions scenario}}{\text{P in feed}} \quad (1)$$

The second indicator is based on the total amount of P recovered compared to the total amount of P input to the system:

$$\text{P recovered per input} = \frac{\text{P in sludge} + \text{P in seaweed}}{\text{P in feed}} \quad (2)$$

The third indicator is based on the total amount of P recovered in seaweed compared to the total amount of P input to the system:

$$\text{P offset as seaweed per input} = \frac{\text{P in seaweed}}{\text{P in feed}} \quad (3)$$

The fourth indicator is based on the total amount of P recovered in sludge compared to the total amount of P input to the system:

$$P \text{ recovered per input} = \frac{P \text{ in sludge}}{P \text{ in feed}} \tag{4}$$

The fifth indicator used by this study is P-use efficiency (PUE) as defined by Huang et al. (2019):

$$PUE = \frac{P \text{ in fish to slaughter}}{P \text{ in feed}} \tag{5}$$

2.7 Visualization

Results at locality-level were visualized with Sankey diagram that was created with the open-source *Python* tool *FloWeaver*, developed by Lupton and Allwood (2017). Sankey diagrams visualize the proportionality of the flows in a system. The most important flows in terms of input and output of the nutrients can then easily be identified.

Geographic coordinates were coupled to each locality. The results on a locality level were then visualized on maps, created with the *Geographic Information System (GIS)* software *ArcGIS Pro*. Even though results for all localities in Norway have been calculated, only localities in the Hitra and Frøya are in Trøndelag have been included in this study.

2.8 Model representation

Figure 10 summarizes the approach used in this project from gathering and managing the data, to quantifying and visualizing the P flows.

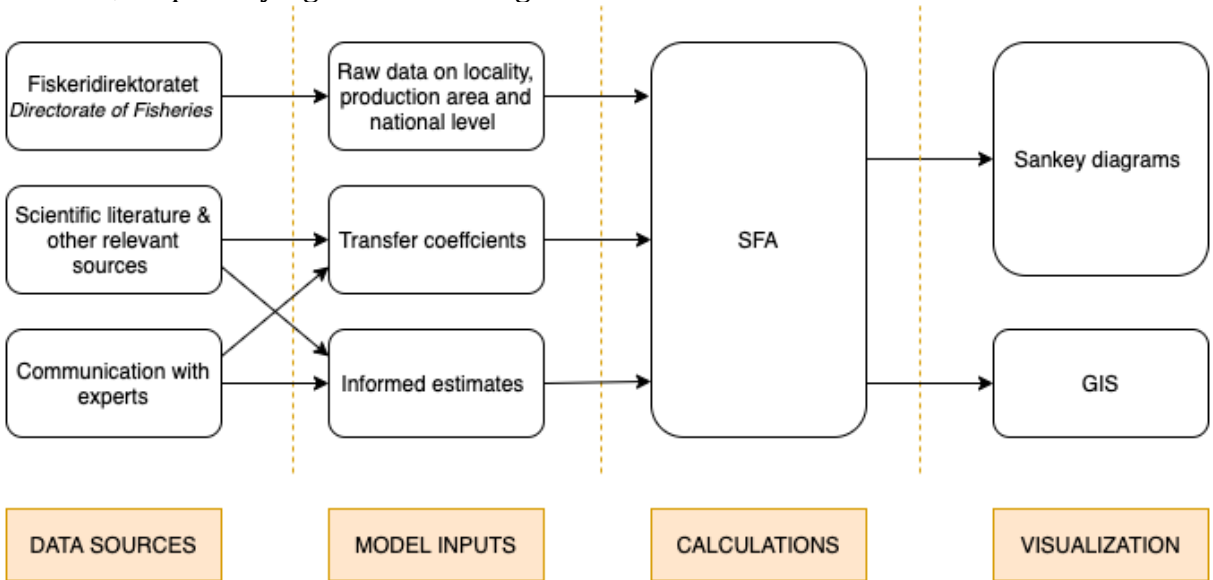

Figure 10: Systematic overview of data management and approach and model used in this project.

3. Results

3.1 Nutrient emissions from the aquaculture sector in Norway 2019

3.1.1 P flows for sea-based salmon and rainbow trout production on a locality level in 2019

The P flows for locality X₁ and X₂ are visualized in Figure 11. The total sludge production in the Hitra area is visualized in Figure 12. Nutrient emissions of P, C and N for the same area is presented in Figure 13. The phosphorus emission flows divided into DIP, DOP and POP are visualized in Figure 14 for the Hitra and Frøya area.

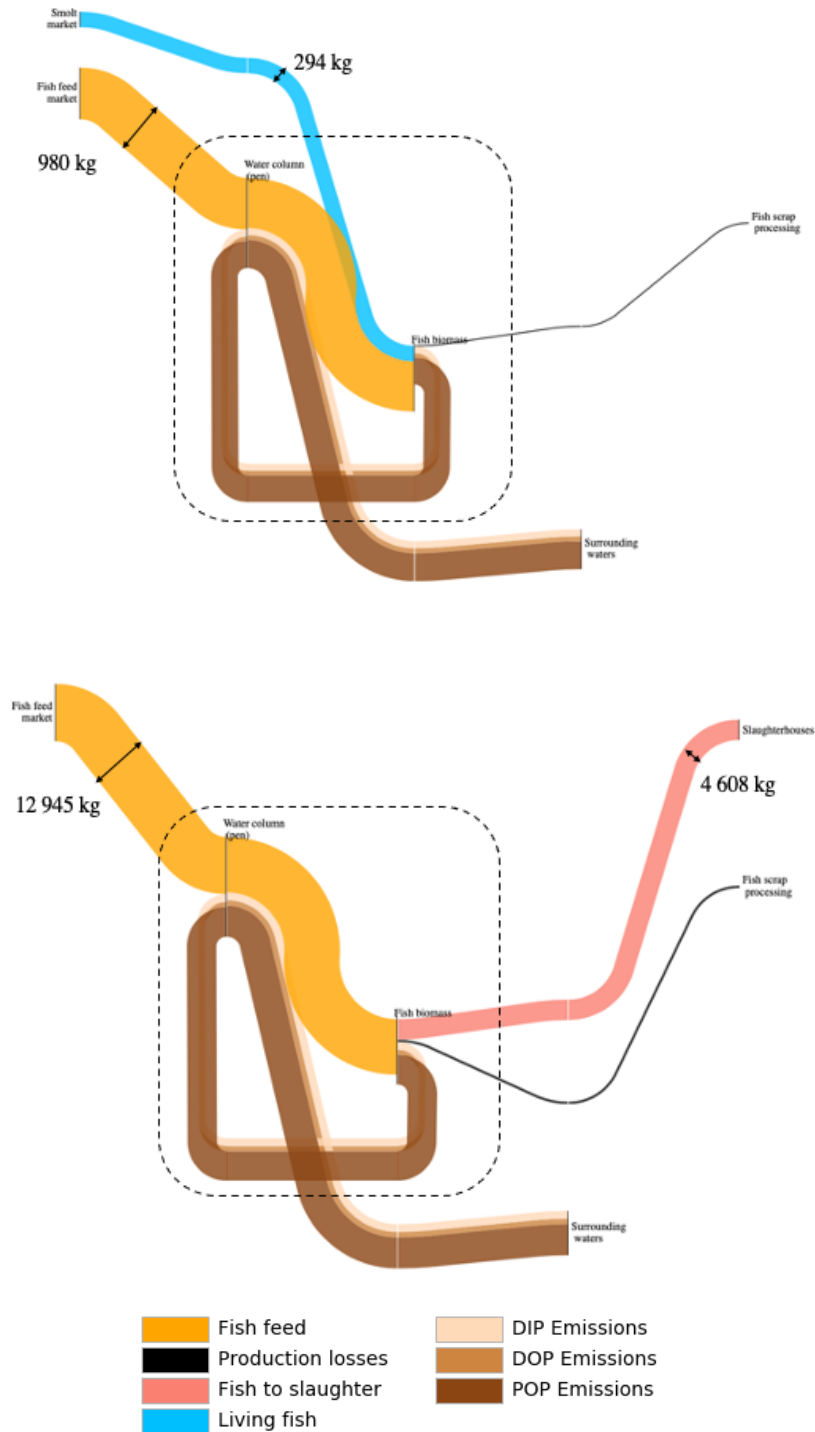

Figure 11: Phosphorus flows in sea-based grow-out fish production for two different localities in 2019.

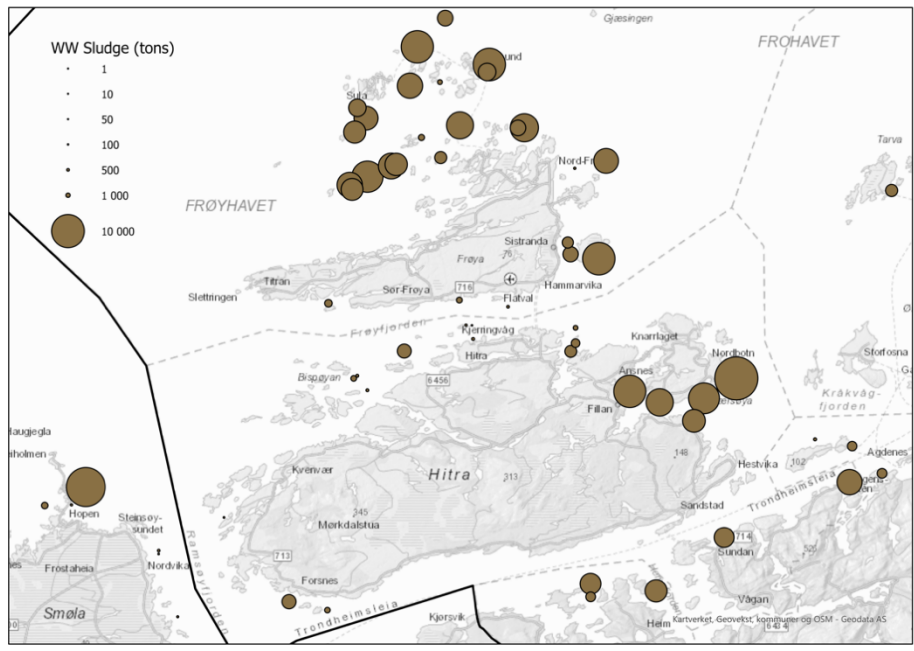

Figure 12: Wet weight sludge produced in the Frøya and Hitra area in Trøndelag in 2019.

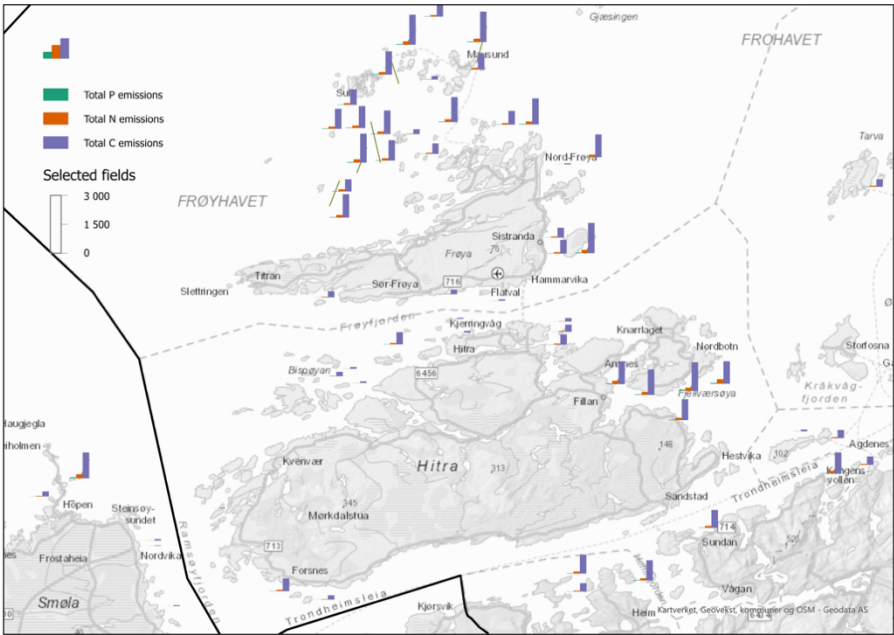

Figure 13: P, N and C emissions in tons from aquaculture in the Frøya and Hitra area in Trøndelag in 2019.

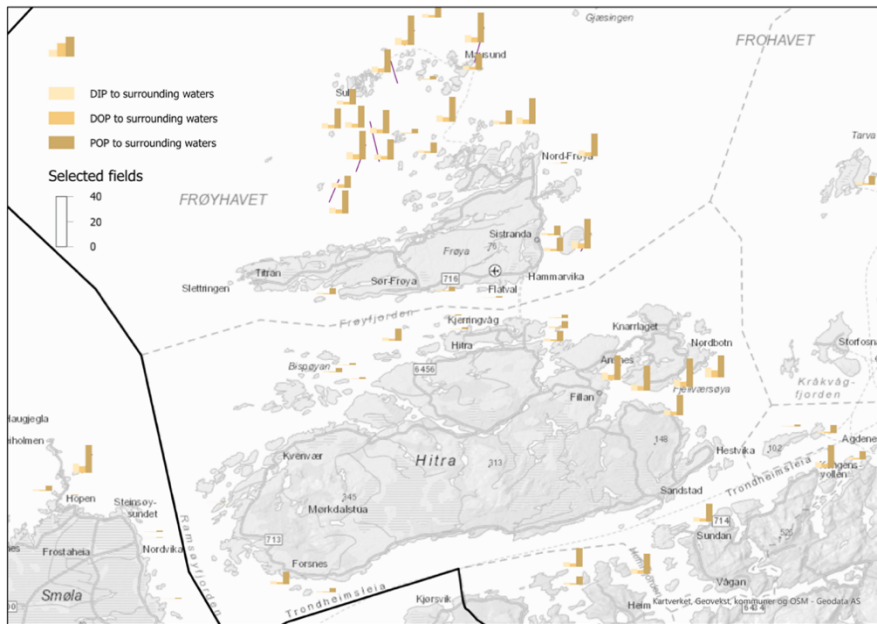

Figure 14: Phosphorus emissions in tons from aquaculture in the Frøya and Hitra area in Trøndelag in 2019.

3.1.2 P flows for sea-based salmon and rainbow trout production on a national level in 2019

Figure 15 (left) shows the phosphorus flows in Norwegian sea-based production of grow-out salmon and rainbow trout in 2019. Smolt production in land-based RAS systems is shown in Figure 15 (right).

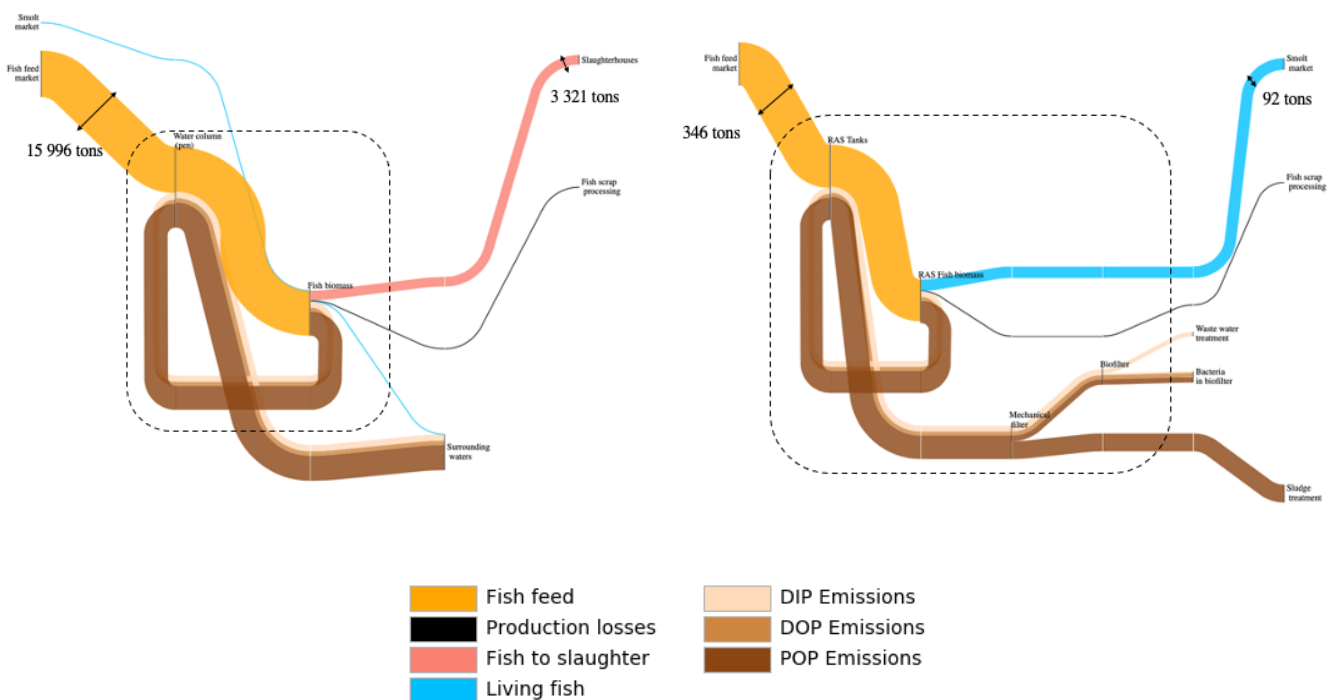

Figure 15: Phosphorus flows in sea-based grow-out fish production (left) and smolt production in Norway 2019.

3.1.3 Nitrogen and carbon flows 2019

Figure 16 right shows the nitrogen (left) and carbon (right) flows in Norwegian sea-based production of grow-out salmon and rainbow trout in 2019

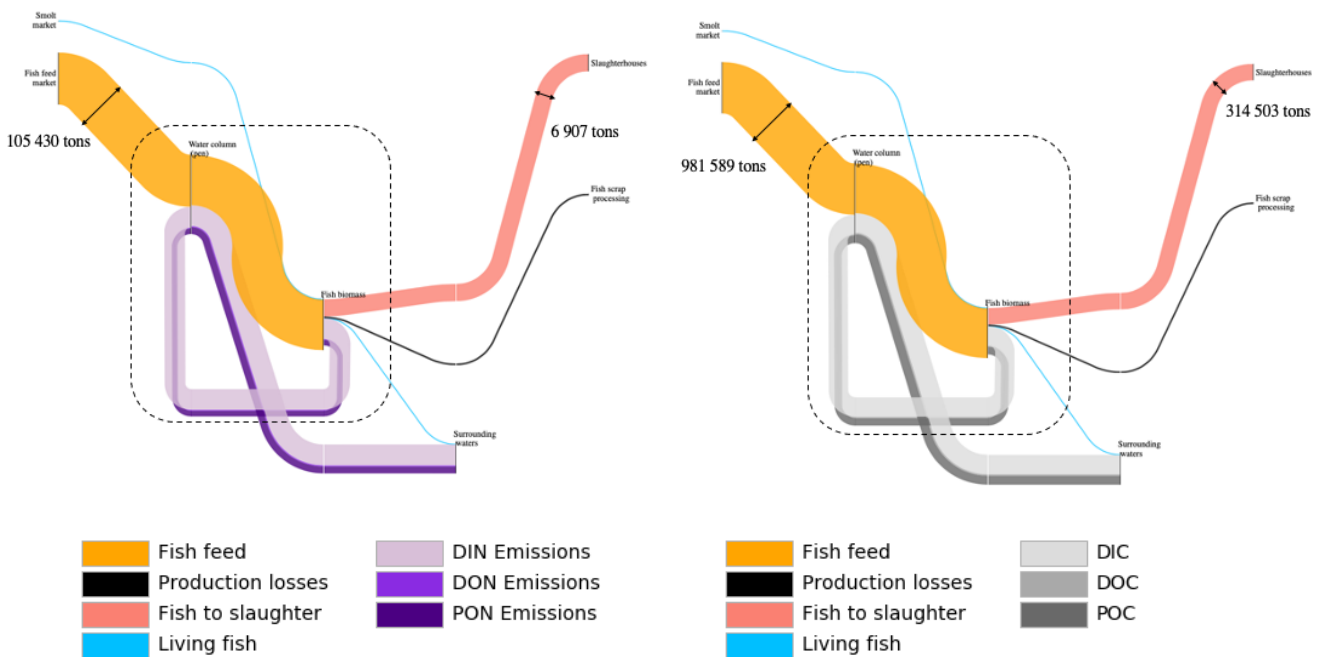

Figure 16: Nitrogen (left) and carbon (right) flows in sea-based grow-out fish production in Norway 2019.

3.1.4 Overview over emissions and sludge production in 2019

An overview of the model estimations of the nutrient emissions of the production of salmon and rainbow trout in 2019 is presented in Table 8.

Table 8: Estimated amount of sludge and nutrient emissions in tons from Norwegian aquaculture in 2019.

Emission type	Grow-out fish production (tons)	Kg emission / ton fish to slaughter	Smolt production (tons)	Kg emission / ton fish to slaughter
Sludge (WW)	3 582 094	2.5 kg / kg fish to slaughter	79 728	2.0 kg / kg fish to slaughter
DIP	2 172	1.5	47	1.2
DOP	1 526	1.1	33	0.8
POP	8 650	6.0	187	4.7
DIN	46 267	32.1	999	25.0
DON	2 724	1.88	58	1.4
PON	15 436	10.7	333	8.3
DIC	371 335	257.6	8 020	200.2
DOC	30 125	20.9	650	16.2
POC	170 708	118.4	3 687	92.0

3.2 Testing of individual strategies

Figure 17-20 present the quantified flows for the sea-based production of salmon and rainbow trout if a strategy to reduce P emissions and resource use was implemented at every production site. All other factors, such as production volume and feed consumption, remain unchanged from the system presented in Figure 15.

3.2.1 LiftUP and IMTA

Figure 17 shows the sea-based system where every site has been implemented a sludge collection technology on-site. It is also assumed that every locality is P, N and C-offsetting their production by growing 150 tons of seaweed.

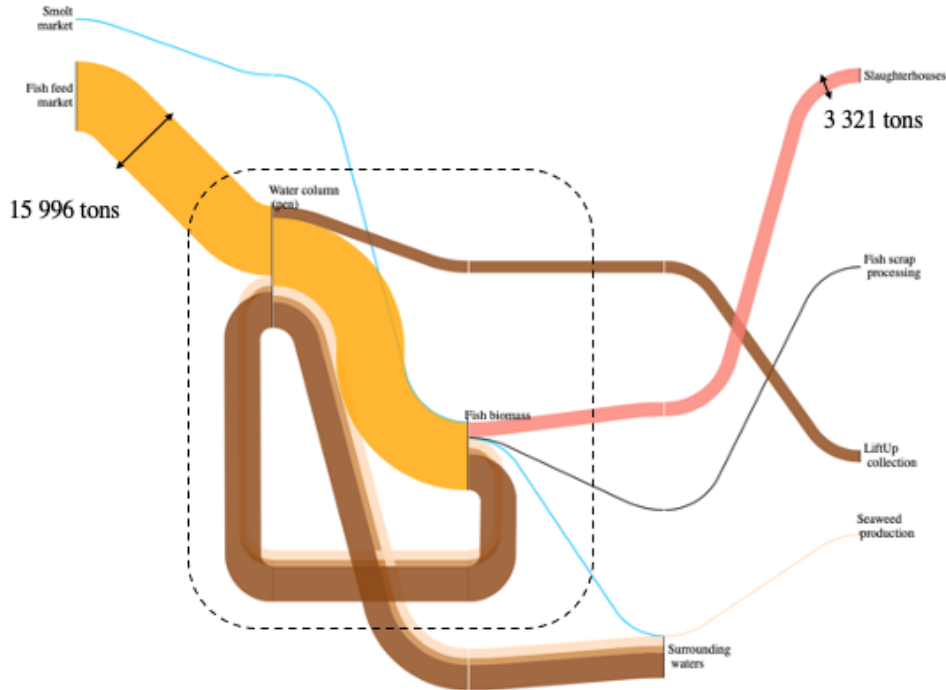

Figure 17: Phosphorus flows in sea-based grow-out fish production in Norway 2019 with implemented sludge collection at open sea cages and P-offset in seaweed production.

3.2.2 Low P feed

Figure 18 shows the exact same system as Figure 15, but in this system the P concentration in the feed has been decreased to 0.6 % compared to 0.88 %.

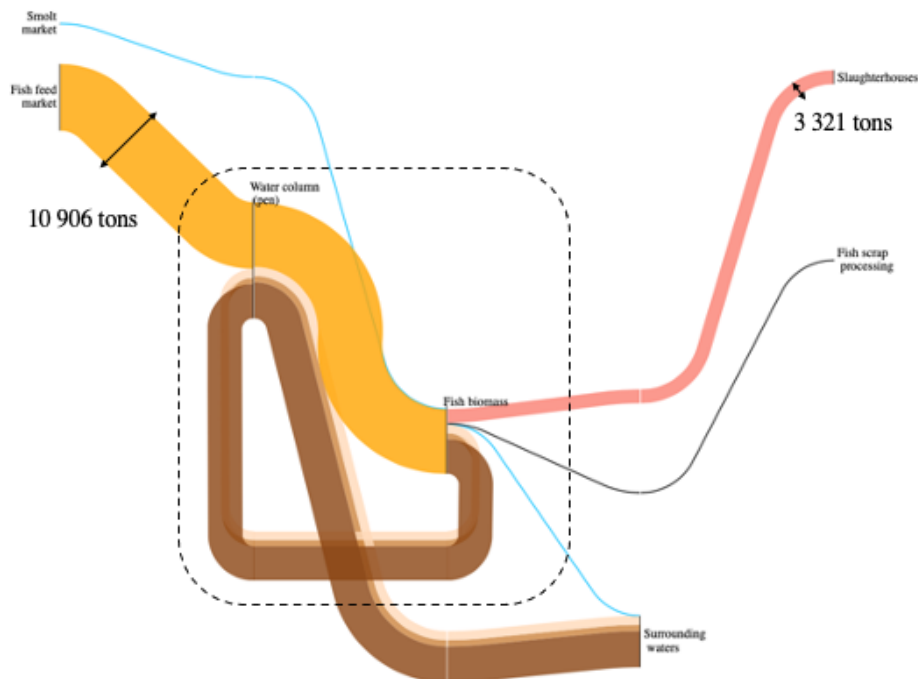

Figure 18: Phosphorus flows in sea-based grow-out fish production in Norway 2019 when the feed has a lower P concentration.

3.2.3 CCS

Figure 19 shows the quantified flows for the thought system where all the sea-based production in 2019 of salmon and rainbow trout has been moved into closed sea-based localities that collect particulate matter as sludge.

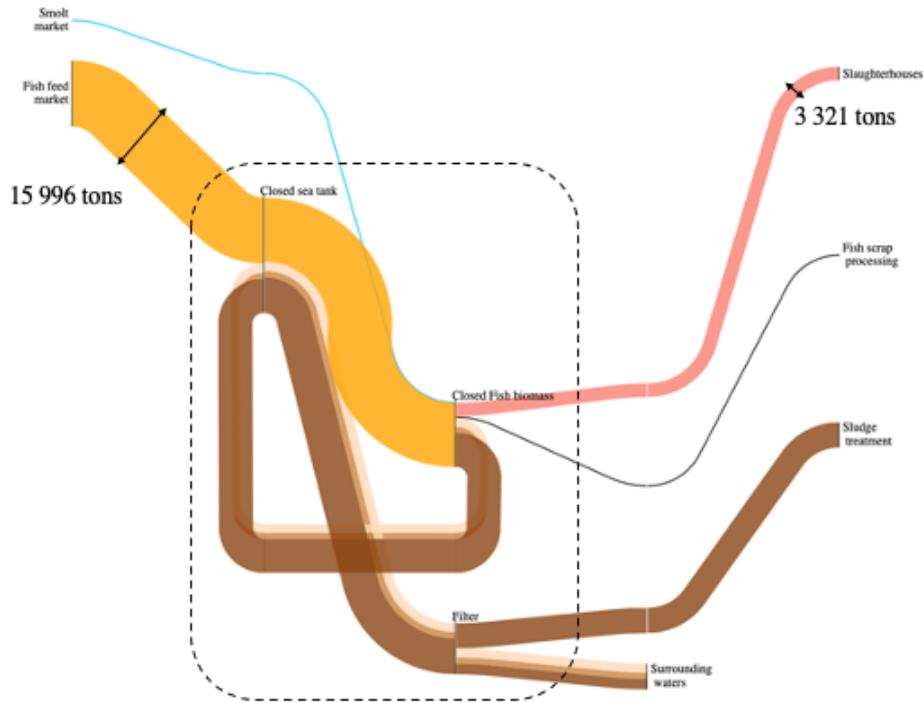

Figure 19: Phosphorus flows in closed sea-based grow-out fish production in Norway 2019.

3.2.4 RAS

Figure 20 shows the quantified flows for RAS case, where all the sea-based production in 2019 of salmon and rainbow trout has been moved into closed land-based facilities with RAS technology that collect particulate matter as sludge.

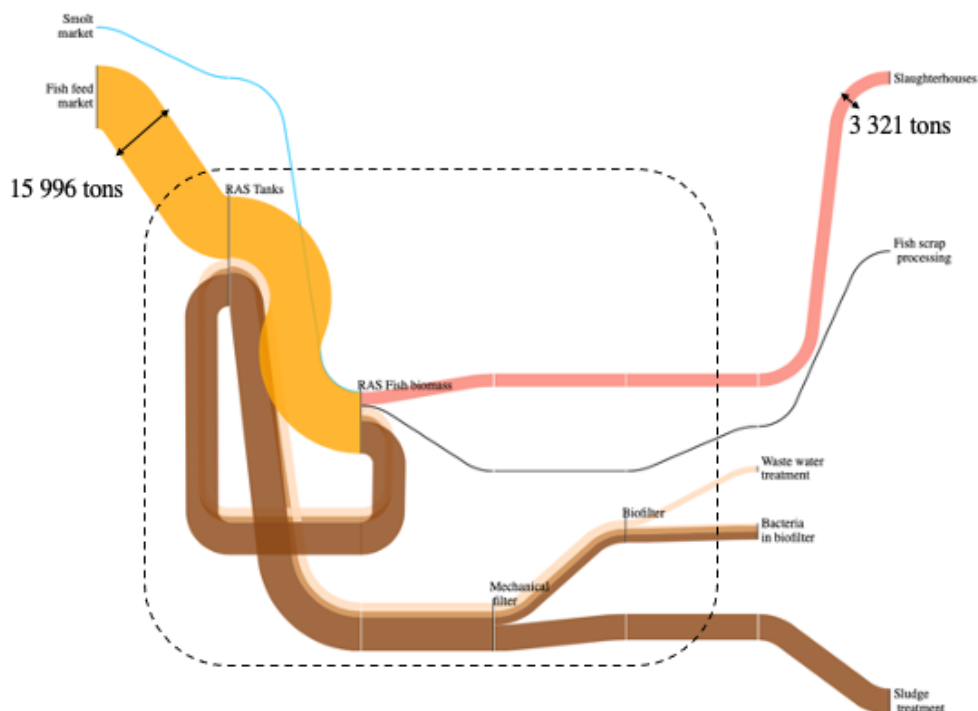

Figure 20: Phosphorus flows in closed sea-based grow-out fish production in Norway 2019.

3.2.5 P Emission comparison of the different systems

Figure 21 shows total P emissions based on data of grow-out fish production of salmon and rainbow trout in sea-based systems in 2019 in Norway. The emissions are divided into POP, DOP and DIP in each of the systems.

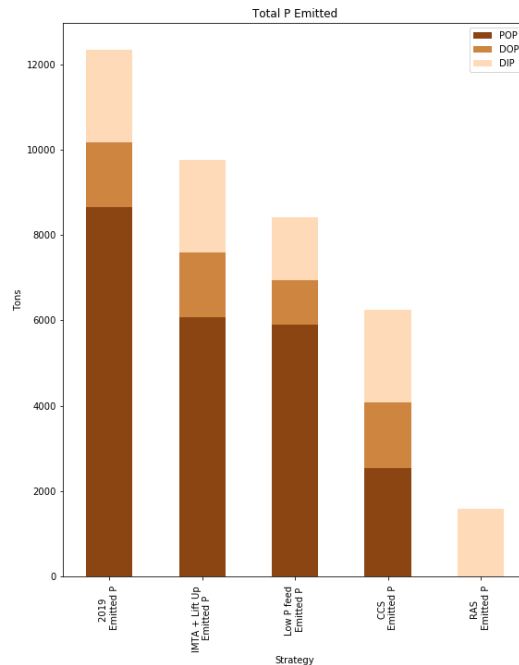

Figure 21: Total emissions based on 2019 data of grow-out fish production of salmon and rainbow trout from the different systems with a 100% implementation of the strategies..

Figure 22 shows the theoretic maximum produced in the different system when emission levels for 2019 are not exceeded. The blue line shows the base case estimation of 3.7 million tons produced fish in 2050 made by (PwC, 2021).

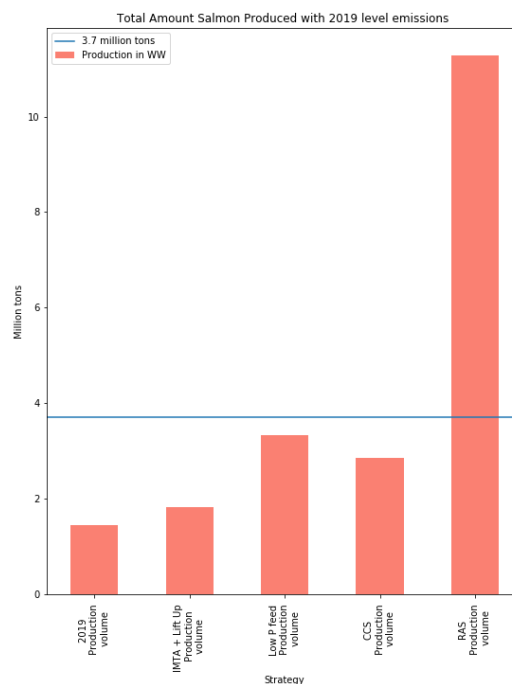

Figure 22: Theoretic maximum production in the different system when the P emission levels for 2019 are not exceeded. The blue line shows the baseline estimation of 3.7 million tons produced fish in 2050.

3.3 Scenarios

3.3.1 Scenario 1: Basecase

Quantified flows for the *Basecase* scenario is presented in Figure 23. The production in this system is divided between production in open net cages in the sea, closed containment systems in the sea and land-based production in RAS systems. The sea-based farms have on-site sludge collection. There is an emission offset with seaweed production. Sludge collected from open and closed sea-based and in land-based RAS systems are sent to sludge treatment.

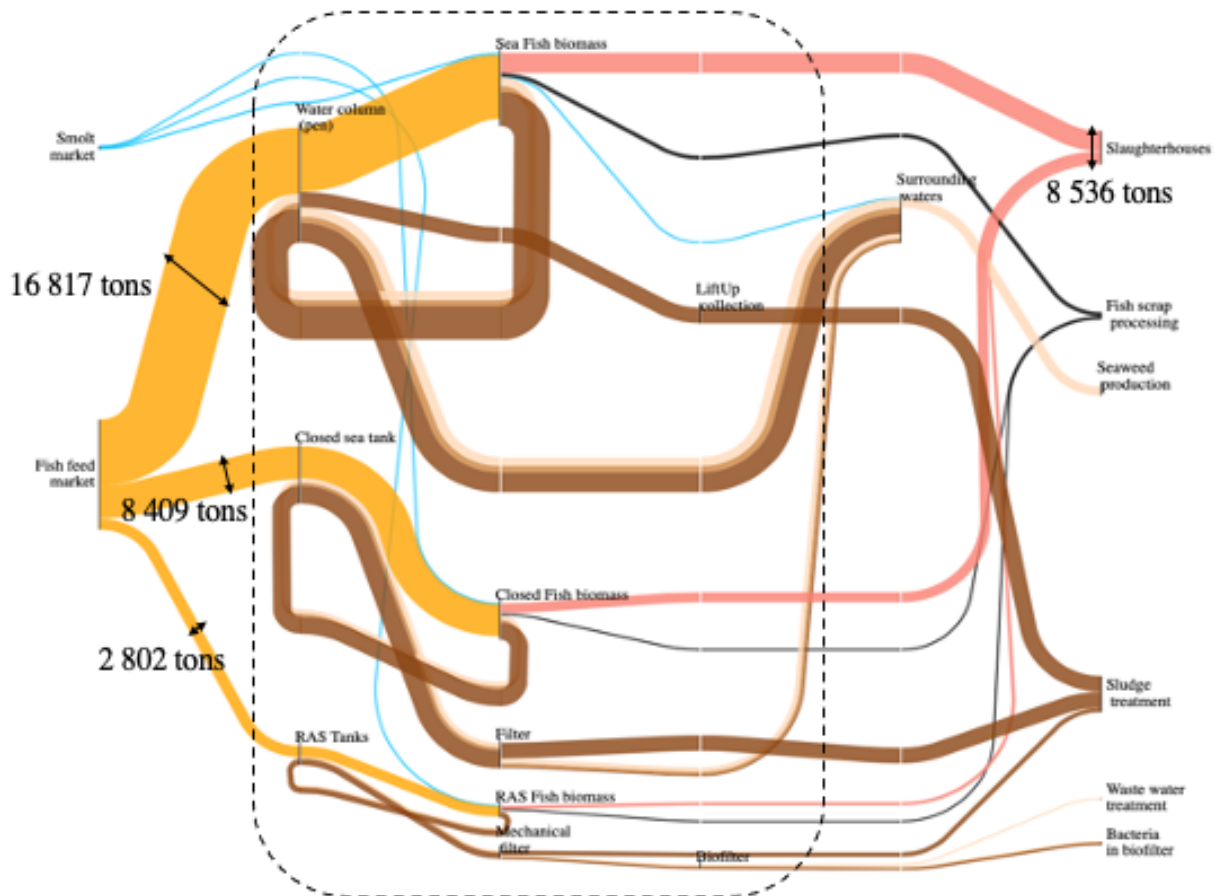

Figure 23: Phosphorus flows in scenario 2 Production growth at SEA, where production is increased to 3.7 million tons in 2050. All production of grow-out fish is sea-based in open net cages.

3.3.2 Scenario 2: Production growth at SEA

Quantified flows for the *Production growth at SEA* scenario is presented in Figure 24. The production in this system is only in open net cages in the sea with LiftUP collection. There is an emission offset with the production seaweed and ragworms.

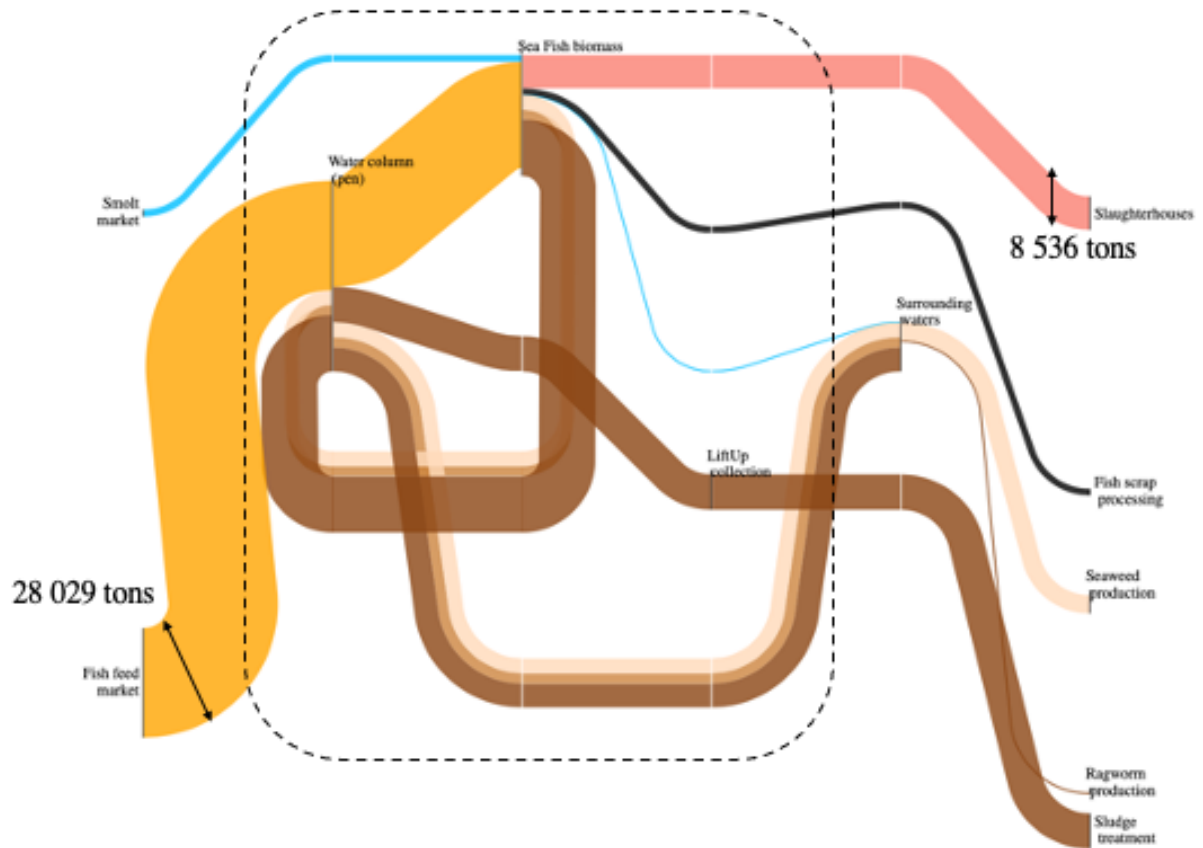

Figure 24: Phosphorus flows in scenario 2 *Production growth at SEA*, where production is increased to 3.7 million tons in 2050. All production of grow-out fish is sea-based in open net cages.

3.3.3 Scenario 3: Production growth at LAND

Quantified flows for the *Production growth at LAND* scenario is presented in Figure 25. The production in this system is divided between production in open net cages in the sea and land-based production in RAS systems. There is only sludge collection in the RAS facilities.

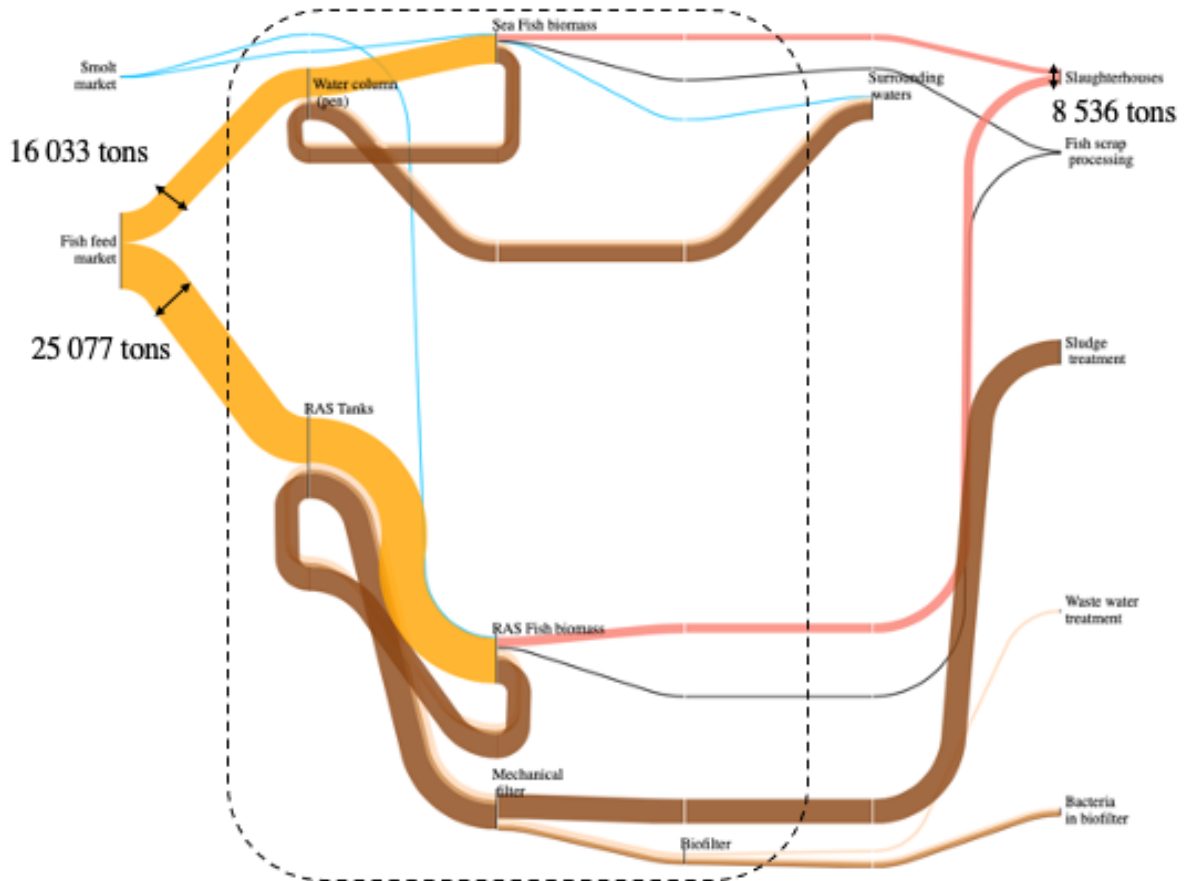

Figure 25: Phosphorus flows in scenario 3 Production growth at LAND, where production is increased to 3.7 million tons in 2050. Production of grow-out fish is divided between land-based facilities with RAS and sea-based open net cages.

3.3.4 Comparison of scenarios

The total amount of P input, P emissions and recovered P in each scenario is presented in Figure 26.

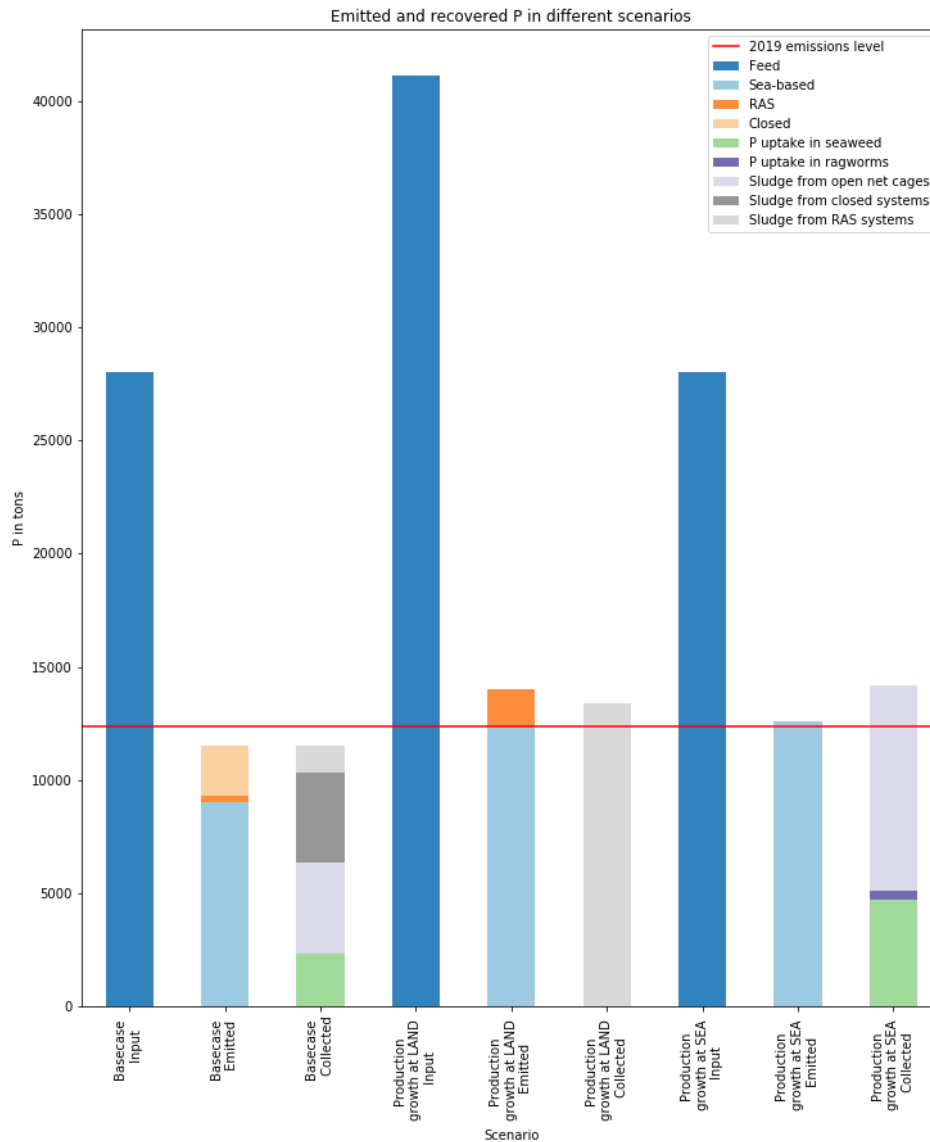

Figure 26: P inflow, P emissions and recovered P as sludge, seaweed and ragworms in the different scenarios.

3.3.4 Overview over P efficiency indicators

The P efficiency indicators are presented in Table 9 for the three scenarios and for 2019.

Table 9: P indicators for emitted and recovered P in the scenarios.

Scenario	Emitted P per Input	Recovered P per input	Offset as seaweed	Recovered as sludge	PUE
2019 reference year	77%	0 %	0 %	0 %	21 %
Basecase	41 %	41 %	8 %	33 %	30 %
Production growth at LAND	34 %	32 %	0 %	32 %	30 %
Production growth at SEA	44 %	51 %	17 %	32 %	21 %

4. Discussion

The aim of this thesis was to investigate how phosphorus resource use and emissions can be optimized in the Norwegian aquaculture sector. This was done by quantifying the current emission level of P, N and C from aquaculture in 2019 on a locality level and national level. The performance of individual strategies to reduce P emissions was tested by implementing them a 100 % on 2019's production data. Three scenarios for P emissions and recovery for the aquaculture industry in 2050 was developed.

The following section discusses the data quality and model robustness as well as the results of quantified level of emissions in 2019 compared to other literature findings. The main findings from the results suggest that even though shifting the entire production of salmon and rainbow trout to land-based facility with RAS would have highest efficiency of reducing P emissions, a combination of strategies, where the input of P is reduced and the P emissions are collected, is the most promising pathway of obtaining a sustainable P management.

4.1 Data quality and model robustness

Data on biomass, slaughtered fish, escapes, production loss and feed consumption for grow-out fish in 2019 was retrieved from Fiskeridirektoratet and have a high certainty. The exception here is the data on production loss, as this is sometimes used to correct inconsistencies in reported data and can therefore sometimes contain negative values. The estimations of emission flows of P, N and C as well as faeces and sludge are the most uncertain flows since they are only based on model estimations. However, concentrations of P, N and C in salmonid species and in faeces are quite certain, but the assimilation efficiency is uncertain for P (Wang et al., 2013, Wang et al., 2012). A sensitivity analysis was not performed in this study. However, since the emissions of P, N and C are directly calculated from the feed input, a 10 % error of feed composition, would give a 10 % error of emission level. Take into account errors on feed consumption, feed loss, assimilation and retention efficiency, the error on emissions values would be even higher. This is illustrated in the test of a low P feed compared to the standard feed, where emissions have decreased with 31 % (Figure 3.).

There is no experimental field data available of the total amount of sludge produced neither on farm level, nor per fish nor on a national level. However, theoretical estimates of sludge production exist, and in 2017 with the production of 1.3 million tons salmon and rainbow trout, total amount of sludge was found to be 2 145 000 tons wet weight sludge with a dry matter content of 10% by (Hilmarsen et al., 2018). For smolt production this was estimated to be 84 150 tons by the same study. In this study, it is estimated that the sludge produced from 1.44 million tons fish was 3 582 094 tons with dry matter content of 10%. It is important to note that the estimations presented by Hilmarsen et al. (2018) was based only on a sludge per feed convert and only used raw data on the production volume. The feed was calculated by using an economic feed conversion ratio (EFCR) of 1.15 kg feed/kg fish. This study based this calculation on raw data of feed consumption,

and calculated the sludge as the sum of faeces and feed loss. The convertor of faeces produced per feed input and the amount of feed loss are still a sources of uncertainty.

Norsk institutt for vannforskning (NIVA) estimates that the total phosphorus emissions from sea-based aquaculture was 10 928 tons in 2019 (Miljødirektoratet, 2020, Guerrero and Sample, 2021). This study found that the P emissions from sea-based aquaculture was 12 348 tons, from 1.44 million tons produced fish. In comparison, the study by Hamilton et al. (2016) estimated that 9000 tons P was emitted annually from aquaculture based on production data from 2009-2011, of approximately 1.1 million tons produced fish. According to the different models for estimating DIP emissions from aquaculture, the emissions varies from -1.5 to 5.1 kg/ton salmon produced (Wang et al., 2012, Torrissen et al., 2016, Svåsand et al., 2016, Norderhaug et al., 2016). Estimations of P emissions are therefore quite uncertain. Havforskningsinstituttet estimates that around 50 000 tons of dissolved nitrogen are emitted annually from sea-based aquaculture (Boxaspen and Husa, 2019). This model estimated that the DIN emissions from sea-based aquaculture was 46 267 tons, which is relatively close to the estimates of Havforskningsinstituttet.

A mass balance check for the N, P and C layer, input flows minus the output flows, is presented in Appendix C. For these layers, all flows have been quantified. There is a mass balance inconsistency in the *Fish Biomass* process on the aggregated national flows for each of these layers. For P, -278.7 tons are unaccounted for, For N 6529.9 tons and 37 351 tons for C. The mass balance check for the P and C layers were calculated for production area levels and national level. For the P and N layers, the inconsistencies are always negative for P and always positive for N. This indicates that either the P concentration in the feed is higher than the values used (0.88%), or that the P content in the fish is too high. The latter is more unlikely as several studies have found a higher P content in the fish (0.85 % by Aas et al. (2019)) than what has been used in this model (0.64% by Wang et al. (2013)). Another source of error could be the estimation on smolt weight coming into the system being too low, or that the escaped or dead fish to *Processing of fish scrap etc.* is too high. However, if this was the case, then the same trend should be observed in the N and C layer as well. In the N layer, too much N is coming into the process *Fish Biomass*, which indicates that either the N concentration in feed is too high, or the N in fish is too low. In the C layer, most production areas have a surplus of C coming into the system, but three production areas have a surplus of C going out of the system. This makes it difficult to identify where the error lies, as it indicates that it is not a systematic error of either too high or low C content in the fish or in the feed.

4.2 Level of nutrient emissions from aquaculture in 2019

4.2.1 Emissions on locality level

P flows at locality level are shown for two different localities in Figure 11. The localities are in a different stages of the production cycle. The top farm has an inflow of smolt, but no outflow of fish to slaughter. The bottom farm is the opposite, where there is and an outflow of fish to slaughter, but no inflow of smolt. The visualization with Sankey

diagrams does not show the stock, which in this case is the fish biomass in the pen, but it is apparent that it exists in the visualization. In Figure 11 (top) the inflow is bigger than the outflow, which means there is an increase of the fish biomass in the pen. In Figure 11 (bottom), the outflow is bigger than the inflow, which indicates that the fish biomass in the pen is decreasing. These figures illustrate that not all farms are synchronized in the production and that the P emissions, as well as N and C emission, will vary after the number of fish in the pen and directly after the feed consumption. In periods of fallowing, there are no emissions from the farms.

Figure 12 shows the total production of sludge in 2019 in the Hitra and Frøya area in Trøndelag. This is an important feature of the model as it can be useful to estimate exactly where and how much sludge is produced when building infrastructure and industry required to tackle the sludge produced. Another important aspect with the high spatial and temporal distribution of the model is the ability to estimate nutrient flows of P, N and C (Figure 13 and 14). These results can be used to estimate risks of eutrophication as well as nutrient availability from aquaculture sites for coupled IMTA production. This aspect is useful both for the producers and policy makers. For the producers the model can be used to investigate how they can optimize production and P use at their individual farm. For policy makers the model can be used as precautionary tool to estimate emissions based on the amount of fish produced. This can be used to decide where new localities can be situated, or if existing localities should reduce the production volume based on current emission levels and local environmental factors.

4.2.2 Emissions on a national level

The aggregation to annual emission levels for 2019 shows that the total emissions of P, N and C are 12 348, 64 427 and 572 168 tons, respectively (Table 8). Around 70% of the P emissions (Figure 15) are in the form of POP, while the N and C emissions (Figure 16) are mostly in the form of DIN (71%) and DIC (64%). Boxaspen and Husa (2019) argues that current emission level does not contribute to a risk of eutrophication in most coastal areas, but with a production growth, this might change. A model estimation by Havforskningsinstituttet reports that a five doubling of sea-based production of salmon and trout in open net cages could potentially contribute to eutrophication and algal bloom in two of the thirteen production areas (Boxaspen and Husa, 2019). Even though risk of eutrophication is fairly low with today's production level, large amounts of valuable P resources are being wasted, when the technology to reduce and collect emissions already exists.

4.3 Testing of individual strategies to reduce P emissions and resource use

The total emissions of DIP, DOP and POP for all strategies are presented in Figure 21. IMTA and LiftUP (Figure 17), have 21 % lower emissions than the emission level of 2019. It is only the POP emissions that are reduced, since this is the only form collected by the LiftUP system. The amount of P-offset in seaweed in the LiftUP and IMTA case is 35.1 kg, which results of less than 0.002 % of the total DIP emissions. This indicates that growing 150

tons seaweed per locality has a low efficiency in recycling P emissions. By decreasing the P concentration of the feed, as shown in the strategy Low P feed (Figure 18), there is a 31 % decrease of DIP, DOP and POP emissions. If production was moved to a CCS at sea (Figure 19), it is estimated that this could decrease the P emissions with 49 %. It is assumed that only POP emissions would be collected. In the RAS case (Figure 20) the overall emissions are reduced with 87%, and it is estimated that it is only DIP emitted in the waste water flow.

It is apparent that shifting the production to a closed system either at land or at sea has the greatest efficiency in reducing P emissions. Producing salmon and rainbow trout in these systems also limits the risk of sea lice and escapes. Compared to investing in closed production system, the LiftUP system is less expensive and can be used at already existing production sites at sea. However, these strategies mainly reduces the POP emissions and not the dissolved fractions of P. This is efficient for P emissions, where approximately 70% is on the form of POP. However, N and C emissions would not be significantly reduced by only implementing sludge collection technologies, since they are mostly in the form of dissolved inorganic matter. Offsetting nutrients with IMTA have a greater potential here, and especially production of seaweed could be a potential strategy to mitigate the negative impacts of dissolved N and CO₂ emissions (Hancke et al., 2021). Reducing the P concentration in the feed is an effective measure to reduce emissions as well, especially since it does not create a product that needs to be further processed, such as seaweed and sludge.

It is only in the RAS case that the production volume can exceed 3.7 million tons without exceeding the 2019 P emission levels (Figure 22). In this case however, the maximum production can be as much as 11.3 million tons. It is of course not realistic to shift the production entirely to either of the proposed strategies, but this test provides a clear image of the potentials and limitations of strategy from a P perspective.

4.3.1 Potential and barriers of each strategy

The following section aims to discuss the potential and limitations of each strategy from a general point of view. From a P perspective, as the results have shown, producing in RAS have the highest potential of reducing P emissions. Many other factors, such as cost and regulations play a key role in the demand and market potential of the discussed strategies.

4.3.1.1 IMTA and LiftUP

Most of the potential customers of the LiftUP technology are the fish producers situated in fjords that have little to no water exchange with the sea, making these locations more exposed to eutrophication (Fossmark, 2021). The LiftUP technology might be a good investment for the producers to increase profits, since the fallowing period might be extended due to emissions. However, only the particulate emissions are collected in the LiftUp system. The combination of coupled IMTA with seaweed and LiftUP could then be a great way to reduce and collect a maximum amount of nutrient emissions from sea-

based aquaculture. However, the LiftUP technology is developed for fish farms in localities that have little currents, and it is uncertain how this technology would perform on more exposed localities with rougher weather conditions.

In coupled IMTA the species are cultivated in proximity of each other, allowing for the benefits of recycling the emitted nutrients and as well as mitigating the potential negative impacts on the local environment, such as eutrophication. In an open system in the sea, tracing the nutrients back to the fish farm is difficult, but several studies have documented that seaweed grown in proximity of aquaculture farms have grown better than those cultivated further away (Handå et al., 2013, Broch et al., 2018). For the cultivation of ragworms, it has been reported better growth when fed fresh faeces rather than dried faeces (Nederlof et al., 2020).

Several fish farmers are opposed to cultivating seaweed in proximity of the farms and there are good reasons for this. Great amounts of seaweed that falls to the seafloor (>8 kg per m²) can lead to high sulfide levels which is poisonous to the fish (Hancke et al., 2021). There has also been found invasive species in seaweed farms and there is a greater risk of transmitting diseases. There are several advantages to decoupled IMTA, where species are cultivated in separate areas. The same offset of nutrients is possible, and in case of limited area, this strategy offers more freedom in the placement of the production sites. This strategy makes it possible for different companies take charge of the cultivation of different species. The risk of transmitting diseases and parasites might be reduced, as this is not uncommon in especially seaweed farms (Hancke et al., 2021). A challenge to this approach is that nutrient availability might be smaller, which could lead to a competition with the wild species of the nutrients. This said, the flow of nutrients from single production site is not constant. To solve this challenge, fish farmers that are in different stages in the production cycle could collaborate by delivering their sludge to common third partner cultivating an IMTA species.

Stricter regulations on emissions from sea-based aquaculture farms has been identified as an important driver to increase the demand for on-site sludge collection in open sea cages and coupled IMTA systems. More awareness of sustainable fish production as well as a demand for marine ingredients in fish feed could be important drivers for IMTA to gain more support (Ellis and Tiller, 2019).

4.3.1.3 Low P feed

Since there are few regulations of nutrient emissions from sea-based aquaculture, there is little pressure on reducing these emissions. Fish farmers have to take the initiative themselves to produce more sustainably and opt for a low P feed (Hamilton, 2021). This feed is more expensive than a standard feed, and BioMar reports that the main customers for this type of feed are fish farmers in the Baltic Sea area. The waters there are at high risk of eutrophication, and the producers are therefore required by law to reduce their nutrient emissions (Hamilton, 2021, Mehta, 2012). BioMar has taken an active role in

educating their clients about the impacts of aquaculture and the role of the feed, and how the farmers can reduce these emissions by investing in more high-quality and low impact feeds, such as the Blue IMPACT™ feed. A significant driver that could help the shift towards a low impact feed becoming the standard, is the demand for sustainable farmed salmon and rainbow trout. This demand requires educated buyers that are aware of which environmental challenges related to aquaculture exist.

4.3.1.4 CCS at sea

Some of the benefits of CCS at sea is that the risk of sea lice and fish escapes are significantly decreased compared to production in open net sea cages. Moreover, these systems allow for filtration and collection of particulate emissions, even though this is considered a bonus (Rosten et al., 2011). Finding suitable areas for CCS at sea can be challenging as these systems are more vulnerable towards wind and waves. There is also a lack of standardization of these structures as most companies are still in R&D phase (Clarke et al., 2018). These facilities would with today's technology not have the possibility to collect the dissolved nutrient emissions, but also medicines, chemicals and other compounds that are not a part of the feed (Braaten et al., 2010). The limited production growth at sea-based localities due to sea lice is one of the main drivers for the development and production in CCS.

4.3.1.5 RAS

Increasing the production of grow-out fish on land might be the most efficient way to reduce the emissions in the sea, but there is also a risk of problem shift towards emissions in limnetic waterbodies. The only RAS-facility in Norway that produces grow-out fish today, Fredrikstad Seafood, emits the waste water into Glomma (Staalstrøm and Johnsen, 2015). This is a river with a low phosphorus concentration, and increasing the phosphorus input to this river introduces a significant risk of eutrophication. On the other hand, production in land-based facilities is the only production form that could solve all problems related to spreading of diseases, risks of toxic algae and escapes as well as reduced emissions of particulate and dissolved nutrients. Producing in RAS is not risk free either. Accidents including technical failures such as electricity stoppage, biological incidents concerning bacteria and hydrogen sulfide (H₂S) or external incidents such as avalanches or problems with the water supply can have great consequences (Bjørndal et al., 2018, Bjørndal and Tusvik, 2019). In worst case scenarios, the whole production volume in the facility is lost.

Producing grow-out fish in RAS, might be too expensive for many fish farmers in Norway. Another strategy that have greater potential is to produce the post-smolt in closed facilities, until they weigh 1 kg. This decreases the sea-phase of the production and is mainly a strategy to reduce the risk of sea lice, diseases and escapes. It is not unlikely that the full production cycle in land-based facilities this will take place abroad, as the demand for salmon is increasing worldwide (Bjørndal and Tusvik, 2019). The producers are no longer dependent on the favorable sea-water conditions, when producing in land-based

facilities. Producing abroad closer to the markets can also reduce the costs and environmental impacts of transportation.

4.5 Scenarios for P emissions and recovery in the future

The current P management in the Norwegian aquaculture industry is not sustainable. An upscaling of the system, without a change of resource use, will lead to up to 31 700 tons emitted P annually. The scenarios developed in this thesis show three pathways in which the sector can upscale, while keeping P emissions at almost the current level and efficiently collecting P resources as either sludge or IMTA products.

In the *Basecase* scenario (Figure 23), it is assumed that half of the production areas have been given a green light every year towards 2050. This means that 50 % of the production growth takes place at sea in open net cages. The other growth takes place in CCS at sea or in land-based facilities. Of the input P, 41 % is emitted to the local environment and 41 % is recovered. In the recovered fraction, 8 % is recovered as seaweed and 33 % is recovered as sludge. This amount is equivalent of 655 425 tons DW sludge. The scenario also assumes that every production site with open net sea-cages have LiftUP system installed to collect sludge. In terms of production structures, this scenario is not unlikely. The Traffic Light system limits the sea-based production growth and production in land-based facilities do not require the same permits as sea-based production (Tveterås et al., 2020). However, if the challenges concerning sea lice and escapes, many producers would probably prefer to keep producing in open net cages at sea. The PUE is 30% in this scenario, an increase from 20 % in 2019. This is due to the use of a low P feed. As the indicator is defined (P in slaughtered fish/ P in feed), the only measures that can increase it, is a reduction of total amount of feed i.e. reducing feed loss or reducing the amount of P in the feed. However if the recovered amount of P in sludge and P in IMTA products were included as well, the PUE would be 69 %. Collecting emissions and production of IMTA species could therefore have a great potential of increasing the PUE of aquaculture.

If problems with sea lice are solved, with for example the use of cleaner fish, it is not unlikely that growth will still happen at sea, though probably more and more at exposed localities. This scenario is investigated in *Production growth at SEA* (Figure 24), where every production area has been given a green light every year until 2050, resulting in an annual growth of 3%. The emitted P per input is 44% in this scenario. As much as 51% of the input P can be recovered, where 17% is offset as seaweed and 32% is recovered as sludge collected at open net sea cages. The amount of seaweed and sludge translates to 20 million WW seaweed and to 552 359 tons DW sludge. A market and infrastructure to produce and treat these products would also be necessary. The total P uptake in ragworm in this scenario is 444 tons. This translates to 67 979 tons WW ragworms. It is important to mention that 20 million tons WW seaweed has the potential to offset 4 680 tons DIP, 96 000 tons DIN and 710 400 tons DIC. The CO₂ offset is equivalent of 48 % of total C emissions from 3.7 million tons salmon and rainbow trout produced. The offset of N is 58 % of total N emissions and the P-offset is equivalent 37 %. This illustrates how emission

offsetting in seaweed is more efficient for N and C than for P. The PUE is 30 % in this scenario, but with the inclusion of sludge and IMTA products, it can be increased to up to 76 %. The P management shown in this scenario would probably require either regulations on collecting emissions from sea-based facilities or a strong pressure on sustainable production from the customer side.

The *Production growth at LAND* scenario (Figure 25), explores what would happen if all future production sites were in land-based facilities with RAS. The emitted P per input is 34%. This is mainly from the sea-based farms. Producing in RAS as the test of individual strategies already have illustrated is the most efficient measure to reduce P emissions. The 32 % of input P is recovered as sludge, which translates to 896 458 tons DW sludge. In this case, an P recovery rate of 84 % is assumed for the RAS facilities. An interesting point here is that recovered amount of P is the same amount of what could be reduced by using a low P feed. A cost-benefit analysis have not been performed in this study, and it would be interesting to investigate which option would be most profitable for the producers of i) opting for a more expensive feed with a lower P concentration or ii) producing the fish in RAS systems, collecting, transporting and treating the sludge. Investing in RAS is more than 1000 times more expensive than producing in open net cages and per today, the producers have to take the costs of sludge processing and transport, which can be an expensive and energy intensive process (Nistad, 2020). Due to the P content in sludge, this could change, as sludge has a potential of becoming a valuable resource (Lundberg and Larsen, 2019). However, for an optimal P management, both of these alternatives, reducing the P in feed and collecting the sludge, should be implemented as they can perfectly well be combined.

The scenarios illustrating tackling the P challenge in aquaculture have two main solutions: i) reducing the P input through the feed or ii) collecting and reducing the emissions. Implementation of only one of these solutions can only take you so far. A holistic approach where both reducing input and emissions are necessary for a sustainable P management in the industry. It is important to keep in mind that only focusing on one type of emission, or other problem for that part, can lead to problem shifts. Even though seaweed production would not be the best solution for recycling P, the potential in mitigating impacts from N and C emissions are promising. The scenarios show that combining IMTA with sludge collection can reduce both particulate emissions and take up dissolved nutrients. There is actually also an on-going research about combining the growth of microalgae in RAS systems for nitrate uptake, which opens up for a combination of RAS and IMTA (Reitan, 2021). Using a feed with a low P content can also be combined with all of the production alternatives.

The results show that collecting sludge and recovering IMTA products as well as employing a low P feed can increase PUE from 20 % to 76 %. For sludge collection and IMTA products to be included in PUE, applications of these products should include nutrient recycling of P.

4.6 A note on sludge and IMTA applications

The processing and end-use of both sludge and IMTA products have not been included in this thesis. However, these steps are important to obtain a circular bioeconomy of P in Norway. This section will briefly discuss what applications are most potential as well as their limitations for nutrient recycling for sludge and IMTA products.

4.6.1 Sludge applications

Fertilizer or soil improver and biogas production are amongst the more developed applications of fish sludge are (Blytt et al., 2011, Rosten et al., 2013b, Aspaas et al., 2016, Hamilton et al., 2017, Cabell et al., 2019). Other applications include sludge as a coal replacer in cement production or sludge as feed for ragworm production. From a P perspective, fertilizer has been one of the most promising options, because of the availability to recycle nutrients. However, it is only a fraction ranging from 39 - 72% of the total P in fish sludge that is available for plants as reported in Cabell et al. (2019). This makes fish sludge a less preferable source of P than for example mineral phosphorus and manure (Brod and Øgaard, 2021). Nutrient recycling is also possible in biogas production, but is currently not being done, as biogas producers do not gain a financial benefit from extracting the nutrients (Aspaas et al., 2016). The salt content in sludge from grow-out fish production can also pose a problem for both fertilizer and bio-gas production. The heavy metal content of fish sludge is another challenge to the application of feed input to ragworms and for fertilizer use in Norway (Aspaas et al., 2016).

4.6.2 IMTA applications

Applications for seaweed includes inputs to biogas or biofuel, carbon sequestration, ingredient in feed for humans, fish and livestock and many more. Seaweed as an ingredient in feed opens up for the possibility of recycling to P content. However, the heavy metal content in seaweed as well as the low DW content makes it a less preferable ingredient for fish feed (Hamilton, 2021). The most potential end-use of ragworms is also as a feed ingredient due to the high content of n-3 fatty acids. However, regulations on animals consuming waste products can limit this option at least for production of fish and shrimp in the EU (Mattilsynet, 2013).

4.7 Missing regulations on emissions from sea-based aquaculture

The results of this thesis have shown that current the current approach of managing P in aquaculture is not sustainable. This study has assessed several strategies, both individually and combined, that have the potential of optimizing the P resource use in aquaculture and reducing emissions. However, regulations on emissions for grow-out fish can be the missing driver to push fish producers towards reducing the nutrient emissions.

Even though new production permits are regulated by the Pollution Control Act (see Appendix D), there are no criteria to collect or reduce emissions from sea-based aquaculture (Miljødirektoratet, 2019). Investigating the conditions on the sea-floor and

in the nearby ecosystems with MOM B and MOM C examinations is not a precautionary measure to avoid negative impacts on the environment (Fiskeridirektoratet, 2019, Fiskeridirektoratet, 2017). These types of regulations are based entirely on local factors and environmental conditions. Optimizing the system with a limit on emissions as for example *kg emissions / kg fish produced* is important for efficient resource use per produced unit, but is not necessarily the best option for an optimized resource use in the whole industry. In the current system, production is only decreased after the impacts have taken place, rather than estimating a tolerance limit or setting the maximum level of emissions. It is difficult to suggest a maximum limit of emission, when local conditions such as oxygen level, currents and water exchange, play an important role in transporting nutrients and decomposing organic matter. It might be an easier task to make a criterion on the amount of P or sludge collected, than what is emitted. This study suggests a P recovery indicator based on the amount of P collected as either sludge or IMTA products compared to the input of P to the system.

4.8 Further work for an optimized P management in the aquaculture industry

To calibrate the model and make the flows of all layers as exact as possible, a validation of the model towards experimental field data would be required. Furthermore, this thesis has only assessed the potential of reducing the phosphorus resource use and emissions by implementing strategies to optimize P use in the aquaculture sector. Only a brief overview over the annual emissions of N and C has been given by this thesis with the purpose of including these layers has been to illustrate and create awareness over potential problem shifts when only focusing on optimizing P resource use and emissions. This thesis proposes IMTA with seaweed production as an important measure to mitigate the impacts of the emissions, even though, as the results have shown, this strategy is not the most efficient to reduce P emissions.

A throughout analysis that covers several aspects such as cost-benefit, social acceptance, energy use, area requirement and other potential problem shifts for the different strategies developed by this thesis would give a better understanding of their market potential and limitations than what have been discussed in this thesis.

Another important aspect of P management is the processing and applications of sludge and IMTA products. The aim of the MIND-P project is independence of mineral P, and this can only be succeeded if the P resources from aquaculture enters a circular bioeconomy where the nutrients are recycled. Therefore a mapping of P from the collection of these products to end-use is important to identify which pathways offers the most efficient recycling of P.

5. Conclusion

This thesis has quantified the annual flows of wet weight (WW), dry weight (DW), phosphorus (P), nitrogen (N) and carbon (C) in multi-scale multi-layer substance flow analysis (SFA) of the Norwegian salmon and rainbow trout aquaculture sector. The aim has been to investigate how P resource use can be optimized in this industry.

Several strategies to reduce the P emissions have been tested. They include i) phytase added to fish feed, ii) nutrient offset in species cultivated in integrated multitrophic aquaculture (IMTA), iii) sludge collection in open net sea cages or iv) production of grow-out fish in CCS either on land or at sea. The results show that emissions can be reduced with 21 – 87 % if these strategies was implemented for 2019's production. If production was completely transitioned to closed land-based facilities, the production could increase to 11.3 million tons fish without exceeding 2019's emission levels. If production volume is to reach 3.7 million tons in 2050, which is estimated by PwC (2021) in the Seafood Barometer, without increasing the P emissions, a combination of the other strategies needs to be implemented.

Three scenarios have been developed with the aim of illustrating different pathways for production growth in the Norwegian aquaculture industry. The results show that production can reach 3.7 million tons without exceeding 2019's emission level and at the same time recover up to 50 % of input P as fish sludge or IMTA products even without producing the fish in closed systems.

One of the most important findings of this thesis, is that a combination of strategies must be implemented to optimize P use in the aquaculture sector. This is because P emissions are divided into a particulate organic, dissolved organic and dissolved inorganic emissions. It is not enough to only reduce the P input from the feed or collect the P emissions, both approaches has to be done for an efficient use of P. This thesis suggests several indicators with the aim of measuring the P efficiency in the aquaculture industry based on the emitted amount of P as well as the recovered amount of P compared to the input of P to the system.

However, for a sustainable P management in the sector, it is not sufficient to only reduce resource use and emissions. P in recovered sludge and IMTA products needs to be recycled to achieve full independence of mineral P. This will require a mapping of the different sludge processing and applications available. The multi-scale multi-layer SFA model presented in this thesis serves as a tool to both estimate current emission levels in aquaculture as well as estimating how the resource use emissions can be optimized both at a locality level, production area level and a national level. This includes estimations on collected sludge per locality, which is an important feature for the further mapping of sludge processing and end-applications.

A sustainable management of P in the global aquaculture system is crucial both on a national and global scale to secure food supply for future generations. Current regulations on emissions from aquaculture, especially in sea-based localities, are not sufficient to drive the development of a more sustainable P management in the industry. The lack of knowledge about the global P challenge and the role of aquaculture in this challenge both for fish farmers, feed producers and consumers is identified as another important missing driver for a sustainable P management in the sector.

6. Bibliography

- ASPAAS, S., HAGEMANN, A. & ROSTEN, T. W. 2016. Identifisering av aktuelle løsninger for håndtering og anvendelse av avløpsslam fra settefiskanlegg i Nordland.
- ATTRAMADAL, K. 2021. *RE: Head of R&D, Nofitech*.
- BARENTSWATCH. *Arealbruk* [Online]. barentswatch.no. Available: <https://www.barentswatch.no/havbruk/arealbruk> [Accessed 24.04 2021].
- BENNETT, E. M., CARPENTER, S. R. & CARACO, N. F. 2001. Human impact on erodable phosphorus and eutrophication: a global perspective: increasing accumulation of phosphorus in soil threatens rivers, lakes, and coastal oceans with eutrophication. *BioScience*, 51, 227-234.
- BERGVIK, M., STENSÅS, L., HANDÅ, A., REITAN, K. I., STRAND, Ø. & OLSEN, Y. 2019. Incorporation of feed and fecal waste from salmon aquaculture in great scallops (*Pecten Maximus*) co-fed by different algal concentrations. *Frontiers in Marine Science*, 5, 524.
- BIOMAR 2020. Blue Impact Aqua
- BJØRNDAL, T., HOLDE, E., HILMARSEN, Ø. & TUSVIK, A. 2018. Analyse av lukka oppdrett av laks-landbaser og i sjø: Produksjon, økonomi og risiko. *b OC2018 A-033*.
- BJØRNDAL, T. & TUSVIK, A. 2019. Economic analysis of land based farming of salmon. *Aquaculture Economics & Management*, 23, 449-475.
- BLYTT, L. D., HARALDSEN, T. K., HELNESS, H., PAULSRUD, B. & ULGENES, Y. 2011. Håndtering av slam fra rensing av avløp i settefiskanlegg: Forprosjektrapport. *SINTEF rapport SBF2011F0081. SINTEF Byggforsk, Trondheim*, 37.
- BOXASPEN, K. K. & HUSA, V. 2019. *Hvor mye løste næringsalter fra oppdrett tåler kysten?* [Online]. Havforskningsinstituttet Available: <https://www.hi.no/hi/nyheter/2019/juni/hvor-mye-loste-neringsalter-fra-oppdrett-taler-kysten> [Accessed 11.05 2021].
- BROCH, O. J., ALVER, M. O., BEKKBY, T., GUNDERSEN, H., FORBORD, S., HANDÅ, A., SKJERMO, J. & HANCKE, K. J. F. I. M. S. 2018. The kelp cultivation potential in coastal and offshore regions of Norway. 5, 529.
- BROCH, O. J., DAAE, R. L., ELLINGSEN, I. H., NEPSTAD, R., BENDIKSEN, E. Å., REED, J. L. & SENNESET, G. 2017. Spatiotemporal dispersal and deposition of fish farm wastes: a model study from central Norway. *Frontiers in Marine Science*, 4, 199.
- BROCH, O. J. & ELLINGSEN, I. 2020. Kunnskaps-og erfaringskartlegging om effekter av og muligheter for utnyttelse av utslipp av organisk materiale og næringsalter fra havbruk -Delrapport 1 - Kvantifisering av utslipp SINTEF: SINTEF.
- BROD, E. & ØGAARD, A. F. 2021. Fosforeffekt av organisk avfall. *NIBIO Rapport*.
- BRUHN, A., TØRRING, D. B., THOMSEN, M., CANAL-VERGÉS, P., NIELSEN, M. M., RASMUSSEN, M. B., EYBYE, K. L., LARSEN, M. M., BALSBY, T. J. S. & PETERSEN, J. K. 2016. Impact of environmental conditions on biomass yield, quality, and bio-mitigation capacity of *Saccharina latissima*. *Aquaculture environment interactions*, 8, 619-636.
- BRUNNER, P. H. & RECHBERGER, H. 2004. Methodology of MFA. *Practical Handbook of Material Flow Analysis*. Lewis Publishers®, Boca Raton London New York Washington, DC, 34-166.
- BRAATEN, B., LANGE, G. & BERGHEIM, A. 2010. Vurdering av nye tekniske løsninger for å redusere utslippene fra fiskeoppdrett i sjø. *Stavanger/Bergen, Klif-Klima-og forurensningsdirektoratet*, 50.

- BUCK, B. H., TROELL, M. F., KRAUSE, G., ANGEL, D. L., GROTE, B. & CHOPIN, T. 2018. State of the art and challenges for offshore integrated multi-trophic aquaculture (IMTA). *Frontiers in Marine Science*, 5, 165.
- CABELL, J., BROD, E., ELLINGSEN, J., LØES, A.-K., STANDAL, I. B., TORDNES, B. & VIVESTAD, H. 2019. Bruk av tørket slam fra settefiskanlegg som gjødsel i norsk landbruk. *NIBIO Rapport*.
- CAO, L., WANG, W., YANG, C., YANG, Y., DIANA, J., YAKUPITIYAGE, A., LUO, Z. & LI, D. 2007. Application of microbial phytase in fish feed. *Enzyme and microbial technology*, 40, 497-507.
- CARPENTER, S. R. & BENNETT, E. M. 2011. Reconsideration of the planetary boundary for phosphorus. *Environmental Research Letters*, 6, 014009.
- CARTER, C. G. & SAJJADI, M. 2011. Low fishmeal diets for Atlantic salmon, *Salmo salar* L., using soy protein concentrate treated with graded levels of phytase. *Aquaculture International*, 19, 431-444.
- CLARKE, R., MAITLAND, D. & BOSTOCK, J. 2018. Technical Considerations of closed containment sea pen production for some life stages of salmonids.
- CORDELL, D., DRANGERT, J.-O. & WHITE, S. 2009. The story of phosphorus: global food security and food for thought. *Global environmental change*, 19, 292-305.
- CORNER, R. A., BROOKER, A. J., TELFER, T. & ROSS, L. G. 2006. A fully integrated GIS-based model of particulate waste distribution from marine fish-cage sites. *Aquaculture*, 258, 299-311.
- DENSTADLI, V., STOREBAKKEN, T., SVIHUS, B. & SKREDE, A. 2007. A comparison of online phytase pre-treatment of vegetable feed ingredients and phytase coating in diets for Atlantic salmon (*Salmo salar* L.) reared in cold water. *Aquaculture*, 269, 414-426.
- DUARTE, C. M., WU, J., XIAO, X., BRUHN, A. & KRAUSE-JENSEN, D. J. F. I. M. S. 2017. Can seaweed farming play a role in climate change mitigation and adaptation? 4, 100.
- ELLIS, J. & TILLER, R. 2019. Conceptualizing future scenarios of integrated multi-trophic aquaculture (IMTA) in the Norwegian salmon industry. *Marine Policy*, 104, 198-209.
- FISKERIDEPARTEMENTET, N.-O. 2014. Forutsigbar og miljømessig bærekraftig vekst i norsk lakse-og ørretoppdrett. Regjeringen Oslo.
- FISKERIDIREKTORATET. *Tall og analyse: akvakultur* [Online]. Available: <https://www.fiskeridir.no/Akvakultur/Tall-og-analyse> [Accessed 25.05 2021].
- FISKERIDIREKTORATET. 2017. *C-undersøkelser* [Online]. Available: <https://www.fiskeridir.no/Akvakultur/Drift-og-tilsyn/Overvaaker-miljoepaavirkningen/C-undersokelser> [Accessed 15.12 2020].
- FISKERIDIREKTORATET. 2019. *B-undersøkelser* [Online]. Available: <https://www.fiskeridir.no/Akvakultur/Drift-og-tilsyn/Overvaaker-miljoepaavirkningen/B-undersokelser> [Accessed 15.12 2020].
- FISKERIDIREKTORATET. 2020. *Akvakulturregisteret* [Online]. Available: <https://www.fiskeridir.no/Akvakultur/Registre-og-skjema/akvakulturregisteret> [Accessed 15.12 2020].
- FOSSMARK, A. 2021. *RE: Project Engineer, LiftUP*.
- FREDRIKSEN, S., OLSEN, Y., HUSA, V., SKJOLDAL, R. H., DALE, T., CHRISTIE, H. & SJØTUN, K. 2011. Vurdering av eutrofieringssituasjonen i kystområder, med særlig fokus på Hardangerfjorden og Boknafjorden. Regjeringen.no.

- GODDEK, S., ESPINAL, C. A., DELAIDE, B., JIJAKLI, M. H., SCHMAUTZ, Z., WUERTZ, S. & KEESMAN, K. J. 2016. Navigating towards decoupled aquaponic systems: a system dynamics design approach. *Water*, 8, 303.
- GREFSRUD, E. S., KARLSEN, Ø., KVAMME, B. O., GLOVER, K. A., HUSA, V., HANSEN, P. K., GRØSVIK, B. E., SAMUELSEN, O. B., SANDLUND, N. & STIEN, L. H. 2021. Risikoreport norsk fiskeoppdrett 2021-kunnskapsstatus-Kunnskapsstatus effekter av norsk fiskeoppdrett. *Rapport fra havforskningen*.
- GUERRERO, J.-L. & SAMPLE, J. E. 2021. Kildefordelte tilførsler av nitrogen og fosfor til norske kystområder i 2019–tabeller, figurer og kart. *NIVA-rapport*.
- HAMILTON, H. 2021. *RE: Global Sustainability Specialist, BioMar*
- HAMILTON, H. A., BROD, E., HANSERUD, O., MÜLLER, D. B., BRATTEBØ, H. & HARALDSEN, T. K. 2017. Recycling potential of secondary phosphorus resources as assessed by integrating substance flow analysis and plant-availability. *Science of the Total Environment*, 575, 1546-1555.
- HAMILTON, H. A., BROD, E., HANSERUD, O. S., GRACEY, E. O., VESTRUM, M. I., BØEN, A., STEINHOFF, F. S., MÜLLER, D. B. & BRATTEBØ, H. 2016. Investigating cross-sectoral synergies through integrated aquaculture, fisheries, and agriculture phosphorus assessments: A case study of Norway. *Journal of Industrial ecology*, 20, 867-881.
- HANCKE, K., BROCH, O. J., OLSEN, Y., BEKKBY, T., HANSEN, P. K., FIELER, R., ATTARD, K., BORGERSEN, G. & CHRISTIE, H. 2021. Miljøpåvirkninger av tare dyrking og forslag til utvikling av overvåkingsprogram.
- HANDÅ, A., FORBORD, S., WANG, X., BROCH, O. J., DAHLE, S. W., STØRSETH, T. R., REITAN, K. I., OLSEN, Y. & SKJERMO, J. 2013. Seasonal-and depth-dependent growth of cultivated kelp (*Saccharina latissima*) in close proximity to salmon (*Salmo salar*) aquaculture in Norway. *Aquaculture*, 414, 191-201.
- HATLEN, B., JAKOBSEN, J. V., CRAMPTON, V., ALM, M., LANGMYHR, E., ESPE, M., HEVRØY, E., TORSTENSEN, B., LILAND, N. & WAAGBØ, R. 2015. Growth, feed utilization and endocrine responses in Atlantic salmon (*Salmo salar*) fed diets added poultry by-product meal and blood meal in combination with poultry oil. *Aquaculture nutrition*, 21, 714-725.
- HAVFORSKNINGSINSTITUTTET. 2019. *Tema: Laks i oppdrett* [Online]. Available: <https://www.hi.no/hi/temasider/arter/laks/laks-i-oppdrett> [Accessed 01.12 2020].
- HAVFORSKNINGSINSTITUTTET. 2020. *Dette er trafikklyssystemet* [Online]. Havforskningsinstituttet Available: <https://www.hi.no/hi/nyheter/2020/februar/trafikklys> [Accessed 30.11 2020].
- HILMARSEN, Ø., EAH, H. B., HØYLI, R. & HOGNES, E. 2018. Konsekvensanalyse av landbasert oppdrett av laks-matfisk og post-smolt. *Trondheim: Sintef*.
- HOWARTH, R. W., BILLEN, G., SWANEY, D., TOWNSEND, A., JAWORSKI, N., LAJTHA, K., DOWNING, J. A., ELMGREN, R., CARACO, N. & JORDAN, T. 1996. Regional nitrogen budgets and riverine N & P fluxes for the drainages to the North Atlantic Ocean: Natural and human influences. *Nitrogen cycling in the North Atlantic Ocean and its watersheds*. Springer.
- HUANG, C.-L., GAO, B., XU, S., HUANG, Y., YAN, X. & CUI, S. 2019. Changing phosphorus metabolism of a global aquaculture city. *Journal of Cleaner Production*, 225, 1118-1133.

- HUANG, Y., CIAIS, P., GOLL, D. S., SARDANS, J., PEÑUELAS, J., CRESTO-ALEINA, F. & ZHANG, H. 2020. The shift of phosphorus transfers in global fisheries and aquaculture. *Nature communications*, 11, 1-10.
- HUSA, V. 2018. 3. Miljøeffekter som følge av utslipp av løste næringsalter fra fiskeoppdrett.
- JANSEN, H. M., HANSEN, P. K., BRENNAN, N., DAHLGREN, T. G., FANG, J., NEDERLOF, M., STROHMEIER, T., SVEIER, H. & STRAND, Ø. 2019. Enhancing opportunistic polychaete communities under fish farms: an alternative concept for integrated aquaculture. *Aquaculture Environment Interactions*, 11, 331-336.
- KRAUGRUD, R. L. 2021. *Verds å vite om slam fra fiskeoppdrett* [Online]. NOFIMA. Available: <https://nofima.no/verdt-a-vite/verdt-a-vite-om-slam-fra-fiskeoppdrett/#tre-grep-for-a-redusere-slammengden> [Accessed 02.06 2021].
- KRAUSE-JENSEN, D. & DUARTE, C. M. J. N. G. 2016. Substantial role of macroalgae in marine carbon sequestration. 9, 737.
- KRISTENSEN, B. S. B. 2021. MSc Student at NTNU.
- LOMNES, B. S., SENNESET, A. & TEVASVOLD, G. 2019. Kunnskapsgrunnlag for rensing av utslipp fra landbasert akvakultur.
- LUNDBERG, H. & LARSEN, S. 2019. -Slam kan skape verdier. *Kyst.no*.
- LUPTON, R. C. & ALLWOOD, J. M. 2017. Hybrid Sankey diagrams: Visual analysis of multidimensional data for understanding resource use. *Resources, Conservation and Recycling*, 124, 141-151.
- MATTILSYNET. *Hjemler i regler iforbindelse med brakkleggingsgrupper* [Online]. Available: https://www.mattilsynet.no/fisk_og_akvakultur/akvakultur/drift_av_akvakulturanlegg/hjemler_i_regelverket_i_forbindelse_med_brakkleggingsgrupper.34443/binary/Hjemler%20i%20regelverket%20i%20forbindelse%20med%20brakkleggingsgrupper [Accessed 02.12 2020].
- MATTILSYNET. 2013. *Krav til fôr* [Online]. Available: https://www.mattilsynet.no/dyr_og_dyrehold/for/krav_til_for.5567 [Accessed 01.06 2021].
- MEHTA, S. 2012. *Phosphorus management in the Baltic Sea historic evidence and future options*. Institutt for vann-og miljøteknikk.
- MILJØDIREKTORATET. 2019. *Akvakultur - fiskeoppdrett* [Online]. Available: <https://www.miljodirektoratet.no/ansvarsomrader/vann-hav-og-kyst/Akvakultur-fiskeoppdrett/> [Accessed 01.06 2021].
- MILJØDIREKTORATET. 2020. *Utslipp av næringsalter fra fiskeoppdrett* [Online]. Miljødirektoratet. Available: <https://miljostatus.miljodirektoratet.no/tema/forurensning/overgjodsling/utslipp-av-naringsalter-fra-fiskeoppdrett/> [Accessed 03.05 2021].
- MOFFITT, C. M. & CAJAS-CANO, L. 2014. Blue Growth: The 2014 FAO State of the World Fisheries and Aquaculture. *Fisheries*, 39, 552-553.
- MOTA, V. 2020. *Sikker på at RAS-teknologier er fremtiden for oppdrettsnæringen* [Online]. Nofima Available: <https://nofima.no/nyhet/2020/12/sikker-pa-at-ras-teknologien-er-fremtiden-for-oppdrettsnaeringen/> [Accessed 01.06 2021].
- NEDERLOF, M. A., FANG, J., DAHLGREN, T. G., RASTRICK, S. P., SMAAL, A. C., STRAND, Ø., SVEIER, H., VERDEGEM, M. C. & JANSEN, H. M. 2020. Application of polychaetes in (de) coupled integrated aquaculture: an approach for fish waste bioremediation. *Aquaculture Environment Interactions*, 12, 385-399.

- NEDERLOF, M. A., JANSEN, H. M., DAHLGREN, T. G., FANG, J., MEIER, S., IVIND STRAND, Å., SVEIER, H., VERDEGEM, M. C. & SMAAL, A. C. 2019. Application of polychaetes in (de) coupled integrated aquaculture: production of a high-quality marine resource. *Aquaculture Environment Interactions*, 11, 221-237.
- NISTAD, A. A. 2020. *Current and Future Energy Use for Atlantic Salmon Farming in Recirculating Aquaculture Systems in Norway*. NTNU.
- NOFIMA. 2018. *Stor smolt ikke alltid best* [Online]. Available: <https://nofima.no/nyhet/2018/03/stor-smolt-ikke-alltid-best/> [Accessed 16.12 2020].
- NORDERHAUG, K., GUNDERSEN, H., HØGÅSEN, T., JOHNSEN, T., SEVERINSEN, G., VEDAL, J., SØRENSEN, K. & WALDAY, M. 2016. Eutrophication status for Norwegian waters. *National report for the third application of OSPARs Common Procedure*. Norwegian Environmental Agency.
- OLAFSEN, T., WINTHER, U., OLSEN, Y. & SKJERMØ, J. 2012. Verdiskaping basert på produktive hav i 2050. *Det Kongelige*.
- PWC 2021. PwC Seafood Barometer 2021. *PwC Seafood Barometer*.
- REID, G., CHOPIN, T., ROBINSON, S., AZEVEDO, P., QUINTON, M. & BELYEA, E. 2013. Weight ratios of the kelps, *Alaria esculenta* and *Saccharina latissima*, required to sequester dissolved inorganic nutrients and supply oxygen for Atlantic salmon, *Salmo salar*, in integrated multi-trophic aquaculture systems. *Aquaculture*, 408, 34-46.
- REID, G., LIUTKUS, M., ROBINSON, S., CHOPIN, T., BLAIR, T., LANDER, T., MULLEN, J., PAGE, F. & MOCCIA, R. 2009. A review of the biophysical properties of salmonid faeces: implications for aquaculture waste dispersal models and integrated multi-trophic aquaculture. *Aquaculture Research*, 40, 257-273.
- REITAN, K. I. 2021. *RE: Personal communication*.
- ROSTEN, T. W., AZRAGUE, K. & TOLDNES, B. 2013a. Karakterisering av avløpsvann fra norske landbaserte settefiskanlegg.
- ROSTEN, T. W., AZRAGUE, K. & TOLDNES, B. 2013b. Primærrensing og aktuelle løsninger for slambehandling i norske settefiskanlegg. *SINTEF Rapport*.
- ROSTEN, T. W., ULGENES, Y., HENRIKSEN, K., TERJESEN, B. F., BIERING, E. & WINTHER, U. 2011. Oppdrett av laks og ørret i lukkede anlegg-forprosjekt. *SINTEF, Trondheim*.
- RUTTENBERG, K. 2003. The global phosphorus cycle. *TrGeo*, 8, 682.
- SMIL, V. 2000. Phosphorus in the environment: natural flows and human interferences. *Annual review of energy and the environment*, 25, 53-88.
- STEEN, K. 2021. *RE: Fagsjef smolt production, Lerøy*
- STEFFEN, W., RICHARDSON, K., ROCKSTRÖM, J., CORNELL, S. E., FETZER, I., BENNETT, E. M., BIGGS, R., CARPENTER, S. R., DE VRIES, W. & DE WIT, C. A. 2015. Planetary boundaries: Guiding human development on a changing planet. *Science*, 347.
- STOREBAKKEN, T., SHEARER, K. & ROEM, A. 1998. Availability of protein, phosphorus and other elements in fish meal, soy-protein concentrate and phytase-treated soy-protein-concentrate-based diets to Atlantic salmon, *Salmo salar*. *Aquaculture*, 161, 365-379.
- STRAND, A. V. 2020. Modelling the phosphorus cycle in Norwegian sea-based salmon aquaculture. NTNU.
- STRAND, Ø. 2021. Forsker, Havforskningsinstituttet.
- STAALSTRØM, A. & JOHNSEN, T. M. 2015. Vurderinger av miljøkonsekvenser av utslipp til Glomma fra landbasert produksjonsanlegg for laks.
- SVEIER, H. 2021. CEO for Ocean Forest, Lerøy

- SVÅSAND, T., KARLSEN, Ø., KVAMME, B. O., STIEN, L. H., TARANGER, G. L. & BOXASPEN, K. K. 2016. Risikovurdering norsk fiskeoppdrett 2016.
- TORRISSEN, O., HANSEN, P. K., AURE, J., HUSA, V., ANDERSEN, S., STROHMEIER, T. & OLSEN, R. E. 2016. Næringsutslipp fra havbruk–nasjonale og regionale perspektiv.
- TVETERÅS, R., HOVLAND, M., REVE, T., MISUND, B., NYSTØYL, R., BJELLAND, H. V., MISUND, A. & Ø, F. 2020. Verdiskapingspotensiale og veikart for havbruk til havs
- TVETERÅS, R., REVE, T., HAUS-REVE, S., MISUND, B. & BLOMGREN, A. 2019. En konkurransedyktig og kunnskapsbasert havbruksnæring. *Handelshøgskolen BI, Oslo. Rapport.*
- WANG, X., ANDRESEN, K., HANDÅ, A., JENSEN, B., REITAN, K. I. & OLSEN, Y. 2013. Chemical composition and release rate of waste discharge from an Atlantic salmon farm with an evaluation of IMTA feasibility. *Aquaculture environment interactions*, 4, 147-162.
- WANG, X., OLSEN, L. M., REITAN, K. I. & OLSEN, Y. 2012. Discharge of nutrient wastes from salmon farms: environmental effects, and potential for integrated multi-trophic aquaculture. *Aquaculture Environment Interactions*, 2, 267-283.
- WINTHER, U., HOGNES, E. S., JAFARZADEH, S. & ZIEGLER, F. 2020. Greenhouse gas emission of Norwegian seafood products in 2017 SINTEF Ocean
- YTRESTØYL, T., AAS, T. S., BERGE, G. M., HATLEN, B., SØRENSEN, M., RUYTER, B., THOMASSEN, M. S., HOGNES, E. S., ZIEGLER, F. & SUND, V. 2011. Resource utilisation and eco-efficiency of Norwegian salmon farming in 2010. *Nofima rapportserie.*
- YTRESTØYL, T., AAS, T. S. & ÅSGÅRD, T. 2015. Utilisation of feed resources in production of Atlantic salmon (*Salmo salar*) in Norway. *Aquaculture*, 448, 365-374.
- ZHANG, Y., BLEEKER, A. & LIU, J. 2015. Nutrient discharge from China's aquaculture industry and associated environmental impacts. *Environmental Research Letters*, 10, 045002.
- AAS, T. S., SIXTEN, H. J., HILLESTAD, M., YTRESTØYL, T., SVEIER, H. & ÅSGÅRD, T. 2020. Feed intake, nutrient digestibility and nutrient retention in Atlantic salmon (*Salmo salar* L.) fed diets with different physical pellet quality. *Journal of Fisheries*, 8, 768-776.
- AAS, T. S., YTRESTØYL, T. & ÅSGÅRD, T. 2019. Utilization of feed resources in the production of Atlantic salmon (*Salmo salar*) in Norway: An update for 2016. *Aquaculture Reports*, 15, 100216.
- AAS, T. S. & ÅSGÅRD, T. E. 2017. Estimert innhold av næringsstoff og energi i fôrspill og faeces fra norsk lakseoppdrett. *Nofima rapportserie.*

Appendix

Appendix A: List of contacts

Name	Company	Contribution
Helen Hamilton	Biomar	Data supply, general discussion and input on P in feed.
Kjell Inge Reitan	NTNU Biology	General insight on IMTA and the aquaculture industry in Norway
Klemet Steen	Lerøy	Data supply, general discussion and input on RAS
Anders Fossmark	LiftUP	Data supply and general discussion on sludge collection in open net sea cages.
Harald Sveier	Lerøy Ocean Forest	Data supply on seaweed production in IMTA
Kari Attramadal	Nofitech	Input on RAS
Bjørn Kristensen	MSc Student, NTNU Biology	Supplied data
Øivind Strand	Institute of Marine Research (IMR)	Discussion about ragworm cultivation

Appendix B: Detailed equations of quantification of flows

Table 10: Equations for WW layer.

Flow name	Detailed equation
Feed consumption	Feed consumption
Feed intake	Feed consumption $\times (1 - F_L)$
Feed loss	Feed consumption $\times F_L$
Escapes	Escaped fish
Fish to slaughter	Fish to slaughter
Dead fish etc.	(Production loss at farm + Production loss at slaughter + Production loss other) \times Avg. weight
Smolt	Smolt input \times Avg. weight
Grow-out fish from other locality	(Total input - Smolt input) \times Avg. weight
Grow-out fish to other locality	Fish transferred to other locality \times Avg. weight
Feces	Feed Consumption \times WW Feces per feed
Sludge	Faeces + Feed loss
Fish to smolt market	Smolt sale per county
Feed consumption	Fish to smolt market \times FCR
Feed intake	Feed consumption $\times (1 - F_{L,smolt})$
Feed loss	Feed consumption $\times F_{L,smolt}$
Production loss	Smolt sale per county \times Production loss smolt
Eggs	-
Faeces	Feed Consumption \times WW Feces per feed
Sludge	Faeces + Feed loss
Collected sludge in RAS	Sludge \times RAS criteria
Sludge to biofilter	Sludge - Collected sludge in RAS

Table 11: Equations for DW layer.

Flow name	Detailed equation
Feed consumption	Feed consumption $\times DM_{feed}$
Feed intake	Feed consumption $\times (1 - F_L) \times DM_{feed}$
Feed loss	Feed consumption $\times F_L \times DM_{feed}$
Escapes	Escaped fish $\times DM_{fish}$
Fish to slaughter	Fish to slaughter $\times DM_{feed}$
Dead fish etc.	(Production loss at farm + Production loss at slaughter + Production loss other) $\times DM_{feed}$
Smolt	Smolt input $\times DM_{feed}$
Grow-out fish from other locality	(Total input - Smolt input) $\times DM_{feed}$
Grow-out fish to other locality	Fish transferred to other locality $\times DM_{feed}$
Feces	Feed Consumption \times WW Feces per feed $\times DM_{faeces}$
Sludge	Faeces + Feed loss $\times DM_{sludge}$
Fish to smolt market	Smolt sale per county $\times DM_{feed}$
Feed consumption	Fish to smolt market \times FCR $\times X_c$
Feed intake	Feed consumption $\times (1 - F_{L,smolt}) \times X_c$
Feed loss	Feed consumption $\times F_{L,smolt} \times X_c$
Production loss	Smolt sale per county \times Production loss smolt $\times DM_{feed}$
Faeces	Feed Consumption \times WW Feces per feed $\times DM_{faeces}$
Sludge	Faeces + Feed loss $\times DM_{sludge}$
Collected sludge in RAS	Sludge \times RAS criteria
Sludge to biofilter	Sludge - Collected sludge in RAS

Table 12: Equations for P, C and N layer .X stands for P, N or C. If the flow name contains P rather than X the flow has only been quantified for P.

Flow name	General Equation
Feed consumption	Feed consumption $\times X_c$
Feed intake	Feed consumption $\times (1 - F_L) \times X_c$
Feed loss	Feed consumption $\times F_L \times X_c$
DIX to water column (pen)	(Feed consumption - Feed loss) $\times X_c \times (A_x \times E_x)$
DOX to water column (pen)	$S \times (1 - A_x) \times (\text{Feed consumption} - \text{Feed loss}) \times X_c$
POX to water column (pen)	$(1 - S) \times (1 - A_x) \times (\text{Feed consumption} - \text{Feed loss}) \times X_c$
DIX to surrounding waters	DIX to water column (pen)
DOX to surrounding waters	DOX to water column (pen) + $S \times (1 - A_x) \times \text{Feed loss} \times X_c$
POX to surrounding waters	POX to water column (pen) + $(1 - S) \times (1 - A_x) \times \text{Feed loss} \times X_c$
Escapes	Escaped fish $\times X_c$
Fish to slaughter	Fish to slaughter $\times X_c$
Dead fish etc.	(Production loss at farm + Production loss at slaughter + Production loss other) $\times X_c$
Smolt	Smolt input $\times X_c$
Grow-out fish from other locality	(Total input - Smolt input) $\times X_c$
Grow-out fish to other locality	Fish transferred to other locality $\times X_c$
Feces	Feed Consumption $\times WW$ Feces per feed
Sludge	Faeces + Feed loss
X in faeces	DOX to water column (pen) + POX to water column (pen)
X in sludge	X_c in faeces + Feed loss $\times X_c$
Fish to smolt market	Smolt sale per county
Feed consumption	Fish to smolt market $\times FCR \times X_c$
Feed intake	Feed consumption $\times (1 - F_{L,smolt}) \times X_c$
Feed loss	Feed consumption $\times F_{L,smolt} \times X_c$
Production loss	Smolt sale per county \times Production loss smolt $\times X_c$
Eggs	-
DIX to RAS tanks	(Feed consumption - Feed loss) $\times X_c \times (A_x \times E_x)$
DOX to RAS tanks	$S \times (1 - A_x) \times (\text{Feed consumption} - \text{Feed loss}) \times X_c$
POX to RAS tanks	$(1 - S) \times (1 - A_x) \times (\text{Feed consumption} - \text{Feed loss}) \times X_c$
DIX to mechanical filter	DIX to RAS tanks
DOX to mechanical filter	DOX to RAS tanks + $S \times (1 - A_x) \times \text{Feed loss} \times X_c$
POX to mechanical filter	POX to RAS tanks + $(1 - S) \times (1 - A_x) \times \text{Feed loss} \times X_c$
X in faeces	DOX to RAS tanks + POX to RAS tanks
X in sludge	X_c in faeces + Feed loss $\times X_c$
Collected P in RAS	X_c in sludge $\times X_c$ collection in RAS
DIP to biofilter	DIP to mechanical filter
DOP to biofilter	DOP to mechanical filter
POP to biofilter	POP to mechanical filter - Collected P_c in RAS
Total P consumed by bacteria	(DIX to biofilter + DOX to biofilter+ POX to biofilter) \times Dissolved P consumed in biofilter
DOP consumed by bacteria	DOP to biofilter
POP consumed by bacteria	POP to biofilter
DIP consumed by bacteria	Total P_c consumed by bacteria - DOP to biofilter - POP to biofilter
DIP in waste water	DIP to biofilter - DIP consumed by bacteria
DOP in waste water	DOP to biofilter - DOP consumed by bacteria
POP in waste water	POP to biofilter - POP consumed by bacteria

Appendix C: Mass balance inconsistencies

A mass balance check was calculated for the P, N and C layer for the quantified flows of grow-out fish production in 2019. This includes two processes, *Open net pens* and *Fish biomass*. This mass balance check has been calculated by adding all input flows minus all output flows. A negative value indicates that the outflow is too big and a positive value indicates that the inflow is too big. Results of the mass balance check is summarized in Table 13.

Table 13: Mass balance inconsistencies.

Production Area	Open net pens			Fish biomass		
	P layer	N layer	C layer	P layer	N layer	C layer
Area 1: Swedish border to Jæren	0.0	0.0	0.0	-3.6	53.4	285.1
Area 2: Ryfylke	0.0	0.0	0.0	-23.8	261.7	1279.9
Area 3: Karmøy to Sotra	0.0	0.0	0.0	-9.1	1109.9	7135.0
Area 4: Nordhordland to Stadt	0.0	0.0	0.0	-0.1	1175.9	7739.4
Area 5: Stadt to Hustadvika	0.0	0.0	0.0	-20.6	289.6	1522.3
Area 6: Nordmøre og Sør-Trøndelag	0.0	0.0	0.0	-8.3	1374.3	8895.9
Area 7: Nord-Trøndelag with Bindal	0.0	0.0	0.0	-4.9	730.0	4720.7
Område 8: Helgeland to Bodø	0.0	0.0	0.0	-37.3	547.1	2907.6
Area 9: Vestfjorden and Vesterålen	0.0	0.0	0.0	-64.7	-1.1	-1210.0
Area 10: Andøya to Senja	0.0	0.0	0.0	-60.1	76.7	-613.2
Area11: Kvaløya to Loppa	0.0	0.0	0.0	-10.4	282.5	1666.4
Area 12: Vest-Finnmark	0.0	0.0	0.0	-25.5	467.7	2604.8
Område 13: Øst-Finnmark	0.0	0.0	0.0	-4.2	0.8	-72.6
Broodstock, research and educational purposes	0.0	0.0	0.0	-3.4	185.9	1159.9
Total	0.0	0.0	0.0	-278.1	6529.9	37819.9

Appendix D: Regulation of the Aquaculture sector

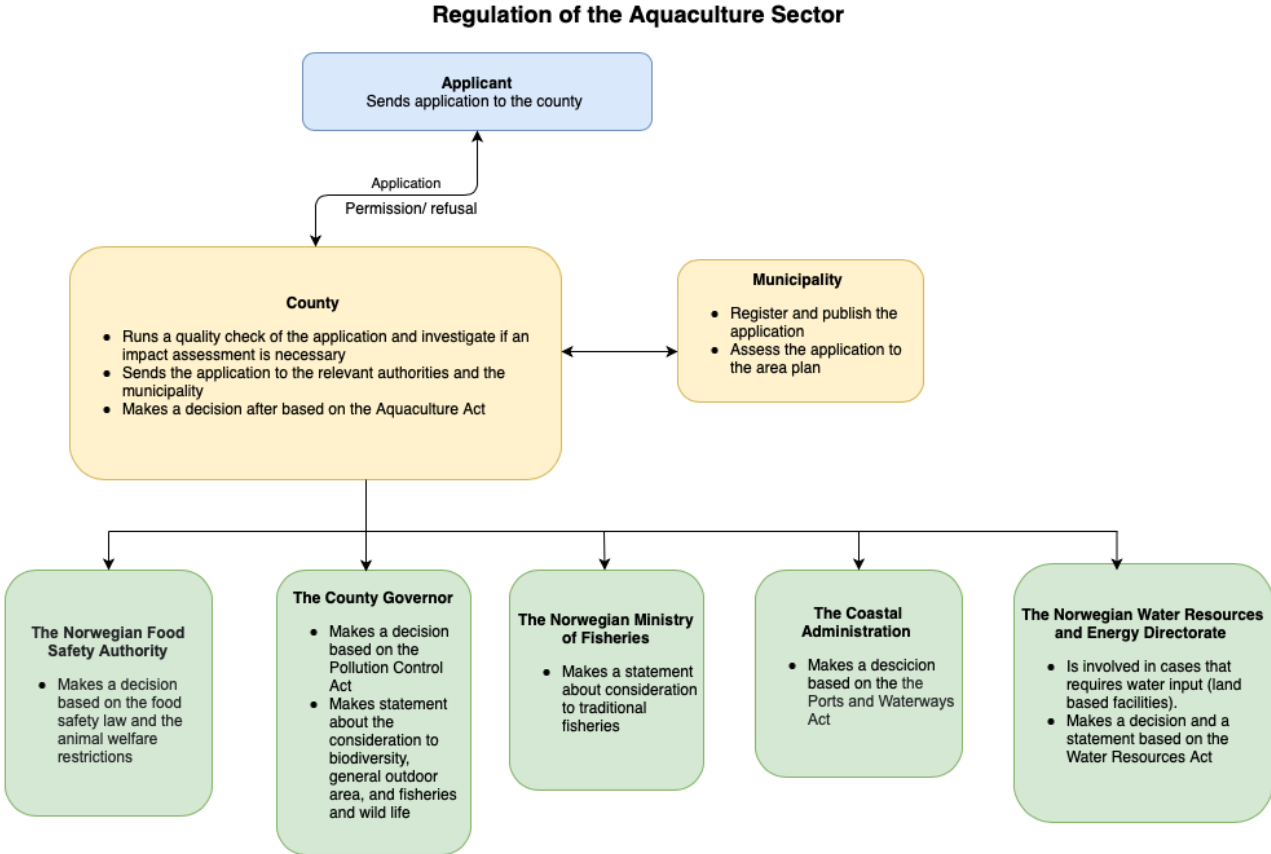

Figure 27: Regulation of the aquaculture sector in Norway. Adapted from Miljødirektoratet (2019).

Appendix E: Overview of the production areas and the Traffic Light System



Dato: 03.05.2021

Figure 28: Production areas with their current light in the Traffic Light System. Figure is created with the mapping tools from the Directorate of Fisheries.

