

Omran Nawfal

Experimental Study of Multiphase Flow Through One-Way Valves for SWEOR Concept

Master's thesis in Petroleum Engineering

Supervisor: Milan Stanko

June 2021

Omran Nawfal

Experimental Study of Multiphase Flow Through One-Way Valves for SWEOR Concept

Master's thesis in Petroleum Engineering
Supervisor: Milan Stanko
June 2021

Norwegian University of Science and Technology
Faculty of Engineering
Department of Geoscience and Petroleum



Acknowledgements

This master thesis was written by Omran Nawfal during the Spring 2021 semester and was presented at the department of Geoscience and Petroleum at the Norwegian University of Science and Technology.

I would first like to thank Professor Milan Stanko for being my supervisor over the course of my work and for providing me with great guidance and support along the way. In addition, I would like to thank Mr. Noralf Vedvik, Mr. Torkjell Breivik, and Mr. Roger Overå for their help in setting up the test benches used for the experimentation at the laboratory.

Finally, I would like to thank my family and my friends for their support which helped me reach this proud moment.

(Intentionally left blank)

Summary

This thesis studies the efficiency of conical seat one-way ball-type valves, and the possibility of their usage in the frac-to-frac method in tight oil reservoirs through the single well enhanced oil recovery method. Thus, an injection valve that only allows flow from the tubing into the formation and a production valve that only allows flow from the formation into the tubing are tested to understand their performance by measure their leakages and rates needed to become functional.

The experimental work was conducted using two test benches, a high-pressure (HP) test bench that was used to measure the leakage rates and closing rates of the valves, and a low-pressure (LP) test bench that allows to visualize the flow and measure and calculate the leakage through the valves. This second low-pressure test bench is useful to propose design improvements. The fluids used during these experiments were air and water, and the results were extracted through the Labview software.

In the experiments using the HP test bench, the valves had a Silicon Nitride ball with a hex-hole lid that keeps the ball in place. In addition, thread seal tape was used to decrease possible leakage through the threading (between the valve body and the cell wall). Leakage rate tests were done at 50, 75, 100, 125, and 150 bar pressure difference. The tests' durations varied between forty minutes and two hours. The results showed an increase in the leakage rate as the pressure was increased. The coefficient of variation of the leakage rates during the stabilization period was high for low leakage rates and were very low, for high leakage rates.

Closing rate tests were performed in the HP test bench to determine the flow rate needed for the ball to be pushed into place, shutting the valve closed. Two closing rate tests were done for each valve and the average of the values obtained is reported.

Leakage tests in the HP test bench were conducted on an injection and a production blind, to quantify the leakage through the threading. The values obtained were then compared against the results with the valves to back-calculate the leakage through the seal surface between the conus and the ball. One peculiar result is that the leakage through the production blind was higher than through the production valve; however, as the leakage rates were very low, it is believed that this may be caused by the thread seal tape that was applied differently in both tests.

Regarding the LP transparent test bench, two types of experiments were conducted, an air-injection water-production cyclic experiment, and an air-injection zero-production cyclic experiment. In the first one, when injection starts, the air rate that causes the closing of the production valve is determined by visual inspection and subsequent check of the measurement loggings. The injection phase then continues until the tank reaches maximum possible pressure. Then, the production phase begins, water is sent through the production valve. During this phase, the air tank will depressurize, due to leakage of air through the injection valve. The leakage rate appeared (visually) to be higher when water production took place after the air injection phase, compared to when the tank leakage through the valve was left to take place by itself. It is believed that this is because in the first case the pressure differential across the valve is lower than for the second case. These tests allowed to visualize the leakage through the valves and understand the nature of the flow within the cell.

After performing the experiments, the valves showed very positive results, having minimal leakage rates compared to the seal thresholds set by NORSOK (0.4 liters/min for water and 15 scfm for gas), proving that the current valves' designs could qualify as a barrier between the formation and the rest of the production system.

Finally, the aim of this work is to provide a completion technology that is simple and cost-effective for usage in the single well enhanced oil recovery through the frac-to-frac method in tight oil reservoirs, which allegedly has a better performance than the Huff-n-Puff method.

Contents

Acknowledgements.....	i
Summary.....	iii
Table of Figures.....	vi
Table of Tables.....	viii
Nomenclature.....	ix
1. Introduction.....	1
1.1 Background.....	1
1.2 Chapters' Overview.....	3
2. Previous Work (Specialization Project and Course).....	4
3. Experimental Setup.....	5
3.1 The Test Benches.....	5
3.1.1 High-Pressure Test Bench.....	5
3.1.2 Low-Pressure Transparent Test Bench.....	12
3.2 Experimental Tests.....	16
3.2.1 High-Pressure Test Bench.....	16
3.2.2 Low-Pressure Transparent Test Bench.....	17
4. Results.....	18
4.1 High Pressure Test Bench.....	18
4.1.1 Leakage Tests Using Water.....	18
4.1.2 Closing Rate Tests Using Water.....	43
4.1.3 Leakage Test and Closing Rate Test Using Air.....	47
4.2 Transparent Low-Pressure Test Bench.....	47
4.2.1 Air Injection.....	48
4.2.2 Air Injection-Water Production Cycle.....	50
5. Discussion.....	55
5.1 Analysis and Uncertainties of Experimental Results.....	55
5.2 Recommendations for Future Work.....	57
6. Conclusion.....	59
References.....	61
Appendix A: Supporting Parts and Tools Used.....	62
Appendix B: Previous Results from the Specialization Project.....	66

Table of Figures

Figure 1 Single Well EOR Process-F2F (Azhar, 2016).....	2
Figure 2 PI&D of the High-Pressure Test Bench	6
Figure 3 Image of the High-Pressure Test Bench	7
Figure 4 The Production Blind, Production Valve, Injection Valve, and Injection Blind (from left to right), with the Silicon Nitride Ball and the Hex-hole Lid Used (Top view and Bottom view)	8
Figure 5 The Pressure Cell Used in the HP Test Bench Before Inserting a Valve (Left) and with an Injection Valve Inserted (Right)	8
Figure 6 Demonstration of Flow Direction During a Leakage Test for an Injection Valve....	10
Figure 7 Demonstration of Flow Direction During a Leakage Test for a Production Valve... 10	
Figure 8 Demonstration of Flow Direction During a Closing Rate Test for an Injection Valve	11
Figure 9 Demonstration of Flow Direction During a Closing Rate Test for a Production Valve	11
Figure 10 The PI&D of the Low-Pressure Transparent Test Bench.....	13
Figure 11 The Transparent Low-Pressure Test Bench	14
Figure 12 The Flow Direction During the Air Injection Phase as Shown in the Labview Application.....	15
Figure 13 The Flow Direction During the Water Production Phase as Shown in the Labview Application.....	15
Figure 14 The Transparent Cell	16
Figure 15 Leakage Flow Rate vs. Time of the IV at 50 Bars	19
Figure 16 Leakage Flow Rate vs. Time of the IV at 75 Bars	20
Figure 17 Leakage Flow Rate vs. Time of the IV at 100 Bars	21
Figure 18 Leakage Flow Rate vs. Time of the IV at 125 Bars	22
Figure 19 Leakage Flow Rate vs. Time of the IV at 150 Bars	23
Figure 20 The Average Leakage Rates Calculated at Stabilization at Each Pressure Differential of IV	24
Figure 21 Leakage Flow Rate vs. Time of the IB at 50 Bars.....	25
Figure 22 Leakage Flow Rate vs. Time of the IB at 75 Bars.....	26
Figure 23 Leakage Flow Rate vs. Time of the IB at 100 Bars.....	27
Figure 24 Leakage Flow Rate vs. Time of the IB at 125 Bars.....	28
Figure 25 Leakage Flow Rate vs. Time of the IB at 150 Bars.....	29
Figure 26 The Average Leakage Rates Calculated at Stabilization at Each Pressure Differential of IB.....	30
Figure 27 Leakage Flow Rate vs. Time of the PV at 50 Bars	31
Figure 28 Leakage Flow Rate vs. Time of the PV at 75 Bars	32
Figure 29 Leakage Flow Rate vs. Time of the PV at 100 Bars	33
Figure 30 Leakage Flow Rate vs. Time of the PV at 125 Bars	34
Figure 31 Leakage Flow Rate vs. Time of the PV at 150 Bars	35
Figure 32 The Average Leakage Rates Calculated at Stabilization at Each Pressure Differential of PV	36
Figure 33 Leakage Flow Rate vs. Time of the PB at 50 Bars.....	37
Figure 34 Leakage Flow Rate vs. Time of the PB at 75 Bars.....	38

Figure 35 Leakage Flow Rate vs. Time of the PB at 100 Bars.....	39
Figure 36 Leakage Flow Rate vs. Time of the PB at 125 Bars.....	40
Figure 37 Leakage Flow Rate vs. Time of the PB at 150 Bars.....	41
Figure 38 The Average Leakage Rates Calculated at Stabilization at Each Pressure Differential of PB.....	42
Figure 39 IV Closing Rate Test Results-Trial 1	43
Figure 40 IV Closing Rate Test Results-Trial 2	44
Figure 41 PV Closing Rate Test Results-Trial 1	45
Figure 42 PV Closing Rate Test Results-Trial 2	46
Figure 43 The Injected Air Flow Rate During the Air Injection Experiment.....	48
Figure 44 Tank Air Leakage Rates Post Injection Phase.....	49
Figure 45 The Injected Air Flow Rate During the Injection-Production Cycle	50
Figure 46 Tank Air Leakage Rates During the Production Phases	51
Figure 47 Tank Pressure vs. Time Post Injection Phase of Air Injection Experiment	52
Figure 48 Tank Pressure vs. Time During the Production Phase of the Air Injection-Water Production Experiment	52
Figure 49 Air Leakage through Injection Valve with Clean Water.....	54
Figure 50 Air Leakage through Injection Valve with Dirty Water.....	54
Figure 51 Tank Leakage Rate vs. Tank Pressure During Both Experiments	57
Figure 52 Bolts and Nuts Used to Keep the Pressure Cell in Place.....	62
Figure 53 Key used to Insert the Injection Valves.....	62
Figure 54 Key Used to Insert the Lid on the Valves.....	63
Figure 55 Stand Used to Hold the Pressure Cell When Changing Valves	63
Figure 56 Transparent Water Tank Used.....	64
Figure 57 Thread Seal Tape Used to Decrease Thread Leakage	64
Figure 58 Wrenches Used to Unscrew the Pressure Cell Bolts.....	65
Figure 59 Air Source at the Laboratory	65
Figure 60 Flow Rate vs. Time of Injection Blind (50 bar)	66
Figure 61 Flow Rate vs. Time of Injection Blind (100 bar)	67
Figure 62 Flow Rate vs. Time of Injection Blind (150 bar)	68
Figure 63 Flow Rate vs. Time of Injection Blind (200 bar)	69
Figure 64 Flow Rate vs. Time of Injection Valve (50 bar).....	70
Figure 65Flow Rate vs. Time of Injection Valve (100 bar).....	71
Figure 66 Flow Rate vs. Time of Injection Valve (150 bar).....	72
Figure 67 Flow Rate vs. Time of Injection Valve (200 bar).....	73
Figure 68 Flow Rate vs. Time of Production Blind (50 bar).....	74
Figure 69 Flow Rate vs. Time of Production Blind (100 bar).....	75
Figure 70 Flow Rate vs. Time of Production Blind (150 bar).....	76
Figure 71 Flow Rate vs. Time of Production Blind (200 bar).....	77

Table of Tables

Table 1 Leakage Rate Tests' Results from the Specialization Project	4
Table 2 Procedures of Leakage and Closing Rate Tests through the HP Test Bench with Water.....	12
Table 3 Closing Rate Tests' Results of Both Valves	47
Table 4 Tank Leakage Rate at Different Tank Pressures Post Injection Phase in Both Experiments	53
Table 5 Leakage Rates of Each Valve at Different Upstream Pressures	55
Table 6 Ratios of Leakage Rate over the Leakage Limit of Sealing Valve by NORSOK	56

Nomenclature

AI: Air Injection

AI-WP: Air Injection-Water Production

COV: Coefficient of Variation

F2F: Frac-to-Frac

HnP: Huff-n-Puff

HP: High Pressure

IB: Injection Blind

IV: Injection Valve

LP: Low Pressure

PB: Production Blind

PV: Production Valve

1. Introduction

Background

As the oil and gas sector continuously searches for more innovative methods of producing hydrocarbons from conventional and unconventional reservoirs, the need for economically reliable tools that help to make that process easier is always a focal point. One of the specific domains that one can mention is the single well enhanced oil recovery method. Although this method is known to be efficient, it is still highly costly and thus, needs optimization.

The huff-n-puff (HnP) method is based on injecting a fluid through all fractures and then producing from them after a certain soaking period. The HnP method depends on the rubble zones' size which is around the hydraulic fractures. Based on the size of the rubble, the quantity of gas injected which enters, mixes, and recovers the oil from the rubble pore space is determined. Therefore, achieving higher recovery is dictated by having a bigger rubble zone for the mixing of the injected gas and the fluid inside the reservoir (Mydland et al, 2020). Compared to other methods such as gas flooding, HnP has a higher production potential in unconventional oil reservoirs due to its shorter soaking time and longer production time (Sheng, 2015). Nevertheless, the production potential often falls below the targeted economic levels in tight oil reservoirs. According to Fu, HnP using CO₂ or methane would only be efficient in gas condensate reservoirs due to the rigidity of the fluid and pressure compatibility requirements when targeting first-contact miscibility conditions. Thus, a more economically friendly method is suggested, which is the frac-to-frac (F2F).

This method specifies certain fractures for injection and others for production. The F2F method is designed to cover all the volume present between the fractures. This allows the F2F to cover a larger absolute target volume than the HnP method. Although the response time, which is the time between implementation and observing a significant uplift, is longer when using the F2F method, F2F still results in higher oil recovery, making the process more cost effective (Mydland et al, 2020). According to Nikolaou, a single well alternating production method, such as F2F, can result in more than 45% as a recovery factor over ten years compared to only 20% through the use of the HnP method. Moreover, according to Wang et al., the current available EOR and IOR methods are yet to become efficient enough for use in unconventional oil reservoirs, such as tight oil reservoirs. Therefore, new technologies are needed to produce oil in a more cost-effective manner, and without having negative implications environmentally along the way; however, for this method to reach its intended potential, the completion design is highly important. The figure below is a representation of the F2F method and how the gas and the oil are expected to flow through the process. Some fracs are assigned to be producing fracs and others are reserved for injection. As both fracs share the same liner, injection and production must be cyclic and one-way valves must be placed in front of the corresponding fracs to allow fluid from the formation only or from the liner only.

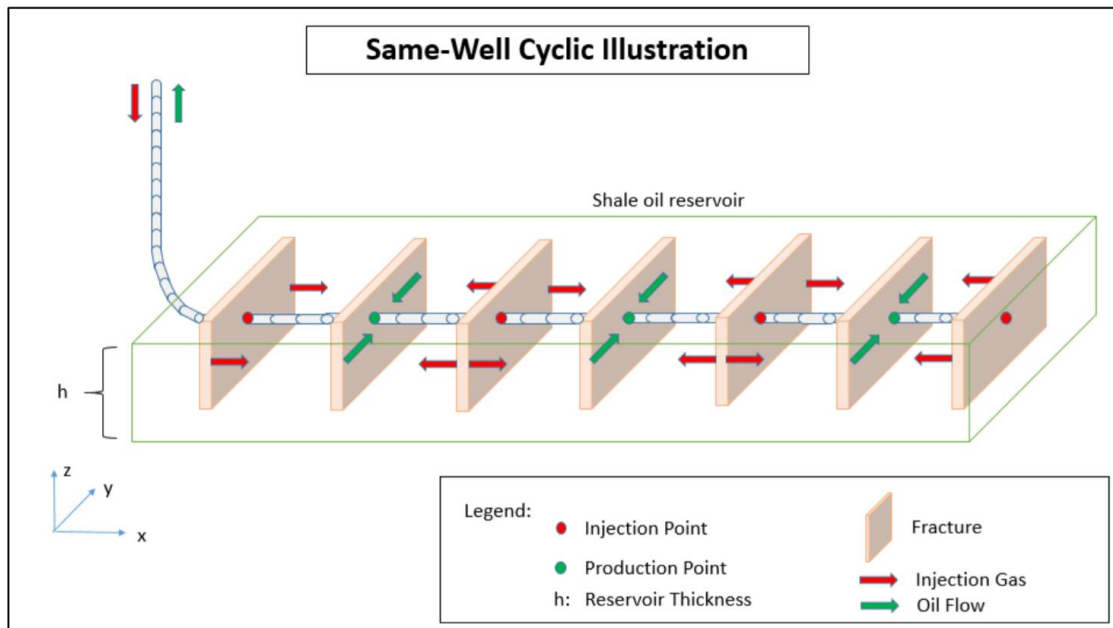

Figure 1 Single Well EOR Process-F2F (Azhar, 2016)

During the specialization project by Nawfal (2020), experimental work started with testing two types of one-way valves, which are the injection and the production valves. The valves were one-way ball type check valves where the seal surface consisted of a cone and a ball. The valve's body is threaded on the outside such that it can be inserted into the pipe wall (e.g., tubing or liner). The opening and closing of the valve (dictated by the movement of the ball) is activated by the flow and the pressure differential across it, and therefore it does not require external actuation.

Leakage and closing rate tests were designed and conducted to confirm the integrity of the design using a high-pressure test bench, and the fluid used was water. In terms of the leakage tests, they were performed at four different differential pressures between 50 and 200 bars with a difference of 50 bars between each test. The tests' duration was around two hours with the final 1000 seconds considered when calculating the average stabilized leakage flow rate. Although the coefficients of variation of the flow rates used to calculate the average rate all fell within the acceptable range, the results were not very conclusive. Each tested valve appeared to have a different change in the leakage rate as the differential pressure increased. While the injection blind had a continuous decrease in the leakage rate with the increase in pressure difference, the injection valve increased at 100 bars before decreasing with pressures above that. On the other hand, the production blind increased at 100 bars and decreased at 150 bars before increasing again at 200 bars. These results made it necessary for further investigation to take place when it comes to the design of the experiments and the procedures being followed to ensure accurate results. In addition, a transparent test bench was believed to be helpful in further understanding the flow nature during the injection and the production phases, once available.

Therefore, changes needed to be done to the experiments performed previously. During this thesis' work the aim was to design an improved experimental procedure for the water leakage tests done using the HP test bench. Moreover, performing closing rate tests on the newly manufactured production valve, which has a slightly longer head to facilitate its unscrewing, was also still needed.

In addition, a new low-pressure transparent test bench was designed and constructed. The purpose behind this test bench is to perform experiments in which the leakage and the closing

rates can be monitored visually, while understanding the nature of the flow associated with the valves during the injection and the production phase.

Having the opportunity to work with both test benches will allow to compare the results between them, making it possible to further verify the results obtained from each. This will allow to possibly confirm the integrity of the injection and the production valves tested by understanding if they can perform as sealing valves with limited leakage rates while estimating the effective closing flow rate of each.

This experimentation will support in the process of reaching a design of the valves needed for an efficient and cost-effective completion to be available for use during the F2F method.

1.2 Chapters' Overview

The thesis report is structured in the following manner:

- Chapter 2: A summary of previous work done during the specialization project and the specialization course.
- Chapter 3: The experimental setup up of both test benches and the tests performed using them, along with the execution of these tests.
- Chapter 4: The results achieved through the tests.
- Chapter 5: A discussion concerning the results obtained and how they serve the goals of the study in terms of leakage limits and pressures and rates required, along with the uncertainties present and recommendations for future work.
- Chapter 6: A conclusion covering the important findings observed.

2. Previous Work (Specialization Project and Course)

During the specialization project, the work was focused on performing leakage and closing rate tests with water in the high-pressure test bench. The injection valve and blind were the valves that underwent the most testing as the production valve was unavailable yet. The main goal was to design tests that would provide the most efficient and precise results possible.

At first it was chosen to perform leakage tests at 50, 100, 150, and 200 bars pressure differential with a duration of around 15 minutes. The pressure at the discharge of the valve was always kept at atmospheric conditions. Nevertheless, the results showed that the leakage rates exhibited significant variations during this period, having very high values initially and then declining with time. Therefore, more time was given (2 hours) to obtain stable readings. This resulted in a more stable leakage rate towards the end of this period, allowing to report a constant value. The table below shows the leakage rate results obtained during the specialization project, with the graphs of the tests present in the appendix.

Delta Pressure (Bar)	Injection Valve	Injection Blind	Production Blind	Production Valve
50	0.0473 l/hr	0.0757 l/hr	0.0888 l/hr	-
100	0.0792 l/hr	0.0505 l/hr	0.2340 l/hr	-
150	0.0704 l/hr	0.0311 l/hr	0.1634 l/hr	-
200	0.0700 l/hr	0.0238 l/hr	0.1716 l/hr	-

Table 1 Leakage Rate Tests' Results from the Specialization Project

The leakage rates did not appear to change in the same manner as the differential pressure increased between the three tested valves although they should in theory. While the injection valve had a leakage rate increase at 100 bars compared to 50 bars and decreased afterwards, the injection blind had a continuously decreasing leakage rate from the beginning. On the other hand, the production blind had a higher leakage rate at 100 bars than at 50 bars, then decreased at 150 bars before increasing again at 200 bars. These results showed that the stabilization time needed for the leakage rates to reach accurate results had to be increased as the pressure difference between the consecutive tests may have been too big. Moreover, the leakage rates recorded at the start of the experiments for each valve (50 bars) appeared to be considerably high. This meant that longer rest times before the start of the experiments may be needed to allow any pre-existing air bubble in the test bench to migrate to the top, and therefore, avoid any flow meter mis-readings.

In addition, the planning of the transparent low-pressure test bench began. At first, the goal was to visualize how would the test bench be set up, what type of stand it needs to be put on and how the connections need to be made. Although not all the needed parts were available at the time, the process diagram of the test bench was in place and ready to be constructed.

3. Experimental Setup

3.1 The Test Benches

Two different test benches were used during the experimental work of this thesis. The first one is the high-pressure test bench which was used to perform tests at differential pressures up to 200 bars, and the second is the transparent low-pressure test bench, which was used to perform tests at pressures up to 10 bars with the focus being on the visualization of the flow within the transparent cell.

3.1.1 High-Pressure Test Bench

The HP test bench included the following parts:

- A Quizix Pump
- A Water Tank
- A Pressure Cell
- Two pressure transmitters with a range between 0 and 250 bars
- Four Flowmeters:
 1. A low-rate liquid flowmeter with a range between 0 and 300 ml/hour
 2. A high-rate liquid flowmeter with a range between 0.1 and 7 l/minute
 3. A low-rate gas flowmeter with a range between 0 and 11.76 ml/min
 4. A high-rate gas flowmeter with a range between 2 and 100 l/min

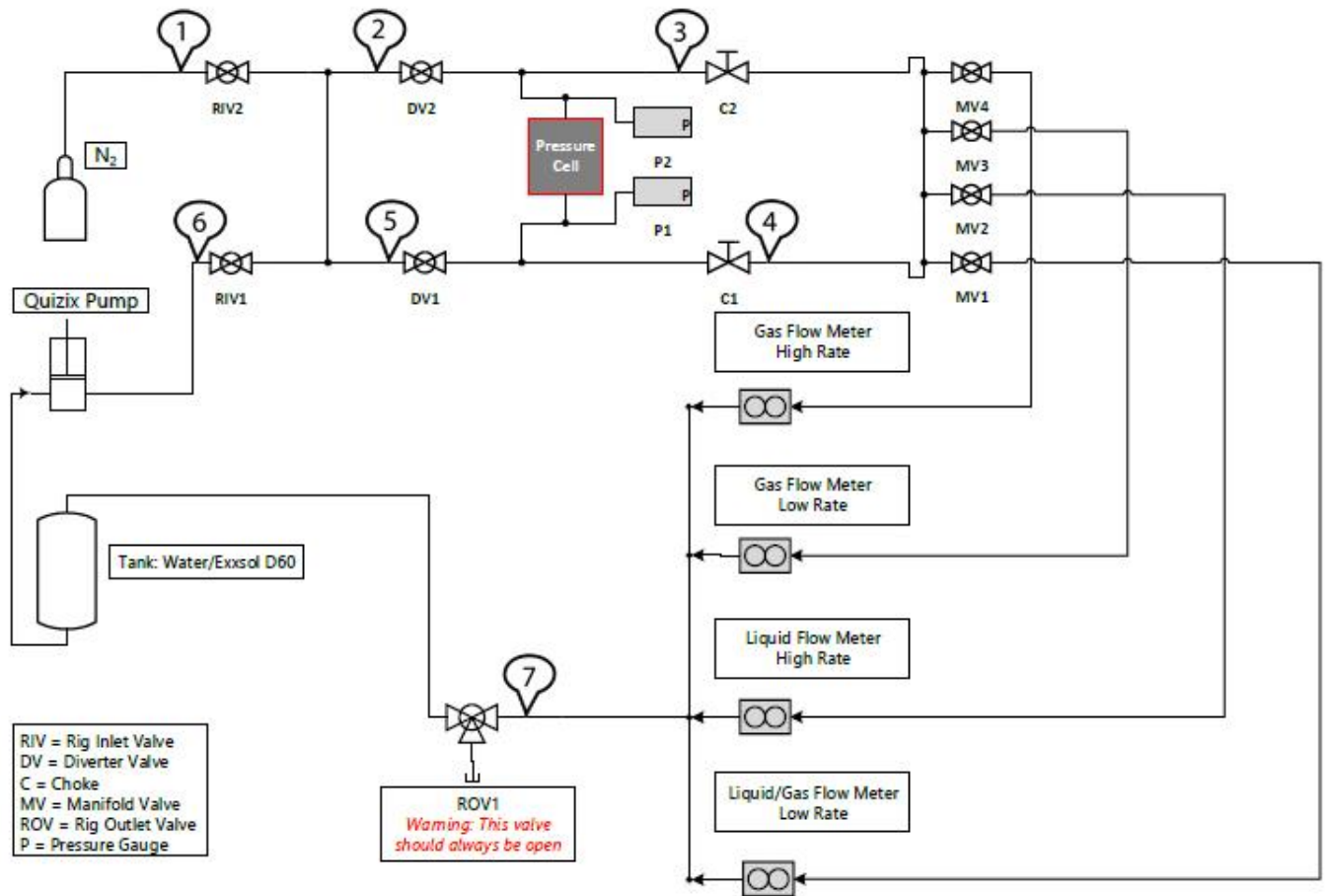

Figure 2 PI&D of the High-Pressure Test Bench

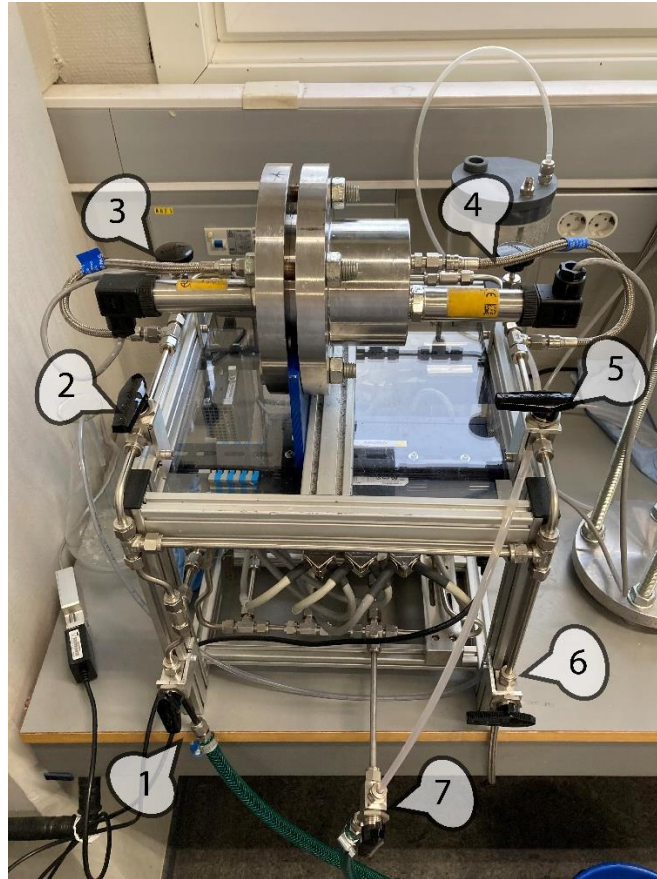

Figure 3 Image of the High-Pressure Test Bench

The HP test bench and its PI&D are shown in the figures above.

Four different valves were used during the experimentation, which are:

1. The Injection Blind
2. The Injection Valve
3. The Production Blind
4. The Production Valve

The injection and production valves are the ones that have a hole in them, on which the Silicon Nitride ball rests. In addition, a lid with holes can be inserted into them to avoid the ball from falling out when the valve opens, and fluids pass through it.

The injection and production blinds are of the same structure as the valves but without a hole in them. The main purpose of these blinds is to be able to deduct the leakage that takes place through the threading of the valves, allowing the calculation of the leakage taking place purely through the hole. This is done by subtracting the leakage through the blinds from the leakage through the valves.

Comparing the injection valve to the production valve, the injection valve is design to allow fluid flow during an injection phase down the well, while preventing any backflow from the formation. On the other hand, the production valve is designed to allow fluid passage during the production phase from the formation and into the well.

It is worth mentioning that the production blind tested was transformed into the production valve tested after conducting the tests, by drilling a hole through it. The injection valve and blind were two valves manufactured separately.

All valves had thread sealing tape applied on their threads to limit leakage through them.



Figure 4 The Production Blind, Production Valve, Injection Valve, and Injection Blind (from left to right), with the Silicon Nitride Ball and the Hex-hole Lid Used (Top view and Bottom view)

Figure 4 shows the injection and production valves on which the experimentation was performed in the high-pressure test bench, along with the Silicon Nitride ball and the hex-hole lid used with them.



Figure 5 The Pressure Cell Used in the HP Test Bench Before Inserting a Valve (Left) and with an Injection Valve Inserted (Right)

In figure 5, the pressure cell which was used in the high-pressure test bench can be seen. The pressure cell has an opening into which the valves can be inserted to perform the tests.

3.1.1.1 Leakage Tests – Experimental Procedure

In order to perform the leakage tests, the production and the injection valves require different setups. When the fluid used for the test is water, a pump is required to provide the needed flow rate into the test bench. In addition, the following steps need to be followed:

- Firstly, the pump needs to be connected to a source of pneumatic air for it to be functional, and to a water tank with a sufficient amount of water.
- The pump is connected to the test bench through valve 6 (figure 3) providing the water inflow, while valve 1 (figure 3) is closed.
- In the case of testing the injection valve, as shown in figure 6 below, the valves need to be set up in the following manner:
 1. The water flows in through valve 5, while valves 2 and 4 are closed to prevent any side-flow, making the only possible way for the flow through the pressure cell.
 2. The water that leaks through the valve in the pressure cell would then go through valve 3 and into the flowmeter F1.
 3. Once the water passes through the flowmeter and the flow rate is measured, the water exits the test bench through valve 7.
- In the case of testing the production valve, as shown in figure 7 below, the valves need to be set up in the following manner:
 1. The water flows in through valve 2, while valves 3 and 5 are closed to prevent any side-flow, making the only possible way for the flow through the pressure cell.
 2. The water that leaks through the valve in the pressure cell would then go through valve 4 and into the flowmeter F1.
 3. Once the water passes through the flowmeter and the flow rate is measured, the water exits the test bench through valve 7.
- Prior to the start of the experiment, the test bench had to be flooded with water to ensure that unwanted air that would cause inaccurate results is flushed out of the system. After flooding the system for around 5 minutes, the test bench is then left to stabilize for around 30 minutes to allow the flow meters' readings to stabilize as that appeared to take considerable time. During the previous experimentation done during the specialization project, it was thought that letting the system stabilize for around 5 minutes after flooding would be enough; however, results showed that it was not the case.
- Once the system is ready, the Quizix pump is turned on using the application available on the PC in the laboratory, with a safety pressure of 250 bars being set, and the upstream pressure that is intended to be tested.
- Finally, the Labview program which was designed for this test bench is initialized to start collecting the data.

Pressure Cell

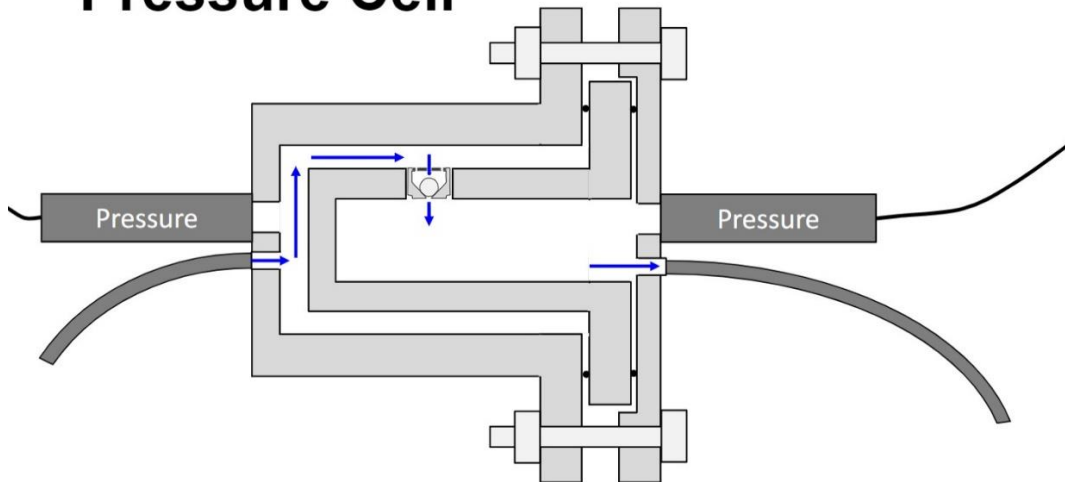

Figure 6 Demonstration of Flow Direction During a Leakage Test for an Injection Valve

Pressure Cell

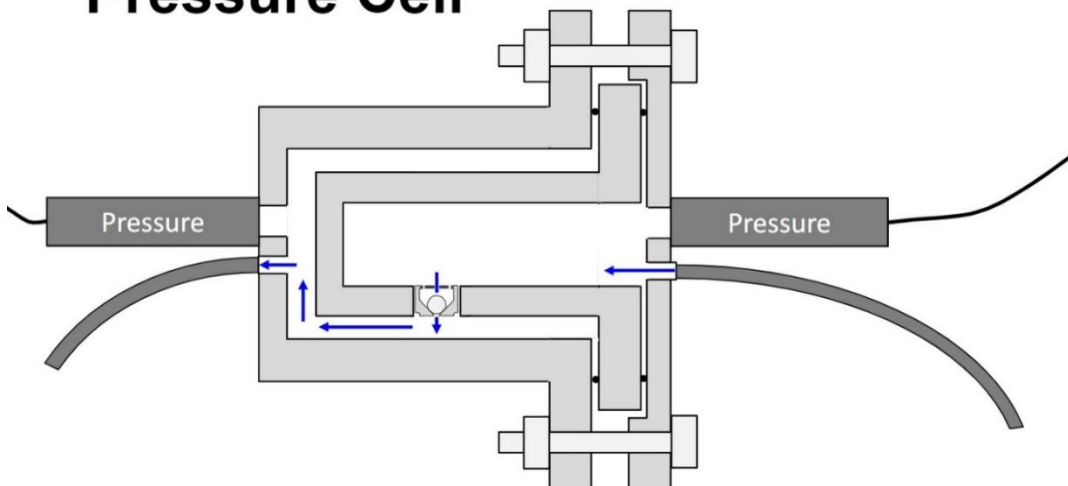

Figure 7 Demonstration of Flow Direction During a Leakage Test for a Production Valve

3.1.1.2 Closing Rate Tests

Regarding the closing rate tests, the setup is almost the same in terms of which valves are open and which are closed as in the leakage tests. Nevertheless, some changes still need to be made. To begin with, the inflowing water is provided through the water sink which is connected to the test bench through valve 1 instead of valve 6. This is because the water sink can provide much higher rates than the Quizix pump. The sink water is used as the valves, as seen in figures 8 and 9, are positioned in a way that the ball must be pushed against the direction of gravity to close the opening which needs a higher flow rate. Thus, the flowmeter used is the high range liquid flow meter F4.

Pressure Cell

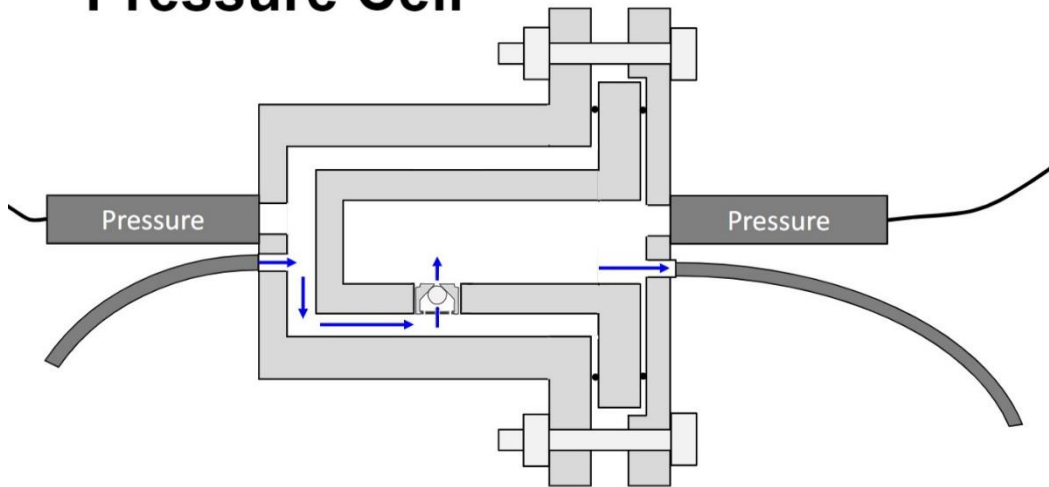

Figure 8 Demonstration of Flow Direction During a Closing Rate Test for an Injection Valve

Pressure Cell

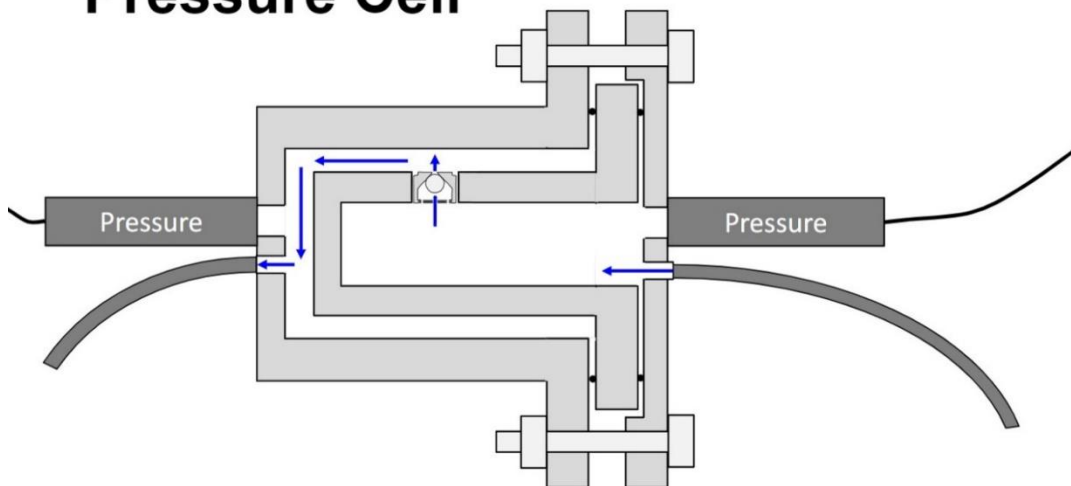

Figure 9 Demonstration of Flow Direction During a Closing Rate Test for a Production Valve

The table below summarizes the setups of each test performed through the high-pressure test bench when water is the fluid used.

Test	Valve/Blind	Water Source	Flow Meter	Valve 1	Valve 2	Valve 3	Valve 4	Valve 5	Valve 6
Leakage Test 1	Production Valve	Pump	F1	Closed	Open	Closed	Open	Closed	Open
Leakage Test 2	Production Blind	Pump	F1	Closed	Open	Closed	Open	Closed	Open
Leakage Test 3	Injection Valve	Pump	F1	Closed	Closed	Open	Closed	Open	Open
Leakage Test 4	Injection Blind	Pump	F1	Closed	Closed	Open	Closed	Open	Open
Closing Rate Test 1	Production Valve	Sink	F4	Open	Open	Closed	Open	Closed	Closed
Closing Rate Test 2	Production Blind	Sink	F4	Open	Open	Closed	Open	Closed	Closed
Closing Rate Test 3	Injection Valve	Sink	F4	Open	Closed	Open	Closed	Open	Closed
Closing Rate Test 4	Injection Blind	Sink	F4	Open	Closed	Open	Closed	Open	Closed

Table 2 Procedures of Leakage and Closing Rate Tests through the HP Test Bench with Water

3.1.1.3 Air Experiments in the HP Test Bench

Leakage and closing rate tests were attempted using air as a fluid instead of water. Nevertheless, the rates appeared to be above the maximum limit of the low-range gas flow meter (11.76 ml/min), and below the minimum limit of the high-range gas flow meter (2 l/min). Thus, the results of the test were unusable.

3.1.2 Low-Pressure Transparent Test Bench

The Low-Pressure test bench included the following parts:

- A high-rate air flowmeter with a range between 2 and 100 l/min
- A metallic tank
- A transparent cell
- A transparent tank
- A water flowmeter with a range between 2 and 16 l/minute
- A water pump
- Three automatic solenoid valves
- Three pressure transmitters with a range between 0 and 25 bars

The test bench was built on a metallic stand with plastic pipe connection as the flow rates used were low and did not require as strong of a structure as in the case of the high-pressure test bench. All the connections' threads were covered with thread sealing tape to limit unwanted leakage.

As seen in the PI&D in figure 10 below, a compressor is added to provide the gas flow into the test bench. Nevertheless, this was not needed during the experiments performed, as the air provided through the air hose in the wall at the lab provided the needed rate.

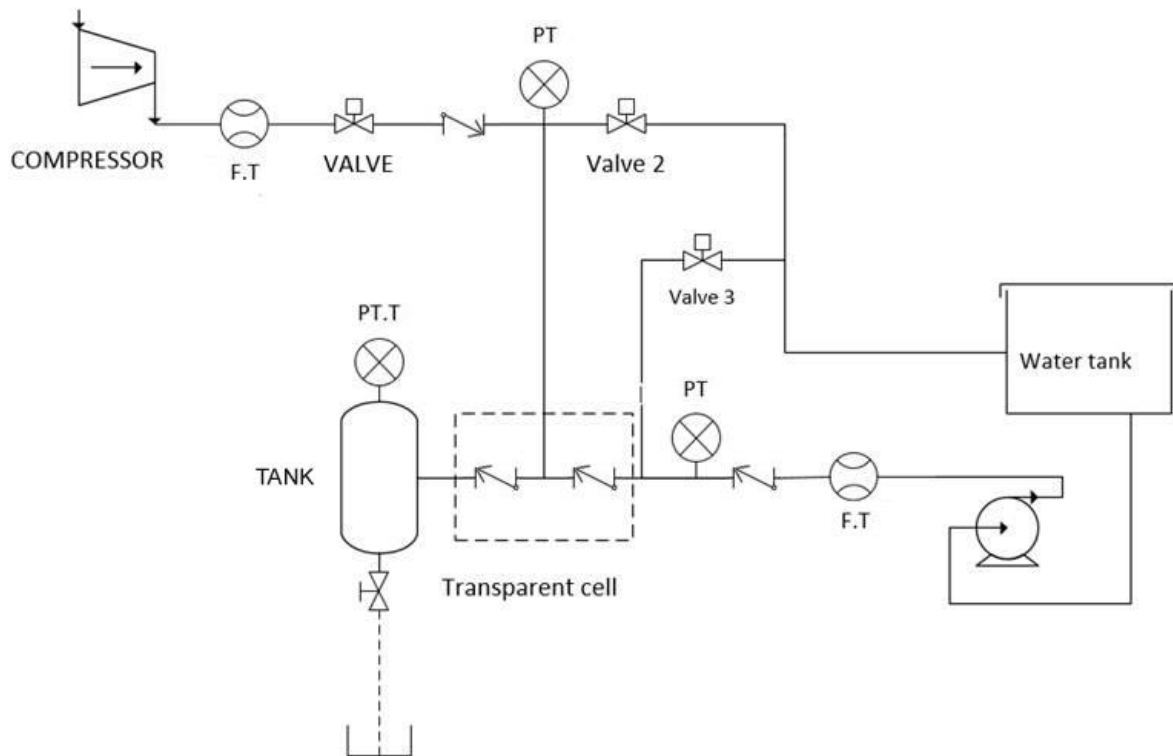

Figure 10 The PI&D of the Low-Pressure Transparent Test Bench

3.1.2.1 Air Injection Water Production Cycle Testing – Experimental Procedure

The main experimentation performed using the LP test bench was focused on a cycle on injecting air followed by producing water afterwards. Each phase included the following steps and based on figures 11, 12, and 13:

- Injection Phase:
 1. Air enters the test bench from the air hose available on the wall at the laboratory and through valve 1.
 2. As valve 2 is closed, the air would flow down the transparent pipe in the middle and into the transparent cell (figure 14).
 3. Air would flow into the left side through the injection valve present in the transparent cell resulting in filling and pressurizing the metallic tank present.

4. The rest of the air injected is the air which leaks through the production valve on the right side of the transparent cell. This air would flow through valve 3 and out of the test bench.
- Production Phase:
 1. Using the Labview application available on the PC, the valve mode is switched to “Production”, closing valves 1 and 3, and opening valve 2.
 2. The water pump which is connected to the transparent water tank is turned on, pumping water into the test bench through the water flow meter and into the right side of the transparent cell through the production valve.
 3. The water then would flow up through the middle of the cell into the transparent pipe and back into the transparent tank through valve 2.

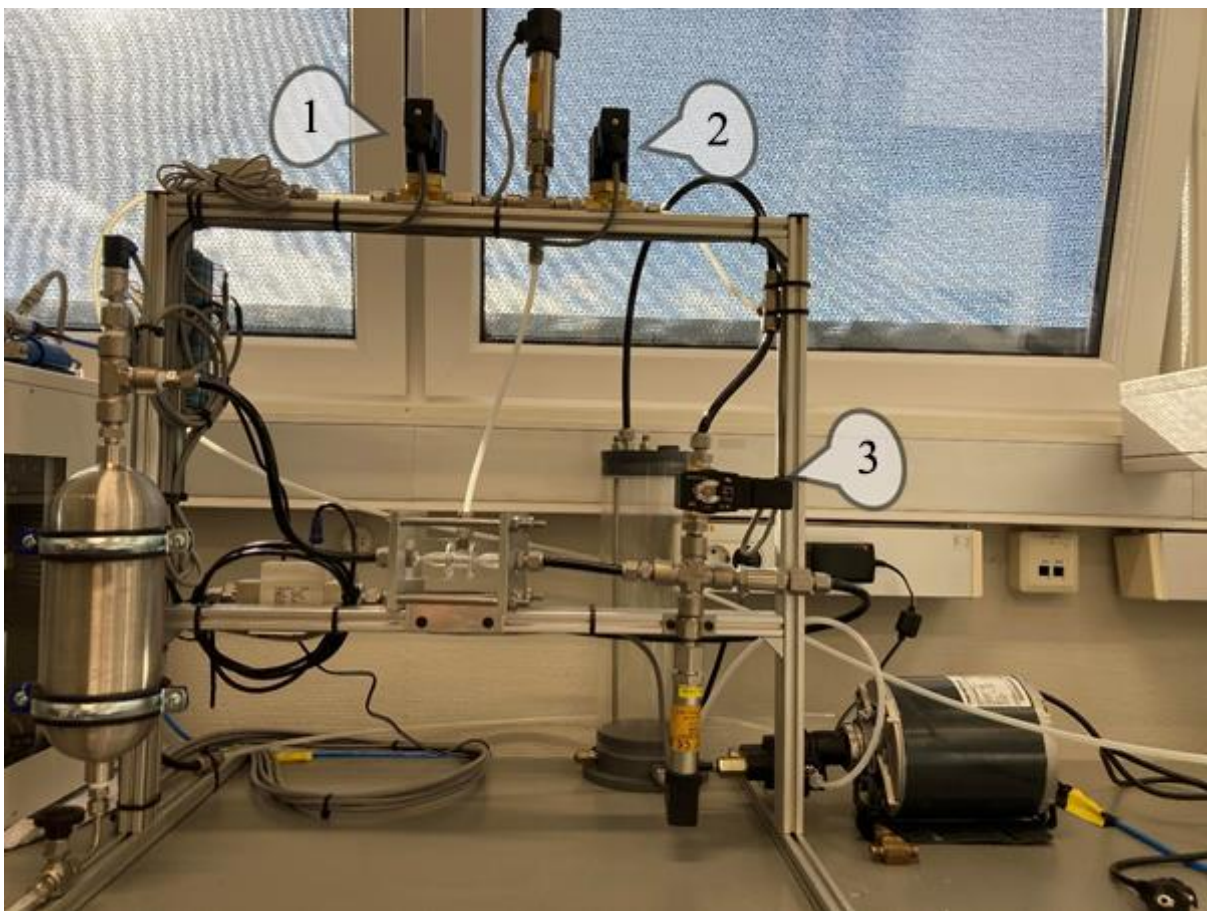

Figure 11 The Transparent Low-Pressure Test Bench

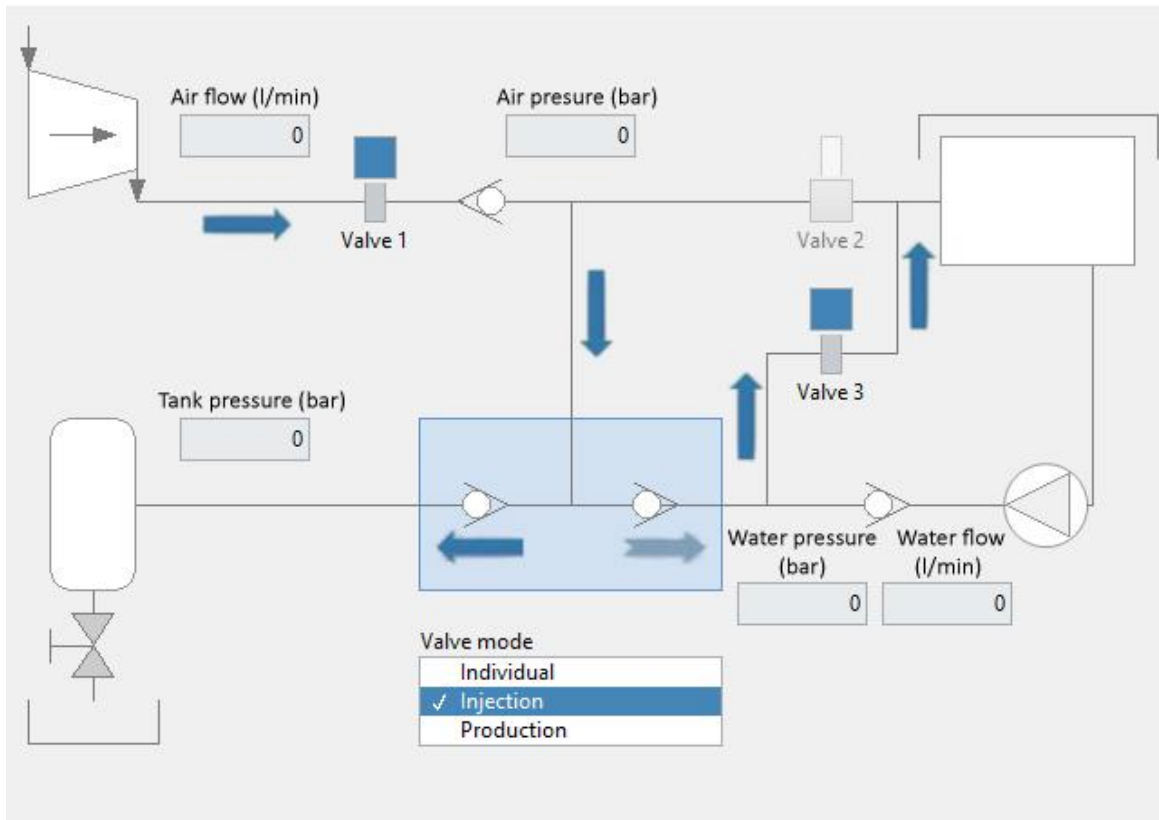

Figure 12 The Flow Direction During the Air Injection Phase as Shown in the Labview Application

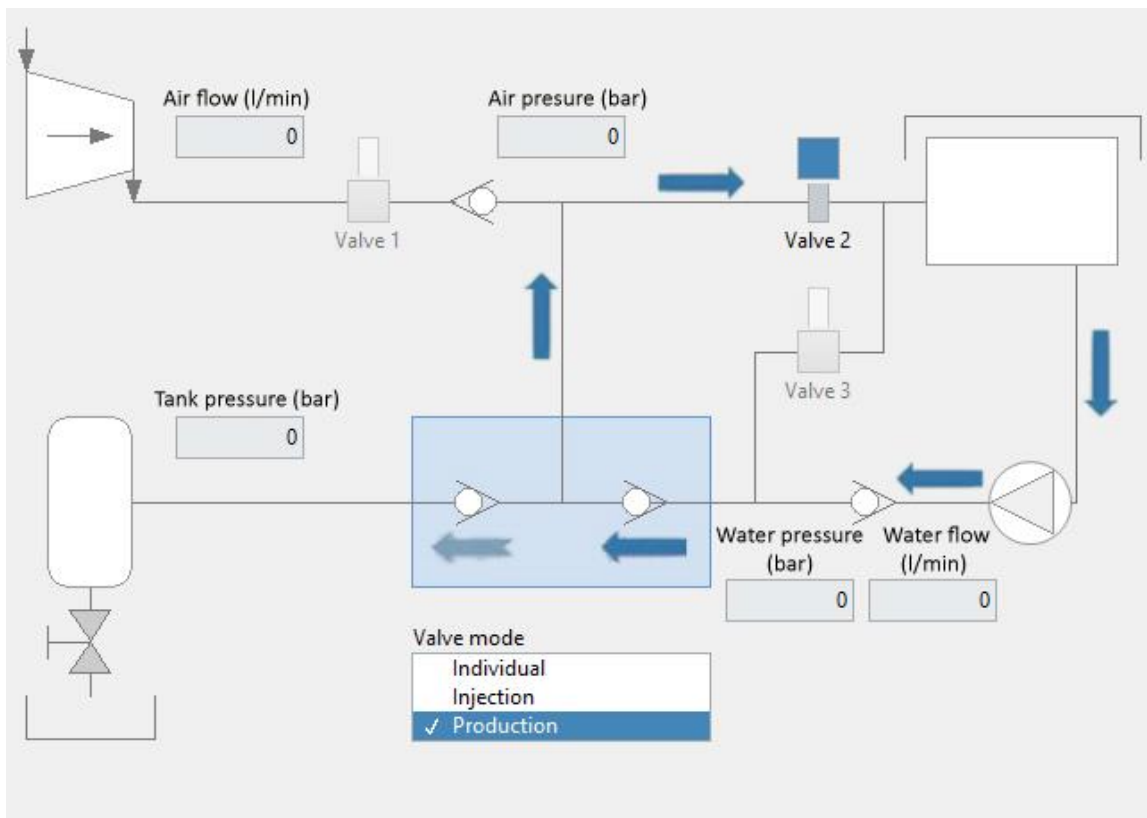

Figure 13 The Flow Direction During the Water Production Phase as Shown in the Labview Application

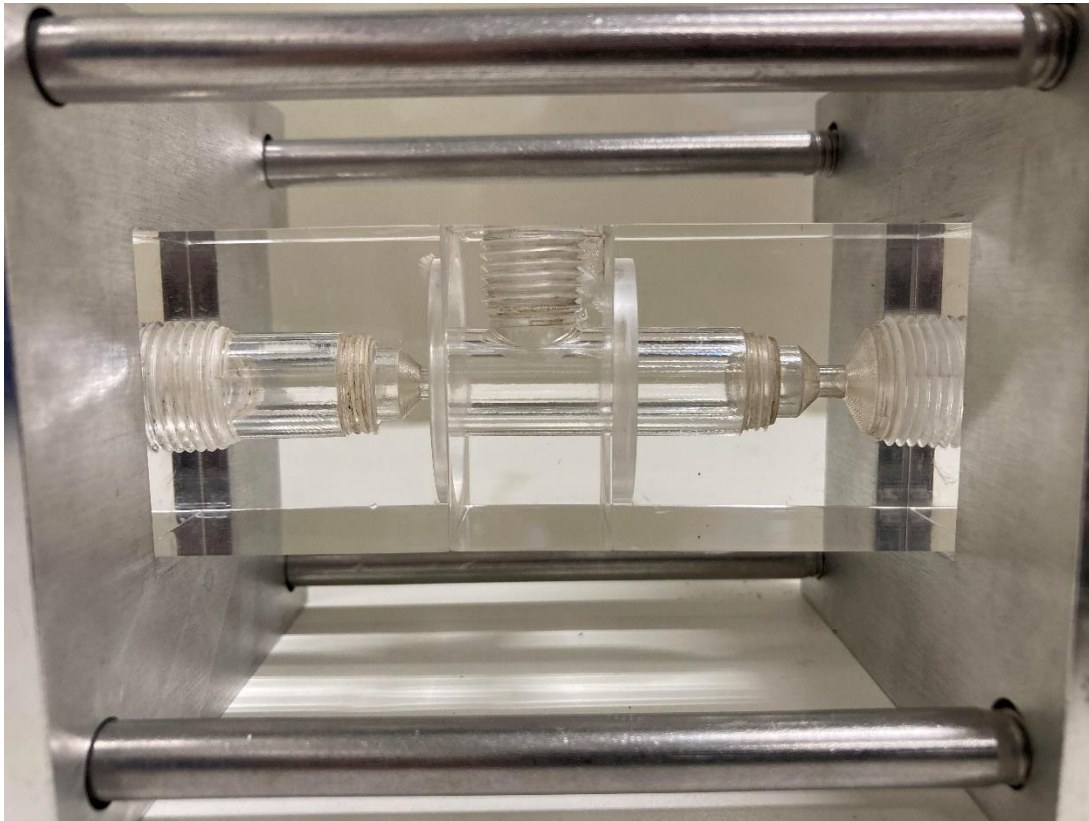

Figure 14 The Transparent Cell

3.2 Experimental Tests

3.2.1 High-Pressure Test Bench

1. The Leakage Tests Done on the Injection Blind and the Injection Valve:

As demonstrated in figure 6, during the leakage tests, the valve is present on the upper side of the pressure cell, allowing the ball to rest on the opening of the valve and with the direction of gravity. Thus, when the fluid enters representing the production phase, the ball would be pushed down and fully closing the opening. In this situation, the fluid which would leak through the opening and through the side threads is measured by the flow meter F1 giving the intended leakage rate value. The test on the blind is performed in the same manner, but the leakage measured would be that of the leakage purely through the side threads. The test is run until the leakage rate has shown to give stable values for around 1000 seconds and then it is stopped, with the average value within this time frame being considered.

2. The Closing Rate Done on the Injection Valve:

As demonstrated in figure 7, during the close rate tests the valve is present on the lower side of the pressure cell, forcing the ball away from the valve opening. The direction of the flow remains the same as with the leakage tests, but in this situation the goal is to measure the rate

needed to push the ball against the direction of gravity closing the valve opening. This flow rate is measured using the high-rate flow meter F4.

3. The Leakage Tests Done on the Production Blind and the Production Valve:

As demonstrated in figure 8, during the leakage tests, the valve is present on the bottom side of the pressure cell, allowing the ball to rest on the opening of the valve with the direction of gravity. Thus, when the fluid enters representing the injection phase, the ball would be pushed down fully closing the opening. Just as in the leakage tests of the injection valve, the fluid which would leak through the opening and the side threads is measured by the flow meter F1. The blind undergoes the same procedure but with the leakage flow rate being purely due to the leakage through the side threads. The test is also run until the rate has stabilized for a duration of 1000 seconds, with the average within this time frame being considered.

4. The Closing Rate Test Done on the Production Valve:

As demonstrated in figure 9, during the closing rate tests the valve is located on the upper side of the pressure cell, making the ball fall away from the valve opening. The direction of flow is the same as that in the leakage tests, with the goal being to measure the rate needed to push the ball towards the opening and closing it. The flow rate is measured using the high-range flow meter F4.

3.2.2 Low-Pressure Transparent Test Bench

During the injection phase, air is injected into the transparent cell, pressurizing the metallic tank as mentioned in 3.1.2.1. Once the tank reaches its maximum pressurization level, the injection phase continues until it is stable for around five minutes. Once the injection is stopped, the air in the tank pushes the ball towards the valve opening of the injection valve that is present in the transparent cell. Then, the production phase begins, with water being injected into the cell. The water injected through the production valve of the cell pushes against the ball in the injection valve, resulting in air leakage and depressurization of the tank. The production phase continues until the tank is fully depressurized and the injection valve is fully open again, and the cycle is repeated. The results were a combination of the numerical results obtained through Labview and visually observing the occurrences inside the transparent cell, such as when the valves is closed or opened.

4. Results

All the values were obtained through the Labview application which was designed specifically for the experiments performed. Data was extracted into excel in which the graphs below were created.

4.1 High Pressure Test Bench

As mentioned previously, more upstream pressures were tested during the leakage test experimentation, allowing for a lower difference in pressure between the consecutive tests. This allowed for a shorter experimentation duration in most cases compared to the specialization project. The starting time of the tests at each pressure differential was the time at which the pressure appeared to stabilize on the Labview application.

4.1.1 Leakage Tests Using Water

Each valve was subjected to five tests at 50, 75, 100, 125, and 150 bars, and the following results were achieved:

4.1.1.1 Injection Valve

During the experimentation done on the injection valve, 0.0003 l/hr was added to the leakage rates as the flow meter was reading a value -0.0003 l/hr before the start of the tests. Therefore, the value was added to correct for the reading error.

Flow Rate F1 (Including a 0,2% Flowmeter Error) vs. Time
(IV-50 Bar)

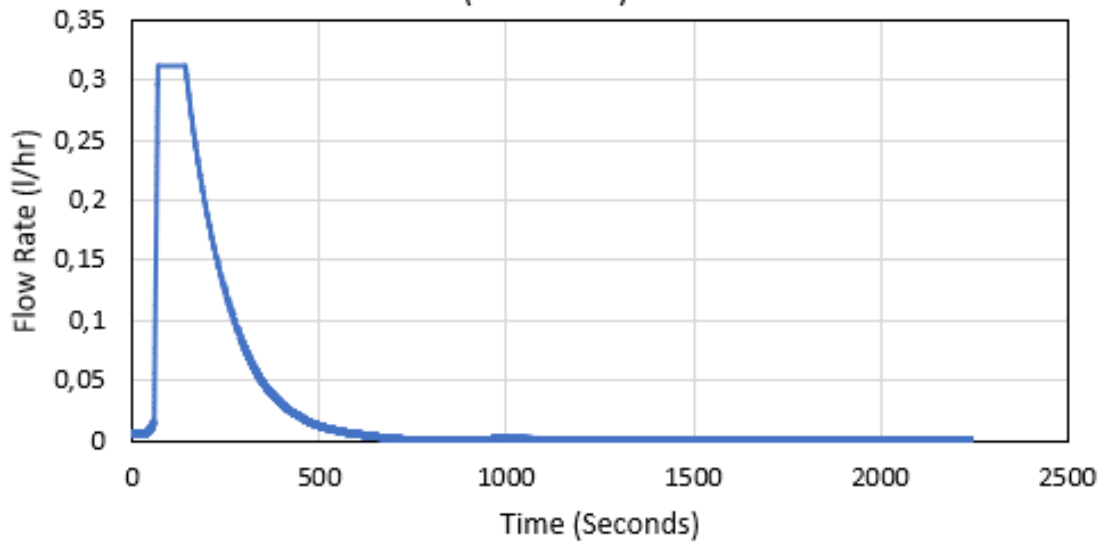

Flow Rate F1 (Including a 0,2% Flowmeter Error) vs. Time
(IV-50 Bar) Stabilized Region

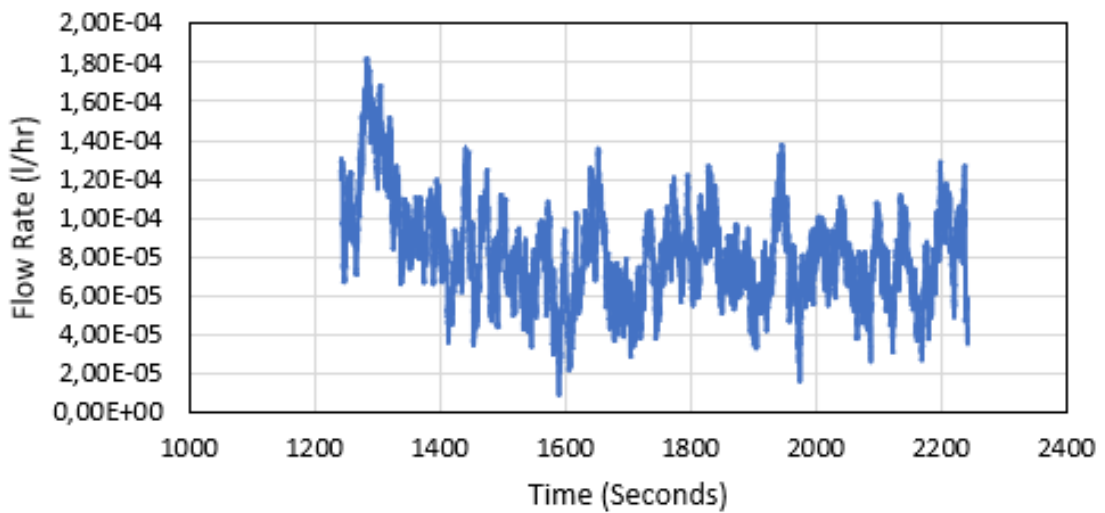
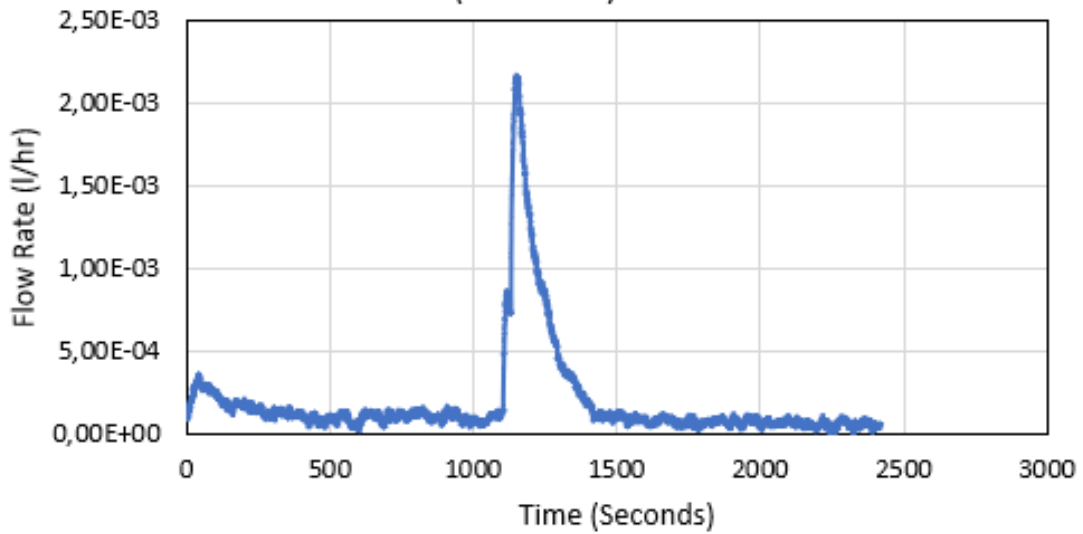

Figure 15 Leakage Flow Rate vs. Time of the IV at 50 Bars

According to figure 15, the flow rate curve seems to stabilize quickly especially after around 1000 seconds where the graph appears to be linear. The stabilized region was taken after around 1250 seconds from the start. The average rate was 8.12×10^{-5} l/hr with a coefficient of variation of 30.59. Although the COV may be high, but that is considered acceptable due to the low degree of the leakage rate.

Flow Rate F1 (Including a 0,2% Flowmeter Error) vs. Time
(IV-75 Bar)



Flow Rate F1 (Including a 0,2% Flowmeter Error) vs. Time
(IV-75 Bar) Stabilized Region

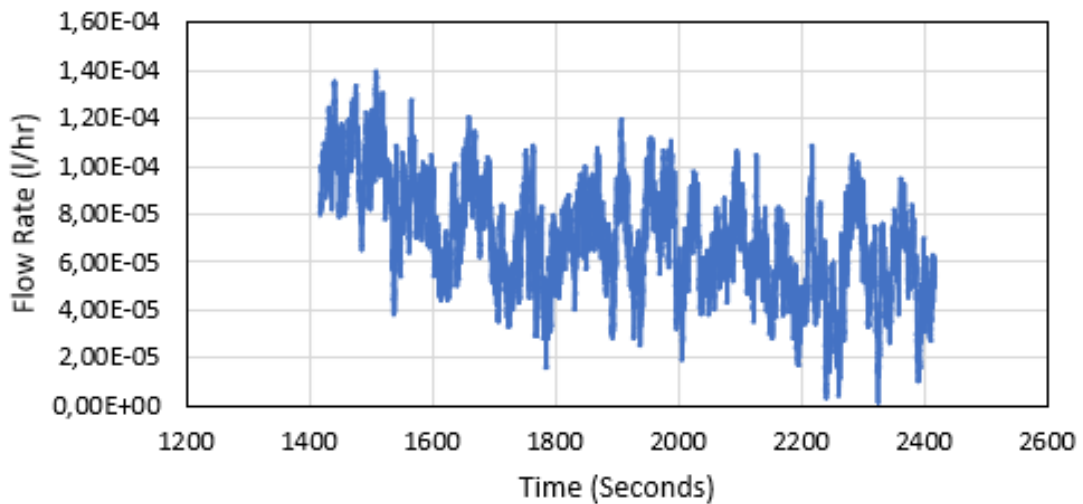
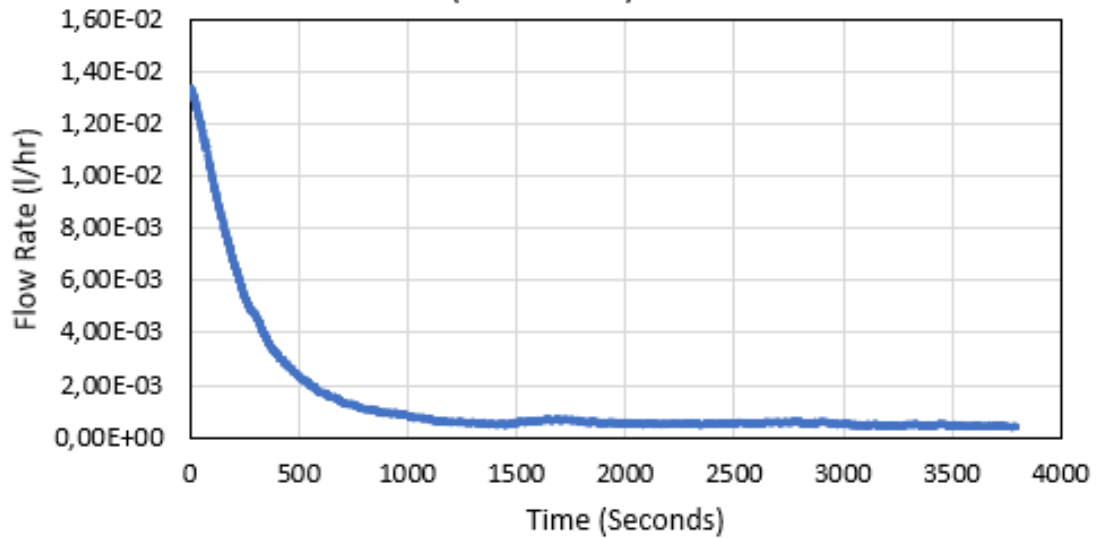

Figure 16 Leakage Flow Rate vs. Time of the IV at 75 Bars

According to figure 16, the flow rate curve seems to be considerably stable from the first few minutes of the test, excluding the peak seen after around 1100 seconds. This peak may be simply due to some noise or surrounding movement around the test bench in the laboratory at the time of the experiment. Nevertheless, this peak does not impact the important outcome which is the final 1000 seconds of the experiment as it drops back to normal rates quickly. The average rate is 7.04×10^{-5} l/hr and the COV is 32.82. The COV is above the acceptable limit of 10, but as the flow rate is still of a low degree, the difference is considered acceptable.

Flow Rate F1 (Including a 0,2% Flowmeter Error) vs. Time
(IV-100 Bar)



Flow Rate F1 (Including a 0,2% Flowmeter Error) vs. Time
(IV-100 Bar)

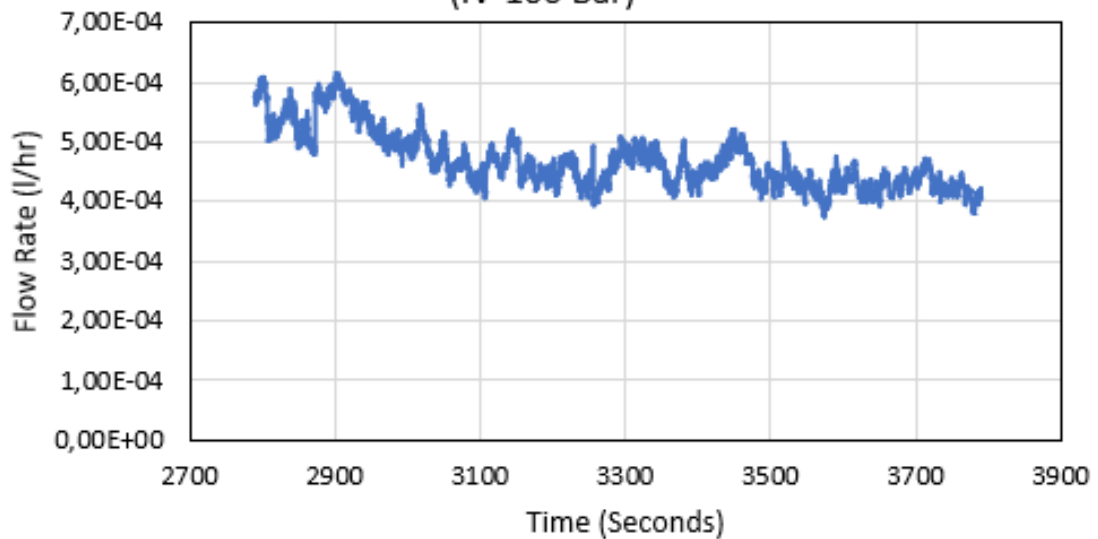
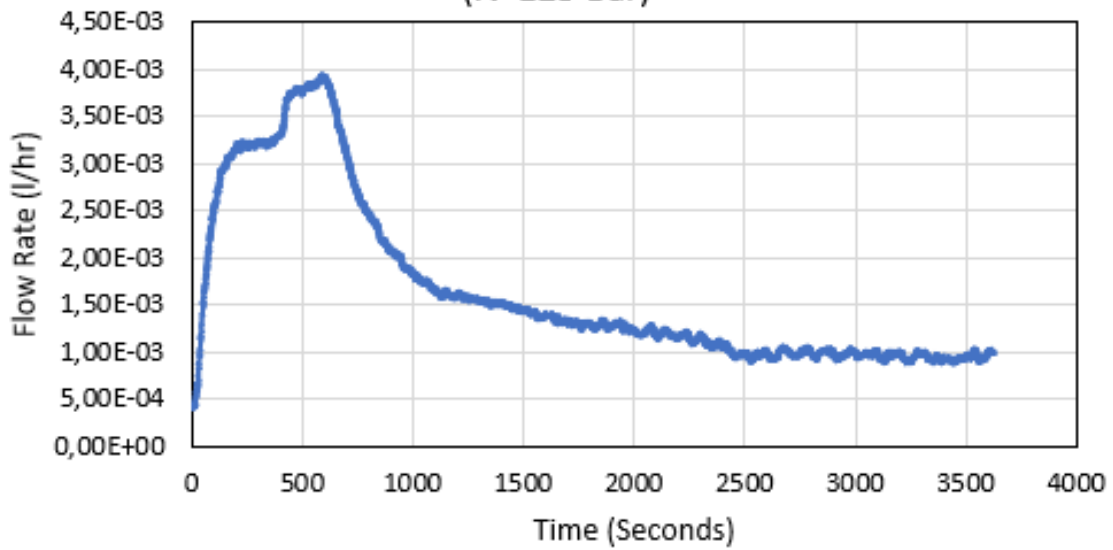

Figure 17 Leakage Flow Rate vs. Time of the IV at 100 Bars

According to figure 17, the rate needed more time to stabilize compared to the tests at the lower pressures, as it needed around 2800 seconds to become stable. The average leakage rate during the final 1000 seconds was 4.73×10^{-4} l/hr with a COV of 10.29. The COV is just above the acceptable limit of 10 but is still acceptable due to the low degree of the leakage rate.

Flow Rate F1 (Including a 0,2% Flowmeter Error) vs. Time
(IV-125 Bar)



Flow Rate F1 (Including a 0,2% Flowmeter Error) vs. Time
(IV-125 Bar) Stabilized Region

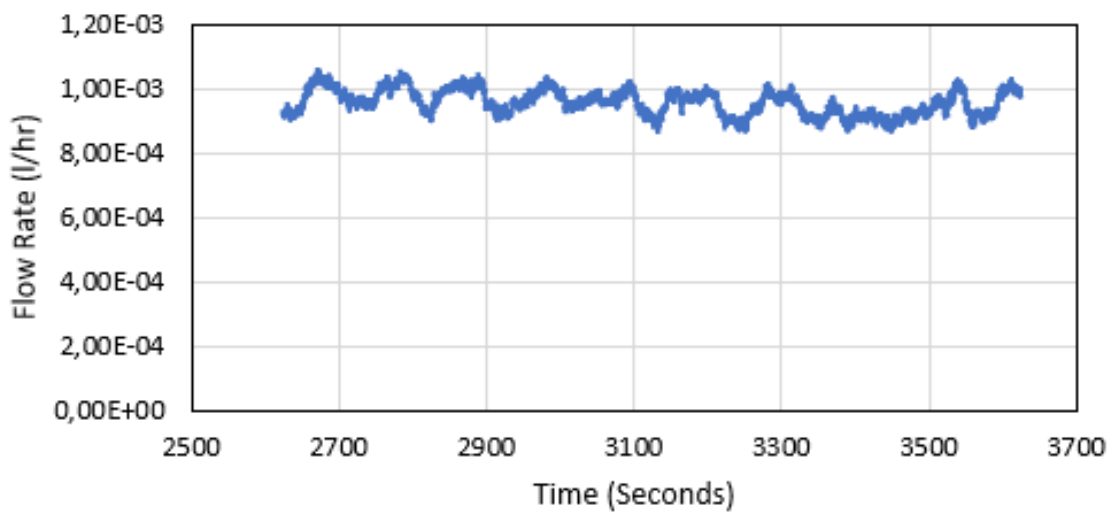
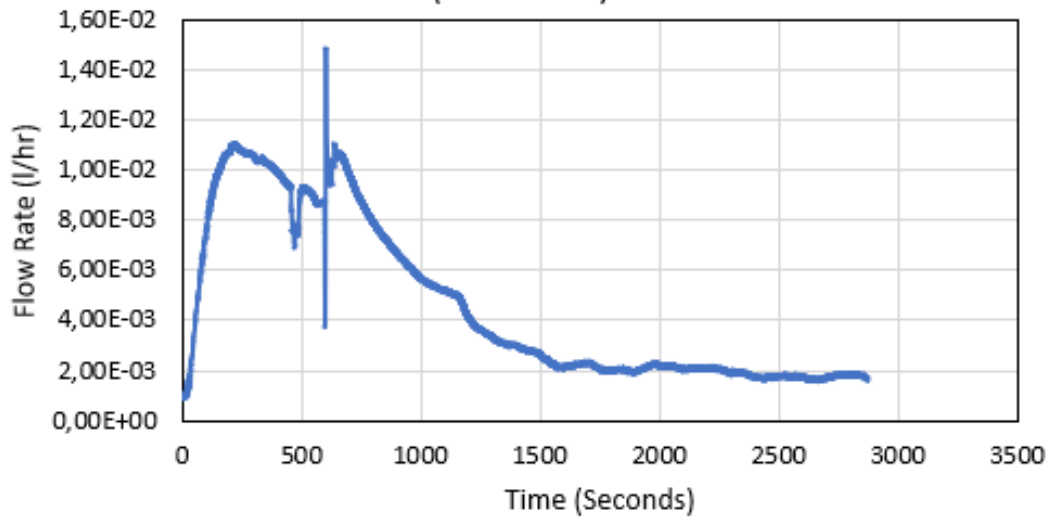

Figure 18 Leakage Flow Rate vs. Time of the IV at 125 Bars

According to figure 18, the test duration was close to that of the previous one at 100 bars, with stabilization starting after around 2500 seconds. The average leakage rate is 9.61×10^{-4} l/hr with a COV of 4.02. The COV is within the acceptable range especially that the leakage rate starts increasing considerably.

Flow Rate F1(Including a 0,2% Flowmeter Error) vs. Time
(IV-150 Bar)



Flow Rate F1 (Including a 0,2% Flowmeter Error) vs. Time
(IV-150 Bar) Stabilized Region

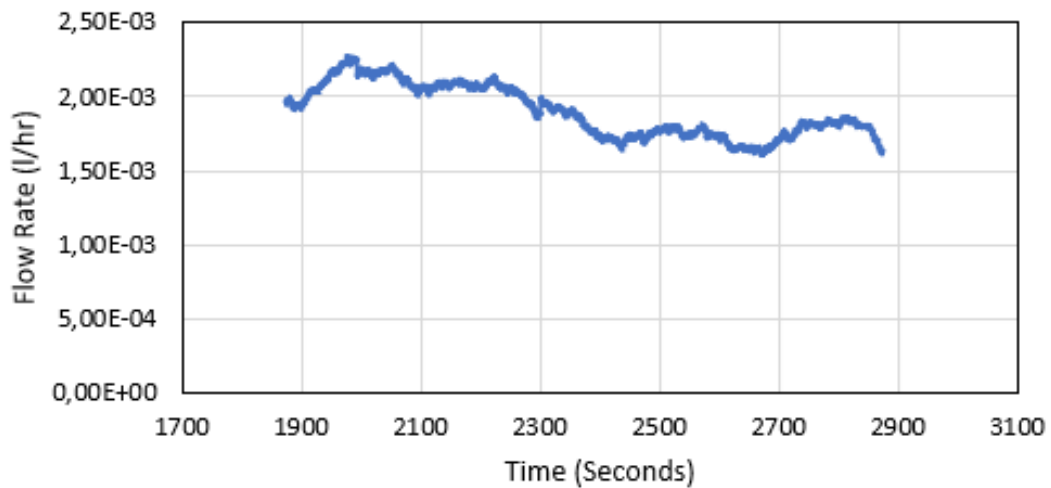

Figure 19 Leakage Flow Rate vs. Time of the IV at 150 Bars

According to figure 19, the stabilization starts to occur after around 1800 seconds. The rate appears to have an unexpected sudden peak after around 600 seconds, but that is probably due to some unwanted noise or movement that may have happened in the surrounding of the test bench at the time. This inaccuracy is ignored as it does not impact the important outcome and as the flow rate seems to go back to normal quickly afterwards. The average leakage rate during the final 1000 seconds is 1.90×10^{-3} l/hr with an acceptable COV of 9.32.

The figure below shows the average leakage rates calculated during the stabilization period of the tests done at each pressure differential using the injection valve.

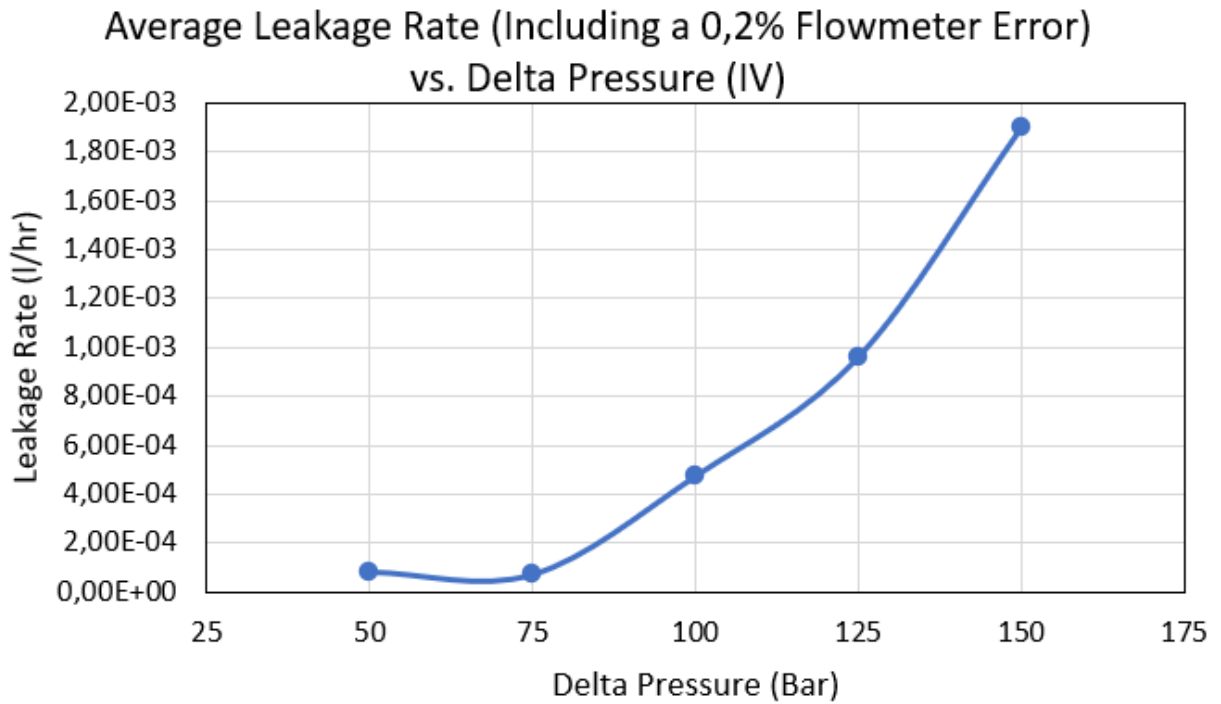
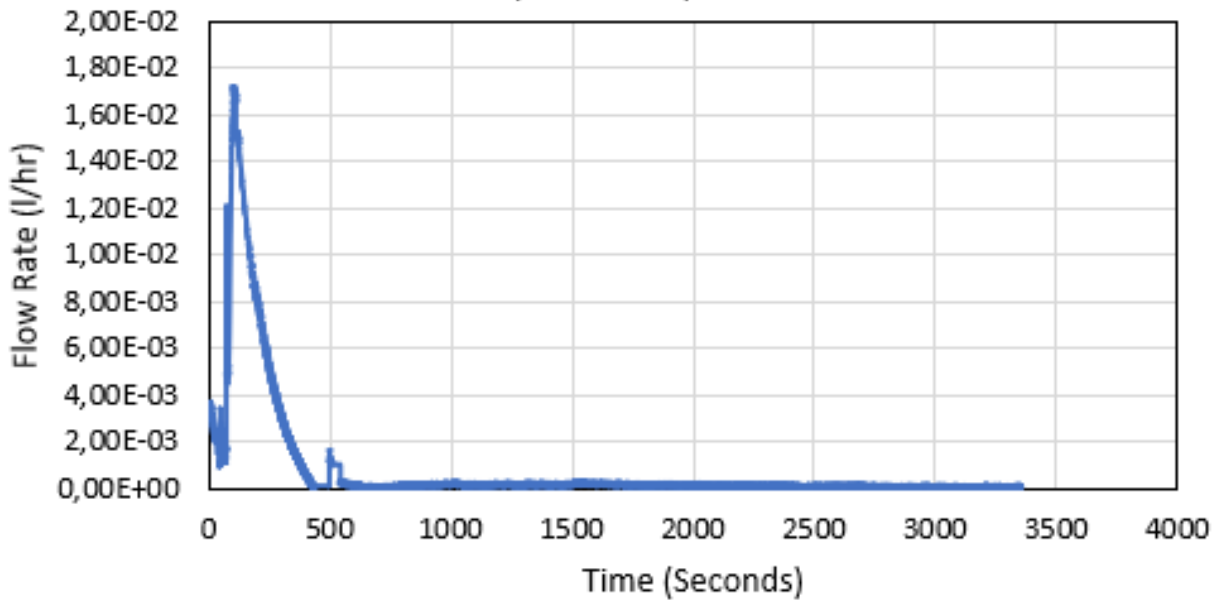

Figure 20 The Average Leakage Rates Calculated at Stabilization at Each Pressure Differential of IV

4.1.1.2 Injection Blind

During the experimentation done on the injection blind, 0.0003 l/hr was added to the leakage rates as the flow meter was reading a value -0.0003 l/hr before the start of the tests. Therefore, the value was added to correct for the reading error.

Flow Rate F1 (Including a 0,2% Flowmeter Error) vs. Time
(IB-50 Bar)



Flow Rate F1 (Including a 0,2% Flowmeter Error) vs. Time
(IB-50 Bar) Stabilized Region

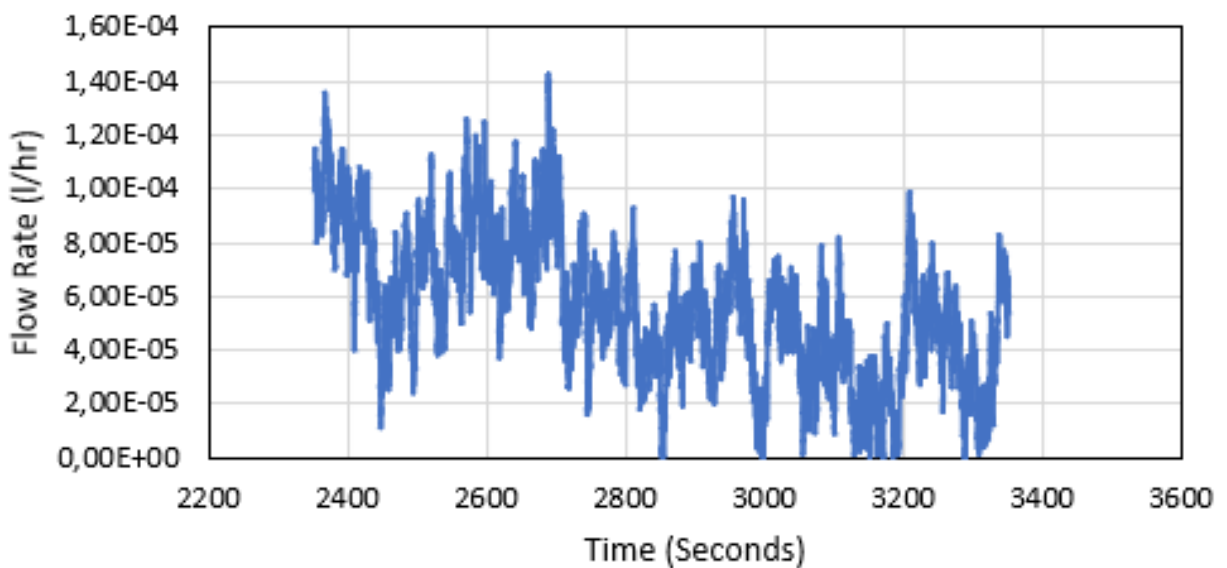
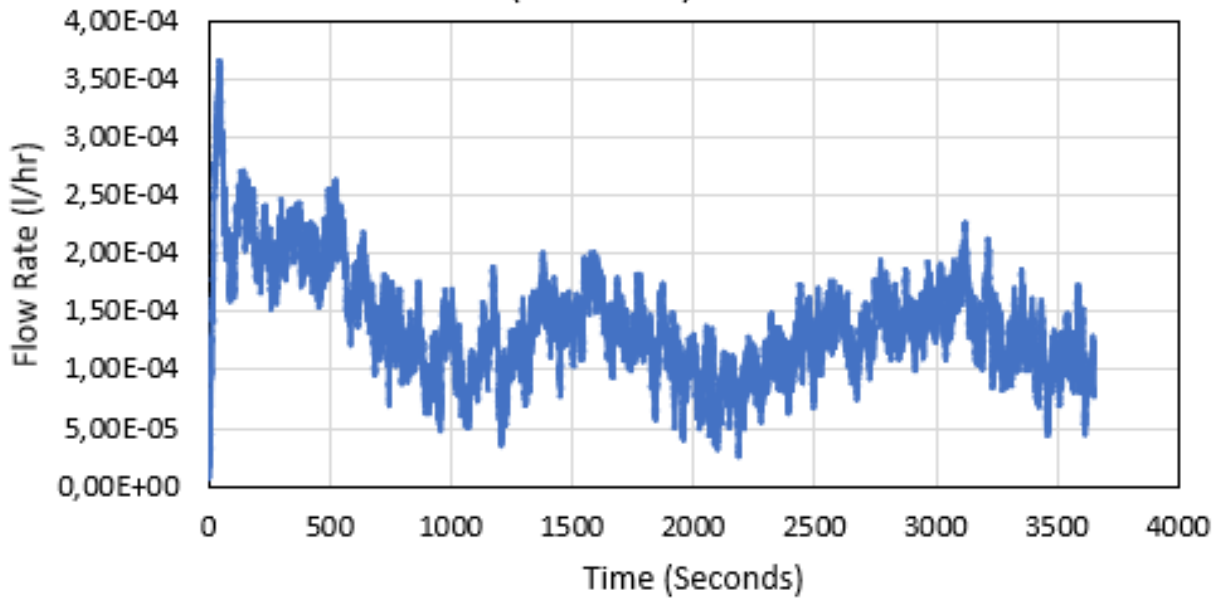

Figure 21 Leakage Flow Rate vs. Time of the IB at 50 Bars

According to figure 21, the rate appears to stabilize quickly, as was the case with the injection valve at the same pressure. Considering the final 1000 seconds of the test, the average leakage rate is 5.62×10^{-5} l/hr with a COV of 47.53. Although the COV appears to be high, the low degree of the leakage rate allows it to be acceptable.

Flow Rate F1 (Including a 0,2% Flowmeter Error) vs. Time
(IB-75 Bar)



Flow Rate F1 (Including a 0,2% Flowmeter Error) vs. Time
(IB-75 Bar) Stabilized Region

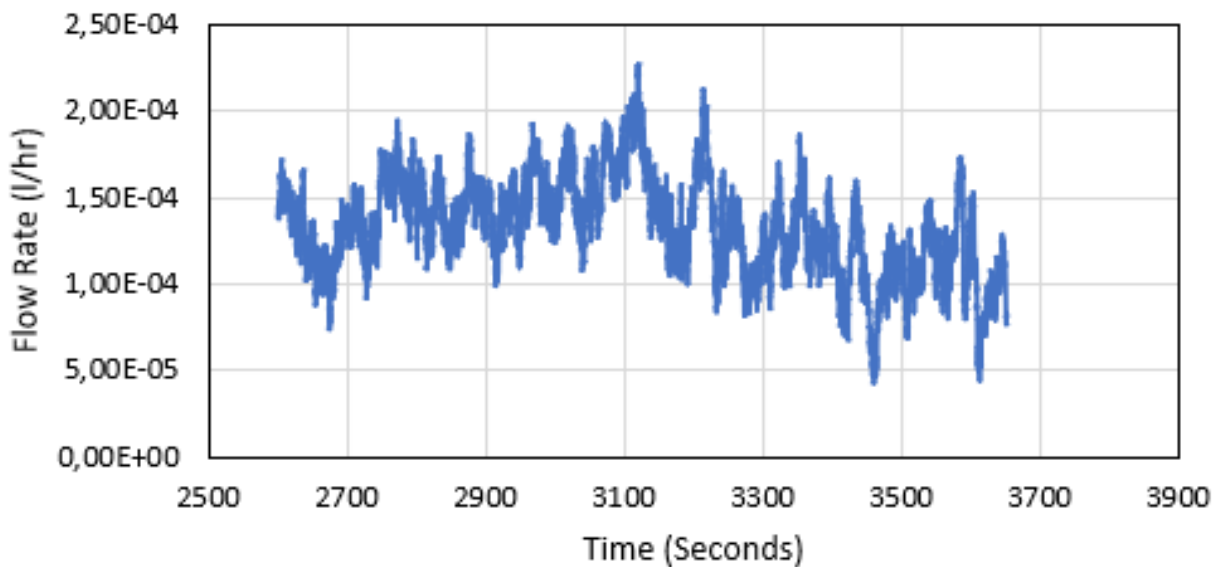

Figure 22 Leakage Flow Rate vs. Time of the IB at 75 Bars

According to figure 22, the leakage rate does not appear to have a high peak at the start. The leakage rate seems to be within a close range from the start. The average leakage rate during the final 1000 seconds of the experiment is 1.33×10^{-4} l/hr with a COV of 21.33. Although the COV is still high, the leakage rate's degree is still very low which allows the result to be acceptable.

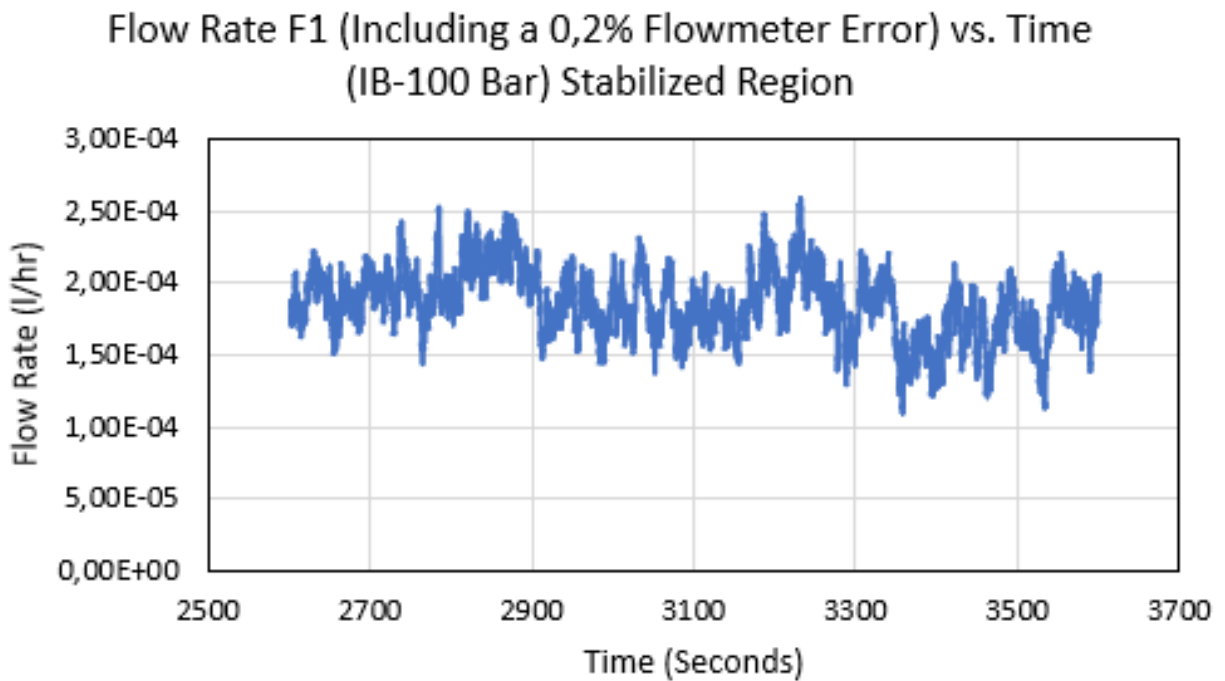
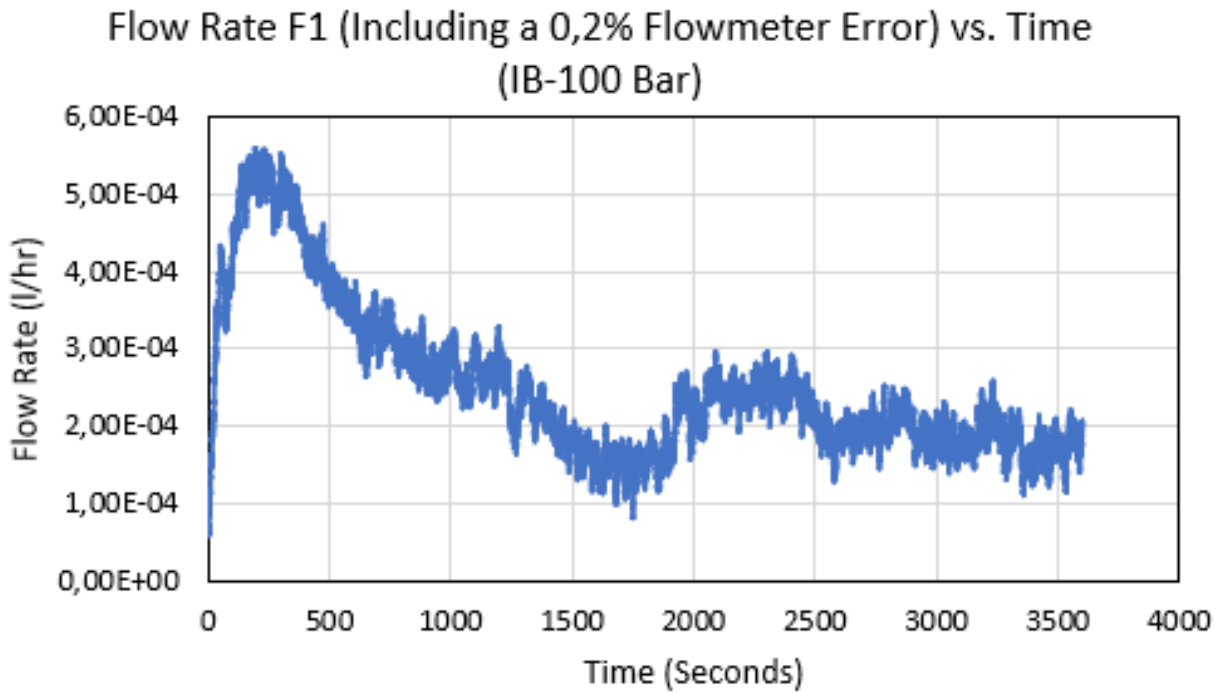
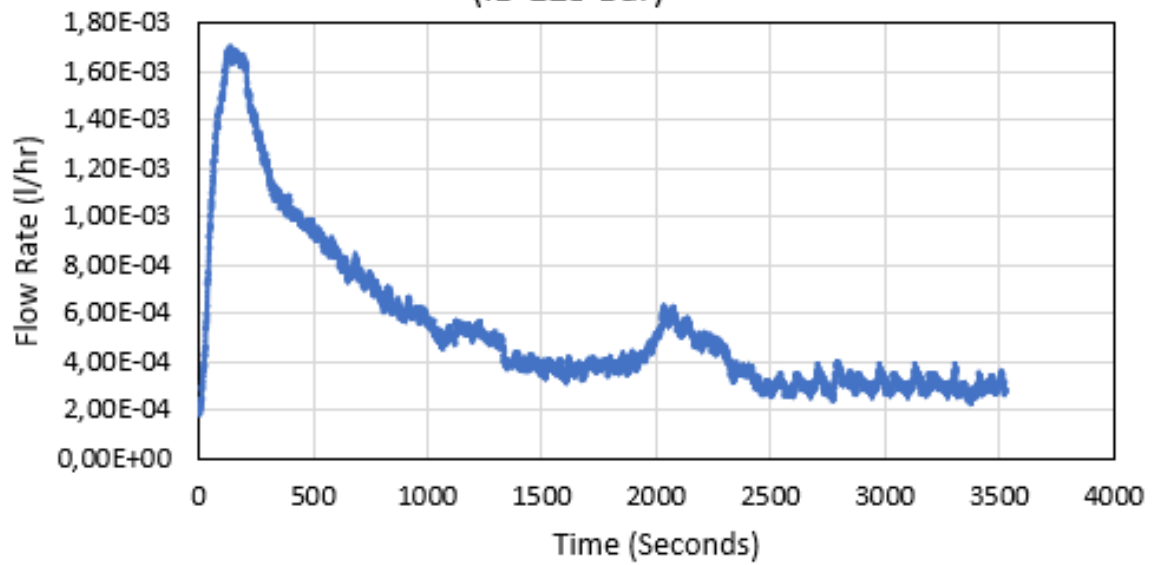

Figure 23 Leakage Flow Rate vs. Time of the IB at 100 Bars

According to figure 23, the rate appears to start stabilizing after around 2500 seconds from the start of the test. The average leakage rate during the final 1000 seconds is 1.86×10^{-4} l/hr with a COV of 12.59. Although the COV is just above the limit of 10, it is considered acceptable as the degree of the leakage rate is still very low.

Flow Rate F1 (Including a 0,2% Flowmeter Error) vs. Time
(IB-125 Bar)



Flow Rate F1 (Including a 0,2% Flowmeter Error) vs. Time
(IB-125 Bar) Stabilized Region

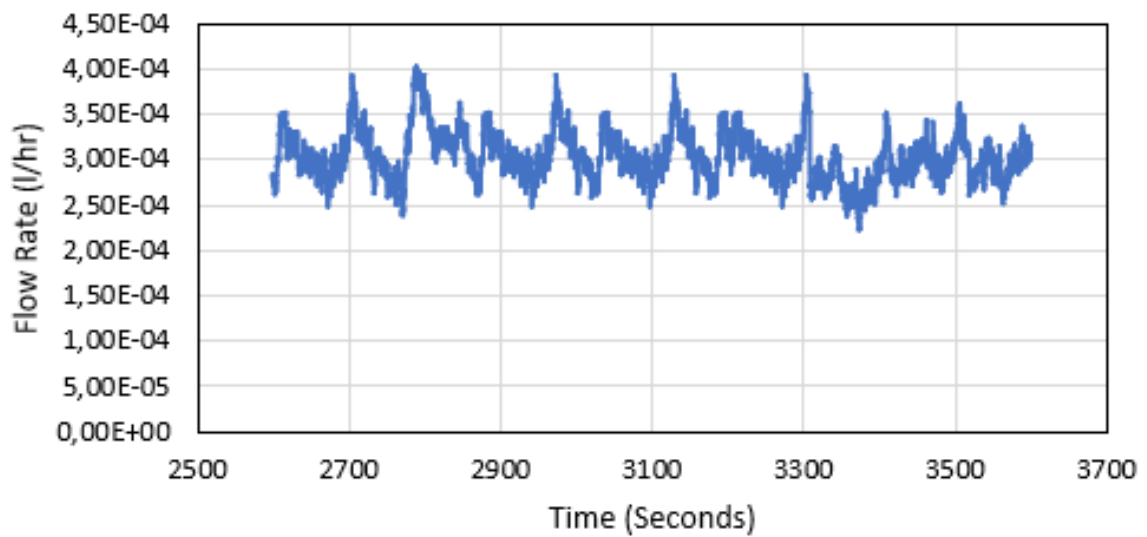

Figure 24 Leakage Flow Rate vs. Time of the IB at 125 Bars

According to figure 24, the leakage rate appears to be stabilizing after around 2500 seconds. The average rate during the final 1000 seconds is 3.03×10^{-4} l/hr with an acceptable COV of 9.02.

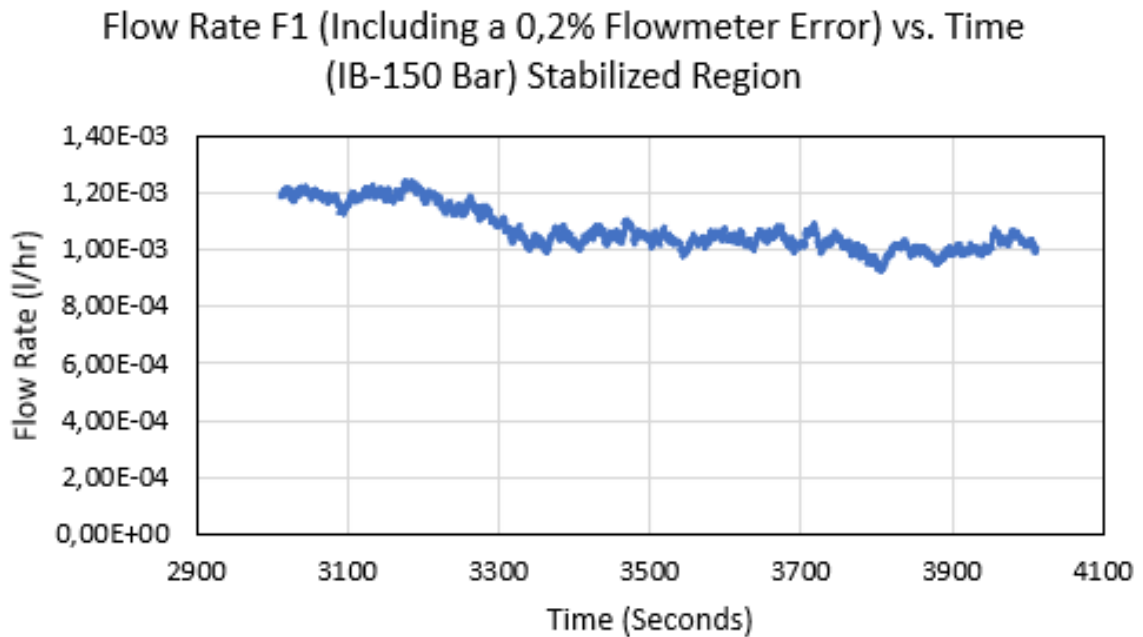
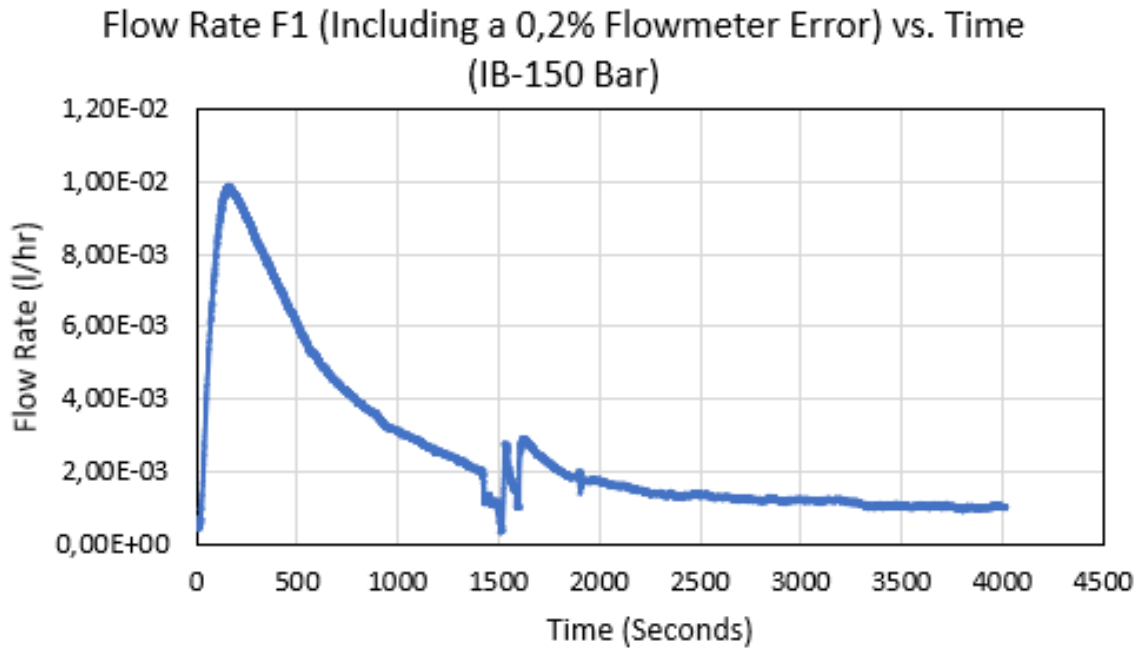

Figure 25 Leakage Flow Rate vs. Time of the IB at 150 Bars

According to figure 25, the leakage rate appears to stabilize after around 3000 seconds. The average rate during the final 1000 seconds is 1.07×10^{-3} l/hr with an acceptable COV of 7.16.

The figure below shows the average leakage rates calculated during the stabilization period of the tests done at each pressure differential using the injection blind.

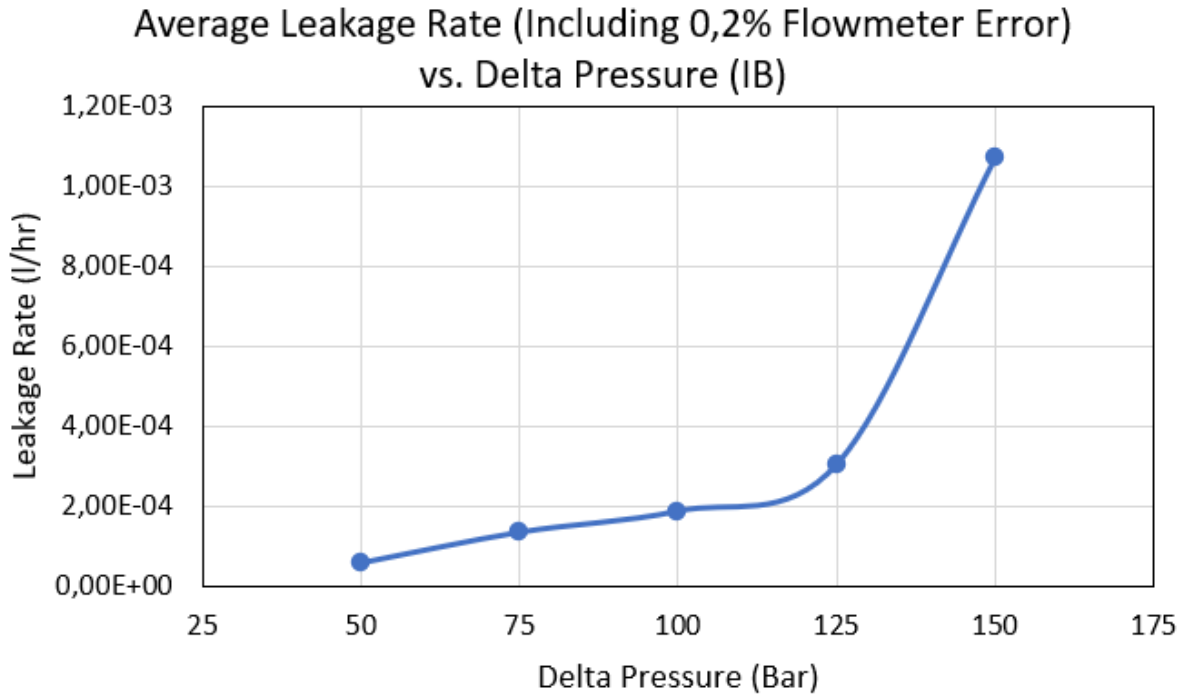
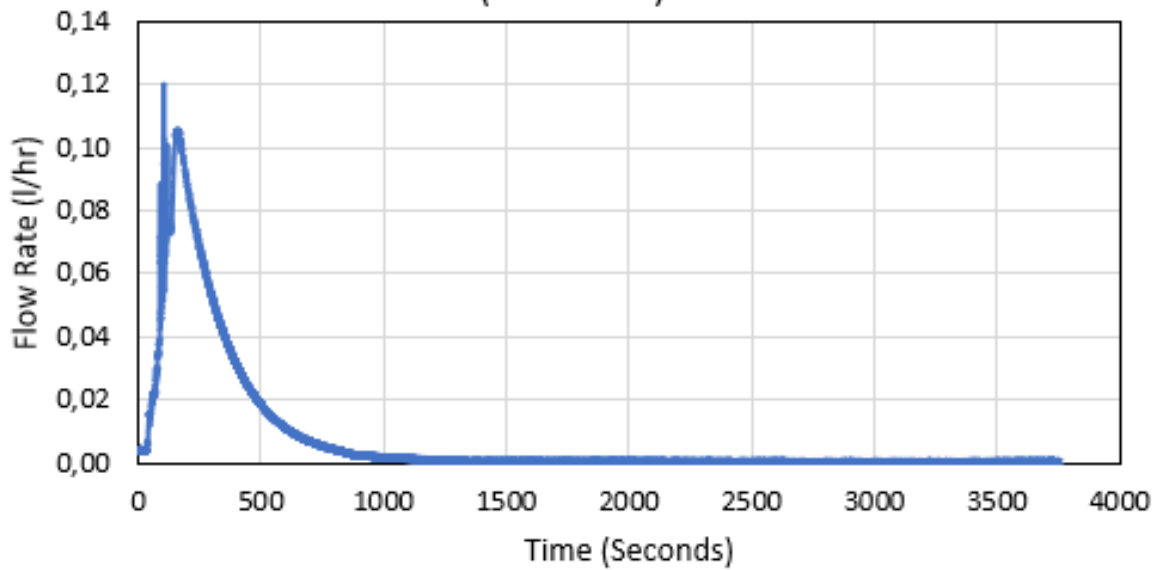

Figure 26 The Average Leakage Rates Calculated at Stabilization at Each Pressure Differential of IB

4.1.1.3 Production Valve

During the experimentation done on the production valve, 0.00025 l/hr was added to the leakage rates as the flow meter was reading a value -0.00025 l/hr before the start of the tests. Therefore, the value was added to correct for the reading error.

Flow Rate F1 (Including a 0,2% Flowmeter Error) vs. Time
(PV-50 Bar)



Flow Rate F1 (Including a 0,2% Flowmeter Error) vs. Time
(PV-50 Bar) Stabilized Region

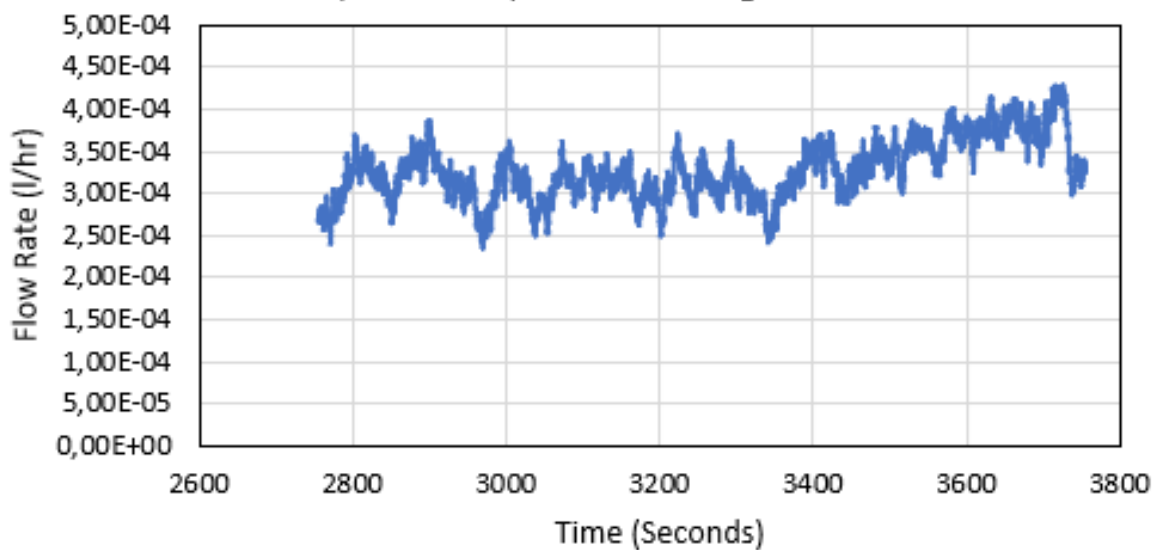
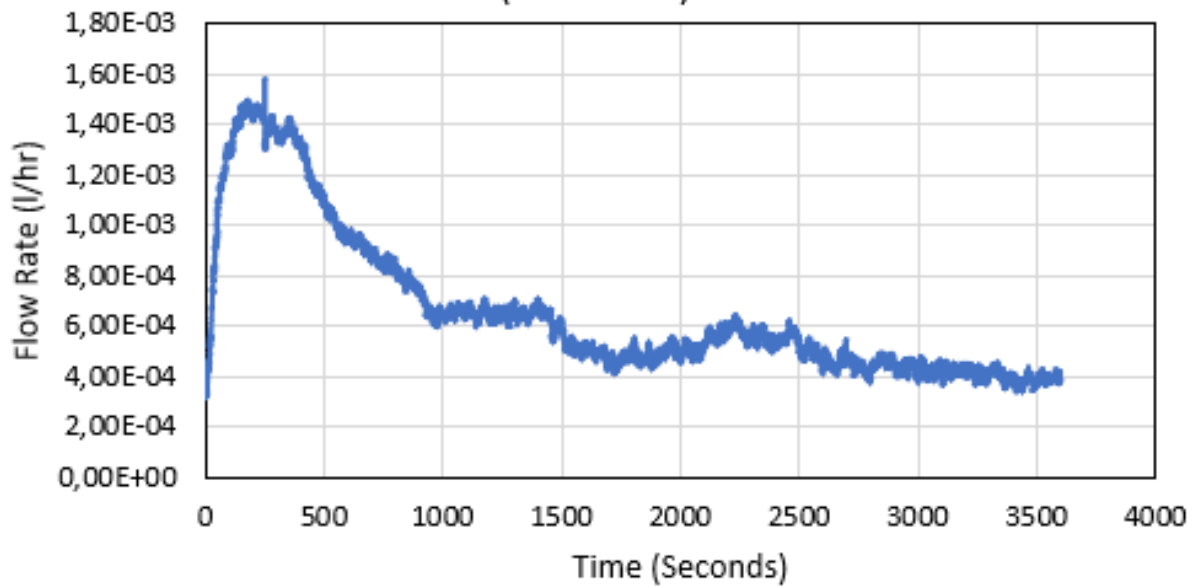

Figure 27 Leakage Flow Rate vs. Time of the PV at 50 Bars

According to figure 27, the leakage rate appears to stabilize after around 1200 seconds. The average rate during the final 1000 seconds of the test is 3.27×10^{-4} l/hr with a COV of 10.98. Although the COV is slightly above the acceptable limit 10, the value is accepted as the leakage rate is of a very low degree.

Flow Rate F1 (Including a 0,2% Flowmeter Error) vs. Time
(PV-75 Bar)



Flow Rate F1 (Including a 0,2% Flowmeter Error) vs. Time
(PV-75 Bar) Stabilized Region

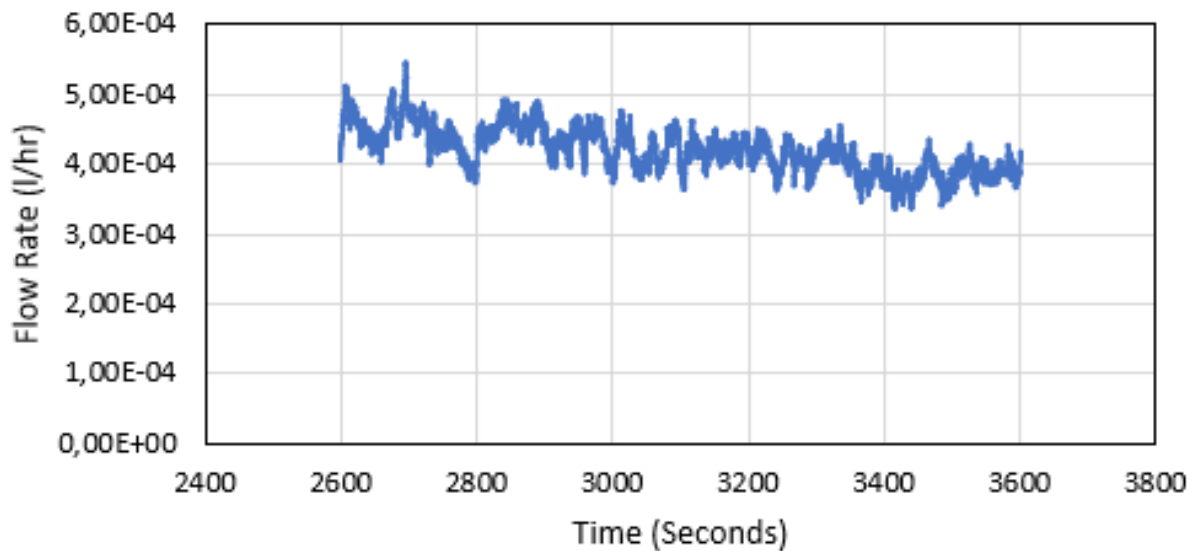

Figure 28 Leakage Flow Rate vs. Time of the PV at 75 Bars

According to figure 28, the leakage rate appears to stabilize after around 2500 seconds. The average rate from the final 1000 seconds is 4.21×10^{-4} l/hr with an acceptable COV of 7.71.

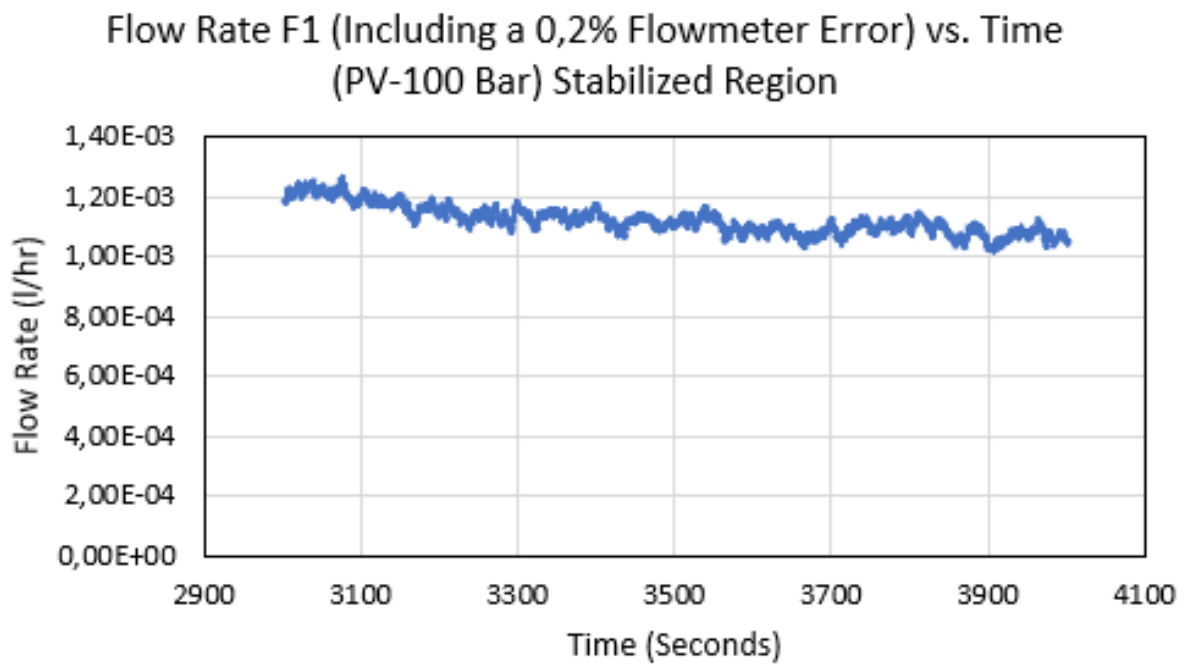
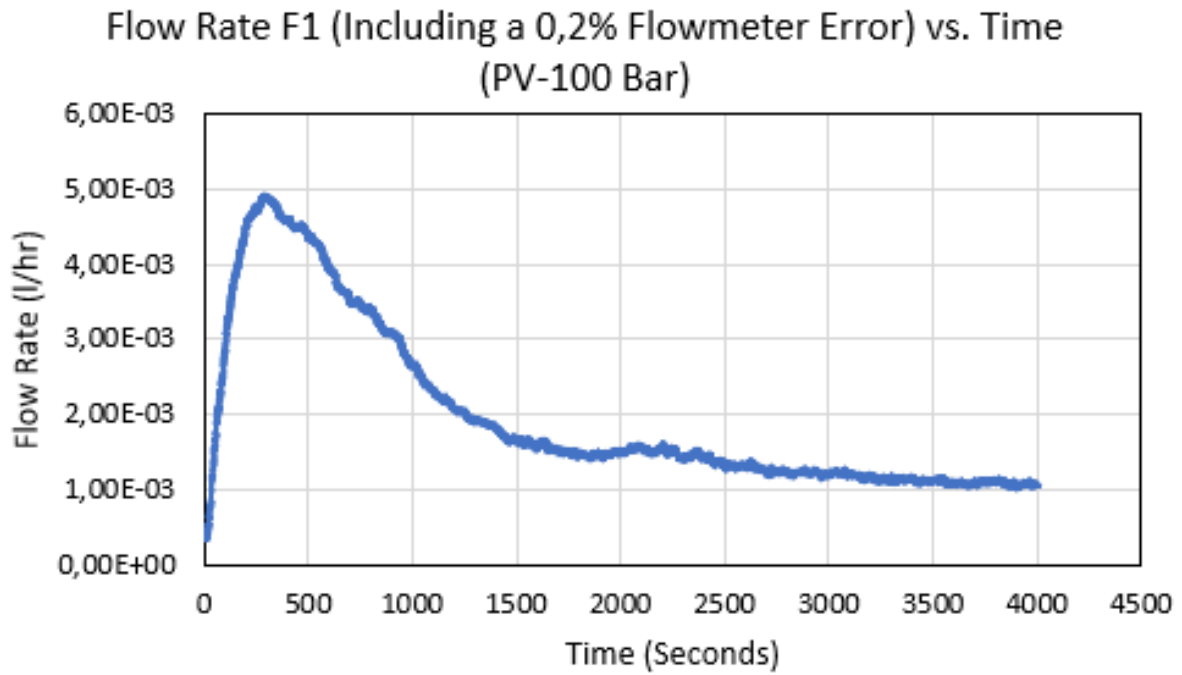
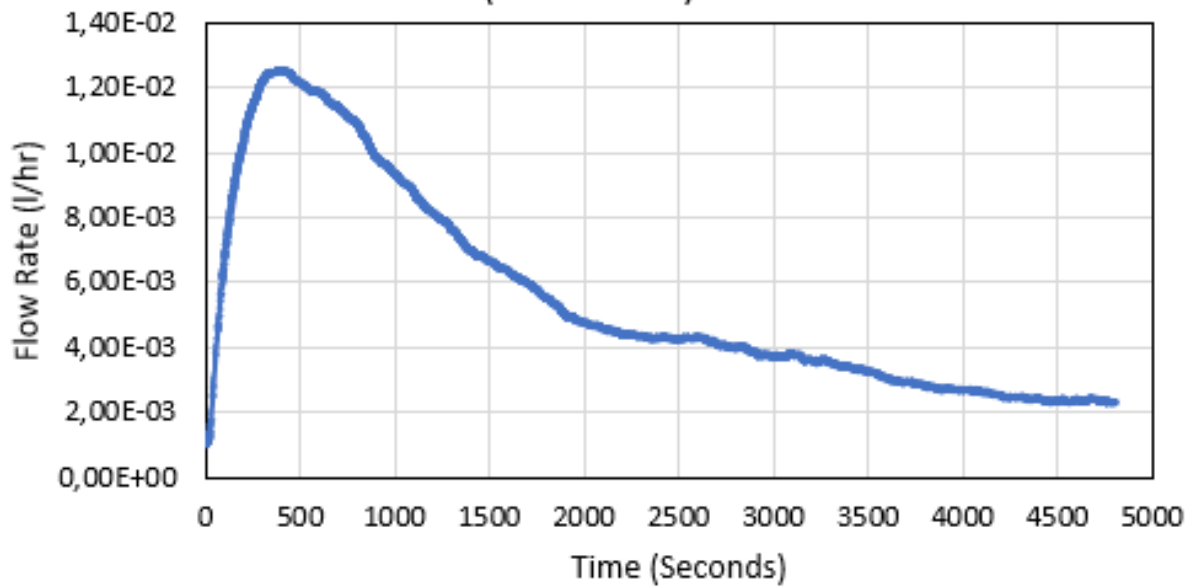

Figure 29 Leakage Flow Rate vs. Time of the PV at 100 Bars

According to figure 29, the leakage rate appears to stabilize after around 3000 seconds. The average rate during the final 1000 seconds is 1.12×10^{-3} l/hr with an acceptable COV of 4.34.

Flow Rate F1 (Including a 0,2% Flowmeter Error) vs. Time
(PV-125 Bar)



Flow Rate F1 (Including 0,2% Flowmeter Error) vs. Time
(PV-125 Bar) Stabilized Region

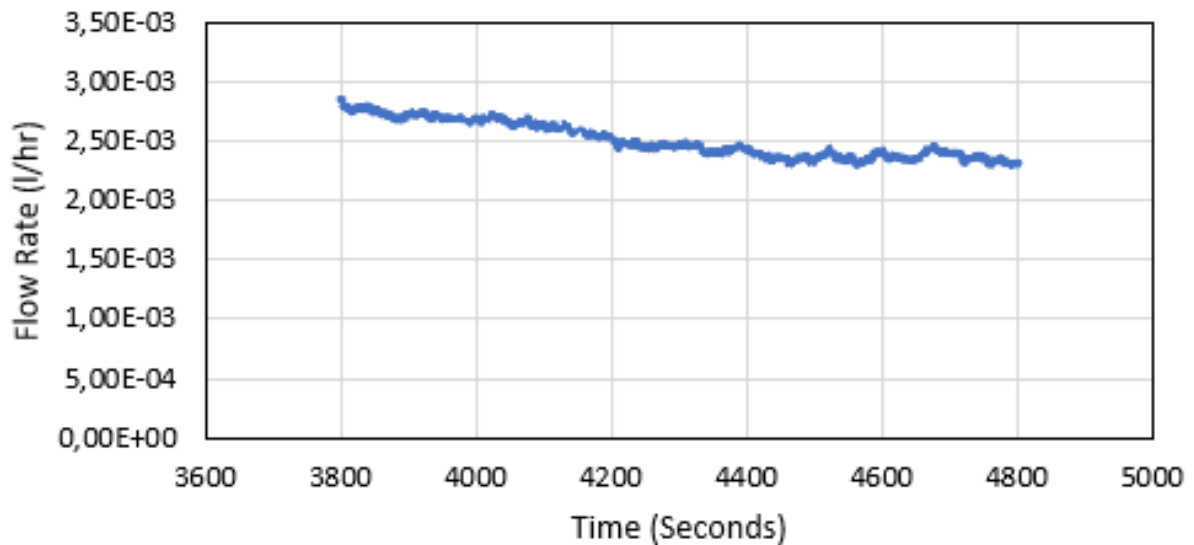

Figure 30 Leakage Flow Rate vs. Time of the PV at 125 Bars

According to figure 30, the leakage rate appears to need a considerably longer time to stabilize compared to tests done at lower pressures. The Stabilization seems to begin after around 3800 seconds with an average rate in the final 1000 seconds after that being 2.52×10^{-3} l/hr. The COV of the rates used is 6.45 which is within the acceptable range.

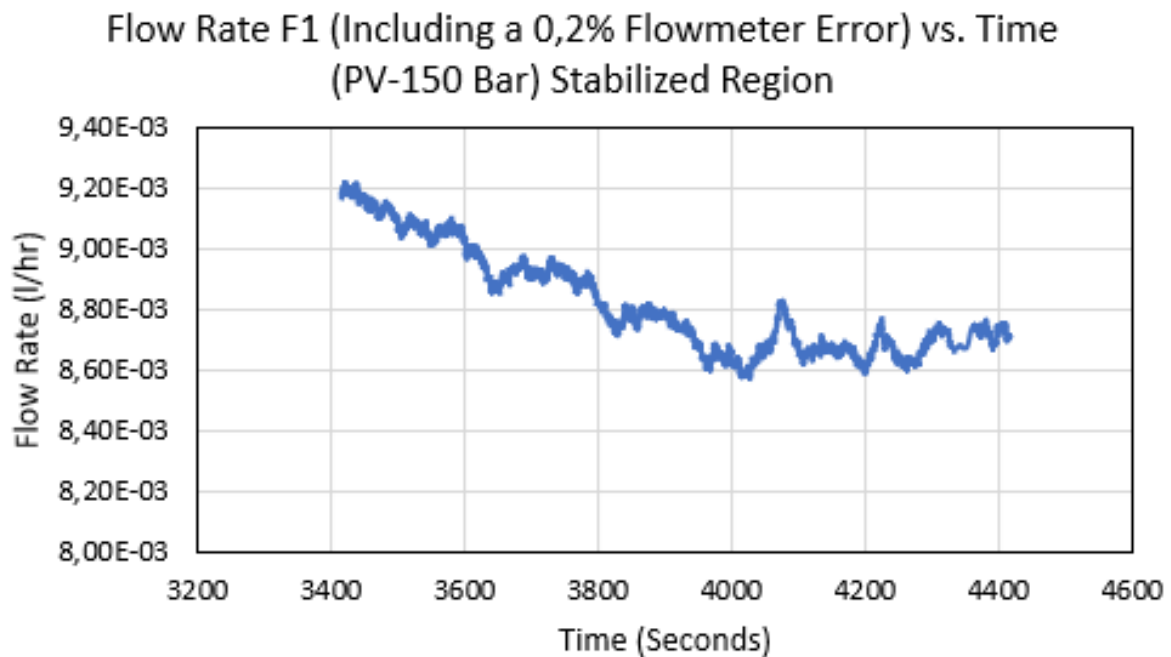
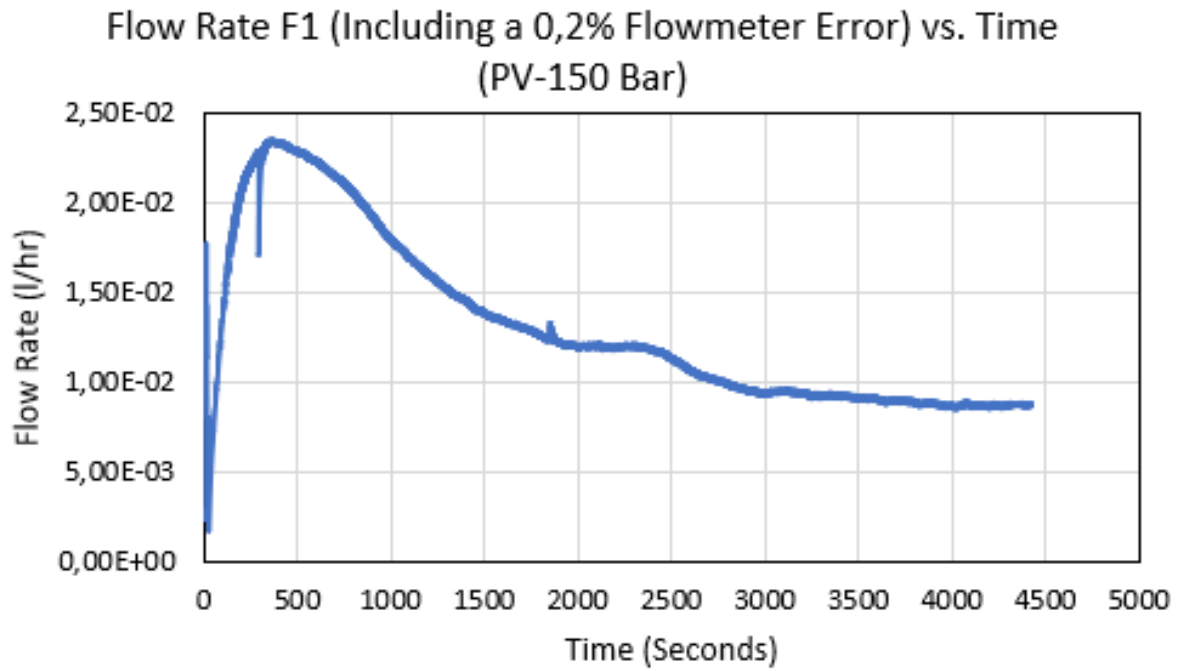

Figure 31 Leakage Flow Rate vs. Time of the PV at 150 Bars

According to figure 31, the leakage rate appears to enter the stabilization region after around 3400 seconds, with the average leakage rate within the final 1000 seconds being 8.84×10^{-3} l/hr. The COV is 1.97 which is within the acceptable range.

The figure below shows the average leakage rates calculated during the stabilization period of the tests done at each pressure differential using the production valve.

Average Leakage Rate (Including a 0,2% Flowmeter Error) vs. Delta Pressure (PV)

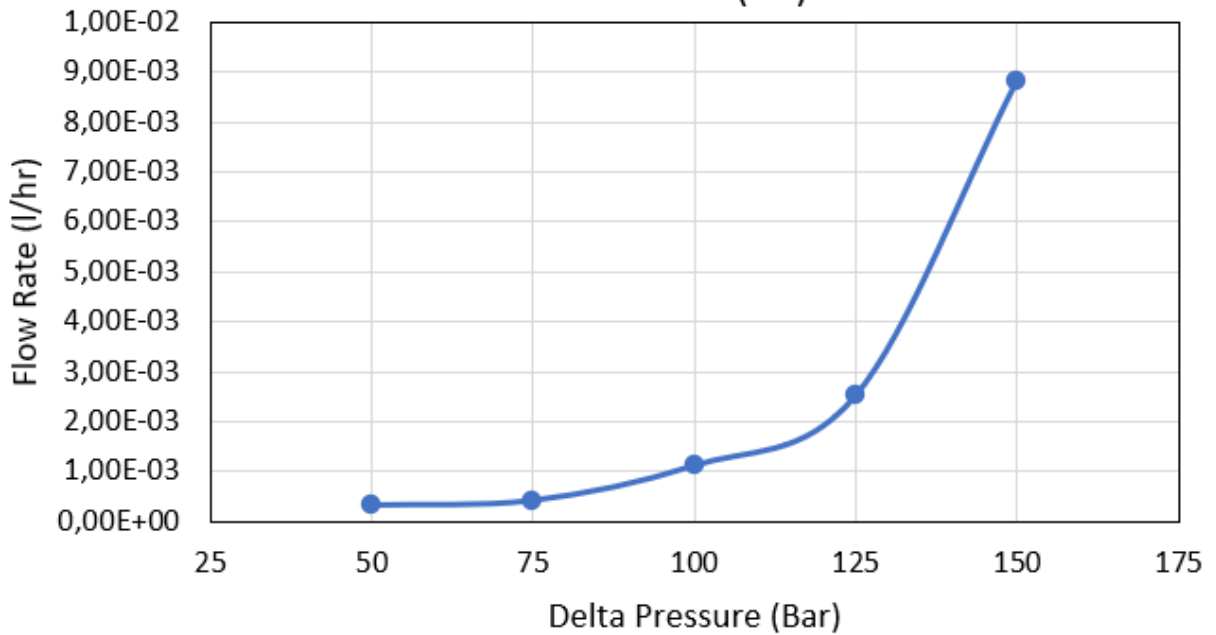
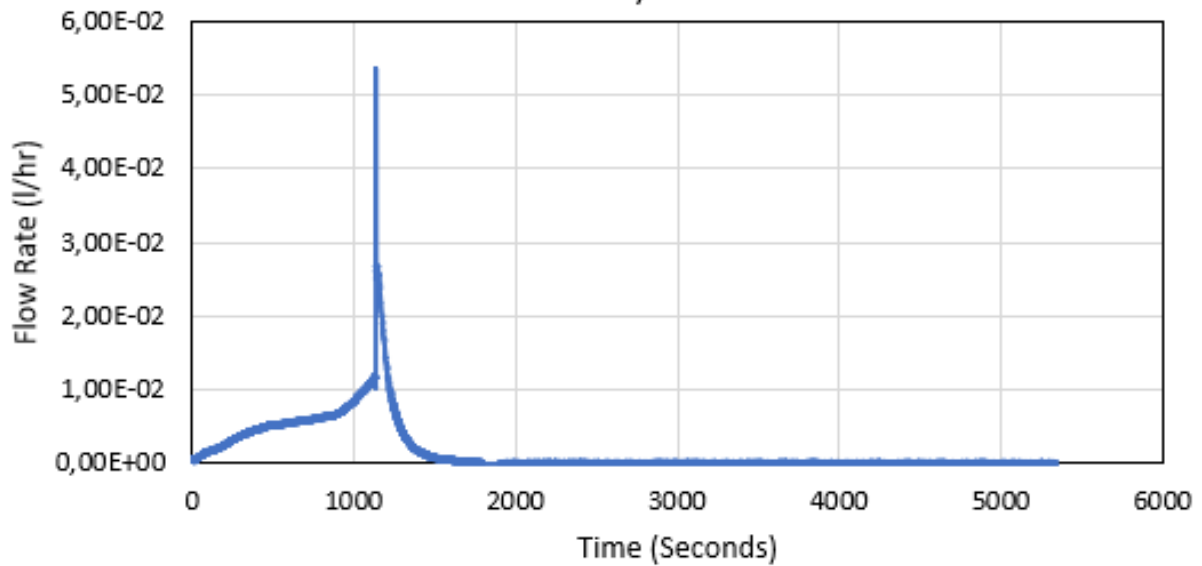

Figure 32 The Average Leakage Rates Calculated at Stabilization at Each Pressure Differential of PV

4.1.1.4 Production Blind

During the experimentation done on the production blind, 0.00025 l/hr was added to the leakage rates as the flow meter was reading a value -0.00025 l/hr before the start of the tests. Therefore, the value was added to correct for the reading error.

Flow Rate F1 (Including a 0,2% Flowmeter Error) vs. Time (PB-50 Bar)



Flow Rate F1 (Including a 0,2% Flowmeter Error) vs. Time (PB-50 Bar) Stabilized Region

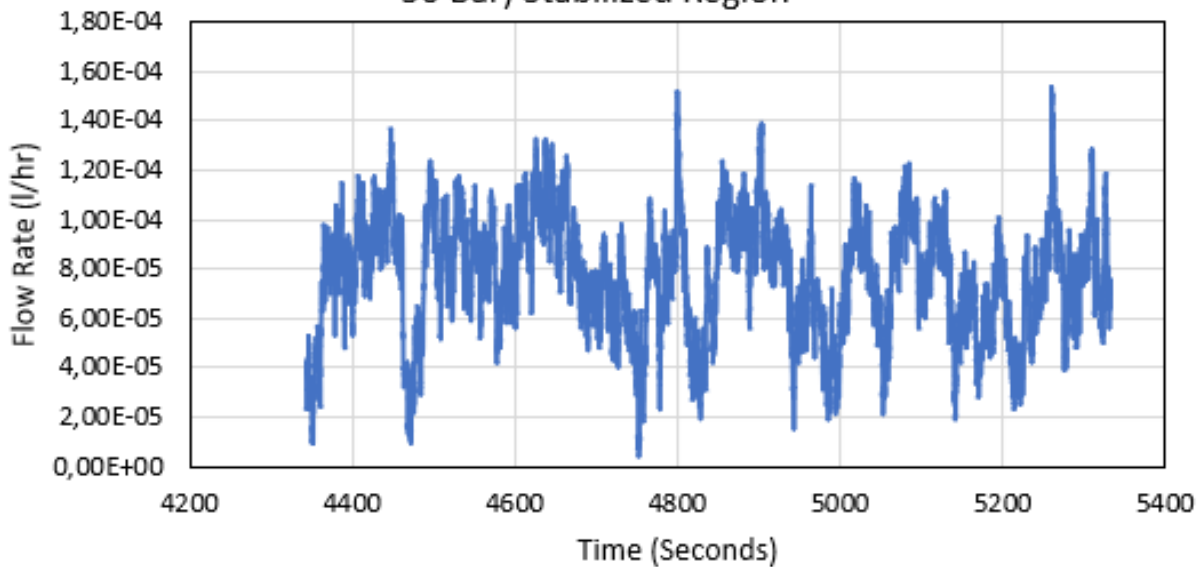

Figure 33 Leakage Flow Rate vs. Time of the PB at 50 Bars

According to figure 33, the leakage rate appears to stabilize after around 2000 seconds. The average leakage rate during the final 1000 seconds is 7.72×10^{-5} l/hr with a COV of 31.06. Although the COV is above the limit, the result is accepted as the degree of the leakage rate is very low.

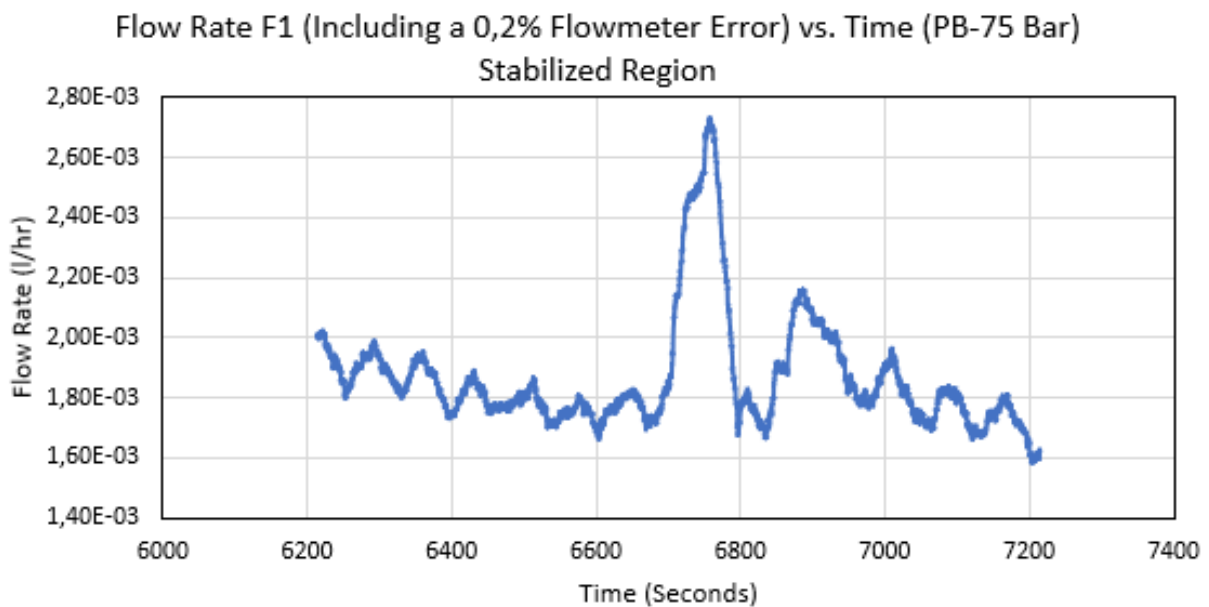
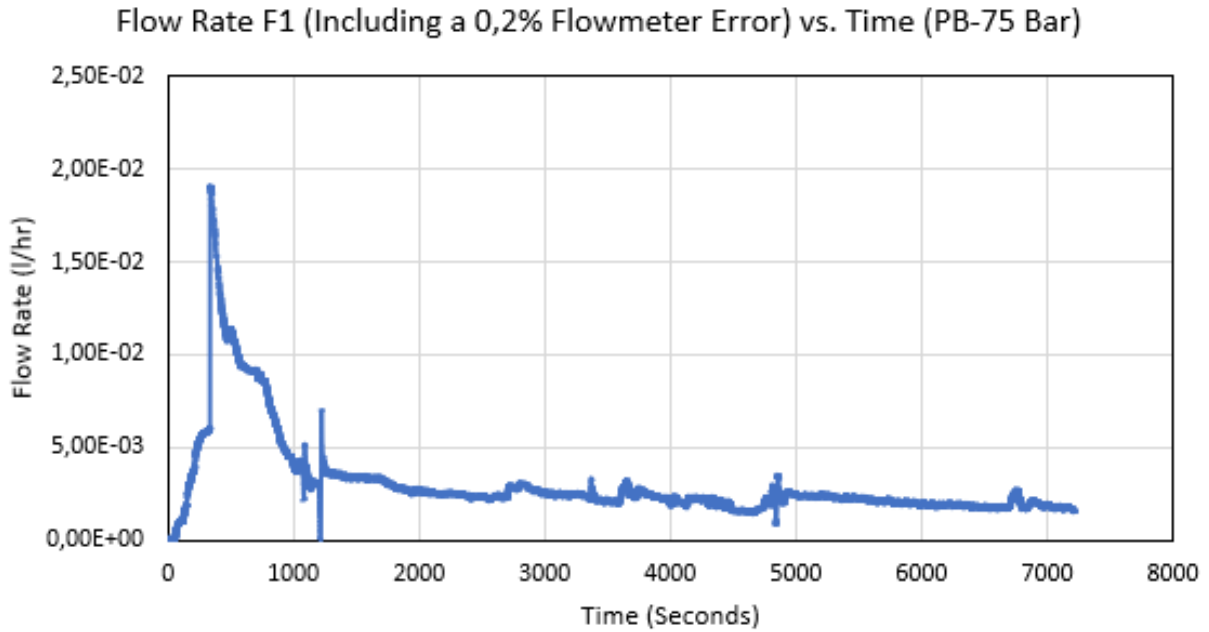

Figure 34 Leakage Flow Rate vs. Time of the PB at 75 Bars

According to figure 34, the leakage rate appears to stabilize after around 6200 seconds. Unlike previous tests, some fluctuations appear in the graph which may be caused due to surrounding noise in the laboratory during the experiment; however, they are not of a major impact on the targeted result. The average leakage rate during the final 1000 seconds is 1.87×10^{-3} l/hr with a COV of 10.57. The COV is slightly above the acceptable limit, 10, but that is overlooked as that is caused by the small peak which we can see in the middle of this period due to noise as mentioned.

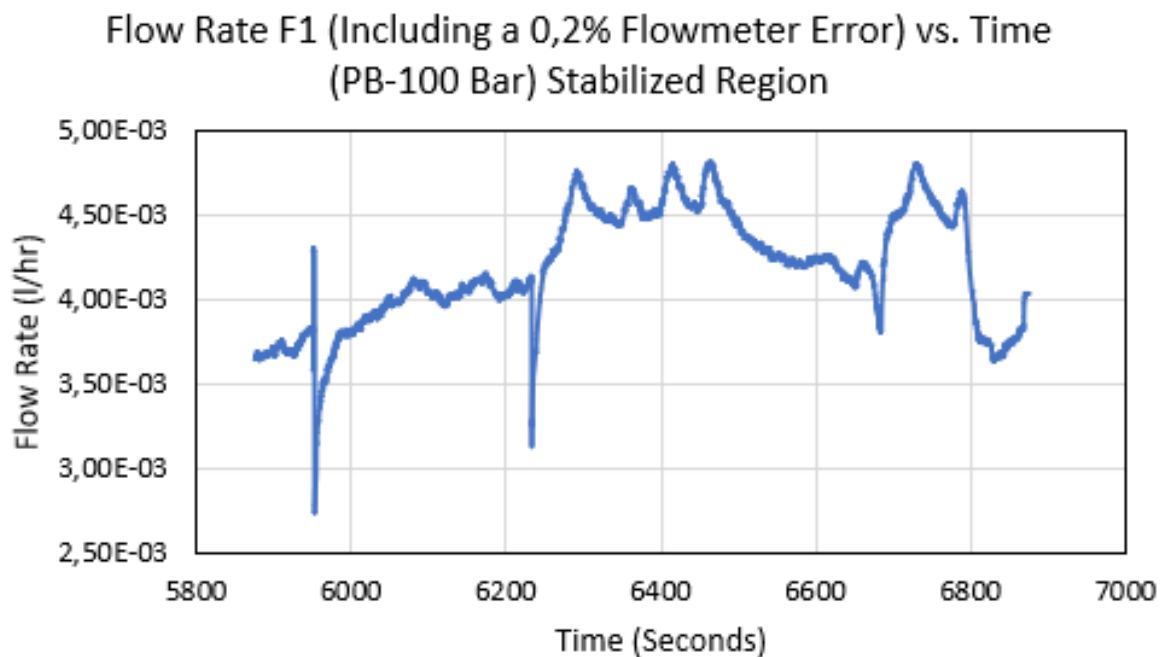
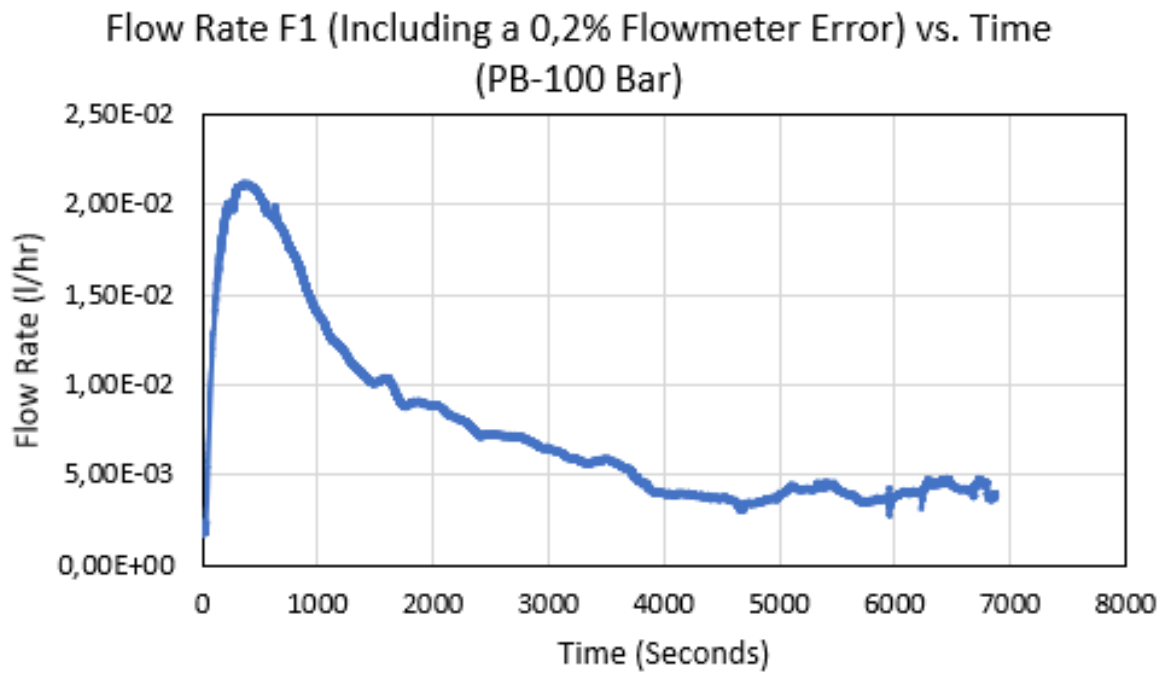

Figure 35 Leakage Flow Rate vs. Time of the PB at 100 Bars

According to figure 35, the leakage rate appears to begin stabilizing after around 5500 seconds. The duration of this test is considerably longer than those of previous tests at lower pressures. In addition, the leakage rate does not appear to be as linear with time as previous tests. The average leakage rate during the final 1000 seconds is 4.20×10^{-3} l/hr with an acceptable COV of 8.26.

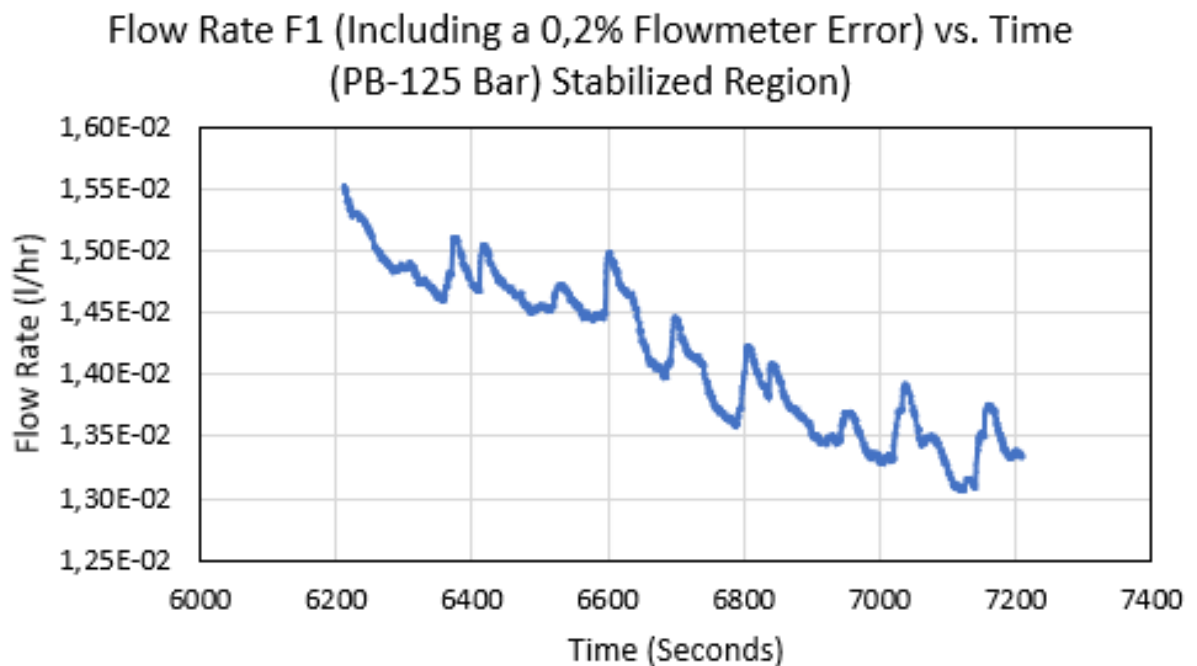
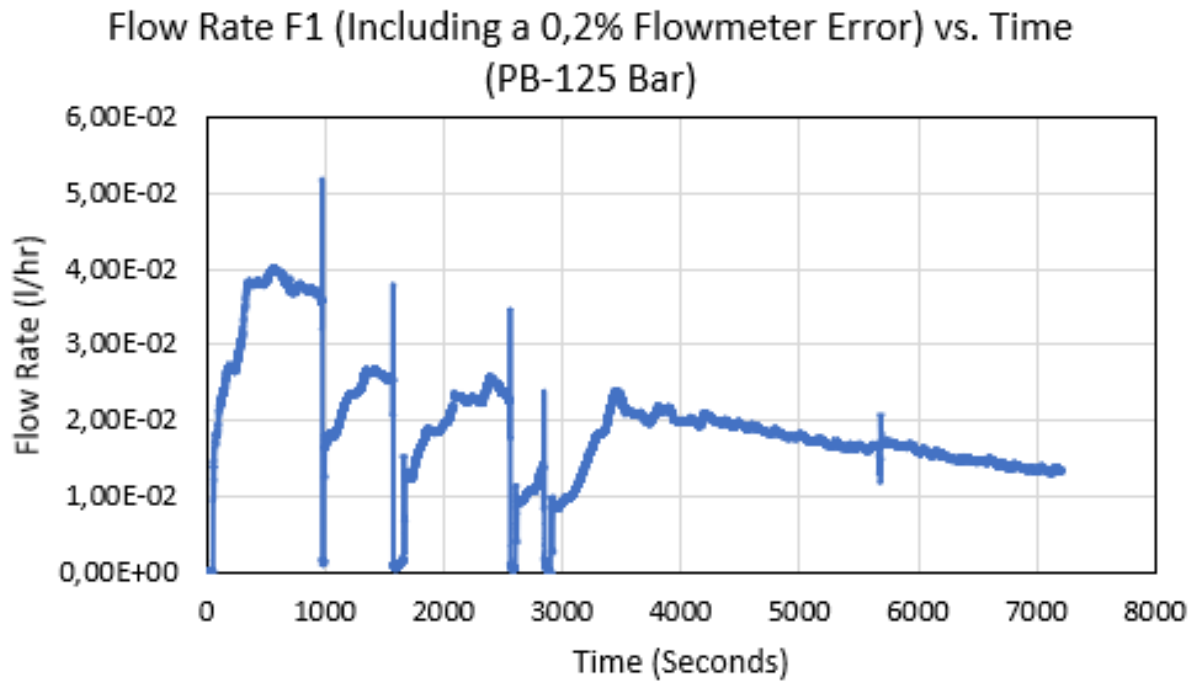
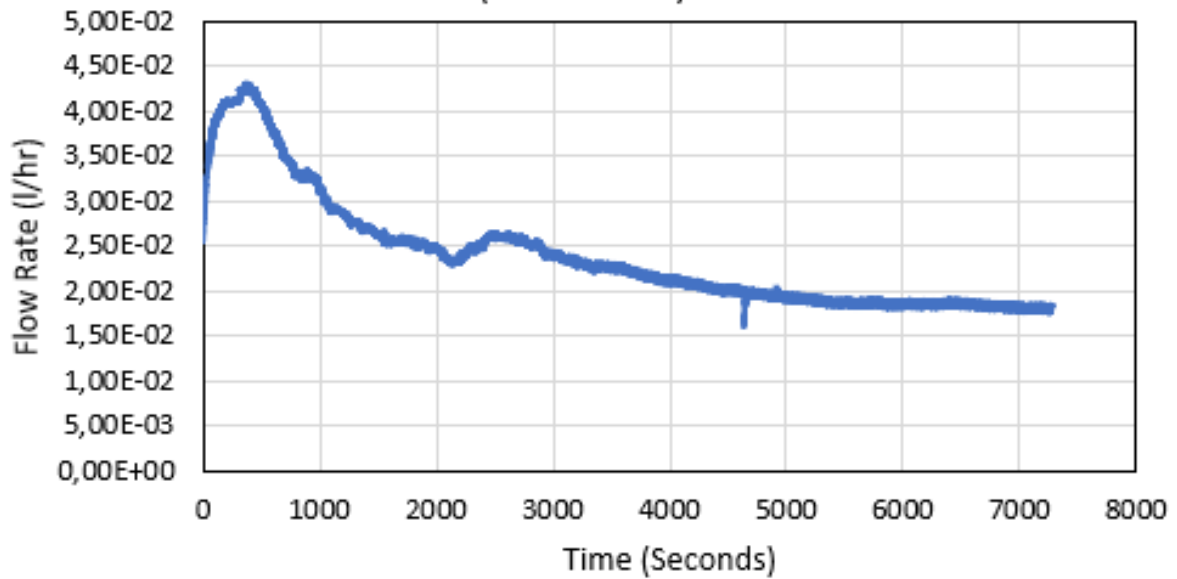

Figure 36 Leakage Flow Rate vs. Time of the PB at 125 Bars

According to figure 36, several fluctuations can be seen during the first 3500 seconds of the experiment. Nevertheless, after that, the rate seems to begin stabilizing. The duration of this test is considerably longer than previously mentioned tests. The average leakage rate during the final 1000 seconds is 1.42×10^{-2} l/hr with an acceptable COV of 4.28.

Flow Rate F1 (Including a 0,2% Flowmeter Error) vs. Time
(PB-150 Bar)



Flow Rate F1 (Including a 0,2% Flowmeter Error) vs. Time
(PB-150 Bar) Stabilized Region

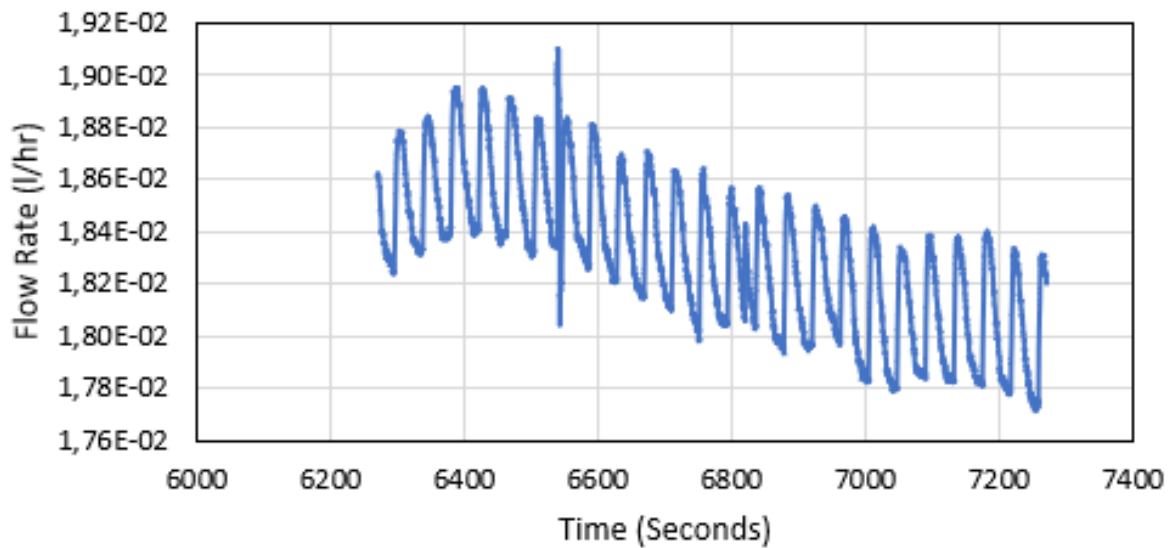

Figure 37 Leakage Flow Rate vs. Time of the PB at 150 Bars

According to figure 37, the leakage rate appears to have a rhythmic nature unseen in previous tests. As with the test done at 125 bar with this blind, the test's duration was considerably long. The average leakage rate during the final 1000 seconds is 1.83×10^{-2} l/hr with an acceptable COV of 1.60.

The figure below shows the average leakage rates calculated during the stabilization period of the tests done at each pressure differential using the production blind.

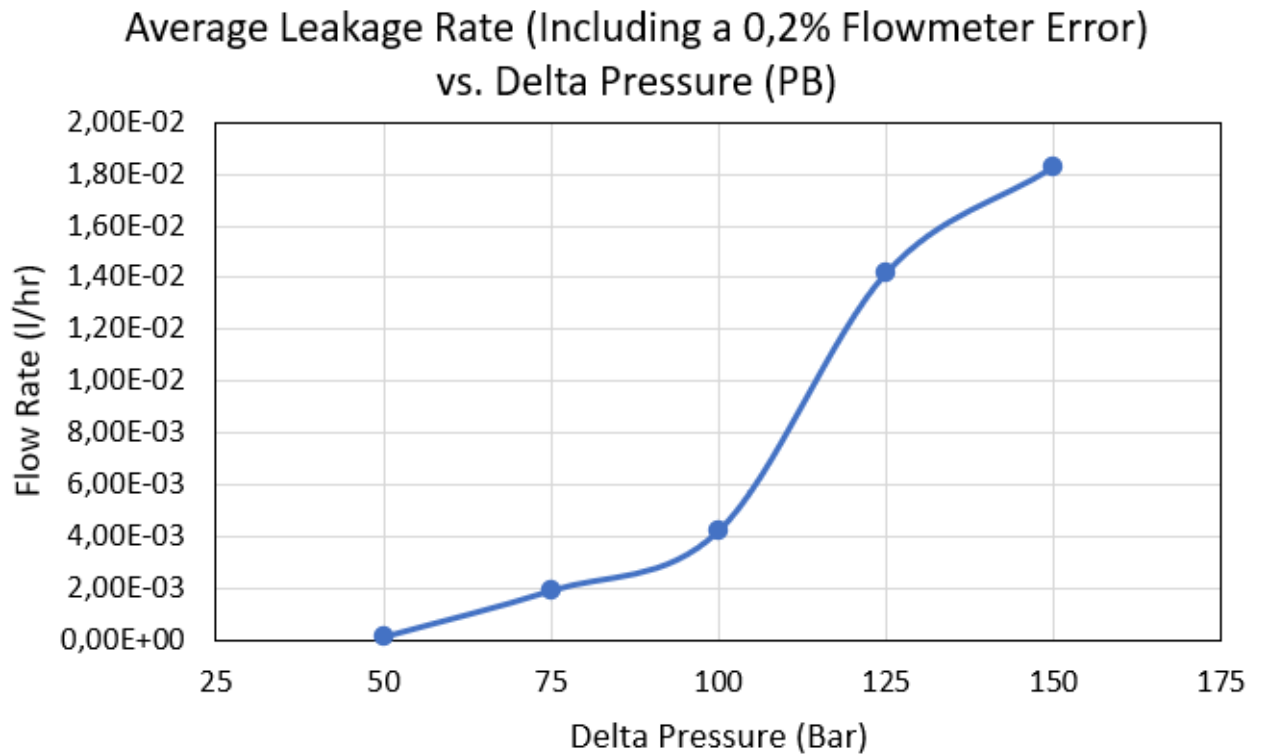

Figure 38 The Average Leakage Rates Calculated at Stabilization at Each Pressure Differential of PB

4.1.2 Closing Rate Tests Using Water

4.1.2.1 Injection Valve

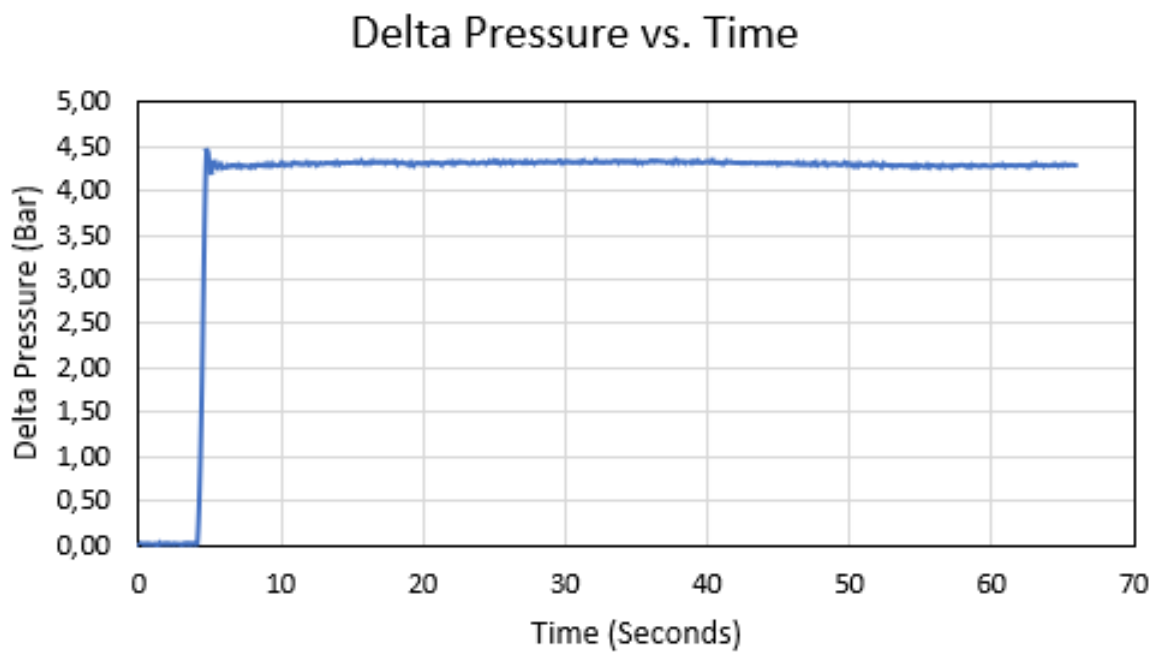
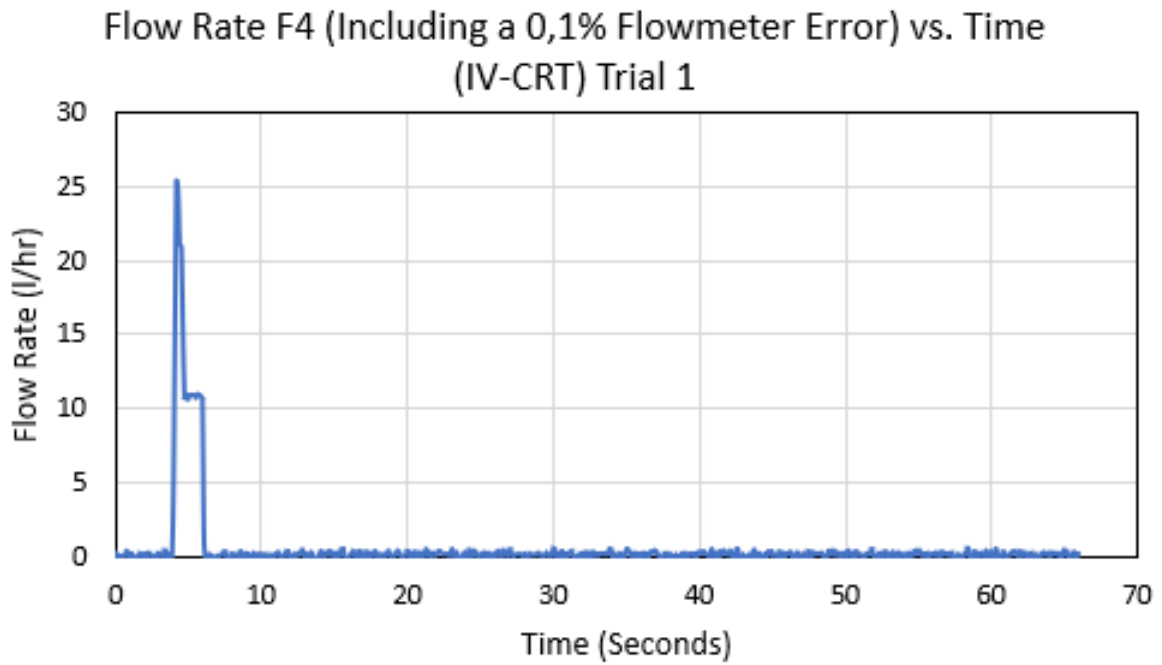

Figure 39 IV Closing Rate Test Results-Trial 1

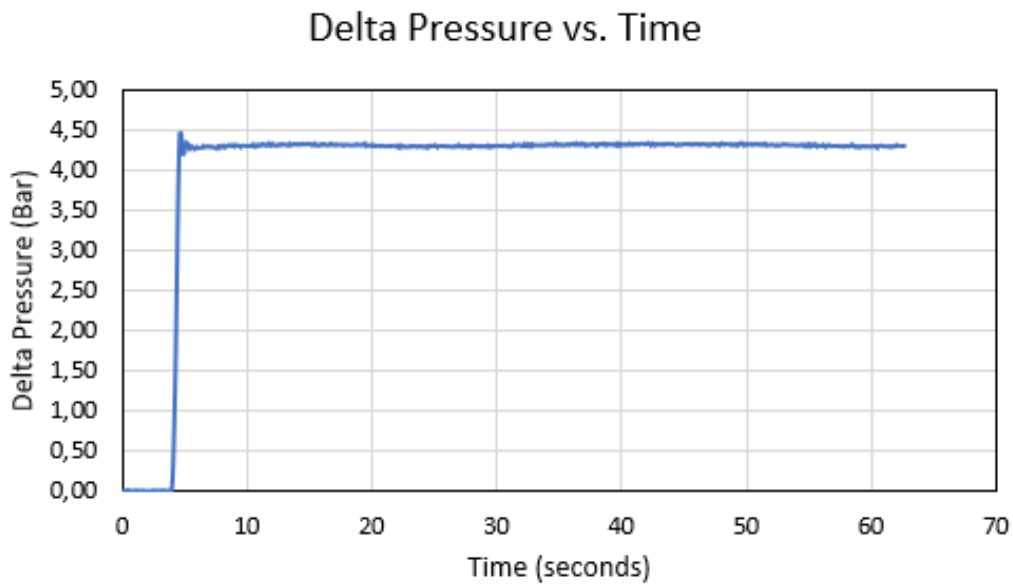
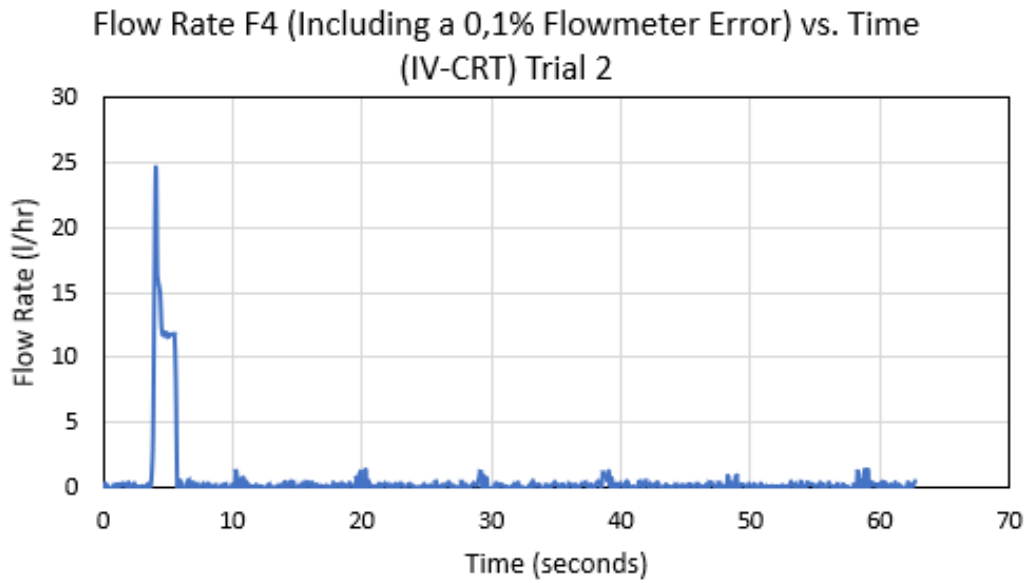

Figure 40 IV Closing Rate Test Results-Trial 2

Figures 39 and 40 show the results of two closing rate tests done on the injection valve. Both trials resulted in an average pressure difference of 4.31 bars. In addition, the first trial showed a closing rate of around 25.29 l/hr compared to 24.63 l/hr from the second trial. Therefore, an average closing rate of 24.96 l/hr at an average of 4.31 bars can be concluded for the injection valve.

4.1.2.2 Production Valve

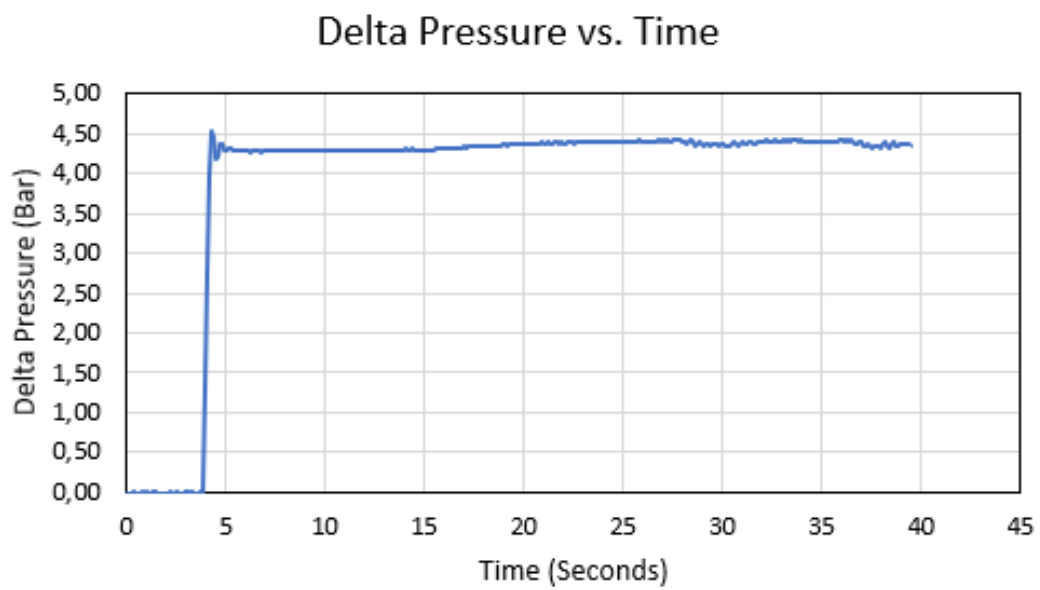
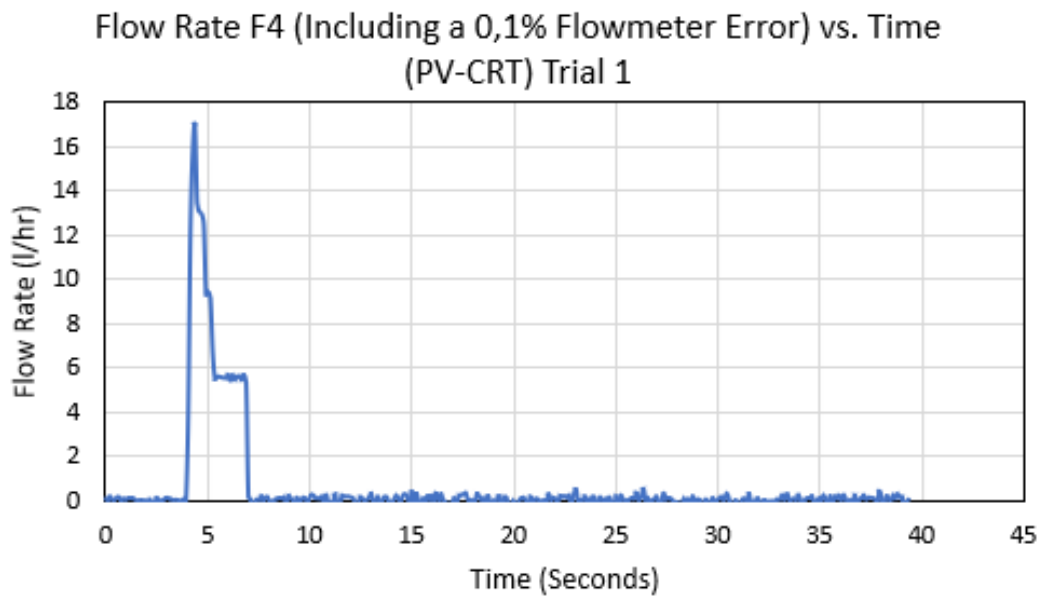
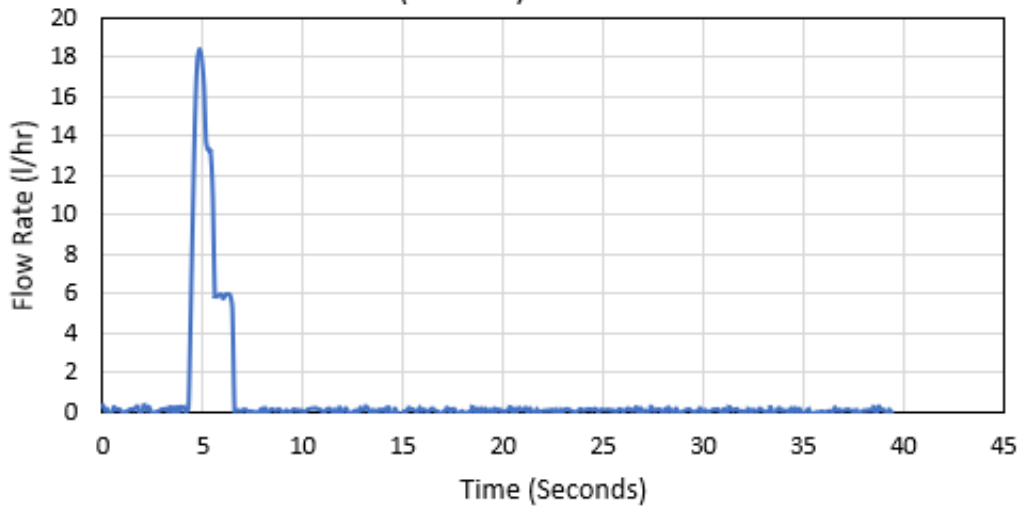

Figure 41 PV Closing Rate Test Results-Trial 1

Flow Rate F4 (Including a 0,1% Flowmeter Error) vs. Time
(PV-CRT) Trial 2



Delta Pressure vs. Time

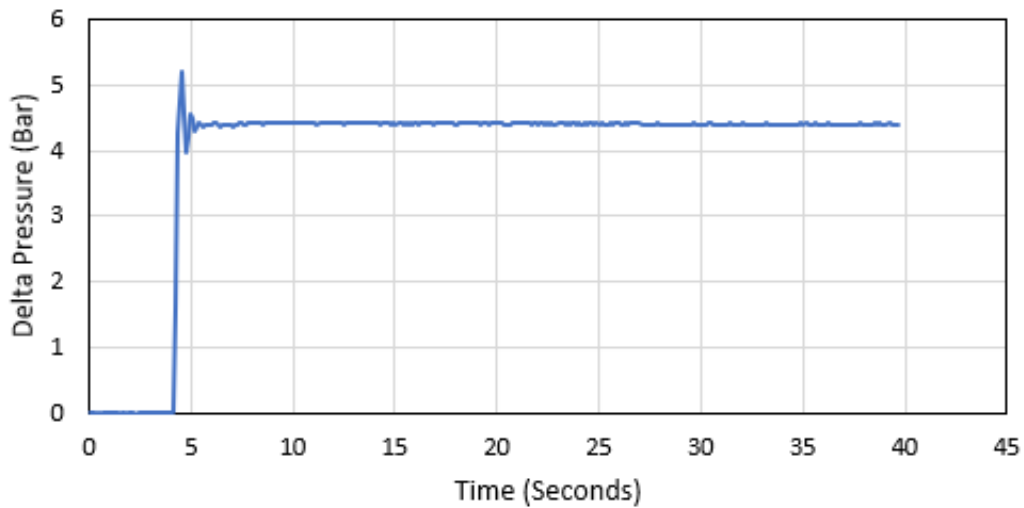

Figure 42 PV Closing Rate Test Results-Trial 2

Figures 41 and 42 show the results of two closing rate tests performed on the production valve. The first one appears to have a closing rate of 16.99 l/hr, while the second has a closing rate of 18.42 l/hr. Regarding the pressure difference, the average during the first test is 4.36 bars, while the average in the second is 4.41. Thus, averaging between both tests we get a closing rate of 17.71 l/hr and a pressure of 4.39 bars.

	IV Trial 1	IV Trial 2	IV Average	PV Trial 1	PV Trial 2	PV Average
Closing Rate (l/hr)	25.29	24.63	24.96	16.99	18.42	17.71
Delta Pressure (Bar)	4.31	4.31	4.31	4.36	4.41	4.39

Table 3 Closing Rate Tests' Results of Both Valves

Table 3 shows the results of the closing rate tests done on the injection and the production valves. The injection valve has an average rate of 24.96 l/hr compared to an average rate of 17.71 l/hr for the production valve. In addition, both valves reached these closing rates at close delta pressures of 4.31 and 4.39, respectively.

4.1.3 Leakage Test and Closing Rate Test Using Air

When attempting to perform the leakage and closing rate tests on the valves using the high-pressure test bench, the flow rate values appeared to fall out of range in both available gas flow meters. The flow rate seemed to be above the upper limit of the low-range gas flow meter and below the lower limit of the high-range gas flow meter.

4.2 Transparent Low-Pressure Test Bench

Two different experiments were done using the low-pressure transparent test bench. The first being the air injection experiment, and the second being the air injection-water production experiment.

As calculating the air leakage rate through the injection from coming from the metallic tank was one of the targets of the tests, the ideal gas law was used. As the tank pressure was made available through the Labview application, the flow rate was calculated, starting with the calculation of mass of air in the tank:

$$\text{Mass (gram)} = \frac{\text{Pressure (kPa)} \times \text{Volume of the tank (L)} \times \text{Molar Mass of air } \left(\frac{\text{g}}{\text{mol}}\right)}{R \left(\frac{\text{J}}{\text{mol}}\right) \times \text{Temperature (K)}}$$

$$\text{Mass (gram)} = \frac{\text{Pressure (kPa)} \times 1 \text{ (L)} \times 28.97 \left(\frac{\text{g}}{\text{mol}}\right)}{8.314 \left(\frac{\text{J}}{\text{mol} \times \text{K}}\right) \times 273.15 \text{ (K)}}$$

After calculating the mass at each second, the following equation was used to calculate the leakage rate:

$$\text{Leakage Rate (scfm)} = \frac{\frac{\text{Mass 1 (kg)} - \text{Mass 2 (kg)}}{\text{Density of Air } \left(\frac{\text{kg}}{\text{m}^3}\right)} \times \text{time (second)} \times 60 \left(\frac{\text{second}}{\text{minute}}\right)}{28.3168 \left(\frac{\text{m}^3}{\text{scfm}}\right)}$$

$$\text{Leakage Rate (scfm)} = \frac{\frac{\text{Mass 1(kg)} - \text{Mass 2(kg)}}{1.225 \left(\frac{\text{kg}}{\text{m}^3}\right)} \times 1 \text{ (second)} \times 60 \left(\frac{\text{second}}{\text{minute}}\right)}{28.3168 \left(\frac{\text{m}^3}{\text{scfm}}\right)}$$

4.2.1 Air Injection

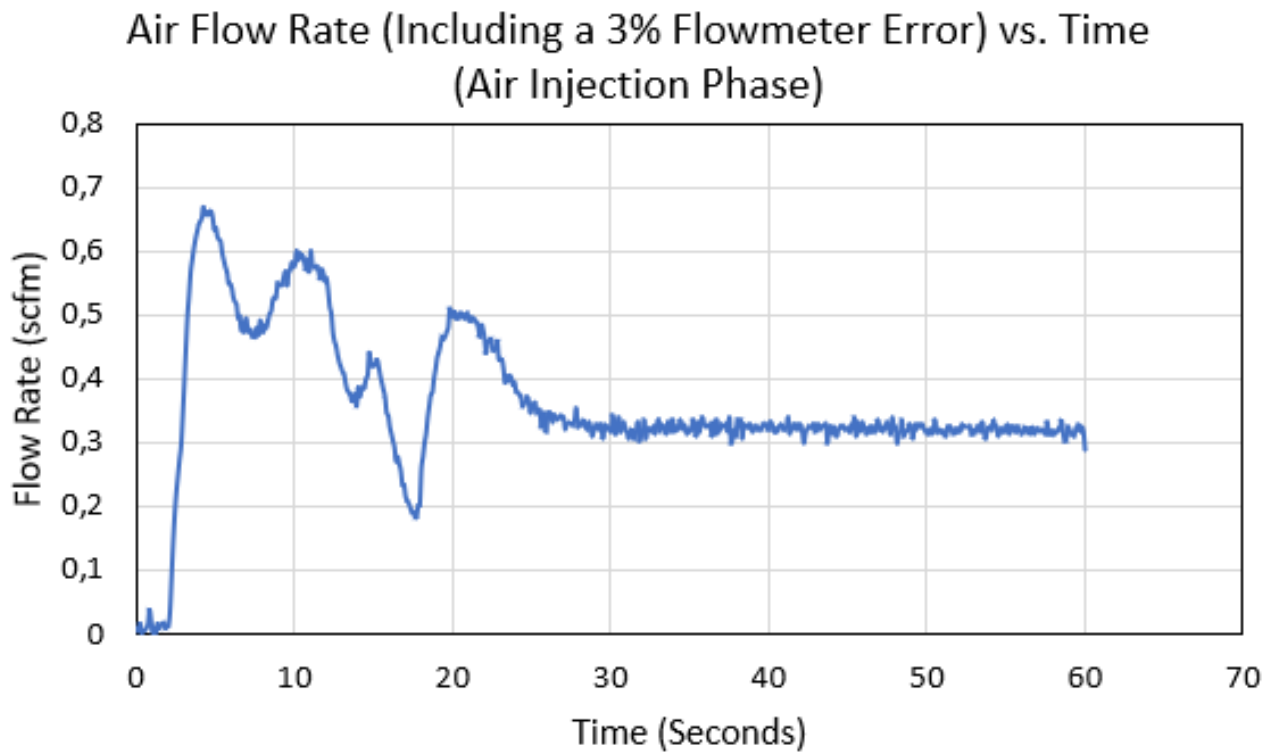

Figure 43 The Injected Air Flow Rate During the Air Injection Experiment

Air Leakage Rate vs. Time (Post Injection Phase)

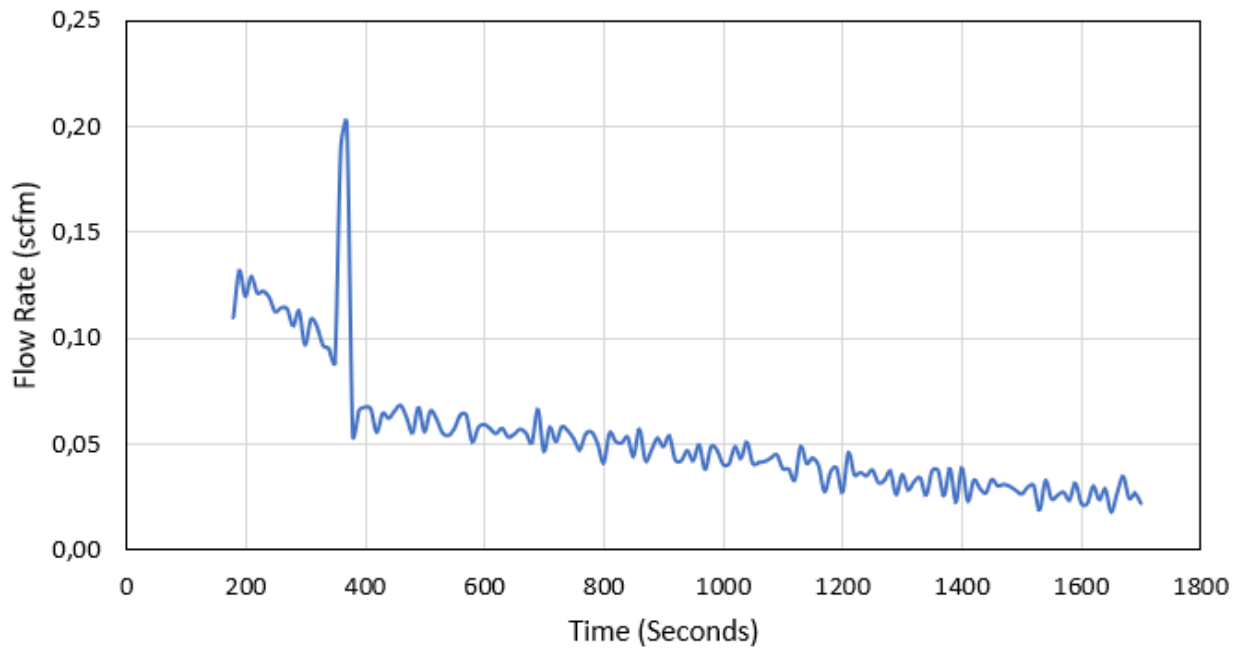

Figure 44 Tank Air Leakage Rates Post Injection Phase

In figures 43 and 44, two graphs can be seen each representing a phase of the experiment. The first shows the flow rate of the air injected into the test bench over time, and the second one shows the air leakage rate out of the metallic tank over time after the injection phase was stopped. According to what was visually seen in the transparent cell, the closing rate appeared to happen at the fourth peak present in figure 43, which is 0.5098 scfm. Figure 44 shows that the maximum air leakage is 0.1300 scfm (disregarding the reading error at around 380 seconds), while the average leakage rate is 0.0532 scfm.

4.2.2 Air Injection-Water Production Cycle

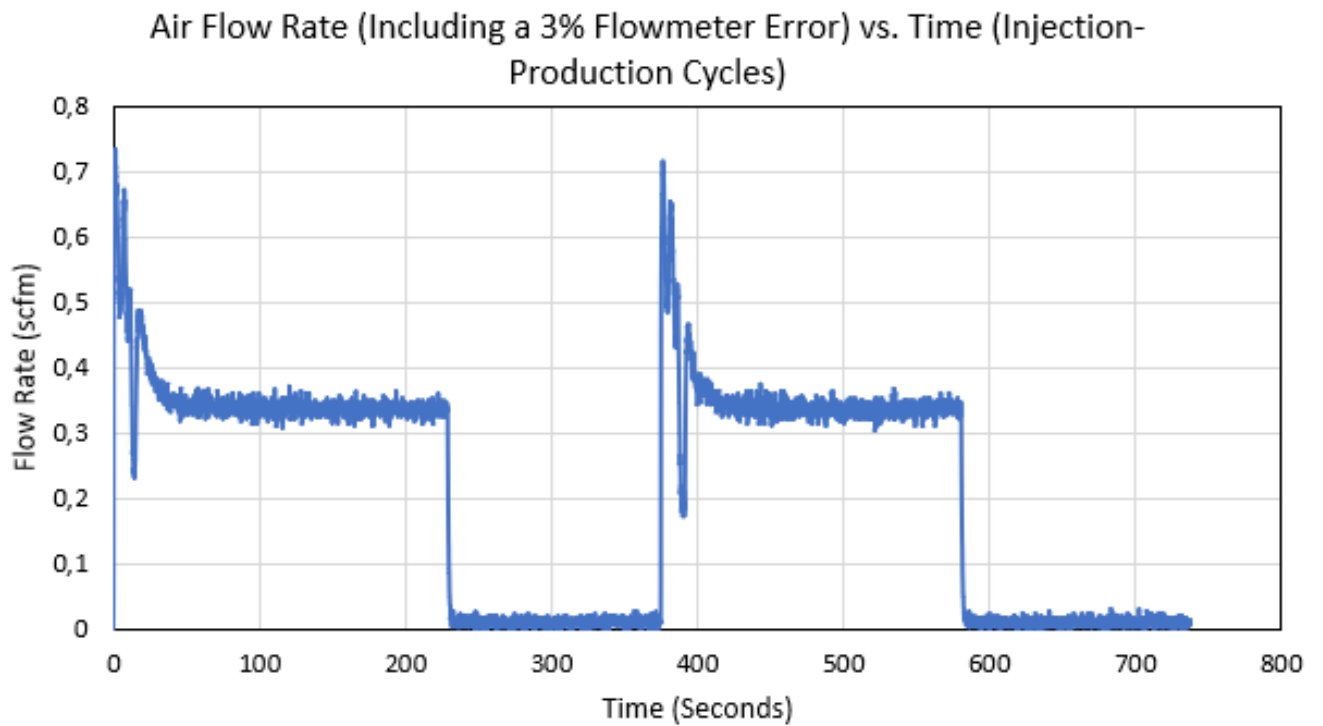
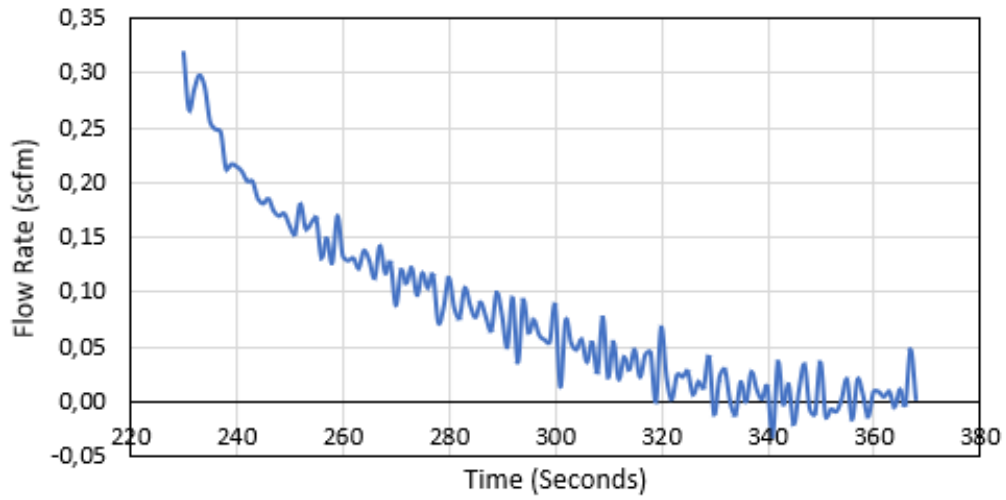

Figure 45 The Injected Air Flow Rate During the Injection-Production Cycle

Figure 45 shows the flow rate of the air injected into the test bench during the air injection-water production cycles. Two cycles can be observed in the graph. As with the Air Injection experiment, the closing rate appeared to be at the fourth peak during the injection phase. In this case, two rates were recorded. The first rate is 0.4881 scfm and the second is 0.4663 scfm.

Air Leakage Rate vs. Time (Cycle 1)



Air Leakage Rate vs. Time (Cycle 2)

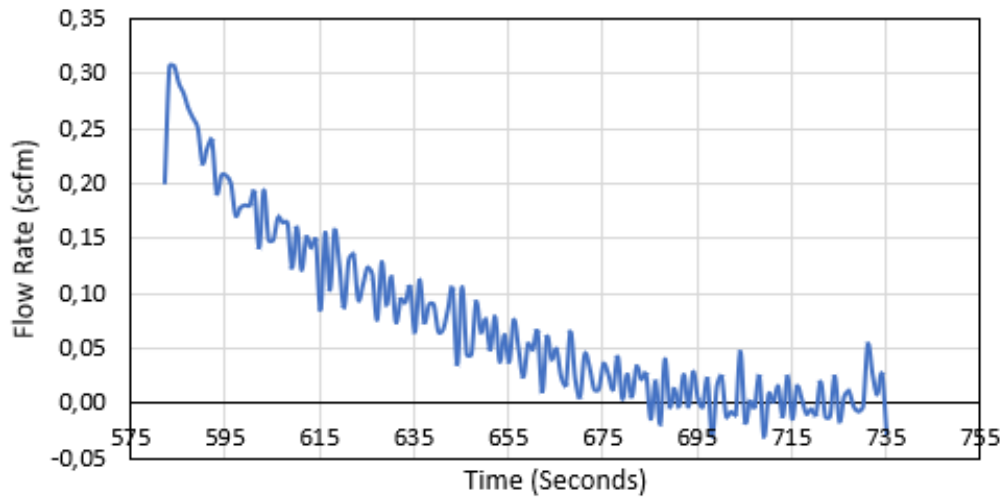

Figure 46 Tank Air Leakage Rates During the Production Phases

Figure 46 shows the air leakage from the metallic tank during the production phase in the first and the second cycles. The first cycle has a maximum leakage rate of 0.3195 scfm, while the second has a maximum leakage rate of 0.3082. In addition, the average leakage rate in the first cycle is 0.1107 scfm, while in the second it is 0.1093 scfm.

Tank Pressure vs. Time (Post Injection Phase)

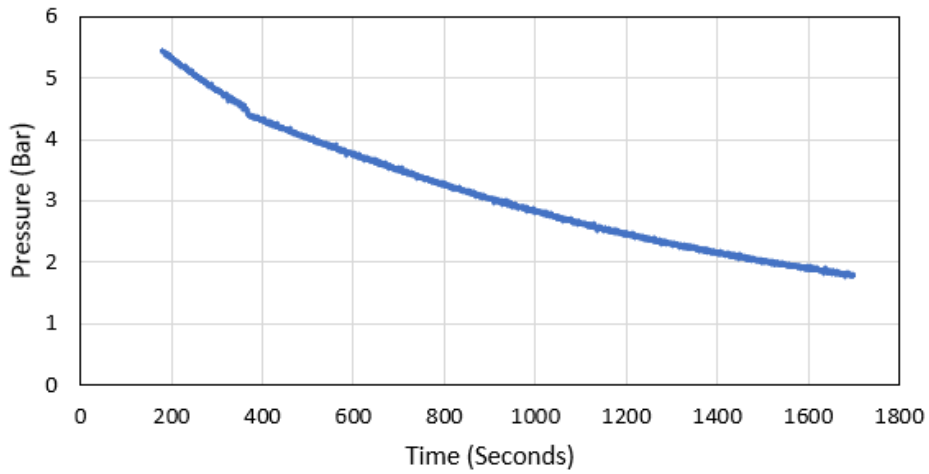
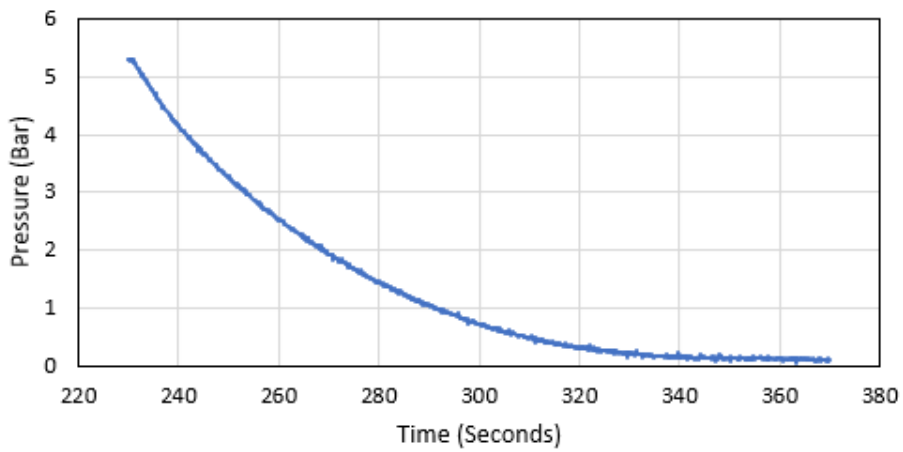

Figure 47 Tank Pressure vs. Time Post Injection Phase of Air Injection Experiment

Tank Pressure vs. Time (Production Phase 1)



Tank Pressure vs. Time (Production Phase 2)

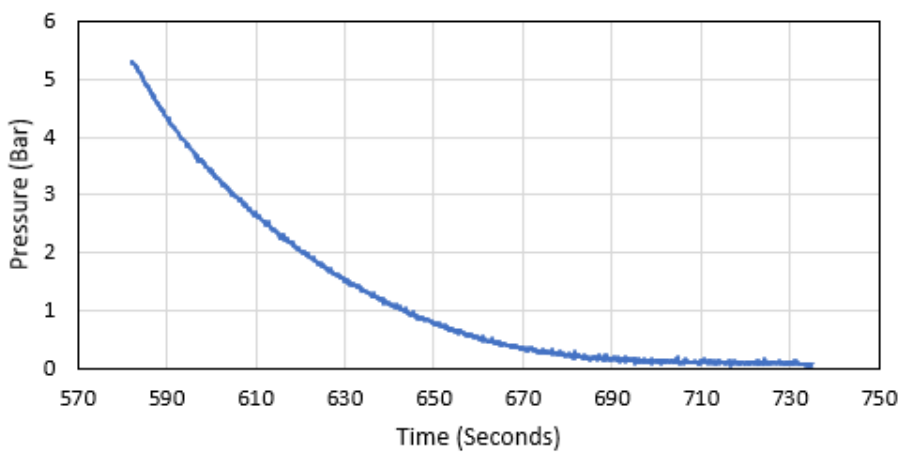

Figure 48 Tank Pressure vs. Time During the Production Phase of the Air Injection-Water Production Experiment

Figures 47 and 48 show the decrease of tank pressure over time after the injection phase in both experiments performed. The time needed for the tank to depressurize was around 2.5 minutes for the Air Injection-Water Production experiment, compared to over 25 minutes needed to depressurize around 66% of the tank’s pressure during the Air Injection experiment. The table below shows the leakage rates at specific tank pressures after the injection phase during both experiments.

Pressure (Bar)	Leakage Rate (scfm)				
	AI Experiment	AI-WP Experiment Cycle 1	AI-WP Experiment Cycle 2	AI-WP Experiment Average	(AI-WP Average)-AI
5.0	0.1140	0.2674	0.3082	0.2878	0.1738
4.6	0.0886	0.2560	0.2560	0.2560	0.1674
4.0	0.0657	0.2164	0.2164	0.2164	0.1507
3.5	0.0580	0.1835	0.1790	0.1813	0.1233
3.0	0.0426	0.1677	0.1496	0.1587	0.1161
2.5	0.0276	0.1435	0.1371	0.1403	0.1127

Table 4 Tank Leakage Rate at Different Tank Pressures Post Injection Phase in Both Experiments

Table 4 shows that the leakage rate is higher in the case of the AI-WP experiment cycles compared to the AI experiment. In addition, the leakage rate is decreasing with pressure in both experiments. Six pressure points were taken with a difference of 0.5 bars between each, except for the case at 4.6 bars. As the leakage rate appears to be at an unstable rate at 4.5 bars as seen in figure 39, a nearby pressure was considered instead where the leakage rate was more accurate. The average of the results of both cycles during the AI-WP experiment are taken, and the leakage rate during the AI experiment is deducted from it. This gave the difference in leakage between both experiments at the specified tank pressures. The difference also appears to decrease with the pressure. In addition, during the AI-WP experiment, it was noticed that the leakage through the valve had a different nature between when the water and the cell were clean, and when they were dirty. Figure 49 shows the leakage through the injection valve when clean water was used. The leaking air bubbles appear to be going through the sides of the opening; however, in figure 50, the valve is shown when the water and the cell are dirty, and the air bubbles appear to be leaking from the bottom of the opening.

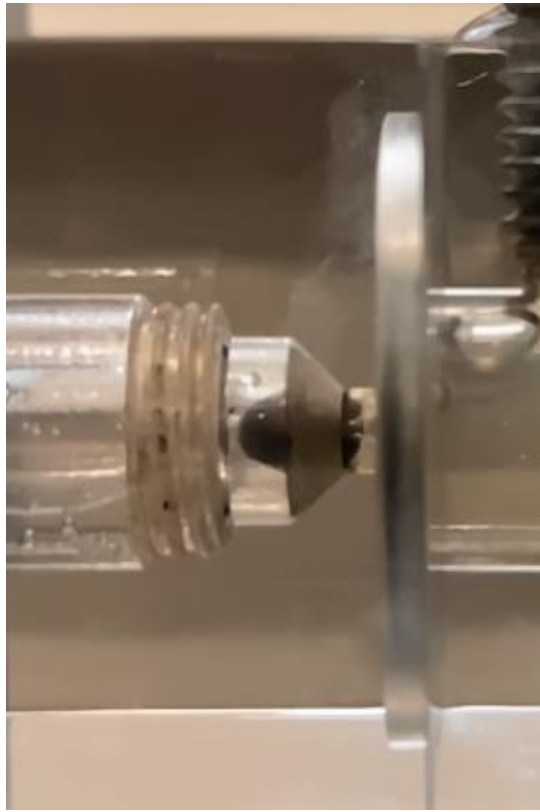

Figure 49 Air Leakage through Injection Valve with Clean Water

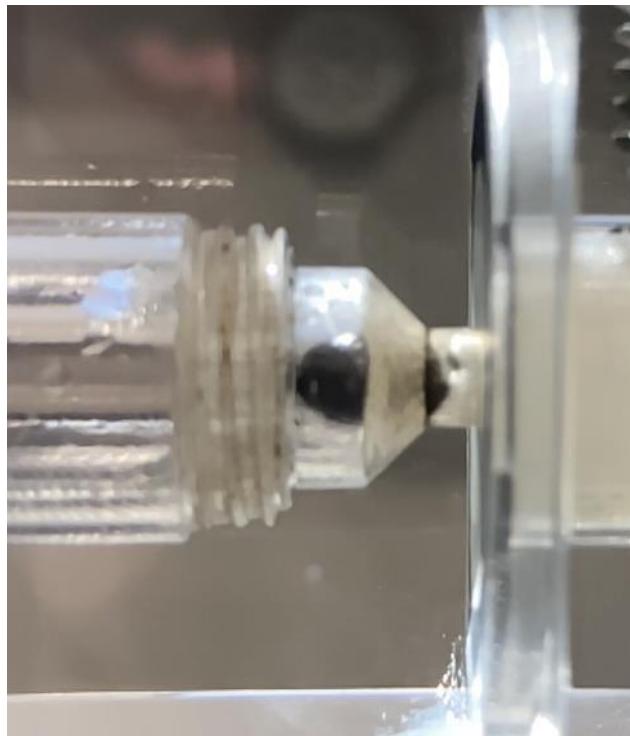

Figure 50 Air Leakage through Injection Valve with Dirty Water

5. Discussion

5.1 Analysis and Uncertainties of Experimental Results

Table 5 summarizes all the leakage rates at all the upstream pressures tested for all four valves. In addition, the deduced leakage rate of the valves minus that of the blinds is also shown to present the leakage value excluding the threads leakage.

Pressure (Bar)	Injection Valve Leakage (l/hr)	Injection Blind Leakage (l/hr)	Injection Leakage Difference Leakage (l/hr)	Production Valve Leakage (l/hr)	Production Blind Leakage (l/hr)	Production Leakage Difference Leakage (l/hr)
50	8.12×10^{-5}	5.62×10^{-5}	2.50×10^{-5}	3.27×10^{-4}	7.72×10^{-5}	2.5×10^{-4}
75	7.04×10^{-5}	1.33×10^{-4}	3.40×10^{-5}	4.21×10^{-4}	1.87×10^{-3}	-1.50×10^{-3}
100	4.73×10^{-4}	1.86×10^{-4}	2.87×10^{-4}	1.12×10^{-3}	4.20×10^{-3}	-3.08×10^{-3}
125	9.61×10^{-4}	3.03×10^{-4}	6.58×10^{-4}	2.52×10^{-3}	1.42×10^{-2}	-1.17×10^{-2}
150	1.90×10^{-3}	1.07×10^{-3}	8.30×10^{-4}	8.84×10^{-3}	1.83×10^{-2}	-9.46×10^{-3}

Table 5 Leakage Rates of Each Valve at Different Upstream Pressures

All four valves appear to have an increasing leakage with the increase of the upstream pressure, except for the case of the injection valve at 75 bars. The leakage rate drops from the value at 50 bars by 1.08×10^{-5} l/hr to 7.04×10^{-5} l/hr. Although this decrease does not match with the rest of the data collected from the other leakage tests, a couple of factors provide possible explanations for it. First, as the leakage limit for a sealing valve is 0.4 l/min, as per NORSOK, this decrease represents just 4.5×10^{-7} of this allowed value, which is basically negligible. Moreover, the low leakage rate measured at 50 and 75 bars through the injection valve are even lower than the reading error of the flow meter before the start of the experiments, which is 3×10^{-4} l/hr. Thus, this unexpected small decrease could simply be a reading error by the flowmeter due to possible inaccuracy.

Regarding the relationship between the valves and the blind, the leakage difference between the injection valve and the injection blind appear to also increase with the increase of pressure. This allows to conclude that the leakage through the opening is increasing with the increase of pressure as subtracting the leakage of the valve and the blind from one another means that the threads' leakage is no longer included. Nevertheless, the relationship between the production valve and blind did not give similar expected results. Although the production valve is the same production blind which was later transformed by drilling an opening into it, the leakage appeared to be higher in the blind than in the valve from 75 bars and up. This means that the results are inaccurate as it means that the leakage through the threads is higher than that through the threads and the opening combined. Two explanations can be presented regarding what may have caused these results. Firstly, as thread sealing tape was always used to limit the threads' leakage, a difference in the way of taping between the two experiments may have played a role

in this inaccuracy. In addition, as the valves are inserted manually into the cell, a difference in the torque when inserting the blind and the valve may have resulted in a less tight insertion in the case of the production valve, resulting in increased leakage. Although the leakage difference results between the blind and the valve may not be accurate, having the leakage rates of both at all the tested pressures fall way below the sealing threshold of 0.4 l/min is still a very positive sign. As shown in table 6, the leakage rates during all the tests performed were less than 10^{-3} of the 0.4 l/min limit.

Pressure (Bar)	Ratio of IV Leakage over Limit Leakage	Ratio of IB Leakage over Limit Leakage	Ratio of Injection Leakage Difference over Limit Leakage	Ratio of PV Leakage over Limit Leakage	Ratio of PB Leakage over Limit Leakage	Ratio of Production Leakage Difference over Limit Leakage
50	3.38×10^{-6}	2.34×10^{-6}	1.04×10^{-6}	1.36×10^{-5}	3.22×10^{-6}	1.04×10^{-5}
75	2.93×10^{-6}	5.54×10^{-6}	1.42×10^{-6}	1.75×10^{-5}	7.79×10^{-5}	-
100	1.97×10^{-5}	7.75×10^{-6}	1.20×10^{-5}	4.67×10^{-5}	1.75×10^{-4}	-
125	4.00×10^{-5}	1.26×10^{-5}	2.74×10^{-5}	1.05×10^{-4}	5.92×10^{-4}	-
150	7.92×10^{-5}	4.46×10^{-5}	3.46×10^{-5}	3.68×10^{-4}	7.63×10^{-4}	-

Table 6 Ratios of Leakage Rate over the Leakage Limit of Sealing Valve by NORSOK

As for the experiments performed on the low-pressure test bench, expected results were obtained. The leakage rate through the injection valve from the metallic tank was higher during the AI-WP experiment than during the AI experiment as shown in figure 51. This was due to the water pushing the ball away from the opening creating more space between the ball and the opening. Thus, more air leakage took place through the valve. In addition, the leakage rate appeared to decrease with the decrease of pressure in both experiments, along with the leakage difference between both experiments also decreasing with pressure. As the gas leakage limit for a sealing valve according to NORSOK is 15 scfm, having a maximum leakage of around 0.3 scfm at most shows that the design of the transparent cell and the injection valve in it is acceptable. Nevertheless, the difference in the leaking nature between the AI-WP experiment with clean water and that with dirty water shows that the presence of some sand-like particles on the contact area between the ball and the valve may impact the leakage.

The rest of the results that were obtained from the LP test bench were focused on physically visualizing and observing the occurrences inside the transparent cell, especially with the production valve. During the injection phase, leakage can be observed through the production valve. Moreover, verifying the air flow injected into the test bench along with the closing rate needed to close the production valve requires quantifying the amount of air leaking out of the valve. This quantification would help understand if there is any other undesired leakage source within the test bench or the transparent cell in specific; however, that was not possible due to the absence of an air flowmeter at the side of the production valve.

Tank Leakage Rate vs. Tank Pressure

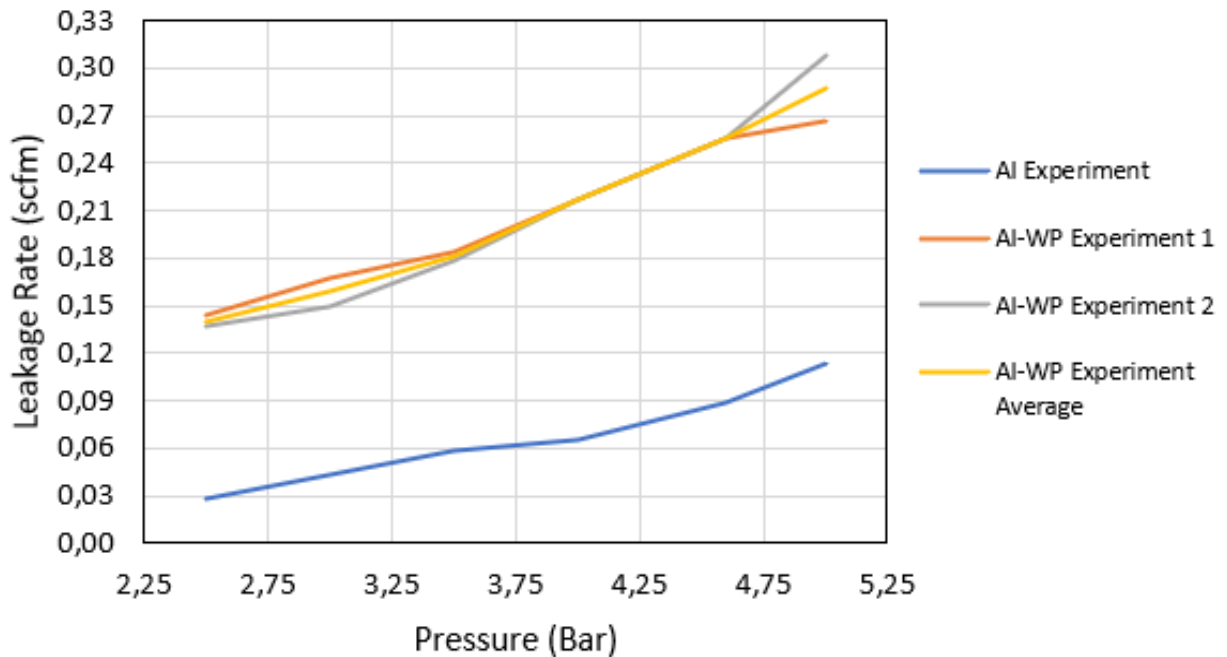

Figure 51 Tank Leakage Rate vs. Tank Pressure During Both Experiments

5.2 Recommendations for Future Work

Regarding the HP test bench:

- Acquiring a gas flow meter that has a compatible range with the air flow available at the laboratory could allow the comparison between the results obtained through the LP test bench and the HP test bench. This will make it possible to further verify the results.
- Conduct experiments using other fluids such as Exxsol D60 (liquid), and Nitrogen (gas) This will allow to test the applicability of the results to other conditions (e.g. different viscosity) and to verify the suitability of the current valve design.
- Conduct the tests at higher or lower temperatures than ambient.

Regarding the LP test bench:

- Add a gas flow meter at the side of the production valve to quantify the leakage rate through the production valve during the injection cycle. This will allow to compare against results from the HP test bench. Moreover, conducting more experiments in which air is injected into the tank continuously from outside the cell could help in simulating an air leakage experiment through the injection valve similar to that which can be performed through the HP test bench. The continuous flow would prevent the pressure decrease in the tank, maintaining a stable pressure as is the case with the HP test bench experiments.
- Conducting experiments using water with solids. This would represent closer the situation in a real well. Having faced some difficulties at the start of the experimentation with the pump used with the test bench, unclean water was pumped into the test bench

with dirt flowing into it. This dirt caused some discrepancies with the results of the leakage and closing rates. Thus, looking further into the impact of having particles covering the contact surface between the ball and the valve is something worth consideration.

6. Conclusion

F2F focuses on using a single well for injection and production simultaneously. Fractures in the reservoir are divided into alternating injection specific and production specific fractures. Such an arrangement requires having one-way valves within the completion to ensure that no unwanted backflow occurs.

Two types of one-way ball check valves were tested, an injection valve and a production valve. The valves included a Silicon Nitride ball along with a hex-hole lid to keep it in place. In addition, two blinds that have the same design of the valves but without an opening in them were made to quantify the leakage through the seal area by deducting any unwanted leakage through the threads.

Two test benches were used to conduct the experiments. The first is a high-pressure test bench. Two types of tests were conducted on this experimental setup with water as the used fluid: leakage tests and closing rate tests. The leakage test experiment was done on all four valves at 50, 75, 100, 125, and 150 bars as upstream pressures. The duration was between around forty minutes and two hours varying between the valves. This test allowed the understanding of the leakage behavior through the valves with the increase of pressure. The valves appeared to all have an increasing leakage with the increase in pressure, except for the case of the IV at 75 bars, which had a negligible decrease in leakage. Moreover, a closing rate test was performed on the IV and PV, with a duration of less than one minute. The main information targeted from this test was reached within the first few seconds when the flow rate peaked showing the rate needed to close the valve.

The second test bench is a low-pressure test bench which included a transparent cell. This test bench was developed during this thesis' work. The advantage of this test bench is that it allowed the visualization of the flow within the cell and the valves. This helped in understanding the nature of the leakage along with the specification of the flow rate needed to close the production valve by matching the numerical results with the actual occurrence of the valve's closing. Two experiments were performed using this test bench which were the air injection experiment, and the air injection- water production experiment. Both experiments began with injecting air into the test bench resulting in the pressurization of the metallic tank; however, the AI experiment was made to measure the air leakage through the injection valve when the tank is depressurizing without any pushback against the ball in the valve. On the other hand, the AI-WP experiment had a water production cycle after the air injection cycle, resulting in water pushing against the closure of the injection valve. This resulted in a higher leakage rate through the injection valve compared to the AI experiment. Furthermore, the leakage rate in both experiments appeared to decrease with the decrease of pressure.

Finally, although some uncertainties were present throughout the experimentation, such as the torque which the valves underwent when inserted into the pressure cell, and the thread sealing tape added to the valves, the results achieved show positive signs for the experimentation work going forward. Leakage rates appeared to fall way below the leaking limit set by NORSOK which proved the integrity of the valves' design. Therefore, the valves will be an integral component in making the F2F method an efficient SWEOR method, which is economic, easy to perform and does not have negative impacts on the environment.

References

- API Recommended Practice 14B, Recommended Practice for Design, Installation, Repair and Operation of Subsurface Safety Valve Systems (1994). (1996). *American Petroleum Institute*.
- Azhar, R. (2016). *Cyclic Same-Well Enhanced Oil Recovery* (Master's thesis, NTNU, 2016) (pp. 13-15). Trondheim: NTNU.
- Fu, X., Bonifas, P., Finley, A., Lemaster, J., He, Z., & Venepalli, K. (2019). Tight Oil EOR through Inter-Fracture Gas Flooding within a Single Horizontal Well. *Society of Petroleum Engineers*. doi:<https://doi.org/10.2118/196078-MS>
- Mydland, S., Yusra, I., Whitson, C., Dahouk, M., & Carlsen, M. (2020). Gas EOR Processes in Tight Unconventionals. *Society of Petroleum Engineers*. doi:<https://doi.org/10.2118/200396-MS>
- Nawfal, O. (2020). *Experimental Testing and Modelling of Water Flow Through a One-Way Valve* (Rep.). Trondheim.
- Nikolaou, M., Luo, G., & Ehlig-Economides, C. (2019). Interactive Session: Systems and Process Control. In *Optimizing Tight Oil Recovery through a Single Well Alternating Production-Injection Procedure*. Orlando, Florida: AIChE.
- Sheng, J. (2015). Enhanced oil recovery in shale reservoirs by gas injection. *Journal of Natural Gas Science and Engineering*. doi:10.1016/j.jngse.2014.12.002
- Wang, L., Tian, Y., Yu, X., & Wang, C. (2017). Advances in improved/enhanced oil recovery technologies for tight and shale reservoirs. *Fuel*. doi:10.1016/j.fuel.2017.08.095

Appendix A: Supporting Parts and Tools Used



Figure 52 Bolts and Nuts Used to Keep the Pressure Cell in Place



Figure 53 Key used to Insert the Injection Valves



Figure 54 Key Used to Insert the Lid on the Valves



Figure 55 Stand Used to Hold the Pressure Cell When Changing Valves

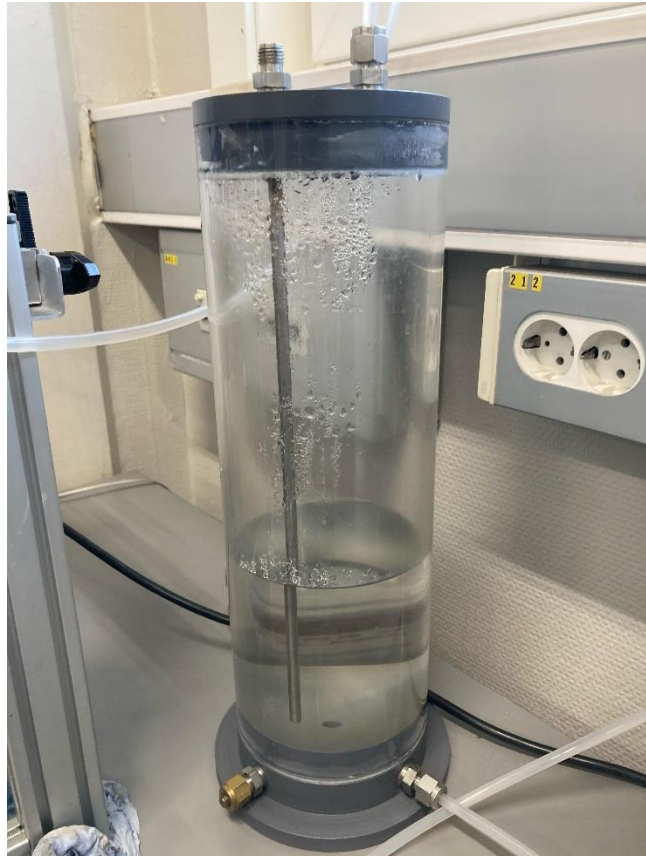

Figure 56 Transparent Water Tank Used



Figure 57 Thread Seal Tape Used to Decrease Thread Leakage



Figure 58 Wrenches Used to Unscrew the Pressure Cell Bolts



Figure 59 Air Source at the Laboratory

Appendix B: Previous Results from the Specialization Project

Flow rate F1 vs. Time (50 bar-IB)

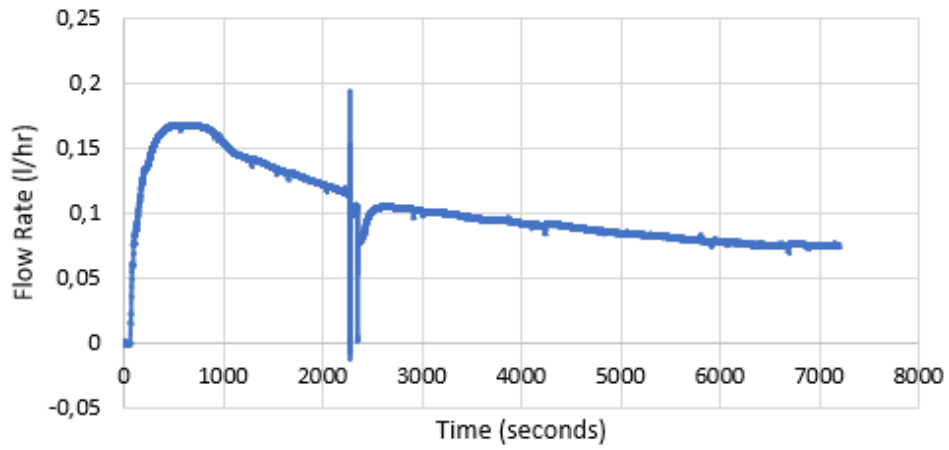

Flow rate F1 vs. Time (50 bar-IB) Stabilized Region

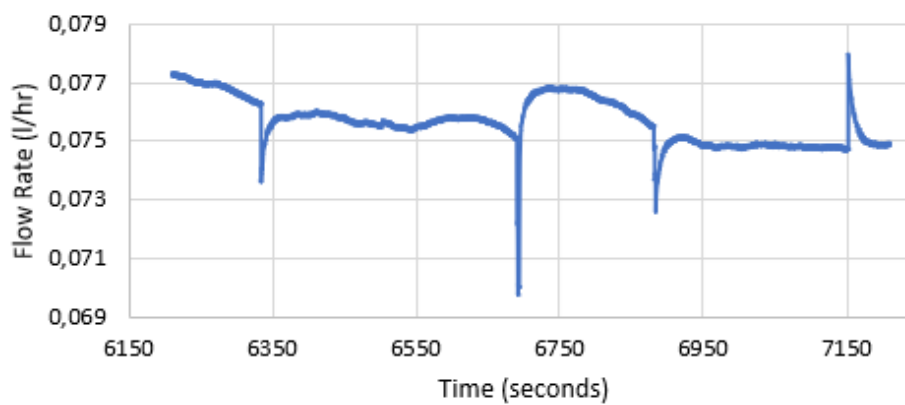
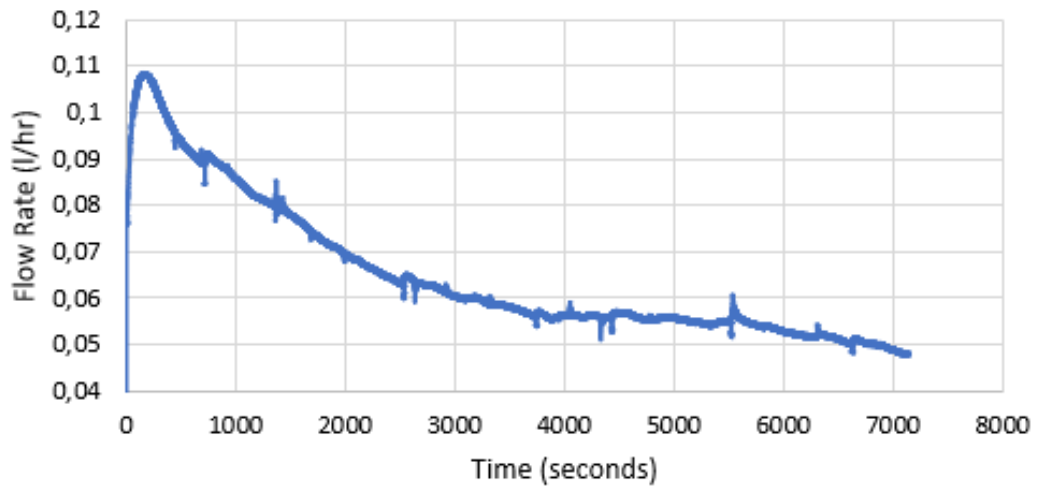

Figure 60 Flow Rate vs. Time of Injection Blind (50 bar)

Flow rate F1 vs. Time (100 bar-IB)



Flow Rate F1 vs. Time (100 bar-IB) Stabilized Region

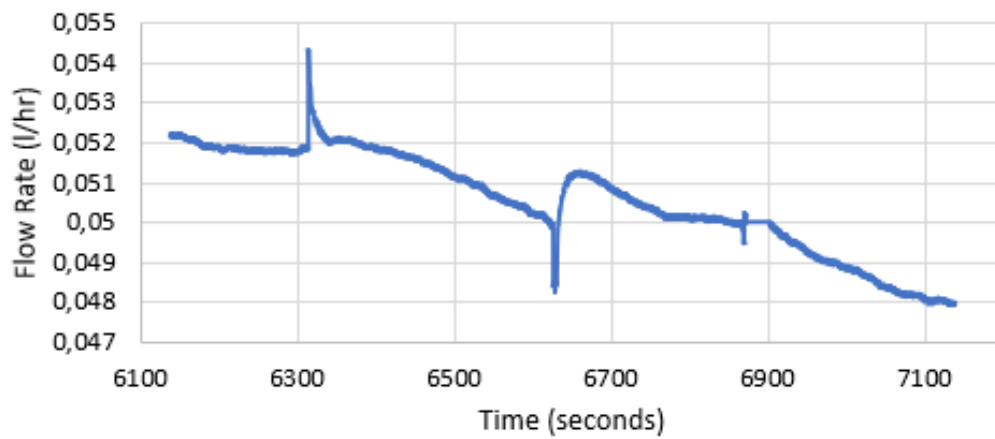
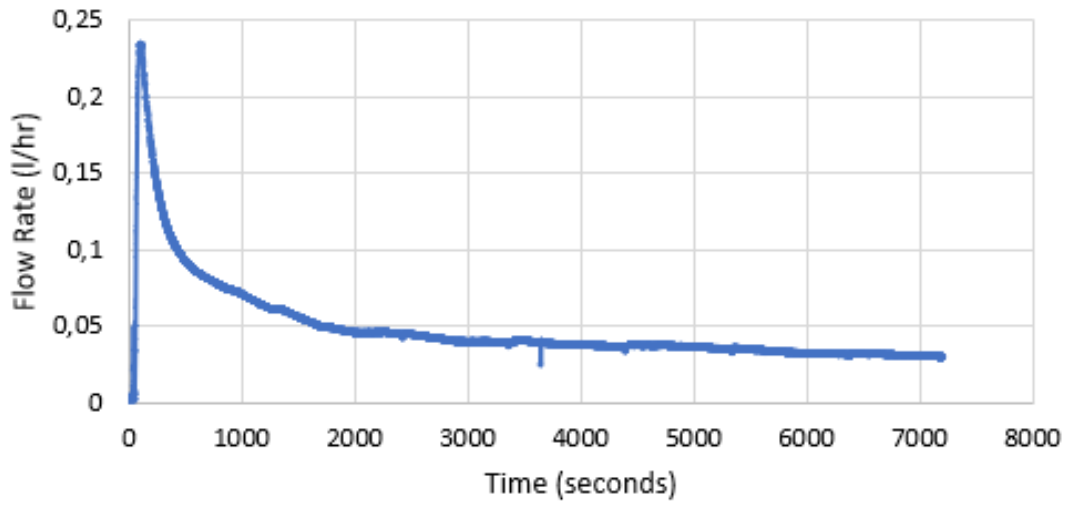

Figure 61 Flow Rate vs. Time of Injection Blind (100 bar)

Flow Rate F1 vs. Time (150 bar-IB)



Flow Rate F1 vs. Time (150 bar-IB) Stabilized Region

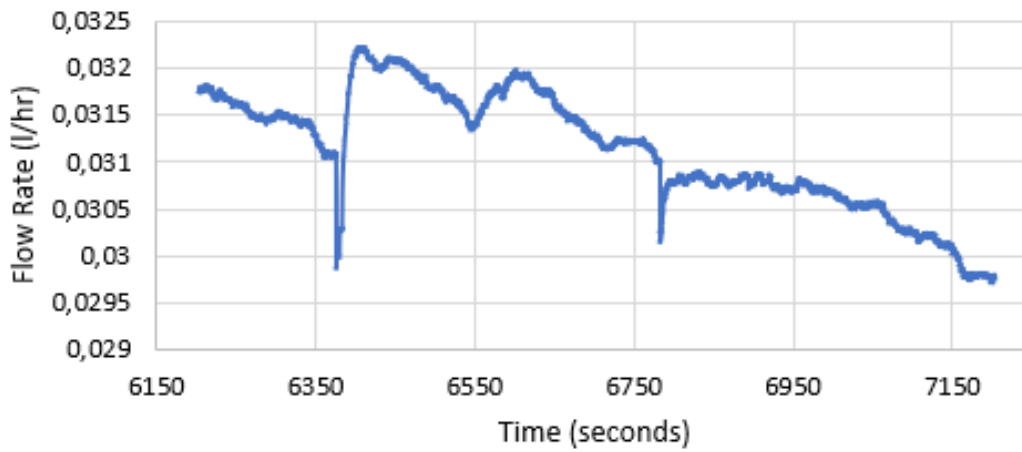
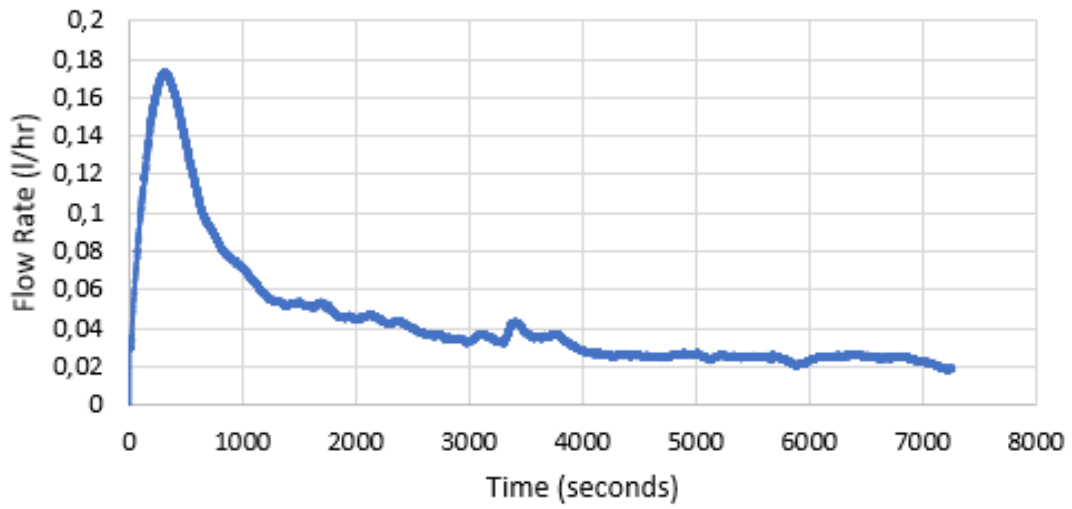

Figure 62 Flow Rate vs. Time of Injection Blind (150 bar)

Flow Rate F1 vs. Time (200 bar-IB)



Flow Rate F1 vs. Time (200 bar-IB) Stabilized Region

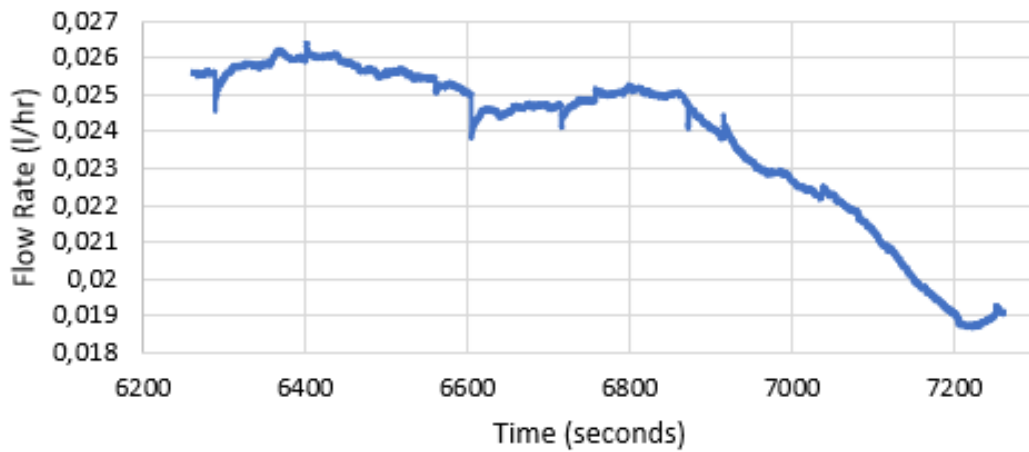
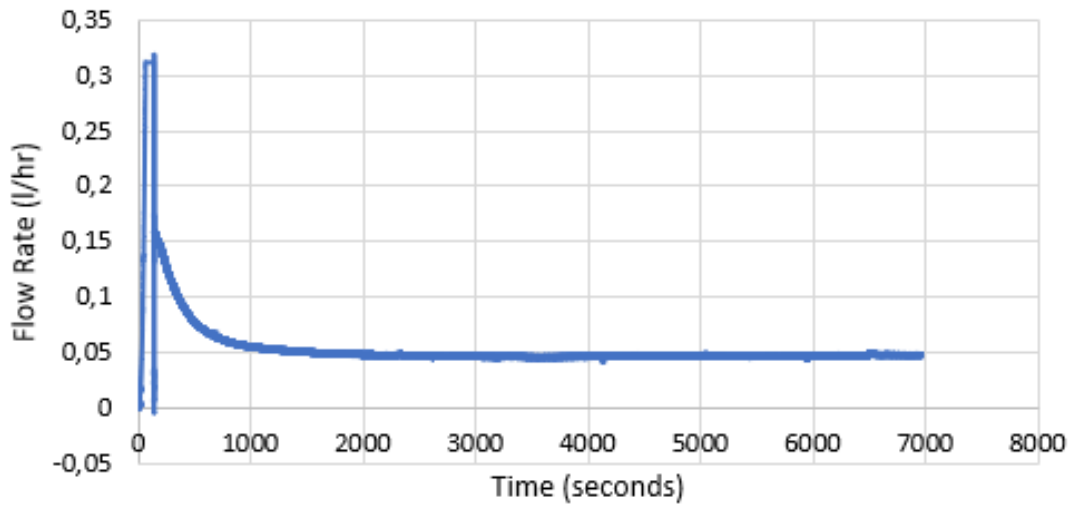

Figure 63 Flow Rate vs. Time of Injection Blind (200 bar)

Flow rate F1 vs. Time (50 bar-IV)



Flow Rate F1 vs. Time (50 bar-IV) Stabilized Region

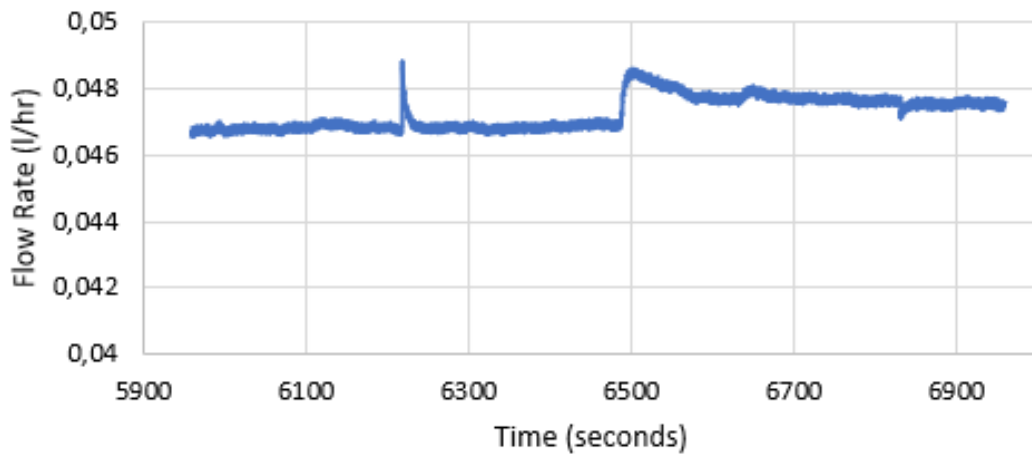
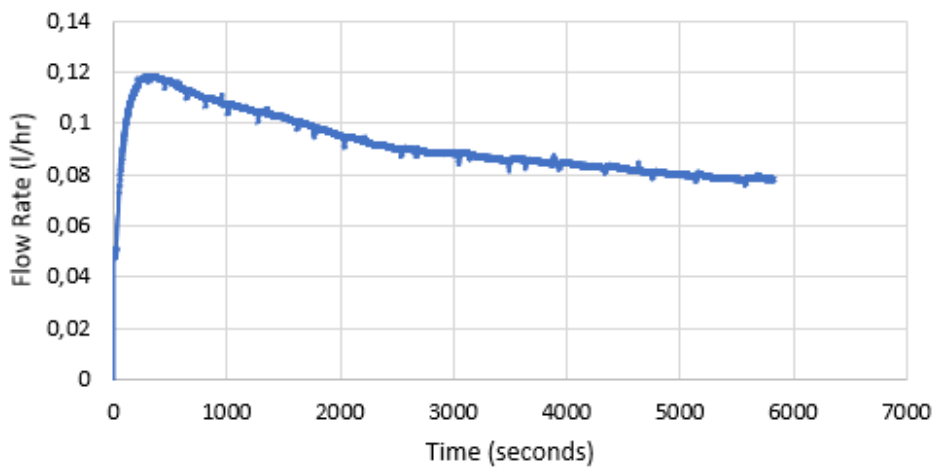

Figure 64 Flow Rate vs. Time of Injection Valve (50 bar)

Flow Rate F1 vs. Time (IV-100 bar)



Flow Rate F1 vs. Time (IV-100 bar) Stabilized Region

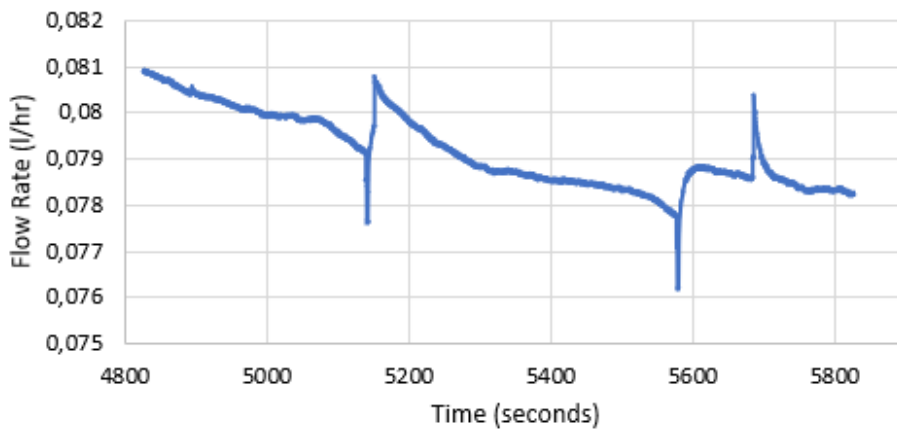
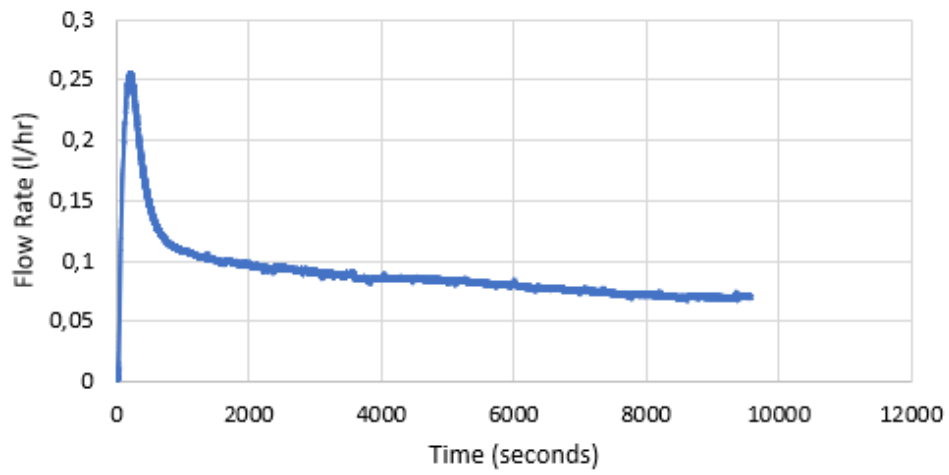

Figure 65 Flow Rate vs. Time of Injection Valve (100 bar)

Flow Rate F1 vs. Time (IV-150 bar)



Flow Rate F1 vs. Time (IV-150 bar) Stabilized Region

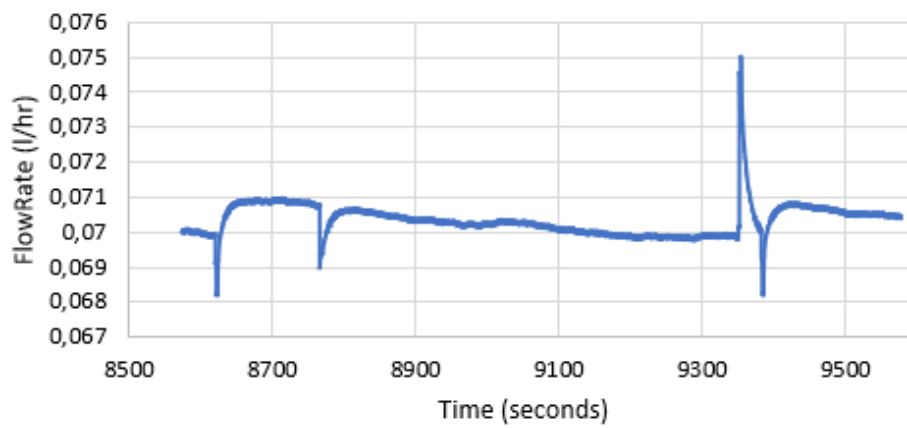
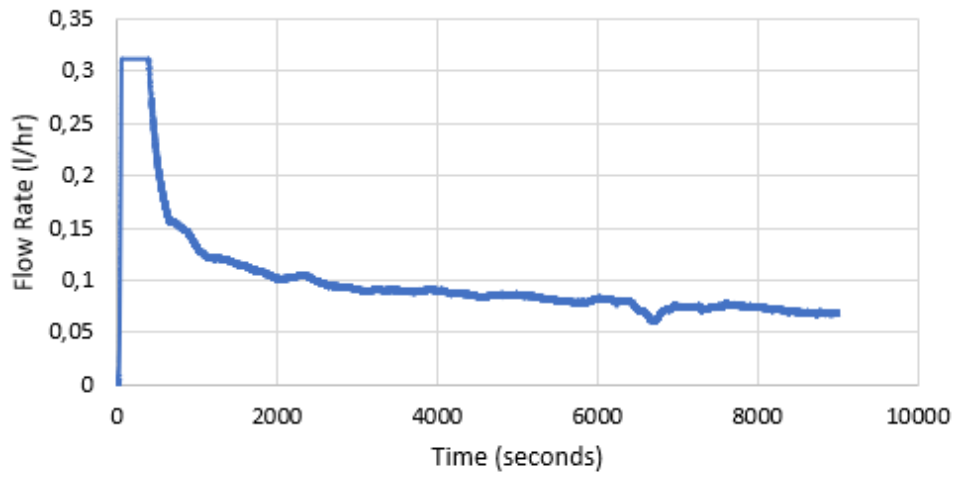

Figure 66 Flow Rate vs. Time of Injection Valve (150 bar)

Flow Rate F1 vs. Time (IV-200 bar)



Flow Rate F1 vs. Time (IV-200 bar) stabilized Region

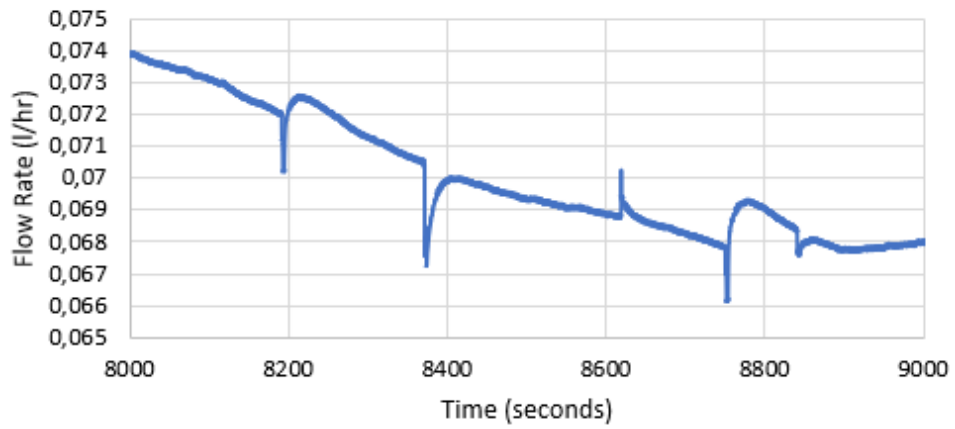
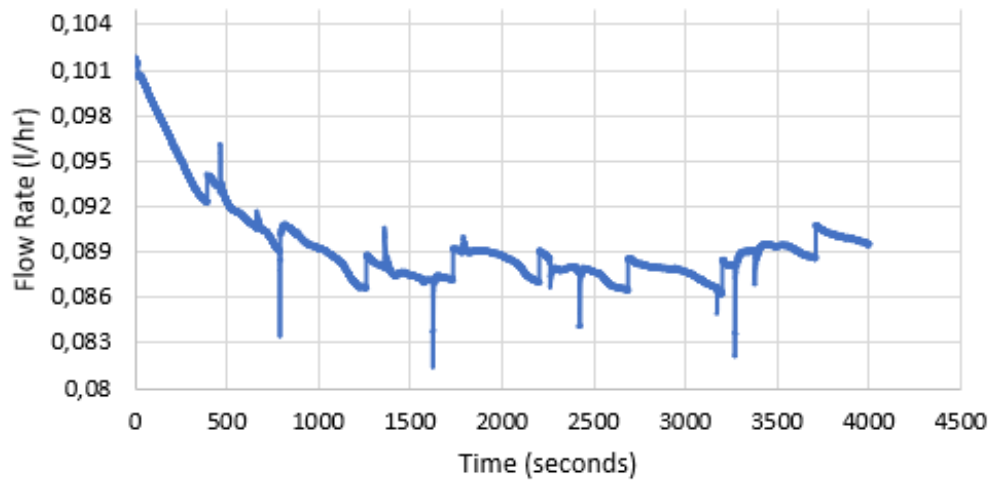

Figure 67 Flow Rate vs. Time of Injection Valve (200 bar)

Flow Rate F1 vs. Time (PB-50 Bar)



Flow Rate F1 vs. Time (PB-50 Bar) Stabilized Region

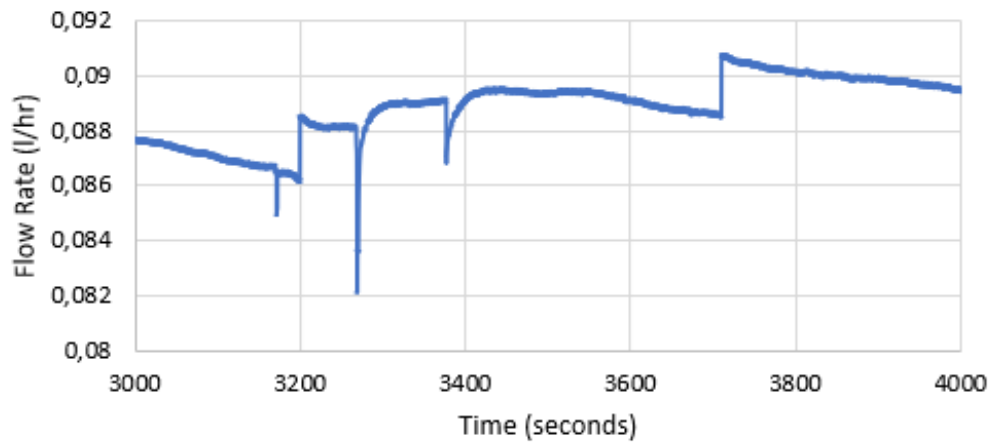
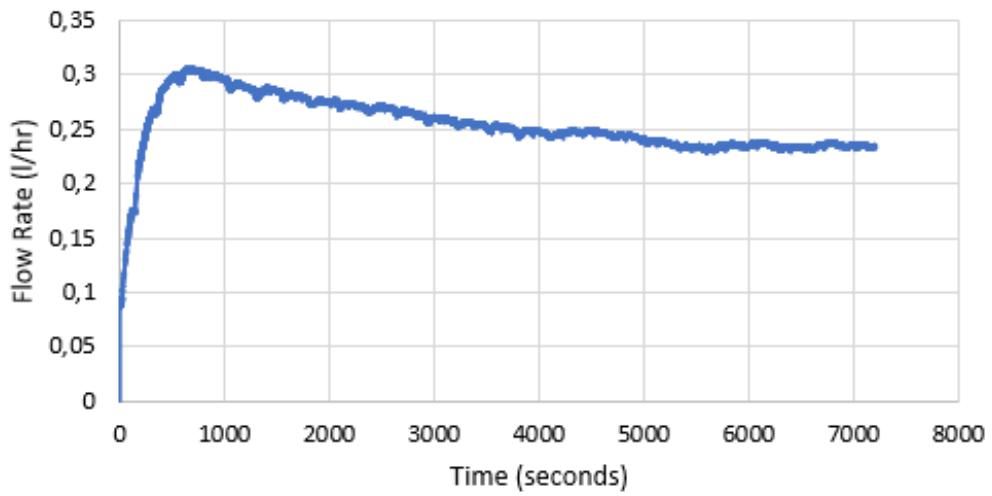

Figure 68 Flow Rate vs. Time of Production Blind (50 bar)

Flow Rate F1 vs. Time (PB-100 Bar)



Flow Rate F1 vs. Time (PB-100 Bar) Stabilized Region

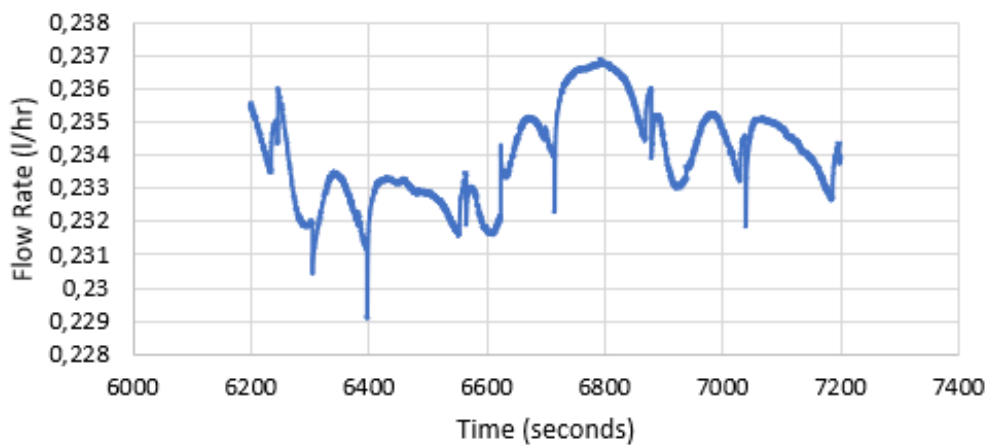
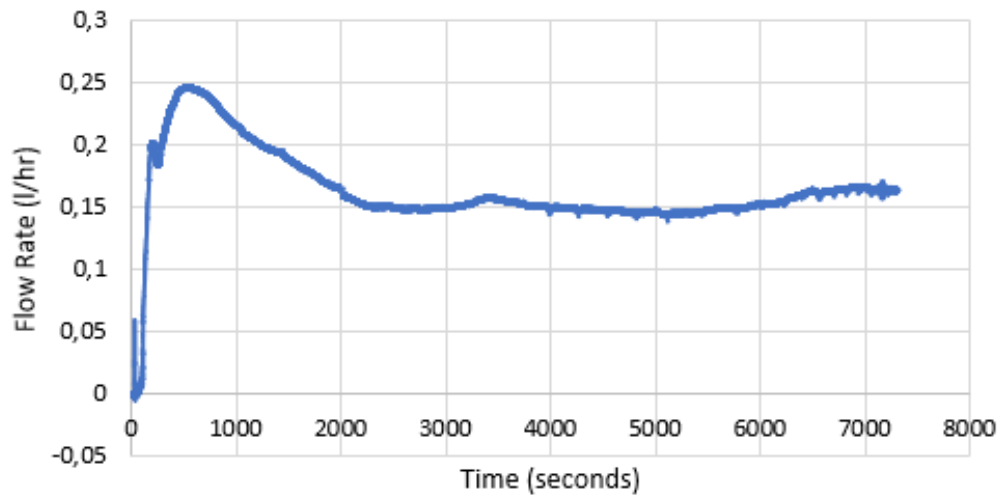

Figure 69 Flow Rate vs. Time of Production Blind (100 bar)

Flow Rate F1 vs. Time (150 bar-PB)



Flow Rate F1 vs. Time (PB-150 Bar) Stabilized Region

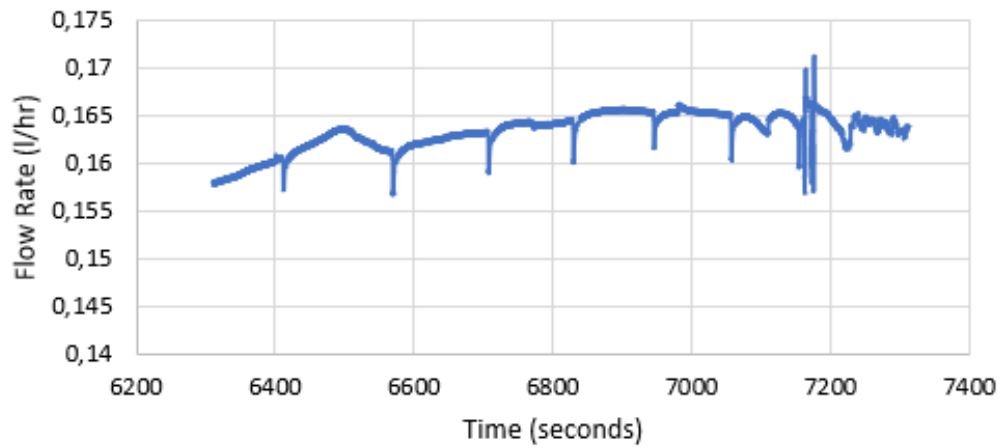
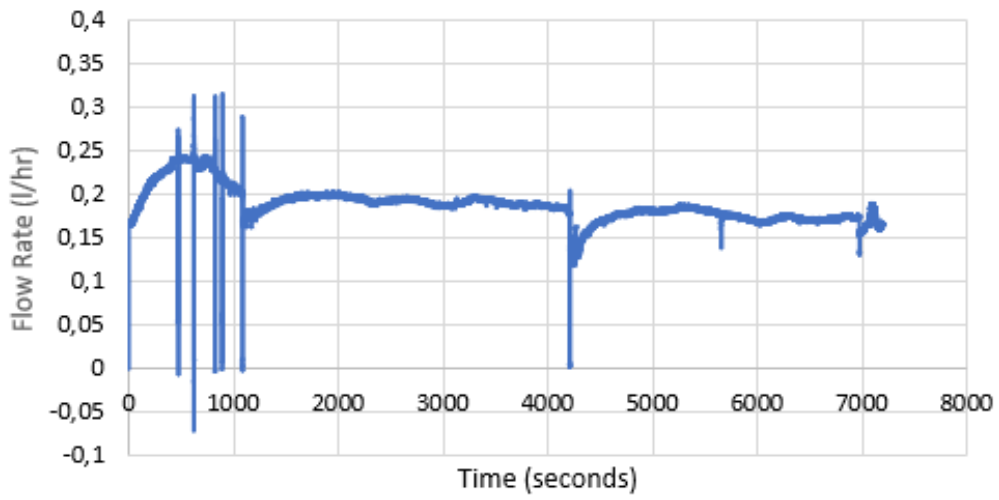

Figure 70 Flow Rate vs. Time of Production Blind (150 bar)

Flow Rate F1 vs. Time (PB-200 Bar)



Flow Rate F1 vs. Time (PB- 200 Bar) Stabilized Region

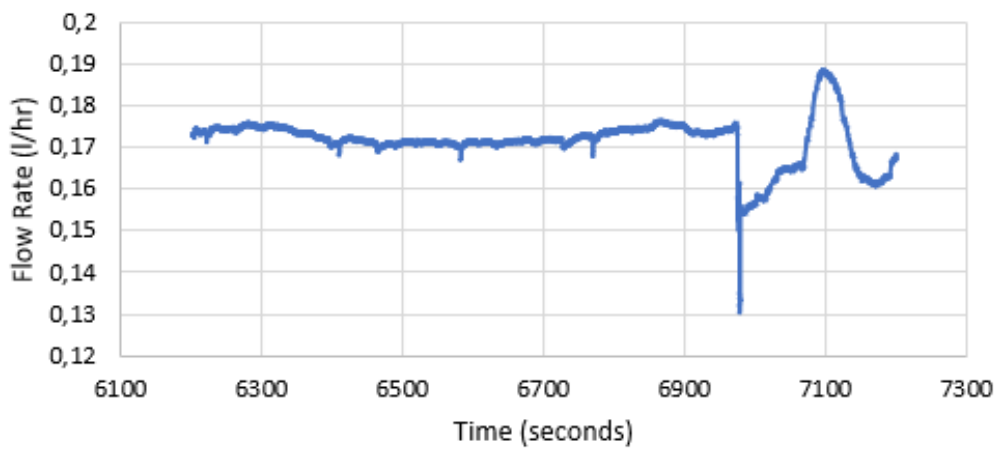

Figure 71 Flow Rate vs. Time of Production Blind (200 bar)

