

Fridtjof Paus Mollatt

# Discussing benefits and strategies for automation using a macroeconomic stock-flow model and modern monetary theory

Master's thesis in Kybernetikk og Robotikk

Supervisor: Trond Andresen

July 2020



Discussing benefits and strategies for automation using a  
macroeconomic stock-flow model and modern monetary theory

Fridtjof Paus Mollatt

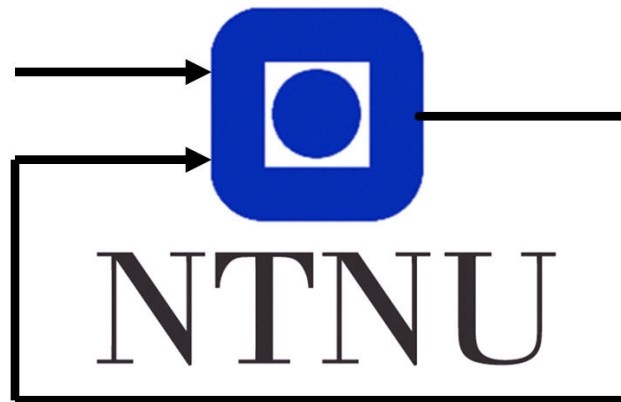

Faculty of Information Technology, Mathematics and Electrical Engineering  
Norwegian University of Science and Technology

Norway  
July 2020

Supervisor: Trond Andresen, IE

## Preface

This thesis is dedicated to the advancement of the system dynamics approach to understanding all forms of systems. In particular, I hope this thesis can help us better understand the monetary system.

I want to thank my supervisor, Trond Andresen, for valuable insights and help during my work with the thesis. As I am an engineering student, I do not have any formal education in economics. Therefore my work started by examining the economic history and macroeconomic theory, and I spent the first few months of my work reading different economic and system theory literature to understand how the model should be implemented. Gradually I started working on the implementation of the stock-flow model in collaboration with my supervisor. This thesis presents my findings and modelling approach.

Trondheim, July 11th, Fridtjof Paus Mollatt

## Summary

This thesis develops a framework for understanding the impacts of automation on society and looks at the possible future outcomes using a macroeconomic stock-flow model based on modern money theory.

1. The thesis starts by examining the impacts automation and technology has had on the society and the individual labourer historically. In developing the framework, macroeconomic changes in the industrial revolution are used to find analogies to the situation we are in today. Further, it reports on the consequences of recent developments in automation and other technologies which makes human labour more productive.
2. The thesis embraces the modern monetary theory and points out some of its most essential criticisms of other economic schools of thought. This thesis focuses on the macroeconomic literature which concerns government spending, the labour market and labour productivity. These are all subjects which will be used later to set up the mathematical relationships and dynamics in the simulation part.
3. To make reasonable conclusions from the observations made in this thesis, it discusses what a prosperous future society might or should be. It draws upon different studies and literature which give a philosophical and scientific understanding of what we want the world to look like for the people living in it to be as prosperous as possible.
4. The thesis uses a stock-flow modelling approach to implement and understand the macroeconomic system. Therefore a section of the thesis draws upon literature on system dynamics and stock-flow modelling and explains the method in detail. The models are explained through diagrams and screen captures of the actual Simulink implementation. Later in the thesis are explanations for the mathematical methods and relationships used and the reasoning for choosing them. Then the parameters and implementation are explained.
5. Later in the thesis are explanations for the mathematical methods and relationships used and the reasoning for choosing them. Then the parameters and implementation are explained.
6. The simulations are then performed and the resulting dynamics, data are presented and discussed. The thesis then reflects on it and talks about the societal implications of the findings and the value of using stock-flow modelling to get valuable insights on the past, present and future.

# Contents

|          |  |           |
|----------|--|-----------|
| <b>1</b> | <b>Introduction</b>  | <b>5</b>  |
| <b>2</b> | <b>History of innovation and employment</b>                                | <b>6</b>  |
| 2.1      | Historical Economic Changes . . . . .                                      | 6         |
| 2.1.1    | Prehistoric Societies . . . . .  | 6         |
| 2.1.2    | Pre Industrial Economic Growth . . . . .                                   | 8         |
| 2.2      | Innovations in Technology . . . . .  | 9         |
| 2.2.1    | The First Industrial Revolution . . . . .                                  | 9         |
| 2.2.2    | The Second Industrial Revolution . . . . .                                 | 10        |
| 2.2.3    | The Third Industrial Revolution . . . . .                                  | 11        |
| 2.3      | Innovations in Management . . . . .  | 12        |
| 2.3.1    | Technofobia . . . . .  | 14        |
| 2.4      | Automation and its consequences in recent years . . . . .                  | 15        |
| 2.5      | The future of automation . . . . .   | 16        |
| <b>3</b> | <b>Economic Theory</b>   | <b>17</b> |
| 3.1      | Modern Monetary Theory . . . . .   | 17        |
| 3.1.1    | How money is created? . . . . .  | 17        |
| 3.1.2    | Fiscal Policy . . . . .  | 18        |
| 3.2      | Does creating money cause inflation? . . . . .                             | 19        |
| 3.3      | Unemployment . . . . .   | 20        |
| 3.3.1    | Frictional Unemployment . . . . .  | 21        |
| 3.3.2    | Hidden Unemployment . . . . .  | 21        |
| 3.3.3    | Structural Unemployment . . . . .  | 22        |
| 3.4      | Education . . . . .  | 22        |
| 3.5      | The Job Guarantee . . . . .  | 23        |
| 3.5.1    | The Unemployment buffer stock . . . . .                                    | 24        |
| 3.5.2    | The Employment buffer stock . . . . .                                      | 24        |
| 3.6      | Productivity and why it is relative . . . . .                              | 25        |
| 3.7      | Economic crisis . . . . .  | 26        |
| <b>4</b> | <b>What do we want the future to look like</b>                             | <b>27</b> |
| 4.1      | The Future of Jobs . . . . .   | 27        |
| 4.2      | The Argument for shorter Working Weeks . . . . .                           | 28        |
| 4.3      | The Argument for not increasing the production of goods . . . . .          | 29        |
| 4.4      | The Argument for wanting an increase in the degree of Automation . . . . . | 29        |
| <b>5</b> | <b>Systems Dynamics Theory</b>   | <b>31</b> |
| 5.1      | Causal Loop Diagrams . . . . .   | 31        |
| 5.2      | Stocks and Flows . . . . .   | 31        |
| 5.3      | System Modelling and Simulation . . . . .                                  | 31        |
| 5.4      | Path dependence . . . . .  | 32        |

|          |   |           |
|----------|---|-----------|
| <b>6</b> | <b>Making a Model of the labour market</b>                      | <b>33</b> |
| 6.1      | The Employees and Productivity . . . . .                        | 33        |
| 6.2      | The Degree of Automation (DA) . . . . .                         | 33        |
| 6.2.1    | How do we measure or calculate the degree of automation?        | 34        |
| 6.3      | The exclusion of money accumulation and banks . . . . .         | 36        |
| 6.4      | Wages, Taxes and Spending . . . . .                             | 37        |
| 6.5      | Increased Productivity from Management and Digitization . . . . | 38        |
| 6.6      | The Government . . . . .  | 39        |
| 6.7      | The Sectors . . . . .   | 41        |
| 6.7.1    | The Government Financed (GF) Sector . . . . .                   | 42        |
| 6.7.2    | The Automatable Sector . . . . .                                | 43        |
| 6.7.3    | The Job Guarantee (JG) and Education Sector . . . . .           | 45        |
| 6.7.4    | The Private Service Sector . . . . .                            | 46        |
| 6.7.5    | People laid off from the private service sector . . . . .       | 48        |
| 6.8      | Measuring prosperity in the society . . . . .                   | 49        |
| 6.8.1    | The amount of hours worked . . . . .                            | 50        |
| 6.8.2    | The amount of money spent in the private service sectors        | 50        |
| 6.8.3    | The BER value . . . . .   | 50        |
| 6.9      | Initial Sector Sizes . . . . .                                  | 50        |
| <b>7</b> | <b>Causal Diagrams</b>  | <b>52</b> |
| 7.1      | The Automatable Sector Diagram . . . . .                        | 53        |
| 7.2      | The Private Service Sector . . . . .                            | 54        |
| 7.3      | The Government . . . . .  | 56        |
| 7.4      | Spending, salaries and taxes diagram . . . . .                  | 57        |
| 7.5      | Change of Employees in JG and Education Sector Diagram . . .    | 58        |
| <b>8</b> | <b>Results and discussion</b>                                   | <b>61</b> |
| 8.1      | Choosing parameters . . . . .                                   | 61        |
| 8.2      | The reference simulation . . . . .                              | 62        |
| 8.3      | Changing the initial Sector Sizes . . . . .                     | 68        |
| 8.4      | The deficit to GDP ratio . . . . .                              | 70        |
| 8.5      | Tax rates . . . . .   | 72        |
| 8.6      | Working Hours . . . . .   | 73        |
| 8.7      | Increasing the labour share in the automatable sector . . . . . | 75        |
| 8.8      | Crisis Dynamics . . . . .                                       | 76        |
| <b>9</b> | <b>Conclusion</b>   | <b>80</b> |

# 1 Introduction

Mathematically formulated causal relationships can describe most systems at many different levels of abstraction. However, the method of making stock-flow models and running simulations on them sees little use. This is unfortunate as mathematical modelling using principles from systems dynamics can give valuable insights into the inner workings of systems. This thesis tries to shed some light on how we can use stock-flow modelling combined with the modern monetary theory to increase our knowledge and understanding of microeconomics and the impacts of increased automation. No literature has been found where the same approach is used to look at the positive and adverse effects of an increasingly automated society. However my approach has been highly influenced by Trond Andresen's Thesis for the degree of Doctor Philosophiae called "On the Dynamics of Money Circulation, Creation and Debt – a Control Systems Approach" [12] where he makes a case for increased use of mathematical tools among academic economists.

This thesis uses the stock-flow modelling approach get observations and insights about the impacts of increased automation on society, with a focus on the effects on the labour market. Design choices are described and chosen through reading economic theory. The basis for macroeconomic understanding in this thesis is the works of William Mitchell, L. Randall Wray and Martin Watts through their comprehensive textbook called "Macroeconomics" [54] where they explain the economic thought of modern money theory.

The literature on automation and its historic and future impacts on society has been gathered from many sources, with a certain emphasis on the work of Carl Benedikt Frey and Michael A. Osborne called "The future of employment: How susceptible are jobs to computerisation?" [38]

To implement the models I have used the Matlab extension called Simulink. Simulink provides an easy way of implementing stock-flow models through the use of blocks and arrows with an extremely versatile toolbox of mathematical operations.



## 2 History of innovation and employment

Technological innovation has been a key driver for change throughout history. The agricultural revolution led to the first permanent settlements as people started farming the land instead of continuously moving about in search of food. This transition started about 10,000 years ago, and as the technology gradually improved the average amount of food produced per individual increased. When each person, on average, became able to produce more food than they needed for themselves and their family, people eventually started conducting other kinds of labour in which they traded their services for food produced by someone else. There were enormous shifts in the labour market during the period leading up to the 18th century. However, the rate of change was slow, and it would be unlikely for a single person living during this time to see any considerable change during his or her lifetime [40].

The industrial revolution started in Great Britain in the mid 18th century and spread to most countries in Europe and North America by the mid 19th century [40]. The industrialisation of production during the 18th and 19th century was primarily driven by technological innovation and led to rapid socio-economic changes. In the time before and during the initial part of the industrial revolution, the opposition to technological innovation was large. The opposition was mostly made up of skilled artisans who saw innovations in technology as damaging to their business. While the artisans saw meagre increases in their capacity for production, the factories became more and more productive by the year. The artisans were quickly unable to compete with the factories on price and quality [38].

### 2.1 Historical Economic Changes

In 2006, Eric D. Beinhocker presented his estimates of inflation-adjusted average incomes worldwide. Based on the 2006 dollar value, he estimated that the material wealth and living conditions of humans living 100,000 years ago would be equal to 100 dollars, people living 3000 years ago lived for about 150 dollars, and in 1750 the average income amounted for about 200 dollars [19]. Compared to the world average of 6,600 dollars per year in 2006, professional science sceptic Michael Shurmer writes: "It took 97,000 years to go from \$100 to \$150 per person per year, then another 2750 years to climb to \$200 per person per year, and finally, 250 years to ascend to today's level of \$6,600 per person per year for the entire world." [63]

#### 2.1.1 Prehistoric Societies

Before the onset of the agricultural revolution some 10 to 20 thousand years ago, people lived in tribes, and their "work" consisted of gathering food and water in nature for nutritional purposes. It is highly discussed how much time these hunter-gatherers spent "working" and whether or not their lives were actually more relaxed than modern-day life. By looking at modern-day hunter-gatherers

in the Amazon jungle, we can get an understanding of what their lives looked like. In his book *Life in the Marked Economy* [43] the author Stuart K. Hayashi claims that a common misunderstanding among anthropologists is that the life of prehistoric hunter-gatherers was more pleasurable than the average life of a modern human. He bases this belief on two common flaws in their reasoning [43].

The first common fallacy is to think that even though the average life expectancy of these people was low, it was mostly due to a high child mortality rate and if you got above the age of 15, you could reasonably expect to get above the age of 50. This fallacy is disclaimed by studies of 416 skeletons found in Still water March, Nevada. By studying the physical attributes of the skeletons they found that about 15 percent of the people were aged 15 or under at the time of their death. Of the 357 aged 15 or above, only 6 of them made it to the age of 50 [25].

The second common fallacy is to think that hunter-gatherers only worked for four hours a day and spent the rest of the time in leisure. Hayashi claims that while the figure might be right since the hunter-gatherers had no means of preserving food for long periods, they spent some periods hunting for food most of the day with hugely varying success rates. They never knew beforehand how long these periods of continuous hunting would last and often stayed hungry and without food for extended periods. The life in these periods is according to Hayashi wrongly glorified by many modern anthropologist [43]. Whether or not the early agricultural societies made the people living within the more prosperous, the agrarian societies gradually started being developed. The historian Jared Diamond describes the transition in his book *Guns, Germs and Steel* [33]. He argues that the transition was gradual and it might have taken several thousand for a society to shift from complete dependence on wild food to a diet consisting of little wild food [33].

Diamond also points out that there might be many factors leading to the rise of agriculture societies [33]. One of these is the fact that as agricultural technology improved and we were able to produce more food per person, women became fertile for a longer period of their life. Paradoxically, the agricultural revolution might not have led to an abundance of food as the population grew faster as a consequence of it. Nevertheless, this led to an increase in population in these societies and therefore it by definition became more widespread [21].

Before the onset of the industrial revolution, about 90 per cent of the people living in agrarian societies spent most of their waking hours farming and most of their surpluses fed a tiny minority of elites - kings, government officials, soldiers, priests, artists and thinkers [40]. These high standing people are the people who have written the history books and the life of a farmer from this era is therefore largely ignored.

The earliest somewhat reliable accounts of the farmer's life come from feudal lords in England where documentation comes from surveys, accounts the rolls of manorial courts. In the book *Everyday life in medieval England* author Christopher Dyer writes:

"Life in the village in the late thirteenth century was not one of abundance for

anybody. Given the productive powers of their soil, their technical knowledge, their capital resources and the burden of their rents and taxes, the number of peasants on the land were greater than than its produce could support”. and continues: ”From the perspective of modern times, the daily drudgery and scant returns of the medieval village appear less the product of the social system than of the state of technology” [34].

Based on these accounts, it is hard to argue that the prosperity of people living today is far higher than that of both the hunter-gatherers and the people living as farmers up until the late 18th century. How and why did the changes in income happen so rapidly in the last 300 years and how have the changes impacted well being of the average human being?

In this thesis, the focus will lie on the economic and technological aspects of the question. In essence, it will try to answer the question of how technological innovation and adaptation has changed the labour market as a whole. The thesis will mainly focus on the changes happening in Europe and North America for two reasons. Firstly there are a lot more accessible data about the early industrialisation within these continents. Secondly, as this thesis will mainly assess the effects of automation has on the labour market in Norway, the changes happening within these two continents will coincide to a large degree with what happened in Norway.

### 2.1.2 Pre Industrial Economic Growth

As Eric D. Beinhocker observed in estimating the average inflation-adjusted income in history, there has an unprecedented growth in the economy in the last three centuries also when accounting for the massive increase in population during the period. Gregory Clark, professor of economics at UC Davis, writes in his book *A farewell to arms* [31] after elaborating on the similarities of the life of the 1600s elite and the middle class of today:

”Thus I make no apologies for focusing on income. Over the long run income is more powerful than ideology or religion in shaping lives. No god has commanded worshippers to their pious duties more forcefully than income as it subtly directs the fabric of our lives.” [31]

As England has a uniquely well-documented wage and price history, the thesis will use this data as observations of change in the period. The change in real wage in England from 1200 to 1700 was variable but did not seem to have been on an upwards trend [30]. Based on the income level in 1860, the real income in the period from the 1200s to 1700s was about half. From 1860 to 2004 the income increased seven-fold [30].

During the industrialisation, there was a significant shift in the type of work conducted by the masses. Agricultural work had been the most prominent type of work leading up the industrial revolution. Today we produce more food than ever before, even after a substantial decline in the number of agricultural workers. Arguments have been made that the increase in productivity of farmers has been essential for growth in all sectors [40, 33].

There are two main reasons for the importance of efficiency increase in the

agricultural sector. Even though the amount of calories and food we consume today is far higher than that of 18th century people, the proportion of our income used for food consumption has declined [57]. As food production got more effective, the price of food declined as less people were needed to produce the same amount of food. Since the increase in efficiency outpaced the combined increase in population and consumption per capita, less hands were needed to work the land [57].

The production growth and the increased population, often attributed to improved medicine, sanitation and nutrition, which meant a larger amount of each persons children survived into adulthood [21]. From 1700 to 2000 the population in Western Europe grew from 81 million to 388 million people. This meant that the amount of people available for work in the factories were ever increasing. However the male workforce of the countryside decreased by 40% between 1861 and 1901, while agriculture as a percentage of the national wealth fell from 20.3% in 1851 to just 6.4% by 1901 [56].

The factories in the cities was not capable of employing the growing population and emigration from Europe to North America increased [16]. From 1815 to 1930, about 33 million Europeans emigrated to the U.S. and a total of 54 million Europeans emigrated when including emigration to Australia and South-America. The need Europe had for jobs might have been one of the causal factors for the technological progress it had.

## 2.2 Innovations in Technology

”There is the air of inevitability about the simultaneous discoveries. When the necessary web of supporting technology is established, then the next adjacent technological step seems to emerge as if on cue. If inventor X does not produce it, inventor Y will. The step will come in the proper sequence.”

-Kevin Kelly, *What technology wants* [51]

### 2.2.1 The First Industrial Revolution

The industrialisation of the economy is often divided into four different industrial revolutions. Each one of these is defined by one or a few innovations which lead to an economic paradigm shift. The first industrial revolution is marked by the transition to mechanical manufacturing in Europe in the mid 18th century. The textiles industry in Britain is often said to be where the introduction of machinery and large scale factory production started. During the 17th century, cotton textiles had become the most imported article in England. As this was cheaper than the domestically produced wool textiles, there was a large decline in demand for the domestic products which caused local farmers to go out of business. This led to the Calico act of 1701 and 1721, which stated that the import and sale of cotton textiles and most other cotton products were prohibited

with an exception for raw cotton. Raw cotton was then imported for weaving. However, as the average wage in England was much higher than those in India and China, they were unable to compete in price [24]. To make their products cheaper, they had to increase the productivity of their workers and this led to a myriad of new inventions in the textile industry in Britain. During the 18th century in England, many new inventions were created, and they became the leading producer of cotton textiles by the early 19th century, even exporting its cheap products to India [43].

During the same time as the cotton industry was industrialised in England, the steam engine was developed. Thomas Newcomen invented the first commercial steam engines in the early 18th century, and their primary use was to pump water out of deep mines. It was improved upon by James Watts in the late 18th century and in 1783 he had perfected it, so it was smaller, much more efficient and capable of producing rotary motion. The steam engine was then introduced into the factories to power even more productive machines which did not rely on power from humans. Later the steam engine saw use outside the factories, most notably in transportation where the first commercial steam-powered railroad system and ships were developed in England in the early 19th century [75].

Throughout the first industrial revolution, English factories were secretive of their new machine technology, and the government even imposed laws which prohibited exportation of the technology and machines developed. This secretive attitude led England to gain a considerable advantage over other nations in their productive capacity. In the late 18th and early 19th century, most of the English technology which found its way out of England was through spies. Soon England realized it was impossible to keep the technology out of reach of the other countries and they changed their tactics to selling machines across the border. Even though England had gotten an enormous head start on the rest of the world, many countries surpassed them in productive capacity during the 20th century [68].

The sudden increase in economic growth had broad implications. As the business leaders and capitalists saw their profits surge due to their investments in machines, capital investments started to shift from trade to factory production. Increasing profits from the factories were reinvested in the factory to increase their productive capacity further. The new form of investments further accelerated the rate of technological innovation and labour decreasingly seen as the primary means of increasing profits in all industries [55].

### **2.2.2 The Second Industrial Revolution**

Although technological and scientific discoveries happened continuously during the 19th century, the end of the first industrial revolution is marked by a slowdown of innovation in the mid 19th century. The downturn did not last long as the second industrial revolution, famously called 'the age of synergy' by science writer Vaclav Smil, started around the 1870s and lasted until the first world war in 1914. While the introduction of new machines in production marks the first industrial revolution, the second also had major innovations in communica-

tion and transportation. The importance of communication and transportation might not be as evident as that of factory machines, but many experts on technological innovation will argue that it is crucial due to the increased spread of ideas [9, 47].

”Like the free market itself, the case for restricting the flow of innovation has long been buttressed by appeals to the ‘natural’ order of things. But the truth is, when one looks at innovation in nature and in culture, environments that build walls around good ideas tend to be less innovative in the long run than more open-ended environments. Good ideas may not want to be free, but they do want to connect, fuse, recombine”.

-Steven Johnson, *Where good ideas come from* [47]

The stagnation in technological development that led to the end of the first industrial revolution might have come to be due to the secretive attitude of countries and companies at the time. The stagnation was short-lived as the second industrial revolution saw ideas and information spread more rapidly. One of the most notable inventions of the second industrial revolution was the telegraph. The telegraph was important because of the significant increase in information transmission it provided [64].

In the ‘age of synergy’, we got better railways, roads and later the introduction of the internal combustion engine which saw uses in cars and planes. Globalisation increased during this period, and states saw more and more benefits of specialisation of production on a national level. Electrical lighting and machines driven by electrical energy were introduced during this period. At the Ford Motor Company, the first assembly lines were introduced in the early 20th century. From 1913 to 1916 the Ford Motor Company were able to increase production from 80.000 to 600.000 cars per year, reduce the price of a car from 600 \$ to 360 \$ while also increasing the average wage at the factories from 2.35 \$ per day to 5 \$ per day [64].

The end of the second industrial revolution is marked by the beginning of the first world war. The reason for the end of the second industrial revolution is the decline in the rate of economic growth. While the United States saw an average of 4 per cent yearly growth in the economy from 1890 to 1910, the average economic growth from 1910 to 1929 had declined to 2.8 per cent [43].

### 2.2.3 The Third Industrial Revolution

In the early to mid 20th century, the western world saw innovations and a higher degree of adaptation of them in areas such as energy, household products, transportation, communication, information sharing, medicine and warfare. The market for products directed at the individual consumer increased both in the number of available products and in total revenue [32] This becomes quite evident if we look at the number of patent applications in the US per year. From 1900 to 1950 the number rose from about 40.000 to 67.000, a

meagre 68 per cent increase. However, from 1950 to 2019, the number of patent applications saw an almost 10-fold rise to 621.000 patent applications [58].

From the late 1900s until the 2020s the computer and the internet are the defining innovations. The computer has far-reaching applications and is used in almost every aspect of most peoples working lives. The internet has enhanced our ability to share ideas, increasing the rate of innovation further. The kind of productivity increase which are caused by the increased use of computers and the internet are not strictly confined to the productive industry. While the decrease in the cost of computation has been instrumental for the development of ever more sophisticated automation techniques, it has had a huge impact in every sector of the economy [51]. The impacts of computers and the internet is discussed further in sections 2.4 and 2.5.

### 2.3 Innovations in Management

In a paper by Raymond Stata, founder of S & P 500 company Analog Devices, Inc and National Academy of Engineering member, from 1989 he wrote that the evidence at the time suggested that the loss of competitiveness in corporate America was the declining rate of innovation and added: "Usually we think of innovation in terms of technologies that give rise to a new class of products or to improvements in the design and manufacture of existing products. But at Analog Devices, and many other U.S. companies, product and process innovation are not the primary bottleneck of progress. The bottleneck is management innovation." [66].

In addition to the technological innovation of new machines, the factories became more and more productive due to their ability to subdivide the different labours tasks involved in the production. Adam Smith illustrates this point in his book *The wealth of nations* (1776). In the book he describes his visit to a pin factory: "one man draws out the wire, another straightens it, a third cuts it, a fourth points it, ... and the important business of making a pin is, in this manner, divided into about eighteen distinct operations, which, in some factories, are all performed by distinct hands."

The benefits of this process, which Smith calls "the division of labour", are many:

"The great increase in the quantity of work, which, in consequence of the division of labour, the same number of people are capable of performing, is owing to three different circumstances; first, to the increase of dexterity in every particular workman; secondly, to the saving of time, which is commonly lost in passing from one species of work to another; and, lastly, to the invention of a great number of machines which facilitate and abridge labour, and enable one man to do the work of many." [65] Half a century later, in 1832, the great inventor Charles Babbage released his book *On the Economy of Machinery and Manufactures* [15] in which he argued that Smith had forgotten to mention another important consequence of the division of labour. He writes:

"That the master manufacturer, by dividing the work to be executed into different processes, each requiring different degrees of skill and force, can pur-

chase exactly that precise quantity of both which is necessary for each process; whereas, if the whole work were executed by one workman, that person must possess sufficient skill to perform the most difficult, and sufficient strength to execute the most laborious, of the operations into which the art is divided”.

By looking at the wage difference between the workers of each of the tasks performed in the pin manufacturing, he concludes: ”The pins would therefore cost, in making, three times and three quarters as much as they now do by the application of the division of labour” [15].

The principle was later coined as the ”Babbage principle” by economic philosopher Harry Berman in his 1976 book ”Labor and Monopoly Capital - The Degradation of Work in the Twentieth Century.” In the book, Berman describes how the Babbage principle would become more and more prevalent as factories grew larger and larger during the 19th century. He writes:

”While these tendencies of the capitalist division of labor were already evident in the nineteenth century, it was not until the maturation of monopoly capitalism in the twentieth century that they came to be applied systematically. The development of the division of labor, as Adam Smith observed, was dependent on the extent of the market and the scale of production. Its full development was therefore impracticable for the small family firm that still predominated in the nineteenth century. With the rise of the giant corporation in the late nineteenth century, however, all of this changed”. [23]

Babbage made many key observations about how large corporations could be managed to make the workers as efficient and productive as possible. His observations were further synthesised by the mechanical engineer Frederick Winslow Taylor in his 1911 book ”The Principles of Scientific Management”. In the book, he describes, using many examples, how the manager of a firm can divide and organise the workers performing the various tasks involved in the production of a product. Essentially he claimed that the managers should look at their workers as machines and went into detail on how they should scientifically introspect each movement of the worker to maximise their efficiency. He called the method of management ”Scientific Management”. [71]

Its hard to quantify the actual impact Taylor has had on the industry of the 20th century and beyond, but in 2001 the book was by Fellows of the Academy of Management voted the most influential management book of the twentieth century [18].

In George Soule’s 1952 paper *Economic forces in the American History* [41] he wrote about Taylorism and said: ”[Taylorism] As a separate movement is virtually disappeared in the great depression of the 1930’s, but at that time knowledge of it had become widespread in industry and its methods and philosophy were commonplace in many schools of engineering and business management”. By this he meant that Taylorism had, after the great depression, become the generalised way of operation and had been superseded as merely a sect [41].

During the 20th century, many studies were conducted trying to find novel ways of increasing the output and profit of corporations. In the 1920s Western Electric Company funded a study conducted by psychologist Elton Mayo and social scientist Fritz Roethlisberger where they looked at how workers performed



in with different amounts of lighting. The conclusion of the study was surprising. It turned out that the participants were more productive than the control group no matter the amount of illumination. Elton Mayo soon concluded that the increase in productivity could be attributed to the increased attention the workers got from evaluators during the study. The effect from the increased attention has later been called the "Hawthorne Effect", and Elton Mayo has been attributed as the father of the Human Relation Movement [26].

The Human Relation (HR) Movement has since gained increased traction, and today most large corporations have an HR division. The contrast between Taylorism and HR is not in its motives but its approach. Both movements seek to make companies more efficient, and while Taylor and Ford largely focused on the productive behaviour of the workers, the HR movement focused more on the psychology of workers and the working groups. This includes aspects of work such as group composition, motivation, job satisfaction, rewards and training. As more studies were conducted, evidence accumulated and the field of organisational psychology was increasingly taught to students of management [14].

### 2.3.1 Technofobia

William Lee invented the stocking frame knitting machine in 1589, hoping that it would relieve workers of hand-knitting. When presenting the machine from Queen Elizabeth I, seeking a patent, she declined saying: "Thou aimest high, Master Lee. Consider thou what the invention could do to my poor subjects. It would assuredly bring to them ruin by depriving them of employment, thus making them beggars" [38].

Opposition to technological innovation, often called technophobia, is often seen by economists as irrational. This is due to the fact that some evidence suggests that increased technological innovation within a country actually increases employment. Nevertheless there are immediate consequences of implementing machines in the factories. The industrial revolution in England illustrates this point vividly [55].

As the Parliament had taken over power from the crown in England, they saw the ways in which the introduction of machinery in factories increased the national output and made them better able to compete on price of goods with other countries. For the workers on the other hand, the introduction of machines in the factory in which they worked could make them obsolete. Due to the resistance from people losing their jobs over new machines during the 18th and 19th century the English Parliament imposed many laws to forbid the destruction of them [38].

The sentiment of the government towards the destruction of machinery was explained by a resolution passed after the Lancashire riots of 1779, stating that: "The sole cause of great riots was the new machines employed in cotton manufacture; the country notwithstanding has greatly benefited from their erection [and] destroying them in this country would only be the means of transferring them to another [. . .] to the detriment of the trade of Britain" [38].

While there might be similar instances of machine destruction today, the most prominent examples of technophobe occurs on the political scene. In a survey by the Norwegian Automobile Federation from 2017, 45 percent of respondents said that they did not want to travel by autonomous vehicles [6]. This kind of opposition to technological innovation does play a major role in deciding whether or not the political parties approves the use of them.

## 2.4 Automation and its consequences in recent years

In the recent years there are several macroeconomic changes which has been attributed solely or partially to automation. One of the most important changes is the global decline of the labour share of income. This means that as the economy grows, the proportion of the increased revenue within states that goes to the workers are diminishing [49]. In a Paper funded by *Den Norske Bank* it is argued that automation is a large if not the largest contributor to this change:

”We remark that an increase in automation has small aggregate effects on output (in some cases even negative in the short run) but a strong re-distributive effects with large displacement of labor in favor of capital and profits.”

This means that the state in which the profit margins of automatable companies are not regulated, due to the fact that more products can be produced with less labour, is undesirable for the average citizen [20]. This will be discussed further as I will suggest and simulate the effects of a cap on the wage-to-revenue ratio within the automatable sectors

Further, people are laid of and in effect formally lack skills which are desired in the workplace. This has dire consequences for the individuals directly affected but the problem might be resolved by a mere restructuring of the education and re-education system. The conclusion in one paper called *The lost race against the machine: automation, education, and inequality in an R&D based growth model* [61] was:

”If workers refuse to exert full effort when they are not allowed to share in the gains from technological progress, unemployment results. Interestingly, as long as higher education is non-stationary, technological progress does not necessarily lead to more technological unemployment. The reason is that it also triggers more higher education, and thus reduces the low-skilled workforce.” [61]

Another notable consequence is that products become cheaper to produce [27]. Some products such as car tires, petrol and salt has a low price elasticity because there are very few good substitutes. However within a category of products there are high price elasticity and the ones who sell the cheaper products often sell more products. Since automation is in most cases a tool for decreasing total production costs more products will ultimately be bought due to high price elasticity [27]. For this reason I will in section 4.3 look at the impacts of setting a cap on the productive capacity.

## 2.5 The future of automation

In 2013 Carl B. Frey and Michael A. Osborne, both prominent academics at Oxford University, published a paper called "The Future of Employment: how susceptible are jobs to computerisation?" in which they examine the susceptibility different professions have to be automatised in the coming two decades. Their method involved using machine learning to quantify 702 different occupations susceptibility to automation by looking at the cognitive and physical skills needed to perform the job [38].

In the study, people of many different professions detail the different knowledge, skills and abilities needed to excel at their job. After they had gathered the data-set, they assessed which of the attributes involved in the jobs were possible to make a machine perform. They then manually assessed 70 occupations on whether or not they were automatable. Since these occupations had been subdivided into all the knowledge, skills and abilities needed, they could run a machine-learning algorithm to assess whether or not all of the other 632 occupations could be automated.

Their conclusion after the results came in was this:

"We distinguish between high, medium and low risk occupations, depending on their probability of computerisation. We make no attempt to estimate the number of jobs that will actually be automated, and focus on potential job automatability over some unspecified number of years. According to our estimates around 47 percent of total us employment is in the high risk category. We refer to these as jobs at risk – i.e. jobs we expect could be automated relatively soon, perhaps over the next decade or two.

Our model predicts that most workers in transportation and logistics occupations, together with the bulk of office and administrative support workers, and labour in production occupations, are at risk." [38]

While this might be cause for concern, the fact that jobs can be automated away does not mean that it will happen overnight. If the state prepares well, it should be possible to avert the most disastrous outcomes and make the state benefit from the increasing availability of labour in other, less automatable sectors.

In an article in the MIT Technology review [74], author Erin Winick reviews many reports which consider how many jobs might be lost. For example, a report by futurist Thomas Frey from 2012 [39] predicted that we would lose 1 billion jobs by 2020 and 2 billion jobs by 2030 due to automation. That means he predicted that half of all jobs worldwide would be considered automated by 2030.

Another report from McKinsey called 'Jobs lost, jobs gained: Workforce transitions in a time of automation' from 2017 [45] predicted that 400 to 800 million jobs would be lost by 2030. These predictions seem bald, and it is hard to imagine that anyone could ever predict the actual number of jobs that will be automated, especially since its tough ever to say if they were right or not.

## 3 Economic Theory

Economists often have a hard time agreeing. As Nobel Laureate George Bernard Shaw once famously said: "If all the economists were laid end to end, they'd never reach a conclusion". This thesis will not delve too much into the different perspectives economists have on the matter at hand. Instead, it will be based on the economic theory called Modern Monetary Theory. The choice is based on my supervisor, Trond Andresen's, recommendation and from the fact that the thesis' modelling approach is highly influenced by his thesis called *On the Dynamics of Money Circulation, Creation and Debt – a Control Systems Approach*.

### 3.1 Modern Monetary Theory

Modern Monetary Theory (MMT) is an economic theory which mainly differs from other economic theories in its emphasis on the governments' function in the economic system. They emphasise heavily the advantages of a state which issues its own currency over the ones that do not. The theory has gained traction following the financial crisis in 2008.

One heavy proponent of MMT is William Mitchell, professor at the University of Newcastle, Australia. In 2019 he wrote a textbook called "Macroeconomics" in collaboration with a professor of Economics at Bard College, Randall Wray and colleague Martin Watts at the University of Newcastle, Australia [54]. From here on the authors will be referenced as MWW. The authors argue for a different perspective on the macroeconomic system where the state has a more central role. From the book:

"Modern Monetary Theory (MMT) is distinguished from other approaches to macroeconomics because it places the monetary arrangements at the centre of the analysis. As we will see, MMT builds on the insights of many economists who have worked in the heterodox tradition. It therefore rejects the main precepts of the orthodox neoclassical approach to macroeconomics. However, because it places an emphasis on monetary arrangements within the capitalist economy, it adds new insights that were not previously available within the heterodox tradition. Learning macroeconomics from an MMT perspective requires you to understand how money 'works' in the modern economy and to develop a conceptual structure for analysing the economy as it actually exists".

#### 3.1.1 How money is created?

Until 1971 the US monetary system was based on the price of gold. This meant that if a foreign state wanted to exchange US dollars into gold, they could do so. When the practice was abolished, there was no longer an intrinsic value behind the dollar. A currency which is not backed by anything with intrinsic value such as precious metals is called a fiat currency [35]. So what gives fiat currencies their value?

According to MWW, what makes a currency valuable is the fact that it is the only means of paying taxes and other payments imposed by the government, such as fines and public services. Even though two private entities could, in theory, make an exchange in some other kind of valuable medium, the taxes imposed on them would ultimately have to be paid in the sovereign governments' currency. They further write: "We can conclude that taxes drive money. The government first creates a money of account, and then imposes tax obligations in that national currency. In all modern nations, this is sufficient to ensure that most debts, assets and prices, will also be denominated in the same money of account, so long as it accepts the currency in tax payments. When we talk about the government 'issuing' currency, the most usual way in which this occurs is through government spending. We say the government spends the currency into existence. It also makes loans" [54].

From this, we can derive that the sovereign government which issues its currency has a significant advantage as it can print money to buy goods and services. This is why going away from the gold standard have had large consequences. When looking at the yearly trade deficits in the U.S., we see a significant shift from a small deficit of under 1 per cent of GDP most years leading into 1971 to a generally rising deficit after 1971 [10]. The actual process which is used to create money is more trivial than one might think. For a sovereign state to create money they do not need to print the money physically, all they need to do is to type the numbers into a portfolio and spend it [54].

All government spending made by a sovereign government issuing its own currency can be said to be done by creating money. While most people think that the government can only spend what they earn through taxes, bonds and other incomes such as fines, what they do is calculate the amount they predict to get and then spend accordingly. If they end up spending more then they receive they get a deficit year while if they spend less, they get a surplus year [54].

### **3.1.2 Fiscal Policy**

Fiscal policy refers to government spending and taxation choices. It is one of the ways in which the government can influence the economy and achieve its economic and social objectives. For a state to maximise its fiscal space two conditions need to be met: 1) it operates with a sovereign currency which is not pegged to a foreign currency 2) Its debt is denoted in its own currency [54].

Under these conditions, according to MWW, the national government can always afford to purchase anything available for purchase in its currency, never default on its debt and in theory, employ every unemployed resource. These are obvious benefits which can help a state reach its goals. According to MWW, MMT is as much a description of how a national government works as it is a prescription for how an ideal state should make choices [54].

In macroeconomic terms, it is important for a state to strive for higher utilisation of its resources. The Office of the United Nations High Commissioner for Human Rights International (OHCHR) has in its Covenant on Economic, Social

and Cultural Rights (ICESC) emphasise the fact that a state must undertake steps, to the maximum of its available resources, to realise the right recognised in the covenants [2]. Also, the ICESC states that in point two of article 6:

”The steps to be taken by a State Party to the present Covenant to achieve the full realization of this right shall include technical and vocational guidance and training program’s, policies and techniques to achieve steady economic, social and cultural development and full and productive employment under conditions safeguarding fundamental political and economic freedoms to the individual” [2].

This means that when the state has unused resources, it has according to MWW an obligation to use fiscal policy to make use of these resources if it benefits the people. According to MWW, the most obvious case of unspent resources are people without work who wants to work. By using fiscal policy, a state can create programs to utilise these unspent resources. In addition, the state can spend money to finance other kinds of programs which might increase the welfare of the people in the state [54].

### 3.2 Does creating money cause inflation?

One of the central tenants of MMT is that it is possible and extremely important to reduce the unemployment rate. Some of the implications of high unemployment are obvious, such as the diminished life quality of the unemployed and the lack of utilisation of productive potential. Contrary to the classical approach to economics where it is often argued that an economy should keep a so-called buffer stock of unemployed people available. To the contrary, the MMT approach suggests that the economy will benefit from full employment which is accomplished by a state-run Job Guarantee approach [54].

MWW claim that the Classical theorists approach is wrong in their assessment of the Quantity Theory of Money. The theory begins with the **equation of exchange**:

$$MV = PY \tag{3.1}$$

On the left-hand side of the equation, the M is the quantity of money in circulation while the V is the money velocity which indicates how many times an average dollar is used in the open market. The right-hand side is the value of total output, where P is the price of goods and Y is the amount of product. MWW points out two flaws in the thinking of Classical theorists. They claimed that at full employment, the output of the economy was reached so that Y was constant. Also, they claimed that the velocity of money was constant as it was only determined by the customs and habits of public spending [54]. **The equation of exchange** would then look like this:

$$M\bar{V} = P\bar{Y} \tag{3.2}$$

indicating that a change in the total quantity of money could only lead to a change in the price of goods. This MWW points out is wrong for two reasons.

First, since there is always some amount of unemployment, there will always be potential to increase the productive capacity of an economy. Secondly, evidence suggests that the velocity of money, that is the number of times one dollar is used to buy goods and services within a defined period (often a year) is not constant. The velocity of money can easily be calculated by dividing the right-hand side of equation 3.1 by the quantity of money in circulation. By this we can deduce that increasing the money supply will not necessarily cause inflationary episodes [54, 11].

### 3.3 Unemployment

To make the argument for reducing the amount of unemployment, there are many aspects to consider. These include economic, social and personal costs such as [54]:

- Loss of national output and income
- Social exclusion and the loss of freedom
- Skill loss
- Psychological harm
- Ill health and reduced life expectancy
- Loss of motivation
- The undermining of human relations and family life
- Racial and gender inequality
- Loss of social values and responsibility

While the costs relating to health and personal life are more or less not disputed, the economic costs are. To answer the economic question of unemployment we first have to explain unemployment further. First of all we have to define unemployment and explain the different types of unemployment.

Unemployment, according to the Organisation for Economic Co-operation and Development (OECD), is persons above a specified age (usually above 15) not being in paid employment or self-employment but currently available for work during the reference period. Within a population, it is measured by the unemployment rate, which is the proportion of unemployed within the labour force. The most common way of assessing whether or not a person is in the labour force is to say that someone is in the labour force if they are employed or unemployed. According to the International Labour Organisation (ILO), the requirements for being employed is that one works for at least one hour a week or are on a temporary leave of absence. The requirements for being unemployed is that a person is not employed and have recently (usually in the last four weeks) actively sought employment. These definitions allow national statisticians to collect data and produce statistics about the labour market [1].

### 3.3.1 Frictional Unemployment

Frictional unemployment is the kind of unemployment that occurs as a natural consequence of the fact that the labour market is in a constant state of flux. As a college or university student graduates from school, it usually takes some time for them to get a job or a person moving from one job to another after quitting or getting fired are typical examples. While this kind of unemployment is undesirable, it is often not looked at as being caused by a systemic economic error. Some types of workers, such as harvesters and asphalt layers, do work that can only be done in certain parts of the year. This kind of frictional unemployment is often called seasonal unemployment as it happens every single year, but it is often small on a macroeconomic scale [54].

### 3.3.2 Hidden Unemployment

We have already considered that the framework for being considered employed, unemployed and the requirements for being considered to be in the workforce. The framework obviously causes a large number of people who wants jobs to be considered outside the labour market and are therefore not counted in the statistics.

MWW are highly critical of those claiming that the definitions give a comprehensive picture of the labour force and claims that when using these strict definitions it is not adequate to only wanting to reduce the unemployment rate [54]. Within the group categorised as the employed there are no distinction made between part-time workers wanting more and better work hours, those unsatisfied with their job for non-time related reasons such as under utilisation of skill and those who are satisfied with their job. Another huge issue is with the requirements for being categorised as being in the labour force. In most countries there are far more people in the working age population being categorised as being outside of the workforce than those categorised as unemployed.

MWW divides those who are categorised as not being in the workforce into four different categories, those wanting work, but not actively seeking, those who want to work but are not available, pension holders who would rather work and those who are satisfied with not working. When dividing the categories of people in this way the picture of the current employment worldwide becomes more grim [54].

In 2017 a Norwegian news channel (TV2) [36] found 223 thousand people who were seeking work, while the official number of unemployed from the Norwegian Labour and Welfare Administration were at 78 thousand. This means that the number of people who are seeking work is almost three times higher than the official number of unemployed. While there might be hard for the government to get the right figure, there may be ways in which the government can provide work for all these people, as will be discussed in section 3.5 on the Job Guarantee programme.



### 3.3.3 Structural Unemployment

In this thesis the main kind of unemployment that will be discussed are Structural Unemployment. This kind of unemployment arises when there is a mismatch between the skills demanded in the labour market and the skills people possess. There are many causes and they can be sudden, such as in the beginning or end of a war when a country need more soldiers than they have trained or it can happen more long term due to permanent changes in demand or supply of skill [54].

The type of unemployment which is most relevant to this thesis is Structural Unemployment. This kind of unemployment arises when there is a mismatch between the skills demanded in the labour market and the skills people possess. There are many causes, and they can be sudden, such as in the beginning or end of the war when a country needs more soldiers than they have trained or it can happen more long term due to permanent changes in demand or supply of skill [54].

Structurally unemployed people formed the Luddite movement in England during the first industrial revolution. Artisans who were highly skilled at making products for the consumers were out-competed by the factories with machines in price and possibly also quality, their skills became obsolete in the labour market. As these skills became obsolete, new skills were required in other areas of manufacturing [55]. This transition in demand in the labour market causes higher unemployment and the demand for new skills can only be met by increasing the number of people with these skills. This can happen in two main ways. The schools can change the size of the classes within the areas of education which have the most considerable discrepancies between demand and supply, or they can create retraining programs such that those workers with obsolete skills can gain other skills which are in higher demand [54].

## 3.4 Education

In Norway, education is the primary means of reducing unemployment as it is meant to provide the skills necessary for someone to be desired in the job market. However, the Norwegian education system has been highly criticised for having a too high proportion of graduates from higher education saying that the skill-set acquired during the education does not meet the requirements from the business world [22].

As stated in section 3.3.3, some of the problems regarding unemployment stem from the fact that most companies today require or want workers with a particular skill-set. Before we had schools where people were educated, most people had to gain their skill-sets from practical work. Traditionally the skill-sets were often learned through working at the farm where they learned by watching and practising all the different kinds of laborious activities involved. Those who did not work at a farm, often gained their skill-sets through apprenticeships from an early age, sometimes as young as seven years old. By law, there was no obligation from the masters to pay the apprentices, but they often

paid small wages to buy necessary articles such as clothes [28].

While apprenticeships still exist today, the way of acquiring skills have primarily become the responsibility of the state and private institutions such as private universities. In Norway, there are many professions which require you to have passed specific exams and/or studies, such as lawyers and doctors [3]. So how can the state create programs to try and match the skills needed in the labour market with the ones inhabited by the labourers? In section 3.5, the Job Guarantee will be discussed as it can function like an apprenticeship which provides the skills needed in the workplace while the apprentices are conducting useful work for society.

### 3.5 The Job Guarantee

MWW argues highly for a full-employment program or policy called the Job Guarantee (JG) and even say it is a centrepiece of MMT reasoning. They claim that historically, markets have not been an adequate tool for securing that economic and social human right has been full-filled. For this reason, they argue that only policy beyond what is naturally driven by the marketplace is necessary to safeguard a population's human rights. Within neo-classical economic thought, it has long considered unemployment and poverty as necessary tools for price and exchange-rate stability. MWW further argues that even if this is true, it will never be ethical to use unemployment as a tool for this purpose, considering the substantial costs to the individuals [54]. They write:

”Only government can guarantee the right to a job because markets have not, and cannot, operate at anything approaching true, full employment on a consistent basis without direct job creation on a large scale. Only the government can create an infinitely elastic demand for labour by offering to hire all who cannot otherwise find employment because it does not need to take account of narrow market efficiency concerns due to its capacity to issue and spend the sovereign currency. Private firms only hire the quantity of labour needed to produce the level of output that is expected to be sold at a profitable price. The government can take a broader view by promoting the public interest, including the right to work. For these reasons, the government must play a role in providing jobs to achieve social justice. A JG programme can secure the right to work, but with minimal undesired impacts on wages, prices, government fiscal policy, and the value of the currency.” [54]

Many people claim that the state should provide welfare programs where the unemployed gain compensation without work, such as the unemployment compensation program through NAV in Norway. Such welfare programs are undesirable as the lack of work in itself has proved to cause harmful effects such as lack of self-esteem, negative attitudes toward the unemployed and deterioration of human capital including skills and experience [50]. For this reason, MWW claims that the government should provide jobs which can take workers regardless of their skills. Furthermore, the jobs can be set up so that those employed there learn valuable skills which can increase their attractiveness in the real labour market [54].

The Job Guarantee programs can be set up in a way such that the ones in them can be provided skills necessary in the workplace. By doing this, there will in macroeconomic terms not be a clear divide between the current educations provided in the universities and the jobs provided in the job guarantee. Just as the universities are free for the individuals attending them and the students are provided money while there (either through loans or scholarships) the people in the Job Guarantee programs will learn valuable skills while being provided by the state. After some amount of years they will be eligible for work outside the Job Guarantee [54]. By this reasoning, the Job Guarantee will be considered an extension of the current education system. These similarities will be discussed further in section 6.7.3.

### **3.5.1 The Unemployment buffer stock**

According to MWW, the mainstream thought about unemployment is called the natural rate of unemployment. This kind of thought claims that the level of aggregate unemployment is temporary and due to shocks, optimal because it is voluntary and a necessary cost of promoting stability. This hypothesis asserts that only this 'natural' unemployment rate is consistent with stable inflation. Therefore they claim that there is no role for the government to play in exercising demand management in the labour market [54].

MWW is highly critical of this approach for many different reasons. They claim that by saying that we need a large number of people to be unemployed for the economy to function undermines one of the central tenants of economic thought, namely that we try to utilise the resources at our disposal as maximally as possible. The unemployment buffer stock helps companies employ people, but MWW points out that the ones who are displaced are often other disadvantaged workers. The unemployment buffer stock also causes low skilled workers to lose their bargaining power over companies because they are easily replaceable. Evidence of this can be seen by looking at the changes in labour share in recent years [20]. MWW also claims that the approach used today is only addressing the symptoms of inflation and not the underlying causes. Some countries, such as Australia, Canada and the UK, announced formal policies in the 1990s there is no evidence suggesting that they have achieved superior macroeconomic outcomes in terms of output growth, inflation variability and output variability to those who did not [54].

### **3.5.2 The Employment buffer stock**

Given the importance MMT puts on employing the people who are unemployed, of working age and wanting of a job, they claim that a better approach than having an unemployment stock is to have an employee stock. They claim that this approach can lower the unemployment rate as well as to enlarge the proportion of working-age people in the labour force without compromising price stability.

In their book "Macroeconomics", MWW has outlined some of the details of

how a government can implement the JG programme to realise the employment buffer stock approach. The JG programme will, in theory, employ anyone who wants a job. Since the program is not meant to compete with the market on wage, the wage will be set low, so that the workers will have the incentive to pursue other jobs in the market. Although it is true that a high wage in jobs created through this program will push the minimum wage up, it could be set at a level which is just above the level which is considered to provide an acceptable standard of living for the workers. This would have the added benefit of pushing private operators who can't afford to pay this wage out of the economy [54].

For inflation control, they introduce the concept called non-accelerating inflation buffer employment ratio (NAIBER) as opposed to the non-accelerating inflation rate of unemployment (NAIRU), which is the prominent inflation control mechanism used today. The buffer employment ratio (BER) is defined as:

$$BER = \frac{JGE}{E} \quad (3.3)$$

where JGE is the total amount of people employed through the JG programme and E is the size of the labour force.

The NAIBER approach will, according to MWW be a better alternative at negating inflationary periods. They claim that when a wage-price spiral occurs, that is the self-reinforcing spiral of rising wages causing rising prices, the fact that those losing their jobs will eventually get employed through the JG program at a relatively low wage. When the BER value is high, the real wage demand will be correspondingly lower, and the capacity for firms to push profit margins up by increasing prices will be weaker. Even if the BER value under NAIBER would have to be higher than the unemployment rate has to be under NAIRU to achieve price stability, it would be more acceptable since the people in the BER value are employed [54].

### 3.6 Productivity and why it is relative

Automation causes the average output per citizen in the society to rise, as does every other productivity increasing invention. So while some professions such as engineers have seen an extreme increase in productivity in the last century, the teachers, nurses and housekeepers have only seen a modest increase [44]. Productivity increase in one job often leads to an increase in salary for that specific job. This, in turn, leads to an increase in salary of many jobs which have not seen the same productivity increase in response. This effect is called the Baumol effect [17].

The reason for this effect is that while some professions, such as engineers, have seen a considerable increase in productivity, we still need all the other professions, such as teachers and nurses. This means that for these low productivity professions to be still desirable, they need to have a salary which makes them desirable. Another consequence of the change in relative productivity is that it has made some consumer goods cheaper relative to other [17].

### **3.7 Economic crisis**

An economic crisis is categorised by several massive changes in the economy and often leads to high unemployment, people going out of business, changes to the interest rate on loans and many other adverse consequences. During the Corona epidemic in early 2020, the Norwegian bank 'Sparebank 1' calculated that the consumption spending of Norwegian citizens had dropped by 20 per cent [46]. In this specific case of an economic crisis caused by an epidemic, people spent less due to people losing their jobs and since many public services such as hairdressers were closed.

## 4 What do we want the future to look like

This thesis will not go into depth on what political ideology is better able to cope with the increase in automation. However, to be able to distinguish a good outcome over a bad one, we need to make assumptions about the state of a utopian future society. These assumptions will be used to measure the usefulness of a new political intervention.

In 1971 political philosopher John Rawls published the book *a theory of justice* on political philosophy and ethics in which the author addresses the problem of distributive justice. He proposes we use a thought experiment called 'the veil of ignorance' to assess the question of how we want the goods and services in the society to be distributed. The thought experiment involves thinking that we do not know anything about our own identity and social standing, and base our political decisions on the fact that we might be randomly assigned an identity and social standing [62]. By this reasoning, the amount of good a change in the society does is considered in relation to the number of people it benefits. Unfortunately, the trend we see in many countries is that the labour share in the large manufacturing corporations is diminishing [49].

We can make predictions on what the world will look like in a future society with a high degree of automation. By making good predictions, we can try to get a better handle on the direction we should move in to get a prosperous society in the future. For the state to get the desired goal for the future society, it can create or change laws, regulations, taxes and other aspects of society. The state needs to base its decisions on economic theory and history.

### 4.1 The Future of Jobs

There are many possible ways in which the future might look. To have a guideline for what we want the effect of our political policies to be, we have to have both a short term and a long term perspective. In 2003 associate professor at Norwegian University of Science and Technology, Trond Andresen, published a paper called *Two feasible Future Scenarios: A high-tech Utopia – and a high-tech Dystopia* [13]. In the paper, he discusses two different future high-tech societies where one is a dystopic high-tech society, and another is a utopic high-tech society. The high-tech societies described both have an extremely small amount of workers in the manufacturing and transport industry.

In the utopic scenario Andresen describes, we would have a shift to where all professions no longer need to be seen as 'value-producing' to be respected as a part of what is worth paying for. This means that we can let people get paid for doing laborious activities based on the satisfaction we get from doing it. There will hopefully be many people who enjoy the work still provided by the manufacturing industry. We can get by with having a majority of the human labour in the public sector be done either by people who enjoy it or by distributing it, letting people work there for far fewer hours per week than is typical today.

In the dystopic scenario Andresen describes, there will also be a highly automated manufacturing sector which is driven by capital owners who want to increase their profit margins by decreasing the labour share of income. As the divide between the rich and poor increases, and the machines are conducting all the necessary work to keep people fed and safe, they will no longer have any opportunity for meaningful work. In the paper, Andresen refers to a report [53] from a conference of the world's most powerful in late September 1995. The report states that in a possible future scenario with an unemployment rate of 80% the solution to keeping the people in good spirits is 'tittytainment' ('tits' plus 'entertainment') to keep people nourished and entertained. To which Andresen comments:

"A future world with 80% unemployment seems unrealistic. But the point of the above is that the world's power elites are willing to accept such scenarios and prepare for them. Based on today's trends, it seems more probable that employment will be higher, but in a dominant low wage and very insecure s/s-sector." [13]

Most people would probably agree with Andresen that a society where most people do not perform meaningful work and where the divide between the rich and poor are large is undesirable. Some arguments for changes which might enable us to move toward the Utopian society and not the Dystopian one will therefore be laid out.

## 4.2 The Argument for shorter Working Weeks

The working conditions of an average 19th-century factory worker would to most of us seem grotesque [60]. In addition to high mortality rates, dirty and unhealthy conditions and low wages, the normal workweek for a Norwegian factory worker in the late 19th century was 12 hour days six times a week, amounting to 72 hours per week [73]. During the late 19th and early 20th century, laws protecting the workers were put into place. In 1919 the 8-hour workday was established by law in Norway and even today the typical working week is 40 hours per week.

Most people today are content with working 40 hours a week, and it seems like there is not a significant strive towards even lower working hours. Still, some studies indicate that many people would be happier (at least in some professions) if the number of working hours was reduced further. One exciting study [7] was performed on female health care and daycare nursery personnel in Stockholm, Sweden. In the study, 41 workers had their weekly working hours reduced from 7.5 to 6 hours per week and several different factors of their lives were assessed before and after a year of conducting the study. While the control group of 50 workers who kept working the 7.5 hours as before saw little change in the metrics used, the 41 workers with reduced hours saw significant increases in many measures of well-being. The subjective assessments from the workers were rated on a scale from 1-5 where one is bad, and five is excellent.

Firstly, among the 41 participants, the most significant findings were that the assessment of sleep quality, sleepiness at work and overall well-being were sig-

nificantly bettered. Furthermore, their assessment of satisfaction of work hours improved from an average of 3.37 to 4.63. A study from Stanford University [59] supports this finding which says that the health hazards of long workweeks are often detrimental to the worker's health as well as to the productivity of their working hours.

There are vast amounts of data suggesting that a shorter workweek would increase the well being in many professions. In 1930, John Maynard Keynes predicted that in 2030, people would not have to work more than 15 hours per week due to the extensive amount of automation innovation that would happen before then [52]. While the reduction has been more modest than he predicted, there is no reason why we should not be able to reduce the number of hours we work as we automate every aspect of working life if we assume that an ever-increasing amount of goods.

### 4.3 The Argument for not increasing the production of goods

As the degree of automation increases, the average cost of producing a good inevitably decreases. This would lead to an increase in the demand for goods following laws of supply and demand. However, it can be argued that this increase in purchases of consumer goods have a negative impact on the people in a society [32].

Another good reason to reduce the amount of goods purchased within a society is due to the environmental impact the production of goods have on society. This is because most sources of human-made global warming and abiotic depletion (the depletion of nonliving resources such as fossil fuels, minerals, clay, and peat) that is happening can in some way or another be linked to the consumption of goods. According to a study from Institute for Prospective Technological Studies, Furnishings, household equipment and routine maintenance of the house can be said to attribute a staggering 27.8 per cent of all abiotic depletion and 15.9 per cent of global warming contribution [72].

### 4.4 The Argument for wanting an increase in the degree of Automation

As stated in section 4.2, one of the reasons for increasing the degree of automation is that it could reduce the needed number of working hours per person in the labour force. This is especially true when we assume that it is possible to not let a reduction in the cost of production lead to a larger output from the goods-producing professions. This would mean that in the end, we could potentially see the production of all the goods needed cost only a small fraction of what it has today.

The most important reason that we want to reduce the number of workers in the production of goods is that it enables us to redistribute them in other sectors and thereby reduce the **need** for long hours in other professions. By automating their jobs and re-educating them for work in another sector, we will increase



the number of available workers in both the public and private service sector. Professions within the service sector might be harder to automate as they do not involve as many physical and repetitive tasks and might in most cases involve human interaction where machines are and probably will be inferior to humans for a long time [38].

Even if we were able to automate jobs in the service sector, we would still have preferred to automate jobs in the production section [38]. When looking at numbers for accidents in the workplace, the manufacturing, construction and transportation industry see almost twice the average of accidents per worker [4].

Even though imports and exports are outside the scope of this thesis, a critical argument for increasing the degree of automation is that it makes the country and companies within it more competitive in the marketplace. By substituting workers for machines, the cost of production goes down. This has made it possible for companies which previously moved their production facilities to countries where labour was cheap, such as China, to move their factories back to Norway [42, 69]. The reason it is beneficial to move them back home is that due to the low cost of highly qualified engineers in Norway, the companies were able to increase their production at a lower cost due to automation.

## 5 Systems Dynamics Theory

Systems dynamics is an approach to analyse a system by determining the causal effects between constituent parts of the system and then looking at how the various parts of the system change over time [70]. Unlike analysing a technical system where the laws of nature determine the causal effects, the systems thinking approach can be used to find reasonable causal effects in other sciences like political science, psychology, medicine and economy. In contrast to conventional approaches to system analysis where the system is usually broken into different parts which are analysed in isolation, the system dynamics approach sees the system as a whole and draws conclusions based on its behaviour over time through simulation.

### 5.1 Causal Loop Diagrams

In the System Dynamics approach, we say that there exists reinforcing and balancing processes [70]. We call these processes feedback-loops where a positive feedback-loop gives a self-reinforcing effect, and a negative feedback-loop gives a self-correcting effect on the affected component of the system. A component of the system can be affected by one or more loops of different complexities and type. By interconnecting all the components and the loops of the system, we get what we call a Causal Loop Diagram. The Causal Loop Diagram is a good tool for visualising the components and the polarity of their effect on each other.

### 5.2 Stocks and Flows

Stocks and Flows are key concepts in System Dynamics [70]. A stock is a component of the system for which we say there is a definite amount at a certain time while a flow is the amount that goes into or out from a stock over time. By combining these two concepts and monitoring the stock, we see the change of the size of a component in the system.

### 5.3 System Modelling and Simulation

In a Causal Loop Diagram, we determine whether a component increases or decreases another component of the system, but it does not say anything about the actual mathematical relationship they have [70]. To simulate a system over time we need to determine the mathematical relationships between its constituent parts. With our system not being determined by the laws of nature at our abstraction level, the relationships need to be determined by reasoning from literature in the relevant scientific disciplines. The simulation will not be a perfect replication of the system at hand due to the inherent complexity. Therefore the simulation and its result help us see how the parts act on each other over time and hopefully by changing the parameters of the system, we can see interesting or unexpected behaviour.

## 5.4 Path dependence

Most dynamic systems have path dependence. This means that the end state of the system might in no small degree be dependent on small and unpredictable permutations early in its history. Systems that exhibit path dependence do so due to a dominant positive feedback mechanism. If a feedback mechanism is powerful, an initial state or small change in the system can fully determine the end state of the system [70].

## 6 Making a Model of the labour market

As discussed in section 5, the systems that are created through the use of system dynamics are simplified representations of the real world. Therefore the simplifications will be pointed out, and their impact on the conclusions from the results are discussed.

The model is based on the description of economic, though described in section 3. This section details how these descriptions can be represented by mathematical relationships and implemented to simulate the real world dynamically. The block description for the Simulink diagrams can be found in Appendix 9.

### 6.1 The Employees and Productivity

In this thesis, the theoretically quantifiable level of utility will be called productivity, and the utility of each worker will be called productivity per worker. People are employed to fill a role in the employers strive to reach a specific goal, whether the goal is for a car producing company to maximize their profits or for the health sector to increase its utility for the sick. Either way, in a theoretical sense (yet practically unmeasurable) we can say that each worker has a quantifiable amount of utility to the employer and that for each state, sector and company there exists an average level of this productivity per worker. This is only true if we can say that there is a total amount of productivity within a particular sector. As discussed in section 3.6, there are ways in which we say that some professions have seen a higher relative increase in their productivity than others in the last few years. Even though this is true, it has no practical implications for my model. This is because some of the professions which have had the smallest amount of relative increase in productivity are in constant need and therefore the relative changes in productivity that have happened in the time before the start of the simulation will be of no interest.

Let us say that the average worker in every sector starts at the same relative productivity value of one and that the increase in the degree of automation makes the productivity of a worker in the automatable sector rise faster than for a worker in a non-automatable sector. Then, the only significance of this is the disparity of their productivity relative to the starting point. This makes it very easy to set an initial productivity level for the sectors.

### 6.2 The Degree of Automation (DA)

As discussed thoroughly in section 2.2, many types of production have irrefutably seen a large increase in their productive capacity per working hour. Some of the most evident examples are the textile-producing machines of the 18th century, and more recently, the computer and the industrial robot. In this thesis' model the Degree of Automation will be defined as the degree of increase in productive capacity per worker per hour which are directly caused by the introduction of robots, either software robots or physical ones.

### 6.2.1 How do we measure or calculate the degree of automation?

The degree of automation can not be measured empirically, but by using the definition described above, we can say that as the value increases, less working hours are needed to produce the same output. However, as it is the automation itself that causes the productivity increase and not the other way around, something has to cause the degree of automation to increase. There are many possible ways people have tried to calculate the productivity increase we see in factories due to automation [37, 8, 29].

In this thesis, the way the automation increases is based on an article indicating that there is a high correlation between the R&D budget of a company and the degree of automation [29]. In the article, it is argued that both the capital stock and the knowledge of automation techniques are directly linked to the R&D budget of a company. The relationship which determines the percentage change in the degree of automation can be set up mathematically based on how much money is spent in the effort.

We define the following variables and parameters; denominations are indicated in brackets ([ ] means no denomination):

[q] = Productive output

[h] = Time in hours

[y] = Time in years

[\$] = Money of account

[w] = Employees

$P_a$  = Productive output in the automatable sector [q]

$E_a$  = The number of workers who are automatable [w]

$K_h$  = Percent decrease in working hours per year [1/y]

$I_a$  = Investments in automation from all sources [\$]

$K_a$  = Constant indicating the percent increase in automation based on investments [1/\$]

$T$  = The average number of hours worked by each employee [h/wy]

$P$  = Initial relative productivity per worker [q/h]

$A_t$  = The degree of automation [ ]

$P_n$  = Productivity increase from innovations not regarded as automation [ ]

$D_a$  = The deprecation of automation factor [ ]

Firstly the degree of automation is continuously increased as a percentage of the already accumulated capital and knowledge within the sector as a whole. The reason for choosing a percentage increase is that we assume the sector as a whole is continuously building upon the already accumulated knowledge. The

depreciation factor accounts for the rate at which accumulated capital investments depreciates and has to be replaced. The implementation in Simulink is shown in figure 6.1.

$$\dot{T} = TK_h \quad (6.1)$$

$$\dot{A}_t = A_t K_a I_a - \frac{A_t}{D_a} \quad (6.2)$$

$$P_a = I_a T P A_t P_n \quad (6.3)$$

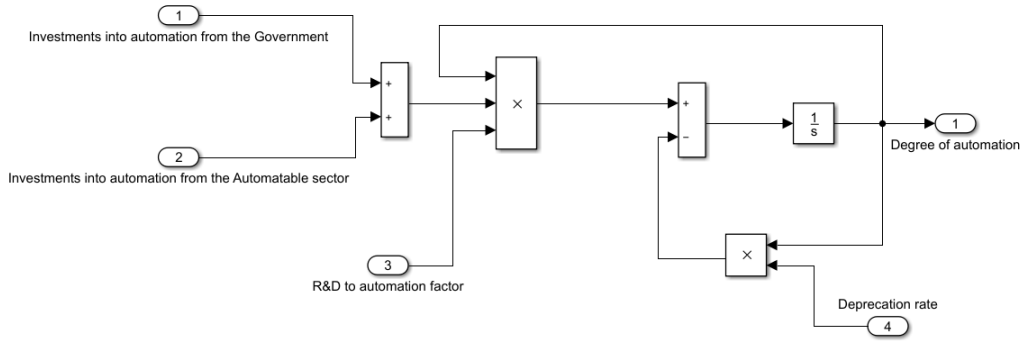

Figure 6.1: Simulink representation of equation 6.2.

The number of working hours will change as a function of the degree of automation. Since part of the model involves decreasing the number of working hours in society, for the number of people working in the automatable sector to decline we need a sharper increase in productivity than the proportional decline in working hours for the number of people working here to decline.

In the model, there will always be a certain number of workers which makes the automatable sector produce the desired amount of products. This amount of workers can easily be calculated from equation 6.3. The Simulink implementation of equation 6.4 is shown in figure 6.2.

$$P_a = E_a T P A_t P_n$$

$$\Downarrow$$

$$E_a = \frac{P_a}{T P A_t P_n} \quad (6.4)$$

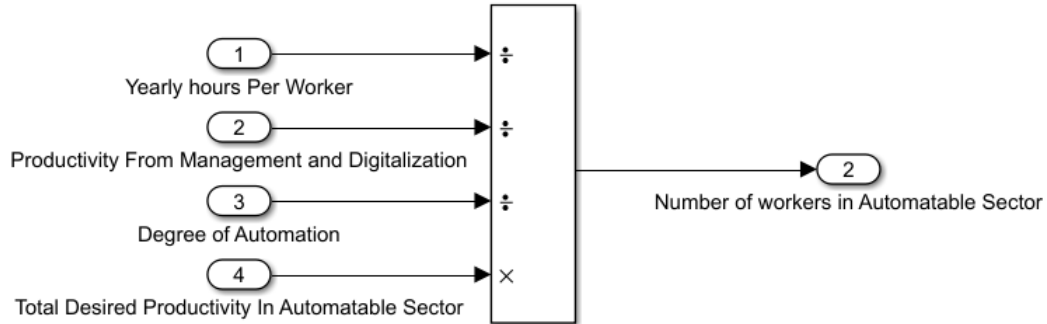

Figure 6.2: Simulink implementation of equation 6.4

### 6.3 The exclusion of money accumulation and banks

The money flow and accumulation within the monetary system, companies and private households are complex and has a lot of intricate dynamics. Therefore it will be made several reductions to the real money flow and try to account for most of the significant simplifications.

Firstly there will be no banks in the model, and there will be no accumulation of capital apart from the accumulation of technology and machines which are integrated with the degree of automation variable described in section 6.2. By not including banks or financial accumulation, I instead assume a system where all the money circulates in real-time through the system. This can, to a more considerable extent, be justified for households than for firms.

By assuming no financial accumulation withing households, the disposable income of employees will be spent immediately for consumption in the market-place. One of the key motivations for not including household spending in the model is that it would make the model unnecessarily complicated due to the meagre average savings percentage in Norway of 10 per cent [5].

The reason for not including banks, which upon inclusion would have the role of providing loans to companies and the government, the reasoning behind the decision are twofold. Firstly, as discussed in section 3.1, a sovereign government which issues its currency can create base money with which it can spend on virtually any government spending post. The bond sales, which are usually included in the financial accounting of a government, are unnecessary. Secondly, the loans which would, in reality, be provided to the companies within the private sector to make investments (e.g. purchasing new robots and spending in research on automation technology) can be largely neglected. This is because the government is providing money for the automatable sector, directly financing the projects in which they would generally take loans. Also, due to the fact that the simulation is continuous, there is no need for sudden large amounts

of money to invest in the project. Instead, the continuous spending of profits within a large sector causes all profits used for investments to directly affect the overarching goal of the investment, such as increased productivity. The way investments have been implemented in the model is described in section 6.7.

## 6.4 Wages, Taxes and Spending

As will be discussed in section 6.7 there are four different sectors, and while one of them, the Job Guarantee (JG) and Education sector, has a low wage per worker relative to the other three, the major difference between them is how the revenue of the sectors and thereby the source of the wages differ. The JG and education sector and the government financed sector have their wages paid by the state while the automatable and the private service sector has their paid by revenue from the salaries after tax obtained by all workers in the society. The tax rate can be set as a simulation parameter, and the ideal tax level will be the one where the outcome is the most positive. What constitutes a good outcome is discussed in section 6.8. The Simulink implementation of equations 6.5 and 6.6 is shown in figure 6.3.

The way money flows through the society can be described mathematically. Note that in the model there are only two different wage levels, one for the JG and education sector and one for the rest. We define the following variables and parameters; denominations are indicated in brackets ([ ] means no denomination):

[\$] = Money of account

[y] = Time in years

[w] = Employees

$W_l$  = The low wage level [\$/y]

$E_{JG}$  = The number of employees in the JG and Education sector [w]

$W_h$  = The high wage level [\$/y]

$E_{\bar{JG}}$  = The number of employees in all sectors other than the JG and Education sector [w]

$S$  = Tax rate in percent, set at an equal rate for all workers regardless of salary [ ]

$J_w$  = Total taxes paid by employees from their wages per year [\$/y]

$C_w$  = Consumption spending from salaries [\$/y]

$$J_w = S(E_{JG}W_l + E_{\bar{JG}}W_h) \quad (6.5)$$

$$C_w = (1 - S)(E_{JG}W_l + E_{\bar{JG}}W_h) \quad (6.6)$$



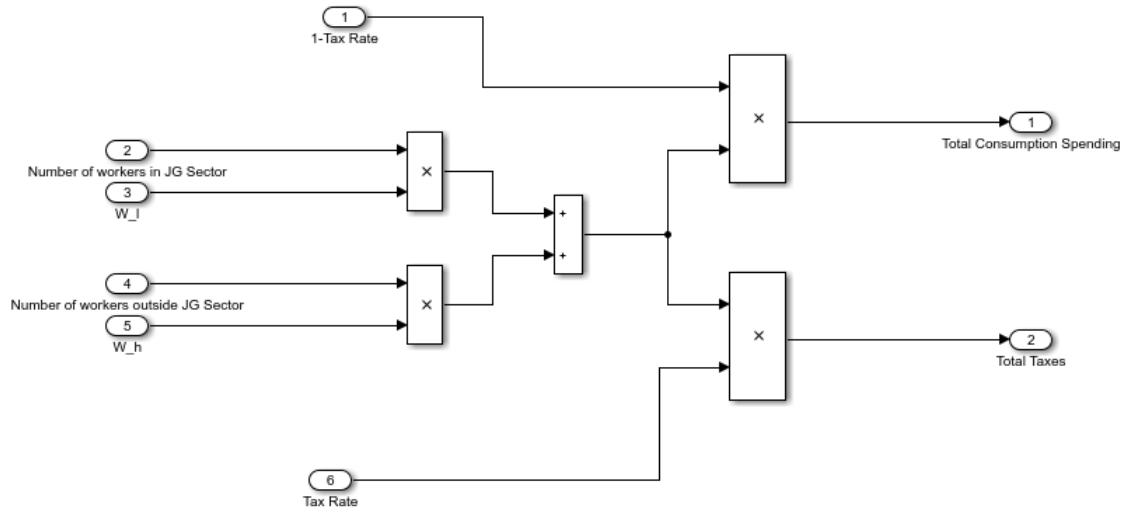

Figure 6.3: Simulink implementation of equations 6.5 and 6.6

## 6.5 Increased Productivity from Management and Digitization

Much of the discussion about the future of jobs is directed towards an increasing realisation that robots will be capable of replacing many jobs, making people obsolete. Even though this is true, there are other kinds of innovations and new technologies which can be regarded as making people more productive. This includes significant innovations, such as the mobile phone, which have caused radical efficiency increases in the workplace and smaller ones such as the efficiency increase in a small company after the leader starts paying more attention to the needs of his employees.

Even though these kinds of innovations do not necessarily cause as radical of a shift in the workplace as the kind of productivity increase that comes from automation, we can not deny that workers in all sectors are getting more productive as a result of innovation. Therefore a value indicating the increase in productivity of all the workers, including those jobs which have the possibility of being automated, have been implemented. This means that the increase in productivity per working hour, relative to the productivity per working hour at simulation start will be increasing in all sectors. The value will initially be set to one and is defined by having a constant per cent increase per year. In contrary to the degree of automation value which is increasing as a function R&D spending, the productive increase from Management and Digitization will be regarded as being an inevitable and constant increase due to the less conscious effort required to make use of these kinds of technologies. The amount of per

cent increase per year will be set to several different stylised values and will be discussed in section 8.

We define the following variables and parameters; denominations are indicated in brackets ([ ] means no denomination):

[y] = Time in years

$P_n$  = Productivity factor from other sources than automation [ ]

$K_Q$  = Parameter setting which indicates yearly increase in productivity from sources endogenous to the system [1/y]

$$\dot{P}_n = K_Q P_n \tag{6.7}$$

## 6.6 The Government

The government has several functions in this model. The essential function of the government in this model is to collect taxes to drive the demand for money and to distribute money for salaries to the public workers. Due to the nature of government spending described in section 3.1, the government does not collect or accumulate the money which is paid through taxes. Instead, it checks how much money is paid in taxes and then how much it spends on paying the workers within the government financed sector. The government can then calculate how much it can spend on other posts.

In the model, I have made the simplification that the government only spends money on paying salaries and subsidising the automation efforts. This simplification can be seen in the light of two aspects of the spending. Firstly it can be said that a large proportion of the spending that is in reality used for goods and services (that is not spent on salaries) ultimately ends up as paying a salary in the real private sector. Secondly, the initial sizes of the different sectors are stylised and do not represent the actual amount of people working in them. This means that we can say that some of the people are split up between the government financed and the private service sector since they get part of their financing from public spending and part indirectly from government spending. This means that it would not be unreasonable to say that the state has two main expenditures in the model where one is the salaries, and one is the subsidies made to the automatable sector for R&D in automation efforts. As discussed in section 4.4 there are such vast amounts of benefits from increasing automation that this should possibly be made a high priority for the state to spend money on.

This leads us to government accounting. As discussed in section 3.1, the spending from the government can exceed the tax income. As we want to spend as much as possible to increase the amount of available resources being utilised, how do we determine the maximal amount of spending?

One way of doing it would be to control for the amount of money we spend by tying the spending to the GDP of the society [54]. This means that the spending from the government would be put at the level where the deficit, that is spending

subtracted from taxes, divided by GDP does not exceed a certain threshold set as a parameter. The reason we can not set the deficit too high compared to the GDP to control the theoretical inflation that will occur. Inflation control is not implemented in the model, which means that while different levels of deficit compared to GDP will be tested for, the limit will be set much lower than what would actually yield the best results. The Simulink implementation is shown in figure 6.4.

Here the math involved in computing the amount of money which can be budgeted for increased automation efforts will be shown. The money which are spent by the government for automation efforts will be regarded as an effort to shift the society towards a one with increased happiness and welfare. We define the following variables and parameters; denominations are indicated in brackets ([ ] means no denomination):

[ $\$$ ] = Money of account

[y] = Time in years

$C_w$  = Consumption spending from salaries per year [ $\$/y$ ]

$J_w$  = Taxes paid by employees from their wages per year [ $\$/y$ ]

$G_a$  = Government spending on automation [ $\$/y$ ]

$G_w$  = Government spending on automation [ $\$/y$ ]

$G$  = Total government spending [ $\$/y$ ]

$I$  = Investments from the the private and the automatable sector including investments in automation from the automatable sector [ $\$/y$ ]

$S_g$  = Deficit spending from government [ $\$/y$ ]

$K_g$  = The factor determining the government spending as a proportion of GDP [ ]

From this we can calculate the amount of money which the government can spend on automation efforts after it has spent on wages:

$$G = G_a + G_w \quad (6.8)$$

$$GDP = C_w + G + I \quad (6.9)$$

$$S_g = J_w - G \quad (6.10)$$

We then define the relationship between the deficit and the GDP to be equal to  $K_g$ .  $K_g$  will be chosen based on what we define as an acceptable value of the relationship. We get:

$$K_g = \frac{S_g}{GDP} \quad (6.11)$$

Now since we can measure all the values directly from the simulation except for  $G_w$  we can rearrange the equations to get the value of  $G_w$  based on the  $K_g$  we choose in the beginning of the simulation.

$$K_g = \frac{J_w - (G_a + G_w)}{C_w + G + I} \quad (6.12)$$

↓

$$G_a = \frac{J_w - K_g(I + C_w)}{K_g + 1} - G_w \quad (6.13)$$

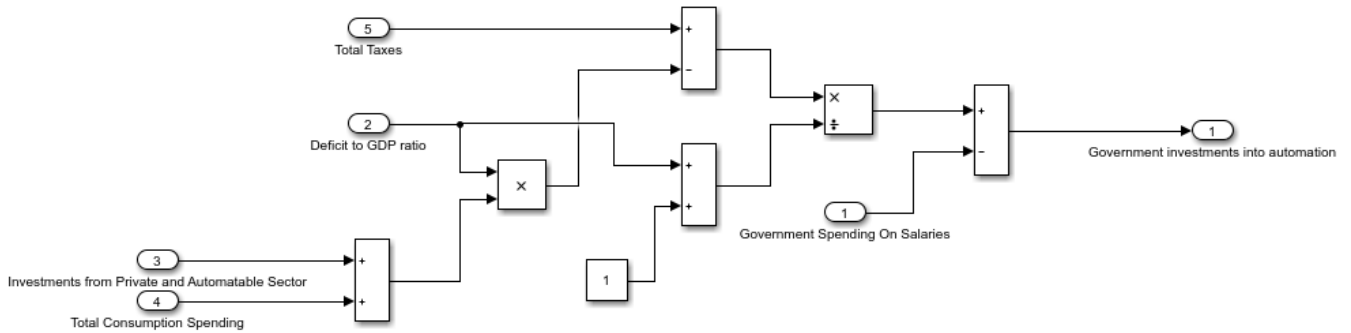

Figure 6.4: Simulink implementation of equation 6.13

## 6.7 The Sectors

In Norway, we usually talk about there being two main sectors work, the public and private sector. The private sector is to a large extent comprised of companies which gain their income from public spending and spend their revenue on wages and investments in the form of profits for shareholders, research or other investments. On the other hand, the companies or institutions in the public sector usually gain their revenue from the state in the form of taxation on the public, partly from the state or they are self-sufficient and are competing in the marketplace with other private companies. The most obvious way to make a divide between the sectors would be to say one is the public sector, and one is the private sector. The more purposeful way to divide the economic sector into subparts in this thesis would be to say that one sector comprises the employees who are directly paid by the state and the other is comprised of the employees directly paid by public spending.

### 6.7.1 The Government Financed (GF) Sector

The Government Payed Sector is defined as being comprised of the workers who have salaries which are paid directly by the state. It is also not directly affected by an increase in the degree of automation. The reasoning for defining it this way is that the interesting information flow into and out from each of the sectors are - where the money which pays the wages of the employees comes from and what proportion or amount of people receive their wages from these sources. For instance, the Norwegian public company VY AS could in some sense be categorised as a private company owned by the state [67]. However, the state subsidises the company even though most of their revenue comes from ticket purchases from consumers. This means that in the model, a large proportion of the workers in VY AS would be considered paid by revenue from consumers through ticket sales, while the remaining workers would be considered paid by the state. This way of subdividing the sectors should theoretically have no negative impact on the realness of the results obtained in the simulation part.

As discussed in section 3.6, there exists a need in our society for jobs which are non-automatable. As for the discussion on what proportion of jobs can be automated, see section 2.5. Examples of jobs that seem hard to automate and that there will always be a need for are nurses, teachers, policemen and administrative workers. With the current state of affairs, there is an increased need for workers in jobs within this sector due to a shortage of, e.g. health- and IT-workers [48]. This 'need' for workers can be looked at as a 'need' for services provided to the citizens within the nation as a whole. We could, for instance, say that if every working hour in the sector had its productivity increased by a factor of two, we would need half the amount of working hours to provide the same services to the public. By this definition, we can write down the equations for how many workers are needed to provide the productivity needed in the public sector. The Simulink implementation is shown in figure 6.5.

We define the following variables and parameters; denominations are indicated in brackets ([ ] means no denomination):

[q] = Productive output

[h] = Time in hours

[y] = Time in years

[w] = number of workers

$Y_d$  = the desired amount of productive output from the GF sector [q]

$P_h$  = The average productivity per working hour in GF sector [q/h]

$T$  = The average number of hours worked per year per employee [h/yw]

$E_{GF}$  = The total number of employees in the public sector [w]

Calculating the amount of employees needed in the public sector to provide the services desired we use the following equations:

$$Y_d = P_h T E_{GF} \quad (6.14)$$

As the labour force is defined as being constant, this equation can be used to calculate the proportion of the labour force needed in the public sector by rearranging equation 6.14:

$$E_{GF} = \frac{Y_d}{P_h T} \quad (6.15)$$

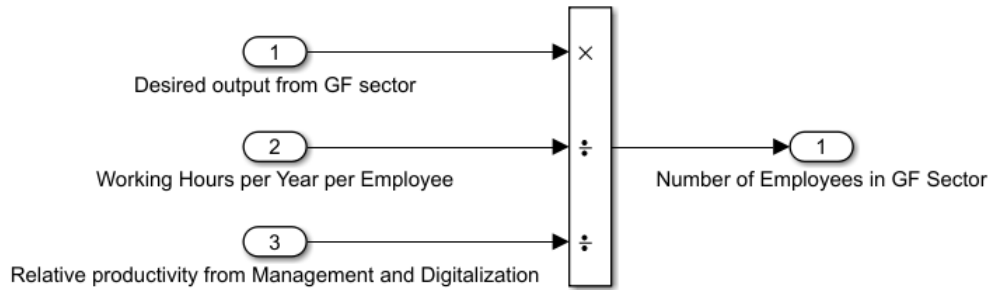

Figure 6.5: Simulink implementation of equation 6.15.

The way this is implemented in the model assumes that the public sector is able to employ all the workers needed to fill the production wanted. This does, for example, mean that as people working in the public sector retire, there will be an immediate influx of newly educated workers replacing them. This also means that even though we assume that the need for public services will increase with time, the number of workers does not necessarily have to increase as the productivity growth per working hour could theoretically outweigh the increase in productivity needed.

The GF Sector loses employees due to retirement. This means that a proportion of the employees are lost each year. As these workers are lost, they need to be replaced by workers ready for work from the JG and Education sector. If the rate of higher need of workers in the public service sector is higher than the rate of people being ready for work from the JG and Education sector, they will be provided workers from the private service sector as the GF sector are defined as necessary while the private service sector is defined as being good.

### 6.7.2 The Automatable Sector

While some of the elements involved in the automatable sector has already been presented mathematically, such as the dynamics of the degree of automation (see section 6.2), the way wages are paid (see section 6.4), and the number of workers needed (see section 6.2.1). However, there are two more aspects that we have to account for.

Firstly we need a definition for a worker in the automatable sector. In short, when choosing the proportion of workers in the automatable sector, we have to assess how many jobs might be automated away. Several people have written about this, as discussed in section 2.5. The fact that more and more technology is developed and therefore, that the number of jobs that can be automated away might increase has to be considered. Therefore, the model will be simulated with many different values for the automatable sector size.

Secondly, as the automatable sector will not increase its output of goods as production costs lower and products become cheaper, there will have to be a change in the proportion of consumption which is spent in this sector. This is regulated by the wage-to-revenue parameter, which is, as discussed in section 2.4, a way to make sure that the divide between the rich and the poor does not get too big. By implementing this parameter, the prices of goods and services in the automatable sector will always change linearly with the number of workers. This would seem to entail that there is not as large of an incentive for business owners to invest in further automation. However, as the state is subsidising the innovations in automation, the society as a whole will reap the benefits from the approach. The implementation is shown in figure 6.6.

We define the following variables and parameters; denominations are indicated in brackets ([ ] means no denomination):

[\$] = Money of account

[t] = Time in years

$K_r$  = Revenue to wage parameter [ ]

$R_a$  = Revenue in the automatable sector [\$/t]

$I_{aa}$  = Investments in automation from the automatable sector [\$/t]

$W_a$  = Average wage in the automatable sector [\$/t]

$$R_a = K_r W_a \tag{6.16}$$

$$I_{aa} = R_a - W_a = W_a(K_r - 1) \tag{6.17}$$

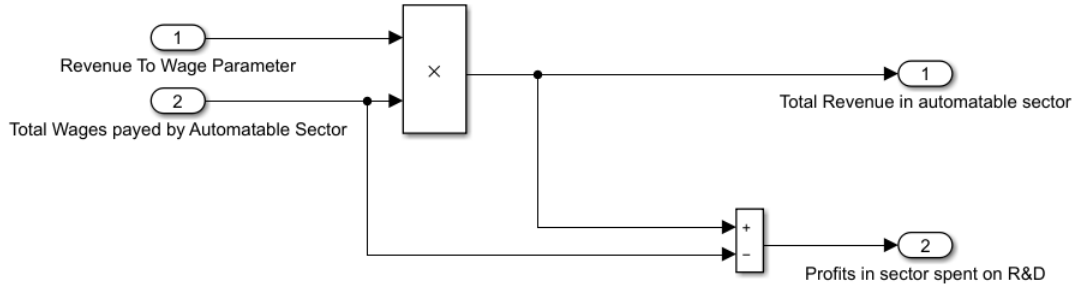

Figure 6.6: Simulink implementation of equation 6.16 and 6.17.

### 6.7.3 The Job Guarantee (JG) and Education Sector

This sector and its properties are based on much of the theory described in section 3.5. The sector will firstly provide jobs for all the unemployed who wants them, which makes it unnecessary to include people outside the labour market in the model. Also, the sector will include the people in education and the people in re-education. The way the differences in dynamics and properties between the people in Job Guarantee, Education and Re-education have been accounted for is that we can say there exists both an average time in the sector and an average wage provided by the state. These averages will make it so that the sector as a whole and its dynamics can be said to have the average of all the properties.

The sector has an influx of workers from the automatable sector, as well as an influx of people who are entering the labour force due to generational changes. Since the labour force is defined as being constant in size, for someone to enter the workforce through education, firstly someone has to leave the workforce through retirement. This is implemented in a way such that any retirees in either the government financed sector or the private service sector will be moved directly into the job guarantee, education and re-education sector. The average length of time a worker is in the labour force has been set to 45 years.

The average period workers are in the JG and Education sector will be set to five years. After a worker is considered ready for the other sectors, they leave this sector. The implementation of the equations is shown in figure 6.7.

We define the following variables and parameters; denominations are indicated in brackets ([ ] means no denomination):

[y] = Time in years

[w] = denomination of a worker

$T_h$  = average length of stay in the JG and Education sector [y]

$E_{jg}$  = the number of workers in the sector [w]



$N_{jg}$  = Influx of new workers to this sector [w/y]

$$\dot{E}_{jg} = N_{jg} - E_{jg} \frac{1}{T_h} \quad (6.18)$$

This means that if the influx of new workers to the sector is larger than the people who are ready for work outside, there will be an increase in the amount of workers. As discussed in section 3.5.2, it is undesirable for the sector to comprise a too large portion of the workforce as it can have dire consequences for the economy.

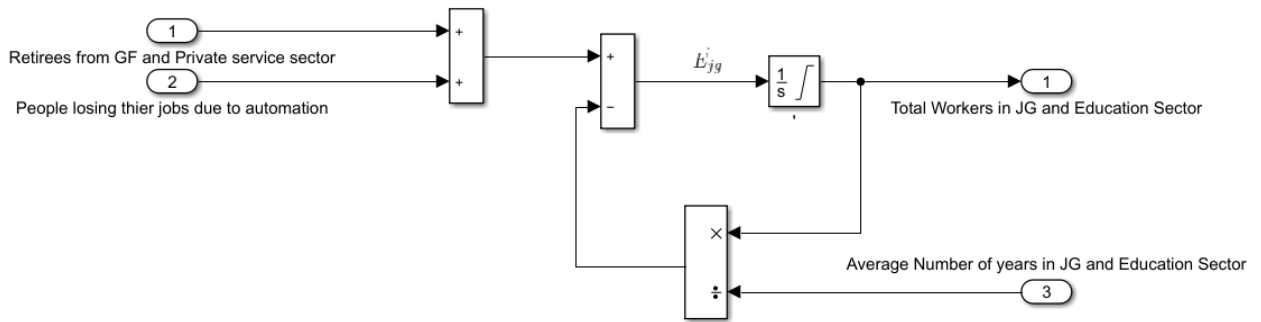

Figure 6.7: Simulink implementation of equation 6.18.

#### 6.7.4 The Private Service Sector

The private service sector is comprised of those workers in the workforce who are not paid by the state and who have work which is defined as not being able to be automated away. This is, therefore, the sector which in theory should be able to capture the people who are not needed in either the automatable or the public sector. This sector would in an ideal society grow since an increasing amount of people will be available for work in other sectors as people are laid off from the automatable sector. In addition to having people available for work in this sector, a larger proportion of the spending from the workers will go to this sector. As discussed in section 6.7.2, the wage to revenue parameter in the automatable sector will make people use less money on goods, and thereby a larger portion of consumer spending will be used towards spending on private sector services. This means that as long as the need for workers in the public sector does not grow too fast, the private service sector will see the largest increase in both people and revenue. The Simulink implementation of equation 6.19 is shown in figure 6.8.

Lets take a look at the mathematical relationships governing the private service. We define the following variables and parameters; denominations are indicated in brackets ([ ] means no denomination):

[\$] = Money of account

[y] = Time in years

[w] = Employees

$E_p$  = Number of employees in Private Service Sector [w]

$T_r$  = Average Retirement age [y]

$E_{GF}$  = The number of employees in the GF sector [w]

$E_{JG}$  = The number of employees in JG and Education sector [w]

$T_h$  = Average length of stay in the JG and Education sector [y]

$R_p$  = Revenue in the private service sector [\$/y]

$R_a$  = Revenue in the automatable sector [\$/y]

$W_h$  = Yearly wage in the private service sector [\$/y]

$Q_p$  = Total Wages payed in Private Service sector [\$/y]

$I_p$  = Investments made by private service sector [\$/y]

$C_w$  = Total consumption spending in society [\$/y]

Equation 6.19 shows how the number of workers in the private sector changes over time. Also  $E_g$  is shown in equation 6.19.

$$\dot{E}_p = E_{JG} \frac{1}{T_h} - E_p \frac{1}{T_r} - \dot{E}_g \quad (6.19)$$

The revenue in the sector is influenced directly by the revenue from the automatable sector as described by equation 6.20.

$$R_p = C_w - R_a \quad (6.20)$$

The total investments made in the private service sector is calculated by subtracting the amount paid in wages to the employees from the total revenue, as shown in equations 6.20 and 6.21. Due to the non-causal relationship between the number of workers in the sector and the total revenue, the total revenue might, at some point be lower than the amount paid in wages. If this happens, the investments from the private service sector turn negative and directly lowers the total GDP, which means that in effect, the government provides the money to the workers. The total investments from the private sector are then calculated:

$$I_p = R_p - E_p W_p = R_p - Q_p \quad (6.21)$$

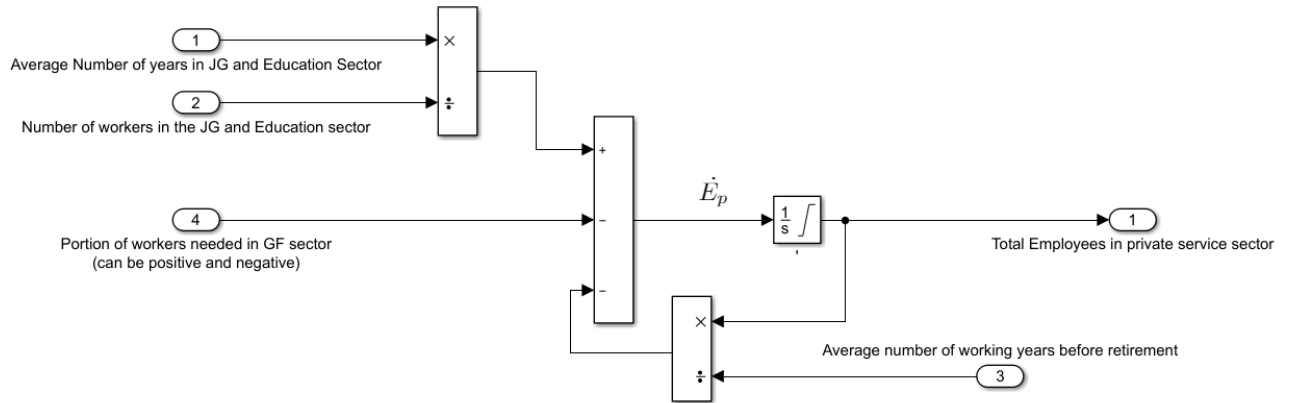

Figure 6.8: Simulink implementation of equation 6.19.

### 6.7.5 People laid off from the private service sector

At some point, the private service sector might no longer have the revenue to be able to pay all of its workers, and at that point, we need some sort of mechanism that is used to indicate that people are laid off. This might be particularly relevant in the event of a financial crisis as discussed in section 3.7. As the amount of people in the private service sector is not bound to a fixed wage to revenue ratio parameter, the sector will lay off people as the ratio approaches 1, not at 1. This is implemented with a sigmoid function. First, the sigmoid function will be presented, and then how it is used to show the full implementation of how people are laid off. We define the following variables and parameters; denominations are indicated in brackets ([ ] means no denomination):

[\$] = Money of account

[y] = Time in years

[w] = Employees

$E_p$  = Number of employees in Private Service Sector [w]

$R_p$  = Revenue in the private service sector [\$/y]

$W_h$  = Yearly wage in the private service sector [\$/y]

$Q_p$  = Total Wages payed in Private Service sector [\$/y]

$\dot{E}_{pr}$  = Jobs lost in the private service sector due to the wage to revenue parameter being too high

$K_l$  = Constant indicating the amount of workers laid off proportionally to the excess amount of people in the sector

$S(x)$  = Sigmoid function

The sigmoid function in equation 6.22 is used as it gives an increasing multiplication factor on the amount of people being laid off.

$$S(x) = \frac{1}{1 + e^{-40(x-1)}} \quad (6.22)$$

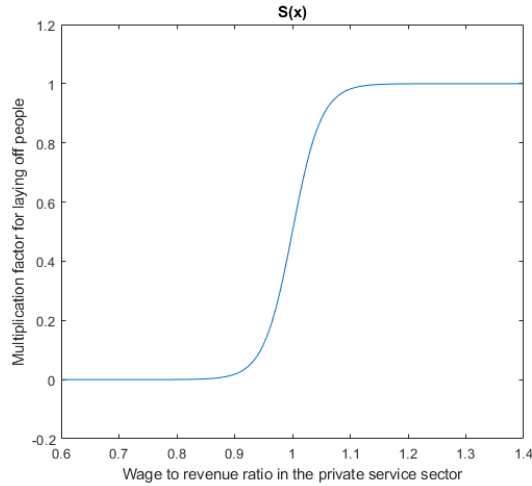

Figure 6.9: Graph showing the behavior of the sigmoid equation with the chosen parameters as a function of the wage to revenue in the private service sector

As the number of people in the private service sector are a stock, we need a flow of people out from it and into the JG and Education sector. The flow is based on the actual discrepancy between the number of employees and the sustainable level of employees. This means that by using the sigmoid function, we can set up the way people are laid off like this:

$$E_{pr}^i = \frac{|R_p - Q_p|}{W_h} K_l S\left(\frac{Q_p}{R_p}\right) \quad (6.23)$$

The equation works the following way. We want the number of people who are laid off to be proportional to the amount of people who in excess. This is done by multiplying the absolute value of the amount of people in excess with the proportionality constant  $K_l$ . However, as we can some people to be laid off even before the the wage to revenue ratio reaches 1, the sigmoid function stops any people from being laid off before the ratio is at about 0.9.

## 6.8 Measuring prosperity in the society

As the goal of this thesis is to shed light on which approaches to tackle the future of employment, we have to include some metric to measure the goodness of the

different outcomes in the simulation. We will consider both the end result after the simulation is done and the variable values during the simulation as we want both the end result and the road to the end result to yield as much prosperity as possible.

### **6.8.1 The amount of hours worked**

As discussed in section 4.2 by reducing the average amount of hours worked for everyone, and we will likely increase peoples satisfaction with many aspects of life, not restricted to their perception of the work itself. Therefore, a high pace at which the number of hours worked by the average worker is decreased will be considered good. As the pace is set as a constant per cent-wise change, the value will be increased while looking at how it affects the other measures of prosperity.

### **6.8.2 The amount of money spent in the private service sectors**

As discussed in section 4.4, there are many second-order benefits from increasing the degree of automation. One of the ones who benefit society the most is the fact that more people can work within the service sector, and a larger proportion of spending can be spent in this sector. While material wealth and consumer goods are considered to not to give a lasting increase in happiness and health, the fact that we on average will have more leisure time and more money to spend on activities such as restaurant visits, sports, exercising and other social activities have been shown to increase happiness. Therefore we can measure the prosperity of the society by looking at the proportion of money and the labour force, which is in the private service sector.

### **6.8.3 The BER value**

As discussed in section 3.5.2, there is an ideal level of the employment buffer stock. We have changed the number of people which comprises the sector containing the employment buffer stock as it now includes all people in the education sector as well. Therefore we can not use the values of between 3.5 to 4.5 per cent indicated by MWW. The goal is for this value not to be too large, and it will be discussed what the value means when presenting the results.

## **6.9 Initial Sector Sizes**

As discussed in section 5.4, the end result of the simulation might vary a lot depending on the initial values of the variables. Firstly as discussed in section 2.5 there are many quite different perspectives on the number of current jobs which are subject to automation. This can be set quite easily by choosing an initial proportion of workers in the automatable sector. To show how the initial sizes of the are set, we define the following variables and parameters; denominations are indicated in brackets ([ ] means no denomination):

[y] = Time in years

[h] = Time in hours

[q] = Productive output

[w] = Number of workers

$P$  = Initial productivity per worker per hour [q/wh] (This is defined as being equal to 1).

$L$  = The initial and constant size of the labour force [w] (This is defined as being 1000)

$T_0$  = Initial amount of hours worked per employee per year in all sectors [h/wy]

$X_a$  = Proportion of labour force in automatable sector [ ]

$E_{a_0}$  = Initial amount of workers in the automatable sector [w]

$P_a$  = Initial total productivity per year in the automatable sector [q/y]

$X_{JG}$  = Proportion of labour force in JG and Education sector [ ]

$E_{JG_0}$  = Initial amount of workers in the JG and Education sector [w]

$X_{GF}$  = Proportion of labour force in GF sector [ ]

$P_{GF}$  = Initial total productivity per year in the GF sector [q/y]

$E_{GF_0}$  = Initial amount of workers in the GF sector [w]

$X_p$  = Proportion of labour force in the private service sector [ ]

$E_{p_0}$  = Initial amount of workers in the private service sector sector [w]

$$X_{GF} + X_p + X_a + X_{JG} = 1 \quad (6.24)$$

$$E_{a_0} = LX_a \quad (6.25)$$

$$P_a = E_{a_0}PT_0 \quad (6.26)$$

$$E_{GF_0} = LX_{GF} \quad (6.27)$$

$$P_{GF} = E_{GF_0}PT_0 \quad (6.28)$$

$$E_{p_0} = LX_p \quad (6.29)$$

$$E_{JG_0} = LX_{JG} \quad (6.30)$$

## 7 Causal Diagrams

Explanations of the causal effects have been explained in previous sections of the thesis. This section is meant to give an overview of how the different parts of the system interact with each other. First, it will be explained how the diagrams should be interpreted and what the different symbols mean.

The parameter, variable or stock which an arrow point from indicates what is causing the value which it points at to change and the plus or minus sign indicates the direction of change. In figure 7, we see an example of such a causal relationship. This notion means that if X increases, it causes Y to increase. If on the other hand there was a minus sign linked to an arrow, an increase in X would cause Y to decrease in value.



Figure 7.1: Causal Relationship between X and Y

The other kind of relationships that exists in the diagrams are the stock-flow links. The variables within the boxes are called stocks since they accumulate over time. Stocks can only change by having a flow in or out from it. The size of the flows is influenced by other variables in the model. In figure 7, we see such a relationship. The cloud symbol indicates that the flow into stock X comes from a source outside the boundary of the model. The hourglass shape with an arrow through it indicates that there is a flow from left to right, and the arrow from Z to the hourglass with a plus sign on it indicates that if Z increases, the flow from left to right increases. The flow from stock X to stock Y indicates that when stock Y increases by an amount, it reduces stock X by the same amount. The W variable with an arrow to the hourglass below indicates that as W increases it reduces the flow from stock X to stock Y, and when W decreases it similarly increases the flow from X to C. Whenever the flow can go both ways, it is indicated by a double arrow, where the reverse direction is indicated by a white tip of the arrow on one side.

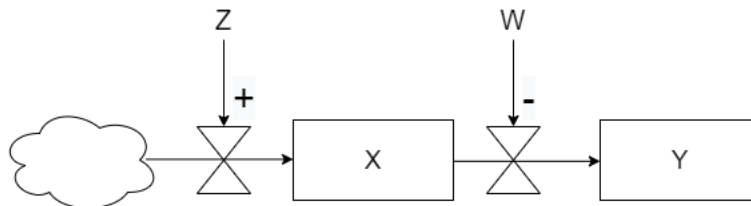

Figure 7.2: Stock Flow Diagram

The third component of the diagrams is the balancing and the reinforcing

loops. An example of these kinds of loops is shown in figure 7. Here we can see that an increase in X causes Y to increase, which in turn causes X to increase. The loop of causal effects is indicated by an arrow indicating its direction and a letter R, indicating that it is a reinforcing loop. On the other hand, we have the loop from X to Z. An increase in X causes an increase in Z, which in turn causes X to decrease. This loop is labelled by an arrow with a B inside, indicating that it is a balancing loop.

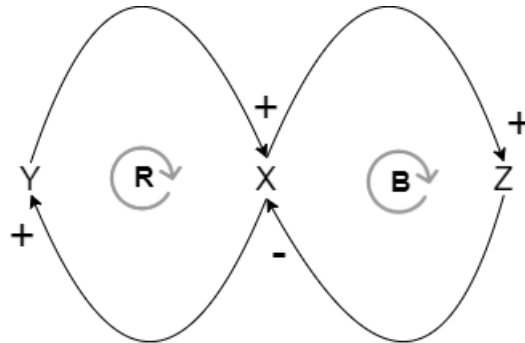

Figure 7.3: Stock Flow Diagram

## 7.1 The Automatable Sector Diagram

The Automatable Sector has been explained thoroughly in section 6.7.2. Figure 7.1 will be used to help us get an overview of the dynamics present in the automatable sector.

The total investments which lead to an increase in the degree of automation is the sum of investments from the government and the profits from the sector after wages are subtracted from the total revenue. Also, the degree of automation causes the average worker in the sector to be more productive. The productivity per worker is also influenced by the number of working hours and the increase in productivity from digitization and management.

As explained in section 4.3, the automatable sector is defined as having no increase in the total production of goods. Therefore whenever the total productivity exceeds the constant desired productivity, the sector lays off the worker so that the total productivity is always equal to the desired productivity. This flow of people is indicated by the flow of employees going from the automatable sector to the other sectors.

The total amount of money spent on wages in the automatable sector is the product of employees and the average yearly wage in the sector. And since the wage to revenue factor is exogenous, the revenue can be directly calculated from the amount spent on wages.



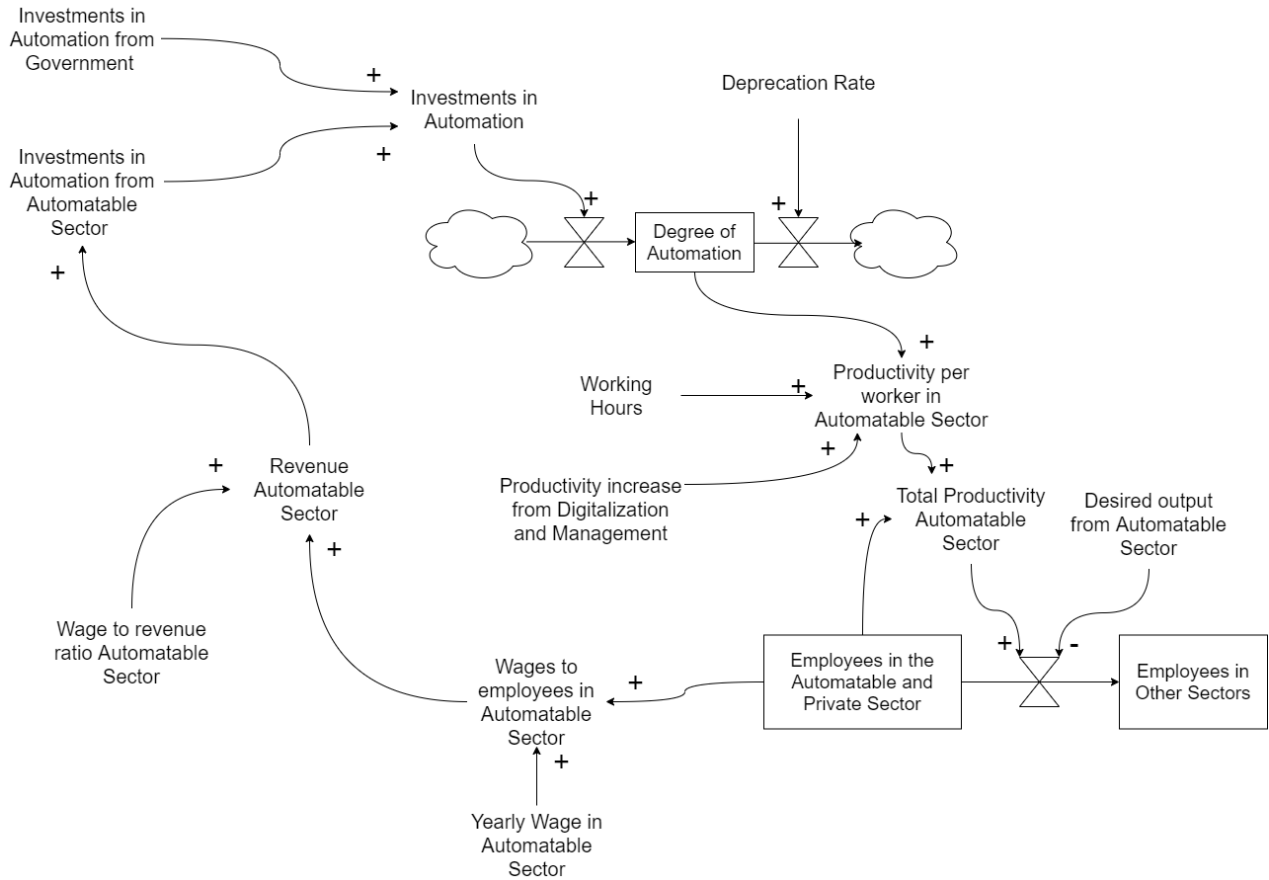

Figure 7.4: Diagram showing the dynamics in the Automatable Sector.

## 7.2 The Private Service Sector

The private service sector has many intricate rules governing it, as shown in figure 7.2. Contrary to the automatable sector, it is absorbing workers from the JG and Education Sector. Like the GF sector, the sector loses some workers each year due to people retiring. Also, whenever the GF sector needs more workers than can be obtained from the JG and Education sector, they will 'steal' workers from the private service sector as these are regarded as already having the required skills.

The total productivity in the private service sector is increased by the working hours and the productivity increase from digitalization and management. While the total productivity in this sector does not directly cause any other variables to increase, it will be used as a measure of prosperity in society as a whole.

The revenue in the private service sector is calculated by subtracting the revenue in the automatable sector from the total consumption spending. This means that the ratio between the wages paid and the total revenue in the sector will fluctuate as the dynamics of the number of employees and the revenue in the sector are not proportional to each other. The investments made by the sector is the difference between the revenue and the wages and is used to calculate the GDP of the state as a whole.

If the wage to revenue ratio approaches one (where the revenue in the sector can no longer support all the workers) the private service sector will start laying off workers. This means that the flow of workers from the private service sector to the JG and Education sector is influenced by the wage to revenue parameter only when it approaches one.

There exists a reinforcement loop as indicated by the loop arrow with an  $r$  inside. This is because the amount of people who move from the private service sector to the JG and Education sector is proportional to the number of people there, and vice versa.

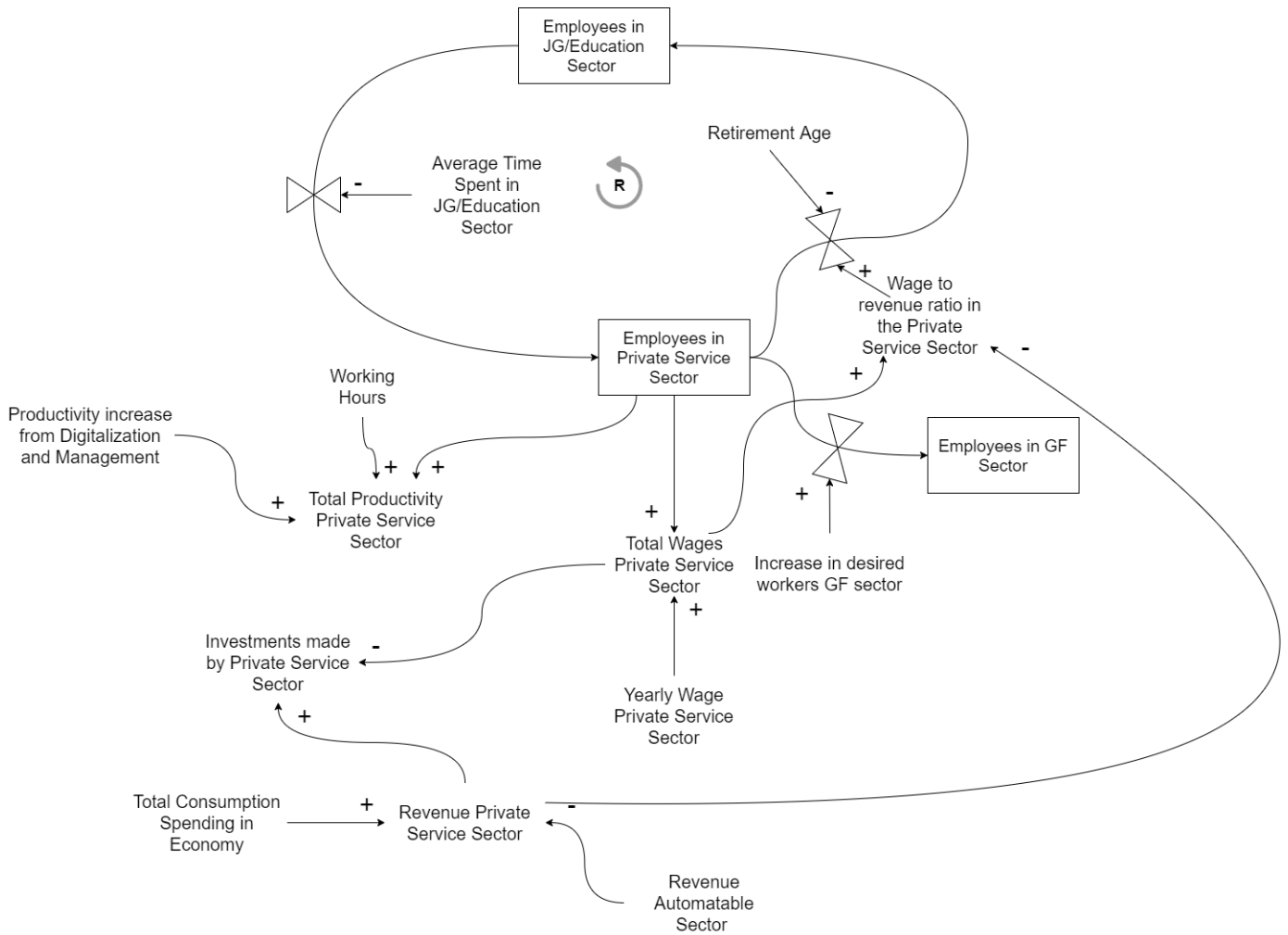

Figure 7.5: Stock-flow diagram of the dynamics involving the Private Service Sector

### 7.3 The Government

The government is calculating the relevant metrics for deciding how much money is spent by the state on automation efforts, as shown in figure 7.3. Total government spending is defined as being the sum of government-paid salaries and investments from the government to increase the degree of automation. The government then calculates the amount of money it spends on investments in increasing the degree of automation by setting the desired level of deficit spending and calculating the number of investments which yields this deficit. This means that when the deficit spending increases or the GDP is reduced, the dif-

ference between the actual deficit and the desired deficit increases, meaning less money can be allocated for investments in automation. Vice versa when the deficit spending decreases or the GDP increases, more money can be allocated to spend on automation efforts.

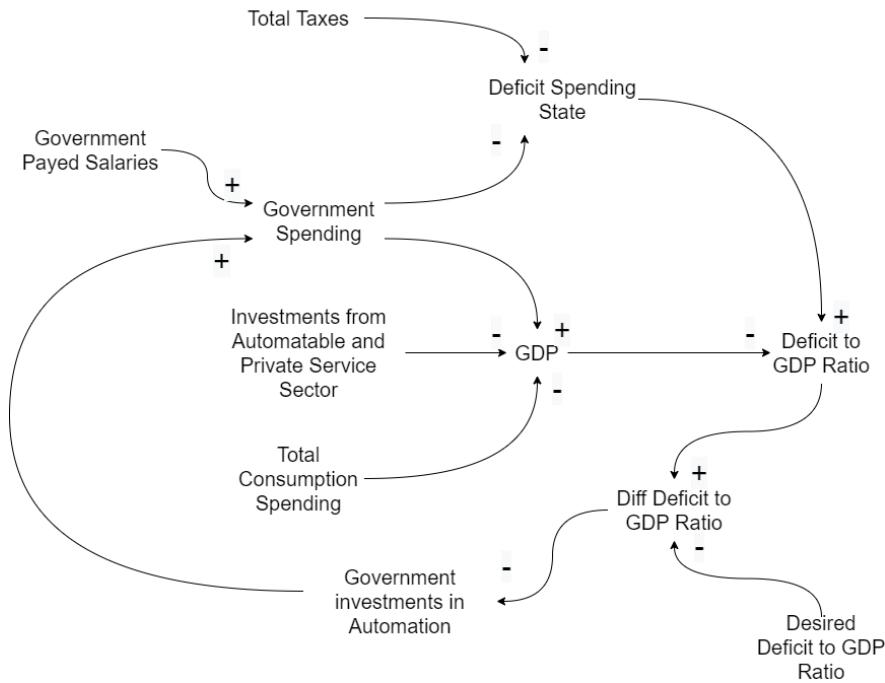

Figure 7.6: Stock-flow diagram showing how the government calculates its spending

#### 7.4 Spending, salaries and taxes diagram

The diagram is shown in figure 7.4. The wages paid in each sector are the product of the number of employees and the average yearly wage in the sector. This means that as the number of employees rises the total wages in the sector rises. Since the government pays the salaries in the GF sector and the JG and Education sector, the total government paid salaries is rising as the number of employees in the two sectors rises.

Total tax payments are the product of the salaries and the tax rate. This means that as either the total salaries or the tax rate rises, the total taxes paid similarly rises. The total consumer spending is the rest of the money, meaning that if the total taxes rise due to an increase in the tax rate, the consumption spending decreases accordingly.

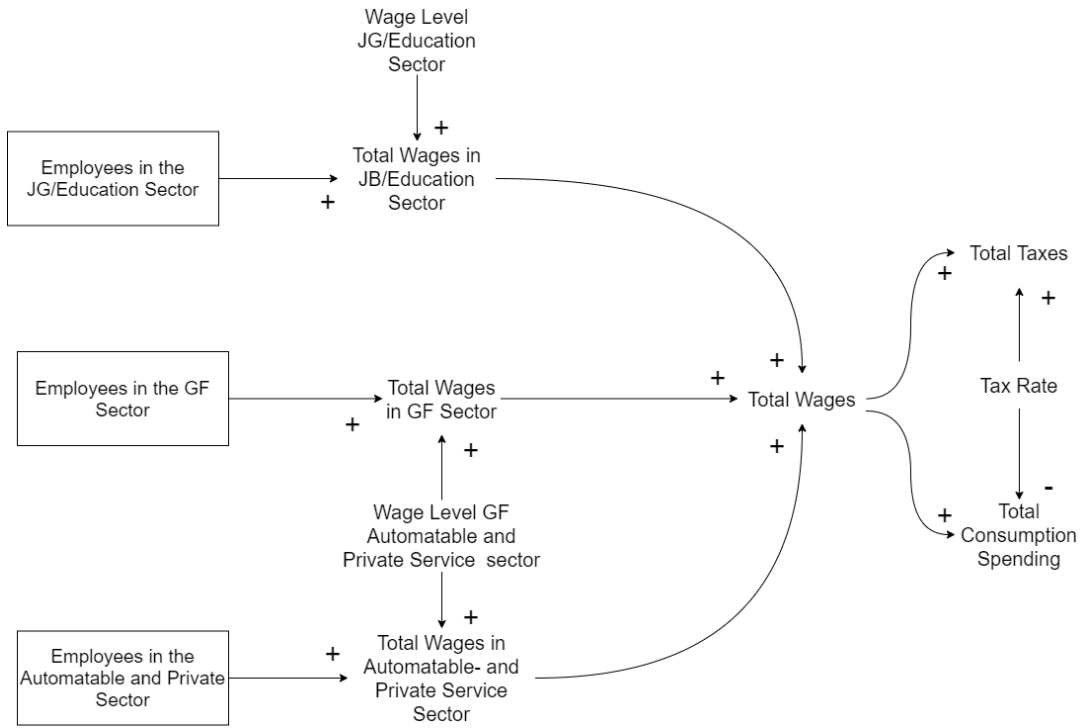

Figure 7.7: Diagram showing how taxes and consumption spending is calculated.

## 7.5 Change of Employees in JG and Education Sector Diagram

There are three ways the number of workers in the JG and Education Sector can increase, as shown in figure 7.5. The primary way is when the automatable sector sees an increase in productivity per worker; it lays off workers until the total productive capacity of the sector is where the initial level was. This means that as the degree of automation increases, more workers are laid off and have to re-educate themselves through the JG and Education Sector before they are ready for work outside.

The system is defined to have a constant amount of people in the labour force. This means that as people retire, the same amount of people are entering the workforce. When people in the JG and Education Sector have been there for the average time, it takes to be ready for work in the GF or private service sector, and they move into the appropriate sector. The way this works is that the GF sector absorbs the number of people it needs as this sector is deemed more critical, while an increase in employees in the private service sector is a mere positive but not necessarily increase.

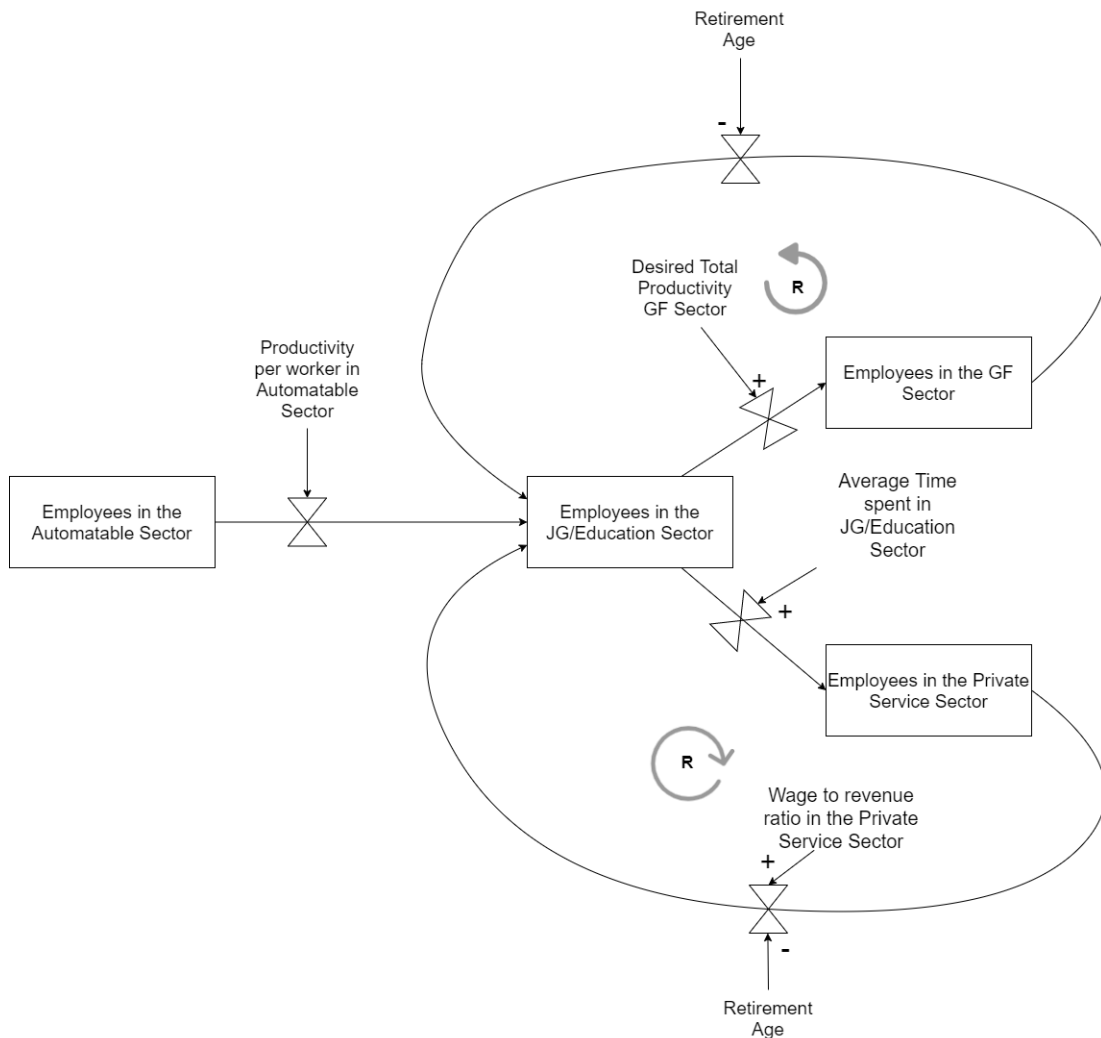

Figure 7.8: Stock-flow diagram showing how people move to and from the JG and Education sector

In figure 7.5, we see the dynamics when there is a larger need for workers in the GF sector than can be absorbed from the JG and Education Sector. The double arrow with a white arrow on one side means that flow can go both ways. This means that when total productivity is larger than the desired productivity there are too many workers in the public sector, and they will be moved to the private service sector as they are considered to have the needed experience and skills to work there. This means that there is a constant exchange of workers between the two sectors, which is controlled by the GF sectors need for more or fewer workers. Note that this diagram only describes part of the flow of workers

between the sectors.

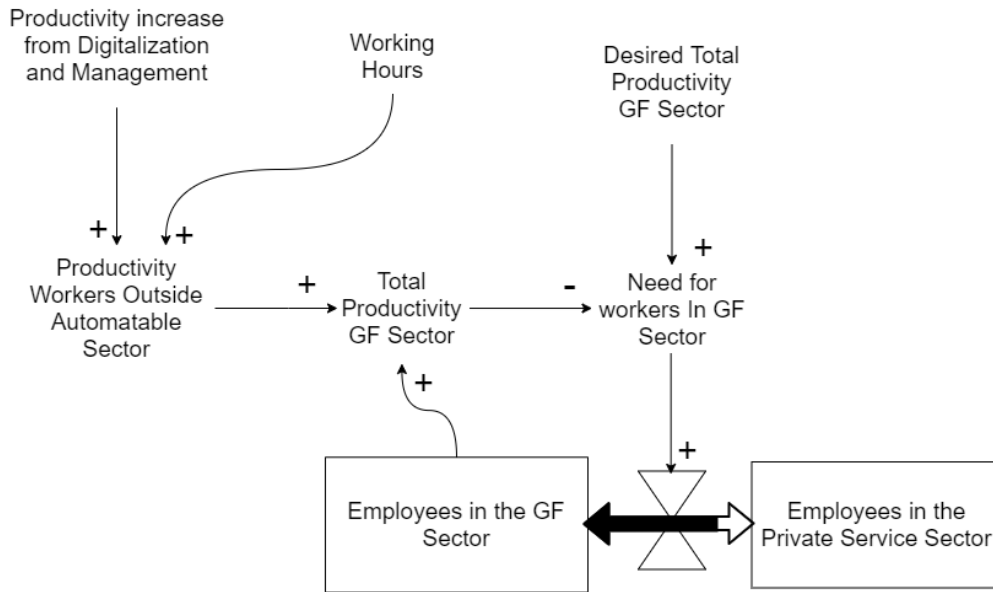

Figure 7.9: Stock-flow diagram showing how people move from the Private Service Sector to the GF Sector

## 8 Results and discussion

In this section of the thesis, results from the simulation of the model described in section 6 will be presented. Initially, the reasoning for choosing the model parameters and descriptions of the simulation data will be presented.

### 8.1 Choosing parameters

Since the model is very complex with many different variables and causal relationships to account for, we will start by examining some of the variables in isolation. Firstly, a simulation which will be a reference simulation will be presented. This simulation will be thoroughly explained so that we can get a feel for how the dynamics depend on the chosen parameters.

The parameters in the model have been discussed in section 6. To see how the model of society behaves over time, we first have to decide the parameters which impact the behaviour. As the model should reflect the Norwegian labour market, some values will be chosen to reflect the current trends or economic metrics in Norway right now, while some will be stylized to induce the behaviour we seek or want to investigate.

All the simulations will run for 80 years. This is because we want to look at the long term consequences of different policies, trends and political changes. Also, the labour force,  $L$ , will stay constant at 1000 participants. This means that the potential impact of lower or higher birthrates or emigration and immigration will not be considered. The total productivity of the GF and the automatable sector will be determined by the initial proportion of the labour force in the sectors as described in section 6.9.

The wages will be set at different levels. Since the money of account in the model is set in an arbitrary currency, the actual wage levels,  $W_l$  and  $W_h$ , are only important for two reasons. Firstly the JG/Education Sector has a low wage relative to the wages in the other sectors and secondly because the relationship between investments in automation and the actual increase in the degree of automation is dependent on the wage levels. Therefore the wage levels will be set to 2 for the JG and education sector and 3 for the other sectors, giving the other sectors a 50 per cent higher salary. The multiplication factor, which indicated the relationship between the investments and the per cent increase in the degree of automation,  $K_a$ , will be held constant at  $10^{-5}$  since it gives the desired behaviour.

The average working time,  $T_r$  will be set to 45 years as this is close to the length of normal working life. The average time for a person to be in the JG and Education sector,  $T_h$  will set to 5 years since education will comprise a large portion of the people in the sector and since the JG programmes will be considered an apprenticeship. While there are different wage levels for different sectors, the tax rate will be the same for all wage levels. However, the tax rate,  $S$ , will be varied, and we will look at the influence a change in tax rate has on the system.



The revenue to wage ratio,  $P_r$ , in the automatable sector will be set at different initial levels, and we will look at how an increasing value impacts the society. The depreciation rate of the degree of automation will be set to 0.5 per cent. As the state can create money to invest in automation, the size of the investments depends on the deficit to GDP ratio,  $K_g$ . This means that the higher the value of  $K_g$ , the faster the degree of automation will increase. As we want to prevent inflation, there will be a theoretical limit to this value.

The number of working hours will decrease with a constant,  $K_h$  per cent per year for the duration of the simulation and will be considered exogenous a will be tested for different values. This means that even though the amount of working hours is one of the measures of prosperity, lowering the number of working hours will have negative impacts on productivity in all sectors, and its therefore vital that its not lowered too fast if we want the other measures of prosperity to be maintained. The desired total productivity in the government financed sector will also increase at a constant rate as described by equation 6.14.

## 8.2 The reference simulation

To set a starting point for the simulation results, we will start by explaining the dynamics from a simulation with the variable parameter values, as shown in table 8.1. This will be the benchmark, and we will later try to find the strength and weaknesses of the chosen parameter values by testing for other values.

| Parameter | Value            |
|-----------|------------------|
| $X_a$     | 0.4              |
| $X_{JG}$  | 0.15             |
| $X_{GF}$  | 0.25             |
| $X_p$     | 0.2              |
| $P_r$     | $\frac{1}{0.75}$ |
| $K_h$     | -0.002           |
| $K_g$     | -0.25            |
| $K_p$     | 0.003            |
| $S$       | 0.15             |
| $W_l$     | 2                |
| $W_h$     | 3                |
| $D_a$     | 0.005            |

Table 8.1: The parameters used in the reference simulation

The primary productivity in the GF sector is the product of the initial amount of working hours per person and the number of people working in the sector. Then the desired productivity in the sector increases by a factor,  $K_p$ , each year. To reach the productivity target, the GF sector needs to hire enough people, so that equation 6.14 is satisfied. As average working hours per year,

productivity per hour and the desired productivity in the sector changes, the number of workers change accordingly.

In figure 8.1, we see the dynamics of the employees and productivity in the public sector. The productivity increase from management and digitalization means that each worker can perform more work per working hour which would indicate a decrease in the need for workers. However, as the need for productivity increases and the number of hours worked decreases, the need for workers in the GF sector increases from 250 to almost 300 over 80 years.

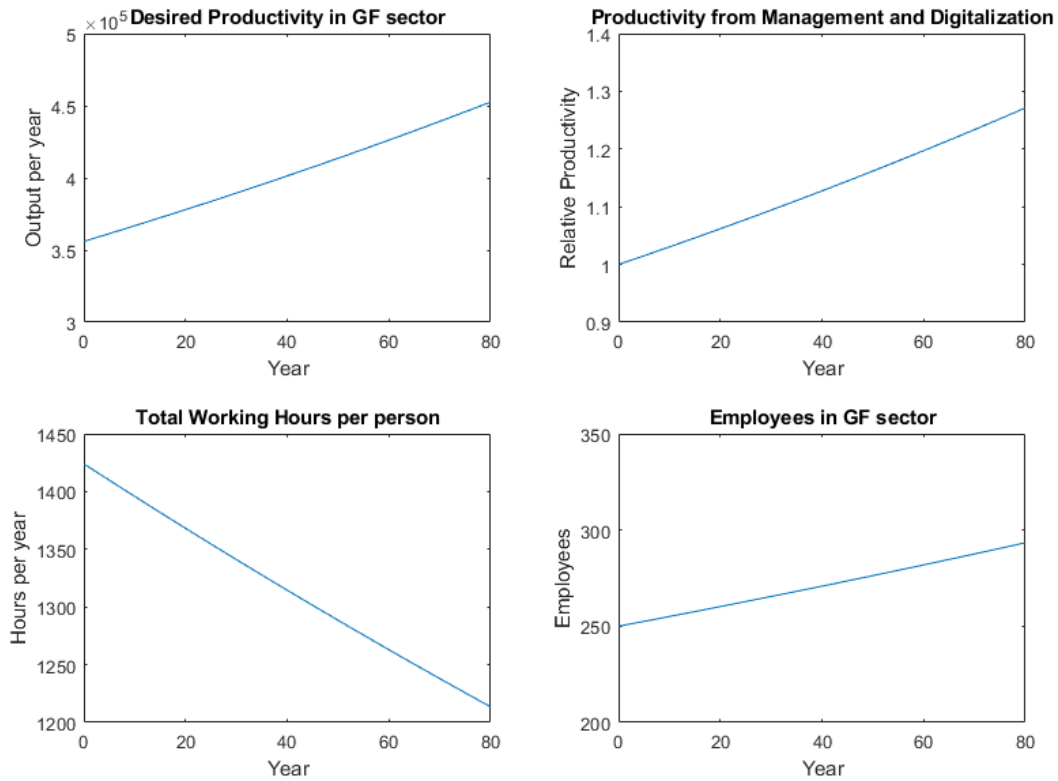

Figure 8.1: Graphs showing the dynamics in the GF sector

In figure 8.2, we see the dynamics of the investments in automation, the degree of automation and the number of people employed in the automatable sector. As we can see from the graphs, the automatable sector sees a sharp decline in the number of employees. This change in the number of employees is largely caused by the increase in the degree of automation, but also by the number of working hours and the productivity increase from digitalization and management as shown in figure 8.1.

The investments into automation from the profits within the automatable sector decline proportionally to the number of workers in the sector as described by equation 6.16. As more and more wages are paid by the government due to a shift from the automatable sector to the GF sector, the investments into automation from the government falls. The initial spike in investments from the government comes from the fact that there is an initial move of workers from the JG and Education sector to the private service sector.

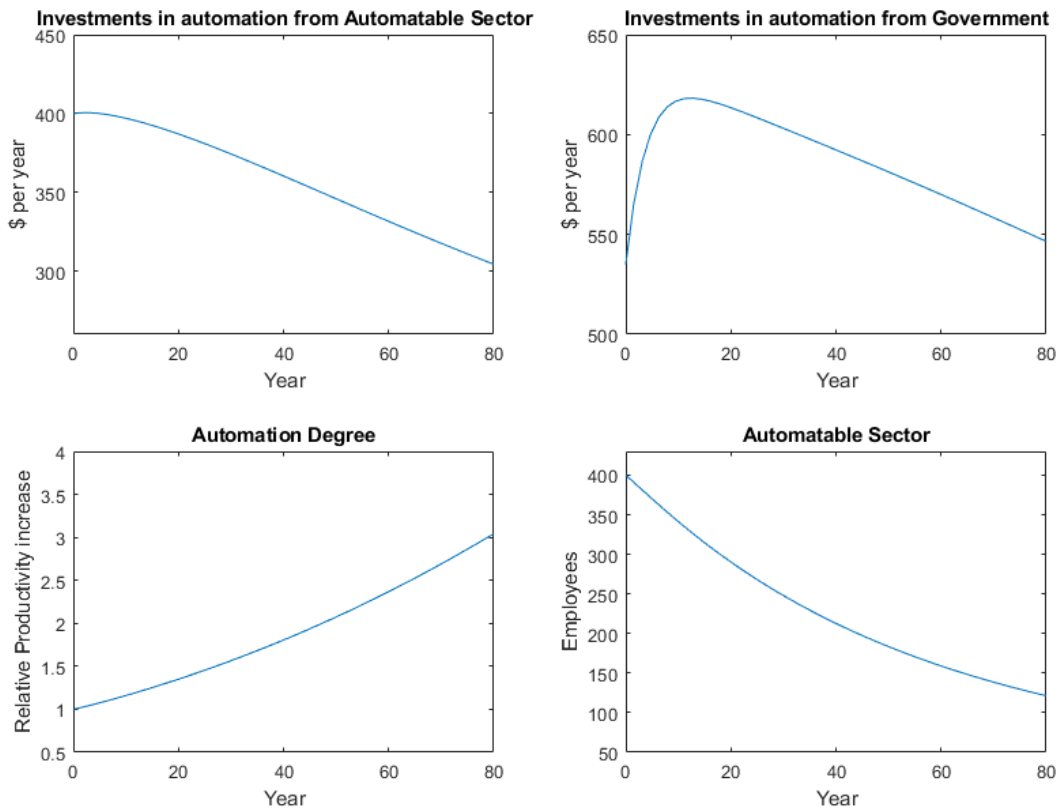

Figure 8.2: Graphs showing the public sector dynamics.

Figure 8.3 shows the dynamics of the stream of employees into and out from the JG and Education sector. The top section of the figure shows the flow of workers from the automatable sector, which is caused by an increase in productivity. The number of retirees from the private service sector and the GF sector is increasing with the number of employees in the sectors, as the number of retirees is proportional to the number of workers. This also explains the slow but steady rise in the number of people in the JG and Education sector.

As a smaller and smaller proportion of the labour force is comprised of the automatable sector, the number of retirees each year increases and the steady-state of the number of employees in the JG and Education sector increases.

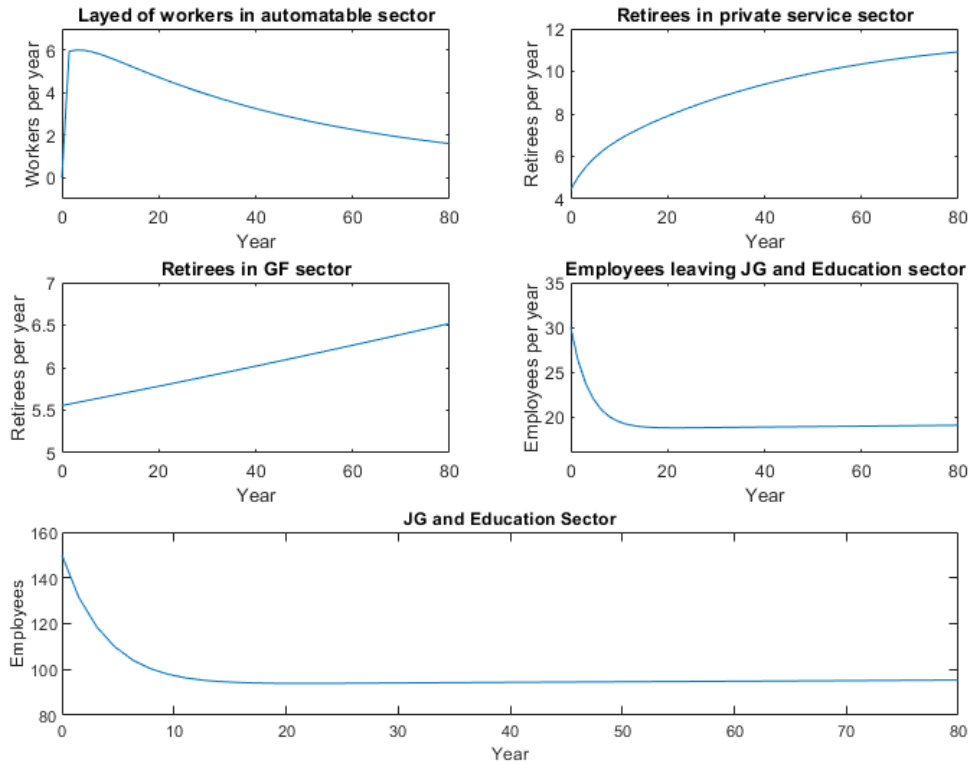

Figure 8.3: Graphs showing how people move to and from the JG and Education sector.

Figure 8.4 shows the dynamics of the total consumption spending, the total tax revenue and the proportions of consumer spending, which go to the private service and automatable sector. As the majority of the population works in the sectors with the  $W_h$  wage level, and the since the tax rate is constant and equal for all sectors, the only change in total taxes and consumer spending is caused by changes in the proportion of the population working in the JG and Education sector.

However, there is a substantial shift in where the money is spent. As much of the work in the automatable sector is being automated, the prices go down, and more money is allocated for spending in the private service sector. This creates a clear shift in the revenues of the two sectors, as shown in the bottom

graphs in figure 8.4.

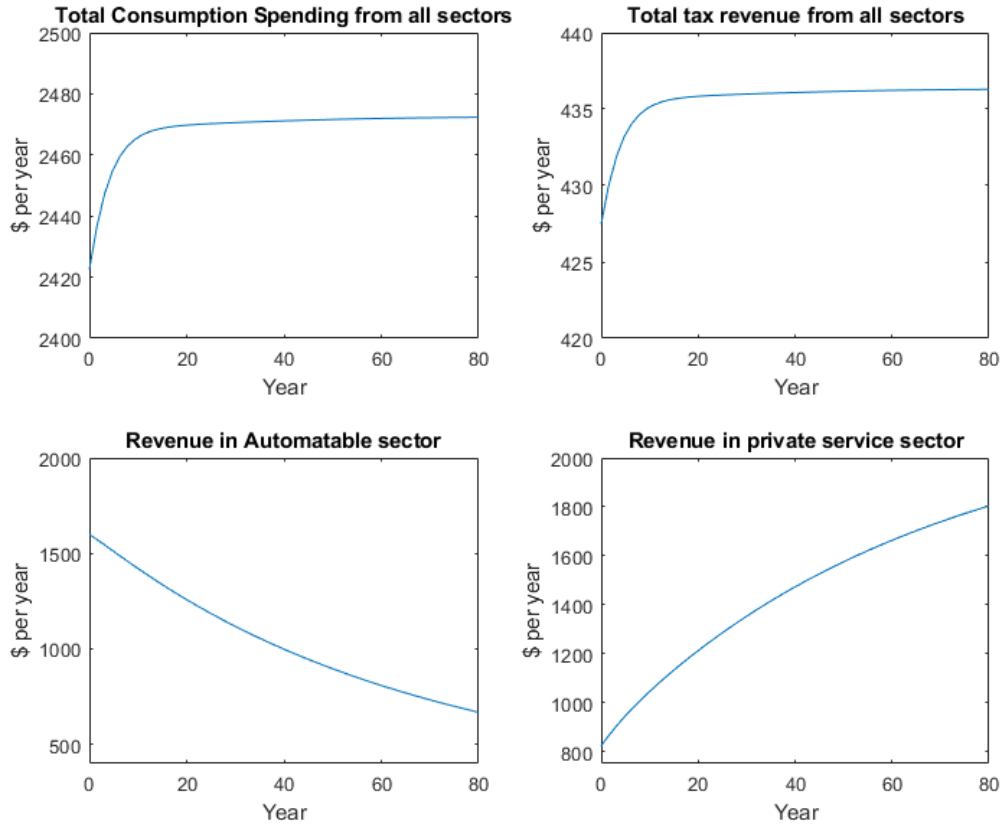

Figure 8.4: Graphs showing the dynamics of the consumption spending and tax revenue.

Figure 8.5 shows the dynamics in the private service sector. The total number of employees in the sector increases as workers who have lost their jobs in the automatable sector has received the appropriate skills for work here. As the revenue in the automatable sector decreases, a larger proportion of consumer spending is being used for services provided by the sector. With the chosen simulation parameters, we see that the labour share of the revenue decreases over time. This is indicative that the GF sector is absorbing a significant proportion of the people who have lost their jobs due to automation.

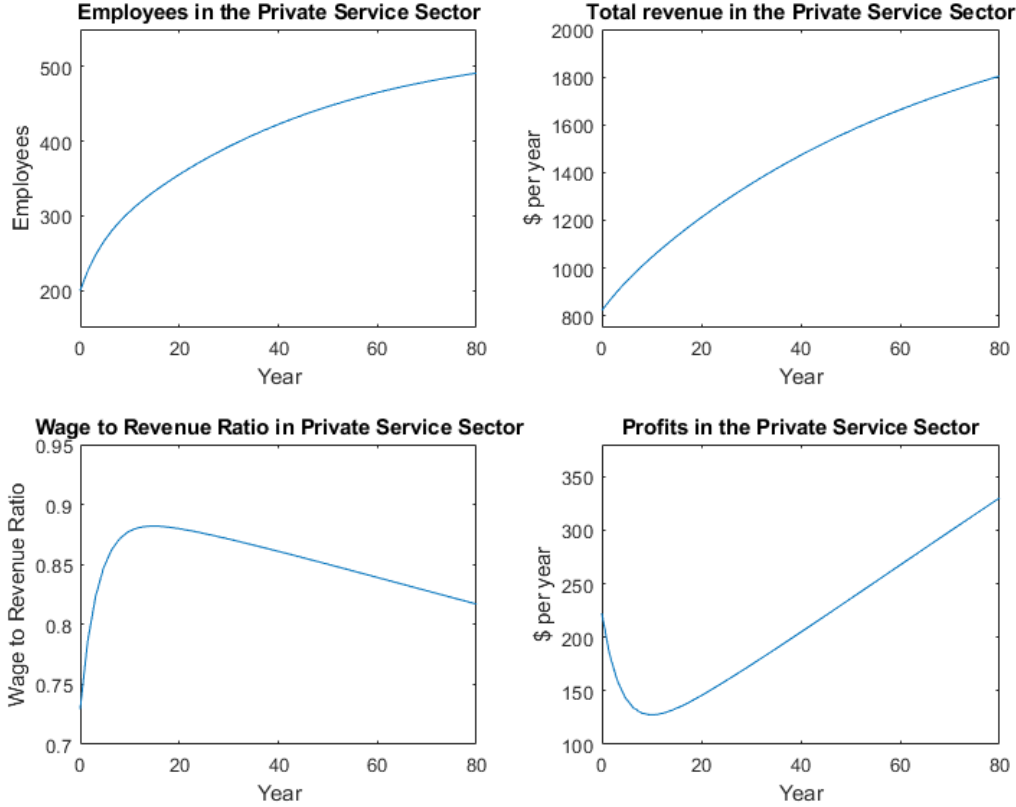

Figure 8.5: Graphs showing the dynamics of money circulation and employment levels in the private service sector.

Figure 8.6 shows the dynamics of government spending, tax revenue and the state GDP. The deficit to GDP ratio is fixed for the entire simulation. This means that for the government to be able to spend more money on investments in automation, either the government spending on salaries needs to decrease or the total GDP has to increase. The initial decrease in the total government spending is caused by workers in the JG and Education sector, moving into working in the private service sector. However, as the number of employees in the GF sector rises steadily, as shown in figure 8.1, the government uses a larger portion of its spending on salaries, thereby lowering its investments in automation.

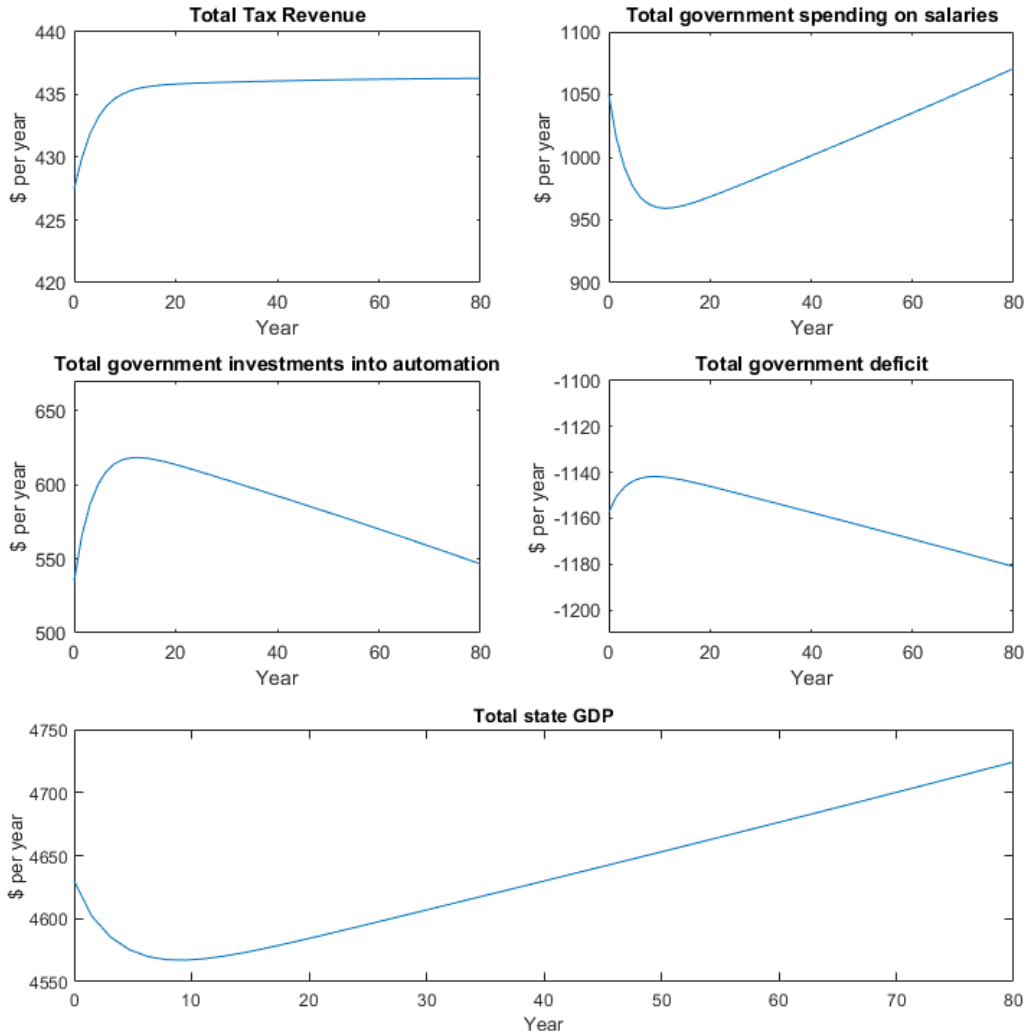

Figure 8.6: Graphs showing the dynamics of money circulation and employment levels in the private service sector.

### 8.3 Changing the initial Sector Sizes

As discussed in section 2.5, there are many different predictions of how many jobs might be subject to automation. Therefore it is interesting to look at how the model reacts to different initial sector sizes. Figure 8.7 shows how the

sector sizes develop after having set the sector sizes at different initial levels. Even though we do not yet know how many jobs that can or will be automated, the results can give us an insight into the benefits of potentially being able to automate many of our current jobs.

The red graphs show us the dynamics when we assume that 40 per cent of jobs can be automated. We see that the automation degree increases faster due to the increased revenue in the automatable sector. Also, since the initial share of the labour force, which is directly paid by the government is the smallest, the automation degree grows even faster. This too means that the size of the private service sector increases faster and even surpasses the green graph with an initial private service sector with 30 per cent of the labour market after 30 years. This simulation also has the healthiest wage to revenue ratio, as the employees get about 80 per cent of the revenue.

The tendency over all the simulations is that a smaller initial size of the automatable sector yields worse long term results. Both since fewer jobs are automated and since the private service sector does not have a great influx of workers, causing a low wage to revenue ratio.



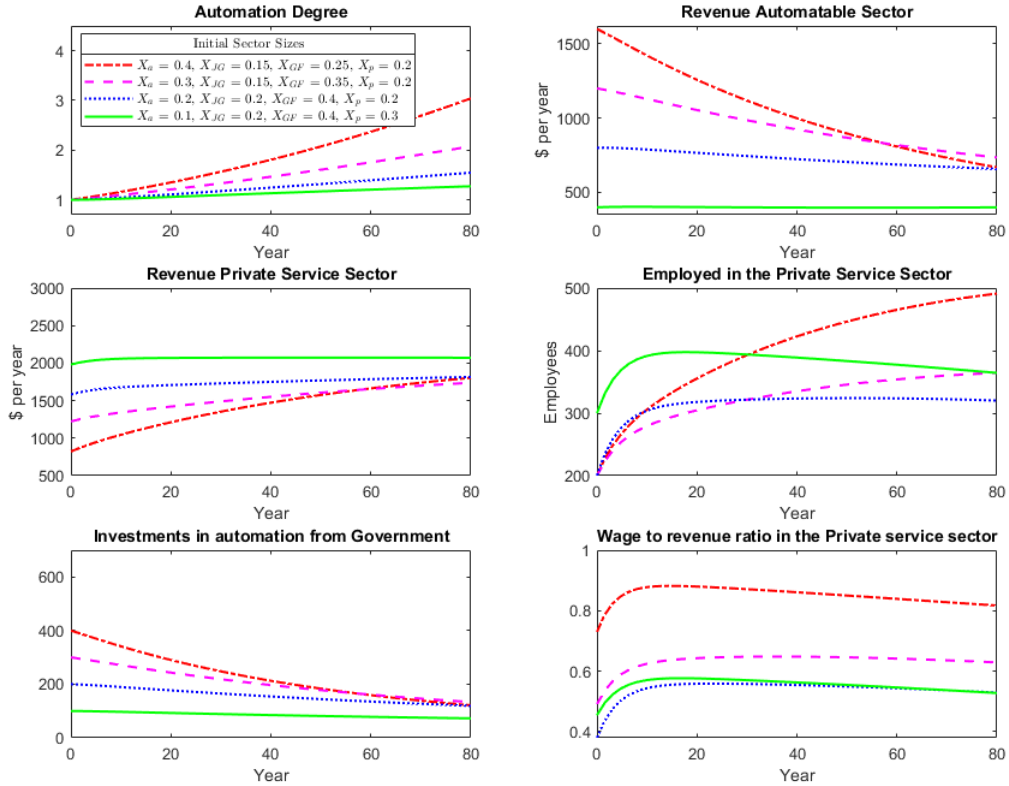

Figure 8.7: Graphs showing the development of the sector sizes with different initial sector sizes.

## 8.4 The deficit to GDP ratio

In figure 8.8, we see the dynamics of the system when different values have been used for the deficit to GDP ratio. A deficit to GDP ratio of  $\frac{-X}{100}$  means that the government can spend  $X$  per cent more than the GDP. The automation degree increases much faster when the deficit to GDP ratio is higher since more money will be spent on increasing the degree of automation by the government. When the deficit spending is lower, the investments into automation are just barely able to make up for the constant depreciation of the automation efforts.

This illustrates the point that there are positive effects on society when the government increases its deficit spending. It is true since more people are and will be employed in the private service sector and the private service sector is still able to maintain a high wage to revenue ratio. However, there might be negative effects of letting the government have a too high deficit to GDP ratio.

As we see from the graphs in figure 8.8, the measures from within my model are all positive except for the fact that the size of the JG and Education sector is larger, with a larger deficit to GDP ratio. This is because the people who are laid off in the automatable sector needs re-education through the JG and Education sector. This illustrates the point that we do not want a too rapid increase in the degree of automation.

The value of -0.25 will be used in further simulations as it will decrease the chances of negative inflationary episodes and also give a low BER value of about 10 per cent.

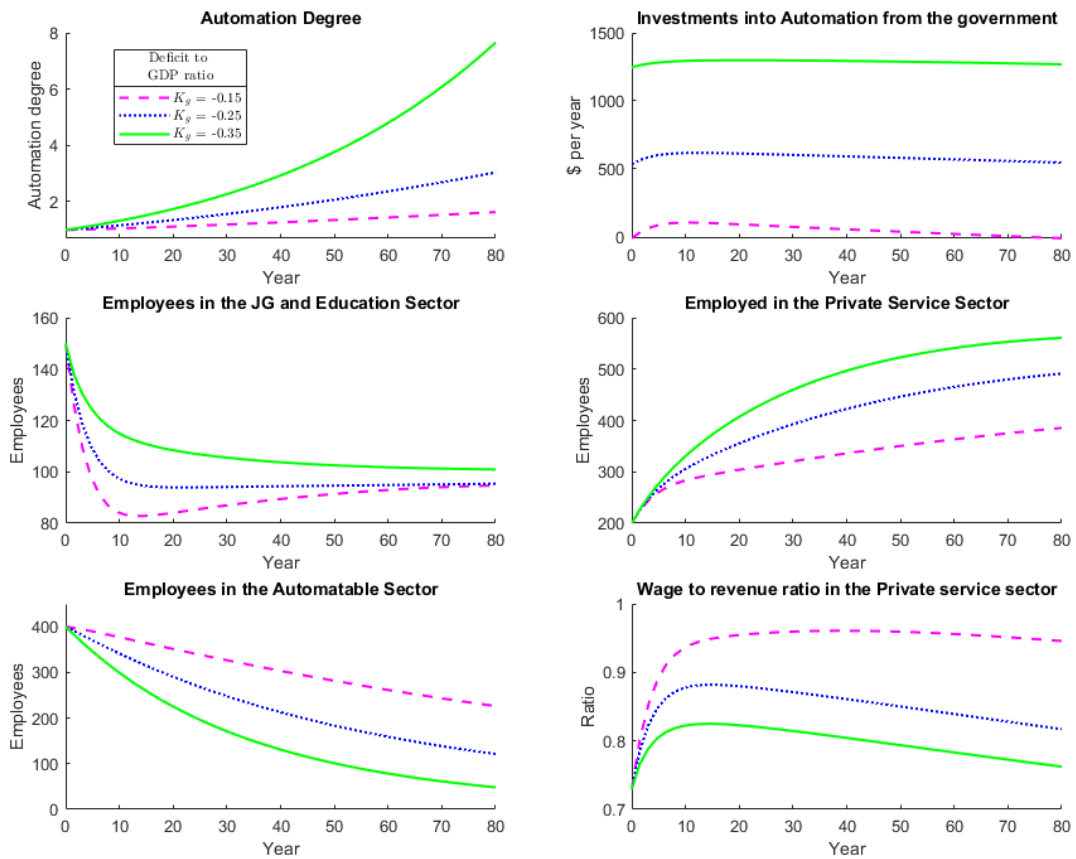

Figure 8.8: Graphs showing the development of the sector sizes and degree of automation with different ratios for the government to use deficit spending.

## 8.5 Tax rates

In figure 8.9, we see some of the dynamics of the system when we change the tax rates. The tax rates have been tested for values between 10 and 25 per cent. As the model is set up with the premise that the government wants to increase the degree of automation, a high tax rate will give it more power to do so. Therefore it is not surprising that a high tax rate gives a high increase in the degree of automation, as the investments from the government increases.

If we look at the wage to revenue ratio in the private service sector, we can see that the high tax rates make the wages for the workers in the private service sector unsustainable and some people are therefore laid off from the initial sector sizes. If we look at the number of employees in the JG and Education sector, we see that the number of employees falls slower when the tax rate is at 25 per cent than for the other tax rates. This is caused by the fact that the tax level makes the revenue in the private service sector lower than the initial amount of money paid in wages. The dip at around 50 years can be explained by the method used to move people from the private service sector to the JG and Education sector explained in section 6.7.5.

We will continue using the tax rate of 20 per cent as it gives the best results in terms of wage to revenue ratio in the private service sector while also yielding a high increase in the degree of automation.

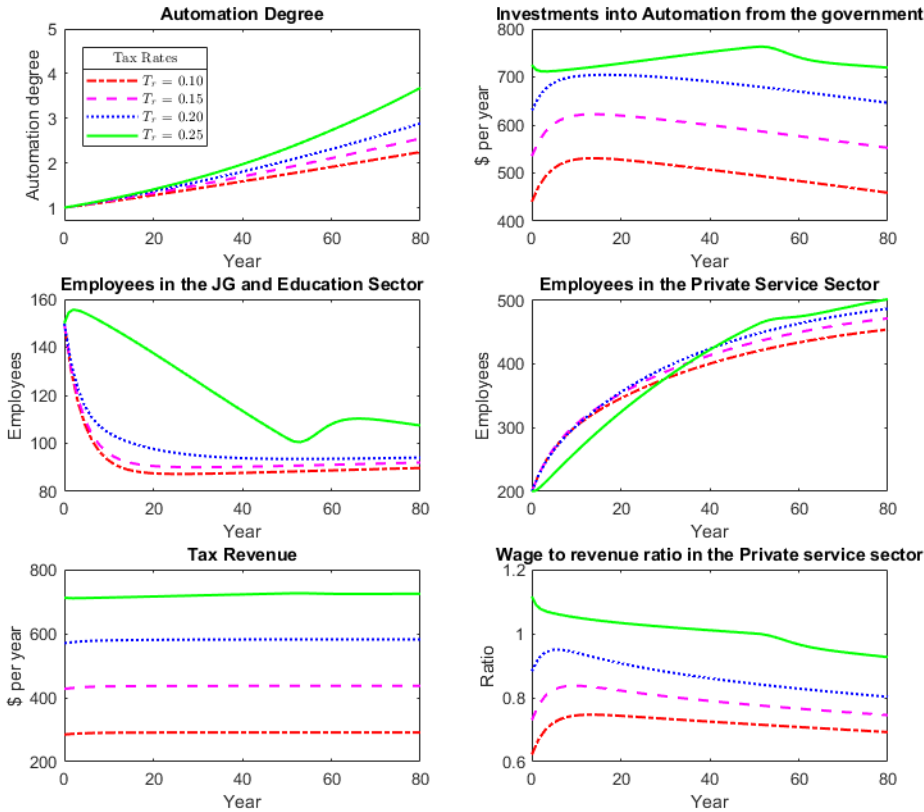

Figure 8.9: Graphs showing the development of the system when the state sets different tax rates on wages

## 8.6 Working Hours

In figure 8.10, we see some of the dynamics of the system when we change the rate at which the number of working hours is reduced. As the number of working hours is a measure of prosperity, the negative impacts of a reduction must be compared to the actual reduction in working hours as the reduction of hours is itself good.

The automation degree increases faster with a lower decrease in working hours since fewer people are needed in the GF sector, and thereby more money can be allocated by the state to increase the degree of automation. Another important consequence of the fact that fewer people are needed in the GF sector is that more people are able to work in the private service sector and the wage to revenue ratio is higher. The negative consequences are large in the long term,

and we, therefore, have to find a per cent yearly decrease where the positives outweigh the negatives.

The reason that the number of employees in the GF sector is stagnant in the red graph where there is no decrease is that the increase in productivity from management and digitalization is equal to the increase in desired productivity in the public sector. While it is extremely hard to weigh the negative impacts of a decrease in working hours to the positive impact of the reduction in working hours itself, we have decided to use the rate of 0.2 per cent in further simulations.

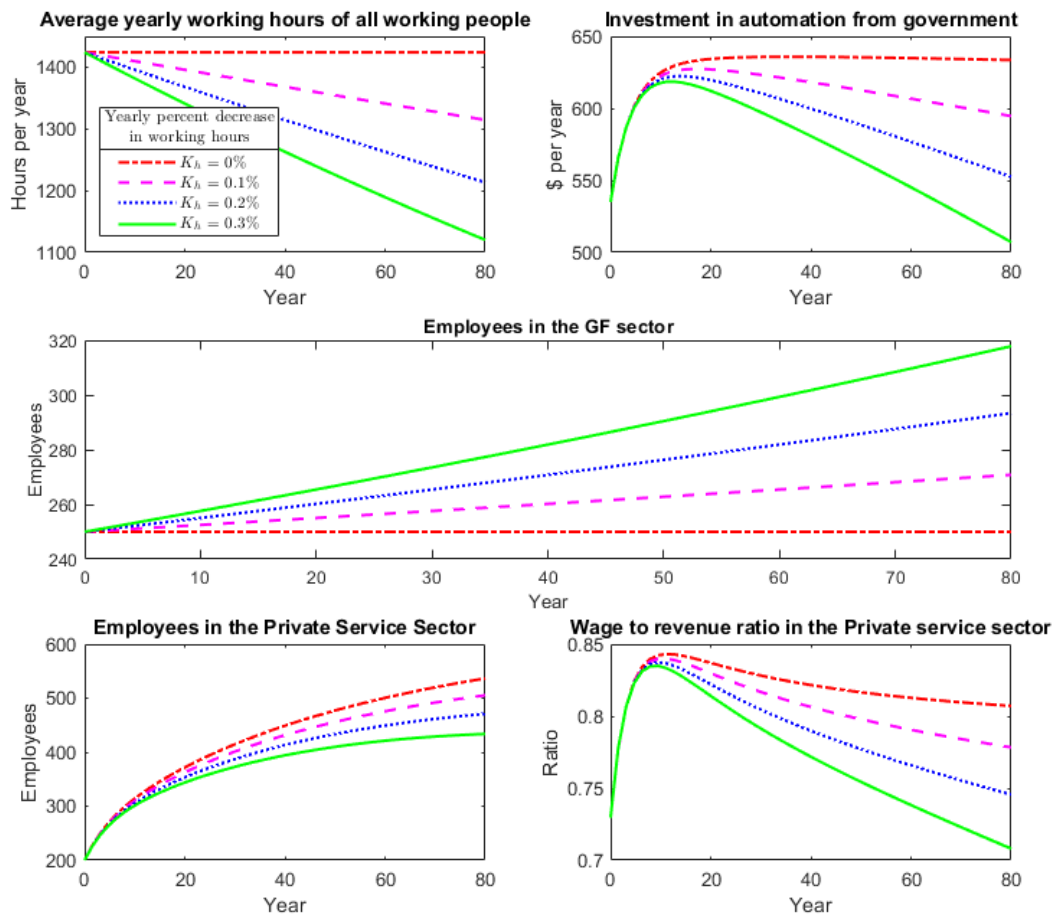

Figure 8.10: Graphs showing the dynamics of the system when the pace at which the number of working hours is reduced.

## 8.7 Increasing the labour share in the automatable sector

As discussed in section 2.4, a negative consequence of increasing the degree of automation might be that the labour share increases, as we have seen in many countries in recent years. To examine this problem, we can look at the effects of decreasing the labour share gradually over time and see how the system reacts.

In figure 8.11, we see the changes that result from a decrease in the labour share over time. As we can see from the graphs, the labour share decreases exponentially from 75 per cent of total revenue to under 20 per cent of total revenue over 80 years when we set the rate of decrease to 2 per cent. In this case, we see that a very large amount of people are laid off from the private service sector, and the number of people in the JG and Education sector rises. This would, of course, be undesirable, and even though the JG and Education sector represents a much better alternative to having them be unemployed, a BER value of almost 50 per cent seems to be unsustainable.

Again the dips we see in the last three graphs are caused by the implementation of the people who are laid off from the private service sector due to wage to revenue going over one. The implementation is described in section

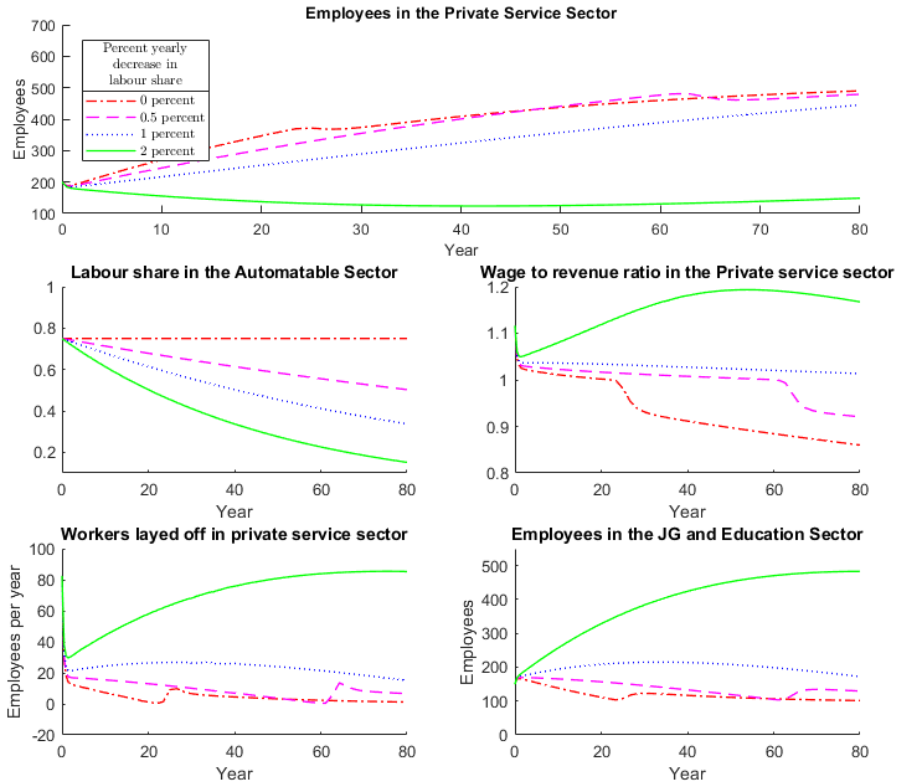

Figure 8.11: Graphs showing what happens when the labour share in the automatable sector is reduced by different percentages

## 8.8 Crisis Dynamics

In figure 8.12 and 8.13, we see some of the dynamics of the system when we implement a reduction in consumer spending to simulate the effects of a financial crisis. To simulate a financial crisis, the consumption spending has been momentarily changed to be 80 per cent of what it was from year 30 to 35. This has many immediate consequences. Due to the decreased flow of money in society, the investments into automation goes down immediately and recovers gradually. This is because the number of employees in the JG and Education sector increases as the private service sector has to lay off many of its workers.

Even though it is not implemented in the model, the temporary impact of the crisis could be reduced by having the government give out money to the private service sector so that it could keep their workers despite the loss of revenue.

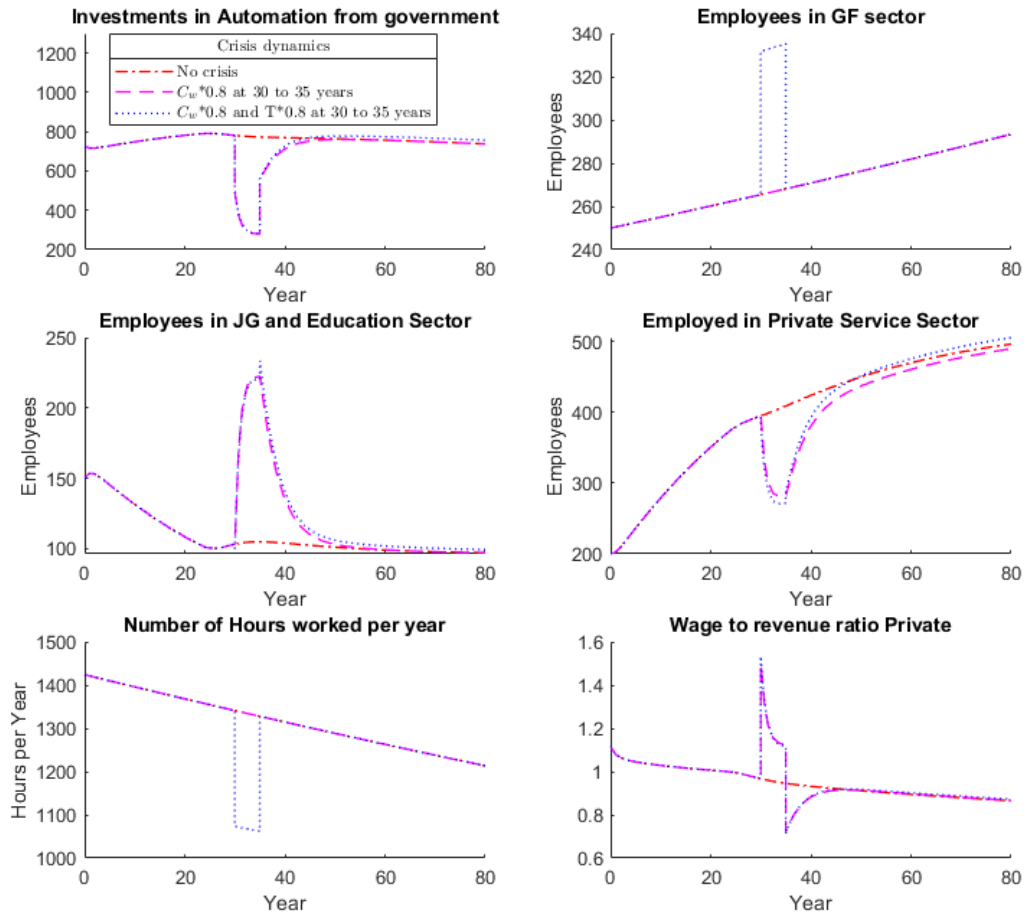

Figure 8.12: Graphs showing the dynamics of the system under a financial crisis.



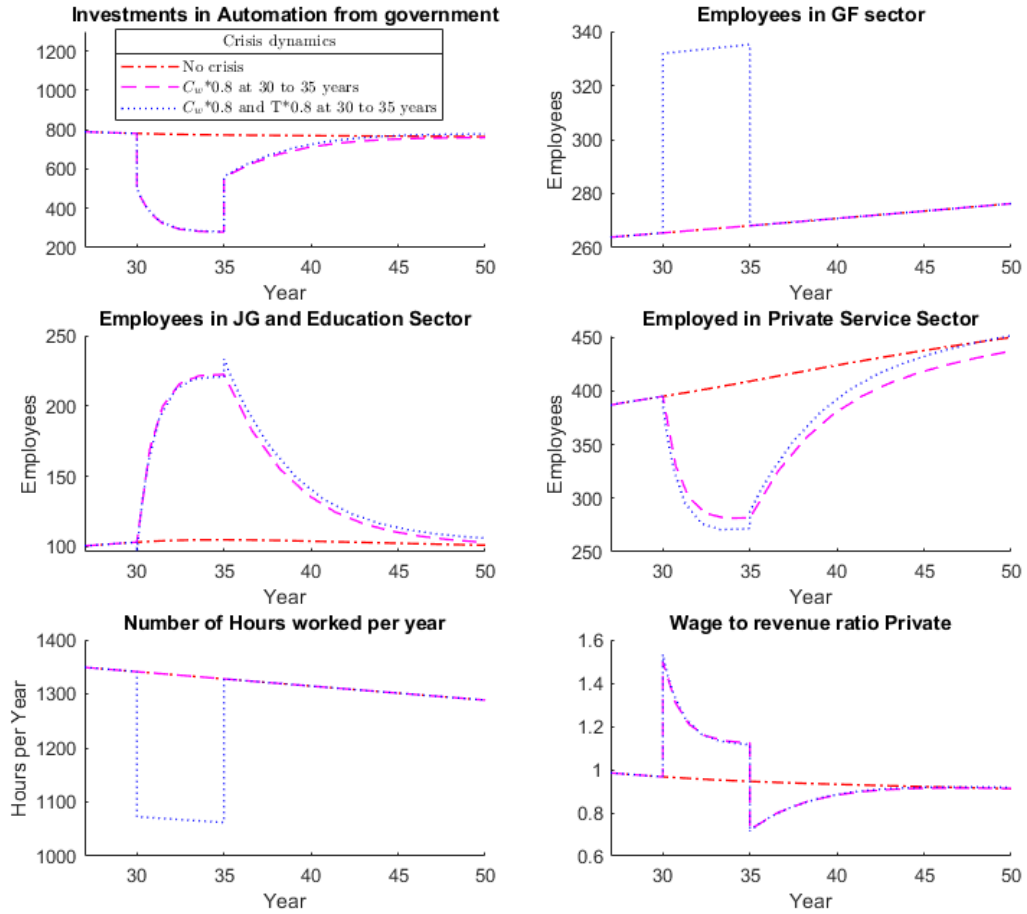

Figure 8.13: Graphs showing the dynamics of the system under a financial crisis (showing year 27 to 50).

In figure 8.14 we see the dynamics of the crisis where the consumption spending has been reduced by 20 percent in year 30 to 35. The different values of  $K_l$  represents the proportionality constant in equation 6.23. As expected the higher the value of  $K_l$  the faster the private service sector lays off workers when the crisis hits. As there are often a high degree of uncertainty in crisis situations, it is hard to know how fast the companies should lay off workers when the salary levels are unsustainable.

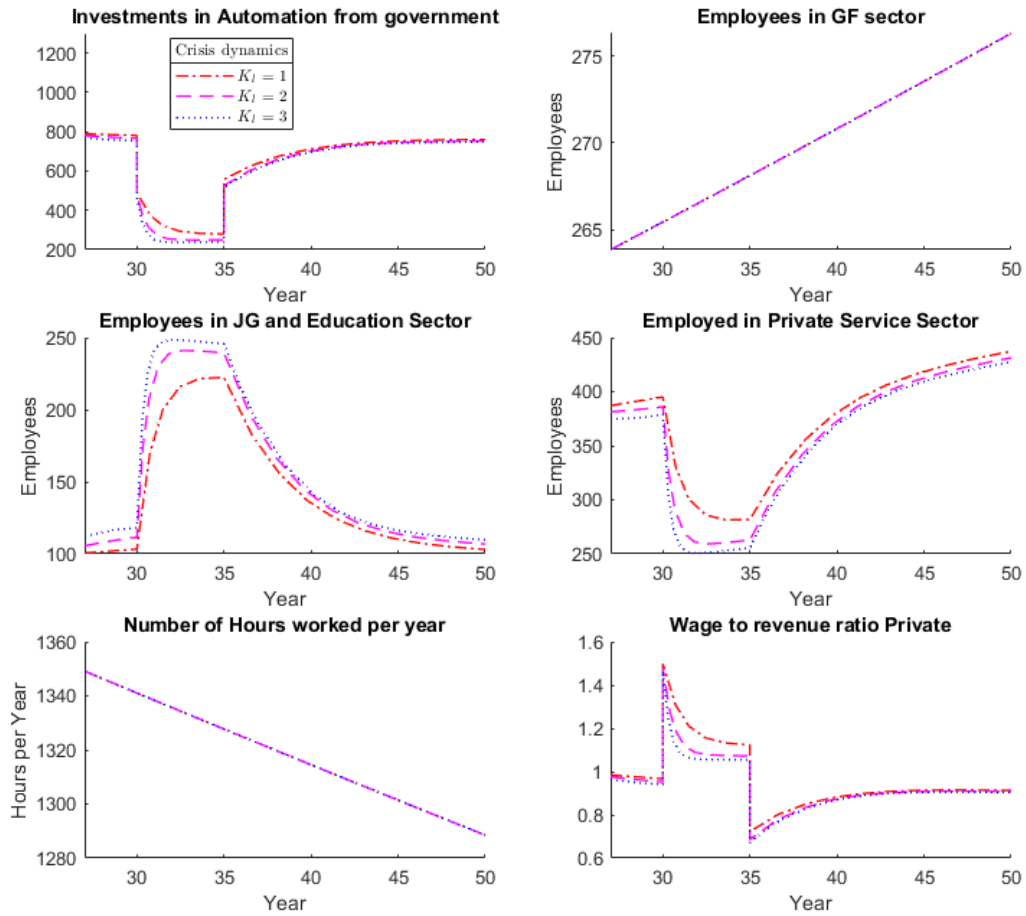

Figure 8.14: Graphs showing the crisis dynamics when changing the value of  $K_l$ .

## 9 Conclusion

The thesis has tried to build a framework for thinking about what we want the future to look like when more and more jobs are becoming automated. In doing so, the possibility of a dystopian future where only a small fraction of society is prosperous and a utopian society where everyone is prosperous is presented. However, the simulations and literature clearly show that when making progress, there are people who are left behind. This is not to say that we should not continue increasing the degree of automation, but rather that we should make decisions which safeguard the people who are the most negatively affected.

These considerations can clearly be made and are most effective if the government makes it a priority. While it is hard to argue for which consideration that should be made, weighing the benefits against each other, there are some steps that can be made to make the way forward better. Rather than making proposals for policy changes, a list is made to reflect on the things that should be considered when discussing how we can make the future better with an increasing degree of automation.

1. When discussing whether or not we will lose jobs due to automation, it is much more productive to reflect on the new possibilities for prosperity that emerges due to the increase in productivity such as:
  - Making the workweeks shorter, especially in professions which are highly prone to sick leave and work-related illness
  - Having more money goes towards the private service sector making people better able to make a living doing something they enjoy
2. Many of the people who lose their jobs due to automation have not other skills which are desirable in the labour market. Therefore we should make it a priority to re-educate these people while also focusing our attention on all education towards the skills needed in the future.
3. While many think that we should measure prosperity in terms of income, wealth and GDP, it might seem more productive to focus on other aspects of life. These include physical and mental health. The practical implications of this would be, as stated above, that we use the increased productiveness of the labourers to make their labour more meaningful and joyful, not more productive.
4. Have states in which the government issue their own currency spend more money to improve the lives of their citizens. This can be done by proactive spending, which makes better use of the countries unspent resources.
5. Implement a better way to provide work for the unemployed. This can be done through the Job Guarantee approach or with a similar approach. The main priority should be that they work (due to the negative consequences of being unwillingly unemployed), not that they are compensated well.

The stock-flow approach to the problem seems to be very valuable. This is not since it solely can change how we think about the society in an macroeconomic sense or any other field for that matter. The reason is that for us even to be able to approach the task of implementing a macroeconomic model of society, and we need to draw upon the current macroeconomic literature. However, when supplemented by the macroeconomic literature, the approach can be used to gain increased insight into the mechanics that govern the economy. In addition, it can be used to prove or disprove hypotheses, predict the outcome of a political change and even get a clearer picture of an extensive system.

By using the stock-flow modelling approach in this thesis, we (hopefully) get a better understanding of the possibilities that lie in using the approach. In addition, it provides some valuable insights into the way we should navigate the future in regards to automation. The possibilities for improvement of my model are many, and the most obvious ones are. One of the ways in which it can be improved is by making it encompass a larger proportion of the economy by including or changing:

1. Inflation dynamics
2. Accumulation of money
3. Banks and loaning
4. Separating education and the job guarantee
5. Including other government spending posts

The possibilities for making the are endless, and we should, therefore, be optimistic about the prospect of making this a more widely used way of approaching economic thought, and other social science disciplines for that matter.

# Appendix A

## Block Diagram Representation

1. When the symbol "s" is used in the block diagram its representing the differentiatiaon operator. This means that the square blocks with an  $\frac{1}{s}$  inside meant that we are taking the integral or "summing" up the signals coming into it over time.
2. A block containing a  $\frac{1}{s}$  and a "time-lag" like  $T_{jg}$  as in 9.1 it represents a first order linear equation. This means that in the case shown in figure 9.1,  $L = \frac{1}{T_H} \int \dot{W} dt$
3. When a square box with a 'x' inside is used, it means that the two signals are multiplied and the multiplied signal comes out from it.
4. When a square or rectangular box has several 'x' and/or '÷' signs it means that what comes out is the product of all the signals coming in by an 'x' divided by the product of all the signals coming in by an '÷'.
5. When a rectangular box with several + and - signs on it meanst that the signals are added or subtracted from each other depending on the sign where it comes into the rectangle.
6. The oval blocks where a single signal comes out from or into means that the signal moves into or out from the current subsystem respectively. In the figures I have named them according to the value or parameter they represent in the system.

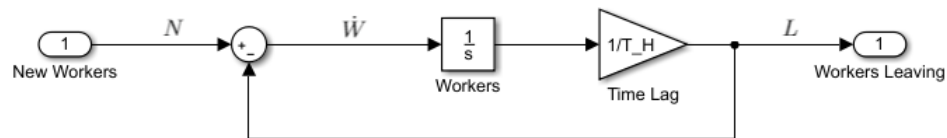

Figure 9.1: Block Representation of a first order differential equation

## References

- [1] Employment rate. *OECD.org*.
- [2] International covenant on economic, social and cultural rights. *Committee on Economic, Social and Cultural Rights, UN*.
- [3] Forskrift om grader og yrkesutdanninger, beskyttet tittel og normert studietid ved universiteter og høyskoler. *Lovdata*, 2005.
- [4] Accidents at work. *SSB.no*, 2015.
- [5] Dette bruker nordmenn penger på. *SSB.no*, 2018.
- [6] Norsk trafikantbarometer 2019. *NAF*, 2019.
- [7] Torbjorn åkerstedt, Birgitta Olsson, Michael Ingre, Mikael Holmgren, and Göran Kecklund. A 6-hour working day-effects on health and well-being. *Journal of human ergology*, 30(1-2):197–202, 2001.
- [8] Michelle Alexopoulos. Read all about it!! what happens following a technology shock? *The American Economic Review*, 101:1144–1179, 2011.
- [9] Robert C Allen. Economic structure and agricultural productivity in europe, 1300–1800. *European Review of Economic History*, 4(1):1–25, 2000.
- [10] Kimberly Amadeo. Us budget deficit by year compared to gdp, debt increase, and events. *The Balance*, 2020.
- [11] Trond Andresen. Improved macroeconomic control with electronic money and modern monetary theory. 2013.
- [12] Trond Andresen. On the dynamics of money circulation, creation and debt—a control systems approach. 2018.
- [13] Trond Andresen et al. Two feasible future scenarios: a high-tech utopia-and a high-tech dystopia. *Full Employment Imperative, The*, page 53, 2003.
- [14] Sharon Armstrong and Barbara Mitchell. *The essential HR handbook: A quick and handy resource for any manager or HR professional*. Red Wheel/Weiser, 2019.
- [15] Charles Babbage. *On the economy of machinery and manufactures*. Taylor & Francis, 1832.
- [16] Dudley Baines. *Emigration from Europe 1815-1930*, volume 11. Cambridge University Press, 1995.
- [17] William J Baumol, William G Bowen, et al. *Performing arts-the economic dilemma: a study of problems common to theater, opera, music and dance*. Gregg Revivals, 1993.

- [18] Arthur G Bedeian and Daniel A Wren. Most influential management books of the 20th century. *Organizational Dynamics*, 3(29):221–225, 2001.
- [19] Eric D Beinhocker. *The origin of wealth: Evolution, complexity, and the radical remaking of economics*. Harvard Business Press, 2006.
- [20] Drago Bergholt, Francesco Furlanetto, and Nicolo Faccioli. The decline of the labor share: New empirical evidence.”. 2019.
- [21] Terje Bongard and Eivin Røskraft. *Det Biologiske Mennesket*. 2010.
- [22] Ellen Brandt, Marianne Dæhlen, Anna Hagen, Dagfinn Hertzberg, Aris Kaloudis, Åsmund Arup Seip, Liv Anne Støren, Taran Thune, and Agnete Vabø. Effekter av samarbeid mellom høyere utdanning og arbeidsliv—en forstudie. *Fafo/NIFU STEP-rapport*, 11, 2008.
- [23] Harry Braverman. *Labor and monopoly capital: The degradation of work in the twentieth century*. NYU Press, 1998.
- [24] Stephen N Broadberry and Bishnupriya Gupta. Cotton textiles and the great divergence: Lancashire, india and shifting competitive advantage, 1600-1850. 2005.
- [25] Sheilagh Brooks. *Osteological Analyses of the Stillwater Skeletal Series, Stillwater Marsh, Churchill County, Nevada*. Number 2. US Department of the Interior, US Fish and Wildlife Service, Region 1, 1988.
- [26] Kyle Bruce. Henry s. dennison, elton mayo, and human relations historiography. *Management & Organizational History*, 1(2):177–199, 2006.
- [27] Erik Brynjolfsson and Andrew McAfee. *The second machine age: Work, progress, and prosperity in a time of brilliant technologies*. WW Norton & Company, 2014.
- [28] Anthony Camp. Apprenticeship in england. *Familysearch*.
- [29] Davide Castellani, Mariacristina Piva, Torben Schubert, and Marco Vivarelli. The productivity impact of r&d investment: A comparison between the eu and the us. 2016.
- [30] Gregory Clark. The condition of the working class in england, 1209–2004. *Journal of Political Economy*, 113(6):1307–1340, 2005.
- [31] Gregory Clark. *A farewell to alms: a brief economic history of the world*, volume 25. Princeton University Press, 2008.
- [32] Mihaly Csikszentmihalyi. The costs and benefits of consuming. *Journal of consumer Research*, 27(2):267–272, 2000.
- [33] Jared M Diamond and Doug Ordunio. *Guns, germs, and steel*. Books on Tape, 1999.

- [34] Christopher Dyer. *Everyday life in medieval England*. A&C Black, 2000.
- [35] Craig Kent Elwell. *Brief history of the gold standard in the United States*. Congressional Research Service, 2011.
- [36] Kenneth Fossheim and Steinar Figved. Dette tallet på arbeidsledighet i norge har du aldri sett før. *TV2.no*, 2017.
- [37] Neville Francis and Valerie A Ramey. Is the technology-driven real business cycle hypothesis dead? shocks and aggregate fluctuations revisited. *Journal of Monetary Economics*, 52(8):1379–1399, 2005.
- [38] Carl Benedikt Frey and Michael A Osborne. The future of employment: How susceptible are jobs to computerisation? *Technological forecasting and social change*, 114:254–280, 2017.
- [39] Thomas Frey. 2 billion jobs to disappear by 2030. *Futurist Speaker*, 2012.
- [40] Yuval Noah Harari. A brief history of humankind. *Publish in agreement with The Deborah Harris Agency and the Grayhawk Agency*, 2014.
- [41] Albert Bushnell Hart. *Social and Economic Forces in American History: From The American Nation: a History*. Harper & Brothers, 1913.
- [42] B Haugan. 10 norske bedrifter flagger hjem:–billigere og bedre enn kina. *e24.no*, 2017.
- [43] Stuart K Hayashi. *Life in the Market Ecosystem*. Lexington Books, 2014.
- [44] Eric Helland and Alexander T Tabarrok. Why are the prices so damn high? *Why Are the Prices So Damn High*, 2019.
- [45] McKinsey Global Institute. Jobs lost, jobs gained: Workforce transitions in a time of automation. 2017.
- [46] Emil Johansson. Forbruket vårt har endret seg drastisk under korona. *Sparebank1.no*, 2020.
- [47] Steven Johnson. *Where good ideas come from: The natural history of innovation*. Penguin, 2011.
- [48] Åshild Male Kalstø and Johannes Sørbo. Navs bedriftsundersøkelse 2018. *Oslo: Arbeids-og velferdsdirektoratet*, 2018.
- [49] Loukas Karabarbounis and Brent Neiman. The global decline of the labor share. *The Quarterly journal of economics*, 129(1):61–103, 2014.
- [50] Sonja C Kassenboehmer and John P Haisken-DeNew. You’re fired! the causal negative effect of entry unemployment on life satisfaction. *The Economic Journal*, 119(536):448–462, 2009.
- [51] Kevin Kelly. *What technology wants*. Penguin, 2010.



- [52] John Maynard Keynes. Economic possibilities for our grandchildren. In *Essays in persuasion*, pages 321–332. Springer, 2010.
- [53] Hans-Peter Martin and Harald Schumann. *The global trap: Globalization and the assault on democracy and prosperity*. Human Sciences Resource Centre, 1997.
- [54] William Mitchell, L. Randall Wray, and Martin Watts. *Macroeconomics*. Red Globe Press, 2019.
- [55] Joel Mokyr. The political economy of technological change. *Technological revolutions in Europe*, pages 39–64, 1998.
- [56] Kevin Morgan. *Local and green vs global and fair: the new geopolitics of care*. BRASS Centre, 2008.
- [57] Megan Nelson. U.s. food expenditures at home and abroad. *Farm Bureau*, 2019.
- [58] United States Patent and Trademark Office. U.s. patent activity calendar years 1790 to the present. 2019.
- [59] John Pencavel. The productivity of working hours. *The Economic Journal*, 125(589):2052–2076, 2015.
- [60] A Poddar. Working and living conditions. <https://firstindustrialrevolution.weebly.com/working-and-living-conditions.html>.
- [61] Klaus Prettnner and Holger Strulik. The lost race against the machine: Automation, education, and inequality in an r&d-based growth model. *Education, and Inequality in an R&D-Based Growth Model (December 1, 2017)*. *cege Discussion Papers*, (329), 2017.
- [62] John Rawls. *A theory of justice*. Harvard university press, 2009.
- [63] Michael Shermer. *The mind of the market: How biology and psychology shape our economic lives*. Macmillan, 2009.
- [64] Vaclav Smil. *Creating the twentieth century: Technical innovations of 1867-1914 and their lasting impact*. Oxford University Press, 2005.
- [65] Adam Smith. *The Wealth of Nations: An inquiry into the nature and causes of the Wealth of Nations*. Harriman House Limited, 2010.
- [66] Ray Stata. Organizational learning-the key to management innovation. *MIT Sloan Management Review*, 30(3):63, 1989.
- [67] G Stavrum. Knusende nederlag for vy sparer skattebetalerne for milliardbeløp. *Nettavisen.no*, 2019.

- [68] Peter N Stearns. *The industrial revolution in world history*. Westview press, 2012.
- [69] T Stensvold. Norske bedrifter flytter hjem produksjonen fra lavkostland. *Teknisk Ukeblad*, 2016.
- [70] John D. Sterman. *Business Dynamics*. Irwin McGraw-Hill, 2000.
- [71] Frederick Winslow Taylor. *The principles of scientific management*. Harper & brothers, 1919.
- [72] A Tukker, G Huppes, J Guinée, R Heijungs, A De Koning, L Van Oers, S Suh, T Geerken, M Van Holderbeke, B Jansen, et al. Analysis of the life cycle environmental impacts related to the final consumption of the eu-25. *Environmental Impact of Products*, 2006.
- [73] Robert Whaples. Hours of work in u.s. history, 2001.
- [74] Erin Winick. Every study we could find on what automation will do to jobs, in one chart. *MIT Technology review*.
- [75] Wendell H Wisner. *Energy resources: occurrence, production, conversion, use*. Springer Science & Business Media, 2012.

