



Norwegian University of
Science and Technology

Haraldrud Municipal Solid Waste Combustion Plant in Oslo

Optimizing, Stabilizing and Modeling the Combustion Process

Simen Johan Gudim

Master of Science in Engineering Cybernetics

Submission date: June 2011

Supervisor: Lars Imsland, ITK

Problem Description

Background

Oslo Waste-To-Energy Agency (EGE) shall recycle waste in an environmentally-, climatic and economic acceptable way. Some of EGE's areas of operations are;

- Incinerate combustible waste from Oslo's households, other municipalities and businesses
- Deliver heat energy for district heating system

Use of waste as fuel in an energy recovery offers many challenges. Some of the challenges are;

- The calorific value of the heat varies widely
- Large variations in the combustion process leading to unnecessary pollution
- Residues from combustion leads to the change of the combustion process over time

Work Description

- A description of Haraldrud municipal solid waste (MSW) combustion process
 - The different stages in the combustion process
 - Describe the combustion process manipulating-, control- and disturbance variables.
- System identification of Haraldrud MSW combustion plant
 - Obtaining a-priori process knowledge
 - Design a system identification test for Haraldrud combustion process
 - Perform an open-loop system identification test
 - Pre-treat the data-set from the open-loop system identification test
 - Develop a model based on the system identification test
 - Validate the model
- On-line parameter estimation of the combustion process with an adaptive-law

Assignment given: 10. January, 2011

Supervisor: Lars Imsland

Abstract

The growing amount of waste is an important environmental issue in our society today. Waste that is not recyclable should be used as an energy source after hazardous waste has been removed. Haraldrud combustion plant in Oslo has been burning the MSW since 1988. In dealing with the waste, Haraldrud seeks to optimize the amount of burned waste with minimum pollution. This thesis examines the combustion process at Haraldrud thoroughly, and suggests possible solutions to optimize and stabilize today's combustion process.

A model of the combustion process could be used for prediction so optimized combustion is achieved. Two different methods were applied to two different model sets and the model parameters were estimated from previously recorded process data. The model parameters were estimated based on system identification theory, and an on-line parameter estimator with an adaptive law.

Burning MSW are a complex process to control and several factors including; unknown calorific value, regulation of the waste flow, and the long time constant for measuring and regulating the energy contributes to this. Therefore a recommended method to estimate the calorific value is essential. When the calorific value is known the produced energy could be measured directly from the flue gas. The energy and calorific value measured from the flue gas can then be used to stabilize today's energy production.

Preface

The way towards this master thesis has been interesting, very exciting and challenging. It was a huge step from reading about MSW combustion plants to actually manipulate the combustion process and discuss various issues with highly experienced operators. Many hours have been spent studying, describing and manipulating the combustion process at Haraldrud. This has helped me to obtain a deeper understanding of Haraldrud and combustion processes in general. It has also given me knowledge in how to apply theoretical literature on a live plant.

Without the help and collaboration of EGE and specially Matthias Franke this thesis would not have been realized. The opportunity to study Haraldrud and practice theoretical literature has been vital for this thesis, since one of the main objectives were to apply theoretical literature on a live combustion plant. EGE has been very understandable when tests have been performed and has shown great interest in helping me analyzing the test results.

A person who has given me concrete and reassuring help is Helge Mordt, Prediktor. His experience and knowledge of Haraldrud combustion plant has solved many of my problems. He has also inspired me by showing such interest in my thesis.

This thesis is written in close collaboration with Goodtech. Goodtech have supplied me with a personal computer, my own office in Oslo and been very helpful when various challenges have arisen. Thanks to Goodtech and specially John Paul Salvador and Tord van Delft. Their knowledge, critical questions and confidence in my work has been invaluable input. I have now been employed by Goodtech and looking forward to future cooperation.

I would also like to thank my professor Lars Imsland for his ability to quickly reply to my questions and giving a good structural feedback.

Finally, I would like to thank my family and specially my darling for love and support.

Simen Gudim
Oslo, Norway - JUNE 6, 2011

Contents

Problem Description	i
Abstract	iii
Preface	v
List of Figures	viii
List of Tables	x
Abbreviations	xiii
1 Introduction	1
1.1 Previous Work	2
1.2 Motivation	2
1.3 Scope of the Assignment	3
1.4 Thesis Outline	3
2 Description of Haraldrud Combustion Process	5
2.1 Stages in the Combustion Process	6
2.1.1 Waste Bunker	6
2.1.2 Waste Crane	6
2.1.3 Feeding Device	7
2.1.4 Horizontal Grate	7
2.1.5 Primary and Secondary Air	8
2.1.6 Airflow Resistance in Zone 1 and Zone 2	9
2.1.7 Inert from the Combustion Process	10
2.1.8 Energy Produced in the Boiler Circuit	10
2.1.9 Flue Gas from the Combustion Process	12
2.2 Instrumentation	14
3 Calculating Produced Energy from Measurements in the Flue Gas	19
3.1 Estimating the Calorific Value	20
3.1.1 Finding the y-value (Hydrogen)	21
3.1.2 Finding the z-value (Oxygen)	22
3.1.3 Calculating the Net Calorific Value of the Waste	23
3.1.4 Calculating the Ash-Free Calorific Value of the Waste	24
3.1.5 Calculating the Calorific Value of the Waste	24

3.2	Calculating the Flue Gas Energy $Q_{\text{flue gas}}$	25
3.3	Calculating the Moister Part H_2O_{air} in Primary and Secondary Air . .	26
3.4	Verification	27
3.4.1	Moister Part in Primary and Secondary Air	27
3.4.2	Comparing Q and $Q_{\text{flue gas}}$	28
3.5	Chapter Summary	33
4	Analysis and Manipulation of the Combustion Process	35
4.1	Combustion Process Knowledge	35
4.1.1	Analysis of the Control Variables	35
4.1.2	Analysis of the Manipulated Variables	38
4.1.3	Step Response Tests	40
4.2	Designing the System Identification Test	47
4.2.1	Test Signal	47
4.2.2	Test Signal for Primary Air	48
4.2.3	Test Signal for Secondary Air and Airflow Resistance in Zone 2	49
4.3	Open-Loop System Identification Test	49
4.3.1	Test signal on Primary Air	50
4.3.2	Test Signal on Secondary Air	52
4.3.3	Test Signal on Airflow Resistance in Zone 2	53
4.4	Chapter Summary	55
5	Model of the Combustion Process Based on System Identification	57
5.1	Pre-Treatment of the Obtained Data	57
5.2	Theory for Developing a Model with System Identification	59
5.2.1	MIMO ARX Model	60
5.3	Simulating the MIMO ARX Model Based on System Identification . .	62
5.4	Discussion on the Simulated MIMO ARX Model	65
6	On-line Parameter Estimation with an Adaptive Law	67
6.1	Parametric Model and the Adaptive Law	68
6.2	Simulating the Adaptive Law	70
6.2.1	Measured and Estimated Effect in the Boiler Circuit	70
6.2.2	Measured and Estimated O_2 in the Flue Gas	72
6.3	Chapter Discussion	73
7	Concluding Remarks	75
7.1	Conclusion	75
7.2	Future Work	76
A	Appendix	1
A.1	Definitions	1
	Nomenclature	3
	Bibliography	6

List of Figures

2.1	Haraldrud MSW combustion process	5
2.2	Position of the feeder arm	7
2.3	Grate zones	8
2.4	HMI picture of boiler circuit at Haraldrud	11
2.5	HMI picture of the overall combustion process at Haraldrud	13
2.6	HMI picture of the combustion chamber at Haraldrud	14
3.1	Calculated produced energy in boiler circuit	19
3.2	Fractions of the waste at Haraldrud based on average household waste in 2010	21
3.3	Measured absolute humidity and calculated H_2O primary air	27
3.4	Measured absolute humidity and calculated H_2O secondary air	28
3.5	Measured CO_2 O_2 and H_2O in the flue gas after scrubber	29
3.6	Estimated calorific value in flue gas and by Haraldrud	30
3.7	Block diagram shows the waste inlet flow to the produced energy in the boiler circuit	30
3.8	Measured effect in flue gas and boiler circuit	31
3.9	Measured primary and secondary air	32
4.1	Measured O_2 in the flue gas	36
4.2	Measured effect in the boiler circuit	37
4.3	Measured primary and secondary air	39
4.4	Measured airflow resistance Zone 2	40
4.5	Measured inputs for the step response test	41
4.6	Measured outputs for the step response test	41
4.7	Measured temperature in the furnace and on the grate during the step response test	42
4.8	Measured inputs when step on primary air	42
4.9	Measured outputs when step on primary air	43
4.10	Measured inputs when step on secondary air	44
4.11	Measured output when step on secondary air	45
4.12	Measured input when step on airflow resistance in Zone 2	46
4.13	Measured output when step on airflow resistance in Zone 2	47
4.14	Test signal for primary air	49
4.15	System identification - Signal on primary air - primary air and SP primary air	50
4.16	System identification- Signal on primary air - Secondary air and airflow resistance Zone 2	51

4.17	System identification- Signal on primary air - Outputs	52
4.18	System identification- Signal on secondary air - Input	52
4.19	System identification- Signal on secondary air - Output	53
4.20	System identification- Signal on airflow resistance Zone 2 - Airflow resistance and SP airflow resistance Zone 2	53
4.21	System identification- Signal on airflow resistance Zone 2 - Output . .	54
4.22	System identification- Signal on airflow resistance Zone 2 - Primary and secondary air	54
5.1	Measured and filtered effect in the boiler circuit	58
5.2	Measured and filtered primary air, secondary air and airflow resistance in Zone 2	59
5.3	GUI interface for system identification toolbox	62
5.4	Measured and simulated model output	63
5.5	Structure of the MSW combustion model	63
5.6	Comparing estimated and measured effect - MIMO ARX model esti- mated from sinus tests	64
5.7	Comparing estimated and measured O_2 - MIMO ARX model estimated from sinus tests	64
5.8	Comparing estimated and measured effect of a 30 th order MIMO ARX model	65
6.1	Direct and indirect adaptive control structure	67
6.2	Measured effect in the boiler circuit compared to estimated effect with the gradient method	70
6.3	Estimation error between estimated and measured effect	71
6.4	Obtained model parameters for θ_{effect} with Gradient method	71
6.5	Measured O_2 in the flue gas compared to estimated O_2 with gradient method	72
6.6	Obtained model parameters for θ_{O_2} with Gradient method	72

List of Tables

1.1	Waste quantities in Norway [1000 ton]	1
2.1	Compliance with emission limits to air	12
2.2	Measurements primary and secondary air	14
2.3	Measurements to airflow resistance	15
2.4	Measurements of the temperature	15
2.5	Measurements boiler circuit	15
2.6	Measurements feeder	16
2.7	Measurements of the flue gas	16
3.1	Composition (mass fractions), y and z values for three different types of waste	22
3.2	y and z values of CH_yO_z for combustible components	22
3.3	Estimated Burned waste and weighted inert from the combustion process	24
3.4	Approximate composition of Dry Air	28
4.1	Sinusoids for the test signal	48
5.1	Cutoff filter frequencies	58

Abbreviations

AH	Absolute humidity
ARMA	Autoregressive Moving Average
ARX	Autoregressive with eXogeneous
CO_2	Carbon Dioxide
CO	Carbon Monoxide
CV	Control Variable (or process output)
GDP	Gross Domestic Product
GUI	Graphical User Interface
EGE	City of Oslo Waste-to-Energy Agency
H_2O	Water
HCl	Hydrogen Chloride
HMI	Human Machine Interface
PLC	Programmable Logic Controller
MIMO	Multiple-Input Multiple-Output
MPC	Model Predictive Control
MSW	Municipal Solid Waste
MV	Manipulated Variable (or process input)
N_2	Nitrogen
NO_x	Nitrogen Oxide
O_2	Oxygen
REN	Agency for Waste Management
RH	Relative Humidity
RPM	Revolution Per Minute
SISO	Single-Input Single-Output
SP	Set Point
SO_2	Sulfur dioxide

Chapter 1

Introduction

Since 1995 Norway has increased the amount of waste more than the gross domestic product (GDP) (Statistic Norway, 2011). Since the waste accounts started in 1995, quantity of waste has increased each year with over 30 %. The government has since 1999 aimed to bring the waste growth down to a considerably lower level than the economic growth, measured in (GDP). Table 1.1 shows the waste quantities in Norway. About 20 % of the waste is today used in energy recovery.

Description	1995	1999	2001	2003	2005	2007	2009
Paper	887	1031	1071	1017	1177	1235	1200
Metal	919	934	940	953	1054	1105	1100
Plastic	327	374	388	414	437	492	510
Glass	189	191	208	232	251	278	270
Wood	1328	1263	1367	1438	1481	1626	1600
Textile	109	115	112	111	116	124	130
Wet organic	1070	1236	1302	1349	1490	1743	1700
Concrete	533	669	690	657	739	821	700
Mud	328	334	357	381	408	401	390
Other materials	1020	1432	1477	1593	1627	1836	1700
Hazardous waste	632	601	642	867	966	1077	1100
Total	7342	8182	8555	9011	9747	10739	10400

Table 1.1: Waste quantities in Norway [1000 ton]

There are three large MSW combustion plants in Oslo, which have permit under the Pollution Control Act for accepting waste for incineration. One of the plants is Haraldrud, completed in 1988. Haraldrud has two almost identical combustion lines which are operated by EGE. The energy produced by the combustion plant is mainly used in the district heating systems to heat up buildings in Oslo. 100.000 tons of waste is incinerated at the plant and 235.000 MW is sold to the district heating system each year. The main objectives for Haraldrud is to incinerate as much waste as possible with as little pollution as possible. It is therefore important to optimize the combustion process so the right amount of waste and air is supplied to the combustion.

The combustion is a multiple-input multiple-output (MIMO) process with constraints. Today the combustion controller is based on fuzzy logic. Both the controller and the combustion process are quite complex and the plant operators have requested that they want to obtain deeper knowledge of the combustion process. The fuzzy logic controller is based on schemes containing control parameters, that needs to be tuned quite often. Today this is done by hired personnel at a high cost. The plant operators would therefore prefer a more adaptive and understanding control philosophy. It is not only the complexity of the controller which is challenging today. The density, moistness, composition and calorific value of the waste going into the combustion today are unknown. This makes the combustion difficult to control and the plant operators needs quite often to run parts of the process control manually. It would be a great advantage to know the calorific value and use this to control the combustion. Since the combustion is a relatively slow process it would also be desirable to use a model for prediction. In (Leskens et al., 2005) it has been proven through simulations that an MPC-based combustion control system is capable of delivering significantly improved control/operation performance in comparison to a conventional combustion control system when large temporary disturbances are acting on the MSW combustion plant. The MPC was not implemented in a real plant.

1.1 Previous Work

This thesis is based on my final year project (Gudim, 2010) where the aim was to study a MSW combustion process and further specific study of today's combustion controller at Haraldrud. The first-hand knowledge of a combustion process was here obtained by articles and books. The next step was to describe today's combustion controller by looking into the program code in the programmable logic controller (PLC). The code was written in ladder code.

1.2 Motivation

With the increase in waste each year (Statistic Norway, 2011) correct waste handling is crucial for the environment. If waste is recyclable new products should be made. If not, it should be used as an energy source after hazardous waste is removed. When the waste has been incinerated the potential energy is gone. It is therefore important to optimize the amount of energy obtained from incinerating the waste with as little pollution as possible.

If the calorific value of the waste is known a more efficient control of the heat production could be done. If also a model is developed for the combustion process, the model could be used to predict optimized waste flow and oxidants to the combustion process. Another important motivation is to obtain a minimum of dangerous gases in the flue gas.

1.3 Scope of the Assignment

A thorough understanding of the process is necessary in order to develop a good mathematical model of the combustion process. It is also important with knowledge of the measured process parameters. In the literature today there are different methods to estimate model parameters based on process measurements. To estimate the parameters from recorded data, two different methods will be applied for two different model sets.

A challenge today is the uncertainty regarding the calorific value of the waste, and the large time constant for measuring the energy produced by the combustion. It is therefore of great importance to estimate the calorific value of the waste and apply a new method to measure the energy produced by the combustion.

1.4 Thesis Outline

Chapter 2

The first part of this thesis will describe the combustion process at Haraldrud in dept. Also, information on relevant meters observing the combustion process is presented.

Chapter 3

An on-line method to estimate the calorific value of the waste is presented. Further, the calorific value can be used to calculate the energy produced by the combustion process. Both the estimated calorific value and the calculated energy are found from measurements in the flue gas and by measuring the amount of air flow to the combustion process.

Chapter 4

The combustion process control and manipulated variables is described. Recorded process data and step response tests are analyzed in order to obtain a-priori information. Then a-priori information is used to design a final test. The final test is performed on the combustion process, in order to obtain a data-set that can be used to estimate the model parameters for the combustion process.

Chapter 5

This chapter describes one method to estimate model parameters for a model describing the combustion process. By using the final test described in Chapter 4 the model parameters is estimated based on a method called system identification.

Chapter 6

This chapter describes another method for estimating the model parameters. The model parameters are estimated on-line with an adaptive law, from measured process data, when the combustion process is running under normal operating conditions.

Chapter 2

Description of Haraldrud Combustion Process

This chapter is based on the directed study by (Gudim, 2010) and additional gathered information during this master thesis. Many hours have been spent in the control room observing and manipulating the combustion process. The obtained knowledge of the combustion process and the instrumentation is described in this chapter.

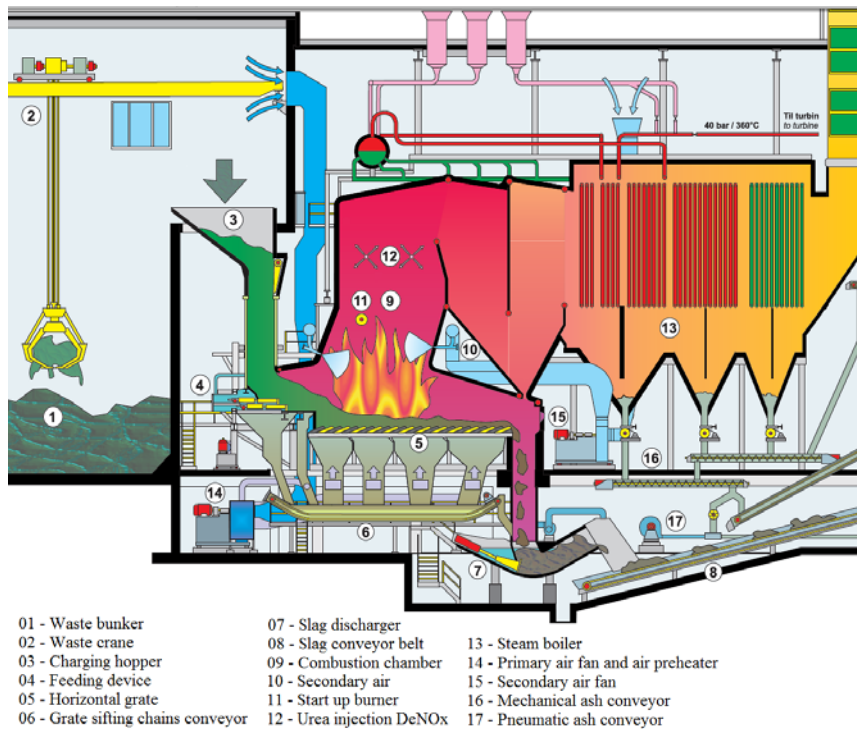

Figure 2.1: Haraldrud MSW combustion process

2.1 Stages in the Combustion Process

Figure 2.1 shows the different stages of Haraldrud's combustion process. Each stage has a number that will be referred to when the stage is explained. After the flue gas leaves the combustion process the flue gas is cleaned according to international regulations. A detailed description of the flue gas will be given, but how the flue gas is cleaned is not relevant for this thesis. The combustion process is quite complex and what happens in the different stages of the combustion will have an impact on each other. For simplicity the different stages are explained in an order that follows the waste from input to output.

2.1.1 Waste Bunker

The waste bunker, number ① in Figure 2.1, is where the waste is stored before it is burned. Before the garbage trucks tip the waste into the bunker the waste has been weighted and recycled. This weighing is not very precise since the truck often has waste containing water and snow. The water and snow will end up at the bottom of the bunker and be pumped out and cleaned before entering the sewers. Recycling of the waste is done at a recycling station nearby the combustion plant. Some of the parts that are removed are plastic, paper, food waste and metal. The plant engineers have reported that the calorific value of the waste has been more stable after recycling has been introduced. Unfortunately, the calorific value has not been measured therefore, the statements are based on experience. Especially the food waste has a low calorific value mainly because of the water content.

2.1.2 Waste Crane

The waste crane ② is used for mixing, piling and lifting the waste into the charging hopper ③. By mixing the waste, a more balanced heat value, size, structure, and composition of the waste is obtained. Furthermore, the crane has a weight installed that shows how much waste that has been lifted into the charging hopper. The weighing is not used in the plant control at the moment. One of the reasons for not using the weight is that some of the waste falls out of the charging hopper when the crane tries to drop the waste into it. This problem should be fixed in the future by building a larger down-lead to the charging hopper. Another reason for this is that the weights needs to be adjusted quite often to measure precisely.

Since the plant receives its income based on the amount of burned waste and delivered energy, it is important to know how many tons of waste that has been burned. The production of energy is explained in Section 2.1.8, but the main idea is to heat water with the combustion process. The amount of heated water is calculated into produced energy and sold to the district heating system. Instead of using the weighting from the crane or the weighting before the waste goes into the bunker a mean calorific value is found. The mean calorific value today is 8,75 [GJ/ton] of waste. This value is adjusted by looking at the waste level in the bunker after some time. If the level in the bunker does not match the amount of waste found by measuring the produced energy, the mean calorific value is adjusted. This is not a very precise way of measuring the waste and each year the deviation is quite large. The plant operators want to get a different method for measuring the amount of burned waste. A suggestion on this problem could be found in Chapter 3.

2.1.3 Feeding Device

The charging hopper leads the waste into the feeding device ④. The feeding device has an arm that pushes the waste onto the grate ⑤. Today the volume of the waste going into the furnace is unknown. This volume could be calculated since the position of the feeder arm is measured and the area of the opening into the furnace is known. Figure 2.2 shows a picture of the position to the feeder arm during a period of two hours. By integrating only the positive movements, the length of how much the feeder arm has pushed into the furnace, could be calculated. Since the area into the furnace is $0,742 \text{ m}^2$ the volume over a chosen time period is found.

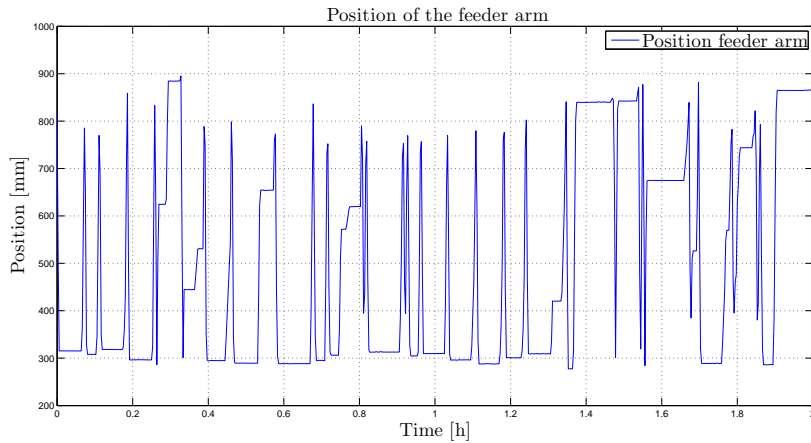

Figure 2.2: Position of the feeder arm

2.1.4 Horizontal Grate

The grate ⑤ is the heart of the combustion process. The grate is divided into three different grate Zones, see Figure 2.3. Zone 2 is where the combustion process takes place. When the combustion needs more waste the grate starts to move and waste from Zone 1 is pushed into Zone 2. Zone 1 is where the waste is dried and where the feeder pushes waste onto the grate. Zone 3 is where the burnout takes place and where the inert leaves the grate. The grate is moved mechanically with a constant speed and receives start or stop signals from the controller. The speed in Zone 1 and Zone 3 is slower than the speed in Zone 2. Minimal mixing is happening on the grate. This is why good mixing in the bunker is important. Good mixing gives better controllability of the combustion process and good burnout.

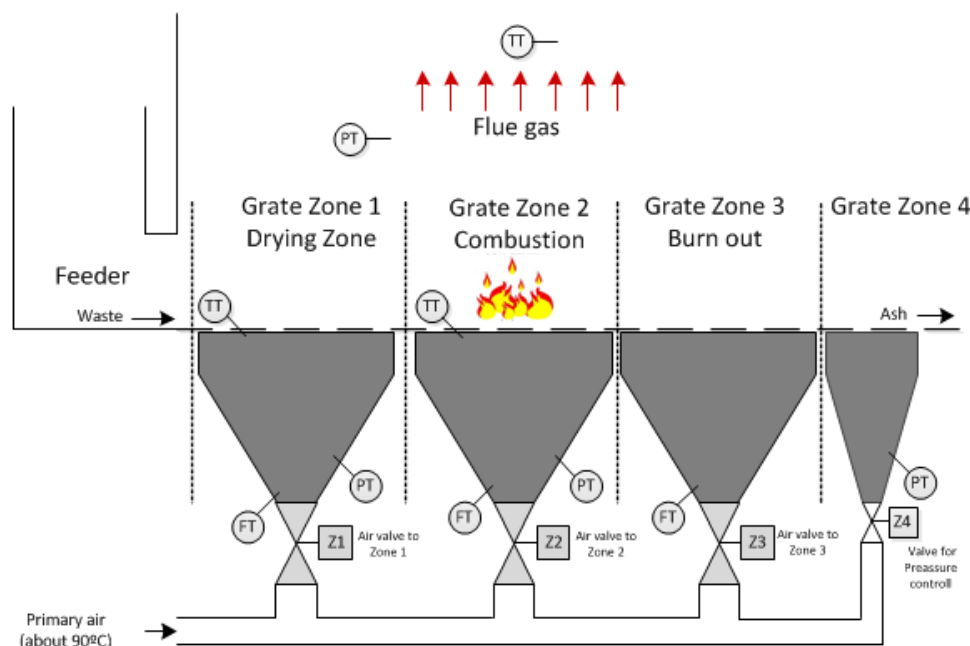

Figure 2.3: Grate zones

2.1.5 Primary and Secondary Air

Primary air ④ to the combustion process is taken from the bunker. This is to reduce the pressure, avoid excessive dust development and gas formation from fermenting processes inside the bunker. Primary air goes into the combustion process through small holes in the grate and valves are used to control the air flow. Figure 2.3 shows that the primary air is divided into four areas. The primary air is preheated to around 90 °C and the waste in Zone 1 is dried by the primary air flowing through the Zone. The primary air in Zone 2 is mainly used for provision of oxidants to the combustion process. In Zone 3 the primary air is used to obtain a complete burn out of the waste. Zone 4 is used to regulate the pressure so the pressure is the same above all the inlets to the airflow valves. Without compensating the pressure it would have been very difficult to control the correct amount of air to the different Zones.

The operators have reported that too much primary air would cool down the combustion process. The reason is that the airflow fans blow too hard so that the flames do not have time to catch fire in the waste. This is important since a drop in produced energy normally means that more waste and primary air is needed. If the temperature on the grate in Zone 1 and 2 is too low, the amount of primary air must be decreased so that the temperature on the grate can increase, before the primary air again can be increased. The operators have reported that around 250 °C on the grate in Zone 1 and around 300 °C on the grate in Zone 2 is recommended set points. Another reported problem with too much primary air is that the air always finds the path of least resistance. The result is that most of the air just flows on each side of the combustion without having time to react with the combustion process. The easiest way to see if the amount of primary air is correct is to look at the color of

the fire. If the color is very white there is too much primary air. If the color is very yellow there is too little primary air. The amount of dioxygen O_2 in the flue gas is also a measurement for too much or too little primary air, but the secondary air has a larger impact on the O_2 value. This is explained in more detail in Section 2.1.9.

Most of the combustion happens above the packed bed, more precisely in the flue gas. This is why the secondary air (II) is blown in with a high speed. This helps mixing and controlling the temperature of the flue gas. Since the secondary air also has a cooling effect on the combustion process it is important not to increase the primary air too much before the temperature in the furnace is high enough. Recommended set point for the primary air is $950\text{ }^\circ C$. If the temperature in the furnace drops below $850\text{ }^\circ C$ two oil burners will start up. Secondary air is also the main source for avoiding a stream of unburned gas and has a great impact on the flue gas which is explained in more detail in Section 2.1.9. The secondary air is taken from a room inside the plant with a temperature of about $25\text{ }^\circ C$.

2.1.6 Airflow Resistance in Zone 1 and Zone 2

One of the largest regulation problems in a MSW combustion plant is to control the amount of waste into the combustion process. Some of the desired and necessary conditions are;

- The amount of waste burning in Zone 2 must be continuous and enough to produce 15 [MW] of hot water, which is what the furnace has been designed to deliver
- Height of waste in Zone 1 should be a bit higher than in Zone 2
- The height of the waste in Zone 1 must be optimized in relation to drying the waste as much as possible before entering Zone 2
- The waste has been completely burned out when leaving Zone 3
- The area of waste burning is controlled so it is held within Zone 2. If the height in Zone 2 is too high the waste starts to burn into Zone 3 with the shape of a tongue. The results are that the waste does not have time to be completely burned out before leaving the furnace. This could be dangerous and start a fire outside the furnace

Today the amount of waste in the different Zones is measured by calculating the airflow resistance $R_a\text{ [mBar/Nm}^3\text{]}$;

$$R_a = \frac{\text{Pressure under grate} - \text{Pressure furnace}}{V_{\text{prim air}}} = \frac{\Delta P}{V_{\text{prim air}}} \quad (2.1)$$

ΔP - Pressure over grate $[\text{mBar}]$

$V_{\text{prim air}}$ - Measured airflow through the Zone $[\text{m}^3]$

Figure 2.3 shows that there is a pressure transmitter (PT) in the air chutes in Zone 1, Zone 2 and one PT inside the furnace. Differential pressure over the grate in Zone 1 and Zone 2 can then be calculated. There is also a flow transmitter (FT) in Zone 1 and Zone 2, so the airflow resistance can be calculated for these two Zones.

After the furnace has had an enhanced service the airflow resistance needs to be calibrated when the grate is empty. This calibration value is found for different amount of airflows flowing through the grate. The registered values are then R_a for empty grate. Two important observations about R_a is;

- The airflow resistance has an important impact on the amount of produced energy. But the calorific value of the waste is highly varying so the R_a could be high but the energy in the waste is low. In Chapter 4 different tests have been described to prove the influence
- The empty grate values for R_a will drift away during runtime. The reason is that the holes in the grates change a bit due to corroding and clogging

2.1.7 Inert from the Combustion Process

When the waste moves through the furnace, the particles fall from the grate and are captured by the grate sifting chain conveyor ⑥. From here it moves onto the slag discharger ⑦ where the rest of the unburned material has fallen into. An important environmental task is to handle the inert after the combustion process correctly. Moreover, an interesting study would be to find a way to automatically control the speed of the grate so the waste gets completely burned out. Today this is done manually by the operator. A camera is watching the end of the belt so the operator could adjust the time the ash is laying on the grate for complete burnout.

2.1.8 Energy Produced in the Boiler Circuit

From the study of thermodynamics we know that the main source of heat in a power plant is the chemical energy of substances called fuels (T.D.Eastop and A.McConkey, 1993). A fuel is simply a combustible substance (Moran and Shapiro, 2004). Furthermore, by mixing the fuel elements with oxygen in a rapid oxidation process, heat is generated. In a MSW plant the fuel is waste from the bunker. Number ⑬ in Figure 2.1 shows a chamber where the flue gas flows through. The temperature of the flue gas entering the chamber is around 950 °C. A shell-and-tube heat exchanger is installed to heat the water. When hot flue gas passes the colder water pipe, heat is transferred to the water. By measuring the water flow and temperature inn and out of the circuit, the produced energy Q can be calculated by Equation (2.2) (T.D.Eastop and A.McConkey, 1993).

$$\dot{Q} = \dot{m}C_w(t_{inn} - t_{out}) \quad (2.2)$$

\dot{Q} - Produced energy [W]

\dot{m} - Water flow in the pipe [$\frac{kg}{s}$]

C_w - Heat capacity of water [$\frac{J}{kgK}$]

t_{inn} - Water temperature in [K]

t_{out} - Water temperature out [K]

The shell and tube heat exchanger is connected to a boiler circuit. Figure 2.4 is the human machine interface (HMI) from Haraldrud and shows the boiler circuit at Haraldrud. Table 2.5 in the Instrumentation section, lists the important parts from Figure 2.4 relevant for this thesis.

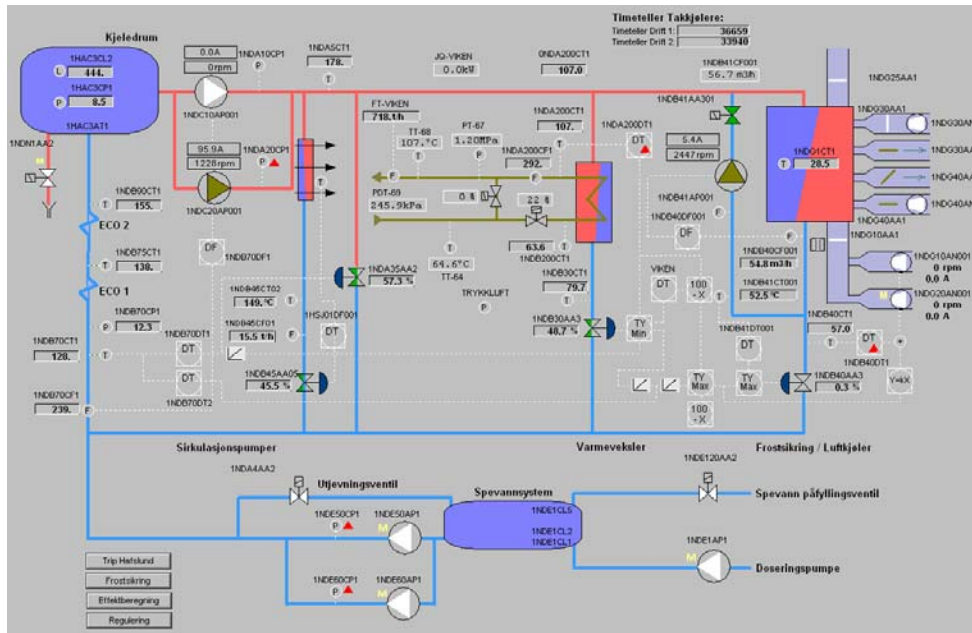

Figure 2.4: HMI picture of boiler circuit at Haraldrud

It is quite a large job to fully understand the boiler circuit but this is not necessary for this thesis. Some important information is;

- The calculated produced energy Q is used in the combustion controller to regulate the heat from the combustion process.
- The boiler circuit is connected to a district heating system. Therefore, the combustion process should be optimized so the boiler circuit delivers maximum amount of heated water to the district heating system. The boiler circuit is constructed to deliver maximum 15 [MW]
- Some of the heated water in the boiler circuit is used to heat up the primary air. Around 0.5 [MW] is used for heating up the water but most of this energy is recovered since the heated primary air has a positive impact on the combustion process
- Q is today not very stable. Variation of 1 [MW] around SP is quite normal. There are three main reasons for these. Firstly, even if the combustion process is burning quite stable the different circuits in the boiler circuits has a quite large disturbance on Q . This will have ripple effects since Q is used to regulate the combustion process. Secondly, the calorific value of the waste is quite fluctuating so the amount of heat from the combustion is constantly varying. Lastly, when the water temperature in the boiler circuit decreases the combustion process must increase so that warmer or more flue gas is produced. But there is a time delay after the flue gas has been increased until the water in the boiler circuit has increased. See Chapter 3 for details around the time delay.

Tests on how primary air, secondary air and the amount of waste on the grate influence the produced energy Q could be found in Chapter 4. Further information

on the boiler circuit could be found in a master thesis concerning the boiler circuit (Smedsrud, 2008).

2.1.9 Flue Gas from the Combustion Process

Flue gas is a product from the combustion process and the components are mainly (van Kessel, 2003);

$$O_2 + H_2O + CO_2 + N_2 = 1 \quad (2.3)$$

One of the most important concerns in a MSW plant is the emission of dangerous gases in the flue gas. Table 2.1 shows the emission limits for Nitrogen oxide NO_x , Carbon monoxide CO , Sulfur dioxide SO_2 and Hydrogen chloride HCl . N in Nm^3 does not stand for Newton, but for normalized. Especially the measured air and water in a plant is normalized to 1 atmospheric pressure and 20 °C. The reason is that the volume of a gas or fluid is varying a lot to different temperatures and pressures. If the measurements are not normalized the values would be difficult to compare against each other. Ideal gas law is used to normalize a measurement.

Description	Limit	Unit
NO_x	200	mg/Nm^3
CO (daily mean value over one year)	50	mg/Nm^3
SO_2	50	mg/Nm^3
HCl	10	mg/Nm^3

Table 2.1: Compliance with emission limits to air

Sufficient amounts of O_2 and correct temperature in the furnace gives a complete burnout so the quantity of dangerous gases is normally neglectable (van Kessel, 2003). But it has been observed that if there is more air into the combustion process then needed, the remaining oxygen will bind very easily to carbon and the level of CO will be high. The plant engineers have also reported that NO_x and CO will be strongly correlated with the distribution of secondary and primary air. Based on experience is the SP for O_2 in the flue gas 7 % when the O_2 measurement is wet. The difference between wet and dry measurements is that in a dry measurement is the moister part of the air removed before the air analyse is performed.

The environmental considerations are a very important aspect for the combustion plant. It is therefore necessary to understand how the flue gas is monitored. Figure 2.5 shows the total combustion plant. The measurement system for the flue gas is named Opsis. There are two Opsis systems at Haraldrud. One is Opsis 1 which is after the bag filters. The only thing the bag filters removes is dust particles from the combustion process and should not have any impact on the level of gases in the flue gas. This means that Opsis 1 is measuring what is happening in the combustion. The traveling delay for the flue gas of about 2 minutes must be taken into consideration. Opsis 2 is after the scrubber which means that the flue gas has been cleaned. The values in Opsis 2 are the values that must not be exceeded in Table 2.1. In addition to the Opsis system there is installed an O_2 transmitter just after the furnace. The traveling delay is just some seconds and this transmitter is today used in the combustion control system.

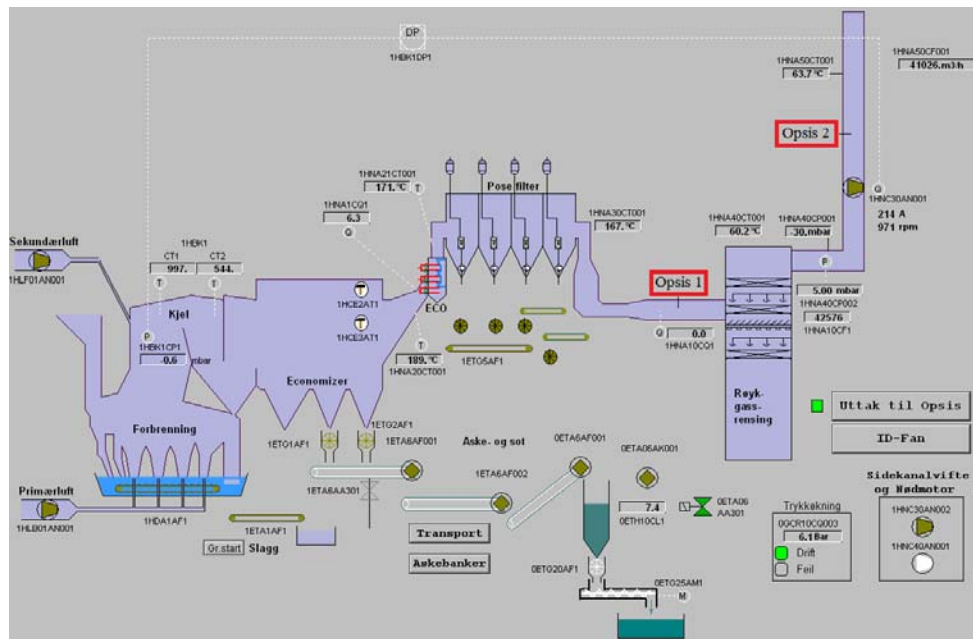

Figure 2.5: HMI picture of the overall combustion process at Haraldrud

It is important to control the pressure in the furnace so that the flue gas does not leak. A large exhaust fan is used to build up an under-pressure in the furnace so the flue gas does not leak out of the furnace. Figure 2.5 shows where the fan is placed with tag number **1HNA30AN001**.

2.2 Instrumentation

The combustion process at Haraldrud is well-instrumented. Since this thesis is concerning a real plant it is important to know the tag number and unit the different measurements. All the relevant tags for this thesis are listed in this Section and could be found in either Figure 2.4, Figure 2.5 or Figure 2.6. These three Figures are all HMI pictures and taken when the plant is running steady around SP. The pictures are essential to the operators for the daily process control.

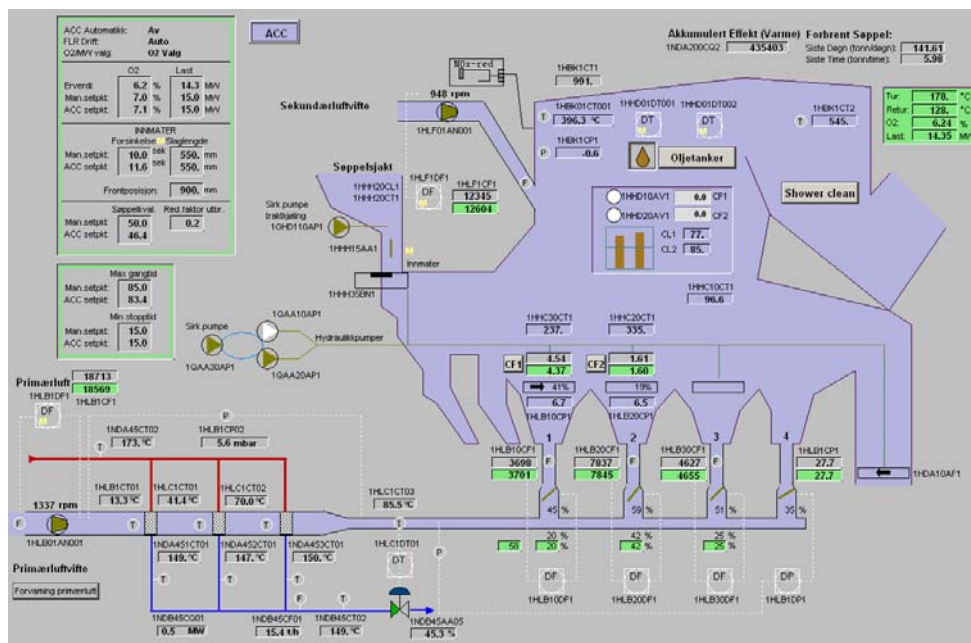

Figure 2.6: HMI picture of the combustion chamber at Haraldrud

Primary and Secondary Air

Description	Tag	Unit	Details
Primary air	1HLB1CF1	Nm^3/h	
Temperature primary air	1HLC1CT03	$^{\circ}C$	
Primary air fan	1HLB01AN001		
Secondary air	1HLF1CF1	Nm^3/h	
Secondary air fan	1HLF01AN001		

Table 2.2: Measurements primary and secondary air

Airflow Resistance - R_a

Description	Tag	Unit	Details
Pressure under grate Zone 1	1HLB10CP1	<i>mBar</i>	
Pressure under grate Zone 2	1HLB20CP1	<i>mBar</i>	
Pressure inside furnace	1HBK1CP1	<i>mBar</i>	
Flow resistance Zone 2	1ACC Zeta2		Height of waste Zone 2
SP flow resistance Zone 2	1ACC SP Zeta2		
Flow resistance Zone 1	1ACC Zeta1		Height of waste Zone 1
SP flow resistance Zone 1	1ACC SP Zeta1		
Primary air Zone 1	1HLB10CF1	<i>Nm³/h</i>	
Primary air Zone 2	1HLB20CF1	<i>Nm³/h</i>	
Primary air Zone 3	1HLB30CF1	<i>Nm³/h</i>	

Table 2.3: Measurements to airflow resistance

Temperature Measurements

Description	Tag	Unit	Details
Temperature furnace	1HBK1CT1	$^{\circ}C$	
Temperature before Economizer	1HBK1CT2	$^{\circ}C$	
Temperature after Economizer	HNA20CT001	$^{\circ}C$	
Temperature on grate Zone 1	1HHC30CT1	$^{\circ}C$	
Temperature on grate Zone 2	1HHC20CT1	$^{\circ}C$	

Table 2.4: Measurements of the temperature

Boiler Circuit - Figure 2.4

Description	Tag	Unit	Details
Q boiler circuit	ACC PV Load	<i>MW</i>	
Heat battery one primary air	1HLB1CT01		
Heat battery two primary air	1HLC1CT01		
Heat battery three primary air	1HLC1CT02		
Water temp before combustion heat exchanger	1NDB70CT1	$^{\circ}C$	
Water temp after combustion heat exchanger	1NDB70CF1	$^{\circ}C$	
Valve water flow through combustion heat exchanger	1NDB70CF1	$^{\circ}C$	
Valve water flow district heating system	1NDB30AA3		
Valve water flow cooling heat exchanger	1NDB40AA3		

Table 2.5: Measurements boiler circuit

Feeder

Description	Tag	Unit	Details
Position feeder arm	1HHH35BN1	mm	

Table 2.6: Measurements feeder

Measurements of the Flue Gas

Description	Tag	Unit	Details
NO after bag filter	1HNA30CQ1	mg/Nm^3	Dry, compensated 11 % O_2
NO_2 after bag filter	1HNA30CQ4	mg/Nm^3	Dry, compensated 11 % O_2
NO_x after bag filter	1HNA20CQ80	mg/Nm^3	Dry, compensated 11 % O_2
CO after bag filter	1HNA30CQ6	mg/Nm^3	Dry, compensated 11 % O_2
H_2O after bag filter	1HNA30CQ5	mg/Nm^3	Compensated 11 % O_2
O_2 after bag filter	1HNA30CQ7	mg/Nm^3	Dry
O_2 after furnace	1HNA1CQ1	%	Wet measurement
Total flue gas	1HNA10CF1	Nm^3/h	
CO_2 after scrubber	1HNA20CQ111	%	Raw value
O_2 after scrubber	1HNA20CQ91	%	Raw value
H_2O after scrubber	1HNA20CQ51	%	Raw value
CO after scrubber	1HNA20CQ61	mg/Nm^3	Raw value

Table 2.7: Measurements of the flue gas

The measurements from the Opsis system have unit [%] or [mg/Nm^3] and is called raw values. The values must be corrected in relation to water vapor H_2O and O_2 (Mordt, 2009).

Correction in Relation to H_2O and O_2

The components in the flue gas must be standardized in relation to 11 % oxygen, 0 °C, 1 atmospheric pressure and displayed as a dry measurement. These are international provisions. A dry measurement means that the amount of H_2O in the flue gas has been removed. The correction factor for H_2O is found with Equation (2.4).

$$k_{H_2O} = 100/(100 - H_2O_{act}) \quad (2.4)$$

H_2O_{act} is the measured H_2O from the Opsis system. The correction factor shall only be done if the measured water vapor is less than 80 %. H_2O_{act} should be based on a 10 minutes mean value. Correction factor for O_2 is found with Equation (2.5).

$$k_{O_2} = (21 - 11)/(21 - O_{2act}) \quad (2.5)$$

O_{2act} is the measured O_2 value from the Opsis system. The correction factor shall only be done if the measured value is less than 20 %. O_{2act} should be based on a 10 minutes mean value. The correct value to be presented is then;

$$x_{dry} = x_{raw} * k_{O_2} * k_{H_2O} \quad (2.6)$$

x_{raw} is the measured value from the Opsi system.

Calculating NO_x

Since the Opsi do not measure NO_x directly, the values needs to be calculated using the measured NO and NO_2

$$NO_x = 1,53 * NO + NO_2 \quad (2.7)$$

Chapter 3

Calculating Produced Energy from Measurements in the Flue Gas

In Chapter 2 it was stated that the amount of produced energy Q from the combustion process was calculated in the boiler circuit. It was also stated that it is the amount of sold energy to the district heating system together with the amount of burned waste the plant gets its income from. With a stable and optimized energy production more waste could be burned and a larger amount of hot water could be sold to the district heating system. Figure 3.1 shows the calculated produced energy in the boiler circuit 27th of March 2011. During this time period the plant was running under normal operating conditions.

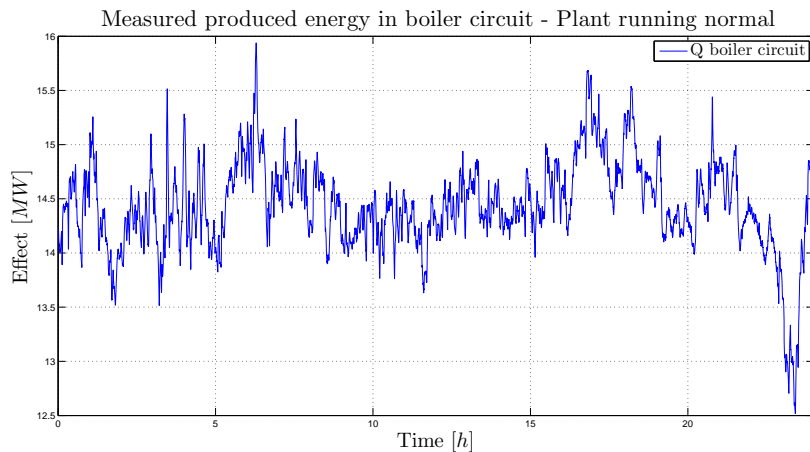

Figure 3.1: Calculated produced energy in boiler circuit

The variation in produced energy is mainly from the variation in the calorific value of the waste and the time delay for the flue gas to heat up the water in the boiler

circuit. The time delay is explained when investigating the regulation of the combustion process. When produced energy is below SP the combustion control system starts to push more waste into Zone 2 and regulate the primary and secondary air. It then takes time before the combustion generates more heat, usually between 10 to 15 minutes. During this delay produced energy will continue to decrease. The combustion generates more heat heating up the boiler circuit with the flue gas. When produced energy reach SP the energy will continue to increase quite a bit before it starts to decrease again. The frequency of the variation is normally between 20 to 25 minutes.

The time delay for moving waste from Zone 1 to Zone2 and further for the waste to start burning is not possible to remove. But the time delay for the flue gas to make an impact on the water in the boiler circuit would not be a problem if produced energy was measured directly from the flue gas. The energy measured in the flue gas could be used, instead of the measured energy in the boiler circuit, to regulate the amount of heat from the combustion. In L.B.M van Kessel's doctoral thesis a method for on-line calculation of the calorific value and energy in the flue gas $Q_{\text{flue gas}}$ (van Kessel, 2003) are described. This method is based on measurements in the flue gas. This chapter presents the theory for calculating $Q_{\text{flue gas}}$ and the waste calorific value. Moreover, how to implemented the theory at Haraldrud and further analyze Q and $Q_{\text{flue gas}}$ based on previous measurements. All the equations found in Section 3.1 and 3.2 could be found in (van Kessel, 2003).

3.1 Estimating the Calorific Value

Many models have been developed to describe the energy content of MSW (Kathrivale et al., 2002). Some of the methods to develop a model are to use a laboratory bomb calorimeter or calculation based on empirical models. The empirical models are developed by analyzing which waste fractions are going into the combustion. Agency for Waste Management (REN) find the different fractions of the waste each year from household consumption, going into the combustion process at Haraldrud. Figure 3.2 shows the results from 2010. The analysis could be used to develop a model but the waste from industry which has not been taken into account is a much larger part than from the households. Instead, the calorific value at Haraldrud is based on experience as explained in Section 2.1.2. Since todays methods are not very accurate it would be a great advantages for the plant operators to use an on-line estimate of the calorific value.

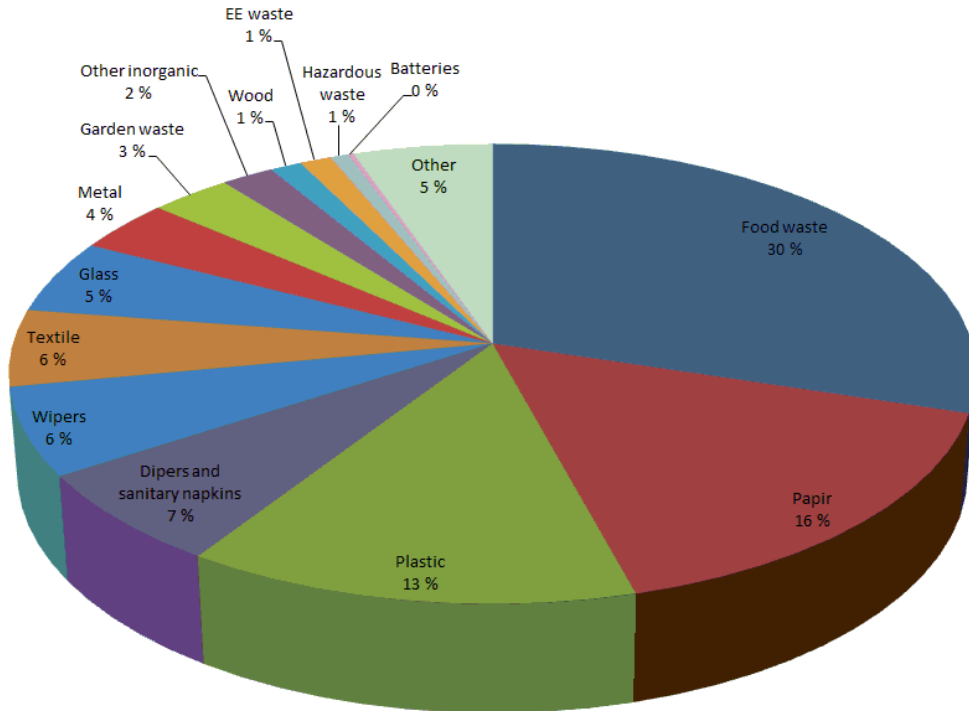
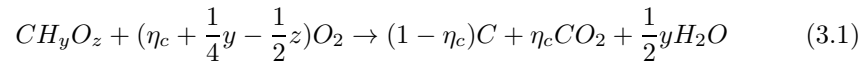

Figure 3.2: Fractions of the waste at Haraldrud based on average household waste in 2010

In (van Kessel, 2003) a method for on-line estimation of the calorific value is explained. Waste could be divided into three parts. This is the *combustible*, *moister* and *inert*. The reaction equation for the combustible part CH_yO_z is defined as;



where η_c is the amount of converted carbon. In a MSW combustion plant, η_c is normally between 0.9 and 1.0. In Equation 3.1 there are two unknowns. The unknowns, y and z are respectively the amount of Hydrogen and Oxygen in the combustible waste for each Carbon. If the y and z values are found, the amount of O_2 to obtain a complete combustion can also be found.

3.1.1 Finding the y-value (Hydrogen)

The hydrogen y in the waste could be found by analyzing the waste in a laboratory (van Kessel, 2003). Table 3.1 shows that the amount of hydrogen in three different types of waste compositions are quite similar.

Component	Waste 1	Waste 2	Waste 3
Paper	0.34	0.34	0.34
Plastic	0.11	0.25	0.05
Food waste	0.37	0.23	0.43
Inert	0.18	0.18	0.18
Total waste	Waste 1	Waste 2	Waste 3
y	1.71	1.75	1.69
z	0.46	0.32	0.54
Water	0.28	0.22	0.31
Inert	0.27	0.26	0.27

Table 3.1: Composition (mass fractions), y and z values for three different types of waste

The mean value of y in Table 3.1 is 1.716. Figure 3.2 shows that the waste analyzed at Haraldrud is 30 % food waste, 13 % plastic and 16 % paper. The composition compared to Table 3.1 is not the same, but y is independent of the waste composition. The best assumption without ordering a specific analyze for the waste at Haraldurd is to use 1.72 as **y-value**.

3.1.2 Finding the z-value (Oxygen)

Table 3.2 shows the variation in oxygen z according to type of waste. The variation is quite large and should therefore be estimated on-line.

Component	y	z
Paper	1.713	0.685
Plastic	1.803	0.023
Food waste	1.619	0.562

Table 3.2: y and z values of CH_yO_z for combustibile components

The z value could be found from combining the mass balance equations for oxygen, total molar flue gas flow ϕ_{fg} and molar flow of the combustibile waste $\phi_{CH_yO_z}$ (van Kessel, 2003).

Oxygen Balance for the System

$$Y_{O_2,air}(\phi_{prim} + \phi_{sec}) + Y_{O_2}\phi_{recirc} = Y_{H_2O}\phi_{fg} + \frac{1}{2}(2\eta_c + \frac{1}{2}y - z)\phi_{CH_yO_z} \quad (3.2)$$

$Y_{O_2,air}$ - Amount of O_2 in moist air [%]

Y_{O_2} - Amount of O_2 in moist flue gas [%]

Y_{H_2O} - Amount of H_2O in moist flue gas [%]

ϕ_{prim} - Molar flow of primary air $\frac{Kg}{mol}$

ϕ_{sec} - Molar flow of secondary air $\frac{Kg}{mol}$

ϕ_{recirc} - Molar flow of exhaust gases from the combustion $\frac{Kg}{mol}$

Total Molar Flue Gas Flow ϕ_{fg}

ϕ_{fg} is found from the mass nitrogen molar balance;

$$\phi_{fg} = \frac{Y_{N_2,air}}{Y_{N_2}}(\phi_{prim} + \phi_{sec}) + \phi_{recirc} \quad (3.3)$$

$Y_{N_2,air}$ - Amount of N_2 in moist air [%]

Y_{N_2} - Amount of N_2 in moist flue gas [%]

Molar Flow of the Combustible Material $\phi_{CH_yO_z}$

$$\phi_{CH_yO_z} + Y_{CO_2}\phi_{recirc} = Y_{CO_2}\phi_{fg} + (1 - \eta_c)\phi_{CH_yO_z} \quad (3.4)$$

Y_{CO_2} - Amount of CO_2 in moist flue gas [%]

z-value

By combining Equation 3.2 - 3.4 the **z** value is found;

$$z = \frac{2\eta_c}{1 - \frac{Y_{O_2,air}}{1 - Y_{H_2O,air}}} \left(1 - \frac{\frac{Y_{O_2,air}}{1 - Y_{H_2O,air}} - \frac{Y_{O_2}}{1 - Y_{H_2O}}}{\frac{Y_{CO_2}}{1 - Y_{H_2O}}} \right) + \frac{1}{2}y \quad (3.5)$$

Haraldrud has measurements of H_2O , CO_2 and O_2 in the flue gas. In this thesis the H_2O in the primary and secondary air was also monitored, and the **z-value** can therefore be calculated.

3.1.3 Calculating the Net Calorific Value of the Waste

In (van Kessel, 2003) a model for calculating the net calorific value $H_{CH_yO_z}$ [MJ/Kg] for the combustible part CH_yO_z of the waste has been presented. The model must be verified against plant data at Haraldrud to see if the model could be used. If the deviation to the actual net calorific value at Haraldrud is to large a specific model for Haraldrud must be developed.

$$H_{CH_yO_z} = \frac{408.4 + 102.4y - 156.8z}{M_{CH_yO_z}} \quad (3.6)$$

$M_{CH_yO_z}$ - Molar mass of the combustible part $\left[\frac{Kg}{mol}\right]$

$H_{CH_yO_z}$ also called *lower calorific value* is defined as the energy content released from the combustion of organic components in an incinerator (Chang et al., 2007). $M_{CH_yO_z}$ [Kg/mol] is the molar mass of the fuel defined in Equation (3.7).

$$M_{CH_yO_z} = M_C + yM_H + zM_O \quad (3.7)$$

M_C - Molar mass of Carbon $\left[\frac{Kg}{mol}\right]$

M_H - Molar mass of Hydrogen $\left[\frac{Kg}{mol}\right]$

M_O - Molar mass of Oxygen $\left[\frac{Kg}{mol}\right]$

3.1.4 Calculating the Ash-Free Calorific Value of the Waste

The amount of inert from a MSW combustion process is very difficult to measure on-line since the type of waste is unknown. The inert at Haraldrud is today measured for the two combustion lines on a weekly bases. Section 3.1.5 will give an estimate and discuss the problem. But first the calorific value is stated without the inert fraction of the waste. This is also the most important calorific value since the inert waste fraction does not generate any energy in the combustion process. To be able to calculate the ash free calorific value $H_{ashfree}$, the ash free moister part $X_{H_2O_{ashfree}}$ of the waste must be calculated (van Kessel, 2003);

$$X_{H_2O_{ashfree}} = \frac{1}{1 + \frac{M_{CH_yO_z}}{M_{H_2O}} \left(\frac{1}{\left(\frac{Y_{H_2O}^{nc}}{Y_{CO_2}} - \frac{Y_{H_2O,air}^{nc} Y_{N_2}}{Y_{CO_2} Y_{N_2,air}} - \frac{1}{2} y \right)} \right)} \quad (3.8)$$

M_{H_2O} - Molar mass of H_2O [$\frac{Kg}{mol}$]

$Y_{N_2,air}$ - Amount of N_2 in moist air [%]

$Y_{H_2O,air}$ - Amount of H_2O in the air [%]

It is now possible to calculate $H_{ashfree}$;

$$H_{ashfree} = (1 - X_{H_2O_{ashfree}}) H_{CH_yO_z} - X_{H_2O_{ashfree}} H_{evap} \quad (3.9)$$

H_{evap} - Latent heat of evaporation for water [$\frac{KJ}{Kg}$]

3.1.5 Calculating the Calorific Value of the Waste

To find the calorific value of the inert, moisture and combustible part, the amount of inert from the combustion must be estimated. This was estimated from records of burned waste and inert from January to March at Haraldrud. Table 3.3 shows the records of burned waste and inert. The amount of burned waste has not been found from weighting the waste but using the estimated calorific value at Haraldrud, as explained in Section 2.1.2. The inert is weighted when it leaves the plant in a container for further processing. It is important to mention that the table is based on the total waste of both the combustion lines.

Month	Total burned [ton]	inert [ton]
January	8194,74	1289,48
February	8019,31	1353,02
March	5809,6	930,6
Total	22023,65	3573,1

Table 3.3: Estimated Burned waste and weighted inert from the combustion process

Table 3.3 gives an inert fraction X_{inert} of waste at 0.16 [%]. It is now possible to calculate the moister fraction of the waste X_{H_2O} ;

$$X_{H_2O} = (1 - X_{inert}) X_{H_2O_{ashfree}} \quad (3.10)$$

Finally the net calorific value H_{waste} of the waste going into the combustion process could be calculated from (van Kessel, 2003);

$$H_{\text{waste}} = (1 - X_{\text{inert}} - X_{\text{H}_2\text{O}})H_{\text{CH}_y\text{O}_z} - X_{\text{H}_2\text{O}}H_{\text{evap}} \quad (3.11)$$

3.2 Calculating the Flue Gas Energy $Q_{\text{flue gas}}$

It is the flue gas that is used to heat up the water in the boiler circuit. Increasing the temperature in the flue gas or the amount will increase the water temperature in the boiler circuit. Since the inert fraction does not generate any energy to the combustion process the energy from the flue gas leaving the combustion process is calculated by;

$$Q_{\text{flue gas}} = (\Phi_{\text{CH}_y\text{O}_z} + \Phi_{\text{H}_2\text{O}})H_{\text{ashfree}} \quad (3.12)$$

$\Phi_{\text{CH}_y\text{O}_z}$ - Mass flow of combustible material [$\frac{\text{Kg}}{\text{s}}$]

$\Phi_{\text{H}_2\text{O}}$ - Mass flow of water [$\frac{\text{Kg}}{\text{s}}$]

Mass flow of water $\Phi_{\text{H}_2\text{O}}$ is described by Equation (3.13)

$$\Phi_{\text{H}_2\text{O}} = M_{\text{H}_2\text{O}}\Phi_{\text{H}_2\text{O}} \quad (3.13)$$

and mass flow of combustible material $\Phi_{\text{CH}_y\text{O}_z}$ is described by Equation (3.14)

$$\Phi_{\text{CH}_y\text{O}_z} = M_{\text{CH}_y\text{O}_z}\Phi_{\text{CH}_y\text{O}_z} \quad (3.14)$$

Molar flow $\Phi_{\text{CH}_y\text{O}_z}$ is found by combining Equation (3.3) and (3.4).

$$\phi_{\text{CH}_y\text{O}_z} = \frac{Y_{\text{CO}_2}Y_{\text{N}_2,\text{air}}}{\eta_c Y_{\text{N}_2}}(\phi_{\text{prim}} + \phi_{\text{sec}}) \quad (3.15)$$

ϕ_{prim} and ϕ_{sec} is the molar flow [mol/s] of primary and secondary air. Primary and secondary air is measured at Haraldrud in [Nm^3/h]. The molar flow could be found by;

$$\phi_{\text{air}} = \frac{\rho_{\text{air}}*V_{\text{air}}}{3600 M_{\text{air}}} \quad (3.16)$$

Φ_{air} - Molar flow of primary or secondary air [$\frac{\text{mol}}{\text{s}}$]

V_{air} - Measured primary or secondary air [Nm^3]

ρ_{air} - Density of dry air = $1204.25 [\frac{\text{g}}{\text{m}^3}]$

M_{air} - Molar mass of dry air = $28.97 [\frac{\text{g}}{\text{mol}}]$

It is now possible to have on-line calculation of the energy in the flue gas.

3.3 Calculating the Moisture Part H_2O_{air} in Primary and Secondary Air

Today at Haraldrud the moisture part in primary and secondary air H_2O is not measured. During this thesis a humidity meter was temporarily monitoring primary and secondary air. Theory of how to calculate the moisture part will now be explained.

Most humidity meters measure relative humidity (RH) [%] in the air. RH is a ratio of actual water vapor pressure p_w [J/m^3]¹ to saturated water vapor pressure p_{ws} [J/m^3] (Gorham\Schaffler Inc., 2011) (Moran and Shapiro, 2004);

$$RH = \frac{p_w}{p_{ws}} 100 \quad (3.17)$$

If RH and the air temperature T_{air} [$^{\circ}C$] is known this could be used to find the density of water vapor in primary and secondary air. This is also called absolute humidity (AH) [kg/m^3]. Before AH can be calculated the dew point temperature $T_{dew\ point}$ must be calculated before the Ideal Gas Law can be used to calculate AH. The dew point temperature is calculated by (Gorham\Schaffler Inc., 2011);

$$T_{dew\ point} = \frac{-430,22 + 237,7 \log(p_w)}{-\log(p_w) + 19,08} \quad (3.18)$$

Equation (3.17) can be used to find p_w but this equation has two unknowns. Since p_{ws} can be calculated if the air temperature is known, and assumes a standard atmospheric pressure, p_{ws} could be calculated first.

$$p_{ws} = 6,11 * 10^{\frac{7,5T_{air}}{237,7+T_{air}}} \quad (3.19)$$

Now is Equation (3.18) used to calculate $T_{dew\ point}$ and the actual vapor pressure p [$mBar$] can be calculated;

$$p = 6,11 * 10^{\frac{7,5T_{dew\ point}}{237,7+T_{dew\ point}}} \quad (3.20)$$

Finally **AH** could be calculated with the use of Ideal Gas Law. To convert p in [$mBar$] to [J/m^3] it must be multiplied by 100 (Gorham\Schaffler Inc., 2011).

$$AH = \frac{p * 100}{(T_{air} + 273,15)R_w} \quad (3.21)$$

$$R_w - \text{Specific gas constant for water vapor} = 461,5 \left[\frac{J}{Kg * K} \right]$$

Now that **AH** is known it is possible to find the volume fraction of both dry air $V_{dry\ air}$ [Nm^3] and water $V_{moist\ air}$ [Nm^3] in the air with the help of ideal gas law (Moran and Shapiro, 2004).

$$V_{air} = V_{dry\ air} + V_{moist\ air} \quad (3.22)$$

$$m_{water} = AH * V_{air} \quad (3.23)$$

$$V_{moist\ air} = \frac{\frac{m_{water}}{M_{H_2O}} * R * T_{air}}{p_a} \quad (3.24)$$

¹Pressure in [Pa] could be written as [J/m^3]

$$\begin{aligned}
p_a & - \text{Atmospheric pressure} = 101,325 \text{ K} \left[\frac{\text{J}}{\text{m}^3} \right] \\
M_{H_2O} & - \text{Molar mass of water} = 18,0153 \left[\frac{\text{g}}{\text{mol}} \right] \\
m_{\text{water}} & - \text{Measured amount of water in the air} [g] \\
R & - \text{Ideal gas constant} = 8,314 \left[\frac{\text{J}}{\text{molK}} \right]
\end{aligned}$$

Now that $V_{\text{moist air}}$ could be calculated the amount of H_2O in primary and secondary air can be calculated.

$$H_2O_{air} = \frac{V_{\text{moist air}}}{\frac{V_{\text{air}}}{100}} \quad (3.25)$$

3.4 Verification

The theory presented in (van Kessel, 2003) is now verified based on previous measurements before it is recommended for further implementation. The first step was to measure the moister part in primary and secondary air since there was no previous records on these. The next step was to implement the theory and study the results. Matlab (R2010b) was used for simulation.

3.4.1 Moister Part in Primary and Secondary Air

A humidity meter was used to measure the humidity in primary and secondary air. Primary air was monitored from 13th to 16th of March and secondary air from 20th to 23th of March with a sampling frequency of two minutes. The current humidity meter calculates RH to AH automatically. Figure 3.3 and 3.4 shows respectively measured AH and calculated H_2O_{air} in primary and secondary air.

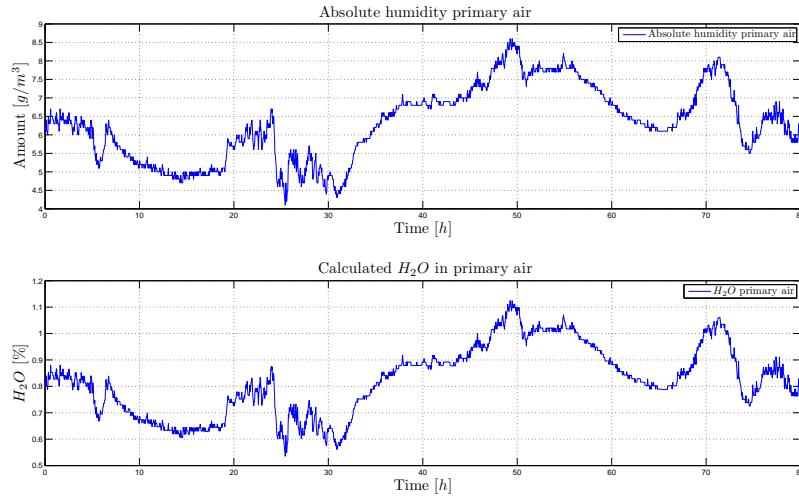

Figure 3.3: Measured absolute humidity and calculated H_2O primary air

Figure 3.4: Measured absolute humidity and calculated H_2O secondary air

Figure 3.3 and 3.4 shows that the amount of H_2O_{air} in the air is low compared to the other components in the air. Mean value for both primary and secondary air is 0.8. Further measurements must be taken to find out if this is the case all year around.

3.4.2 Comparing Q and $Q_{flue\ gas}$

Section 3.1 stated that in order to calculate the calorific value of the waste and further use this to calculate $Q_{flue\ gas}$, H_2O , O_2 , CO_2 and N_2 in the flue gas and O_2 , N_2 and H_2O in the air must be measured. Also, the amount of primary and secondary air must be measured. In Section 2.1.9 the main components in the flue gas was explained as $H_2O + O_2 + CO_2 + N_2 = 1$. It is therefore only necessary to measure H_2O , O_2 and CO_2 . Air is described earlier as one dry and one wet component. Dry air is assumed to be constant, and an approximation is found in Table 3.4 (Moran and Shapiro, 2004).

Components	Mole Fraction [%]
Nitrogen - N_2	78.08
Oxygen - O_2	20.95
Argon - A_r	0.93
Carbon dioxide - CO_2	0.03
Neon, helium, methane, and others	0.01

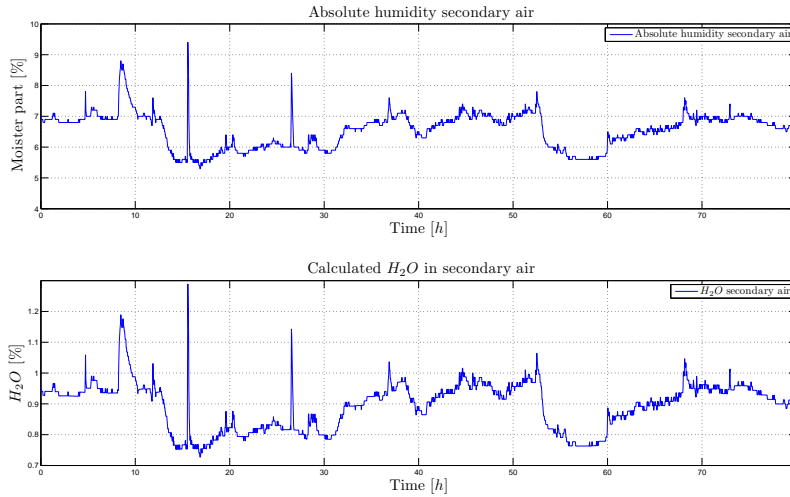
Table 3.4: Approximate composition of Dry Air

Figure 3.5 shows the flue gas after the gas have left the scrubber over a three days period. CO_2 is only measured here so this is the only place all three measurements are measured simultaneously. The most optimal place would have been just after the flue gas leaves the furnace. This is due to the transportation delay from the furnace to the scrubber exit, air leakage under transportation and the scrubbers impact on the flue gas. From 13/4 to 16/4 the moister part in primary air was measured but not the moister part in secondary air. H_2O_{air} for secondary air is assumed to be the same as H_2O_{air} for primary air during this time period.

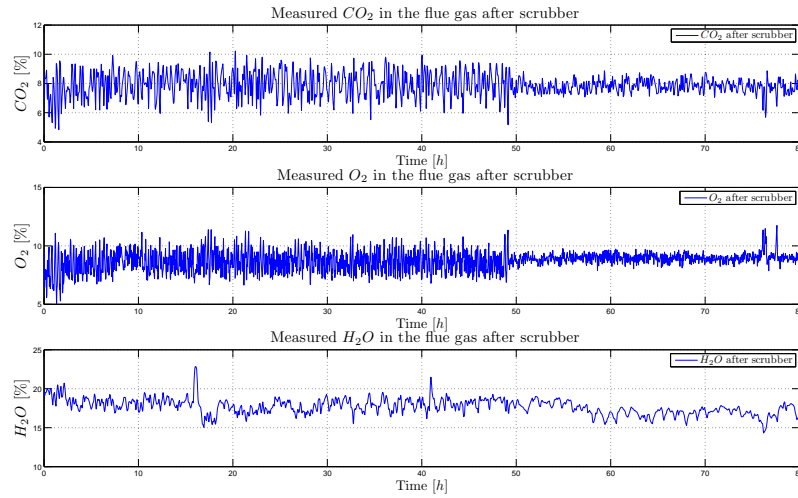

Figure 3.5: Measured CO_2 O_2 and H_2O in the flue gas after scrubber

Figure 3.6 shows the ash free calorific value $H_{ashfree}$ calculated by Equation (3.9). The red line is the estimated calorific value Haraldrud is using today. Figure 3.6 shows that during these 80 hours the mean calorific value estimated by the flue gas measurements is 21 % higher than the value Haraldrud use today.

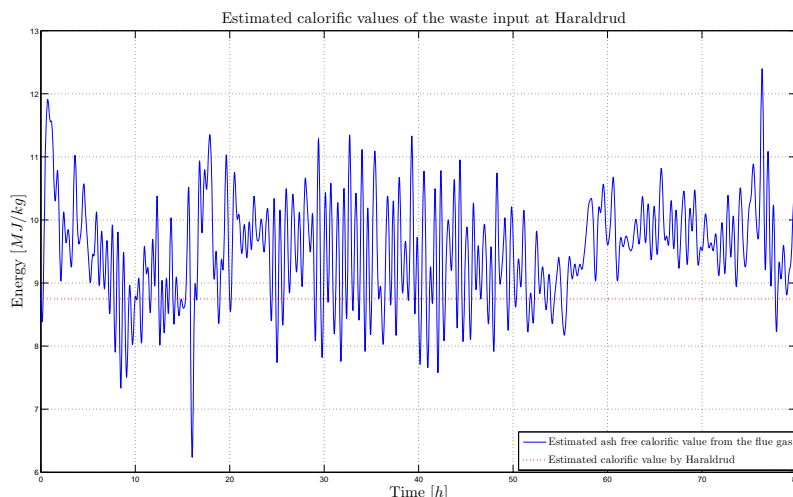

Figure 3.6: Estimated calorific value in flue gas and by Haraldrud

The estimation from the flue gas must be higher since the value used by Haraldrud also includes the waste inert. It is also important to remember that the value estimated by Haraldrud is not necessarily the correct value since the value is a yearly mean value, and adjusted each year since it has been incorrect.

Figure 3.7 shows a block diagram from the waste goes into the combustion process until effect is produced in the boiler circuit. The main reason for calculating the on-line calorific value is to use this value to find the amount of energy in the flue gas $Q_{flue\ gas}$. This is possible when the primary and secondary air is measured. It is then possible to remove the last two segments in Figure 3.7 and control the combustion process after the effect in the flue gas. This will reduce today's time delay problem.

From waste to energy

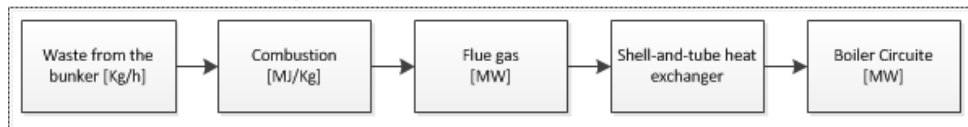

Figure 3.7: Block diagram shows the waste inlet flow to the produced energy in the boiler circuit

The top figure in Figure 3.8 shows the measured effect in the boiler circuit Q and measured effect from the flue gas $Q_{\text{flue gas}}$ during a period of 80 hours. The lower picture is a segment of 10 hours during the same time period. It can here be seen that the amplitude of $Q_{\text{flue gas}}$ is higher than Q .

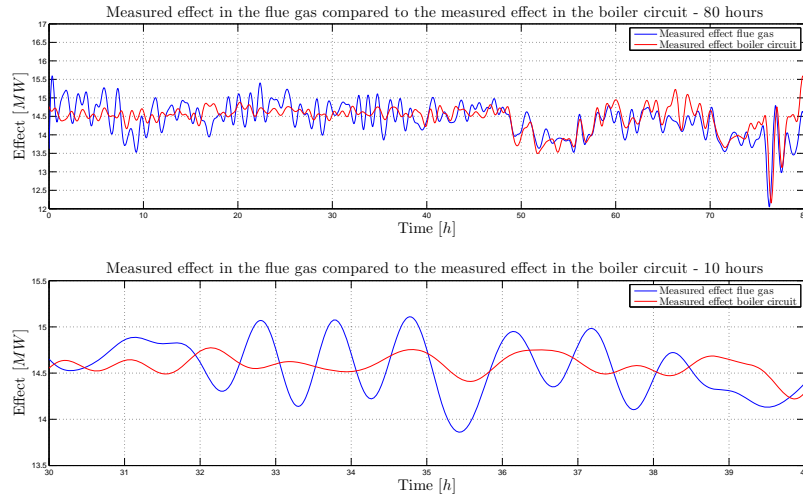

Figure 3.8: Measured effect in flue gas and boiler circuit

This must be correct since the flue gas heat up the water with a heat exchanger and there would be some loss of energy. Figure 3.8 also shows the time delay in the response. After about 76 hours there is an energy drop. Figure 3.9 shows that there is a drop in both primary and secondary air.

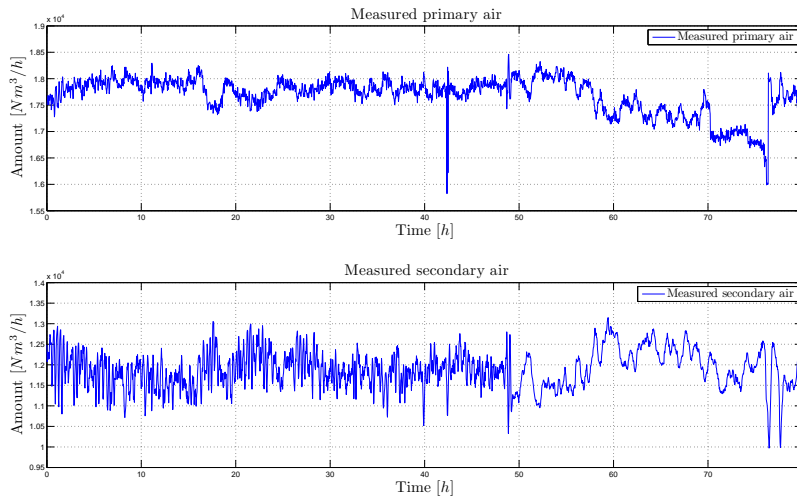

Figure 3.9: Measured primary and secondary air

Since the flue gas is the source of heat, a drop in mass flow or temperature in the flue gas means less energy. It is not unusual to have a drop like this and the reasons for that are sometimes difficult to know. The plant operators have reported that the cause could be broken mechanical parts, inaccurate measurements, low calorific value of the waste or a bad mix of air and waste on the grate.

Further verification of $Q_{\text{flue gas}}$ is done by;

- Mark the level in the waste bunker
- Record the waste inlet flow with adjusted waste cranes
- Install the humidity meter for primary and secondary air since this has not been permanently done

By dividing $Q_{\text{flue gas}}$ and the calorific value H_{waste} the waste input flow is found. Some months should be enough time to see if there is any deviation in the waste bunker or records from the waste crane compared to the waste input flow measured from the flue gas. If the deviation is small $Q_{\text{flue gas}}$ should be used instead of Q to control the combustion process. Since the measured effect in the boiler circuit is correct this could also be used as a control parameter to calculate the waste calorific value and compare with $Q_{\text{flue gas}}$.

3.5 Chapter Summary

- This chapter has introduced a new method to measure the calorific value of the waste and measure the energy from the flue gas based on the work of (van Kessel, 2003). At Haraldrud today the energy from the combustion is measured in the boiler circuit. This is a problem since this measurement has a large time-delay. It would therefore be preferable to measure the energy from the combustion directly in the flue gas
- It has been described how to implement the presented theory at Haraldrud. Plots have been generated based on previous recorded measurements at Haraldrud and the plots have been analyzed
- After a test period, the measured energy in the flue gas $Q_{\text{flue gas}}$ should be used to control the heat in the combustion process instead of the measurement in the boiler circuit
- The amount of burned waste is today recorded manually and the plant operators have requested a more efficient way. The plant operator could therefore use the calorific value and the measured energy to monitor the waste inlet flow automatically.

Chapter 4

Analysis and Manipulation of the Combustion Process

System identification is a field of mathematical modeling of a process with help of test data (Zhu, 2001). There are three important steps involved in system identification. These are; to obtain a set of data from the process, a model set, and a criterion for model estimation. Most of the methodology throughout this chapter is found in (Zhu, 2001). (Zhu, 2001) is a practical introduction to system identification and is based upon the theory developed in (Ljung, 2006).

This chapter describes the combustion process control variables (CV's) and manipulated variables (MV's). An analysis of recorded process data when the process is controlled by today's controller, and step response analysis is presented. The purpose of this analysis is basically for obtaining a-priori information before a final test is performed. The chapter ends with a description on the final test and an analysis of the performed test. The obtained set of data from the final test, also called system identification test, could then be used to develop a model of the combustion process.

4.1 Combustion Process Knowledge

Before a system identification test could be performed as much process information as possible should be collected. The combustion process have been carefully described in Chapter 2. The next step is to describe the CV's and MV's to the combustion process and further analyze recorded process data. The datasets that were used for analyzing the process were recorded on the 23th of February 2011 between 7 am and 11 pm with a samplings frequency of 10 seconds. During these 16 hours the plant was running under normal operating conditions, controlled by todays control system. The obtained process information will be used further when designing the system identification test.

4.1.1 Analysis of the Control Variables

Two of the most important CV's in a combustion process (Leskens et al., 2005) are the amounts of O_2 in the flue gas and how much energy Q that has been produced by the combustion. Since the energy in the flue gas, as described in Chapter 3, has

not been considered used in the plant, Q measured in the boiler circuit will be used throughout this chapter.

O_2 in the Flue Gas

The flue gas from the combustion process is a mixture of primary and secondary air and gases from burning the waste. Sufficient amount of O_2 is needed to obtain a complete combustion. A complete combustion is when all the carbon present in the fuel is burned to CO_2 , all the hydrogen is burned to H_2O , all the sulfur is burned to SO_2 , and all other combustible elements are fully oxidized (Moran and Shapiro, 2004). O_2 is thus an important CV. O_2 is measured three places in the plant. The first meter is just after the flue gas leaves the furnace and is the one used in the control system today. This is also the most reliable measurement since it is closest to the combustion process and air leakage and transportation time is a minimum. Those other two O_2 meters are used to monitor the flue gas after the flue gas leaves the bag filter and leaves the scrubber. Figure 4.1 shows the measured O_2 . The large variance in O_2 after $t=4$ is basically caused by the variance in secondary air. Today's combustion controller could switch between regulating on O_2 or measured effect in the boiler circuit. When regulating on energy, the energy is optimized and O_2 is not a CV. To obtain an optimized energy production, primary and secondary air often needs to vary more. This usually results in a larger variation in O_2 .

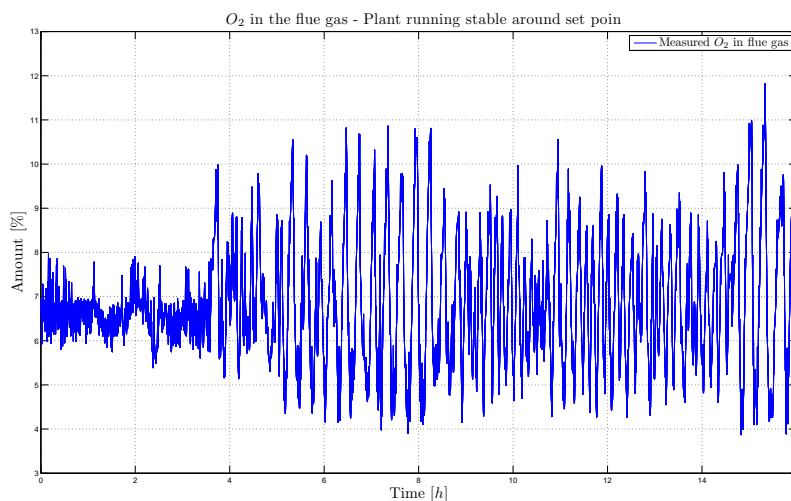

Figure 4.1: Measured O_2 in the flue gas

Important a-priori information for O_2 is;

- SP - 7 [%] based on experiance
- Measurement accuracy - The meter is calibrated each year
- Noise - The measurement is based on a 10 minutes mean value and the operators have not reported any faults

Measured Energy in the Boiler Circuit

The produced energy Q in the boiler circuit is today used to regulate the amount of heat in the combustion process. The main objective for the combustion plant is to burn as much waste as possible and at the same time stay within the flue gas emission limits. Haraldrud is designed to produce maximum 15 [MW] of hot water in the boiler circuit. The plant operators have reported that it is possible to produce more but this leads to unnecessary abrasion. Figure 4.2 shows the produced energy Q .

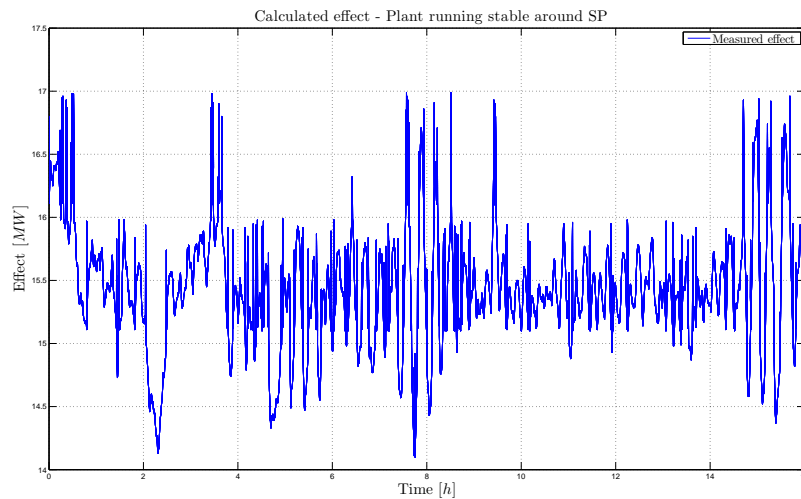

Figure 4.2: Measured effect in the boiler circuit

Important a priori information for Q is;

- SP - 15 [MW] which is what the boiler circuit is designed for
- Measurement accuracy - The calculation of produced energy is accurate and is calculated by Equation 2.2
- Noise - Measured energy in the boiler circuit is used to control the heat in the combustion process. This is a problem since the boiler circuit has its own control system which also has an influence on measured energy. As an example, the district heating system has a stronger influence on the boiler circuit then the combustion process. The boiler circuit must sometimes bypass some of the water to the district heating system so the boiler circuit is not cooled down.

Other times the boiler circuit must be cooled down with a cooling system since the district heating system do not need as much energy as provided. What is important to know is that the combustion process could be stable but measured energy is varying quite a lot because of the influence within the boiler circuit.

4.1.2 Analysis of the Manipulated Variables

In (Zhu, 2001) there are listed some rules for selecting the inputs for control purpose;

- The selected inputs (MV's) should have strong influence on (part of) the outputs (CV's) both in amplitudes and in wide frequency range
- Different inputs have essentially different effects on the output
- A reliable manipulation of the inputs must be possible
- Preferably, input-output relations are almost linear or linearizable
- When it is not clear if a variable should be included as an input for control, due to the lack of quantitative information, then use it in the identification stage. The discussion will later on be easier when a corresponding model is available

At Haraldrud there are three MV's. These are primary and secondary air which are the sources of oxidants to the combustion process and the amount of waste flow to the combustion.

Measured Primary and Secondary Air

Primary and secondary air is used to dry the waste and supply oxidants to the combustion. They have both strong influence on the CV's. Primary air has a slightly different influence than secondary air. Primary air is used in the regulation of the slow dynamic of the combustion process. The slow dynamic is the regulation of burning the waste to obtain SP for produced energy in the boiler circuit. Secondary air is used to both mix the flue gas for complete combustion and quickly handle smaller deviation in produced energy and O_2 , normally due to the variation in the calorific value, size, weight and density of the waste. Figure 4.3 shows the measured primary and secondary air.

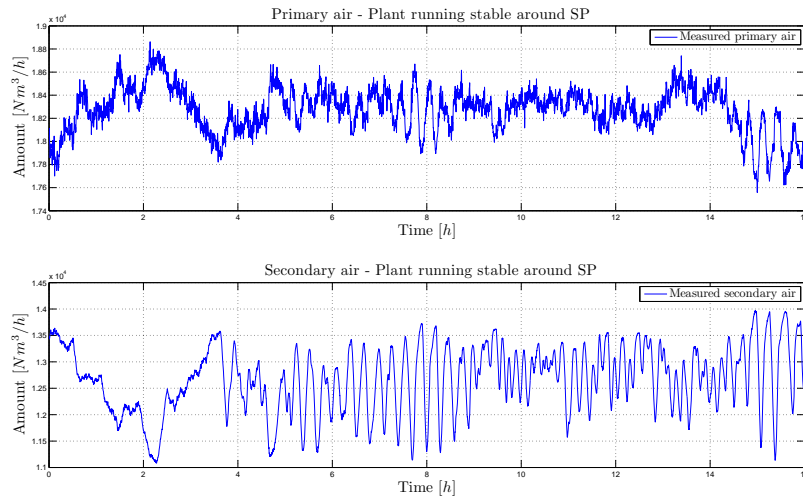

Figure 4.3: Measured primary and secondary air

Airflow Resistance in Zone 2

The amount of waste to the combustion process is the main MV and imposes a difficult control problem. This is due to unknown calorific value, size, weight and density of the waste. At Haraldrud the airflow resistance in Zone 2 is used to control the waste inlet flow as explained in Section 2.1.6. The idea is to control the height of the waste burning in Zone 2, so a stable SP for produced energy in the boiler circuit is obtained. If the waste flow was controlled by the feeding device the amount of waste where the combustion takes place would have been difficult to control. The reason is that the waste is not pushed continuously forward but sometimes pushed upwards or it falls backwards on the grate. Figure 4.4 shows the measured airflow resistance. The larger variance after $t=5$ is caused by switching from O_2 to energy regulation as explained in Section 4.1.1.

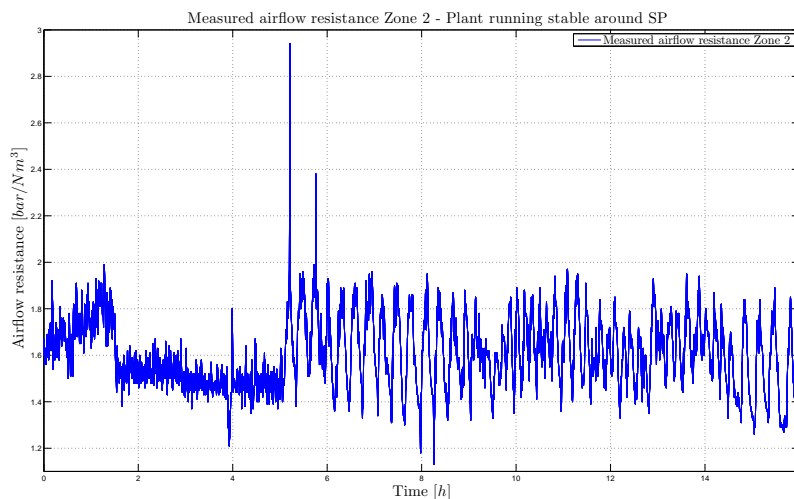

Figure 4.4: Measured airflow resistance Zone 2

4.1.3 Step Response Tests

The first tests that were performed on the process were steps on the airflow resistance in Zone 2, primary air and secondary air. The control feedback was turned off during the tests. A rule of thumb is to use an amplitude on the step around 10 to 15 % higher than during normal operating conditions (Zhu, 2001). It is important to have a stable process before the step is performed. The test is finished when the process has stabilized after the step. Further, when the step is performed it is also important not to smother the combustion and keep the environmental limits for the flue gas.

Theory is not always easy to put into practice. The results from the first steps were less informative. Mainly because of the combination between too little time between the steps and that the control feedback was turned on between each test. Plots of the first steps has not been included. New steps were performed on the system one week after the first steps. Figure 4.5 and 4.6 shows the measured input and output during all these three new tests. Figure 4.7 shows the measured temperature in the furnace and the grate temperature in Zone 1 and Zone 2.

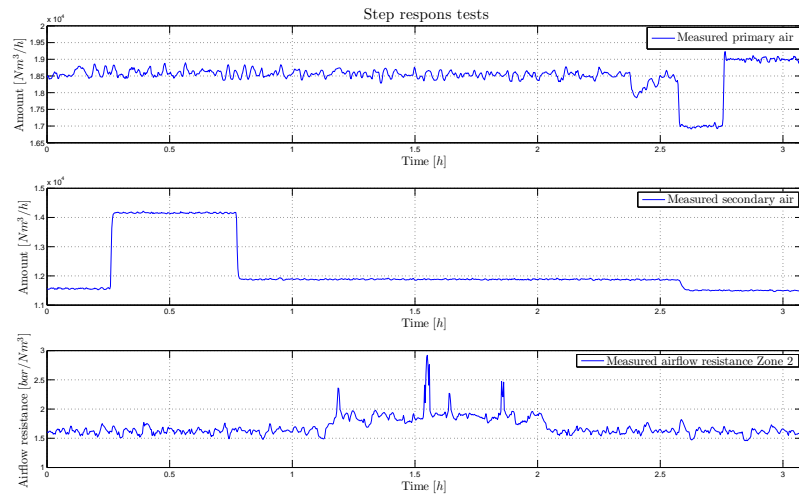

Figure 4.5: Measured inputs for the step response test

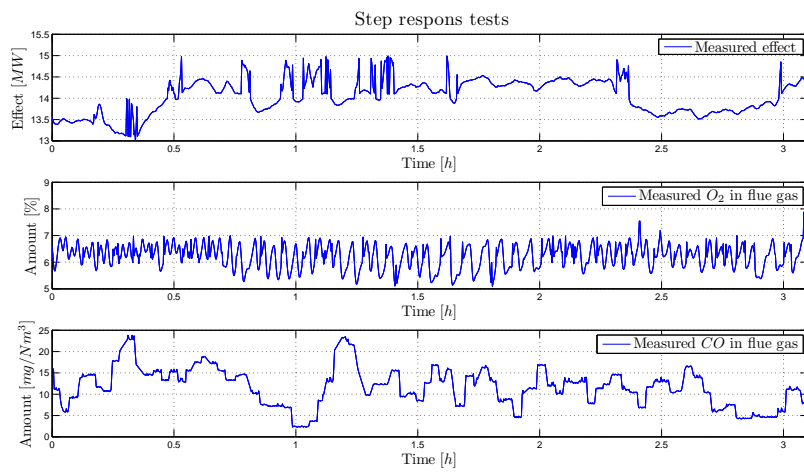

Figure 4.6: Measured outputs for the step response test

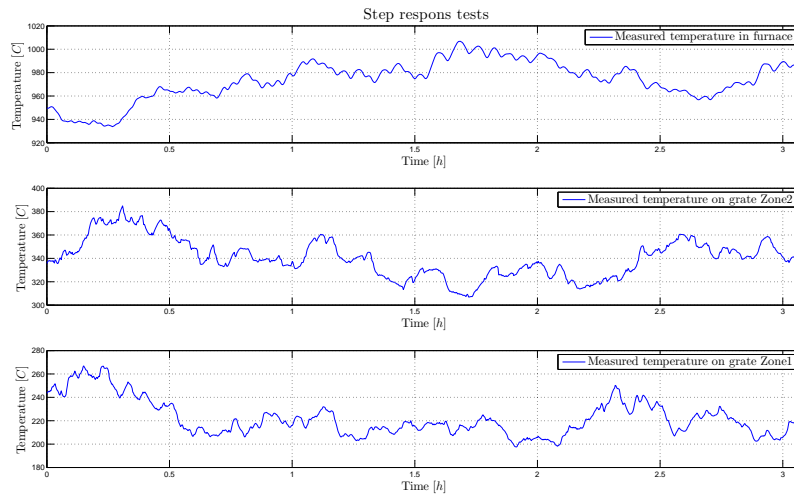

Figure 4.7: Measured temperature in the furnace and on the grate during the step response test

Step on Primary Air

When a step on primary air was performed, input for secondary air and airflow resistance in Zone 2 were a constant. Figure 4.8 shows that the measured secondary air was quite stable during the test but the measured airflow resistance in Zone 2 was not.

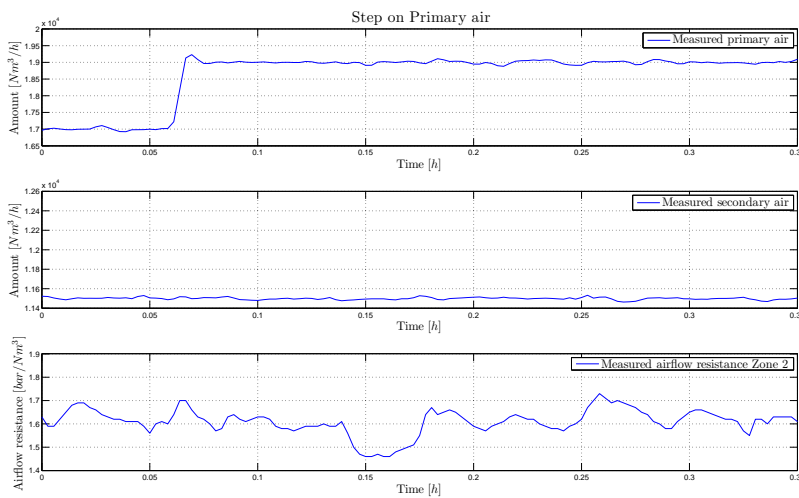

Figure 4.8: Measured inputs when step on primary air

The variation in airflow resistance in Zone 2 could be explained by looking at how the airflow resistance is calculated, Equation (2.1). Since the airflow resistance is calculated by the pressure over the grate and the airflow through Zone 2, the composition of the waste and the waste flow must be even for the airflow resistance to be even. This is not the case on the grate. The waste is far from even in both composition and density. As an example, when waste is pushed from Zone 1 to Zone 2 a large pile of waste can suddenly fall into Zone 2 and the airflow resistance will rise above SP. There is also a time delay for the waste to be transported from Zone 1 to Zone 2 which creates a disturbance. A test on the primary air fan found that $19000 [Nm^3/h]$ is the maximum amount of air that fan could deliver. And in consideration to not smother the combustion process, $17000 [Nm^3/h]$ were set as the lowest value. The lowest value might vary and depends on the type of waste and amount burning on the grate. A step from 17000 to $19000 [Nm^3/h]$ was performed on primary air which is an 11 % increase. Figure 4.9 shows the output result after a step on primary air. The step was applied at $t=0.06$.

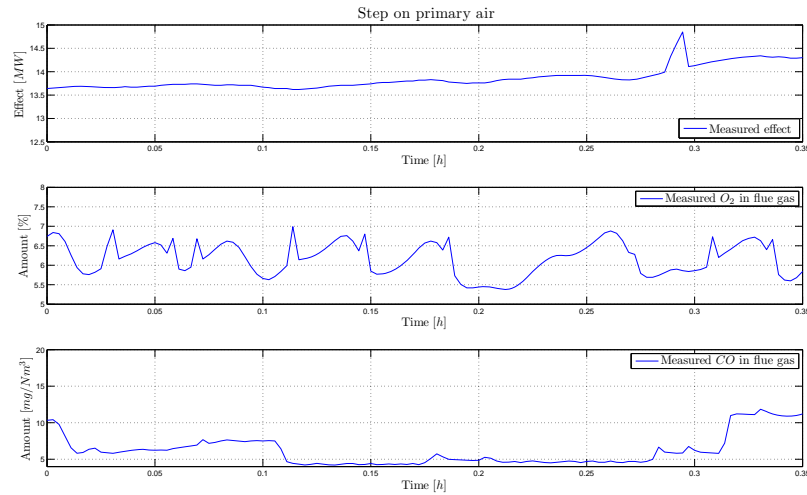

Figure 4.9: Measured outputs when step on primary air

Measured effect in the boiler circuit increased $0.8 [MW]$ as a first order function. There was no change in O_2 . The plant operators have reported that it is not always the case that the effect rises if primary air is increased. If the grate temperature in Zone 2 is low, primary air will instead cool down the process. The reason is that the primary air fans blows quite hard, and the air do not have time to react with the waste at the bottom of the pile in grate Zone 2. The combustion will then only happen at the top of the pile. It was a bit unexpected that there was no response in O_2 . This could be explained by looking at the amount of CO in the flue gas. If too much air is blown into the combustion process the air would have reacted with the carbon and the amount of CO would have increased quickly. Instead all the air is reacting with the combustion. The plant operators have reported that the

total amount of primary and secondary air has an impact on O_2 . An assumption is therefore to increase the amount of waste on the grate and perform another test. But this will increase both the amount of burned waste and produced energy in the boiler circuit. It has earlier been explained that the boiler circuit influence the calculation of the energy in the boiler circuit. The peak in measured energy in Figure 4.9 is a typical measurement that is not caused by the flue gas but within the boiler circuit.

Step on Secondary Air

The step in secondary air is from 11500 to 14200 $[Nm^3/h]$ which is a 23.5 % increase. Primary air and airflow resistance in Zone 2 was held constant during the test. Figure 4.10 shows that primary air varies more than secondary air did in the step test of primary air. The main reason for the variation in primary air is the variation in the pressure over the grate and will be further explained in Section 4.3.1.

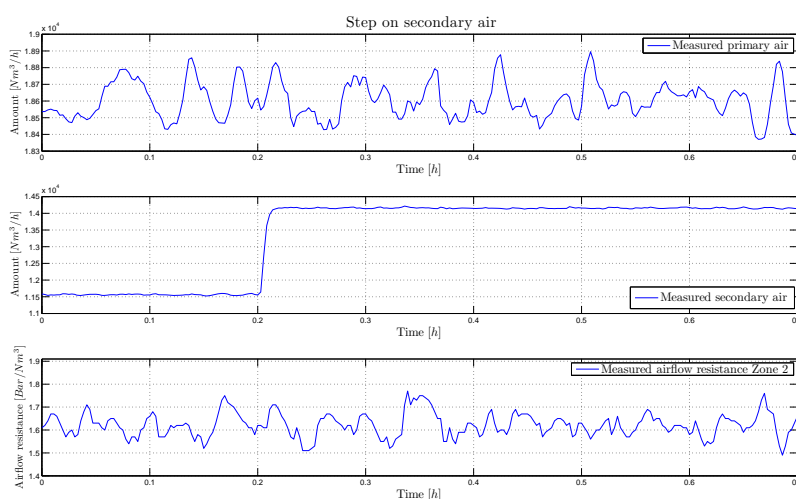

Figure 4.10: Measured inputs when step on secondary air

Figure 4.11 shows the outputs when a step on secondary air was applied at $t=0.2$. Measured effect in the boiler circuit goes up with about 1 $[MW]$ as a first order function. There was no change in O_2 .

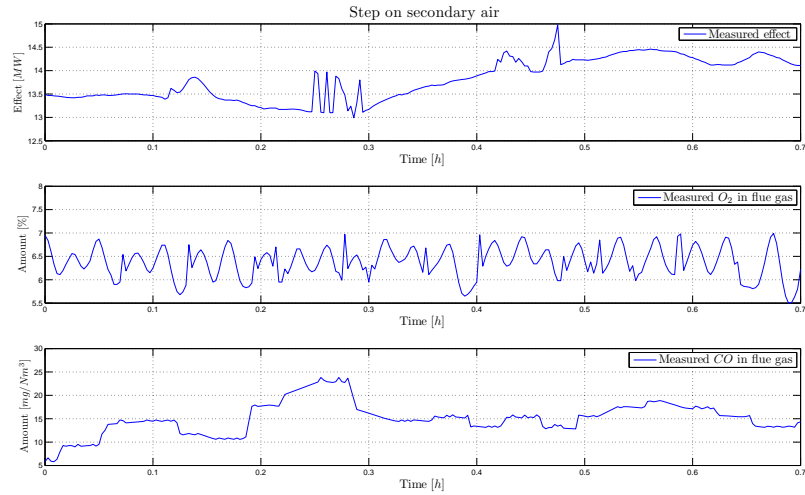

Figure 4.11: Measured output when step on secondary air

Figure 4.11 shows that the amount of CO rise from $17 \text{ mg}/Nm^3$ to $24 \text{ mg}/Nm^3$ than decreased and stabilized around $15 \text{ [mg}/Nm^3]$. This means that some of the air has not been used in the combustion and instead reacted with free carbons. It was unexpected, as it was for the step on primary air, that there was no response in O_2 . The plant engineers agree that the step in secondary air should be large enough to obtain a response in O_2 . By looking at the temperature in the furnace Figure 4.7, the temperature increase from around $935 \text{ }^\circ C$ to $960 \text{ }^\circ C$. The conclusion is therefore that some of the O_2 was converted to CO and the rest was used up in the combustion.

Step on Airflow Resistance in Zone 2

The step in the airflow resistance was from 1.5 to 1.9 [Bar/Nm^3]. Both primary and secondary air input was constant during the step. Figure 4.12 shows the measured input as the step takes place at $t=0.1$.

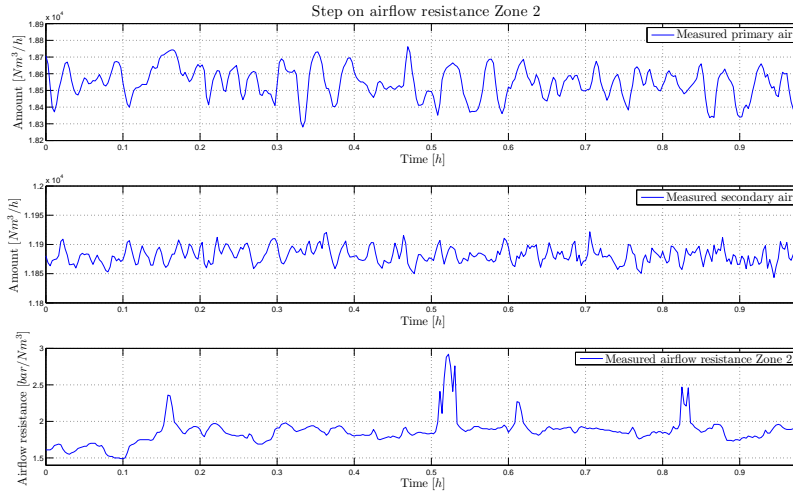

Figure 4.12: Measured input when step on airflow resistance in Zone 2

Figure 4.13 shows that the measured effect increases 0.5 [MW] and there is no response in the O_2 measurements. The amount of CO increased 20 [mg/Nm^3] and then decreased to the level before the step.

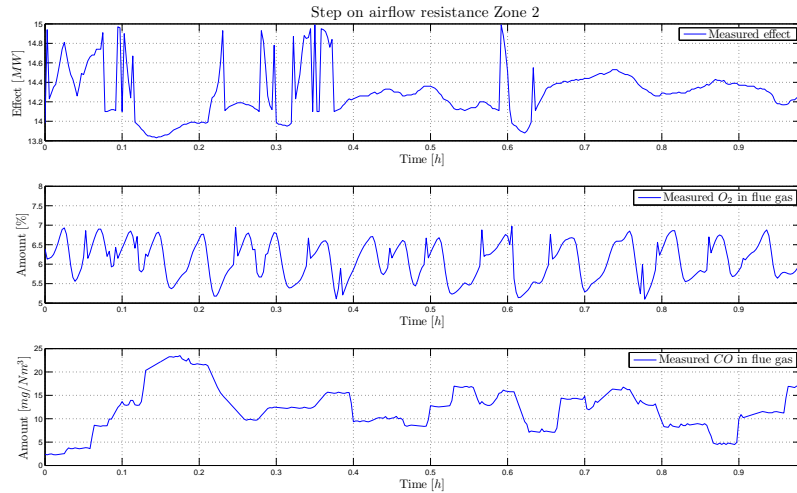

Figure 4.13: Measured output when step on airflow resistance in Zone 2

As mentioned before this is not a small test furnace in a laboratory but a live large combustion plant. It would have been informative to perform further testing, but each test is both costly and time consuming. There is specially one test result that would have been interesting to investigate further. This is the expected increase in O_2 when primary and secondary air was increased.

4.2 Designing the System Identification Test

The final test is the system identification test (Zhu, 2001). This test shall later be used to develop a model of the combustion process. Before the test was performed a document clarifying all the details around the test was sent to Haraldrud. It was off course important that the test gave a result which could be used later. But it was equally important that the test impacted in such a way that did not harm the plant or the environment. The flue gas can be quite toxic, and the test needed to be stopped if the level of CO exceeds $50 [mg/Nm^3]$, O_2 level becomes close to zero or the temperature in the furnace becomes lower or higher than $850\text{ }^\circ C$ and $1050\text{ }^\circ C$ respectively. All the tags listed in Section 2.2, and many more, are saved in a data-base. The values are saved for at least two years. This could be informative for future work.

4.2.1 Test Signal

To be able to use system identification described in (Ljung, 2006), (Zhu, 2001) and (Guidorzi, 2003) the test signal must be persistence of excitation (PE). This means that the signal must have large enough variance so that the connection between input and output is found. Another recommended requirement is that the signal has a low crest factor (Zhu, 2001). A signal $u(t)$ with zero mean value has a defined crest

factor as;

$$C_r = \sqrt{\frac{\max_t u^2(t)}{\lim_{n \rightarrow \infty} \frac{1}{N} \sum_{t=1}^N u(t)}} \quad (4.1)$$

One way to achieve a PE signal, is to choose $\mathbf{u}(t)$ as a sum of sinusoids. Another reason to choose sinusoids is that the average production often not changes, preferably only short-term changes will occur.

$$u(t) = \sum_{j=1}^m a_j \sin(\omega_j t + \phi_j) \quad 0 < \omega_1 < \dots < \omega_m < \pi \quad (4.2)$$

- a_j - Peak amplitude (nonnegative)
- ω_j - Radian frequency $[\frac{rad}{sec}] = 2\pi f$
- ϕ_j - Initial phase [radians]
- t - Time [s]
- f - Frequency [Hz]
- m - Number of sinusoids

If the amplitude and phase is the same, the crest factor becomes $C_r = \sqrt{2m}$. This means that the crest factor will become high if the numbers of sinusoids are high. The crest factor can be reduced by choosing unequal phases. One way of minimize the crest factor is to follow Schroeder phase optimization algorithm (Zhu, 2001).

$$\rho_1 = \text{arbitrary} \quad (4.3)$$

$$\rho_j = \rho_1 - \frac{j(j-1)}{m} \quad 2 \leq j \leq m \quad (4.4)$$

To achieve good noise reduction the numbers of sinusoids should be larger than the model that shall be developed. The idea is to develop a second order model of the combustion process. The chosen numbers of sinusoids to sum together is six.

4.2.2 Test Signal for Primary Air

Table 4.1 shows the values for the sinusoids generating the test signal for primary air.

Signal	Frequency [Hz]	Amplitude	Phase [Deg]
Signal 1	0,00174	600	1
Signal 2	0,00233	600	-0,5708
Signal 3	0,00299	600	-3,7124
Signal 4	0,00419	600	-8,4248
Signal 5	0,00689	600	-14,7080
Signal 6	0,0209	600	-22,5619

Table 4.1: Sinusoids for the test signal

Figure 4.14 shows the generated test signal for primary air.

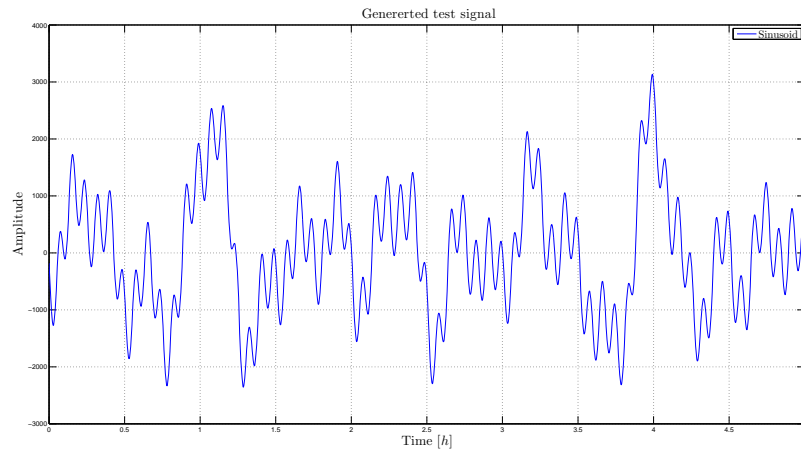

Figure 4.14: Test signal for primary air

From the step response test, the conclusion was that the air fan could deliver a maximum of $19.000 [Nm^3/h]$ of primary air. It was concluded with that the internal control of the primary air had a slow response, so the test signal should regulate on the air fan revolution per minute (rpm). A test was performed to see which rpm values corresponded to the desired amount of air. Further, a 15 minute test was performed to see if the measured primary air followed the desired amount.

4.2.3 Test Signal for Secondary Air and Airflow Resistance in Zone 2

The same procedure as for primary air was performed on primary air and airflow resistance in Zone 2. The amplitude for the test signal to secondary air was the same as for primary air. The amplitude for the test signal to the airflow resistance in Zone 2 was max 1.9 and min 1.2.

4.3 Open-Loop System Identification Test

In many plants the feedback controller cannot be turned off since the process is unstable or the process must stay within certain boundaries (Zhu, 2001). At Haraldrud the plant operators have long experience running the plant manually since the controller today do not work sufficiently. Because of this experience and the robustness of the process it was possible to perform the sinus tests in open loop. Three tests where performed, one on each MV. Since the numbers of inputs are small the test time could be 5 to 8 times the longest settling time (Zhu, 2001). From previous analysis, the longest settling time is the response of the produced energy in the boiler circuit which is around 30 minutes. Total length on each test should therefore be at least

four hours. During a test of one MV the other MV's has constant values. Before the test was started the combustion process was running stable. It was controlled by todays controller and was used as a starting point for the test.

4.3.1 Test signal on Primary Air

Figure 4.15 shows the rpm on the primary air fan and the measured primary air.

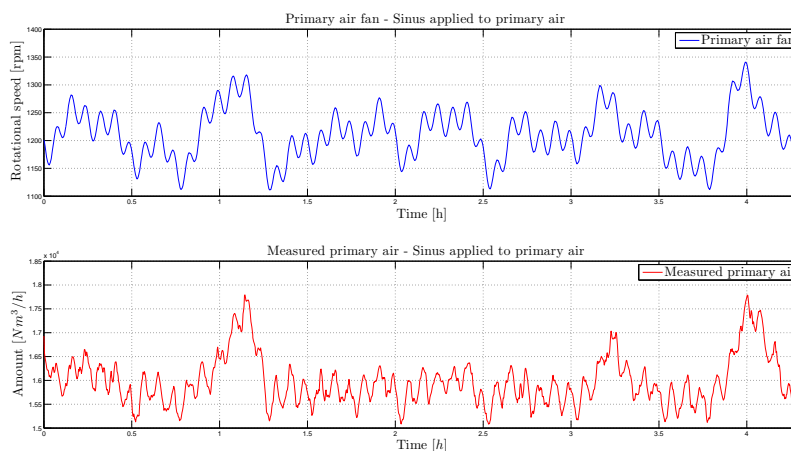

Figure 4.15: System identification - Signal on primary air - primary air and SP primary air

Figure 4.15 shows that the measured primary air did not follow the SP. Figure 2.6 in Chapter 2 shows that before the primary air reach the furnace the air needs to pass three heat batteries, the valves to the zones and the waste on the grate. The conditions for the primary air fan are therefore never the same, mainly because of the variance in pressure. Example, if 1200 rpm is measured to give an air flow of 16.000 $[Nm^3/h]$ this might not be the same one hour later since the pressure can then be different. It would probably be better, even though the regulator to the primary air fan was found out to be very slow, to use the regulator of the primary air to control the air flow. The plant engineers have also reported that the pipes for the primary air are old and not aerodynamic. Figure 4.16 shows the measured secondary air and the measured airflow resistance in Zone 2. Both of them had constant SP's.

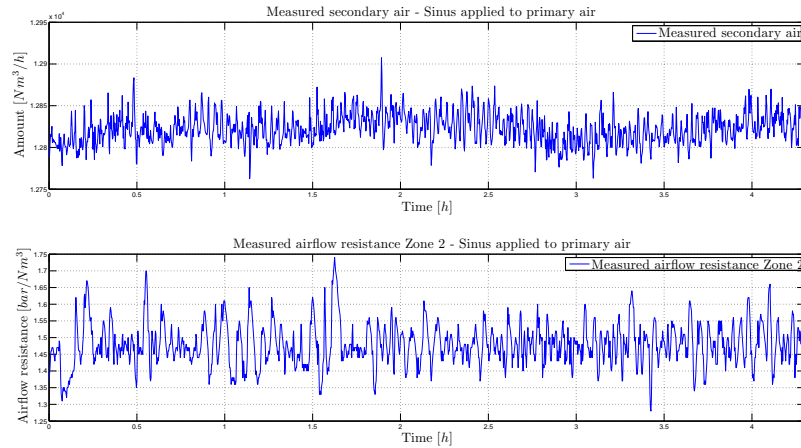

Figure 4.16: System identification- Signal on primary air - Secondary air and airflow resistance Zone 2

Figure 4.17 shows the measured outputs during the test on primary air. Measured effect is decreasing from 16 [MW] to 14.2 [MW]. The main reason for the decrease in the effect is the variation in the calorific value to the waste. It is not possible to find an airflow resistance which gives a constant effect since the calorific value to the waste variates. A constant airflow resistance gives almost a constant waste flow but the calorific value will always variates. The amount of O_2 is quite constant but the amount of CO have a peak just after one hour. This is also at the time the primary air have a peak. After four hours, there are no peak in CO when primary air is increased. This is an example that the conditions in the furnace gives different responses.

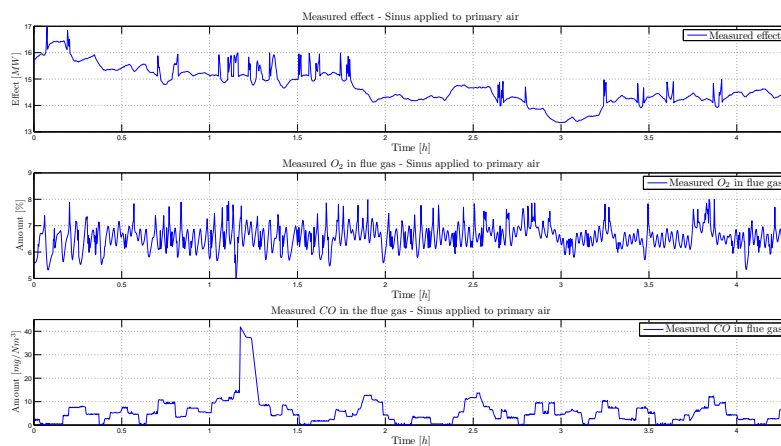

Figure 4.17: System identification- Signal on primary air - Outputs

4.3.2 Test Signal on Secondary Air

Figure 4.18 shows the test on secondary air. Primary air and airflow resistance in Zone 2 was held constant. The measured secondary air followed the test signal as it should. The airflow resistance was increased a bit compared to the primary air test, to avoid the drop in effect caused by too little waste on the grate.

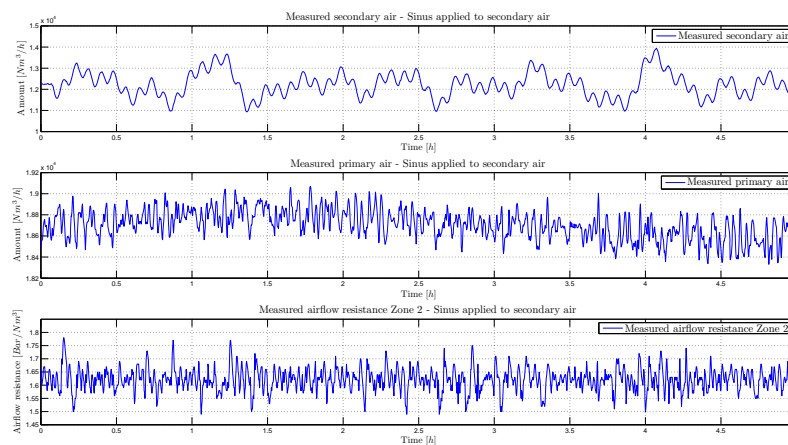

Figure 4.18: System identification- Signal on secondary air - Input

Figure 4.19 shows the measured outputs during the test on secondary air. The figure shows that both effect and **CO** respond to the changes in secondary air. Measured effect and **CO** goes up when secondary air is increased. **O₂** is quite constant.

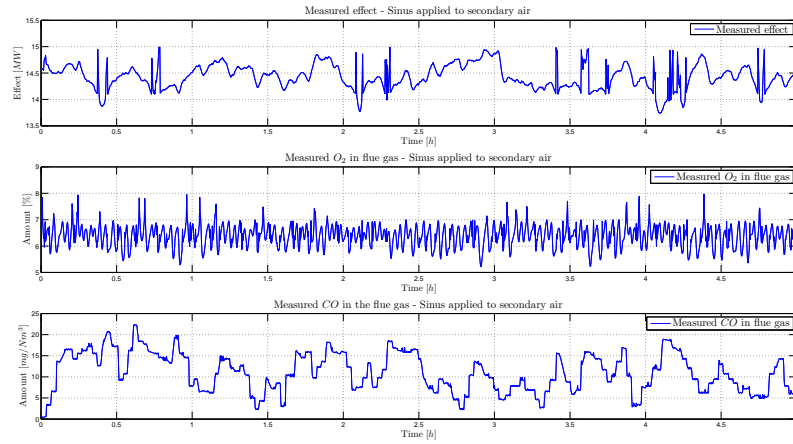

Figure 4.19: System identification- Signal on secondary air - Output

4.3.3 Test Signal on Airflow Resistance in Zone 2

Without the waste it would not have been any combustion. As Figure 4.20 shows, the measured airflow resistance followed the SP quite well. Keep in mind that the wide-range of waste and how the waste is pushed forward on the grate disturbers the airflow resistance as explained earlier in this chapter.

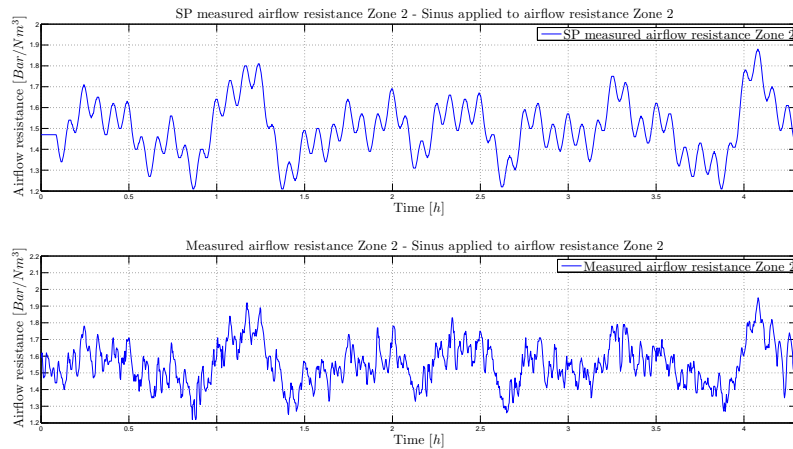

Figure 4.20: System identification- Signal on airflow resistance Zone 2 - Airflow resistance and SP airflow resistance Zone 2

Figure 4.21 shows the measured outputs during the test on airflow resistance in Zone 2. The measured effect followed the airflow resistance quite clearly. An increase

in the airflow resistance was followed by an increase in measured effect. The figure also shows that the amount of CO decrease and O_2 increase when there is a drop in the airflow resistance.

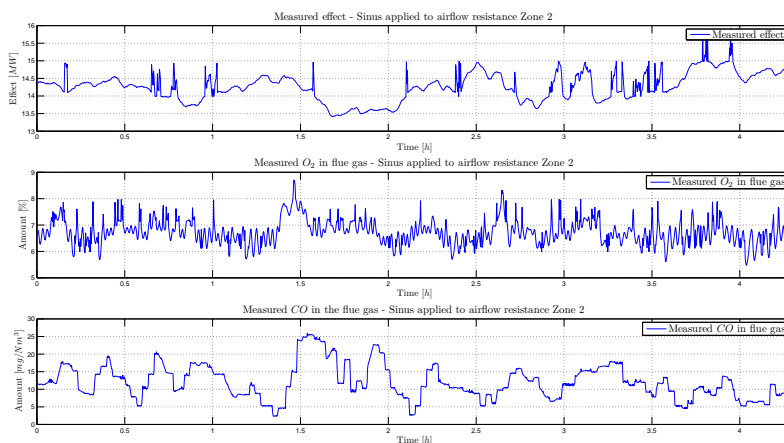

Figure 4.21: System identification- Signal on airflow resistance Zone 2 - Output

Figure 4.21 shows the measured primary and secondary air during the test on airflow resistance in Zone 2. Both of them were set constant.

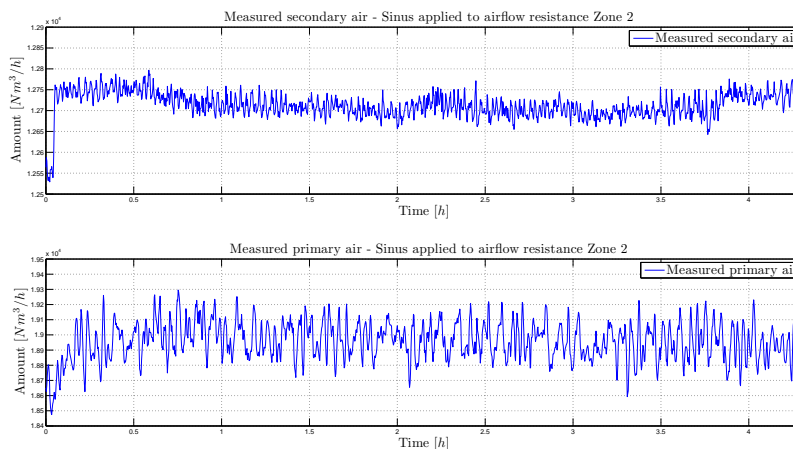

Figure 4.22: System identification- Signal on airflow resistance Zone 2 - Primary and secondary air

4.4 Chapter Summary

This chapter has described the MV's and CV's to the combustion process. The MV's to the combustion process are primary air, secondary air and airflow resistance in Zone 2. The CV's are O_2 and measured effect in the boiler circuit Q . A discussion on three different step response tests respectively on primary air, secondary air and airflow resistance in Zone 2 have been presented. Sinus tests were designed and performed to obtain datasets which can be used with system identification theory to develop a model of the combustion process, this model is presented in Chapter 5.

The tests performed in this chapter showed that the type of waste and temperature in the furnace influence the test results. This influence makes it more difficult to predict a model based on measurements. Example, if two steps are performed on secondary air on different days, the results might not be the same. It depends on the type of waste and the temperature on the grate and in the furnace. Some conclusions could be drawn based on the tests and discussions with the plant operators;

- Measured effect in the boiler circuit could be controlled with the airflow resistance in Zone 2, if the amount of O_2 is around SP and the temperature on the grate and in the furnaces is high enough.
- With an increase in primary or secondary air, the measured energy in the boiler circuit will increase if there is high enough temperature in the furnace and on the grate. But this is only temporarily. To hold this increase correct waste flow is needed. The calorific value of the waste will also make a large impact.
- If primary or secondary air is increased the amount of CO will increase if the air is not reacting with the combustion
- The combustion process is quite robust. When the process runs around SP, quite a lot of disturbance on the MV's will still not make the process unstable. But the disturbances on the system is large, specially from the variation in the calorific value, and causes a large variation in the outputs.

Chapter 5

Model of the Combustion Process Based on System Identification

There are typically two different methods to obtain a mathematical model of a physical system (Guidorzi, 2003). These are classified into physical modeling and identification. Physical modeling is a description based on known physical laws like Newton's second law. This approach requires a general knowledge of the system and of the laws describing their behavior. The advantage is the use of a-priori information which gives a physical meaning to the model parameters, when constructing the model. Identification is only based on measured process data. The identified model parameters may lack of any physical meaning. But the models are simple, accurate and can be extracted from complex framework. It is also quite often that physical laws have been obtained as a result of identification procedures (Guidorzi, 2003).

In (Leskens et al., 2000) system identification was used to develop a MIMO autoregressive with eXogeneous (ARX) model of a MSW combustion process. According to system identification validation measures, the model was good and used to validate a first principle model. This validation showed that most of the dynamics of the MSW incinerator was incorporated well in the first principle model. If modeling of Haraldrud MSW combustion process is developed from physical laws or identified by measured process data should therefore be the same.

In Chapters 4 the combustion process was manipulated and data from the process was analyzed. Different tests was applied to the process with the aim of obtaining data-sets which could be used with system identification theory. This chapter describes how to pre-treat the data-sets before it is used in a system identification. Further, presents the theory for developing a model based on measured process data. The chapter ends with a modeling discussion.

5.1 Pre-Treatment of the Obtained Data

Before the obtained data-sets could be used in identification, the data must be filtered and bad measurements must be removed (Zhu, 2001). When filtering, noise and dynamic which is not necessary to include in the model is removed. Example, the

amount of O_2 is regulated by the primary and secondary air which is controlled by air fans. It is therefore not possible to regulate on O_2 faster than the fans can respond. It should also be considered how much the fans should be used for compensating the variation in O_2 . This is important since the fans are powered by an engine where minimum change in rpm increases the life span. The datasets were filtered with a 10th order Butterworth filter. The order of the filter was chosen by plotting different order and comparing the filtered data against the original measurements in a plot. The chosen cutoff frequencies are based on a-priori information, and by comparing filtered and original data in a plot. The cutoff frequencies are presented in Table 5.1.

Type of measurement	Cutoff frequency [Hz]
Effect in boiler circuit	0,0055
O_2 in the flue gas	0,0083
Primary air	0,016
Secondary air	0,016
Airflow resistance Zone 2	0,0055

Table 5.1: Cutoff filter frequencies

Figure 5.1 and 5.2 shows an example of measured and filtered CV's and MV's. The filtered process data used as an example is the first 5 hours of the same data-set that was used in the analyze in Section 4.1.

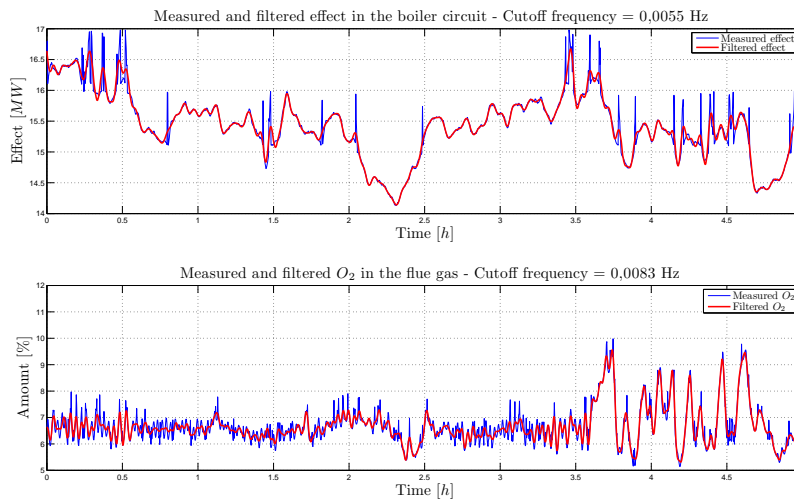

Figure 5.1: Measured and filtered effect in the boiler circuit

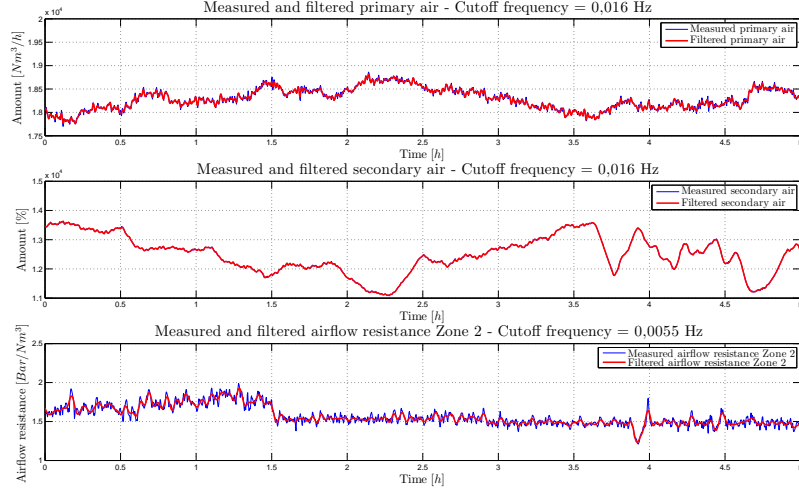

Figure 5.2: Measured and filtered primary air, secondary air and airflow resistance in Zone 2

5.2 Theory for Developing a Model with System Identification

MIMO equation error models can be defined as (Guidorzi, 2003);

$$y(t) = A_\mu y(t-1) + \dots + A_1 y(t-\mu) + B_\mu u(t-1) + \dots + B_1 u(t-\mu) + e(t) \quad (5.1)$$

where $u(t) \in \mathfrak{R}^r$ and $y(t) \in \mathfrak{R}^m$ are the input and output vectors, A_i and B_i are real $(m \times m)$ and $(m \times r)$ matrices and $e(t) \in \mathfrak{R}^m$ is the equation error. Denoting with α_{ijk} and β_{ijk} the entries of A_i and B_i ,

$$A_i = [\alpha_{ijk}] \quad (j, k = 1, \dots, m) \quad (5.2)$$

$$B_i = [\beta_{ijk}] \quad (j = 1, \dots, m), (k = 1, \dots, r) \quad (5.3)$$

model (5.1) can also be written in the forms

$$y_i(t) = \sum_{j=1}^m \sum_{k=1}^{\mu} \alpha_{ijk} y_j(t+k-\mu-1) \quad (5.4)$$

$$+ \sum_{j=1}^r \sum_{k=1}^{\mu} \beta_{ijk} u_j(t+k-\mu-1) + e_i(t) \quad (i = 1, \dots, m) \quad (5.5)$$

$$A(z^{-1})y(t) = B(z^{-1})u(t) + e(t) \quad (5.6)$$

where

$$A(z^{-1}) = [q_{ij}(z^{-1})] = I - A_\mu z^{-1} - \dots - A_1 z^{-\mu} \quad (5.7)$$

$$B(z^{-1}) = [p_{ij}(z^{-1})] = B_\mu z^{-1} - \dots - B_1 z^{-\mu} \quad (5.8)$$

and I is the unity matrix.

5.2.1 MIMO ARX Model

ARX models are the most simple member of the equation error family (Guidorzi, 2003).

$$y_1 = A_n y(t-1) + \dots + A_1 y(t-n) + B_n u(t-1) + B_n u(t-1) + e(t) \quad (5.9)$$

where $e(\cdot)$ is a stochastic white process with null expected value, $\mathbf{E}[e(t)] = 0$, that is assumed as independent of the input sequence $\mathbf{u}(\cdot)$. The integer n defines the order and the memory of the model. When identifying a real process the only available information is the recorded input-output sequences. Estimation of a suitable model order consists of tests, allowing a comparison between different model orders (Guidorzi, 2003).

A first order MIMO ARX model of the combustion process can be described as;

$$\begin{bmatrix} y_1(t) \\ y_2(t) \end{bmatrix} = \begin{bmatrix} a_1 & a_2 \\ a_3 & a_4 \end{bmatrix} \begin{bmatrix} -y_1(t-1) \\ -y_2(t-1) \end{bmatrix} + \begin{bmatrix} b_1 & b_2 & b_3 \\ b_4 & b_5 & b_6 \end{bmatrix} \begin{bmatrix} u_1(t-1) \\ u_2(t-1) \\ u_3(t-1) \end{bmatrix} + e(t) \quad (5.10)$$

- y_1 - Produced energy in the boiler circuit
- y_2 - O_2 in the flue gas
- u_1 - Measured primary air
- u_2 - Measured secondary air
- u_3 - Measured airflow resistance in Zone 2

Before the unknown parameters in the MIMO ARX model could be estimated the model must be parameterized. In a MIMO model $\mathbf{y}(t)$ and $\mathbf{u}(t)$ are vectors and the model can not be parameterized in the same way as a single input single output (SISO) system. Instead a Kronecker product¹ \otimes is used (Ljung, 2006). Equation 5.10 can be written as;

$$y(t) = \phi^T(t)\theta^* + e(t) \quad (5.11)$$

where

$$\theta^* = \begin{bmatrix} a_1 \\ a_2 \\ a_3 \\ a_4 \\ b_1 \\ b_2 \\ b_3 \\ b_4 \\ b_5 \\ b_6 \end{bmatrix} \quad (5.12)$$

¹The Kronecker product is defined in Appendix A.1

and

$$\phi(t) = \begin{bmatrix} -y_1(t-1) \\ -y_2(t-1) \\ u_1(t-1) \\ u_2(t-1) \\ u_3(t-1) \end{bmatrix} \otimes I_p = \begin{bmatrix} -y_1(t-1) \\ -y_2(t-1) \\ u_1(t-1) \\ u_2(t-1) \\ u_3(t-1) \end{bmatrix} \begin{bmatrix} \begin{bmatrix} 1 & 0 \\ 0 & 1 \end{bmatrix} \\ \begin{bmatrix} 1 & 0 \\ 0 & 1 \end{bmatrix} \\ \begin{bmatrix} 1 & 0 \\ 0 & 1 \end{bmatrix} \\ \begin{bmatrix} 1 & 0 \\ 0 & 1 \end{bmatrix} \\ \begin{bmatrix} 1 & 0 \\ 0 & 1 \end{bmatrix} \end{bmatrix} \quad (5.13)$$

where I_p is the identity matrix and p is the number of outputs.

The Least-square technique is a mathematical procedure by which the unknown parameters of a mathematical model are estimated such that the sum of the squares of some chosen error is minimized (Zhu, 2001). The estimated model can be described as;

$$\hat{y} = \phi^T(t)\theta \quad (5.14)$$

Introducing a prediction error $\epsilon(t)$, and let

$$\epsilon(t) = y(t) - \hat{y}(t) = y(t) - \phi^T(t)\theta \quad (5.15)$$

Now we will choose θ such that the criterion

$$V_{LS}(\theta) = \frac{1}{2N} \sum_{t=1}^N \epsilon(t)^2 = \frac{1}{2N} \sum_{t=1}^N |y(t) - \phi^T(t)\theta|^2 \quad (5.16)$$

is minimized. Taking the first derivative of $V_{LS}(\theta)$ with respect to θ and equating the result to zero, the least squares method is described as;

$$\hat{\theta}_N^{LS} = \left[\frac{1}{N} \sum_{t=1}^N \phi(t)\phi^T(t) \right]^{-1} \frac{1}{N} \sum_{t=1}^N \phi(t)y(t) \quad (5.17)$$

The validation of a model consists in validating its capability to describe the process that has generated the data in a way compatible with its plan (Guidorzi, 2003).

5.3 Simulating the MIMO ARX Model Based on System Identification

Matlab have developed an additional toolbox named System Identification based on the theory in (Ljung, 2006). This toolbox includes both a graphical user interface (GUI) and function blocks to both estimate and validate equation error models. Figure 5.3 shows the GUI.

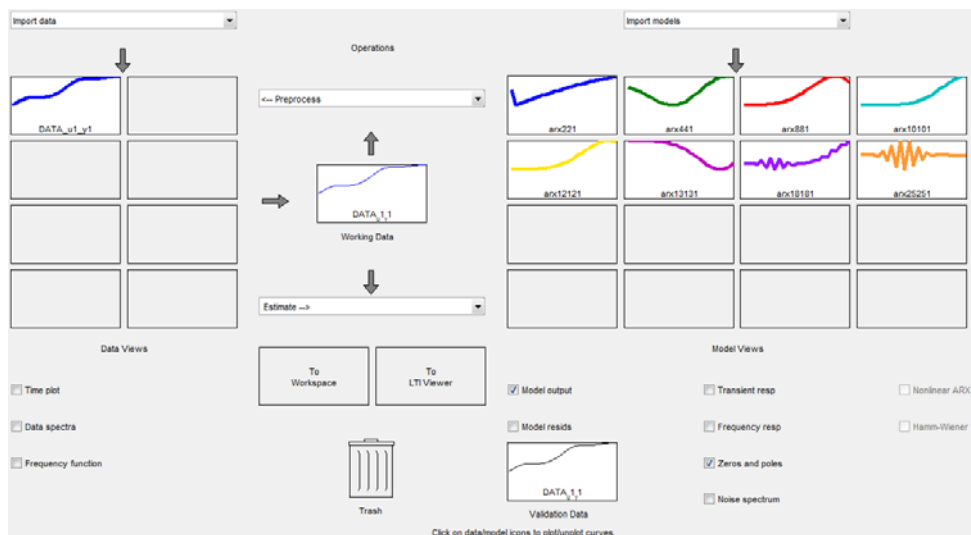

Figure 5.3: GUI interface for system identification toolbox

In the GUI different types of models and orders could be estimated. The model outputs are compared against original data-sets and poles, zeros and frequency responses could easily be analyzed. There is also a function which estimates the parameters so a stable model is obtained. In Section 4.3, three different tests was applied to the combustion process respectively on primary air, secondary air and airflow resistance in Zone 2. The three data-sets from the tests was then used to develop six 12th order models. The order of the models was chosen by comparing the output results, as Figure 5.4 shows.

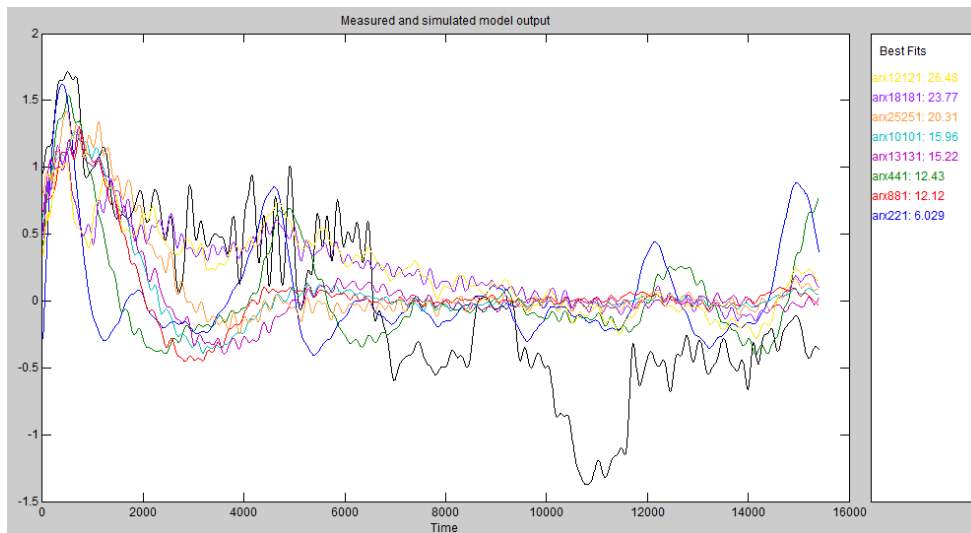

Figure 5.4: Measured and simulated model output

Figure 5.4 shows that the best fit for a model between primary air and energy in the boiler circuit is a 12th order model. Order of ARX models in literature ranging from 10 to 50 are found (Leskens et al., 2000). Figure 5.5 shows the structure of the six models and the final MSW combustion model.

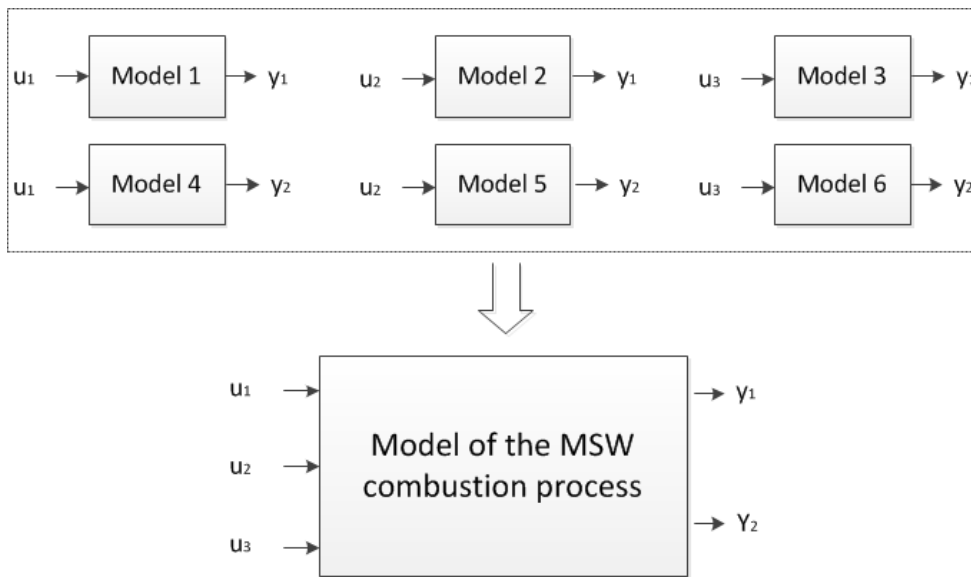

Figure 5.5: Structure of the MSW combustion model

Figure 5.6 compares the estimated and measured energy in the boiler circuit during a time period of 24 hours. The data-set that was used to verify the model was recorded 7th of April 2011.

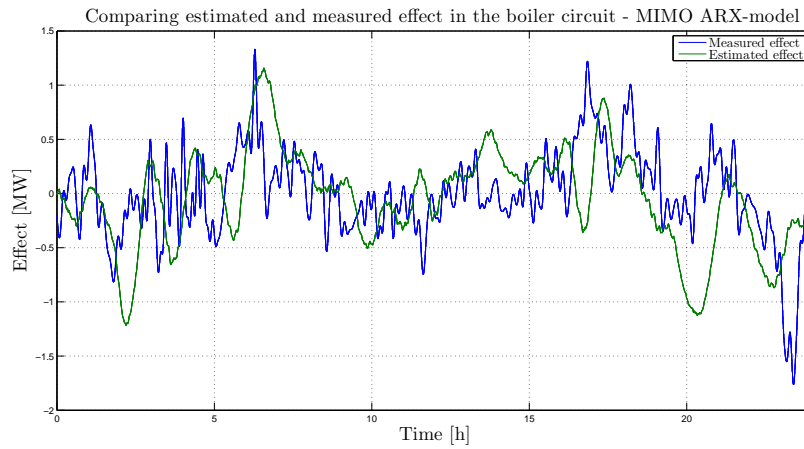

Figure 5.6: Comparing estimated and measured effect - MIMO ARX model estimated from sinus tests

Figure 5.7 compares the estimated and measured O_2 in the flue gas.

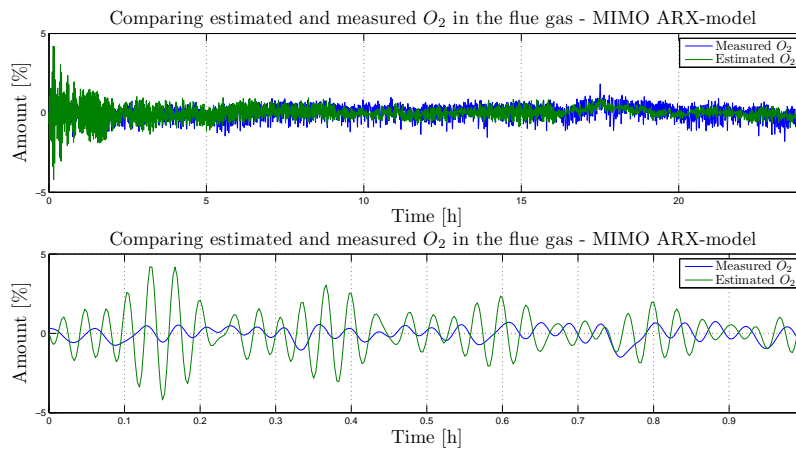

Figure 5.7: Comparing estimated and measured O_2 - MIMO ARX model estimated from sinus tests

5.4 Discussion on the Simulated MIMO ARX Model

Figure 5.6 and 5.7 shows that the estimated are not following the measured energy very well. More research could improve the model, but the question is; are the data-sets from the open-loop sinus tests suitable for estimating a better model? In (Leskens et al., 2000) a MIMO ARX model was estimated based on system identification theory. But the data-sets that were used to estimate the model parameters was based on closed-loop identification. (Leskens et al., 2000) also concludes that the disturbances acting on the MSW incinerator is large, so a closed-loop identification is necessary in order to obtain a good model of the process. Even when the process is regulated by todays controller the process variation is quite large, as explained in Chapter 4. A conclusion is therefore that the disturbances from the process makes it difficult to obtain a good model based on open-loop identification.

In closed-lopped identification, estimating the model directly from the input and output data $\mathbf{y}(t)$ and $\mathbf{u}(t)$ may result in a biased model. In order to prevent this bias a specific closed-loop identification method called the two-stage method could be used (Leskens et al., 2000). Further research is needed to develop a model based on the two stage method. But a model have been estimated directly from the data-set used to analyze the combustion process, Section 4.1. The data-set that was used to verify the MIMO ARX model in Section 5.3 is also used now. Figure 5.8 compares the estimated and mesured primary air.

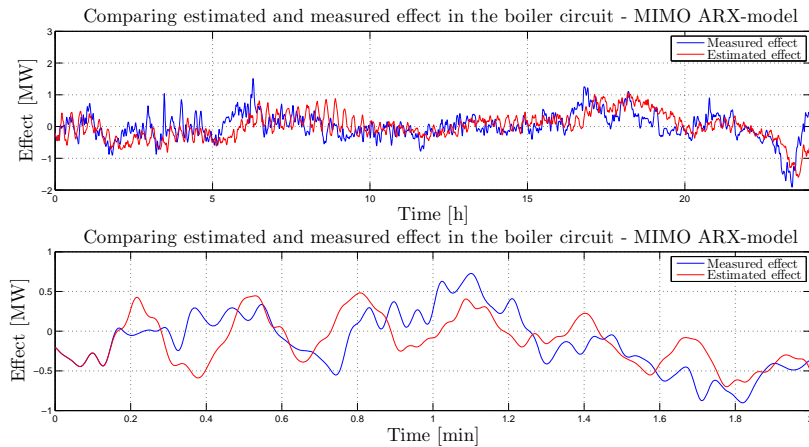

Figure 5.8: Comparing estimated and measured effect of a 30th order MIMO ARX model

Figure 5.8 shows that the estimated energy follows the measured much better then in Figure 5.6. The model order is higher, but still with a 12th order model the estimated followed the measured better. Further research should be based on closed-loop identification.

Chapter 6

On-line Parameter Estimation with an Adaptive Law

Adaptive control is the combination of a parameter estimator, which generates parameter estimates on-line, with a control law in order to control classes of plants whose parameters are completely unknown and/or could change with time in an unpredictable manner (Ioannou and Fidan, 2006). When combining the parameter estimator, with a control law, two different approaches are used. These are referred to as *indirect* and *direct* adaptive control structure. In the indirect approach, the plant parameters are estimated on-line and used to calculate the controller parameters. In the direct adaptive control structure, the plant model is parameterized in terms of the desired controller parameters, which are then estimated directly without intermediate calculations involving plant parameter estimates. Figure 6.1 illustrates these approaches.

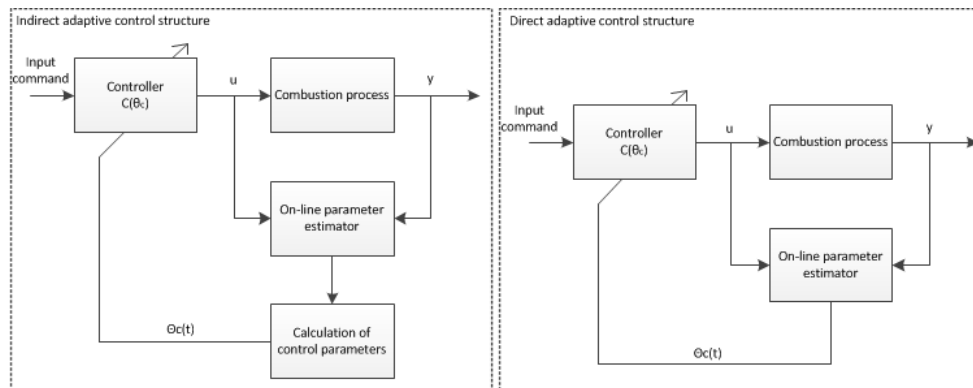

Figure 6.1: Direct and indirect adaptive control structure

In this chapter a parametric model and the adaptive law for estimating the unknown parameters on-line is presented. Also the adaptive law have been simulated in Matlab (R2010b) based on recorded process data from the combustion process at Haraldrud.

6.1 Parametric Model and the Adaptive Law

Autoregressive moving average (ARMA) is one parametric model that can be used to describe the combustion process. The model is based on previous recorded measurements and with the use of an adaptive law the model parameters could be estimated on-line. A second order ARMA model for the combustion process could be presented as;

$$\begin{bmatrix} y_1(k) \\ y_2(k) \end{bmatrix} = \begin{bmatrix} -a_1 y_1(k-1) - a_2 y_1(k-2) + B_1 \begin{bmatrix} u_1(k-1) \\ u_2(k-1) \\ u_3(k-1) \end{bmatrix} \\ -a_3 y_1(k-1) - a_4 y_1(k-2) + B_3 \begin{bmatrix} u_1(k-1) \\ u_2(k-1) \\ u_3(k-1) \end{bmatrix} \end{bmatrix} + \begin{bmatrix} B_2 \begin{bmatrix} u_1(k-2) \\ u_2(k-2) \\ u_3(k-2) \end{bmatrix} \\ B_4 \begin{bmatrix} u_1(k-2) \\ u_2(k-2) \\ u_3(k-2) \end{bmatrix} \end{bmatrix} \quad (6.1)$$

- y_1 - Produced energy in the boiler circuit
- y_2 - O_2 in the flue gas
- u_1 - Measured primary air
- u_2 - Measured secondary air
- u_3 - Measured airflow resistance in Zone 2

where

$$\begin{aligned} B_1 &= [b_1 \ b_2 \ b_3] \\ B_2 &= [b_4 \ b_5 \ b_6] \\ B_3 &= [b_7 \ b_8 \ b_9] \\ B_4 &= [b_{10} \ b_{11} \ b_{12}] \end{aligned}$$

In order to find the unknown parameters in Equation 6.1 with an adaptive law the model must be parameterized (Ioannou and Fidan, 2006). Equation 6.1 can be written on the form;

$$\begin{aligned} z(k) &= \theta^{*T} \phi \\ z(k) &= \begin{bmatrix} y_1(k) \\ y_2(k) \end{bmatrix} = \begin{bmatrix} \theta_{\text{effect}}^{*T} \phi_{\text{effect}} \\ \theta_{O_2}^{*T} \phi_{O_2} \end{bmatrix} \end{aligned} \quad (6.2)$$

where

$$\begin{aligned} \theta_{\text{effect}}^* &= [a_1 \ a_2 \ b_1 \ b_2 \ b_3 \ b_4 \ b_5 \ b_6]^T \\ \theta_{O_2}^* &= [a_3 \ a_4 \ b_7 \ b_8 \ b_9 \ b_{10} \ b_{11} \ b_{12}]^T \\ \phi_{\text{effect}} &= \begin{bmatrix} -y_1(k-1) \\ -y_1(k-2) \\ u_1(k-1) \\ u_2(k-1) \\ u_3(k-1) \\ u_1(k-2) \\ u_2(k-2) \\ u_3(k-2) \end{bmatrix}, \phi_{O_2} = \begin{bmatrix} -y_2(k-1) \\ -y_2(k-2) \\ u_1(k-1) \\ u_2(k-1) \\ u_3(k-1) \\ u_1(k-2) \\ u_2(k-2) \\ u_3(k-2) \end{bmatrix} \end{aligned}$$

It is important to have in mind that the model shall represent the combustion process and that the model parameters are found from already known input and output measurements ϕ . It is quite normal to present the real process as Equation (6.2) where θ^* is the actual model parameter vector and the estimated process as;

$$\hat{z}(k) = \theta(t)\phi \quad (6.3)$$

The error between the actual and the estimated could then be written as;

$$\epsilon = \frac{z - \hat{z}}{m_s^2} \quad (6.4)$$

which is often referred to as the estimation error. $m_s^2 \geq 1$ is a normalization signal designed to guarantee that $\frac{\phi}{m_s}$ is bounded. A straightforward choice for m_s is $m_s^2 = 1$ since ϕ is bounded (Ioannou and Fidan, 2006).

In the literature today there are many different adaptive laws to estimate the unknown parameter vector $\theta(t)$. One is the Gradient method. The basic is to update $\theta(t)$ in a direction that minimizes a certain cost of the estimation error ϵ . $\theta(t)$ is adjusted in a direction that makes $|\epsilon|$ smaller and smaller until a minimum is reached at which $|\epsilon| = 0$. The cost function could be written as (Ioannou and Fidan, 2006);

$$J(\theta) = \frac{\epsilon^2 m_s^2}{2} = \frac{(z - \phi\theta)^2}{2m_s^2} \quad (6.5)$$

which is minimized with respect to θ using the gradient method to obtain;

$$\dot{\theta} = -\Gamma \Delta J(\theta) \quad (6.6)$$

where $\Gamma > 0$ is a scaling constant which is referred to as *adaptive gain* and $\Delta J(\theta)$ is the gradient of J with respect to θ .

$$\Delta J(\theta) = \frac{dJ}{d\theta} = -\frac{(z - \theta\phi)}{m_s^2} \phi = -\epsilon\phi \quad (6.7)$$

which leads to the adaptive law

$$\dot{\theta} = \Gamma\epsilon\phi \quad \theta(0) = \theta_0 \quad (6.8)$$

6.2 Simulating the Adaptive Law

The recorded process data that is used for simulation was recorded 23th of February 2011 between 7 am and 11 pm with a samplings frequency of 10 seconds. During these 16 hours the plant was running under normal operating conditions, controlled by todays control system. The data-set was filtered before simulation with the same filter, order and cutoff frequency as used in Section 5.1. The initial values for $\theta = 1$ and the gain Γ was optimized so $|\epsilon| \rightarrow 0$.

6.2.1 Measured and Estimated Effect in the Boiler Circuit

Figure 6.2 shows that the estimated effect follows the measured effect in the boiler circuit.

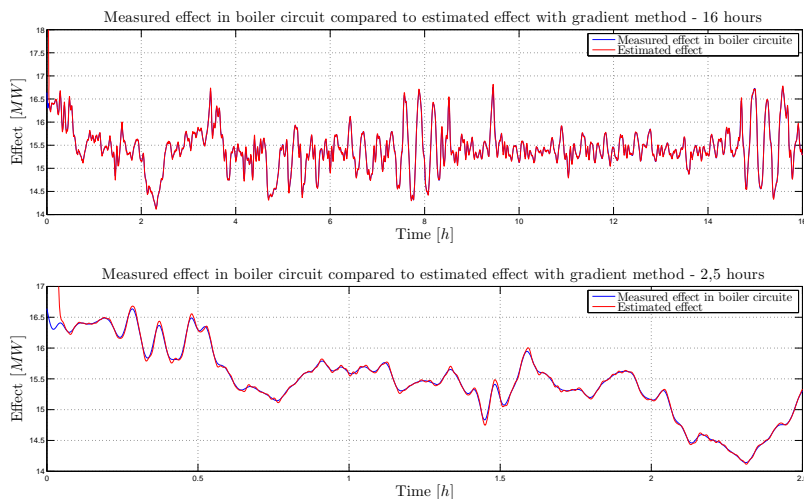

Figure 6.2: Measured effect in the boiler circuit compared to estimated effect with the gradient method

The bottom picture in Figure 6.2 is a section of the first 2,5 hours. By looking at the picture it is found that the estimated effect could not be found in the start. The reason is that θ have not converged to θ^* . So the error between estimated and measured effect is very large. Figure 6.3 shows the estimation error. The figure also shows that $|\epsilon| \rightarrow 0$.

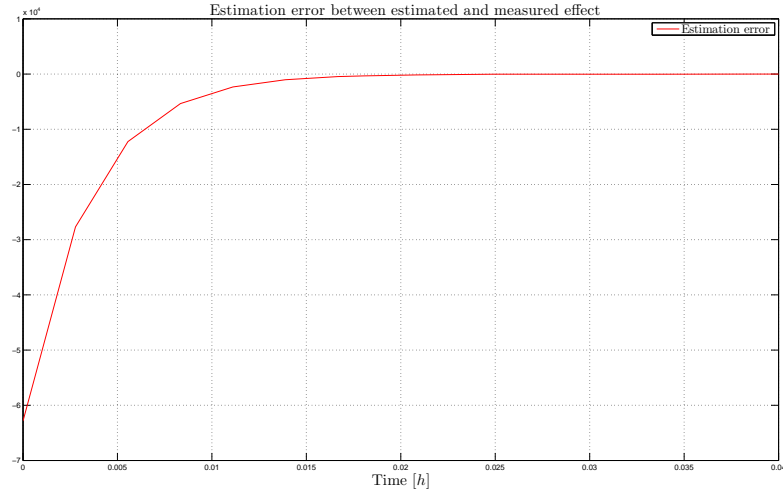
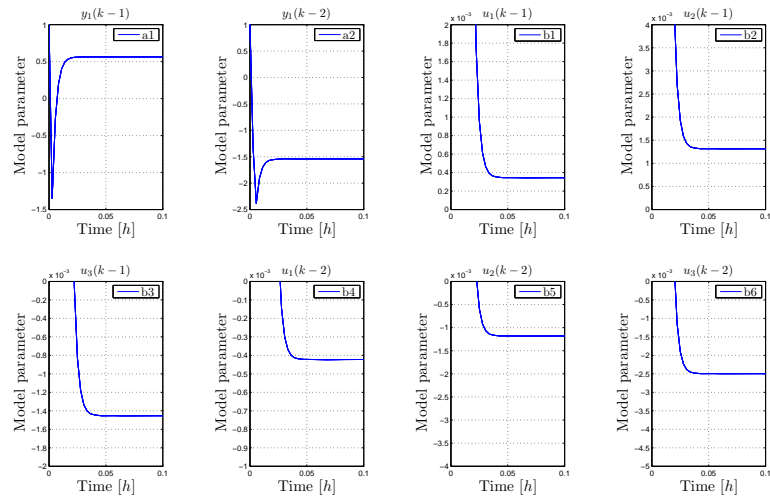

Figure 6.3: Estimation error between estimated and measured effect

When the estimation error becomes smaller the model parameters converge to the correct values. This could be found in Figure 6.4. When $t=0.025$ the parameters have converged and Figure 6.3 shows that $|\epsilon| \approx 0$. The parameters in Figure 6.4 is approximately equal to the converged values the rest of the simulation.

Figure 6.4: Obtained model parameters for θ_{effect} with Gradient method

6.2.2 Measured and Estimated O_2 in the Flue Gas

The same analyze was performed for O_2 as it was for the effect. Figure 6.5 shows that the estimated and measured O_2 follows each other and Figure 6.6 shows that the parameters converge.

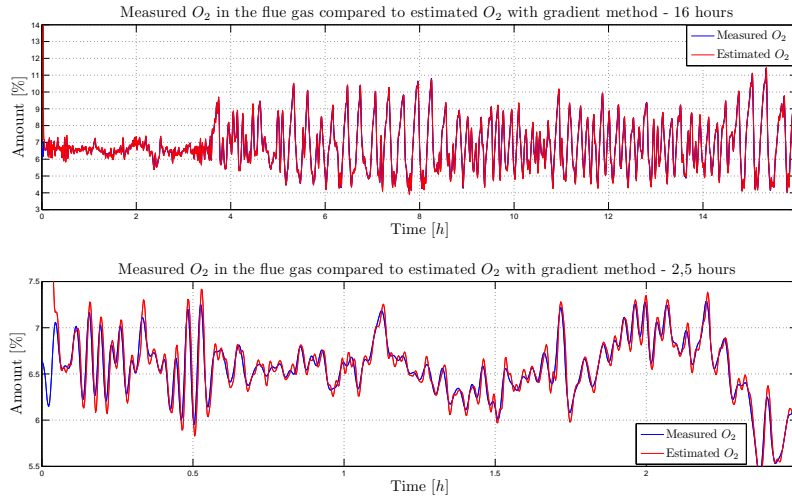

Figure 6.5: Measured O_2 in the flue gas compared to estimated O_2 with gradient method

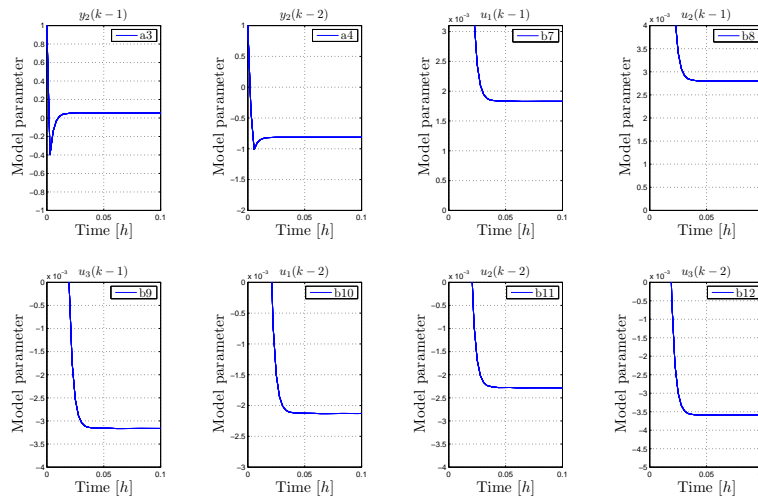

Figure 6.6: Obtained model parameters for θ_{O_2} with Gradient method

6.3 Chapter Discussion

This chapter shows that the model parameters were estimated by using today's process measurements without manipulating the MV's. The parameters converge quickly and the estimated CV's follows the measured results very well. Is the conclusion therefore that the variation in the MV's satisfy PE? It is clear that if there was no variation at all, PE is not satisfied. So how much variation is needed in a live-plant to satisfy PE and what happens if a new controller minimize today's variation? When designing and implementing a new controller these questions are important to have in mind. If $|\epsilon|$ drifts away a suggestion is to design a signal as explained in Section 4.2.1 and apply the signal for a necessary time period.

Before simulation the measured \mathbf{O}_2 was filtered with a cutoff frequency of 0.0083 Hz (2 minutes). If \mathbf{O}_2 is filtered with a slower cutoff frequency the estimated \mathbf{O}_2 follows the measured even better. Since the \mathbf{O}_2 measurement is based on a 10 minutes mean value, the cutoff frequency could be reduced without losing necessary model dynamic.

Chapter 7

Concluding Remarks

7.1 Conclusion

This thesis has studied Haraldrud MSW combustion process. Haraldrud is a real combustion plant burning waste for citizens of Oslo. A thoroughly description of the combustion process has been presented based on manipulating and analyzing the process, together with long discussions with the plant engineers. Working with a real plant is time-consuming, challenging and very informative. Rarely theories are easy to implement on a real plant, and the focus of this thesis has been to connect theory and practice. All simulations are based on real process data.

Burning MSW is a complex process to control, and several factors including; unknown calorific value, regulation of the waste flow, and the long time constant for measuring and regulating the energy contributes to this. Today's unknown calorific value and measuring the energy from the combustion can be calculated from flue gas measurements. By implementing these in a new controller at Haraldrud the variation in energy from the combustion will be reduced and results in waste flow increase.

One method to develop a model and estimate the model parameters is to decide a model set and estimate the model parameters based on system identification theory. An open-loop system identification test was applied to the combustion process. Further, the model parameters to a MIMO ARX model were estimated from recorded test data. It was concluded that the process variation in the gathered open-loop data was too large, which resulted in a poor model. The model should instead be estimated based on closed-loop identification.

Another method to estimate the model parameters is to use a control law to estimate the parameters on-line. Gradient method is one control law and has been validated from recorded process data. The simulation shows that the estimated and measured outputs followed each other perfectly.

7.2 Future Work

The main purpose of this thesis was to describe the combustion process at Haraldrud and develop a model of the combustion process based on system identification. During this thesis simulations have been directed based on recorded process data, but it has not been enough time to implement the results in the plant. Suggested future work is therefore;

- Fully verify the estimation of the calorific value and the new method to measure the produced energy, by comparing the new with todays measured energy in the boiler circuit, over a chosen time period.
- Two methods to estimate the model parameters have been presented. It is therefore recommended to develop a model based on closed-loop system identification, or continue the work of the adaptive controller. It would also be very interesting to investigate the possibilities to use an MPC.

Appendix A

Appendix

A.1 Definitions

Definition 1. (Persistence of Excitation (PE))

A piecewise continuous signal vector $\phi : \mathfrak{R}^+ \mapsto \mathfrak{R}^n$ is PE in \mathfrak{R}^n with a level of excitation $\alpha_0 > 0$ if there exist constants $\alpha_1, T_0 > 0$ such that

$$\alpha_1 I \geq \frac{1}{T_0} \int_t^{t+T_0} \phi(\tau) \phi^T(\tau) d\tau \geq \alpha_0 I, \quad \forall t \geq 0 \quad (\text{A.1})$$

Found in (Ioannou and Sun, 1995)

Definition 2. (The Kronecker product)

The Kronecker product of an $m \times n$ matrix $A = (a_{ij})$ and a $p \times r$ matrix $B = (b_{ij})$ is defined as;

$$A \otimes B = \begin{bmatrix} a_{11}B & a_{12}B & a_{1n}B \\ a_{21}B & a_{22}B & a_{2n}B \\ \vdots & \vdots & \vdots \\ a_{m1}B & a_{m2}B & a_{mn}B \end{bmatrix} \quad (\text{A.2})$$

Nomenclature

CH_yO_z = Combustible part of the waste

C_r = Crest factor

$H_{CH_yO_z}$ = Net calorific value - combustible part $[\frac{MJ}{Kg}]$

H_{waste} = Net calorific value $[\frac{J}{Kg}]$

K_{H_2O} = Correction factor for H_2O

K_{O_2} = Correction factor for O_2

$M_{CH_yO_z}$ = Molar mass of the combustible part of the waste $[\frac{Kg}{mol}]$

η_c = Amount of converted carbon in the combustion process

Q = Measured energy in the boiler circuit $[W]$

$Q_{fluegas}$ = Measured energy in the flue gas $[W]$

R_a = Airflow resistance in the combustion zones $[\frac{mBar}{m^3}]$

$X_{H_2O_{ashfree}}$ = Ash free moisture part [%]

y = Amount of Hydrogen in the combustible part of the waste

z = Amount of Oxygen in the combustible part of the waste

θ = Model parameters

ϕ = input- output measurements

ϵ = Prediction error

Γ = Scaling constant in the adaptive law

Bibliography

- Y.F. Chang, C.J. Lin, J.M. Chyan, I.M. Chen, and J.E. Chang. Multiple Regression Models For the Lower Heating Value of Municipal Solid Waste in Taiwan. *Department of Environmental Resource Management, Chia Nan University of Pharmacy and Science, Taiwan. Department of Environmental Engineering and Science, Chia Nan University of Pharmacy and Science, Taiwan. Department of Environmental Engineering, National Cheng Kung University, Taiwan*, 2007.
- Gorham\Schaffler Inc. Humidity Formulas. http://www.gorhamschaffler.com/humidity_formulas.htm, May 2011.
- Simen Gudim. Directed Study of a Municipal Solid Waste Combustion Plant. *NTNU Trondheim*, 2010.
- Roberto Guidorzi. *Multivariable System Identification*. Bononia University Press, 1st edition, 2003.
- Petros Ioannou and Baris Fidan. *Adaptive Control Tutorial*. Siam, 1st edition, 2006.
- Petros A. Ioannou and Jing Sun. *Robust Adaptive Control*. Prentice Hall, 1st edition, 1995.
- Sivapalan Kathrivale, Muhd Noor Muhd Yunus, K Sopian, A.H. Samsuddin, and R.A Rahman. Modeling the Heat Value of Municipal Solid Waste. *MINT Incineration Renewable Energy Center, Malaysian Institute for Nuclear Technology Reserach, Malaysia. Departmant of Mechanical and Material Engineering, Faculty of Engineering, University Kebangsaan Malaysia, Malaysia*, 2002.
- M. Leskens, L.B.M. Van Kessel, and P.M.J. Van den Hof. MIMO Closed-Loop Identification of an MSW Incinerator. *Control Engineering Practice 10 (2002) 315-326*, 2000.
- M. Leskens, L.B.M. van Kessel, and O.H.Bosgra. Model Predictive Control as a Tool For Improving the Process Operation of MSW Combustion Plants. *Waste Management*, 2005.
- Lennart Ljung. *System Identification*. Prentice Hall, 2nd edition, 2006.
- Michael J. Moran and Howard N. Shapiro. *Fundamentals of Engineering Thermodynamics*. John Wiley & Sons, inc, 5th edition, 2004.
- Helge Mordt. Utarbeidede Detaljer om Haraldrud. *OSLO Trondheim*, 2009.

Helge Smedsrud. Dynamic Modeling and Control of Brobekk Incineration Plant. *Master Thesis, Norwegian University of Science and Technology*, 2008.

Statistic Norway. Waste. <http://www.ssb.no/emner/01/05/avfall/>, May 2011.

T.D.Eastop and A.McConkey. *Applied Thermodynamics For Engineering Technologists*. Butterworth Heinemann, 5th edition, 1993.

L.B.M. van Kessel. Stochastic Disturbances and Dynamics of Thermal Processes. *Ph.D Thesis, Eindhoven University of Technology*, 2003.

Y. Zhu. *Multivariable System Identification For Process Control*. Elsevier, 1st edition, 2001.