

# We are IntechOpen, the world's leading publisher of Open Access books Built by scientists, for scientists

4,200

Open access books available

116,000

International authors and editors

125M

Downloads

Our authors are among the

154

Countries delivered to

TOP 1%

most cited scientists

12.2%

Contributors from top 500 universities



WEB OF SCIENCE™

Selection of our books indexed in the Book Citation Index  
in Web of Science™ Core Collection (BKCI)

Interested in publishing with us?  
Contact [book.department@intechopen.com](mailto:book.department@intechopen.com)

Numbers displayed above are based on latest data collected.  
For more information visit [www.intechopen.com](http://www.intechopen.com)



---

# Development of a Field Robot Platform for Mechanical Weed Control in Greenhouse Cultivation of Cucumber

---

Amid Heravi, Desa Ahmad, Ibrahim A. Hameed,  
Redmond Ramin Shamshiri,  
Siva K. Balasundram and Muhammad Yamin

Additional information is available at the end of the chapter

<http://dx.doi.org/10.5772/intechopen.80935>

---

## Abstract

A prototype robot that moves on a monorail along the greenhouse for weed elimination between cucumber plants was designed and developed. The robot benefits from three arrays of ultrasonic sensors for weed detection and a PIC18 F4550-E/P microcontroller board for processing. The feedback from the sensors activates a robotic arm, which moves inside the rows of the cucumber plants for cutting the weeds using rotating blades. Several experiments were carried out inside a greenhouse to find the best combination of arm motor (AM) speed, blade rotation (BR) speed, and blade design. We assigned three BR speeds of 3500, 2500, and 1500 rpm, and two AM speed of 10 and 30 rpm to three blade designs of S-shape, triangular shape, and circular shape. Results indicated that different types of blades, different BR speed, and different AM speed had significant effects ( $P < 0.05$ ) on the percentage of weeds cut (PWC); however, no significant interaction effects were observed. The comparison between the interaction effect of the factors (three blade designs, three BR speeds, and two AM speeds) showed that maximum mean PWC was equal to 78.2% with standard deviation of 3.9% and was achieved with the S-shape blade when the BR speed was 3500 rpm, and the AM speed was 10 rpm. Using this setting, the maximum PWC that the robot achieved in a random experiment was 95%. The lowest mean PWC was observed with the triangular-shaped blade (mean of 50.39% and SD = 1.86), which resulted from BR speed of 1500 rpm and AM speed of 30 rpm. This study can contribute to the commercialization of a reliable and affordable robot for automated weed control in greenhouse cultivation of cucumber.

**Keywords:** agricultural robot, weed control, cucumber, greenhouse

---

## 1. Introduction

The demand for off-season cultivation of fruits and vegetables require different aspects of automation and robotics in closed-field plant production environments like greenhouses [1]. Modern greenhouse bioproduction systems are required to exhibit integration of automation, biological culture practices, and control systems through the concept of Automation-Culture-Environment-oriented SYStems analysis (ACESYS) as defined in [2, 3]. The growth condition for Solanaceae vegetables in the greenhouse provides the leeway for the growth of other plants as well. In greenhouse cultivation of Cucumber (*Cucumis sativus*), the growth of weeds like cleavers, amaranth, camelthorn, grass quack, and oat wild decreases the final crop yield and quality. These weeds compete with cucumbers for nutrients, water, and photosynthesis. During the growing period, weeds use a large portion of water and nutrient, and because of their physiological properties, they grow simultaneously and rapidly with the original plant. It is, therefore, necessary to eliminate them before causing serious damage to the original plants. Various mechanical and chemical methods, as well as cultivation techniques, have been proposed to prevent the growth of weeds, including mechanical techniques, hand picking, spraying, environment heating, herbicides and biocontrols, and soilless cultural practices. For example, weed biocontrol is the suppression of weeds by insects and microorganisms that feed on the target plants or otherwise parasitize them. The success in this method is not always guaranteed because biocontrol is species specific, and there are hundreds of serious weed species. Cultural control includes those management practices that modify the agro-ecosystem to make the pasture, crop, or forest ecosystem resistant to weed establishment, i.e., integrating sheep or goats to browse brush species and fowl to graze herbs and grasses [4]. Prior to the development of modern herbicides, rancher and forest managers relied mainly on mechanical methods of weed control, such as grubbing, bulldozing, dragging, cabling, and mowing. Compared to mechanical weed control methods, herbicides are more effective at a lower cost. Herbicidal weed control results in greater grass production in pastures than does clipping of weeds [5]. In order to apply chemical directly to the weed's vascular tissue, a direct chemical application end effector is required to cut the weed's stem and spread the chemical on the cut surface. An example of such application can be found in [6] where a prototype weed control robot was developed to spray weeds in cotton plants in the seed line. A real-time intelligent weed control system was introduced in [7] for selective herbicide application to in-row weeds using machine vision and chemical application. A minirobot to perform spraying activities based on machine vision and fuzzy logic has been described in [8, 9]. More examples of autonomous vehicle robot for spraying the weeds can be found in [10–12].

The use of labor force that manually pulls out the weeds is still practiced by local growers. This is, however, not an efficient method since the availability of the skilled workforce that accepts repetitive tasks in the harsh greenhouse and field conditions impose uncertainties and timeliness costs [13]. It is, therefore, necessary to select a proper method for effective weed control. The trends in the agricultural robotics in the past 10 years show that automation of plant trimming with simultaneous localization and mapping techniques will change the industry in future [14]. The available time, labor, equipment, costs, and types of weeds and the areas infested need to be considered when planning a weed control program. In this regard, agricultural robotic and automation technology plays an essential role in improving

the interactions between human, machine, and plants [15]. For example, the prevention of musculoskeletal disorders in manual harvesting operations in Dutch greenhouses has motivated various researchers for replacement of human labor by automaton robot for picking cucumber [16] and sweet pepper [13] fruits. Automation is a viable and sometimes necessary method to ensure maximum profits with minimum costs. In fact, one of the main purposes of agricultural automation has been always concerned with the substitution of human workforce by robots or mechanized systems that can handle the tasks more accurately and uniformly at a lower cost and higher efficiency [17–22].

Research and development in agricultural robotics date back to 1980s, with Japan, the Netherlands, and the USA as the pioneer countries. Example of such research works included the works of [7, 23] for robotic weed control and automated harvesting of tomato. Development of an autonomous weeding machine requires a vision system capable of detecting and locating the position of the crop. Such vision system should be able to recognize the accurate position of the plant stem and protect it during the weed control [24]. A near-ground image capturing and processing technique to detect broad-leaved weeds in cereal crops under actual field conditions has been reported in the work of [25]. Here, the researchers proposed a method that uses color information to discriminate between vegetation and background, while shape analysis techniques were applied to distinguish between crop and weeds. Shape features of the radish plant and weed were investigated by [26]. They proposed a machine vision system using a charge coupled device camera for the weed detection in a radish farm resulting 92% success rate of recognition for radish and 98% for weeds.

A combined method of color and shape features for sugar beet weed segmentation was proposed by [27] with 92% success rate in classification. This rate increased to 96% by adding two shape features. Another approach extracted a correlation between the three main color components R, G and B, which constitute weeds and sugar beet color classes by means of discriminant analysis [28]. Their method resulted in different classification success rates between 77 and 98%. The segmentation of weeds and soybean seedlings by CCD images in the field was studied by [29]. Texture features of weed species have been applied for distinguishing weed species by [30] with grass and broadleaf classification accuracies of 93 and 85%, respectively. Textural image analysis was used to detect weeds in the grass [31]. Gabor wavelet features of NIR images of apples were extracted for quality inspection and used as input to kernel PCA [32]. Kernel PCA first maps the nonlinear features to linear space, and then, PCA is applied to separate the image Gabor wavelet (5 scales and 8 orientations) combined with kernel PCA that had the highest recognition rate (90.5%). Improvements in vision-based control system [13, 33–36] have enabled several applications of robotic manipulators for greenhouse and orchard tasks and have contributed to the decrease in workload and labor's fatigue, while improving the efficiency and safety of the operations. These achievements were considered a challenge in the earlier agricultural robotics works [23, 37, 38]. For example, spray equipment for weed control has been developed with vertical spray booms that increase the deposition in the canopy [39–41]. Some of these alternatives are self-propelled vehicles such as Fumimatic® (IDM S.L, Almería, Spain) and Tizona (Carretillas Amate S.L., Almería, Spain), or autonomous vehicles such as Fitorobot (Universidad de Almería, Cadia S.L., Almería, Spain) that have been designed specifically to move without difficulty over loose soils and in spaces with

a large number of obstacles [41]. These vehicles rely on inductive sensors to follow metal pipes buried in the soil. Few studies have addressed the navigation problem of vehicles in greenhouses operating completely autonomously [9, 11, 15]. The main challenge of these systems is that localization approaches needed for feeding the closed-loop controllers would lead to inaccurate measurements after a few steps fail for long trajectories [42]. A stereovision system along with an image processing algorithm was used to recognize the weeds and also to estimate their location in the field. In order to experiment with vision sensors and agricultural robots, [13] created a completely simulated environment in V-REP, ROS, and MATLAB for improvement of plant/fruit scanning and visual servoing task through an easy testing and debugging of control algorithms with zero damage risk to the real robot and to the actual equipment. In another study, [43] designed a field survey mobile robot platform based for navigating inside greenhouses and open-field cultivation for automated image acquisition. A functional model shown in **Figure 1** was introduced by [44] in the field test of an autonomous robot for deleafing cucumber plants grown in a high-wire cultivation system. This model was also adapted and used by [13] for the robotic harvesting of sweet pepper and on a greenhouse field survey mobile platform [43]. Artificial neural networks have also been used by many researchers to discriminate weeds [45, 46] with machine vision as shown in **Figure 2**. A fixed-position weed robot was presented by [47], which is interfaced to a standard belt-conveyor displacement system and provides the robot with pallets containing the crops. These reviews indicate that a commercial robotic platform for the elimination of weeds in a cucumber greenhouse has not been materialized yet. In addition, most of the research works in the area of robotic weed control are applicable prior to the plant growth or in some cases when the main plant height is between 0.2 and 0.3 m.

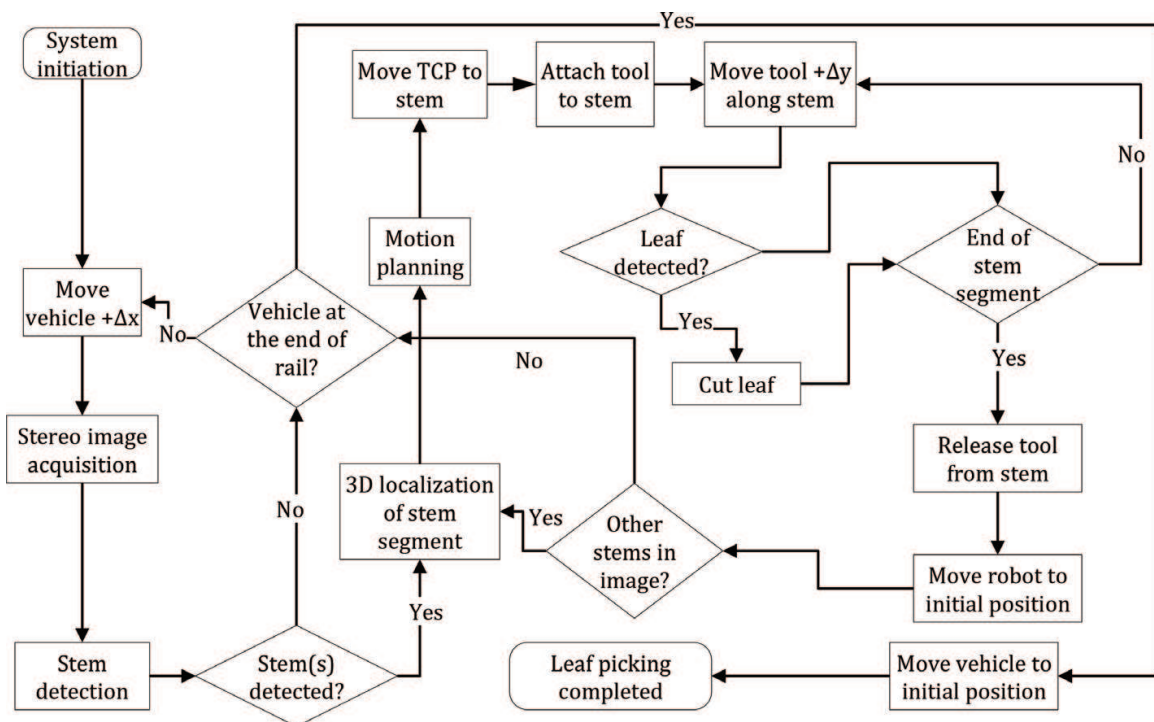

**Figure 1.** Task sequence during leaf picking of cucumber, adapted from [44].

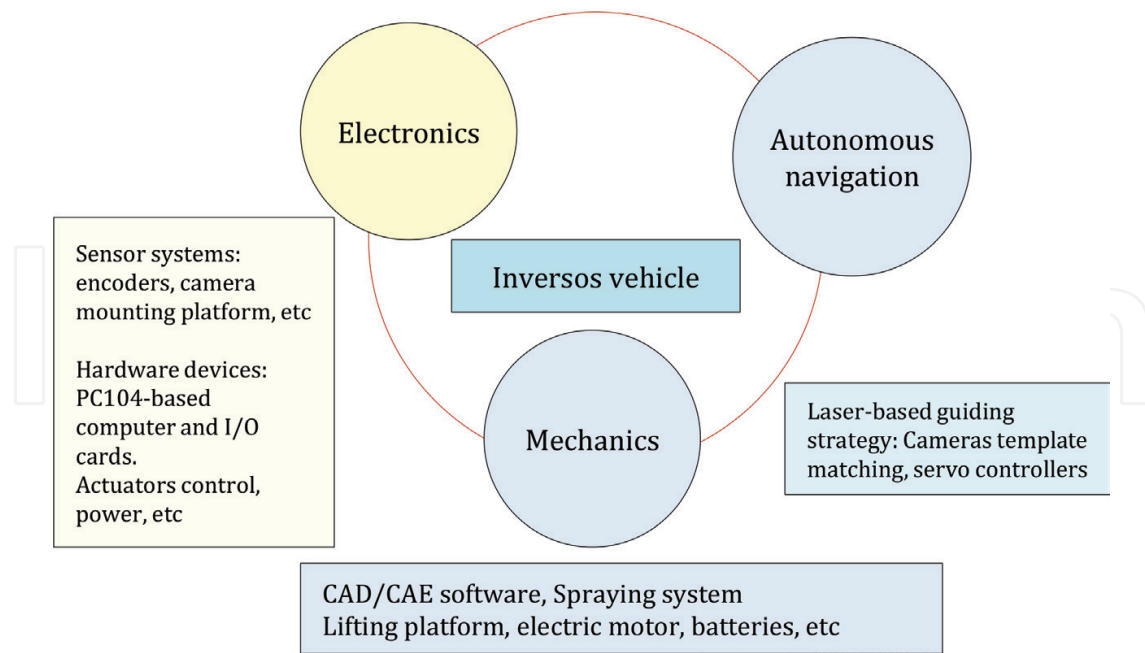

Figure 2. Mechatronic paradigm followed in this research, adapted from [41].

The overall objective of this study was to design and develop an affordable robotic weed control system for application in greenhouse cultivation of cucumbers where plants can reach to a height of 10 m. Our design is based on mechanical weed removal techniques without using chemical materials. The specific objectives were to determine (i) the best blade design for cutting the weeds among cultivation rows, (ii) the best blade rotation (BR) speed, and (iii) the best arm motor (AM) speed.

## 2. Materials and methods

### 2.1. Overview of the prototype robot weed

A flowchart of the methodology is shown in Figure 3. A prototype robot was designed using AutoCAD software 2011 v18.1 (Autodesk Inc., San Rafael, CA, USA). Schematic views of the prototype robot, as well as the corresponding dimensions and parts are shown and illustrated in Figures 4 and 5. The main mechanical components of the robotic platform consist of a monorail, main chassis, ball bearings, wheels, arms, blade, and adjusting mechanism. Major electrical components include DC motors, microswitches, a 12 V 7.2–9 amp sealed lead acid battery, SRF05 ultrasonic sensors, pic 18F4550 microcontroller, and 2 × 24 LCD monitor (Figure 6). We began with the design of a monorail that was responsible to support the robot navigations and stops between two cucumber rows inside the greenhouse. The monorail has a width of 0.06 m and was placed 0.4 m above the ground (Figure 5A and B). The algorithm for robot navigation between two consecutive stops points on the monorail is also illustrated in the flowchart of Figure 5. Right after the robot is switched on, it starts moving on the monorail that is fixed along the greenhouse from one row to another. Upon reaching the first

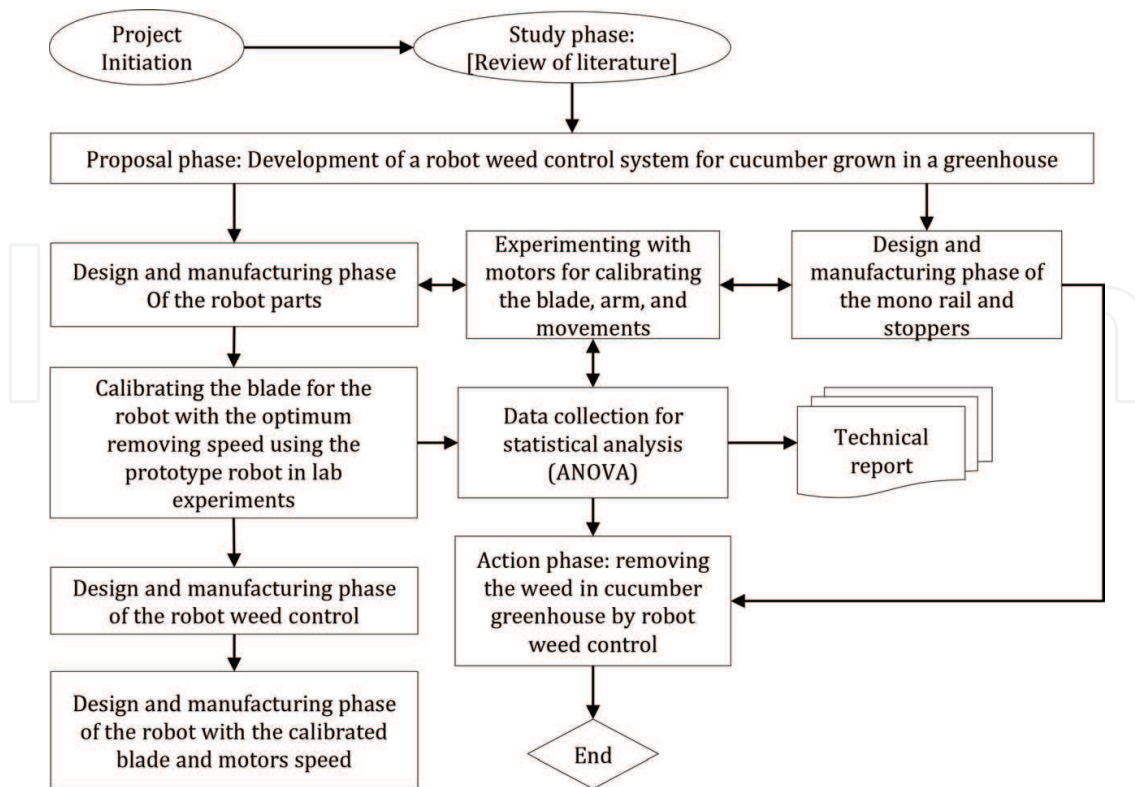

Figure 3. Flowchart of the research methodology.

stopper point on the rail, the robot strikes the first microswitch, which sends a deactivation signal to the first motor responsible for moving the robot. While stopped between two cucumber plant rows, the robot scans for weeds and determines the distance between the detected weed and the blade arm using the ultrasonic sensors. Subsequently, a command signal is sent to the arm motor and blade motor for activating the blade rotation as illustrated in the flowchart of Figure 5.

## 2.2. Design of the mechanical parts

The moving mechanical arm consists of a chassis, a small arm, and the main arm. Two main criteria were considered in designing the robot frame including minimum weight (for increasing the motor efficiency), and strength (for standing vibrations). The frame was made from an iron band bearing with the dimensions of  $0.02 \times 0.18 \times 0.005$  m. In order to provide support for the battery, bearing bases, microswitches, and the main arm, we installed additional extensions to the frame in a way that the robot gravity center is placed on the monorail. The battery is the heaviest part of the robot and can power the robot for 2 h. It was installed on the central frame above the rails and wheels. The battery weight creates stability for the robot when the main arm is outstretched, and this weight and location for the battery can hold the spinning wheel implemented in place. We placed several holes on the frame to facilitate the installation of the motor, wheels, and the required electrical fragments (Figure 5C and D). The robot makes use of four ball bearings of diameter 0.02 m, out of which three were used to hold the robot to the rail and to facilitate a smooth movement (two bearings were placed

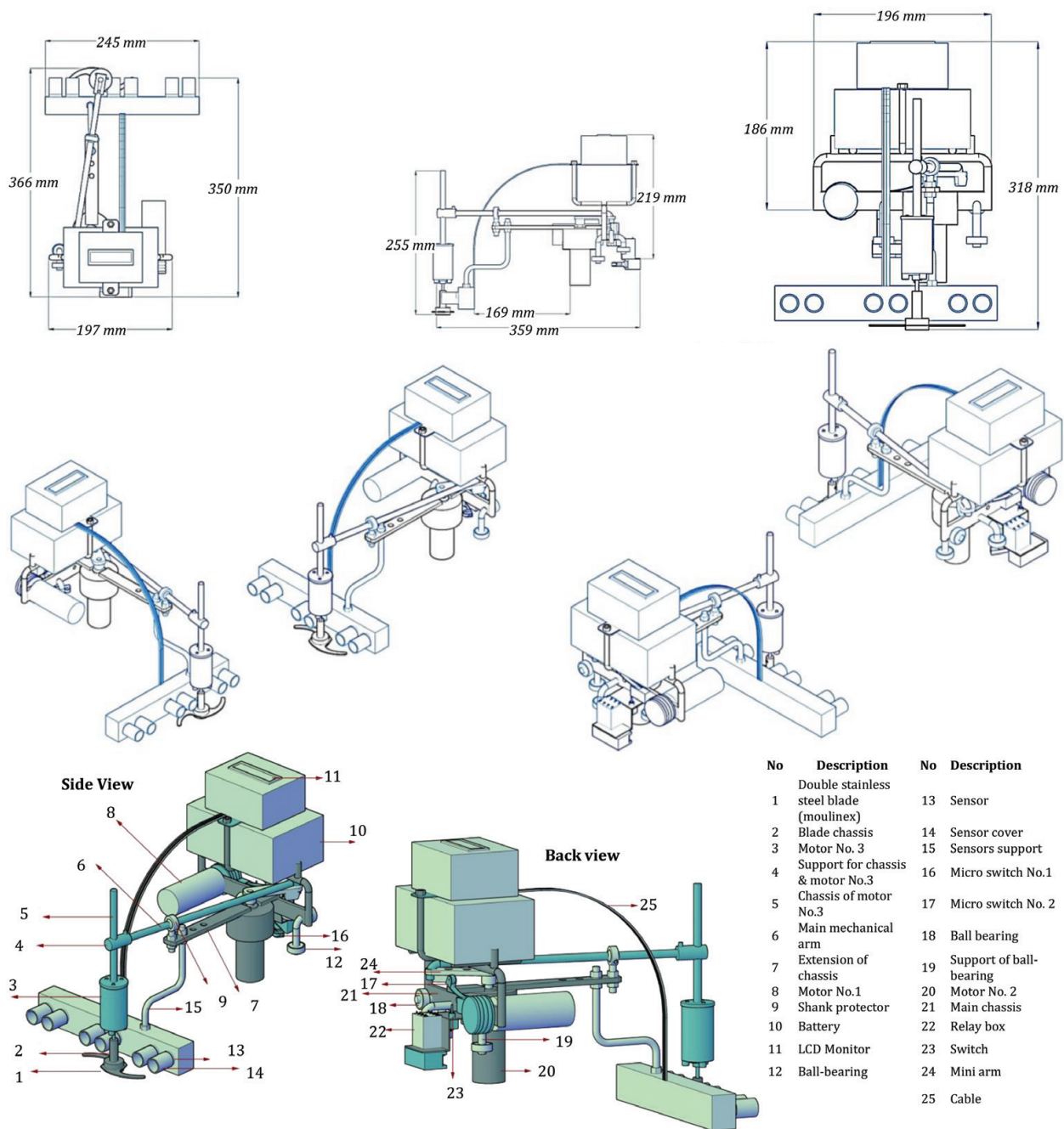
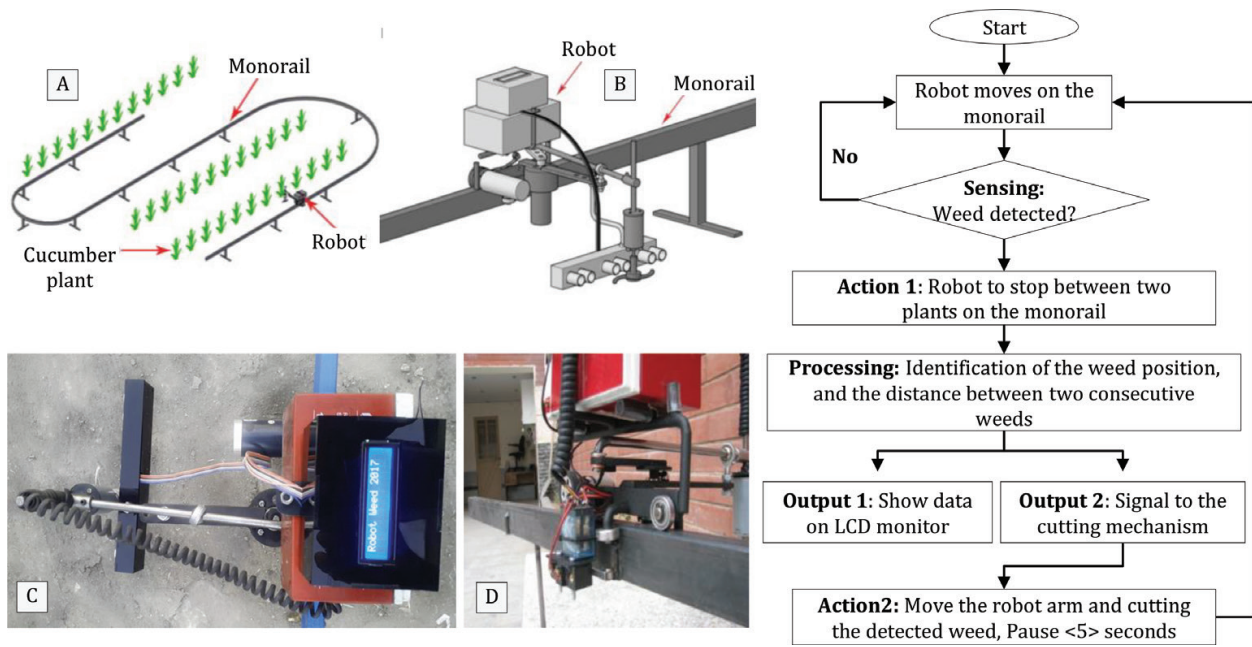

Figure 4. The CAD model design of the weed control robot.

on the right and one on the left side). The fourth bearing was used to act as the second wheel for the robot. All the ball bearings have a diameter of 0.02 m and are installed on the central frame. The diameter of the robot main wheel is 0.04 m, and the ideal speed was determined using trial and errors and time-motion studies during the conducted tests. The arm frame is made of an iron band bearing with a dimension of  $0.02 \times 0.2 \times 0.005$  m. A blade was installed on the main arm that moves forward and enables robot access to the weeds between the main plants. A shank protector in one of the holes in the arm frame makes the movement and the selection of the angle for smooth cutting.





**Figure 5.** The mechanism and flowchart for the robot navigation and control on the monorail showing (A) the monorail layout, (B) the robot mounted on the monorail, (C) the robot main body and manipulator arm, and (D) the joint setup between the robot and the monorail.

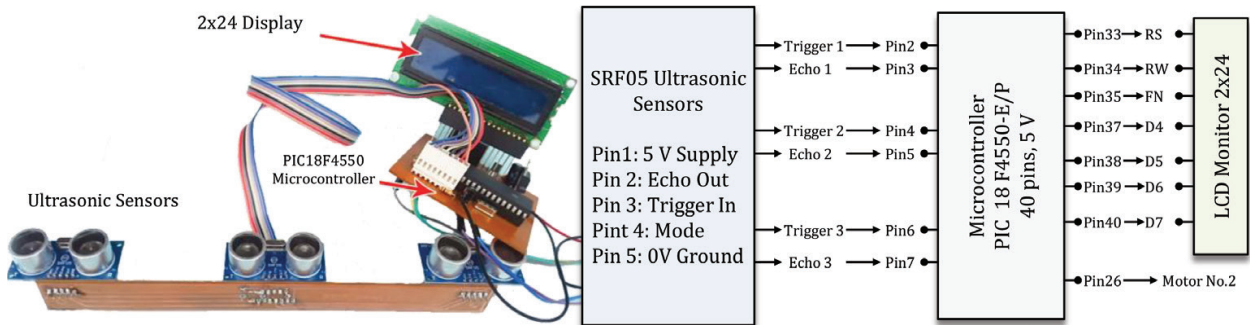

**Figure 6.** Major electrical module and wiring connections of the weed control robot.

### 2.3. Design of the electronic parts: sense and action mechanism

Major electronic components of the robot are three sets of SRF05 ultrasonic sensors, a PIC18F4550 microcontroller, and a 2 × 24 LCD monitor (**Figure 6**). The ultrasonic sensors were placed in a row having 0.10 m distance from each other. The sensors are specially positioned in a way that they cover the space between two cucumber plants on the cultivation row. As mentioned earlier, upon receiving a signal indicating weed existence, the microcontroller program determines the distance between the weed and the sensors and whether the weed is on the left, right, or middle of the sensors. This signal activates the cutting mechanism. Finally, the information of the entire process, including the distance between weed and sensors, and the specific sensor that identified the weed are shown on the robot LCD. During the experimental phase, we considered several improvements and adjustment on the sensing part and corresponding microcontroller program. For example, we used a tube pipe cover for each of the ultrasonic micro sensors to change the circular waves to linear waves. This was necessary

because sound waves that broadcast from transmitters of ultrasonic sensors are circular. When these sensors are close to the ground, the broadcasting waves that bounce off from the ground are misinterpreted as weeds.

The robot movements are supported by three 12 V, 0.89 A DC motors that are labeled for this paper by motor 1, 2, and 3. The first motor was fixed directly to the wheels in front of the robot and was responsible for the robot movement on the monorail. To select the optimum speed for the robot, six motor speeds of 30, 40, 50, 60, 80, and 120 rpm were tested. We found that the motor with 60 rpm, 1.358 N·m torque, 12 V, 0.89 A had the best performance in the greenhouse under study. The second motor was connected to the small arm and is responsible to rotate the big arm that moves the blade of the robot at a selected speed of 10 rpm and torque of 8.15 N·m. The third motor was fixed to the frame of the main arm for rotating the blade at a high speed of 3500 rpm for efficient weed cutting and removal. This frame can move up and down and can fix the distance between the blade and the ground level. It should be noted that the 3500 rpm blade rotation speed and the 10 rpm arm motor speed were found from the experiments.

#### 2.4. Blade design and analysis

Three types of blade, namely the S-shaped, the triangle-shaped, and the circular-shaped blade (**Figure 7**) were initially considered in the weed cutting experiments. We conducted several tests to find the best blade width (equal to 0.1 m) for matching the 0.4 m distance between two cucumber plants. Based on our field tests, we found that the S-shaped blade was the most efficient design for the purpose of weed cutting. The blade was built from double stainless steel material to resist the corrosion in high humidity greenhouse environment. Analysis and calculations were carried out for finding the blade tip speed and corresponding vector components according to the formulations given in [48]. The corresponding diagrams of this analysis are shown schematically in **Figure 7**. It can be observed from **Figure 7A** that the direction of the tip of the blade follows a cycloid curve on the ground level. The component of blade speed in the direction of robot forward speed vector, as well as the demonstration of vector gradient in the blade speeds, is shown in **Figure 7B–D**. Here,  $WB$  is the circular speed of the blade (rad/s),  $V_f$  is the forward speed of robot [m/s],  $V_{bf} = V_f + V_b$  is the ratio of the total speed of blade to ground [m/s],  $v_b = rb \times WB$  is the circumferential speed of blade [m/s],  $rb$  is the radius of blade [m],  $U$  represents the direction of the robot movement, and  $V$  is the linear speed of blade [m/s]. The speed of the tip of the blade on the ground is equal to the sum of robot forward speed and its circumferential speed. Having the direction of robot moving ( $U$ ), the direction of the moving blade will be in the direction of  $V_{bf}$ , which changes its direction as the blade rotates in the time frame  $t$  [s]. Therefore, to find the components of  $U$  and  $V$ , the speed of the blade tip can be written as the component of blade speed in direction of moving  $U$  [48], that is  $V_u = V_f - rb \times WB \sin(\theta)$ , and  $V_v = V_b \cos\theta = rb \times WB \cos(\theta)$ , where  $\theta = WB \times t$  is the angle between blade and movement direction,  $V_u$  and  $V_v$  are the speed component [m/s], and  $t$  [s] is the measured time from the initial angle  $\theta = 0$ . Therefore, the speed of the blade tip with respect to the ground is calculated as  $|V_{bf}| = \sqrt{|V_v|^2 + |V_u|^2}$ . **Figure 7E** shows forces and torque vectors of the cutting strike on the weed stem. Here, the force  $f_b$  [N] is the bending strength of the plant body,  $f_r$  is the cutting force [N],  $I_p$  is the pant geometry hardness torques, and  $mp$  is the weight of the cutting part of the plant [kg]. During the trial and error experiments, it was found that a minimum strike speed of between 50 and 75 m/s is required for cutting the weeds.

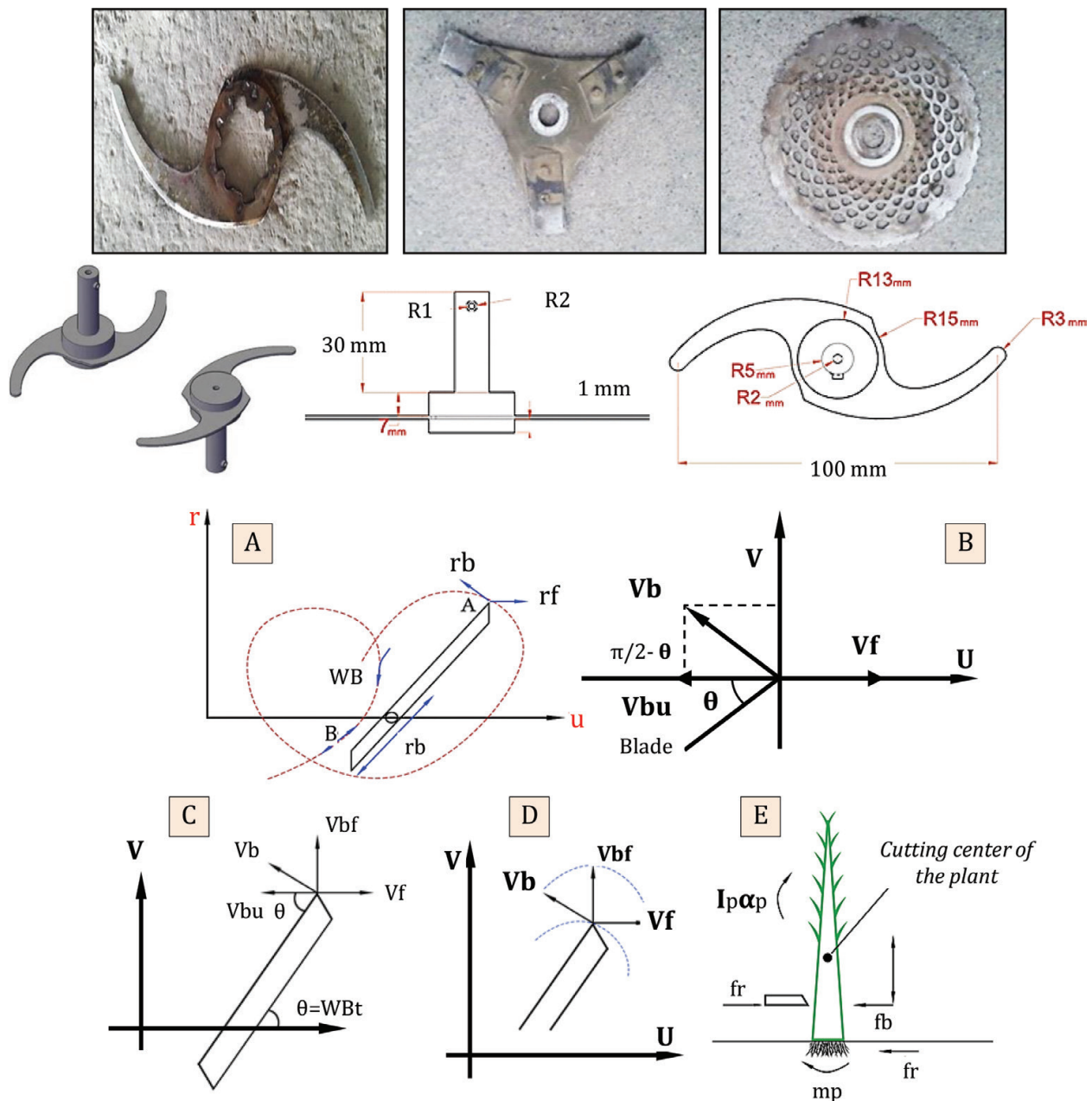

**Figure 7.** Design of the cutting blade, (A): calculating the velocity of rotating blade in stickles, (B): component of blade speed in direction of moving  $U$ , (C, D): calculating  $U$  and  $V$ , (E): components of forces, and (F): vector demonstration of the blade speed. Adapted from [48].

## 2.5. Experiment setup

The weed control robot was tested in a 5000 m<sup>2</sup> greenhouse in Jiroft city (28°40'41"N 57°44'26"E) located to the south of Kerman province of Iran (**Figure 8**). We planted over 10,000 cucumber seeds in pots and placed them in the greenhouse with spaces between the two plants being 0.4 m. It should be noted that in order to manually remove the weeds from 1 ha of the greenhouse under study, four seasonal workers had to perform the task every day, for 8 months (equivalent to 832 man/hour). Three experiments were conducted at different growth stages as follows: (i) during the seedling and germination stage, 15 days after the crop was cultivated

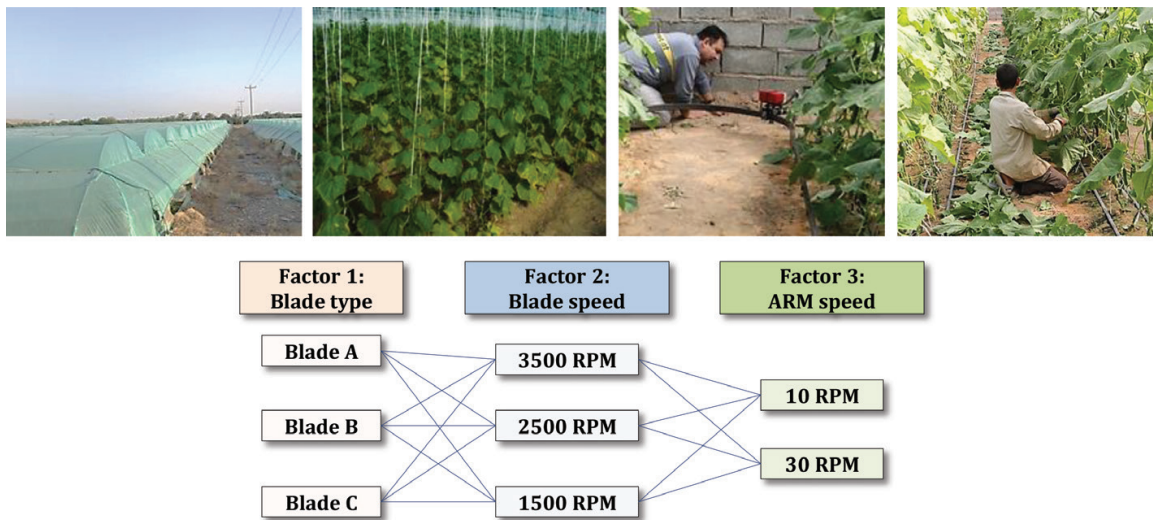

**Figure 8.** Outside and inside views of the experimental site (top), and corresponding factorial design of experiment (bottom) for determining the best combination of blade type, blade speed, and arm speed.

and the surrounding weeds were also 15 days old (these weeds usually have thin and very flexible stalks and are 10 cm high), (ii) during the vegetation and early fruiting stage, when the cucumber plants were 2 months old, and (iii) during the mature fruiting stage, when the plants were at their mature height. Three types of blades were selected, namely the S-shaped, triangular-shaped, and circular-shaped blade. For each blade, we assigned three blade rotation (BR) speeds of BR1 = 3500, BR2 = 2500, and BR3 = 1500 rpm with two arm motor (AM) speed of AM1 = 10 and AM2 = 30 rpm. A factorial design with two-way analysis of variance (ANOVA) was used to determine variation effects in the cutting weed performance of each blade due to BR speed, AM speed, and their interaction. For the  $k$ th blade type, under the  $i$ th level of blade speed and the  $j$ th level of arm speed factor, the two-way ANOVA model was stated as  $Y_{ijk} = \mu + b_i + a_j + (b \cdot a)_{ij} + \epsilon_{ijk}$ , where  $Y_{ijk}$  is the dependent variable representing the percentage of weeds cut (PWC) in an experiment. Time and motion study was conducted for the robot to move from one stopper to another. For motor no. 1, with a typical rotational speed of 60 rpm, and the wheel diameter of 0.04 m, the forward speed of the robot (VF) becomes 0.1256 m/s. Hence, the required time  $T$  [s] for the robot to travel the distance of  $X = 0.40$  [m] between two consecutive stoppers is equal to  $T = 3.2$  s using Eq. (1). The possibility for the robot to pass through the two stoppers within a row was considered for the consequent calculations. For the arm motor, the typical speed is 10 rpm, which implies that it takes  $T = 6$  s for the robot to remove the weed between two plants.

$$T = \frac{3.6 \times X}{V_F} \tag{1}$$

### 3. Results

Results of statistical analysis are summarized in **Tables 1–3** showing that the effects of blade type (T), blade rotation (BR) speed, and arm motor (AM) speed are significant at the 0.05 level. Moreover, it was found that the S-shaped blade with a mean ( $\mu$ ) of 67.8% and standard error ( $\sigma$ )

Blade type	$\mu$ : Mean percentage of weeds cut (%)	$\sigma$ : Std. error (%)
A: S shaped	67.8	3.05
B: Triangular shape	61.38	3.08
C: Circular shape	64.3	3.38
Blade rotation speed (rpm)		
1500	50.3	1.86
2500	64.9	1.51
3500	78.2	1.71
Arm motor speed (rpm)		
10	69.148	2.457
30	59.88	2.461

**Table 1.** Factor effects on the percentage of weeds cut.

Model	Sum of squares	Mean sum of squares	P-value
Blade type (T)	110.3	110.3	0.0462
Blade rotation speed (BR)	6977.1	3488.6	0.000
Arm motor speed (AM)	1157.4	1157.4	0.000
Error	1264.6	26.3	
Interaction types			P-value
T $\times$ BR	114.1	57.1	0.1272
T $\times$ AM	5.4	5.4	0.6493
BR $\times$ AM	73.6	36.8	0.2560
T $\times$ BR $\times$ AM	16	8	0.7356

**Table 2.** Variance analysis and effects of the robot blade type (T), blade rotation (BR) speed, and arm motor (AM) speed on the percentage of weed cutting performance.

of 3.052% had the highest effect, and triangular-shaped blade with  $\mu = 61.38\%$  and  $\sigma = 3.083\%$  had the lowest effect on the percentage of the weeds cut (PWC). The BR factor was significant at  $P < 0.05$ , indicating that blade rotation speed of 3500 rpm with  $\mu = 78.23\%$  and  $\sigma = 1.71\%$  had the highest effect and the 1500 rpm with  $\mu = 50.39$  and  $\sigma = 1.86\%$  had the lowest effect. The AM speed factor was also found to be significant at  $P < 0.05$ , which indicates that the speed of 10 rpm with  $\mu = 69.1\%$  and  $\sigma = 2.45\%$  had the highest effect and the speed of 30 rpm with  $\mu = 59.8\%$  and  $\sigma = 2.46\%$  has had the lowest effect on the PWC. It was found that (**Table 1**) different blade shapes with the AM speed of 10 rpm had a significant effect on the PWC. While the mean PWC by the S-shaped blades was the highest, increasing AM speed to 30 rpm reduced the efficiency of the S-shaped blade (as well as with the other two blades), resulting a mean PWC of 59.39%. According to the P-values in **Table 2**, while all of the main effects of blade type, BR, and AM speeds are significant at 0.05 level, their interactions were not found to have a significant

	Mean differences	P-value
Blade type		
A-B	6.4444	0.000
A-C	3.5000	0.036
B-C	-2.9444	0.076
Blade rotation (rpm)		
BR1-BR2	-14.5556	0.000
BR1-BR3	-27.8333	0.000
BR2-BR3	-13.2778	0.000

**Table 3.** Comparison of significant difference between blade types (A: S-shape, B: Triangular shape, and C: Circular shape), and blades rotation speed (BR1: 1500, BR2: 2500, and BR3: 3500 rpm).

effect on the PWC. The results provided in **Table 3** show that the difference between the two blades, S-shape and triangular shape is significant at the 0.05 level. In other words, the mean of weeds cut by these two blades are significantly different, and according to the mean differences column, the mean of the PWC by the S-shape blade is larger than the PWC by the triangular-shaped blade. The mean difference between the S-shaped and the circular-shaped blade with P-value of 0.036 is also significant at the 0.05 level. This implies that the average PWC by these two blades are significantly different, and according to the mean differences column, the mean PWC by the S-shaped blade is larger than the mean of the PWC by the circular-shaped blade. It was found that the difference between the means of the triangular-shaped blade and circular-shaped blade with the P-value of 0.076 is not significant at the 0.05 level, that is, the mean of the PWC by these two blade types are not significantly different.

Results of analysis of variance also showed that the mean differences between the BR speeds are significant, indicating that the resulted PWC with BR1 = 1500, BR2 = 2500, and BR3 = 3500 rpm are not equal. More specifically, the PWC in 1500 rpm was found to be smaller than those of 2500 and 3500 rpm. In addition, the mean PWC in 2500 rpm was also smaller than that of 3500 rpm. This can also be observed from the bar plots of **Figure 9**,

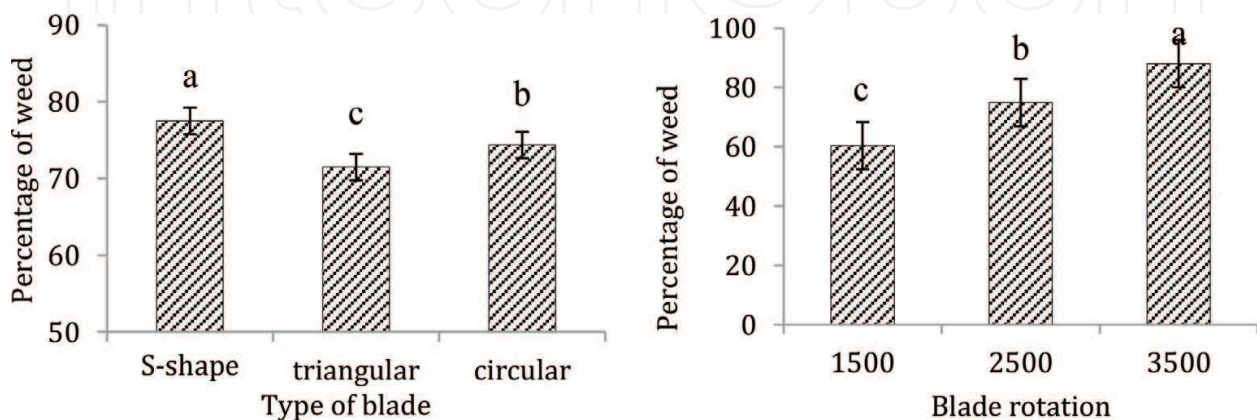

**Figure 9.** Comparison of the effects of various blade types on (left) and various blade rotation speeds (right) on the percentage of weeds cut.

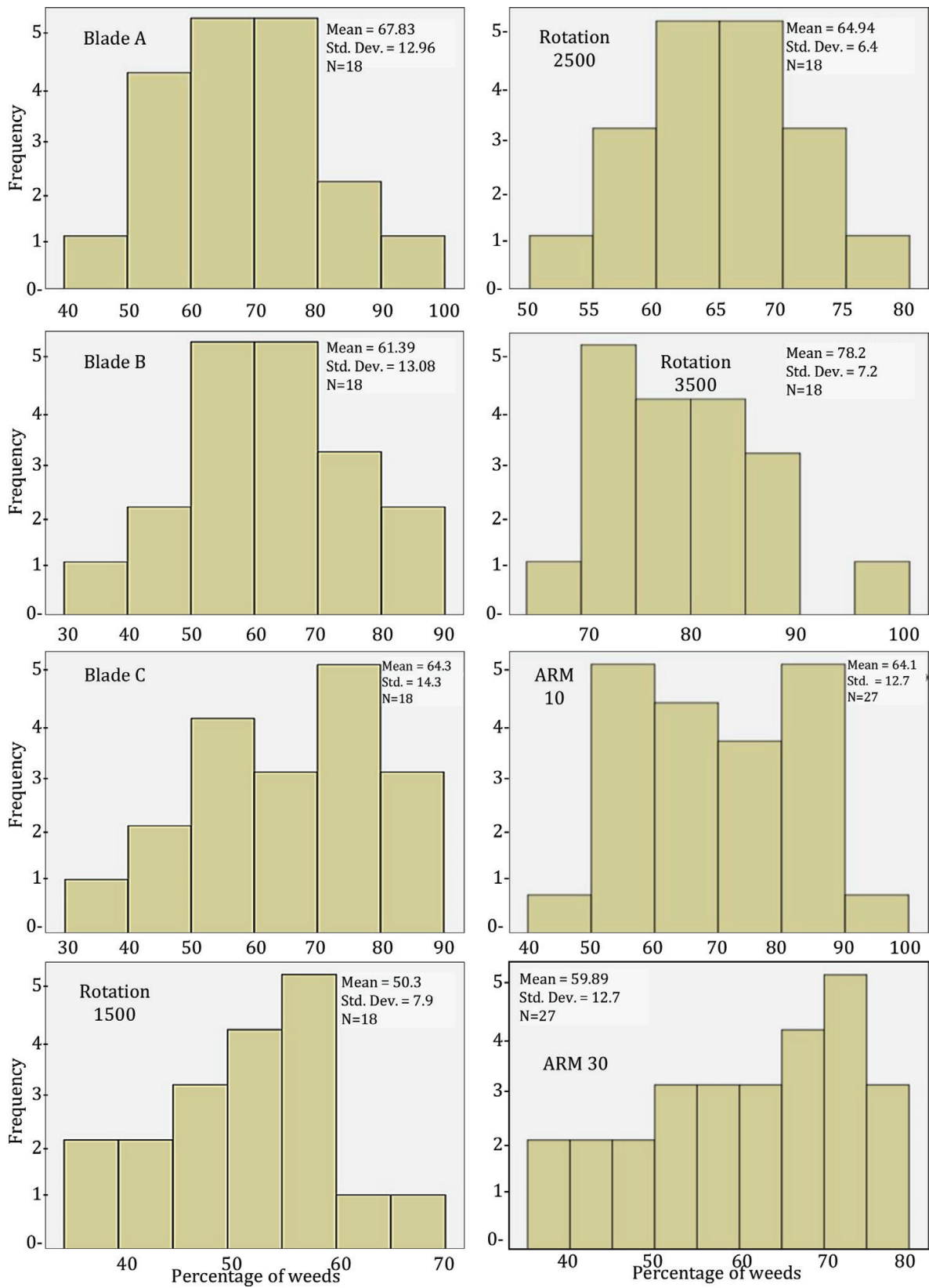

**Figure 10.** Bar plots describing percentage of weeds cut with different blade type, blade rotation speed, and robot arm speed.

showing that the mean PWC in 1500 rpm is the smallest (59.39%) and that of 3500 rpm was the largest (78.23%). The bar plots in **Figure 10** illustrate descriptive statistics and frequency of the PWC for the experiments with the robot using all factors (blade types A, B, C, blade rotation speeds of 1500, 2500, 3500 rpm, and arm motor speed of 10 and 30 rpm). It can be seen from **Figure 10** that the average PWC by the blades was significantly different. Consequently, the highest PWC cut was related to S-shaped at the blade rotation speed of 3500 rpm. In each motor arm speed, the increase in the rotational blade speed caused an increase in the PWC. In each rotational blade speed, if the motor arm speed increases, the PWC cut will decrease. Comparing the interactions between the three different types of blades, blade speed, and the speed of the arm the following results was obtained: the highest PWC in the entire experiment was 95%, which was obtained when the S-shaped blade at the rotational speed of 3500 rpm was used and motor speed was 10 rpm. The lowest PWC was 45%, which was obtained when the blade speed was 1500 rpm, AM speed was 30 rpm, and the blade type was triangular in shape. The analysis of the interaction of the BR speed and blade type showed that (i) none of the mutual interactions was significant in the variance test, (ii) t-test showed that if the rotational speed of the blade is low, the blade type will have a significant effect on the PWC, and (iii) for all the blade types, the highest PWC cut was at BR speed of 3500 rpm.

#### 4. Conclusion

In this study, we designed, developed, and fabricated a prototype robot for mechanical weed control in greenhouse cultivation of cucumber. Automatic weed cutting experiments that were carried using the robot consist of ultrasonic sensor, which senses the existence of weeds between the cucumber plants. The robot then moves between cucumber rows on a monorail in the greenhouse, with an arm that moves the blade between the plants for cutting the detected weeds. The entire process of weed detection, moving the arm and blades, and weeds cutting is carried out in 10 s. Among the three blade types tested (S-, triangular-, and circular shapes), it was concluded that the S-shape was the most efficient design. For the best blade rotation (BR) and arm motor (AM) speeds, it was concluded that as the AM speed increased, the percentage of weeds cut (PWC) reduces; therefore, the motor with 10 rpm, 8.15 N·m torque, 12 V, and 0.89 A was selected to for moving the arm. The average weeds cut at 10 and 30 rpm was 69.1 and 58.9%, respectively. Finally, it was concluded that the best robot performance corresponding to the highest percentage of weeds cut was achieved with the S-shaped blade when the BR speed was 3500 rpm, and the AM speed was 10 rpm.

#### Conflict of interest

The authors declare no conflict of interest.



## Author details

Amid Heravi<sup>1</sup>, Desa Ahmad<sup>1</sup>, Ibrahim A. Hameed<sup>2</sup>, Redmond Ramin Shamshiri<sup>1\*</sup>, Siva K. Balasundram<sup>3</sup> and Muhammad Yamin<sup>4</sup>

\*Address all correspondence to: [raminshamshiri@upm.edu.my](mailto:raminshamshiri@upm.edu.my)

1 Department of Biological and Agricultural Engineering, Faculty of Engineering, Universiti Putra Malaysia, Selangor, Malaysia

2 Department of ICT and Natural Sciences, Faculty of Information Technology and Electrical Engineering, NTNU, Ålesund, Norway

3 Department of Agriculture Technology, Faculty of Agriculture, Universiti Putra Malaysia, Selangor, Malaysia

4 Department of Farm Machinery and Power, University of Agriculture Faisalabad, Pakistan

## References

- [1] Shamshiri RR, Kalantari F, Ting KC, Thorp KR, Hameed IA, Weltzien C, et al. Advances in greenhouse automation and controlled environment agriculture: A transition to plant factories and urban agriculture. *International Journal of Agricultural and Biological Engineering*. 2018;**11**(1):1-22
- [2] Shamshiri RR, Mahadi MR, Thorp KR, Ismail WIW, Ahmad D, Man HC. Adaptive management framework for evaluating and adjusting microclimate parameters in tropical greenhouse crop production systems. In: Jurić S, editor. *Plant Engineering*. Rijeka: InTech; 2017
- [3] Ting KC, Lin T, Davidson PC. Integrated urban controlled environment agriculture systems. In: Kozai T, Fujiwara K, Runkle ES, editors. *LED Lighting for Urban Agriculture*. Singapore: Springer Singapore; 2016. pp. 19-36
- [4] Popay I, Field R. Grazing animals as weed control agents. *Weed Technology*. 1996;**10**(1):217-231
- [5] Baumann PA, Bade DH, Biediger DL. Forage grass response to chemical and mechanical weed control measures. *Weed Science*. 1991;**193**:32-40
- [6] Lamm RD, Slaughter DC, Giles DK. Precision weed control system for cotton. *Transactions of ASAE*. 2002;**45**(1):231
- [7] Lee WS, Slaughter DC, Giles DK. Robotic weed control system for tomatoes. *Precision Agriculture*. 1999;**1**(1):95-113
- [8] Burks TF, Subramanian V, Singh S. Autonomous greenhouse sprayer vehicle using machine vision and ladar for steering control. In: *Proceedings of the Conference of Automation Technology for Off-Road Equipment*; 2004. p. 79

- [9] Subramanian V. Autonomous Vehicle Guidance Using Machine Vision and Laser Radar for Agricultural Applications. Doctoral dissertation, University of Florida. 2005
- [10] Ollero A, Mandow A, Muñoz VF, De Gabriel JG. Control architecture for mobile robot operation and navigation. *Robotics and Computer-Integrated Manufacturing*. 1994;**11**(4): 259-269
- [11] Mandow A, Gomez-de-Gabriel JM, Martinez JL, Munoz VF, Ollero A, Garcia-Cerezo A. The autonomous mobile robot AURORA for greenhouse operation. *IEEE Robotics and Automation Magazine*. 1996;**3**(4):18-28
- [12] Martínez JL, Mandow A, Morales J, Pedraza S, García-Cerezo A. Approximating kinematics for tracked mobile robots. *International Journal of Robotics Research*. 2005;**24**(10): 867-878
- [13] Shamshiri RR, Hameed IA, Karkee M, Weltzien C. Robotic harvesting of fruiting vegetables: A simulation approach in V-REP, ROS and MATLAB. In: *Automation in Agriculture-Securing Food Supplies for Future Generations*. Rijeka, Croatia: InTech; 2018
- [14] Billingsley J, Visala A, Dunn M. Robotics in agriculture and forestry. In: *Springer Handbook of Robotics*. Berlin, Heidelberg: Springer; 2008. pp. 1065-1077
- [15] González R, Rodríguez F, Sánchez-Hermosilla J, Donaire JG. Navigation techniques for mobile robots in greenhouses. *Applied Engineering in Agriculture*. 2009;**25**(2):153-165
- [16] Bontsema J, van Os EA, Van Henten EJ, Hemming J, van Tuijl BAJ, Kornet JG, et al. An autonomous robot for harvesting cucumbers in greenhouses. *Journal of Autonomous Robots*. 2002;**13**:241-258
- [17] Hopkins M. Automating in the 21st century career and technical education. *Greenhouse Grower*. 2000:4-12
- [18] Pilarski T, Happold M, Pangels H, Ollis M, Fitzpatrick K, Stentz A. The demeter system for automated harvesting. *Autonomous Robots*. 2002;**13**(1):9-20
- [19] Sezen B. Modeling Automated Guided Vehicle Systems in Material Handling. *Dogus Oniversiiesi Dergisi*. 2003;**4**(2):207-216
- [20] Shamshiri R, Ismail WIW. A review of greenhouse climate control and automation systems in tropical regions. *Journal of Agri-Food and Applied Sciences*. 2013;**2**(3):176-183
- [21] Bac CW, Roorda T, Reshef R, Berman S, Hemming J, van Henten EJ. Analysis of a motion planning problem for sweet-pepper harvesting in a dense obstacle environment. *Biosystems Engineering*. 2016;**146**(Supplement C):85-97
- [22] Bloch V, Degani A, Bechar A. A methodology of orchard architecture design for an optimal harvesting robot. *Biosystems Engineering*. 2018;**166**:126-137
- [23] Monta M, Kondo N, Ting KC. End-effectors for tomato harvesting robot. In: *Artificial Intelligence for Biology and Agriculture*. Dordrecht: Springer; 1998. pp. 1-25

- [24] Kiani S, Jafari A. Crop detection and positioning in the field using discriminant analysis and neural networks based on shape features. *Journal of Agricultural Science and Technology*. 2012;**14**:755-765
- [25] Perez AJ, Lopez F, Benlloch JV, Christensen S. Colour and shape analysis techniques for weed detection in cereal fields. *Computers and Electronics in Agriculture*. 2000;**25**(3):197-212
- [26] Cho S, Lee DS, Jeong JY. AE—Automation and emerging technologies: Weed–plant discrimination by machine vision and artificial neural network. *Biosystems Engineering*. 2002;**83**(3):275-280
- [27] Åstrand B, Baerveldt A-J. An agricultural mobile robot with vision-based perception for mechanical weed control. *Autonomous Robots*. 2002;**13**(1):21-35
- [28] Jafari A, Mohtasebi SS, Jahromi HE, Omid M. Weed detection in sugar beet fields using machine vision. *International Journal of Agriculture and Biology*. 2006;**8**(5):602-605
- [29] Huang M, He Y. Crop and weed image recognition by morphological operations and ann model. In: *Instrumentation and Measurement Technology Conference Proceedings (IMTC 2007)*. IEEE; 2007. pp. 1-4
- [30] Meyer GE, Mehta T, Kocher MF, Mortensen DA, Samal A. Textural imaging and discriminant analysis for distinguishing weeds for spot spraying. *Transactions of ASAE*. 1998;**41**(4):1189
- [31] Polder G, van Evert FK, Lamaker A, de Jong A, van der Heijden GWAM, Lotz LAP, van der Zalm AJA, Kempenaar C. Weed detection using textural image analysis. *EFITA/WCCA conference; 2007*
- [32] Zhu B, Jiang L, Luo Y, Tao Y. Gabor feature-based apple quality inspection using kernel principal component analysis. *Journal of Food Engineering*. 2007;**81**(4):741-749
- [33] Mehta SS, Burks TF. Vision-based control of robotic manipulator for citrus harvesting. *Computers and Electronics in Agriculture*. 2014;**102**:146-158
- [34] Zhao Y, Gong L, Huang Y, Liu C. A review of key techniques of vision-based control for harvesting robot. *Computers and Electronics in Agriculture*. 2016;**127**(Supplement C): 311-323
- [35] Choi D, Lee WS, Ehsani R, Roka FM. A machine vision system for quantification of citrus fruit dropped on the ground under the canopy. *Transactions of the ASABE*. 2015;**58**(4): 933-946
- [36] Mehta SS, MacKunis W, Burks TF. Robust visual servo control in the presence of fruit motion for robotic citrus harvesting. *Computers and Electronics in Agriculture*. 2016;**123**: 362-375
- [37] Sandini G, Buemi F, Massa M, Zucchini M. Visually guided operations in green-houses. In: *IEEE International Workshop on Intelligent Robots and Systems' 90. Towards a New Frontier of Applications, Proceedings. IROS'90; 1990*. pp. 279-285

- [38] Dario P, Sandini G, Allotta B, Bucci A, Buemi F, Massa M, Ferrari F, Magrassi M, Bosio L, Valleggi R. The Agrobot project for greenhouse automation. In: International Symposium on New Cultivation Systems in Greenhouse 361; 1993. pp. 85-92
- [39] Langenakens J, Vergauwe G, De Moor A. Comparing hand held spray guns and spray booms in lettuce crops in a greenhouse. *Aspects of Applied Biology*. 2002;**66**:123-128
- [40] Nuyttens D, Windey S, Sonck B. Comparison of operator exposure for five different greenhouse spraying applications. *Journal of Agricultural Safety and Health*. 2004;**10**(3):187
- [41] Sánchez-Hermosilla J, Rodríguez F, González R, Guzmán JL, Berenguel M. A mechatronic description of an autonomous mobile robot for agricultural tasks in greenhouses. In: *Mobile Robots Navigation*. Rijeka, Croatia: InTech; 2010
- [42] Borenstein J, Everett HR, Feng L. *Navigating Mobile Robots: Systems and Techniques*. Wellesley, MA: AK Peters, Ltd.; 1996
- [43] Shamshiri R, Ishak W, Ismail W. Design and simulation of control systems for a field survey mobile robot platform. *Research Journal of Applied Sciences, Engineering and Technology*. 2013;**6**(13):2307-2315
- [44] Van Henten EJ, Van Tuijl BAJ, Hoogakker GJ, Van Der Weerd MJ, Hemming J, Kornet JG, et al. An autonomous robot for de-leafing cucumber plants grown in a high-wire cultivation system. *Biosystems Engineering*. 2006;**94**(3):317-323
- [45] Burks TF, Shearer SA, Heath JR, Donohue KD. Evaluation of neural-network classifiers for weed species discrimination. *Biosystems Engineering*. 2005;**91**(3):293-304
- [46] Granitto PM, Verdes PF, Ceccatto HA. Large-scale investigation of weed seed identification by machine vision. *Computers and Electronics in Agriculture*. 2005;**47**(1):15-24
- [47] Belforte G, Deboli R, Gay P, Piccarolo P, Aimonino DR. Robot design and testing for greenhouse applications. *Biosystems Engineering*. 2006;**95**(3):309-321
- [48] Persson S. *Mechanics of Cutting Plant Material*. St. Joseph, Michigan, USA: American Society of Agricultural Engineers; 1987

