



Norwegian University of  
Science and Technology

# Investment Analysis with the EMPS Model with Emphasis on Central Norway

**Steinar Beurling**

Master of Science in Energy and Environment

Submission date: June 2010

Supervisor: Gerard Doorman, ELKRAFT

Norwegian University of Science and Technology  
Department of Electric Power Engineering



# Problem Description

The EMPS model is a fundamental model for optimizing and simulation of large power systems with a substantial amount of hydro power. It is developed by SINTEF Energy Research and is commonly used among participants in the Nordic power market. SINTEF Energy Research has recently developed investment functionality which makes it possible to optimize implementation of certain capacity in production or transmission

The purpose of this thesis is multi-sectional:

1. Study and learn how to use the EMPS model
2. Study the newly developed investment model
3. The investment model uses average prices. Especially for analysis of exchange with continental Europe it is necessary to divide the week in several periods (peak, high day etc). Implement this feature.
4. Implement a maximum capacity on investments.
5. Model relevant alternatives to solve the difficult supply situation in Central Norway
6. Do an investment analysis with the investment model to find optimal investments.
7. Do sensitivity analysis for important assumptions (e.g. investment costs, demand),
8. Document and discuss the analysis as well as the functionality of the investment model

Point 1-4 are done together with Mats Elvethon Bakken

Assignment given: 22. January 2010  
Supervisor: Gerard Doorman, ELKRAFT



## Abstract

Central Norway has had a significant growth in power consumption over the last few years, and demand is expected to rise. Due to lack of investment in sufficient generation and transmission capacity, Central Norway is expected to have a significant power deficit in an average year and severe deficits in dry years. This thesis investigates the power situation in Central Norway by using the EMPS model developed at SINTEF Energy Research combined with newly developed investment functionality.

The thesis has studied the EMPS model and developed new functionality for the investment model in order to do more precise investment analyses. Simulations on optimal investments in different cases concerning increased load and subsidies on wind power investments have been done as well.

The simulations show that the power situation Central Norway is close to critical and that investments must be executed to avoid high risk of rationing in a future situation with higher demand.

The investment analysis based on the present state show that the proposed transmission investments on Nea–Järpstrømmen and Ørskog–Fardal are sensible and very useful for the power situation in Central Norway.

Simulations show that subsidies to encourage wind power development might cause more uncertain and variable prices due to lower price incentives to build new transmission capacity. Simulations also show that large wind power investments will have a substantial impact on how hydro power is utilized in Norway.

The investment functionality has shown a good capability to obtain sensible solutions that give less price variation throughout the system and reasonable price distributions as long as the investments are small enough to not have substantial impact on hydro power utilization.



---

# Preface

This master thesis is carried out at the Department of Electric Power Engineering at the Norwegian University of Science and Technology in spring 2010.

I would like to thank my supervisor professor Gerard Doorman at NTNU. In addition I would like to thank Stefan Jaehnert and Ove Wolfgang at SINTEF Energy Research for help with the EMPS model and the investment functionality respectively. I would also like to thank my fellow students, especially Mats Elvethon Bakken which I have collaborated with on parts of this thesis.

---



# Contents

<b>1</b>	<b>Introduction</b>	<b>1</b>
1.1	Background . . . . .	1
1.2	Scope . . . . .	2
1.3	Limitations . . . . .	2
1.4	Collaboration . . . . .	3
<b>2</b>	<b>EMPS</b>	<b>5</b>
2.1	Physical modeling . . . . .	6
2.1.1	Hydro power . . . . .	7
2.1.2	Thermal power . . . . .	10
2.1.3	Wind power . . . . .	10
2.1.4	Demand . . . . .	10
2.1.5	Grid data . . . . .	12
2.2	Strategy . . . . .	12
2.2.1	Area aggregation . . . . .	12
2.2.2	Water values . . . . .	14
2.3	Simulation . . . . .	19
2.3.1	Reservoir drawdown . . . . .	20

2.3.2	Interaction between area optimization and reservoir drawdown . . . . .	21
<b>3</b>	<b>Investment analysis</b>	<b>23</b>
3.1	Background . . . . .	23
3.2	Functionality overview . . . . .	24
3.3	Mathematical description . . . . .	26
3.4	Convergence in the investment algorithm . . . . .	30
3.5	Algorithm improvements . . . . .	31
<b>4</b>	<b>Input data</b>	<b>33</b>
4.1	Areas . . . . .	33
4.1.1	Netherlands . . . . .	35
4.2	Production, consumption and transmission . . . . .	35
4.2.1	Transmission changes . . . . .	35
4.3	Investment parameters . . . . .	36
4.3.1	The cost of thermal and wind power . . . . .	36
4.3.2	Wind power utilization . . . . .	38
4.3.3	Transmission lines . . . . .	38
4.4	Price segments . . . . .	40
<b>5</b>	<b>Improvements</b>	<b>41</b>
5.1	Maximum investment . . . . .	41
5.2	Price segments . . . . .	42
<b>6</b>	<b>Simulations</b>	<b>49</b>
6.1	Calibration . . . . .	50
6.2	Basecase . . . . .	50
6.3	Investments with standard costs . . . . .	52

## CONTENTS

---

6.4	Investments with wind power subsidies . . . . .	57
6.5	10 % higher demand in Central Norway . . . . .	63
6.6	20% higher demand in Central Norway . . . . .	68
<b>7</b>	<b>Discussion</b>	<b>73</b>
7.1	Current situation . . . . .	73
7.2	10% increased demand . . . . .	74
7.3	20% increased demand . . . . .	75
7.4	Calibration . . . . .	76
<b>8</b>	<b>Conclusion</b>	<b>77</b>
<b>9</b>	<b>Further Work</b>	<b>79</b>
9.1	Thorough model verification . . . . .	79
9.2	Changes to the investment model . . . . .	79
9.3	Other simulations . . . . .	81
<b>A</b>	<b>Areas and transmission lines</b>	<b>87</b>
<b>B</b>	<b>Wind power license applications</b>	<b>90</b>
<b>C</b>	<b>Simulation results</b>	<b>93</b>



# List of Figures

2.1	Aggregate System model[5] . . . . .	6
2.2	Hydro power module[5] . . . . .	8
2.3	Example of an annual demand profile[5] . . . . .	11
2.4	Planning period from week k to week N, [5] . . . . .	15
2.5	Basis of estimation the water value $\kappa_0$ , [5] . . . . .	17
2.6	Water value iteration process, [5] . . . . .	18
2.7	The weekly decision process in the EMPS model[5] . . . . .	22
3.1	Investment functionality in EMPS . . . . .	25
4.1	Areas in the model . . . . .	34
6.1	Basecase results . . . . .	51
6.2	New and upgraded transmission lines . . . . .	53
6.3	Standard investment results . . . . .	56
6.4	Weekly prices with wind power subsidies . . . . .	61
6.5	Percentile prices in NORGEMIDT with wind power subsidies	62
6.6	Weekly prices in NORGEMIDT, OSTLAND and VESTSYD with 10% increase in demand . . . . .	66

6.7 Percentile prices in NORGEMIDT with 10% increase in demand . . . . .	67
6.8 Percentile prices in NORGEMIDT with 20% increase in demand . . . . .	71
6.9 Weekly prices in NORGEMIDT, OSTLAND and VESTSYD with 20% increase in demand . . . . .	72
C.1 The problem of iterations with only transmission changes . . . . .	95
C.2 Investment results with 10 percent subsidies . . . . .	95
C.3 Investment results with 20 percent subsidies . . . . .	96
C.4 Investment results with 30 percent subsidies . . . . .	96
C.5 Investment results with 40 percent subsidies . . . . .	96
C.6 Investment results with 50 percent subsidies . . . . .	97
C.7 Investment results with 10 percent demand increase and no subsidies . . . . .	97
C.8 Investment results with 10 percent demand increase and 20 percent subsidies . . . . .	97
C.9 Investment results with 10 percent demand increase and 40 percent subsidies . . . . .	98
C.10 Investment results with 20 percent demand increase and no subsidies . . . . .	98
C.11 Investment results with 20 percent demand increase and 20 percent subsidies . . . . .	98
C.12 Investment results with 20 percent demand increase and 40 percent subsidies . . . . .	99

# List of Tables

3.1	List of symbols . . . . .	27
4.1	Transmission capacity into NORGEMIDT . . . . .	36
4.2	Investment costs . . . . .	38
4.3	Wind power utilization . . . . .	39
4.4	Line investment costs . . . . .	39
4.5	Price segments . . . . .	40
5.1	<code>norgemidt.inv</code> example . . . . .	42
5.2	<code>data.gen</code> example . . . . .	43
5.3	Investment options for thermal power production . . . . .	44
5.4	Investment options for wind power production . . . . .	44
5.5	Investment options for transmission . . . . .	45
5.6	First iteration results . . . . .	46
5.7	Investment results . . . . .	47
6.1	Investments with standard costs . . . . .	54
6.2	Wind power subsidies . . . . .	57
6.3	Investments with wind power subsidies . . . . .	60

6.4	Investments with 10% increased demand in Central Norway and different wind power subsidies . . . . .	65
6.5	table: Overview of rationing amount and costs . . . . .	65
6.6	Investments with 20% increased demand in Central Norway and different wind power subsidies . . . . .	70
A.1	List of areas . . . . .	87
A.2	Transmission capacity in the Nordic grid . . . . .	88
B.1	Wind power licence applications in NORGEMIDT . . . . .	90
B.2	Wind power licence applications in HELGELAND . . . . .	91
B.3	Wind power licence applications in TROMS . . . . .	92
B.4	Wind power licence applications in FINNMARK . . . . .	92
C.1	Calibration parameters . . . . .	93



---

# Chapter 1

## Introduction

### 1.1 Background

After the power market deregulation in 1991, the power system strategy changed from focus on supply reliability to focus on market optimization. This has led to a decline in investments, while the demand has increased steadily. The combination of these has caused some years with power scarcity and subsequent high energy prices. This has been especially dominant in the winters of 2003 and 2010, with prices reaching  $1000 \frac{\text{€}}{\text{MWh}}$  in some areas during peak hours in January 2010.

Central Norway has had a significant growth in power consumption over the last few years, and demand is expected to rise. Due to lack of investment in sufficient generation and transmission capacity, Central Norway is expected to have a significant power deficit in an average year and severe deficits in dry years.

## 1.2 Scope

This thesis will look on a newly developed investment functionality connected with SINTEF Energy Research's EMPS model in order to establish optimal socioeconomic investments to improve the power situation in Central Norway. The simulations will consider present state simulation in addition to future scenarios with 10-20% increase in demand.

The investment simulations will consider realistic investment parameters based on actual projects and do a reasonable approach in order to modify these parameters to the investments in question. The system will also consider different subsidy schemes in order to make wind power more profitable and see how the market will react to the corresponding optimal investments.

A significant part of the work is to study the manner of operation and usage of the EMPS model as well as study the investment model. This model will be further developed by adding maximum capacity on investments and include price segments to make the investment model consider daily consumption patterns.

## 1.3 Limitations

This thesis will not consider all possible investment options, but will focus on increased transmission capacity from surrounding areas, wind power production from Central Norway and northwards in addition to possible gas powered thermal power plants in Central Norway.

This thesis is also limited to issues concerning Central Norway. Possible increase in demand in other areas that could affect the situation in Central Norway is considered outside the scope of this thesis.

## 1.4 Collaboration

The study of applicable models and development of new functionality is done in collaboration with Mats Elvethon Bakken.



---

## Chapter 2

# EMPS

Production scheduling for power systems where large parts consists of hydro power is a complex task. These systems are characterized by large differences in supply due to changing hydrological conditions, both within a year and between years.

To analyze these power systems, a power market simulator that can handle the complexity is needed. The EMPS model is one such simulator that aims at optimal use of hydro resources, in relation to uncertain future inflows, thermal generation, power demand and spot type transactions within or between areas. The model consists of two main parts, one strategy part and one simulation part. [13]

In the strategy part, regional decision tables in the form of water values are computed for each area in the system, using stochastic dynamic programming. [13] In the simulation part optimal decisions are evaluated based on historic hydrological data, typically 30-100 years. Power production is determined for each time step in a market clearing process, based on the computed water values for each area. This will be further discussed in

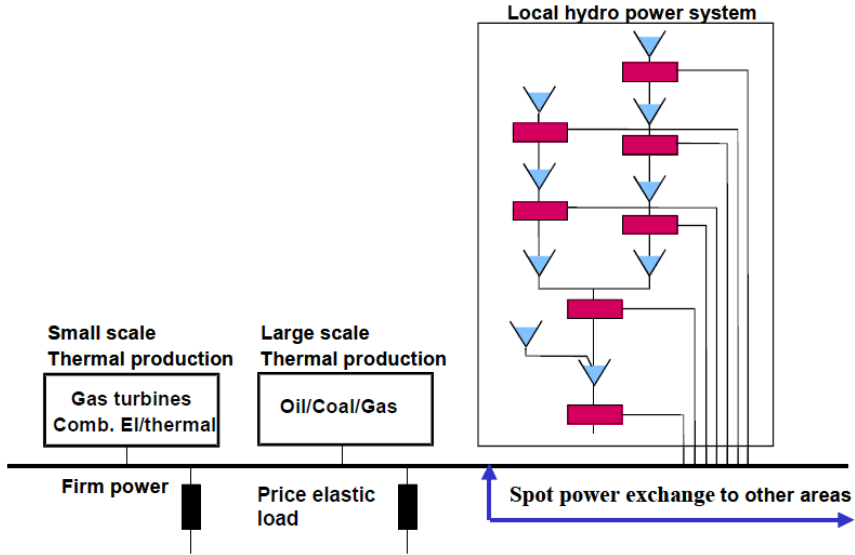

Figure 5-3: Aggregate system model

Figure 2.1: Aggregate System model[5]

chapters 2.2 and 2.3.

## 2.1 Physical modeling

The power system is modeled by dividing it into multiple areas. Each area can contain power production modeled as either hydro or thermal power, in addition to demand contracts. Each area will also have electrical connections with the surrounding areas. A schematic diagram of an area is shown in figure 2.1. An area could, but does not have to, include all elements.

### 2.1.1 Hydro power

Hydro power is modeled by a series of hydro power modules, with either regulated or unregulated inflow, or a combination of both. The unregulated inflow is the inflow that can not be stored in the module's reservoir. The EMPS model uses a standard module to describe each hydro module. The module consists of a reservoir, a generator and information about inflow and restrictions. Different endpoints may be defined for spillage, bypass and discharge. E.g. can bypass and discharge continue down the same river system, while spillage may be lost. Figure 2.2 shows a schematic diagram of a standard hydro power module. [5] As figure 2.1 indicates, the local hydro system could consist of several hydro modules that can be both series and parallel coupled. A single river can have multiple hydro modules, and several rivers can congregate into one river, causing one module to possibly have multiple reservoirs.

#### Reservoir

The most important parameter for the reservoir is its volume, which is given in  $Mm^3$  and must always be specified. A completely unregulated reservoir would be modeled with a reservoir volume of 0. Since the power output increases with the water column above the generator, a piecewise linear curve describing the relation between the volume and the corresponding reservoir level can be specified. This results in a more realistic model where production will depend on the reservoir level.

#### Plant

The minimum specifications that are needed for the plant are the discharge capacity in  $\frac{m^3}{s}$  and its average energy equivalent in  $\frac{kWh}{m^3}$ . The energy equiv-

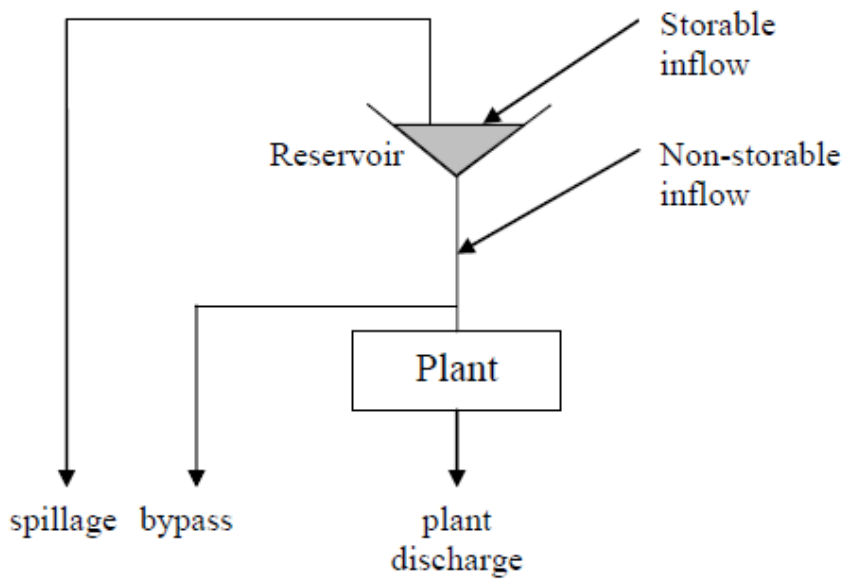

Figure 2.2: Hydro power module[5]



## 2.1. PHYSICAL MODELING

---

alent states how much energy is stored in the reservoir per  $m^3$  of water in the reservoir, and is calculated as in (2.1). [5]

$$e = \frac{1}{3.6 \cdot 10^6} \cdot \gamma \cdot g \cdot H \cdot \eta \quad (2.1)$$

where

- $\gamma$  - Water density  $\left[\frac{kg}{m^3}\right]$
- $g$  - Gravity acceleration  $\left[\frac{m}{s^2}\right]$
- $H$  - Plant Head  $[m]$
- $\eta$  - Plant efficiency

### Constraints

Multiple constraints could be attributed to each module. It may have one or more of the following constraints: [5]

- Maximum and minimum reservoir level
- Maximum and minimum discharge
- Maximum and minimum bypass

The constraints can be hard, i.e. satisfied at any cost, or soft which means that they are satisfied as long as production is not lost. Failure to satisfy the soft constraints is penalized by a given penalty function.

### Pumping

In some modules, pumping is used to pump water between reservoirs in order to increase the potential energy of the water. This is done at times with low prices, typically during night in systems with much thermal power.

In systems with much hydro power, this is often used to improve the total utilization of the water. [5]

### 2.1.2 Thermal power

A thermal power plant is usually modeled as price dependent supply. It is represented by its expected capacity and the associated production costs, which is mainly fuel costs. Capacity is given in MW, production costs in  $\frac{\text{cent}}{\text{kWh}}$  and expected availability in %. E.g. a 100 MW plant with 80% availability will be treated as an 80MW plant in the simulations. This model assumes that fuel can be bought whenever needed, which is a valid assumption for coal, oil and nuclear powered plants and for some types of gas power plants. Gas power can also be modeled with fixed supply, local gas storage or with specified gas tapping within periods. [5]

### 2.1.3 Wind power

Wind power in EMPS is in this report modeled as a hydro unit. Inflow is created from wind patterns and used as unregulated inflow, thus eliminating the need for a reservoir. Wind power could also be modeled as a contract with a sale price of zero.

### 2.1.4 Demand

Demand can be modeled as either **firm demand** or **price elastic demand**. Traditionally, the firm demand, which include industrial, service and domestic sectors, has been considered completely inelastic. But after deregulation of power markets it has become clear that even firm demand has some price elasticity. [5]

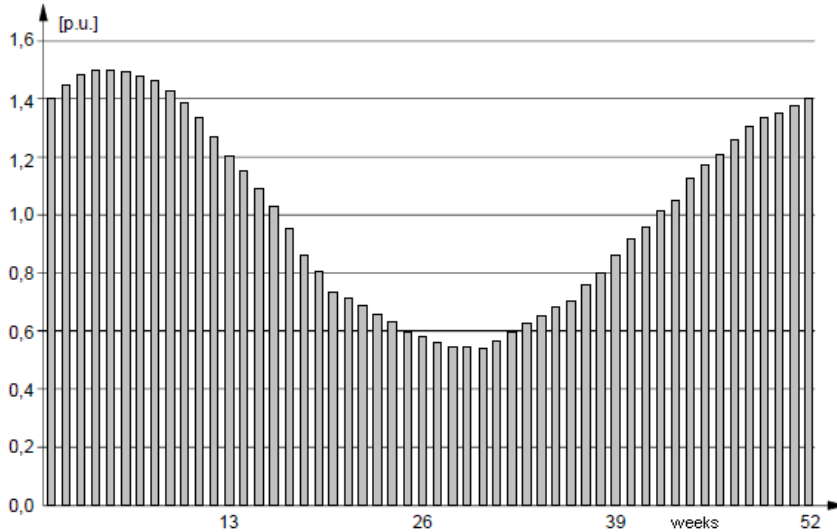

Figure 2.3: Example of an annual demand profile[5]

### Firm demand

An example of an annual firm demand profile can be seen in figure 2.3. Firm demand is defined by: [5]

- An annual quantity in GWh
- An annual profile with a time step of one week
- A distribution between load periods within the week

Demand for a single week is given in (2.2), where  $f_i$  is the relative demand factor for week  $i$ .

$$W_i = \frac{f_i}{\sum_{i=1}^{52} f_i} \cdot W_{year} \quad (2.2)$$

Demand within the week is described by a number of factors relative to each other, dividing weekly demand between peak hours, weekend, night, etc. This way, EMPS operates with time periods shorter than the basic time step of one week.

### **Price elastic demand**

The price elastic demand is defined by: [5]

- A weekly quantity in GWh
- A switch-off price in  $\frac{\text{cent}}{\text{kWh}}$

The intention of is that a price elastic demand will have a certain electricity demand until the electricity price is above a certain point. An example could be that gas or oil would be used for heating if the energy price for that were cheaper than that of electricity.

#### **2.1.5 Grid data**

Information about the grid between the different areas in the system is specified with aggregated lines between the areas. Areas connected by the line, transmission capacity in each direction and energy loss in percent must be given. Transmission fees can also be specified where applicable. [14]

## **2.2 Strategy**

### **2.2.1 Area aggregation**

As discussed in chapter 2.1, the system is aggregated by dividing it into several areas and specifying production and consumption within each area in addition to transmission capacity between areas.

### **Equivalent reservoir**

Energy from each reservoir within an area in the detailed model is added to one equivalent reservoir. The energy in each reservoir is found from multiplying reservoir volumes with the corresponding energy equivalents as discussed in chapter 2.1.1, with plant head as meters above sea level. Reservoir constraints that are specified in the detailed model are also converted to the equivalent model. [5]

### **Equivalent plant**

The maximum capacity for all plants in an area is added to one equivalent plant. Discharge constraints are converted to  $\frac{GWh}{week}$  and represented as minimum and maximum capacity constraints in the aggregate model, thus creating variable capacities for each week throughout the year. [5]

### **Energy inflow**

Because all reservoirs are modeled as one large reservoir in the aggregate model, inflow has to be treated in a special way in order to avoid unrealistic reservoir utilization. Without special considerations, the large aggregated reservoir would not consider overflow and spillage in the real reservoirs from the detailed model. To avoid this situation, the real plants would be running at maximum capacity, and it is important that this is reflected in the aggregate model. Because of this, the distribution between storable and non-storable energy inflow in the aggregate model is calculated by simplified runs of the detailed model, as shown in equations (2.3) and (2.4). [5]

**Non-storable inflow =**

$$\begin{aligned} & \text{Generation due to non-storable inflow to the power systems} \\ + & \text{ Generation due to minimum discharge and/or bypass constraints} \\ + & \text{ Generation necessary to avoid spillage} \\ - & \text{ Energy used for pumping to avoid spillage} \end{aligned} \tag{2.3}$$

**Storable inflow =**

$$\begin{aligned} & \text{Sum production (including time-of-use purchase contracts)} \\ + & \text{ Increase in reservoir volume (or - decrease in reservoir volume)} \\ - & \text{ Energy used for pumping} \end{aligned} \tag{2.4}$$

**2.2.2 Water values**

To determine when hydro power plants should run to maximize its profits, a value has to be placed on the water. There is no cost attached to using the water itself but it has a potential future value and it can therefore be looked upon as an opportunity cost. The potential future value is dependent on many factors including inflow to the reservoirs, market prices and load.

To calculate the water values an extensive computer program has to be used, one such is the EMPS model developed by SINTEF. The EMPS model uses a planning period of one to five years with a time step of one week. For every week the goal is to minimize the operation dependent costs of the next and all the following weeks' generation [5]. The function  $J(x, k)$  gives the value of the total expected operation dependent costs from  $k$  until

## 2.2. STRATEGY

---

the end of the planning period.  $J(x, k)$  is a function of reservoir level  $x$  and the time  $k$ . This cost dependent function can be derived from figure 2.4.

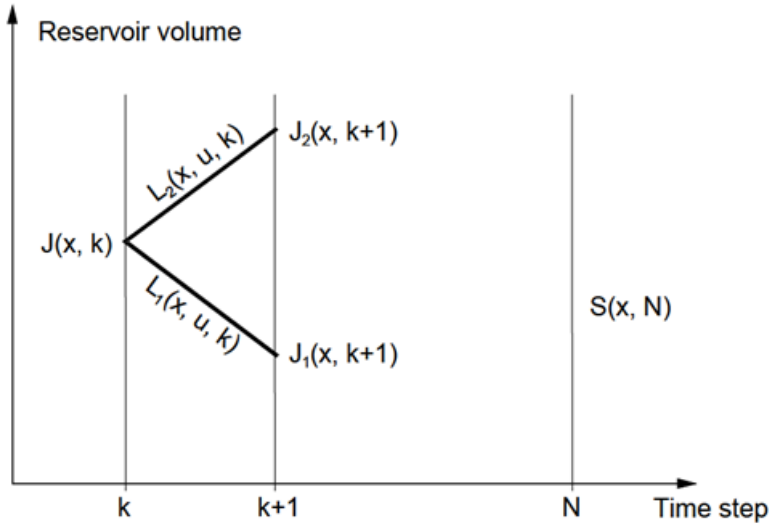

Figure 2.4: Planning period from week  $k$  to week  $N$ , [5]

The equation for the cost dependent function can then be formulated as (2.5).

$$J(x, k) = S(x, N) + \sum_{i=k}^N L(x, u, i) = L(x, u, k) + J(x, k+1) \quad (2.5)$$

Where  $S(x, N)$  is the cost related to the change in the reservoir level. In other words the value at  $k$  minus the value at  $N$  as a function of the reservoir level,  $x$ , at the end of the planning period,  $N$ .  $L(x, u, i)$  is the operation dependent cost going from  $i$  to  $i+1$ .  $u$  is the energy drawn from

the reservoir to produce power  $p$ ,  $u = f(p)$ .

The optimal handling of the reservoir is achieved when the total operation dependent costs are minimized with regard to the energy  $u$  used from the reservoir:

$$\min_u J = \min_u L(x, u, k) + J(x, k + 1) \Rightarrow \frac{\partial J}{\partial u} = 0 \quad (2.6)$$

The result of this derivation, and thereby the optimal handling of the reservoir for period  $k$  is:

$$\frac{\partial L}{\partial u_k} = \frac{\partial J}{\partial x_{k+1}} \quad (2.7)$$

Where  $\frac{\partial L}{\partial u_k}$  is the marginal operation dependent cost for, amongst others, sale and purchase.  $\frac{\partial J}{\partial x_{k+1}}$  is the derivative of the total future operation dependent costs with regard to the reservoir level. This is the marginal water value.

This means that if the water value for one week is known the optimal water value the week before would be the same.

It is important to be aware of the fact that this derivation assumes that the inflow is known. To take into account the uncertainty related to the inflow this calculation has to be run with a number of different inflow scenarios. When using stochastic inflow the water value will have to be calculated for each of the different inflow scenarios as described above. This will give  $n$  different water values for each of the reservoir points that are calculated,  $\kappa_i$ . The optimal water value is then calculated with the formula:

$$\kappa_0 = \sum_{i=1}^n \kappa_i k_i \quad (2.8)$$



## 2.2. STRATEGY

---

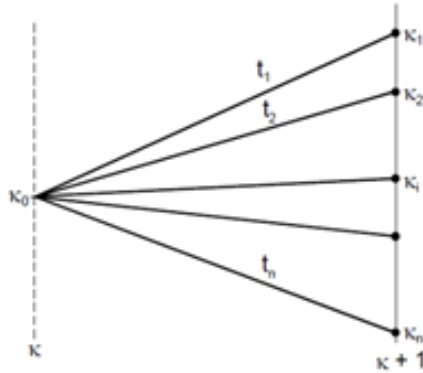

Figure 2.5: Basis of estimation the water value  $\kappa_0$ , [5]

Where  $\kappa_i$  are the water values for the different inflow scenarios,  $k_i$  is the probability of the inflow scenario to occur and  $\kappa_0$  the resulting optimal water value. This is illustrated in figure 2.5.

To get correct calculations of the water values it is important to model what happens when the reservoir is either full or empty correctly.

When the reservoir is full any inflow will be spilled, this means that the water is not worth anything and the water value at this point is set to zero. To avoid overflow generation can be increased above what the water value at the end of the week normally would tell you to produce. This means that the power will be sold at a lower price than the water value. The water value at the beginning of the week will be set to the price of the last sold kWh. [5]

An empty reservoir will result in the water value being equal to the last purchased or curtailed kWh. This means that the water value near the lower reservoir limit is highly dependent on the rationing or curtailment cost. [5]

To calculate the water values backward dynamic programming is used,

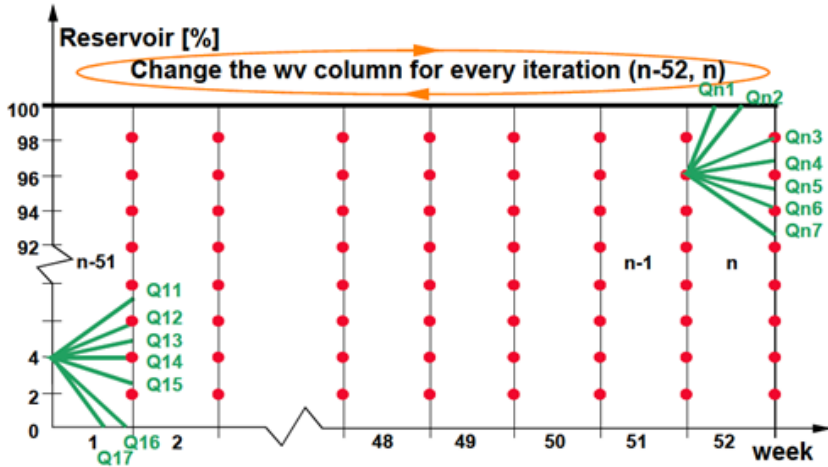

Figure 2.6: Water value iteration process, [5]

storing the derivative of the total costs instead of the total cost. To be able to solve (2.7) the water value at the end of the period needs to be known. This value will have to be estimated and if a significantly long enough planning period is chosen the present week water value will be independent of the estimated end water value. The estimated water value at the end is with other words not important as long as the time horizon is long enough. How long the time frame has to be is determined by the reservoir's degree of regulation, for a big degree of regulation a long time span is needed. A reservoirs degree of regulation is expressed by:

$$\alpha = \frac{R_{max}}{Q_a} \quad (2.9)$$

Where  $\alpha$  is the degree of regulation,  $R_{max}$  is the maximum reservoir capacity and  $Q_a$  the annual inflow to the reservoir.

Instead of using a guessed starting value an iteration process is used. Initial water values are set and the water value is calculated back one year. The water value at the start of the year is then compared with the initial guess. If the deviation between them is above a certain tolerance the water values at the start of the year is set as initial values and the water values back a year is calculated again. This is done until a satisfactory precision is reached. The water values for the remaining years are then calculated. This process can be seen in figure 2.6.

## 2.3 Simulation

After the strategy phase and water value computations, a system simulation based on optimal power flow must be done in order to obtain the system operation state for different inflow scenarios. The system simulations will not give the accurate optimal solution, since future inflow is unknown. The water values are rather calculated in a way that gives the optimal system utilization in the long run, based on expected inflows, taking into account extreme conditions and their economic impact. The simulation logic is based on two steps: [5]

1. Optimal decision on the aggregate area level using a network algorithm based on the water values computed in the strategy phase. This is called area optimization.
2. Detailed reservoir drawdown in a rule based model to distribute the optimal total production from the first step between the available plants. In this step it is verified if the desired production is obtainable within all constraints at the detailed level.

### 2.3.1 Reservoir drawdown

In the aggregated simulation, a total production for each area is calculated. In the drawdown model, this production is distributed between the individual modules within each area. The detailed reservoir allocation from this production is not calculated by a formal optimization, but by a rule based strategy described below. Interaction between the aggregate area and the reservoir drawdown model can be seen in figure 2.7.

The reservoir drawdown strategy makes a distinction between different kinds of reservoirs:

- Buffer reservoirs that are run according to rule curves. These curves are model determined but may be modified by the user.
- Regulation reservoirs that are run according to a rule based strategy for the allocation of the stored energy in the system.

**Buffer reservoirs** are small reservoirs that have a low degree of regulation. That means that the ratio between reservoir volume and annual inflow is low, causing an empty reservoir to be filled up in a matter of weeks. The rule curve is a piecewise linear curve specifying reservoir level as a function of week number. This is a soft constraint which can be violated due to hard constraints such as maximum/minimum discharge.

**Regulation reservoirs** are all reservoirs that are not specified to be buffer reservoirs, and are run according to the allocation strategy between reservoirs. The drawdown model does not specify total amount of energy in the reservoirs, but the distribution of energy in regulation reservoirs based on total energy calculated on the aggregate level and specified energy stored in buffer reservoirs.

The reservoir drawdown model divides the year in two seasons, where each season has different strategies:

## 2.3. SIMULATION

---

- **Filling season**, where inflow is larger than discharge.
- **Depletion season**, where discharge is larger than inflow.

### Filling season

During the filling season, the main objective is to avoid spilling. This is achieved by keeping reservoirs at a level where they have equal damping,  $D$ , which can be seen on as a risk of spillage. [5] The damping is given as the difference between reservoir capacity,  $R_{max}$  and actual reservoir,  $R$ , divided by reservoir capacity and multiplied with the degree of regulation  $\alpha$ , as seen in (2.10).

$$D = \frac{R_{max} - R}{R_{max}} \cdot \alpha \quad (2.10)$$

### Depletion season

The strategy in the depletion season has two objectives: [5]

- The rated plant capacity must be available as long as possible to avoid emptying some reservoirs too early and causing a capacity deficit.
- At the end of the depletion season, the reservoirs should have equal relative damping according to (2.10) in order to minimize spillage in the coming filling season.

### 2.3.2 Interaction between area optimization and reservoir drawdown

Figure 2.7 shows a flow chart for the decision making process in the EMPS model. For a comprehensive description of the flow chart, see [5].

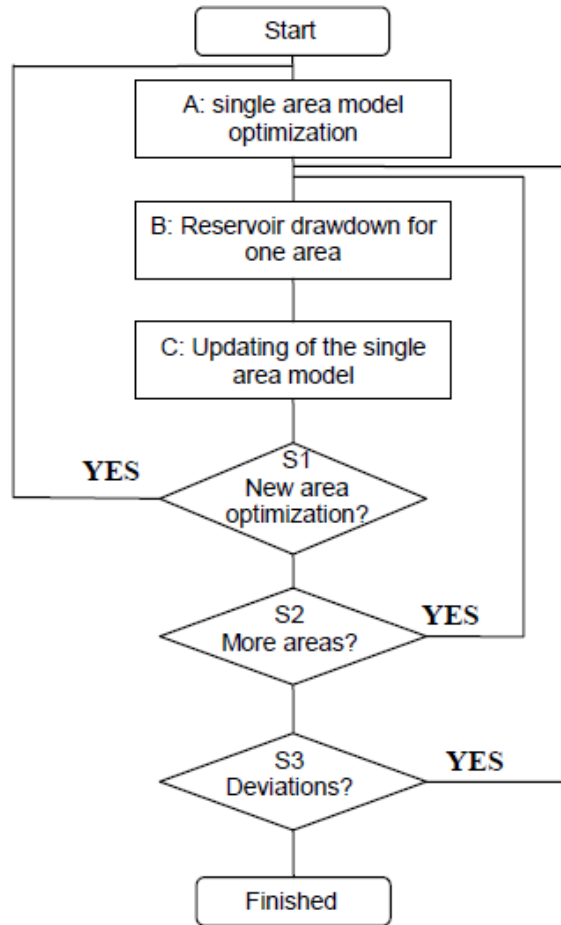

Figure 2.7: The weekly decision process in the EMPS model[5]

---

## Chapter 3

# Investment analysis

The functionality for investment analysis in the EMPS model is thoroughly described in Norwegian in [20]. This chapter gives a short English summary of the programs functionality.

### 3.1 Background

Investments in new production and transmission capacity in the Norwegian power system has the last few years gained much attention. Discussions have among others been about whether the market is working as intended. Especially in regards to new investments three main questions have to be answered:

- Is it profitable?
- Geographical placement?
- Choice of technology?

When the Norwegian power system is analyzed, the EMPS model is frequently used. Earlier, there was no functionality for comparing different investment options in this model. It has, however, been used to manually test different options regarding technology, rating and localization. Manual analysis does however limit the number of scenarios due to the time consumed running the simulations. This new functionality makes it possible to compute a set of investments in the power system which is consistent with simulated power prices.

## 3.2 Functionality overview

The analysis is computed for a given future stage, e.g. the year 2020. The model calculates the investments in thermal power production, wind power production and in the transmission grid. Sequential dynamic analysis is also possible. This means that the results from e.g. 2020 can be used in the simulations for 2030.

Figure 3.1 shows the structure of the investment model. The left side of the figure shows the input into the model, the iterative algorithm is located in the middle and the right side shows the results.

All input data for the system has to be adapted to the future stage and specified according to point 2 in figure 3.1. The user also has to specify what investment options there are in addition to the technical and economic information for these alternatives (see point 5). This information has to be specified before start of the analysis.

When the investment analysis is run the data for the future stage of the system is loaded and the EMPS model calculates the optimal operation of the system. Some of the results of this simulation are the weekly prices in all the areas of the model. These prices together with the predefined in-



### 3.2. FUNCTIONALITY OVERVIEW

---

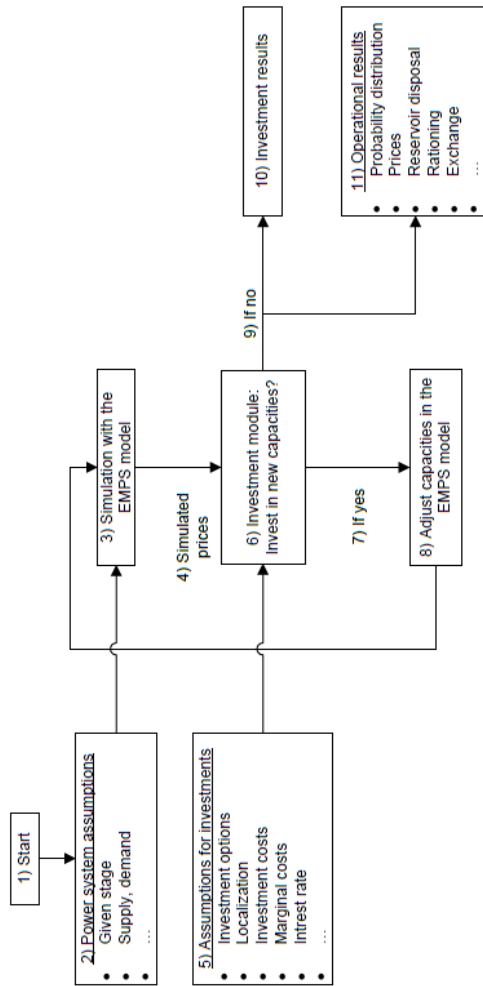

Figure 3.1: Investment functionality in EMPS

vestment options are then used to calculate the profitability of the different investment alternatives. If the profit is high enough for a given alternative then the program will invest in this alternative in the first iteration. In the next iteration the capacity of the investment is increased by a predefined amount. If the profit in a specific iteration is negative the capacity is reduced compared to the previous iteration. If the profit of a capacity increase is positive but lower than a predefined minimum profit required for an investment the capacity is set to the size of the previous iteration. This predefined minimum profit has to be big enough compared to the change of capacity to make sure that the investment analysis converges.

If the capacities are changed the EMPS model is run again and new weekly prices are found. This process continues until the profit of investing in additional capacity is positive but below the minimum profit threshold for all investment alternatives.

The output from the investment analysis is a file that shows the iterative solutions in addition to the final investment result for each investment alternative.

### **3.3 Mathematical description**

Table 3.1 contains all the symbols used in this chapter to describe the mathematical calculations used in the investment analysis model. [20]

### 3.3. MATHEMATICAL DESCRIPTION

---

Table 3.1: List of symbols

Symbol	Description	
<b>Array</b>		
J	= Simulated inflow years (i.e.)	J=1931,...,2005
I	= Simulated weeks	I=1,...,52
<b>Indices</b>		
i	= Week	$i \in I$
j	= Inflow year	$j \in J$
k	= Investment alternative	
l	= Model number (for wind power)	
$m^k$	= Area for investment alternative k	
$n^k$	= Transmission line in investment alternative k, goes between area $m^k$ and $n^k$	
<b>Other</b>		
N	= Number of simulated years (i.e. elements in J)	
$p_{i,j,m^k}$	= Simulated weekly prices from Samkjøringsmodellen in area $m^k$	$(\frac{\text{EuroCent}}{\text{kWh}})$
$p_{i,j,n^k}$	= Simulated weekly prices from Samkjøringsmodellen in area $n^k$	$(\frac{\text{EuroCent}}{\text{kWh}})$
$c_k$	= Marginal production cost	$(\frac{\text{EuroCent}}{\text{kWh}})$
$l_k$	= Annual investment cost	$(\frac{\text{€}}{\text{MW}\cdot\text{year}})$

Continued on Next Page...

Table 3.1 – Continued

Symbol	Description	
$z_k$	= Investment profit required to increase capacity from one iteration to the next, as a part of the investment cost. This comes in addition to the demand of normal expectation when calculating the annual investment cost.	(Share)
$t_{m^k, n^k}$	= Transmission loss between areas $m^k$ and $n^k$	(Share)
$y_{i,j,m^k,l}$	= Wind power production	( $\frac{\text{GWh}}{\text{week}}$ )
$\bar{y}_{m^k,l}$	= Installed wind power	(MW)
$u_{i,j,m^k}$	= Utilization factor for wind power	(Share)
$\pi_k$	= Expected value for the profit of alternative k	( $\frac{\text{€}}{\text{MW}\cdot\text{year}}$ )

To determine whether an investment pays off the marginal profit of adding one extra MW of capacity is calculated. The marginal profit is calculated using the weekly prices from the last iteration. For thermal power the marginal profit is calculated with equation 3.1.

$$\pi_k = \sum_{\substack{i \in I \\ j \in J}} \max \{0; p_{i,j,m^k} - c_k\} \cdot \frac{24 \cdot 7 \cdot 1000}{N \cdot 100} - I_k \quad (3.1)$$

$p_{i,j,m^k} - c_k$  is the profit of adding an extra MW of thermal power. This is multiplied with  $24 \cdot 7$  to get the weekly profit and with  $\frac{1000}{100}$  which is the factor to convert from EuroCent to Euro and from  $\frac{\text{kWh}}{h}$  to  $\frac{\text{MWh}}{h}$ . Further

### 3.3. MATHEMATICAL DESCRIPTION

---

it is summed over all simulated weeks and years and then divided by the years simulated. The annual investment cost  $I_k$  is in the end subtracted so that the equation shows the change in profit ( $\frac{\text{€}}{\text{year}}$ ) for investing in an additional MW.

The program does not calculate the annual investment cost so this has to be calculated manually by the user and specified in the input files. As previously mentioned, if the profit is positive and above the predefined required profit  $z_k$  an investment will be made. If it is positive but below  $z_k$  the capacity will be kept at the same level as the previous iteration and if it is negative it will be decreased below that of the last iteration.

For wind power two equations are needed. First the expected average production in a given week if one extra MW is added has to be calculated using equation 3.2.

$$u_{i,j,m^k} = \frac{\sum_l y_{i,j,m^k,l} \cdot 1000}{\sum_l \bar{y}_{m^k,l} \cdot 24 \cdot 7}, \quad u_{i,j,m^k} \in [0, 1] \quad (3.2)$$

To be able to use 3.2 there has to be an initial wind power capacity in the area where it is invested. If there is no wind power production in that area a marginal capacity has to be added. The marginal profit is calculated using equation 3.3.

$$\pi_k = \sum_{\substack{i \in I \\ j \in J}} p_{i,j,m^k} u_{i,j,m^k} \cdot \frac{24 \cdot 7 \cdot 1000}{N \cdot 100} - I_k \quad (3.3)$$

The profit of building additional transmission capacity is determined by the price difference between the two areas it is built between. The marginal profit for 1MW of additional transmission capacity is given by equation 3.4.

$$\pi_k = \sum_{\substack{i \in I \\ j \in J}} \max \left\{ \begin{array}{l} 0; \\ [p_{i,j,m^k} (1 - t_{m^k n^k}) - p_{i,j,n^k}]; \\ [p_{i,j,n^k} (1 - t_{n^k m^k}) - p_{i,j,m^k}]; \end{array} \right\} \frac{24 \cdot 7 \cdot 1000}{N \cdot 100} - I_k \quad (3.4)$$

The marginal profit is calculated by subtracting the weekly prices in the areas from each other, multiplied by the transmission loss. It is then multiplied with  $\frac{24 \cdot 7 \cdot 1000}{N \cdot 100}$  to convert it to €/MW/year. Finally the annual investment cost is subtracted.

### 3.4 Convergence in the investment algorithm

It is important to note that the procedure shown in figure 3.1 will not necessarily converge. The program can possibly iterate between several solutions where balance requirements are not satisfied.

It is important that a big enough minimum required profit  $z_k$  compared to the change in capacity between two iterations is needed. The relation between these two variables has to be considered when specifying the initial investment data. Trial and error can also be used to find this relation.

Another problem is how to evaluate one investment's profitability when it relies upon another investment. For instance can an increase in production possibly require additional transmission capacity.

One way of getting around this problem is to specify in the input files the increase in transmission capacity that is needed for a given increase in production capacity. This way the cost of building additional transmission capacity increases the required annual investment costs needed for the investment alternative. The potential increase in profits is however not included when calculating the profits of the production capacity increase. The

reasoning behind this is that the transmission capacity expansion is required for the area prices from the last simulations to be useable. If additional increase in transmission capacity is considered then this can be specified as its own investment alternative, evaluated by equation 3.4.

This will make sure that the program avoids iteration between solutions where the capacity for production and transmission works against each other.

Another way of handling this problem is to add increased capacity in every other iteration. In these iterations only a possible increase in transmission capacity is evaluated. This means that decreased transmission capacity and change in production capacity is not evaluated. This is done to make sure that the algorithm does not rotate between different solutions. It is also not believed that this will lead to too big increases in transmission capacity as that would lead to negative marginal profit and reduced transmission capacity in the other iterations.

## 3.5 Algorithm improvements

Since the investment analysis model is still under development, several improvements can still be made. The background work of this work has consisted of implementing the following new features:

- Maximum capacity
- Price segments

These changes and their verification are thoroughly discussed in chapter 5.





---

# Chapter 4

## Input data

### 4.1 Areas

The model is split in 34 different areas. 13 of the areas only contain wind power production, with no load or other generation capacity. The wind power areas are connected to their "normal" areas by transmission lines with endless transmission capacity. The remaining 21 areas contain both consumption and production. The areas defined can be seen in table A.1. The area numbering is based on how they are numbered in the EMPS model. The geographical location of areas can be seen in figure 4.1 along with the interconnecting transmission lines.

The transmission line representation is an aggregated model of the exact network, and is represented by 32 transmission lines in addition to 13 infinite transmission lines connecting wind power areas with the main grid, making a total of 45 lines. An overview of transmission lines and their transmission capacity can be seen in table A.2.



Figure 4.1: Areas in the model

### 4.1.1 Netherlands

In addition to the Nordic model, a representation of Netherland were made to model the power flow on the subsea cable between Norway and the Netherlands. This representation is based on price segments and prices from APX. A thorough explanation on how the transmission on this cable is modeled can be seen in [2].

## 4.2 Production, consumption and transmission

Production and consumption, with all underlying data such as capacities, reservoirs, inflows etc, is from data given in the model upon receiving it from SINTEF Energy Research. These data are from a 2009 edition of the EMPS model, and should therefore be up to date. This is also the case for transmission capacities.

### 4.2.1 Transmission changes

The original transmission capacities to NORGEMIDT from the bordering areas from the original data were compared to statistics from Statnett. According to the original data, 2250MW of transmission capacity is available from other areas. However, the license application for the new transmission line between Ørskog and Fardal states that between 1100 and 1500MW were available before the recent upgrade between NORGEMIDT and Sweden. [17] These numbers are also pretty consistent with numbers used in reports at SINTEF Energy Research. [8] Since the transmission capacity is dependent on temperature, it is safe to say that 1500 MW would be the actual transmission capacity into NORGEMIDT during a normal winter. Since the transmission problems to NORGEMIDT are worst during

Table 4.1: Transmission capacity into NORGEMIDT

From Area	Capacity in model	Capacity change	Capacity after change
OSTLAND	600 MW	-200 MW	400 MW
HELGELAND	900 MW	-300 MW	600 MW
SVER-NN2	750 MW	-250 MW	500 MW
<b>Total</b>	<b>2250 MW</b>	<b>-750 MW</b>	<b>1500MW</b>

the winter, it is a safe approximation to say that the limiting transmission capacity is 1500MW. In lack of better sources that states exact transmission capacities, the original given numbers are reduced by 33% in order to achieve a total import capacity of 1500MW, as shown in table 4.1

### 4.3 Investment parameters

In order to perform an investment analysis, essential parameters such as marginal production costs and investment costs have to be given. Investment costs are given in  $\frac{\text{€}}{\text{MW}}$ , while the investment algorithm requires annualized investment costs given in  $\frac{\text{EuroCent}}{\text{kW}\cdot\text{year}}$ . To accomplish this, the investment cost is annualized using (4.1), where the annual investment cost is calculated based on initial investment cost, interest rate and payment period in years.

#### 4.3.1 The cost of thermal and wind power

Marginal production costs consist of various operation and maintenance costs in addition to relevant emission taxes. O&M costs for gas power plants and wind farms are found in a report by the European Wind Energy

### 4.3. INVESTMENT PARAMETERS

---

$$A = \frac{I \cdot (i + 1)^n}{(i + 1)^n - 1} \cdot i \quad (4.1)$$

where:

- A = Annual investment cost
- I = Initial investment cost
- i = Interest rate
- n = Number of years

Association. [9] CO<sub>2</sub> emission cost is taken from Nord Pool emission market, where the forward price for December 2014 of 18.10  $\frac{\text{€}}{\text{tonne}}$  is used.[12] Emission rate is found from a report from the US Department of Energy and the Environmental Protection Agency, which states an average of 1.314 and 1.321 pounds, or 0.596 and 0.599 kg, of CO<sub>2</sub> emissions per kWh electricity produced in 1998 and 1999 respectively.[18] For simplicity, and assuming higher plant efficiencies due to tighter emission restrictions in the future, this value is assumed to be 0.55kg emissions per kWh electricity produced.

$$\text{Emission costs} = \frac{0.55\text{kg}}{\text{kWh}} \cdot \frac{1000\text{kWh}}{\text{MWh}} \cdot \frac{1}{1000} \frac{\text{tonne}}{\text{kg}} \cdot \frac{18.10\text{€}}{\text{tonne}} = 10 \frac{\text{€}}{\text{MWh}}$$

Table 4.2 show the investment costs for a natural gas thermal power plant and a typical onshore wind farm. Offshore wind is excluded from analysis because of high investment costs. Expected investment costs is around  $\frac{\text{£}1.900.000}{\text{MW}}$ , or around  $\frac{\text{€}2.200.000}{\text{MW}}$ , which is substantially higher than the costs of on-shore wind farms.[11] Expected output might be higher due to more consistent wind speeds, but this is considered outside of the scope of this report. The investment costs for natural gas assume an existing gas pipeline. Pipelines are therefore not a part of the investment costs

Table 4.2: Investment costs

	Natural gas	Onshore wind
Investment costs, $\frac{\text{€}}{\text{MW}}$	1,000,000[6]	1,600,000[4]
Interest rate[7]	5.5%	6.5%
Payment period	25 years	25 years
Annual investment costs, $\frac{\text{€}}{\text{MW}}$	74,549	122,972
O&M costs, $\frac{\text{€}}{\text{MWh}}$	27[9]	2[9]
Emission tax, $\frac{\text{€}}{\text{MWh}}$	10	0
Total Operation costs, $\frac{\text{€}}{\text{MW}}$	37	2

considered here.

### 4.3.2 Wind power utilization

Wind power farms, in contradiction to thermal power plants, have a varying efficiency depending on where it is located. Since the wind conditions are different in different areas, several areas should be considered for new wind power. Utilization factor, or the amount of yearly energy in GWh per MW installed is found from Norwegian Water Resources and Energy Directorate (NVE)[19] for areas in Norway, while data for a wind farm planned by Statkraft in Sweden is found on their web-page.[1] An overview of relevant areas and their utilization factors can be seen in table 4.3. The complete data set, on which these figures are based on, can be seen in appendix B.

### 4.3.3 Transmission lines

For transmission lines, the investment cost is highly dependent on length and terrain. The procedure of estimating an investment cost per MW is not

### 4.3. INVESTMENT PARAMETERS

---

Table 4.3: Wind power utilization

Area	MW	$\frac{GWh}{year}$	$\frac{GWh}{MW \cdot year}$
SVER-NN2	1140	2400	2.105
NORGEMIDT	3133	8050	2.569
HELGELAND	2142	5804	2.710
TROMS	130	380	2.923
FINNMARK	2125	6985	3.287

Table 4.4: Line investment costs

	VESTMIDT	SVER-NN2
Capacity	700[17]	200[17]
Investment cost $\frac{kr}{MW}$	3,250,000,000[15]	593,000,000[10, 16]
Investment cost $\frac{€}{MW}$	406,250,000	74,125,000
Interest rate[7]	4.5%	4.5%
Payment period	25 years	25 years
Annual investment costs, $\frac{€}{MW \cdot year}$	39,139	25,290

necessarily reasonable, but it is a fair approximation to compare investment costs on different options. To obtain as realistic values as possible, the actual costs of two new lines in the NORGEMIDT area is determined using official figures from Statnett. The projects in question is the newly built line between Nea in Norway and Järpströmmen in Sweden [10, 16] and the proposed line between Ørskog and Fardal on the Norwegian western coast that would match a line between NORGEMIDT and VESTMIDT[15]. The proposed total cost of these lines and the corresponding annual investment costs per MW are given in table 4.4.

Table 4.5: Price segments

#	Code	Time of week	Hours
1	HD	High day	30
2	HK	High evening	10
3	LD	Low day	50
4	N	Night	30
5	HELG	Weekend	37
6	N-LOR	Night Saturday	7
7	N-SON	Night Sunday	7

## 4.4 Price segments

In order to simulate hours of peak consumption, the total 168 hours of a week is split into 7 price segments. This is done by specifying how much demand is in each price segment, thus creating different energy prices accordingly based on available power. Table 4.5 give an overview of the price segments used in this model.



---

## Chapter 5

# Improvements

Two changes were done in order to do more complete investment analyses. These are

- Maximum investment for both generation and transmission
- Inclusion of price segments

### 5.1 Maximum investment

In order to limit investment where this is extremely profitable, a small input alteration has been done in order to make it possible to have an investment peak. This could be applicable on e.g. transmission lines which will have a certain thermal capacity at certain voltage levels, at wind farms where only a certain amount of windmills can be placed due to space constraints or thermal power or for thermal power plants that can only utilize a certain amount of fuel per hour. An example of this alteration is shown in table 5.1. In this case, the thermal capacity in NORGEMIDT has a maximum increase of 500MW. If there are no constraints on investment size, maximum

Table 5.1: norgemidt.inv example

Omraade	NORGEMIDT				
Antall investeringer	1				
1.					
Typenummer:	13	Terskel:	0.10	Jump:	100
Margkost:	3.70	Inv.kost:	7455	Startkap:	0 Maxkap: 500
Antall inkluderte nettinvesteringer:	0				
Linjenummer:					

capacity can be set to "0" which will be interpreted as infinite maximum capacity and the investment will only be constrained by the profitability.

## 5.2 Price segments

Price segments are a part of the EMPS model in order to split a week into different periods based on expected demand. Previously, the investment model based new investments on revenues that were calculated from average weekly prices without considering day/night price variations. This new addition to the model has extended the analysis to include all price segments throughout the week. This will especially have an effect when the system has interconnections with large thermal power plants that do not shut down during the night, thus having large price gaps between day and night.

In order to test if this model is correct. A simulation was done with and without the price segments implemented in the investment model. The expected differences in simulation results are small, but some differences should occur. As an example, the investment parameters from the invest-

## 5.2. PRICE SEGMENTS

---

Table 5.2: `data.gen` example

```
''This file is for general data''
Weeks:                               52
Years:                               53

Hours:                               168
Areas_with_defined_investments:     3
Antall_prisomraader:                 34
Antall_prisavsnitt:                  7

Delomraade  Investment_file  enmdat_makro
  2          ostland.inv     ostland.makro
  7          vestsyd.inv    vestsyd.makro
  9          norgemidt.inv   norgemidt.makro
```

ment analysis functionality report were used [20]. The investment parameters are given in tables 5.3-5.5.

Thermal power investment is considered in three different areas; East, South West and Central Norway. In contradiction to the functionality report, only one investment option is considered in Central Norway.

Wind power is considered in three areas; Central Norway, Helgeland and Finnmark. In addition to the power production itself, investment of wind power production is dependent on sufficient transmission capacity to consumption areas. This is handled by including one line in each of the two first areas, and three lines from the wind power production in Finnmark.

The input data from `data.gen` has to be altered slightly in order to read in number of price segments, as indicated in table 5.2. At this stage, the number of price segments has to be entered here, and must be consistent with information in other files.

Table 5.3: Investment options for thermal power production

	Investment options		
	1	2	3
Area #	OSTLAND	VESTSYD	NORGEMIDT
Marginal cost ( $\frac{cent}{kWh}$ )	3.2	3.0	3.0
Investment cost ( $\frac{cent}{kW \cdot year}$ )	3200	3200	3200
Threshold (unit)	0.2	0.2	0.2
Jump (MW)	200	200	200

Table 5.4: Investment options for wind power production

	Investment options		
	1	2	3
Area #	WIND-NORMI	WIND-HELGE	WIND-FINNM
Capacity ( $\frac{GWh}{year \cdot MW}$ )	2.0	2.3	3.85
Investment cost ( $\frac{cent}{kW \cdot year}$ )	6000	6000	6000
Threshold (unit)	0.15	0.2	0.2
Jump (MW)	200	200	200
Lines line #	38	40	14,15,41
included Inv. cost	1500	1500	1500,1500,1500

## 5.2. PRICE SEGMENTS

---

Table 5.5: Investment options for transmission

	Investment options				
	1	2	3	4	5
Line #	12	13	17	18	19
Investment cost ( $\frac{cent}{kW \cdot year}$ )	1500	1500	1500	1500	1500
Threshold (unit)	0.3	0.5	0.3	0.3	0.3
Jump (MW)	100	50	100	100	50
Initial capacity 1→ 2	600	1980	2200	1950	150
Initial capacity 2→ 1	600	1980	2200	1950	250

Transmission capacity is considered between Sweden and the central areas in Norway that are bordering Sweden; Helgeland, Central and East Norway in addition to extra capacity from Central Norway to Helgeland and East Norway.

As tables 5.6 and 5.7 are indicating, there are not large differences between these simulations. The differences can be explained by the fact that when price segments are utilized, peak hours with associated higher prices are available for the thermal power plants. This causes the thermal plants to be economical feasible to a larger extent than with weekly averages. Because of this, the thermal power plants in NORGEMIDT will have increased capacity when price segments are included due to the availability of increased transfer capacity between NORGEMIDT and OSTLAND and further on to SVER–MIDT.

Note that these results are not a product of a real life simulation with realistic prices. It is a simulation with the same input parameters as that of [20]. Hence they should not be looked upon as a proper investment analysis, but as a verification of the inclusion of price segments. For this purpose,

these simulations are adequate and the results show that the two results are close enough for the inclusion of price segments to be validated.

Table 5.6: First iteration results

Nr.	Investment	Profit weekly	Profit segments	Investment costs
<u>Thermal power production</u>				
2	OSTLAND	6988.7	7140.6	3200
7	VESTSYD	8079.6	8226.4	3200
9	NORGEMIDT	9162.3	9305.3	3200
<u>Wind power production</u>				
27	WIND-NORMI	8035.9	8074.9	7500
28	WIND-HELGE	9105.4	9146.0	7500
30	WIND-FINNM	15462.9	15533.7	10500
<u>Transmission capacity</u>				
12	NORGEMIDT ↔ OSTLAND	3626.3	3625.3	1500
13	HELGELAND ↔ NORGEMIDT	117.6	126.0	1500
17	OSTLAND ↔ SVER-MIDT	2172.3	2183.7	1500
18	NORGEMIDT ↔ SVER-NN2	224.1	227.7	1500
19	HELGELAND ↔ SVER-NN2	1498.3	1516.0	1500

## 5.2. PRICE SEGMENTS

---

Table 5.7: Investment results

Nr.	Investment	Investment weekly	Investment segments
<u>Thermal power production</u>			
2	OSTLAND	0	0
7	VESTSYD	600	400
9	NORGEMIDT	1200	1400
<u>Wind power production</u>			
27	WIND-NORMI	0	0
28	WIND-HELGELAND	200	200
30	WIND-FINNMARK	1400	1400
<u>Transmission capacity</u>			
12	NORGEMIDT ↔ OSTLAND	100	200
13	HELGELAND ↔ NORGEMIDT	0	0
17	OSTLAND ↔ SVER-MIDT	100	200
18	NORGEMIDT ↔ SVER-NN2	0	0
19	HELGELAND ↔ SVER-NN2	300	350





---

## Chapter 6

# Simulations

Simulations within the Nordic power system were done for two reasons:

- Verify that the improvements discussed in the previous chapter are valid.
- Simulate how the market will respond to system investments, and optimalization of these investments

Simulations of new system investments and the relating market response were done for many different scenarios.

1. A basecase without any investments
2. New transmission, wind and thermal capacity based on input data given in chapter 4.3
3. Same as 2, but with different levels of subsidies for wind power investment
4. Simulations with higher demand in Central Norway

## 6.1 Calibration

In order to optimize area interaction with respect to socioeconomic surplus, a calibration is performed before simulations are initiated. This is done by doing some hundred simulations where the area interaction parameters are altered slightly for each simulation in order to maximize the socioeconomic surplus. All inflow scenarios are considered, to make sure that the calibration find the optimal parameters for an average year.

This calibration is not necessarily necessary, as the EMPS default interaction parameters is generally well suited for the generic Nordic system. However, every system model is slightly different, thus the need for calibration arises.

In the case of the calibration done with the model used for these simulations, a general socioeconomic profit gain of 10.27M€ is achieved, which confirms the effect of the calibration algorithm.

The final calibration parameters can be seen in table C.1. Only areas with hydro power have had their parameters adjusted, the other areas have all calibration parameters set to 1.000.

A thorough calibration with maximum iterations (20) take about 24 hours, so it is important to set the parameters right to avoid having to do this unnecessarily many times.

## 6.2 Basecase

Firstly, a basecase were performed in order to establish a foundation to base further simulations on. This basecase is meant to simulate the present situation. Figure 6.1 shows the price variation in NORGEMIDT throughout the year. Figure 6.1a show the average price for each week in both

## 6.2. BASECASE

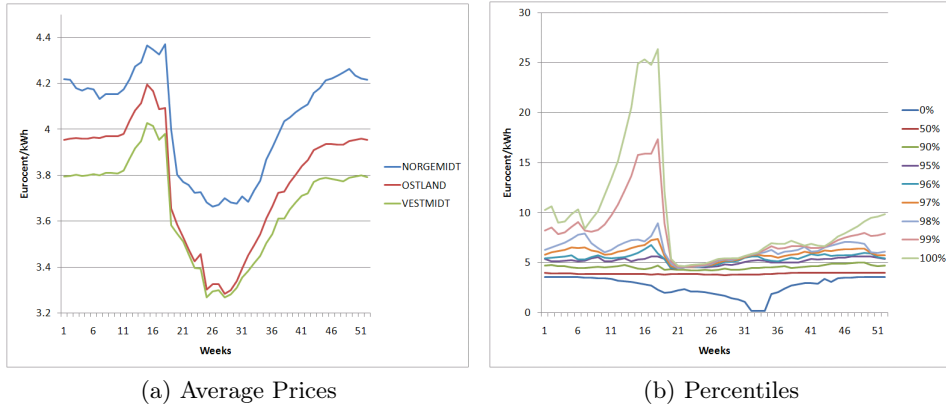

Figure 6.1: Basecase results

NORGEMIDT and OSTLAND, while figure 6.1b show percentile price distribution in NORGEMIDT based on given inflow scenarios. The inflow scenarios are based on hydrological data over 53 years, between 1948 and 2000. As figure 6.1b shows, the price for both 50% and 90% is just below  $5 \frac{\text{eurocent}}{\text{kWh}}$ , which means that prices are fairly equal in this percentile interval. Because of this, small percentile steps is chosen above 90% to be able to see the effect on other percentiles than 100%. From the 0%-line, a scenario with close to free power is possible for three weeks of the year due to reservoir flooding.

The most interesting part of this figure is that prices above  $5 \frac{\text{eurocent}}{\text{kWh}}$  will happen in around 5% of the scenarios, and that peak prices will reach  $25 \frac{\text{eurocent}}{\text{kWh}}$  in some cases. Investment in transmission and production capacity in NORGEMIDT will cause more even prices between different scenarios and different areas.

### 6.3 Investments with standard costs

In this case, investment analyses were performed based on calculations done in chapter 4.3. One simulation were done without any maximum investment constraints, and one simulation were done with constraints on transmission lines according to the actual plans: 700MW between NORGEMIDT and VESTMIDT and 200 MW between NORGEMIDT and SVER-NN2. Table 6.1 show the final investment results when maximum capacities are applied, with the corresponding marginal profit and marginal investment costs (in  $\frac{\text{€}}{\text{MW}\cdot\text{year}}$ ), as well as the final investment results without maximum capacities. The marginal profit indicates that an investment in both line 13 and 18 would be profitable. However, when these investments are applied, neither of them are profitable. This could be solved either with applying stricter investment restrictions or by only investing in the most profitable transmission option in the iteration that only consider transmission investments. This issue is also discussed in chapter 9.2. An map of the applicable transmission investments is shown in figure 6.2.

As the simulation with capacity restrictions suggests, a larger line from VESTMIDT would be highly profitable. This suggestion is proven in the simulation without restrictions where the transmission capacity is 200MW larger than that with capacity restrictions.

Since there are rather large investments being done, prices in NORGEMIDT is expected to fall and thus getting closer to the prices in Eastern Norway. The yearly price variations, indicated by percentile price distribution, is also expected to fall.

Both of the above-mentioned expectations are confirmed in figure 6.3. The peak weekly prices fall from almost 4.4 to around  $4.15 \frac{\text{Eurocent}}{\text{kWh}}$ , and the prices in extreme situations fall considerably. Prices above  $5 \frac{\text{Eurocent}}{\text{kWh}}$

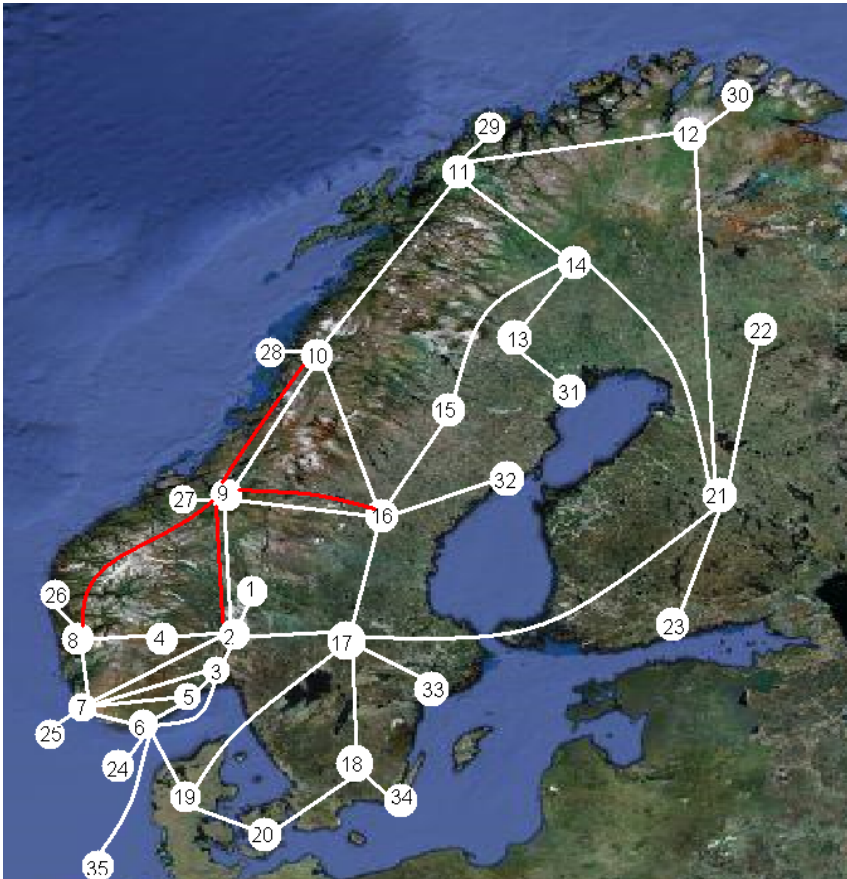

Figure 6.2: New and upgraded transmission lines

Table 6.1: Investments with standard costs

<b>Line/Area</b>	<b>Incl. max. cap.</b>	<b>Profit</b>	<b>Inv.cost</b>	<b>Excl. max. cap.</b>
<u>Thermal power production</u>				
NORGENMIDT	-	24470	74550	-
<u>Wind power production</u>				
VIND_NORMI	-	84230	122970	-
VIND_HELGE	-	86160	122970	-
VIND_TROMS	-	94180	122970	-
VIND_FINNM	-	114150	122970	-
VIND_SVENN	-	67770	122970	-
<u>Transmission capacity</u>				
12 (OSTLAND)	-	28180	33000	-
13 (HELGELAND)	-	40810	33000	-
18 (SVER-NN2)	100 MW	30430	25290	100 MW
46 (VESTMIDT)	700 MW	70650	39140	900 MW

### 6.3. INVESTMENTS WITH STANDARD COSTS

---

now only occur in around 3% of the scenarios, and the worst case scenario has peak prices of around  $11 \frac{\text{Eurocent}}{\text{kWh}}$ , which is a 50% decline. Increased transmission capacity also eliminates the risk of flooding in NORGEMIDT in very wet years, which is seen from that the 0 percentile line in figures 6.3c and 6.3d never reach  $0 \frac{\text{Eurocent}}{\text{kWh}}$  as it does in figure 6.1b.

The size of the investments is also consistent with the plans in increased transmission capacity from Statnett that indicates a total increase of 900MW between 2005 and 2012. The place of investment, from VEST-MIDT and SVER-NN2 is also consistent with the newly built line between Nea and Järpstrømmen and the planned line between Ørskog and Fardal. However, these figures are without future increase in demand and without wind power subsidies, which are both realistic future scenarios. These scenarios will be discussed in chapters 6.4 – 6.6.

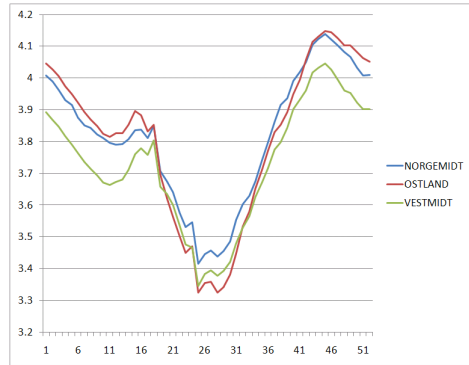
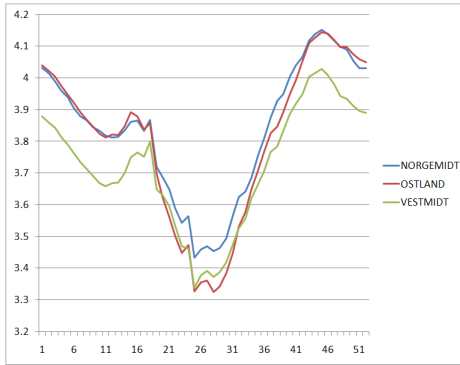

(a) Weekly prices including max. capacities

(b) Weekly prices excluding max. capacities

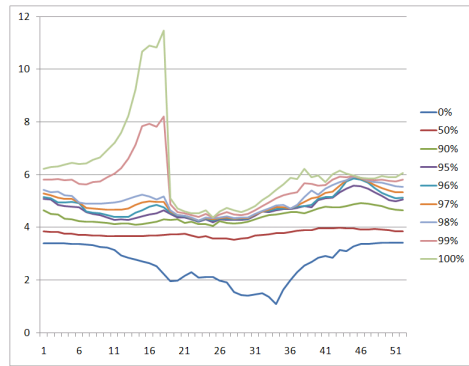
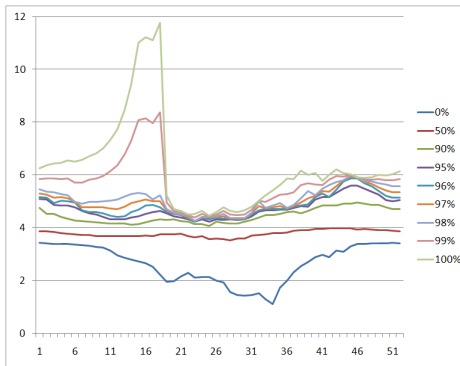

(c) Percentile prices including max. capacities

(d) Percentile prices excluding max. capacities

Figure 6.3: Standard investment results



Table 6.2: Wind power subsidies

Subsidies		New inv. costs
[%]	$\frac{\text{€}}{\text{MW}\cdot\text{year}}$	$\frac{\text{€}}{\text{MW}\cdot\text{year}}$
0	0	12297
10	1230	11067
20	2459	9838
30	3689	8606
40	4919	7378
50	6148	6149

## 6.4 Investments with wind power subsidies

As the previous section indicates, wind power is not economic feasible at this stage. This is also consistent with a study performed by Statistics Norway, which states that 85% of licenced wind power is put on hold due to low profitability. [3] One solution to make wind power more profitable is to ensure governmental subsidies, e.g. as a percentage of investment cost. The same analysis as in the previous section were done with adjusted investment costs for wind power, as show in table 6.2. Results from the investment analysis with different levels of subsidies is shown in table 6.3, and a total overview of these investments, and their profitability, can be seen in figures C.2–C.6.

As the table shows, wind power is starting to get profitable at 20% subsidies, this also increases the demand for import capacity to NORGEMIDT because of increased cheap power production north of NORGEMIDT. This indicates that line 13 from HELGELAND is not in demand for an upgrade in the present state. However, if the subsidies increase further (or wind power become generally cheaper) increased transmission capacity is needed. This

is clear from the investment results in table 6.3, where subsidies are at 40% and 50% cause massive investments in both wind power and transmission capacity. Above 40% subsidies, the wind power production is so large that the need for import to NORGEMIDT from southern areas are not that crucial. A small investment of 200MW to VESTMIDT and a large investment of 1000MW to OSTLAND would suggest that the price in NORGEMIDT are now close to that of VESTMIDT and lower than that of OSTLAND, which is confirmed in figure 6.4 that show average weekly prices in NORGEMIDT, OSTLAND and VESTMIDT. With increased wind power subsidies, and subsequent increased wind power production, the prices in NORGEMIDT are falling. At 20%–30% subsidies, the prices in NORGEMIDT are close to that of OSTLAND except in the summer months. At 40%–50% subsidies, the prices in NORGEMIDT fall below OSTLAND in most of the year and closer to that of VESTMIDT.

Figure 6.5 show the percentile price distribution for the different subsidy cases. The figures shows that the worst case scenario for 20% and 30% subsidies are actually worse than that of no subsidies. This is caused by generally lower prices that eliminates the profitability of a transmission line between NORGEMIDT and SVE-NN2. In extreme dry years there is now too low import capacity, causing high prices during peak weeks. This is not a problem with subsidies above 30% as the wind power investments are so large that extra transmission capacity is needed as well. With these high subsidies, the problem of flooding become apparent. This is because the model at the current stage is calibrated as if there were no investments, thus the hydro power will act as if there are no investments and save too much water for the depletion season.

In order to find an optimal subsidy level, the model must be recalibrated and the simulations rerun to examine if the obtained results are feasible

#### 6.4. INVESTMENTS WITH WIND POWER SUBSIDIES

---

with proper calibration. Due to time consuming calibrations and time constraints, this has not been examined in this report. There should however be implemented an automatic calibration that do calibrations during the investment analysis. This is further discussed in chapter 9.2.

Table 6.3: Investments with wind power subsidies

<b>Line/Area</b>	<b>10%</b>	<b>20%</b>	<b>30%</b>	<b>40%</b>	<b>50%</b>
<u>Thermal power production</u>					
NORGENMIDT	-	-	-	-	-
<u>Wind power production</u>					
VIND_NORMI	-	-	-	300 MW	2200 MW
VIND_HELGE	-	-	-	500 MW	2600 MW
VIND_TROMS	-	-	100 MW	1900 MW	2800 MW
VIND_FINNM	-	300 MW	600 MW	600 MW	600 MW
VIND_SVENN	-	-	-	-	-
<u>Transmission capacity</u>					
12 (OSTLAND)	-	-	-	-	1000 MW
13 (HELGELAND)	-	-	100 MW	600 MW	1400 MW
18 (SVER-NN2)	100 MW	-	-	-	200 MW
46 (VESTMIDT)	700 MW	700MW	700 MW	500 MW	200 MW

## 6.4. INVESTMENTS WITH WIND POWER SUBSIDIES

---

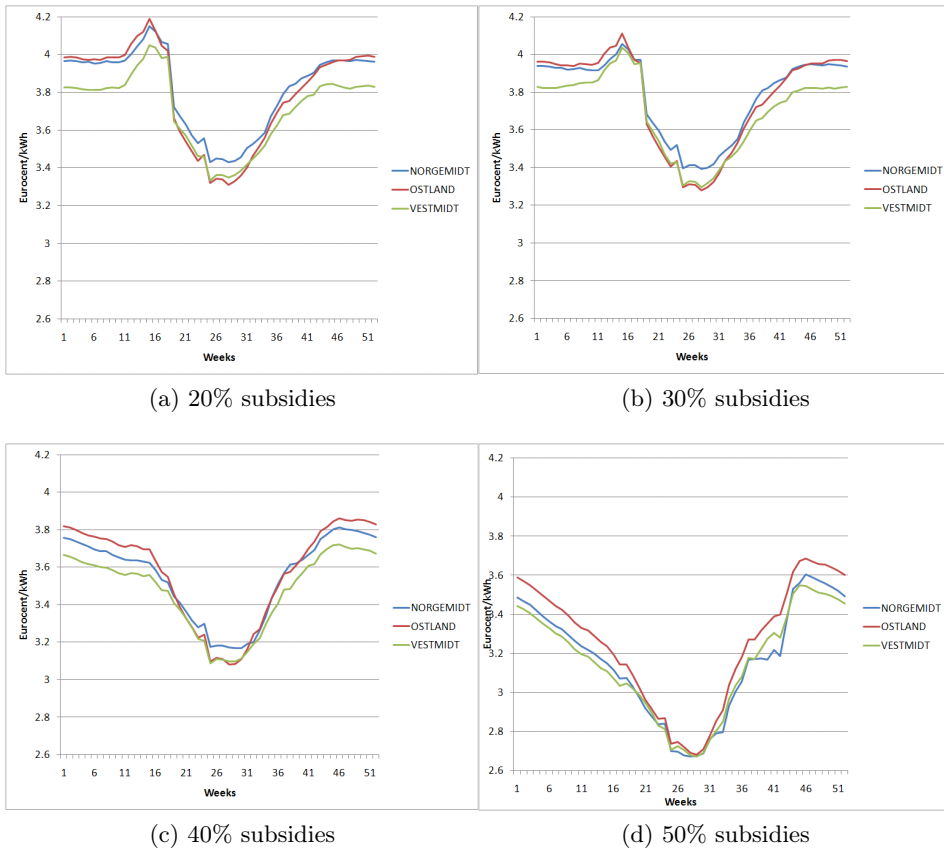

Figure 6.4: Weekly prices with wind power subsidies

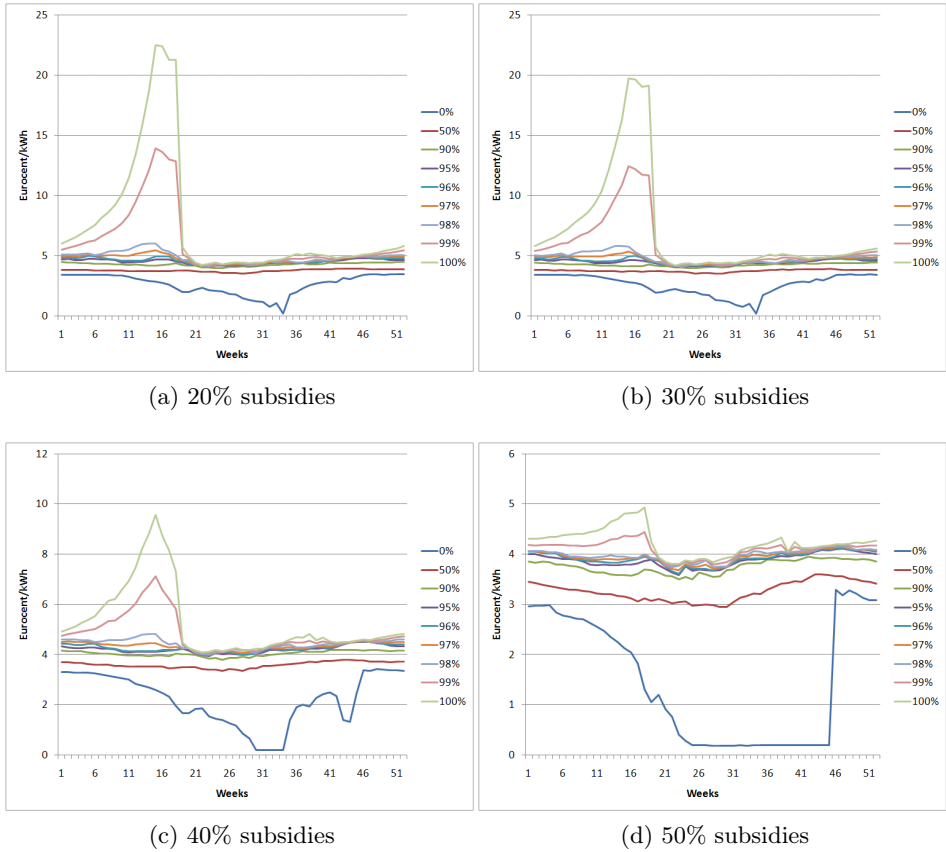

Figure 6.5: Percentile prices in NORGEMIDT with wind power subsidies

## 6.5 10 % higher demand in Central Norway

Due to the expected increase in demand, similar simulations as in the previous chapters were done with a load increase of 10%, or around 2.15TWh. This scenario was tested for four different cases: Without investments, investments without wind power subsidies and investments with wind power subsidies at 20% and 40%. Investment results can be seen in table 6.4, and corresponding weekly prices and price percentiles can be seen in figures 6.7 and 6.6.

If no investments are made in a scenario with a 10% increase in load, weekly energy prices will reach  $9.5 \frac{\text{eurocent}}{\text{kWh}}$ , and NORGEMIDT will experience rationing in around 5% of the simulated scenarios. Rationing will average at 75GWh at a total cost of 28.2 million Euros. From these results, it is obvious that investments that give necessary power to Central Norway is needed.

If investments are done without wind power subsidies, the resulting transmission investments are increased by 200 MW divided between SVER–NN2 and HELGELAND due to the 200MW restriction on the line to SVER–NN2. The prices will obviously fall due to a higher availability on cheap power. There will no longer be rationing, the price is around  $5 \frac{\text{eurocent}}{\text{kWh}}$  in 95% of the simulated scenarios and the average price will be similar to that of OSTLAND throughout the year.

With 20% subsidies in wind power investments, wind power will start to get profitable in the northernmost area, FINNMARK, which is the area with the best wind resources. The transmission capacity will also increase slightly compared to that of a scenario without subsidies.

As in the case with normal demand, 20% subsidies will cause higher worst case prices but lower average prices. There will actually be some

rationing that is valued at a total of 2.2 million euros per year. The reason for this is probably due to poor calibration as the area has more available import capacity than in the case without wind power investments, thus prices should be more stable. This shows how important a decent calibration is if there are major changes in the system. The average prices will in be comparable to that of OSTLAND in this case as well, while the prices are still considerably larger than in VESTMIDT.

With 40% subsidies in wind power investments, the trend is the same as earlier. Wind power will get extremely profitable, and the total wind power investments will be 3.7GW. This will also affect the prices and need for transmission capacity as it did before the increase in demand. It is no longer profitable to build the line to Sweden, or to build the line to VESTMIDT at full capacity. However, there is a need for a line northwards to HELGELAND in order to transport newly available wind power from areas north of NORGEMIDT. With these investments, prices in NORGEMIDT will be between prices in OSTLAND and VESTMIDT except from during summer. The problem of rationing is now gone, but in wet years NORGEMIDT will experience flooding, which is socioeconomic very expensive. This is again because the investments has caused large alterations in the system that the hydro power is not aware of and a recalibration of the model would be in order.

The final investments, and their profits and investment costs can be seen in figures C.7-C.9.



## 6.5. 10 % HIGHER DEMAND IN CENTRAL NORWAY

---

Table 6.4: Investments with 10% increased demand in Central Norway and different wind power subsidies

<b>Line/Area</b>	<b>0%</b>	<b>20%</b>	<b>40%</b>
<u>Thermal power production</u>			
NORGEMIDT	-	-	-
<u>Wind power production</u>			
VIND_NORMI	-	-	400 MW
VIND_HELGE	-	-	500 MW
VIND_TROMS	-	-	2200 MW
VIND_FINNM	-	400 MW	600 MW
VIND_SVENN	-	-	-
<u>Transmission capacity</u>			
12 (OSTLAND)	-	-	-
13 (HELGELAND)	100 MW	200 MW	600 MW
18 (SVER-NN2)	200 MW	200 MW	-
46 (VESTMIDT)	700 MW	700 MW	600 MW

Table 6.5: table: Overview of rationing amount and costs

Demand increase	Wind power subsidies	$\frac{GWh}{year}$	$\frac{€}{year}$ (millions)
10%	No investments	75	28.2
	0%	0	0.0
	10%	6	2.2
	20%	0	0.0
20%	No investments	721	270.3
	0%	0	0.0
	10%	15	5.6
	20%	0	0.0

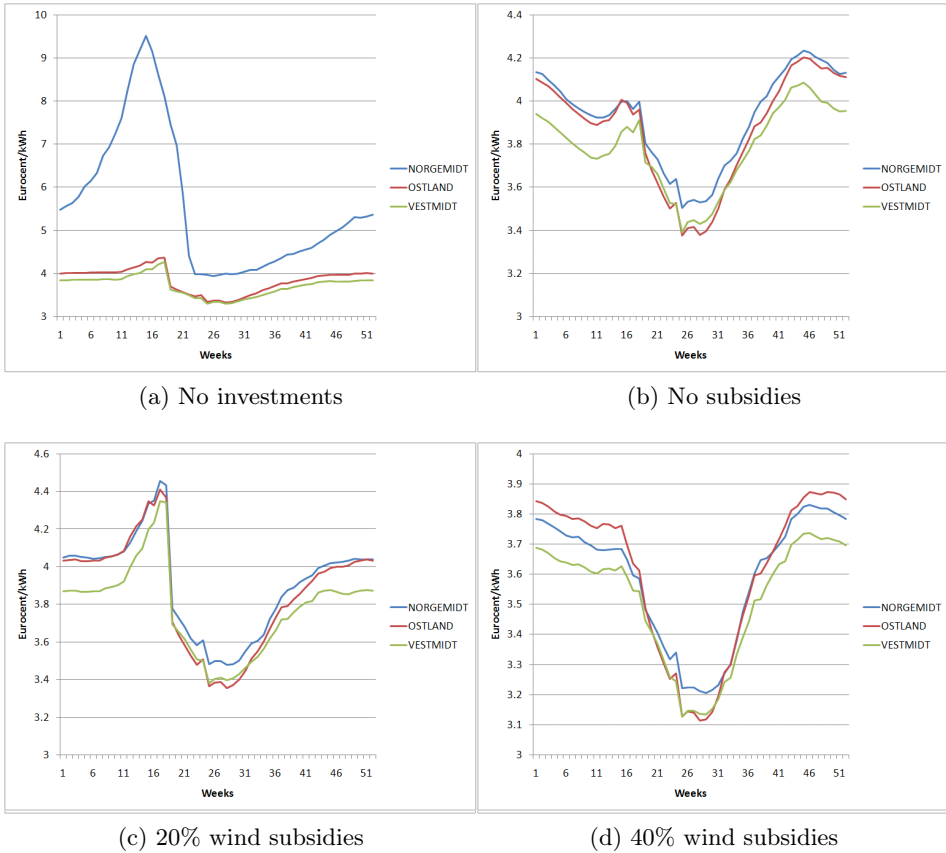

Figure 6.6: Weekly prices in NORGEMIDT, OSTLAND and VESTSYD with 10% increase in demand

## 6.5. 10 % HIGHER DEMAND IN CENTRAL NORWAY

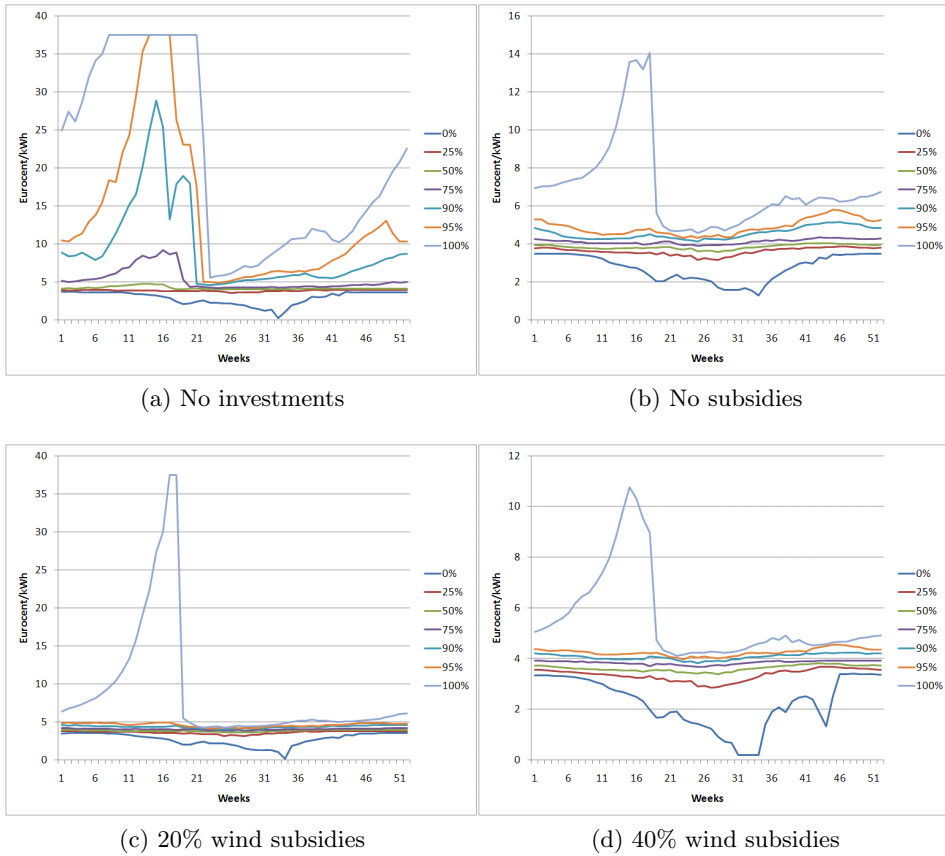

Figure 6.7: Percentile prices in NORGEMIDT with 10% increase in demand

## 6.6 20% higher demand in Central Norway

As a continuation of the previous chapter, the increased demand in Central Norway was changed to 20% or about 4.3TWh. The same simulations were made: Without investments, without subsidies, 20% subsidies and 40% subsidies. Investment results can be seen in table 6.6, and corresponding weekly prices and price percentiles can be seen in figures 6.8 and 6.9.

With no investments done in this scenario, weekly energy prices will reach 23  $\frac{\text{eurocent}}{\text{kWh}}$  at in a normal year, and NORGEMIDT will experience rationing in over 25% of the inflow scenarios. Rationing will average at 721GWh at a total cost of 270.3 million euros. These results shows that investment in the Central Norway area is crucial.

With standard investment costs, without subsidies, the results from the investment analysis give a total of 1300MW of new capacity from the surrounding areas to NORGEMIDT. Even with 20% increase in demand, wind power is still not economically feasible without subsidies. This is compensated for with investments in transmission capacity that are 300 MW higher than that of the simulation with 20% demand increase. These investments will eliminate the risk of rationing, but peak price in a very dry year can still be above 18  $\frac{\text{eurocent}}{\text{kWh}}$ . Prices in a normal year will, as in the previous cases, get close to that of the OSTLAND area but higher than earlier due to a higher demand.

With wind power subsidies of 20%, there will again be a risk of rationing due to lower transmission investments caused by cheaper wind power production in FINNMARK. The prices will generally be lower than in the case without subsidies, but in extreme conditions rationing will occur. This is calculated to a total amount of 15GWh valued at 5.6 million euros. The reservoirs will however not flood as they could in the equivalent simulation

## 6.6. 20% HIGHER DEMAND IN CENTRAL NORWAY

---

with 10% demand increase. In a normal year, the energy price will peak at about  $4.6 \frac{\text{eurocent}}{\text{kWh}}$  and be slightly higher than that of OSTLAND throughout the year.

With wind power subsidies of 40%, there are no longer a risk of rationing since the wind power will be very cheap. A total of 3.8GW can be invested and this will, together with renewed transmission lines from HELGELAND, cause energy prices to stay low throughout the year. In a very dry year, the price will only peak at  $12 \frac{\text{eurocent}}{\text{kWh}}$ , which is only slightly larger than in the same investment scenario before the increased demand. As in earlier simulations with large investments, there is a risk of flooding in very wet years. This problem could again be solved by recalibrating the model in order to adjust the existing hydro power to the new transmission and wind power capacities.

The final investments and the corresponding profits and investment costs can be seen in figures C.10-C.12.

Table 6.6: Investments with 20% increased demand in Central Norway and different wind power subsidies

Line/Area	0%	20%	40%
<u>Thermal power production</u>			
NORGEMIDT	-	-	-
<u>Wind power production</u>			
VIND_NORMI	-	-	400 MW
VIND_HELGE	-	-	200 MW
VIND_TROMS	-	-	2600 MW
VIND_FINNM	-	400 MW	600 MW
VIND_SVENN	-	-	-
<u>Transmission capacity</u>			
12 (OSTLAND)	200 MW	-	-
13 (HELGELAND)	200 MW	200 MW	600 MW
18 (SVER-NN2)	200 MW	200 MW	100 MW
46 (VESTMIDT)	700 MW	700 MW	700 MW

## 6.6. 20% HIGHER DEMAND IN CENTRAL NORWAY

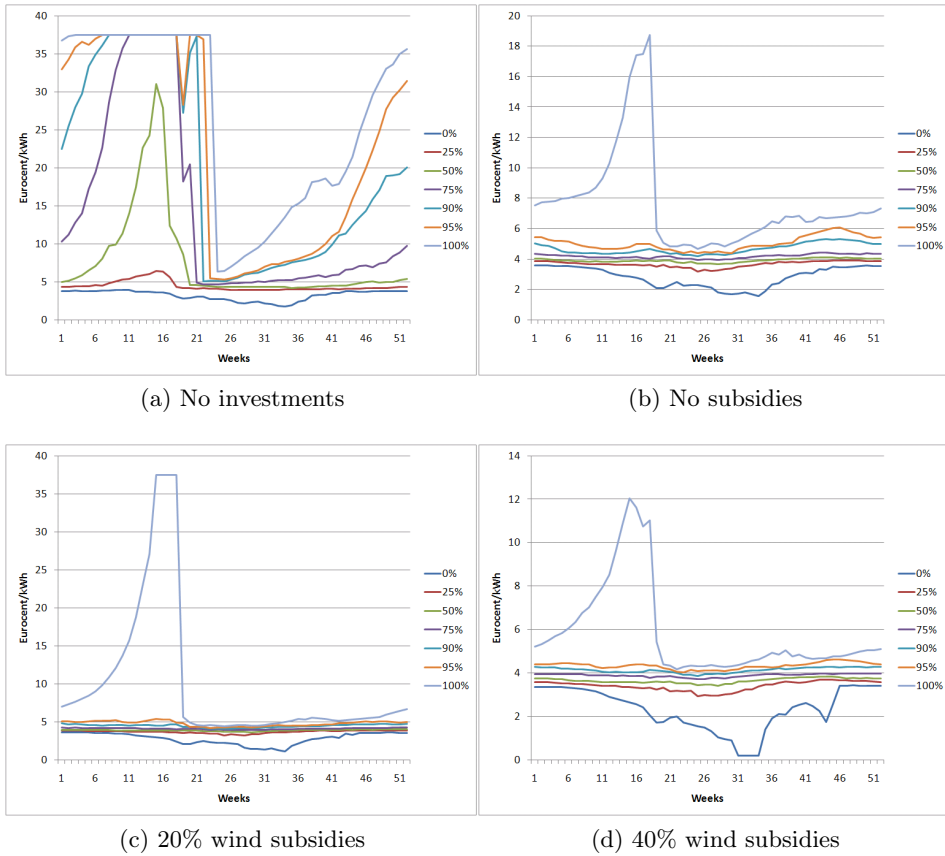

Figure 6.8: Percentile prices in NORGEMIDT with 20% increase in demand

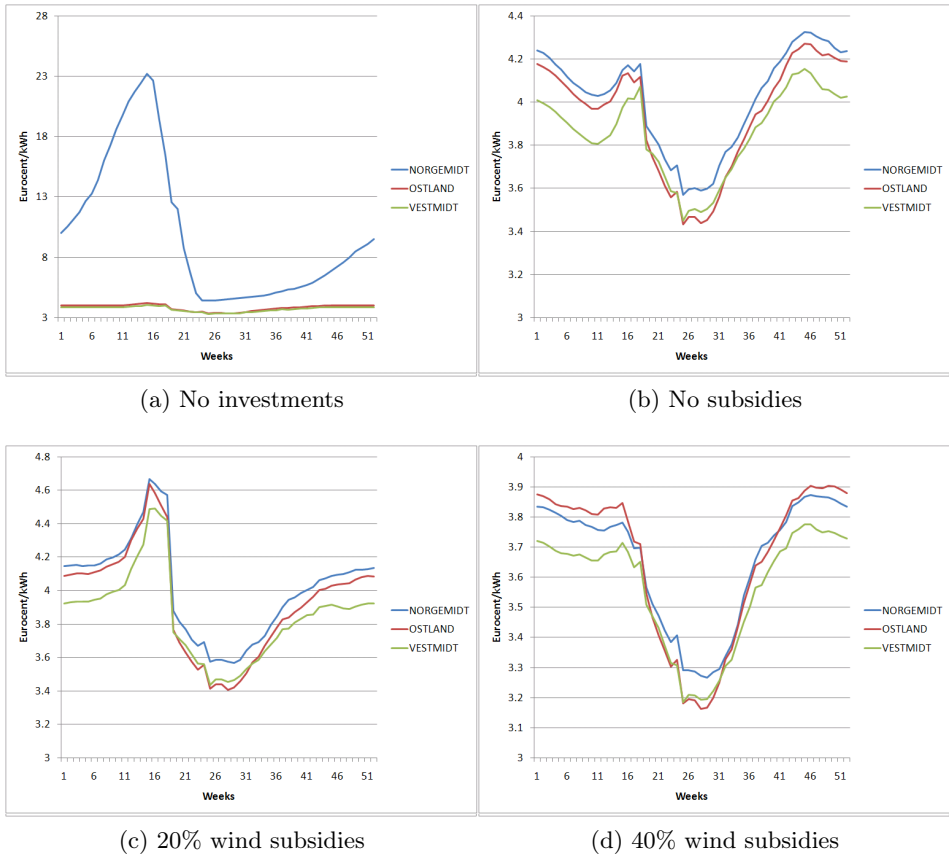

Figure 6.9: Weekly prices in NORGE MIDT, OSTLAND and VESTSYD with 20% increase in demand



---

# Chapter 7

## Discussion

### 7.1 Current situation

Simulations from the current situation show that prices in Central Norway are considerably higher than other Norwegian areas. Without investments, the general price in Central Norway is 0.2–0.4  $\frac{\text{eurocent}}{\text{kWh}}$  higher than in Eastern Norway and around 0.4  $\frac{\text{eurocent}}{\text{kWh}}$  higher than in Western Norway. The prices are however fairly stable, with small risks of flooding in wet years and no risk of rationing in a dry year, based on the historical inflow data, but prices in extremely dry years may reach 25  $\frac{\text{eurocent}}{\text{kWh}}$ .

The investment analysis with current price levels give a result close to the expansions planned by Statnett of 700 MW transmission from Western Norway and 200 MW transmission from Sweden. These investments will cause the price in Central Norway to be close to that of Eastern and Western Norway. The peak prices in dry years is also about halved.

From investment analysis including wind power subsidies, it is clear that subsidies at above 30% will cause major wind power investments and reduce

the general energy price in Central Norway as well as other areas. Subsidies lower than 30% seem to make transmission capacities less profitable, and this may lead to higher prices in dry years compared to investments that would have been done if subsidies were not in effect. If subsidies are larger 40% or above, the resulting investments are so large that the whole model is affected and should be recalibrated accordingly.

## 7.2 10% increased demand

Simulations of a situation with 10% increased demand in Central Norway compared to the given model give much higher prices and a 5% risk of rationing. The cost of rationing is in this report set to  $37.5 \frac{\text{eurocent}}{\text{kWh}}$ , which is an energy price that has only been seen in some hours during the winter of 2010 and didn't result in rationing. This price is still very high for the Nordic system and should occur very rarely. The energy price in a normal year may be twice that of other areas during some weeks, and generally between 0.5 and  $1.5 \frac{\text{eurocent}}{\text{kWh}}$  above Eastern and Western Norway.

Investment analysis give fairly similar results compared to results from the given model, both in amount invested and resulting prices, but the profitability of the system as a whole is much better causing the investments to be slightly larger in each case. Without subsidies, peak prices are only slightly higher than before the increased demand and percentile pricing is also acceptable. With 20% wind power subsidies, there is a small risk of rationing, but the general energy price is low and comparable to that of other Norwegian areas.

40% wind power subsidies will again cause massive wind power investments and therefore cause a stable power situation in Central Norway in addition to prices that are lower than in Eastern Norway and comparable

### 7.3. 20% INCREASED DEMAND

---

to prices in Western Norway. There is also a slight risk of flooding during some weeks in the filling season, which is probably caused by poor calibration considering the new wind power investments of 3.7 GW in total.

## 7.3 20% increased demand

Simulations of a situation with 20% increased demand in Central Norway compared to the given model give severely higher prices and a 25% risk of rationing. The energy price in a normal year is 2-7 times that of other Norwegian areas if no investments are done. This average situation is worse than that of a very dry year in the given model, both in peak price and in average yearly price.

Investment analysis give even more investments than earlier due to a higher income potential, but again the final prices are comparable to that of the given model. Average prices get close to other Norwegian areas and worst case scenarios suggest a price of up to 18  $\frac{\text{eurocent}}{\text{kWh}}$  in a very dry year, but acceptable prices in other scenarios.

Investments with wind power subsidies still cause a chance of rationing if the subsidy is at 20%, and a small chance of flooding during a wet year. If the subsidy level is at 40%, energy prices will be lower than in Eastern Norway and the price will peak at 3.9  $\frac{\text{eurocent}}{\text{kWh}}$  in an average year and 12  $\frac{\text{eurocent}}{\text{kWh}}$  in a very dry year. High level of subsidy will cause investments of 3.8 GW of wind power. This will suppress the need for transmission capacity to southern areas, and possibly cause high level of flooding during a wet year. This must however be confirmed through a recalibration before the flooding probability can be established.

## 7.4 Calibration

The simulations have shown that the model calibration could be crucial to the utilization of hydro power. Ideally, there will never be rationing or flooding as this has very high socioeconomic costs. Rationing cause consumers to suffer to high prices and lack of supply and flooding is a waste of energy that could have been utilized for generation. The calibration algorithm maximizes the socioeconomic profit, thus minimizing rationing and flooding as this has a high cost.

This has become clear in simulations where large investments are being made. The hydro power areas are not aware of new generation or transmission capacity, and will therefore not respond correctly to prices and reservoir levels at any given times. This might cause hydro power to produce too little power in the filling season to prepare for the depletion season and therefore start flooding at the end of the filling season.

Ideally, this should be done as often as possible in order to adjust for every system change, but this might not be feasible as the calibration is a time consuming task that take several hours.

---

## Chapter 8

# Conclusion

During the work on this thesis, the investment functionality in EMPS has been thoroughly tested and has been found to be robust. It is based on the well tested EMPS model that is in use by large parts of the power community in Norway, and that is especially well suited for systems with high share of hydro power generation.

The investment functionality is still in its developing phase, and it has possibilities for several extensions that will make it even more robust. These include, but are not limited to automatic recalibration and non-linear investments.

The simulations that have been done show that the power situation Central Norway is close to critical and that investments must be done to avoid high risk of rationing in a future situation with higher demand.

The investment analysis based on the present state show that the proposed transmission investments on Nea–Järpstrømmen and Ørskog–Fardal are sensible and very useful for the power situation in Central Norway.

Simulations show that subsidies to encourage wind power development

might cause more uncertain and variable prices due to lower price incentives to build new transmission capacity. Simulations also show that large wind power investments will have a substantial impact on how hydro power is utilized in Norway. Reservoir drawdown strategies based on an old system might be outdated and far from optimal, and that erroneous hydro utilization will cause spilling in the filling season instead of lower prices in other seasons.

All simulations also show that gas powered thermal power plants are not economically feasible in Central Norway due to high O&M-costs in addition to a substantial investment cost.

The investment functionality has shown a good capability to obtain sensible solutions that give less price variation throughout the system and reasonable price distributions as long as the investments are small enough to not have substantial impact on hydro power utilization.

Experience with the model show that some areas need to be improved through further work and testing, which is discussed in the next chapter.

---

# Chapter 9

## Further Work

### 9.1 Thorough model verification

As the transmission capacity was found to be inaccurate for lines connected to Central Norway, it is a fair assumption that this may also be the case for other lines in other areas. Due to the area aggregation, the actual transmission capacity between areas is not always easy, or even possible, to achieve. The capacities should however be verified to see if they are at least fairly consistent with actual values.

### 9.2 Changes to the investment model

Since the investment model is fairly new, there are still many possible improvements that can be made. Many of these are covered in the technical report about the model[20], but some issues arose during the work on this thesis.

- **Sensible input values.** At this stage, investment costs must be

entered in  $\frac{\text{cent}}{\text{kW}\cdot\text{year}}$  instead of the conventional  $\frac{\text{€}}{\text{MW}\cdot\text{year}}$ . This will not make the analysis qualitative better, but it will make the input parameters more intuitive.

- **No investment.** At this stage, there must always be an investment option for transmission, wind and thermal capacities. This is due to a matrix being created in each investment script with the size of number of investment for that type. If the number of investments is set to zero, this matrix can not be created and the investment algorithm fails. At this stage, the way to work around this problem is to set investment costs or operating costs unreasonably high for the investment options that are unwanted, e.g. wind power if an area without wind power capabilities are being simulated.
- **Transmission only iterations.** As discussed in chapter 3.4, every other iteration is transmission only iterations. These iterations are supposed to only consider transmission investments to avoid rotation between different possible solutions. However, these iterations seem to only consider the first transmission investment which is not necessarily the most profitable one. An example of this can be seen in figure C.1, where investment is only done on line 12 but line 13,18 and 46 are also profitable. In this case, the inclusion of one transmission line will decrease the profitability of the other lines. A solution to this problem could be to only invest in the most profitable transmission line, which would be line 46 in figure C.1.
- **Non-linear investments.** At this point, the investment algorithm assumes linear investment costs. This could be a fair approximation in some cases, but for many investments this is not the case. One solution to this problem is to implement the possibility of piecewise linear investment costs, causing the overall investment costs to be



### 9.3. OTHER SIMULATIONS

---

more accurate for all investment sizes. Another possibility is to say that an investment has a certain "project cost", which is constant from the first investment, and a linear or piecewise linear investment cost after that. The problem with these changes are that proper data could be difficult to collect, but there could always be an option where the investment cost is linear for all investment sizes.

- **Automatic calibration.** Since the whole model changes as investments are done, hydro power utilization should also be calibrated to the new system. Since the calibration is a rather time consuming the model can not be fully calibrated after every small investment, so a compromise has to be made. One solution could be to recalibrate after the investment analysis is done and compare profits in order to establish if the investments are still feasible. Another, but more time consuming, solution could be to do one iteration of one calibration parameter after every or every other investment iteration. This will be very time consuming, but the model will always be up to date with respect to the new investments.

### 9.3 Other simulations

Other simulations might be done in order to further investigate solutions to the power situation in Central Norway.

- **Subsidies and increased demand.** Further simulations with subsidies included, e.g. 15% increased load combined with 30% wind power subsidies
- **Green certificates.** Use negative O&M costs to simulate a green certificate scheme in stead of using direct subsidies.

- **Offshore wind.** Offshore wind might be simulated separately with different investment and O&M costs, different utilization factors and possibly different subsidy schemes.
- **Other simulations, areas or systems.**

# Bibliography

- [1] Statkraft SCA Vind AB. <http://www.statkraft.no/prosjekter/sverige/statkraft-sca-vind-ab/default.aspx>. Visited 6.June 2010.
- [2] Mats Elvethon Bakken. Investment analysis with the emps model, with emphasis on cable connections with other systems. Master's thesis, Norwegian University of Science and Technology, 2010.
- [3] Ann Christin Bøeng. Vekslende vær for vindkraft. *Statistics Norway*, December 2006.
- [4] Simon Bryars and Jo Holt. European Wind Farm Project Costs. History and Projections. 2008 Study. Technical report, Garrad Hassan and Partners Limited, 2008.
- [5] Gerard L. Doorman. *Course ELK15 Hydro Power Scheduling*. Department of Electric Power Engineering, NTNU, 2009.
- [6] Gerard L. Doorman, May 2010. Personal conversation.
- [7] Gerard L. Doorman and Rolf Ulseth. *Energy System Planning and Operation, TET4135*. Department of Electric Power Engineering and Department of Energy and Process Engineering, NTNU, 2008.
- [8] Oddbjørn Gjerde, June 2010. Personal conversation.

- [9] M Korpås, J Warland, J.O.G Tande, K Uhlen, K Purchala, and S Wage-mans. D3.2 Grid modelling and power system data. Technical report, European Wind Energy Association, December 2007.
- [10] Svenska Kraftnät. Ansöknad om ny nätkoncession för linje avseende ny 400 kV ledning mellan Järpströmmen och norska gränsen, March 2006. Page 4. Translated from Swedish.
- [11] Bo Mørup. Driving down the cost of offshore wind. In *EOW*. Vestas, 2007.
- [12] Nord Pool. Carbon Contracts. <http://www.nordpool.com/System/FinanceMarket/emissions/>. Visited May 30<sup>th</sup> 2010.
- [13] SINTEF Energy Research. EMPS. <http://www.sintef.no/Home/Petroleum-and-Energy/SINTEF-Energy-Research/Expertise/Hydro-thermal-operation-and-expansion-planning/EMPS/>.
- [14] SINTEF Energy Research. *Samkjøringsmodellen, dokumentasjon, brukerveiledning*.
- [15] Statnett. Ørskog - Fardal. <http://www.statnett.no/no/Prosjekter/Orskog-Fardal/>. Visited May 30<sup>th</sup> 2010.
- [16] Statnett. Nea - Riksgrensen, Søknad om konsesjon, ekspropriasjonstillatelse og ferdigstilling, March 2006. Page 24, translated from Norwegian.
- [17] Statnett. 420kV ledning Ørskog-Fardal, Søknad om konsesjon, ekspropriasjonstillatelse og ferdigstilling, February 2007. Page 78. Translated from Norwegian.
- [18] US Department of Energy and Environmental Protection Agency. *Carbon Dioxide Emissions from the Generation of Electric Power in the United States*, July 2000.

## BIBLIOGRAPHY

---

- [19] Norges vassdrags-og energidirektorat. Konsesjonssøknader på høyring - vindkraft. <http://www.nve.no/no/Konsesjoner/Konsesjonssaker/Vindkraft/>. Visited 3.June 2010.
- [20] Ove Wolfgang. Funksjonalitet for investeringsanalyse til Samkjøringsmodellen. Technical Report TR A6720, SINTEF Energiforskning, 2008.



---

## Appendix A

# Areas and transmission lines

Table A.1: List of areas

Area #	Area name	Area #	Area name
1	GLOMMA	18	SVER-SYD
2	OSTLAND	19	DANM-VEST
3	SOROST	20	DANM-OST
4	HALLINGDAL	21	FINLAND
5	TELEMARK	22	VIND_FINO
6	SORLAND	23	VIND_FISY
7	VESTSYD	24	VIND_SORLA
8	VESTMIDT	25	VIND_VESTSY
9	NORGEMIDT	26	VIND_VESTMI
10	HELGELAND	27	VIND_NORMI
11	TROMS	28	VIND_HELGE
12	FINNMARK	29	VIND_TROMS
13	SVER-ON1	30	VIND_FINNM
14	SVER-ON2	31	VIND_SVEON
15	SVER-NN1	32	VIND_SVENN
16	SVER-NN2	33	VIND_SVEMI
17	SVER-MIDT	34	VIND_SVESO

---

APPENDIX A. AREAS AND TRANSMISSION LINES

---

Table A.2: Transmission capacity in the Nordic grid

Line number	From Area	To Area	Capacity [MW]
1	SOROST	OSTLAND	2000
2	TELEMARK	SOROST	1800
3	SORLAND	SOROST	800/600
4	SORLAND	TELEMARK	800
5	VESTSYD	SORLAND	1200
6	VESTSYD	TELEMARK	900
7	VESTSYD	VESTMIDT	500
8	VESTMIDT	HALLINGDAL	2600
9	VESTSYD	OSTLAND	900
10	VESTSYD	SOROST	1000
11	HALLINGDAL	OSTLAND	3300
12	NORGEMIDT	OSTLAND	600
13	HELGELAND	NORGEMIDT	900
14	TROMS	HELGELAND	600
15	FINNMARK	TROMS	150
16	GLOMMA	OSTLAND	5000
17	OSTLAND	SVER-MIDT	2200
18	NORGEMIDT	SVER-NN2	750
19	HELGELAND	SVER-NN2	150/250
20	TROMS	SVER-ON2	700
21	FINNMARK	FINLAND	120/100
22	SVER-ON2	FINLAND	1650/1050
23	SVER-MIDT	FINLAND	550
24	SORLAND	DANM-VEST	1500
25	SVER-MIDT	DANM-VEST	720
26	SVER-SYD	DANM-OST	1770/1770
27	SVER-NN2	SVER-MIDT	7000
28	DANM-OST	DANM-VEST	600
29	SVER-ON1	SVER-ON2	2700
30	SVER-ON2	SVER-NN1	20000

Continued on Next Page. . .



Table A.2 – Continued

Line number	From Area	To Area	Capacity [MW]
31	SVER-NN1	SVER-NN2	20000
32	SVER-MIDT	SVER-SYD	1500
33	FINLAND	VIND_FINO	$\infty$
34	FINLAND	VIND_FISU	$\infty$
35	SORLAND	VIND_SORLA	$\infty$
36	VESTSYD	VIND_VESTSY	$\infty$
37	VESTMIDT	VIND_VESTMI	$\infty$
38	NORGEMIDT	VIND_NORMI	$\infty$
39	HELGELAND	VIND_HELGE	$\infty$
40	TROMS	VIND_TROMS	$\infty$
41	FINNMARK	VIND_FINNM	$\infty$
42	SVER-ON1	VIND_SVEON	$\infty$
43	SVER-NN2	VIND_SVENN	$\infty$
44	SVER-MIDT	VIND_SVEMI	$\infty$
45	SVER-SYD	VIND_SVESO	$\infty$

## Appendix B

# Wind power license applications

Table B.1: Wind power licence applications in NORGEMIDT

<b>Project name</b>	<b>Power [MW]</b>	<b>Energy [GWh]</b>	<b><math>\frac{\text{MW}}{\text{GWh}}</math></b>
Hitra 2	75	175	2.33
Geitfjellet	180	540	3.00
Heimsfjellet	90	280	3.11
Sørmarkfjellet	150	375	2.50
Roan	330	825	2.50
Kvenndalsfjellet	120	400	3.33
Frøya	200	500	2.50
Storheia	260	650	2.50
Blåheia	300	500	1.67
Grøndalsfjellet	200	560	2.80
Nordre Grøndalsfjellet	110	275	2.50
Beingårdsheia og Mefossheia	140	350	2.50
Grønningfjella	378	1000	2.65

Continued on Next Page...

Table B.1 – Continued

<b>Project name</b>	<b>Power [MW]</b>	<b>Energy [GWh]</b>	<b><math>\frac{\text{MW}}{\text{GWh}}</math></b>
Breivikfjellet	60	170	2.83
Innvordfjellet	90	250	2.78
Jektheia	150	375	2.50
Staurheia	100	325	3.25
Sandvassheia og Follaheia	200	500	2.50
<b>Total</b>	<b>3133</b>	<b>8050</b>	<b>2.57</b>

Table B.2: Wind power licence applications in HELGELAND

<b>Project name</b>	<b>Power [MW]</b>	<b>Energy [GWh]</b>	<b><math>\frac{\text{MW}}{\text{GWh}}</math></b>
Slenseset	225	675	3.00
Sjonfjellet	436	1200	2.75
Hovden	9	29	3.22
Røst	10	40	4.00
Mosjøen	360	750	2.08
Kalvatnan	225	560	2.49
Ånstadblåheia	50	150	3.00
Skogvatnet	80	240	3.00
Stortuva	70	200	2.86
Kovfjellet	57	170	2.98
Seiskallåfjellet	147	440	2.99
Kvalhovudet	33	100	3.03
Sjonfjellet	360	1000	2.78
Sørfjord	80	250	3.13
<b>Total</b>	<b>2142</b>	<b>5804</b>	<b>2.71</b>

---

APPENDIX B. WIND POWER LICENSE APPLICATIONS

---

Table B.3: Wind power licence applications in TROMS

<b>Project name</b>	<b>Power [MW]</b>	<b>Energy [GWh]</b>	<b><math>\frac{\text{MW}}{\text{GWh}}</math></b>
Måsvik	15	40	2.67
Rieppi	80	240	3.00
Flatneset	35	100	2.86
<b>Total</b>	<b>130</b>	<b>380</b>	<b>2.92</b>

Table B.4: Wind power licence applications in FINNMARK

<b>Project name</b>	<b>Power [MW]</b>	<b>Energy [GWh]</b>	<b><math>\frac{\text{MW}}{\text{GWh}}</math></b>
Sørøya	15	40	2.67
Dønnesfjord	10	40	4.00
Laksefjorden	100	280	2.80
Rakkocearro	350	1200	3.43
Bjørnevatn	60	155	2.58
Kvalsund	400	1350	3.38
Nordkyn	750	2600	3.47
Skjøtningsberg	400	1200	3.00
Eliastoppen	40	120	3.00
<b>Total</b>	<b>2125</b>	<b>6985</b>	<b>3.29</b>

---

## Appendix C

# Simulation results

Table C.1: Calibration parameters

<b>Area number</b>	<b>Area name</b>	<b>Feedback factor</b>	<b>Form factor</b>	<b>Elasticity factor</b>
1	GLOMMA	0.800	0.400	1.000
2	OSTLAND	1.000	2.200	1.400
3	SOROST	1.000	1.000	1.000
4	HALLINGDAL	1.000	1.000	1.000
5	TELEMARK	1.000	1.000	1.000
6	SORLAND	0.900	1.675	0.900
7	VESTSYD	0.950	1.300	0.900
8	VESTMIDT	0.950	1.300	0.900
9	NORGEMIDT	1.000	1.000	1.025
10	HELGELAND	1.000	1.300	1.000
11	TROMS	1.000	1.000	1.100
12	FINNMARK	0.950	1.000	0.922
13	SVER-ON1	2.500	3.900	1.300
14	SVER-ON2	2.500	1.900	1.000
15	SVER-NN1	2.025	0.100	0.975
16	SVER-NN2	1.875	0.775	0.703

Continued on Next Page...

---

APPENDIX C. SIMULATION RESULTS

---

Table C.1 – Continued

Area number	Area name	Feedback factor	Form factor	Elasticity factor
17	SVER-MIDT	1.950	1.000	1.000
18	SVER-SYD	2.000	1.100	1.000
19	DANM-VEST	1.000	1.000	1.000
20	DANM-OST	1.000	1.000	1.000
21	FINLAND	1.300	1.000	1.000
22	VIND_FINO	1.000	1.000	1.000
23	VIND_FISY	1.000	1.000	1.000
24	VIND_SORLA	1.000	1.000	1.000
25	VIND_VESTSY	1.000	1.000	1.000
26	VIND_VESTMI	1.000	1.000	1.000
27	VIND_NORMI	1.000	1.000	1.000
28	VIND_HELGE	1.000	1.000	1.000
29	VIND_TROMS	1.000	1.000	1.000
30	VIND_FINNM	1.000	1.000	1.000
31	VIND_SVEON	1.000	1.000	1.000
32	VIND_SVENN	1.000	1.000	1.000
33	VIND_SVEMI	1.000	1.000	1.000
34	VIND_SVESO	1.000	1.000	1.000
35	NETHERLAND	1.000	1.000	1.000

---

---

Runde: 2(B)

Ternisk kapasitet:

( 2) OSTLAND	Typenr.: 13	Kapasitet: 0 (MW)	Avanse: 2259.0	Inv.kost.: 7455.
( 7) VESTSYD	Typenr.: 13	Kapasitet: 0 (MW)	Avanse: 1795.5	Inv.kost.: 7455.
( 9) NORGEMIDT	Typenr.: 13	Kapasitet: 0 (MW)	Avanse: 3125.5	Inv.kost.: 7455.

Vindkraft:

(27) VIND_NORMI	Modulnr.: 500	Kapasitet: 1 (MW)	Avanse: 8670.5	Inv.kost.: 12297.
(28) VIND_HELGE	Modulnr.: 500	Kapasitet: 1 (MW)	Avanse: 8848.1	Inv.kost.: 12297.
(29) VIND_TROMS	Modulnr.: 500	Kapasitet: 1 (MW)	Avanse: 9588.6	Inv.kost.: 12297.
(30) VIND_FINNM	Modulnr.: 500	Kapasitet: 1 (MW)	Avanse: 11555.2	Inv.kost.: 12297.
(32) VIND_SVENN	Modulnr.: 500	Kapasitet: 1 (MW)	Avanse: 6820.9	Inv.kost.: 12297.

Transmisjonslinjer:

(12) NORGEMIDT - OSTLAND	Ekstra: 100 (MW)	Avanse: 8398.8	Inv.kost.: 3300
(13) HELGELAND - NORGEMIDT	Ekstra: 100 (MW)	Avanse: 4242.1	Inv.kost.: 3300
(18) NORGEMIDT - SVER-NN2	Ekstra: 100 (MW)	Avanse: 8156.2	Inv.kost.: 2529
(46) VESTMIDT - NORGEMIDT	Ekstra: 100 (MW)	Avanse: 19297.7	Inv.kost.: 3914

Runde: 3(A)

Ternisk kapasitet:

( 2) OSTLAND	Typenr.: 13	Kapasitet: 0 (MW)	Avanse: 2270.6	Inv.kost.: 7455.
( 7) VESTSYD	Typenr.: 13	Kapasitet: 0 (MW)	Avanse: 1804.5	Inv.kost.: 7455.
( 9) NORGEMIDT	Typenr.: 13	Kapasitet: 0 (MW)	Avanse: 2983.0	Inv.kost.: 7455.

Vindkraft:

(27) VIND_NORMI	Modulnr.: 500	Kapasitet: 1 (MW)	Avanse: 8626.6	Inv.kost.: 12297.
(28) VIND_HELGE	Modulnr.: 500	Kapasitet: 1 (MW)	Avanse: 8810.0	Inv.kost.: 12297.
(29) VIND_TROMS	Modulnr.: 500	Kapasitet: 1 (MW)	Avanse: 9557.2	Inv.kost.: 12297.
(30) VIND_FINNM	Modulnr.: 500	Kapasitet: 1 (MW)	Avanse: 11530.6	Inv.kost.: 12297.
(32) VIND_SVENN	Modulnr.: 500	Kapasitet: 1 (MW)	Avanse: 6816.2	Inv.kost.: 12297.

Transmisjonslinjer:

(12) NORGEMIDT - OSTLAND	Ekstra: 200 (MW)	Avanse: 6431.3	Inv.kost.: 3300
(13) HELGELAND - NORGEMIDT	Ekstra: 100 (MW)	Avanse: 4090.4	Inv.kost.: 3300
(18) NORGEMIDT - SVER-NN2	Ekstra: 100 (MW)	Avanse: 6603.7	Inv.kost.: 2529
(46) VESTMIDT - NORGEMIDT	Ekstra: 100 (MW)	Avanse: 17388.2	Inv.kost.: 3914

Figure C.1: The problem of iterations with only transmission changes

Ternisk kapasitet:

( 2) OSTLAND	Typenr.: 13	Kapasitet: 0 (MW)	Avanse: 2306.1	Inv.kost.: 7455.
( 7) VESTSYD	Typenr.: 13	Kapasitet: 0 (MW)	Avanse: 1852.7	Inv.kost.: 7455.
( 9) NORGEMIDT	Typenr.: 13	Kapasitet: 0 (MW)	Avanse: 2445.1	Inv.kost.: 7455.

Vindkraft:

(27) VIND_NORMI	Modulnr.: 500	Kapasitet: 1 (MW)	Avanse: 8421.1	Inv.kost.: 11067.
(28) VIND_HELGE	Modulnr.: 500	Kapasitet: 1 (MW)	Avanse: 8616.1	Inv.kost.: 11067.
(29) VIND_TROMS	Modulnr.: 500	Kapasitet: 1 (MW)	Avanse: 9416.8	Inv.kost.: 11067.
(30) VIND_FINNM	Modulnr.: 500	Kapasitet: 1 (MW)	Avanse: 11412.5	Inv.kost.: 11067.
(32) VIND_SVENN	Modulnr.: 500	Kapasitet: 1 (MW)	Avanse: 6777.7	Inv.kost.: 11067.

Transmisjonslinjer:

(12) NORGEMIDT - OSTLAND	Ekstra: 0 (MW)	Avanse: 2809.7	Inv.kost.: 3300
(13) HELGELAND - NORGEMIDT	Ekstra: 0 (MW)	Avanse: 4093.2	Inv.kost.: 3300
(18) NORGEMIDT - SVER-NN2	Ekstra: 100 (MW)	Avanse: 3011.0	Inv.kost.: 2529
(46) VESTMIDT - NORGEMIDT	Ekstra: 700 (MW)	Avanse: 7041.7	Inv.kost.: 3914

Figure C.2: Investment results with 10 percent subsidies

## APPENDIX C. SIMULATION RESULTS

---

```

Termisk kapasitet:
( 9) NORGEMIDT Typenr.: 13 Kapasitet: 0 (MW) Avanse: 2282.9 Inv.kost.: 7455.

Vindkraft:
(27) WIND_NORMI Modulnr.: 500 Kapasitet: 1 (MW) Avanse: 8364.4 Inv.kost.: 9838.
(28) WIND_HELGE Modulnr.: 500 Kapasitet: 1 (MW) Avanse: 8566.5 Inv.kost.: 9838.
(29) WIND_TROMS Modulnr.: 500 Kapasitet: 1 (MW) Avanse: 9313.5 Inv.kost.: 9838.
(30) WIND_FINNM Modulnr.: 500 Kapasitet: 301 (MW) Avanse: 10635.9 Inv.kost.: 9838.
(32) WIND_SVENN Modulnr.: 500 Kapasitet: 1 (MW) Avanse: 6740.0 Inv.kost.: 9838.

Transmisjonslinjer:
(12) NORGEMIDT - OSTLAND Ekstra: 0 (MW) Avanse: 2694.6 Inv.kost.: 3300
(13) HELGELAND - NORGEMIDT Ekstra: 0 (MW) Avanse: 3590.1 Inv.kost.: 3300
(18) NORGEMIDT - SVER-NN2 Ekstra: 0 (MW) Avanse: 3025.3 Inv.kost.: 2529
(46) VESTMIDT - NORGEMIDT Ekstra: 700 (MW) Avanse: 6479.0 Inv.kost.: 3914
    
```

Figure C.3: Investment results with 20 percent subsidies

```

Termisk kapasitet:
( 9) NORGEMIDT Typenr.: 13 Kapasitet: 0 (MW) Avanse: 2044.0 Inv.kost.: 7455.

Vindkraft:
(27) WIND_NORMI Modulnr.: 500 Kapasitet: 1 (MW) Avanse: 8264.2 Inv.kost.: 8606.
(28) WIND_HELGE Modulnr.: 500 Kapasitet: 1 (MW) Avanse: 8475.2 Inv.kost.: 8606.
(29) WIND_TROMS Modulnr.: 500 Kapasitet: 101 (MW) Avanse: 9036.0 Inv.kost.: 8606.
(30) WIND_FINNM Modulnr.: 500 Kapasitet: 601 (MW) Avanse: 8636.1 Inv.kost.: 8606.
(32) WIND_SVENN Modulnr.: 500 Kapasitet: 1 (MW) Avanse: 6661.6 Inv.kost.: 8606.

Transmisjonslinjer:
(12) NORGEMIDT - OSTLAND Ekstra: 0 (MW) Avanse: 2661.3 Inv.kost.: 3300
(13) HELGELAND - NORGEMIDT Ekstra: 100 (MW) Avanse: 3207.4 Inv.kost.: 3300
(18) NORGEMIDT - SVER-NN2 Ekstra: 0 (MW) Avanse: 2898.7 Inv.kost.: 2529
(46) VESTMIDT - NORGEMIDT Ekstra: 700 (MW) Avanse: 6035.5 Inv.kost.: 3914
    
```

Figure C.4: Investment results with 30 percent subsidies

```

Termisk kapasitet:
( 9) NORGEMIDT Typenr.: 13 Kapasitet: 0 (MW) Avanse: 1021.0 Inv.kost.: 7455.

Vindkraft:
(27) WIND_NORMI Modulnr.: 500 Kapasitet: 301 (MW) Avanse: 7527.0 Inv.kost.: 7378.
(28) WIND_HELGE Modulnr.: 500 Kapasitet: 501 (MW) Avanse: 7706.5 Inv.kost.: 7378.
(29) WIND_TROMS Modulnr.: 500 Kapasitet: 1901 (MW) Avanse: 8126.9 Inv.kost.: 7378.
(30) WIND_FINNM Modulnr.: 500 Kapasitet: 601 (MW) Avanse: 7756.0 Inv.kost.: 7378.
(32) WIND_SVENN Modulnr.: 500 Kapasitet: 1 (MW) Avanse: 6256.7 Inv.kost.: 7378.

Transmisjonslinjer:
(12) NORGEMIDT - OSTLAND Ekstra: 0 (MW) Avanse: 3122.8 Inv.kost.: 3300
(13) HELGELAND - NORGEMIDT Ekstra: 600 (MW) Avanse: 3443.7 Inv.kost.: 3300
(18) NORGEMIDT - SVER-NN2 Ekstra: 0 (MW) Avanse: 2267.3 Inv.kost.: 2529
(46) VESTMIDT - NORGEMIDT Ekstra: 500 (MW) Avanse: 4760.3 Inv.kost.: 3914
    
```

Figure C.5: Investment results with 40 percent subsidies



---

```

Termisk kapasitet:
( 9) NORGEMIDT Typenr.: 13 Kapasitet: 0 (MW) Avanse: 272.2 Inv.kost.: 7455.

Vindkraft:
(27) VIND_NORMI Modulnr.: 500 Kapasitet: 2201 (MW) Avanse: 6577.6 Inv.kost.: 6149.
(28) VIND_HELGE Modulnr.: 500 Kapasitet: 2601 (MW) Avanse: 6620.2 Inv.kost.: 6149.
(29) VIND_TROMS Modulnr.: 500 Kapasitet: 2801 (MW) Avanse: 6402.8 Inv.kost.: 6149.
(30) VIND_FINNM Modulnr.: 500 Kapasitet: 601 (MW) Avanse: 6425.4 Inv.kost.: 6149.
(32) VIND_SVENN Modulnr.: 500 Kapasitet: 1 (MW) Avanse: 5650.8 Inv.kost.: 6149.

Transmisjonslinjer:
(12) NORGEMIDT - OSTLAND Ekstra: 1000 (MW) Avanse: 3318.3 Inv.kost.: 3300
(13) HELGELAND - NORGEMIDT Ekstra: 1400 (MW) Avanse: 5271.8 Inv.kost.: 3300
(18) NORGEMIDT - SVER-NN2 Ekstra: 200 (MW) Avanse: 3699.5 Inv.kost.: 2529
(46) VESTMIDT - NORGEMIDT Ekstra: 200 (MW) Avanse: 4153.5 Inv.kost.: 3914

```

Figure C.6: Investment results with 50 percent subsidies

```

Termisk kapasitet:
( 9) NORGEMIDT Typenr.: 13 Kapasitet: 0 (MW) Avanse: 3017.8 Inv.kost.: 7455.

Vindkraft:
(27) VIND_NORMI Modulnr.: 500 Kapasitet: 1 (MW) Avanse: 8651.3 Inv.kost.: 12297.
(28) VIND_HELGE Modulnr.: 500 Kapasitet: 1 (MW) Avanse: 8854.5 Inv.kost.: 12297.
(29) VIND_TROMS Modulnr.: 500 Kapasitet: 1 (MW) Avanse: 9641.5 Inv.kost.: 12297.
(30) VIND_FINNM Modulnr.: 500 Kapasitet: 1 (MW) Avanse: 11642.5 Inv.kost.: 12297.
(32) VIND_SVENN Modulnr.: 500 Kapasitet: 1 (MW) Avanse: 6924.0 Inv.kost.: 12297.

Transmisjonslinjer:
(12) NORGEMIDT - OSTLAND Ekstra: 0 (MW) Avanse: 3423.2 Inv.kost.: 3300
(13) HELGELAND - NORGEMIDT Ekstra: 100 (MW) Avanse: 3801.2 Inv.kost.: 3300
(18) NORGEMIDT - SVER-NN2 Ekstra: 200 (MW) Avanse: 3600.2 Inv.kost.: 2529
(46) VESTMIDT - NORGEMIDT Ekstra: 700 (MW) Avanse: 9117.4 Inv.kost.: 3914

```

Figure C.7: Investment results with 10 percent demand increase and no subsidies

```

Termisk kapasitet:
( 9) NORGEMIDT Typenr.: 13 Kapasitet: 0 (MW) Avanse: 2718.6 Inv.kost.: 7455.

Vindkraft:
(27) VIND_NORMI Modulnr.: 500 Kapasitet: 1 (MW) Avanse: 8534.6 Inv.kost.: 9838
(28) VIND_HELGE Modulnr.: 500 Kapasitet: 1 (MW) Avanse: 8752.8 Inv.kost.: 9838
(29) VIND_TROMS Modulnr.: 500 Kapasitet: 1 (MW) Avanse: 9441.9 Inv.kost.: 9838
(30) VIND_FINNM Modulnr.: 500 Kapasitet: 401 (MW) Avanse: 10329.2 Inv.kost.: 9838
(32) VIND_SVENN Modulnr.: 500 Kapasitet: 1 (MW) Avanse: 6839.1 Inv.kost.: 9838.

Transmisjonslinjer:
(12) NORGEMIDT - OSTLAND Ekstra: 0 (MW) Avanse: 3120.3 Inv.kost.: 3300
(13) HELGELAND - NORGEMIDT Ekstra: 200 (MW) Avanse: 3230.7 Inv.kost.: 3300
(18) NORGEMIDT - SVER-NN2 Ekstra: 200 (MW) Avanse: 3256.5 Inv.kost.: 2529
(46) VESTMIDT - NORGEMIDT Ekstra: 700 (MW) Avanse: 8430.5 Inv.kost.: 3914

```

Figure C.8: Investment results with 10 percent demand increase and 20 percent subsidies

## APPENDIX C. SIMULATION RESULTS

---

```

Termisk kapasitet:
( 9) NORGEMIDT Typenr.: 13 Kapasitet: 0 (MW) Avanse: 1171.0 Inv.kost.: 7455.

Vindkraft:
(27) VIND_NORMI Modulnr.: 500 Kapasitet: 401 (MW) Avanse: 7614.9 Inv.kost.: 7378.
(28) VIND_HELGE Modulnr.: 500 Kapasitet: 501 (MW) Avanse: 7745.6 Inv.kost.: 7378.
(29) VIND_TROMS Modulnr.: 500 Kapasitet: 2201 (MW) Avanse: 8084.4 Inv.kost.: 7378.
(30) VIND_FINNM Modulnr.: 500 Kapasitet: 601 (MW) Avanse: 7734.4 Inv.kost.: 7378.
(32) VIND_SVENN Modulnr.: 500 Kapasitet: 1 (MW) Avanse: 6309.4 Inv.kost.: 7378.

Transmisjonslinjer:
(12) NORGEMIDT - OSTLAND Ekstra: 0 (MW) Avanse: 2959.0 Inv.kost.: 3300
(13) HELGELAND - NORGEMIDT Ekstra: 600 (MW) Avanse: 4783.4 Inv.kost.: 3300
(18) NORGEMIDT - SVER-NN2 Ekstra: 0 (MW) Avanse: 2521.7 Inv.kost.: 2529
(46) VESTMIDT - NORGEMIDT Ekstra: 600 (MW) Avanse: 4581.8 Inv.kost.: 3914

```

Figure C.9: Investment results with 10 percent demand increase and 40 percent subsidies

```

Termisk kapasitet:
( 9) NORGEMIDT Typenr.: 13 Kapasitet: 0 (MW) Avanse: 3667.1 Inv.kost.: 7455.

Vindkraft:
(27) VIND_NORMI Modulnr.: 500 Kapasitet: 1 (MW) Avanse: 8886.4 Inv.kost.: 12297.
(28) VIND_HELGE Modulnr.: 500 Kapasitet: 1 (MW) Avanse: 9105.9 Inv.kost.: 12297.
(29) VIND_TROMS Modulnr.: 500 Kapasitet: 1 (MW) Avanse: 9869.2 Inv.kost.: 12297.
(30) VIND_FINNM Modulnr.: 500 Kapasitet: 1 (MW) Avanse: 11884.5 Inv.kost.: 12297.
(32) VIND_SVENN Modulnr.: 500 Kapasitet: 1 (MW) Avanse: 7078.2 Inv.kost.: 12297.

Transmisjonslinjer:
(12) NORGEMIDT - OSTLAND Ekstra: 200 (MW) Avanse: 3369.6 Inv.kost.: 3300
(13) HELGELAND - NORGEMIDT Ekstra: 200 (MW) Avanse: 3509.1 Inv.kost.: 3300
(18) NORGEMIDT - SVER-NN2 Ekstra: 200 (MW) Avanse: 4569.8 Inv.kost.: 2529
(46) VESTMIDT - NORGEMIDT Ekstra: 700 (MW) Avanse: 10748.2 Inv.kost.: 3914

```

Figure C.10: Investment results with 20 percent demand increase and no subsidies

```

Termisk kapasitet:
( 9) NORGEMIDT Typenr.: 13 Kapasitet: 0 (MW) Avanse: 3588.5 Inv.kost.: 7455.

Vindkraft:
(27) VIND_NORMI Modulnr.: 500 Kapasitet: 1 (MW) Avanse: 8826.0 Inv.kost.: 9838.
(28) VIND_HELGE Modulnr.: 500 Kapasitet: 1 (MW) Avanse: 9051.3 Inv.kost.: 9838.
(29) VIND_TROMS Modulnr.: 500 Kapasitet: 1 (MW) Avanse: 9725.3 Inv.kost.: 9838.
(30) VIND_FINNM Modulnr.: 500 Kapasitet: 401 (MW) Avanse: 10686.9 Inv.kost.: 9838.
(32) VIND_SVENN Modulnr.: 500 Kapasitet: 1 (MW) Avanse: 7040.3 Inv.kost.: 9838.

Transmisjonslinjer:
(12) NORGEMIDT - OSTLAND Ekstra: 0 (MW) Avanse: 3973.3 Inv.kost.: 3300
(13) HELGELAND - NORGEMIDT Ekstra: 200 (MW) Avanse: 3104.7 Inv.kost.: 3300
(18) NORGEMIDT - SVER-NN2 Ekstra: 200 (MW) Avanse: 4791.7 Inv.kost.: 2529
(46) VESTMIDT - NORGEMIDT Ekstra: 700 (MW) Avanse: 10882.1 Inv.kost.: 3914

```

Figure C.11: Investment results with 20 percent demand increase and 20 percent subsidies

---

```

Termisk kapasitet:
( 9) NORGEMIDT Typenr.: 13 Kapasitet: 0 (MW) Avanse: 1449.1 Inv.kost.: 7455.

Vindkraft:
(27) VIND_NORMI Modulnr.: 500 Kapasitet: 401 (MW) Avanse: 7773.7 Inv.kost.: 7378.
(28) VIND_HELGE Modulnr.: 500 Kapasitet: 201 (MW) Avanse: 7930.4 Inv.kost.: 7378.
(29) VIND_TROMS Modulnr.: 500 Kapasitet: 2601 (MW) Avanse: 7863.8 Inv.kost.: 7378.
(30) VIND_FINNM Modulnr.: 500 Kapasitet: 601 (MW) Avanse: 7685.1 Inv.kost.: 7378.
(32) VIND_SVENN Modulnr.: 500 Kapasitet: 1 (MW) Avanse: 6406.0 Inv.kost.: 7378.

Transmisjonslinjer:
(12) NORGEMIDT - OSTLAND Ekstra: 0 (MW) Avanse: 2849.3 Inv.kost.: 3300
(13) HELGELAND - NORGEMIDT Ekstra: 600 (MW) Avanse: 4387.3 Inv.kost.: 3300
(18) NORGEMIDT - SVER-NN2 Ekstra: 100 (MW) Avanse: 2774.9 Inv.kost.: 2529
(46) VESTMIDT - NORGEMIDT Ekstra: 700 (MW) Avanse: 5291.4 Inv.kost.: 3914

```

Figure C.12: Investment results with 20 percent demand increase and 40 percent subsidies