



Potential power setups, fuels and hull designs capable of satisfying future EEDI requirements



Elizabeth Lindstad^{a,*}, Torstein Ingebrigtsen Bø^{a,b}

^a Sintef Ocean AS (MARINTEK), Trondheim, Norway

^b Norwegian University of Science and Technology (NTNU), Trondheim, Norway

ARTICLE INFO

Keywords:

Maritime transport
Greenhouse gases
Climate change mitigation
Energy efficiency
EEDI
IMO

ABSTRACT

Maritime emission regulations set limits for SO_x and NO_x emissions for health and environmental reasons, and for CO₂, through the Energy Efficiency Design Index (EEDI), with the general aim of mitigating global warming. EEDI verification is performed at the vessel's design speed and design loads, under calm-water conditions. This, although calm seas are the exception in shipping, and that even with calm-water conditions, ships usually operate at lower speeds than their design speed. A major challenge, if greenhouse gases (GHG) reduction targets are to be met through the EEDI, will be to identify EEDI-compliant solutions that reduce energy consumption and GHG emissions under realistic operational conditions, from lying idle at berth in port to when full power is required in critical situations at sea. In view of all the above, we use the Aframax tanker class to illustrate how such an assessment can be performed, and to display the differences in costs and benefits of options, all of which meet the requirements of the EEDI.

1. Introduction

The EEDI limits will demand a reduction of 30% in CO₂ emissions per ton nautical mile (nm) by 2025, compared to those permitted for vessels built in 2013–2014, and 20% reduction compared to vessels built in 2015–2019. The options available to meet these forthcoming EEDI requirements are first, to reduce hull resistance to achieve the desired speed with less power; second to switch to fuels with lower carbon content; third to reduce the design speed through installing less power; and fourth, various combinations of these measures.

First; reducing hull resistance. Ships are designed to operate at their boundary speeds (Faltinsen et al., 1980). For any given hull form, the boundary speed can be defined as the range of speeds within which the resistance coefficient goes from virtually constant to rising rapidly and making further increases costly (Silverleaf and Dawson, 1966). Kristensen (2010), Stott and Wright (2011), Lindstad et al. (2013) and Lindstad (2015) have studied how hull forms can be made more efficient by modifying the main ratios between beam, draught and length to reduce block coefficients while keeping the cargo-carrying capacity unchanged. The results show that these novel hull designs, which we term *slender designs*, are less full-bodied, which reduces drag and significantly lower power requirements and fuel consumption. Measures, such as light-weighting, improved hull coatings and better lubrication can contribute to upgrading hull performance (Buhaug et al., 2009; Hertzberg, 2009; Wang et al., 2010; Faber et al., 2011; Wang and Lutsey, 2013; Tillig et al., 2015).

Secondly, switching to fuels with lower carbon content reduces CO₂ emissions directly from combustion (Bengtsson, 2011; Chryssakis et al., 2014; Gilbert, 2014; Taljegard et al., 2014; Thomson et al., 2015; Psaraftis, 2016). Liquid Natural Gas (LNG), is

* Corresponding author.

E-mail address: Lindstad@sintef.no (E. Lindstad).

<https://doi.org/10.1016/j.trd.2018.06.001>

favourable due to its hydrogen to carbon ratio, which reduces the emitted carbon per kWh by approximately 25% compared to diesel. However, when LNG is burnt in ships' engines, un-combusted methane CH₄, a GHG with an impact 28–34 times as great as that of CO₂ in a one hundred-year perspective (IPCC, 2013), offers a GHG challenge (Verbeek et al., 2011; Verbeek and Verbeek, 2015; Stenersen and Thonstad, 2017). For biofuels, the CO₂ emitted at combustion is per definition zero (IPCC), since it is first extracted from the atmosphere and absorbed by the crops used to produce the biofuel. The carbon-neutrality assumption of biofuels is highly dependent on the rotation periods of the source crop, its geographical location, and direct and indirect albedo changes due to harvesting, all of which have effects on climate (Cherubini et al., 2013). Hydrogen is attracting growing attention (Bouman et al., 2017) since it emits no CO₂ at combustion, and so are renewable energy sources such as wind (Perkins et al., 2004; Clauss et al., 2007; Traut et al., 2014; Teeter and Cleary, 2014; Tillig et al., 2015; Psaraftis, 2016) and solar power (Sjöbom and Magnus, 2014).

A third option is to reduce the design speed through installing less power. Because the power needed for propulsion increases with the speed by the 3rd power and beyond (Silverleaf and Dawson, 1966), fuel consumption per nautical mile also drops by approximately the quadratic of the speed (Corbett et al., 2009; Lindstad et al., 2011). With today's higher fuel prices compared to those in the 1990s and early 2000s combined with overcapacity in shipping markets, vessels now typically operate at around 50% or less of their available power (Smith et al., 2014). As far as EEDI is concerned, reducing operational speed is irrelevant, while reducing the installed power is one way to remain within the permitted limits of the EEDI. The explanation is that if we reduce installed power by around 30%, both the speed and distance traveled will be reduced by around 10%, resulting in a 20% reduction in emissions per ton nautical mile (nm). On the other hand, the EEDI scheme punishes higher maximum speeds, since a 10% speed increase CO₂ emission per ton nm by 20%.

Combination of policies, regulations, and legislation such as the EEDI can reduce GHG emissions from the shipping sector, but successful implementation need to be supported by studies that address multiple effects and measures simultaneously, to avoid effects that counteract one another. There are multiple studies which discuss the EEDI (Devanney, 2011; Kruger, 2011; Armstrong and Banks, 2015; Lindstad and Eskeland, 2015; Lindstad et al., 2015c; Ančić et al., 2018; Psaraftis, 2018; Vladimir et al., 2018). IMO have also an additional voluntarily regulation called Energy Efficiency Operational Index (EEOI). EEOI is an index which can be used by operators to evaluate the energy efficiency of the vessels operation (in contrast to EEDI which evaluate the design).

Our motivation for this study has been to identify and rank EEDI-compliant solutions that would reduce energy consumption and GHG emissions under realistic operational conditions, ranging from lying idle in port to when peak power is required in critical situations at sea. As discussed earlier, there are many studies which presents abatement technologies and discuss the EEDI, but by the knowledge of the authors the novelty of this study is to investigate cost increases and GHG reductions as a function of alternative EEDI compliant options for ships employed in typical trading pattern. For this purpose, we use the Aframax tanker class as a typical representative of bulkers and tankers

2. Description of the model

The model provides for a full evaluation of fuel consumption, costs and emissions as functions of vessel operation, abatement options and fuel prices; see Lindstad et al. (2011, 2015a, 2017).

A vessel's fuel consumption for a given trip is given by Eq. (1).

$$F = \sum_{i=1}^n t_i p_i \text{spfc}(p_i) \quad (1)$$

During a voyage, the sea conditions will vary and the model deals with this by dividing each voyage into sections, with a time duration t_i , power P_i , and specific fuel consumption spfc as a function of power. The time duration is either the time spent in port or the time duration of traveling a certain distance D_i , such that $t_i = D_i/v_i$. The power is calculated from the power curve later presented in Fig. 2. The specific fuel consumption curve is later presented in Fig. 4.

The cost per freight unit transported, i.e. per ton-mile is given by Eq. (2):

$$C = \frac{1}{D \cdot M} \cdot (F \cdot C_{\text{Fuel}} + \text{CAPEX} \cdot T/365 + \text{OPEX} \cdot T/365) \quad (2)$$

The first factor converts total costs to cost per ton-mile, where M is the mean weight of the paying cargo carried on the roundtrip voyage and D is distance sailed. While large bulkers and tankers typically sail one way fully loaded and return or are repositioned empty in ballast, container vessels tend to carry more cargo in one direction than the other, and are usually neither empty nor completely full. Inside the main bracket, the first term refers to the cost of fuel, where C_{Fuel} is the cost of fuel per ton. The second term includes the cost of capital for the vessel, CAPEX is the yearly capital cost of the vessel and is set to 8% of the investment cost, T is the time duration per trip measured in days and 365 are days per year. The third terms give the operational cost and is set to 4% of the investment cost.

Emissions, ε per pollutant, comprises fuel and freight work as expressed by Eq. (3):

$$\varepsilon = \left(\frac{F}{D_c \cdot M \cdot N_c} \right) \cdot K_{ep} \quad (3)$$

K_{ep} is the emission factor for each exhaust gas as a function of power and fuel. D_c is the distance of the cargo voyage, M is the weight of the cargo and N_c is the annual number of cargo voyages. SOx and CO₂ are always strictly proportional to fuel consumption by fuel

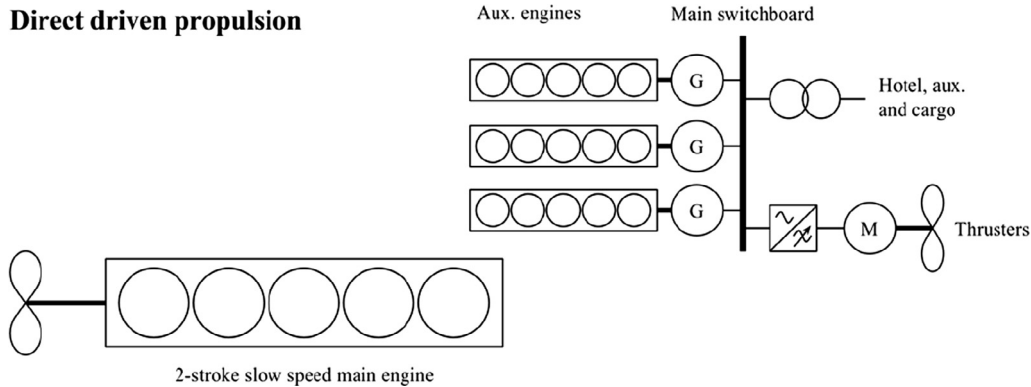

Fig. 1. Power and propulsion machinery setup for direct-driven propulsion.

type, while the other pollutants increase relative to fuel consumption when engine operates at high or low power. This ratio is identical to the EEOI when it is evaluated for CO_2 .

Metrics that weight emitted greenhouse gases according to their global warming potential (GWP), in order to report them in terms of “ CO_2 equivalents” have become a standard (Shine, 2009). Eq. (4) gives total GWP impact per energy unit produced and ton transported.

$$GWP_T = \sum_{i=1}^n \varepsilon_e \cdot GWP_{ei} \quad (4)$$

where ε_e represents emissions of pollutant i and GWP_{ei} is the GWP factor for each pollutant for the time frame, usually, 20, or 100 years consistent with Houghton et al. (1990).

3. Application and data

This paper investigates alternative power setups, fuels and hull designs, focusing on the Energy Efficiency Design Index (EEDI) requirements. The Aframax tanker class are used to illustrate how such assessments can be made and to display the differences in cost and benefits for the various options, all of which would satisfy the EEDI requirements. The average crude oil tanker is 180' dwt and there are three distinct size-classes: Aframax; 100–120' dwt, Suezmax; 150–200' dwt and Very Large Crude Carriers (VLCC); around 300' dwt. Together they perform nearly one-fifth of world seaborne freight work (Smith et al., 2014; Lindstad and Eskeland, 2015).

Most crude oil tankers are propelled by a large engine with direct connection to the propeller. All other energy requirements are met by smaller auxiliary engines (G), which generate the power required by auxiliary and ‘hotel’ functions and cargo-handling gear. Electric motors are denoted M, and they convert electric energy into mechanical energy (see Fig. 1).

Historically, the cost of fuel has been low compared to other operating costs, most of which are fixed, with the result that using 85–90% of available power in calm water and moderate sea states has minimized costs per unit transported, and maximized profits. Recently, lower freight markets and rising fuel prices have made it profitable to operate at around 50% or less of the installed power (Lindstad and Eskeland, 2015). It is therefore tempting nowadays to downsize the engine, i.e. install less power in new vessels, given that reducing installed power is one of the options available for meeting the EEDI thresholds. For fast container carriers and Ro-Ro vessels, which tend to have large power reserves, this is quite straightforward. However, in today's fleet of tankers and bulkers, the installed power generally reflects the fact that the vessels need to be seaworthy and maneuverable in high sea-states (Lindstad et al., 2015b). Moreover, since a vessel experiences the largest accelerations when the wavelength is of the same magnitude as the vessel's length, the ‘excess power’ required for survival increases for larger vessels. The explanation is that the wave energy increases with the square of the wave amplitude. For this reason, the largest bulkers and tankers end up with propulsion power sufficient to make 15–17 knots in calm water compared to 13–15 knots for bulkers and tankers half their size. The methodology for avoiding underpowered vessels due to the EEDI regulations is discussed in IMO resolution MEPC.232(65) and IMO Circ.850 Rev.1 and is currently on the agenda for the IMO correspondence group on the EEDI Review. For these reasons we reject downsizing the engine as a stand-alone solution, but keep it as an option in combination with other measures.

3.1. Investigated options

This section describes three main options for meeting the EEDI requirements: (1) a slender vessel, (2) a hybrid power system, and (3) liquid natural gas (LNG) as a fuel.

3.1.1. Slender vessel

The EEDI thresholds can be met by reducing the hull resistance, which reduces the power required for propulsion. One way to achieve this is to increase hull length, beam or both to reduce the block coefficient, enabling a slenderer design, keeping the vessel's

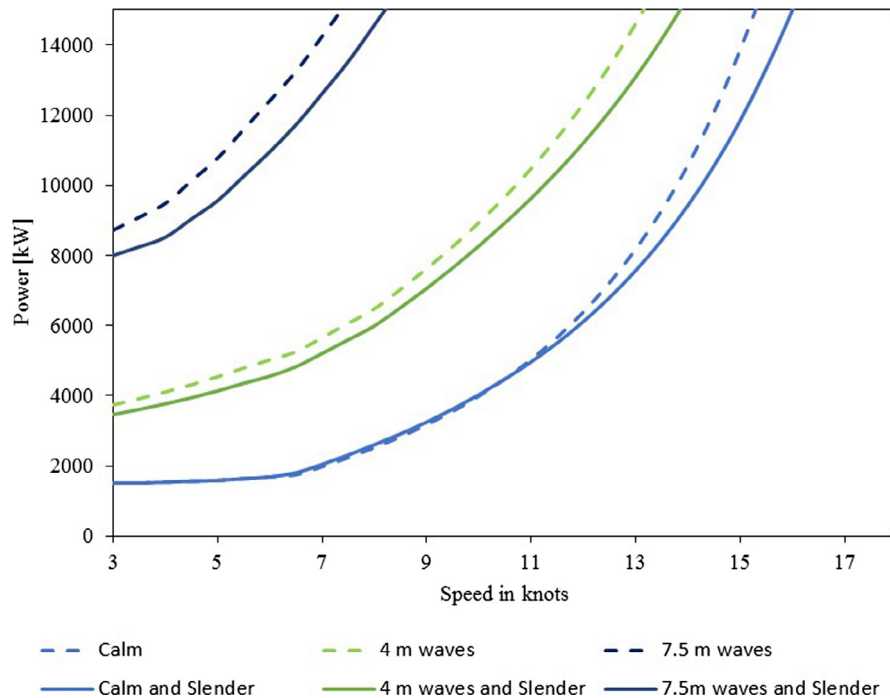

Fig. 2. Power requirements for conventional and slender hulls.

cargo-carrying capacity unchanged. This increases the boundary speed (Silverleaf and Dawson, 1966), i.e. enables a higher operational speeds or lower fuel consumption when speed is kept at the same level as the more full-bodied designs (Lindstad et al., 2013, 2014; Lindstad, 2015). See Larsson and Raven (2010) for a more extensive discussion of how hull resistance depends on speed and hull form.

Fig. 2 presents the average power demand for a conventional vessel design with a block coefficient of 0.82, versus a slender design with a block of 0.75, both with a deadweight of 110,000 tons. The required power for the alternative designs in this study are based on ShipX, which is a hydrodynamic workbench developed by MARINTEK (now Sintef Ocean). We compare the designs for three typical sea conditions: calm water, four-meter significant wave height ($H_s = 4$ m) which serves as a proxy for typical wave height on the high sea (Lindstad et al., 2013), and adverse sea conditions. For an Aframax adverse sea conditions correspond to a wave spectrum in which the significant wave height ($H_s = 7.5$ m) is the mean wave height (trough to crest) of the highest third of the waves ($H_{1/3}$). For the conventional hull, the minimum installed power would need to be 13,000 kW, as given by MEPC.1/Circ.850. For the slender hull we estimate that the minimum installed power should be 11,000 kW, due to its lower power requirements and better performance in adverse worst sea conditions.

The main conclusions to be drawn from Fig. 2 are the following: first, the slender hull form offer no advantages in calm water for speeds below 11–12 knots; second, the slender hull form has a significantly lower power requirement at 14–15.5 knots, which are typical design speeds; third, with $H_s = 4$ m the slender design performs better over the whole range of speeds; fourth, under worst sea conditions the difference in required power increases. When the peak power required in rough seas exceeds the installed power, the speed will be reduced, and will pick up again with less power-demanding waves.

3.1.2. Hybrid power systems

Under the hybrid power option, the main engine provides the energy required both for propulsion and for auxiliary and hotel loads when running normally at sea, while batteries are used to compensate for load variations and to boost propulsion power in critical situations. Moreover, if the main engine fails, the batteries, in combination with the auxiliary engines, could provide sufficient propulsion power to take the vessel to port (“take me home” function). Power from the batteries can also serve as the primary energy source when the vessel is idle at the quayside at night. Fig. 3 illustrates a hybrid power setup for an Aframax tanker with one main propulsion engine, shaft generator and motor (PTO/PTI), variable-pitch propeller, battery and auxiliary engines.

Historically, main engines on ships have been optimized to perform best and with the lowest fuel consumption per kWh at high power. Recently, due to lower freight rates and higher fuel prices, ship-owners have begun to ask for main engines to be optimised for lower average power loads, or for their power to be reduced, to better match today's typical power requirements, just as for newbuilt container vessels. For bulk and tank vessels main engine sizes today tend to reflect what is required in a critical situation, i.e. a hybrid power setup supplemented by batteries could allow the size of the main engine to be reduced.

The results of this study, a hybrid solution suggest installing a smaller main engine (for example 11,000 kW), plus batteries in combination with PTO/PTI to provide the additional 2000 kW to bring maximum power availability up to 13,000 kW when required.

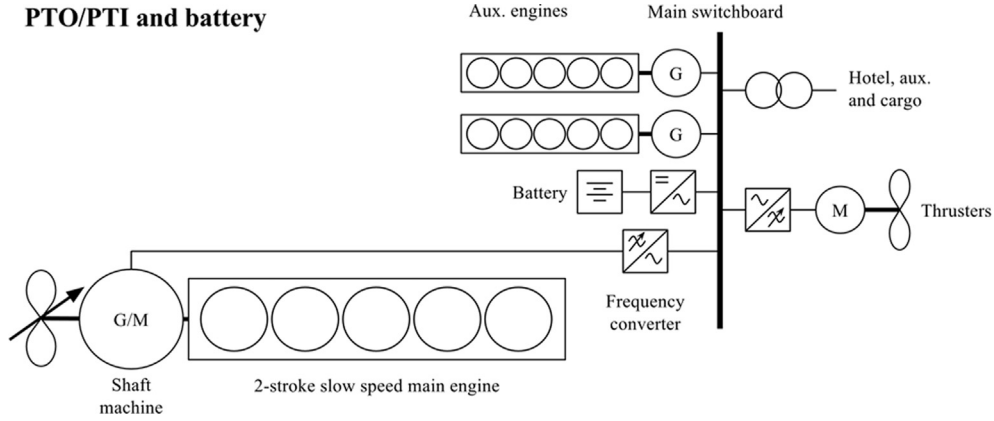

Fig. 3. Configuration of a hybrid power system with PTO/PTI and batteries.

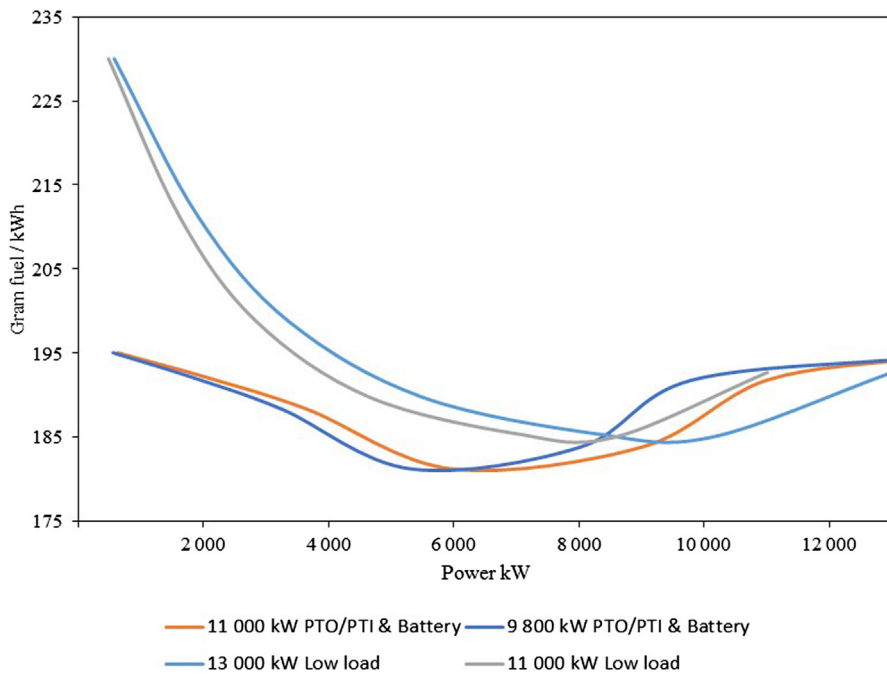

Fig. 4. Specific fuel oil consumption (SFOC) as a function of power option.

Fig. 4 shows fuel consumption per kW h for the full operational range, i.e. from idle at berth to peak power, for each of the options studied, including all conversion losses related to the PTO/PTI system and batteries. The curves are established by contact with engine manufacturers Man and Wärtsilla (as described in the acknowledgment section) and are based on using heavy fuel oil (HFO), with adjustments to compensate for real-world operational usage, rather than the manufacturers’ test laboratory results. Although it can be argued that HFO is less relevant with the forthcoming 2020 sulphur limit of 0.5%, we have calculated the EEDI baselines and thresholds on the assumption of using HFO. Moreover, HFO in combination with exhaust-gas scrubbers to remove the sulphur or desulphurised HFO oils, i.e. LSHFO less than 0.5% S might still be the cheapest fuel option after 2020 (Lindstad et al., 2017).

Conclusions than can be drawn from Fig. 4 are that the hybrid power options, i.e. 9800 kW & battery or 11,000 kW plus battery give the lowest fuel consumption when the required power is less than 8500 kW. The conventional setups with one engine offer the lowest fuel consumption from 9500 kW up to 13,000 kW. Combining these power curves with annual operating profiles and realistic weather data enables us to compare and evaluate the alternative power setups.

3.1.3. Low-carbon fuel – LNG

The third option for improving the EEDI would be to use a low-carbon fuel such as liquid natural gas (LNG), with has higher hydrogen to carbon ratios compared to conventional bunker oils and diesel. There are two main engines concepts for LNG; high and low-pressure. In the high-pressure dual-fuel LNG concept, the LNG is injected under high pressure and ignited by a small quantity of diesel. This produces virtually complete combustion of the gas, and thus virtually no un-combusted methane. In the low-pressure

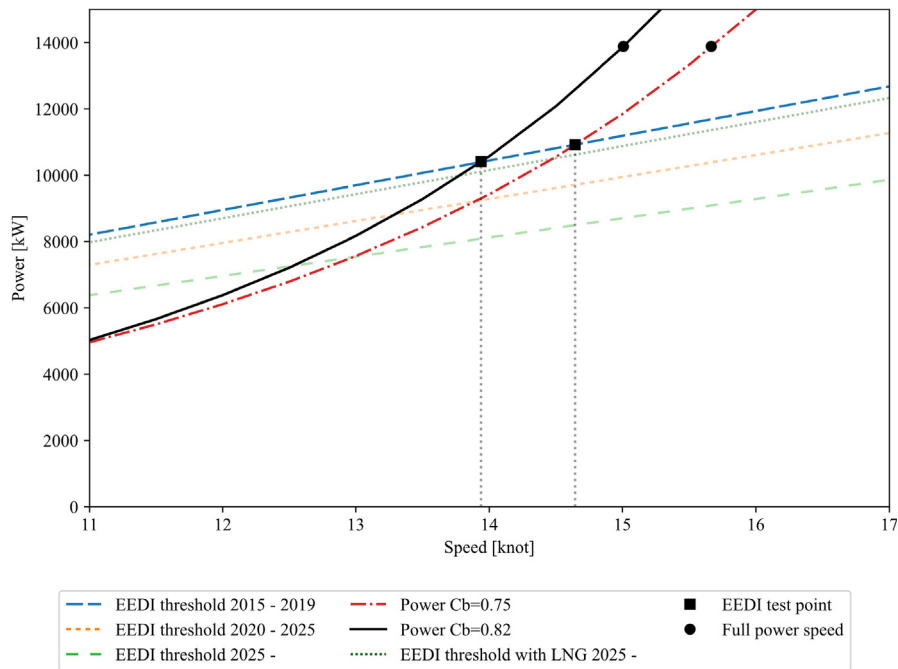

Fig. 5. Graphic representation of the EEDI score.

system, the LNG is injected under low pressure and ignited by a small amount of diesel. This produces low NO_x emissions that meet IMO tier III, the strictest NO_x requirements, while high-pressure LNG requires additional abatement technologies to satisfy IMO tier III. However, low-pressure LNG injection engines emit high levels of un-combusted methane. In a recent study for the Norwegian NO_x Fund (Stenersen and Thonstad, 2017), based on a representative sample of existing gas-fueled ships with low-pressure gas engines, average methane emissions were 5.3 g CH₄ per kW h produced, which basically cancels out their GHG advantage over conventional fuels (600 g/kW h * 0.75 + 5.3 g/kW h * 30 = 609 g/kW h, where 600 is g CO₂ per kW h). With newbuilt state-of-the-art (SoA) low-pressure gas engines with more advanced engine control systems, average methane emissions can be reduced to 3–4 g CH₄ per kW h.

For these reasons, we will use 5% as the average GHG reduction for the low-pressure dual fuel technology, which we term *standard technology* in the following calculations. For the high-pressure technology we use 20% as an average GHG reduction and we term it *best technology*. The 5% deduction from the 25% potential is related to extra energy needed to achieve the high injection pressure, marginal methane emissions, which still need to be addressed and that the proportion of diesel in the fuel mix, which is 1–2% at high power, increases at lower power.

3.2. EEDI thresholds

First, we investigate the challenges presented by the EEDI requirements, with focus on conventional versus slender vessel designs. The solid curve in Fig. 5 shows the power demand (main + auxiliary) in calm water for a typical Aframax tanker of 110,000 dwt with a block coefficient (C_b) of 0.82. The red dash-dotted line shows the power demand for a slender vessel with block of 0.75 and the same carrying capacity. The test point for the EEDI score is measured at 75% of maximum continuous rated power. Therefore, the maximum power of the main engine can be $\frac{100\%}{75\%} \approx 1.33$ of the power used at the test point. The square dot shows the power and speed at 75% power and the round dot shows power and speed at full power. The blue, orange, and green dashed lines show the EEDI threshold requirements for 110,000 dwt tankers built in 2015, 2020, and 2025, all based on using conventional HFO. The dashed lines show the maximum permitted power at the EEDI test point. The dotted green line shows the EEDI requirement for 2025 when LNG is used as the fuel.

The main conclusion we can draw from Fig. 5 are that: the conventional design will meet the 2015 EEDI requirements if it achieves a speed of 13.8 knots or more when using a maximum of 10,500 kW (including auxiliary machinery). Second, due to its lower demand for power, the slender design will meet both the 2015 and the 2020 EEDI requirements. Fig. 6 shows how EEDI requirements will gradually become stricter after 2015, 2020 and 2025, and compares a range of options that would fulfil these requirements. The left plots show the power demand for the standard vessel ($C_b = 0.82$) while the right plots illustrate the slender design ($C_b = 0.75$).

The first row shows that both the conventional and the slender design lie pass the 2015 EEDI thresholds. The plots in the second row show that the conventional design with a main engine reduced from 13,000 to 11,000 kW and hybridized with batteries to provide peak power will pass the EEDI 2020 thresholds, and that the slender design, which passed the 2015 thresholds, also satisfies the 2020 EEDI thresholds.

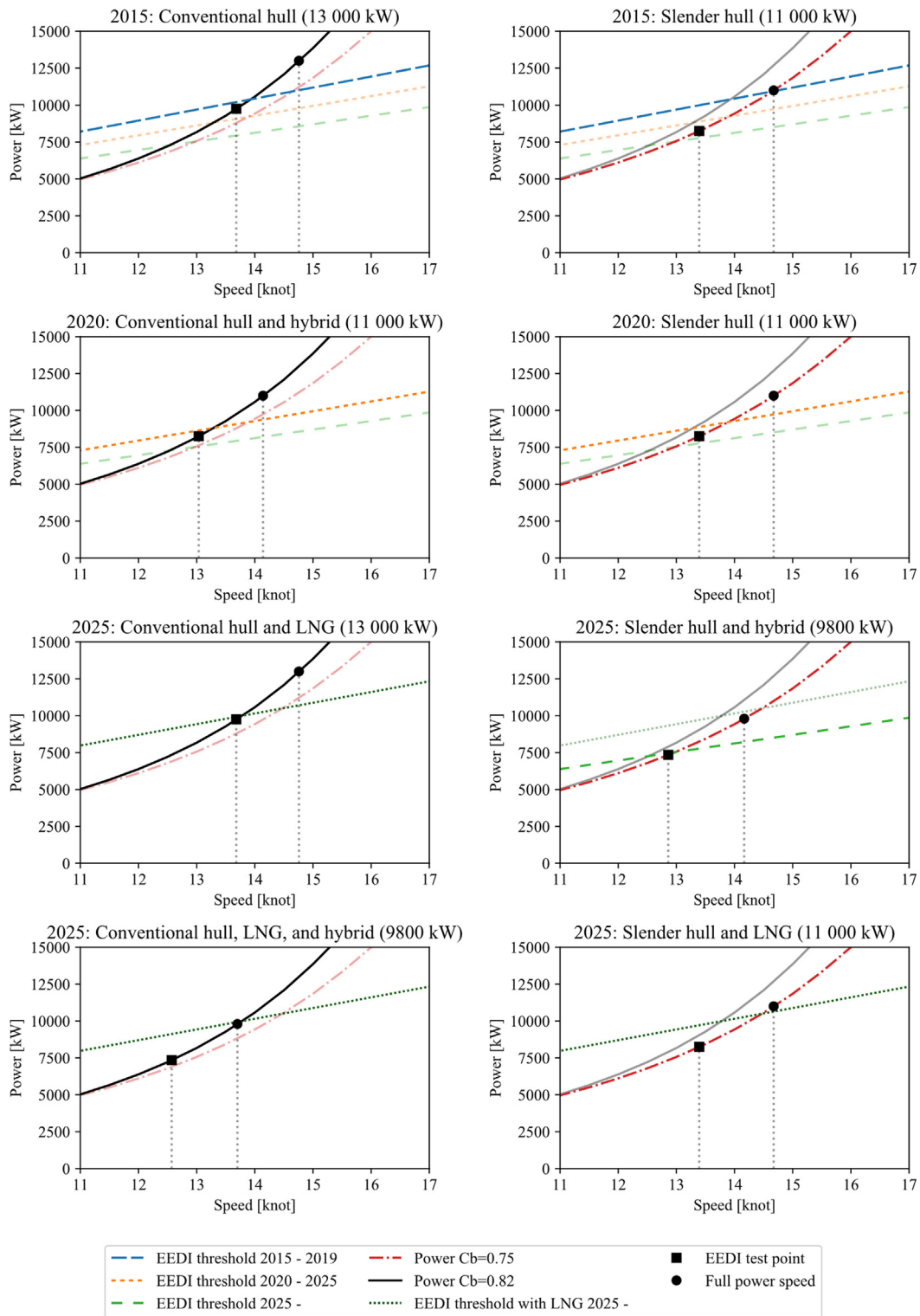

Fig. 6. Power and EEDI thresholds in 2015, 2020 and 2025 for a 110,000-dwt tanker.

Four alternatives are shown for the 2025 EEDI requirement. First, in row three on the left, with a switch from HFO to LNG for the conventional design, and then in row 4, we show that the EEDI scores could be further reduced by combining LNG with batteries, i.e. hybrid-power setups, or as shown in row 3 on the right, by combining a hybrid power train with the slender design.

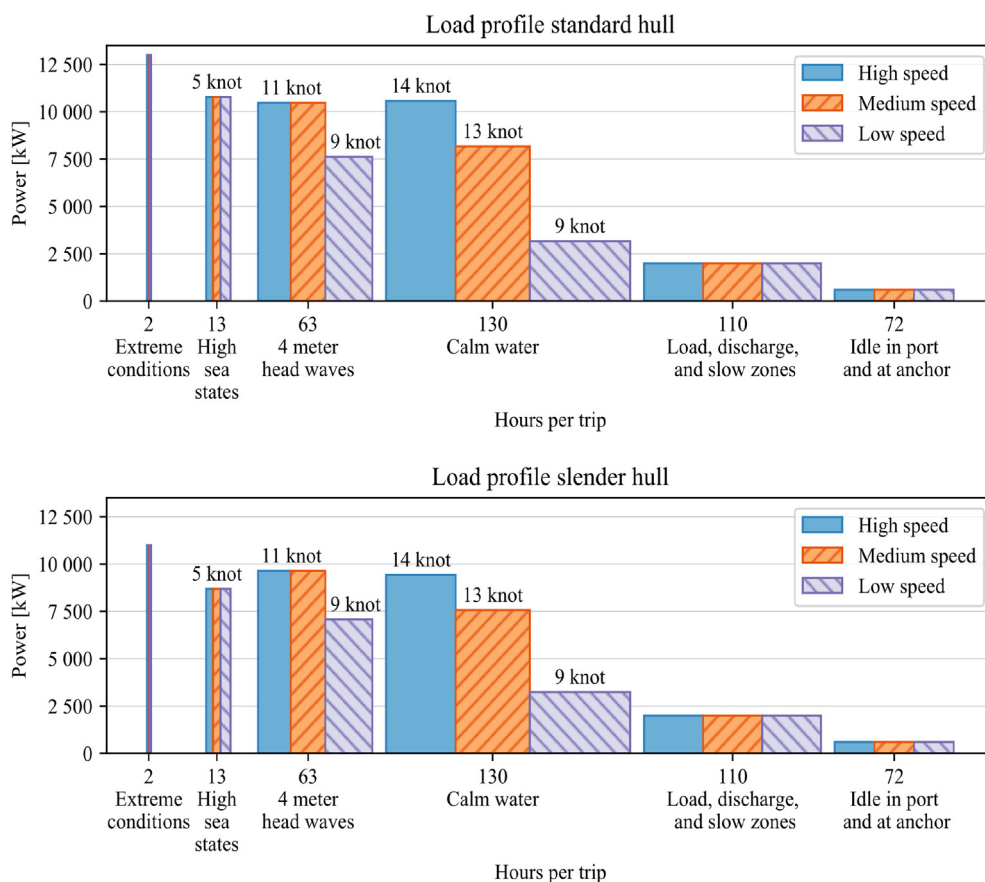

Fig. 7. Power demand and duration of the different sailing modes.

3.3. Operational profile

These tankers typically sail one way fully loaded and return empty in ballast, which gives an average capacity utilization of 50% for a roundtrip voyage. The vessels spend around 200 days at sea, 100 days loading, discharging, leaving or entering ports or in speed-restricted zones such as estuaries and canals, and the remaining 65 days idle in port or waiting at anchor (Smith et al., 2014; Lindstad and Eskeland, 2015). Regarding sea conditions, we have assumed that 30% of voyage time spent in 2–5 m head-waves for which we use $H_s = 4$ m as a proxy, 7% in high sea states for which we use $H_s = 7.5$ m as a proxy, 1% requiring full power corresponding to peak demands of $H_s = 7.5$ m. The remaining 62% are spent in calm water conditions. We believe that our assumptions are reasonable since the round-trip consideration effectively negates the increased power required in headwind conditions, as power requirements for sailing in tailwinds typically are like or lower than calm-water conditions.

We evaluated three different speed profiles; low, medium, and high speed. The low speed scenario is 9 knots in calm water and in head seas with $H_s = 4$ m, and 5 knots in high sea-states. This typically results in close to the minimum emissions, as further reductions below 9 knots (approximately) raises fuel consumption per ton transported due to the added resistance from sea and wind and the quite constant consumption for auxiliary and bridge purposes. The medium-speed scenario illustrates the speeds typically used since 2010, with 13 knots in calm weather, 11 knots in head waves, and 5 knots in high sea-states. The high-speed scenario illustrates typical behavior in a good freight market (Lindstad and Eskeland, 2015), in which shipowners make a profit, i.e. 14 knots in calm weather, 11 knots in head waves and once again, 5 knots in high sea-states.

Fig. 7 shows the operational profile per voyage with the associated power demands for each of the scenarios for the standard and slender hulls. The height of the graph represents the average power demand, and the width represents the number of hours spent in each mode per trip. For the sake of simplification, the plots are based on loaded conditions, and we simply assume that the ships would use the lower resistance in ballast to sail 1–1.5 knots faster when loaded in calm sea and with 4 m head waves. For all other sea states and in port, the power requirement will be the same under loaded and ballast conditions. Note that the width of each bar is different for each scenario, as higher speeds reduce the duration of the voyage.

3.4. Fuel consumption

Fig. 8 shows fuel consumption for the different speed scenarios and vessel configurations, calculated by combining the load profile

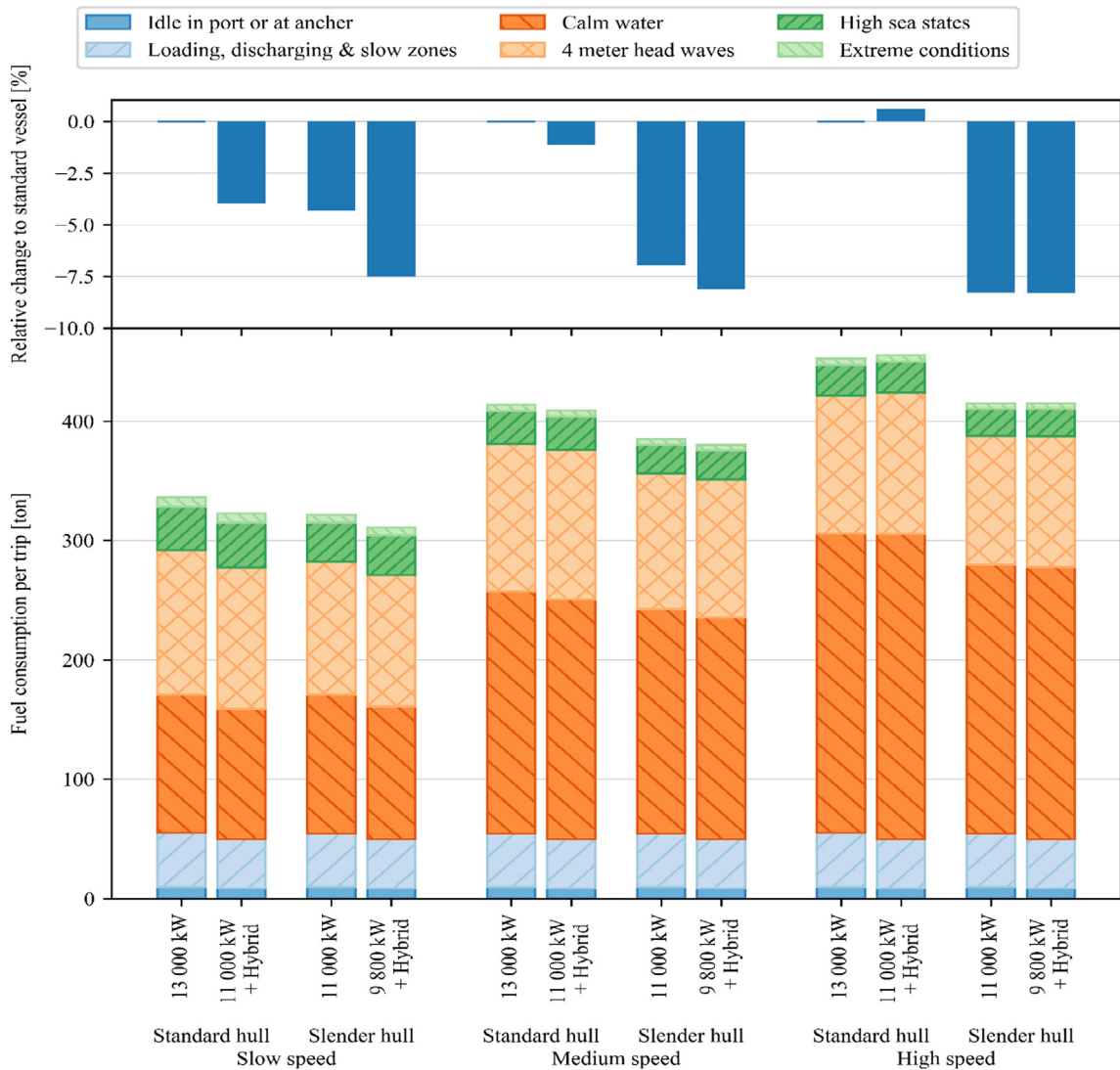

Fig. 8. Fuel consumption.

from Fig. 7 and specific fuel consumption from Fig. 4.

The main conclusion to be drawn from Fig. 8 are that the maximum fuel reduction for a roundtrip voyage for the various options is in the range of 7–9%, which is less than the 20% reduction called for by the stricter EEDI thresholds from 2015 to 2025. The main explanation is that the vessels operate under a range of sea conditions and speed priorities in contrast to the EEDI verification, which takes place in calm water at 75% of main engine power.

3.5. Voyage cost

The investment costs of the individual options are shown in Table 1. The conventional design with a standard hull form and the largest main engine, i.e. 13,000 kW, results in the lowest cost. The cost of all the other options will be higher. Parts of the additional cost of the hybrid and LNG solutions is offset against operating cost reductions, in the first place, through reducing the main engine, and secondly, by reducing the number of auxiliary engines from three to two. Similarly, the additional maintenance costs of PTO/PTI and batteries are offset against reduced maintenance of the auxiliary engines and their generators.

Combining operational profiles and their associated fuel consumptions per voyage (round-trip) with the capital expenditure (CAPEX), operational expenditure (OPEX) and the fuel costs of the alternative options gives us trip cost figures. This is presented in Fig. 9, assuming a fuel price of 300 USD per ton, for both LNG and HFO. LNG has so far been more expensive, even when the additional cost of HFO exhaust gas scrubbing is included (Lindstad et al., 2017), but the LNG price might come down.

The main conclusion to be drawn from Fig. 9 is that meeting EEDI requirements increases the cost with up to 8–9%. One exception is the slender design with the 11,000 kW engine, which meets the 2020 EEDI thresholds, without any rise in costs. In 2025, the most

Table 1
Investment costs of the different configurations (thousand USD).

	Standard hull form				Slender hull form			
	13,000 kW	13,000 kW + LNG	11,000 kW + Hybrid	11,000 kW Hybrid + LNG	11,000 kW	11,000 kW + LNG	9800 kW + Hybrid	9800 kW + Hybrid + LNG
Vessel cost excluding power & propeller	42,000	42,000	42,000	42,000	44,000	44,000	44,000	44,000
Power & propeller cost	8000	8000	7300	7300	7300	7300	6900	6900
Cost hybridization			3500	3500			3500	3500
Cost LNG		7200		7200		6400		6400
Total cost	50,000	57,200	52,800	60,000	51,300	57,700	54,400	60,800

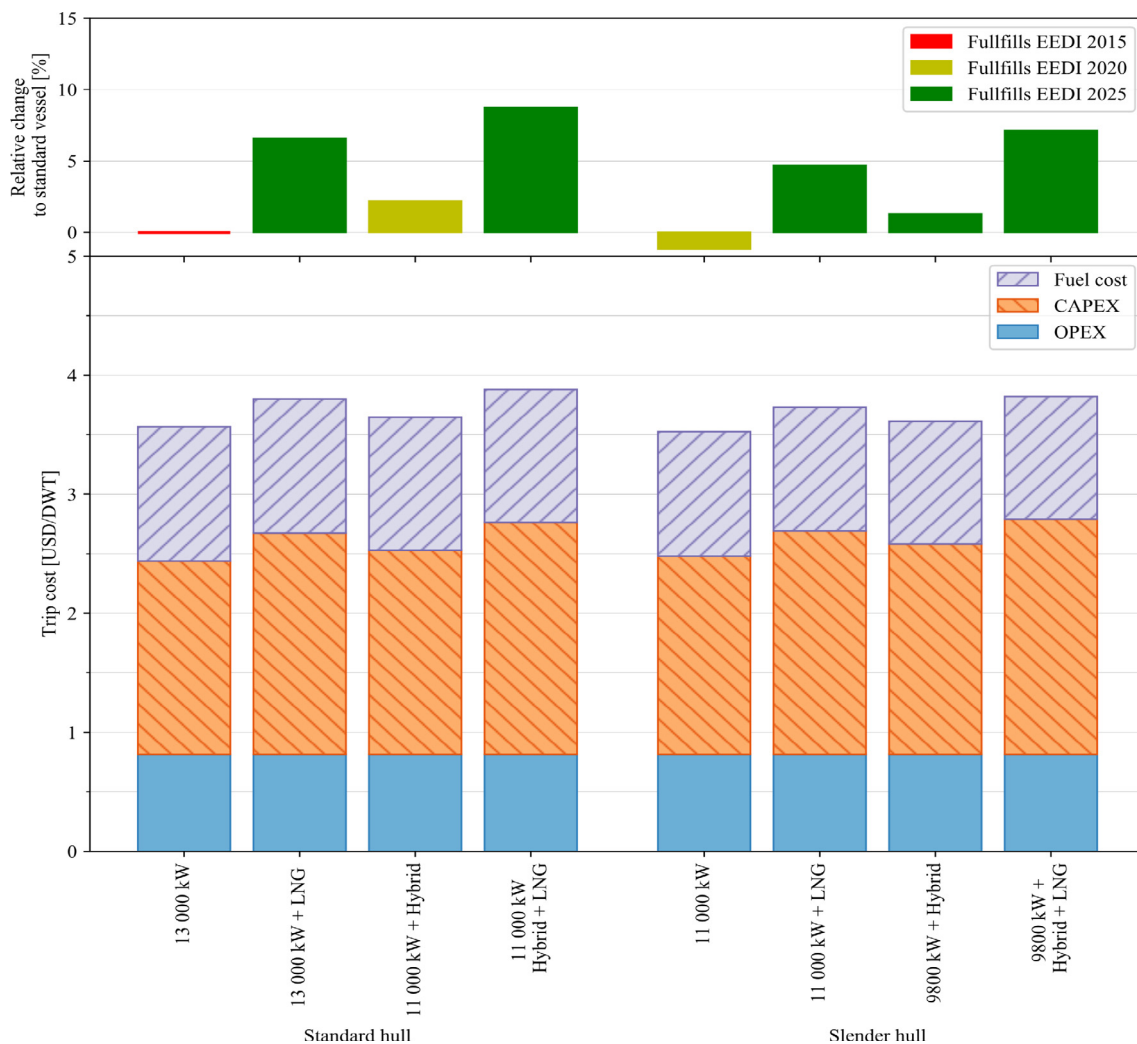

Fig. 9. Roundtrip voyage cost for vessels sailing at medium speed.

cost-effective solution meeting the requirements is the slender vessel with a 9800 kW main engine and a hybrid setup with batteries.

3.6. Abatement cost

The abatement costs for all the options are presented in Fig. 10. The first column shows the total annual cost increase for each of the options. The second column shows the annual reduction in GHG. The third column shows GHG abatement cost per ton of GHG reduced.

Fig. 10 illustrates the wide spread in both annual costs and GHG emissions. The annual cost increases range from less than zero with the 11,000 kW slender design in 2020 up to 0.8 MUSD per year for the most expensive options in 2025. The reductions in GHG emissions range from 5%, i.e. with only the standard LNG technology to 25–27% when a slender hull form is combined with best LNG technology and a hybrid power setup. However, shipping lines are in business to make a profit, which suggests that their ranking will be based on minimizing costs, i.e. using slender vessels with an 11,000 kW engine to meet the 2020 EEDI standard, and the slender vessel with the 9800 kW engine and a hybrid power plant to meet the 2025 EEDI standard. The real GHG savings achieved by EEDI scheme will therefore be around 7–9% for newbuilt tankers.

4. Sensitivity

Shipping is a global business, with free competition within most shipping sectors, in which major fluctuations in freight and fuel prices can be observed over the 20–25 years from a newbuilt vessel tanker is delivered until it is scrapped. For example, in autumn 2003, freight rates in the dry bulk segment rose by a factor of more than 10 and peaked in 2008 at an all-time high level. Fuel prices follow oil price fluctuations, where diesel is priced slightly higher and HFO comes with a rebate. At present, crude oil prices are

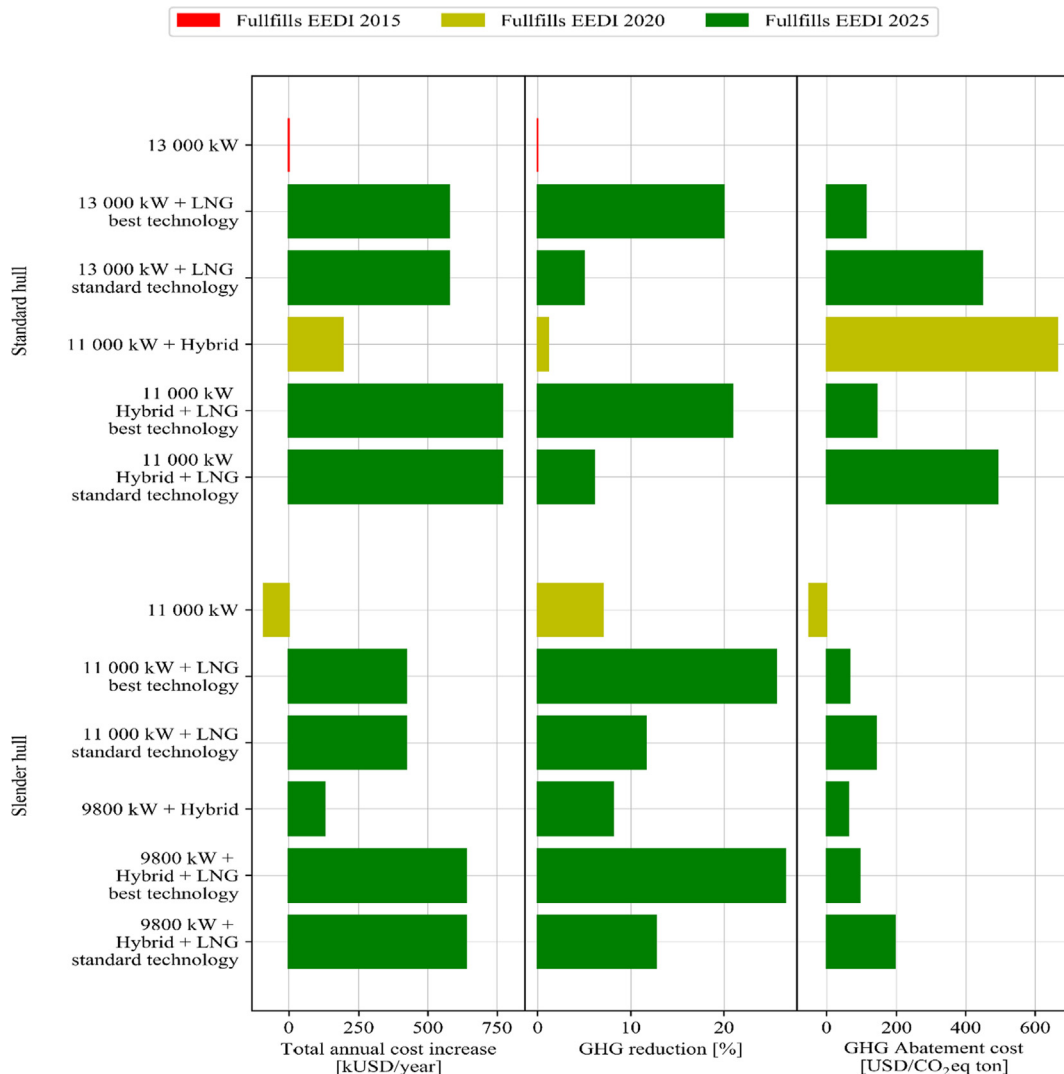

Fig. 10. Abatement cost of the various options.

around 60 USD per barrel, having peaked at USD 150 in early 2008, before dropping to around USD 40 in 2009, remaining above USD 100 in 2012–2013 and then starting to drop in late 2014, bottoming at around USD 25 per barrel. For these reasons, a sensitivity analysis is needed to test the robustness of our results.

4.1. Speed and fuel cost

Fig. 11 shows the differences in costs per round-trip voyage for the three speed scenarios and three fuel costs for each of the options.

The first observation is that the slender design with a standard 11,000 kW engine, which satisfies the 2020 EDI, results in the lowest cost for all fuel prices and speed priorities. Second, in 2025 the slender vessel with a 9800 kW main engine hybrid powertrain will have the lowest cost for all combinations of fuel price and speed. These results are consistent with the results shown in Fig. 10: Abatement cost.

4.2. Impact of voyage distance

Fig. 12 illustrates the impact of increasing the distance from 2500 NM to 7500 NM, while the time in port is kept constant. This increases the ratio of the fuel cost of the total trip cost, as the vessel spends relatively less time in port.

Again, note that the same conclusions are valid as for the shorter trip. The slender vessel with standard machinery produces the lowest cost capable of meeting the EEDI 2020 requirements, except at slow speed and with a fuel price of 150 USD/ton. For the EEDI

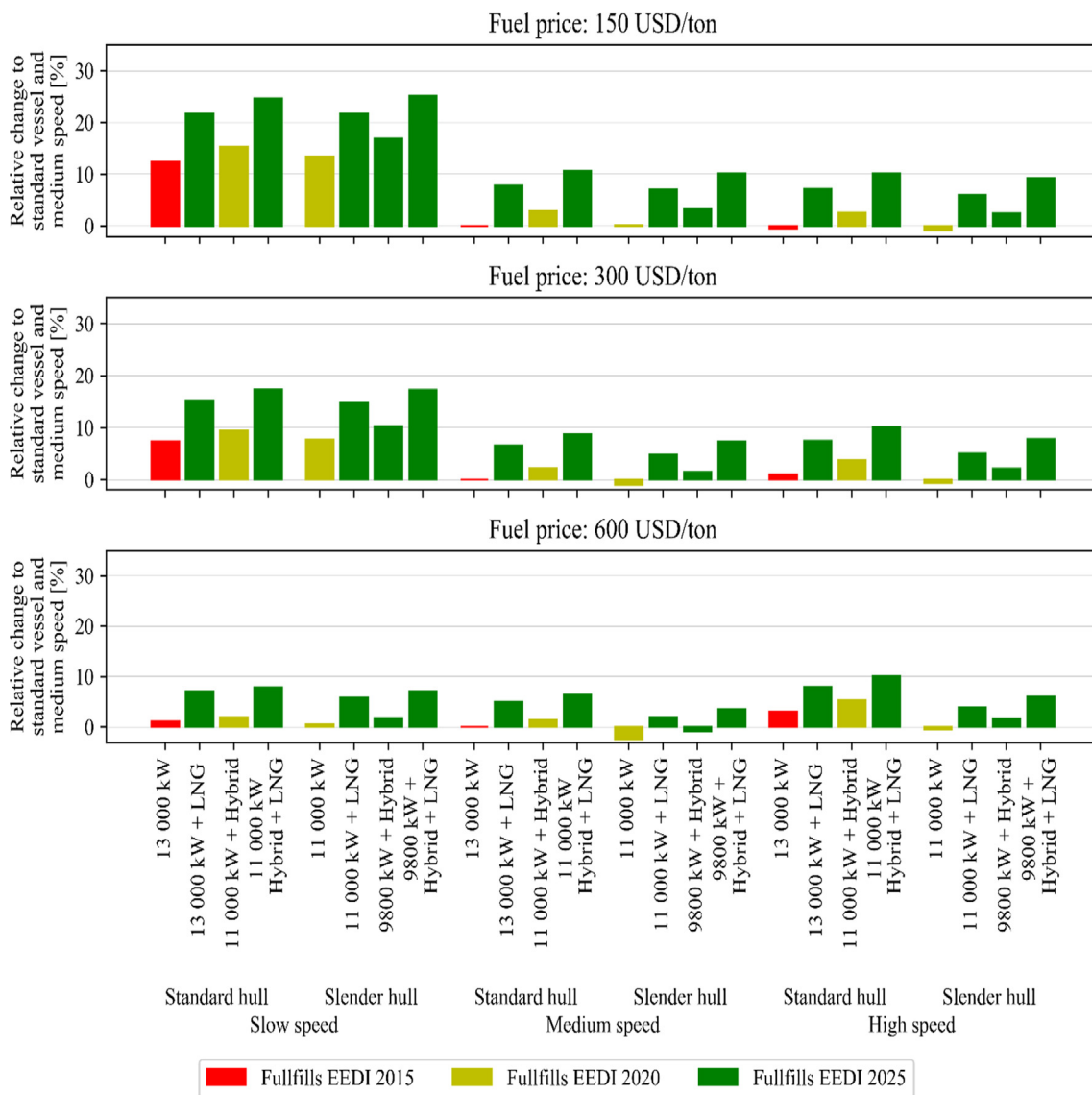

Fig. 11. Cost differences as a function of speed and fuel price.

2025 requirements, the slender vessel with a 9800 kW main engine and a hybrid power setup results in the lowest cost. These results are consistent with the results from Fig. 10; Abatement cost.

5. Conclusions

This study has identified EEDI-compliant solutions that reduce energy consumption and GHG emissions under realistic operational conditions from lying idle in port to when full power is required in critical situations at sea. We have focused on standard commodity ships, here represented by Aframax tankers.

Our results indicate, first, that a slender hull in combination with a conventional engine is the most cost-competitive solution capable of satisfying the 2020 EEDI requirements, while hybrid power setups combined with slender designs are the most cost-competitive solution for the 2025 EEDI requirements. These results seem to be robust with respect to changes in fuel prices and voyage length. Combining a reduction in main engine size with batteries to boost power in peak load situations would also enable ship-owners to satisfy the EEDI requirements without compromising on safety at sea.

Moreover, the reduction in GHG emissions is generally less than the reduction in the EEDI score. The main reasons for this are: First, that vessels generally operate at lower power than the EEDI test point of 75% power. Second, that they operate under real sea conditions with wind and waves rather than the calm-water conditions specified by the EEDI. Third, that the EEDI ignores the impact of other greenhouse gases than CO₂, i.e. the reductions in GHG emissions range from 5%, when only the standard LNG technology is

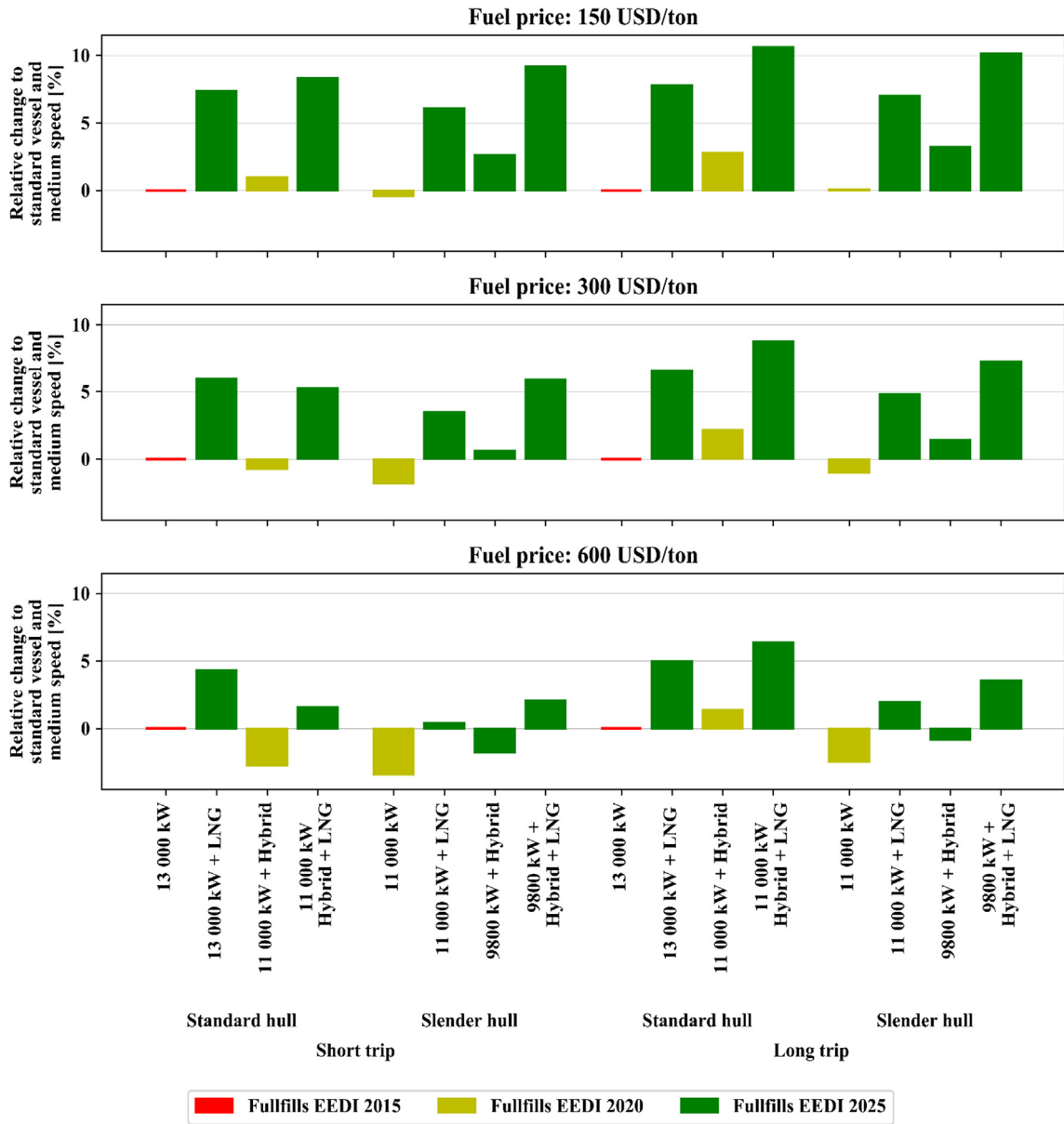

Fig. 12. Relative voyage costs of round-trip of 7500 NM.

employed, to 20% reduction with best LNG technology. Fourth the best solutions even overperforms, i.e. they deliver 25–27% when a slender hull form is combined with best LNG technology and a hybrid power setup. However, unless they are encouraged by policies and legislation, the options which produce the largest GHG reductions, will not be selected, due to their higher capital costs.

Acknowledgments

We are grateful to Bent Ørndrup Nielsen, at MAN Diesel & Turbo (<http://marine.man.eu/two-stroke/ceas>) which provided us with detailed power consumption curves for two-stroke engines.

We also thank Hannu Aatola and Director Robert Ollus at Wärtsilä, which provided us with detailed power consumption curves for the full operational range of the new Wärtsilä 31 diesel engine (www.wartsila.com).

Finally, we are grateful to Bjarne Lindfors at We-Tech (www.wetech.fi) for useful comments on PTO& PTI setups and solutions. This study has been financially supported by the Research Council of Norway through the SFI Smart Maritime. Project number. 237917/O30.

References

- Armstrong, V.N., Banks, C., 2015. Integrated approach to vessel energy efficiency. *Ocean Eng.* 110 (B), 39–48.
- Ančić, I., Theotokatos, G., Vladimir, N., 2018. Towards improving energy efficiency regulations of bulk carriers. *Ocean Eng.* 148, 193–201.
- Bengtsson, S., 2011. Life Cycle Assessment of Present and Future Marine Fuels. Thesis for the Degree of Licentiate of Engineering. Department of Shipping and Marine Technology. Chalmers University of Technology, Gothenburg, Sweden. ISSN 1652-9189.
- Bouman, E.A., Lindstad, E., Rialland, A.I., Strømman, A.H., 2017. State-of-the-art technologies, measures, and potential for reducing GHG emissions from shipping – a review. *Transp. Res. Part D* 52 (2017), 408–421.
- Buhaug, Ø., Corbett, J.J., Endresen, Ø., Eyring, V., Faber, J., Hanayama, S., Lee, D.S., Lee, D., Lindstad, H., Markowska, A.Z., Mjelde, A., Nelissen, D., Nilsen, J., Pålsson, C., Winebrake, J.J., Wu, W.-Q., Yoshida, K., 2009. Second IMO GHG Study. International Maritime Organization, London.
- Cherubini, F., Bright, R.M., Strømman, A.H., 2013. Global climate impacts of forest bioenergy: what, when and how to measure? *Environ. Res. Lett.* 8 (1), 014049.
- Corbett, J.J., Wang, H., Winebrake, J.J., 2009. The effectiveness and cost of speed reductions on emissions from international shipping. *Transp. Res. D* 14, 593–598.
- Chryssakis, C., Balland, O., Anton Tvete, H., Brandsæter, A., 2014. Alternative Fuels for Shipping. DNV GL, Høvik, Norway.
- Clauss, G.F., Siekmann, H., Tampier B.G., 2007. Simulation of the Operation of Wind-Assisted Cargo Ships. 102 Hauptversammlung der Schiffbautechnischen Gesellschaft, 21–23 November 2007, Berlin.
- Devanney, J., 2011. EEDI—William Froude Must be Spinning is his Grave, *Lloyds List* (Accessed 23 March 2011).
- Faber, J., Wang, H., Nelissen, D., Russell, B., St Amand, D., 2011. Marginal Abatement Costs and Cost Effectiveness of Energy-efficiency Measures. Institute of Marine Engineering, Science and Technology (IMarEST), London.
- Faltinsen, O.M., Minsaas, K.J., Liapis, N., Skjördal, S.O., 1980. Prediction of resistance and propulsion of a ship in a seaway. In: Proceedings of the 13th Symposium on Naval Hydrodynamics, Tokyo, Shipbuilding Research Association of Japan, pp. 505–529.
- Gilbert, P., 2014. From reductionism to systems thinking: how the shipping sector can address sulphur regulation and tackle climate change. *Mar. Policy* 43, 376–378.
- Hertzberg, T., 2009. LASS, Lightweight Construction Applications at Sea, SP Report. SP Technical Research Institute of Sweden, Borås.
- Houghton, J.T., Jenkins, G.J., Ephraums, J.J. (Eds.), 1990. Climate Change. The IPCC Scientific Assessment. Cambridge University Press, Cambridge, UK and New York, NY, USA.
- IPCC, 2013. Fifth Assessment Report of the Intergovernmental Panel on Climate Change. <<http://www.ipcc.ch>>.
- Kristensen, H.O.H., 2010. Model for Environmental Assessment of Container Ship Transport. Society of Naval Architects and Marine Engineers (SNAME), 3–5 November, Seattle, USA.
- Kruger, S., 2011. Mathematical Evaluation of the Applicability of the EEDI Concept for RoRo Vessels. Hamburg Harburg Institute of Ship Design and Ship Safety, March, 2011.
- Larsson, L., Raven, H.C., 2010. The Principles of Naval Architecture Series: Ship Resistance and Flow. SNAME 2010. ISBN: 978-0-939773-76-3.
- Lindstad, H., Asbjørnslett, B.E., Strømman, A.H., 2011. Reductions in greenhouse gas emissions and cost by shipping at lower speed. *Energy Policy* 39, 3456–3464.
- Lindstad, H., Jullumstrø, E., Sandaas, I., 2013. Reduction in costs and emissions with new bulk ship designs enabled by the Panama Canal expansion. *Energy Policy* 59, 341–349.
- Lindstad, H., Steen, S., Sandaas, I., 2014. Assessment of profit, costs, and emissions for slender bulk vessel designs. *Transp. Res. Part D* 29, 32–39.
- Lindstad, H., 2015. Assessment of bulk designs enabled by the Panama Canal expansion. Society of Naval Architects and Marine Engineers (SNAME). Transactions 121, 590–610.
- Lindstad, H., Eskeland, G.S., 2015. Low-carbon maritime transport: how speed, size and slenderness amount to substantial capital energy substitution. *Transp. Res. Part D* 41, 244–256.
- Lindstad, H.E., Eskeland, G., Psaraftis, H., Sandaas, I., Strømman, A.H., 2015a. Maritime shipping and emissions: a three-layered, damage-based approach. *Ocean Eng.* 110, 94–101.
- Lindstad, H.E., Eskeland, G.S., Mørch, H.J., Psaraftis, H., Sandaas, I., 2015b. Reducing cost and environmental impacts through hybrid power options. In: World Maritime Technology Conference WMTC-2015. Rhode Island, November 2015.
- Lindstad, H., Verbeek, R., Blok, M., Zyl, S., Hübscher, A., Kramer, H., Purwanto, J., Ivanova, O., 2015c. GHG emission reduction potential of EU-related maritime transport and on its impacts. Ref CLIMA.B.3/ETU/2013/0015. TNO report/TNO 2014 R11601. Delft, The Netherlands.
- Lindstad, H.E., Rehn, C.F., Eskeland, G.S., 2017. Sulphur abatement globally in maritime shipping. *Transp. Res. Part D* 57 (2017), 303–313.
- Perkins, T., Dijkstra, G., Perini Navi Team, Roberts, D., 2004. “The Maltese Falcon: the realization”. Hiswa Symposium 2004.
- Psaraftis, H.N., 2016. Green maritime transportation: market-based measures. In: Psaraftis, H.N. (Ed.), *Green Transportation Logistics*. Springer International Publishing, pp. 267–297.
- Psaraftis, H., 2018. Decarbonization of maritime transport: to be or not to be? *Marit Econ. Logist.* <http://dx.doi.org/10.1057/s41278-018-0098-8>.
- Shine, K., 2009. The global warming potential: the need for an interdisciplinary retrieval. *Clim. Change* 96, 467–472.
- Silverleaf, A., Dawson, J., 1966. Hydrodynamic design of merchant ships for high-speed operation. In: Summer Meeting in where, Germany 12th–16th June 1966. Schiffbau-technische Gesellschaft e.V, Institute of Marine Engineers, Institute of Engineers and Shipbuilders in Scotland, North-East Coast Institution of Engineers and Shipbuilders, Royal Institution of Naval Architects.
- Sjöbom, K., Magnus, P., 2014. Energieeffektiver ombord M/S Sydfart: Med hjälp av solceller. Fakulteten för teknik, Uppsala, Sjöingenjörprogrammet, Uppsala, Sweden.
- Smith et al., 2014. The Third IMO GHG Study. <<http://www.imo.org>>.
- Stenersen, D., Thonstad, O., 2017. GHG and NOx Emissions from Gas-fuelled Engines: Mapping, Verification, Reduction Technologies. Sintef Ocean. OC2017 F-108. Report for the Norwegian NOx Fund.
- Stott, P., Wright, P., 2011. Opportunities for improved efficiency and reduced CO₂ emissions in dry bulk shipping stemming from the relaxation of the Panamax beam constraint. *Int. J. Maritime Eng.* 153 (Part A4) Trans RINA.
- Taljegard, M., Brynolf, S., Grahn, M., Andersson, K., Johnson, H., 2014. Cost-effective choices of marine fuels in a carbon-constrained world: results from a global energy model. *Environ. Sci. Technol.* 48 (21), 12986–12993.
- Thomson, H., Corbett, J.J., Winebrake, J.J., 2015. Natural gas as a marine fuel. *Energy Policy* 87, 153–167.
- Teeter, J.L., Cleary, S.A., 2014. Decentralized oceans: sail-solar shipping for sustainable development in SIDS. *Nat. Resour. Forum* 182–192.
- Tillig, F., Mao, W., Ringsberg, J., 2015. Systems Modelling for Energy-efficient Shipping. Chalmers University of Technology.
- Traut, M., Gilbert, P., Walsh, C., Bows, A., Filippone, A., Stansby, P., Wood, R., 2014. Propulsive power contribution of a kite and a Flettner rotor on selected shipping routes. *Appl. Energ.* 113, 362–372.
- Verbeek, R. et al., 2011. Environmental and Economic Aspects of Using LNG as a Fuel for Shipping in The Netherlands. Den Haag, The Netherlands, TNO report TNO-RPT-2011-00166.
- Verbeek, R.P., Verbeek, M.M.J.F., 2015. LNG for Trucks and Ships Fact Analysis Review of Pollutant and GHG Emissions. Den Haag, The Netherlands, TNO Report 2014 R 11668.
- Vladimir, N., Ančić, I., Šestan, A., 2018. Effect of ship size on EEDI requirements for large container ships. *J. Mar. Sci. Technol.* 23 (1), 42–51.
- Wang, H., Faber, J., Nelissen, D., Russell, B., St Amand, D., 2010. Marginal abatement costs and cost effectiveness of energy-efficiency measures. In: Organization, I.M. (Ed.), *The Society of Naval Architects and Marine Engineers (SNAME)*. London.
- Wang, H., Lutsey, N., 2013. Long-term potential for increased shipping efficiency through the adoption of industry-leading practices. International Council on Clean Transportation September, 30th.