

**OPEN ACCESS**

## Resolution of tower shadow models for downwind mounted rotors and its effects on the blade fatigue

To cite this article: M Reiso and M Muskulus 2014 *J. Phys.: Conf. Ser.* **555** 012084

View the [article online](#) for updates and enhancements.

### Related content

- [An assessment of the effectiveness of individual pitch control on upscaled wind turbines](#)  
Z J Chen and K A Stol
- [Analysis of long distance wakes of Horns Rev I using actuator disc approach](#)  
O Eriksson, R Mikkelsen, K S Hansen et al.
- [Transitional DDES computations of the NREL Phase-VI rotor in axial flow conditions](#)  
Niels N Sørensen and Scott Schreck

## Resolution of tower shadow models for downwind mounted rotors and its effects on the blade fatigue

**M Reiso and M Muskulus**

Department of Civil and Transport Engineering, Norwegian University of Science and Technology, Høgskoleringen 7a, 7491 Trondheim, Norway

E-mail: [marit.reiso@ntnu.no](mailto:marit.reiso@ntnu.no)

**Abstract.** A simulation study on the wind field resolution in computer load simulations has been conducted, both in transversal/vertical and longitudinal direction, to determine the effect on blade fatigue loading. Increasing the transversal/vertical resolution decreased the loading significantly, while only small changes to the load, at very low frequencies were found for increased longitudinal resolution. Next the influence of the tower shadow for a downwind mounted rotor was investigated, with respect to blade fatigue loading. The influence of different components to the total tower shadow effect was studied, both for a monopile and a truss tower, latter at inclination 0 and 22.5 degrees with respect to the incoming wind direction. Four components were considered, both individually and in combinations: mean wind speed, mean velocity deficit, unsteady motions from vortex shedding, and turbulence. The mean velocity deficit and turbulence were the main contributors to blade fatigue loading, and the unsteady motions can be neglected for the truss tower. For the monopile, neglecting the unsteady motions resulted in an underestimation of fatigue loading in the order of 3 percent.

### 1. Introduction

The classical wind turbine configuration, i.e., an upwind mounted rotor on a monopile tower, might be challenged by other configurations when going offshore where the installation costs are higher and the maintenance level is restricted due to access and weather windows. E.g. using a downwind mounted rotor has the advantage of reducing the root flapwise bending moment (RFM), as the blades cone away from the tower [1].

With a rotor mounted on the downwind side, the tower will introduce a shadow region onto the blade as it passes behind the tower. The tower shadow becomes more transparent if one uses a truss type tower instead of the traditional monopile tower. To simulate the effect of the tower shadow currently existing software approximates the wind field behind such a truss tower using a deterministic mean velocity deficit. Varieties of Powles' model [2] are the most commonly used to calculate the tower shadow. The drawback with Powles' model is that the user needs to choose the parameters for tower deficit and tower wake width. As these are often not known in advance it could cause discrepancies to the actual wind load if chosen incorrectly. Even if the parameters are chosen correctly it has been shown that Powles' model still is not fully able to reproduce the actual flow field behind the towers, including speed up on the sides of the towers and for the more complex truss tower configurations also underestimating the central wakes with as much as 20 percent [3] [4]. Latter indicating that the interaction between the truss tower members is also crucial to the total wake and Powles' model simply adds the contributions from each single truss tower member without



considering their interaction. As the blade experiences an impact like load due to the disturbance in the wind field caused by the tower structure as it passes behind the tower, an underestimation of this disturbance could have fatal consequences overestimating the lifetime of the wind turbine blade.

The tower shadow effect is really a dynamic phenomenon, but we currently only use static tower shadow models, i.e., for the mean velocity deficit. Here we also study different ways of extending these models to include more dynamical effects, and assess their importance for fatigue of rotor blades. These dynamic effects are included through time series obtained by computational fluid dynamic simulations, CFD, and are further imported through a turbulent wind file into the commercial software tool Bladed to study the unsteady motions behind such a support structure and how these affect the turbine. The present paper also shows that these effects can be approximated adjusting the turbulence intensity values (TI), through an up-scaling of the turbulent fluctuations present in the wind directly behind the towers.

In load simulations turbulent wind fluctuations are typically resolved at discrete points across the rotor disc. These typically have a lateral resolution of 2-5 m, which is thought to be sufficient as high-frequency turbulent fluctuations are averaged out spatially along the blade on a scale of about 10m. However, to the best of our knowledge this has not been studied systematically. Therefore a simulation study has been included herein to show how the blade loading is affected by changing the wind field resolution, both in transversal/vertical and longitudinal direction. Results are given as damage equivalent loads (to allow for comparisons, without a fully detailed assessment of fatigue lifetime) of root flapwise moments for the NREL Offshore 5-MW Baseline Wind Turbine [5].

The influence of the resolution of the velocity grid is studied here both for the one component Kaimal spectrum and for the total wind field obtained from CFD simulations of a full-height truss tower, as well as for a monopile tower [3] [4].

## 2. Material and methods

The study was conducted in two parts. The first part is a resolution study, performed with a typical turbulent wind field, and with an unsteady tower shadow model. The second part is a study of the impact of different wind field components on damage equivalent loading (DEL) on the RFM.

### 2.1. Wind turbine

The wind turbine used in the present study was based on the NREL Offshore 5-MW Baseline Wind Turbine [5]. The turbine was changed from an upwind to a downwind configuration, and some of the simulations were run using a truss tower instead of the conventional monopile tower; the truss tower is based on work by Long et al. [6]. Shaft tilt and cone angles were adjusted from 5 and 2.5 degrees, to 2 degrees each.

**Table 1.** Parameters for the turbulent wind fields.

Turbulence model	One-dimensional Kaimal
Width of field [m]	150/130
Number of points across [-]	1503/750/300/100/50/40/30/20/10
Height of field [m]	200/150/130
Number of points in vertical	10/20/30/40/50
Length of field [m]	1800
Along wind spacing [m]	0.06/0.12/0.24/0.48/1/2/4/8/17/31.5/63.2/133
Mean wind speed [m/s]	12
Simulation time [s]	150
Longitudinal turbulence length scale:	
Longitudinal [m]	340.2
Transversal [m]	0.1
Vertical [m]	0.1
Longitudinal turbulence intensity [%]	10

## 2.2. Wind field

The one dimensional Kaimal model was used to generate a three dimensional wind field (Table 1).

For the tower shadow a numerical study was previously conducted, in which the detailed flow field behind a conventional monopile and a truss tower was investigated for two dimensional cross sections [4]. Results were output in the form of time series for a distance 3D (D=4m being the monopile diameter) behind the tower centres, corresponding to the approximate position where the rotor will pass. Two different configurations of the truss tower, aligned with the flow, and at an angle of 22.5 degrees (not shown), were considered, latter representing the more frequent positioning of the rotor behind the tower (not fully aligned at e.g. 0 degrees), Figure 1. Results included wind velocity and turbulent kinetic energy, and were obtained for 30 seconds flow time at 200 Hz resolution. This corresponds to 6000 time steps, of which the first 1000 were neglected. Only one wind speed (12 m/s) was considered.

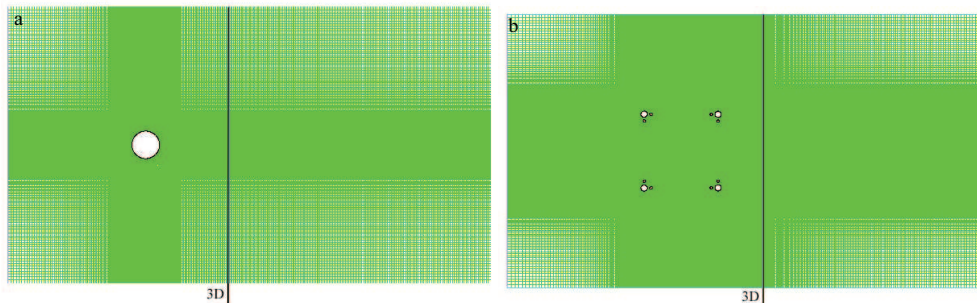

**Figure 1.** Grid for CFD simulations, line at 3D where rotor passes; monopile (left) and K-brace position for truss 0 degrees (right).

Wind turbine load simulations require three dimensional wind fields, this was achieved by reusing the two dimensional time series at different vertical positions (with random offsets in the time series). For the truss tower two different cross sections were combined (close to X- and K-brace position, Figure 2) and the cross section closest to each vertical grid position was used. The series were also looped in time. To avoid artificial increases in loading, the first and last values were compared to see if there would be a large change at the transition point, no such deviation was found and the time series were simply re-looped.

The domain of the CFD simulations extended 40m in transversal direction (corresponding to 401 grid points) with the tower placed in the centre. This domain was embedded in a larger domain of size 150m in the transversal direction (corresponding to 1503 grid points), to encompass the entire rotor (Figure 3). In the vertical direction ten discrete layers of the CFD simulations were used (at 10m spacing). Additional ten layers of pure turbulence were included to encompass the entire rotor in the vertical direction, total vertical domain spanning 200m (Figure 3).

The wind speed at the lateral boundaries of the computational domain was slightly higher than the free stream velocity of 12m/s, this was most likely an artifact due to the presence of periodic boundaries in the CFD simulations [4]. To correct for this, the observed offset from 12 m/s at the domain boundaries was subtracted from the velocities, to avoid artificial discontinuities when embedding into the larger domain. These offsets were 0.27 m/s, 0.47 m/s and 0.48 m/s for the monopile, and the truss towers at 0 and 22.5 degrees, respectively.

The combined wind fields including both the realization of the Kaimal spectrum and the tower shadow were assembled using MatLab (The MathWorks, Inc.; R2012a). As the highest transversal resolution that could be obtained for the Kaimal spectrum was 50 points across the domain, the spectrum was first interpolated to obtain a total of 1503 points across, using the *meshgrid* function in MatLab (above 50 grid points the interpolation systematically underestimates the fluctuations). Secondly stochastic realizations from the Kaimal spectrum (with unit standard deviation) were scaled

by the standard deviation (derived from the local TI values resolved by the  $k-\omega$  sub-grid parameterization) for each point in time and space, where the boundary values from the  $k-\omega$  sub-grid parameterization were used to extend the total CFD domain from 40 to 150m. Further the absolute value of the mean velocity deficit and unsteady motions were added across the central part of domain (Figure 3) before the total wind field was normalized and compiled into a wind file that could be used directly in the software Bladed (Version 4.2, GL Garrad Hassan; Bristol, UK). An exponential vertical wind shear component of 0.14 was used. Total simulation time was 150 seconds, where the first 30 seconds were used for initialization purposes and discarded from the output to remove the initial transient.

As the highest wind field resolution file (1503 transversal points, 20 vertical points and 200Hz longitudinal) exceeded the maximum array size MatLab could store in memory, the wind files were processed in six parts.

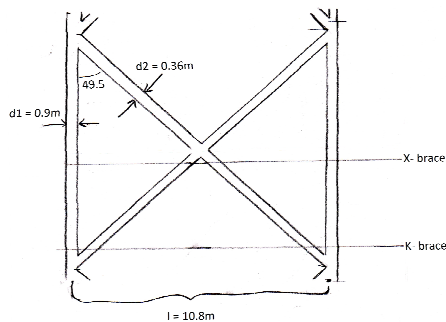

**Figure 2.** X- and K-brace positions shown on a side panel of the truss tower.

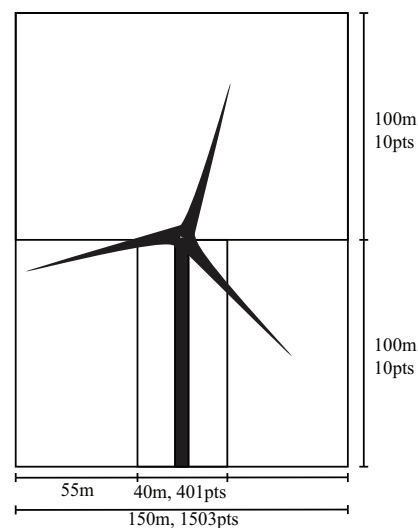

**Figure 3.** Wind field domain (fixed size) with maximum grid resolution, CFD domain at bottom centre (40m times 100m).

#### 2.4. Resolution study

How both the spatial and temporal resolution changed within the resolution limitations of the software was investigated both for turbulent wind, and for the unsteady tower shadow.

**Table 2.** 12 longitudinal and five lateral/vertical resolutions combined to obtain 60 different turbulent resolution combinations.

Longitudinal [Hz]			
0.09	0.7	6	50
0.19	1	12	100
0.38	3	25	200
Number of grid points (transversal/vertical)			
10/10		40/40	
20/20		50/50	
30/30			

**Table 3.** Five longitudinal resolutions (transversal resolution fixed at 1503) and six transversal resolutions (using the longitudinal resolution result) were used for the wind field including the unsteady tower shadow.

Longitudinal [Hz]	
12	100
25	200
50	
Number of grid points (transversal)	
40	300
50	750
100	1503

*2.4.1. Resolution of turbulent wind field.* For this study five lateral and vertical resolutions and 12 longitudinal resolutions were combined to obtain a total of 60 cases (Table 2).

All simulations were run using a downwind rotor with no tower shadow effect. Linear interpolation between grid points was used to achieve a common output time step of 0.005s (corresponding to the 200Hz case) for all simulations. Four different turbulent seeds were used to obtain a better estimate. A domain size of both 150x150m and 130x130m were included.

*2.4.2. Resolution of wind field including unsteady tower shadow.* First the longitudinal resolution was assessed, using five different longitudinal resolutions with 16 different turbulent seeds (transversal resolution kept constant at 1503 points) and output time step of 0.005s. Results from the longitudinal resolution study were thereafter used with the six transversal resolutions (Table 3).

The resolution study for the tower shadow on the downwind rotors was based on the most complex flow pattern, including CFD mean velocity deficit, unsteady motion and  $k-\omega$  sub-grid parameterization as well as the one component Kaimal spectrum.

### 2.5. Wind field component influence study

The second part of this paper separates the contributions of the complete wind field into four different components; mean wind speed, mean velocity deficit, unsteady motions and turbulence across the rotor plane to address their separate and interacting contribution to DEL varying in time and space on the RFM (Table 4).

In addition a simplified method for representing the tower shadow has been included, through an increase in the mean TI (3B\*, Table 4). This would, if applicable limit the time consuming CFD simulations to short dynamic studies for the relevant tower structure.

The recommended resolutions found in the resolution study of the wind field including the unsteady tower shadow were used here.

**Table 4.** Wind field components.

Wind field component	Description of wind field component
0	Mean wind speed
1	Mean velocity deficit
2	Unsteady motions (CFD)
3A	Turbulence (Kaimal spectrum)
3B	Turbulence (Kaimal spectrum) with different turbulence intensity, TI (averaged) for each lateral point
3B*	Same as case 3B with increased TI (including case 2)
3C	Turbulence (Kaimal spectrum) with different TI for each lateral point and time step

## 3. Results and discussion

### 3.1. Resolution study

Time domain simulations are time consuming but although necessary for wind turbine analysis in the last design phase. The presented results show how decreasing simulation time through reducing grid resolution affects the load accuracy.

*3.1.1. Resolution of turbulent wind field.* The DEL on the RFM based on loads from the turbulent wind field (without tower shadow effects) show similar values across the different longitudinal resolutions for the same transversal resolutions (Figure 4), except at 0.09Hz (transversal grid point resolution 10x10), where a 3 percent lower mean DEL was found compared to the 200Hz case. Hence using a resolution of at least 1Hz is recommended for including the full effect from the turbulent wind.

The transversal resolution exhibits a different behaviour with the DEL progressively decreasing by 19 percent (from 10x10 to 50x50 transversal and vertical grid points). It was not possible to

investigate higher resolutions on the 150x150m domain, so results might still change somewhat for increasing resolutions. For the 130x130m domain the grid point resolution increased by 13 percent (compared to the 50x50 grid points on the 150x150m domain), while the average DEL only decreased by 2 percent. The blade is more severely fatigue loaded at the lower transversal grid resolutions, where the load is more constant across the blade length (Figure 4). A resolution of at least 50 points is recommended to include the effect from the turbulent wind. Preferably this should be increased but the software resolution had a limit of 50 grid points.

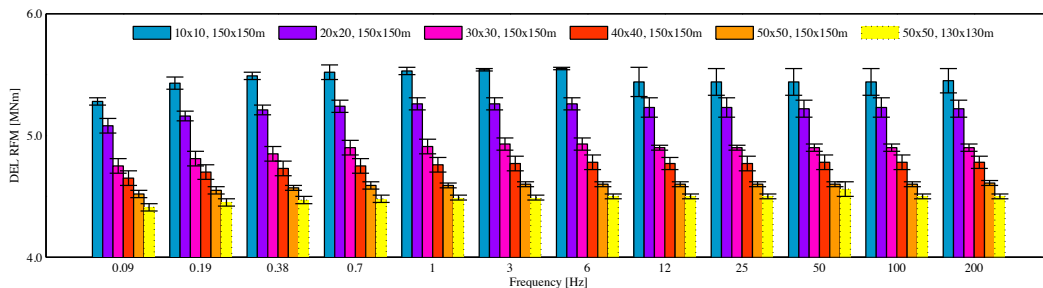

**Figure 4.** DEL on RFM with changing longitudinal and transversal resolutions for the wind field based on the one component Kaimal spectrum (no tower shadow present). Frequencies increase from 0.09Hz to 200Hz and grid point resolution from 10x10 to 50x50 points across domains of 150x150m and 130x130m.

*3.1.2. Resolution of wind field including unsteady tower shadow.* The longitudinal resolution does not change the DEL on the RFM by much; the maximum difference in mean DEL is 2 percent at 50Hz (with respect to the 200Hz case for the monopile). Although due to the increased complexity of the wind field a resolution of at least 25Hz is required to re-capture the DEL at 200Hz (Figure 5a, c, e).

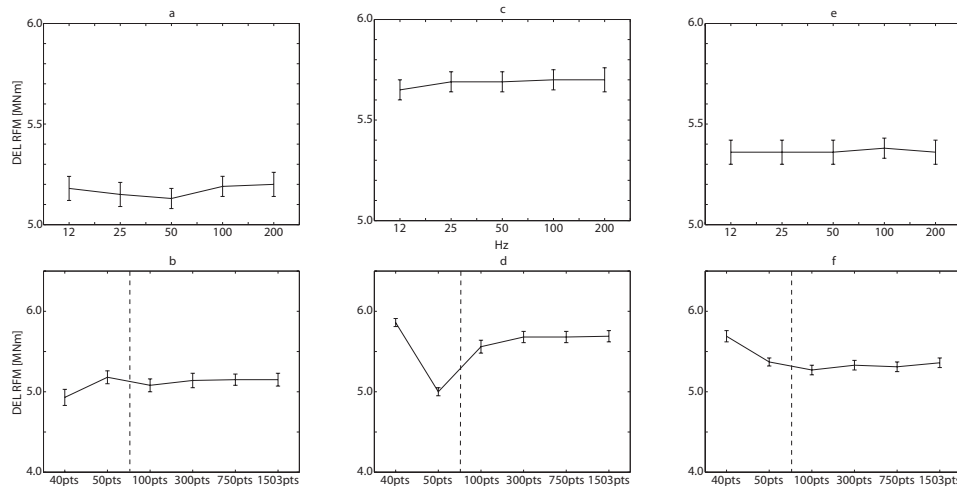

**Figure 5.** DEL for longitudinal (top) and lateral tower shadow resolutions (bottom). Left monopile tower, middle truss tower at 0 degrees and right truss tower at 22.5 degrees (dotted line show transition into interpolated turbulence).

The higher DEL at 40 versus 50 points in both truss tower setups is in agreement with the results from the turbulent wind field resolution (resolutions beyond 50 points is obtained through linear interpolation, making 50 points the highest turbulent resolution). The low transversal resolution at 50 points could be too coarse to fully represent the narrow truss tower members, which causes a significantly lower DEL for the truss tower at 0 degrees (Figure 5d). A transversal resolution of at

least 300 points across the domain is required to re-capture the DEL on the RFM at 200Hz (Figure 5b, d, f).

### 3.2. Wind field component influence study

All cases were run at a mean wind speed of 12m/s, which has been isolated in case 0 (Figure 6), showing a DEL on the RFM of 3.42MNm, arising mainly from oscillating gravity and centrifugal forces as the blade rotates on the rotor plane at a frequency of 1P (corresponding to 0.2Hz at 12.1rpm).

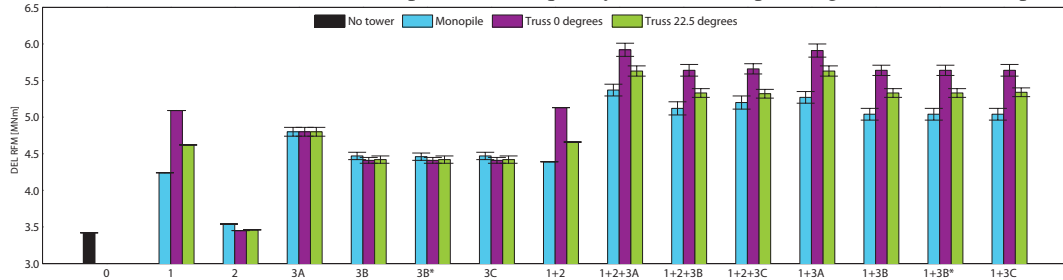

**Figure 6.** DEL on RFM behind monopile, truss 0 and truss 22.5 degree towers. Complexity of wind field increasing from left to right. All results presented at longitudinal resolution 25Hz and transversal and vertical grid resolutions 300 and 20 respectively, error bars showing standard deviation of the mean (details on wind field complexity components in Table 4).

Introducing a mean velocity deficit behind the tower increases the DEL in the range of 25 to 50 percent (from case 0) for the three tower setups (case 1, Figure 6). The truss tower at 0 degrees exhibits a 20 percent higher DEL than the monopile tower. This points in the direction of although more transparent, the truss tower covers a larger cross sectional area (11.7m versus 4m for the monopile) with deeper throughs which contributes more to the DEL than the solid monopile (Figure 7a, c). But at 22.5 degrees the truss tower covers an even larger cross sectional area (15.7m) exhibiting only a 9 percent higher DEL compared to the monopile. So the DEL on the RFM is higher for the truss tower aligned at 0 degrees than for the staggered trusses at 22.5 degrees (off by 10 percent), Figure 7c, e, as the aligned trusses magnify the deficit from each of the legs, while the staggered arrangement smoothens the deficit.

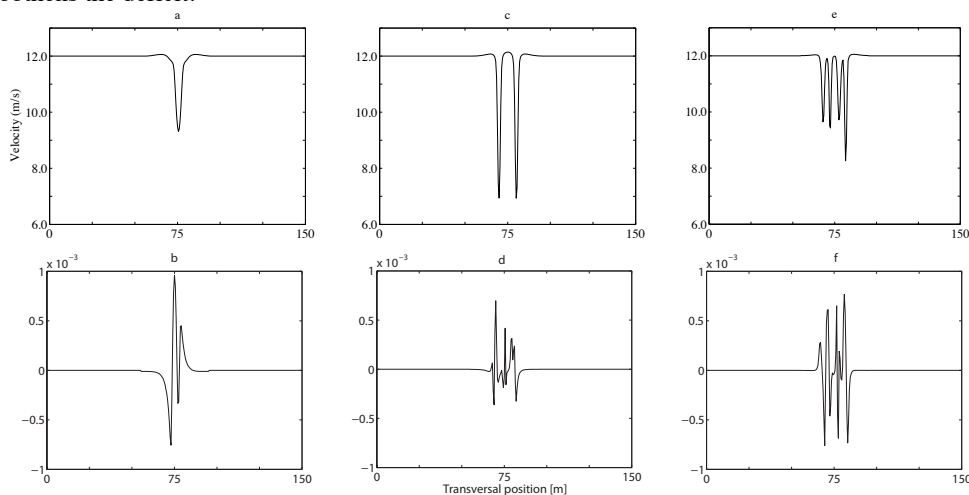

**Figure 7.** Mean velocity deficit (top) and time averaged unsteady motions (bottom) for monopile (left), truss 0 (middle) and truss 22.5 degrees (right).

For the unsteady motion (case 2) the picture is different from case 1, with the DEL being only 1 and 4 percent higher than in case 0 for the truss and monopile towers respectively. This means that the



vortex sheddings arising from the tower structures are not that important when it comes to the fatigue loading on the blades. From Figure 7b, d, f one would expect to see a larger effect on the DEL from the unsteady motions than what is present in Figure 6 (case 2). This means that the influenced area is too small compared to the total rotor plane and the passing frequency of the blade. Combined case 1+2 also reflects this, with case 1+2 only accounting for additional 1 and 3 percent DEL for the truss and monopile towers, respectively (compared to case 1).

Case 3A represents the turbulent wind field (no tower shadow present) and results in a DEL of 4.80MNm for all three tower configurations, corresponding to a 40 percent increase in DEL compared to the mean wind speed (case 0). Including the turbulence from the  $k-\omega$  sub-grid parameterization (case 3C) the mean DEL decreased by 8 and 7 percent for the truss and monopile towers, respectively, similar finding also in case 3B and 3B\*. This indicates a conservative approach for the tower shadow representation in commercial software methods (using 3A).

For the truss towers the full dynamic simulations (case 1+2+3C) can be approximated using the time averaged TI from the  $k-\omega$  parameterization. While the monopile tower needs to include the unsteady motions to avoid a three percent underprediction of the DEL on the RFM.

The overall picture for the combined cases 1+3A/B/C and 1+2+3A/B/C is that the mean tower shadow deficit and the Kaimal spectrum are the main contributor to the DEL on the RFM, with the Kaimal spectrum increasing the averaged mean DEL by 13 and 4 percent (compared to case 1) for the monopile tower and truss tower at 22.5 degree, respectively, while a decrease of 6 percent was found for the truss tower at 0 degrees.

#### 4. Conclusion

The turbulent wind field resolution study recommends longitudinal and transversal/vertical resolutions of at least 1Hz and 50 points across the domain to include the full effect of the turbulent wind. For the wind field including the tower shadow these resolutions increase to 25Hz and 300 points across the domain.

The most interesting result from the wind field component influence study was that the most complex case (1+2+3C) for the truss tower could be approximated using an averaging of the turbulence from the  $k-\omega$  sub-grid parameterization, case 1+3B, while the same approximation for the monopile tower resulted in an underestimation of DEL of 3 percent.

Preferably one would like to run three dimensional CFD simulations both to get a correct shape of the tower (smaller diameter at top could cause different loading on the blade) at the different elevations (here looked at leg spacing of 10.8m corresponding to blade length position 1/3 from the blade root) and to be able to capture all three dimensional effects.

#### 5. References

- [1] Reiso M and Moe G 2010. *Blade response on offshore bottom fixed wind turbines with downwind rotors*. In Proceedings of the ASME 29<sup>th</sup> International Conference on Ocean, Offshore and Arctic Engineering, 499-504.
- [2] Powles SRJ 1983. The effect of tower shadow on the dynamics of a horizontal-axis wind turbine. *Wind Engineering*, **7** 26-42.
- [3] Hagen T, Reiso M and Muskulus M 2011. *Numerical analysis of turbulent flow past a truss tower for offshore downwind turbines*. In Proceedings of the ISOPE 21<sup>st</sup> International Offshore and Polar Engineering Conference, 319-326.
- [4] Hagen T, Reiso M and Muskulus M 2011. *Numerical tower shadow modeling for a downwind wind turbine truss tower*. In Proceedings of the ASME 30<sup>th</sup> International Conference on Ocean, Offshore and Arctic Engineering, 859-870.
- [5] Jonkman J, Butterfield S, Musial W and Scott G 2009. *Definition of a 5-mw reference wind turbine for offshore system development*. NREL Technical Report NREL/TP-500-38060, National Renewable Energy Laboratory, Golden, CO.
- [6] Long H, Fischer T, Moe G 2009. *Design methodology and optimization of lattice towers for offshore wind turbines in 35m water*. In Proceedings of EWEC, Marseilles.