



Norwegian University of
Science and Technology

Particle Size Distribution and Specific Surface Area Measurements with X-ray SediGraph on Filler, Cement and Fly Ash

Patricia Ysabel Sosa

Civil and Environmental Engineering

Submission date: June 2017

Supervisor: Stefan Jacobsen, KT

Co-supervisor: Rolands Cepuritis, KT
Elisabeth Leite Skare, KT

Norwegian University of Science and Technology
Department of Structural Engineering

Abstract

The focus of this thesis is producing the Particle Size Distribution (PSD) of filler, cement and fly ash using X-ray sedimentation technique. The Micromeritics SediGraph III Plus (5125) applies the sedimentation theory to determine the particle size and directly measures the particle mass through X-ray absorption. Particle size is measured in equivalent spherical diameter, the diameter of a sphere of the same material with the same falling rate. By using Stokes' law to calculate the particle falling rate, the SediGraph is able to determine the size of the particle that has fallen beyond a specific analysis point of the analysis cell. Concrete performance can be optimized through concrete Micro-proportioning by adjusting the grading of fines to control the matrix rheology. The Specific Surface Area (SSA) is however a better parameter in describing the fineness and is easier to apply in practice. The SSA can be calculated from the size distribution. An accurate analysis of particles with particle size below 5 μm is therefore significant as most of the SSA comes from the smallest particles. The SediGraph was used to determine the distribution of Velde Fine filler, Industrisement and Fly Ash (FA) with a particle size range of 1 – 125 μm . The precision of the SediGraph analysis is mainly dependent on how well dispersed the particles are in the liquid. Studies of suitable dispersing liquids concluded that the SediSpurse A-12 is the most promising liquid. The liquid density and liquid viscosity are temperature dependent, meaning that the temperature during the analysis must be kept stable for accurate analysis. The procedure for determining PSD including sampling, rinsing and agitation seems to be well-developed and provides reproducible results. In addition, the PSD of the same material shows good repeatability. The SSA calculated from the PSD indicates that 90 % of the SSA is concentrated in the particle size below 20 μm , where more than 50 % of the SSA is generated from the particles with particle size below 5 μm .

Sammendrag

Denne oppgaven fokuserer på å produsere partikkelstørrelsesfordeling (PSD) av filler, sement og flygeaske med røntgen sedimentasjonsteknikk. Micromeritics SediGraph III Plus (5125) bruker sedimentasjonsteorien til å bestemme partikkelstørrelsen og måler partikkelmassen direkte gjennom røntgenabsorpsjon. Partikkelstørrelsen måles i ekvivalent sfærisk diameter, diameteren av en sfære av samme materiale med samme fallende hastighet. Ved å bruke Stokes lov til å beregne partikkelens fallende hastighet, er SediGraph i stand til å bestemme størrelsen på partikkelen som har falt utover et bestemt analysepunkt i analysecellen. Betongens kvalitet kan optimaliseres ved hjelp av mikroproporsjonering ved å justere fillergraderingen for å kontrollere reologien til matrisen. Det spesifikke overflatearealet (SSA) er imidlertid en bedre parameter i å beskrive finheten og er lettere å anvende i praksis. SSA kan beregnes ut fra partikkelstørrelsesfordelingen. En nøyaktig analyse av partikler med partikkelstørrelse under 5 μm er derfor signifikant, da det meste av SSA kommer fra de minste partiklene. SediGraph ble brukt til å bestemme fordelingen av Velde Fin filler, Industrisement og Flygeaske (FA) med et partikkelstørrelsesområde på 1 - 125 μm . Presisjonen på SediGraph-analysen er hovedsakelig avhengig av hvor godt spredt partiklene er i væsken. Studier av egnede dispergerende væsker konkluderte med at SediSperser A-12 er den mest lovende væsken. Densiteten og viskositeten til væsken er temperaturavhengig, noe som betyr at temperaturen må holdes stabil under analysen for nøyaktig resultat. Prosedyren for å bestemme PSD, inkludert prøvetaking, rensing og agitasjon, synes å være godt utviklet og gir reproducerbare resultater. I tillegg viser PSD av samme materiale god repeterbarhet. SSA beregnet fra PSD indikerer at 90% av SSA befinner seg under partikkelstørrelse 20 μm , hvor mer enn 50% av SSA genereres fra partiklene med partikkelstørrelse under 5 μm .

Preface

This Master thesis was written during the spring of 2017 as a requirement upon completion of Master's degree in Civil and Environmental Engineering at the Norwegian University of Science and Technology in Trondheim. The thesis was written by the undersigned under the Department of Structural Engineering and has a topic within Concrete Technology, which is my field of specialization.

This thesis is the outcome of long days at the lab, the struggles of unfortunate events, enthusiasm of supervisors, the long process of experimenting and hoping for good results, months of reading, rewriting and stress eating, and last but not least the encouragements of people around me.

To begin with, I would like to thank my main supervisor Professor Stefan Jacobsen for his excellent supervision, contribution of relevant theoretical background, feedbacks and advice. I am really grateful for his great enthusiasm all the way back to my summer internship at NTNU, and for keeping my spirits up especially at times of unexpected misfortunes.

I would like to express my gratitude to my co-supervisors Post Doc Rolands Cepuritis and Ph.D. candidate Elisabeth Leite Skare for their good guidance, providing relevant information and helping with the calculations. I would also like to thank Elisabeth for providing assistance with the SediGraph, proofreading and her support when things went wrong.

The collaboration in summer and fall with Evgeny Ramenskiy is highly valued as he was both an excellent mentor, when it came to learning me the SediGraph and AccuPyc, and willingly answered my questions at late hours and during weekends.

I am sincerely grateful to all of my supervisors for creating a light environment filled with great enthusiasm during our meetings. I could not possibly have better supervisors than you. Thank you! :)

I would also like to thank Engineer Steinar Seehuus and Staff Engineer Ove Loraas for good guidance and enthusiasm at the laboratory and for providing the required equipment, Senior Engineer Torill Sørørkk for lending me the riffle box for sampling and Tom Andre Brubak (CEO of Mikro Tek AS) for relevant information.

A Big thanks to my family and friends, friends that are more like a family, for all of your love and encouragements, I could not have come this far without you all.

Finally, my special thanks to my very special friend Daniel Groos for always being there for me especially when I need it the most.

Trondheim, June 16, 2017

A handwritten signature in cursive script that reads "Patricia Ysabel Sosa". The signature is written in black ink and is positioned above a solid horizontal line.

Patricia Ysabel Sosa

Table of Contents

List of Figures.....	ix
List of Tables.....	xi
List of Formulas.....	xii
Abbreviations.....	xii
List of Symbols.....	xiii
1 Introduction.....	1
1.1 Background.....	1
1.2 Scope.....	3
1.3 Limitations.....	4
2 Theoretical Background.....	5
2.1 Review of Previous Research.....	5
2.2 SediGraph.....	7
2.3 Particle Size Distribution.....	9
2.4 Frequency curves.....	10
2.5 Reynolds number.....	11
2.6 Specific Surface Area.....	12
2.6.1 Specific Surface Area Calculation.....	13
2.6.2 Surface Area Population.....	14
3 Experiments.....	15
3.1 Materials.....	15
3.1.1 Filler.....	15
3.1.2 Cement.....	19
3.1.3 Fly Ash.....	19
3.1.4 Dispersing Liquid.....	20
3.2 Sampling.....	22
3.2.1 Preparation of the Velde filler for the SediGraph Analysis.....	23
3.3 SediGraph.....	24
3.3.1 SediGraph Method of Analysis.....	24
3.3.2 Baseline Measurement.....	27
3.3.3 Full – scale Measurement.....	28

3.3.4	Test Run Analysis.....	29
3.3.5	SediGraph Analysis.....	30
3.4	pH and hydration of cement.....	32
4	Results.....	35
4.1	SediGraph.....	35
4.1.1	Baseline Measurement.....	35
4.1.2	Full – Scale Measurement.....	37
4.1.3	Test Run Analysis.....	38
4.1.4	Temperature.....	39
4.2	Particle Size Distribution.....	42
4.3	Frequency curve.....	43
4.4	Specific Surface Area.....	44
4.5	pH and hydration.....	46
5	Discussion.....	47
	Possible sources of errors.....	52
6	Conclusion.....	55
	Further work.....	57
	References.....	59
	Appendix.....	61
	A. Product Information of Industrisement.....	61
	B. Norcem Presentation of Cement Products and Quality.....	66
	C. Industrisement Quality Test Report.....	68
	D. Particle Size Distribution of Industrisement using Laser Diffraction.....	70
	E. Fly Ash Quality Test Report.....	72
	F. Particle Size Distribution of Fly Ash using Laser Diffraction.....	74
	G. SediGraph Procedure.....	76
	H. AccuPyc Helium Pycnometry Procedure.....	80
	I. Particle Size Distribution and Frequency Curves.....	83
	J. SSA Calculation Printout of Excel Sheet.....	91
	K. pH and Hydration.....	93
	L. List of Dispersing Liquids.....	95

List of Figures

Figure 1: X-ray sedimentation	7
Figure 2: Particle Size Distribution of Industrisement (IND Cement) with a particle size range 1 – 125 μm . SediSperser A-12 is used as the dispersing liquid. The Set temperature for the analysis is 30 $^{\circ}\text{C}$	9
Figure 3: The Frequency curve is plotted against the Particle Size Distribution of Industrisement (IND Cement) with particle size range 1 – 125 μm . SediSperser A-12 is used as the dispersing liquid. The Set temperature for the analysis is 30 $^{\circ}\text{C}$	10
Figure 4: Large-scale sieving machine with a lid, 3 sieves, and a bottom tray	18
Figure 5: Splitting with Riffle box	22
Figure 6: Micromeritics SediGraph III Plus (5125)	24
Figure 7: Beam – Split	25
Figure 8: pH and Hydration test	33
Figure 9: pH indicator strips	33
Figure 10: Baseline Measurement of SediSperser A-12	36
Figure 11: Baseline and Full-Scale Measurement	37
Figure 12: PSD curves of Velde Fine filler from 1 – 125 μm with SediSperser A-12 at different Set Temperatures.....	41
Figure 13: PSD curves of Velde Fine filler, Industrisement and Fly Ash from 1 – 125 μm with SediSperser A-12 at 30 $^{\circ}\text{C}$	42
Figure 14: Frequency curves of Velde Fine filler, Industrisement and Fly Ash from 1 – 125 μm with SediSperser A-12 at 30 $^{\circ}\text{C}$	43

Figure 15: Particle Size Distribution of Velde Fine Filler 1-125 μm with different analysis temperature [Figure 12]	83
Figure 16: Particle Size Distribution of Velde Fine Filler 1-125 μm	84
Figure 17: Particle Size Distribution of Industrisement 1-125 μm	84
Figure 18: Particle Size Distribution of Fly Ash 1-125 μm	85
Figure 19: PSD and Frequency Curve of Velde Fine Filler 1- 125 μm Test no.1	85
Figure 20: PSD and Frequency Curve of Velde Fine Filler 1- 125 μm Test no.2	86
Figure 21: PSD and Frequency Curve of Velde Fine Filler 1- 125 μm Test no.3	86
Figure 22: PSD and Frequency Curve of Industrisement 1- 125 μm Test no.1.....	87
Figure 23: PSD and Frequency Curve of Industi Cement 1- 125 μm Test no.2.....	87
Figure 24: PSD and Frequency Curve of Fly Ash 1-125 μm Test no.1	88
Figure 25: PSD and Frequency Curve of Fly Ash 1-125 μm Test no.2	88
Figure 26: Particle Size Distribution of Velde Fine Filler, Industrisement and Fly Ash. 1-125 μm . SediSpere A-12 as dispersing liquid. [Figure 13]	89
Figure 27: Frequency Curves of Velde Fine Filler, Industrisement and Fly Ash. 1-125 μm . SediSpere A-12 as dispersing liquid. [Figure 14]	90

List of Tables

Table 1: Crushing process at Velde AS	17
Table 2: Set of sieves for large sieving	18
Table 3: Liquid Properties of the dispersing liquids used in the specialization project and in this thesis.....	21
Table 4: Densities and Viscosities at given temperatures for dispersing liquid SediSperse A-12	21
Table 5: Amount of filler before and after drying	23
Table 6: Values chosen and values calculated by the SediGraph for the Material Properties .	30
Table 7: Weight of materials determined through the SediGraph Test Run Analysis.....	31
Table 8: X-ray absorption of SediSperse A-12	35
Table 9: X-ray absorption of pure SediSperse A-12 and dispersed sample of Velde Fine filler in SediSperse A-12	37
Table 10: Minimum amount of sample material needed for the SediGraph analysis [Table 7]	38
Table 11: Material Properties.....	40
Table 12: Particle Size Distribution for Velde Fine Filler with SediSperse A-12 at different Set Temperatures.....	41
Table 13: Average Specific Surface Area calculated from the SediGraph analysis.....	44
Table 14: Specific Surface Area Population	44
Table 15: Blaine Surface calculated from the results from method in 2.6.1 and 2.6.2.....	45
Table 16: pH results	46
Table 17: Hydration results	46
Table 18: Comparison of liquids.....	46
Table 19: Design of Experiment	57

List of Formulas

Stokes' law equation for spherical particles (i).....	7
Beer – Lambert – Bouguer law (ii)	8
Maximum Diameter (iii)	11
Reynolds number (iv)	11
General Surface Area (v)	13
Specific Surface Area (vi)	13
Surface Area Population (vii)	14

Abbreviations

PSD	Particle Size Distribution
SSA	Specific Surface Area
E.S.D.	Equivalent Spherical Diameter
FA	Fly Ash
R&D	Research and Development
ASTM	American Society for Testing Materials
ISO	the International Organization for Standardization

List of Symbols

D	Diameter of a sphere particle [μm] or d
ρ	Sample density [g/cm^3]
ρ_0	Liquid density [g/cm^3]
η	Liquid viscosity [mPas] = [$\text{cP} = 10^{-2} \text{g}/\text{cms}$]
g	Acceleration due to gravity = $9.82 \text{ [m}/\text{s}^2]$
v	Terminal velocity of a particle,
K	Stokes' constant = 18
M_t	Measurement zone
T_t	X-ray transmission at time t
T_i	X-ray transmission at any time
T	Transmittance
N	Number of particles per gram [$1/\text{g}$]
r	Radius of a spherical particle
C	calculated coefficient = 0.9440609

CHAPTER 1

Introduction

1.1 Background

This thesis is written as a continuation of the specialization project written by the undersigned, during the autumn of 2016. The interest of using crushed sand in concrete production is increasing due to the diminishing of sources of natural sand. Crushed sand properties differ from those of natural sand. In addition, crushed sand also contains a huge amount of fine with particle size $\leq 125 \mu\text{m}$ compared to natural sand. Accumulating further knowledge on how to utilize this 'waste' sand from coarse aggregate production would benefit not only the concrete industry, but also the environment.

In previous study [1], the Micromeritics SediGraph III Plus (5125) was used to obtain the particle size distribution (PSD) of Fine filler from Velde AS. A small amount of filler with particles $\leq 63 \mu\text{m}$ was splitted with a riffle box to obtain a representative sub sample for the SediGraph analysis. Three dispersing liquids (0.2% Sodium Hexametaphosphate, Isopropanol, and SediSpurse A-11) were investigated with respect to the influence on the PSD of crushed fines with particle size $1 - 63 \mu\text{m}$. During the specialization project, a method was developed, making it possible to reproduce the SediGraph measurements for repeatability analysis. The rinsing procedure of the SediGraph plays an important role in acquiring the most correct particle size distribution. By rinsing the SediGraph with the same liquid as the analysis liquid, chemical reactions are avoided during analysis.

The particle size distribution of fines is one of the properties that influences the fresh concrete rheological properties. Through concrete micro-proportioning, the effects on the rheology can be controlled by adjusting the grading of the fines for optimized performance [2]. However, the specific surface area is a better parameter in describing the fineness of the filler considering that most of the specific surface area comes from the smallest particles. It is also a more applicable parameter in modelling the paste in micro-proportioning. Therefore, the SSA of the filler, cement and fly ash will be calculated in this study by utilizing the PSD obtained from the SediGraph analysis. The specific surface area calculated from the particle size distribution mainly rely on the precision of the SediGraph analysis of the smallest particles, primarily particles below 5 μm [5]. Further studies in finding the most suitable dispersing liquid will have a large impact on attaining the utmost true particle size distribution, and consequently the specific surface area.

1.2 Scope

This study is to give a brief overview of measurements of particle size distribution (PSD) on crushed fines for concrete, as well as cement and fly ash (FA), using XR SediGraph. In the previous study [1], three different dispersing liquids (0.2% Sodium Hexametaphosphate, Isopropanol and SediSperser A-11) were used to produce the PSD of fine filler from Velde AS with particle diameter range of 1 – 63 μm .

Applying the Particle-Matrix model developed by Ernst Mørtzell, the matrix phase consists of all materials with particle size $\leq 125 \mu\text{m}$ [4]. Crushed sand from coarse aggregate production contains large amount of fines, particles $\leq 125 \mu\text{m}$. The dispersing liquid must therefore have the ability to produce particle size distribution with a particle size range of 1 – 125 μm . Hence, there will be further studies of suitable dispersing liquids that may be used for attaining PSD measurements of filler, cement and fly ash.

The main objective is to produce PSD with good precision and further develop the SediGraph procedure through the process. The specific surface area (SSA) will be calculated from the PSD according to Post Doc Cepuritis method [5], and automatically by the SediGraph.

1.3 Limitations

In this study, the PSD analysis is limited to a particle range of 1 – 125 μm . This is due to lack of time to perform the analysis with a particle size $< 1 \mu\text{m}$, and the uncertainties in the analysis of particles below this size. Particles smaller than 1 μm are governed by the Brownian motion, the random movement of particles suspended in a fluid as a result of their collision, that drives the X-ray sedimentation analysis to overestimate the amount of particles below this size [2].

In the Particle-Matrix model, the matrix phase is defined to consist of free water, additives, and all solid materials with a particle size less than 125 μm [4]. For practical concrete mix design purposes, it is common that all material less than 125 μm is defined as aggregate fines or filler [2]. For these reasons, the maximum diameter for this study is set to 125 μm .

Due to the lack of time, one dispersing liquid that is suitable for all materials (filler, cement and fly ash) is used for the SediGraph analysis. Therefore, this liquid may or may not be the best suitable liquid for one or more of the given materials.

CHAPTER 2

Theoretical Background

2.1 Review of Previous Research

During the specialization project of autumn 2016 [1], three dispersing liquids (0.2% Sodium Hexametaphosphate, Isopropanol and SediSperser A-11) were used as analysis liquids to produce PSD curves of Fine filler from Velde AS with particle diameter range of 1 – 63 μm . Three parallel analysis were performed for each of the dispersing liquids.

Using the same dispersing liquid, the PSD curves relatively lie on the same curve, which shows good repeatability of the analysis. However, this is only true when using the same dispersing liquid for the analysis. The analysis liquids 0.2% Sodium Hexametaphosphate and SediSperser A-11 generated roughly similar PSD curves, while the Isopropanol generated coarser curves.

Frequency curves for 0.2% Sodium Hexametaphosphate, SediSperser A-11, and Isopropanol have a peak at 21 μm , 23 μm , and 24 μm with a mass frequency of 3.4%, 3.5%, and 4.7%, respectively. In addition, the frequency curves for Isopropanol had a more defined peak.

For the specialization project, both 0.2% Sodium Hexametaphosphate and SediSperser A-11 appeared to be the best suitable analysis liquids for PSD measurements of Fine filler from Velde with particle diameter range of 1 – 63 μm .

This thesis includes further studies of suitable dispersing liquids that are suitable for attaining PSD measurements of filler, as well as cement and fly ash. The dispersing liquid must fulfill three fundamental requirements. First of all, it has to be suitable for all three materials (filler, cement, fly ash). It must also produce PSD curves with particle size range of 1 – 125 μm . Lastly, the analysis time required should be not more than one hour. The most suitable dispersing liquid determined in this thesis will be used in the SediGraph analysis to obtain the particle size distribution of the sample materials. The PSD measurements will be further used to calculate the specific surface area (SSA).

2.2 SediGraph

The Micromeritics SediGraph III Plus (5125) is an analytical instrument used for particle size analysis. It employs the X-ray sedimentation technique which is based on two physical principles, the sedimentation theory and the X-ray absorption. The SediGraph applies the sedimentation theory to determine the particle size and directly measures the particle mass through X-ray absorption [1].

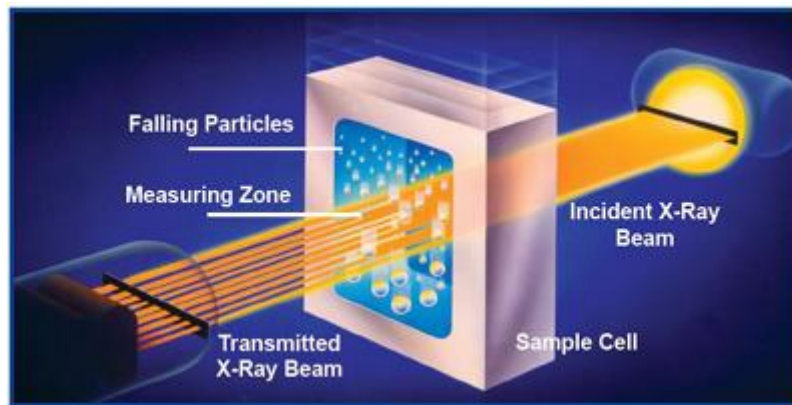

Figure 1: X-ray sedimentation [8]

Stokes' law determines the particle size by measuring the velocities of spherical particles of various diameters settling under gravity through a dispersing liquid with known properties.

Stokes' law equation for spherical particles is expressed by

$$D = \left[\frac{18\eta}{(\rho - \rho_0)g} \right]^{\frac{1}{2}} v^{\frac{1}{2}} \quad (i)$$

where D is the diameter of a sphere particle, η is the fluid viscosity, ρ is the particle density, ρ_0 is the liquid density, g is the gravitational force and v is the terminal velocity of a particle. The SediGraph can predict when all particles below any particular size falls below any given level. More information about Stokes' law for spherical particles is in [1].

Beer – Lambert – Bouguer law determines the relative mass concentration for each size class by measuring the X-ray absorption through a sample fraction suspended in the dispersing liquid. The mass fraction in the measurement zone at any time can be calculated from the X-ray transmission at that time.

$$M_t = \frac{\ln T_t}{\ln T_i} \quad (ii)$$

where M_t is the Measurement zone, T_t is the X-ray transmission at time t and T_i is the X-ray transmission at any time i , where $i > t$. Transmittance, T , has a range of values from 0 to 1, zero meaning total absorbance and 1 indicating no absorbance [8].

2.3 Particle Size Distribution

The particle size distribution or particle grading analysis is determined by the mass % passing or mass % retained. PSDs of filler, cement and fly ash have been characterized by a Micromeritics SediGraph III Plus (5125), which uses X-ray gravity sedimentation technique. The SediGraph determines the particle size in terms of the E.S.D. (equivalent spherical diameter) or Stokes' spherical diameter by measurement of the terminal settling velocities of sample particles of various sizes. The relative mass concentration for each size class is measured by attenuation of an X-ray beam through the dispersed sample in suspension [6].

Results are plotted as cumulative mass percent versus Stokes' spherical diameter on an exponential logarithmic scale. In the case of a plot, the diameters will be placed on the abscissa (horizontal X – axis) with the smallest particle size in the origin, and the cumulative mass on the ordinate (vertical Y – axis). Figure 2 shows that the PSD have a typically S-shaped curve.

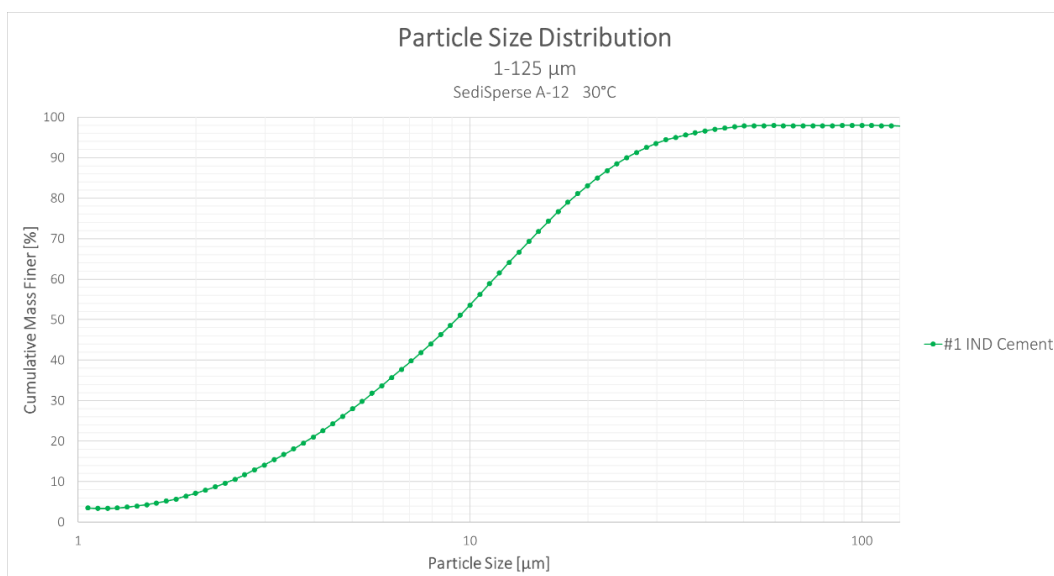

Figure 2: Particle Size Distribution of Industrisement (IND Cement) with a particle size range 1 – 125 μm. SediSpere A-12 is used as the dispersing liquid. The Set temperature for the analysis is 30 °C.

The particle size distribution plays an important role in fresh concrete rheology. The specific surface area can be calculated from the PSD produced by the SediGraph, by dividing the size distribution into a finite amount of bins and assuming equivalent spherical diameters of particles that correspond to the mean size of each bin [5].

2.4 Frequency curves

A Frequency curve shows the relative amount at each size class. The mass frequency of a particle size interval is the difference between the cumulative mass percent interpolated at the end points of the interval [1]. The Frequency curve is the particle size distribution expressed in differential form. It is obtained by differentiating the cumulative curve. The advantage of the Frequency is that it directly shows the modal (most frequently occurring) particle size.

The skewness represents the asymmetry of a distribution in comparison to a normal distribution, which means there are more particles on one of the sides of the mode. Figure 3 shows a positively skewed Frequency curve; the curve is skewed to the right and the tail is longer in the positive direction. This denotes a mass distribution that is concentrated on the left side of the figure.

Results are plotted as mass finer percent versus Stokes' spherical diameter on an exponential logarithmic scale. The diameters will be placed on the abscissa with the smallest particle size in the origin, and the mass frequency on the ordinate.

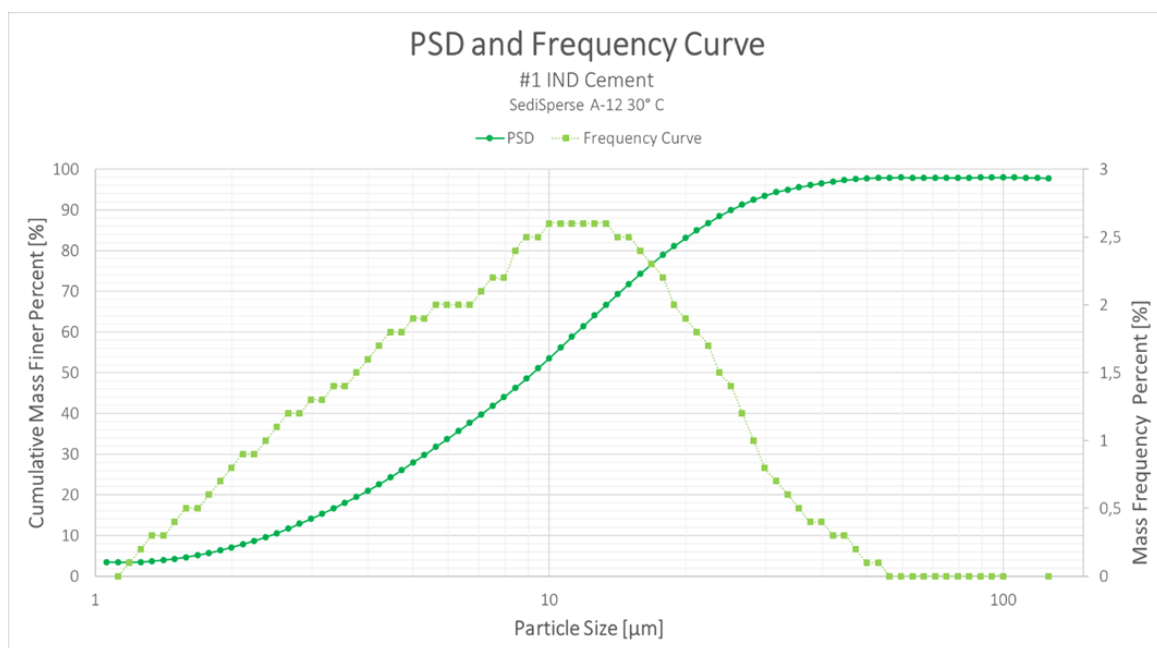

Figure 3: The Frequency curve is plotted against the Particle Size Distribution of Industrisement (IND Cement) with particle size range 1 – 125 μm. SediSpere A-12 is used as the dispersing liquid. The Set temperature for the analysis is 30 °C.

2.5 Reynolds number

A maximum Reynolds number of 0.30 is used to calculate the maximum diameter of a particle with a given density and known liquid density and viscosity at a given temperature [6]

$$\text{Maximum diameter } [\mu\text{m}] = \sqrt[3]{\frac{0.30 \cdot K \cdot \eta^2}{\rho_0(\rho - \rho_0)g}} \cdot 10^{-2} \quad (\text{iii})$$

For the particle range of 1 – 125 μm , the starting diameter D in the SediGraph analysis is equal to 125 μm . The Reynolds number should be ≤ 0.30 for the given sample density and liquid properties to be able to have a maximum diameter (D_{max}) larger than the starting diameter.

Only when $D_{max} \geq D$ or in other words the Reynolds number ≤ 0.30 , the SediGraph can detect particles with a particle diameter equal to the starting diameter.

$$\text{Reynolds number} = D^3 \cdot \frac{\rho_0(\rho - \rho_0)g}{K \cdot \eta^2} \cdot 10^{-6} \quad (\text{iv})$$

where D is the diameter of a sphere particle [μm]

ρ is the sample density [g/cm^3]

ρ_0 is the liquid density [g/cm^3]

η is the liquid viscosity [mPas] = [$\text{cP} = 10^{-2} \text{g}/\text{cms}$]

g is the acceleration due to gravity = 9.82 [m/s^2]

K is the Stokes' constant = 18

2.6 Specific Surface Area

It was estimated in [5] that for crushed aggregate fines below a particle size of 125 μm , 90 % of the specific surface area is concentrated in the particle size range with equivalent spherical diameters below 20 μm and more than 50 % is concentrated below 5 μm . This is due to the fact that the ratio of surface area to volume increases exponentially with decreasing particle size.

The specific surface area (SSA) can be calculated from the PSD obtained from the SediGraph, by dividing the size distribution into a finite amount of bins and assuming equivalent spherical diameters of particles that correspond to the mean size of each bin [5]. Considering most of the SSA comes from the small particles with spherical diameter below 5 μm , the calculation of the SSA from the PSD is mainly dependent on the precision of the SediGraph analysis below 5 μm . However, by assuming spherical particles an underestimation error of SSA by 20 – 30 % is introduced [5].

The paste rheology is governed mainly by the specific surface of the fines as calculated from the SediGraph measurements [2]. Rheological properties of the paste are proportional to the surface of the fines. Therefore, SSA is used in modelling the performance of crushed fines in concrete. By adjusting the grading of the fines through Micro-proportioning and varying the volume fraction of the fines in the paste, the rheological properties of the paste can be influenced. For instance, Fine filler will have higher specific surface than coarser filler and this contributes to reduced flow properties of the matrix paste due to the excessive water demand of Fine filler.

2.6.1 Specific Surface Area Calculation

The calculation of the specific surface area is performed according to the method of Post Doc Cepuritis [5,3]. A printout of the Excel sheet for the SSA calculation is in Appendix J.

By assuming spherical particles, the general surface area is calculated using the average particle diameter for each size class determined through the SediGraph analysis of the particle size distribution.

$$\text{General surface area} = \frac{\text{area}}{\text{volume}} = \frac{4\pi r^2}{\frac{4}{3}\pi r^3} = \frac{3}{d/2} \quad (v)$$

where r and d is the radius and the diameter of a spherical particle, respectively.

The specific surface area is a summation of the general surface area multiplied by the differentiated bin volume passing percent.

$$SSA \left[\frac{1}{mm} \right] = \sum_{d=1.0\mu m}^{d=125.0\mu m} \frac{3}{\frac{d/2}{1000}} \cdot (\text{Diff. Bin Volume Passing } \%) \quad (vi)$$

2.6.2 Surface Area Population

The manual of the SediGraph does not contain information about how the SediGraph calculates the SSA. By doing back-calculation, it seems that the SediGraph uses a coefficient of 0.9440609 to calculate the surface area population.

$$\textit{Surface Area Population} \left[\frac{m^2}{g} \right] = N \cdot 4\pi \left(\frac{D}{2} \cdot 10^{-6} \right)^2 \cdot C \quad (vii)$$

where N is the number of particles per gram [1/g]

D is the particle diameter [μm]

C is the calculated coefficient = 0.9440609

The surface area population calculated by the SediGraph is further used to calculate the Blaine surface [m^2/kg]. This is then compared to the Blaine surface calculated from the SSA calculation in 2.6.1.

CHAPTER 3

Experiments

3.1 Materials

3.1.1 Filler

Origin

The filler used for this project is the Fine filler fraction produced by Velde AS in Sandnes [3]. Velde produces Fine filler by crushing the aggregates and runs the particles through vertical shaft impactor(VSI) and wind sieve. By using the VSI and wind sieve, Velde can produce fillers with a more spherical shape. Spherical particles have less specific surface area than particles with angular shape. The amount of cement can therefore be reduced by using filler with spherical particle shape, and therefore reduce the CO₂ – emissions related to the cement and concrete production.

Composition

Fine filler (0/0.063 mm) is the finest filler fraction accumulated from the wind sieving process in the crushed aggregate production [13]. This filler fraction is usually used for asphalt production, and partly for concrete production.

The Velde Fine filler is from crushed rock of homogeneous granite with a filler density of 2.640 g/cm³ [1,3]. To confirm that the density provided by Velde AS is valid, a density measurement of Velde Fine filler using Micromeritics AccuPyc II 1340 (helium pycnometer) was performed in July 2016 by Evgeny Ramenskiy [1]. From the density measurement, the Velde Fine filler has a density of 2.6456 g/cm³. This is relatively close to the filler density (2.640 g/cm³) provided by Velde AS. More details about the helium pycnometer and density measurements can be found in [1]. The procedure for the density measurement using AccuPyc II 1340 is in Appendix H.

For this thesis, the density provided by Velde AS is used considering that only one density measurement was performed.

Table 1: Crushing process at Velde AS according to Kjos-Hanssen's Master Thesis [3]

#	Crushing stages	Type of Crushing machine	Function	Output sizes[mm]
K1	Coarse	C160 STD Nordberg Jaw Crusher	- Crushes the first input of masses	0/300
K2	Extra Coarse	GP500S Metso Cone Crusher	- Crushes the surplus sizes from K1 - Sieves into fractions - Recruses the surplus sizes	20/80 - 0/18 - 0/22 - 0/4 - 4/16
K3	Coarse	GP300 Metso Cone Crusher	- Crushes 20/80 from K2 - Sieves into fractions - Recruses the surplus sizes	Railway gravel(22/63) - 0/5 - 0/30 - 0/4 - 4/8 - 8/11 - 11/16 - 16/22
K4	Fine	HP3 Nordberg Cone Crusher	- Crushes the undefined fractions from K3 - Sieves into Fractions	0/4 - 4/8 - 8/11 - 11/16 - 16/22
VSI	Fine	Barmac B9100SE DTR rotor	- Runs particles from K3 and K4 - Sieves into Fractions	0/2 - 2/5 - 5/8 - 8/11 - 11/16 - 16/22
Wind sieving	Super Fine	AC30 GI Wind sieve	- Runs particles from the VSI - Sieves into Fractions	0/0.063 - 0.063/0.5 - 0.25/2

Sieving

No sieving was done for this project. The filler used was from the large-scale sieving performed during the summer of 2016.

The procedure for the large-scale sieving is as follows:

1. The filler was dried at a drying oven at 105 °C overnight before sieving.
2. After drying the filler, the filler was mechanically sieved.

Sieving about 5 kg of dried filler at a time, for 15 minutes.

The large-scale sieving includes a set of sieves; 0.500 mm, 0.250 mm and 0.125 mm.

Table 2: Set of sieves for large sieving

Large-scale sieves [μm]
500
250
125



Figure 4: Large-scale sieving machine with a lid, 3 sieves, and a bottom tray

3. Since we are studying particles $\leq 125 \mu\text{m}$, the particles in the bottom tray is kept while discarding the rest. The particles with particle size $\leq 125 \mu\text{m}$ were stored in a container with a lid.

A more detailed sieving procedure can be found in the specialization project [1].

3.1.2 Cement

The *Industrisement* CEM I 42.5RR from Norcem is used in this study. The new term for this cement is *Industrisement* CEM I 42.5R. This is a Portland cement with rapid heat and strength development. It is suitable for use in the production of pre-cast concrete elements and concrete products. This type of cement is specially adapted for Norwegian climate which makes it suitable for casting during winter.

From NORCEM Report on Quality Test (Prøvningsrapport) in Appendix C, the *Industrisement* has a Blaine surface of 545 m²/kg. This contributes to the short setting time. According to the particle size distribution stated in the report, the cement contains no particles larger than 90 µm. The *Industrisement* has a density of 3.13 g/cm³ as reported in the presentation of Norcem R&D head Dr. Kjellsen. The presentation is in Appendix B.

3.1.3 Fly Ash

Fly ash (FA) is a bi-product generated from the production of electricity in coal-fired power plants and combined heat and power (CHP) plants [4]. FA is siliceous and is a pozzolanic material used as cement replacement to improve the workability of concrete. Reducing the demand for cement has both economical and environmental advantages. It contributes to high strength and/or to the reduction of the amount of mixing water, and thereby reducing the risk of cracks in structures. The use of supplementary cementitious materials is strongly encouraged by governments to reduce large amounts of CO₂ – emissions associated with Portland cement production.

The fly ash from Norcem AS Brevik is used in this study. From the NORCEM Report on Quality Test (Prøvningsrapport) in Appendix E, the fly ash has a Blaine surface of 355 m²/kg and density of 2,38 g/cm³. According to the particle size distribution stated in the report, 3.7% of the fly ash are particles with particle size larger than 90 µm. For normal concrete structures the fraction for fly ash is between 20 – 35 % of the total binder content.

3.1.4 Dispersing Liquid

From the list of analysis liquids, with liquid properties stored in the SediGraph, a selection of liquids can be used to determine particles $\leq 125 \mu\text{m}$. The lists of dispersing liquids is in Appendix L. Out of this selection, liquids that have an analysis time of more than an hour are eliminated. Another requirement for the analysis liquid is that it must be able to be used in the SediGraph analysis for all materials (Velde Fine filler, *Industrisement* and Fly ash). With this requirement, only 5 analysis liquids are left in the selection. The five analysis liquids are 40% Glycerin, 50% Glycerin, A-12 Lot 102 SediSpere, P-12 Lot 101 SediSpere and W-12 Lot 198 SediSpere. Two out of five liquids are glycerin diluted in water. Hence, these may not be suitable for the analysis of *Industrisement*, due to hydration of cement in contact with water.

The remaining three analysis liquids left in the selection are SediSpere liquids. There are three types of SediSpere liquids, A-, P- and W-series. The A-series SediSpere liquids have the greatest application and will disperse most powders, including metals, oxides, silicates, pigments, Portland cements, and propellants. The materials that are not dispersing well in the A-series liquids may usually be dispersed in the P-series SediSpere liquids. These are special formulations, slightly cationic, developed to disperse difficult metal and pigmented resin powders. The W-series SediSpere liquids should be used to disperse those materials which are soluble in the organic SediSpere liquids [6].

After some evaluation, the SediSpere A-12 is selected to be used in this study. It is a A-series SediSpere liquid, the same type of SediSpere liquid used in the previous study [1], where the SediSpere A-11 is one of the analysis liquids.

Table 3: Liquid Properties of the dispersing liquids used in the specialization project and in this thesis

Study		Specialization Project			Master Thesis
Particle size range [μm]		1 – 63			1 – 125
Dispersing Liquid		0.2% Sodium Hexametaphosphate	Isopropanol	SediSpers A-11	SediSpers A-12
Set Temperature: 26.5 °C	Density [g/cm^3]	0.9967	0.7797	0.7522	0.8112
	Viscosity [$\text{mPa}\cdot\text{s}$]	0.8643	2.0370	1.3192	4.3046
X-ray Intensity		Normal	Low	Low	Low

The density and viscosity of the liquid at different temperatures is written on the label of the SediSpers bottle. Three temperatures were selected for the SediGraph to be able to interpolate the density and viscosity of the liquid during the analysis.

Table 4: Densities and Viscosities at given temperatures for dispersing liquid SediSpers A-12

Temperature [$^{\circ}\text{C}$]	Density [g/cm^3]	Viscosity [$\text{mPa}\cdot\text{s}$]
24.0	0.8130	4.6000
34.0	0.8060	3.5400
45.0	0.7990	2.6900

*For the SediGraph analysis a temperature of 30 °C is selected.

3.2 Sampling

Sampling is an important preparation needed to obtain a representative sub sample of a larger sample for material testing. There are three main alternative methods for sample reduction: quartering, riffling, and fractional shoveling [10]. A combination of these methods may be used.

In this thesis, the splitting method using the riffle box is carried out to reduce the size of the sample. The riffle box must have an even number of equal width slots, at least 12 slots for fine aggregate with a width of at least twice the upper grain size of the fraction to be splitted [10]. The riffle box used in this study has 20 slots with a width of 2 mm openings, which is way larger than twice the largest particles (125 μm) in the sample to be splitted.



Figure 5: Splitting with Riffle box

The riffle box divides the sample into two equal parts. The sample is divided until the necessary laboratory sample is obtained. This method is done to acquire the sample needed for the SediGraph analysis. For the SediGraph, particles with a size $\leq 125 \mu\text{m}$ is used. A 30.0 g sample of filler is dried and splitted with the riffle box for the SediGraph analysis.

3.2.1 Preparation of the Velde filler for the SediGraph Analysis

During the summer of 2016 about 15 kg of filler with particle size $\leq 125 \mu\text{m}$ was sieved and stored in a container. The container of Fine filler with particle size $\leq 125 \mu\text{m}$ is rolled on the floor to homogenize the filler. To prevent the very light particles that remains aloft in the container to drift into the air after opening, the lid was not opened immediately.

Table 5: Amount of filler before and after drying

	Filler weight [g]
Before drying	30.0
*After drying for one hour at 105 °C	30.0

*30.0 g of filler with particle size $\leq 125 \mu\text{m}$ is dried at 105 °C for one hour.

Before the SediGraph analysis, the Velde Fine filler is splitted in a riffle box as shown in Figure 5. The necessary amount of filler is determined to be 2.0 g through the Test run analysis. The dried filler sample, having a weight of 30.0 g as presented in Table 5, is divided into two parts until the necessary laboratory sample is obtained. It is most unlikely to split the sample and obtain the exact amount of laboratory sample needed. Therefore, the sample of Velde Fine filler is splitted until the sample is less than twice the necessary sample amount, meaning that the splitted sample is $< 4 \text{ g}$ and $\geq 2 \text{ g}$. If the splitted sample is more than 2.0 g, a laboratory sample spoon is used in transferring 2.0 g of sample to a 100 mL beaker, which is used later on step 4 of the short procedure of the SediGraph analysis.

3.3 SediGraph



Figure 6: Micromeritics SediGraph III Plus (5125)

3.3.1 SediGraph Method of Analysis

The SediGraph scans the sedimentation cell from bottom to top to produce accurate results while minimizing the necessary amount of time to perform the analysis. This is achieved by moving the cell down during the analysis to speed up the sedimentation process. The computer calculates the particle falling rates according to the cell movement. It is also fully automatic, and thus reduce the possibilities of error associated to operator involvement. The SediGraph has a temperature controlled analysis, which ensures that the properties of the dispersing liquid remain constant throughout the analysis to produce accurate and reproducible results.

A pure dispersing liquid is used to establish the baseline value. The X-ray beam is projected through the liquid with 0% concentration, and the SediGraph registers the X-ray absorption of the liquid in X-ray kilo counts. A sample is dispersed in a dispersing liquid with known density and viscosity properties. Note that the density and viscosity of the dispersing liquid is temperature dependent. To get accurate results, the SediGraph interpolates the density and viscosity of the liquid at the time of analysis by using three given values of the density and viscosity at different temperatures [1].

The dispersed sample is poured into the mixing chamber, where it is continuously agitated with a magnetic stirrer to maintain homogeneous dispersion. The homogeneous sample mixture is pumped into the analysis cell. The X-ray intensity of the 100% sample concentration is registered and the full-scale value is calculated. After the full-scale value calculation, the agitation of the sample mixture is ceased and sedimentation of the particles is permitted.

The larger the particle, the higher the settling velocity. The particle falling rate is calculated by the Stokes' law and this determines the size of the particle that has fallen beyond a specific analysis point of the cell. Particle size is measured in equivalent spherical diameter, the diameter of a sphere of the same material with the same falling rate. The particle mass concentration is determined by applying Beer–Lambert–Bouguer law and measuring the relative amount of X-ray absorption of the particles dispersed in the liquid [1].

Beam – Split

The top of the analysis cell is used as the reference point for measuring the particle falling rates. In order for the SediGraph to calculate the correct particle falling rates, the exact cell position must be determined. The SediGraph determines the exact cell position by moving the cell until the beam splits. Beam – Split occurs when the top edge of the cell splits the X-ray beam in half. The SediGraph uses Beam – Split for establishing a reference cell position for the next analysis. Beam – Split is done automatically at the start of any scanning operation.

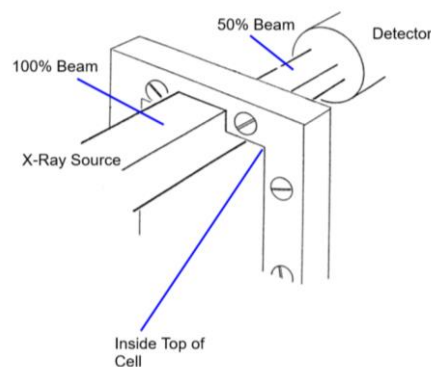

Figure 7: Beam – Split (Figure E-5 in [6])

Equipment needed for the SediGraph measurement

- Micromeritics SediGraph III Plus (5125)
- Ultra-sonic bath (METASON 50)
- Dispersing liquid: SediSperser A-12
- Materials: Velde Fine filler, *Industrisement*, Fly Ash
- Weighing scale with two decimals
- 2 100 mL Beaker
- Petri dish
- Laboratory sample spoon
- Air condition

3.3.2 Baseline Measurement

As mentioned earlier, X-ray absorption of a pure dispersing liquid is utilized to establish the baseline value. The baseline measurement (0% concentration or minimum absorption) is used as reference for the full-scale measurement, 100% concentration.

A baseline measurement is required for the collection of data and is recommended to be performed both before a SediGraph analysis and when changing dispersing liquid. It is not necessary to perform a baseline measurement for each analysis, as long as it is performed once at the beginning of every period working with the SediGraph.

There are two options for the X-ray intensity settings, normal intensity for high X-ray absorption liquids (such as water) and low intensity for low X-ray absorption liquids (such as hydrocarbons). If the X-ray absorption of the dispersing liquid is unknown, check the pre-determined intensity for the liquid in the liquid properties installed in the SediGraph.

Procedure for Baseline Measurement

1. Go to Unit1 and select Baseline
2. Select Leave liquid in mixing chamber for Test Run analysis or select Leave mixing chamber empty for SediGraph analysis
3. Select appropriate X-ray intensity for the liquid
For dispersing liquid SediSpere A-12, select low intensity.
4. Load 60 mL of the Baseline liquid in the mixing chamber
5. Note X-ray counts [kCnts]

3.3.3 Full – scale Measurement

A sample is dispersed with a dispersing liquid. The dispersed sample is poured into the mixing chamber, where it is continuously agitated with a magnetic stirrer to maintain homogeneous dispersion. The homogeneous sample mixture is pumped into the analysis cell [1].

The SediGraph determines the X-ray absorption of particles dispersed in liquid. The full-scale measurement is the maximum absorption value for 100% concentration, which represents the highest particle concentration for the given analysis. This measurement is performed by the SediGraph before each analysis. This is indicated by “Full scale scan in progress” and the full-scale is plotted against the baseline measurement. In this thesis, the full-scale measurement has a value of 30% reduction of X-ray counts. After the full-scale measurement, the analysis (sedimentation) starts indicated by “Analysis operation in progress”. See more details in the SediGraph procedure in Appendix G.

Since the minimum absorption (baseline measurement) and maximum absorption (full-scale measurement) values are known for each analysis point in the cell before the analysis, the absorption during the sedimentation is a percentage somewhere between the minimum and maximum absorption. The size of the particles that have fallen beyond each specific analysis point in the cell is determined by the particle falling rates. At each specific analysis point in the cell, the percentage of particles below a certain particle size is determined by the absorption percentage [6]. Thus, the particle size distribution can be determined.

3.3.4 Test Run Analysis

This analysis is run to determine the necessary amount of material needed for the SediGraph analysis. The Test Run analysis differs in a way from the real SediGraph analysis, this is due to lack of ultra-sonic dispersion and manual agitation that aids particle dispersion as the material is transferred directly into the mixing chamber.

Short Procedure for the Test Run Analysis

1. Create a sample file.
2. Weigh 3.0 g of sample material.
3. Load 60 mL of baseline liquid into the mixing chamber.
Select the intensity that is compatible with the liquid: Check the liquid properties
4. Move Cell Position to 2000 steps.
Note the X-ray counts and calculate the target X-ray counts, X-ray counts with 30% reduction.
5. Pour sample material into the mixing chamber little by little, while checking the X-ray counts. Stop when target X-ray counts is reached.
6. Start Sample Analysis.
Note X-ray Counts: (Example: 109 kCnts/s)
Note Baseline %: (Example: 31 % Good)
Good Baseline %: 30-70% reduction of kCnts/s
7. Note the weight of filler used to get target X-ray counts.
 - If the Baseline % is equal to 30% low, round up the weight of the material for the real SediGraph analysis.
 - If the Baseline % is less than 30%, repeat the Test Run analysis.

A more detailed procedure for SediGraph III Plus (5125) is in Appendix G.

3.3.5 SediGraph Analysis

This analysis is performed after the necessary amount of material needed for the analysis has been determined. Dispersing too little or too much of the material in the liquid, or how well the particles are dispersed will cause inaccuracy in the results. Agitation aids dispersion of particles. In this thesis, the Metason 50 ultrasonic bath and manual stirring of the mix were utilized to achieve the best dispersion.

Short procedure of the SediGraph Analysis

1. Sample Information: Create a file and enter the sample information and material properties.

Table 6: Values chosen and values calculated by the SediGraph for the Material Properties

MATERIAL PROPERTIES			
Sample Material	Velde Fine Filler	<i>Industrisement</i>	Fly Ash
Density [g/cm ³]	2.64	3.13	2.38
Analysis Liquid	SediSpere A-12		
X-ray Intensity	Low		
Analysis Type	High Resolution		
Starting diameter [μm]	125.0		
Ending diameter [μm]	1.0		
Analysis Unit	S/N 2162: 30.0 °C		
Reynolds number	0.10	0.13	0.09
Maximum diameter [μm]	178.93	165.49	188.32
Analysis time [min]	33	26	38

High resolution – provides high resolution at the smallest diameters, but takes a longer time

For the Analysis Option select the following:

- Wait for temperature stabilization
To have the temperature in the analysis compartment and mixing chamber stabilize before the analysis begins.
- Rinse after analysis: 2
- Pump speed: 3
The speed at which the cell pump should operate during the full-scale scan. Use a pump speed of 2 or 3 if analyzing fine samples since they pump through the tubing easily.
- Bubble detection: Coarse

For the Report Option select the reports to be generated.

2. Sample Analysis: Select the saved file

Table 7: Weight of materials determined through the SediGraph Test Run Analysis

Baseline liquid	SediSperser A-12		
	Velde Fine Filler	<i>Industrisement</i>	Fly Ash
Test Run Analysis (determined weight)	1.97 g	0.93 g	1.69 g
SediGraph Analysis (*rounded up weight)	2.00 g	1.00 g	1.80 g

*For both Velde Fine filler and *Industrisement* the weight is rounded up to the nearest hundredth for simplification. Considering the Baseline % was equal to 30% low for Fly Ash, more Fly Ash is added for compensation.

- Weigh amount of material needed
- Add 60mL of analysis liquid
- Stir the mix and place it in the ultra-sonic bath (METASON 50) for 15 seconds
- Stir it again and pour it into the mixing chamber
- Add 20mL of the analysis liquid in the mixing chamber
- Start the analysis

More detailed procedure for SediGraph III Plus (5125) is in Appendix G.

3.4 pH and hydration of cement

A simple experiment of mixing *Industrisement* with the dispersing liquids in the previous study [1] (0.2% Sodium Hexametaphosphate, Isopropanol and SediSperser A-11) is performed to check if SediSperser liquids permit hydration of cement.

In this experiment, 4 g of *Industrisement* is mixed with 20 g of dispersing liquid. Three 30 mL disposable plastic cups with lid are used as containers for this experiment. Each cup contains 4 g of *Industrisement*, which is then added with 20 g of the following dispersing liquids:

Dispersing liquids

1. 0.2% Sodium Hexametaphosphate

To make the dispersing liquid 0.2% Sodium Hexametaphosphate, 4 grams of Sodium Hexametaphosphate flakes are dissolved in 2 liters of de-ionized water overnight.

2. Isopropanol

It is assumed that Isopropanol is completely non-reactive with cement.

3. SediSperser A-11

The SediSperser A-12 is used as the dispersing liquid in the SediGraph analysis in this thesis. Both A-11 and A-12 are A-series SediSperser liquids, and therefore it is assumed that the liquids' reaction with cement will be similar. These tests are performed before the SediGraph analysis to find if the SediSperser A-12 liquid can be used as dispersing liquid for cement.

After adding the dispersing liquid to the cement, it was stirred well with a laboratory spatula. The lid was placed on and the mixture was let to stand.

The pH is measured with pH indicator strips and a needle is used for the penetration test of the mixture. These tests are performed after 1 minute, 10 minutes, 1 hour, 1 day and 1 week.



Figure 8: pH and Hydration test

The pH indicator strips used are Merck non-bleeding universal indicator with pH 0 – 14. Non-bleeding indicator strips contain special indicator dyes that are covalently bound to the reagent papers, which prevents the strips from bleeding during measurement and contaminating the sample [15].

The pH indicator strips are dipped into the liquid mixture until all four different reaction zones are submerged, and there is no further color change. The pH indicator strips are then reversed, so that the reaction zones are at the bottom of the strip and the white zone is where the pH value is stated, as seen on Figure 9. The pH value should be evaluated according to the color respective to the pH scale provided while the strip is still moist.



Figure 9: pH indicator strips

The results from the pH and penetration tests, as well as the differences observed are recorded for every period.

CHAPTER 4

Results

4.1 SediGraph

4.1.1 Baseline Measurement

The SediSperser A-12 is the baseline liquid selected and used in this study. The SediSperser A-12 is a low X-ray absorption liquid, therefore it is important to select low intensity in the settings to decrease the X-ray intensity during the measurement. 60 mL of SediSperser A-12 is run through for every baseline measurement. The results from the baseline measurements of the SediSperser A-12 as the dispersing liquid is given in Table 8.

Table 8: X-ray absorption of SediSperser A-12

Baseline Liquid	X-ray counts [kCnts/s]
SediSperser A-12	157-158

Figure 10 shows an example of a baseline measurement using SediSperser A-12 as dispersing liquid.

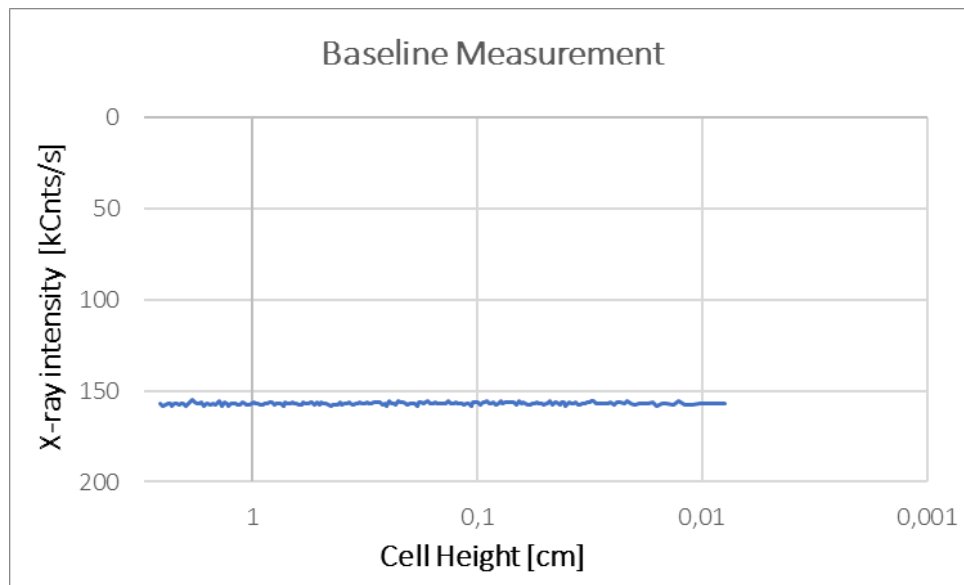

Figure 10: Baseline Measurement of SediSperser A-12

4.1.2 Full – Scale Measurement

A sample of 2.0 g of Velde Fine filler is dispersed in 60 mL of dispersing liquid SediSpere A-12 for the analysis. The results from the baseline measurements of pure SediSpere A-12 and full-scale measurement of Velde Fine filler dispersed in SediSpere A-12 are given in Table 9.

Table 9: X-ray absorption of pure SediSpere A-12 and dispersed sample of Velde Fine filler in SediSpere A-12

Measurement	X-ray counts [kCnts/s]
Baseline	157
Full-Scale	107

The full-scale measurement yields a 32% reduction of the baseline measurement.

Figure 11 shows an example of a baseline measurement using SediSpere A-12 as dispersing liquid and a full-scale measurement of Velde Fine filler dispersed in SediSpere A-12.

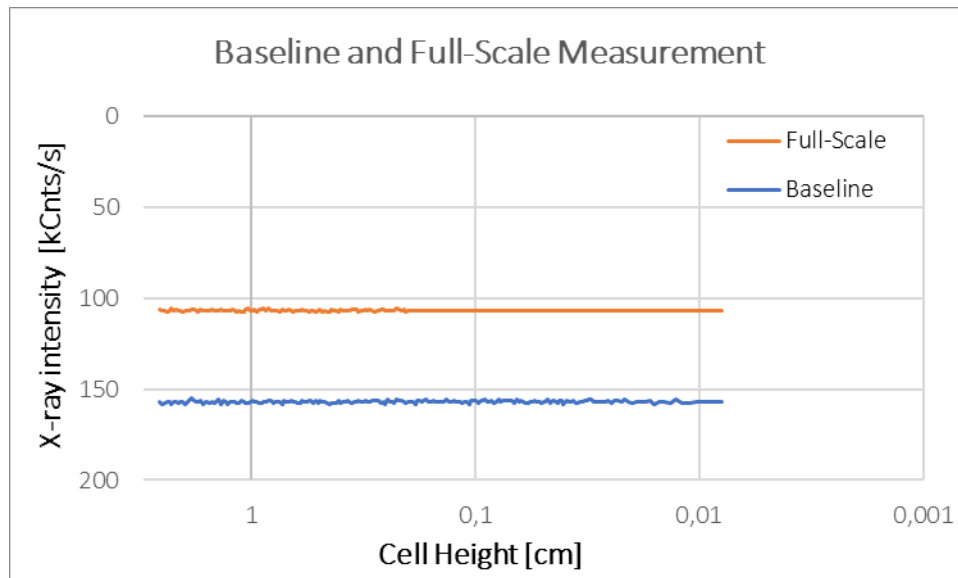

Figure 11: Baseline and Full-Scale Measurement

4.1.3 Test Run Analysis

The Fine filler from Velde AS is first dried, then splitted with a riffle box which is necessary to obtain a representative laboratory sample for the SediGraph analysis. Splitting of filler is time consuming, and is therefore only performed for the real SediGraph analysis and skipped for the test run analysis which is less important. The test run analysis is only needed to determine the minimum sample material needed for the SediGraph analysis. The minimum sample material is determined through the X-ray absorption (X-ray in kilo counts per second [kCnts]). A reduction between 30 – 70 % of the baseline X-ray counts, which is the amount of X-rays absorbed by the baseline liquid, indicates that the concentration level is appropriate for the SediGraph to conduct the particle size distribution analysis [6].

For this study, a 30% reduction in the baseline X-ray counts is selected to obtain the minimum amount of sample material needed for the SediGraph analysis. Using the SediSperser A-12 as the dispersing liquid, a 30% reduction in X-ray counts is equivalent to 109 – 110 kCnts. An amount of sample material is dispersed in the mixing chamber until the necessary reduction, 109 – 110 kCnts or less is obtained. The results from the test run analysis for the three materials, filler, cement and fly ash, are given in Table 10.

Table 10: Minimum amount of sample material needed for the SediGraph analysis [Table 7]

Baseline liquid	SediSperser A-12		
Material	Velde Fine Filler	<i>Industrisement</i>	Fly Ash
Test Run Analysis (determined weight)	1.97 g	0.93 g	1.69 g
SediGraph Analysis (*rounded up weight)	2.00 g	1.00 g	1.80 g

*For both Velde Fine filler and *Industrisement* the weight is rounded up to the nearest hundredth for simplification. Considering the Baseline % was equal to 30% low for Fly Ash, more Fly Ash is added for compensation.

4.1.4 Temperature

The liquid properties, density and viscosity of the liquid, is temperature dependent. Therefore, the SediGraph analysis depends on the ambient temperature and the set temperature for the analysis. It is recommended to have a set temperature, the target temperature, with a minimum of 10 °C higher than the ambient temperature for accurate control. A set temperature in the range between 25.0 °C and 50.0 °C is recommended [6].

In the previous study [1], a set temperature of 26.5 °C was selected for all analysis. This is the maximum temperature to obtain a Reynolds number of 0.30 for the dispersing liquid 0.2% Sodium Hexametaphosphate. A maximum Reynolds number equal to 0.30 is necessary to obtain the maximum diameter of a spherical diameter of 63.0 µm, which is the starting diameter for the SediGraph analysis.

In this study, a set temperature of 26.5 °C (the same temperature as used in the previous study) was used to begin with. However, it was found to be difficult to prevent the temperature from exceeding 26.5 °C in the mixing chamber even with air conditioning. The notification “Out of Band” in red script indicates that the temperature difference between the mixing chamber temperature and cell temperature is ≥ 0.2 °C. When the temperature difference exceeds 0.2 °C, or in other words the temperature in the mixing chamber is higher than the set temperature, it becomes problematic to decrease the mixing chamber temperature. This further leads to an uncertainty in the accuracy of the analysis. The precision of the SediGraph analysis is extremely important in determining the particle size distribution, and hence the specific surface area of the material. Due to this difficulty, it is decided to increase the set temperature to 30.0 °C and 35 °C.

Table 11: Material Properties

Sample Material	Velde Fine Filler				
Baseline Liquid	SediSperse A-12				
Temperature [°C]	Liquid Density [g/cm ³]	Liquid Viscosity [mPa·s]	Maximum Diameter [µm]	Reynolds number	Analysis Time [min]
26.5	0.8112	4.3046	190.21	0.09	36
30.0	0.8087	3.9268	178.82	0.10	33
35.0	0.8054	3.4548	164.37	0.13	29

First, the air conditioning is set to 20 °C and a set temperature of 35.0 °C is selected. However, this temperature combination just led to variations in the mixing chamber temperature and even larger temperature difference.

Second, the set temperature is decreased to 30.0 °C while the air conditioning is still set to 20 °C. The variations in the temperature difference is no higher than 0.2 °C, and the “Out of Band” notification is absent.

After this temperature experiment it was decided to use 30.0 °C as set temperature and 20.0 °C as the ambient temperature. This seems to be the best temperature combination to have an accurate control. Note that the air conditioning could have been increased to 25 °C, to keep a 10 °C lower temperature than set temperature of 35.0 °C. However, this temperature combination was not performed. Moreover, the time needed for the SediGraph to heat up to the set temperature, right after the SediGraph is switched on, is increasing with an increasing set temperature.

A Test Run analysis of Velde Fine filler with SediSperse A-12 as dispersing liquid is performed for each of the set temperatures, 26.5 °C, 30.0 and 35.0 °C.

Table 12: Particle Size Distribution for Velde Fine Filler with SediSperse A-12 at different Set Temperatures

Sample Material	Velde Fine Filler		
Baseline Liquid	SediSperse A-12		
Temperature [°C]	26.5	30.0	35.0
Particle Size [µm]	Cumulative Mass Finer Percent [%]		
125.90	100.2	96.0	96.3
63.10	94.1	93.7	95.1
19.95	49.4	50.2	49.6
10.00	22.0	22.5	21.4
5.012	8.0	7.8	7.5
1.995	1.2	2.1	1
1.059	0.3	0	-2.1

Figure 12 presents PSD curves with a particle size range of 1 – 125 µm. The SediSperse A-12 is used as dispersing liquid for all three test run analysis of Velde Fine filler. The set temperature for the analysis is varied from 26.5 °C, 30 °C and 35 °C. The PSD results from the SediGraph analysis shows a S-shaped curves, which is typical. The PSD curves are quite similar within the range 2 – 80 µm. The differences are found below 2 µm and above 80 µm.

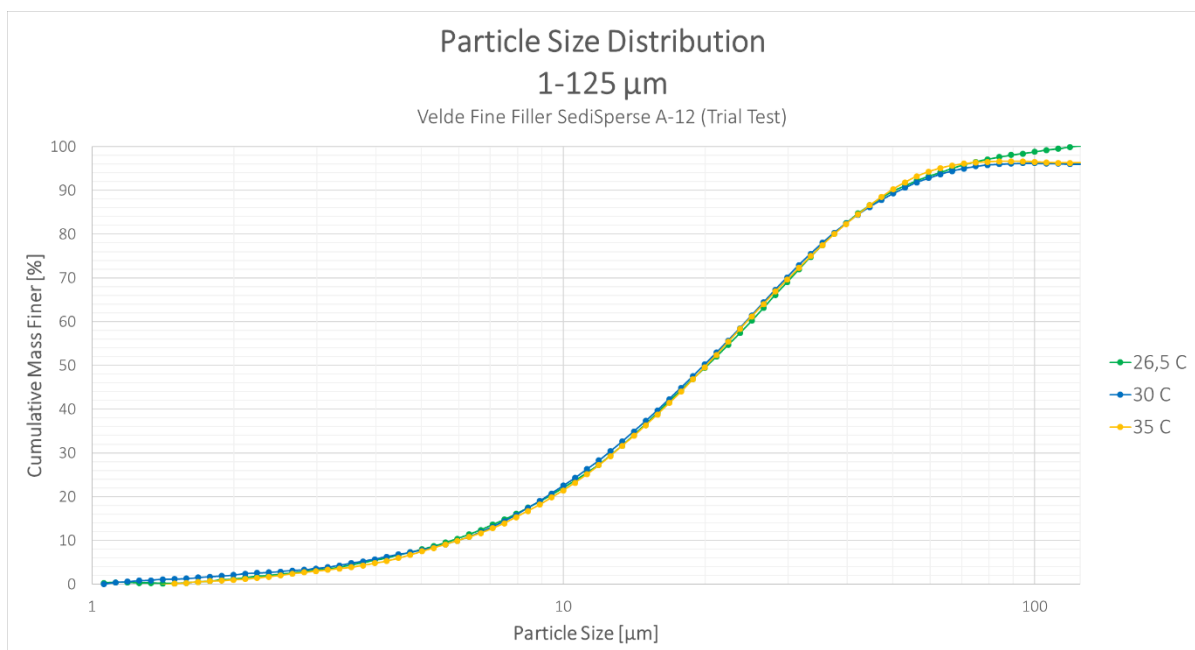

Figure 12: PSD curves of Velde Fine filler from 1 – 125 µm with SediSperse A-12 at different Set Temperatures

4.2 Particle Size Distribution

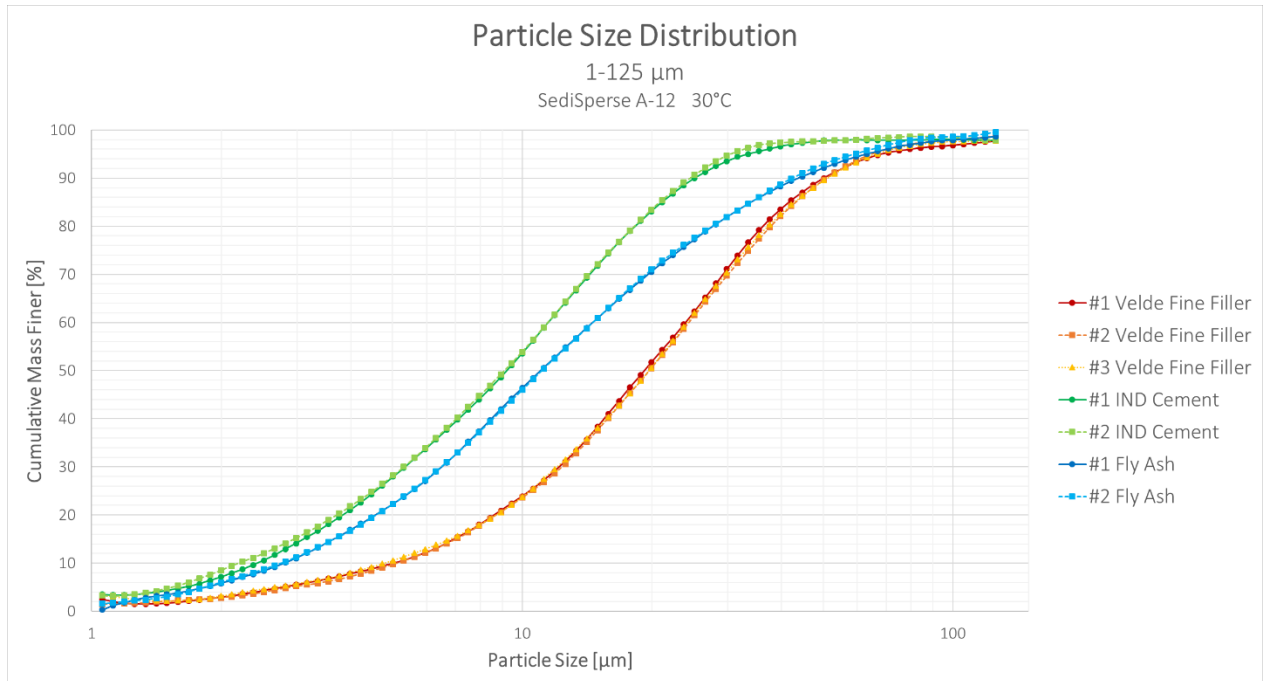

Figure 13: PSD curves of Velde Fine filler, Industrisement and Fly Ash from 1 – 125 µm with SediSpere A-12 at 30 °C

Figure 13 presents PSD curves with a particle size range of 1 – 125 µm. The SediSpere A-12 is used as dispersing liquid for the three materials, filler, cement and fly ash. The set temperature for all analysis is set to 30.0 °C and an ambient temperature of 10 °C lower than the set temperature, 20 °C, is selected for accurate control. Three identical analysis was performed for Velde Fine filler, and two identical analysis for cement and fly ash. The PSD results from the SediGraph analysis shows S-shaped curves, which again is typical. The PSD curves of the same material shows good repeatability of the analysis. As presumed, the *Industrisement* contains most fine particles and Velde Fine filler contains least fine particles.

The PSD curves are steepest around 22 – 28 µm for Velde Fine filler. For *Industrisement*, the PSD curves are steepest around 12 µm. For fly ash, the PSD curves are steepest around 8 µm. The amount of fines is highest at the steepest part of the curve.

Additional PSD curves for each sample material are in Appendix I. The PSD and Frequency curves plotted in the same graph for each SediGraph analysis are also found in Appendix I.

4.3 Frequency curve

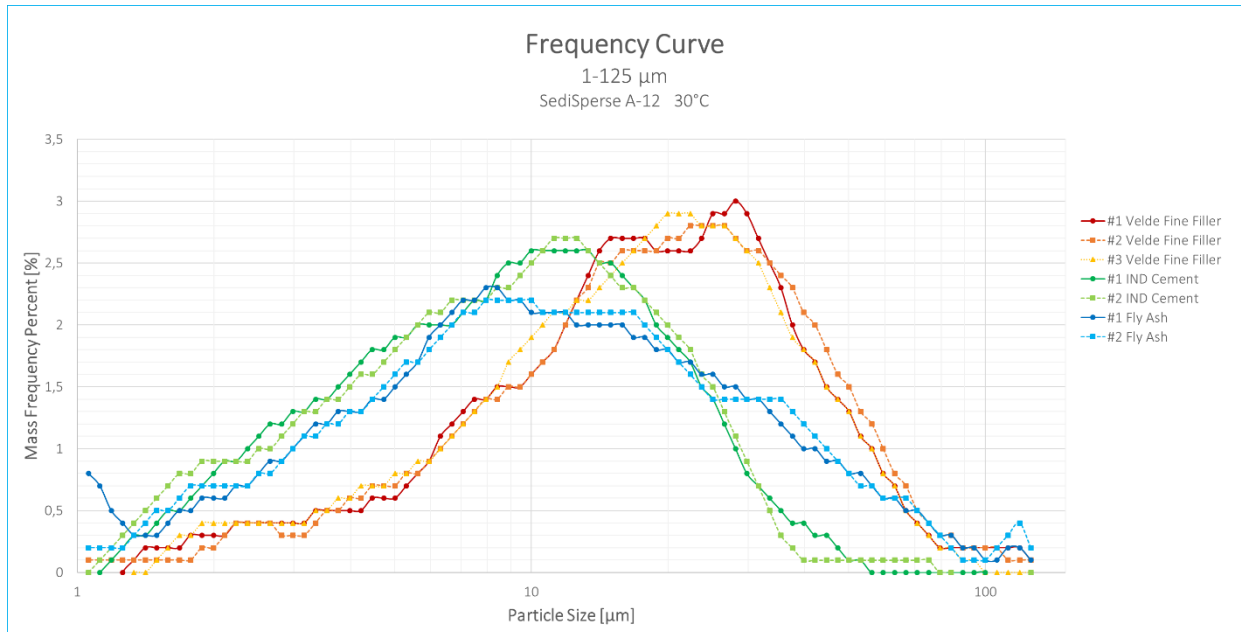

Figure 14: Frequency curves of Velde Fine filler, Industrisement and Fly Ash from 1 – 125 µm with SediSpere A-12 at 30 °C

Figure 14 presents Frequency curves with a particle size range of 1 – 125 µm for the three sample materials, filler, cement and fly ash, with SediSpere A-12 as dispersing liquid. A set temperature of 30.0 °C and an ambient temperature of 20 °C are selected for all analysis.

Frequency curves for Velde Fine filler have a peak around 25 µm with a mass frequency of 2.9 %. Frequency curves for *Industrisement* have a peak at 12 µm with a mass frequency of 2.65 %. Frequency curves for Fly Ash have a peak at 8 µm with a mass frequency of 2.25 %.

Additional frequency curves for each sample material are in Appendix I. The PSD and Frequency curves plotted in the same graph for each SediGraph analysis are also found in Appendix I.

4.4 Specific Surface Area

The specific surface area (SSA) is calculated from the particle size distribution determined through the SediGraph analysis. The calculation of SSA is explained in section 2.6.1.

Table 13: Average Specific Surface Area calculated from the SediGraph analysis

Sample Material	Velde Fine Filler	<i>Industrisement</i>	Fly Ash
Minimum size [μm]	Average Specific Surface Area [mm^{-1}]		
20.0	87	34	51
10.0	201	163	158
5.0	313	381	359
2.0	445	755	659
1.0	456	917	862
Total	728	1302	970

Having the highest SSA, indicates a higher content of fine particles. As expected, the smallest particles have the largest specific surface area.

The Specific Surface Area Population is calculated by the SediGraph. The calculation is explained in section 2.6.2.

Table 14: Specific Surface Area Population

Sample Material	Velde Fine Filler	<i>Industrisement</i>	Fly Ash
Minimum size [μm]	Specific Surface Area Population [m^2/g]		
20.0	0.035	0.012	0.023
10.0	0.080	0.056	0.071
5.0	0.124	0.129	0.159
2.0	0.175	0.252	0.289
1.0	0.191	0.304	0.372
Total	0.191	0.304	0.372

From Table 14, it seems that most of the Specific Surface Area Population comes from particles below 5 μm .

Table 15: Blaine Surface calculated from the results from method in 2.6.1 and 2.6.2

Sample Material	Velde Fine Filler		<i>Industrisement</i>		Fly Ash	
Minimum size [μm]	Blaine Surface [m^2/kg]					
	2.6.1	2.6.2	2.6.1	2.6.2	2.6.1	2.6.2
20.0	33	35	11	12	21	23
10.0	76	80	52	56	66	71
5.0	119	124	122	129	151	159
2.0	169	175	241	252	277	289
1.0	173	191	293	304	362	372
Total	276	191	416	304	408	372

The total Blain Surface calculated from method in 2.6.1 is much higher than the results from method in 2.6.2.

4.5 pH and hydration

Table 16: pH results

Dispersing Liquid	0.2% Sodium Hexametaphosphate	Isopropanol	SediSpere A-11
Time	pH		
1 min	13	5	5
10 min	13	5	5
1 hour	13	5	5
1 day	13	5	5
1 week	14	5	7

Table 17: Hydration results

Dispersing Liquid	0.2% Sodium Hexametaphosphate	Isopropanol	SediSpere A-11
Time	Set		
1 min	NO	NO	NO
10 min	NO	NO	NO
1 hour	NO	NO	NO
1 day	NO	NO	NO
1 week	YES	NO	NO

Table 18: Comparison of liquids

Dispersing Liquid	0.2% Sodium Hexametaphosphate	Isopropanol	SediSpere A-11
Time	Differences		
1 min	No difference observed	No difference observed	No difference observed
10 min (30 min*)	Thin film on the liquid surface. Clearest liquid	Cloudy liquid	3 well defined layer
1 hour	Thin film on the liquid surface. Clearest liquid	Cloudy liquid	3 well defined layer
1 day	Thin film on the liquid surface. Lines	Clearest liquid Well defined dots	Least clear liquid Dots
1 week	White crystals on top of the film	Clearest liquid	Not quite clear liquid

* There are no noticeable remarks after 10 minutes. The differences are observed after 30 minutes. The differences are illustrated in Appendix K.

CHAPTER 5

Discussion

Dispersing Liquid

The dispersion of particles affects the particle falling rates. Flocculated particles will behave as a single particle with greater falling rate than if the particles are completely dispersed. Flocculation prevents accurate particle size analysis. Therefore, better dispersion of particles and stabilization techniques must be sought. Selecting the dispersing liquid is a difficult task, the most suitable dispersing liquid can be only determined after experimental testing. Theoretically, to achieve fully dispersion of different materials, different dispersing liquids are necessary.

To make the task easier, it is decided to use one dispersing liquid for all three materials (filler, cement and fly ash). The dispersing liquid must have a low absorptivity of X-rays and is compatible with the analysis cell materials. Liquids such as water, glycols, kerosene, mineral oils, alcohols, mineral spirits and SediSpense liquids may be used. The next step was to use the available information of liquids and their properties stored in the SediGraph. All liquids that lack the ability of producing a PSD curve with a particle range 1 – 125 μm for all materials were eliminated from the list. Then, liquids that need over an hour in analysis time were also eliminated. Only a few liquids were left in the list, and SediSpense A-12 was selected as the dispersing liquid. SediSpense A-12 was selected for the reason that it is the most similar to the dispersing liquid (SediSpense A-11) used in the previous study [1]. In addition, sand, fly ash and cement can be categorized as metal oxides and the A-series SediSpense liquids can disperse powders including metals, oxides and cements.

Baseline and Full-Scale Measurements

Although there is no particle sample concentration required for the SediGraph analysis, as long as the X-ray intensity is reduced by 30 to 70 percent by the dispersed sample, it is recommended to prepare a dispersion of 5 weight percent concentration. Portions of this prepared sample material (3.0 g) are added to pure dispersing liquid (60 mL) until an adequate concentration for analysis is achieved (30% reduction of X-ray intensity). The advantage of this procedure is that less concentrated dispersions can generally be produced without fear of flocculation.

The Baseline measurement for SediSpere A-12 has a constant value of 157 – 158 kCnts/s. The Full-Scale measurement varied from 30 – 35 % (Good) of the baseline value. Good indicates a reduction between 30 – 70 % meaning that the concentration level is appropriate for all of the analysis. This verifies the results, necessary amount of materials for the SediGraph analysis, obtained from the test run analysis.

Temperature

The set temperature was initially set to 26.5 °C, just like in the previous study [1]. In the previous study, this set temperature is the maximum temperature to be able to have a Reynolds number of 0.30 using 0.2% Sodium Hexametaphosphate as dispersing liquid for Velde Fine filler with particle range 1 – 63 µm.

Figure 12 shows that with a set temperature of 26.5 °C the SediGraph produced a PSD curve that approximately starts from 100 and ends at 0. This set temperature could have been used, however, the ambient temperature would either have been difficult to control without air conditioning or the room would have been too cold to work in with air conditioning. In Norway, *Arbeidstilsynet* (The Norwegian Labour Inspection Authority) recommends that the temperature is kept below 22 °C in physically easy conditions during periods of heating, and temperatures below 19 °C or above 26 °C must be avoided [14].

On the other hand, a set temperature of 35 °C gives a PSD curve that starts below 100% and ends with a negative value, -2.1%. This can be due to the ambient temperature of 20 °C, which may be too low and cause the temperature to fluctuate during analysis. Hence, influences the liquid viscosity and liquid density, which are temperature dependent.

As mentioned earlier, it is recommended to have an ambient temperature that is at least 10 degrees lower than the set temperature (35 °C). The ambient temperature could therefore have been set to 25 °C to manage temperature control to achieve the minimum temperature difference between the set and ambient temperature. This was not executed, instead the set temperature was lowered to 30 °C to compensate for the disadvantages of a set temperature of 26.5 °C or 35 °C. Using this set temperature, the SediGraph produced a PSD curve that starts below 100% and end at 0, which is a curve that seems to be a combination of the two previous curves. For the rest of the study, it was decided to use 30 °C as the set temperature for the SediGraph analyses.

Analysis of PSD and Frequency Curves

The tests are run for a couple of times for cement and fly ash, and three times for the filler. The PSD results from the SediGraph analysis show the typical S-shaped curves. The PSD curves of the same material shows good repeatability of the analysis. Figure 13 shows the relation between the PSD curves for the three materials. The Velde Fine filler as the coarsest material, the Fly Ash in between and *Industrisement* as the finest material, as presumed. The results seem reasonable and reliable, although there are fluctuations near 1 µm of the PSD curves of the same material. Since the maximum diameter (165 – 188 µm) is much greater than the starting diameter (125 µm) and the Reynolds number (0.09 – 0.13) is much less than 0.3, a solution for this could be to change to a dispersing liquid with a lower viscosity, so that the smallest particles fall faster.

Additionally, the curves do not reach 100 %. This could be due to the diameter used in the analysis being the average Stokesian diameter of a size class. The relative particle concentration measured at the selected distance and time is the concentration of particles smaller than or equal to that size.

Even though there are small differences, the PSD curves of the same material are very consistent. This only means that the dispersing technique, including the dispersing liquid and procedure (sampling, agitation, rinsing) is well developed.

Fly ash seems to be slightly magnetic, since some of the sample tends to stick to the magnetic stirrer in the mixing chamber. The magnetic stirrer is a convenient means for maintaining a homogeneous particle dispersion but will cause flocculation in certain magnetically susceptible materials. Dispersion of such particles is accomplished by using the ultrasonic bath. By stirring a suspension while subjecting it to ultrasonic dispersion achieves the best dispersion as this ensures that all portions of the mix are brought into the active zones of greatest cavitation energy. Generally, the more violent the agitation (application of strong shear forces), the better is the dispersion.

However, there seems to be no sign of flocculation. A sign of flocculation will likely be an increase in the indicated particle concentration followed by a precipitous drop in the plotted percentage in the PSD curves. The second frequency curve for fly ash is a little peculiar at the lower end, where the curve is increasing towards 1 μm . A couple more of SediGraph analysis of Fly Ash should be done to be able to determine if this is a common tendency for fly ash. Otherwise, the frequency graphs are considerable.

SSA

The specific surface area is highest with minimum particle size 1.0 μm for all three materials. This is as expected, as most of the SSA comes from the smallest particles. More than 50 % of the SSA comes from the particles with particle size below 5 μm and 90 % of the SSA is concentrated in the particle size below 20 μm . This is consistent with the findings of Post Doc Cepuritis in his dissertation [2]. It is also reasonable that the *Industrisement* have the highest SSA since it is the finest material. The same argument can also be used for the Velde Fine filler which is the coarsest material and has therefore least SSA of the three materials.

The Blaine Surface for methods in 2.6.1 and 2.6.2 is not easy to compare, since the method in 2.6.1 is based on mass measurements while the method in 2.6.2 is number-based measurements. Although, the same trend that more surface area comes from particles below 5 μm still applies.

pH and Hydration

From the results, the cement mix with the dispersing liquid 0.2% Sodium Hexametaphosphate is the only one that hardened which is expected as the liquid is basically water. It also appears that the Isopropanol is completely non-reactive with cement as presumed. As promised by Micromeritics, SediSpense A-series liquids can be used as dispersing liquid for powders like cement. Further it can be assumed that SediSpense A-12 can also be used as dispersing liquid for cement. This can of course be checked by repeating the test with the SediSpense A-12.

As anticipated the pH for 0.2% Sodium Hexametaphosphate (water) and cement is 12.5 – 13 while the pH is approximately neutral for alcohols and cement. Mineral oxides are stabilized by a surface charge. The pH is a principal parameter controlling the surface charge, hence it is desired to avoid or minimize changes in pH to maintain stability. There is no change in pH before 1 day, meaning that the mix is stable. After 1 week, there is an unusual increase in pH. Usually the pH is stable or decreasing. It could have been something that takes time to dissolve that leads to changes in pH. However, this is unimportant for this study as long as the dispersed mixture is stable during the SediGraph analysis.

After 30 minutes, the cement mixed with SediSpense A-11 has developed three well-defined layers. The particles seem to be divided into three size classes. However, even after one week the liquid is still not as clear as it is supposed to be. SediSpense A-11 appears to be not the most suitable dispersing liquid for cement. It is therefore necessary to check if the results will be the same for SediSpense A-12 since most of the SSA comes from the smallest particles. However, this is not performed and it is assumed that the agitation of the cement particles and the downward movement of the cell are enough to be able to detect the particle concentration during the analysis.

Possible sources of errors

Splitting

The riffle box used were not supplied with three metal collecting containers. Trays and scoop were made from paper to fit the dimensions of the riffle box. The filler particles might have stuck to the paper and too light particles may have drifted into the air during splitting due to lack of closed containers.

Analysis cell, mixing chamber and tubing

The analysis cell was cleaned once along with the change of tubings. The analysis cell and the tubes could have been cleaned more often since there are a few people using the SediGraph and testing different materials. The mixing chamber was not cleaned except from the usual cleaning/rinsing procedure. It should have been detached from the SediGraph and rinsed with IPA (isopropyl alcohol) or a mild detergent.

For more maintenance details of the SediGraph [6].

Dispersing liquid

The liquid was measured with a 100 mL beaker. For more accurate measurements, the liquid could have been weighed with a scale. The materials must also be tested with different dispersing liquids, to determine if SediSpense A-12 is the most suitable liquid. Select a liquid with lower viscosity or a liquid that can acquire a Reynolds number = 0.25 (Reynolds number < 0.30, but not much lesser) to let the smallest particles sink faster.

Magnetic stirrer

For measuring slightly magnetic materials, like fly ash the magnetic stirrer could have been removed and replaced with a mechanical stirrer.

Bubble detection

Coarse bubble detection is used for all analysis. Fine or Medium bubble detection could have been selected. Due to bubble elimination difficulties encountered during analysis using Fine bubble detection in summer 2016, Coarse bubble detection was used since. This might not be the case now as the SediGraph procedure is more developed. If there are still difficulties with Fine bubble detection, Medium bubble detection might be more appropriate.

pH indicator strips

The pH test must be repeated with several strips because there may be outliers (deviations). It is hard to see the differences in the color shades on the strips if there is only a small change in pH.

CHAPTER 6

Conclusion

From Figure 13 the PSD curves of the same material shows good repeatability of the analysis. This suggest that the SediGraph procedure is well-developed and is reproducible. The PSD curves have a typical S-shaped curves and no sudden precipitous drop, which suggest that there are no signs of flocculation of particles and the SediSpurse A-12 is a suitable dispersing liquid for all three materials (Velde Fine filler, *Industrisement*, and Fly Ash). The maximum diameter (165 – 188 μm) for all materials are much greater than the starting diameter (125 μm) and the Reynolds number (0.09 – 0.13) is much less than 0.30. A solution for this could be to change to a dispersing liquid with a lower viscosity so that the smallest particles fall faster.

As expected, the *Industrisement* is the finest, then the FA and Velde Fine filler is the coarsest material. The *Industrisement* and FA have a peak at 12 μm and 8 μm , respectively. However, the Velde Fine filler have a broader peak of 22 – 28 μm . This could be due to the production of filler or the sample not being representative enough. The filler from Velde AS arrived in big bags and only 20 kg was sieved. Further, only 30.0 g of filler was splitted for the SediGraph analysis. In addition, the riffle box is not fully equipped with three metal collecting containers to ensure nothing is lost when reducing the sample.

Although the SediGraph produced good results, there is room for further improvements to produce more accurate measurements. To obtain the complete particle size range 1 -125 μm , the starting diameter should be larger than the largest particle in the sample ($> 125 \mu\text{m}$) and the ending diameter should be less than the smallest particle size of interest ($< 1 \mu\text{m}$). Fine or Medium bubble detection could have been selected instead of Coarse bubble detection, to be able to eliminate finer air bubbles present in the liquid during the analysis that can cause misleading results. Aid better dispersion of particles by increasing the duration (30 or 60 seconds) of ultrasonic bath, as the mix will then be brought into the active zones with greatest cavitation energy. The magnetic stirrer could be removed and replaced with a mechanical stirrer to avoid magnetic particles in fly ash to stick to the magnetic stirrer, which can reduce the accuracy of the analysis. Better maintenance of the SediGraph by cleaning the analysis cell, mixing chamber and tubings will ensure that the SediGraph has the best possible performance and produces accurate results.

The specific surface area is highest with minimum particle size 1.0 μm for all three materials. Most of the SSA comes from the smallest particles, more than 50 % of the SSA comes from the particles with particle size below 5 μm and 90 % of the SSA is concentrated in the particle size below 20 μm . This is consistent with the findings of Post Doc Cepuritis in his dissertation [2].

Further work

Further develop SediGraph procedure

Repeat SediGraph analysis using Fine or Medium bubble detection, and different dispersing liquids (probably liquid with lower viscosity). Remove magnetic stirrer in the mixing chamber and replace it with a mechanical stirrer, and repeat the analysis for fly ash. Use the ultrasonic bath Metason 50 for a longer duration (30 or 60 s) to bring the mix to a higher energy and aid better dispersion of particles.

Further develop Micro-proportioning with cement and fly ash

Using the SSA calculated from the PSD analysis to determine if the total SSA of all three materials (filler, cement and fly ash) has a linear relation to the matrix rheology (Flow resistance λ_Q , Mini-slump flow diameter, Yield stress τ and Plastic viscosity μ) for approximately constant solid volume fraction Φ . Perform mixing procedure according to [2] and FlowCyl, Mini-slump flow and Rheometer measurements. Use liquid thickness T (Water Film Thickness, WFT) to describe the rheology of the mix. It is a better parameter in describing since it shows relation between the SSA and solid volume fraction.

Table 19: Design of Experiment

Category	Mix No	w/c	w/b	FA/b	fi/b	w/p	SP
							%
Cement	1	0,50	0,50	0,00	0,00	0,50	0,60
	1a	0,45	0,45	0,00	0,00	0,45	0,60
Cement + Fly Ash	2	0,63	0,50	0,20	0,00	0,50	0,60
	3	0,71	0,50	0,30	0,00	0,50	0,60
	4	0,77	0,50	0,35	0,00	0,50	0,60
	4b	0,69	0,45	0,35	0,00	0,45	0,60
Cement + Filler	5	0,50	0,50	0,00	0,20	0,42	0,60
	6	0,50	0,50	0,00	0,60	0,31	0,60
Cement + Fly Ash + Filler	7	0,63	0,50	0,20	0,20	0,42	0,60
	8	0,63	0,50	0,20	0,60	0,31	0,60
	9	0,77	0,50	0,35	0,20	0,42	0,60
	10	0,77	0,50	0,35	0,60	0,31	0,60

References

- [1] P. Y. Sosa. *Measuring Particle Size Distribution of crushed sand fines using XR SediGraph*. Specialization Project, NTNU, Trondheim. December 2016.
- [2] R. Cepuritis. *Development of Crushed Sand for Concrete Production with Microproportioning*. PhD Thesis, NTNU, Trondheim. 2016.
- [3] H. S. Kjos-Hanssen. *Micro Proportioning – Use of Industrially Produced Filler*. Master Thesis, NTNU, Trondheim. 2016.
- [4] NTNU. *TKT4215 - Concrete Technology 1*. Course Compendium. 2016.
- [5] R. Cepuritis et al., *Measurement of particle size distribution and specific surface area for crushed concrete aggregate fines, Advanced Powder Technology (2017)*. <http://dx.doi.org/10.1016/j.appt.2016.11.018>. The Society of Powder Technology Japan. Published by Elsevier B.V. and The Society of Powder Technology Japan. November 01 2016.
- [6] Micromeritics Instrument Corporation. *SediGraph III Plus*. Operator Manual. V1.01. October 2014.
- [7] Micromeritics Instrument Corporation. *SediGraph III PLUS Particle Size Analyzer*. Brochure.
- [8] Micromeritics Instrument Corporation. *The SediGraph Method of Particle Sizing*. Poster.
- [9] E. Ramenskiy. *Operating Manual for SediGraph III Plus (5125)*. NTNU, Trondheim. 2016.
- [10] ASTM International. *Standard Practice for Reducing Samples of Aggregate to Testing Size*. ASTM C702/C702M-11. September 2011.
- [11] Standard Norge & Pronorm AS. *Prøvmåter for generelle egenskaper for tilslag Del 1: Metoder for prøvetaking*. NS-EN 932-1. V1. October 1996.
- [12] Statens Vegvesen. *101 Neddeling av prøver*. R210 Laboratorieundersøkelser. March 2015.
- [13] S. Smeplass et al., *Mikroproporsjonering med fillere fra Velde: Effekt av fillersammensetning på matriksens flytmotstand*. COIN Project report 63. 2015.
- [14] Arbeidstilsynet. *Temperatur – varme og kulde på jobben*. <http://www.arbeidstilsynet.no/fakta.html?tid=78340>

- [15] Merck. *pH-Indicator Strips (Non-Bleeding)*.
http://www.merckmillipore.com/NO/en/products/analytcs-sample-prep/test-kits-and-photometric-methods/visual-tests-for-semi-quantitative-analyses/ph-tests/ph-indicator-strips/UJWb.qB.jtAAAAE_9A93.Lxj.nav. 2017.
- [16] H. Merkus. *Particle Size Measurements*. Springer. 2009.
- [17] ISO. *Determination of particle size distribution by gravitational liquid sedimentation methods – Part 3: X-ray gravitational technique*. ISO 13317-3:2001(E). First edition, March 01 2001.
- [18] ISO. *Determination of particle size distribution by gravitational liquid sedimentation methods – Part 1: General principles and guidelines*. ISO 13317-3:2001(E). First edition, May 01 2001.
- [19] ISO. *Sample preparation – Dispersing procedures for powders in liquids*. ISO 14887:2000(E). First edition, September 01 2000.
- [20] ISO. *Particulate materials – Sampling and sample splitting for the determination of particulate properties*. ISO 14488:2007(E). First edition, December 15 2007.

APPENDIX **A**

Product Information of Industrisement

PRODUKTINFORMASJON

Industri sement



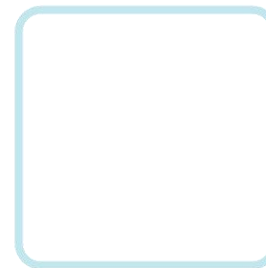

Fasthetsutvikling

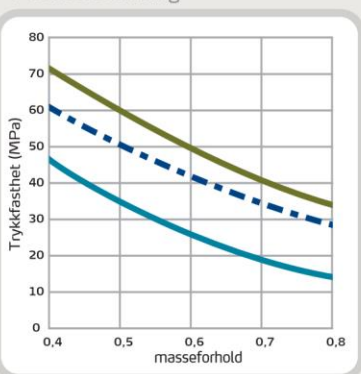

Figur 1

Tidligfasthet

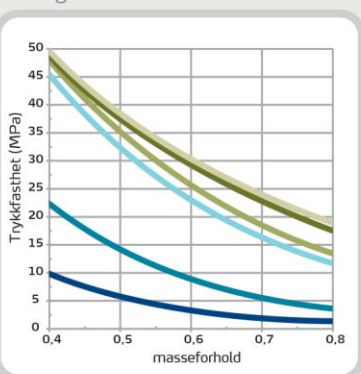

Figur 2

Fasthetsutvikling

Fasthetsutvikling er en sentral egenskap for planlegging, styring og utførelse av alle betongarbeider. Fasthetsutviklingen er avhengig av sementtype, masseforhold, herdeforhold (temperatur, tid og fuktighet) og eventuell bruk av tilsetningsmaterialer eller -stoffer. I figur 1 er vist trykkfasthetsutviklingen som funksjon av masseforhold og alder ved 20°C vannlagring for betong med Industrisement.

Tidligfasthet

Tidligfastheten i betong er meget avhengig av temperatur og eventuell dosering av tilsetningsstoff med retarderende effekt. I figur 2 er vist trykkfasthet i betong etter 1 døgn med forskjellig masseforhold med og uten 1% plastiserende tilsetningsstoff (P-stoff) med Norcem Industrisement. Prøvene er lagret ved 95% luftfuktighet ved varierende temperatur.

Fasthetsklasse – masseforhold

Med normal, god styring av betongproduksjonen er det behov for en overhøyde på ca. 7 MPa ved de ulike fasthetsklassene for å produsere med tilstrekkelig sikkerhet mot undermålere. Industrisement gir følgende retningsgivende verdier for største masseforhold i ulike fasthetsklasser for betong uten luftinnføring, se tabell 1.

Fasthetsklasse	B20	B25	B30	B35	B45	B55
Største masseforhold	0,82	0,75	0,66	0,57	0,48	0,38

Tabell 1

Norcem Industrisement er en spesialsement tilpasset norsk byggepraksis ved vinterarbeid. Sementen gjør det mulig å gjennomføre støpearbeider vinterstid i Norge på en rasjonell og økonomisk måte. Med sin raske fasthetsutvikling er den i tillegg velegnet for bruk ved produksjon av betongelementer og betongvarer.

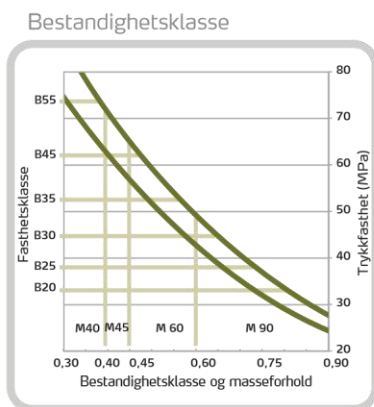

Figur 3

Bestandighetsklasse

NS-EN 206-1 klassifiserer betongens miljøpåvirkninger bl.a. i eksponeringsklasser. I nasjonalt tillegg til denne standarden er de ulike eksponeringsklassene gruppert i seks bestandighetsklasser med krav til betongens maksimale masseforhold (se tabell 3). Tabell 2 viser anbefalte kombinasjoner av bestandighets- og fasthetsklasser. Retningsgivende verdier for største masseforhold i de ulike fasthetsklassene er gitt i tabell 1. I figur 3 er vist sammenhengen mellom bestandighetsklasse og fasthetsklasse, i et variasjonsbelte forårsaket av ulike produksjonsforutsetninger. Figuren gjelder for betong med Industrisement uten luftinnføring.

Anbefalte kombinasjoner

Bestandighetsklasse M90	Fasthetsklasse B20 eller høyere
Bestandighetsklasse M60	Fasthetsklasse B30 eller høyere
Bestandighetsklasse M45	Fasthetsklasse B35 eller høyere
Bestandighetsklasse M40	Fasthetsklasse B45 eller høyere

Tabell 2

Valg av bestandighetsklasse (nasjonale krav)

Eksponeringsklasse	M90	M60	M45	MF45*	M40	MF40*
X0	▪	▪	▪	▪	▪	▪
XCI, XC2, XC3, XC4, XF1		▪	▪	▪	▪	▪
XD1, XS1, XA1, XA2, XA4			▪	▪	▪	▪
XF2, XF3, XF4				▪		▪
XD2, XD3, XS2, XS3, XA3					▪	▪
XSA	Betongsammensetning og beskyttelsestiltak fastsettes særskilt. Betongsammensetningen skal minst tilfredsstillende kravene til M40.					
Største masseforhold $v/(c + \Sigma kp)$	0,90	0,60	0,45	0,45	0,40	0,40

*Minst 4% luft

Tabell 3

Tekniske data

Norcem Industrisement tilfredsstillter kravene til Portlandsement
EN 197-1-CEM I 42,5 R og NS 3086-CEM I-42,5 RR

Kjemiske data

Egenskap	Typiske data	Krav ifølge NS-EN 197-1 og NS 3086
Finhet (Blaine)	550 m ² /kg	
Trikalsiumaluminat G _A	7,8%	
Alkali (ekv N ₂ O)	1,20%	
Mineralske tilsetninger	4%	≤ 5%
Glødetap	2,5%	≤ 5%
Uløselig rest	1%	≤ 5%
Sulfat (SO ₃)	3,7%	≤ 4%
Klorid	<0,08%	≤ 0,1%
Vannløselig Cr ⁶⁺	< 2ppm	≤ 2 ppm
Spesifikk vekt	3,12 kg/dm ³	

Fysikalske data

Egenskap	Typiske data	Krav ifølge NS-EN 197-1 og NS 3086*
Trykkfasthet 1 døgn	35 MPa	≥ 20 MPa
Trykkfasthet 2 døgn	42 MPa	≥ 30 MPa
Trykkfasthet 7 døgn	49 MPa	
Trykkfasthet 28 døgn	57 MPa	≥ 42,5MPa ≤ 62,5MPa
Begynnende bindetid	100 min	≥ 60 min
Ekspansjon	1 mm	≤ 10 mm

*Karakteristiske verdier

APPENDIX B

Norcem Presentation of Cement Products and Quality

This presentation is from an event called "Sementskolen" that took place on
February 8 – 9, 2017 in Skien, Norway.

Sementprodukter og Sementkvalitet

Knut O Kjellsen
Norcem AS FoU

NORCEM
HEIDELBERGCEMENT Group

Sementprodukter

	STD FA	IND	ANL FA
Type iht NS-EN 197:2011	CEM II/B-M 42,5 R	CEM I 42,5 R	CEM II/A-V 42,5 N
Betegnelsen	Portlandblandingssement	Portlandsement	Portlandflygeaske-sement
Flygeaske (%)	18	-	17
Kalksteinsmel (%)	4	4	-
Klinker (%)	78	96	83
CO ₂ (kg CO ₂ ekv/tn)	604 / 625	748 / 859	637

NORCEM
HEIDELBERGCEMENT Group

Sementprodukter

	STD FA	IND	ANL FA
Blaine finhet (m ² /kg)	450	550	390
Bindetid (min)	135	110	165
Fasthet, 1 dg (MPa)	20	33	15
Fasthet, 28 dg (MPa)	55	59	55
Densitet (kg/l)	3,00	3,13	3,02
Volum (l/m ³)	104	100	104

NORCEM
HEIDELBERGCEMENT Group

APPENDIX **C**

Industrisement Quality Test Report

REPORT ON QUALITY TEST

Customer: Tor Magnus Zakkariassen
Date received: 29.04.2016
Sample Marked: Til bruksprøving og Rilem
Pakket 21.01.16, uttatt lager 29.04.16

Your ref.: 40/16
Our ref.: **CL-2016-0005**

Parameter:		Results:		Method:
CHEMICAL COMPOSITION				
Chemical Parameters				
Free Lime		2.07	%	PD0468
Loss On Ignition	LOI	1.60	%	EN196-2
Sulfur Trioxide-IR	SO3	3.77	%	PD1752
Carbon	C	0.11	%	PD1752
Total Chloride	Cl	0.082	%	EN196-2
Water soluble Chromium	Cr(VI)	1.61	mg/kg	EN196-10
Insoluble Residue	I.R	0.30	%	EN196-2
XRF Analysis				
Silica Oxide	SiO2	19.92	%	EN196-2
Aluminum Oxide	Al2O3	5.22	%	EN196-2
Ferric Oxide	Fe2O3	3.05	%	EN196-2
Calcium Oxide	CaO	61.51	%	EN196-2
Potassium Oxide	K2O	1.18	%	EN196-2
Sodium Oxide	Na2O	0.52	%	EN196-2
Magnesium Oxide	MgO	2.50	%	EN196-2
Titanium Dioxide	TiO2	0.313	%	EN196-2
Phosphorous Pentoxide	P2O5	0.144	%	EN196-2
Manganic Oxide	Mn2O3	0.062	%	EN196-2
Sodium Oxide Equivalent	Na2O Eq.	1.30	%	EN196-2
TECHNICAL PARAMETERS				
Compressive Strength				
After 1 day		30.8	MPa	EN196-1
After 2 days		37.6	MPa	EN196-1
After 7 days		47.2	MPa	EN196-1
Fineness				
Specific surface, Blaine		545	m2/kg	EN196-6
Particle Size Distribution				
Sieve Passing	<24 µm	84.8	%	PD1749
Sieve Passing	<30 µm	91.1	%	PD1749
Sieve Residue	>64 µm	0.1	%	PD1749
Sieve Residue	>90 µm	0.0	%	PD1749
Other Technical Parameters				
False Set		0	min	PD1793
Time of Setting				
Initial		120	min	EN196-3
Soundness				
Le Chatelier		1.0	mm	EN196-3
Normal Consistency				
Temperate climate 20°C		33.0	%	EN196-3

Norcem A.S Brevik, Cement and Concrete Laboratory,

23.05.2016

Laboratory Manager

NORCEM AS

Address:
Setreveien 2
P.O. Box 38
N-3991 Brevik

Phone:
Telefax:
Ent.no.:
Bank Account:

+47-35-57 20 00
+47-35-57 04 00
NO 934 949145 VAT
6003 06 12488

Head Office:
Lilleakerveien 2b
P.O. Box 143 Lilleaker
0216 Oslo

APPENDIX D

Particle Size Distribution of Industrisement using Laser Diffraction

MasterSizer 2000 E - [Cement_Mai]

File Edit View Measure Configure Tools Security Window Help

Records Kalkmet Cement UnderSize Cement Result Analysis (M) Data (M) Fit (M) Result Statistics (M) Parameter report (M) Trend (M)

Current User: labuser

Sample Name: CL-2016-0005 - Average
SOP Name: Cement
 6. mai 2016 12:30:28

Sample Source & type: LLABX0
Factory = Brevik
Result Source: Averaged
 6. mai 2016 12:30:29

Sample bulk tot ref: -1

Particle Name: Cement18
Accessory Name: Hydro 2000SM (A)
Particle Rt: 1.680
Absorption: 0.1

Analysis model: General purpose
Sensitivity: Enhanced
Obscuration: 15.03 %
Size range: 0.100 to 1000.000 um
Weighted Residual: 1.014 %

Percentage below 24.00 um : 84.77%
 Percentage below 30.00 um : 91.10%
 Percentage above 64.00 um : 0.14%
 Percentage above 90.00 um : 0.00%

Specific Surface Area: 1.49 m²/g
Surface Weighted Mean D[5,2]: 4.015 um
Vol. Weighted Mean D[4,3]: 12.792 um
Result units: Volume

d(0.1): 1.480 um
d(0.2): 3.026 um
d(0.5): 9.563 um
d(0.9): 28.718 um

Particle Size Distribution

CL-2016-0005 - Average, 6. mai 2016 12:30:28

Size (um)	Vol Under%	Vol Over%
0.1	0.00	100.00
0.2	0.03	99.97
0.5	0.32	99.68
1.0	1.125	98.875
2.0	3.026	96.974
3.0	4.015	95.985
4.0	4.777	95.223
5.0	5.024	94.976
6.0	5.204	94.796
7.0	5.329	94.671
8.0	5.400	94.600
9.0	5.440	94.560
10.0	5.460	94.540
12.0	5.500	94.500
15.0	5.540	94.460
20.0	5.600	94.400
30.0	5.700	94.300
40.0	5.780	94.220
50.0	5.840	94.160
60.0	5.890	94.110
70.0	5.930	94.070
80.0	5.960	94.040
90.0	5.980	94.020
100.0	5.990	94.010
150.0	6.000	94.000
200.0	6.000	94.000
300.0	6.000	94.000
400.0	6.000	94.000
500.0	6.000	94.000
600.0	6.000	94.000
700.0	6.000	94.000
800.0	6.000	94.000
900.0	6.000	94.000
1000.0	6.000	94.000

Operator notes:

APPENDIX E

Fly Ash Quality Test Report

PRØVNINGSRAPPORT

Oppdragsgiver: SKB
Prøven merket: Flyveaske tatt ut 25.03.13 for forsendelse

Prøve kode: LN2-13

Ref:

KJEMISK ANALYSE EN 196-2

Glødetap		2,05	%
Karbon		1,43	%
Svovel trioksyd	(SO ₃)	0,83	%
Silika	(SiO ₂)	58,47	%
Aluminiumoksyd	(Al ₂ O ₃)	22,41	%
Jernoksyd	(Fe ₂ O ₃)	8,11	%
Kalsiumoksyd	(CaO)	4,13	%
Magnesiumoksyd	(MgO)	2,05	%
Fosfor pentoksyd	(P ₂ O ₅)	0,35	%
Kaliumoksyd	(K ₂ O)	2,07	%
Natriumoksyd	(Na ₂ O)	1,15	%
Alkali		2,52	%
Partikkelanalyse	+90my	3,7	%
" "	+64my	7,9	%
" "	-24my	68	%
" "	-30 my	74,8	%
Spesifikk overflate;	Blaine	355	m ² /kg
Spesifikk vekt		2,38	g/cm ³

Norcem A.S Brevik, Sement- og betonglaboratoriet, 12.april 2013

kcs.

Laboratoriesjef

APPENDIX **F**

Particle Size Distribution of Fly Ash
using Laser Diffraction

Sample Name: LN2-13 - Average
Sample Source & type: Cement
Factory = Brevik
Sample bulk lot ref: -1
Measured: 5. april 2013 10:00:35
Analysed by: LLABX0
Result Source: Averaged
Analysed: 5. april 2013 10:00:37

Particle Name: Cement
Accessory Name: Hydro 2000SM (A)
Particle Rt: 1.680
Absorption: 0.01
Analysis model: General purpose
Sensitivity: Enhanced
Obscuration: 10.28 %
Size range: 0.100 to 1000.000 um
Weighted Residual: 0.163 %

Percentage below 24.00 um : 68.03%
Percentage below 30.00 um : 74.76%
Percentage below 64.00 um : 7.88%
Percentage above 90.00 um : 3.67%
Specific Surface Area: 0.278 m²/g
Surface Weighted Mean D[5,2]: 6.847 um
Vol. Weighted Mean D[4,3]: 24.934 um
Result units: Volume
d(0.1): 2.647 um
d(0.2): 4.632 um
d(0.5): 13.714 um
d(0.9): 56.504 um

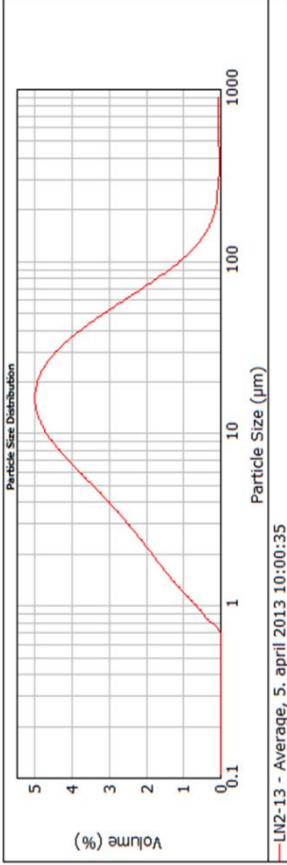

LN2-13 - Average, 5. april 2013 10:00:35

Size (um)	Vol Under %	Vol Under %	Vol Under %	Vol Under %	Vol Under %	Vol Under %	Vol Under %	Vol Under %	Vol Under %
0.0	0.00	0.00	0.00	0.00	0.00	0.00	0.00	0.00	0.00
0.05	0.00	0.00	0.00	0.00	0.00	0.00	0.00	0.00	0.00
0.10	0.00	0.00	0.00	0.00	0.00	0.00	0.00	0.00	0.00
0.20	0.00	0.00	0.00	0.00	0.00	0.00	0.00	0.00	0.00
0.30	0.00	0.00	0.00	0.00	0.00	0.00	0.00	0.00	0.00
0.40	0.00	0.00	0.00	0.00	0.00	0.00	0.00	0.00	0.00
0.50	0.00	0.00	0.00	0.00	0.00	0.00	0.00	0.00	0.00
0.60	0.00	0.00	0.00	0.00	0.00	0.00	0.00	0.00	0.00
0.80	0.00	0.00	0.00	0.00	0.00	0.00	0.00	0.00	0.00
1.00	0.00	0.00	0.00	0.00	0.00	0.00	0.00	0.00	0.00
1.25	0.00	0.00	0.00	0.00	0.00	0.00	0.00	0.00	0.00
1.50	0.00	0.00	0.00	0.00	0.00	0.00	0.00	0.00	0.00
2.00	0.00	0.00	0.00	0.00	0.00	0.00	0.00	0.00	0.00
2.50	0.00	0.00	0.00	0.00	0.00	0.00	0.00	0.00	0.00
3.00	0.00	0.00	0.00	0.00	0.00	0.00	0.00	0.00	0.00
4.00	0.00	0.00	0.00	0.00	0.00	0.00	0.00	0.00	0.00
5.00	0.00	0.00	0.00	0.00	0.00	0.00	0.00	0.00	0.00
6.00	0.00	0.00	0.00	0.00	0.00	0.00	0.00	0.00	0.00
8.00	0.00	0.00	0.00	0.00	0.00	0.00	0.00	0.00	0.00
10.00	0.00	0.00	0.00	0.00	0.00	0.00	0.00	0.00	0.00
12.50	0.00	0.00	0.00	0.00	0.00	0.00	0.00	0.00	0.00
15.00	0.00	0.00	0.00	0.00	0.00	0.00	0.00	0.00	0.00
20.00	0.00	0.00	0.00	0.00	0.00	0.00	0.00	0.00	0.00
25.00	0.00	0.00	0.00	0.00	0.00	0.00	0.00	0.00	0.00
30.00	0.00	0.00	0.00	0.00	0.00	0.00	0.00	0.00	0.00
40.00	0.00	0.00	0.00	0.00	0.00	0.00	0.00	0.00	0.00
50.00	0.00	0.00	0.00	0.00	0.00	0.00	0.00	0.00	0.00
63.00	0.00	0.00	0.00	0.00	0.00	0.00	0.00	0.00	0.00
80.00	0.00	0.00	0.00	0.00	0.00	0.00	0.00	0.00	0.00
100.00	0.00	0.00	0.00	0.00	0.00	0.00	0.00	0.00	0.00
125.00	0.00	0.00	0.00	0.00	0.00	0.00	0.00	0.00	0.00
150.00	0.00	0.00	0.00	0.00	0.00	0.00	0.00	0.00	0.00
200.00	0.00	0.00	0.00	0.00	0.00	0.00	0.00	0.00	0.00
250.00	0.00	0.00	0.00	0.00	0.00	0.00	0.00	0.00	0.00
315.00	0.00	0.00	0.00	0.00	0.00	0.00	0.00	0.00	0.00
400.00	0.00	0.00	0.00	0.00	0.00	0.00	0.00	0.00	0.00
500.00	0.00	0.00	0.00	0.00	0.00	0.00	0.00	0.00	0.00
630.00	0.00	0.00	0.00	0.00	0.00	0.00	0.00	0.00	0.00
800.00	0.00	0.00	0.00	0.00	0.00	0.00	0.00	0.00	0.00
1000.00	0.00	0.00	0.00	0.00	0.00	0.00	0.00	0.00	0.00

Operator notes:

APPENDIX **G**

SediGraph Procedure

SediGraph III Plus (5125)

- **Preparation**

1. Start computer
2. Start SediGraph by pressing on/off switch on the side
3. Launch SediGraph III Plus software
4. Turn Key to the right position "X-RAY ON"

- **Establish a baseline of the liquid if a new solution is used**

(Skip steps 5-6 if the baseline for the solution was previously established)

Note: After turning the machine on, wait 20-30 min or until the temperature stabilizes/reaches set temperature. As the temperature can affect the baseline measurements.

Check the **temperature**:

Unit1 → Show instrument schematics:

Temperature = Cell temp. ± 0.1 °C

(Wait until caution: **Out of Band** disappears before running your tests.)

Clean the magnet and the mixing chamber.

For **Trial Test**:

Follow steps on the **left** side and in **blue** text

5. Unit1 → Baseline

→ **Leave liquid in mixing chamber** → Next

X-Ray intensity: Normal or Low

Select the intensity that is compatible with the liquid: Check the liquid properties

Drain operation in progress

Clean the magnet and the mixing chamber after the drain operation is completed.

6. Load baseline liquid into mixing chamber

Load 60 mL or 80 mL of the baseline liquid.

(Example: 60 mL of 0.2% Sodium Hexametaphosphate)

→ Next

Load operation in progress

Baseline operation in progress

Note X-Ray Counts: (Example: 137 kCnts/s)

→ Close

For **Real Test**:

Follow steps on the **right** side and in **green** text

5. Unit1 → Baseline

→ **Leave mixing chamber empty** → Next

X-Ray intensity: Normal or Low

Select the intensity that is compatible with the liquid: Check the liquid properties

Drain operation in progress

Clean the magnet and the mixing chamber after the drain operation is completed.

6. Load baseline liquid into mixing chamber

Load 60 mL or 80 mL of the baseline liquid.

(Example: 60 mL of 0.2% Sodium Hexametaphosphate)

→ Next

Load operation in progress

Baseline operation in progress

X-Ray Counts: (Example: 137 kCnts/s)

→ Close

- **Sample analysis**

7. Create a Folder in C:\5125\Mlab

8. File → Open → Sample information → Choose your folder from the directories → OK
→ Do you wish to create it? → Yes

File numeration is automatic.

9. Input parameters into five tabs

10. First tab: **Sample Information** (Sample Name, Operator, Submitter, Comments) → Next

11. Second tab: **Material Properties** → Next
(Description, Sample Material, Density, Analysis Liquid, Analysis Type,
Starting Diameter, Ending Diameter, Analysis Unit)

The analysis is temperature dependent.

Therefore, it is recommended to use analysis unit **S/N 2162** for better results.

Select **S/N 2162** when the given temperature is equal to the set temperature.

(Example: Analysis Unit: **S/N 2162: 30 °C** ; Set temperature = 30 °C)

The temperature for the analysis unit will be updated everytime you click on **S/N 2162**.

12. Third tab: **Analysis Option** → Next
Wait for temperature stabilization: Checked
Rinse after analysis: Checked

13. Fourth tab: **Report Options** → Next
Reports to be generate: Select the reports that are required to be produced by checking it.

14. Fifth tab: **Collected Data** → Save → Close

15. Unit1 → Drain and load
→ Leave liquid in mixing chamber → Continue

15. Skip to step 17.

Drain operation in progress

16. Load dispersed sample or baseline liquid
into mixing chamber → Continue

Load operation in progress

Unit1 → Show instrument schematics

Unit1 → Enable Manual Control

Right click on Cell → Move Cell Position

Cell Position: (Example: 2000 steps) → OK

X-Ray Counts: (Example: 137 kCnts/s)

Pour sample in mixing chamber little by little,
while checking the X-Ray counts.

Note weight of filler used to get

target X-Ray Counts: 30% - 70% reduction

17. Unit1 → Sample Analysis → Browse
→ Choose saved file, make sure analysis conditions are set correctly → Next
→ Leave liquid in mixing chamber
→ Start

Drain operation in progress

Load dispersed sample into mixing chamber
→ Next

Load operation in progress
Full scale scan in progress

Note X-Ray Counts: (Example: 94 kCnts/s)
Note Baseline %: (Example: 31 % Good)
Good Baseline %: 30-70% reduction of kCnts/s

Analysis operation in progress

Reports: **Save** as .smp file
Save As as .xps file
→Close

Rinse operation in progress

SediGraph: Idle → Close

18. Rinse SediGraph: Unit1 → Rinse SediGraph → Rinse: (Example: 3) → Continue

Rinse operation in progress
(Skip step 18 if the cell and the mixing chamber are clean, and ready to use for the next test)

19. After completion, turn Key to the left position "X-RAY STANDBY"

- **Shutting down equipment**

20. Close the software, turn off the computer, make sure that the Key is in the left position "X-RAY STANDBY" and turn off the SediGraph by pressing the on/off switch on the side.

Clean the magnet and the mixing chamber.

17. Unit1 → Sample Analysis → Browse
→ Choose saved file, make sure analysis conditions are set correctly → Next
→ Leave mixing chamber empty
→ Start

Drain operation in progress

Weigh amount of filler needed and add 40 mL or 60 mL of baseline liquid.
Stir the mix and place it in the ultra-sonic bath (METASON 50) for 15 seconds.

Load dispersed sample into mixing chamber
→ Next

Stir the mix again before loading it into the mixing chamber. Pour quickly.
Add 20 mL more of the baseline liquid, stir and shake before loading.
Place the lid back on.

These steps are done to ensure transfer of "all" fillers during loading.

Load operation in progress
Full scale scan in progress

X-Ray Counts: (Example: 94 kCnts/s)
Baseline %: (Example: 31 % Good)

Analysis operation in progress

Reports: **Save** as .smp file
Save As as .xps file
→Close

Rinse operation in progress

SediGraph: Idle → Close

APPENDIX H

AccuPyc Helium Pycnometry Procedure

AccuPyc II 1340

Helium Pycnometry – Density Measurements

Start software and create a sample file

1. Start the virtual computer: **WM – XP**
2. In the virtual computer: Start **1340 – AccuPyc**
3. Make a folder in the virtual computer: **C:\1340\data**
4. Go to File → Open → Sample Information
5. Select your folder which is located under C:\1340\data in the directories.
Leave File name as it is, file numeration is automatic.
Click OK to create a new sample file.
6. Fill in Sample Information: Sample (Choose a Sample Name), Operator, Submitter

Analysis Conditions:

Analysis Gas: Helium

Number of purges: 20

Purge fill pressure: 19.500 psig

Number of cycles: 20

Cycle fill pressure: 19.500 psig

End equilibration by:

Rate: 0.0050 psig/min

Check Use run precision

Percent full scale 0.05%

Report Options:

Selected Reports: Select reports to be generated

Sample Preparation

Handling the sample cup:

Always use cotton gloves when handling sample cups or other internal components of the pycnometer. Wear latex or nitrile, powder-free gloves. This is to avoid fat or dirt from your skin contaminating these components. Only use tweezers or tongs made from plastic to avoid deforming/scratching the sample cup.

7. Rinse the sample cup with distilled water, and then with alcohol (ethyl alcohol/ethanol).
Dry the sample cup in the drying oven for 15-20 seconds at 120 °C.
Weigh the empty sample cup using the Analytical Balance (METTLER TOLEDO XS205 Dual Range) and note the mass. **Mass** Sample Cup
8. Fill the sample cup $\frac{2}{3}$ full with sample material.
Pack powders and undensified materials (if permissible) to obtain maximum sample weight in the cup.
9. Weigh the sample cup with the sample.

Samples must be properly prepared to obtain accurate results. Samples must be free of moisture in order to obtain true sample mass and to avoid the distorting effect of water vapor on the volume measurement. Avoid exposure of the dried sample to atmospheric moisture during each step of the preparation process. This means weighing as rapidly as possible and installing in the instrument without unnecessary delay.

10. Place the sample cup with the sample in a drying oven at 120 °C.
11. Repeat steps 9. – 10. until the weight is stable.
12. Place the sample cup with the sample in a exicator/dessicator provided with active desiccant.
Allow it to cool until near room temperature.

Greasing the Chamber Cap O-Ring

The cell chamber cap contains an O-ring that requires routine maintenance because it is often exposed. The chamber cap O-ring should be greased at the beginning of each period of use. Rubber gloves should be worn to prevent contaminating the grease with oil from your fingertips. Carefully apply a thin layer of grease; Too much grease may alter cell volume. There should be no visible ridges of grease. Too little grease results in an imperfect seal and leaks.

13. While waiting for the sample to cool down, use the greasing disk to grease the Chamber Cap O-Ring.
Using your fingertip, apply a thin layer of grease (DOW CORNING high vacuum grease) to the greasing disk.
14. Remove the chamber cap by turning it counterclockwise then lifting off.
15. Wipe off the old grease using lint-free tissue (laboratory light-duty tissue).
16. Insert the greasing disk into the chamber cap and turn slightly to apply a very light coating of grease to the O-ring.
17. Wipe the mating surface in the cell chamber with lint-free tissue.
18. Replace the chamber cap.

Loading Sample

Always keep the cap on the sample chamber at all times, except when inserting/removing the sample cup. Try to be quick when inserting the sample into the sample chamber, to avoid moisture from getting in the instrument. When the chamber is left uncapped, water vapor will adsorb on the inner surface of the chamber and/or temperature instability will occur. These conditions can affect the analysis results. Do not spill any sample, dust or powders in the sample chamber. It is best not to lay the cap down while loading the sample. This will prevent particles from accumulating in the greased surface, which can also affect analysis results.

19. After cooling, weigh the sample cup with the sample and note the mass. **Mass** Sample Cup + Sample
20. Remove the cell chamber cap. Carefully insert the sample cup with the sample into the sample chamber, using plastic tweezers or cotton gloves.
21. Immediately replace the cap when the sample is loaded.
22. Calibrate Zero Pressure:
Unit1 → Calibration → Zero Pressure
Click Start to calibrate the pressure offset.
23. While waiting for the zero pressure operation to be finish, calculate the sample mass:
Mass Sample = **Mass** Sample Cup + Sample – **Mass** Sample Cup
24. Type in the Sample Mass in the Sample Information → Save → Close

Running an analysis

25. Unit1 → Sample Analysis
Choose the sample file you want to run and click OK.
26. Fill in, or edit the information for your analysis.
Remember to select the correct Chamber Insert: Sample cup volume (10cc, 35cc or 100cc [NONE])
27. Click Report after analysis to generate reports automatically when the analysis is complete.
Remember this computer is not connected to a printer. You will have to send all reports to another computer: using webmail or a memory stick, in order to print your reports.
28. Click Start to start the analysis.
29. When the analysis is finished save your report in the Print-folder as .txt or .xls.

Finishing the analysis

30. Use the plastic tweezer to remove the sample cup from the sample chamber.
Empty the sample cup, and rinse it with distilled water and ethanol.
Let it cool down until near room temperature after drying it in the drying cabinet.
Place the sample cup back in the wooden box.
31. Shut down 1340-AccuPyc: File → Exit

Particle Size Distribution and Frequency Curves

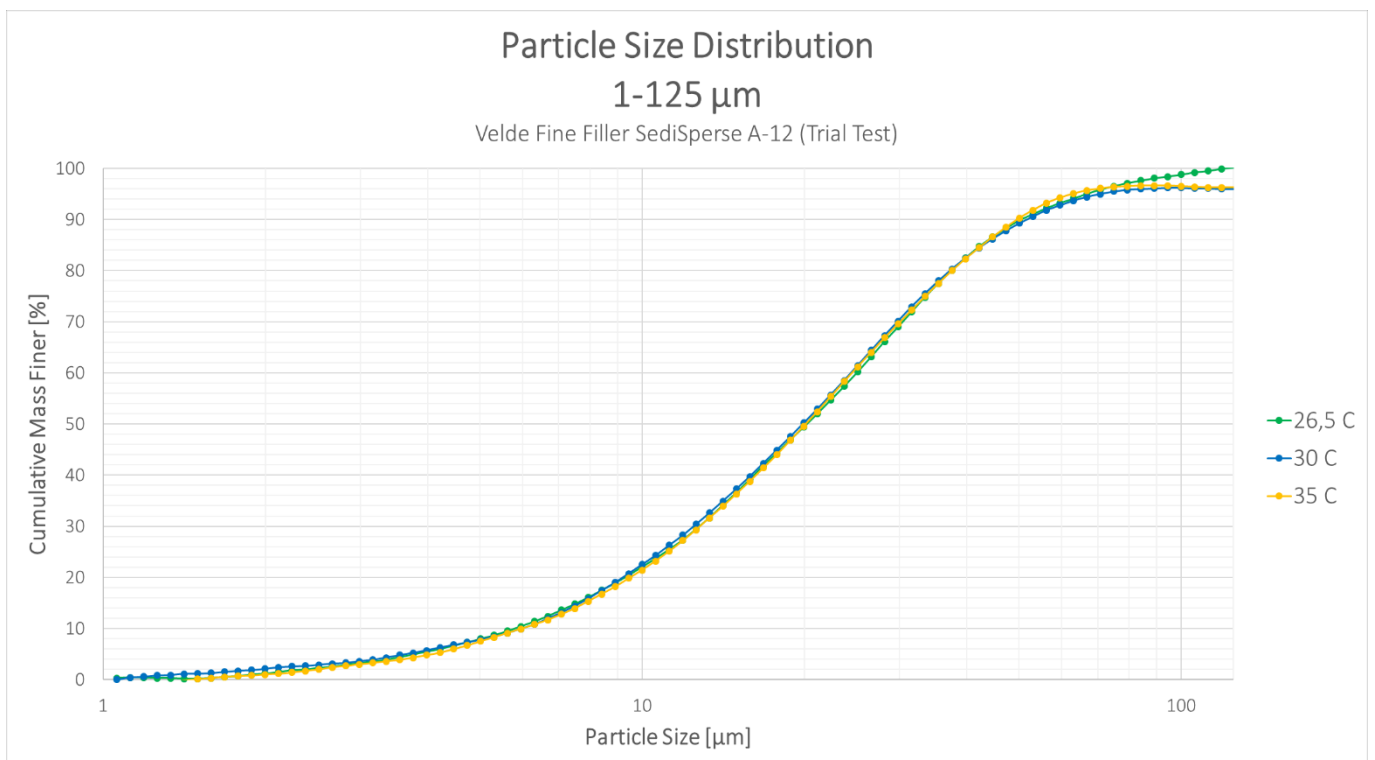

Figure 15: Particle Size Distribution of Velde Fine Filler 1-125 µm with different analysis temperature [Figure 12]

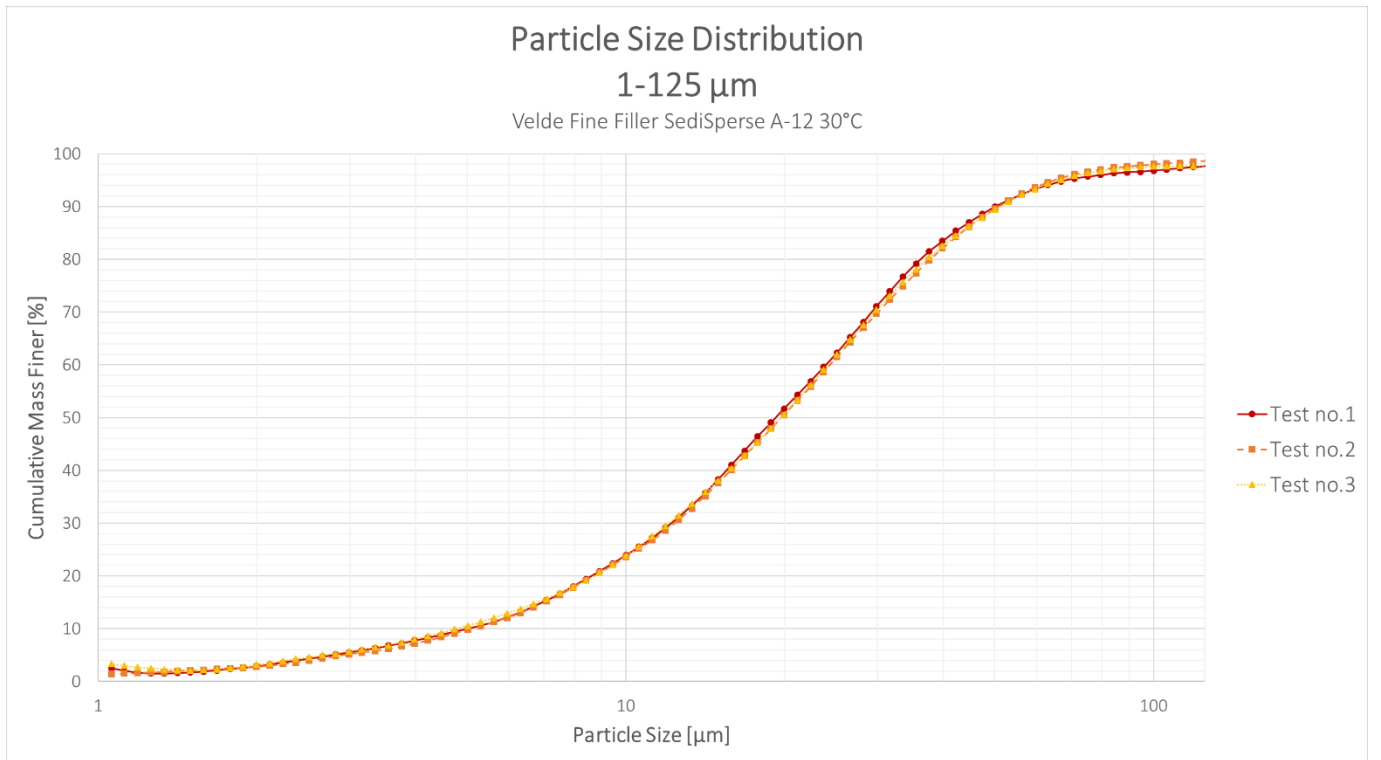

Figure 16: Particle Size Distribution of Velde Fine Filler 1-125 μm

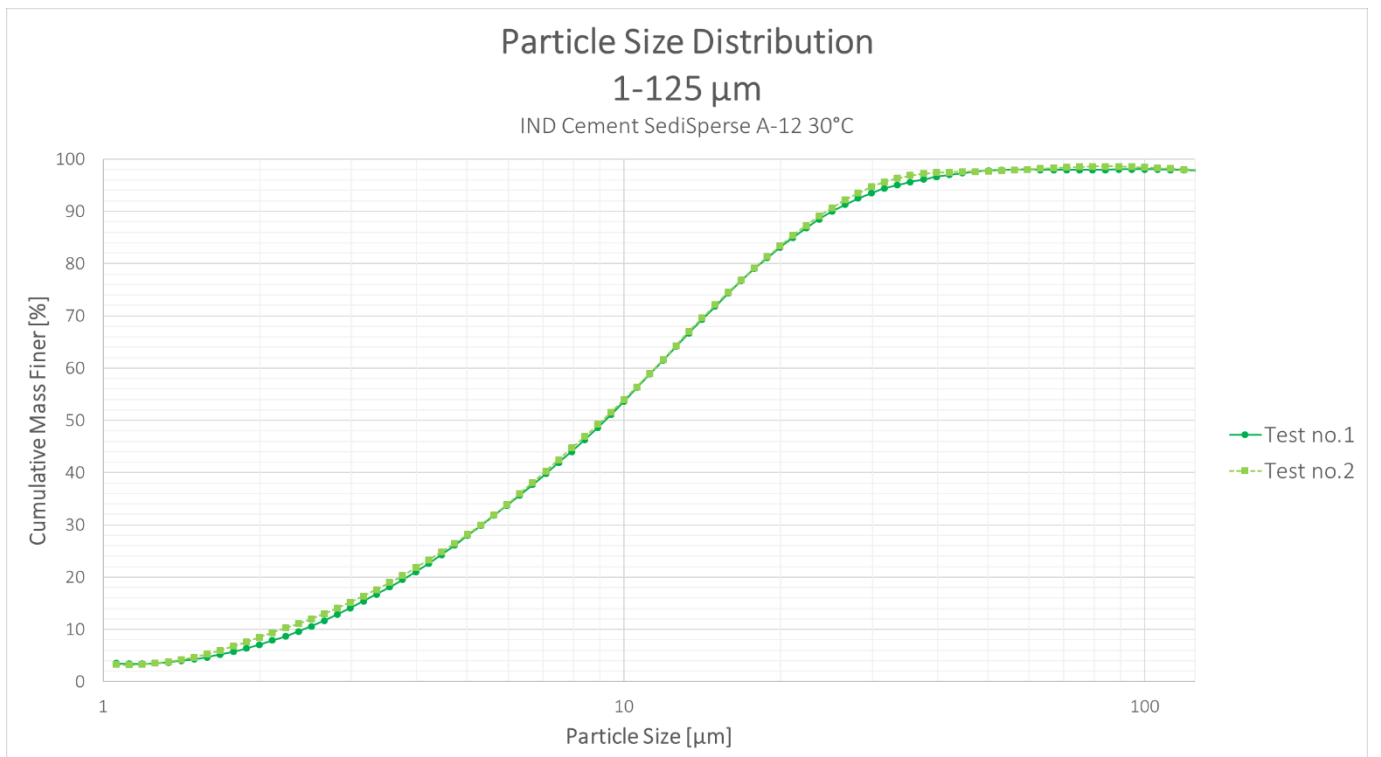

Figure 17: Particle Size Distribution of Industrisement 1-125 μm

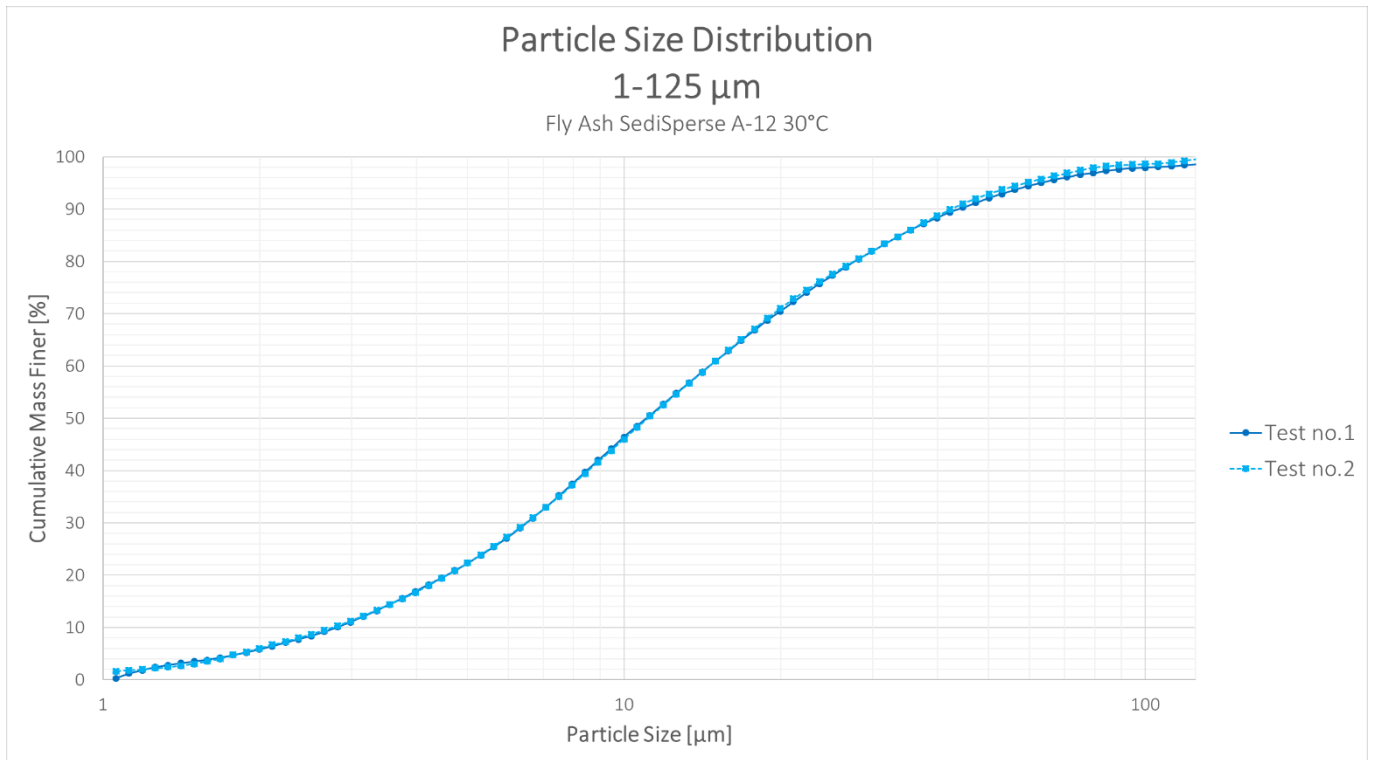

Figure 18: Particle Size Distribution of Fly Ash 1-125 μm

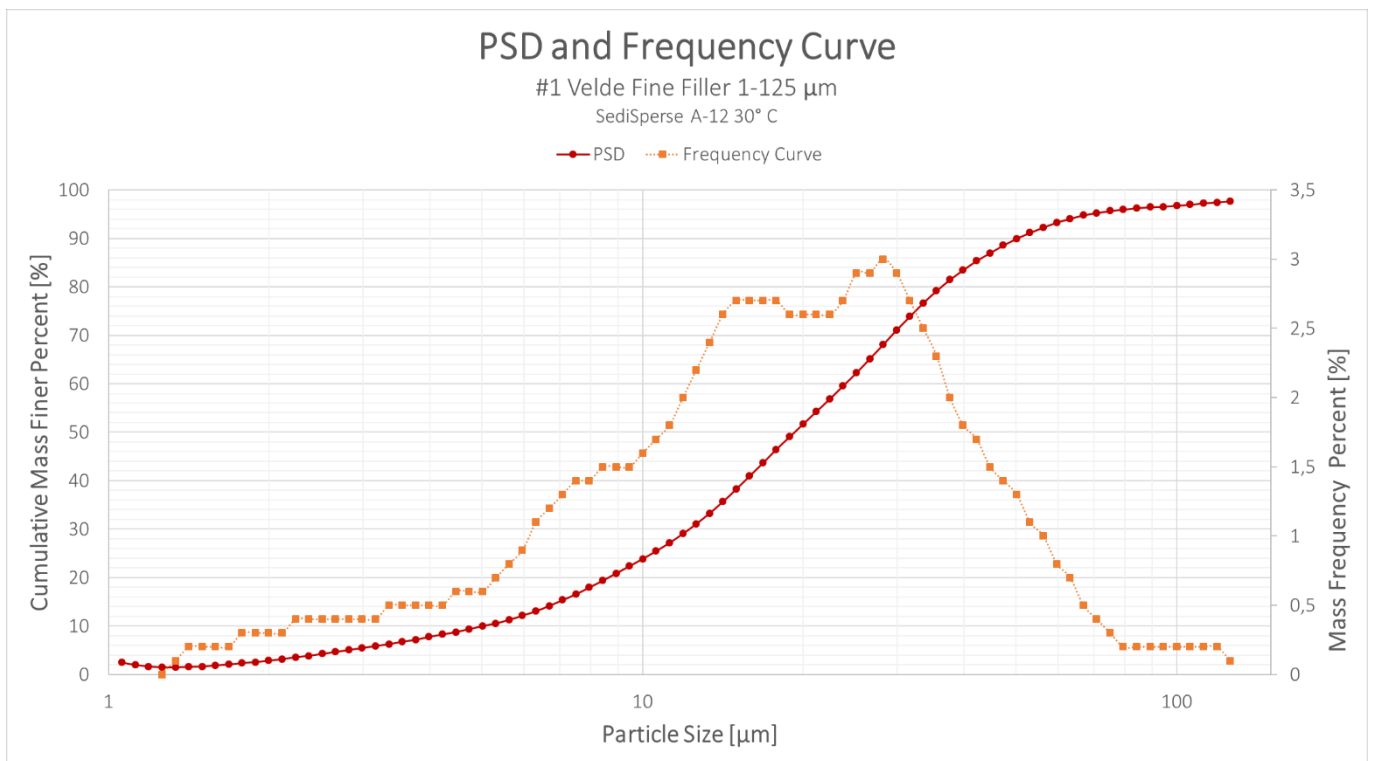

Figure 19: PSD and Frequency Curve of Velde Fine Filler 1- 125 μm Test no.1

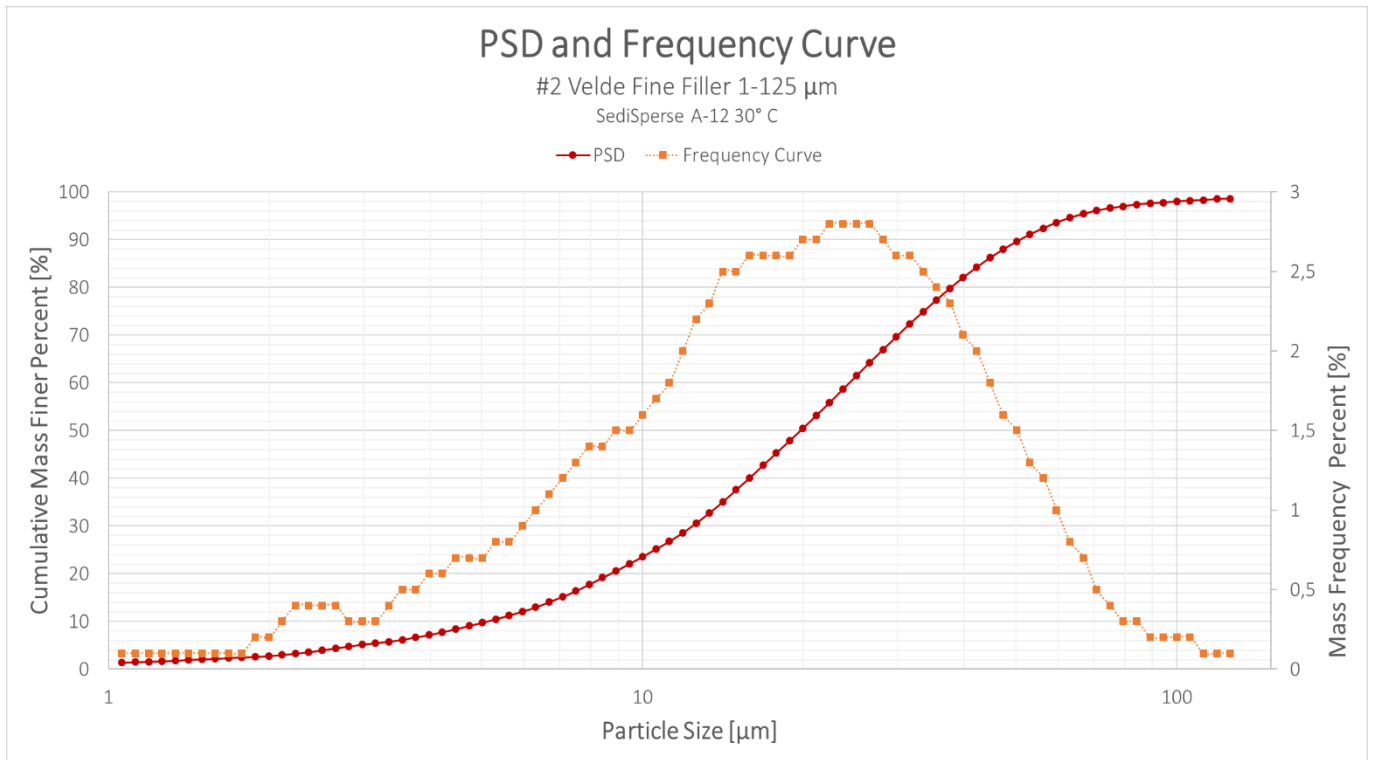

Figure 20: PSD and Frequency Curve of Velde Fine Filler 1- 125 μm Test no.2

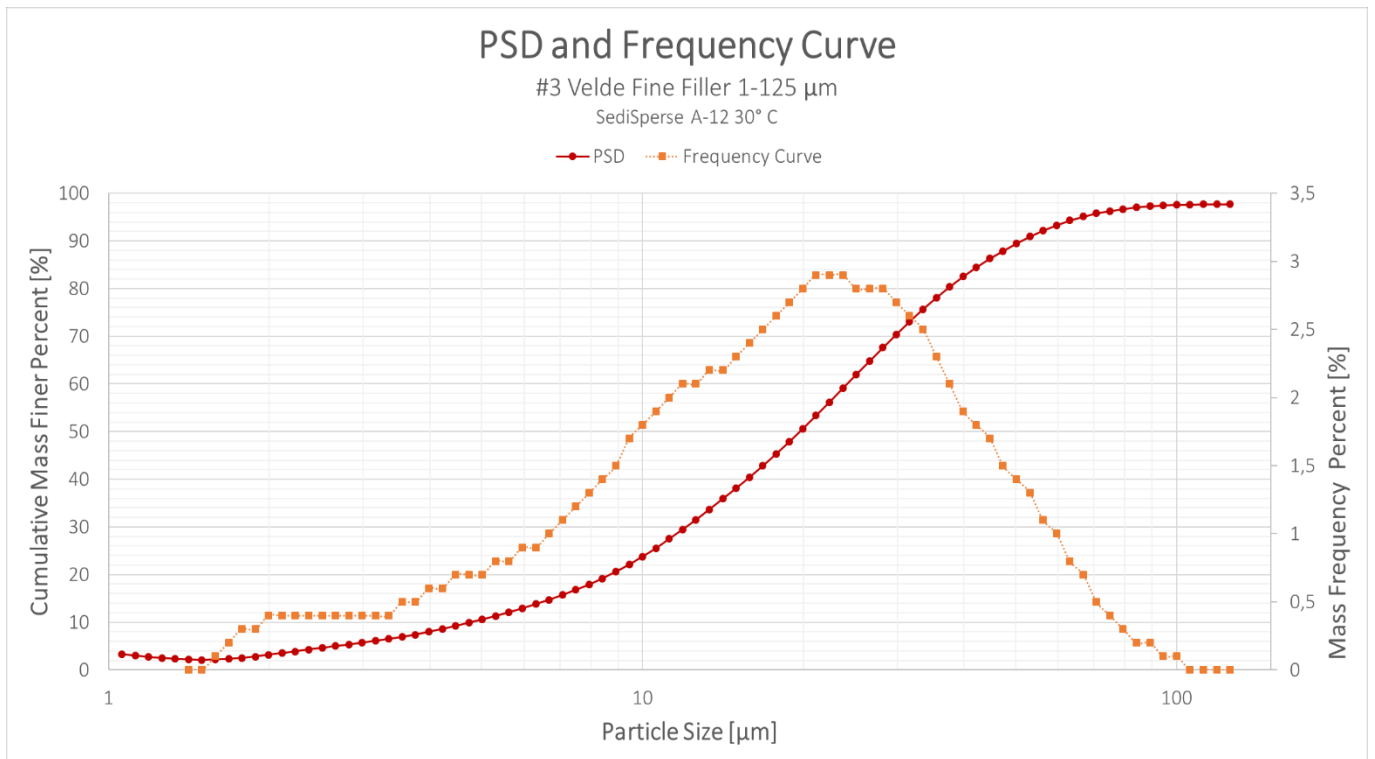

Figure 21: PSD and Frequency Curve of Velde Fine Filler 1- 125 μm Test no.3

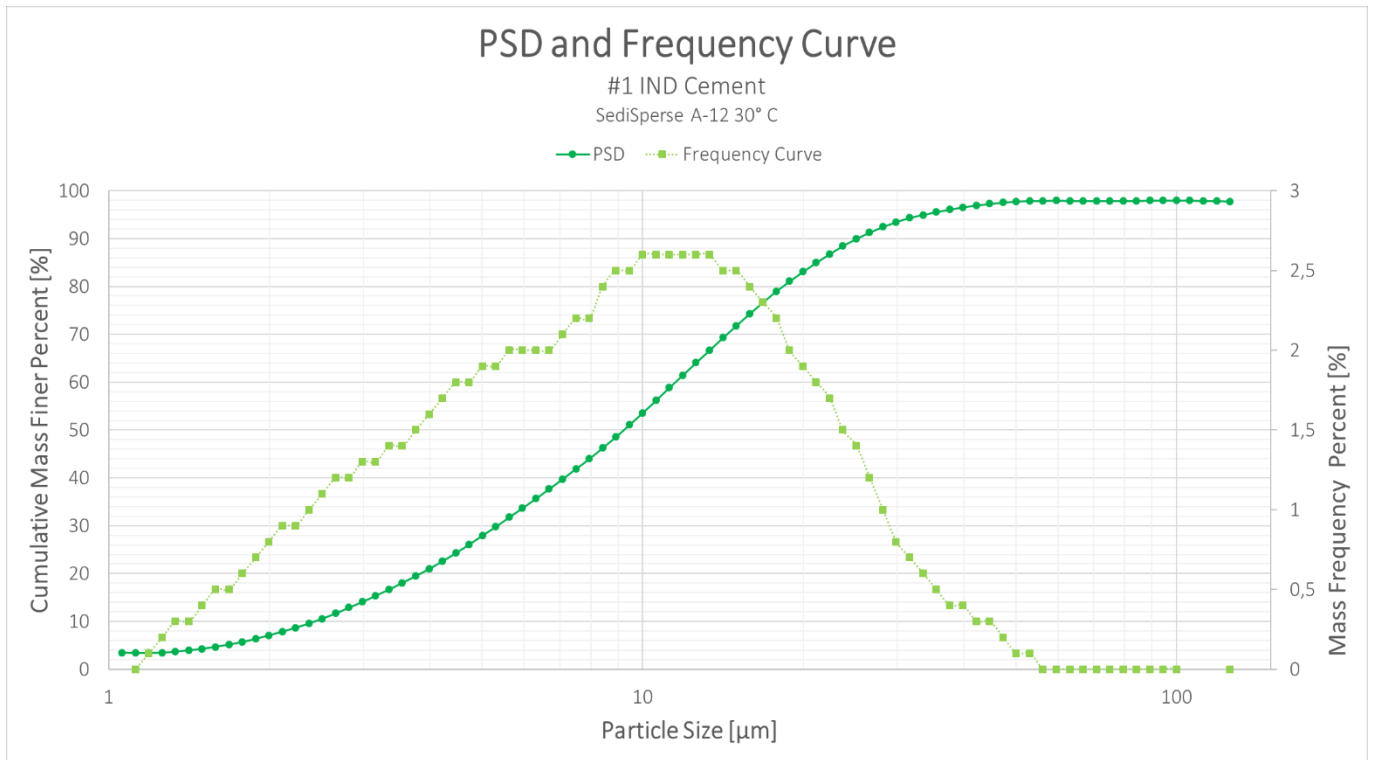

Figure 22: PSD and Frequency Curve of Industrisement 1- 125 μm Test no.1

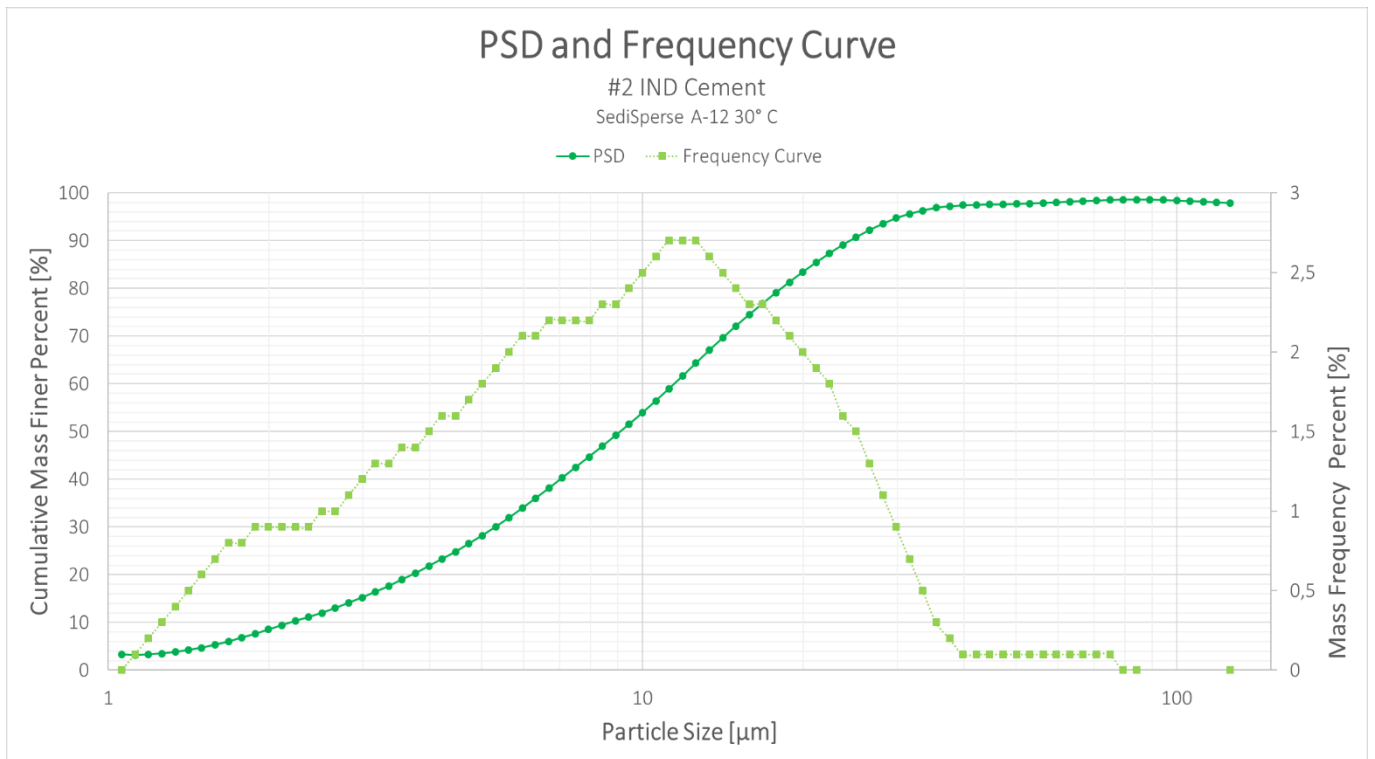

Figure 23: PSD and Frequency Curve of Industri Cement 1- 125 μm Test no.2

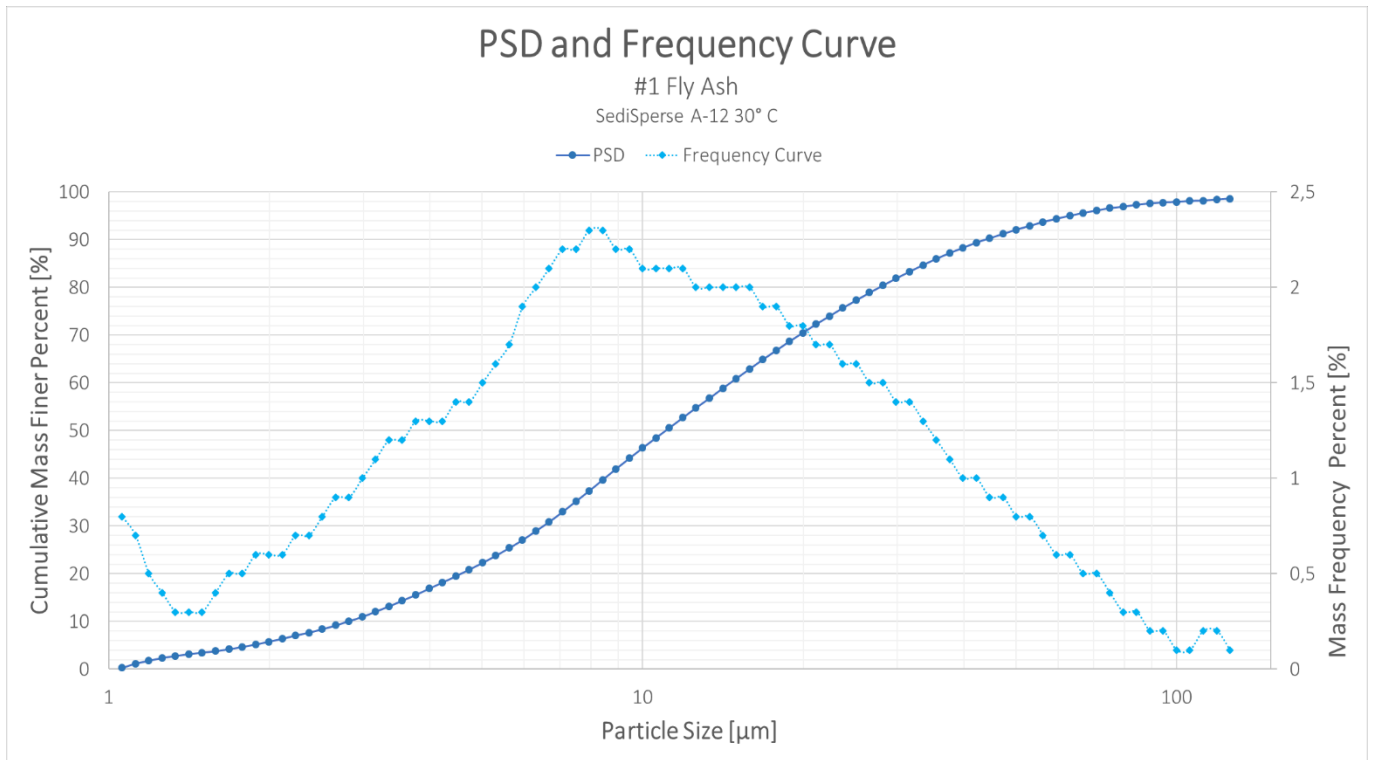

Figure 24: PSD and Frequency Curve of Fly Ash 1-125 μm Test no.1

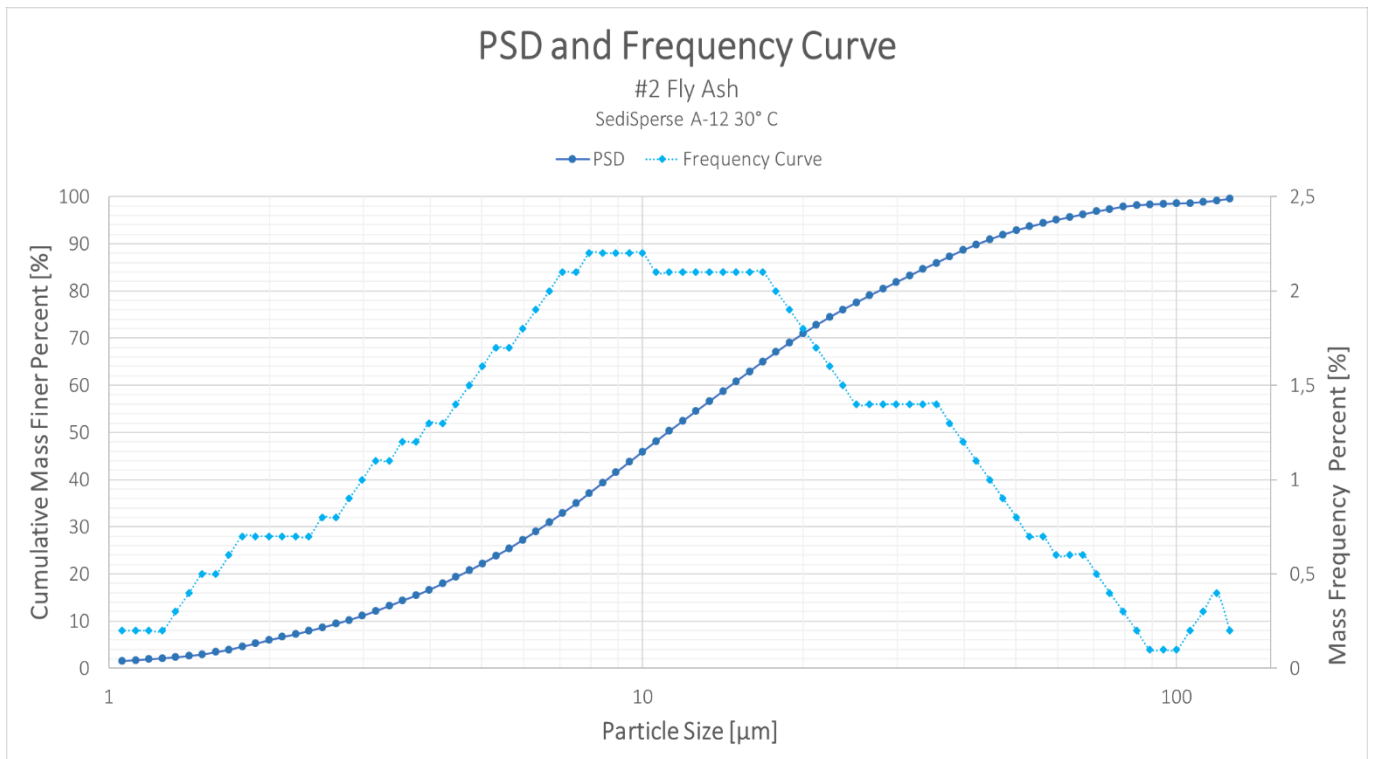

Figure 25: PSD and Frequency Curve of Fly Ash 1-125 μm Test no.2

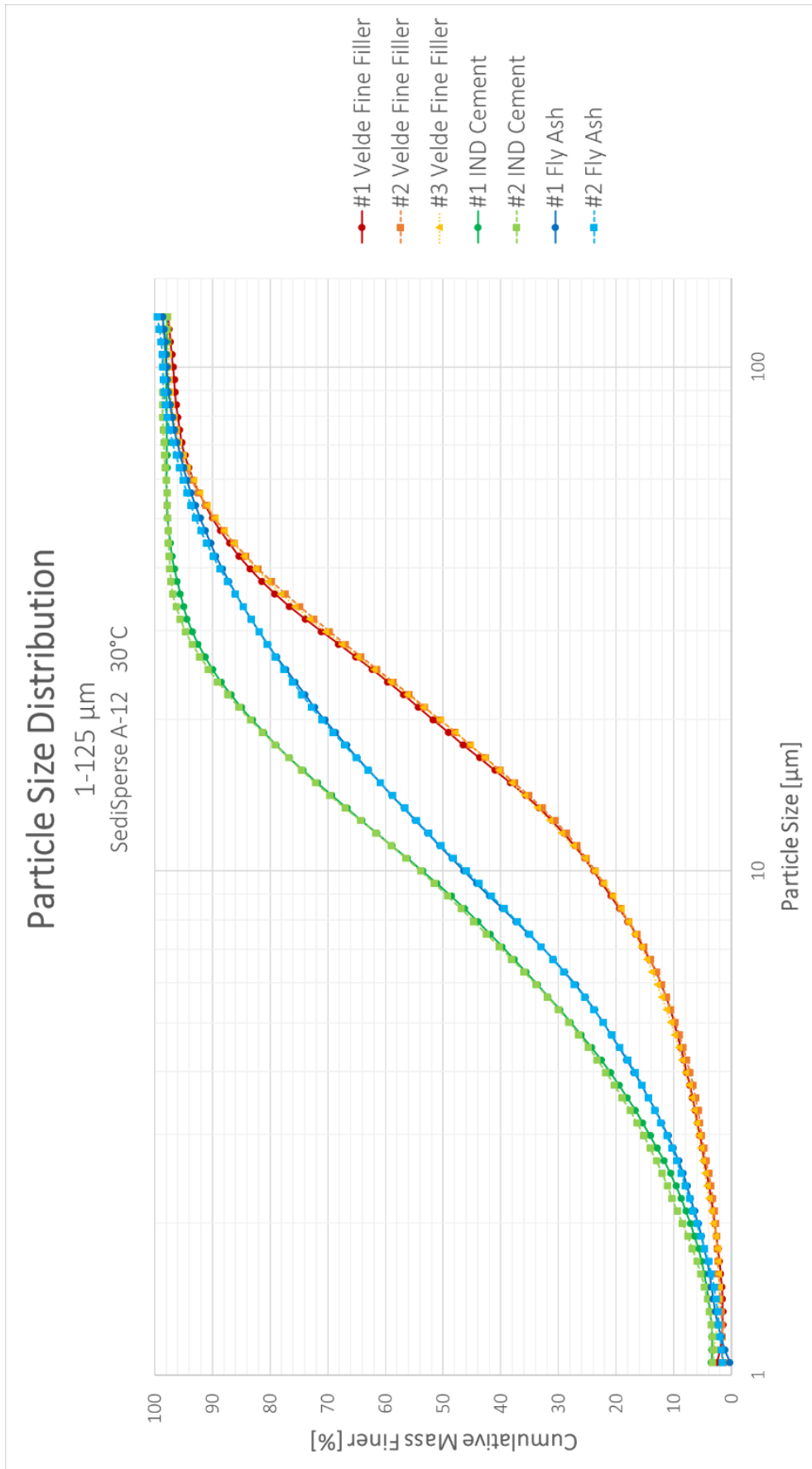

Figure 26: Particle Size Distribution of Velde Fine Filler, Industrisement and Fly Ash. 1-125 µm. SediSpere A-12 as dispersing liquid. [Figure 13]

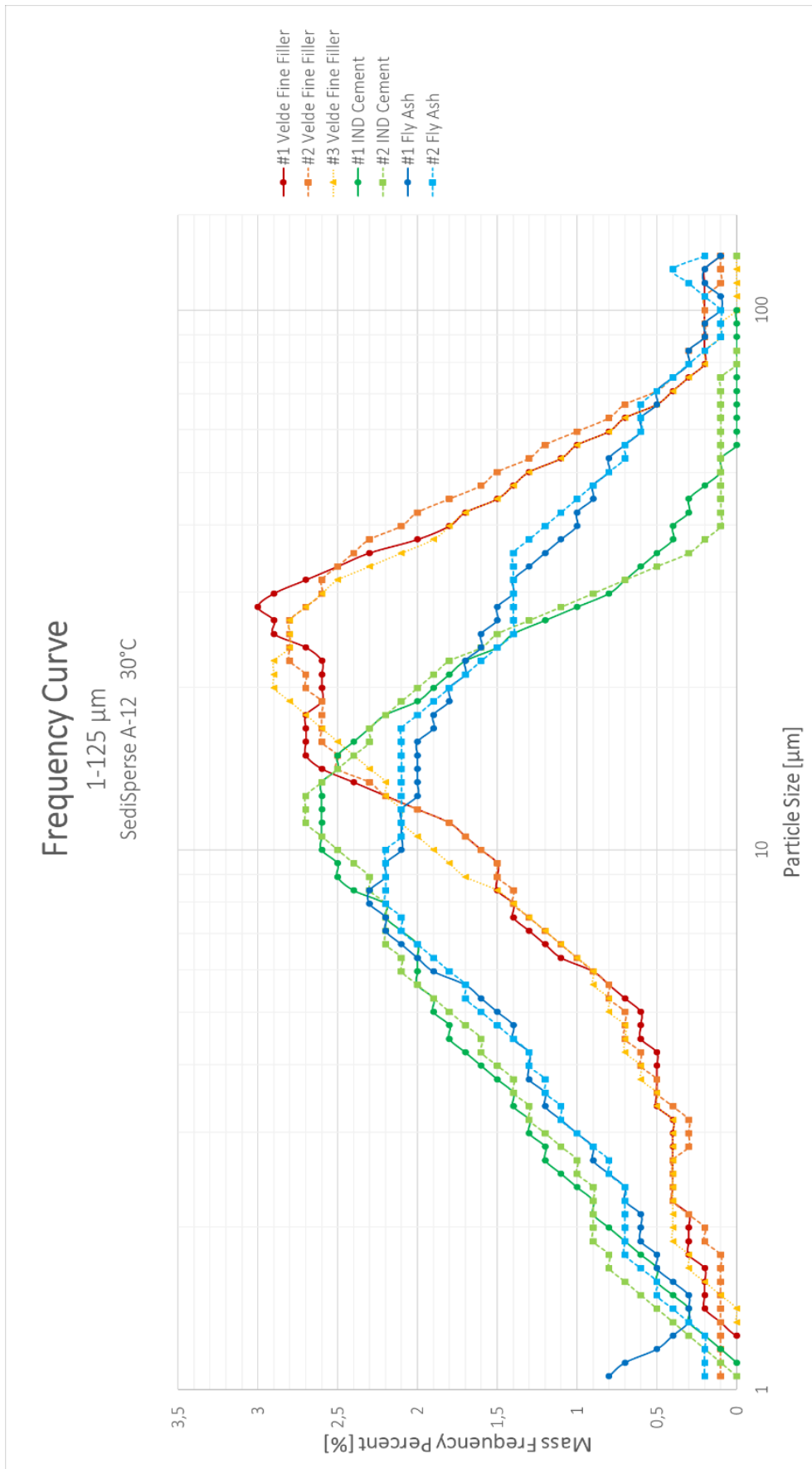

Figure 27: Frequency Curves of Velde Fine Filler, Industrisement and Fly Ash. 1-125 μm . SediSperser A-12 as dispersing liquid. [Figure 14]

APPENDIX

SSA Calculation Printout of Excel Sheet

Specific surface calculation - Velde Fine Filler 125 micron #1 SediSperse A-12 30C							
000-117							
S_p/V_p Sphere= $3/r$							
Size	Cumulative Finer Mass Percent	Vol, passing	Bin mean diamter	Diff, Bin volume	Specific surface	Diff, specific surface	Cumulative specific surface
[μ m]	[%]	[%]	[mm]	[%]	[1/mm]	[%]	[%]
125,9	97,7	97,7	-	-	-	-	100,00
118,9	97,5	97,5	122,4	0,20	0,1	0,01	99,99
112,2	97,3	97,3	115,6	0,20	0,1	0,01	99,97
105,9	97	97,0	109,1	0,30	0,2	0,02	99,95
100	96,8	96,8	103,0	0,20	0,1	0,02	99,93
94,41	96,6	96,6	97,2	0,20	0,1	0,02	99,92
89,13	96,5	96,5	91,8	0,10	0,1	0,01	99,91
84,14	96,3	96,3	86,6	0,20	0,1	0,02	99,89
79,43	96	96,0	81,8	0,30	0,2	0,03	99,86
74,99	95,7	95,7	77,2	0,30	0,2	0,03	99,83
70,79	95,3	95,3	72,9	0,40	0,3	0,05	99,78
66,83	94,8	94,8	68,8	0,50	0,4	0,06	99,72
63,1	94,1	94,1	65,0	0,70	0,6	0,09	99,63
59,57	93,3	93,3	61,3	0,80	0,8	0,11	99,53
56,23	92,3	92,3	57,9	1,00	1,0	0,14	99,38
53,09	91,2	91,2	54,7	1,10	1,2	0,17	99,22
50,12	90	90,0	51,6	1,20	1,4	0,19	99,03
47,32	88,6	88,6	48,7	1,40	1,7	0,24	98,79
44,67	87	87,0	46,0	1,60	2,1	0,29	98,50
42,17	85,4	85,4	43,4	1,60	2,2	0,30	98,20
39,81	83,5	83,5	41,0	1,90	2,8	0,38	97,82
37,58	81,5	81,5	38,7	2,00	3,1	0,43	97,39
35,48	79,2	79,2	36,5	2,30	3,8	0,52	96,88
33,5	76,7	76,7	34,5	2,50	4,3	0,60	96,28
31,62	73,9	73,9	32,6	2,80	5,2	0,71	95,57
29,85	71,1	71,1	30,7	2,80	5,5	0,75	94,82
28,18	68,1	68,1	29,0	3,00	6,2	0,85	93,97
26,61	65,2	65,2	27,4	2,90	6,4	0,87	93,10
25,12	62,3	62,3	25,9	2,90	6,7	0,92	92,18
23,71	59,6	59,6	24,4	2,70	6,6	0,91	91,27
22,39	56,9	56,9	23,1	2,70	7,0	0,96	90,30
21,13	54,3	54,3	21,8	2,60	7,2	0,98	89,32
19,95	51,7	51,7	20,5	2,60	7,6	1,04	88,28

19,95	51,7	51,7	20,5	2,60	7,6	1,04	88,28
18,84	49,1	49,1	19,4	2,60	8,0	1,10	87,17
17,78	46,5	46,5	18,3	2,60	8,5	1,17	86,01
16,79	43,7	43,7	17,3	2,80	9,7	1,33	84,67
15,85	41	41,0	16,3	2,70	9,9	1,36	83,31
14,96	38,3	38,3	15,4	2,70	10,5	1,44	81,87
14,13	35,7	35,7	14,5	2,60	10,7	1,47	80,40
13,34	33,3	33,3	13,7	2,40	10,5	1,44	78,96
12,59	31,1	31,1	13,0	2,20	10,2	1,40	77,56
11,89	29,1	29,1	12,2	2,00	9,8	1,34	76,22
11,22	27,2	27,2	11,6	1,90	9,9	1,35	74,86
10,59	25,5	25,5	10,9	1,70	9,4	1,28	73,58
10	23,9	23,9	10,3	1,60	9,3	1,28	72,30
9,441	22,4	22,4	9,7	1,50	9,3	1,27	71,03
8,913	20,9	20,9	9,2	1,50	9,8	1,35	69,69
8,414	19,4	19,4	8,7	1,50	10,4	1,42	68,26
7,943	18	18,0	8,2	1,40	10,3	1,41	66,85
7,499	16,6	16,6	7,7	1,40	10,9	1,49	65,36
7,079	15,4	15,4	7,3	1,20	9,9	1,35	64,01
6,683	14,2	14,2	6,9	1,20	10,5	1,44	62,57
6,31	13,1	13,1	6,5	1,10	10,2	1,39	61,18
5,957	12,2	12,2	6,1	0,90	8,8	1,21	59,97
5,623	11,3	11,3	5,8	0,90	9,3	1,28	58,69
5,309	10,6	10,6	5,5	0,70	7,7	1,05	57,64
5,012	10	10,0	5,2	0,60	7,0	0,96	56,68
4,732	9,4	9,4	4,9	0,60	7,4	1,01	55,67
4,467	8,8	8,8	4,6	0,60	7,8	1,07	54,59
4,217	8,3	8,3	4,3	0,50	6,9	0,95	53,64
3,981	7,8	7,8	4,1	0,50	7,3	1,00	52,64
3,758	7,2	7,2	3,9	0,60	9,3	1,28	51,36
3,548	6,8	6,8	3,7	0,40	6,6	0,90	50,46
3,35	6,3	6,3	3,4	0,50	8,7	1,19	49,27
3,162	5,9	5,9	3,3	0,40	7,4	1,01	48,26
2,985	5,5	5,5	3,1	0,40	7,8	1,07	47,19
2,818	5,1	5,1	2,9	0,40	8,3	1,13	46,05
2,661	4,7	4,7	2,7	0,40	8,8	1,20	44,85
2,512	4,3	4,3	2,6	0,40	9,3	1,27	43,58
2,371	3,9	3,9	2,4	0,40	9,8	1,35	42,23
2,239	3,6	3,6	2,3	0,30	7,8	1,07	41,16
2,113	3,2	3,2	2,2	0,40	11,0	1,51	39,65
1,995	2,9	2,9	2,1	0,30	8,8	1,20	38,44
1,884	2,6	2,6	1,9	0,30	9,3	1,27	37,17
1,778	2,4	2,4	1,8	0,20	6,6	0,90	36,27
1,679	2,1	2,1	1,7	0,30	10,4	1,43	34,84
1,585	1,9	1,9	1,6	0,20	7,4	1,01	33,84
1,496	1,7	1,7	1,5	0,20	7,8	1,07	32,77
1,413	1,6	1,6	1,5	0,10	4,1	0,57	32,20
1,334	1,5	1,5	1,4	0,10	4,4	0,60	31,60
1,259	1,5	1,5	1,3	0,00	0,0	0,00	31,60
1,189	1,7	1,7	1,2	-0,20	-9,8	-1,34	32,95
1,122	2	2,0	1,2	-0,30	-15,6	-2,14	35,08
1,059	2,5	2,5	1,1	-0,50	-27,5	-3,77	38,86
0		0,0	0,5	2,50	283,3	38,86	0,00
				97,70	729,0	100,00	
				min 1 micro	445,8		
				min 2 micro	448,8		
				min10micro	201,9		
				min20micro	85,5		

APPENDIX K

pH and Hydration



0.2% Sodium Hexametaphosphate

Thin film on the liquid surface.



SediSpere A-11

3 well defined layer



After 1 week

0.2% Sodium Hexametaphosphate

White crystals on top of the film

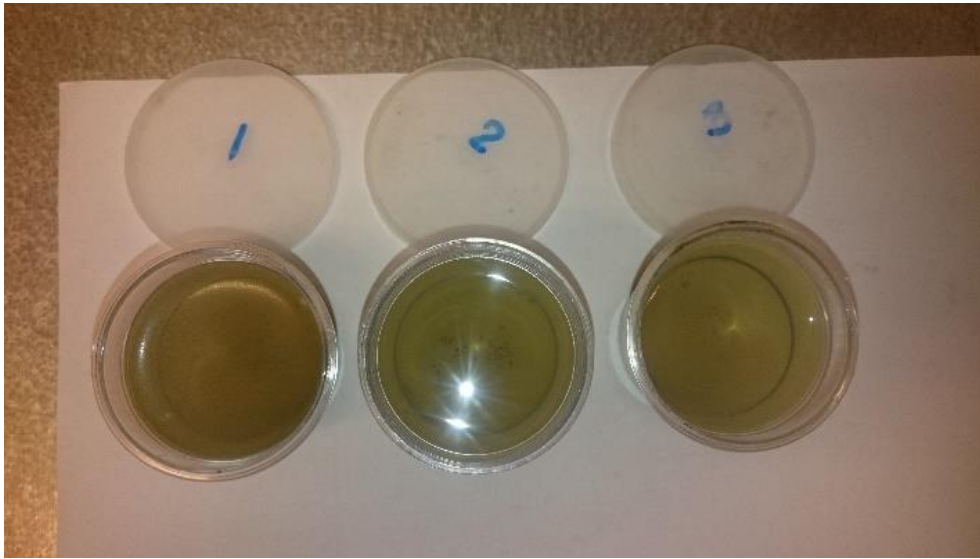

After 1 day

1. 0.2% Sodium Hexametaphosphate: Thin film on the liquid surface and lines on the surface.
2. Isopropanol: Clearest liquid and well-defined dots on the surface.
3. SediSpers A-12: Least clear liquid and dots on the surface.

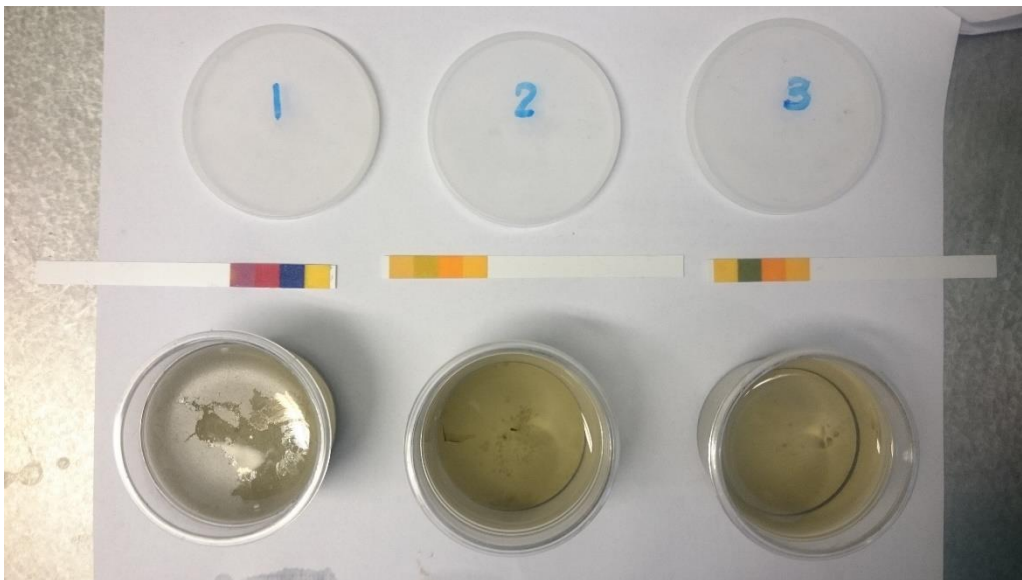

After 1 week

1. 0.2% Sodium Hexametaphosphate
2. Isopropanol
3. SediSpers A-12

List of Dispersing Liquids

1 – 125 µm, Analysis time ≤ 1 hour

Velde Fine Filler: 2.64 g/cm³

Dispersing Liquids	Set Temp 1: 26,5 °C					Set Temp 2: 30 °C					Set Temp 3: 35 °C				
	Density [g/cm ³]	Viscosity [mPa·s]	Maximum Diameter [µm]	Reynolds Number	Time [min]	Density [g/cm ³]	Viscosity [mPa·s]	Maximum Diameter [µm]	Reynolds Number	Time [min]	Density [g/cm ³]	Viscosity [mPa·s]	Maximum Diameter [µm]	Reynolds Number	Time [min]
30% Sucrose	1.1246	2.6209	130.47	0.26	26	1.1232	2.3751	122.19	0.32	24	1.1211	2.0767	111.75	0.42	21
40% Glycerin	1.0963	3.0413	144.45	0.19	30	1.0948	2.7291	134.37	0.24	27	1.0926	2.3400	121.30	0.33	23
40% Sucrose	1.1737	4.9091	197.61	0.08	52	1.1721	4.3773	183.07	0.10	46	1.1699	3.7467	165.07	0.13	39
50% Glycerin	1.1229	4.7956	195.21	0.08	49	1.1211	4.2505	180.12	0.10	43	1.1184	3.5400	159.50	0.14	36
A-12 Lot 102 Sedisperse	0.8112	4.4950	195.79	0.08	38	0.8088	4.0285	182.09	0.10	34	0.8053	3.4687	164.94	0.13	29
Kerosene	0.7818	2.6718	139.38	0.22	22	0.7771	2.1053	119.05	0.35	17	0.7730	1.8200	108.14	0.46	15
n-Butanol	0.8046	2.4977	132.53	0.25	21	0.8019	2.2935	125.28	0.30	19	0.7979	2.0217	115.29	0.38	17
P-12 Lot 101 Sedisperse	0.8150	4.8932	207.01	0.07	41	0.8130	4.4342	193.93	0.08	37	0.8107	3.8641	177.03	0.11	32
W-12 Lot198 Sedisperse	1.1175	4.3734	183.66	0.09	41	1.1155	3.8910	169.91	0.12	39	1.1130	3.3300	153.19	0.16	33

1 – 125 µm, Analysis time ≤ 1 hour

Cement: 3.15 g/cm³ (Cement used in this thesis: Industrisement: 3.13 g/cm³)

Dispersing Liquids	Set Temp 1: 26,5 °C					Set Temp 2: 30 °C					Set Temp 3: 35 °C				
	Density [g/cm ³]	Viscosity [mPa·s]	Maximum Diameter [µm]	Reynolds Number	Time [min]	Density [g/cm ³]	Viscosity [mPa·s]	Maximum Diameter [µm]	Reynolds Number	Time [min]	Density [g/cm ³]	Viscosity [mPa·s]	Maximum Diameter [µm]	Reynolds Number	Time [min]
40% <u>Sucrose</u>	1.1737	4.9095	178.91	0.10		1.1721	4.3790	165.85	0.13		1.1699	3.7467	149.47	0.18	
40% <u>Glycerin</u>	1.0963	3.0417	131.32	0.26		1.0948	2.7317	122.33	0.32		1.0926	2.3400	110.31	0.44	
50% <u>Glycerin</u>	1.1229	4.7957	177.24	0.11		1.1211	4.2512	163.57	0.13		1.1184	3.5400	144.85	0.19	
A-12 Lot 102 <u>Sedisperse</u>	0.8112	4.4945	180.36	0.10		0.8088	4.0292	167.80	0.12		0.8053	3.4687	151.99	0.17	
P-12 Lot 101 <u>Sedisperse</u>	0.8150	4.8940	190.70	0.08		0.8130	4.4331	178.63	0.10		0.8107	3.8641	163.10	0.14	
W-12 Lot198 <u>Sedisperse</u>	1.1175	4.3749	166.83	0.10		1.1155	3.8903	154.31	0.16		1.1130	3.3300	139.16	0.22	

1 – 125 µm, Analysis time ≤ 1 hour

Fly Ash: 2.38 g/cm³

Dispersing Liquids	Set Temp 1: 26,5 °C					Set Temp 2: 30 °C					Set Temp 3: 35 °C				
	Density [g/cm ³]	Viscosity [mPa·s]	Maximum Diameter [µm]	Reynolds Number	Time [min]	Density [g/cm ³]	Viscosity [mPa·s]	Maximum Diameter [µm]	Reynolds Number	Time [min]	Density [g/cm ³]	Viscosity [mPa·s]	Maximum Diameter [µm]	Reynolds Number	Time [min]
30% <u>Sucrose</u>	1.1246	2.6201	138.89	0.22		1.1232	2.3748	130.09	0.27		1.1211	2.0767	118.97	0.35	
40% <u>Glycerin</u>	1.0963	3.0414	153.57	0.16		1.0948	2.7307	142.92	0.20		1.0926	2.3400	128.97	0.27	
50% <u>Glycerin</u>	1.1229	4.7958	207.84	0.07		1.1211	4.2521	191.83	0.08		1.1184	3.5400	169.78	0.12	
n-Butanol	0.8046	2.4979	139.46	0.22		0.8019	2.2930	131.80	0.26		0.7979	2.0217	121.28	0.33	
A-12 Lot 102 <u>Sedisperse</u>	0.8112	4.4949	206.05	0.07		0.8088	4.0273	191.59	0.08		0.8053	3.4687	173.56	0.11	
P-12 Lot 101 <u>Sedisperse</u>	0.8150	4.8938	217.90	0.06		0.8130	4.4334	204.09	0.07		0.8107	3.8641	186.31	0.09	
W-12 Lot198 <u>Sedisperse</u>	1.1175	4.3743	195.51	0.08		1.1155	3.8908	180.84	0.10		1.1130	3.3300	163.03	0.14	