



Norwegian University of
Science and Technology

Energy Consumption of a Hybrid Additive- Subtractive Manufacturing Process

Espen Braastad

Master of Science in Mechanical Engineering

Submission date: June 2017

Supervisor: Torgeir Welo, MTP

Co-supervisor: Omar Fergani, MTP

Norwegian University of Science and Technology
Department of Mechanical and Industrial Engineering

PREFACE

This Master's thesis serves as the completion of the five-year-long integrated Master's degree program in Mechanical Engineering at the Department of Mechanical and Industrial Engineering, at the Norwegian University of Science and Technology (NTNU), Trondheim, Norway, under the supervision of Professor Torgeir Welo and Omar Fergani.

The project and work for this Master's thesis started from scratch in mid-January 2017. The author has no prior experience with environmental analysis, nor system engineering, and the initial phase of the work went to literature studies and gaining as much insight and knowledge as possible. The project proved to be exciting and stimulating, yet challenging. The author has a background in Mechanical Engineering with a specialisation in Material Science. Additive manufacturing is one of the author's greatest interests and is what that drew him into the project.

ACKNOWLEDGEMENT

I would like to address my sincere thanks to Professor Torgeir Welo for giving me the opportunity to work on this exciting project for my last semester at NTNU. Further, my sincere gratitude goes to Omar Fergani for your close supervision, encouragement, and valuable input. Thank you for always being ambitious and eager on my behalf. I have learned a lot from you, and I am glad to call you my friend.

I would like to thank Professor Cecilia Haskins for introducing me to system engineering and for pointing me in the right direction, and Marit Moe Bjørnbe from SINTEF for introducing me to the ways of life cycle assessment. Further, I would like to thank Frédéric Le Moullec from BeAM Machines, France, for being so kind and providing me with valuable data for my analysis.

I would like to thank the examination committee for the time and effort it takes to review my work.

I would like to thank my close and "extended" family for their continuous support and encouragement through my entire life, and for always cheering me on. I wouldn't be where I am today if it weren't for you teaching me from an early age to be curious and to stay motivated. Home has never been farther away than a phone call or a train ride.

These past five years have been some of the best time in my life, and my close friends and colleagues from my study played a huge part in that experience. I am grateful for all the fun times we shared in and outside of the university, home and abroad, and I hope there is still more to come. Thank you all.

ABSTRACT

Manufacturing account for a significant portion in the global electricity use and CO₂ emissions, and it has become essential to mitigate the environmental impact with more efficient manufacturing and resource utilisation (United Nations Environment Program (UNEP), 2011). Additive Manufacturing (AM) has proven to be a promising manufacturing process regarding environmental and economic aspects, where one of the key environmental benefits of AM has been accounted to material savings. Recently, a new class of manufacturing processes called Hybrid Manufacturing (HM) have emerged, where AM and traditional machining are combined in one machine tool, exploiting the strengths of additive and subtractive manufacturing. As the energy requirements in HM is seldom explored in existing literature, the work of this Master's thesis aims towards developing an energy assessment framework for the HM system. This was achieved by identifying the underlying subsystems as energy consuming units. A system engineering methodology was employed for the design and analysis of the framework. To validate the proposed framework, a case study was designed to investigate the environmental footprint of multiple components made of a Titanium alloy using different processing routes. The outcome of the case study identified the energy consuming units within an HM machine and provided a baseline for a life cycle-based environmental comparison of different manufacturing approaches. The results suggested that the energy consumption in HM is stable, where the auxiliary systems account for the dominant part of the energy consumption, and that process parameters not influencing the process time is relatively insignificant. The comparative study showed that AM and HM processes are more environmental friendly for components with small solid-to-cavity ratio. For larger ratios, machining proved to be more efficient.

This is the abstract in Norwegian.

Produksjon har blitt kjent til å utgjøre en vesentlig andel av det globale elektrisitetsforbruket og CO₂-utslipp, og det har blitt viktig å redusere miljøbelastningen ved å rette fokus mot effektiv produksjon og ressursutnyttelse (United Nations Environment Program (UNEP), 2011). Additiv tilvirkning (AM) har vist seg å være en lovende produksjonsprosess når det kommer til miljømessige og økonomiske aspekter, hvor en av de viktigste miljøfordelene til AM kan relateres til effektiv materialutnyttelse. Nylig utvikling av produksjonsprosesser har ført til en hybrid-prosess (HM) som kombinerer AM og tradisjonell maskinering i en og samme produksjonsmaskin, hvor kombinasjonen utnytter styrken til både additive og subtraktiv produksjon. Da energiforbruk i HM sjeldent utforskes i den eksisterende litteraturen, rettes arbeidet i denne masteroppgaven mot utviklingen av en analysemodell for energiforbruk i HM-systemet ved å identifisere de underliggende delsystemene som energi-forbrukende enheter. En System Engineering-metode ble anvendt i designfasen av system- og analyserammeverket. For å validere den foreslåtte modellen, ble den tatt i bruk i en case-studie som undersøkte miljøbelastningen for varierende produkter av en titanlegering, produsert basert på forskjellige teknologier. Resultatet fra case-studien identifiserte de energi-forbrukende enhetene i en HM-maskin, og dannet et grunnlag for en livssyklus-basert komparativ miljøanalyse for alternative produksjonsteknologier. Videre viste resultatene at energifordelingen i HM er stabil, hvor støttesystemene utgjorde hoveddelen av energiforbruket, og at prosessparametere som ikke endrer prosesseringstiden er relativt ubetydelige. Den komparative studien viste at AM- og HM-prosessene er mer miljøvennlige for komponenter med lav solid-til-hull-forhold. For større forholdstall ble maskinering vist til å være mer effektivt.

Preface	iii
Acknowledgement	v
Abstract	vii
Sammendrag	ix
Table of Contents	xii
List of Tables	xiii
List of Figures	xvi
List of Appendices	xvii
Abbreviations	xix
Chapter 1 Introduction and Background	1
1.1 Introduction	1
1.1.1 Problem Description and Thesis Scope	2
1.1.2 Structure of Thesis	2
1.2 Literature Review	3
1.3 Background	8
1.3.1 System Engineering	8
1.3.2 Life Cycle Based Modelling	9
1.3.3 Conventional Machining	12
1.3.4 Additive Manufacturing	13

1.3.5	Hybrid Manufacturing	17
1.4	Identification of System Stakeholders and Needs	20
1.5	Problem Statement and Research Question	21
1.5.1	Measure of Effectiveness	23
1.5.2	System Boundaries	23
1.6	Analysis	26
1.6.1	System Requirements	26
1.6.2	Behaviour	26
1.6.3	Verification and Validation	27
1.7	Trade-offs	29
Chapter 2	Physics-Based Modelling	31
2.1	Conventional Machining	31
2.2	Additive Manufacturing	35
2.3	Hybrid Manufacturing	37
Chapter 3	Case Study and Analysis	39
3.1	Life Cycle Based Modelling	39
3.1.1	Case Study Presentation	39
3.1.2	Goal and Scope of Case Study	39
3.1.3	Functional Unit	40
3.1.4	The Product	40
3.1.5	System Boundaries	42
3.1.6	Impact Metrics	43
3.2	Analysis	46
3.2.1	Life Cycle Inventory	46
3.3	Results	51
Chapter 4	Discussion and Conclusion	59
4.1	Discussion	59
4.2	Conclusion	62
4.3	Further Work	63
Bibliography		65
Appendix		I

LIST OF TABLES

1.1	Summary of different existing additive manufacturing technologies based on standard ASTM f2792 (2013)	16
1.2	Stakeholders and their needs	21
1.3	MoEs of HM framework and thesis work	23
3.1	Dimensions and geometrical features	42
3.2	Life Cycle Inventory for Ti6Al4V	47
3.3	Process parameters in conventional machining operations	49
3.4	Process parameters in additive manufacturing (EBM)	49
3.5	Process parameters in hybrid manufacturing	49
3.6	Power requirement data for manufacturing platforms	50

LIST OF FIGURES

1.1	The SPADE methodology	8
1.2	System boundary levels in LCA	10
1.3	The principles of a turning process	12
1.4	Principles of powder bed fusion	14
1.5	Illustration of the EBM process	15
1.6	Illustration of processing in hybrid manufacturing	18
1.7	Illustration of a DMD deposition head	19
1.8	WSOI and life cycle for hybrid manufacturing	25
1.9	Framework for energy consumption in hybrid manufacturing	26
1.10	Functional flow block diagram of the system analysis behaviour	28
2.1	Environmental analysis dimensions for manufacturing processes	32
2.2	Schematic drawing of a typical turning machine tool	33
2.3	Fuzzy values for power consumption during machining process	34
2.4	The decomposition of the HM system into subsystems, identifying the ECUs in HM	38
3.1	Design of the component for the study. The geometry has interior and exterior features.	41
3.2	Cross section showing the increasing mass of the component	42
3.3	Life cycle for conventional machining	44
3.4	Life cycle for additive manufacturing (EBM)	45
3.5	Building strategy in EBM	48
3.6	Energy distribution sorted by energy consuming subsystems in hybrid manufac- turing for Geometry no 1	52

3.7	Energy consumption and CO ₂ .eq through the life cycle for Geometry no 1 . . .	53
3.8	Energy distribution sorted by energy consuming subsystems in hybrid manufacturing for Geometry no 2	54
3.9	Energy consumption and CO ₂ .eq through the life cycle for Geometry no 2 . . .	54
3.10	Energy distribution sorted by energy consuming subsystems in hybrid manufacturing for Geometry no 3	56
3.11	Energy consumption and CO ₂ .eq through the life cycle for Geometry no 3 . . .	56
3.12	Energy consumption for all manufacturing processes and all three geometries, showing the change in energy requirement based on change in solid-to-cavity ratio	58
3.13	CO ₂ .eq emissions for all manufacturing processes and all three geometries, showing the change in CO ₂ .eq cost based on change in solid-to-cavity ratio . .	58

LIST OF APPENDICES

A - Risk Assessment I
B - Technical Drawings III

ABBREVIATIONS

AM	=	Additive Manufacturing
CLAD	=	Direct Additive Laser Manufacturing (Construction Laser Additive Directe in French)
CM	=	Conventional Manufacturing
CO ₂ .eq	=	Carbon-Equivalent
DfAM	=	Design for Additive Manufacturing
DLD	=	Direct Laser Deposition
DMD	=	Direct Metal Deposition
EBM	=	Electron Beam Melting
ECU	=	Energy and resource Consuming Unit
FCGR	=	Fatigue Crack Growth Rate
FDM	=	Fused Deposition Modelling
FFBD	=	Functional Flow Block Diagram
GWP	=	Global Warming Potential
HM	=	Hybrid Manufacturing
LCA	=	Life Cycle Assessment
LCI	=	Life Cycle Inventory
LCIA	=	Life Cycle Impact Assessment
MoE	=	Measure of Effectiveness
SDG	=	Sustainable Development Goal
SEC	=	Specific Energy Consumption
SFF	=	Solid Freeform Fabrication
SLM	=	Selective Laser Melting
SLS	=	Selective Laser Sintering
SoI	=	System-of-Interest
V&V	=	Verification and Validation
WSoI	=	Wider System-of-Interest

CHAPTER 1

INTRODUCTION AND BACKGROUND

1.1 Introduction

It is reported that manufacturing accounts for some 35 % of the global electricity use, 20 % of the CO₂ emissions, and a quarter of the primary resource extraction. It becomes evident that manufacturing has a significant impact on the environment and that there are possibilities to mitigate the impact with more efficient manufacturing (United Nations Environment Program (UNEP), 2011). Making a shift towards circular economy in the way industries manufacture products will contribute towards reducing the negative environmental impacts of manufacturing. In some cases, just redesigning a product can improve not only the product's life span, but also lead to a more efficient use of resources, easier recycling, and less pollution during the manufacturing process and use-phase of the product (United Nations Environment Program (UNEP), 2011; Despeisse and Ford, 2015). Managing the environmental aspects during discrete part manufacturing has become more important as stakeholders awareness has increased.

Additive manufacturing of metallic parts has proven to be a promising manufacturing process with the ability to create complex structures with little to no waste. The technology can be used alongside more conventional manufacturing processes, and it can be combined with traditional subtractive manufacturing in a new hybrid process. Hybrid manufacturing utilises the flexibility of freeform fabrication with additive manufacturing and the precision and robustness of material removal operations, all in the same machine tool. The research in this field regarding the technological integration of the hybrid process and the environmental aspects is seldom explored in existing literature.

Employing system engineering tools and managing the hybrid manufacturing process holistically, the energy requirement of the hybrid process can be assessed. Further, important aspects of the life cycle of a product contribute to the final environmental signature, and must, therefore, be considered. The overall energy requirement and environmental footprint of discrete part manufacturing can be assessed with a life cycle based approach.

1.1.1 Problem Description and Thesis Scope

The primary goal of this Master's thesis has been to develop an energy requirement analysis framework for a hybrid manufacturing process. By identifying the stakeholders related to this project and their needs, and the gaps in the literature, an accurate problem description was formulated. A detailed problem statement and research question can be found in Section 1.5. The further objectives were to assess the environmental life cycle signature of a component undergoing hybrid manufacturing and to compare it to similar analyses of alternative manufacturing approaches in a case study.

1.1.2 Structure of Thesis

The structure of the thesis follows the SPADE framework (Haskins, 2008) to provide a problem-solving method by presenting the requirements, identifying stakeholders and needs, and formulating the problem. Following in Chapter 1 the background for the SPADE framework will be further described, followed by the theoretical mechanical background to accompany the analysis in the later chapters, by introducing the main theories and concepts pertaining the problem domain. Further, the stakeholders will be identified followed by the problem formulation and research question, before measures of effectiveness of the research are described. Following the problem formulation and the definition of system boundaries, the development of the analysis framework is presented. Chapter 2 presents the physics-based modelling based on the fundamentals of conventional machining, additive manufacturing and hybrid manufacturing, utilised in the proposed analysis framework. Further, in Chapter 3 the framework is validated in a case study considering discrete part manufacturing. Lastly, in Chapter 4 the discussion of the results obtained from the case study and the overall execution of the thesis work is found, followed by the conclusion of the Master's thesis and further works.

1.2 Literature Review

With the growing interest in quantifying CO₂ emissions and working towards a greener and more sustainable industry, an increasing amount of research follows. WCED (1987), commonly known as The Brundtland Commission Report, coined the term sustainable development as the ability to ensure to meet the needs of the present without compromising the ability of future generations to meet their own needs.

Models to predict energy consumption in machining has been developed. Power demand and energy consumption of machining operations can be calculated theoretically based on either cutting forces or thermal equilibrium. Oxley (1998) utilised orthogonal machining theory to predict the cutting forces, whereas Armarego et al. (2000) used an empirical approach. However, studies have shown that the energy demand for cutting at the tool tip is merely a small part of the total energy demand for the machine tool (He et al., 2012; Li et al., 2013; Balogun and Mativenga, 2013). The energy consumption of manufacturing operations can be related to the efficiency of the machinery. Auxiliary operations, such as driving motors, pumps, and computer consoles contribute to the energy consumption, resulting in an energy efficiency always lower than 1. Gutowski et al. (2006) introduced an exergy framework based on thermal equilibrium. The model described unit process energy requirement for machining operations and realised that the specific energy requirement for manufacturing processes is not constant, and identified the process rate, i.e. Material Removal Rate (MRR) as the predominant variable. Due to the limitation of the analytic approaches, empirical modelling becomes useful for characterising the relationship between energy consumption and process variables. An empirical model was proposed by Li and Kara (2011). In this study, Li and Kara developed a model for process Specific Energy Consumption (SEC) based on MRR and two empiric coefficients, in agreement to Gutowski et al. exergy framework. The first coefficient was a function of the workpiece material, tool geometry, and spindle drive characteristics, whereas the other coefficient was dependent on the individual machine tool. Hence, the coefficients must be determined experimentally for each case before the model can be utilised. The model was validated for a series of turning processes. Mori et al. (2011) found that power consumption could be reduced for machining operations with higher processing rates, thus shortening the processing time. However, this may compromise surface finish and tool life. It was confirmed by Diaz et al. (2011) that faster processing rates, which leads to increased loads on the spindle motor and axis drives, did not result in an increased total energy consumption. Rajemi et al. (2010) developed a model for optimising machining operations considering minimum energy footprint. The model incorporated optimal tool life and tool manufacturing footprint. Additionally, Rajemi et al. discussed the trade-offs between economic and environmental optimisation, and found that optimising for

minimum energy does not necessarily correlate to minimal cost.

Additive manufacturing, with its ongoing emergence and some 30-year development (Wohlers and Gornet, 2014), suggests an intelligent, sustainable, and cost-effective manufacturing process. It is recognised that the integration of additive manufacturing in conventional manufacturing is more a matter of complementing subtractive manufacturing, rather than replacing it entirely (Wohlers, 2012). Despeisse and Ford (2015) identified the role AM could play in sustainable industrial systems, and how it can lead to resource efficiency in both material realisation and product manufacturing. The environmental aspects of laser-based AM were evaluated and compared to conventional machining for mould and die manufacturing (Morrow et al., 2007). The investigation indicated that for moulds with large solid-to-cavity volume ratio AM had a bigger environmental impact compared to CNC machining, whereas for smaller ratios AM was less environmentally burdensome. It was also shown that DMD's ability to enable remanufacturing and repairs was a critical opportunity to reduce the environmental impact.

The CO2PE!, the Cooperative Effort on Process Emissions in Manufacturing, is an international effort working to document, analyse, and to assess the environmental impact of emerging and available manufacturing processes concerning their direct and indirect emissions. From here Kellens et al. (2012) mentioned the lack in quantitative analysis of environmental impact, and proposed a systematic Life Cycle Inventory (LCI) data collection framework. The proposed framework consists of two approaches with varying level of detail, screening approach and the in-depth approach respectively. Screening, as the name suggests, consists of screening through publicly available data, energy consumption calculations, or software with built in LCI libraries, whereas the in-depth approach is an empiric investigation composed of a time study, a power requirement study, a consumables study, and an emission study, mapping all process related in- and output. Based on the proposed approach, Kellens et al. (2014) described a parametric process model able to assess the environmental impact of the Selective Laser Sintering (SLS) process. It was found that two dominant design features influenced the energy consumption, i.e. volume and build height respectively. Investigating if shape complexity affected the overall energy consumption, Baumers et al. (2016) found no significant correlation between energy consumption and feature richness. The analysis was carried out by applying a computationally quantifiable convexity-based characteristic associated to shape complexity and correlating this with per-layer expended process energy. However, the geometry in the analysis was made so not to incorporate any support structure. Thus a more realistic representation could be achieved by employing this into the analysis. Further, the geometry height was relatively low, and the added complexity did not add to the height, thus keeping the processing time, and by extension the specific energy consumption relatively small.

A case study, covering the data collection effort of impact generating energy and material flow in Selective Laser Melting (SLM) and SLS was conducted (Kellens et al., 2011). A subsequent impact assessment showed that in addition to the electricity consumption, the consumption of inert gasses proved to play an important part of the environmental impact. Furthermore, it was documented that the recyclability for SLS powder suffers from melting of neighbouring binder due to excess heat from the laser, resulting in clumping of powder, rendering it to waste material. As much as 45 % of the input powder turned to waste material.

Mognol et al. (2006) explored optimal process parameters with the intent of reducing energy consumption. They investigated the influence of various parameters, mainly part orientation, volume, and height, for three different AM systems, FDM, Thermojet and SLS respectively. They concluded with the importance of minimising the production time, but there was no universal solution for each AM process. For the thermojet and SLS system, build height contributed more to the production time, whereas for FDM the volume of support structure was the minimising parameter. A mathematical model of the required laser energy in SLS was developed by Paul and Anand (2012). The expended energy was calculated as a function of the total sintered area, which is in correlation with part geometry, layer thickness and the build orientation. However, only laser energy was considered as opposed to the total processing energy. Baumers et al. (2010) carried out a comparative power consumption study between metallic AM platforms, i.e. SLM and Electron Beam Melting (EBM). The comparative assessment revealed that EBM had a significantly lower power consumption rate (kW/kg), as much as 70 % less than SLM. Considering that EBM has a higher mean real power consumption than SLM, EBM still has a lower rate due to higher processing speeds. EBM utilises a high power electron beam, with no moving parts, allowing for high scanning speeds. However, the parameters were not standardised in this study. It was used 316L stainless steel in the SLM platform, and Ti6Al4V titanium in the EBM platform. Steel and titanium have similar specific heat capacity, but Titanium has a lower density, resulting in less energy required to melt it. This can account for some of the variations in the power consumption rates. Even more so, the study did not systematically deal with support structure, leaving the SLM print with a substantial amount of support structure. Furthermore, Strutt (1980) pointed out that energy transfer by an electron beam is around ten times more efficient than by laser beam, in that case, a CO₂ laser.

Serres et al. (2011) compared the environmental aspects of conventional machining to a CLAD process, (Direct additive laser manufacturing, Construction Laser Additive Directe in French), similar to DMD. They performed a Life Cycle Assessment (LCA) with the use of SimaPro software. The study pointed out major environmental savings for CLAD due to the ability to generate minimal scraps, with an impact reduction as much as 70 %. Further, it was proposed to

combine the two processes in a hybrid process, where solid bodies were made conventionally, and features were added additively. This proved to be both economical and environmentally advantageous. The concepts of hybrid manufacturing have been explored and developed by researchers (Hur et al., 2002; Song and Park, 2006; Xiong et al., 2009). In the works of Le Bourhis et al. (2013) it was presented a new methodology for energy consumption and environmental impact assessment for the DMD process, accounting for all elementary flows, i.e. material, fluids, and electricity. They divided the energy consumption into three parts, namely laser system, cooling system and motor drives. The developed methodology utilised both analytic and experimental models. It was found that the biggest impact came from the electricity consumption. Further, the model was tested experimentally by comparing two laser scanning strategies, which culminated in one strategy requiring 11 % more powder material than the other.

It has been shown through life cycle analyses that the adoption of AM can lead to significant economic and environmental savings in the manufacturing and use phase of a product (Despeisse and Ford, 2015). Priarone et al. (2016) conducted in a recent contribution a comparative case study quantifying the factors of influence for both additive and subtractive manufacturing with regards to energy demand and CO₂ emissions. The conventional machining process was compared to an EBM process. They authors conducted a life-cycle based analysis concerning energy demand and CO₂ emissions throughout the life cycle of a component, from material extraction to part disposal. The analysis was carried out with a top-down approach, where different stages of the life cycle were seen as "black boxes". Priarone et al. utilised the model for specific energy consumption proposed by Li and Kara (2011) for the energy calculation of the machining route. However, for the calculations for EBM, an empiric SEC was taken from literature. Hence, the energy calculation for AM was based on mass, not processing time, which has been shown as the predominant factor. The case study showed that for components with a small solid-to-cavity ratio, e.g. thin-walled structures, AM processes are beneficial due to the material savings. A later study by Priarone and Ingarao (2017) continued on the same model. Here the influence of a change in mechanical properties, i.e. reduction in weight for AM compared to CM, on the final component was investigated in the use phase of the life cycle. It was shown that if the components were to be used in transportation, e.g. a plane or truck, the reduction in weight would result in less fuel consumption and therefore, fewer emissions in the use phase. With the use of AM technology and topological design, it is possible to manufacture a more lightweight structure, which otherwise would not be possible to produce with conventional machining. Further, the authors developed a geometry-independent model, taking only mass of the material into account at any stage of the life cycle. The model serves as a useful tool to act as an indicator of the environmental impact of a product with a life cycle perspective. However, if a more accurate estimate is desired, a more detailed model is needed.

Based on the works as mentioned above, it can be seen that research on energy analysis and environmental impact in additive manufacturing and especially for hybrid manufacturing are emerging, but still lacking. Most models rely on experimental work and only consider one specific process or just a part of it. It was shown that environmental aspects are not well studied in AM, and barely touch upon for hybrid manufacturing. The coverage is limited to more conventional machining. It is evident that the relationship between process and design parameters and energy utilisation is unclear, and more analytic based models incorporating this needs to be developed. LCA studies show that AM is more energy demanding concerning electric energy, but the ability to use less material gives it environmentally friendly attributes. With the growing interest in hybrid manufacturing, it will be important to assess the process energy requirement and to substantiate environmental impact using a life-cycle based approach, and quantify how it compares to existing CM and AM processes.

1.3 Background

The theoretical background and framework for the thesis can be found in this section. The background will cover the fundamental aspects of the framework and tools related to this thesis, namely a system engineering framework, life cycle based modelling and a mechanical foundation related to manufacturing processes. The mechanical background provides context to the physics-based modelling found in Chapter 2, and it presents the principles of the manufacturing processes employed in the case study in Chapter 3.

1.3.1 System Engineering

System Engineering (SE) is known to be an iterative and interdisciplinary problem-solving process, which aims to define and configure technical and complex systems (International Council on Systems Engineering and Haskins, 2011). SE implies a systematic and a systemic procedure (Chestnut, 1967). The systematic aspect refers to a thorough and methodical approach to solving a set of problems. Further, systemic refers to pertaining to or affecting a body or system as a whole, implying a holistic view of the system of interest (Haskins, 2008). SE models typically consist of analysis, objective determination, synthesis, decision, and implementation. SE methodology was employed in this thesis to enable a broad and detailed solution and to provide a framework during the structuring of the thesis.

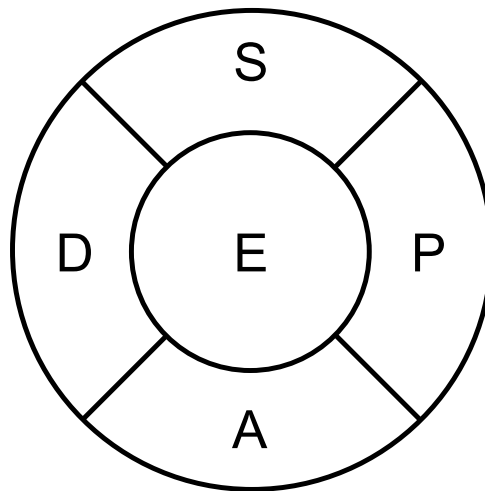

Figure 1.1: The SPADE methodology introduced in Haskins (2008)

To design the study effectively, system engineering as a holistic approach is essential. There is a demand for a systematic methodological way to describe the complex system of a product life cycle and how the various phases behave and interact. Designing the problem formulation of the thesis after the SPADE methodology, a streamlined and visually representative framework of the iterative nature of systems engineering (Haskins, 2008), will aid the author to structure this

thesis and to communicate the motivation and impact of the problem. The SPADE methodology, developed by Haskins (2008), is a non-linear representation, meaning it can be entered at any point and traversed left, right, or across the centre (Figure 1.1). SPADE is an acronym for Stakeholder, Problem, Alternative, Decision-making and Evaluation. According to the SPADE framework, the remainder of the thesis will cover the following:

- S** Stakeholders with an interest in the outcome of the study
- P** Problem formulation, in light of the energy assessment of hybrid manufacturing
- A** Alternatives, presenting life cycle inventory data and applying it to a case study
- D** Trade-offs (Decision-making process)
- E** Discussion and conclusion (Evaluation is continuous throughout the thesis)

1.3.2 Life Cycle Based Modelling

Products and materials have a life cycle, starting with the material acquisition from ores and feedstock. The cycle continues with the manufacturing of components, which are distributed and used. By the end of the products' usable life, they are disposed of and end up as scraps. However, the materials of those products can reenter the life cycle as recycled material and become new products to be used later. This progression can be traced with a life cycle based approach or a thorough life cycle assessment (LCA), documenting the consumption of resources and the emissions during each stage in the life cycle. The outcome of such an approach is a documentation of the handling of materials, where they have been, what they have done, and the consequences and impact for the surrounding environment (Ashby, 2012).

The first formal methods for life cycle assessment came forth by the Society of Environmental Toxicology and Chemistry (SETAC) with a series of guidelines in "A Code of Practice" (Consoli et al., 1993). This gave later rise to a set of standards for conducting an LCA, ISO standard 14040-14043, which were subsequently replaced by two updated versions, ISO 14040:2006 and 14044 (ISO, 2006a,b). These describe LCA as a tool to make comparative assertions to be disclosed to the public. ISO 14040 describes the principles and structure for conducting an LCA, whereas ISO 14044 provides the requirements and guidelines. An LCA study, according to ISO 14040, addresses the environmental aspect and environmental impact throughout a product's life cycle. It considers the use of resources and the potential impact and consequences emissions and releases has on the environment, from raw material extraction/refinement, through the manufacturing stage, use phase and final disposal or recycling, i.e. cradle-to-grave. Further, the standard lists four phases of an LCA study; the goal and scope definition phase, the inventory

analysis phase, the impact assessment phase, and the interpretation phase (ISO, 2006a). The scope definition should include the system boundary and the level of detail (Figure 1.2). The scope depends on the matter and intended use of the study, and the specific goal of an LCA affects the depth and breadth of the analysis considerably. The second phase, the Life Cycle Inventory phase (LCI), consists of generating an inventory of input and output data by collecting the data necessary to meet the goals of the defined study. Third, the Life Cycle Impact Assessment phase (LCIA) provides additional information to further explain the environmental impact and significance of the LCI data. Lastly, the interpretation phase. Here the results from the previous steps are summarised and discussed, and this serves as a basis for conclusions, recommendations and decision-making in accordance with the goal and scope definition of the analysis. Furthermore, in standard ISO 14044, section 6.1, the following items are listed as points that must be considered during any critical review (ISO, 2006b);

the methods used to carry out the LCA are consistent with this International Standard,

the methods employed to carry out the LCA are scientifically and technically valid,

the data used are appropriate and reasonable concerning the goal of the study,

the interpretations reflect the limitations identified and the purpose of the study,

the study report is transparent and consistent.

Figure 1.2 illustrates a life cycle with different levels of system boundaries. System boundary

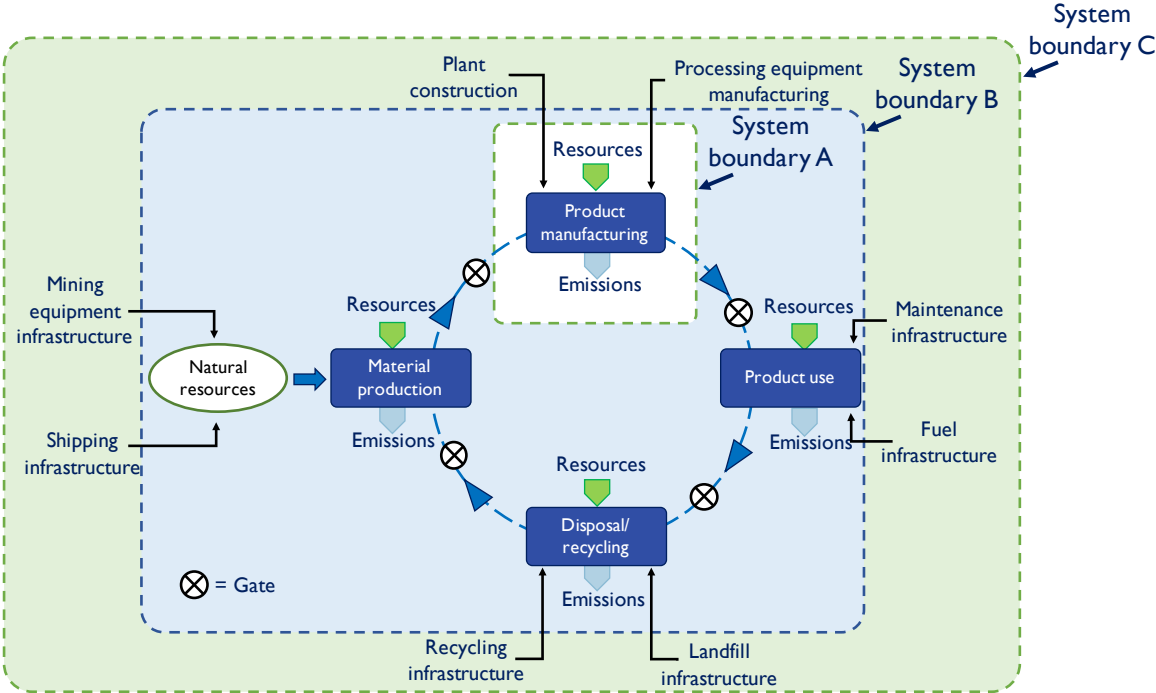

Figure 1.2: Different levels of system boundaries in LCA. System boundary A encapsulates a single unit process of the life cycle, whereas system boundary B includes direct inputs and emissions of the entire life cycle. System boundary C has no definite end. Modified from Ashby (2012)

A encompasses a self-contained unit, i.e. a life cycle phase with a notional gate on each side in-which elementary flow passes, and focuses solely on the aspects of that phase. A study with system boundary A is known as a gate-to-gate study (Ashby, 2012). Further, system boundary B includes the whole life cycle, including the extraction of natural resources and material. However, system boundary C has no clear end. System boundary C includes the resources and effort needed to create mining equipment, manufacturing plants and infrastructure, and the material needed to create that and so forth.

1.3.3 Conventional Machining

The term Conventional Machining (CM) refers in this case to subtractive manufacturing operations, i.e. machining processes that change the shape of a solid body by material removal in the form of chips. The thesis will investigate three main operations, milling, turning and drilling. The principles of a turning process can be seen in Figure 1.3. The operations take place in a machine tool, controlled by Computer Numerical Control (CNC), where computers control the movement and functions of the cutting tools. Modern machines can perform different machining operations within the same machine, e.g. both milling and turning. Operations, such as movement of the tool, cutting parameters, lubrication, etc., are controlled using G and M code based on a three-dimensional Cartesian coordinate system. CNC machine tools are often capable of 3-axes or 5-axes movement.

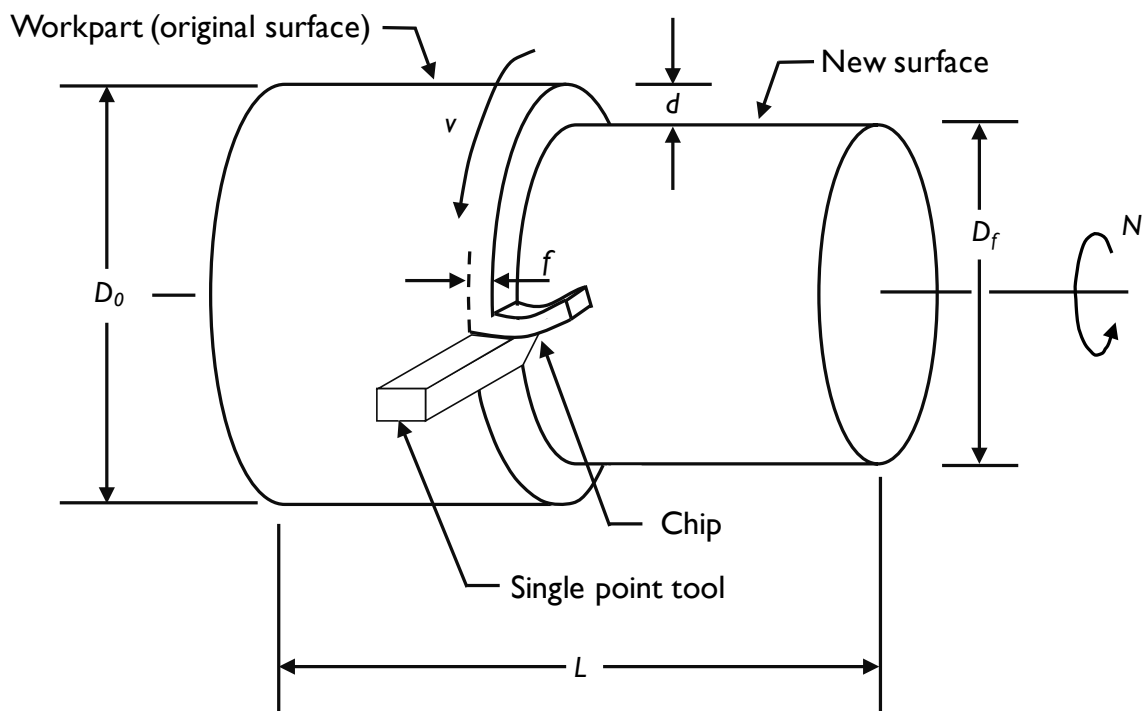

Figure 1.3: The principles of a turning process

1.3.4 Additive Manufacturing

Additive manufacturing (AM) is a new and exciting production process that is seen as a pillar in the next industrial revolution (Rifkin, 2012). It is an enabling technology with applications ranging from auto and aircraft parts, medical and dental implants, prototypes in different industries and much more. Originally, AM was primarily used as a rapid prototyping tool. The goal was to quickly visualise a part or product by making a solid prototype (Gibson et al., 2015). Doubrovski et al. (2011) presented a literature survey on the impact that AM can have on design. The study was focused on the new opportunities of fabrication processes, the relationship between structure and performance, and optimisation approaches. It is evident that AM opens up new possibilities for bionic design. However, there is still a limited knowledge in the field of Design for Additive Manufacturing (DfAM) to further improve design performance (Gao et al., 2015). Challenges related to residual stresses and thermal cracks and deformation are also known challenges related to additive manufacturing. To get a wider understanding of what influences the characteristics of an AM component, exploring the nature of the process is valuable. Mechanical properties have been investigated and documented. However, the lack of standards gives rise to challenges regarding certifying and ensuring part quality and repeatability (Gao et al., 2015). Mechanics of AM concerning residual stresses and tensile properties have been investigated (Vrancken et al., 2014; Zhang et al., 2013; Brice and Hofmeister, 2013; Wu et al., 2014; Carroll et al., 2015). Table 1.1 lists different AM technologies utilising different materials according to ASTM standard f2792. The table also lists the strengths and downside to the different processes.

AM methods of metallic parts are capable of producing three-dimensional fully dense, near-net-shape, complex monolithic structures that can be light weight with optimal geometry and produced on demand. The manufacturing is based on CAD computer files, making the design to manufacturing transition seamless. The most common AM technique utilises a high energy beam to selectively melt a precursor material from either powder or wire form. The parts are manufactured layer-by-layer with fusion by a beam of the added material between each layer, as seen in Figure 1.4. Due to the additive manner of AM parts, less material is wasted, which will, in turn, reduce the material cost for AM parts and also the manufacturing time (Geraedts et al., 2012).

The following paragraph aims to present the principles of the EBM process since this was the baseline for the AM process in the case study in Chapter 3. The EBM process was first commercialised in Gothenburg in Sweden in 1997 (Hopkinson et al., 2006). The processing utilises an electron beam to selectively melt metallic powder, and it takes place inside a vacuum chamber at about 10^{-4} mbar to 10^{-5} mbar. The need for vacuum inside the building chamber is due

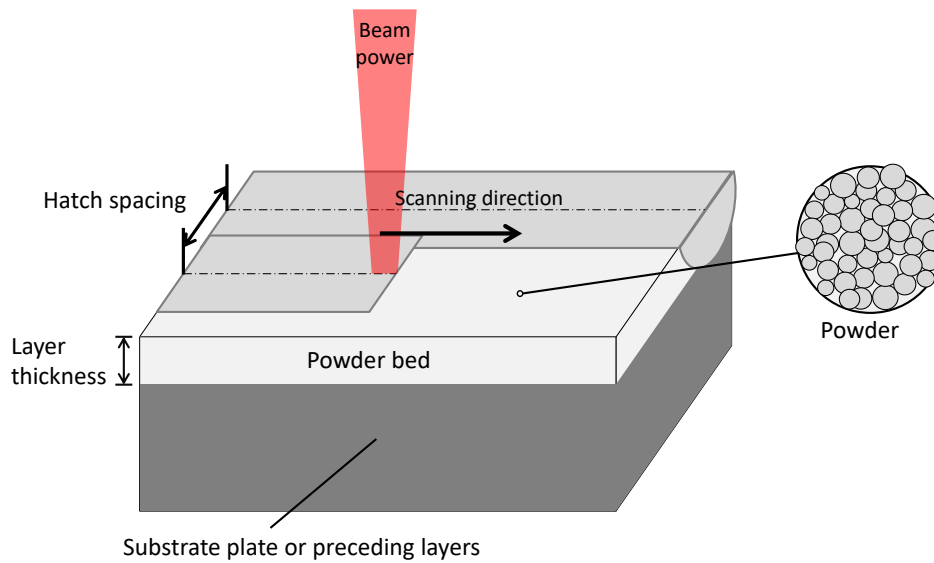

Figure 1.4: Illustration of the principles of powder bed fusion, where a high energy beam selectively melts metallic powder, fusing it to the preceding layers.

to the electron beam easily scatters and diffracts when passed through a gaseous atmosphere. The principles of the EBM process are illustrated in Figure 1.5. The product is manufactured by adding material layer-upon-layer, fusing them selectively together, scanning the top layer line-by-line, to make up a solid geometry. The beam is directed by deflecting it through an adjustable electromagnetic field. This removes the need for scanning mirrors and moving parts, allowing for greater scanning speeds (Hopkinson et al., 2006). The EBM can be seen as an electron optical system, similar to a Scanning Electron Microscope (SEM) (Murr et al., 2009). The chamber consists of a building tank, a build platform, a powder hopper on each side of the platform, a powder coating system comprised of a rake respectively on each side, and a heat shield surrounding the fusing area. The platform is vertically adjustable, and it is lowered by the equivalent to one layer thickness subsequently after each layer of powder has been deposited and scanned. The electron gun is arranged above the building platform. The electrons are accelerated from a high voltage of 60 kV to a velocity between 0.1 and 0.4 of the light-speed (Heinl et al., 2007). The beam is focused by a set of electromagnetic coils into a high energy electron beam. When the electrons hit the powder in the building chamber, their kinetic energy is released as thermal energy, resulting in powder melting with high efficiency. The maximum power of the beam lay around 3500 W, with a spot size of about 0.1 mm to 0.4 mm. After building completion, the part is cooled down either under vacuum or in a helium atmosphere, and the part is cleaned for adherents, mostly partly molten particles. This is done by powder blasting using the same powder as in the build chamber. The unmelted powder can be reused in the next build, after a sieving process (Heinl et al., 2007; Hopkinson et al., 2006).

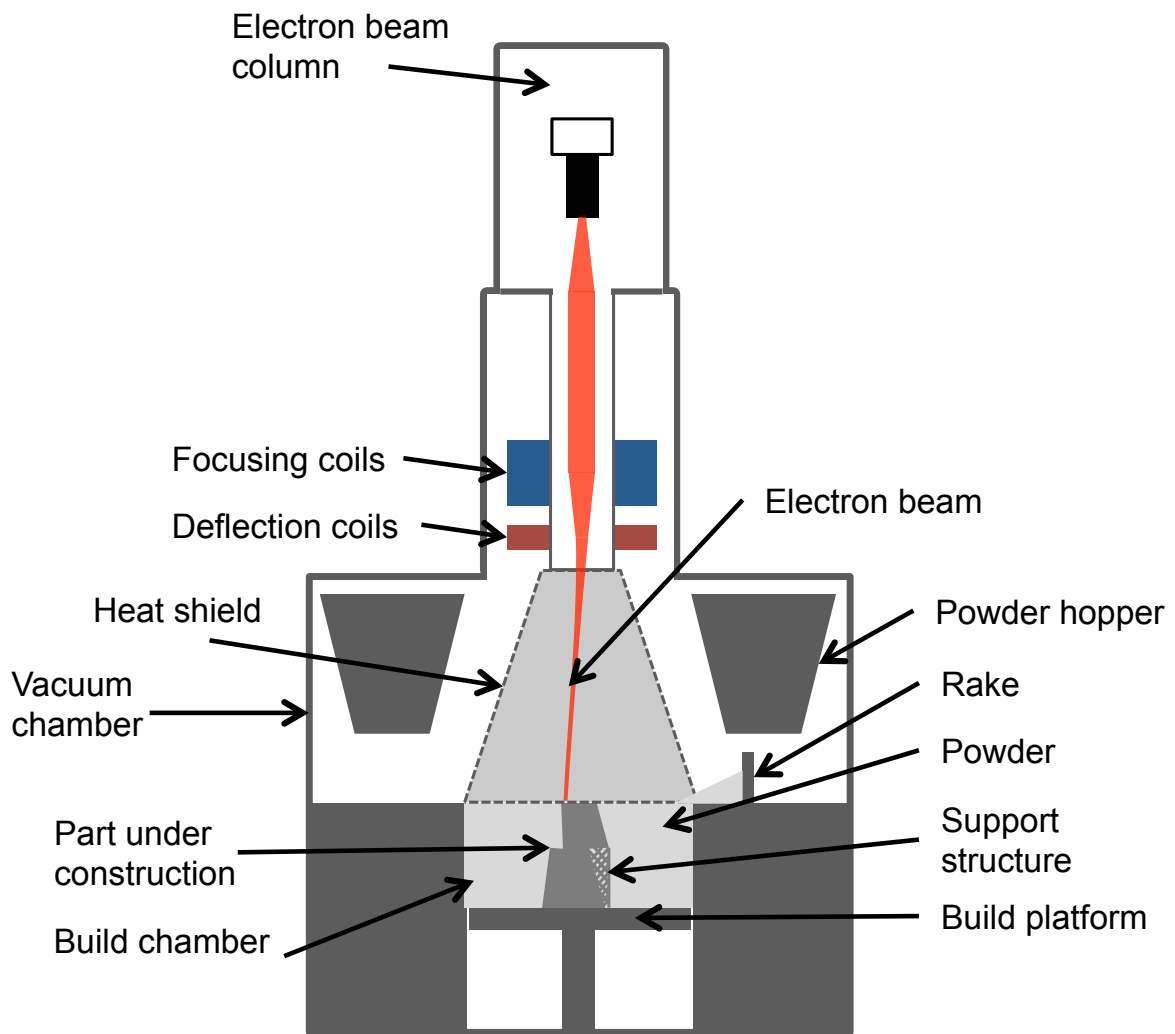

Figure 1.5: Illustration of the EBM process

Table 1.1: Summary of different existing additive manufacturing technologies based on standard ASTM F2792 (2013)

Categories	Technologies	Materials	Power Source	Strengths/ Downsides
Materials extrusion	Fused deposition modelling (FDM)	Thermoplastics, ceramic slurries, metal paste	Thermal energy	Multimaterials Cheap technology Poor surface finish
	Contour crafting	Polyamide/ Polymer		Poor resolution Accurate and fully dense
Powder bed fusion	Selective Laser Sintering SLS			Specific strengths and mechanical properties
	Selective Laser Melting SLM	Atomised metal powder (316L, Ti6Al4V, 17-4 PH), Ceramic powder	High powered laser beam	Powder handling and recycling
	Direct Metal Laser Melting DMLS			Build structures
	Electron Beam Melting EBM		Electron beam	
Photopolymerisation Material jetting	Stereolithography	Photopolymer, ceramic, zircona, PZT	Ultra violet laser	High building speed High resolution Overcuring cost High cost
Material jetting	Polyjet/ Inkjet printing	Photopolymer/ wax	Thermal energy/ Photocuring	Multimaterials printing Low strength
Binder jetting	Indirect inkjet printing (Binder 3DP)	Polymer, ceramic, metal	Thermal energy	Full color printing High porosity
Sheet lamination	Laminated Object Manufacturing (LOM)	Plastic film, metallic sheet, ceramic tape	Laser beam	Low cost Decubing issues
Direct Energy Deposition	Laser Engineered Net Shaping (LENS)			Repair of damaged part Functionally graded materials
	Electronic Beam Welding (EBW)	Molten metal powder	Laser beam	Require post-processing

1.3.5 Hybrid Manufacturing

Hybrid Manufacturing (HM) in its nature is a combination of manufacturing processes. In the context of this thesis, hybrid manufacturing represents the combination of additive and subtractive processes. Companies like the French BeAM (BeAM, 2017) and the German DMG MORI (DMG MORI, 2017) are developing machines capable of executing additive manufacturing and machining operations within the same machine. It is done by integrating a laser based AM process of metal powder deposition by fitting an interchangeable powder nozzle into a 5-axis CNC machine (Figure 1.6). The machine is then capable of performing DMD processing, creating a new part with AM, then swap the powder nozzle with a tool piece, e.g. a face mill, and continue with machining operations. At any point in the manufacturing process can the tools change from powder nozzle to machining tools. In this form of HM, the additive state will be the dominating state. The subtractive state will be important, but relatively insignificant regarding processing time and energy consumption. Concerning whether the machine will utilise additive or subtractive processing for a given feature, a decision must be made dependent on desired accuracy, geometry, functional requirements, etc. The component can be machined in a specific location to enhance the local tolerances. Some of the deposited material can be sacrificial for creating holes and clearances in a subsequent machining operation (Gibson et al., 2010).

The functions of the processing heads are controlled by the machine tool controller using G and M codes, i.e. the same system as in a CNC machine. The process is particularly suitable for repairs on used components, with the ability to deposit material on existing solid bodies. It is also possible to deposit a different metal than the substrate, in addition to material gradients. The hybrid principle can easily be retrofitted into virtually any existing CNC machines, without proprietary information from the original machine builder (Karunakaran et al., 2010). Another company, called Hybrid Manufacturing Technologies (Hybrid ManuTech, 2017), is developing deposition heads and docking systems as a retrofit for existing CNC machines. The heads can be integrated into the spindle and stored in the tool turret. This allows for the use of cutting fluids during machining since the deposition head is stowed away.

The AM process, in this case, utilises Direct Energy Deposition (DED), also known as Direct Laser Deposition (DLD) or Direct Metal Deposition (DMD). DMD is a Solid Freeform Fabrication (SFF) technology, which may employ closed-loop feedback control to achieve high dimensional resolution (Morrow et al., 2007). In principle, laser-based SFF techniques such as DMD are net-shape manufacturing processes, able to manufacture objects to near-final dimensions from metal powders and electricity without creating engineered scrap. Unlike powder bed processes, material is not melted in a pre-laid bed but melted as the material is deposited onto a work surface. In the DMD process, the deposition nozzle ejects metallic powder in a cone

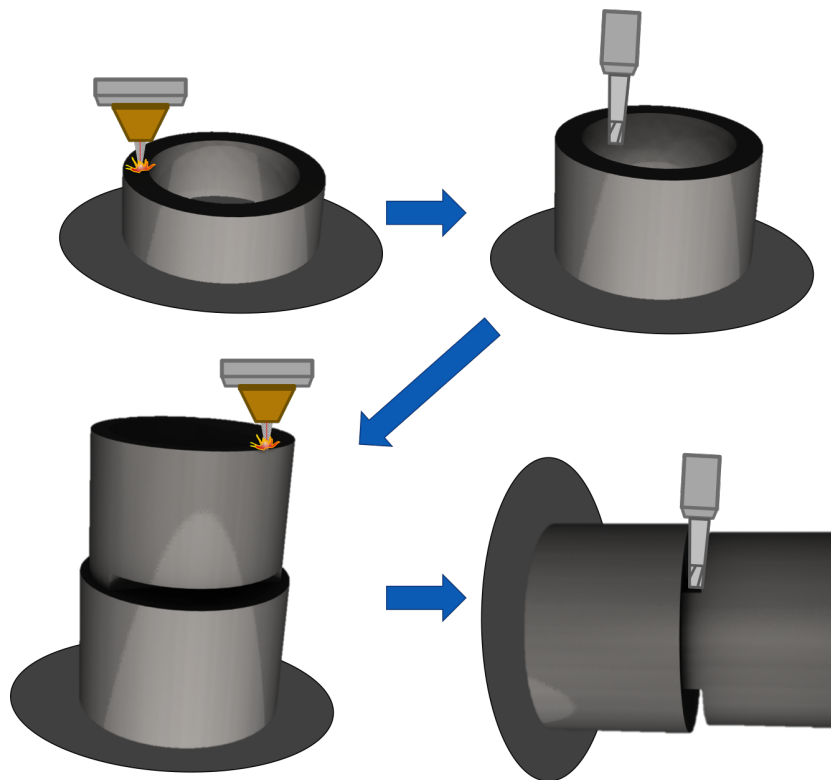

Figure 1.6: Illustration of processing in hybrid manufacturing. In this case, processing starts with additive manufacturing, followed by intermediate machining operation, and the processing can continue with the additive state later.

shape into the focal point of a laser beam, typically a fibre or Nd-YAG laser, to create a small melt pool on the workpiece (Figure 1.7). The substrate can either be a flat surface, where a new component will be fabricated, or an existing geometry on which features will be added, particularly suitable for repairs. The melt pool is protected by an inert gas delivered from the same nozzle, and the metallic powder is carried by gas from a powder hopper, typically argon. As the deposition head moves relative to the substrate, the deposited, melted material cools rapidly and becomes solid. The part is built by consecutive nozzle passes in a layered fashion. The movement of the deposition head is accomplished by moving either the head, the build table, or both relative to each other, resulting in 5-axes motion, i.e. three linear axes and two rotational axes. The DMD process is able to fuse precursor material in powder or wire form. Processes utilising wire fed feedstock experience lower dimensional accuracy, but experience a 100% feedstock capture efficiency. On the other hand, powder deposition suffers from a powder capture efficiency lower than 100%. Not all of the projected cone of the powder feed is captured in the melt pool, resulting in excess powder use and loss of powder. However, powder fed DMD has a higher dimensional accuracy (Gibson et al., 2010). The Norwegian company Norsk Titanium is utilising wire fed DED process utilising a plasma arc to fuse titanium wire into solid components.

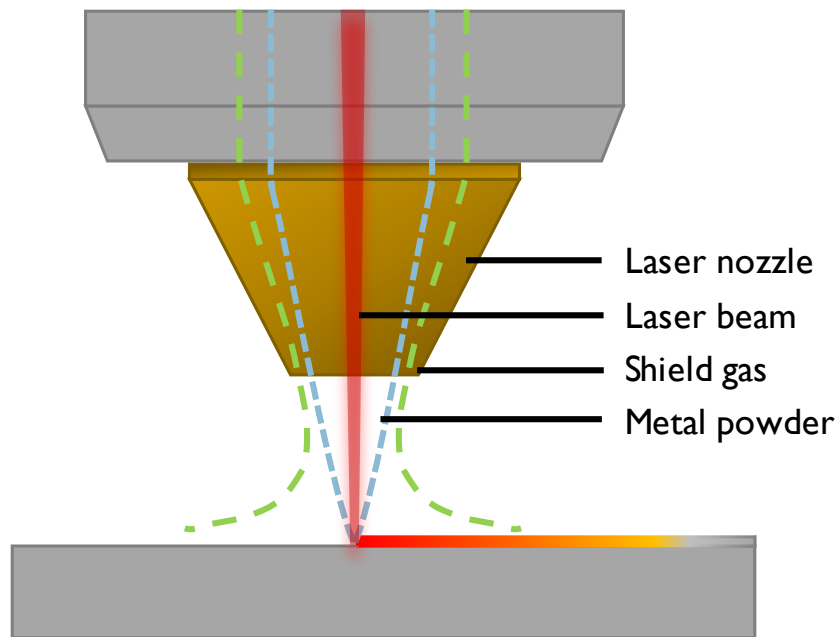

Figure 1.7: Illustration of a DMD deposition head. Metallic powder is deposited into the laser, adding melted material in the wake of the deposition head moving across the substrate. The melted material is protected with a local inert atmosphere.

The process parameters in DMD include powder feed rate, track scan spacing and traverse scan speed, beam power, and beam spot size, in addition to parameters such as nozzle size and catchment efficiency. The process parameters are interrelated, where one parameter affects the other. For instance, by increasing the powder feed rate and beam power, while decreasing the scanning speed, the deposition thickness will increase (Gibson et al., 2010).

1.4 Identification of System Stakeholders and Needs

Before the problem is defined, it is critical to identify the stakeholders of the problem. System stakeholders can be defined as a group or individual who can affect or is affected by the system under consideration (Freeman, 2010). In this section, the term stakeholder is used to identify the parties directly or indirectly affected by the energy assessment of manufacturing processes, with an emphasis on the novel hybrid manufacturing process. Clarkson (1995) classified stakeholders based on their attributes as primary, secondary or tertiary. The stakeholders will be defined as primary and secondary in this thesis, where the primary stakeholder are those who may see immediate value in the model and outcome proposed in this thesis, whereas secondary stakeholders are influenced by the actions taken by the primary stakeholders as a result of this thesis.

Sustainable engineering has gotten increasingly more attention in both research and industry. Recognising the fact that hybrid manufacturing is seldom explored in the literature, thus making it an interesting research opportunity for the Department of Mechanical and Industrial Engineering at the Norwegian University of Science and Technology (NTNU). The continuation of this research work may spawn academic research opportunities in the future.

Due to the rising trends in CO₂ emissions, where a relevant share can be ascribed to material production and manufacturing, (Gutowski et al., 2013), energy efficiency combined with material efficiency becomes key towards mitigating the negative impact from the industry. Further, to stay competitive, European companies have been forced to adjust towards shorter series of customised products with added value, leading to additive manufacturing, as a response to migration of production to third world countries (Petrovic et al., 2011). Product manufacturers and machine development companies, e.g. BeAM Machines, can use the model proposed herein to map the impact of their production and to take informed decisions in a design process.

The mitigation of the environmental impact in manufacturing will have a positive effect for the environment and society. The Paris agreement, and its goal of keeping the global temperature rise to below 2 °C within this century (United Nations, 2015a), and the Sustainability Development Goals (SDG) proposed by the United Nations General Assembly (United Nations, 2015b), specifically SDG 6, 9, 12, and 13, can all give the primary stakeholders incentive to improve their production and mitigate their environmental impact. The SDGs are listed in United Nations (2015b). Table 1.2 lists a summary of the stakeholder, their involvement, and their needs.

Table 1.2: Stakeholders and their needs

Stakeholder	Involvement	Needs
·Norwegian University of Science and Technology (NTNU)	Primary	·Research opportunity
·Product manufacturer	Primary	·Easy model to predict energy consumption during production planning
·Machine tool and AM machine developer (BeAM Machines)	Primary	·Knowledge about ways of improving machines (develop more efficient machines)
· The global environment and society	Secondary	·Reduced emissions, mitigate negative impact, reach SDGs

1.5 Problem Statement and Research Question

In order to find a solution, one must truly understand the problem at hand. The problem definition entails defining measures of performance and success criteria to determine if the proposed solution has a satisfactory result (Haskins, 2008). Following in these paragraphs the problem statement is defined by first expressing what the problem is and why it is a problem. Further, it will be discussed what must be done to solve it. Lastly, the Measures of Effectiveness (MoE) are presented to assess the quantitative and qualitative impact of the thesis.

What is the problem

Referring to the above mentioned stakeholders and the conclusion of the literature review, the problem to be considered becomes to assess the energy consumption of a hybrid manufacturing process. Little is known about the influence of the various energy consuming components within the machine system and how the process parameters affect the energy demand. Therefore, the components in the machine system seen as HM must be structured into subsystems to orderly assess the energy requirements. The methodology for HM developed herein will be used to compare the environmental impact for an HM made component to a similar component made either from conventional machining or an alternative additive manufacturing process. Before the material ends up in the manufacturing stage, it has undergone several phases, generating a wide range of emissions and wastes. It is therefore vital to trace the environmental impact of the life cycle of a product undergoing either HM, AM, or CM to fully grasp the impact of each process. This can be managed holistically with a life cycle based approach. The life cycle based modelling will not be the main focus of the thesis, rather be a supplement for validation of the HM process and the modelling proposed herein.

Why is it a problem

It can be seen from the increasing interest in additive manufacturing in both industry and academia, and the growing adoption of hybrid manufacturing, that it is of paramount importance to fill the gap in the literature and provide where the data is limited. Generation of wastes and emissions combined with the energy consumption of a process can be reflected on the final cost of a component. As the presented stakeholders suggest, incentives towards sustainable development will make it the interest of manufacturers to keep the energy footprint of a product to a minimum. Due to the increasing adoption and development of hybrid manufacturing, it becomes important to calculate the energy consumption to be able to accurately map impact and CO₂ emission.

What must be done

The problem must be explored with a systematic approach in order to get a fundamental understanding of manufacturing processes in terms of energy consumption, emissions and wastes. The project will use a system engineering approach to preform a structural analysis. An HM machine can be seen as a complex system in its self, containing various subsystems handling different tasks of a manufacturing process, e.g. machine tool spindle and laser system. Recognising these energy consuming units as subsystems within a holistic manufacturing system, while also identifying their shared subsystems, the total machine energy requirement can be assessed from empiric data and physics based modelling. In the calculation of the energy requirements, physical principles will be used to form a model for energy assessment in hybrid machining. Due to the scarcity of energy models of AM in the literature, models for both the EBM and DMD process must be developed for the analysis. The EBM model will be a part of a comparative life cycle based study presented later in a case study. The physics based model will be structured in a matlab program, able to calculate the energy requirements. The energy related to material processing during the life cycle of the product will be assessed utilising a life cycle based approach. This is done to evaluate the actual environmental impact of a particular manufacturing route. A comparative life cycle based case study was executed where alternative processing approaches were investigated. Given that the various manufacturing routes use and consume different kinds and amounts of material, the effect of material flow is expected to play an important part on the environmental performance. Furthermore, comparative assessment studies are essential to properly grade the manufacturing approaches from an environmental and sustainable perspective. It is important to define the boundaries of such a life cycle system, and to define the functional units and elementary flow through each life cycle stage. In order to preform a life cycle based analysis, LCI data must be gathered. There will be done no empiric

study in this thesis, so the LCI data will be gathered in a screening process. For hybrid manufacturing, the author will reach out to a manufacturing company to provide machine power demand data. Further, the proposed model will be used in a case study to develop a quantitative analysis. The case study will include a sensitivity study and trade analysis for variations in complexity to define a balanced solution.

1.5.1 Measure of Effectiveness

The Measures of Effectiveness (MoEs) is a quantifiable way of measuring the quality of a solution and how the solution meets the needs (Sproles, 2002). The MoEs of this thesis should reflect the needs of the stakeholders so that they ensure a solution able to assess the energy consumption of manufacturing processes in a reliable way. MoEs for the HM framework of energy assessment is related to the efficiency of integrating information input to manage the environmental aspects of HM, and how this framework will support sustainable development.

Table 1.3: MoEs of HM framework and thesis work

Aim	MoE
To assess energy requirement in HM process	<ul style="list-style-type: none"> · Quantifiable results assessed in successful analysis · Results agree with empiric data
To provide a new analysis framework	<ul style="list-style-type: none"> · Environmental performance is assessed and analysed · The number of adopted users · The number of academic publications
Generate knowledge about machine efficiency and manufacturing planning	<ul style="list-style-type: none"> · Environmental goals reached · Reduction in energy use and emissions from manufacturing

1.5.2 System Boundaries

It is important to apply the system approach to an engineered system context and not just to a single system (International Council on Systems Engineering and Haskins, 2011). The system will consist of the manufacturing process of hybrid manufacturing (HM). This will serve as the System-of-Interest (SoI). As a reminder, the hybrid manufacturing is a superposition of additive manufacturing, more specifically laser deposition (DMD), and machining operations, all in the same machine and manufacturing stage. This HM machine will be treated holistically as a system, to orderly identify the Energy and resource Consuming Units (ECU) as subsystems

within the manufacturing system. The system boundaries can then typically be set at system boundary A in Figure 1.2, encapsulating the gate-to-gate manufacturing life cycle state. The resource input to the system is seen as electrical energy requirement, whereas as the output is viewed as the environmental impact in the form of the CO₂.eq to the true emissions. The material flow is considered as raw material in the form of metallic powder entering the system as input, and the finalised product leaving as output in addition to material scraps in the form of lost powder and machined off chips. Moreover, the SoI will interact with a Wider System-of-Interest (WSOI), namely a simplified representation of the life cycle of a product undergoing hybrid manufacturing. The WSOI is depicted in Figure 1.8. This diagram represents the life cycle of the named component and illustrates how it interacts throughout its life cycle, in the material and energy dimensions. Employing life cycle based modelling, the environmental impact from the upstream processes can be assessed all the way back to material realisation and extraction. The purpose of the WSOI will later be to serve as a basis for a comparative study of similar life cycles revolving alternative processing routes, i.e. additive manufacturing with EBM, and conventional machining.

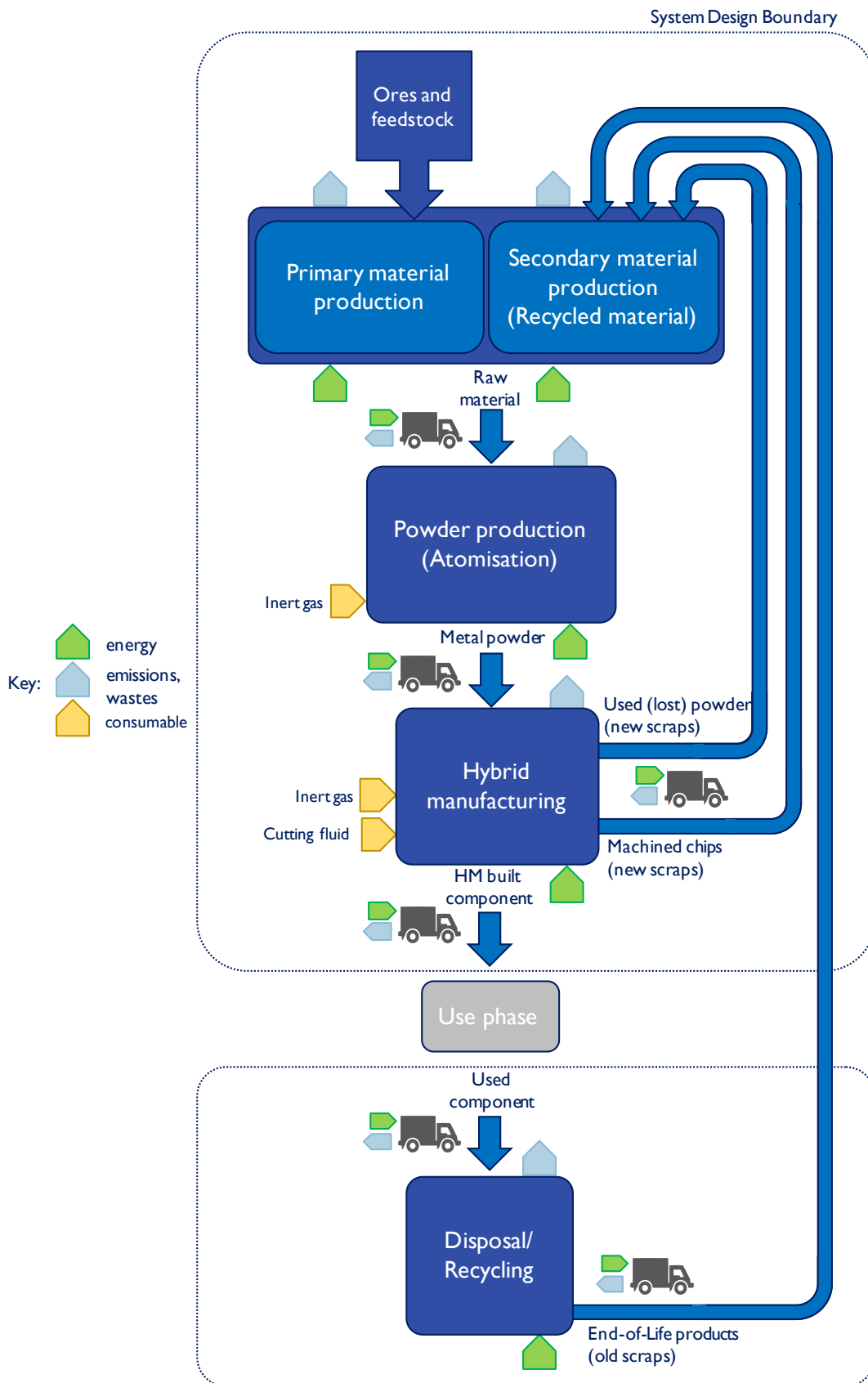

Figure 1.8: WSoI and life cycle for hybrid manufacturing

1.6 Analysis

The framework proposed in this work is to assess the energy consumption in the novel hybrid manufacturing process, and compare life cycle impact with conventional machining and additive manufacturing.

1.6.1 System Requirements

In the requirements domain, needs are generated into system-level requirements. The requirements are demands that call for an object or institution to perform in some way or to meet a certain quality standard. Various levels of the framework call for different requirements, if it is at subsystem, system, or life cycle level. The requirements point to a certain attribute that needs to be fulfilled to make the model viable. Results of the requirement can be the environmental performance of the analysed product and yet meet eventual mechanical tolerances. For the framework to function properly, certain aspects need to be in place, that being in the form of physics-based equations, the definition of elementary and functional flow, or LCI data. The requirements of the framework are illustrated in Figure 1.9. Considering life cycle based modelling, the requirement can be drawn from source documents such as the ISO standards 14040 and 14044, which state the principles and requirements for conducting an environmental analysis.

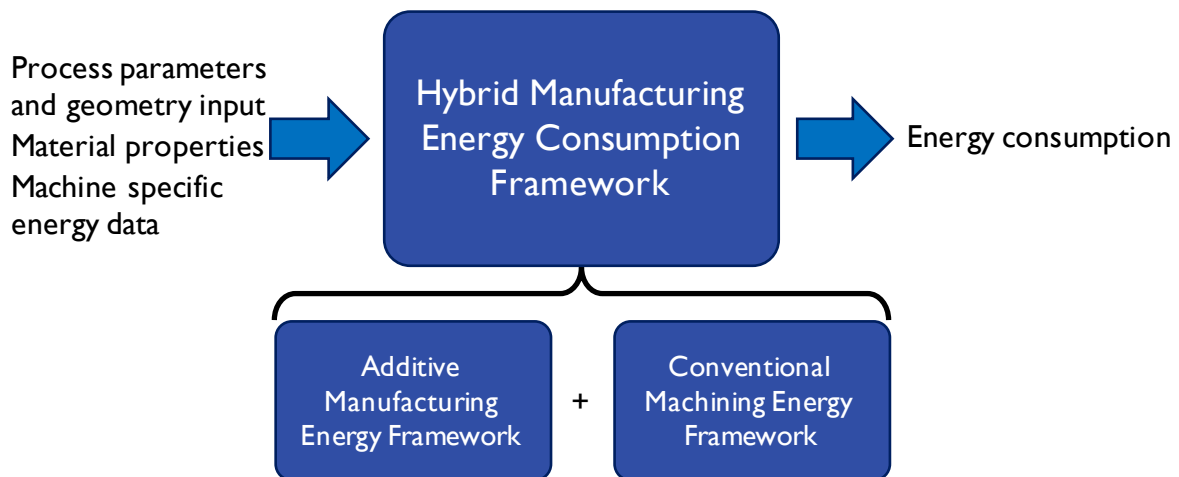

Figure 1.9: Framework for energy consumption in hybrid manufacturing

1.6.2 Behaviour

The behaviour of the system can be described using Functional Flow Block Diagram (FFBD), as seen in Figure 1.10, describing the functions and requirements of the framework. By defining

the physical framework of the energy assessment, an outline for analysis execution is determined. The information conveyed between the stages reflects the physical resource requirements of the system. The behaviour is indented as an iterative process, where the knowledge gained from each iteration can serve to improve the next iteration. The functions become;

- Identify the system boundaries (as discussed in Section 1.5.2)
- Define the system input and output based on the resolution of detail of the study and the goal of the investigation
- Then, identify the subsystems and their boundaries, in the case of HM the energy consuming units within the machine system
- Identify and define the inputs and outputs of the subsystems
- Perform energy assessment for each subsystem, based on the production determined by a CAD model and the coupled processing strategy, later to be cumulated to the total system energy demand
- Determine if the energy can be assessed from theoretical, physics-based modelling or based on empiric LCI data
- Determine if the process step is subtractive or additive and assess the energy thereafter
- Add the energy requirement from each subsystem to the total system energy demand. This reflects the energy requirement to manufacture said component. If the result is not satisfactory, the analysis can enter the iterative process of either altering the design features of the component or the processing strategy, still operating within the mechanical requirements, or the system can be redefined by modifying the boundaries or input/output if the level of detail was not satisfactory.

1.6.3 Verification and Validation

The SE model SPADE encourages continuous evaluation between the system steps and design layers, implying Verification and Validation (V&V) process to ensure confidence in the model and results, and making sure the model meets the requirements. As proposed in the behaviour of the model and in Figure 1.10, the last step in the model is to perform a system design review, making sure it covers the original requirements. Points to cover during V&V for this framework are;

- Does the design of the system satisfy the requirements?

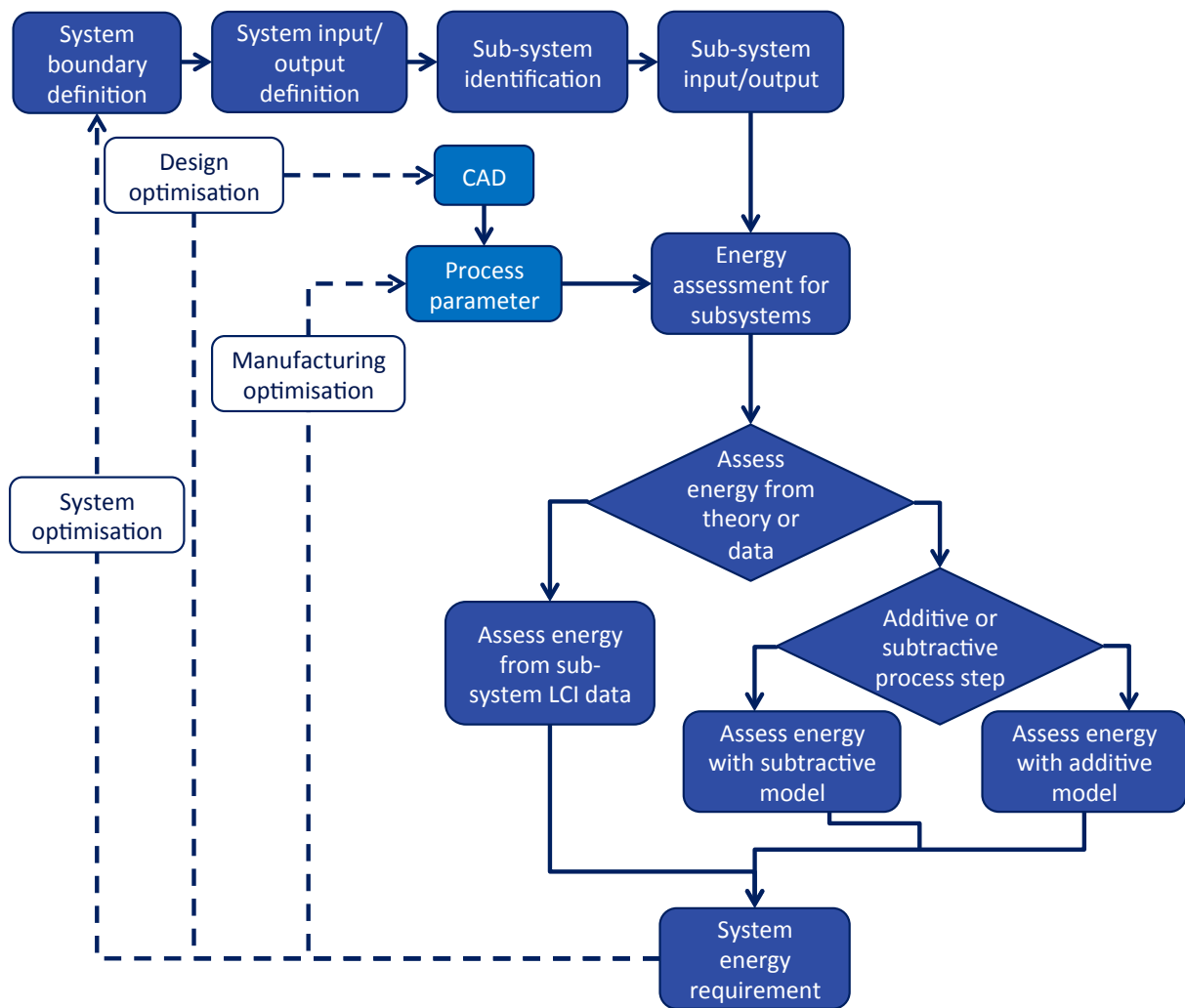

Figure 1.10: Functional flow block diagram of the system analysis behaviour

-
- Are the needs of the stakeholders met?
 - Does the system input/output reflect the true nature of the process, and does it satisfy the level of detail of the analysis?
 - Does the assessed result agree with observed empiric data?

Furthermore, the result can be validated according to environmental target goals of an eventual manufacturer, i.e. a stakeholder, not to validate the framework, but to validate the design of the component in manufacturing and the process parameters to manufacture it.

The framework was validated in a case study in Chapter 3, where the energy of the unit process of hybrid manufacturing was assessed. The verification of the framework was later discussed in Section 4.1.

1.7 Trade-offs

The Trade-offs represents the decisions that have been taken or needs to be taken. The first trade-offs came in the initial design phase of the system and framework. The trade-offs between the analysis' level of detail and the available data and resources made the first restrictions. Based on earlier works in the literature, a trend was found for the acceptable precision, which served as a basis for the modelling of this framework, and a compromise was made to make the model work with the available data, still satisfying the desired accuracy. Another trade-off revolved around the assessment of energy consumption, and how it would be calculated. LCA software is able to easily structure a life cycle based analysis with large databases, however, this would restrict the ability to make an analytic analysis based on process parameters and component geometry. Further, this kind of software was not easily available in the initial stages of the study, and due to sufficient LCI data being available in the literature, LCA software was not considered as a necessity. One trade-off that came as a result of leaving the LCA software was the uncertainty that every aspect of the life cycle was considered, and caution had to be taken to call this analysis a true LCA. It was rather called a life cycle based approach, for that reason.

Decisions that needs to be made when utilising the proposed framework is to determine a satisfactory environmental goal for a product entering the analysis so that the quantifiable result can be verified and deemed adequate or to realise if optimisation is needed in product design or processing strategy.

CHAPTER 2

PHYSICS-BASED MODELLING

The environmental data and energy assessments can either be obtained through databases and software, such as Ecoinvent or SimaPro or using analytic calculations from physics-based principles. The analytic approach presented here takes into account process and manufacturing parameters. A model for machining, electron beam melting, and laser-based deposition is introduced here. The analytic approach proposed by Munoz and Sheng (1995) is employed to determine the environmental analysis dimensions (Figure 2.1) during the development of the model. Here, the dimensions represent the different contributions in the model. The time dimension represents the processing time. Ways of calculating the processing time are presented in the following paragraphs. The input of the energy dimension represents the energy requirement for a manufacturing process based on the experienced loads, i.e. machining force or laser processing, whereas the output can be seen as emissions and environmental impact. The material dimension takes into account the material need, primary material and other auxiliary material/consumables, and the generation of a finalised product with the addition of scraps.

2.1 Conventional Machining

Manufacturing operations are made up of a series of processing steps and auxiliary systems, which are often highly automated, see Figure 2.2 for a schematic drawing of a typical turning tool. These systems can include a variety of functions, such as lubrication, cooling, tool changing, tool break detection, in addition to the basic function of cutting metal. These miscellaneous systems consume energy, and the predominant part of energy consumption is often the support functions independently of the applied load from cutting (Balogun and Mativenga,

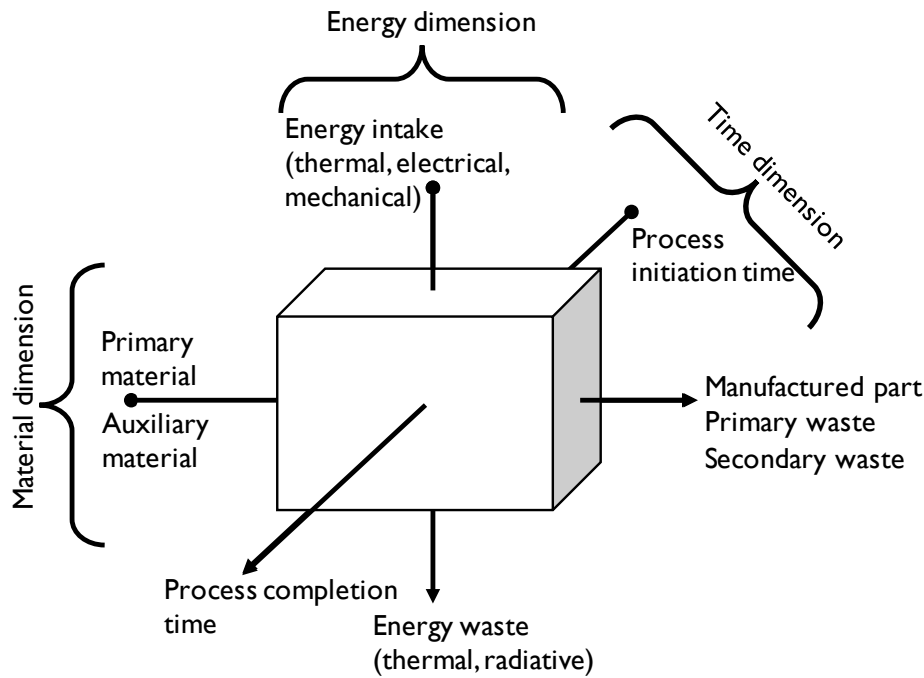

Figure 2.1: Environmental analysis dimensions for manufacturing processes, modified from Munoz and Sheng (1995)

2013). Depending on the machine tool and operation, only 5 % to 15 % of the total required energy go to changing the shape at the chip generation zone, with heavy roughing work it is up to 30 % (Abele et al., 2005). The power demand and energy consumption due to applied loads at the chip generating zone can be calculated theoretically. However, the power demand for a specific machine and all auxiliary systems must be assessed by empirical measurements or screening in environmental data specific libraries (LCI-data). Consumption for auxiliary systems is individual for each machine tool, and can therefore not be assessed with a universal, analytic value.

The basic power of a machine tool is allocated as the power demand while the machine is in stand-by mode, i.e. no relative movement between the workpiece and the tool, while auxiliary systems, such as control computer and pumps, are running. Furthermore, the ready state power is characterised as when there is relative movement between the workpiece and tool, but no cutting involved. This is also known as an air-cut. These values, including the cutting power, can be represented as fuzzy values (Figure 2.3) as an optimistic and a pessimistic interval (Abele et al., 2005). The predominant part of the energy in machining processes is used by machine tool and process periphery independently of the load. Draganescu et al. (2003) defined machine tool efficiency as direct cutting power demand over total machine power requirements,

$$\eta = P_{\text{machining}} / P_{\text{total}}.$$

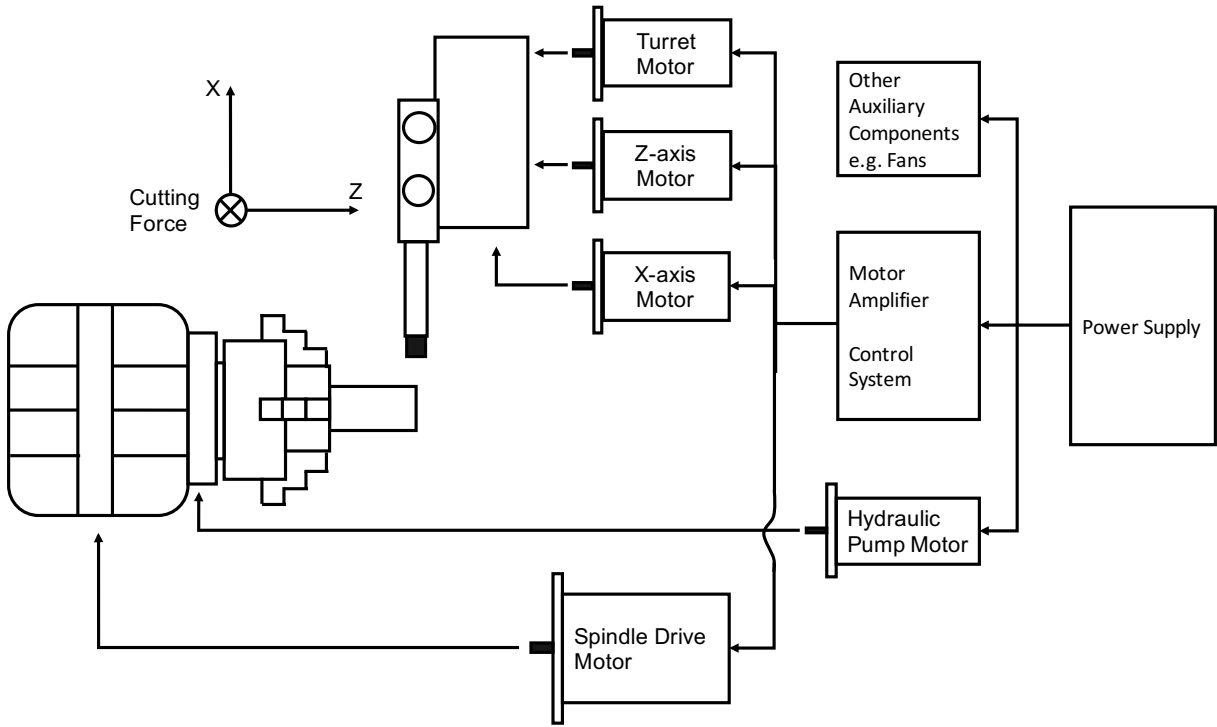

Figure 2.2: Schematic drawing of a typical turning machine tool, modified after Li and Kara (2011)

A basis for analysing energy use in machining is through Gutowski et al. (2006) mathematical model for direct energy requirement in machining as shown in Equation 2.1.

$$E_{tot} = (P_0 + k\dot{v})t \quad (2.1)$$

Where, E_{tot} is the total energy in J or W s, P_0 is the power in W to power the machine before cutting, k is the specific cutting energy in Ws/mm^3 , which is closely related to the work-piece machinability and the specifics of the cutting parameters, \dot{v} is the material removal rate in mm^3/s , whereas t is the total operational time in s. Expanding on this model, Mori et al. (2011) split the P_0 into basic and idle power (Equation 2.2)

$$E_{tot} = P_{basic} \cdot (t_{basic} + t_c) + P_c \cdot t_c + P_{ready} \cdot t_{ready} \quad (2.2)$$

Here, P_{basic} is the constant basic power required to power the machine regardless of running state, t_{basic} is the time for non-cutting, whereas P_c and t_c is the cutting power and cutting time respectively. The latter two values depend on the cutting parameters. P_{ready} is the ready state power, e.g. to position and accelerate/decelerate the spindle or change tools, and t_{ready} is the time required to do so. Further, Balogun and Mativenga (2013) improved upon this model by incorporating Gutowski et al. specific cutting energy k into Mori et al. model and came up with the model in Equation 2.3.

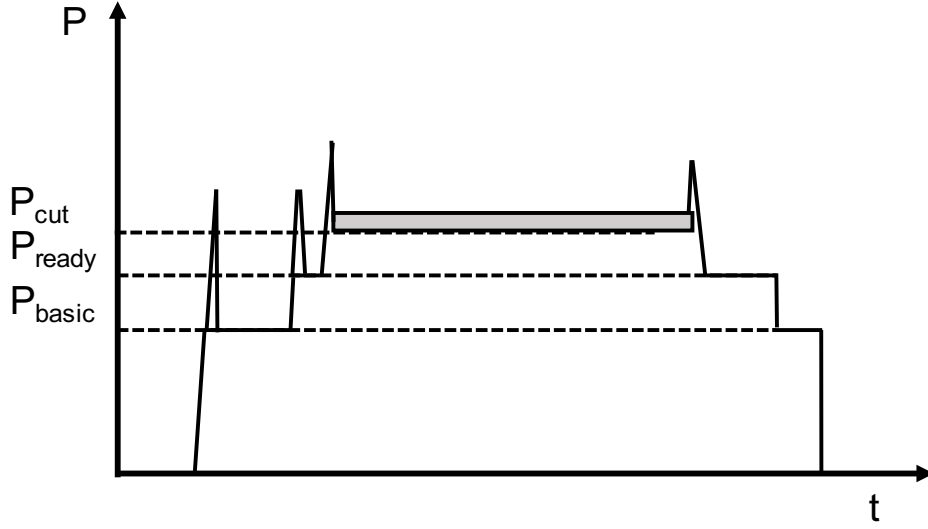

Figure 2.3: Fuzzy values for power consumption during machining process

$$E_{tot} = P_{basic}(t_{basic} + t_{ready} + t_c) + P_{ready} \cdot t_{ready} + P_{air} \cdot t_{air} + (P_{ready} + P_{cool} + k\dot{v})t_c \quad (2.3)$$

Here, E_{tot} is the direct total energy demand, P_{air} represents power demand for non-cutting approach and retract moves of the tool, whereas t_{air} represents the time for this kind of operation, and P_{cool} represents the power requirements to drive the coolant pump during machining. The specific cutting energy and material removal rate is still represented by k and \dot{v} respectively. The objective of a machine operation should always be to minimise the non-cutting time to improve the actual machine cutting utilisation. Furthermore, k and \dot{v} together forms the basis of the theoretical cutting power, P_{cut} . This can be calculated in Equations 2.4-2.6, and the cutting time in Equations 2.7-2.9.

$$P_{cut}^{milling} = \frac{ap \cdot ae \cdot v_f \cdot K_c}{60 \cdot 10^6} \quad (2.4)$$

Where, P_{cut} is cutting power in kW, ap and ae are the cutting depth and width in mm respectively, v_f given in mm/min is the table feed, and K_c is the specific cutting force in MPa.

$$P_{cut}^{turning} = \frac{ap \cdot f \cdot v_c \cdot K_c}{60 \cdot 10^3} \quad (2.5)$$

Here, f is the feed per revolution mm/rev and v_c is the cutting speed in m/min.

$$P_{cut}^{drilling} = \frac{D_c \cdot f \cdot v_c \cdot K_c}{24 \cdot 10^4} \quad (2.6)$$

Where, D_c is the drill tool diameter given in mm.

$$t_{cut}^{milling} = \frac{L}{v_f} \cdot 60 \quad (2.7)$$

The cutting time for one milling pass, t_{cut} , is given in s. L is the table length plus the cutting tool diameter in mm.

$$t_{cut}^{turning} = \frac{l_m}{f \cdot n} \cdot 60 \quad (2.8)$$

Here, l_m is the length of the turning pass, and n is the main axis spindle speed min^{-1} .

$$t_{cut}^{drilling} = \frac{l_d \cdot i_h}{v_f} \cdot 60 \quad (2.9)$$

Lastly, here l_d is the hole depth in mm, and i_h is the number of holes. Equation 2.3, supported by Equations 2.4-2.6 and Equations 2.7-2.9, served as the baseline for the analysis in the case study for conventional machining.

2.2 Additive Manufacturing

Based on the same observations as for conventional machining, that the auxiliary systems of a manufacturing machine account for the predominant part of the energy consumption (Peng and Sun, 2017), the energy requirements for additive manufacturing can be assessed. In a study of a laser based AM processes, the laser system was shown to account for 13 % of the total energy consumption, whereas the stepper motors consumed 26 % (Yoon et al., 2014).

The modelling for AM in this Master's thesis focused on the EBM process. Peng (2016) developed for the first time an analytic model to calculate the total energy consumption for Fused Deposition Modelling (FDM). This is a process mostly used for polymers. However, most of the principles can be carried over to metallic processes, such as EBM. The energy requirements of AM can be divided into multiple steps, i.e. machine start up, preheating, building state, and cool-down. Simply, the prediction of the energy demand for a layered AM process can be calculated as in Equation 2.10, again considering the environmental analysis dimensions in Figure 2.1.

$$E_{tot} = P_{basic}(t_{basic} + t_{exp}) + P_{exp} \cdot t_{exp} \quad (2.10)$$

Where E_{tot} is the direct energy requirement in J, P_{basic} in W is the background power requirement for when the machine is on, but not exposing the laser/electron beam, P_{exp} in W is the additional beam exposure power requirement for the exposure state, and t_{basic} and t_{exp} are the idle and exposure time in s respectively. However, this model does not consider the auxiliary

steps, such as preheating and cool-down, in addition to powder recoating between each layer. The building state will alternate between powder recoating and heating, and fusion state with beam exposure. In EBM the electron beam is focused and deflected/positioned with a set of electromagnetic lenses, i.e. coils, which contribute to the power requirement. This is accounted for in the basic power requirement of the machine in the building state. The total energy requirement for an EBM process can be characterised as in Equation 2.11.

$$E_{tot} = E_{startup} + E_{preheat} + E_{build} + E_{cooldown} \quad (2.11)$$

Here, $E_{startup}$ represents the required energy for machine start up, which includes the process of providing a vacuum in the build chamber. Further, $E_{preheat}$ is the consumed energy during preheating of substrate, whereas E_{build} is the energy requirement for the building stage. Lastly, the $E_{cooldown}$ is the required energy for cooling down the machine and workpiece at the end of processing. This can be rewritten as Equation. 2.12

$$E_{tot} = P_{start} \cdot t_{start} + P_{preheat} \cdot t_{preheat} + P_{build} \cdot t_{build} + P_{cool} \cdot t_{cool} \quad (2.12)$$

P_{start} , $P_{preheat}$, P_{cool} , t_{start} , $t_{preheat}$, t_{cool} depend on the individual machine, and are empiric values obtained by either monitoring the machine or by LCI screening. However, P_{build} and t_{build} depend on the process parameters, and can be calculated theoretically (Equation 2.13), but they will still depend on the characteristics of the individual machine.

$$E_{build} = P_{basic} \cdot (t_{exp} + t_{coat} + t_{stage}) \cdot n + P_{exp} \cdot t_{exp} \cdot n + P_{coat} \cdot t_{coat} \cdot n + P_{stage} \cdot t_{stage} \cdot n \quad (2.13)$$

Where, P_{basic} represents the background power demand for auxiliary systems, e.g. computers, fans, etc. P_{exp} is the power requirement during beam exposure, e.g. powering the electron beam and electromagnetic lenses for focusing and deflecting the beam, P_{coat} represents the power requirement for recoating the build stage with a new layer of powder, and P_{stage} is the power required to move the building platform, all given in W. The times t_{exp} , t_{coat} , and t_{stage} are given in s and are the time for beam exposure, powder recoat, and moving of platform for one layer respectively. n represent the number of layers and is found by $n = H/h$, where H is part height, and h is layer thickness. This implies that the building time is reduced for shorted part height with the same volume, i.e. building time can be optimised based on building orientation. The exposure time t_{exp} can be calculated based on the geometry of the printed part (Equation 2.14).

$$t_{exp} = \frac{V}{H \cdot d \cdot v} \quad (2.14)$$

Where t_{exp} is time of beam exposure (fusing state), V is part volume, H is part height, d is beam spot diameter, and v is scanning velocity.

2.3 Hybrid Manufacturing

In this case, HM combines a CNC machine with a DMD nozzle, thus the energy calculations from Section 2.1 on machining can serve as a basis for HM energy requirements. However, with the introduction of a DMD system in a CNC machine, additional auxiliary systems follows. As it was presented in the behaviour of the model in Figure 1.10, it is important to decompose the machine system into subsystems based on the Energy and resource Consuming Units (ECU), and to identify the shared subsystems between the processing states. The decomposition of the subsystems in HM can be seen in Figure 2.4, where the branches represent the subsystems found in the additive and subtractive state, and the shared subsystems found in the middle branch. The energy consumption in the HM process is a superposition of the energy consumed in the additive state, E_{DMD} , and in the subtractive state, E_{CM} , (Equation 2.15)

$$E_{HM} = E_{DMD} + E_{CM} \quad (2.15)$$

Here, E_{CM} is represented by the energy requirements from Equation 2.3, however since this is a different machine, some of the values will vary from a typical machining operation. The energy requirement for the additive state is shown in Equation 2.16

$$E_{DMD} = P_{basic} \cdot (t_{ready} + t_{exp}) + (P_{laser} + P_{lasercool} + P_{feed} + P_{gas}) \cdot t_{exp} + P_{cooldown} \cdot t_{cooldown} \quad (2.16)$$

Here, the base power requirement for the DMD machine is represented by P_{base} , P_{laser} represents the power requirement of the laser, where as the $P_{lasercool}$ is the power requirement of the laser cooling system. P_{feed} is the power required to feed the powder from the powder hoppers and through the nuzzle, and P_{gas} is the power demand for the shielding gas pump. Again, these values are machine dependent, thus an empiric power study or LCI screening is needed to assess these. The time t_{ready} is the time of which the machine is in its ready state, without adding material, whereas t_{exp} in s is the time of exposure, i.e. material deposition. The exposure time is dependent on volume of the part, V in mm^3 , and build rate, Q in mm^3/h , as seen in Equation 2.17.

$$t_{exp} = \frac{V}{Q} \cdot 3600 \quad (2.17)$$

As it was described in Section 1.3.5, the process parameters are all interrelated. Changing the scan speed or the powder feed rate will affect the deposition rate, and increasing the scan speed

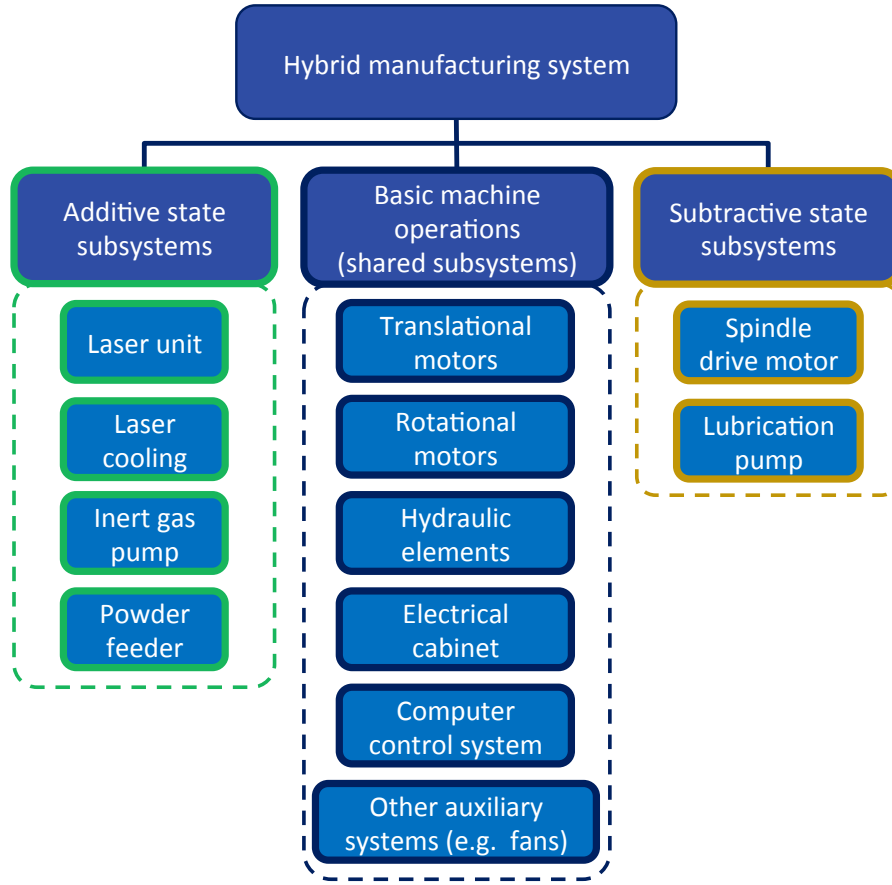

Figure 2.4: The decomposition of the HM system into subsystems, identifying the ECUs in HM. The left column represent the active subsystems in the additive state of HM, whereas the right column represent the machining state subsystems. The middle column represent the shared subsystems, which are active in both additive and subtractive states, in addition to the ready and standby state.

effectively decreases the input beam energy to the substrate, all influencing the volumetric build rate, Q . For simplicity, Equation 2.17 utilises Q in the processing time. It is of utmost importance that the material deposition rate remains constant for the duration of the deposition state to maintain a uniform thickness and melt-pool. The nozzle might accelerate or decelerate in the movement relative to the workpiece, whereas the material flow through the nozzle remains constant. This will cause a material build up or thinner sections if not counteracted, thus the laser power is continuously fluctuating, adjusting the energy density.

Combining Equations 2.3 and 2.16, the energy requirement for the HM process becomes Equation 2.18. This was the baseline for the HM model utilised in the proposed analysis framework.

$$\begin{aligned}
 E_{tot} = & P_{basic} \cdot (t_{ready} + t_{basic} + t_{exp} + t_{change}) + (P_{laser} + P_{lasercool} + P_{feed} + P_{gas}) \cdot t_{exp} + \\
 & P_{ready} \cdot t_{ready} + P_{air} \cdot t_{air} + (P_{basic} + P_{ready} + P_{cool} + P_{cut})t_{cut}
 \end{aligned}
 \tag{2.18}$$

Where t_{change} is the time of tool change between additive and subtractive state.

CHAPTER 3

CASE STUDY AND ANALYSIS

3.1 Life Cycle Based Modelling

3.1.1 Case Study Presentation

As the main focus of the thesis was to develop a framework for energy assessment in hybrid manufacturing processes, the goal of the following case study has been to employ the proposed model on a realistic but fictional manufacturing scenario. Further, the goal of the case study has been to identify energy consuming elements and how the energy is shared between the elements within the HM system. In order to measure the environmental impact and potential of HM, an investigation utilising life cycle based tools has been conducted, where the impact of HM has been compared to the impact from other processing routes. In the following sections the scope of the case study, the functional unit, the component and material, the system boundaries, and the impact metrics are presented.

3.1.2 Goal and Scope of Case Study

The goal of this case study was to assess and verify the energy model for the hybrid manufacturing framework, and to compare the environmental impacts associated with various manufacturing processes, whether it be from a solid block of titanium using conventional machining, from metallic powder using additive manufacturing, or a combination of the both in a hybrid process. The component to be manufactured in this study had the same geometry for all processes, thus eliminating any weight reduction factors. However, AM technology has the ability to allow topologically optimised design, which can result in lighter parts and material reduction, but this is outside of the scope. The environmental aspects of discrete part manufacturing were

investigated using life cycle based tools. A life cycle based analysis require detailed information about the product and process under consideration, and LCA software is often used to facilitate this process. However, due to lack of access to a software of this kind in this study, the assessment will be based on data found in the literature. There is a broad spectre of phases and activities a product and its material undergoes through its life cycle, hence the importance of investigating the environmental impact of the whole life cycle. According to the ISO standards, a life cycle based assessment must examine energy and material flow in raw material acquisition, processing and manufacturing, transport and storage, use, maintenance and repair, recycling and disposal. Transportation, storage, use and maintenance were left outside of the scope for reasons explained in the following sections.

3.1.3 Functional Unit

During the lifetime of a material, the quantifiable amount, i.e. functional unit of resources, entering one phase can be found to differ from what is leaving it, e.g. it can change from a continuous amount (per unit weight) to a discrete amount (per unit product). The term functional unit is introduced to track the quantity of material throughout the life cycle. ISO standard 14040 defines the functional unit as the quantified performance of a product system for use as a reference unit (ISO (2006a) section 3.20). The assessment of the environmental impacts of the manufacturing processes herein is based on the manufacturing of one component. This implies that for the evaluation of energy in the material extraction stage, material required for one unit was considered, i.e. energy/material/unit and for manufacturing it was energy/unit and so on.

3.1.4 The Product

Material

The materials of engineering have a life cycle. Materials are created from ores and feedstock. These are manufactured into products ready to be used. Products have a finite life, and at the end they become scrap. However, the materials of the product are still usable, and they can be resurrected and enter a second life as recycled material. The component under investigation is a fictional component indented for subsea or aerospace applications. The chosen material is a titanium alloy, Ti6Al4V with a density of $\rho = 4.429 \text{ g/cm}^3$ (Ashby, 2012). Ti6Al4V is chosen due to its widespread use as it is known as the workhorse of titanium alloys, representing more than 50 % of the worldwide titanium production. The global production of Ti6Al4V is 2×10^5 tonne/year. Further, titanium alloys have the highest strength-to-weight ratio of any structural metal, and it can withstand temperatures up to $500 \text{ }^\circ\text{C}$, making titanium a good material for e.g. compressor blades in an aircraft turbine (Ashby, 2012). However, there are

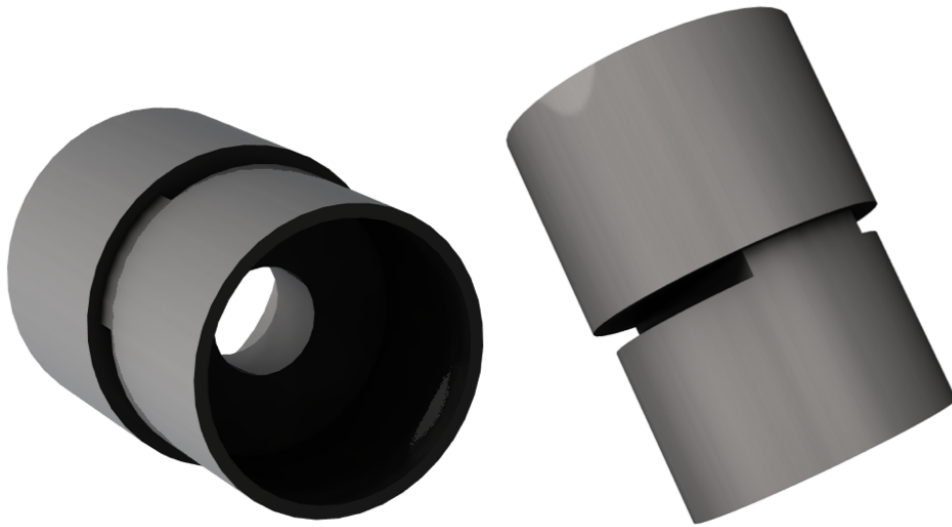

Figure 3.1: Design of the component for the study. The geometry has interior and exterior features.

difficulties related to the machining of titanium alloys (Khanna and Sangwan, 2013). The low thermal conductivity leads to high accumulations of heat and mechanical stress at the edge of the cutting tool at high cutting speeds, which subsequently leads to increasing cutting forces and tool wear. Titanium is shown to generate segmented chips at relatively low cutting speeds (Arrazola et al., 2009). On the other hand, titanium is seeing greater use in additive manufacturing. The Norwegian company Norsk Titanium will manufacture the World's first FFA approved 3D-printed structural aircraft part for the Boeing 787, cutting the buy-to-fly ratio by a factor of four (Norsk Titanium, 2017).

Geometry

The geometry of the component was designed to resemble a connection with typical applications in subsea or aerospace. It was designed with functional features such as grooves on the outer surface, and a narrow sectioning on the inside, depicted in Figure 3.1. The component was design so it would not be biased to one manufacturing approach over the other, to encourage a balanced analysis. In the analysis, the proposed model was tested for sensitivity by changing the solid-to-cavity ratio of the component. The solid-to-cavity ratio was defined as the final mass of the component divided by the mass of the minimal enveloping volume as if the component was completely solid, i.e. increasing ratio means more massive (Morrow et al., 2007). This was done by increasing the inner wall thickness, increasing the overall mass of the product, seen in Figure 3.2. Dimensions of the various geometries can be found in Table 3.1, technical drawings of each component can be found in Appendix B.

Table 3.1: Dimensions and geometrical features

	Geometry no 1	Geometry no 2	Geometry no 3
Height	80 mm	80 mm	80 mm
Maximum external diameter	60 mm	60 mm	60 mm
Maximum internal diameter	55 mm	45 mm	35 mm
Wall thickness	5.00 mm	15.00 mm	25.00 mm
Part volume	51 934.45 mm ³	90 615.31 mm ³	131 456.02 mm ³
Part mass	230.0 g	401.3 g	582.2 g
Solid-to-cavity ratio	0.24	0.41	0.59
Mass of machined chips	909.9 g	738.6 g	557.7 g
Mass of deposited powder (EBM)	241.3 g	410.2 g	589.8 g
Mass of deposited powder (DMD)	287.5 g	501.6 g	727.8 g

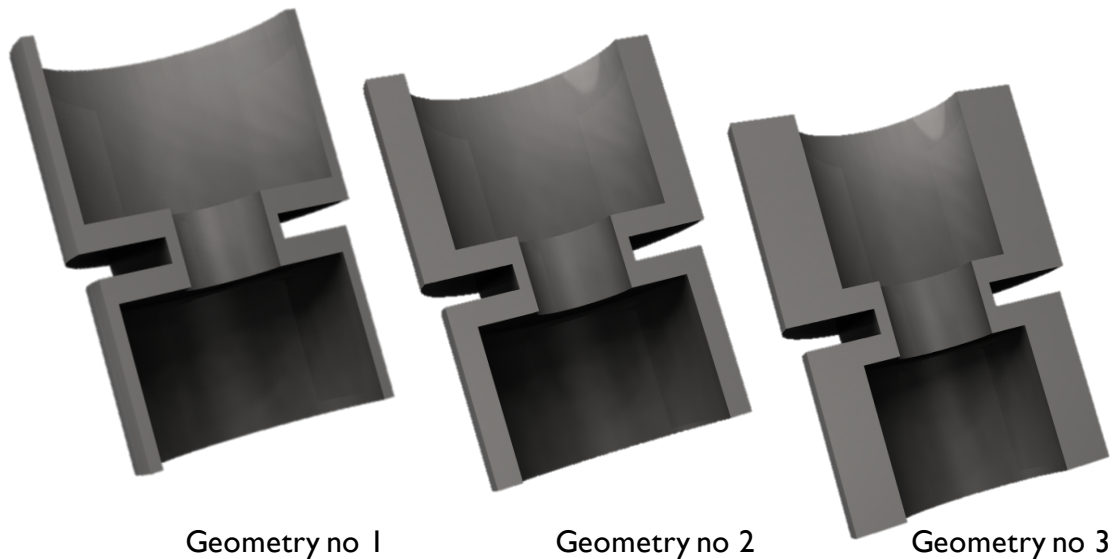

Figure 3.2: Cross section showing the increasing mass of the component

3.1.5 System Boundaries

The case study was structured around four main life cycle phases, material extraction, material processing, part manufacturing, and the end-of-life scenario (EoL). The system included all elements required to manufacture a component. The lifespan and resources required to make up the manufacturing machines and production plants were not taken into account, i.e. system boundary C in Figure 1.2 was out of bounds. As presented earlier in Figure 1.8, and shown here in Figure 3.3 and Figure 3.4, the system boundaries for the various manufacturing life cycles are found. The figures illustrate how the material interacts with different processes through the system boundaries and how it changes form from one phase to the other. In the additive manufacturing stage in Figure 3.4, the powder returns directly to the manufacturing phase, as the

powder was considered directly recyclable (Richard Degenhardt et al., 2015).

The end-of-life scenario was considered as recycling and was seen as an energy consuming process related to secondary material production. The fraction of recycled material in material production is set to 22.5 % (± 1.5 %) (Ashby, 2012). This includes end-of-life components and manufacturing scraps, e.g. machined chips and used/lost powder. However, handling and disposal of scraps in any other way apart from recycling was not considered. This was due to the component in the study being a stationary non-energy consuming part while the component is in its use phase. The operating life span of the component was not determined for this study. However, it was assumed that the component had the same useful life span for all the manufacturing processes, i.e. identical mechanical properties, product specifications, and use conditions. Thus, the comparison of the energy-consuming aspects of the use phase was neglected, since this would be identical for the three manufacturing scenarios. The same could be said for transportation. One possible way of incorporating transportation was to take the specific energy required to drive a vehicle, i.e. a truck, and multiply it by the mass of the cargo and the distance travelled. It could be assumed that the material and component is transported the same distance throughout the life cycle. However, since the AM processes require less material, less mass would be transported in the early phases, yet since the functional unit was per component, the contribution of transportation was rendered negligible (Priarone et al., 2016).

3.1.6 Impact Metrics

The ISO standards call for an impact assessment. The main focus of this study was directed towards the energy consumption of manufacturing processes, and as a supplement and means of comparison, it was investigated how the resource consumption and emissions affect the environment. Thus, the outcome of this case study used the energy requirement and the carbon-equivalent ($\text{CO}_2.\text{eq}$) of the emissions, based on a European energy mix (Ashby, 2012), as comparative metrics for the process energy assessments. The CO_2 -footprint of a material was characterised as the mass of CO_2 released to the atmosphere per unit mass of material, with units kg/kg (Ashby, 2012). It was interesting to investigate the CO_2 -footprint, due to its Global Warming Potential (GWP). The carbon-equivalent, (kg/kg), was the equivalent mass of CO_2 with the same GWP as the real emission (Ashby, 2012). The values in Table 3.2 reflects the $\text{CO}_2.\text{eq}$ of the various life cycle phases.

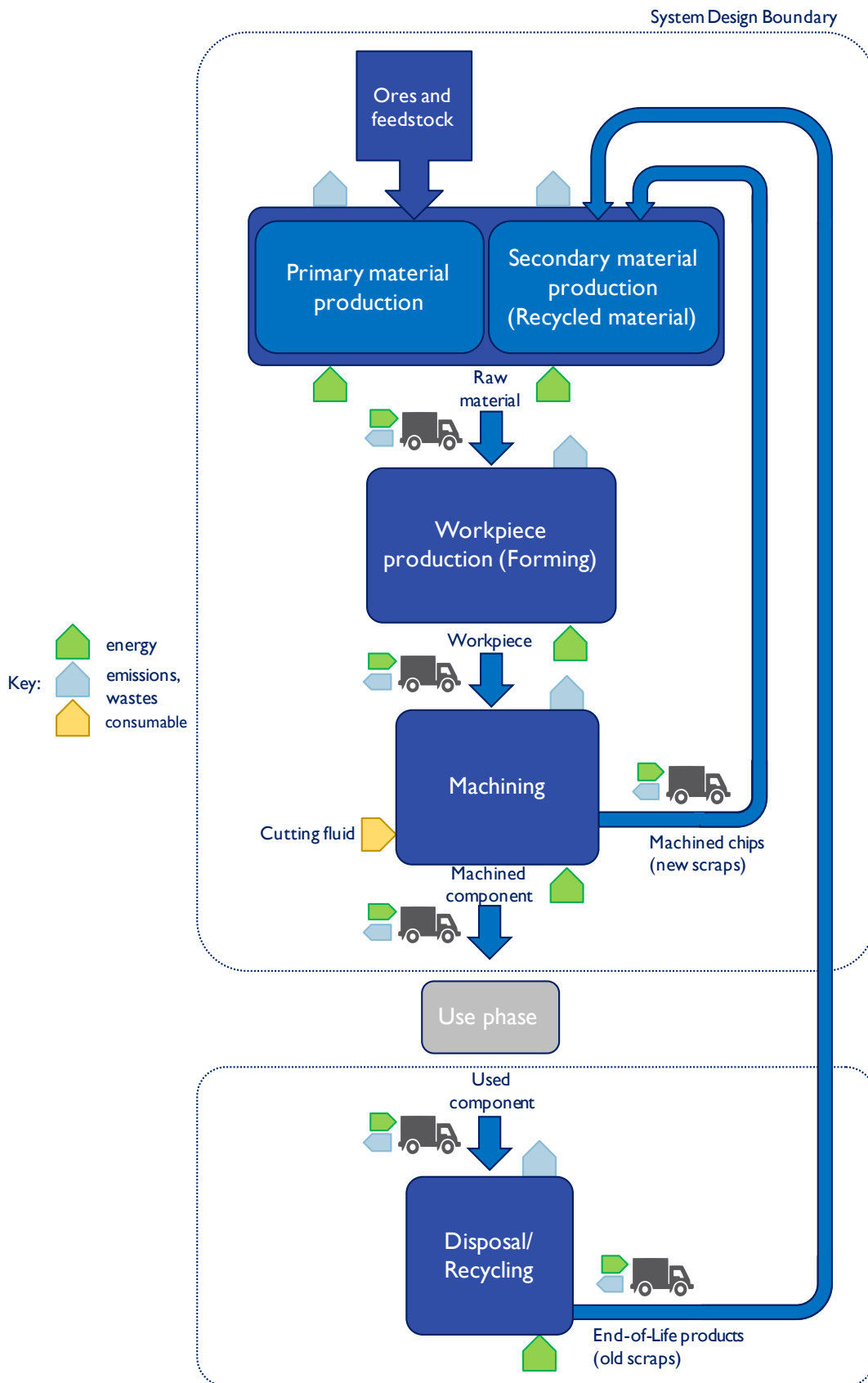

Figure 3.3: Life cycle for conventional machining

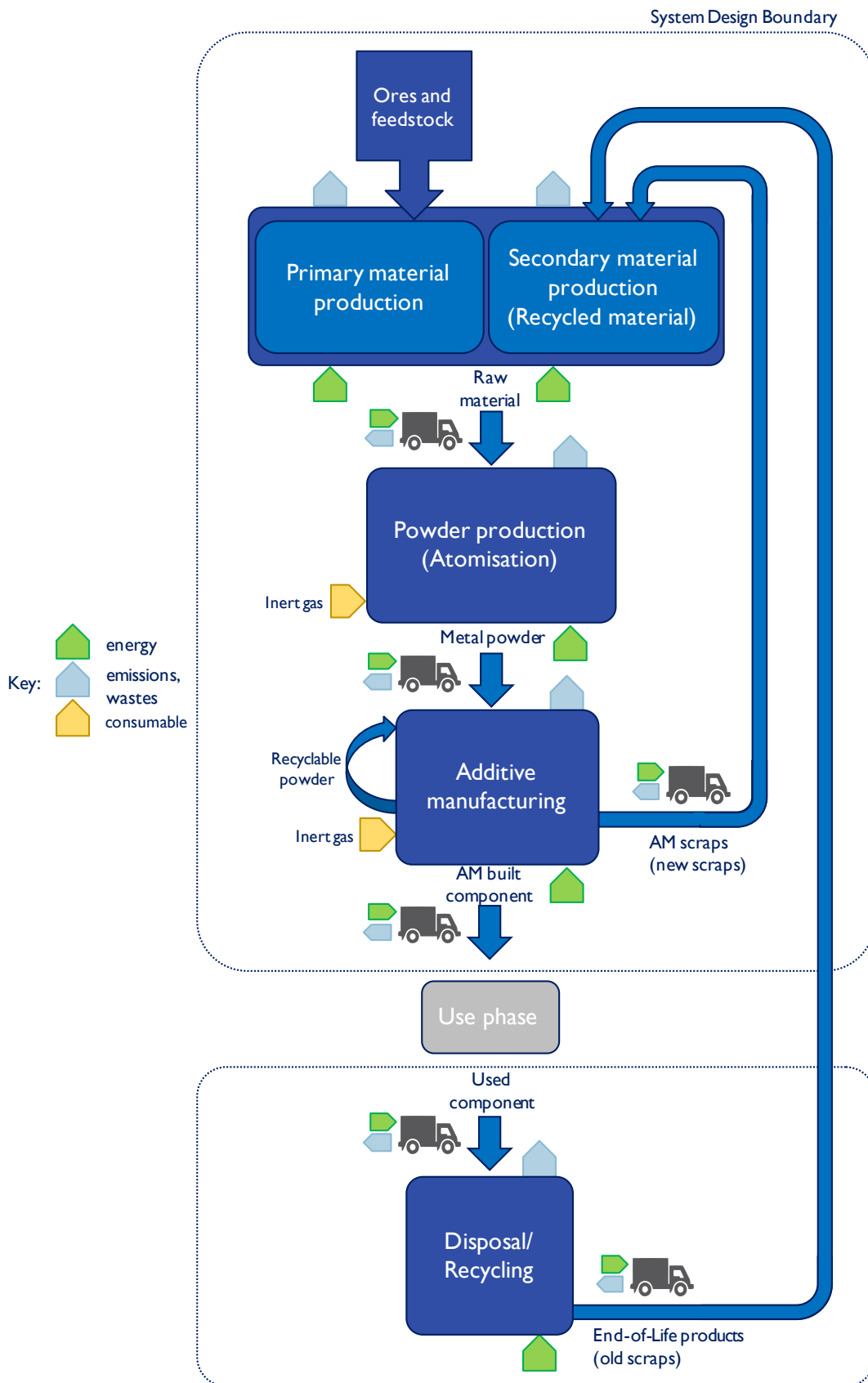

Figure 3.4: Life cycle for additive manufacturing (EBM)

3.2 Analysis

3.2.1 Life Cycle Inventory

Based on the above-mentioned scope and boundaries, the proposed framework was employed in a case study. The case study employed the proposed energy analysis framework for HM to investigate energy distribution of the ECUs in HM, and the modelling proposed in Chapter 2. The following sections explain the process of calculating the energy requirements for the various life cycle stages.

Material Production and Recycling

As seen in Figures 3.3 and 3.4, the material undergoes different processing routes for the various manufacturing approaches. However, the life cycle starts out the same, with the embodied energy for raw material extraction and refinement. Ashby (2012) defined embodied energy as the energy per unit mass required to make a material from ores and feedstock. Further, the material is processed into either workpiece in the case of subtractive manufacturing or atomised into powder for additive manufacturing. The equations for material processing, based on the substitution method for recycling proposed by Hammond and Jones (2010), can be found in Equations 3.1 and 3.2. A measure of energy referred to as Unit Material Embedded Energy (UMeE) is employed. It is the specific energy for material realisation. The total energy requirement can be calculated by the product of UMeE and the mass of a unit (Equation 3.2).

$$UMeE = UMeE_{orig} - r \cdot (UMeE_{orig} - UMeE_{recy}) \quad (3.1)$$

$$E_{mat} = m \cdot (UMeE + UMprE) \quad (3.2)$$

Here, the $UMeE_{orig}$ is the embodied energy to create new material from ores in MJ/kg, i.e. the primary material production, $UMeE_{recy}$ is the energy required to recycle material into usable material in MJ/kg, i.e. the secondary material production, r is the fraction of recycled material in production, and the $UMeE$ is the total material embodied energy, given in MJ/kg. The difference in Equation 3.1 represents the energy savings by recycling material opposed to creating all new material. Considerable energy savings can be achieved by recycling metals. Aluminium as an example, has an energy intensive material production process, with a consumption of 173 MJ/kg, whereas secondary material production has a theoretical requirement of 1.14 MJ/kg (Paraskevas et al., 2014).

E_{mat} in Equation 3.2 is the total energy requirement for material related processes for one component, given in MJ/part, m (kg) represents the total mass going into manufacturing, typically

larger than the final mass of a product, and $UM_{pr}E$ is the energy required to ready the material for the manufacturing phase, i.e. workpiece forming or powder atomisation. Values for UM_eE_{orig} , UM_eE_{recy} , and $UM_{pr}E$ can be found in Table 3.2. The $CO_2.eq$ emissions can be calculated the same way as in Equation 3.2, opting out the unit material energy with the specific $CO_2.eq$.

Table 3.2: Life Cycle Inventory for Ti6Al4V (Ashby, 2012)

Eco-property	Energy (MJ/kg)	$CO_2.eq$ (kg/kg)
Embodied energy, primary material production (UM_eE_{orig})	685.0 (± 35.0)	46.5 (± 2.5)
Embodied energy recycling, secondary material production (UM_eE_{recy})	87.0 (± 9.0)	5.2 (± 0.5)
Processing (forging/rolling) ($UM_{pr}E$)	14.5 (± 0.5)	1.15 (± 0.05)
Powder production (atomisation) ($UM_{pr}E$)	31.7 (± 1.6)	1.74 (± 0.2)
Machining (UM_rE)	Equation 3.6	4.4 (± 0.3)
EBM (UM_rE)	Equation 3.6	9.8 (± 0.2)
DMD (UM_rE)	Equation 3.6	7.9 (± 0.3)

Manufacturing

As just mentioned, the mass going into manufacturing is typically larger than what is leaving it. The total mass (m^{CM} , m^{AM} , and m^{HM} , in kg) entering manufacturing with machining, additive, or hybrid manufacturing are found in Equations 3.3, 3.4, and 3.5 respectively.

$$m^{CM} = m_p + m_c \quad (3.3)$$

$$m^{AM} = m_p + m_s \quad (3.4)$$

$$m^{HM} = \frac{(m_p + m_m)}{k} \quad (3.5)$$

Here, m_p is the mass of the finalised product, m_c is the mass of the machined off chips, m_s is the mass of the support structure to be removed after additive manufacturing, and m_m is the mass to be machined off in the hybrid process. The factor k is the powder catchment efficiency, due to some of the projected powder from the deposition head is not scanned by the laser, and is therefore scattered away. This dictates a larger mass of deposited powder to that of the fused part mass. One of the key advantages of AM is the material savings (Dobrovski et al., 2011), hence $m^{AM} < m^{CM}$. As the remaining powder in AM processes like EBM is not considerably affected by the beam exposure (Richard Degenhardt et al., 2015), the powder can be directly recycled and used in a subsequent build. Thus, the mass included in m^{AM} is only the mass of the fused component and the support structure, excluding the total mass in the volume of the

build chamber.

It was in this life cycle stage the modelling in Chapter 2 was employed, where the energy requirement for manufacturing was calculated based on the proposed model. The energy requirement for the manufacturing phase can be found in Equation 3.6. In the case of machining, the cutting speed was held at about 60 m/min with a specific cutting force $K_c = 2500$ MPa to provide good tool life (Arrazola et al., 2009). Studies considering indirect energy consumption related to tool life and wear can be found in Rajemi et al. (2010); Ingarao et al. (2016), however, this was not a focus of this study. The cutting parameters can be found in Table 3.3. The energy calculation for CM was based on reported power demands from Balogun and Mativenga (2013) on a Mikron HSM 400 machine, found in Table 3.6.

The process parameters for additive manufacturing were drawn from literature (Baumers et al., 2016), and can be found in Table 3.4. The printing strategy was so that it requires some support structure in the case of EBM to accommodate overhang (Figure 3.5), hence the extra mass in Table 3.1. The orientation was not optimised for build height, due to the geometry would require considerable more support structure if oriented otherwise. The energy calculation for AM was based on reported power demands from Baumers et al. (2016) on an Arcam A1 machine, found in Table 3.6.

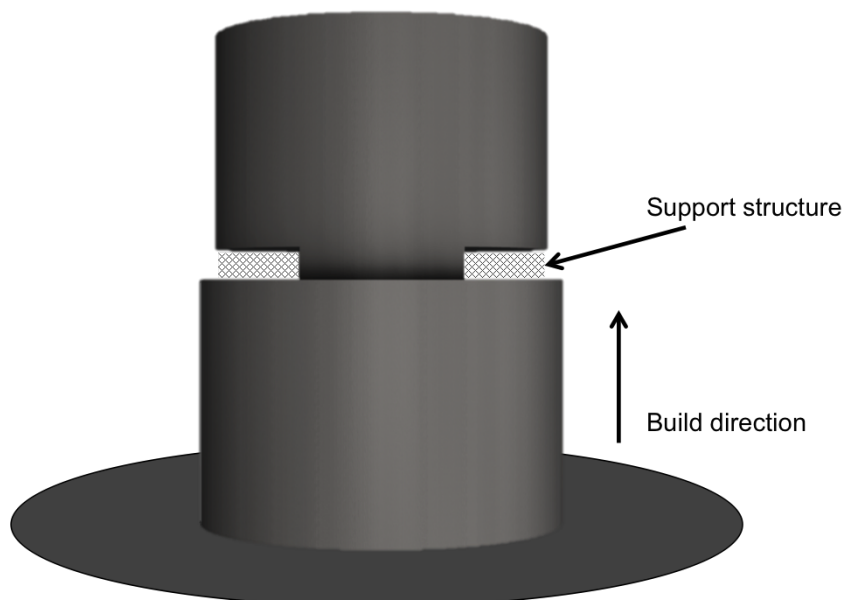

Figure 3.5: Building strategy in EBM

For hybrid manufacturing, the volumetric build rate and the powder catchment efficiency were set according to the information provided by the machine manufacturer BeAM Machines (BeAM, 2017). Parameters for HM are found in Table 3.5. The analysis was based on power data on a

BeAM Magic 2.0 machine capable of 5-axes laser deposition and CNC machining. The power demand data for the Magic 2.0 can be found in Table 3.6.

$$E_{prod} = UMrE \quad (3.6)$$

In Equation 3.6, E_{prod} is the total energy consumed in the production phase of the life cycle (given in MJ/unit), whereas $UMrE$ is the Unit Manufacturing Related Energy. $UMrE$ can be calculated based on the models in Chapter 2 for each manufacturing approach. $UMrE$ is given in MJ/unit rather than MJ/kg considering $UMrE$ is a product of process power requirement and processing time.

Table 3.3: Process parameters in conventional machining operations

Milling	
Depth of cut (ap)	1 mm
Cutting width (ae)	5 mm
Table feed (v_f)	30 mm/min
Turning	
Depth of cut (ap)	0.5 mm
Feed (f)	0.20 mm/rev
Cutting speed (v_c)	60 m/min
Drilling	
Cutting speed (v_c)	35 m/min
Feed (f)	0.05 mm/rev

Table 3.4: Process parameters in additive manufacturing (EBM)

Process parameters in EBM	
Scan speed	300 mm/s
Beam spot diameter	0.1 mm
Layer thickness	0.07 mm

Table 3.5: Process parameters in hybrid manufacturing

Process parameters in DMD	
Volumetric build rate (Q)	70 mm ³ /h
Powder catchment rate (k)	0.8
Parameters were the same as in Table 3.3 in the subtractive state	

Table 3.6: Power requirement data for manufacturing platforms

Mikron HSM 400		Arcam A1		BeAM Magic 2.0	
Machine base	2904 W	Machine start up	1090 W	Machine start up	1210 W
Machine ready	401 W	Machine preheating	3900 W	Machine base	20 700 W
Air cut	2917 W	Building power	2220 W	Machine ready	542 W
Coolant system	1790 W	Machine cool-down	600 W	Powder feed	2000 W
				2 kW laser unit	5800 W
				Laser cooler	12 600 W
				Inert gas system	2800 W
				Air cut	2917 W
				Machine cool-down	460 W
				Machining coolant system	1282 W

In addition to the primary material and energy consumption, auxiliary materials are consumed in the manufacturing stage. The use of lubrication and cooling liquids in CM is a case in point, in addition to tools getting worn out and needing to be changed. Further, in AM inert gases are used to protect from oxidation in both powder atomisation and in product production. EBM platforms consume helium to maintain a controlled vacuum and during the cool-down phase. The Arcam A1 machine has a consumption of 1 L/h during the build state and a 50 L/build to 75 L/build during cool-down (Baumers et al., 2016). Argon and nitrogen are used in the gas atomisation process of metal powder production, 5.5 m³ of argon for 1 kg atomised Ti6Al4V powder (Paris et al., 2016). For DMD processes argon might be used as both a protective gas and as a carrier gas for the metallic powder. As mentioned in the literature review, Le Bourhis et al. (2013) performed a study on DMD accounting for the flow of all fluids. In this thesis, however, the embodied energy to create these consumables were not considered, nor the impact from utilising them, due to a lack of reliable data. However, the energy requirement to drive the systems utilising these materials, e.g. cooling pumps, was taken into account as processing energy. This is because the main focus of this study was the energy use in the manufacturing. If this study was a true LCA, then the impact arising from the consumables had to be considered as well.

3.3 Results

In this section, the result of the physics-based analysis to calculate the energy consumption of the manufacturing process routes are presented. The subsequent environmental impact concerning carbon dioxide is also presented. The energy consumption in each life cycle stage have been presented, and the main environmental impact represented by the CO₂.eq have been assessed. The main energy consuming elements in HM have been identified on a system level. The model has been tested for sensitivity by changing the solid-to-cavity ratio, and by extension the mass of the investigated component. In Figures 3.7, 3.9, and 3.11, the energy requirement (left) and CO₂ emissions (right) throughout the life cycle boundary have been found.

The analysis for the component described in the Geometry no 1 is depicted in Figure 3.6 and 3.7. In Figure 3.6, the Energy and resource Consuming Units (ECU) in HM have been identified, based on the analysis framework proposed in Chapter 2 and Figure 1.10. It was shown that the predominant contribution came from the machine base power (45 %) and other auxiliary subsystems. 27 % of the energy requirement went to the laser cooling system, and 6 % and 4 % went to the inert gas pump and powder feeder pump respectively. Less than 1 % each went to machine start up and cool down procedure. Only 12 % was required to power the laser unit, whereas 4 % went into the machining operations. The combined energy requirement for HM processing of Geometry no 1 was 124.13 MJ/unit.

The stacked bars in Figure 3.7 represents different manufacturing methods, i.e. conventional machining, additive manufacturing, and hybrid manufacturing, denoted by CM, AM, and HM respectively. The lower sections of the bars represent material realisation related processes, whereas the upper sections are the various manufacturing processes, determined by their colour. In this first instance, about 80 % of the initial bulk volume was machined off, and as a result, CM required a greater initial mass compared to the other manufacturing routes, as seen in the lower, dark blue regions of Figure 3.7. About 9 % of the energy consumption within the life cycle system boundary was allocated to machining, with a total life cycle consumption of 276.7 MJ/unit. The total CO₂-footprint of the CM process was shown to be 20.72 kg/unit, where 19 % was emitted during manufacturing. In this first instance, CM was shown to have the biggest impact on both energy consumption and CO₂.eq, mostly due to the larger mass.

In the additive case of EBM, more energy was consumed in the processing stage, about 60 % out of 190.2 MJ/unit in total, whereas the CO₂.eq for this EBM processing was 36 % out of a life cycle emission of 7.58 MJ/unit.

Energy Contributions in HM by Component
 (weight=**230g**, total energy=**124.13MJ/part**)

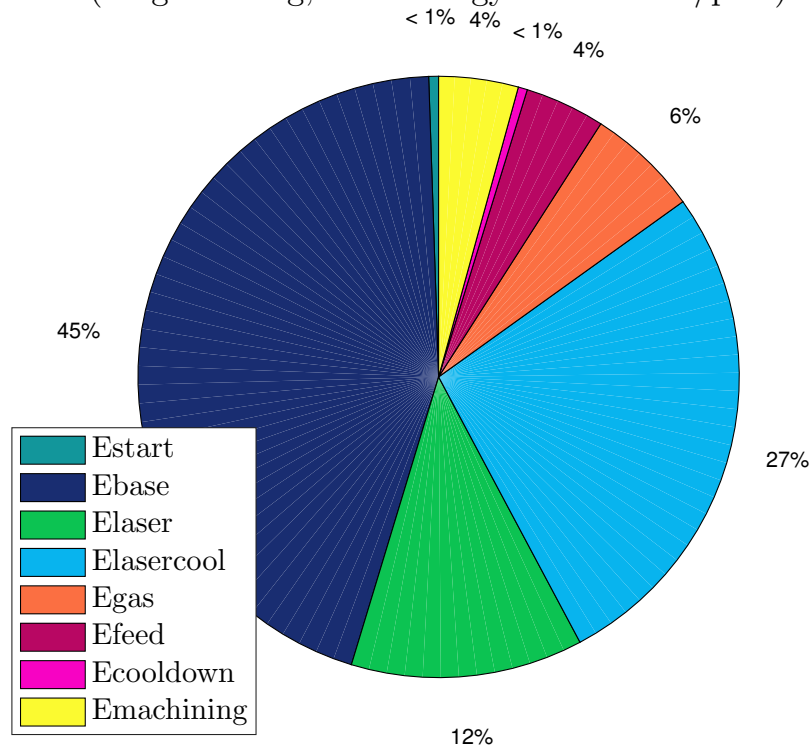

Figure 3.6: Energy distribution sorted by energy consuming subsystems in hybrid manufacturing for Geometry no 1

The manufacturing stage of HM was divided into additive state (DMD) and subtractive state (machining). The additive state required 118.8 MJ/unit and the subtractive state required 5.36 MJ/unit, adding up to 49 % out of a total life cycle demand of 254.6 MJ/unit. The CO₂.eq was 30 %, 5 %, and 65 % for DMD, machining, and material production respectively, adding up to 12.52 kg/unit total. It was observed that the additive processes (both EBM and DMD) were more energy intensive processes. However, the total impacts were lower than CM in this case. The observed difference in material related impact between AM and HM can be traced back mostly to the powder fusion efficiency (k) introduced in Equation 3.5. The process of powder atomisation was shown to be both an energy demanding and environmentally heavy process, represented by the burgundy region, compared to workpiece forming, shown as the teal section, despite the fact that less material is processed in both AM and HM compared to CM.

The energy requirements by ECU for Geometry no 2 is depicted in Figure 3.8. An expected increase in processing energy, due to an increase in deposited mass and processing time, was observed. It is shown that the distribution was similar to the first case, with the machine base

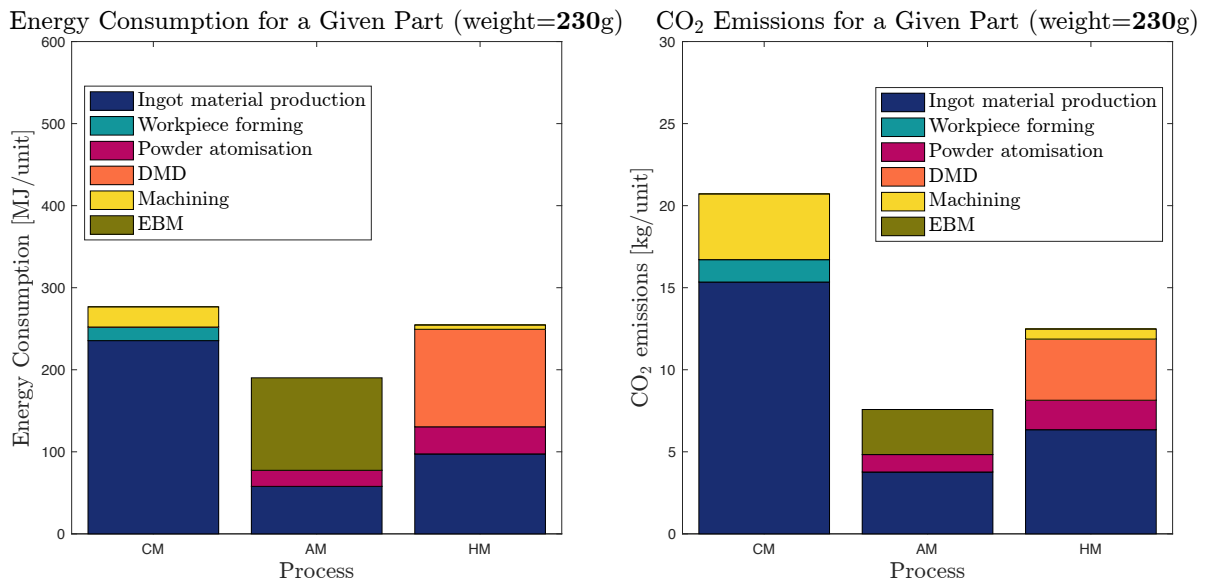

Figure 3.7: Energy consumption and CO₂.eq through the life cycle for Geometry no 1

power as the predominant element. The machining operation was down to 3%, showing that the additive state of HM is more demanding with more material deposition.

The mass of the component for Geometry no 2 was 0.40 kg, resulting in less material removal in CM and more material deposition in AM and HM. This is shown in Figure 3.9, with a reduction in processing energy for CM. The energy requirement for machining operations was 8%. However, the material related impact remained unchanged, due to the same amount of bulk material entering CM. This was reflected in the CO₂-footprint as well.

The increased product mass lead to the production of more ingot and powder material in the additive cases, resulting in growth in energy and CO₂.eq impacts related to material production and powder atomisation in AM and HM. An increase of 70% material deposition in EBM resulted in an increase of 36% in processing energy and an increase of 46% in total life cycle energy demand. This made AM slightly more energy demanding than CM. However, the CO₂ emissions were still the lowest for EBM.

The same tendency was shown in HM. More material was deposited, resulting in HM becoming the most energy demanding manufacturing route at 401.1 MJ/unit in total, 46% more than CM. The processing energy for HM was 53% out of the total lifelong energy demand. The manufacturing state accounted for about 30% of the total CO₂.eq at 17.89 kg/unit, 10% behind CM.

Energy Contributions in HM by Component
 (weight=401g, total energy=211.46MJ/part)

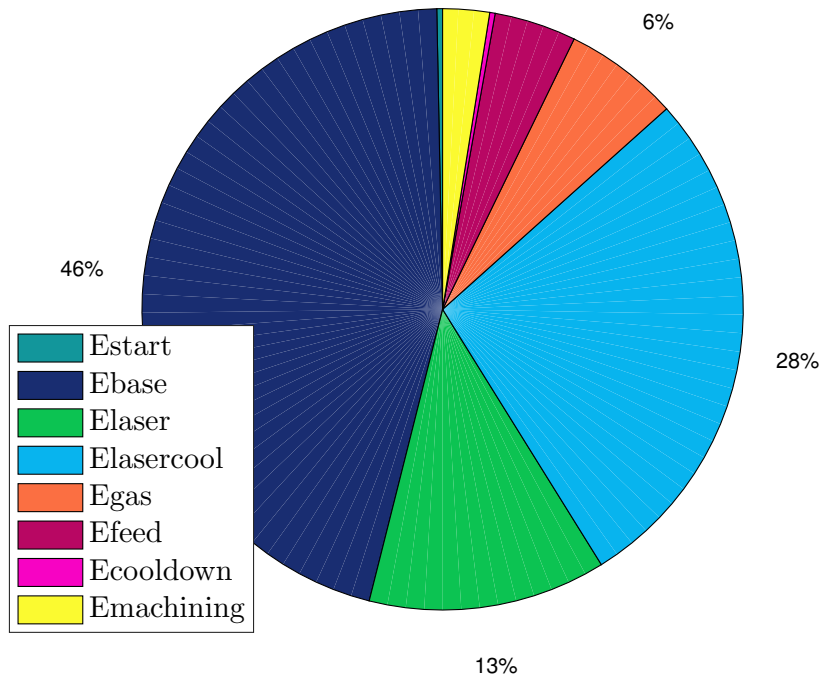

Figure 3.8: Energy distribution sorted by energy consuming subsystems in hybrid manufacturing for Geometry no 2

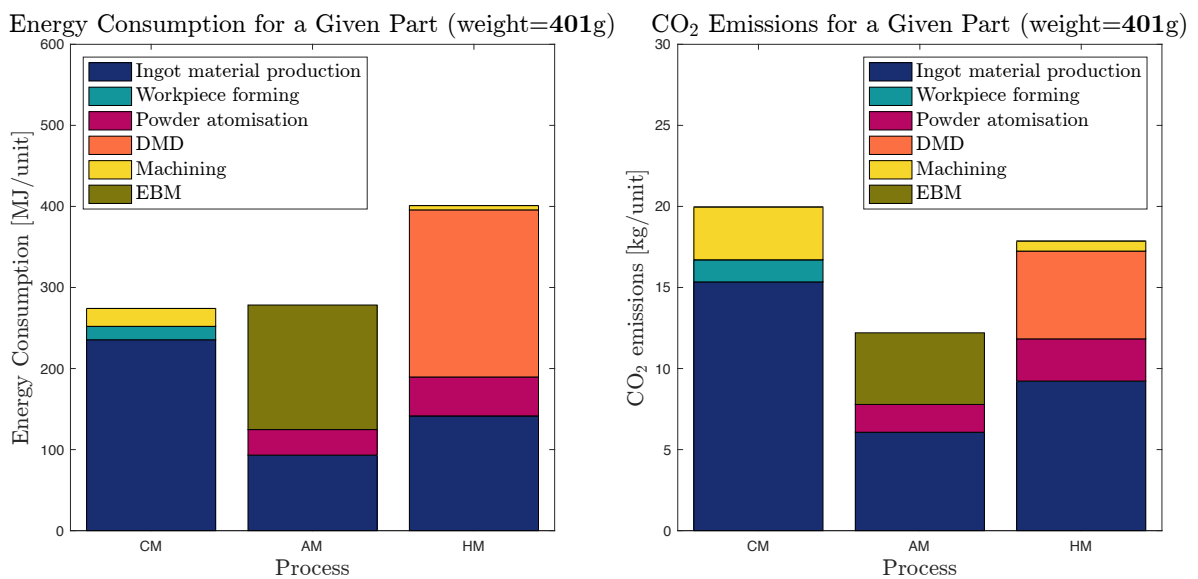

Figure 3.9: Energy consumption and CO₂.eq through the life cycle for Geometry no 2

The results for Geometry no 3 can be found in Figures 3.10 and 3.11. The mass of the component in case three was 0.58 kg. It can be seen in Figure 3.10 that not much changed from previous iterations, showing the machine to be quite stable. The machining operations accounted for 2 % out of the processing energy at 303.67 MJ/unit, and the predominant elements were the machine base power, laser cooling unit, and laser system, in that order.

Figure 3.11 shows that geometries with substantial solid-to-cavity ratios were very energy demanding for additive processes, where both AM and HM surpassed CM in terms of energy consumption. The same trends were observed that an increase in solid-to-cavity ratio leads to more material production, increased processing time, energy consumption, and CO₂ emissions in AM and HM. Machining in HM accounted for 2 % in processing energy consumption and 8.5 % of the processing emissions. EBM still proved to be the processing route with the lowest CO_{2,eq}, whereas HM rose to the top with a total CO_{2,eq} of 23.59 kg/unit.

Energy Contributions in HM by Component
 (weight=582g, total energy=303.67MJ/part)

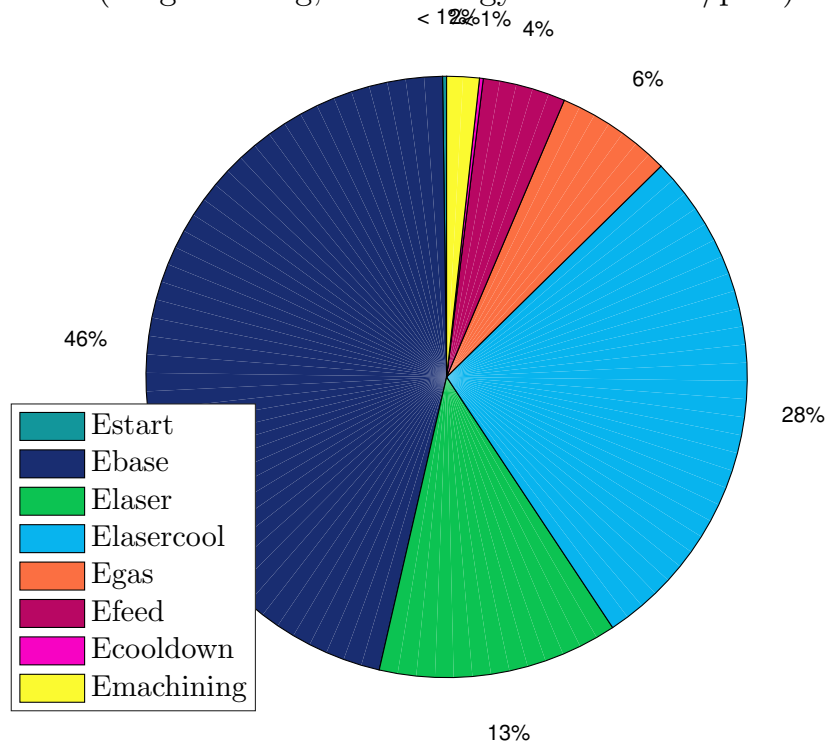

Figure 3.10: Energy distribution sorted by energy consuming subsystems in hybrid manufacturing for Geometry no 3

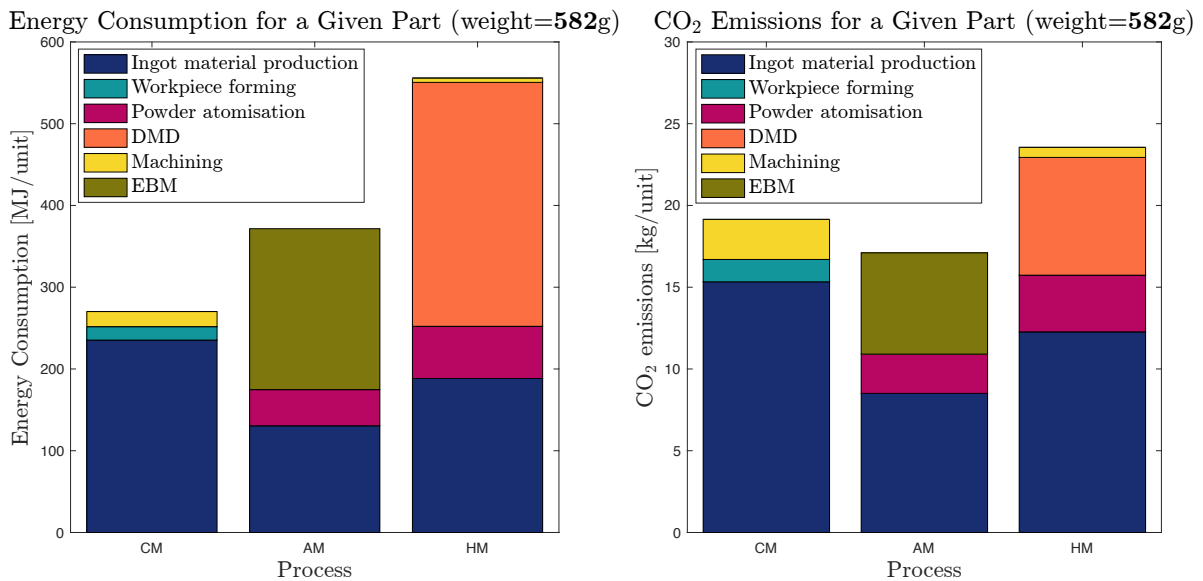

Figure 3.11: Energy consumption and CO₂.eq through the life cycle for Geometry no 3

Key Findings

Machine base power and auxiliary subsystems are predominant in HM - It was found that in all cases, the machine base power accounted for about 46 % of the processing energy requirement in hybrid manufacturing, followed by the laser cooling at 28 % and the 2 kW laser system at 13 %. The machining operations faded in comparison regarding energy requirement. The energy distribution was more or less unchanged between the cases, i.e. not affected by an increase in processing time.

Biggest contribution in CM is due to material realisation - The biggest impact in terms of energy demand and CO₂-footprint was traced back to the material related processes in CM, which is held constant in all cases, due to the same sized billet, i.e. equal amount of mass, entering CM in all cases. Less processing energy was required for increasing solid-to-cavity ratio since less machining was required.

AM and HM processing have higher energy demand, but lower emissions - It was found that AM and HM had a ~10-fold higher energy requirement than CM in all cases, however, due to material savings, the additive processes tended to have lower total CO₂.eq emissions. HM was seen as the process with the highest electrical energy requirement overall, and the greatest environmental impact in the third case.

Reduced machining and increased material deposition for increase in solid-to-cavity ratio - The trends in energy demand and CO₂ emissions can be observed in Figures 3.12 and 3.13, respectively. The bars are grouped by processing route, where the numbers in the labels of the first axis represent the various geometries. It was observed that for increasing solid-to-cavity ratios, less material was machined off, hence the reduction in energy demand and emissions in CM. However, the increased solid-to-cavity ratio lead to increased material related impacts and processing impacts in AM and HM.

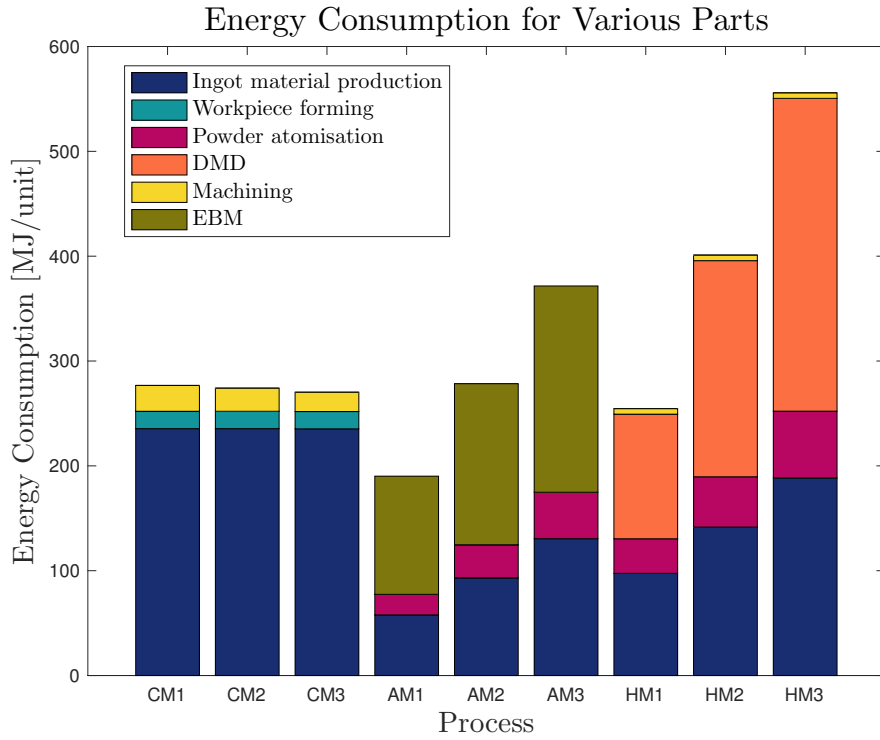

Figure 3.12: Energy consumption for all manufacturing processes and all three geometries, showing the change in energy requirement based on change in solid-to-cavity ratio

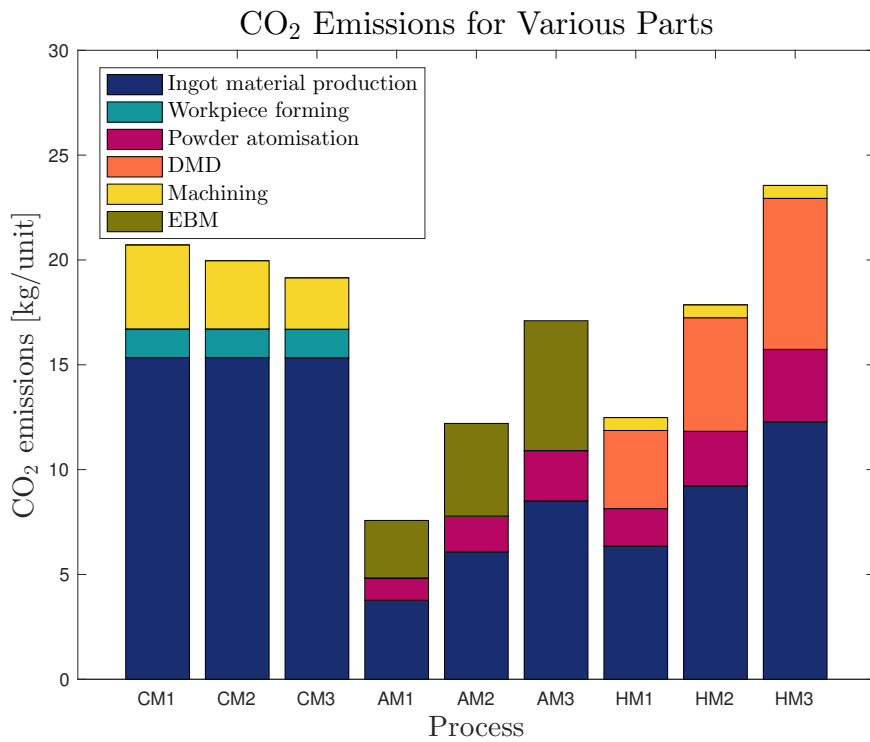

Figure 3.13: CO₂.eq emissions for all manufacturing processes and all three geometries, showing the change in CO₂.eq cost based on change in solid-to-cavity ratio

CHAPTER 4

DISCUSSION AND CONCLUSION

4.1 Discussion

The presented results act as a baseline for the discussion section. As a reminder, the analysis of the presented case study utilised a proposed analysis framework for energy assessment in hybrid manufacturing, complimented with a comparative life cycle based study where the analysis was tested for sensitivity by changing the internal dimensions of the analysed product. During the development of the analysis, the system engineering framework SPADE was employed.

As seen in Figures 3.6, 3.8, and 3.10 the energy distribution between the ECUs were identified. As previously mentioned, the rather stable results of the distributions indicated that the energy distribution in the hybrid process was not considerably affected by increasing product mass. The total energy consumption increased with increasing material deposition and processing time, whereas the distribution between the ECUs remained stable. However, if the model were tested for sensitivity to laser power, the distribution would most likely be somewhat altered. It can be argued that an increase in laser power would lead to the laser system requiring more energy. This would, in turn, lead to the laser cooling system demanding more power, so the energy distribution might not be too different from the demonstrated iteration. However, the amount of machining compared to material deposition will affect the energy distribution to some minor extent. The energy consumption of HM was mainly affected by the build rate of the product minimising the processing time. By identifying the machine base power and auxiliary systems as the predominant ECUs, it was demonstrated that process parameters not affecting the processing time have a smaller influence on the total energy demand and that energy consumption is not a question of process parameters, rather a question of volume and building strategy.

As summarised in the key findings, the trend for each manufacturing route was observed in Figure 3.12 and Figure 3.13. As expected, the processing energy was higher in the additive states (AM and HM), compared to CM, in agreement to Yoon et al. (2014). When moving from Geometry 1 to Geometry 3, the material gap between the subtractive and additive processes decreases. Considering the impacts from a life cycle perspective, accounting for the energy use and emissions in the upstream processes, CM experienced greater impacts for designs with lower solid-to-cavity ratios. This indicated that the additive processes, especially DMD, are best suited for thin-walled structures and that the key environmental benefit for AM and HM traces back to their material savings. Also, it is implied that these processes are more benign to the environment, relating their impacts mostly to electricity consumption and the methods utilised to produce the electricity.

The case study was tested for sensitivity concerning product geometry. The complexity regarding component features remained untouched while the dimensions of the product were altered. As investigated by Baumers et al. (2016), shape complexity would not affect the energy requirements in EBM. It would, however, affected the machining operations in CM and HM for complex geometries requiring extensive machining. It was observed quite high energy requirement in AM and HM compared to the reported values in Baumers et al. (2016). However, this is still in good relation with the observed values herein when considering the difference in geometry in the presented case study and in the study of Baumers et al.. The geometry of Baumers et al. was rather flat and wide relative to its height, whereas in this presented case study the height of the component was greater in magnitude compared to its width. This resulted in a substantial amount of scanning layers and high processing times. A trend was observed when the relative energy demand in EBM decreased for increasing wall thickness. It can be argued that this is due to the decreasing ratio of height over the cross-sectional area, making the energy consumption during layer recoating a less significant portion of the total energy distribution. In addition, the process parameters were not optimised for energy efficiency in either of the processing routes, which may contribute to the higher energy values. Moreover, Baumers et al. optimised for space utilisation, i.e. manufacturing multiple components simultaneously, reducing the individual energy requirement additionally. Further, it has been shown that EBM requires less energy than DMD, and this can be related to the efficiency of the electron beam compared to a laser and that there are fewer moving parts in EBM, as pointed out by Strutt (1980).

As just stated, the model proved to be sensitive to product geometry. Furthermore, it can be argued to be sensitive to process parameters affecting the processing time, such as the scanning speed in Equation 2.14 and the build rate in Equation 2.17. Particularly in the additive

processing routes, the energy consumption is highly process-time dependent. By reducing the processing time, e.g. by increasing the scanning speed in EBM or the deposition rate or catchment rate in DMD, the energy consumption can be argued to decrease, optimising the process parameters to meet environmental goals of the stakeholders. This can be done iteratively in the planning stages early in the model as depicted in Figure 1.10. However, the component must still fulfil the mechanical requirements. This is a part of the decision making, and the weighing and evaluation processes.

It is recognised that the EBM made component would require some machining finishing to meet potential tolerances and that this would contribute to the overall energy consumption in the AM life cycle. However, seeing the rather small impact of machining in HM, the addition of finish machining in AM would not make a considerable difference. On the other hand, post-processing in the form of stress relieving heat treatment would in some cases be required for both EDM and DMD, which would contribute to the final energy requirement and should be considered in an eventual improved model.

One opportunity that arises with HM is to explore the ability of HM to deposit material onto an existing part. The base part can be manufactured with either conventional means, such as casting or machining, or a powder bed based additive process, expanding the concept of hybrid manufacturing. Serres et al. (2011) proposed a variant of this strategy and found it to be both economically and environmentally beneficial. The results of the modelling can be used as a baseline to determine when it is advantageous to utilise one manufacturing technique over the other. For large and massive geometries, casting or machining should be the dominant state, supplemented by additive manufacturing to add external features. As an example, the company BeAM is investigating the possibility to manufacture components starting off with EBM for bodies with complex internal structures, and continues with DMD processing for tall, thin-walled structures, otherwise too large for the restricted build chamber of EBM.

By utilising SE principles and the SPADE methodology, the problem formulation could be accurately determined based on the identification of the stakeholder's needs. The problem formulation was then a key contributor when determining the system boundaries and the desired precision of the analysis. The verification and validation process of the model was mentioned in Section 1.6.3. The model was validated with a case study, which showed promising results that demonstrated the initial capabilities of the model. To further verify the model, analytic results could be compared to empiric measurements from the initial machine that the model was based on. Further, an empiric study could be used to make a model to incorporate process parameters such as the influence of laser power and scanning speed. This could be done by performing sev-

eral builds with various process parameters and use curve fitting tools and regression to make a model based on measured power data. This new model could then be used to analytically assess the energy requirement for future builds. Such a study was not accessible for the duration of this thesis, but it should be considered in the further works.

4.2 Conclusion

This thesis presented a modelling approach of a framework for energy assessment in a novel hybrid manufacturing process. Hybrid manufacturing was defined as the coupling of additive and subtractive manufacturing. The modelling procedure and the system design process were based on the system engineering framework that is SPADE, developed by Haskins (2008). The utilisation of the SPADE methodology encouraged structure in the initial phases of the thesis work. Further, the thesis illustrated how SPADE could be used in the development of an energy assessment model, by identifying stakeholders, formulating the problem, evaluation and decision making. The proposed model suggests an iterative analysis to meet energy requirement goals.

The proposed energy assessment model was tested and validated in a case study. The goal of the case study was to identify the energy consuming units in HM and to investigate the energy distribution among these units. It was demonstrated that the machine base power and auxiliary support system accounted for the predominant part of the energy requirement, where only about 13 % was allocated to the laser system, fusing the metallic powder in the additive state. As it was expected, the subtractive machining operations were relatively insignificant regarding processing time and energy demand in HM processing. The model was shown to be sensitive to product mass, which affected the processing time. The results showed that the energy distribution did not change considerably by an increase in processing time.

The case study contained a life cycle based approach for a comparative energy assessment for three alternative manufacturing approaches, namely conventional machining, additive manufacturing using EBM as an example, and the novel hybrid manufacturing combining the additive process of powder fed DMD and CNC machining. This investigation was conducted to properly label the manufacturing process from a sustainability point of view. The impact metric in the life cycle analysis was the CO₂.eq based on a European energy mix. It was shown that the additive processes in AM and HM were considerably more energy demanding concerning electrical power in the processing life cycle stage, but the material savings related to additive

manufacturing resulted in lower overall CO₂-footprint. This was the case for components with low solid-to-cavity ratios, i.e. thin walled structures. On the contrary, for components with larger solid-to-cavity ratios the energy demand and CO₂ emissions in HM largely surpassed the savings gained from using less material. This indicated that for components with large solid-to-cavity ratios, subtractive manufacturing should be the dominant manufacturing state, supported by additive manufacturing to add extra features. Recognising the effect product mass and geometry had on the environmental signature, it would be wrong to label one manufacturing approach as absolutely more energy efficient compared to another. The model can be used as a tool to determine when one processing route is more beneficial than the other, and how to combine them.

4.3 Further Work

The presented work in this Master's thesis is the result of one semester of continuous work. The presented results have been promising, yet there are work and improvements that can be addressed. As the model in Figure 1.10 suggest, the next step is to evaluate the model framework and make iterative improvements. Expanding the system boundaries and the elemental flow to account for consumables and auxiliary material, e.g. lubrication and gases, and incorporating eventual post-processing, the model can achieve a higher degree of detail. The model can incorporate build capacity utilisation to investigate to optimal building scenario. By incorporating an LCA software, if all necessary data is available, the assessment can be managed in a systematic way.

As it was discussed, it would be valuable to compare and validate the analytic values obtained from the proposed model to empirical data. Further, by performing an empirical sensitivity study on various process parameters, e.g. laser power and movement speed, an analytic model to be used for future builds can be developed based on regression from the observed data. This, however, requires access to a manufacturing machine to perform the power requirement measurements on and must be planned accordingly.

As the model is improved and expanded, it can be used in new case studies and academic publications, and eventually be adopted by industry stakeholders to use in their production planning. The process of Verification and Validation should always be considered to further improve upon the model.

BIBLIOGRAPHY

- Abele, E., Anderl, R., and Birkhofer, H. (2005). *Environmentally-Friendly Product Development*. Springer.
- Armarego, E., Ostafiev, D., Wong, S., and Verezub, S. (2000). An appraisal of empirical modeling and proprietary software databases for performance prediction of machining operations. *Machining science and technology*, 4(3):479–510.
- Arrazola, P.-J., Garay, A., Iriarte, L.-M., Armendia, M., Marya, S., and Le Maitre, F. (2009). Machinability of titanium alloys (Ti6Al4V and Ti555.3). *Journal of materials processing technology*, 209(5):2223–2230.
- Ashby, M. F. (2012). *Materials and the environment: eco-informed material choice*. Elsevier.
- ASTM f2792 (2013). Standard terminology for additive manufacturing technologies. Standard.
- Balogun, V. A. and Mativenga, P. T. (2013). Modelling of direct energy requirements in mechanical machining processes. *Journal of Cleaner Production*, 41:179–186.
- Baumers, M., Tuck, C., Hague, R., Ashcroft, I., and Wildman, R. (2010). A comparative study of metallic additive manufacturing power consumption. In *Solid freeform fabrication symposium*, pages 278–288.
- Baumers, M., Tuck, C., Wildman, R., Ashcroft, I., and Hague, R. (2016). Shape Complexity and Process Energy Consumption in Electron Beam Melting: A Case of Something for Nothing in Additive Manufacturing? *Journal of Industrial Ecology*.
- BeAM (2017). Online. <http://beam-machines.fr/en/about>. Accessed: 2017-05-08.
- Brice, C. A. and Hofmeister, W. H. (2013). Determination of bulk residual stresses in electron beam additive-manufactured aluminum. *Metallurgical and Materials Transactions A*, 44(11):5147–5153.
- Carroll, B. E., Palmer, T. A., and Beese, A. M. (2015). Anisotropic tensile behavior of ti-6al-4v components fabricated with directed energy deposition additive manufacturing. *Acta Materialia*, 87:309–320.

-
- Chestnut, H. (1967). Systems engineering methods..
- Clarkson, M. E. (1995). A stakeholder framework for analyzing and evaluating corporate social performance. *Academy of management review*, 20(1):92–117.
- Consoli, F., of Environmental Toxicology, S., and Chemistry (1993). *Guidelines for life-cycle assessment: a" code of practice"; from the SETAC Workshop held at Sesimbra, Portugal, 31 March-3 April 1993*. Setac.
- Despeisse, M. and Ford, S. (2015). The Role of Additive Manufacturing in Improving Resource Efficiency and Sustainability. In *IFIP International Conference on Advances in Production Management Systems*, pages 129–136. Springer.
- Diaz, N., Redelsheimer, E., and Dornfeld, D. (2011). Energy consumption characterization and reduction strategies for milling machine tool use. *Glocalized solutions for sustainability in manufacturing*, pages 263–267.
- DMG MORI (2017). Online. <http://en.dmgmori.com/products/lasertec/lasertec-additivemanufacturing/lasertec-65-3d>. Accessed: 2017-05-08.
- Dobrovski, Z., Verlinden, J. C., and Geraedts, J. M. (2011). Optimal design for additive manufacturing: opportunities and challenges. In *ASME 2011 International Design Engineering Technical Conferences and Computers and Information in Engineering Conference*, pages 635–646. American Society of Mechanical Engineers.
- Draganescu, F., Gheorghe, M., and Doicin, C. (2003). Models of machine tool efficiency and specific consumed energy. *Journal of Materials Processing Technology*, 141(1):9–15.
- Freeman, R. E. (2010). *Strategic management: A stakeholder approach*. Cambridge University Press.
- Gao, W., Zhang, Y., Ramanujan, D., Ramani, K., Chen, Y., Williams, C. B., Wang, C. C., Shin, Y. C., Zhang, S., and Zavattieri, P. D. (2015). The status, challenges, and future of additive manufacturing in engineering. *Computer-Aided Design*, 69:65–89.
- Geraedts, J., Dobrovski, E., Verlinden, J., and Stellingwerff, M. (2012). Three views on additive manufacturing: business, research and education. In *Ninth Int. Symp. Tools Methods Compet. Eng., I. Horváth, A. Albers, M. Behrendt, and Z. Rusák, Eds*, pages 1–15.
- Gibson, I., Rosen, D., and Stucker, B. (2015). *Additive manufacturing technologies: 3D printing, rapid prototyping, and direct digital manufacturing*. Springer.
- Gibson, I., Rosen, D. W., Stucker, B., et al. (2010). *Additive manufacturing technologies*, volume 238. Springer.
- Gutowski, T., Dahmus, J., and Thiriez, A. (2006). Electrical Energy Requirements for Manufacturing Processes. In *13th CIRP international conference on life cycle engineering*, volume 31, pages 623–638.
- Gutowski, T. G., Allwood, J. M., Herrmann, C., and Sahni, S. (2013). A global assessment of manufacturing: Economic development, energy use, carbon emissions, and the potential for energy efficiency and materials recycling. *Annual Review of Environment and Resources*, 38:81–106.

-
- Hammond, G. and Jones, C. (2010). Inventory of Carbon and Energy (ICE), Annex B: How to Account for recycling a Methodology for Recycling. *Bath, UK: The University of Bath.*
- Haskins, C. (2008). Systems Engineering Analyzed, Synthesized, and Applied to Sustainable Industrial Park Development.
- He, Y., Liu, F., Wu, T., Zhong, F., and Peng, B. (2012). Analysis and estimation of energy consumption for numerical control machining. *Proceedings of the Institution of Mechanical Engineers, Part B: Journal of Engineering Manufacture*, 226(2):255–266.
- Heinl, P., Rottmair, A., Körner, C., and Singer, R. F. (2007). Cellular titanium by selective electron beam melting. *Advanced Engineering Materials*, 9(5):360–364.
- Hopkinson, N., Hague, R., and Dickens, P. (2006). *Rapid manufacturing: an industrial revolution for the digital age.* John Wiley & Sons.
- Hur, J., Lee, K., Kim, J., et al. (2002). Hybrid rapid prototyping system using machining and deposition. *Computer-Aided Design*, 34(10):741–754.
- Hybrid ManuTech (2017). Online. <http://www.hybridmanutech.com>. Accessed: 2017-05-08.
- Ingarao, G., Priarone, P. C., Di Lorenzo, R., and Settineri, L. (2016). A methodology for evaluating the influence of batch size and part geometry on the environmental performance of machining and forming processes. *Journal of Cleaner Production*, 135:1611–1622.
- International Council on Systems Engineering and Haskins, C. (2011). *Systems engineering handbook: A guide for system life cycle processes and activities.* International Council of Systems Engineering.
- ISO (2006a). 14040: 2006. *Environmental management-Life cycle assessment-Principles and framework.* European Committee for Standardization.
- ISO (2006b). 14044. *Environmental management. Life cycle assessment. Requirements and guidelines Managements environmental. Analyse du cycle de vie.*
- Karunakaran, K., Suryakumar, S., Pushpa, V., and Akula, S. (2010). Low cost integration of additive and subtractive processes for hybrid layered manufacturing. *Robotics and Computer-Integrated Manufacturing*, 26(5):490–499.
- Kellens, K., Dewulf, W., Overcash, M., Hauschild, M. Z., and Duflou, J. R. (2012). Methodology for Systematic Analysis and Improvement of Manufacturing Unit Process Life-Cycle Inventory (UPLCI)—CO2PE! Initiative (Cooperative Effort on Process Emissions in Manufacturing). Part 1: Methodology Description. *The International Journal of Life Cycle Assessment*, 17(1):69–78.
- Kellens, K., Renaldi, R., Dewulf, W., Kruth, J.-p., and Duflou, J. R. (2014). Environmental impact modeling of selective laser sintering processes. *Rapid Prototyping Journal*, 20(6):459–470.

-
- Kellens, K., Yasa, E., Renaldi, R., Dewulf, W., Kruth, J.-P., and Duflou, J. (2011). Energy and resource efficiency of sls/slm processes (keynote paper). In *SFF Symposium 2011*, pages 1–16.
- Khanna, N. and Sangwan, K. S. (2013). Machinability analysis of heat treated ti64, ti54m and ti10. 2.3 titanium alloys. *International Journal of Precision Engineering and Manufacturing*, 14(5):719–724.
- Le Bourhis, F., Kerbrat, O., Hascoët, J.-Y., and Mognol, P. (2013). Sustainable manufacturing: evaluation and modeling of environmental impacts in additive manufacturing. *The International Journal of Advanced Manufacturing Technology*, 69(9-12):1927–1939.
- Li, L., Yan, J., and Xing, Z. (2013). Energy requirements evaluation of milling machines based on thermal equilibrium and empirical modelling. *Journal of Cleaner Production*, 52:113–121.
- Li, W. and Kara, S. (2011). An empirical model for predicting energy consumption of manufacturing processes: a case of turning process. *Proceedings of the Institution of Mechanical Engineers, Part B: Journal of Engineering Manufacture*, 225(9):1636–1646.
- Mognol, P., Lopicart, D., and Perry, N. (2006). Rapid prototyping: energy and environment in the spotlight. *Rapid prototyping journal*, 12(1):26–34.
- Mori, M., Fujishima, M., Inamasu, Y., and Oda, Y. (2011). A study on energy efficiency improvement for machine tools. *CIRP Annals-Manufacturing Technology*, 60(1):145–148.
- Morrow, W., Qi, H., Kim, I., Mazumder, J., and Skerlos, S. (2007). Environmental aspects of laser-based and conventional tool and die manufacturing. *Journal of Cleaner Production*, 15(10):932–943.
- Munoz, A. and Sheng, P. (1995). An analytical approach for determining the environmental impact of machining processes. *Journal of materials processing technology*, 53(3-4):736–758.
- Murr, L., Quinones, S., Gaytan, S., Lopez, M., Rodela, A., Martinez, E., Hernandez, D., Martinez, E., Medina, F., and Wicker, R. (2009). Microstructure and mechanical behavior of ti-6al-4v produced by rapid-layer manufacturing, for biomedical applications. *Journal of the mechanical behavior of biomedical materials*, 2(1):20–32.
- Norsk Titanium (2017). Norsk Titanium to Deliver the World’s First FAA-Approved, 3D-Printed, Structural Titanium Components to Boeing. Online. <https://tinyurl.com/kz9ywjc>. Accessed: 2017-04-14.
- Oxley, P. (1998). Development and application of a predictive machining theory. *Machining Science and Technology*, 2(2):165–189.
- Paraskevas, D., Vanmeensel, K., Vleugels, J., Dewulf, W., Deng, Y., and Duflou, J. R. (2014). Spark plasma sintering as a solid-state recycling technique: the case of aluminum alloy scrap consolidation. *Materials*, 7(8):5664–5687.

-
- Paris, H., Mokhtarian, H., Coatanéa, E., Museau, M., and Ituarte, I. F. (2016). Comparative environmental impacts of additive and subtractive manufacturing technologies. *CIRP Annals-Manufacturing Technology*, 65(1):29–32.
- Paul, R. and Anand, S. (2012). Process energy analysis and optimization in selective laser sintering. *Journal of Manufacturing Systems*, 31(4):429–437.
- Peng, T. (2016). Analysis of energy utilization in 3d printing processes. *Procedia CIRP*, 40:62–67.
- Peng, T. and Sun, W. (2017). Energy modelling for fdm 3d printing from a life cycle perspective. *International Journal of Manufacturing Research*, 12(1):83–98.
- Petrovic, V., Vicente Haro Gonzalez, J., Jorda Ferrando, O., Delgado Gordillo, J., Ramon Blasco Puchades, J., and Portoles Grinan, L. (2011). Additive layered manufacturing: sectors of industrial application shown through case studies. *International Journal of Production Research*, 49(4):1061–1079.
- Priarone, P. C. and Ingarao, G. (2017). Towards Criteria for Sustainable Process Selection: on the Modelling of Pure Subtractive Versus Additive/Subtractive Integrated Manufacturing Approaches. *Journal of Cleaner Production*.
- Priarone, P. C., Ingarao, G., di Lorenzo, R., and Settineri, L. (2016). Influence of Material-Related Aspects of Additive and Subtractive Ti-6Al-4V Manufacturing on Energy Demand and Carbon Dioxide Emissions. *Journal of Industrial Ecology*.
- Rajemi, M., Mativenga, P., and Aramcharoen, A. (2010). Sustainable Machining: Selection of Optimum Turning Conditions Based on Minimum Energy Considerations. *Journal of Cleaner Production*, 18(10):1059–1065.
- Richard Degenhardt, Dr Leslie J. Cohen, P., Petrovic, V., and Niñerola, R. (2015). Powder recyclability in electron beam melting for aeronautical use. *Aircraft Engineering and Aerospace Technology: An International Journal*, 87(2):147–155.
- Rifkin, J. (2012). The third industrial revolution: How the internet, green electricity, and 3-d printing are ushering in a sustainable era of distributed capitalism. *World Financial Review*, 1:4052–4057.
- Serres, N., Tidu, D., Sankare, S., and Hlawka, F. (2011). Environmental comparison of MESO-CLAD® process and conventional machining implementing life cycle assessment. *Journal of Cleaner Production*, 19(9):1117–1124.
- Song, Y.-A. and Park, S. (2006). Experimental investigations into rapid prototyping of composites by novel hybrid deposition process. *Journal of Materials Processing Technology*, 171(1):35–40.
- Sproles, N. (2002). Formulating measures of effectiveness. *Systems Engineering*, 5(4):253–263.
- Strutt, P. (1980). A comparative study of electron beam and laser melting of m2 tool steel. *Materials Science and Engineering*, 44(2):239–250.
-

-
- United Nations (2015a). Paris Agreement, *Framework convention on climate change*.
- United Nations (2015b). Transforming our world: the 2030 Agenda for Sustainable Development, *Sustainable Development knowledge platform*.
- United Nations Environment Program (UNEP) (2011). Manufacturing - Climate Change Mitigation. <https://tinyurl.com/k9vjtnc>. Accessed: 2017-04-18.
- Vrancken, B., Cain, V., Knutsen, R., and Van Humbeeck, J. (2014). Residual stress via the contour method in compact tension specimens produced via selective laser melting. *Scripta Materialia*, 87:29–32.
- WCED (1987). Report of the World Commission on Environment and Development: Our Common Future.
- Wohlers, T. (2012). Wohlers report 2012: Additive manufacturing and 3d printing, state of the industry, wohlers associates, ft. *Collins, CO*.
- Wohlers, T. and Gornet, T. (2014). Wohlers report 2014: History of additive manufacturing. *Wohlers Report 24*.
- Wu, A. S., Brown, D. W., Kumar, M., Gallegos, G. F., and King, W. E. (2014). An experimental investigation into additive manufacturing-induced residual stresses in 316l stainless steel. *Metallurgical and Materials Transactions A*, 45(13):6260–6270.
- Xiong, X., Zhang, H., and Wang, G. (2009). Metal direct prototyping by using hybrid plasma deposition and milling. *journal of materials processing technology*, 209(1):124–130.
- Yoon, H.-S., Lee, J.-Y., Kim, H.-S., Kim, M.-S., Kim, E.-S., Shin, Y.-J., Chu, W.-S., and Ahn, S.-H. (2014). A comparison of energy consumption in bulk forming, subtractive, and additive processes: Review and case study. *International Journal of Precision Engineering and Manufacturing-Green Technology*, 1(3):261–279.
- Zhang, B., Dembinski, L., and Coddet, C. (2013). The study of the laser parameters and environment variables effect on mechanical properties of high compact parts elaborated by selective laser melting 316l powder. *Materials Science and Engineering: A*, 584:21–31.

A - Risk Assessment

NTNU	Risikovurdering				Utarbeidet av	Nummer	Dato
 HMS					HMS-avd.	HMSRV2601	22.03.2011
		Godkjent av		Erstatter			
		Rektor		01.12.2006			

Enhet: Institutt for Produktutvikling og Materialer

Linjeleder: Torgeir Welo

Deltakere ved kartleggingen (m/ funksjon): Torgeir Welo, veileder/Espen Braastad, Student.

Kort beskrivelse av hovedaktivitet/hovedprosess: Masteroppgave for Espen Braastad.

Develop model for energy consumption in hybrid manufacturing

Er oppgaven rent teoretisk? (JA/NEI):

JA

Dato: 18.05.2017

Signaturer: Ansvarlig veileder: Torgeir Welo

Torgeir Welo

Studenter: Espen Braastad

Espen Braastad

ID nr.	Aktivitet/prosess	Ansvarlig	Eksisterende dokumentasjon	Eksisterende sikringstiltak	Lov, forskrift o.l.	Kommentar
1	Utvikle en matematisk modell for å bergne energibruk i hybridmaskinering. Modellen blir tatt i bruk i programmet matlab i form av et case study, hvor hybridmaskinering blir sammenliknet med vanlig maskinering og additiv tilvirkning.					
1a						
1b						
1c						

B - Technical Drawings

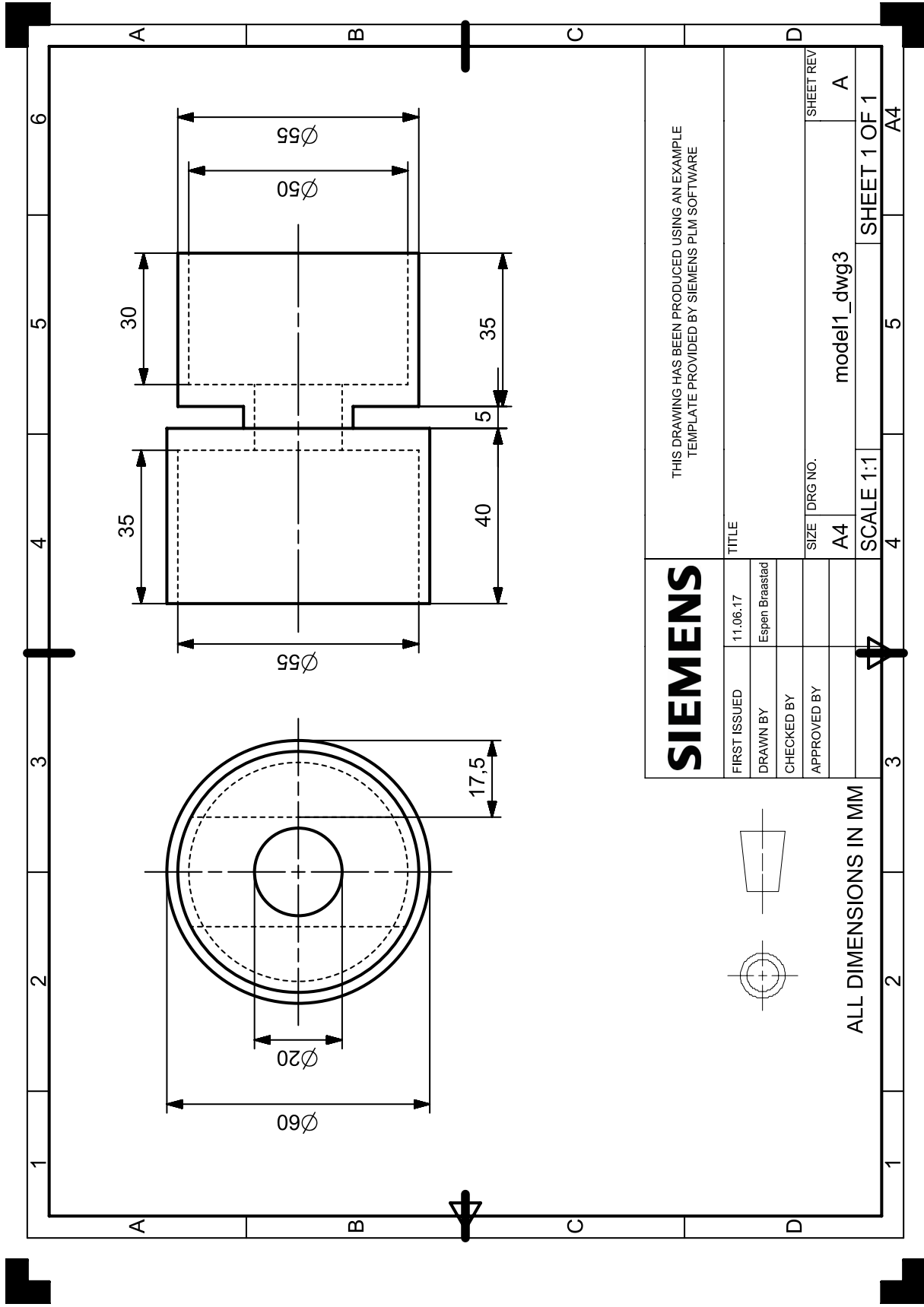

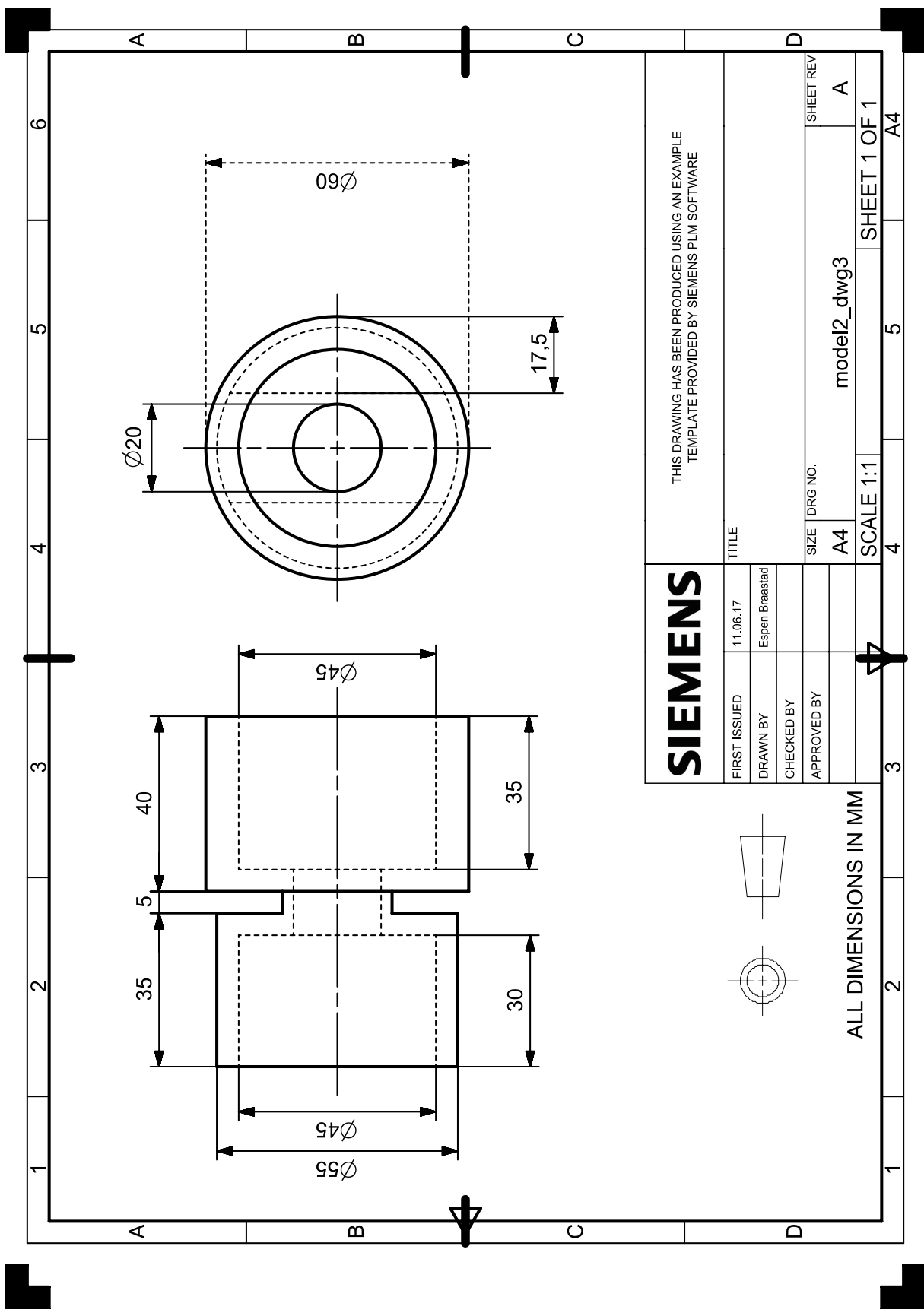

SIEMENS		THIS DRAWING HAS BEEN PRODUCED USING AN EXAMPLE TEMPLATE PROVIDED BY SIEMENS PLM SOFTWARE	
FIRST ISSUED	11.06.17	TITLE	
DRAWN BY	Espen Braastad	SHEET REV	
CHECKED BY		A	
APPROVED BY		SIZE	DRG NO.
		A4	model2_dwg3
		SCALE	1:1
		4	5
		SHEET 1 OF 1	
		A4	

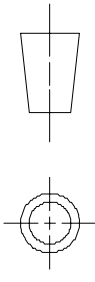

ALL DIMENSIONS IN MM

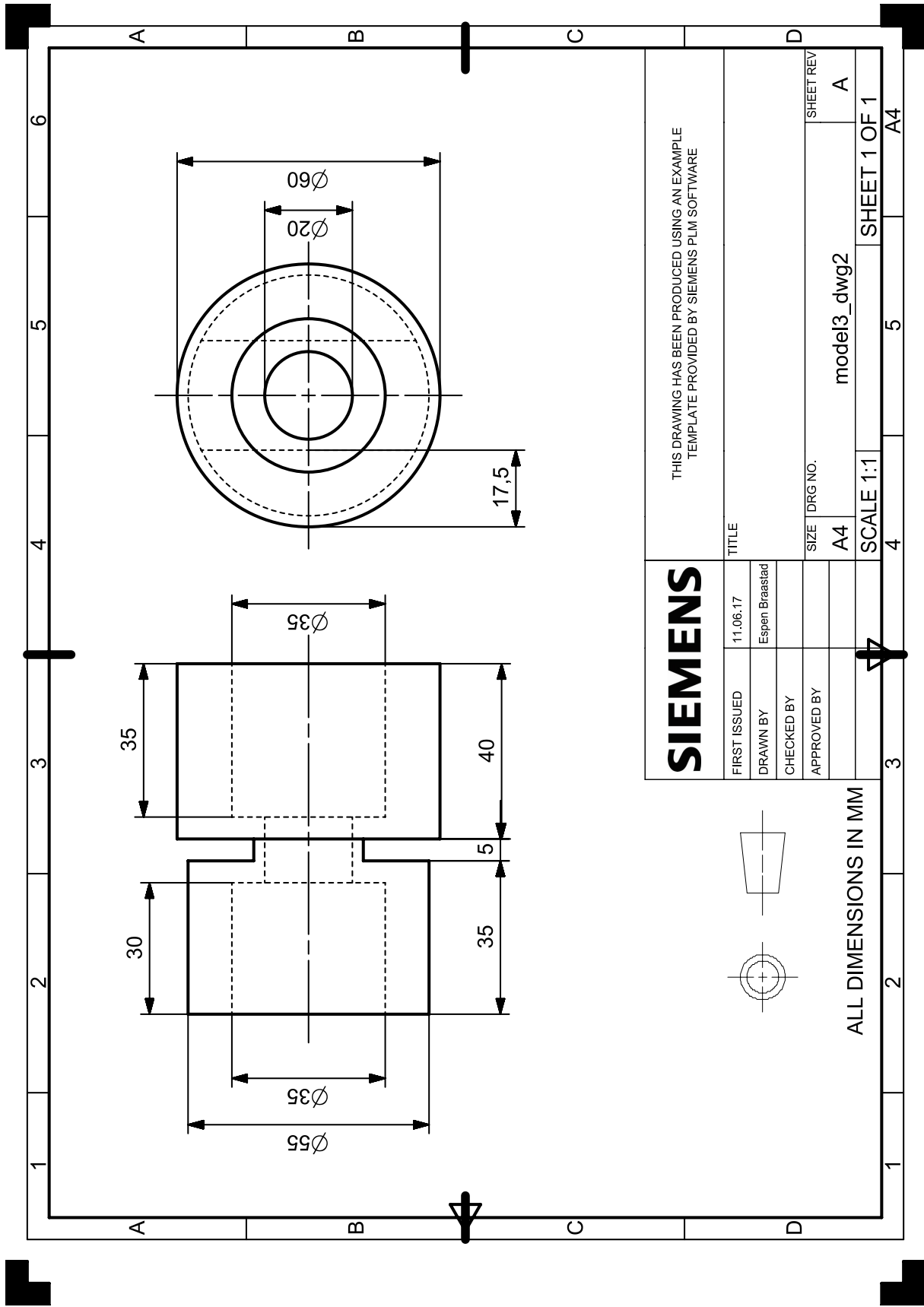

SIEMENS		THIS DRAWING HAS BEEN PRODUCED USING AN EXAMPLE TEMPLATE PROVIDED BY SIEMENS PLM SOFTWARE	
FIRST ISSUED	11.06.17	TITLE	
DRAWN BY	Espen Braastad	DRAWING NO.	
CHECKED BY		SIZE	
APPROVED BY		A4	
		DRG NO.	
		A4	
		model3_dwg2	
		SHEET REV	
		A	
		SCALE 1:1	
		SHEET 1 OF 1	
		A4	

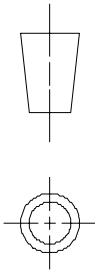

ALL DIMENSIONS IN MM