



Norwegian University of
Science and Technology

Predictive Control of a District Heating System

Andreas Hamre

Master of Science in Cybernetics and Robotics

Submission date: June 2017

Supervisor: Bjarne Anton Foss, ITK

Norwegian University of Science and Technology
Department of Engineering Cybernetics

Master project

Name of candidate: Andreas Hamre
Subject: Engineering Cybernetics
Title: Predictive Control for Distric Heating System operations
Title (in Norwegian):

Background

There exists a well-established predictive control methodology, which is extensively used in the process industries, called Model Predictive Control and Real-Time Optimization. We will use the term Predictive Control (PC). PC relies on a prediction model of the system itself, which in our case means a District Heating System (DHS), and disturbances, including varying load. All DHS operations are limited by constraints such as capacity constraints (e.g. pump power or heat exchanger capacity) and safety constraints (e.g. upper pressure level constraints). PC is useful since it enables the use of constraints in a consistent manner. An online optimization problem needs to be solved repetitively (e.g. once an hour) as a part of PC. This master project will explore the use of PC for DHS and use the DHS in Stjørdal as case.

Task description:

1. Give an overview of DHS and how such systems are controlled and operated. Explain also how PC fits into a control hierarchy for DHS.
2. Develop a suitable simulation model of the heat generation in the heat plant (HP) and the flow network between the HP and the end-users. The simulator should be validated against operational data.
3. Develop a predictive controller for optimal heat-generation in the DHS. The predictive controller should include as input the load prediction for a set of end-users provided by a load-prediction model, as well as appropriate constraints for the flow network, heat plant and customer demands.
4. Assess the performance of the controller under realistic operating conditions.
5. Propose a plan for implementing PC in medium-sized DHS similar to the Stjørdal system. The plan should identify potential obstacles for implementation.

The master thesis project is done in cooperation with Statkraft Varme AS.

Starting date: 16.01.2017
End date: 12.06.2017
Co-supervisor: Brage Rugstad Knudsen, NTNU

Trondheim, 26.01.2017

Bjarne Foss
Professor/supervisor

Abstract

This thesis aims to use MPC to control the District Heating System situated in Stjørdal. It is a small district heating system with one production unit and 45 consumers attached to the network. The main goal is to reduce the supply temperature delivered from the plant, and thereby reduce heat losses in the network and the fuel used at the plant. For the MPC controller, a model of the distribution network and a model for load prediction of the consumers has been developed and tested against data from the network. The controller was simulated for a day in February and was able to reduce the supply temperature significantly. However, there was some problem with simulating the return temperature, meaning the model still needs some refinement. The thesis is the result of a collaboration between NTNU and Statkraft.

Sammendrag (Abstract in Norwegian)

Denne mastergraden tar for seg prediktivt styring av et fjernvarmenett i Stjørdal. Stjørdal har et lite fjernvarmenett med en varmesentral som leverer varme til 45 kunder. Hovedmålet med oppgaven er å laget en regulator som kan senke temperaturen i nettet, for dermed å minimiere varmetap og spare brenselforbruk. En modell av fjernvarmenettet samt en modell for lastprediksjon har blitt utviklet og validert mot data fra nettet. Nettverket ble simulert for en dag i februar og den prediktive styringsmodellen klarte å reduserer turtemeprturen betraktelig. Imidlertid viste simuleringene store svingninger i returtemepratur som tyder på at modellen trengs å utbedres. Oppgaven er et resultat av et samarbeid mellom NTNU og Statkraft.

Acknowledgements

The thesis is a result of a collaboration with Statkraft, which have an ongoing cooperation with NTNU regarding predictive control of district heating networks.

I would like to thank my supervisor Bjarne Anton Foss and co-supervisor Brage Rugstad Knudsen for valuable contribution and discussions on the subject. Their insights have been helpful and crucial for the completion of this assignment. I would also like to thank all the people at Statkraft for being helpful and taking their time to fulfill all the requests I have made. They have been very generous by giving me access to data and their internal computer systems. I would especially like to thank Morten Fossum, my contact at Statkraft, for being quick to reply and helpful with putting me in contact with the right person whenever I had any questions. Also, I would like to thank Per Christian Håpnes and Trond Espet for showing me around the plant in Stjørdal and giving me valuable insights on how a district heating system is operated.

Trondheim, June 2017
Andreas Hamre

List of Figures

1.1	A simple district heating system	2
2.1	The heating plant of Stjørdal DHS	11
2.2	Simplified sketch of the heating plant	12
4.1	The top plot shows transport time from the plant to each consumer. Each color represents a different consumer in the network. The plot below shows the flow out from the plant 5th of January.	28
4.2	Total demand for consumer group 1, shifted demand and the largest consumer	30
4.3	Total demand for consumer group 2, shifted demand consumer and the largest consumer	31
4.4	Total demand for consumer group 3, shifted demand and the largest consumer	32
4.5	Total demand for consumer group 4, shifted demand and the largest consumer	33
4.6	Total demand for consumer group 5, shifted demand and the largest consumer	34

4.7	Measured and simulated return temperature without heat loss, January 2017	38
4.8	Measured and simulated return temperature with heat loss, January 2017	39
4.9	Measured and simulated return temperature without heat loss, 6th to 16th of February 2017	40
4.10	The flow through each consumer group	41
5.1	Ambient air temperature in Stjørdal measured from Værnes and Kvithamar	44
5.2	24 hour prediction, one consumer. Different inputs	45
5.3	1 hour prediction, consumer group 1	47
5.4	1 hour prediction, consumer group 2	48
5.5	1 hour prediction, consumer group 3	49
5.6	1 hour prediction, consumer group 4	50
5.7	1 hour prediction, consumer group 5	51
5.8	1 hour prediction, total load	52
5.9	11 hour prediction, consumer group 1	53
5.10	11 hour prediction, consumer group 2	54
5.11	11 hour prediction, consumer group 3	55
5.12	11 hour prediction, consumer group 4	56
5.13	11 hour prediction, consumer group 5	57
5.14	11 hour prediction, total load	58
6.1	Supply temperature from plant compared too the MPC controllers supply temperature	66
6.2	Flow from plant compared with the MPC simulation, 6th of February	67
6.3	Return temperate to plan compared with the MPC simulation, 6th of February 2017	68

List of Tables

3.1	Kinematic viscosity of water (Values are taken from www.engineeringtoolbox.com)	19
4.1	Operating areas. \dot{m} is the flow out from the plant	27
4.2	Consumer groups based on delays in operating area 1	29
4.3	RMSE for different value sof the heat loss coefficient	38
6.1	Operating areas. \dot{m} is the flow out from the plant	63

Contents

Abstract	i
Sammendrag (Abstract in Norwegian)	ii
Acknowledgements	iii
1 Introduction	1
1.1 The Production Unit	3
1.1.1 Operating a DHS	3
1.2 The Distribution Network	4
1.3 The Consumer Substations	5
1.4 Optimization of DHS	5
1.4.1 The Goal of this Thesis	6
1.5 Previous work	8
2 Stjørdal District Heating System	10
2.1 The Heating Plant	12
2.1.1 The Flue Gas Condensation System	14

2.1.2	Available data	15
3	Physical Modelling of District Heating Systems	17
3.1	The Distribution Network	18
3.1.1	Fluid and Flow Properties	18
3.1.2	Conservation laws	21
3.1.3	Steady Flow in Pipe Networks	22
3.1.4	Linear Theory Method	23
3.2	Heat Transfer	24
4	Modelling the Stjørdal DHS	26
4.1	Consumer delay model	27
4.2	The transport model	35
4.3	Validating the model	37
4.3.1	Estimating the heat loss	37
4.3.2	Validating the Flow Distribution Model	40
5	Load Prediction	42
5.1	Weather data	43
5.2	The Model	44
5.3	Results	46
5.3.1	1 hour prediction	46
5.3.2	11 hour predictions	53
6	MPC on the Stjørdal DHS	59
6.1	MPC	60
6.2	MPC on Stjørdal DHS	62
6.3	Results	65
7	Discussion	69
7.1	The Return Temperature	69
7.2	Improvements of the Distribution Network Model	70

7.3	Including the internal dynamics of the plant	71
7.4	Implementing MPC in Stjørdal DHS	72
7.5	Conclusion	73
8	Future Work	74

CHAPTER 1

Introduction

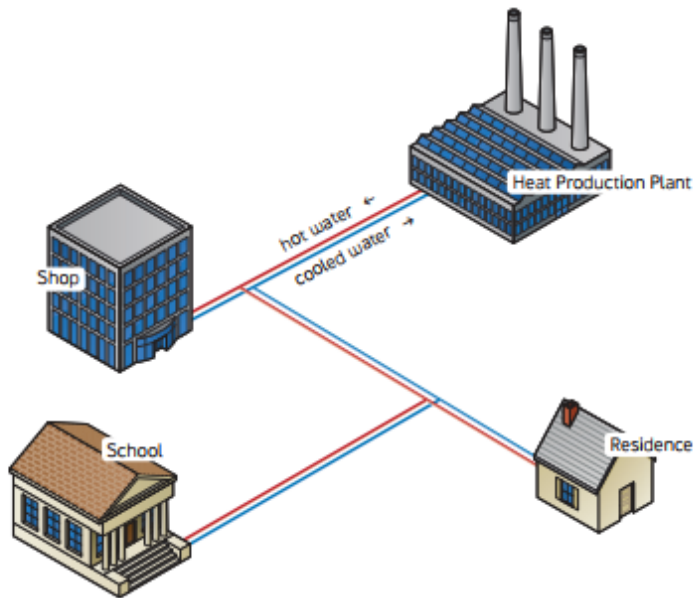

Figure 1.1: A simple district heating system

A District Heating System (DHS) provides heat, transported as hot water or steam in pipes, to heat consumers. Usually these consumers require heat for space heating and hot tap water. A DHS consists of three main components:

- The production units
- The distribution network
- The consumer substations

A simple sketch of a DHS is shown in figure 1.1 (the picture is taken from www.statkraft.com). The red lines are pipes transporting hot water from the heating plant, while the blue lines are the pipes returning the cooled water from the heat consumers.

1.1 The Production Unit

A DHS can be connected to several production units each which consists of one or more boilers and a pump(s) connected to the distribution network. The boilers can run on different fuels like for example wood chips, coal, or natural gas. The production unit can produce heat as its main product or the heat can be a byproduct from some industrial process. From a production unit, heated water flows out into the network. The temperature of the water leaving the production unit is referred to as the *supply temperature*, while the cooled water returning to the plant is referred to as the *return temperature*.

1.1.1 Operating a DHS

Some networks consist of several heating plants, while smaller ones only have one. At the heating plant there are several boilers and pumps. The plant

is usually operated from a control room where the operator has access to a display showing measurements and states of all the production units at the plant. With this and the aid of computer software, the operator is able to make decisions about set points for supply temperature, how much fuel should be used, starting and stopping of boilers, maintenance of equipment and production units. The three most interesting variables when it comes to controlling a DHS is the flow, the supply temperature and return temperature. While the flow distribution in the network and the return temperature are largely a consequence of consumer behaviour, the operator is in full control of the supply temperature. The energy delivered from plant is given by the following energy balance:

$$Q = \dot{m}c_p(T_S - T_R) \quad (1.1)$$

Q = Power delivered from plant [kW]
 \dot{m} = Flow from the plant [kg/s]
 T_S = Supply temperature °C
 T_R = Return temperature [°C]

From this equation one can deduce that a reduction in supply temperature must give an increase in flow given that the return temperature is the same. It is therefore important that the operator chooses a supply temperature that doesn't exceed the pumping capacity of the network.

1.2 The Distribution Network

The distribution network connects the production unit to the consumers. It is a large pipe network usually including loops, many branches, pipes and insulation with varying diameters. The network of a DHS usually stretch for several kilometers which gives large time delays in the transported heat, therefore pumps are sometimes installed at different part in the network to

increase the flow rate. This is usually the case for larger networks. While changes in the flow happen almost instantaneously, the supply temperature from the plant might not reach far out consumers in several hours. Because of these large time delays combined with the limited controlling possibilities makes controlling a DHS a highly difficult task.

1.3 The Consumer Substations

Attached to the distribution network are the consumer substation. The consumers are able to adjust the flow through the substation, and the cooling of the water that runs through it. One difficult aspect of modelling the substations is that one usually have little information about how the it is controlled on the consumers side of the heat exchanger.

The power taken from the network can be expressed by the energy balance in equation 1.1 with T_S being the delivered supply temeparture to the consumer, T_R being the return water from the consumer and Q be the power consumption of the consumer. It is the configuration of the substations that decides the return temperature. One thing to notice is that an increased flow through the substation means a higher return temperature as the heat exchanger have less time to extract heat from the water. District heating companies are usually interested in the substations giving low return temepratures as this reduces the heat losses in the network, and sometimes improves the effcinecy of the boilers.

1.4 Optimization of DHS

DHS are large and complex system, and optimization is complicated task. Optimization of DHS is a large field, that includes everything from design, maintenance, expansion of the network, long and -short term production

planning. The optimal action is decided by the time horizon one is using. With a time horizon of a couple of hours, the best one can do is utilize the existing production units as best as possible, while a time horizon of one year means one can consider maintenance of existing old production units versus investing in new units. All of these optimization problems are tied together in a way. The design problem decides dimensions of pipes and network layout among other things. This will again affect the short term optimization as it gives constraints on flow rate and supply temperature. The same can be said about investing in production equipment, which can change the optimal operation. Also, the short term optimization will give the operator insight in how well the network is performing and can aid in decisions regarding new investments.

1.4.1 The Goal of this Thesis

This thesis will only consider short term planning, meaning how one can utilize the current state of the system as best as possible. This usually means how to deliver energy to the consumer as efficient as possible, from an economical perspective (minimize fuel usage). As mentioned in the preceding section, the behaviour of a DHS is largely controlled by the consumers. The limited controlling options and the large time delays make it challenging to operate. The complexity of the problem suggests that it would be useful to formulate it mathematically, find suitable constraints and use an optimization scheme to find the optimal control. This thesis aims to use model predictive control (MPC) for this. MPC is a method that at each sampling instant solves an open loop optimization problem on a finite time horizon. The current state (in our case, the return temperature, supply temperature and flow) is used as the initial state. From the optimization problem one gets a control sequence on the whole horizon. The first input from this sequence is applied to the plant and optimization continues for the next sampling in-

stant. Obviously, to be able to use such a method, one needs a model that is able to predict future states of the system. The idea of the method is that you apply an input that is not just optimal based on the current state, but it also optimal on some time horizon. The time horizon is usually chosen to be longer than the largest delays of the system. This makes it possible for the controller to be able to handle large time delays and other complicated dynamics. To be able to utilize MPC for controlling a DHS three steps need to be done:

- Build a model for load prediction in the network
- Build a model of the actual DHS
- Formulate an MPC based on constraints of the system

The first step, making a model for the heat load prediction was done last fall as a project assignment. Here, predictions for 12- and 24 hours were researched. For the MPC controller, one needs the predictions $1 - N$ hours ahead in time, where N is the prediction horizon. The second step, building a model of the DHS can be done in many different ways and can be arbitrarily complex. However, when using MPC one needs quick calculations as one need to deliver the optimal input for each sample time. Thus, the sample time gives an upper bound for the maximum calculation time the controller can use. Hopefully, the model can be linear as linear MPC controllers are much quicker than non-linear ones. It is to be expected that the DHS has a lot of non-linear behavior, but this can be solved by linearization. Also, it would be desirable to have a model that is based on physical properties of the network, as such models are easier to understand and improve. While the other alternative would be a black box model, which often performs well but is difficult for the user to understand the dynamics involved. This thesis is a continuation of [2] which developed an MPC formulation for controlling the DHS in Klæbu. This thesis hopes to further develop this model. The two main goals is to include a model for the return temperature and a model for the heat loss in the network.

1.5 Previous work

How design choices of the network affects the optimal supply temperature and pumping has been investigated in [7]. Two different network designs were considered, one designed for low pressure loss ($100Pa/m$) and one for high pressure loss ($1276Pa/m$). Two objective functions were used, one which tried to minimize the energy losses and energy consumption, and one which tried to minimize operational costs. They found that for the network with low pressure loss the pump energy consumption was not significant compared to the heat losses. This was because the heat losses were quite high due to a choice of pipes with large diameters. For the the network designed for high pressure loss, smaller pipe diameters were chosen and reduction of pump energy was achieved by increasing the supply temperature.

In [9] the problem of scheduling schedule the production components of a DHS in Uppsala, Sweden. The objective is to maximize profit and the mixed-integer linear programming (MILP) problem was formulated as a unit commitment problem (UCP). They found that it was possible increase revenue of the DHS with this approach. Hourly sample time was used and 5 days prediction horizon gave the best result.

Alot of work has been done when it comes to modelling of DHS. Authors which have focused on model useful for operational optimization include [1] and [10]. In [1] the focus is on heat load prediction, heat transfer in the distribution network and modelling of the substations, while in [10] modelling of the distribution network was the main focus. Both authors investigates the propagation of heat in the network and presents the "node method" which calculates the outlet temperature for each pipe based on the inlet temperature history. The advantage of this method is that it can solve for the temperature at each pipe at the same time.

In short term planning there exists a lot of literature regarding heat load

prediction, modelling of the network, optimization regarding production units or production components (boilers) etc. But few authors consider everything as a whole. But this is for example done in [3] which developed mathematical models for weather, the production units, the distribution network and the substations. The thesis resulted in a computer system called "EnerPlan" used for operational optimization. The system was installed at a DHS and the operators found the aid of EnerPlan helpful.

There is not much literature on MPC and control of DHS. In [5] MPC is used for short term optimization. The aim of the study is to design a control law that is robust against load prediction errors. 12 hour prediction horizon is used and a two day simulation is presented. A simulation model and a model for optimization was developed and the controller was tested on the simulation model, giving positive results.

CHAPTER 2

Stjørdal District Heating System



11

Figure 2.1: The heating plant of Stjørdal DHS

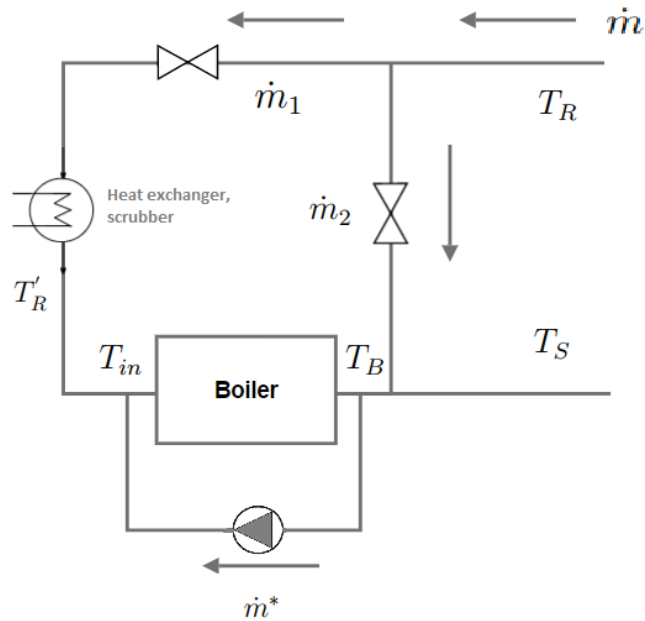

Figure 2.2: Simplified sketch of the heating plant

The heating plant of Stjørdal DHS is located in Lillemoen, a little bit outside of the Stjørdal town centre. The plant has two boilers that run on biofuel and two oil-fired boilers that works as a backup. The distribution network runs for about 12 km and most consumers are mostly situated in the Stjørdal town centre. The biggest consumers are Stjørdal Municipality and the Norwegian Ministry of Defence. The DHS is owned 85% by Statkraft and 15% is owned by Stjørdal Municipality.

2.1 The Heating Plant

In this section a the heating plant is presented and a suggestion for how one can model the internal dynamics of the plant is put forward. In figure 2.2 one can see a simplified sketch of the internal plant dynamics. The return

water enters with temperature T_R . The flow \dot{m} is split in two where \dot{m}_1 enters the boiler while \dot{m}_2 is used to mix the return water with the output water from the boiler which has temperature T_B . This is controlled so that the supply temperature is as close to its set point as possible. Today, the choice of set point is based on the ambient air temperature. The function for deciding the set point is based off the operators experience while operating the plant. The flow \dot{m}_1 is heated as it flows through the heat exchanger that is connected to the gas condensation unit (which is described in the next section), then the water is mixed with water from the boiler as the return water is too cold for the boiler to heat up directly. The temperature of the water entering the boiler is T_{in} . This system might be described as (with the two boilers aggregated into one boiler):

$$\dot{m}_k = \dot{m}_{1,k} + \dot{m}_{2,k} \quad (2.1)$$

$$T'_R = F_1(T_R, \dot{m}_1, x) \quad (2.2)$$

$$T_{in,k} = \frac{T_{B,k}\dot{m}_k^* + T'_{R,k}\dot{m}_{1,k}}{\dot{m}_{1,k} + \dot{m}_k^*} \quad (2.3)$$

$$x_{B,k+1} = F_2(x_{B,k}, T_{in,k}, \dot{m}_k^* + \dot{m}_{1,k}) \quad (2.4)$$

$$T_{B,k+1} = F_3(x_{B,k}, T_{B,k}, T_R, \dot{m}_1, \dot{m}^*) \quad (2.5)$$

$$T_{S,k} = \frac{T_{B,k}\dot{m}_{1,k} + T_{R,k}\dot{m}_{2,k}}{\dot{m}_k} \quad (2.6)$$

$$Q_{B,k} = (\dot{m}_{1,k} + \dot{m}_k^*)c_p(T_{B,k} - T_{in,k}) \quad (2.7)$$

Here, T'_R is the temperature of the return water after it has been through the heat exchanger of the flue gas condensation system. F_1 is meant to be a function that describes this heating. x some other variable affecting this relation. $x_{B,k+1}$ is the temperature inside the boiler and F_2 is a function describing how this changes. It is here assumed that the variables affecting the boiler are its previous state, the inlet temperature and the flow going through the boiler. T_B is the outlet temperature of the water from the boiler.

It is described by the function F_3 and it is assumed that it depends on the state of the boiler, the previous outlet temperature and the flow through the boiler. This model would give the following constraints on the variables:

$$0 \leq Q_B \leq \begin{cases} 4000 MW & \text{One boiler running} \\ 8000 MW & \text{Two boilers running} \end{cases} \quad (2.8)$$

$$80 \leq T_S \leq 100 \quad (2.9)$$

$$80 \leq T_B \leq 117 \quad (2.10)$$

$$\dot{m}_{min} \leq \dot{m} \leq \dot{m}_{max} \quad (2.11)$$

Note here that the drawing in figure 2.2 is a simplification. In reality there are two boilers. In addition there are two oil-fired boilers connected to the system. When the flow \dot{m}_2 gets too small (the valve is closing because the boilers can't keep the desired output temperature) the oil-fired boilers are connected to the system. Many other dynamics of the plant have been omitted as they are most likely not that interesting for the control problem investigated in this thesis. If one wants to model both of the boilers, it would be possible to do so by formulating a unit commitment problem. This would require a longer planning horizon, as the boilers usually needs one day to heat up and be ready for use.

2.1.1 The Flue Gas Condensation System

The bio-fuel boilers are fueled by wood chips which has a certain moisture. The boilers can handle fuel with moisture up to 50%. More moisture means lower efficiency for the boiler. To compensate for this, a flue gas condensation system has been installed in Stjørdal. When the fuel is burned it produces water vapor that is discharged from the boiler together with the flue gas. For the condensation, the flue gas needs to be cooled down below its water dew point. This is done by connecting the flue gas condensation unit to the return water by a heat exchanger. This setup can improve the efficiency of the boiler by 10 – 15%. With lower return temperature the better

efficiency one get's from the gas condensation system, meaning it is desirable to achieve a lower return temperature. According to [6] lowering the return temperature by $1^{\circ}C$, the value of the gs condensing unit efficiency increases by 0.7%. In [6] the efficiency of a gas condensation unit at a plant in Latvia was analyzed and the following equation, containing 7 independent variables was put forward:

$$E_c = 7.84433 + 0.0793491\dot{m} - 1.82416K_{sh} + 0.394416K_{sv} \\ - 1.96617N_b - 0.0255361T_{g2} + 0.966587T_{k2} - 1.07552T_R$$

N_b = Boiler capacity [MW]

\dot{m} = Flow in DHS [m^3/h]

T_{g2} = Temperature of flue gas after the condensing unit [$^{\circ}C$]

T_{k2} = Temperature of water after gas condensing unit, but before heat exchanger [$^{\circ}C$]

T_R = Return temperature of the DHS before the heat exchanger $^{\circ}C$

K_{sh} = Spray water ratio in horizontal part of gas condensing unit (dimensionless)

K_{sv} = Spray water ratio in vertical part of gas condensing unit (dimensionless)

This result was obtained through statistical analysis of data and the seven independent variables are significant at the 95% confidence interval [6]. The equation suggests that modelling the flue gas condensation unit is rather complex. However, if one is to develop a model of the boilers it is essential to include this system as it increases boilers efficiency significantly. Without considering the condensation unit one will overestimate the fuel usage. In this thesis no model has been developed for the internal plant dynamics. The focus has been on finding the optimal set point for the supply temperature (T_S). The assumption being that minimizing this temperature will minimize the fuel usage of the plant.

2.1.2 Available data

A lot of data is available from the plant. One challenge is to pick out the most relevant data for building a suitable model for the control problem that

is to be investigated. The following data was gathered from the plant in the time period of October-April 2017:

- Supply temperature from plant, 10 minute samples
- Return temperature to plant, 10 minute samples
- Total flow, 1 hour samples
- Water temperature from boiler 1 and 2, 10 minute samples
- Flow entering boiler 1 and 2, 10 minute samples
- Total load of boiler 1 and 2, 10 minute samples
- Power delivered from the flue gas condensation system, 10 minute samples
- Total power produced from the plant, 10 minute samples
- bio fuel usage (in kgs), weekly samples
- Moisture test of the bio fuel, weekly samples

Not all the data has been used when building the model of the DHS. In retrospect, some interesting data was not collected from the plant that could have been used. For example the temperature inside the boilers would have been interesting to analyze. This could have made it possible to develop a model of the boiler state.

CHAPTER 3

Physical Modelling of District Heating Systems

This chapter deals with physical modelling of DHS. The first part is about modelling of the distribution network and the second part deals with the heat transfer. DHS are highly complex systems, which can be modelled with very sophisticated models. The goal of this thesis is not to model a DHS perfectly, but rather to build a simple model for optimization purposes. However, it would be useful to have a model based around physical properties of the network and therefore this has been investigated.

3.1 The Distribution Network

The distribution network consists of several pipes connecting the consumers and the plant. When analyzing a DHS it is useful to know the flow distribution in the network, as it can help analyzing the delays for different consumers. In a DH network, changes in pressure and flow is about 1000 times faster than changes in temperature. Because of this, we can assume that changes in flow happen instantaneously. For each time step the flow in each pipe is updated and assumed constant for the rest of the time step. Pipe network analysis is a large branch of fluid mechanics and many methods exists for calculating the flow distribution. In this section a method for calculating the flow distribution in a looped network, called the Linear Theory method, will be presented.

3.1.1 Fluid and Flow Properties

An important fluid property viscosity, tells us about the "resistance to flow" in the fluid. It is defined as:

$$\tau = \mu \frac{dv}{dy} \quad (3.1)$$

τ = shearing stress [Pa]
 μ = viscosity [Ns/m^2]
 $\frac{dv}{dy}$ = velocity gradient []

It is often common to divide the viscosity by the fluid density. This is called the kinematic viscosity:

$$\nu = \mu/\rho \quad (3.2)$$

where ν is the kinematic viscosity. The viscosity and kinematic viscosity of water are function of temperature. In table 3.1 the kinematic viscosity of water is shown for a range of temperatures. In this thesis the kinematic viscosity is treated as a constant equal to $0.365 \times 10^{-6} \frac{m^2}{s}$ which is the kinematic viscosity for water at $80^\circ C$.

Temperature [$^\circ C$]	Kinematic viscosity [$10^{-6}m^2/s$]
70	0.413
80	0.365
90	0.326
100	0.294

Table 3.1: Kinematic viscosity of water (Values are taken from www.engineeringtoolbox.com)

The two most important variables for determining fluid flow is the velocity and the pressure. One can say that it is the pressure difference between two pipe ends that drives the flow. The equation for determining the pressure head (pressure difference in meters) is given by the D'arcy-Weisbach equation:

$$h_f = \frac{\Delta p}{\gamma} = \frac{8fLQ^2}{\pi^2 D^5 g} \quad (3.3)$$

h_f = pressure head (pressure difference in meters) [m]
 f = friction factor (dimensionless)
 Δp = differential pressure [Pa]
 γ = Specific weight of water [kg/(m²s²)]
 L = Length of the pipe [m]
 Q = mass flux [kg/s]
 D = Diameter of the pipe [m]
 g = Acceleration of gravity [m/s²]

The friction factor for turbulent flow can be determined by the Colebrook-White equation:

$$\frac{1}{\sqrt{f}} = -2 \log \left(\frac{\epsilon}{3.7D} - \frac{2.51}{Re\sqrt{f}} \right) \quad (3.4)$$

Where

f = friction factor
 ϵ = roughness of the pipe
 D = diameter of the pipe

Because this equation is implicit you need to use an iterative scheme to solve it, for example Newton's method. To get started with a good guess, one can use the Haaland equation, which is an approximation of the Colebrook-White equation for a full flowing circular pipe:

$$\frac{1}{\sqrt{f}} = -1.8 \log \left(\left(\frac{\epsilon/D}{3.7} \right)^{1.11} + \frac{6.9}{Re} \right) \quad (3.5)$$

f = friction factor (dimensionless)
 ϵ = roughness of the pipe [m]
 Re = Reynolds number (dimensionless)

The Reynold's number in the above equation is defined

$$Re = \frac{VD}{\nu} \quad (3.6)$$

For a DHS one can assume turbulent flow, which means $Re > 2100$.

The head loss can be approximated by:

$$h_f = KQ^n \quad (3.7)$$

This formula is referred to as the exponential formula and is often useful when analyzing flow in pipe networks.

To determine K and n in the exponential formula one can approximate f by the formula:

$$f = \frac{a}{Q^b}$$

When substituting this into the Darcy-Weisbach equation, we get:

$$n = 2 - b \quad (3.8)$$

$$K = \frac{aL}{2gDA^2} \quad (3.9)$$

3.1.2 Conservation laws

The conservation of mass principle can be applied to fluid flowing through a pipe. Instead of dealing with the mass, it is more convenient to deal with the mass flux (the flow of mass per time). The conservation of mass principle then states that the mass flux for steady flow (definer steady flow) for a pipe is:

$$\rho_1 A_1 V_1 = \rho_2 A_2 V_2 \quad (3.10)$$

ρ = Density of water [kg/m^3]

A_1 = Cross-sectional area of the pipe at the inlet [m^2]

V_1 = Average velocity of the flow at the inlet [m/s]

A_2 = Cross sectional area of the pipe at the outlet [m^2]

V_2 = Average velocity of the water at the outlet [m/s]

We assume that we deal with incompressible flow (constant density regardless of pressure), and the continuity equation reduces to:

$$A_1V_1 = A_2V_2 \quad (3.11)$$

The conservation of energy principle between two points (subscripts 1 and 2), also known as Bernoulli's equation in fluid mechanics, can be expressed as:

$$z_1 + \frac{p_1}{\gamma} + \frac{V_1^2}{2g} + h_m = z_2 + \frac{p_2}{\gamma} + \frac{V_2^2}{2g} + h_L \quad (3.12)$$

where

- z = Vertical distance from some reference point [m]
- p = The fluid pressure [Pa]
- γ = Specific weight of water [N/m^3]
- V = Velocity of the fluid [m/s]
- g = Acceleration of gravity [m/s^2]
- h_m = Energy added to the system [m]
- h_L = Energy lost [m]

3.1.3 Steady Flow in Pipe Networks

For each junction (or node) of a pipe network, the continuity principle tells us that the flow in to the junction must equal the flow out of the junction:

$$(\sum \dot{m}_i)_{out} - (\sum \dot{m}_i)_{in} = C \quad (3.13)$$

A pipe network containing J nodes will, given that all external flows are known, give rise to $J-1$ independent continuity equations. In a network containing loops (like the Stjørdal DHN) the continuity equations will not be enough for determining the flow distribution, even if all external flows are known. To be able to determine the flow distribution for these types of network, one needs to consider the conservation of energy principle given in

equation 3.12, which can be applied to the loops of the network. ... The head loss through each loop must equal to zero:

$$\sum_{l=1}^I h_{fl} = \sum_{l=1}^I \frac{8fLQ^2}{\pi^2 D^5 g} = 0 \quad (3.14)$$

where I is the number of non-overlapping loops in the network. Given J continuity equations and I non-overlapping loops, these mass conservation and energy conservation principles give rise to $N = (J-1) + I$ independent equations [8] (which is one for each pipe). If one assumes all external flows are now, it is the flow rate in each pipe that are unknowns meaning one has N equations with N unknowns. The only problem is that there are I non-linear equations. This will be discussed in the next section.

3.1.4 Linear Theory Method

The linear theory method (also known as called the Wood - Charles linearization) linearizes the head loss equations presented in the preceding section which then gives you a linear system of equations. Given that all external flows are known, the flow distribution in the network can now be calculated using methods of linear algebra.

The head loss is approximated for each pipe by the linearization:

$$h_{f_i} = [K_i \dot{m}_i(0)^{n-1}] \dot{m} = K'_i \dot{m}_i \quad (3.15)$$

The expression $\dot{m}_i(0)^{n-1}$ is an approximation of the flow rate in the pipe. For the first iteration it is set to unity.

Combining these equations with the continuity equations, one gets enough equations to solve for the flow distribution. An important step in the method is, when two iterative solutions has been obtained, to average them. Otherwise the method will oscillate between the solution [8]

The steps of the method can be summarized as follows:

- Obtain K and n for the exponential formula given in equation 3.7 for each pipe in the network
- Write out the continuity equations for the network
- For each loop, write out the linearized hhead loss equations given in 3.15
- Solve the system of equations. If a solution was obtained at last iteration. Average your new solution with the previous one.
- When the estimated flow rate for step n : $\dot{m}_i(n)$, is equal within some tolerance for each pipe, a solution has been found.

The fact that you don't need to make an initial guess with this method, like you have to in for example Newton's method makes it very easy to use. Also, the method converges in very few steps [8].

3.2 Heat Transfer

In [3] a partial differential equation that describes the heat transfer in the network pipes has been put forward:

$$A \frac{\partial T}{\partial t}(x, t) + \dot{m} \frac{\partial T}{\partial x}(x, t) + \frac{2k'}{c_p} \sqrt{A\pi} (T(x, t) - T_{gnd}) = 0 \quad (3.16)$$

where

- T = temperature of the water [$^{\circ}C$]
 \dot{m} = is the flow through the pipe [m^3/h]
 c_p = Specific heat capacity of water [$J/(kg^{\circ}C)$]
 A = Cross sectional area of the pipe [m^2]
 k' = Thermal loss coefficient between pipe and ground [$J/(m^2s^{\circ}C)$]
 T_{gnd} = Temperature of the surrounding ground [$^{\circ}C$]

The equation is derived from the energy conservation law. In [3] a first order Taylor approximation is used while in a analytical solution is provided. The analytical solution can be obtained from the method of characteristics or a computer program like mathematica. The solution is given as:

$$T_{out}(t) = T_{gnd} + [T_{in}(t - t_0(t)) - T_{gnd}]e^{-\frac{2k'}{c_p R \rho}(t - t_0(t))} \quad (3.17)$$

where

- T_{out} = Temperature of the water flowing out of the pipe [$^{\circ}C$]
 T_{in} = The temperature of the water flowing in through the pipe [$^{\circ}C$]
 R = Radius of the pipe [m]
 ρ = density of water [kg/m^3]

The exponential term is usually very small, meaning one can use the approximation $e^{ax} \approx 1 - ax$:

$$T_{out}(t) = T_{gnd} + [T_{in}(t - t_0(t)) - T_{gnd}] \left[1 - \frac{2k'}{c_p R \rho}(t - t_0(t)) \right] \quad (3.18)$$

So it seems reasonable that one can approximate the heat loss by a constant loss factor for each sample time. This will be investigated further in the next chapter.

CHAPTER 4

Modelling the Stjørdal DHS

Flow \dot{m} [m^3/h]	Operating area
$\dot{m} \leq 76$	1
$76 < \dot{m} \leq 102$	2
$102 < \dot{m} \leq 128$	3
$128 < \dot{m} \leq 154$	4
$154 < \dot{m}$	5

Table 4.1: Operating areas. \dot{m} is the flow out from the plant

In the preceding chapter, the underlying physical equations for a DHN were presented. When modelling Stjørdal DHS network it is of interesting to find a simpler model for the MPC formulation. However, it is also desirable to have a model based on the physical properties of the network. When using a physical model it is easier to understand what is going on within the model, and also how and what could or should be changed based on measurements. The other option would be to use a black-box model like a neural network. While this is possible and has been done in [10] it is easier to adjust and expand a model that one can understand.

4.1 Consumer delay model

The Stjørdal DH network consist of 45 customers. Time delays for each customer have been analyzed by calculating the transport time of the water from the plant to each customer. First, the flow distribution of the network was calculated by the linear theory method for each hour of the first week of January 2017. The flow is assumed to be constant between each hourly sample. In 4.1 we can see the delay for each consumer for each hour of the day and also the flow out from the plant. From these two plots it looks like the most important variable for determining the transport time for the water at time t is the flow out from the plant at time t .

The consumers have been aggregated based on their time delay. Five operating areas have been defined and is shown in table 6.1. The flow \dot{m} represents the flow out from the plant. For each operating area, the average transport time of the water have been calculated for each consumer. The consumers have been aggregated based on the average delay in operating area 1. Table 4.2 shows how the partitioning.

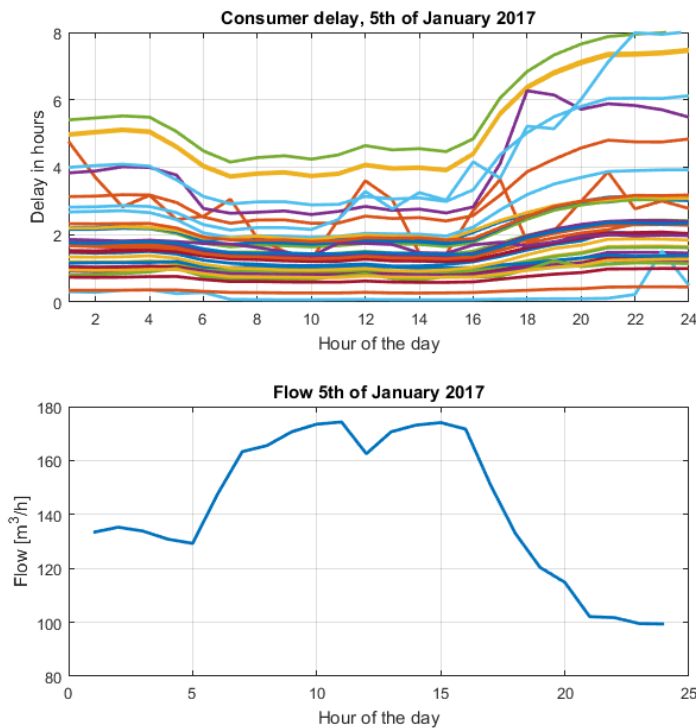

Figure 4.1: The top plot shows transport time from the plant to each consumer. Each color represents a different consumer in the network. The plot below shows the flow out from the plant 5th of January.

For each group the consumer consumption is shifted to the consumer largest consumer of the group. If consumer A is the largest of its group and consumer B is in the same group, then the consumption of B is shifted based

Average delay τ [h]	Consumer group	Number of consumers
$\tau \leq 2$	1	16
$2 < \tau \leq 4$	2	10
$4 < \tau \leq 5$	3	8
$5 < \tau \leq 8$	4	5
$8 < \tau$	5	6

Table 4.2: Consumer groups based on delays in operating area 1

on A's consumption. Meaning if A's delay in operating area 1 is 12 samples and B's delay is 14 samples, then B's consumption is shifted two steps back in time. The shifts of operating area 1 for each group is showed in figure 4.2, 4.3,4.4,4.5, and 4.6.

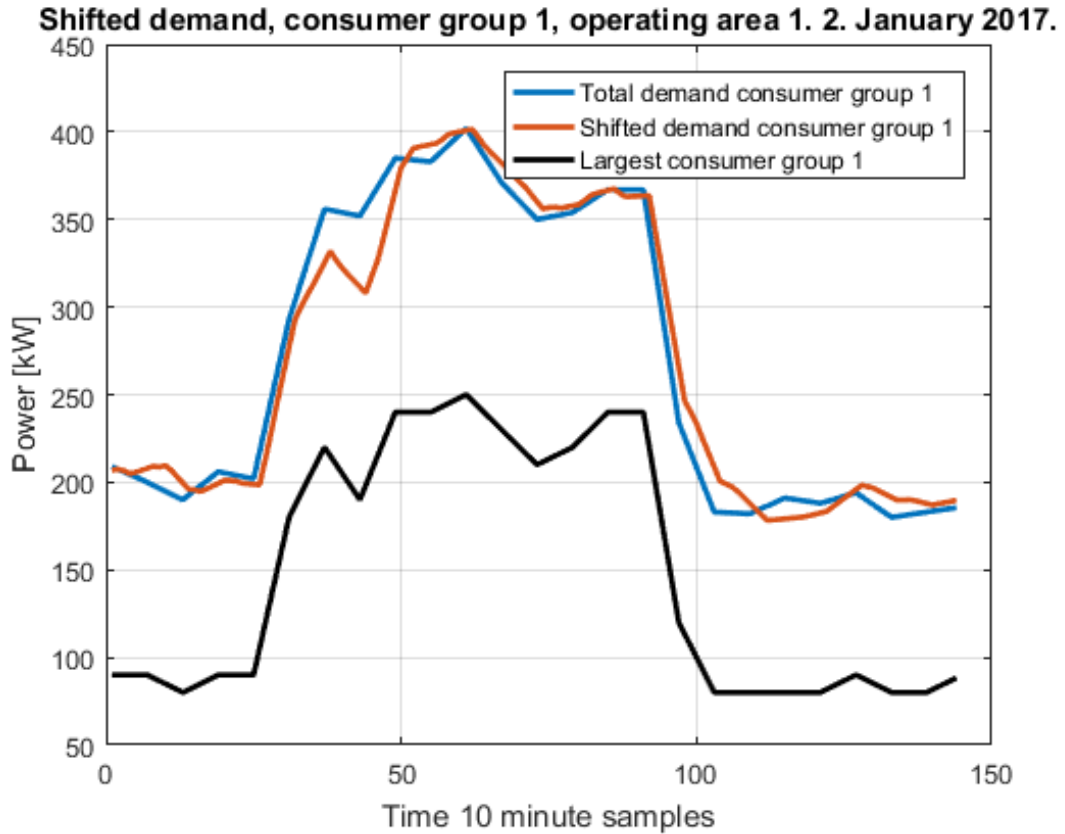

Figure 4.2: Total demand for consumer group 1, shifted demand and the largest consumer

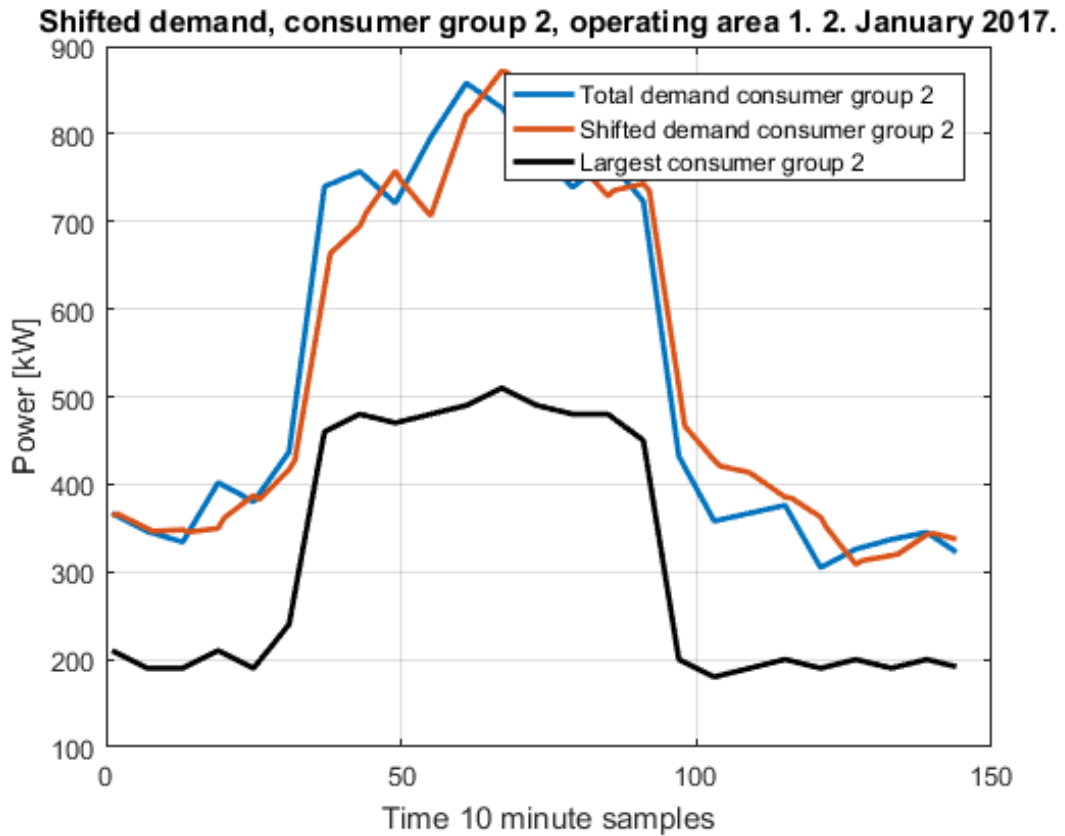

Figure 4.3: Total demand for consumer group 2, shifted demand consumer and the largest consumer

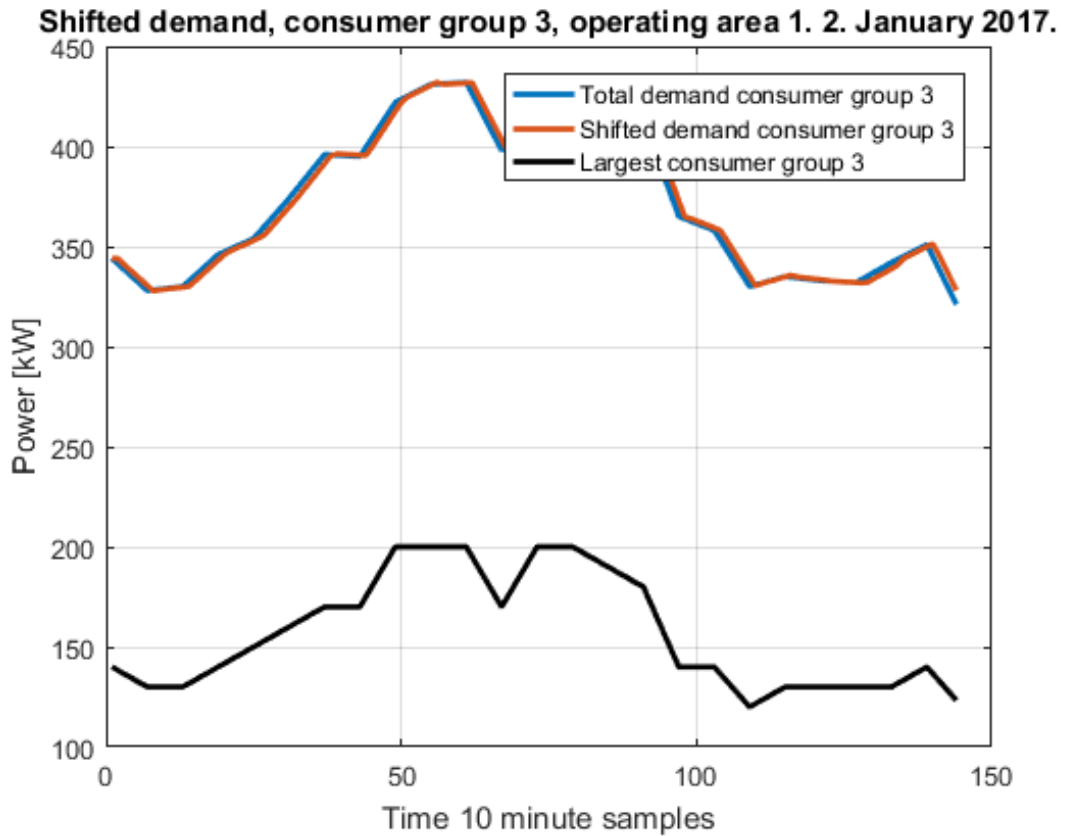

Figure 4.4: Total demand for consumer group 3, shifted demand and the largest consumer

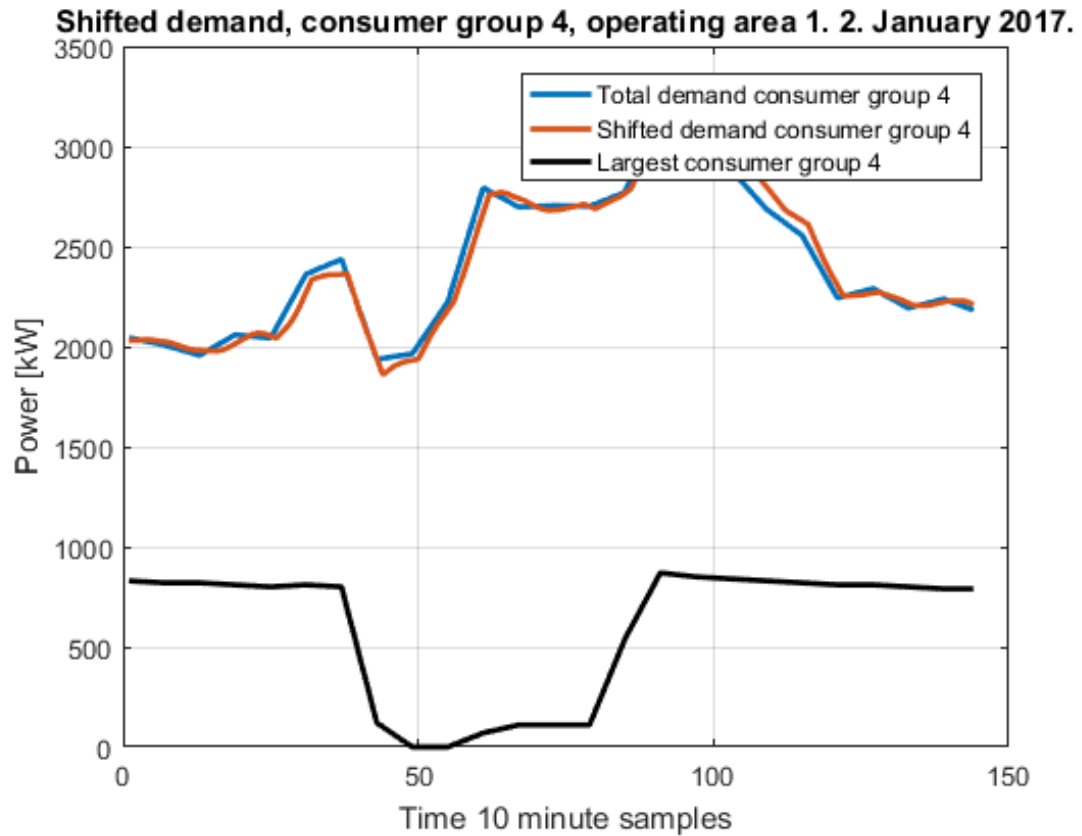

Figure 4.5: Total demand for consumer group 4, shifted demand and the largest consumer

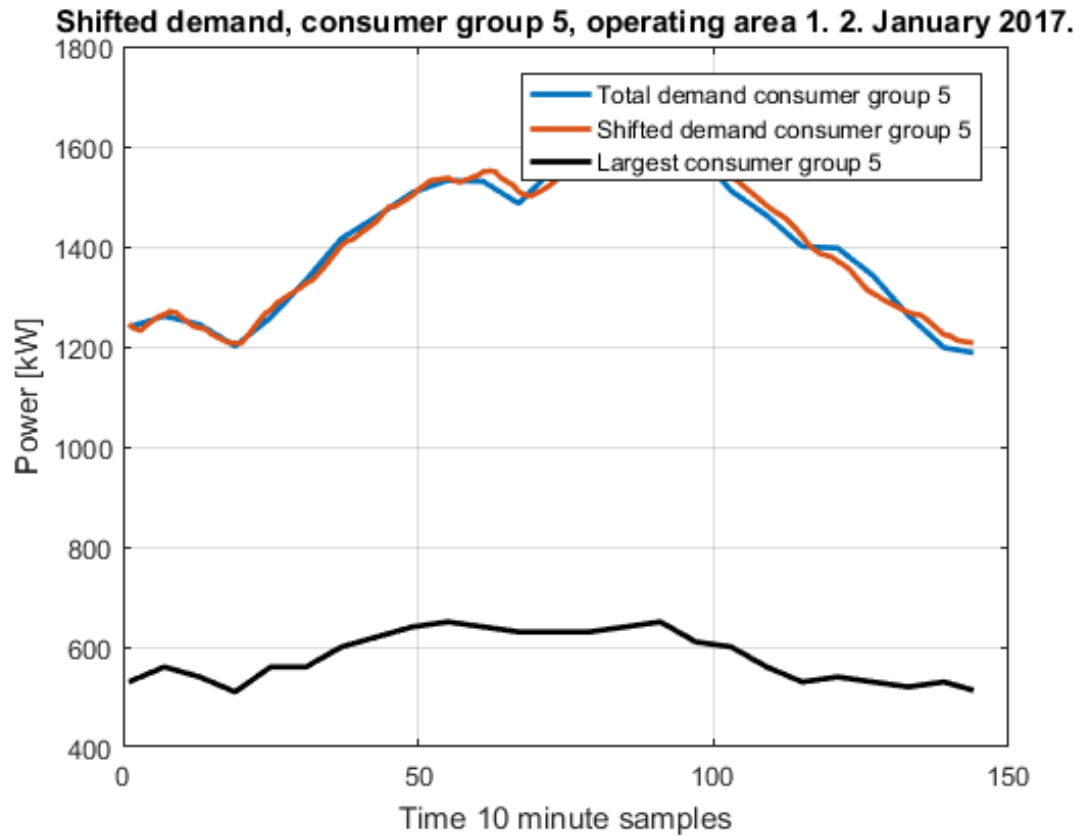

Figure 4.6: Total demand for consumer group 5, shifted demand and the largest consumer

4.2 The transport model

The following state space formulation has been made to describe how the water propagates from the plant throughout the network:

$$\mathbf{x}_{\mathbf{k}+1} = \mathbf{A}\mathbf{x}_k + \mathbf{B}u_k - a\mathbf{A}\mathbf{x}_k \quad (4.1)$$

$$y_i = \mathbf{C}_{i,j}x_k \quad (4.2)$$

where

$$\mathbf{x}_{\mathbf{k}} = \begin{bmatrix} x_{1,k} \\ x_{2,k} \\ \vdots \\ x_{N,k} \end{bmatrix}, \mathbf{x}_{\mathbf{k}+1} = \begin{bmatrix} x_{1,k+1} \\ x_{2,k+1} \\ \vdots \\ x_{N,k+1} \end{bmatrix}$$

$$\mathbf{A} = \begin{bmatrix} 0 & 0 & \dots & 0 & 0 \\ 1 & 0 & \dots & 0 & 0 \\ 0 & 1 & & \vdots & \vdots \\ \vdots & & \ddots & \vdots & \\ 0 & \dots & 0 & 1 & 0 \end{bmatrix}, \mathbf{B} = \begin{bmatrix} 1 \\ 0 \\ \vdots \\ 0 \end{bmatrix}$$

Here, u_k is the supply temperature delivered from the plant at time step k . At time step $k + 1$, $x_{1,k+1} = u_k - au_k$. Meaning the water is now one time step away from the plant and has lost au_k degrees Celsius. In general, $x_{i,k+1}$ is the water i samples away from the plant at time step $k + 1$. y_i is the temperature of the water delivered to consumer group i . The matrix $C_{i,j}$ is the delay matrix for operating area j . For example, consumer group 1 has a delay of 24 samples in operating area 1, and its corresponding delay matrix $C_{1,1}$ is a row vector with just zeros except for index number 24.

The flow that is delivered to each customer is a function of the pressure conditions in the network. As this is complicated to model, the power consumption is used as an approximation of the pressure in the network. The

flow through each consumer group i is calculated as a weighted average:

$$\dot{m}_i = \frac{\dot{m}Q_i}{\sum_{j=1}^5 Q_j} \quad (4.3)$$

where

\dot{m} = is the flow from the plant [m^3/h]

Q_j = power consumption at consumer j [kW]

When the water is delivered to the consumer it is cooled down at the substation and then returned back to the plant. This dynamic is described using the same state space formulation as above, for each consumer:

$$u_{k,i}^R = y_i - \frac{Q_i}{c_p \dot{m}_i} \quad (4.4)$$

$$\mathbf{x}_{k+1,i}^R = \mathbf{A}\mathbf{x}_{k,i}^R + \mathbf{B}u_{k,i}^R - a\mathbf{A}\mathbf{x}_{k,i}^R \quad (4.5)$$

$$y_i^R = \mathbf{C}_{i,j}x_{k,i}^R \quad (4.6)$$

Here, the subscript i is consumer number i and the superscript R is there to emphasize that this is returned water. This formulation avoids pressure calculations and instead used the consumer consumption as a approximation of the pressure conditions in the network. The y_i^R is the temperature of the water delivered from consumer i back to the plant.

The return temperature delivered to the plant is then calculated as:

$$T_R = \frac{\sum_{j=1}^5 Q_j y_j^R}{\sum_{j=1}^5 Q_j} \quad (4.7)$$

4.3 Validating the model

Available data is used to validate the model described in the previous section. The model is simulated with data of the supply temperature, flow from the plant and the consumer consumption. The simulated return temperature is then compared with the measured return temperature.

4.3.1 Estimating the heat loss

The model was first simulated with the heat loss coefficient set to zero. Data from the plant and consumers from January 2017 were used. The result can be seen in figure 4.7. Because of no heat loss, the model overestimated the return temperature slightly. To adjust for this the heat loss coefficient were decided by minimized the Root-mean square error (RMSE). Different choices for the heat loss coefficient and the corresponding RMSE can be seen in table 4.3.

The model was used to predict the return temperature for February 2017, and the result can be seen in figure 4.9. Note that the ground temperature was not taken into consideration. This could have been done if the return temperature was simulated for a different season, maybe during spring or summer and then compared the heat losses with the ambient air temperature. As no measurements of the ground temperature was available one could assume that the ground temperature is a slowly varying function of the average daily air temperature.

Heat loss coefficient	RMSE
0	41.0074
0.001	20.9146
0.002	9.3833
0.003	5.4039
0.004	8.0754

Table 4.3: RMSE for different value sof the heat loss coefficient

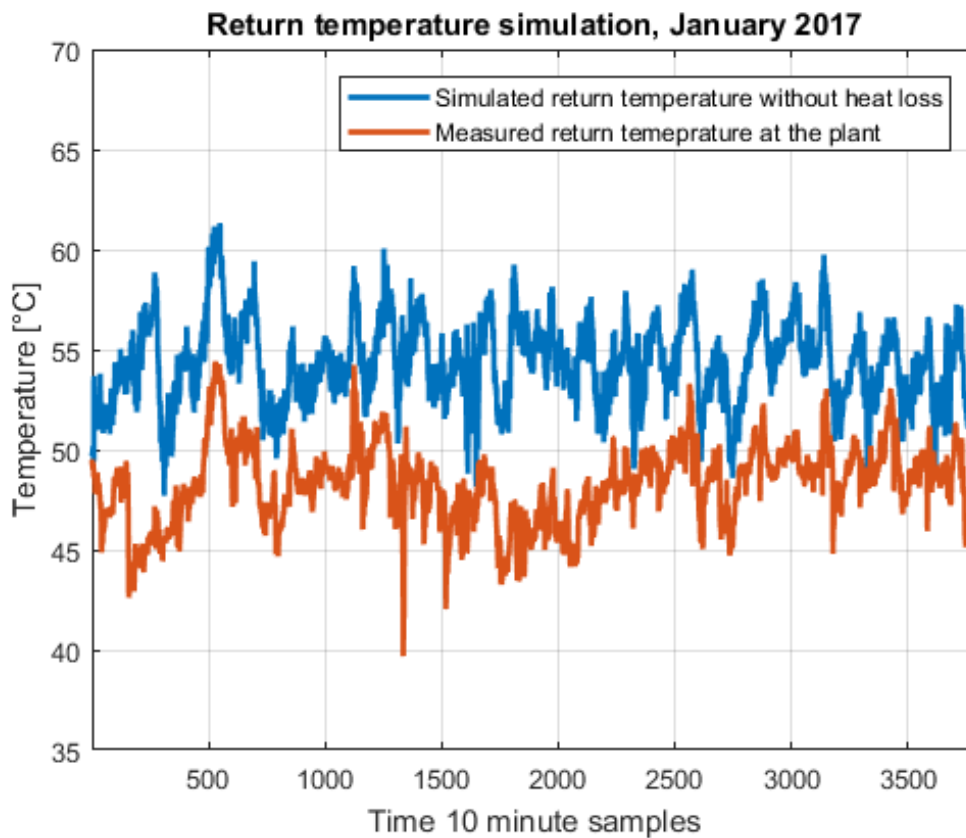

Figure 4.7: Measured and simulated return temperature without heat loss, January 2017

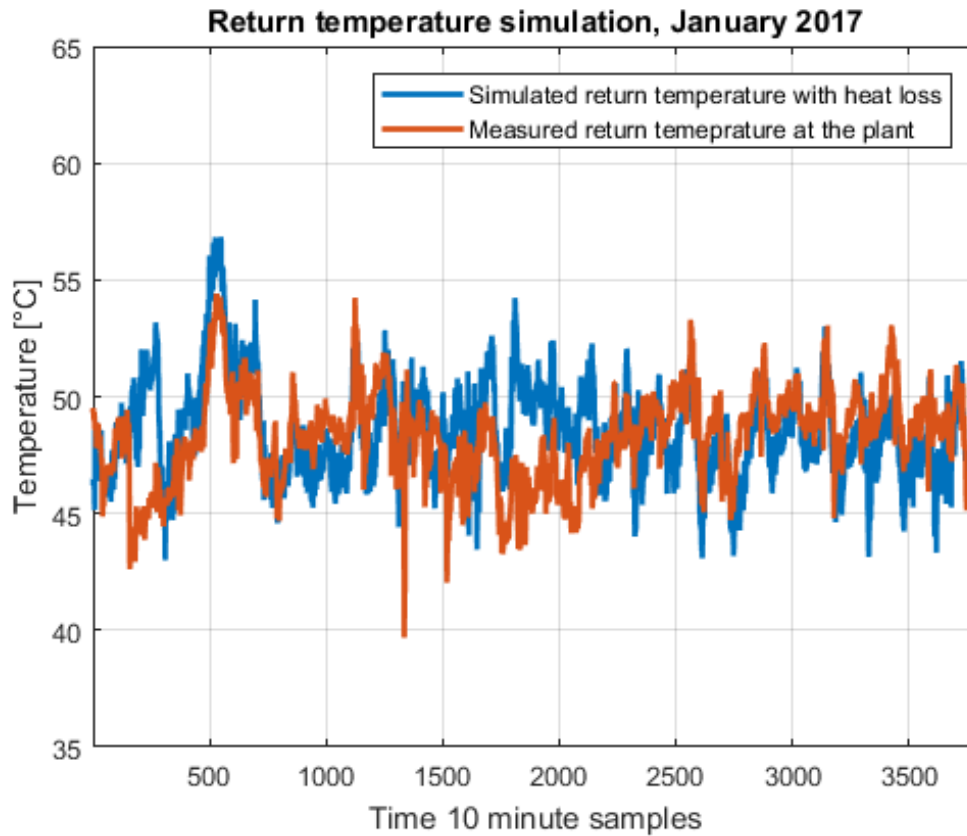

Figure 4.8: Measured and simulated return temperature with heat loss, January 2017

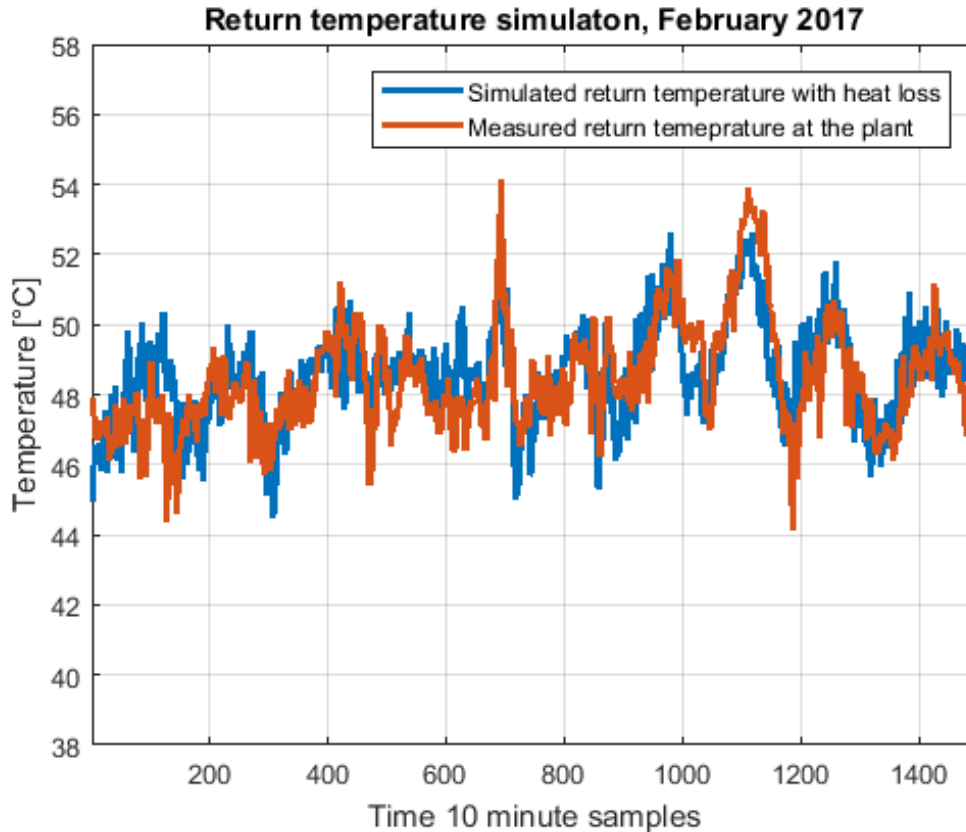

Figure 4.9: Measured and simulated return temperature without heat loss, 6th to 16th of February 2017

4.3.2 Validating the Flow Distribution Model

The flow distribution model given in equation 4.3 was tested and compared to the measured flow. In figure 4.10 one can see that the model gives a quite good approximation of the flow through consumer 1,2 and 4 while it overestimates 3 and underestimates 5 a little bit. A way to improve this model could be to "lift" the graph of consumer 5 and lower the graph of consumer 3.

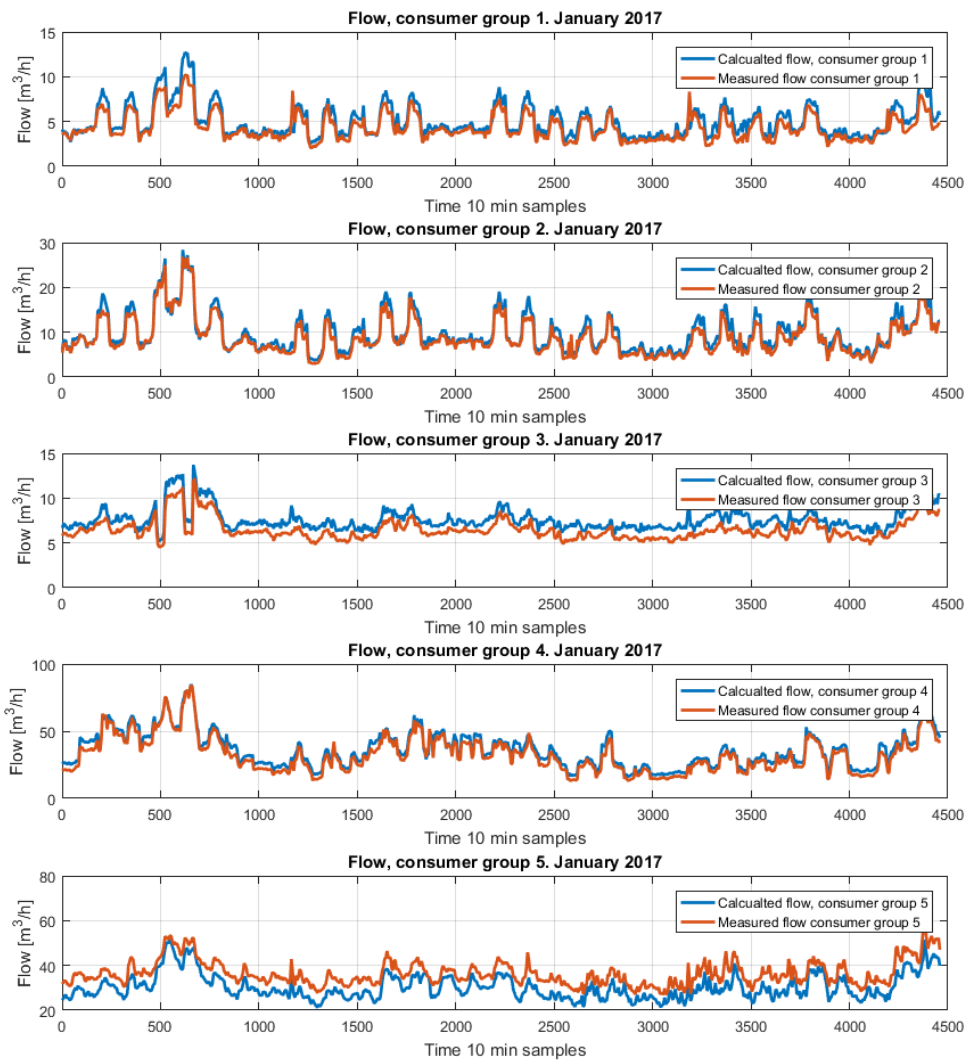

Figure 4.10: The flow through each consumer group

CHAPTER 5

Load Prediction

The behaviour of a district heating network is mainly decided by the consumer behaviour, as they have control over how much energy is taken from the network. This is because every consumer can control the flow going through it's substation by a valve. Also, the cooling of the water is a function of the consumption. This means that the control possibilities are very limited and to be able to predict future states of the system one needs a good understanding of the consumer behaviour. Because the delays in the network usually are quite large, one has to be able to predict the consumer behaviour several hours in advance.

The most important factor regarding load prediction is the ambient temperature [1],[3]. Rain, wind, air humidity and radiation does also affect the heat load, but their influence is neglectable compared to the ambient air temperature [1],[3]. This does not mean that some consumers can be heavily independent on one weather variable like rain. For example street heating will be affected by snowfall. However, it is the total heat load of the network that is mostly dependent on air temperature.

5.1 Weather data

In Stjørdal there are two weather stations, situated in Værnes and in Kvithamar. Data from both stations are available from Norwegian Meteorological Institute. In addition, Statkraft measures the ambient air temperature at Lillemoen (where the heating plant is situated). In figure 5.1 one can see the ambient air temperature in Stjørdal from January 2017 measured at Stjørdal and Kvithamar. For this thesis the differences are neglectable and the data from Værnes has been used as some of the data from the Kvithamar measurements were missing. Rainfall and wind has not been considered for the model, but it is possible that there are larger differences in the measurements for the two stations. If one wants to include this in the heat load prediction it might be useful to investigate if these differences could be significant for

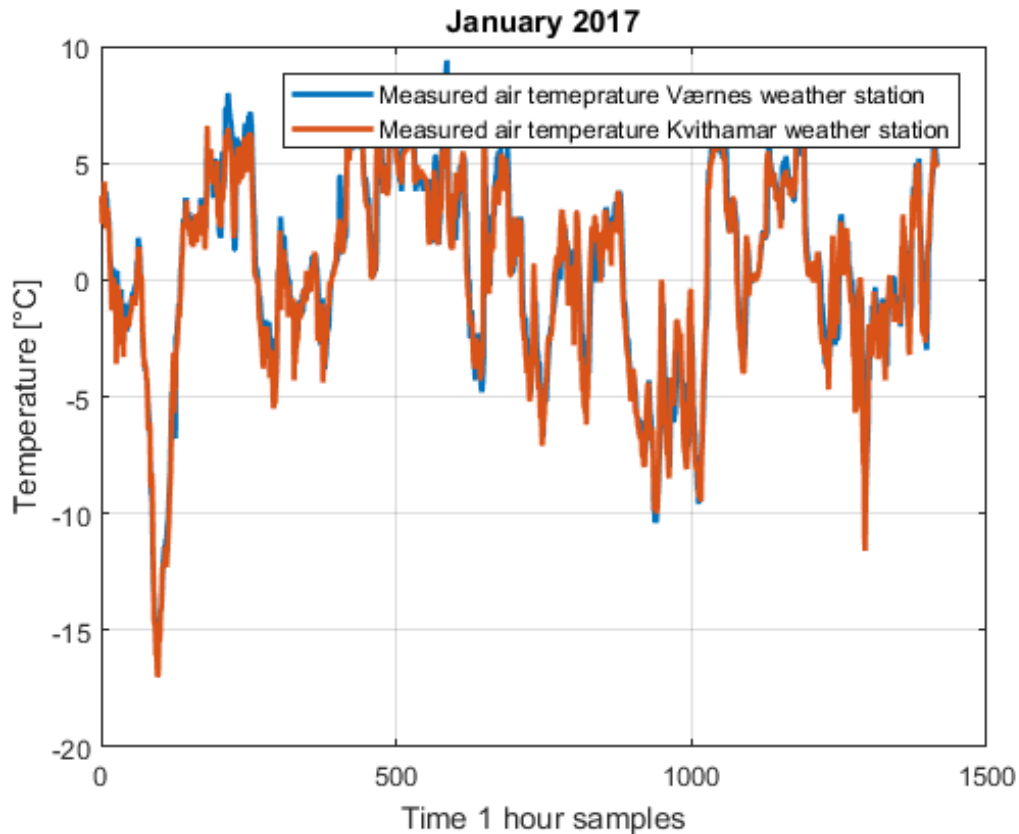

Figure 5.1: Ambient air temperature in Stjørdal measured from Værnes and Kvithamar

the model.

5.2 The Model

This thesis is a continuation of a project assignment which was completed autumn/winter 2016. The assignment was to build a model for heat load prediction for Stjørdal DHS. In this assignment 12- and 24 hour predictions were studied. It was found that that the most important variables regarding

RMSE				RMSE				RMSE			
	Input:	SVR	LSM		Input:	SVR	LSM		Input:	SVR	LSM
1	T_0	13.21	11.84	1	T_0	18.46	17.28	1	T_0	7.57	7.51
2	T_0, Q_0	12.14	11.83	2	T_0, Q_0	18.31	17.53	2	T_0, Q_0	10.38	10.32
3	T_0, T'_{24}	9.96	9.64	3	T_0, T'_{24}	14.49	14.18	3	T_0, T'_{24}	5.80	6.14
4	T_0, Q_0, T'_{24}	9.12	9.35	4	T_0, Q_0, T'_{24}	9.95	10.34	4	T_0, Q_0, T'_{24}	4.68	4.91
5	Q_{-24}, T_0, T'_{24}	10.07	9.90	5	Q_{-24}, T_0, T'_{24}	12.66	13.17	5	Q_{-24}, T_0, T'_{24}	5.86	5.53
6	T_{-24}, T_0, T_{24}	10.93	10.32	6	T_{-24}, T_0, T_{24}	14.58	14.27	6	T_{-24}, T_0, T_{24}	5.97	6.47
7	Q_{-24}, T_0, Q_0	12.59	11.98	7	Q_{-24}, T_0, Q_0	19.28	18.88	7	Q_{-24}, T_0, Q_0	10.24	10.14
8	Q_{-24}, Q_0	11.55	11.23	8	Q_{-24}, Q_0	19.35	18.67	8	Q_{-24}, Q_0	8.19	7.95
9	Q_0	11.33	10.82	9	Q_0	18.75	17.93	9	Q_0	8.31	8.21
10	$Q_{-24}, T_0, Q_0, T'_{24}$	9.80	9.46	10	$Q_{-24}, T_0, Q_0, T'_{24}$	10.17	11.04	10	$Q_{-24}, T_0, Q_0, T'_{24}$	4.51	4.79
11	T'_{24}	9.27	9.32	11	T'_{24}	17.30	15.64	11	T'_{24}	5.89	6.14
Monday				Tuesday-Friday				Saturday-Sunday			

Figure 5.2: 24 hour prediction, one consumer. Different inputs

24- and 12 hour predictions were the current air temperature, the current consumption, the weather forecast of the air temperature. Two methods were compared to each other, the least squares method and support vector regression, the first being linear while the latter is non-linear. The two methods gave approximately the same results suggesting that the problem is linear. In figure 5.2 shows how well the different input behaves for 24 hour predictions for one consumer, where T_i is the temperature at time i , Q_i is the consumption at time i and T'_i is the weather forecast for hour i . The way the model was built, was testing different inputs for different type of consumers. The input number 4 was the one performing best in general and is the one that will be used for the predictions in this thesis. One thing to note is that the model was designed for 24 hour predictions, while a lot shorter predictions are necessary here. So ideally, more analysis should have been done on the load prediction model.

The longest delay was in the Stjørdal network was found to be 11 hours, while normally the delay are from 0-5 hours when the flow is in the network is large. This means that 1-11 hour predictions are needed. One thing to note

is that the delays were calculated for a couple of days in January. During winter the consumption in the network is usually high and so is the flow, therefore the delays are shorter than for example during summertime. This suggests that a longer prediction horizon is needed for other seasons. Also the delays were analyzed for a short period of days so it is possible the longer delays arise during winter also.

5.3 Results

In this section the results for the 1 hour and the 11 hour predictions are presented, The 2-10 hour predictions are omitted as they are all very similar. In general the predictions gets slightly worse with longer horizon (which is to be expected).

5.3.1 1 hour prediction

The model was trained with data from January 2016, February 2016, and January 2017. For some consumers, the that were added to the network later than winter 2016, only January 2017 have been used for training. The prediction model has been validated on data from February 2017. For the one hour prediction it was found that the SVR responded better. In figure 5.3 one can see the 1 hour ahead load prediction of consumer 1 (note that each point on the blue graph are 1 hour predictions). The prediction seems to have a reasonable accuracy. For consumers 2,4, and 5 this also seems to be the case (can be seen in figure 5.4, 5.6, 5.7 respectively). However, the predictions for group 3 seems to have difficulties with some oscillations for the first 150 hours. It seems as if the energy consumption at one (or more) consumers are dependent on some variable other than the air temperature. When we look at the total load in figure 5.8 we can see the the error from consumer 3 is almost vanished.

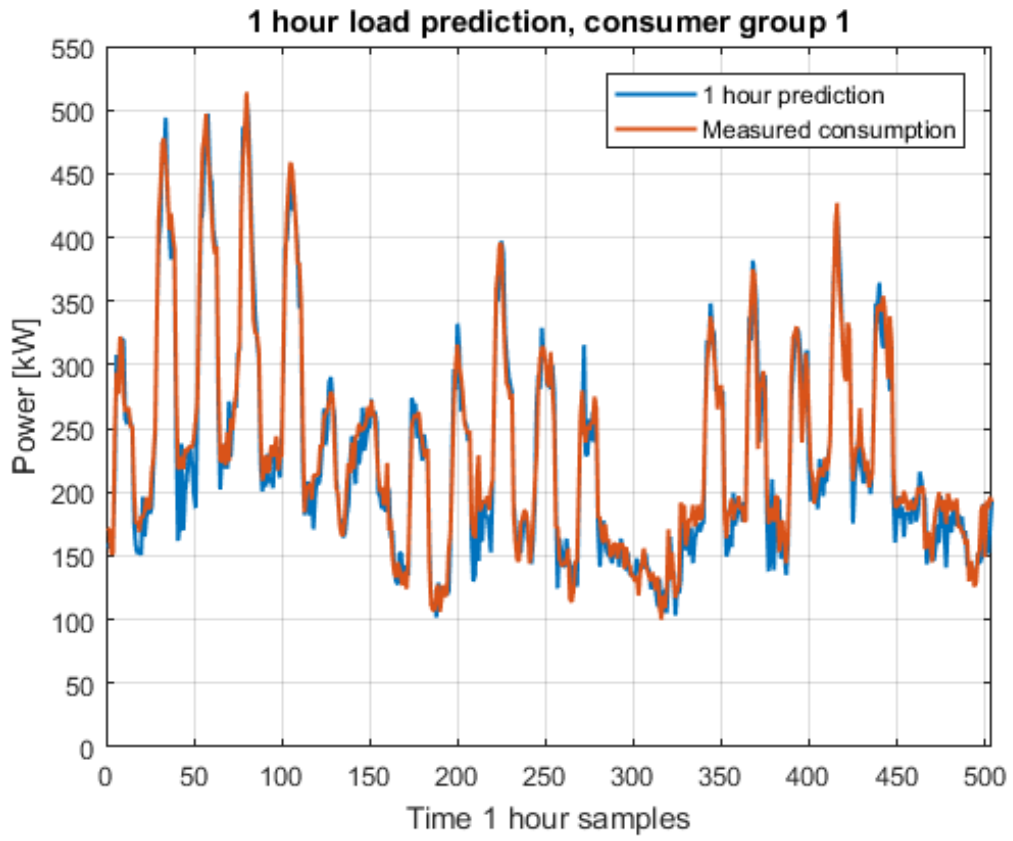

Figure 5.3: 1 hour prediction, consumer group 1

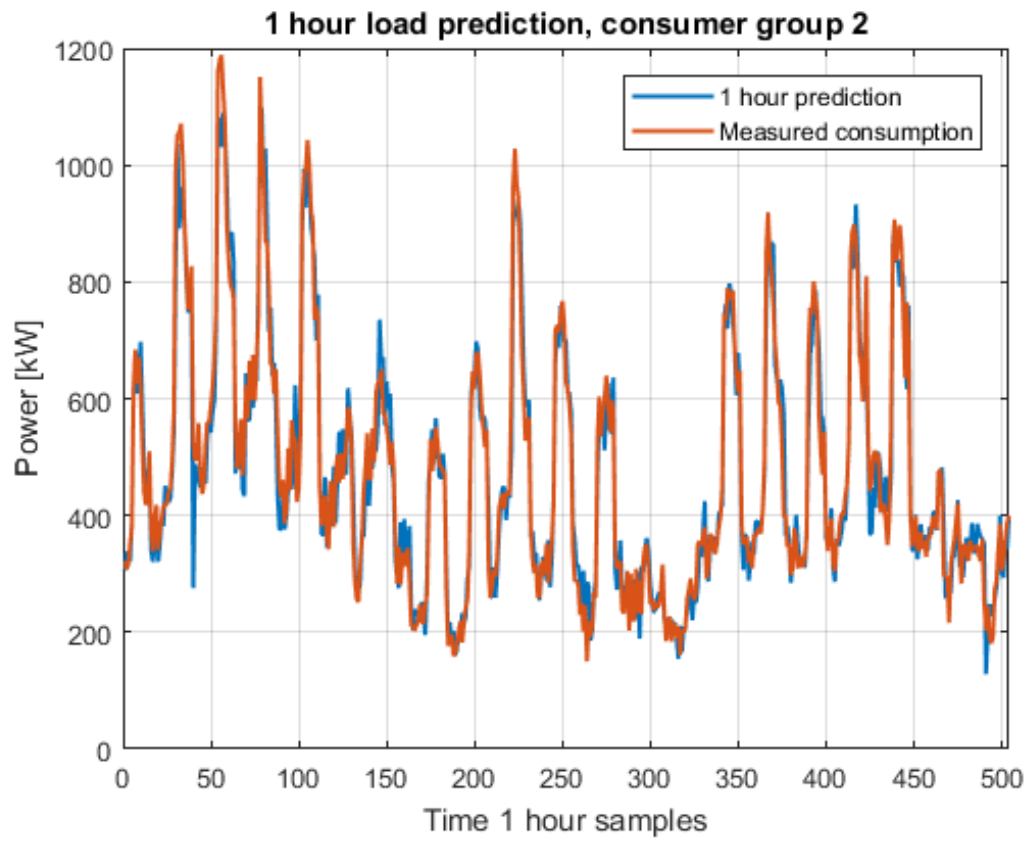

Figure 5.4: 1 hour prediction, consumer group 2

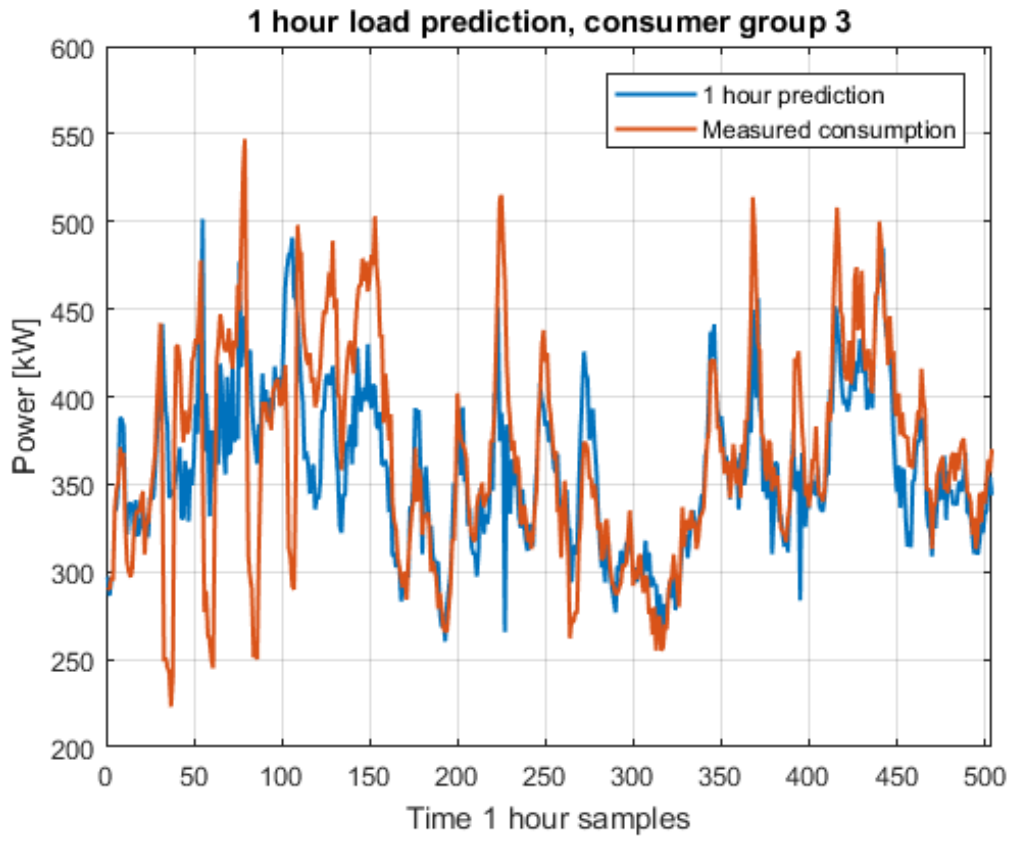

Figure 5.5: 1 hour prediction, consumer group 3

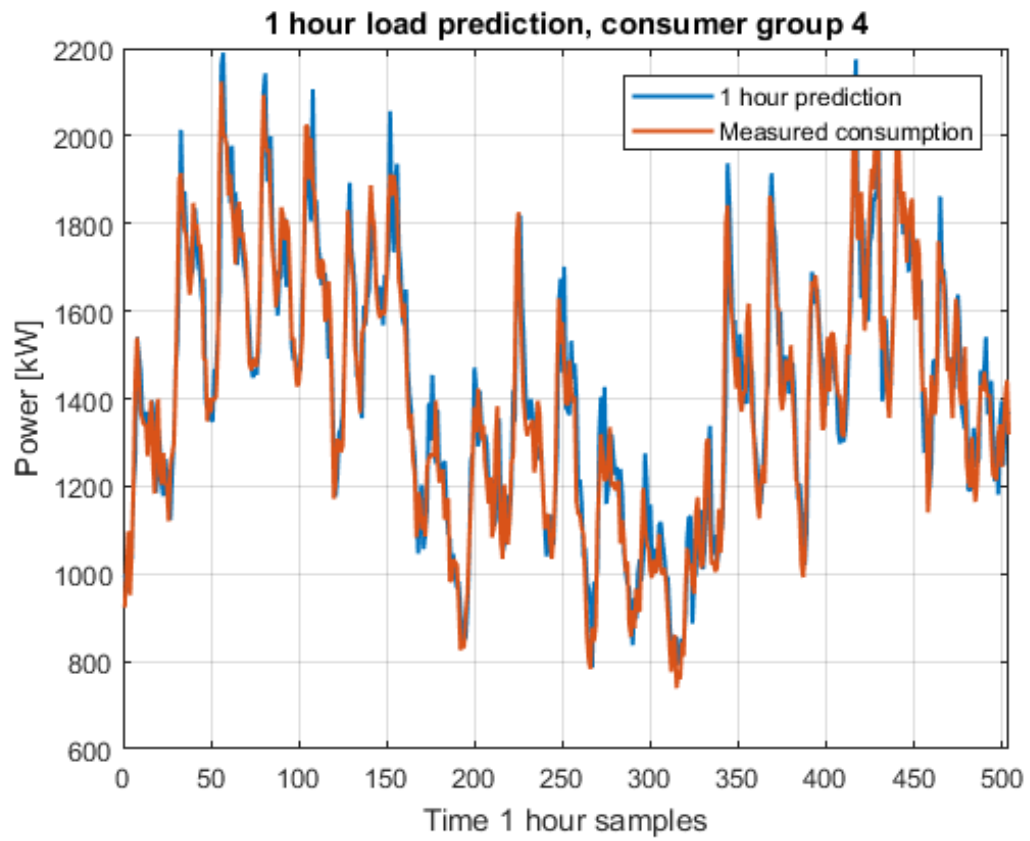

Figure 5.6: 1 hour prediction, consumer group 4

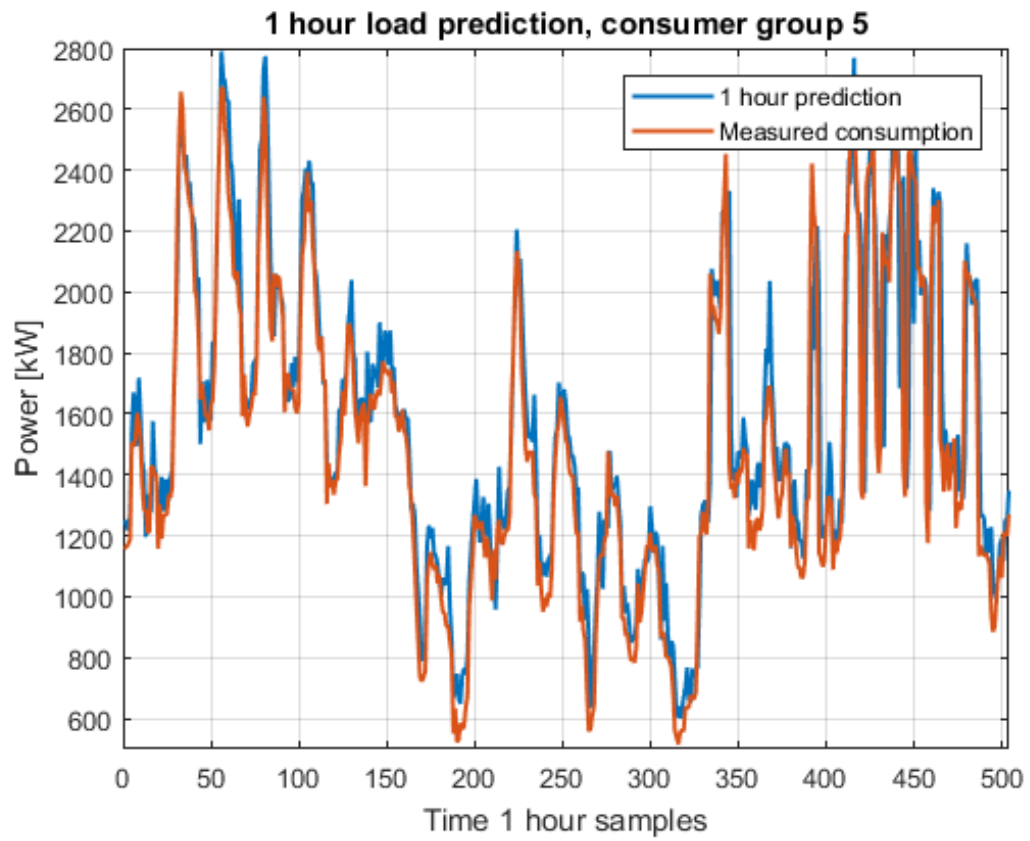

Figure 5.7: 1 hour prediction, consumer group 5

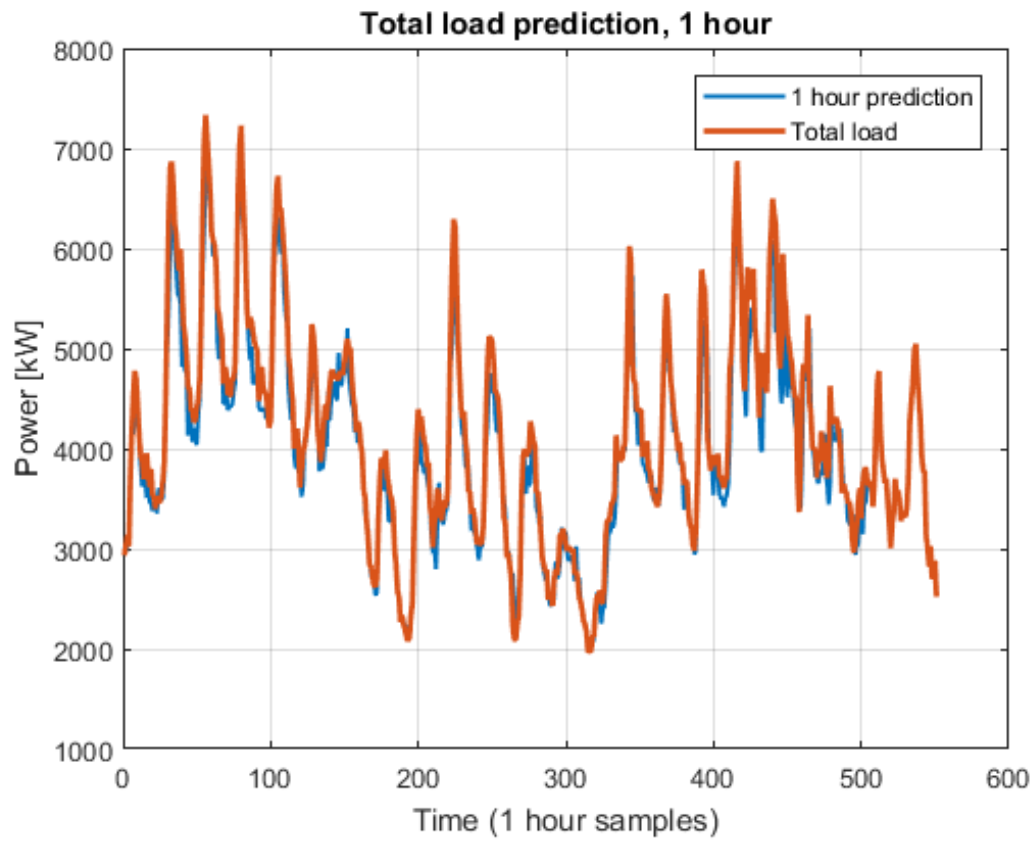

Figure 5.8: 1 hour prediction, total load

5.3.2 11 hour predictions

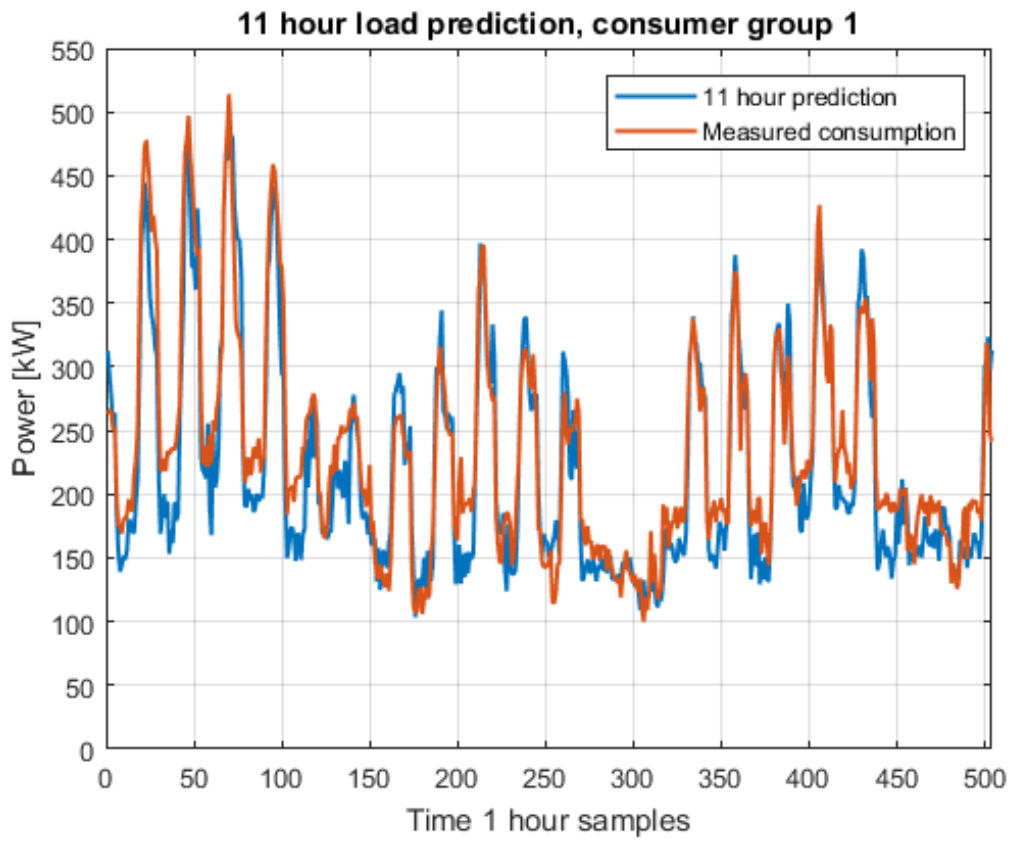

Figure 5.9: 11 hour prediction, consumer group 1

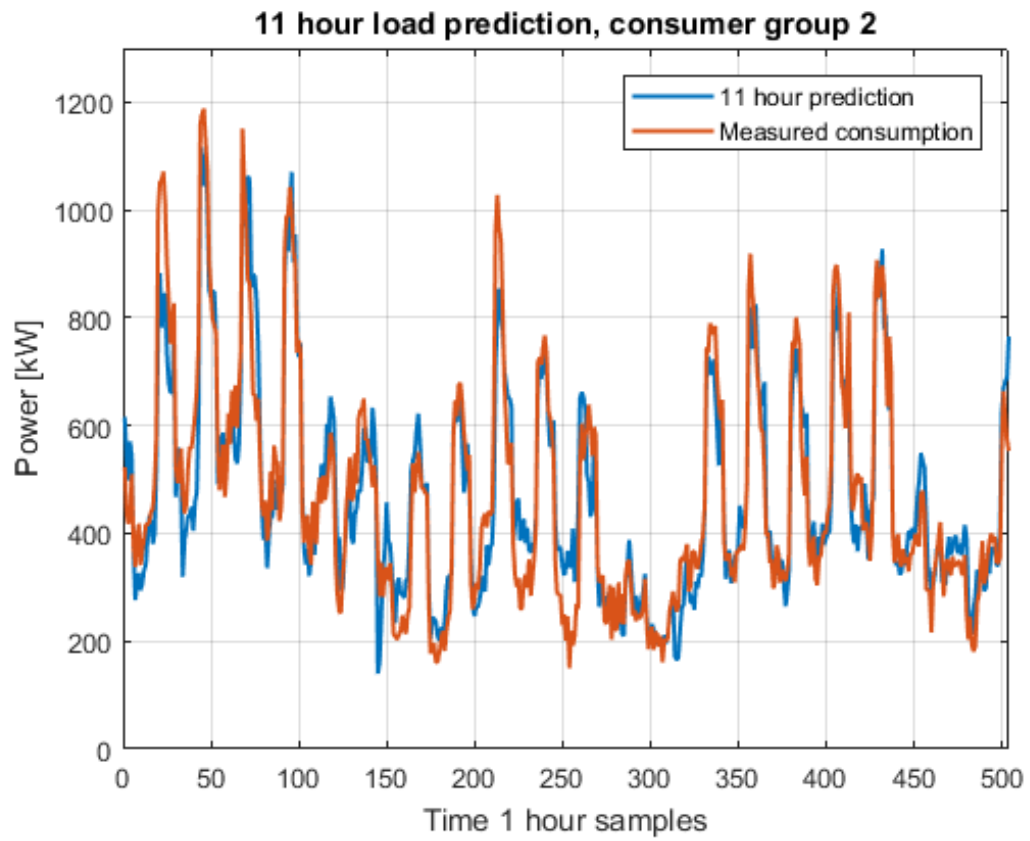

Figure 5.10: 11 hour prediction, consumer group 2

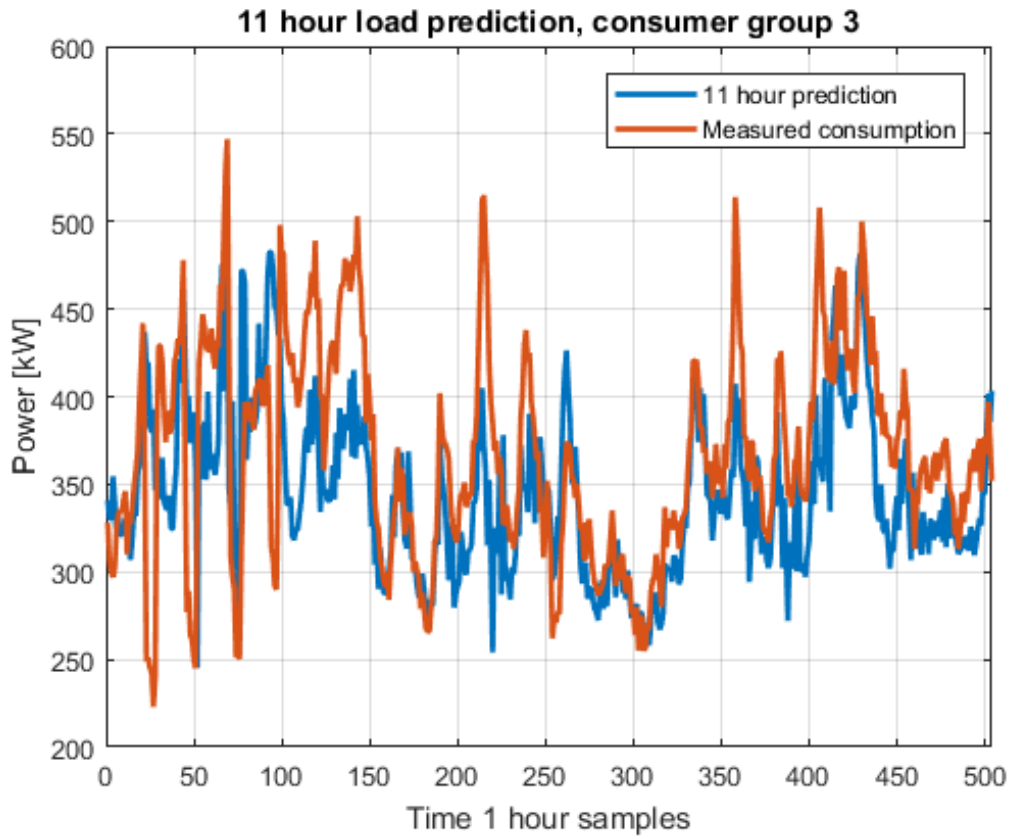

Figure 5.11: 11 hour prediction, consumer group 3

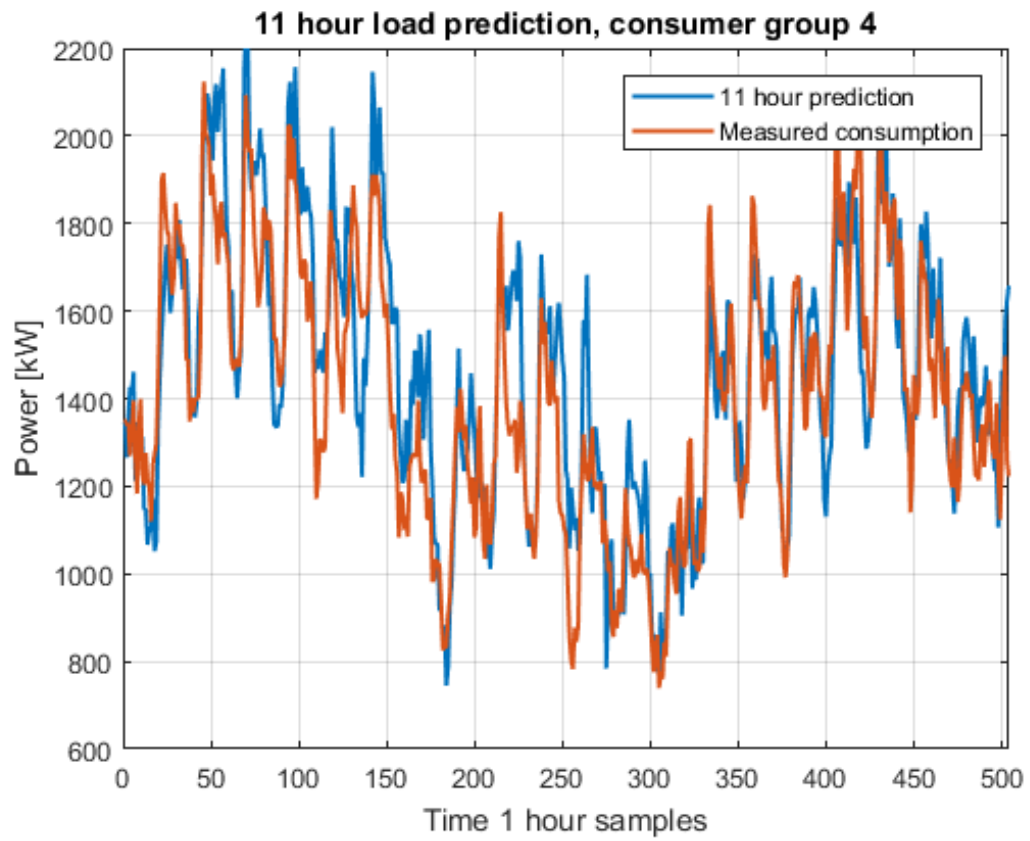

Figure 5.12: 11 hour prediction, consumer group 4

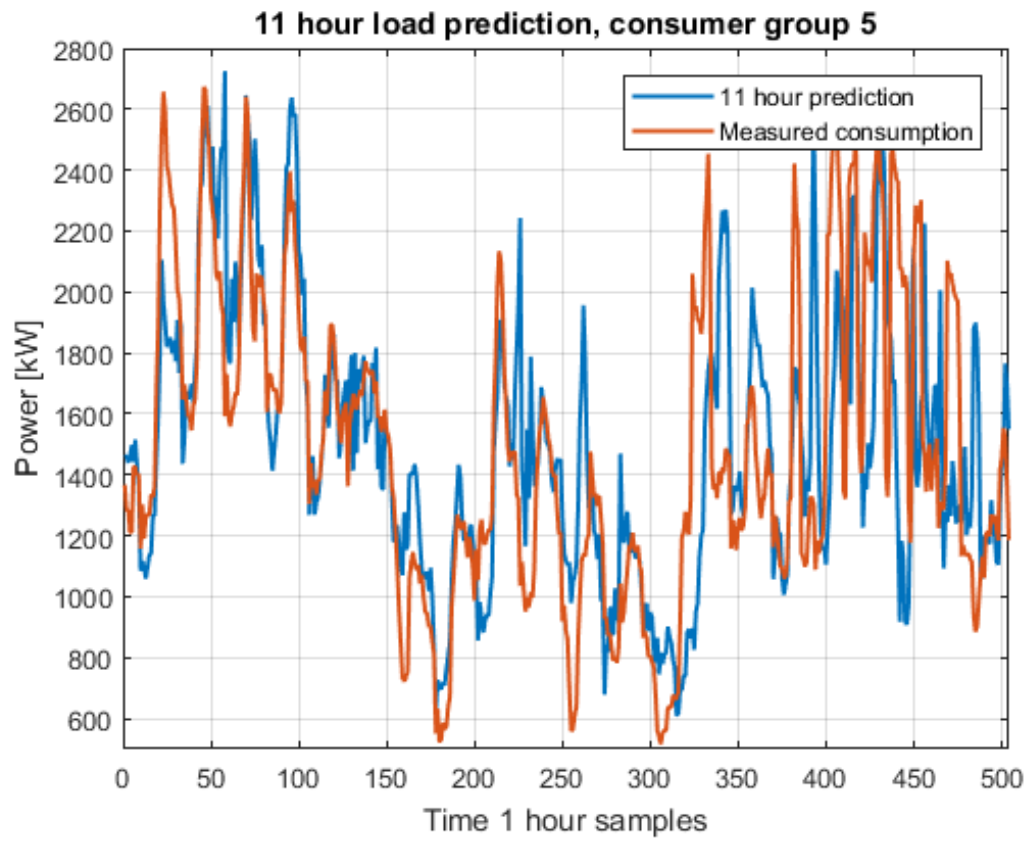

Figure 5.13: 11 hour prediction, consumer group 5

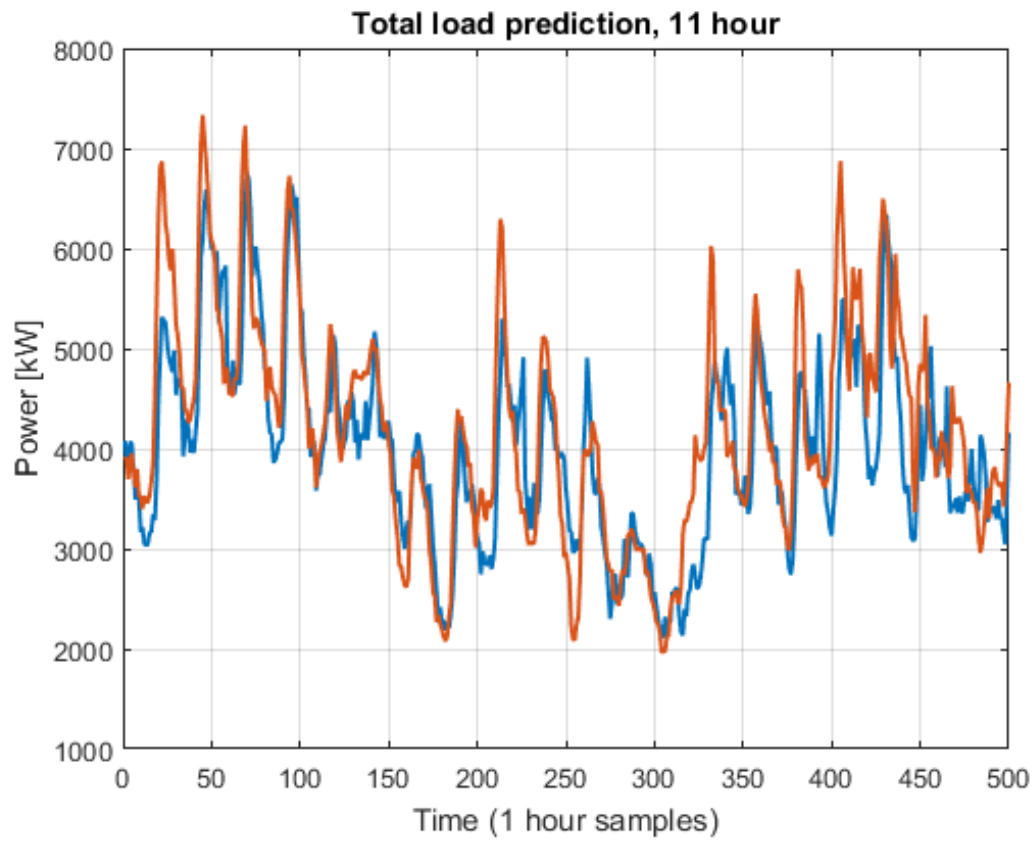

Figure 5.14: 11 hour prediction, total load

CHAPTER 6

MPC on the Stjørdal DHS

This presents the MPC formulation for the Stjørdal DHS and the results from the simulation. The results are discussed in the following chapter.

6.1 MPC

Model Predictive Control (MPC) is a method of process control that has gained a lot of popularity since the 1980s. The method finds the optimal control input on a finite time horizon, and then applies the first step of this input. In other words, it finds the optimal input for the current state, while keeping future states in mind. This strategy makes MPC very suitable for systems with large time delays where simple control schemes like PID controllers will fail. To be able to implement an MPC controller one needs to be able to predict future states of the system. This can be done by methods from system identification or by developing a physical model of the system. Usually discrete time is used. Given a process model:

$$x_{k+1} = g(x_k, u_k) \tag{6.1}$$

$$y_k = f(x_k) \tag{6.2}$$

and a reference trajectory $y_{k,ref}$ for the output y , a non-linear MPC formulation might be:

$$\begin{aligned}
& \underset{u}{\text{minimize}} && J(u, x, y) = \sum_{k=1}^N F(x, y - y_{k,ref}, u) + c_{u_k} u_k + c_{\Delta u_t} (u_k - u_{k-1}) \\
& \text{subject to} && x_{k+1} = g(x_t, u_k) \\
& && y_t = f(k_t) \\
& && x_{min} \leq x_t \leq x_{max} \\
& && u_{min} \leq u \leq u_{max} \\
& && \Delta u_{min} \leq u_k - u_{k-1} \leq \Delta u_{max} \\
& && x_0, u_{-1} \text{ given}
\end{aligned} \tag{6.3}$$

where

- N - Is the prediction horizon. Should be longer than the largest delay of the process.
- J - The cost function for the whole prediction horizon. Penalizes deviation from reference and increase in input. It is assumed that the reference comes from some outside source.
- F - Is a quadratic function that penalizes the deviation from the reference and the size of x and u . It is possible to include references for u and x in this function
- c_{u_k} - The input cost
- $c_{\Delta u_k}$ - Cost of increase in input

6.2 MPC on Stjørdal DHS

The MPC formulation is based on the formulation found in [2]. Here there are two optimization problems, one which delivers set points to the MPC and the MPC formulation itself. The difference between the formulation in [2] and this one, is that the set points are delivered hourly (instead of daily), there are more than one consumer and that the return temperature is not assumed to be constant. The idea behind the slow model is to find the ideal temperature and flow that should be delivered to each consumer based on the heat load predictions. The slow model is formulated as follows:

$$\begin{aligned}
 & \underset{y_i, \dot{m}}{\text{minimize}} && c\dot{m} + \sum_{i=0}^5 [(y_i - y_{ref}^*)P(y_i - y_{ref}^*)] \\
 & \text{subject to} && Q_i^{Pred} = \dot{m}_i c_p (y_i - T_{R,i}) \\
 & && \dot{m} = \sum_{i=1}^5 m_i \\
 & && \dot{m}_{min} \leq \dot{m} \leq \dot{m}_{max} \\
 & && y_{i,min} \leq y_i \leq y_{i,max} \\
 & && x_{k+1} = Ax_k + Bu - aAx_k \\
 & && y_i = C_{i,j}x_k \\
 & && T_{R,i} = y_i - Q_i^{Pred} / (\dot{m}_i c_p) \\
 & && T_{R,i} \geq T_{R,i,min}
 \end{aligned} \tag{6.4}$$

where

- $y_{ref}^* = T_{R,i} + 40$ - Supply temperature delivered to the consumer that is assumed to maximize the efficiency of the heat exchanger.
- P - The cost of deviating from the reference. In the literature, the

letter Q is often used. As this was reserved for the heat load the letter P is used here.

- c - Cost of increase in flow.
- $T_{R,i,min}$ - The lowest possible return temperature from the consumer substation. This constraint is meant to model the limitations of the substations. The minimum values is set to be equal for all consumers and equal to $45^{\circ}C$.
- Q_i^{Pred} is the heat load prediction for consumer i .

The MPC controller needs to handle constraints based on maximum change in input. The max and min values for the input was found by analyzing data from the plant and can be seen in table 6.1.

Variable	minimum value	maximum value
\dot{m}	35	185
T_s	80	100
ΔT	14	14
$\Delta \dot{m}$	5	5

Table 6.1: Operating areas. \dot{m} is the flow out from the plant

The MPC controller is formulated as follows:

$$\begin{aligned}
& \underset{T_S}{\text{minimize}} && \sum_{i=1}^N [(y - y_{ref})^T P (y - y_{ref})] + c_{T_S} T_S + c_{\Delta T_S} (T_{S,k} - T_{S,k-1}) \\
& \text{subject to} && Q_k^{Pred} = \dot{m} c_p (T_S - T_R) \\
& && \dot{m}_{min} \leq \dot{m} \leq \dot{m}_{max} \\
& && \Delta T_{S,min} \leq T_{S,k} - T_{S,k-1} \leq T_{S,max} \\
& && x_{k+1} = Ax_k + Bu_k - aAx_k \\
& && y_i = C_{i,j} x_k \\
& && T_{R,k,i} = y_{k,i} - Q_{k,i}^{Pred} / (\dot{m}_{k,i} c_p) \\
& && T_{R,i} \geq T_{R,i,min} \\
& && x_{k+1,i}^R = Ax_{k,i} + BT_{R,k,i} - aAx_{k,i} \\
& && y_{k,i}^R = C_{i,j} x_{k,i}^R \\
& && T_R = \frac{\sum_{i=1}^5 (y_{k,i}^R Q_{k,i}^{Pred})}{\sum_{i=1}^5 (Q_{k,i}^{Pred})}
\end{aligned} \tag{6.5}$$

where

- N - The prediction horizon.
- k - The current time step. Goes from 1 to N .
- y - The supply temperature delivered to each consumer. $y \in R^5$.
- y_{ref} - Is the reference given from the slow model. Note that the slow model does not give a reference for the mass flow as this is automatically decided by the return temperature and the choice of supply temperature.
- c_{T_S} - The input cost

- $c_{\Delta T_S}$ - Cost of change in input
- $T_{R,i,min}$ - The lowest possible return temperature from the consumer substation. This constraint is meant to model the limitations of the substations. The minimum values is set to be equal for all consumers and equal to $45^\circ C$.
- $T_{R,k,i}$ - The return temperature at consumer i at time step k .

The MPC controller was implemented in Matlab using the `fmincon` function with an SQP algorithm. The computation time was about 1 minute for each sample which is well within the upper bound of 10 minutes.

6.3 Results

The model was simulated with the MPC controllers for two days of February. In figure 6.1 one can see the supply temperature delivered from the plant compared with the MPC input for the 6th of February. The MPC controller successfully lowers the supply temperature from the plant. As to be expected, a decrease in supply temperature would result in higher flow (as we can see in figure 6.2), given that the return temperature is the same. We see however, in figure 6.3 that the return temperature is significantly higher with the input from the MPC controller.

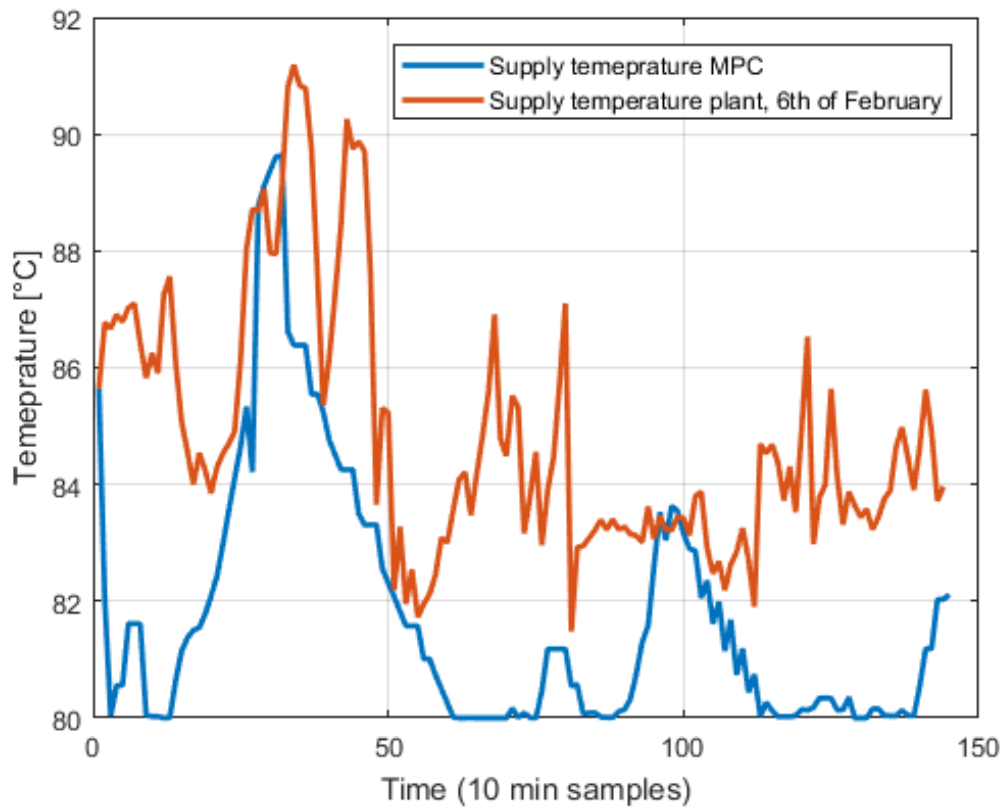

Figure 6.1: Supply temperature from plant compared too the MPC controllers supply temperature

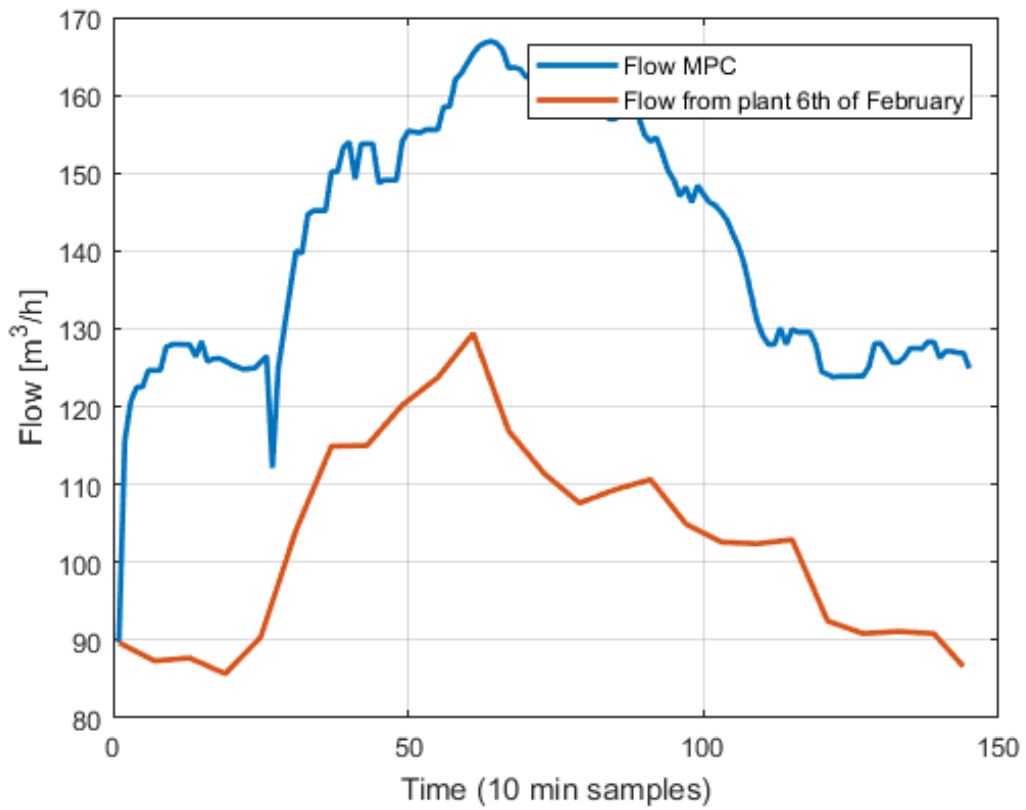

Figure 6.2: Flow from plant compared with the MPC simulation, 6th of February

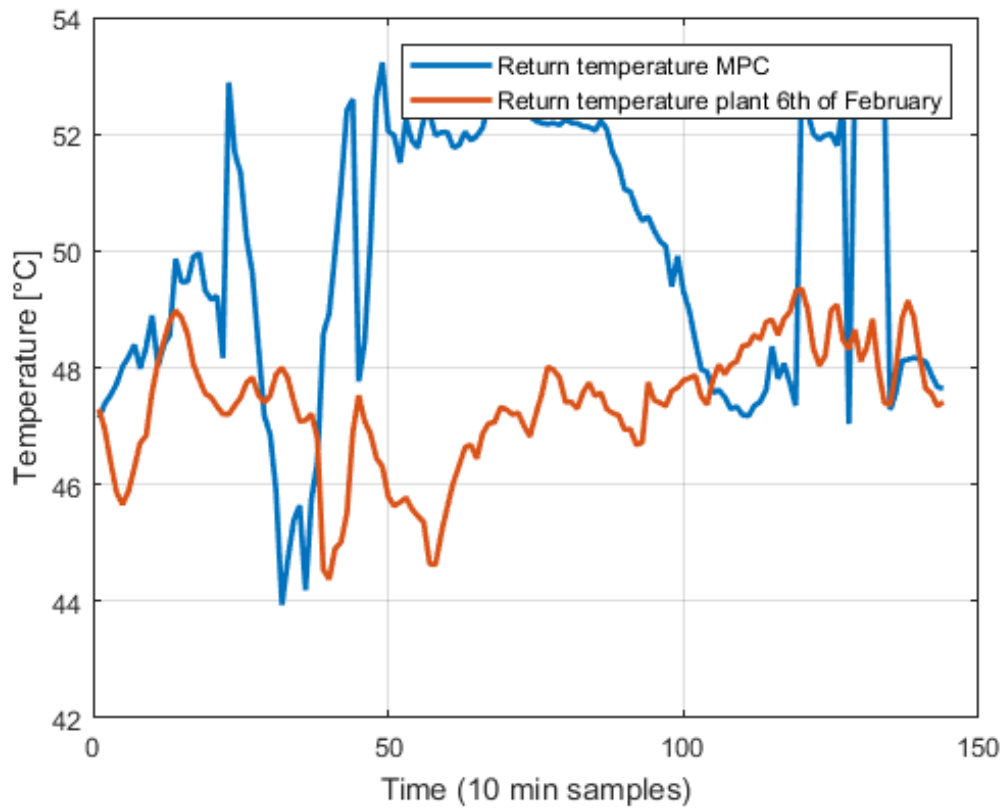

Figure 6.3: Return temperate to plan compared with the MPC simulation, 6th of February 2017

CHAPTER 7

Discussion

7.1 The Return Temperature

As was seen in the previous chapter, the return temperature didn't respond well to the MPC controller input. There can be several explanations for this. One reason might be that some of the constraints of the system are wrong or some constraints are missing. One reason to believe this is that the return temperature model behaves reasonably well with data from the plant. The most likely cause of the error is the lack of modelling of the consumer substations. The cooling function of the consumer should probably be analyzed more. This would be easier if data of the supply and return temperature at the consumer were available. However, this could still be analyzed by simulating the network.

The return temperature in the MPC simulation fluctuated more than compared to data from the plant (as we can see in figure 4.9). This might a prob-

lem with the model. In the model, the return temperature of the consumers are mixed back at the plant, while in the real network the water returning from the consumers are mixed several places in the network before returning to the plant which probably leads to less variation in the return temperature. The model could then probably be improved by including mixing of the water before it reaches the plant.

Another interesting approach regarding the return temperature would be to investigate how the operation at the plant affects the return temperature. With an sufficiently accurate model, is it possible to make choices that can lower the return temperature? If so, one might include the return temperature in the objective function. However, this would require a larger prediction horizon, as the water needs to travel to the consumers and back effectively doubling the prediction horizon and the computation time.

Another thing to be aware of is that the simulator did not get any feedback from the actual plant during the simulation. This means that errors in the simulation will give a snowballing effect, and the error will be larger the longer you simulate. If the method were implemented in practice, feedback from the plant would continuously readjust the model. However, to get the most out of the MPC controller, the prediction of the states should be relatively accurate for the whole prediction horizon.

7.2 Improvements of the Distribution Network Model

There are a lot of possible improvements that can be done on the distribution network model. First of all, the best way to aggregate consumers have not been investigated. The approach in this thesis was to aggregate the consumers based on delay in the slowest operating area. The optimal number

of consumer groups have not been analyzed, but it is reasonable to believe that the more groups the more accurate the model will be, at the cost of increased computation time.

One dynamic this model does not have is the fact that large consumers will affect the delay of the other consumers in the network, because the large flow variations going through their substations can greatly affect delay to other consumer. A way to build a model that includes this could be to aggregate the consumers based on location in the network and then analyze how the delays of the different groups affect each other.

Also, the operating areas were evenly split into five regions. This could be analyzed more as one would think that more operating areas gives a finer model, but also longer computation time. If one seeks to linearize the model so one can use linear MPC, an approach could be to linearize the non-linear equations for each operating area. This means that the choice of operating areas becomes more important and needs to be analyzed further.

7.3 Including the internal dynamics of the plant

Right now, the MPC formulation has only focused on giving an optimal set point for the supply temperature. The assumption was that with lower supply temperature, you will get lower heat losses and thus save fuel. Another approach would be to try to minimize the fuel usage at the plant. The advantage with such a formulation is that the MPC controller can optimize using an objective function that focus on optimizing the actual production costs of the plant.

Such a model would need to include the gas condensation unit, otherwise it would overestimate the boiler's fuel usage. Even though it seems that the gas condensation unit seems complicated to model, it is likely that it could

be model with sufficiently accuracy using the state of the boiler, the return temperature and an estimate of the fuel moisture.

Another thing to consider is, if this approach is used, if one wants to tackle the unit commitment problem of the boilers. If so, one needs heat load prediction on a longer horizon than what is used in this thesis. The boilers need up to one day to be ready meaning an horizon of several days is needed. In [9] a horizon of 5 days were used.

A simpler approach could be, rather than including the complicated dynamics of the plant, to change the constraints of the MPC formulation. Right now the maximum change in supply temperature is constant and is based off of the maximum change found in data measured at the plant. In reality this is probably not a constant, but dependent on the return temperature and the flow, meaning $\Delta T_{max} = \Delta T_{max}(T_R, \dot{m})$. This would be a simple way to include the limitations of the boiler, and should probably be investigated first.

7.4 Implementing MPC in Stjørdal DHS

With small refinements, the model could be implemented in Stjørdal. It should be relatively safe to test it as the model only gives set points to the supply temperature and does not affect the control system of the plant. The operator would be able to control that the set point seems reasonable. For initial testing, it should probably not be tested in winter. During the winter the demand for heat is high and failure to deliver would not be good for the company nor for the consumers.

The only thing needed for implementation of the MPC controller would be a desktop computer connected to the internet with for example a commer-

cial MATLAB license. The computer would need to communicate with a weather forecast service, for example www.yr.no. Then the set points delivered from the MPC controller would need to communicate with the control software of the plant. One issue would be how to handle server downtime at www.yr.no. A possibility would be to communicate with several weather forecast services. An advantage with this approach is that it could probably help the heat load prediction model to get access to weather forecast from different sources. However, weather forecast services can be expensive and another approach would be to use the old procedure for deciding the set point until the servers are back online.

As was discussed in the previous section, it could be possible for the MPC controller to operate the boilers. An implementation of such a procedure would require a lot more work, as the internal plant dynamics needs to be analyzed.

It seems feasible for a master's thesis to complete this project by refining the model and making an implementation at the Stjørdal DHS as the model only needs small adjustments.

7.5 Conclusion

The method seems to be able to lower the supply temperature significantly. However, the prediction model of the return temperature needs to be improved. Improvements of the substation modelling would probably make the method ready for implementation. It seems safe to test the model after some refinement as it only decides the set points for the supply temperature and doesn't affect other parts of the plant. Also, it seems feasible to adjust the model so linear MPC can be used.

CHAPTER 8

Future Work

A lot of improvements can be done on the model presented in this thesis. Most which are discussed in the previous chapter. It seems reasonable to try to refine the model so that it is ready for implementation. As the method does not include any dynamics unique for Stjørdal it is also reasonable to believe that it could be implemented on similar systems, where there is only one production plant. If the implementation is successful at Stjørdal, one could, with more research, try to find a general framework for how to decide the supply temperature set point for similar systems. When a such a model is in place, one could go one step further and expand the model to be used for larger networks, like the one in Trondheim. Another approach would be to focus more on the internal plant dynamics and try to design a method for controlling the plant that combines the dynamics of the plant with the consumer behaviour.

Bibliography

- [1] Atli Benonysson, (1991) *Dynamic Modelling and Operational Optimization of District Heating Systems*, Phd, Technical University of Denmark, Laboratory of Heating and Air Conditioning.
- [2] Anders Svenheim Rene, (2016) *Model Predictive Control of District Heating Systems*, Master's thesis, NTNU (Department of Engineering Cybernet
- [3] Lars Arvastson, (2001) *Stochastic Modeling and Operational Optimization in District Heating Systems*, Phd, Lund University (Lund Institute of Technology)
- [4] Bjarne Foss, Tor Aksel N Heirung, (2016) *Merging Optimization and Control*, NTNU (Department of Engineering Cybernetics)
- [5] G. Sandou, S. Font *Predictive Control of a Complex District Heating Network* Proceedings of the 44th IEEE Conference on Decision and Control
- [6] Girts Vigants, Gundars Galindoms, Ivars Veidenbergs (2015) *Efficiency*

diagram for district heating system with gas condensing unit Energy Procedia 72 (2015) 119-126

- [7] Marouf Pirouti, Audrius Bagdanavicius, Janzhong Wu (2012) *Optimization of Supply Temperature and Mass Flow Rate for a District Heating Network* Proceedings of ECOs 2012
- [8] Roland W. Jeppson (1979) *Analysis of Flow in Pipe Networks* Ann Arbor Science Publishers, Inc. Third printing
- [9] Sara Modarres Razavi, Anreas Nilsson, Markus Bohlin (2014) *Production Planning for District Heating Networks* SICS Technical Report T2014:04
- [10] Hongping Zhao. *Analysis, Modelling and Operational Optimization of District Heating Systems*. Centre for District Heating Technology, 1995.