



Norwegian University of
Science and Technology

Compositional Infrastructure based on Periodic Well Tests

Production Allocation for the Eagle Ford Field

**David Hossein Yves
Emadzadeh**

Petroleum Engineering

Submission date: July 2016

Supervisor: Curtis Hays Whitson, IPT

Norwegian University of Science and Technology
Department of Petroleum Engineering and Applied Geophysics

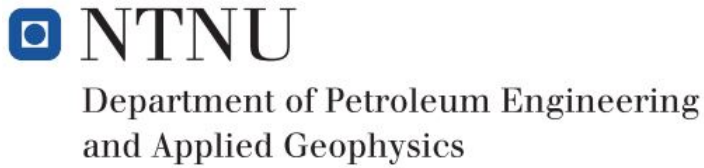

Compositional Infrastructure based on Periodic Well Tests

Production Allocation for the Eagle Ford Field

David Emadzadeh

June 2016

MASTER THESIS

Department of Petroleum Engineering and Applied Geophysics
Norwegian University of Science and Technology

Supervisor: Professor Curtis Hays Whitson

Abstract

This study suggests a way of building an as-accurate-as-possible compositional infrastructure to generate continuous wellstreams, from periodic well tests. It also studies the influence of well test measurements on the reservoir and production management. Since well tests are recorded at varying separator temperature and pressure, the measurements are not consistent with each other, and may lead to misinterpretations, wrong decisions, which would result in a lowered production, and ultimately to less incomes.

The Well Test Conversion module is used to estimate the actual reservoir wellstream, considering it as molar compositional rates. From this point of view, a better understanding of the flow is possible. In this model, the importance of accurate wellstream generations is emphasized. By reprocessing at any separator conditions, all the well test measurements are simulated, and the comparison between the measurements is more meaningful. The deviations due to the varying separator conditions are flagged. Once the effect of the separator conditions has been removed, actual variations of the fluid properties can be studied.

The continuous data are limited to rate measurements, while the periodic well tests are richer in information. A method is proposed to feed the continuous production data with molar rates, generated from periodic well tests. This algorithm produces a database of continuous wellstreams that can be sent through the actual process facilities. In this work, a compositional description of the production is discussed. The data characterizing the production can then be studied (API density and Shrinkage Factor among others) from the simulations. This leads to discussions about the reservoir behaviour, and supports an improved production management. Once the compositional infrastructure is built and the facilities on surface are modelled, an enhanced back-allocation of the production can be achieved.

Preface

This report summarizes the work conducted during the last semester of Master of Petroleum Engineering at the Department of Petroleum Engineering and Applied Geophysics of the Norwegian University of Science and Technology (NTNU) in Trondheim. From January 2016 to June 2016 a collaboration was established with Petrostreamz, an engineering consulting company based in Trondheim, and an oil and gas company based in the United-States (called "the Company" for confidentiality purpose). The company provided the data, stated the problem and listed the main requests, in order for Petrostreamz to conduct a study on shale gas wells in the Eagle Ford field (Texas, USA).

Trondheim, June 2016

David Emadzadeh

Acknowledgment

First, I would like to express my gratitude to my supervisor Pr. Curtis Hays Whitson at the Department of Petroleum Technology and Applied Geophysics of NTNU, for his excellent guidance throughout the project, and the opportunity to travel to Houston. I learnt a great deal from his comments, experience and advices for which I am forever grateful.

I would especially like to thank Mohamad Majzoub Dahouk (Petrostreamz) for welcoming me in Houston, advising me and helping me throughout my studies in Trondheim and Houston. I would also like to thank Arnaud Hoffman (Petrostreamz), for his involvement in the project, his wise advices and his time. The engagement and remarks of Mohamad and Arnaud were extremely useful helping me to learn from my mistakes, stay curious and delve into the details. They were instrumental in helping me develop my engineering skills. I would also like to thank the whole team at Petrostreamz and PERA, for their welcoming and constant help throughout this work.

Furthermore, I would like to thank Talita Miranda Costa for her support, friendship, as well as to all my friends in Trondheim. Working alongside these friends helped me stay focused and motivated. I also would like to thank Maria José de las Llanderas Ramirez. Her advices were truly inspiring.

I wish to express my gratitude to Reyhaneh Shenassa for her wise advices and her encouragement during my studies.

I will be forever grateful to my parents and my sister for their unconditional support. Their encouragements were truly helpful to me throughout this study. This would not have been possible without them.

D.E.

Contents

Abstract	i
Preface	ii
Acknowledgment	iii
1 Introduction	2
1.1 Background on the Eagle Ford Field	2
1.2 "The Company" Layout	3
1.3 Motivations and Objectives of this work	3
1.3.1 Consistent Well Test Measurements	3
1.3.2 Reliable Back-allocation	4
1.3.3 Challenges	5
1.4 Methodological Approach	6
2 Well Test Conversion	8
2.1 Background and Presentation	8
2.2 Requirements	10
2.2.1 Equation of State	10
2.2.2 OGR_{sp}	11
2.2.3 Separator Conditions	11
2.2.4 Estimation of the Wellstream Composition: the "Seed Feed"	11
2.3 Separator Conditions and Reprocessing	12
2.4 API Density Dependency upon the Seed Feed	13
2.5 Other Purposes of the WTC	16
2.6 Conclusions	16

3	Pipe-It Template	18
3.1	Available Data and Game Plan	18
3.2	Data Management	19
3.3	Seed Feed Selection	19
3.3.1	First Attempt: using PVT Reports	20
3.3.2	Enhance the Wellstream Estimation: using more results from the Well Tests and PhazeComp	27
3.3.3	Using Measured Separator Sample Compositions and Properties: Recommendation for further work	37
3.4	Preparing the Reprocessing	38
3.4.1	Corrected wellstream composition available	38
3.4.2	Feeding the Production Database	39
3.5	Further Processing of the Corrected Compositions	41
3.5.1	Presentation	41
3.5.2	Quality Check of the Seed Feed Estimate	42
3.5.3	Calculations at Common Separator Conditions	45
3.5.4	Plots	46
3.6	Conclusion	47
4	Results	49
4.1	First Method to Estimate the Wellstream	49
4.2	Actual Estimation of the Wellstream	49
4.2.1	Discussion over the Incomplete Set of Data	50
4.2.2	Discussion over the Generation of the Continuous Composition	53
4.2.3	Summary of the Available Data	54
4.2.4	Conclusions	55
4.3	EOS Selection for Reprocessing	55
4.4	Processing at the reported conditions	57
4.4.1	Quality Check on OGR_{sp} Calculations	57
4.4.2	Quality Check on API Calculations	57

4.4.3	Quality Check on Separator-gas Composition Calculations	58
4.4.4	Analysis with Shrinkage Factor	61
4.4.5	Analysis with Condensate Oil-Gas Ratio	64
4.4.6	Conclusion	66
4.5	Influence of the Separator Conditions	67
4.5.1	Influence of the Separator Pressure	69
4.5.2	Influence of the Separator Temperature	70
4.5.3	Conclusion	71
4.6	Processing at Other Conditions	72
4.6.1	Selection of the Common Separator Conditions	72
4.6.2	Periodic Data	73
4.6.3	Suggestions of Correlations from Periodic Well Tests	81
4.6.4	Continuous Data	90
4.6.5	Conclusion for the Continuous Streams Generation	118
4.7	Uncertainties	118
4.8	Conclusion	120
5	Illustration of the Use of a Compositional Infrastructure	122
5.1	Issues	122
5.2	Proportional Allocation	122
5.3	Case when Continuous Well Test Data are not available	123
5.3.1	Petroleum Back-allocation: Using WTC and Integrating the Processes for each AF calculation	124
5.3.2	Conclusions	126
6	Suggestions and Conclusion	127
6.1	Suggestions for Further Work	127
6.2	Conclusions	128
A	Acronyms	130

B PVT data	133
B.1 Extract from a PVT Report	133
B.1.1 GPM Conversion to Separator-gas Composition	133
B.1.2 EOS PERA2013	136
B.1.3 PhazeComp Software	136
B.1.4 Gawk Algorithms	136
C Industry Standards for Back-allocation	141
C.1 DrillingInfo Services: an upgraded proportion-based allocation	141
C.2 IHS	142
Bibliography	145

List of Figures

1.1 Eagle Ford Reservoir (Texas), from (KED Interests)	2
2.1 Requirements for the Well Test Conversion	10
2.2 API Processing at Low Separator Pressures	14
2.3 API Processing at High Separator Pressures	14
2.4 GOR Influence on API density at High- and Low Separator Pressures	15
3.1 GOR_{sp} if Seed Feed from Geocalizing	22
3.2 API if Seed Feed from Geocalizing	22
3.3 Allocating the Seed Feeds from an API study, well ID 2	23
3.4 API Deviations from Seed Feeds to Real Composition	24
3.5 GOR_{sp} if Seed Feed from API Matching	25
3.6 API if Seed Feed from API Matching	25
3.7 Gain of Accuracy by basing the Seed Feed Selection on an API study	26
3.8 Separator Gas Measurements	28
3.9 M/d vs p_{sp} , component C_2	29
3.10 M/d vs T_{sp} , component C_2	29
3.11 M/d vs p_{sp} , component nC_5	29
3.12 M/d vs T_{sp} , component nC_5	29
3.13 N_2 fraction among the non-HC fraction	31
3.14 Summary of the Seed Feed Generation using PhazeComp	35
3.15 As-accurate-as-possible Seed Feed Library feeding the WTC Module	38

3.16 Physical Adjustment on the theoretically-generated Composition, for different (Well ID, date)	39
3.17 Generation of a Streams Library for the Continuous Database	40
3.18 Continuous Stream generated using or not using Interpolation	40
3.19 Template of the QC in Pipe-It	42
3.20 Calculation of the OGR_{sp}	43
3.21 Calculation of the Separator Gas Composition	44
3.22 Calculation of the API density	44
3.23 Changing the Separator Conditions to a Common Set	46
3.24 Template for the Plotting	47
4.1 API Matching using <i>case 63</i>	51
4.2 API Matching using <i>case 370</i>	51
4.3 Sep-gas iC_4 matching using <i>case 63</i>	51
4.4 Sep-gas iC_4 matching using <i>case 370</i>	51
4.5 Sep-gas nC_4 matching using <i>case 63</i>	52
4.6 Sep-gas nC_4 matching using <i>case 370</i>	52
4.7 Continuous Calculations without Interpolation	53
4.8 Continuous Calculations with Interpolation	53
4.9 RMS Values for each Periodic Stream, after PhazeComp Convergence	54
4.10 SF Calculations using different EOS	56
4.11 OGR_{sp} Matching	57
4.12 API Matching	58
4.13 Sep-gas N_2 matching	58
4.14 Sep-gas CO_2 matching	58
4.15 Sep-gas C_2 matching	59
4.16 Sep-gas C_3 matching	59
4.17 Sep-gas iC_4 matching	59
4.18 Sep-gas nC_4 matching	59
4.19 Sep-gas iC_5 matching	59

4.20 Sep-gas nC_5 matching	59
4.21 Sep-gas C_1 matching	60
4.22 Sep-gas C_{6+} matching	60
4.23 Separator Gas composition Matching	60
4.24 SF Matching for a two-stage Separation, from Separator Conditions to Standard Conditions	62
4.25 SF Variations with Separator Conditions. Stream from (Well ID 16, date 42072) . .	63
4.26 OGR_{cond} Matching for a two-stage Separation, from Separator Conditions to Stan- dard Conditions	65
4.27 Errors in the Reprocessed SF and OGR_{cond}	66
4.28 OGR_{sp} and API Calculations	69
4.29 Influence of the Separator Pressure on OGR_{sp} and API. Stream from (Well ID16, date 42072)	70
4.30 Influence of the Separator Temperature on OGR_{sp} and API. Stream from (Well ID16, date 42072)	71
4.31 Pressure Range for All Data	72
4.32 Temperature Range for All Data	72
4.33 Reprocessed API at Common Conditions	74
4.34 API vs time for Periodic Measurements, Well ID 18	75
4.35 API vs time for Periodic Measurements, Well ID 29	76
4.36 API vs time for Periodic Measurements, Well ID 31	77
4.37 Reprocessed OGR_{sp} at Common Conditions	78
4.38 OGR_{sp} vs time for Periodic Measurements, Well ID 18	79
4.39 OGR_{sp} vs time for Periodic Measurements, Well ID 29	80
4.40 OGR_{sp} vs time for Periodic Measurements, Well ID 31	81
4.41 OGR_{sp} vs $\sqrt{(p_{sp})}$, $T_{sp}=65.76$ F, Well ID 21, date 42072	82
4.42 OGR_{sp} vs $\exp(-0.006.T_{sp})$, $p_{sp}=101.7$ F, Well ID 21, date 42072	82
4.43 Influence of T_{sp} on OGR_{sp}	83
4.44 Correlation Factors vs T_{sp}	84
4.45 Correlation applied to OGR_{sp} Calculations of Well ID 16	85

4.46 API vs $\exp(-x.Tsp)$	86
4.47 Correlation Factors vs p_{sp}	86
4.48 API Correlation applied on Well ID 16	87
4.49 API Correlation applied on Well ID 15	88
4.50 API Correlation applied on Well ID 7	88
4.51 API Correlation applied on Well ID 4	89
4.52 Continuous Composition of the Production of Well ID 18	93
4.53 Continuous API Variations of the Production of Well ID 18	94
4.54 Continuous Light Components Variations of the Gas Production of Well ID 18	94
4.55 Continuous Heavy Components Variations of the Gas Production of Well ID 18	95
4.56 Continuous Composition of the Production of Well ID 29	96
4.57 Continuous API Variations of the Production of Well ID 29	96
4.58 Continuous OGR_{sp} Variations, All Wells Included	97
4.59 Continuous OGR_{sp} Variations, Well ID 6	98
4.60 Continuous OGR_{sp} Variations, Well ID 29	99
4.61 OGR_{sp} Variations for two different Separator Pressures	99
4.62 Continuous OGR_{sp} Variations, Well ID 18	100
4.63 Continuous OGR_{sp} Variations, Well ID 10	101
4.64 Continuous OGR_{sp} variations, Well ID 28	102
4.65 Continuous OGR_{sp} Variations, Well ID 30	102
4.66 Continuous Separator Gas Light Composition Variations, Well ID 28	103
4.67 Continuous Separator Gas Heavy Components Variations, Well ID 28	104
4.68 Continuous API Variations, Well ID 28	105
4.69 Continuous Separator Gas Light Composition Variations, Well ID 6	106
4.70 Continuous Separator Gas Heavy Components Variations, Well ID 6	107
4.71 Continuous API Variations, Well ID 6	108
4.72 Continuous API Variations, Well ID 10	109
4.73 Continuous Separator Gas Light Composition Variations, Well ID 10	109
4.74 Continuous Separator Gas Heavy Components Variations, Well ID 10	110
4.75 Continuous API Variations, Well ID 4	111

4.76 Continuous Separator Gas Light Composition Variations, Well ID 4	112
4.77 Continuous Separator Gas Heavy Components Variations, Well ID 4	113
4.78 Continuous API Variations, Well ID 13	114
4.79 Continuous API Variations, Well ID 14	114
4.80 Continuous SF Variations, Well ID 13	115
4.81 Continuous SF Variations, Well ID 28	116
5.1 Back-allocation Method	125
B.1 Example of a PVT Report	134

List of Tables

3.1	Wellstream Composition used for Each Well	21
3.2	API Calculations	23
3.3	Ratio taken from a PVT Report of a well	29
3.4	Standard Deviation per Component	30
4.1	Measurements of the Wellstream used	68
4.2	Composition of the Wellstream used	68
4.3	Coefficients study for the correlation	83

Chapter 1

Introduction

1.1 Background on the Eagle Ford Field

The Eagle Ford field area is a hydrocarbon (HC) field in Texas (Figure 1.1), producing shale gas mostly. Its ownership is shared by more than 40 operators, and the Eagle Ford field has been one

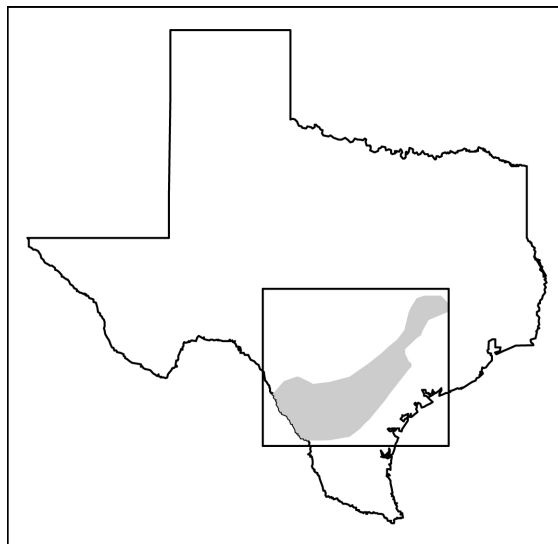

Figure 1.1: Eagle Ford Reservoir (Texas), from ([KED Interests](#))

of the most active oil and gas fields in the world (drilling and production) since 2008, with the most investments (\$30 billion in 2013, [KED Interests](#)). Fracking is used to produce the HC (from depths 4,000 ft to 14,000 ft), and the reserves being estimated at around 3 billion barrels of oil and 50 trillion scf of gas ([Wikipedia](#)).

The decrease in oil and gas prices considerably lowered the activity in the Eagle Ford field: the number of active rigs was cut by 65% in 2015. To avoid overspending, the operators of the Eagle Ford field need to optimize their production and better understand the asset.

1.2 "The Company" Layout

The Company operates mostly in several counties southern Texas next to the border with Mexico. It is crucial for the Company to understand as accurately as possible their production data from the Eagle Ford field.

The asset of the Company in the Eagle Ford field is very complex. The range of OGR's is wide (from dry gas to gas-condensate). Moreover, a given well does not always flow in the same pipeline, not even in the same direction. Some of the wells can flow directly to different gathering facilities (CDP, Central Delivery Point), according to the pressure differential. Some other wells flow to well gathering lines, which in turn flow to different CDPs. Therefore, looking at a CDP, it seems extremely difficult to determine where the stream comes from, and which wells have contributed. Assuming the flow patterns can be known for a given time, the pressure conditions can vary quickly, which changes all the flows. The study here focusses on an isolated area, where all the wells flow to the same pipe (see next section).

1.3 Motivations and Objectives of this work

The unique technology of Petrostreamz is used in this work: the well test conversion module, implemented in the software Pipe-It. A continuous set of molar compositional rates is generated from a limited amount of production data. A compositional point of view considerably enhances the understanding of the asset's production.

1.3.1 Consistent Well Test Measurements

The Company uses the well test measurements (Oil-Gas Ratio¹, API density, Shrinkage Factor and others) for reservoir management purposes (behaviour of the well, of the reservoir, history

¹OGR and GOR are used indifferently in the report

matching, forecasts) and production optimization purposes (adjust the production of each well, use of gas lift or Enhanced Oil Recovery techniques). For example, if an increasing GOR_{sp} in a well is noticed, the Company might want to change the production conditions of this well, in order to counteract and extract more liquid. The API data are also crucial to know the type of produced oil, and see the evolution with time.

These well tests are conducted by a laboratory company, using tests separators operating at varying temperature and pressure. Indeed, when testing a well, the test temperature is really dependent upon the outside temperature (that can vary from less than 30 F to more than 100 F); the pressure is also changing (to a more-limited extent). It has been shown (Hoda and Whitson, 2013) that varying separator conditions have a big impact on the well test measurements; and it can lead to wrong interpretations (*e.g.* an increasing density is reported, while it is actually decreasing) and wrong decision-making.

The Company wants to obtain these well test measurements at a common set of separator temperature and pressure, so that comparing the values well-to-well with time will be consistent. For this purpose, Petrostreamz uses the Well Test Conversion technology and the software Pipe-It (see below) to convert the well test data to a molar rate, that can be reflashed at a new set of separator conditions, resulting in well test data “corrected” regarding the separator conditions.

1.3.2 Reliable Back-allocation

The Company meters gas and oil rates continuously from individual separators. The separator pressure and temperature conditions change continuously, and often significantly. To conduct proper allocation of individual wells to gathering-center fiscally-metered rates, it is necessary to convert continuous test separator rates to a compositional rate which can then be re-processed to a "common" process, *i.e.* the same process used at the gathering center (or some average "gathering-center" set of conditions).

Other reasons (than allocation) why compositional wellstream conversion can be useful in eliminating time-varying separator conditions for a given well, and well-to-well differences, include:

1. determine how each bottomhole is behaving, and how the reservoir is evolving;
2. decide on methods to improve the recovery and monitor the individual well performance;
3. improve history matching, and enhance the simulations (for forecasts);
4. be able to track streams and, if possible, components throughout the operations (from the reservoir to the sales);
5. better understand the production, and have a closer sight at a smaller scale.

The back-allocation method consists of determining allocation factors from molar rates processed through the whole facility. The allocation suggested in this report is to be more reliable than the classical allocation factor calculations. The classical allocation does not take the process into account, and integrates well tests that are not consistent with each other (because conducted at different separator conditions).

1.3.3 Challenges

- Correcting the well test measurements requires all the inputs of the WTC module: EOS, seed feed, separator conditions, gas and oil rates. Obtaining them accurately is discussed in the chapter “Well Test Conversion”.
- Modeling the entire facility is possible, but would be very time consuming, and outside of the scope of this project. In one part of the layout, one CDP is independent from the others. It gathers flow from twenty wells, in an isolated-area. The scope of Petrostreamz is to show the reliability of the compositional infrastructure for this given set of wells. Once approved, the WTC technology could be extended to all wells, and to the whole facility.

From well tests periodic data and continuous production measurements:

- The well test data correction is applied to all the wells in Area B and some of the wells in Area A (real names hidden for confidentiality reasons), but can easily be extended to the whole asset, assuming enough input data are available.
- The back-allocation is applied to the isolated-CDP zone (the Area B wells).

The wells of interest are reported in the Appendix. For confidentiality reasons, numbers have been assigned to them.

Remark: In this study, the WTC technology and the back-allocation are to be proved from a limited number of wells. It can be extended to the whole asset, but not to any group of wells. Indeed, the selected wells might flow to different CDP's, and might be processed differently.

The wells selected for the study all flow to the same CDP, it is a *sine qua non* condition for the validity of the method.

1.4 Methodological Approach

Petrostreamz developed a Well Test Conversion (WTC) module to convert volumetric rates to a molar rate (Chapter 2) that can be processed further. Using this module and separators (single or double stages), well tests can be simulated and the measurements recalculated, at other separator conditions than the actual measurement. This method, based on OGR_{sp} matching, makes it possible to convert the measurements from one set of separator conditions to another set. The WTC technology also suggests a better back-allocation than the usual allocation method.

The implementation of the WTC in Pipe-It is explained (Chapter 3), together with the ways the inputs are obtained (wellstream estimation, equation of state). From the data provided by the Company, two main approaches were used to estimate the composition. The first one uses PVT reports from a limited number of wells. The second approach uses additional data from the well tests, and converging to fit them. The main purpose in here is to have the most accurate “seed feed” library, for processing. Once the WTC is implemented in Pipe-It, the resulting wellstream is processed at different separator conditions, depending on the data to estimate.

After setting up the main template, results show the reprocessed well test data (API, OGR_{sp} , separator-gas composition) at common conditions; and correction correlations are sought (Chapter 4). The corrected periodic wellstream is also input into the continuous production data, in order to study the continuous evolution of some PVT properties. This helps understanding the reservoir behaviour, and eases a back-allocation of the production.

As an illustration of the compositional infrastructure, an enhanced back-allocation is dis-

cussed in Chapter 5. It happens that only periodic well tests are available, while allocation is requested on a continuous basis. Industry standards that cope with this are discussed, including the method of Petrostreamz. Building a compositional infrastructure is a significant improvement of the back-allocation accuracy, as it brings a more-detailed understanding of the flows.

Chapter 2

Well Test Conversion

2.1 Background and Presentation

Since the 1970's, well tests are conducted on a regular basis to each well in production (typically 3-4 times per year, depending on the variations of Gas-Oil Ratio and Water-Cut). It consists of diverting the well flow from the producing line to a test line, where measurements can be made, and samples can be taken. These samples are collected and analysed in laboratory. Several tests are operated: compositional analysis, separator test for both oil and gas, constant composition expansion, constant volume depletion, recombination ([Whitson and Brulé \(2000\)](#) chapter 6), to determine the properties of the reservoir fluid. The results are then input in a PVT report and sent to the Company. Some of the data given in such report are provided in the Appendix.

This PVT analysis is then used, firstly to define an Equation Of State (EOS) representing the concerned well/reservoir/field, but also to monitor the well performance, according to the GOR, SF, API, *etc.* Most of the decisions concerning the operations and production managements actually rely on well test measurements. Indeed, it is extremely crucial that the operator can trust it.

To obtain the well test results, the sample is flashed at separator conditions (also reported in the PVT report). It is well acknowledged (from experiments and in the literature) that the separator conditions are of great influence in the measurements. This dependency is demonstrated in the [chapter 4](#).

The reported API values are a key extra data in the periodic samples. Indeed, as stated in

the previous sections, an API analysis can provide useful information on the seed feed, and help determining a reliable seed feed.

Having the API, GOR and other data for a given time is valuable for the operator, but it is also interesting to have these data varying with time. For example regarding the API, the API measurements must be consistent throughout the whole time period, *i.e.* well tests must be reported at a fixed set of separator temperature and pressure. This is physically not achievable, since the separator temperature depends on the surrounding conditions (temperature, wind, weather), that vary a lot.

The Company has a whole set of well test measurements that have been reported at different separator conditions. Even for the same well, comparing the rates is not consistent, as stated in (Hoda and Whitson, 2013).

Hoda and Whitson (2013) developed a method to correct the well tests, and adjust the measurements to other separator temperature and pressure. As stated above, this method adds consistency to the well tests, and makes it possible to know the time evolution of some wellstream data such as API, SF, GOR, *etc.* Correlations can be suggested, to correct the measurements with respect to the separator conditions. This is discussed in the section 4.

A molar estimation of the stream (per component) is assumed and flashed at the reported separator conditions, using a defined equation of state. The resulting equilibrium gas and oil flows are recombined to match the reported OGR_{sp} (after reported oil and gas rates). The output of the module is a molar rate per component, which would match the reported OGR_{sp} if reflashed at the reported separator conditions. This reflash is implemented as a Quality Check, the plot Reported OGR_{sp} vs Measured OGR_{sp} is expected to overlap the main diagonal “ $y=x$ ” (see 4).

The remaining variations of the OGR_{sp} are due to the intrinsic reservoir behaviour, and also to the EOS, but the separator conditions effect has been removed. Since the OGR_{sp} is a good indicator of the wellstream composition (OGR_{sp} is strongly linked to the ratio of C_{6-} component by C_{7+} components), changes in its values are a good indication of changes in the reservoir composition.

Once the molar wellstream is obtained, it can be processed to the actual field facilities, or can be reflashed at a new set of separator conditions. The “adjusted” (regarding separator con-

ditions) well test measurements are then obtained.

2.2 Requirements

Following is an explanation on how the required inputs are obtained. It is shown in Figure 2.1.

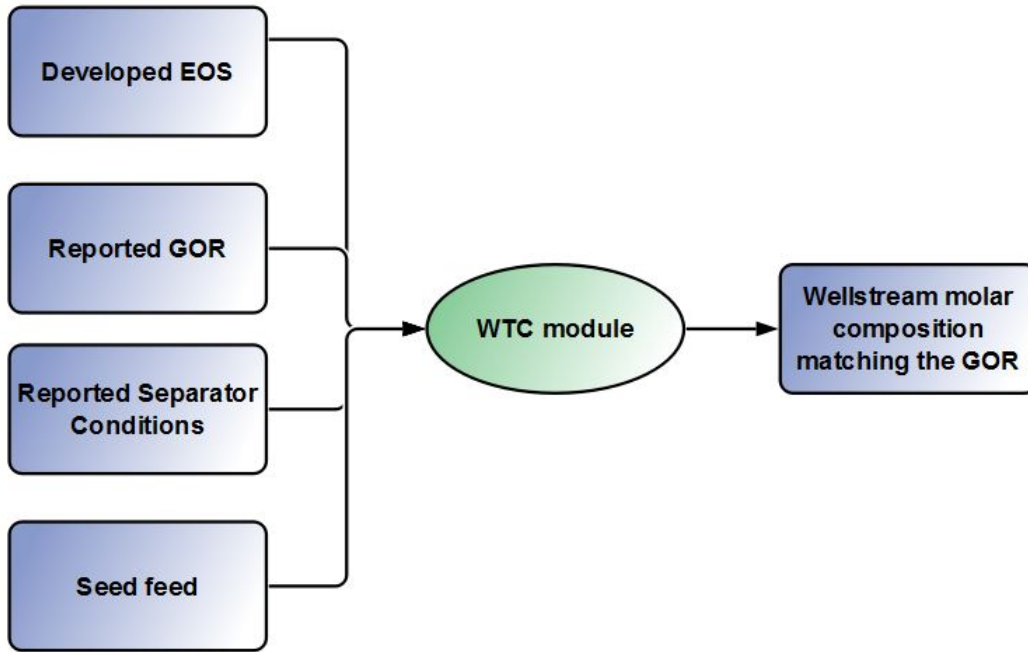

Figure 2.1: Requirements for the Well Test Conversion

2.2.1 Equation of State

The flash calculations to separate the oil phase from the gas phase uses the Rachford-Rice procedure, presented in (Whitson and Brulé, 2000) chapter 4. The equation of state consists of an equation (Peng-Robinson, Redlich-Kwong or Soave-Redlich-Kwong), a table of components with their properties, and a table of Binary Interaction Parameters. These two tables can vary significantly from one EOS to another.

The equation of state used was developed by PERA in 2013 and refers to the SRK equation (section 4.2.3 in (Whitson and Brulé, 2000)), the characterization of the stream being up to C_{26+} . The software PhazeComp was used to build this EOS, together with a procedure from PERA: PVT reports of several wells (from the Eagle Ford field) are input in PhazeComp, and iterations

change the chosen variables until convergence is reached (the regressed variables being the Søreide factor, the Binary Interaction Parameters between C_1 and heptane-plus components, and the critical Z -factor of heptane-plus components for viscosity correlations).

This EOS was selected for two reasons. First of all, it has a consistent background, as it was developed for two actual wells in the Eagle Ford field. Secondly, a Shrinkage Factor study shows (see “EOS selection for reprocessing”) that this EOS results in the best match regarding the reported SF (among the set of available EOS), while overlapping OGR_{sp} , API, and separator-gas composition up to C_{7+} . Though, further analysis would be necessary to know whether PERA2013 is a good representation for the Eagle Ford area.

It is important that the EOS is built after data from the Eagle Ford field, as the WTC will be applied on the wellstreams from the Eagle Ford field. An alternative attempt would be using an EOS that has been developed by the operator (the Company) before, for this specific field.

2.2.2 OGR_{sp}

The oil and gas rates measured during the well test are used to calculate the Oil-Gas Ratio (OGR_{sp}). The flashed oil and gas streams will be recombined so that they match this reported OGR_{sp} .

2.2.3 Separator Conditions

The separator conditions at which the rates were reported, hence at which the GOR_{sp} was reported, have to be input in the WTC module. The gas and oil rates will be flashed at the same conditions than those at which the GOR_{sp} was reported.

2.2.4 Estimation of the Wellstream Composition: the “Seed Feed”

Different data from the well tests can be used as a first estimation of the wellstream composition:

- The composition can be interpolated from the GOR_{sp} itself and pre-defined tables from reservoir simulation (method used in (Hoda and Whitson, 2013)). These tables have to be updated each time a new composition is known. After Hoda & Whitson, the composition is linear with the OGR_{sp} variations, hence a few data are enough.

- The recombined wellstream analysis in the PVT reports can be used (first approach implemented in this project).
- The seed feed can be estimated from the separator-gas composition (up to C_{6+}), the API density and the oil-gas ratio (Whitson and Sunjerga, 2012) (second approach used in this project).
- The wellstream determined during the previous time step can also be considered as a satisfying seed feed.
- The initial reservoir composition, if known, can also be an estimation of the wellstream composition.

These methods are discussed in the next section. The best method is selected regarding the available data, in order to build the most accurate seed feed library.

2.3 Separator Conditions and Reprocessing

The separator conditions have to be specified for the flash calculations, but one should beware of the different sets of separator conditions that are available from the Company:

1. The reported separator conditions at which the oil and gas rates were measured, hence at which the GOR_{sp} was reported. This is the set of conditions to input in the WTC module.
2. The reported separator conditions at which the gas analysis was conducted.
3. The reported separator conditions at which the oil analysis was conducted.
4. The user-defined set of separator conditions, at which the wellstream should be reprocessed. This set may be defined by the Company, according to the needs for reprocessing.

The three last sets of separator conditions are not used for the WTC, but are used farther in the reprocessing. Once the molar compositional wellstream is recombined, it matches the reported OGR_{sp} at the reported separator conditions. This wellstream can be reflashed at another set of separator conditions, and this experiment reproduces what happens during an actual well

test. As stated above, most of the time the “user-defined separator conditions” are the same for all the streams from all the wells, for the sake of consistency. It can also be a varying set of separator conditions for a given wellstream, in order to see their impact on the reprocessing and on the recalculations.

The resulting gas and oil streams are then flashed at different separator conditions (the second and third dots above), reproducing the gas and condensate analysis. The reprocessed OGR_{sp} (flashed at the fixed gas analysis separator conditions) will vary only if the wellstream composition varies.

These reprocessed OGR_{sp} and API are discussed in the chapter 4.

2.4 API Density Dependency upon the Seed Feed

As stated above, the WTC technology flashes the wellstream and recombines it to match the OGR_{sp} . In this section, it is shown that if the seed feed has been chosen quite “randomly”, there is a little chance that the resulting stream matches the API or the gas specific gravity.

The K -value of component i is the equilibrium gas fraction y_i divided by the equilibrium liquid fraction x_i . It indicates the relative preference of component i to be rather in the gas phase ($K_i > 1$) or in the liquid phase ($K_i < 1$) (Whitson and Brulé (2000) chapter 3). The K -values define the split of a fluid into its vapour and liquid parts, and are a function of the pressure, the temperature and the overall composition z_i .

At separator pressures lower than 1,000 psia, the separation process is more or less the same, independent of the stream composition (Hoda and Whitson, 2013). The composition of the recombined stream varies according to the varying GOR_{sp} , but the second separation is also independent upon the composition (Figure 2.2). Hence, the separator-oil after recombination has the same properties, including the API.

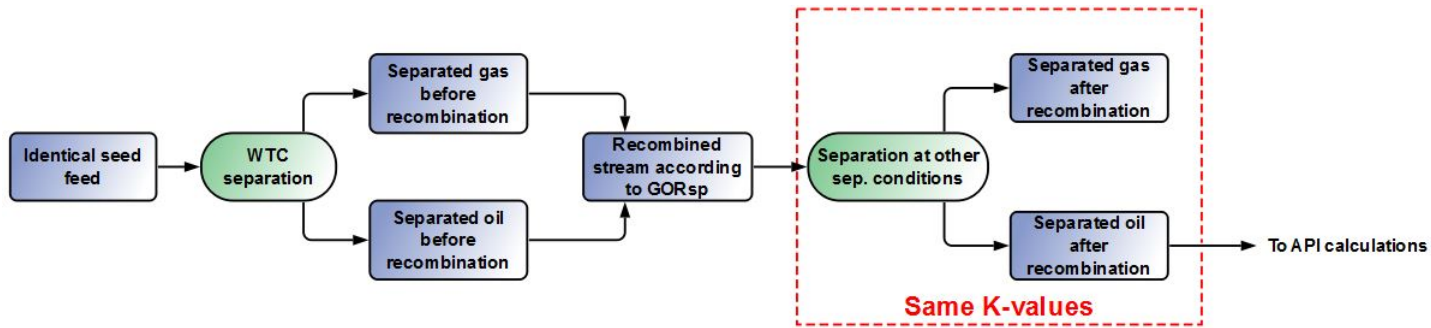

Figure 2.2: API Processing at Low Separator Pressures

At high separator pressures, the K -values and the separation depend on the composition. The seed feed composition is the same, hence the first separation gives the same gas and oil streams. They are recombined in different ways, to match the changing GOR_{sp} . Since the composition of the recombined stream is varying, the second separation gives different results, according to the GOR_{sp} (Figure 2.3). Therefore, the API values of the separator-oil will depend upon the GOR_{sp} .

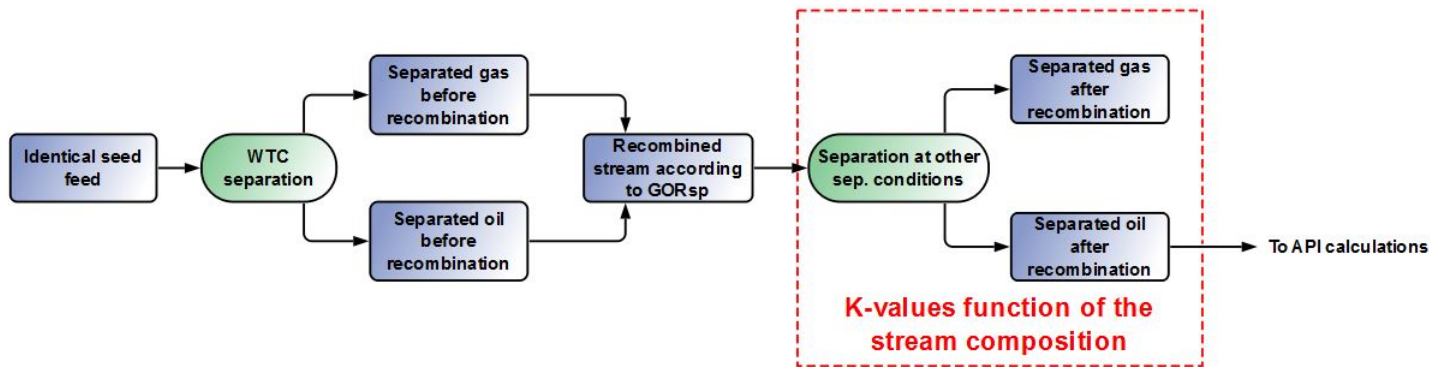

Figure 2.3: API Processing at High Separator Pressures

Figure 2.4 shows the API dependency to the GOR_{sp} for both cases, either a low separator pressure (164.7 psia) or a high separator pressure (2,300 psia) for the second separator. The WTC was conducted in the exact same conditions for both cases, the GOR_{sp} being the only variable.

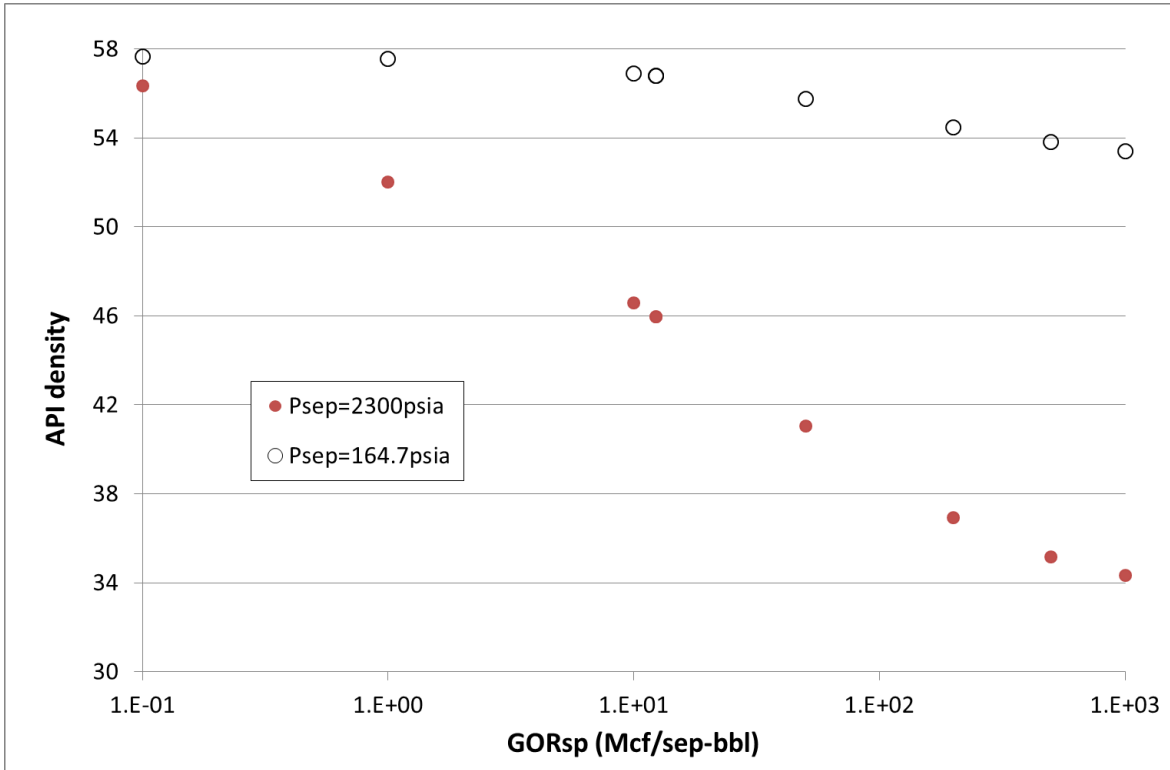

Figure 2.4: GOR Influence on API density at High- and Low Separator Pressures

The slight variations in the API for a low separator pressure are due to the assumption that “the K -values are independent from the composition at low pressures”, which is not totally correct.

The API fluctuations are much more important if the separator pressure is very high. Indeed, the recombined stream is separated differently according to its varying composition, affecting the API. For the same value of GOR_{sp} though, different gas and oil rates yield the same separation, and ultimately with the same API density. Indeed, no matter the ratio gas rate/oil rate, the same GOR_{sp} means that the composition is the same.

Since the usual separator pressures are lower than 1,000 psia, a varying GOR_{sp} does not impact the API calculations. In other words, the WTC module cannot match (or even change) the API from the GOR_{sp} variations. This fact highlights the need of an accurate seed feed, in order to match separator-gas and separator-oil properties.

Since the WTC module is not sufficient to have a correct wellstream, it is preceded by a more consistent convergence, using the PVT software PhazeComp. Once the seed feed is estimated

(from [Whitson and Sunjerga \(2012\)](#)), PhazeComp matches the API, OGR_{sp} and separator-gas composition. The output stream is a wellstream estimation that is more reliable, and more robust, than if matching OGR_{sp} only. The WTC module is the next step, as a Quality Check, but has a very limited effect on the stream (since OGR_{sp} was matched already).

A complementary explanation for the constant API while varying OGR_{sp} at low pressures, is that the OGR_{sp} depends on the ratio C_{7+} / C_{6-} (heavy components/light components), while the API density depends upon the C_{7+} distribution. Indeed, the main contributions to the oil density come from the heavy components. According to how the heavy fraction is distributed, the oil will be more or less dense. Using the same seed feed means that the C_{7+} distribution is fixed, even though the ratio C_{7+} / C_{6-} changes.

2.5 Other Purposes of the WTC

Apart from obtaining well tests at different separator conditions, the Well Test Conversion technology has several uses. It can ensure a consistent history matching, enhance the reservoir simulation model, and it can suggest a new approach of the back-allocation. This is explained in the section dealing with allocation, and is also discussed in ([Hoda and Whitson, 2013](#)).

2.6 Conclusions

- If the separator conditions are not constant, similar wellstreams can, during consecutive well tests, lead to very different GOR_{sp} . Consequently, a measured-increasing GOR_{sp} might actually be decreasing, once the influence of varying separator conditions is removed. It is then crucial, for the sake of a consistent analysis, to have the data at common separator conditions.
- The WTC module developed by Petrostreamz meets this request: it converts volumetric oil and gas rates into a molar compositional rate. Its inputs need to be reliable: the EOS must apply to all the wells concerned. The seed feed composition is of great influence for reprocessing purposes (*i.e.* when not only GOR_{sp} needs to be matched, and when components tracking is involved).

- From the molar rates, the volumetric rates can be calculated (knowing the surface process), and the GOR_{sp} variation with time can be estimated.
- The WTC has other skills than measurement corrections only, such as back-allocation of the production, at the well scale.

Chapter 3

Pipe-It Template

3.1 Available Data and Game Plan

As stated above, the Company provided Petrostreamz with two different kinds of data:

1. Continuous measurements of oil and gas rates at separator conditions.
2. Periodic well test measurements:
 - GOR_{sp} from the wellstream;
 - Gas analysis (GPM numbers, Specific Gravity *etc*);
 - Condensate analysis (API, GOR_{cond} , Shrinkage Factor *etc*).
3. A limited number of PVT reports are also available, for the wells of interest (3 reports out of the 20 wells of the Area B, 2 reports out of the 12 wells of the Area A).

Molar compositional wellstreams of the periodic data are generated first. These wellstreams are reprocessed at other sets of separator conditions, in order to obtain $OG R_{sp}$ measurements independent of the separator conditions. The wellstreams are also used to generate a database, to feed the continuous production data: for a given well, the wellstream composition is generated at different times, and it becomes possible to interpolate the composition for other times. Therefore, every continuous measurement is associated with a wellstream composition, enriching this initially-poor database. These wellstreams are seed feeds for the WTC module, with which corrected wellstreams are processed.

All in all, this method enables the estimation of the reservoir composition of each well, and of hydrocarbon properties such as API, SF... from GOR_{sp} measurements only.

3.2 Data Management

The well tests are given in two different files: the gas analysis, and the condensate analysis. These are gathered in a common datasheet, together with the separator conditions of each test. The separator conditions are similar if the gas and condensate analysis are conducted the same day. Though, gas analysis might be reported on a day without condensate analysis, and the opposite is also possible. This can be figured out (see 3.3.2), but non-zero GOR_{sp} values are required for the procedure. Therefore, any date without reported oil rate or gas rate was removed from the production database, as it cannot be used. Some tests are also labelled as non-reliable by the Company.

Also, some of the well tests (either gas analysis or condensate analysis) have been flagged by the laboratory company. In case this test did not enable a PhazeComp match, it was removed (bad sample).

The units of each variable have also been normalized: the pressures in psia, the GOR in Mcf/sep-bbl, the OGR in STB/MMscf. Indeed, they were provided with varying units in both the continuous and the periodic spreadsheets.

3.3 Seed Feed Selection

As explained in the WTC section, the OGR_{sp} (and GOR_{sp}) will always be matched, no matter the seed feed. Hence, if no other calculation was required, the seed feed would not be of importance.

However, in the case studied, further processing of the compositional wellstreams is crucial. In addition, an interpolation table “well *vs* composition” is supposed to be generated out of it. Besides, measurements are to be reprocessed at other separator conditions. For these reasons, the wellstream composition must be an as-accurate-as-possible estimation of the actual reservoir composition.

Several attempts are discussed in the following. The more parameters are matched with the seed feed, the smaller the non-uniqueness of the solution is. But one should admit a small error margin. Indeed, matching too many parameters adds a significant complexity for a little improvement of the solution. After the analysis based on well test measurements, it appears clearly that the most satisfying option is by creating a seed feed, that will match API density, OGR_{sp} and separator-gas composition measurements.

3.3.1 First Attempt: using PVT Reports

The available PVT reports (sampled by the so-called “Laboratory company”) provide the Company with the recombined reservoir composition for a few wells (5 out of the 32 studied), up to C_{30+} . A very simple way of estimating the seed feed is by using these compositions. On the one hand, no calculations or additional uncertainties are added to the WTC; on the other hand, several concerns can be raised with such a method.

Method

First of all, the way the PVT reports are allocated is questionable. Given the area B, since only three wells have been tested, how to allocate these three reservoir compositions (from the so-called “reference wells”) to the 17 other wells? Two methods were tested. The first method is an allocation based on the geographical position of each well: the seed feed for an untested well is assumed equal to that of the closest well with a PVT analysis associated. The second method is by using all compositions for all wells, processing the API calculations, and selecting the composition with which the API is the closest to the reported API.

Table 3.1: Wellstream Composition used for Each Well

Wellstream Allocation		
Well ID	Geographical Positioning	API Matching
1	4	7
2	4	7
3	4	7
5	4	7
6	7	7
8	10	10
9	10	10
11	4	7
12	4	7
13	4	7
14	4	7
15	4	7
16	7	7
17	7	7
18	10	7
19	10	7
20	4	7

Table 3.1 sums up the wellstream composition used for each well of area B acreage, for both methods. For only 5 wells out of 17, the wellstream allocation is the same. Hence, these methods cannot be considered consistent with each other. It is shown that none of them can be trusted for API calculations and processing.

Allocation from Geographical Position From the wells and pipelines layout provided by the Company, and the list of the wells with PVT analysis available, a reservoir composition was allocated for each of the wells according to its distance to the three “reference wells”. This distance is measured as the crow flies, on surface. After the WTC has been used, the *GOR* match (as expected) (Figure 3.1), but the reprocessed API values are far from the reported API (Figure 3.2):

Figure 3.1: GOR_{sp} if Seed Feed from Geocalizing

Figure 3.2: API if Seed Feed from Geocalizing

The processed API suggests a constant oil density, around 54 °API. This is because only three different compositions (from very close wells) are assigned to all the 20 wells. Hence, all the streams have very similar compositions. Consequently, even after conducting the individual WTC, the oil has the same properties (and the same density). An explanation why this method is not satisfying is also that the geographical allocation is made from a top view of the field, which does not take the subsurface into account. Two wells close on surface do not mean that their bottomholes are close as well. In fact, the geometry of each well is different. Based on this fact, another technique is discussed to allocate the compositions from the PVT reports.

Allocation from an API study Contrary to the previous method, assigning the composition is based on an actual measurement, not on subjective data.

During well testing, the reported API values were measured at given separator conditions. In theory, using the same reservoir composition and separation process, it is possible to recalculate exactly the same API, for each well, at each time. Using the WTC implemented in Pipe-It, the API values are calculated using the three different seed feeds. For each seed feed (*i.e.* for each assumed reservoir composition), the calculated API values are compared to the reported API values (Table 3.2).

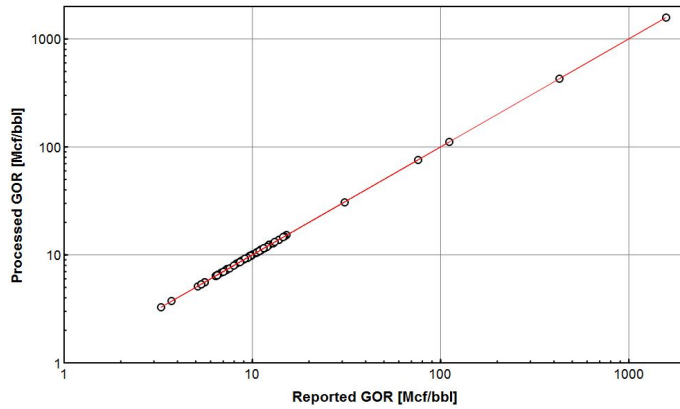
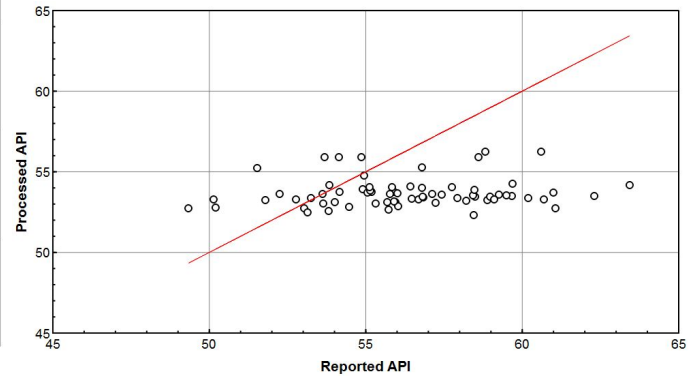
Table 3.2: API Calculations

Well ID 2					
Days	$p_{sp}(psig)$	$T_{sp}(F)$	Re-calculated API at Sep. Conditions	Reported API	API Absolute Difference (%)
41536	343	85.84	53.92	54.90	1.79
41541	145	86.97	53.43	56.84	6.01
41768	93	85.51	52.81	54.46	3.02
42065	139	95.99	53.03	53.65	1.15
Total API Absolute Difference (%) for Well ID 2, with Seed feed from Well ID 4				11.97	

The total absolute API differences are gathered for each well, for the three seed feeds. The selected seed feed is the one giving the smaller absolute API difference:

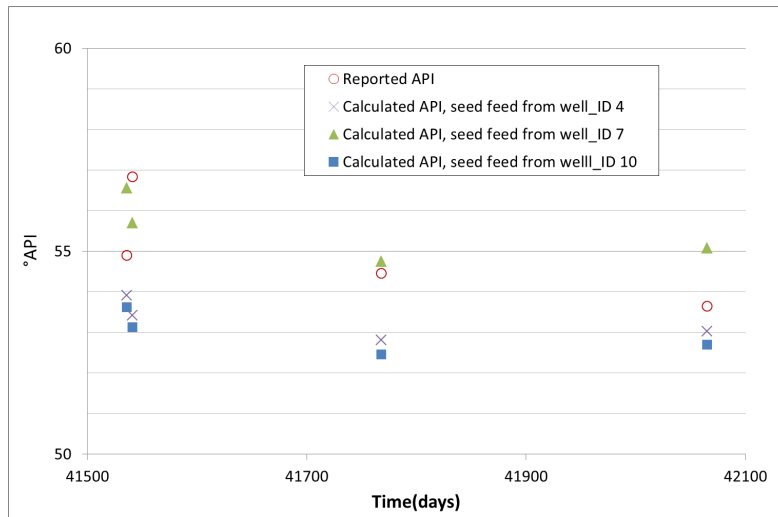

Figure 3.3: Allocating the Seed Feeds from an API study, well ID 2

For example for the Well ID 2 (Figure 3.3), it is clear that using the seed feed from Well ID 7 gives the closest API to the reported API.

The reported API values, together with the available PVT reports and the Pipe-It layout, help estimate the reservoir composition of each well at a given time, assuming that it does not change with time (see below for further explanations).

With a more-accurate seed feed for each well, the WTC can be applied with more reliability.

Still, this seed feed is not the optimum approximation of the reservoir composition, near the bottomhole of each well. The deviation to the real composition was estimated, once again comparing the reported API values to the calculated API values (which come from the best-matching seed feed) (Figure 3.4).

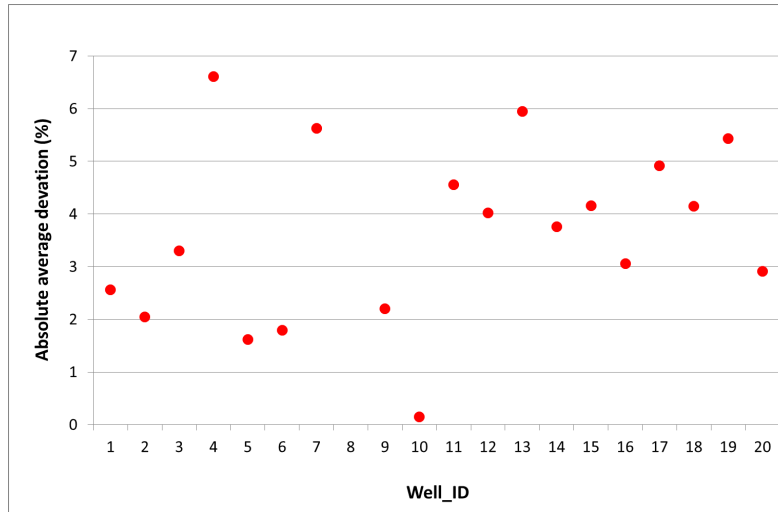

Figure 3.4: API Deviations from Seed Feeds to Real Composition

The number on the y-axis is a normalized value, to estimate how close the seed feed composition is, regarding the other wells:

- The API values at the new set of separator conditions differ from those at the reported separator conditions. This is because the so-called corrected wellstream matches the GOR_{sp} , but does not match the API. Indeed, any input wellstream could, with an adapted recombining factor, match the GOR. This is why the WTC method has a very little dependency upon the seed feed.
- It can seem surprising that the seed feed does not estimate correctly the reservoir composition of Well IDs 4, 7, 10 (for which the actual composition from the PVT report was used). This is partly due to the fact that the recombined reservoir composition from the PVT reports was assumed to be constant with time; while the calculated API values vary with time, each day having its own separator conditions, and probably its own composition. Other reasons are the uncertainties, both in the API measurement and in the composition estimation, and in the EOS calculations (the EOS not being adapted to this fluid).

- The estimated reservoir composition is more satisfying for the Well IDs 1 to 9, than for the Well IDs 11 to 20. On the pipeline layout, it appears that Well IDs 11 to 20 are the farthest from the reference wells (*i.e.* those with available recombined reservoir composition). Therefore, the geographical position could also indicate how to estimate the reservoir composition, to some extents (see above).
- From this point, it is clear that some uncertainties are unavoidable, unless new PVT tests are made. Having the estimated reservoir composition change with time could also improve the solution, since the bottomhole composition is likely to change throughout the life of the well.

The processed OGR_{sp} match the reported OGR_{sp} (as expected) (Figure 3.5), but the recalculated API still does not match the reported API (Figure 3.6).

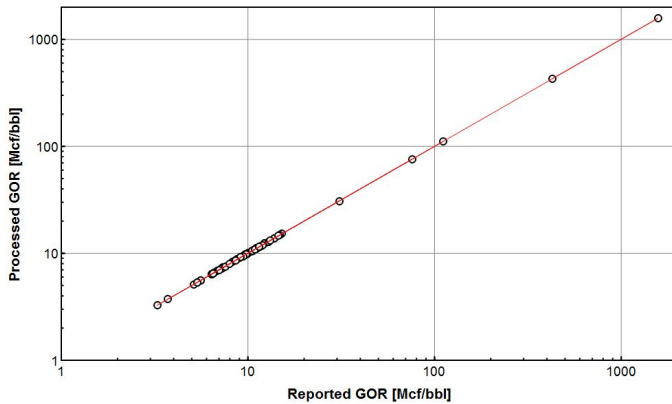

Figure 3.5: GOR_{sp} if Seed Feed from API Matching

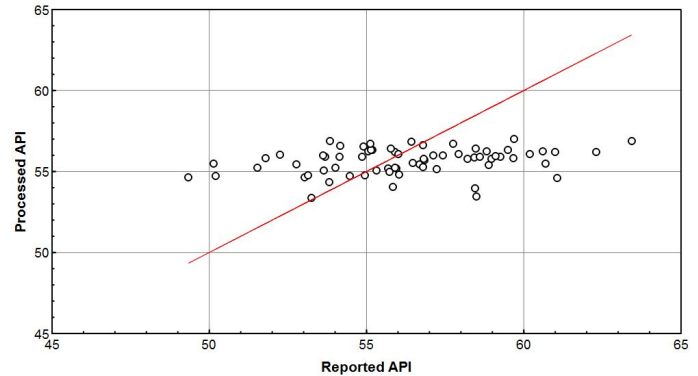

Figure 3.6: API if Seed Feed from API Matching

After processing and recombining, the separator-oil has the same density; which is shown here (near 55 °API). From the API-matching study, 66 streams out of 69 were assigned the exact same composition. Hence, even more streams are identical compared to the first approach, which explains why the API values vary even less here.

The two API plots (from each allocation approach) reveal that the API matching is still not acceptable. Figure 3.7 plots the API relative deviation (calculated and measured values, at the same separator conditions) for the two approaches discussed. The API-matching method improves the allocation a bit, but the results are still not accurate enough.

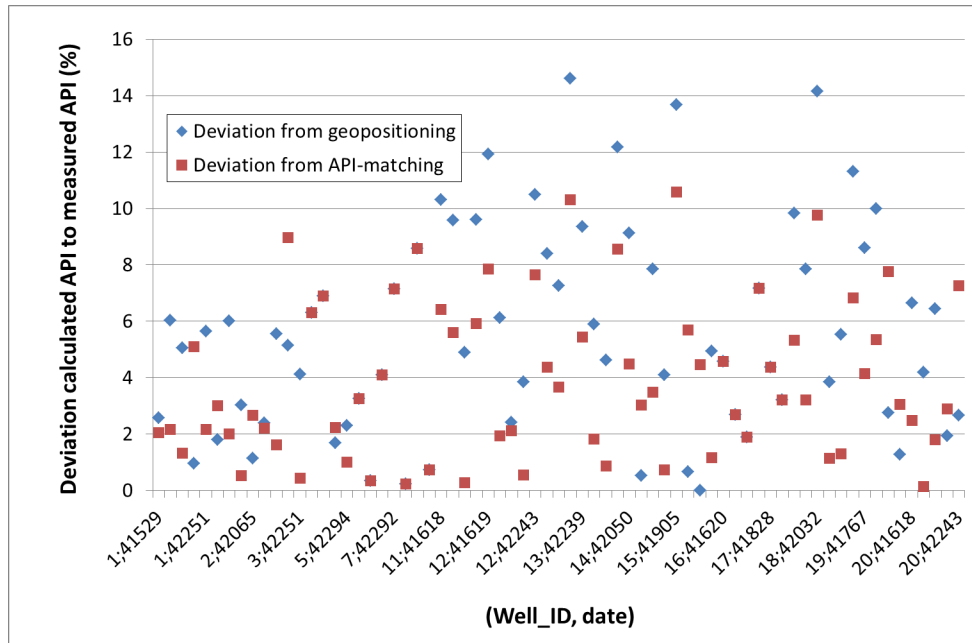

Figure 3.7: Gain of Accuracy by basing the Seed Feed Selection on an API study

Consequently, estimating the seed feeds from the PVT reports do not allow a reliable estimation of the real reservoir composition of each well. This is detailed in the other limitations of the method.

First Limitation: the Accuracy of the PVT reports themselves

The well tests reported in the PVT reports were conducted at a given time. The resulting recombined composition is representative of the actual reservoir composition for this time only: bottomhole and production conditions vary on a continuous basis, and these compositions cannot be assumed as an accurate estimate of the reservoir composition over a long period of time (up to five years).

Second Limitation of this method: the Composition Allocation

The results above show that no composition allocation is satisfying. Indeed, the API values from the estimated wellstreams are far from those reported in the well tests. This shows that the actual composition of each well has not been guessed accurately. Besides, even for the wells that had been tested (for which a PVT report is available), the API values do not match. This can be due

to the facts that:

- The sample was collected at a different time from when the API density was measured, and the reservoir composition has changed between these two times;
- The EOS used by the laboratory company (testing the wells) is different from the one used here (PERA2013, introduced above).

Conclusions

Even though both, *PVT study* (reservoir composition) and *well tests* (OGR_{sp} measurements), are used for the seed feed generation, this first attempt is not acceptable. Still, it is a useful way of building the initial Pipe-It template. It is clear that the API values (reported in the well tests) do not agree with the molar compositional wellstreams (Table 3.2). This was expected, as a non-trustable wellstream composition is fed (with a very limited consistency) to wells that had not even been sampled.

Another attempt is discussed in the next section.

3.3.2 Enhance the Wellstream Estimation: using more results from the Well Tests and PhazeComp

Hoda and Whitson (2013) used OGR_{sp} -interpolation tables (from reservoir simulation and previous WTC) to generate seed feeds.

Compared to the first attempt above, the method proposed in this section makes an extended use of the data contained in the well tests.

Estimating the Separator-gas Composition

Gas Molar Fraction of Hydrocarbon Components The gas analysis of the well test reports the GPM numbers (up to C_{6+}) of each sample and the dry gas BTU, at the given separator conditions. For a gas mixture, the GPM number (gallons per thousand standard cubic feet) represent the amount of liquid that can be produced from 1 MMscf of gas (Whitson and Brulé (2000) chapter 6) (Figure 3.8), for a given component.

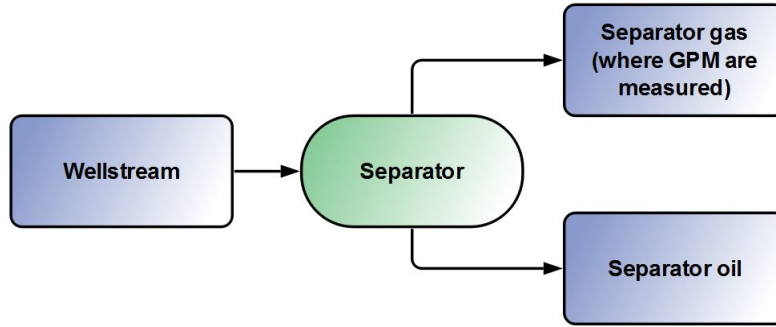

Figure 3.8: Separator Gas Measurements

From (6.19) in [Whitson and Brulé \(2000\)](#), it is possible to estimate the separator-gas composition (up to C_{6+}) of the sample:

$$L_i = 19.73 y_i \frac{M_i}{d_i} \quad (3.1)$$

Where:

- L_i is the GPM value of component i (the liquid volumes that can be theoretically processed from 1 MMscf of separator gas)
- y_i is the component i mole fraction in gas phase
- M_i is the molecular weight of component i
- d_i is the liquid density of component i at standard conditions in lbm/ft^3

The requirements are the GPM values, together with the intrinsic properties of the single carbon component (respectively $C_1, C_2 \dots nC_5, C_{6+}$).

The ratio $\frac{M_i}{d_i}$ is first studied using all the PVT analysis for all the wells available. It is legitimate using all of them, since they are all located in the Eagle Ford area, hence they are producing a similar fluid. For each PVT analysis, the separator-gas composition was reported by the laboratory company, in moles-% and in terms of GPM values (*cf* Appendix). The composition is lumped to obtain the mol-% and GPM of the separator gas up to C_{6+} (Table 3.3).

Table 3.3: Ratio taken from a PVT Report of a well

	Separator Gas		M_i/d_i
	Mole %	GPM	$\text{ft}^3/\text{lbmole}$
C_1	80.310	0.000	0.000
C_2	11.467	3.050	1.348
C_3	3.743	1.024	1.387
iC_4	1.003	0.326	1.647
nC_4	1.056	0.331	1.589
iC_5	0.448	0.164	1.855
nC_5	0.294	0.106	1.827
C_{6+}	0.671	0.276	2.085

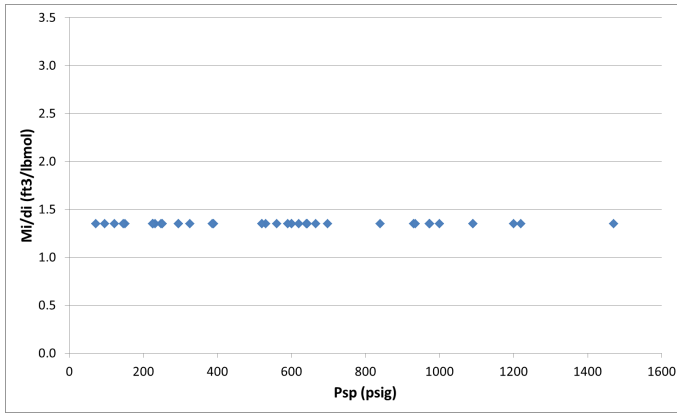

Figure 3.9: M/d vs p_{sp} , component C_2

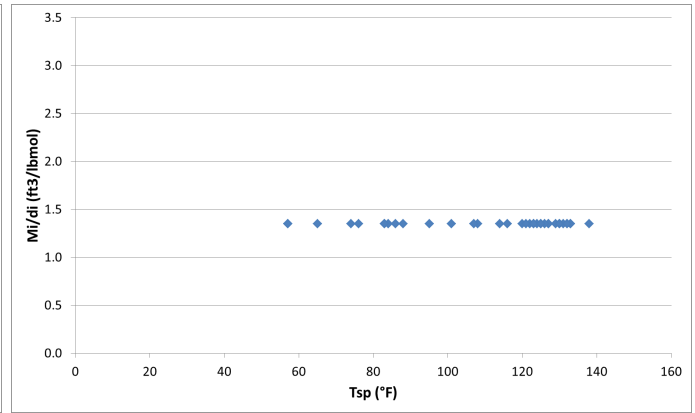

Figure 3.10: M/d vs T_{sp} , component C_2

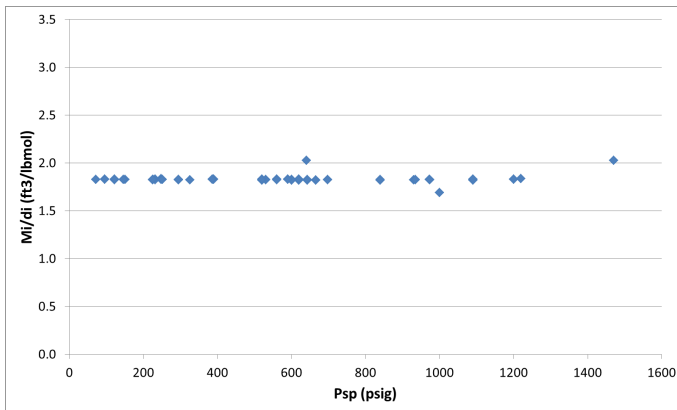

Figure 3.11: M/d vs p_{sp} , component nC_5

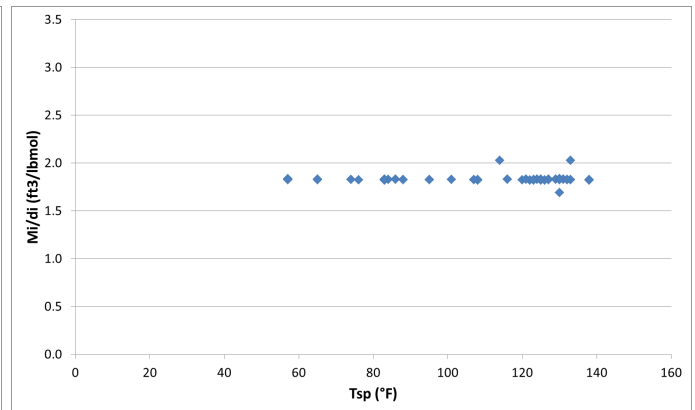

Figure 3.12: M/d vs T_{sp} , component nC_5

The ratio is quite independent upon the separator conditions (until pentane) (Figures (3.9,

3.10, 3.11, 3.12), and the averages correspond to the theoretical values (Table 3.4). Hence, the average ratios $\frac{M_i}{d_i}$ are selected as input in Pipe-It (*cf.* .stm macro in the Appendix). These values were preferred to the theoretical, as they have a “practical” background: they come from real data of the Eagle Ford field.

Table 3.4: Standard Deviation per Component

Component	Average Ratio	Standard Deviation in the Average Calculations	Theoretical Ratio	Ratio %-Deviation
C_2	1.348	0.000	1.072	25.8
C_3	1.388	0.001	1.393	0.3
iC_4	1.647	0.011	1.660	0.8
nC_4	1.585	0.016	1.595	0.6
iC_5	1.797	0.299	1.844	2.5
nC_5	1.833	0.051	1.836	0.1

Concerning the hexane-plus fraction, the estimation of the properties is more uncertain. It was decided to use the measured data from the separator gas, and take the average as ratio $\frac{M_i}{d_i}$. The advantage is that the actual separator conditions (varying) are taken into account for this calculation.

From the GPM values, together with 3.1 and the estimated $\frac{M_i}{d_i}$ ratios, the separator-gas composition of C_2 to C_{6+} can be calculated for each well test:

$$y_{i,fromGPM} = \frac{GPM_i}{19.73 \frac{M_i}{d_i}} \quad (3.2)$$

The C_1 fraction is calculated using the total dry gas gross heating value (labelled “BTU” in the well test); knowing that the non-HC are not involved in the total BTU calculation. Indeed, the total BTU is a weighted average of each SCN-BTU with their gas molar fraction (Kay’s mixing rule, (6.18) in Whitson and Brulé (2000)):

$$y_{C_1,fromGPM} = \frac{BTU_{total} - \sum_{i=2}^{6+} y_{i,fromGPM} \cdot BTU_i}{BTU_{C_1}} \quad (3.3)$$

Gas Molar Fraction of Non-hydrocarbon Components Up to now, the fraction of C_1, C_2, \dots, C_{6+} has been determined. There is no hydrogen sulphide in the fluid, hence its fraction is 0. What

remain are the N_2 and CO_2 fractions.

The relative molar fraction of N_2 and CO_2 were studied from all the available PVT reports in the Eagle Ford area; with an average calculated (Figure 3.13).

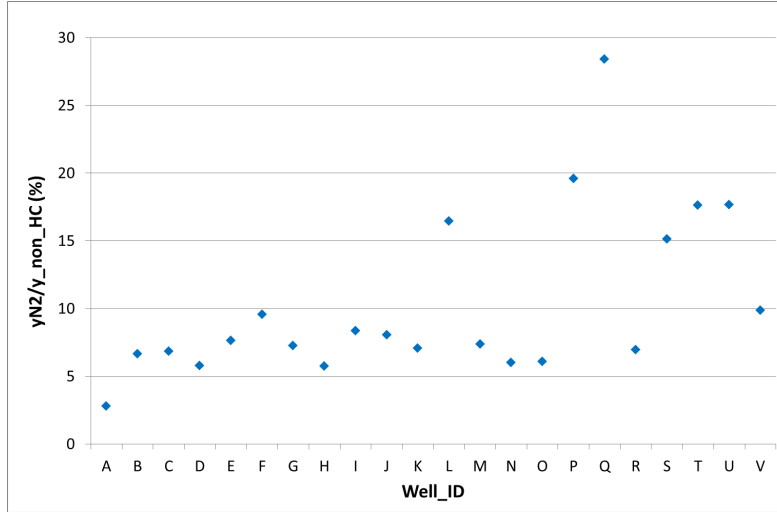

Figure 3.13: N_2 fraction among the non-HC fraction

It appears that this fraction is almost constant, once the outliers are removed. It is legitimate calculating the average value, and using it in order to determine the gas molar fractions of both N_2 and CO_2 :

$$y_{N_2,fromGPM} = (1 - y_{HC,fromGPM}) \frac{y_{N_2}}{y_{non-HC}} \quad (3.4)$$

Then the CO_2 fraction is obtained from the constrain $\sum_{i=1}^{C_6+} y_{i,fromGPM} = 1$

At this point, the separator gas composition is estimated, up to C_{6+} .

Estimating the Wellstream Composition

Whitson and Sunjerga suggest a method (Whitson and Sunjerga (2012)) to guess the initial wellstream composition, from limited production data (the macro is given in the Appendix). The separator-gas composition up to C_{6+} , the producing OGR_{sp} , and the API density are used to estimate the wellstream composition up to C_{7+} . This method links the gas stream, from which the GPM numbers are measured, to the wellstream that was flashed to obtain this gas stream:

The gas fraction in the wellstream can be estimated from the producing OGR:

$$f_{g,estimate} = \frac{1}{1 + \frac{133,000\gamma_{oil}}{M_{oil}} OGR} \quad (3.5)$$

The oil molecular weight uses Cragoe correlation:

$$M_{oil} = \frac{6084}{\gamma_{API} - 5.9} \quad (3.6)$$

From $f_{g,estimate}$ and the gas estimates obtained by 3.2, the wellstream estimate (for components lighter than C_4) is obtained:

$$z_{i,wellstream} = f_{g,estimate} \cdot y_{i,fromGPM} \quad (3.7)$$

This estimation lumps the heaviest components into C_{7+} :

$$z_{C_{7+},wellstream} = 1 - f_{g,estimate} \quad (3.8)$$

For components iC_5 , nC_5 , C_6 the fraction is assumed identical, constrained by:

$$\sum_{i=1}^{7+} z_{i,wellstream} = 1 \quad (3.9)$$

Remark: This algorithm uses the API value and the separator-gas molar composition; hence it requires that both the gas analysis and the condensate analysis are available for a given well, and a given time.

From C_{7+} to C_{26+} : the Gamma Distribution Model

The guessed wellstream cannot be used as seed feed, mainly because its characterization is only up to C_{7+} . In fact, the EOS used in the processing uses a more detailed characterization of the fluid (up to C_{26+} with the EOS PERA2013). The gamma distribution model can be used to extend the current description to a more detailed description.

For any HC mixture, the distribution of heavy components (from hexane / heptane) has a

similar behaviour that can be modelled by the gamma probability density function (Whitson and Brulé (2000) section 5.3.2). Three parameters define this model (Whitson (1983)): the shape of the curve α , the bound η (minimum molecular weight found), and the average β . α can be fit to the measured data. From its definition, η can be estimated accurately. The parameters α and η were determined in a previous study, from the same set of samples representative of the Eagle Ford field than used to develop the EOS PERA2013. They are input as fixed values in the algorithm.

The shape is lower than 1, which means that the distribution is accelerated exponential (typical of a gas reservoir): the heavier the component, the smaller its molar fraction (Whitson). This can actually be verified once PhazeComp has iterated: for two given SCN components, the fraction is smaller for the heavier component.

The gamma distribution is defined internally in PhazeComp, with the keyword “GAMMA” (PhazeComp files are available on request). The input (C_{7+}) and output starting components (C_7) for Gamma conversions are set up, together with the parameters of the distribution, alpha and eta. During the iterations, the average molecular weight (called “GAVG”) is changed, until convergence is achieved. Therefore, the output composition (after running PhazeComp) has a different characterization than the input wellstream estimate.

All in all, the gamma parameters that can describe this field accurately have first been determined, from an initial set of measured distributions. This gamma distribution is then used, to split up a heptane-plus distribution in the PhazeComp iterations. From it, a detailed seed feed distribution can be found.

Estimating the Seed Feed

The PVT software PhazeComp is used for calculations, based on the input data discussed above, to output a consistent seed feed up to C_{26+} . It is shortly presented in the Appendix.

The estimated wellstream composition (up to C_{7+}) is input, together with the parameters to match: OGR_{sp} , API and separator-gas composition up to C_{6+} . Using the gamma distribution model described above and a well-defined procedure, PhazeComp will iterate, trying to converge to a consistent and up-to- C_{26+} wellstream composition that would match with all the variables. Examples of such PhazeComp input and output files for one set of Well ID, DATE are

provided in the Appendix.

The variables are the average molecular weight (for the gamma function), the gas fraction, and the wellstream composition up to C_{7+} . Three experiments are input in PhazeComp; the matches are done in this way:

1. the stream (variable) is flashed at the production separator conditions, with the gas and oil volumes calculated. Changing the gas molar fraction f_g , the OGR_{sp} is matched. The resulting stream (*i.e.* a new mix) is flashed at two different conditions (given in the datafiles).
2. a flash at the “gas analysis” separator conditions, followed by a lumping up to C_{6+} , to match the separator gas compositions (obtained from the GPM measurements). When trying to match the hexane-plus fraction, the algorithm does not converge. Consequently, this variable is not requested to match. Indeed, since the Søreide factor has been fixed, the algorithm has less degrees of freedom, and is not able to match the C_{6+} fraction as well. Therefore, the C_{6+} values are uncertain, but this is not a tremendous issue, as the fractions of all the other components are to be matched. Generally speaking, the heavier-plus composition and properties are uncertain: the molar amount is calculated from a mass measurement, together with an estimation of the heavy-components molecular weight, which is not accurate (Whitson and Brulé (2000), chapter 5). For these two reasons above, it is acceptable that the C_{6+} fraction does not match.
3. a flash at the “condensate analysis” separator conditions, to match the API value.

In this PhazeComp procedure, the wellstream gas composition (up to C_{26+}), the average molecular weight, and the gas molar fractions are changed, until the matching are fulfilled. The iterations are consistent, obeying to PhazeComp PVT calculations background.

The two other parameters of the gamma function (the shape and the bound) have been determined with a theoretical background (from reports from the same area).

The convergence is very quick (less than four seconds per stream), and the calculated Root Mean Square (RMS) is very small (from 10^{-11} to 10^{-6} for most of the convergences). Therefore, the convergence can be considered as satisfying in most of the cases (4 for a discussion). Indeed, this method estimates a reservoir composition that matches the OGR_{sp} measurement (like the

first approach), but also the API measurement and the separator-gas composition, with a great accuracy.

The two main issues faced with the previous seed feed estimation are solved:

- The GPM values are given per well, therefore no allocation is needed (*i.e.* assigning the same seed feed for different wells).
- For a given well, the GPM values are given per date, hence they change with time, together with the other measurements.

The degree of non-uniqueness of this wellstream has been considerably reduced, compared to the first estimation of the seed feed, that was matching the OGR_{sp} only. By construction, the seed feed will match the data considered (API, OGR_{sp} , separator-gas fractions). From now on, the discussion about the project deals with this method only. Estimating the seed feed from a limited PVT analysis (the PVT reports) was excluded for the sake of consistency.

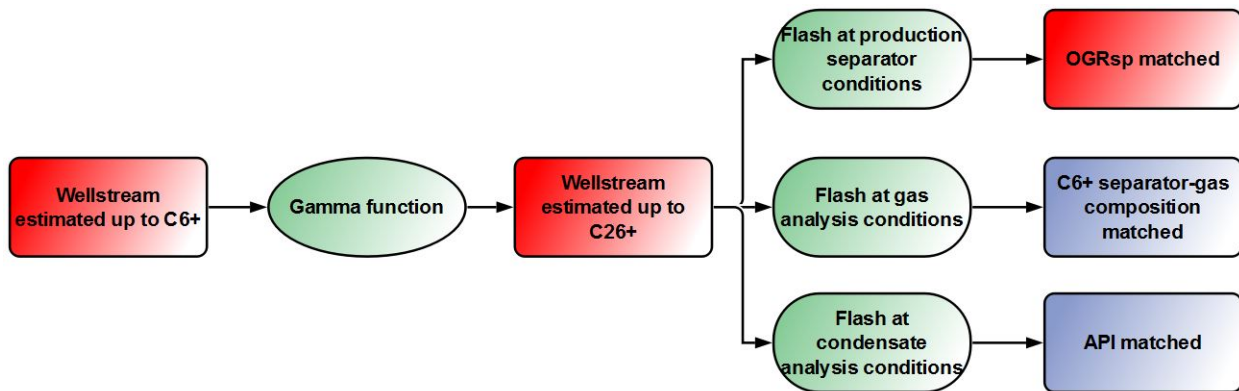

Figure 3.14: Summary of the Seed Feed Generation using PhazeComp

The red boxes in Figure 3.14 show the regressions: GAVG (the average molar fraction for the gamma split), f_g (the vapour molar fraction for the OGR_{sp} matching), and the wellstream composition up to C_{26+} are regressed until convergence.

Uncertainties

The rate of each component is unknown (around 30 variables), while very few data can be matched (few measurements have been reported and are used: API, GOR_{sp} , GPM numbers). Besides, the complexity of the flash and the EOS calculations make it very hard to define a proper

system of equations to solve. Therefore, one cannot expect too much from the solution: it hardly seems possible to match all the measured data from such limited information on the seed feed.

The reservoir fluid, after processing, matches the separator gas composition, the API and the GOR_{sp} . Therefore, this recalculated wellstream can be considered as a good estimation of the real reservoir composition. Nevertheless, using the GPM numbers to estimate the seed feeds fixes some of the uncertainties due to the initial estimation. But still, this method is not entirely satisfying, as major uncertainties remain (mostly the estimation of the wellstream composition from the GPM values using both 3.1 and Whitson and Sunjerga (2012), and the gamma split).

Limitation: Different Frequencies of Gas Analysis and Condensate Analysis

As stated above, the well tests are provided in two different parts: the gas analysis (reporting the GPM and BTU at specified separator conditions) and the condensate analysis (reporting the API, SE, GOR_{cond} at specified separator conditions), for a given well at a given date. The main issue with these data is that there is little consistency between these two analyses. In fact, gas and condensate analysis have seldom be ran on the same day (less than 20% of the time, for the well tests provided), which means that few streams have gas and condensate analysis together. Nevertheless, the seed feed estimation requires both API (from condensate analysis) and GPM values (from gas analysis) values. Therefore, for each calculation, both gas analysis data and condensate analysis data are required.

Two methods can be applied to fulfil this request. 370 streams are initially available for the selected wells (both Area B and Area A), among which only 63 have both gas and condensate analysis reported.

Limited Data The first method is to remove any input, without either gas analysis or condensate analysis. Therefore, only consistent data will be used, from actual measurements. But very few wellstreams are available per well (between zero and five), throughout the five years considered. Hence, this method is not satisfying. Besides it causes the loss of data (ex: when the condensate analysis is not provided, the gas analysis is removed and not even considered): only 63 streams are kept, out of the 370 initial streams.

Extended Data The second method is to keep all the inputs, to avoid any loss of information. If the gas analysis is lacking for a given well, the gas analysis from the previous (or the next, in case the very first date is lacking these data) date will be used. If the condensate analysis is lacking, the one from the previous or the next date will be used.

To sum up, the 370 streams are kept, and filled with non-measured data. These filling data are either assumed constant, or interpolated (see the Gawk code in appendix). In the next chapter, it is discussed which case to keep. The conclusion is that the model with limited datasets (63 streams) and interpolation to feed the continuous database is the most accurate.

3.3.3 Using Measured Separator Sample Compositions and Properties: Recommendation for further work

During the laboratory analysis of the samples, the reservoir fluid composition is estimated for each well, and for each time step (information provided by the laboratory company). This seems to be the best estimation of the seed feed, and would not need the assumptions made above. Indeed, using the "raw" laboratory data is more accurate than using GPM numbers and APIs, which are processed or calculated by the laboratory company. Then, if the actual reservoir composition can be provided (including the measurements uncertainties), it will most likely match the measurements, and be a very accurate estimate. For better accuracy, this composition could be input in the PhazeComp process described above; to add some corrections and diminish the uncertainties.

Using them as a seed feed would definitely be the most reliable seed feed estimation, among those discussed earlier: while the first method (seed feeds from PVT reports) matches the GOR_{sp} only, the second method (using PhazeComp and well tests) matches the GOR_{sp} , API and separator-gas composition. This third method is expected to match all the measurements, since it consists of the real reservoir composition, from which the measurements were recorded.

For time and means reasons, the second approach was kept for further work, assuming its estimation is reliable. It is a legitimate assumption, regarding the three parameter matched in this method (GOR_{sp} , API, separator-gas composition).

3.4 Preparing the Reprocessing

3.4.1 Corrected wellstream composition available

All the tasks described above are achieved to define a trustable wellstream composition up to C_{26+} that matches the measurements of OGR_{sp} , API and the separator-gas composition. This composition can be considered as accurate, and is fed in the WTC module, as “seed feed” (cf the WTC section) (Figure 3.15).

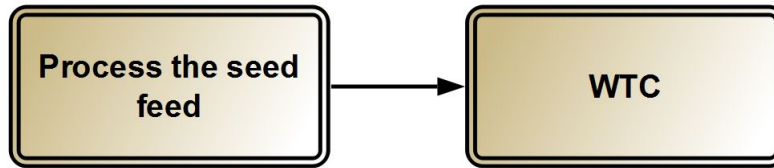

Figure 3.15: As-accurate-as-possible Seed Feed Library feeding the WTC Module

Together with the recorder separator pressure and temperature, the reported gas and oil rates, and the EOS PERA2013 (developed for the Eagle Ford field), the WTC is applied to correct the seed feed by matching the OGR_{sp} .

The OGR_{sp} was already matched during the PhazeComp iterations while defining this seed feed, with a great accuracy (RMS less than 10^{-6}). Therefore, the WTC module does not correct the composition significantly; but this step was set up for QC reasons. It suggests more physical consistency, even though the theory was already respected: for some streams, PhazeComp iterations converged to a 0-fraction for heavy components. But such a stream (without heavy components at all) is not physical. An additional flash and recombination according to the OGR_{sp} attributes non-0 fractions to these heavy Single Carbon Numbers, yielding more physical meaning to the stream:

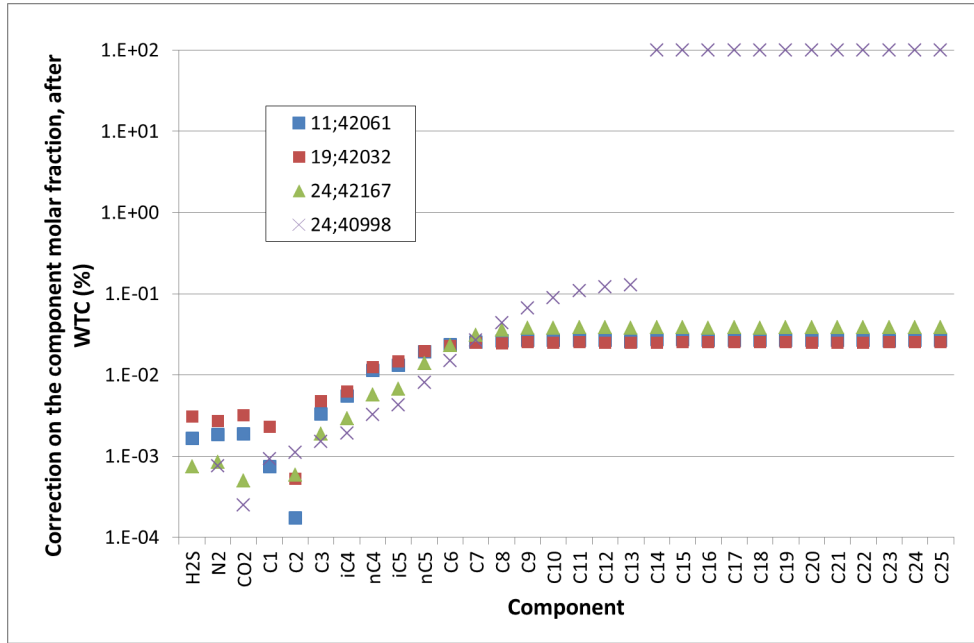

Figure 3.16: Physical Adjustment on the theoretically-generated Composition, for different (Well ID, date)

The streams (11;42061), (19;42032), (24;42167) have very small corrections (less than 0.1%), while the stream (24;40998) is adjusted significantly, from C₁₅ (Figure 3.16). This last case means that the heavy components are assigned non-0 fractions, which were initially 0 (discussed above).

To sum up, the WTC module enhances the physical consistency of the streams.

All in all, the corrected molar stream resulting of the WTC module is assumed as the actual reservoir composition of the sampled well, at the time of the sample. The procedure ends up with such a corrected stream for each well, and each time (the compiling Gawk procedure is provided in the Appendix).

3.4.2 Feeding the Production Database

First of all, an interpolation table (well + date) *vs* (compositional molar rates) is generated out of these wellstreams (see the Gawk procedure in the Appendix), as a conversion (.cnv) file (Figure 3.17).

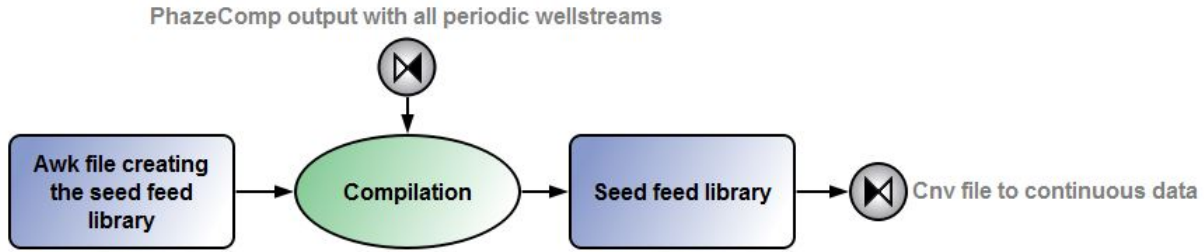

Figure 3.17: Generation of a Streams Library for the Continuous Database

Such table is used to assign a seed feed to each continuous measurement, from its well and date. For the dates not specified in the interpolation table, two options are available:

1. STREAMZ assumes that the same composition is produced, until next update.
2. STREAMZ interpolates the composition.

In case the composition of a well is requested at a date anterior to any date provided, the composition at the first date is given. This is achieved by assuming that the first estimated composition was the same very early in the life of the well, before any continuous measurement (the 1st of January, 2000 was selected, while no continuous data was reported before May 2010).

On Tables 3.18, the two procedures are shown, for a given well. The compositions of this interpolation table are either from complete well tests (both gas and condensate analysis available), or from incomplete sets (either gas analysis or condensate analysis lacking).

No interpolation			Interpolation		
Date	Well test sampled?	Composition of the continuous data	Date	Well test sampled?	Composition of the continuous data
1			1		
2			2		
3	yes		3	yes	
4			4		<i>interpolated from 3 and 6</i>
5			5		<i>interpolated from 3 and 6</i>
6	yes		6	yes	
7			7		<i>interpolated from 6 and 10</i>
8			8		<i>interpolated from 6 and 10</i>
9			9		<i>interpolated from 6 and 10</i>
10	yes		10	yes	

Figure 3.18: Continuous Stream generated using or not using Interpolation

The four cases (complete or incomplete well tests; with or without interpolation) are discussed in Chapter 4, to find out the optimum case.

It is clear in this method that the more well tests are available, the better the continuous stream will be estimated. The time evolution of the reservoir is taken into account: periodic well tests give periodic information about the production, and every new well test is an update of how the reservoir conditions have changed since the last test. Therefore, updating the continuous streams is a consistent way of assigning a reliable reservoir composition for each continuous measurement.

Once the seed feeds have been assigned to each and every continuous measurement, the WTC module is implemented in the continuous process, in order to obtain a continuous set of molar compositional rates for each well, varying with time. These streams are corrected according to the continuous measurements of GOR_{sp} , at the correct set of separator conditions. Further processing of these data is discussed in the following.

Remark: One of the biggest assets of the method implemented here is that from periodic well tests and GOR_{sp} only, it is possible to estimate the wellstream composition of a given well, at a given date. Assuming the GOR_{sp} are measured continuously, the continuous evolution of the composition can be generated. This enables the continuous study of API, SF and others, and a better understanding of the production, than if only periodic data were available.

3.5 Further Processing of the Corrected Compositions

3.5.1 Presentation

Periodic well tests and the WTC technology were used to estimate the compositional molar wellstream for each well, both continuously (production data) and periodically (well tests). These wellstreams match respectively the OGR_{sp} of the production data, and the API, and separator-gas composition measured in the well tests.

The same processing can be implemented on both sides (production data and well tests), in order to reflash the composition at different separator conditions, and to calculate different parameters at these conditions. Any process (even up to economical calculations) can be integrated, following the compositional infrastructure, to the sales. Besides, the back-allocation (5)

can be achieved from the continuous production data.

The only difference between the continuous and periodic data is that for periodic data, measurements are available (for comparisons and QC purposes), while they are not for the continuous data.

3.5.2 Quality Check of the Seed Feed Estimate

Using the measurements from the well tests, it is possible to check the accuracy of the wellstream, by reprocessing it at the correct set of separator conditions, and compute the measurements:

- the GOR_{sp} and OGR_{sp} can be calculated after flashing the wellstream at “production” separator conditions.
- the separator-gas composition can be calculated after flashing the wellstream at “gas-analysis” separator conditions, then lumping up to C_{6+} .
- the API can be calculated after flashing the wellstream at “condensate-analysis” separator conditions, then flashing the oil part at standard conditions.

Each of these three flash and calculations are achieved from the same wellstream (Figure 3.19).

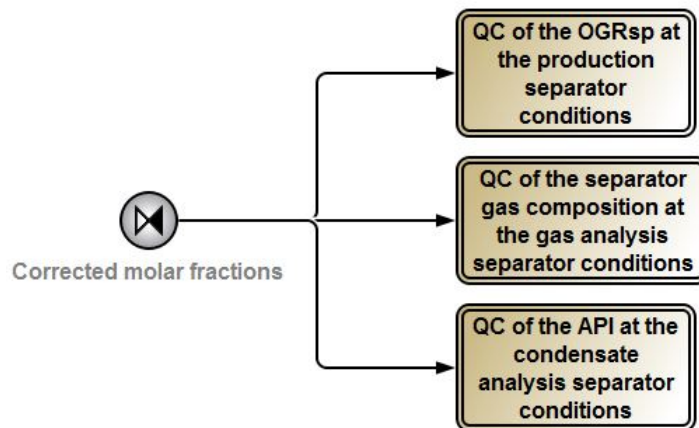

Figure 3.19: Template of the QC in Pipe-It

The methods are introduced here, and the general templates are shown. The results will be discussed in the next Chapter.

QC of the GOR_{sp}

The wellstream is flashed at the production separator conditions using the same EOS that was used for the seed feed generation (for consistency reasons). Both the gas molar rate and the oil molar rate are converted into volumetric rates (Figure 3.20).

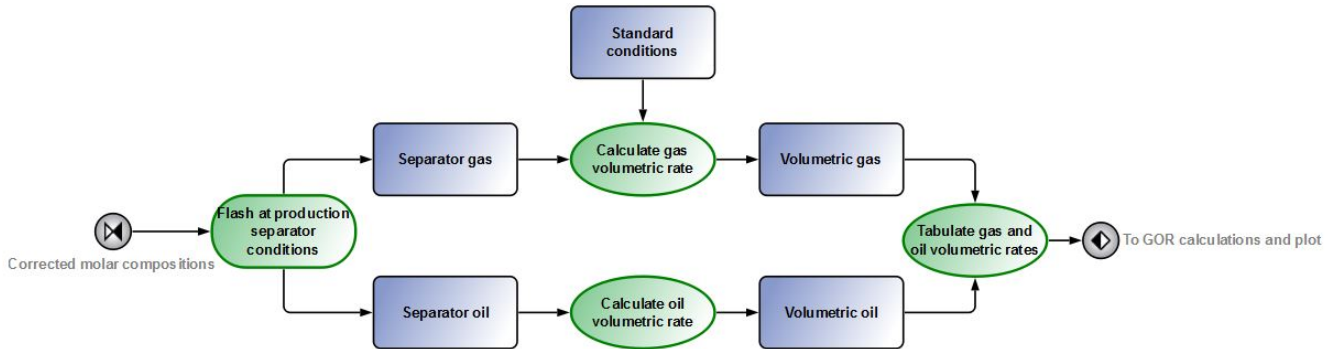

Figure 3.20: Calculation of the OGR_{sp}

The ratio $\frac{V_g}{V_o}$ can then be calculated, and compared to the reported value. Results are discussed in the next section.

Both the GOR_{sp} and the OGR_{sp} are processed. Indeed, while the Company reports gas-oil ratios, Whitson & Hoda suggest in [Hoda and Whitson \(2013\)](#) that the oil-gas ratio can also be used.

QC of the Separator-gas Composition

The estimated wellstream is flashed at the gas-analysis separator conditions, and the resulting gas is lumped, in order to change its description from the EOS description to a C_{6+} description. The conversion from the initial wellstream characterization to the C_{6+} characterization depends upon the EOS in use. The lumped wellstream can then be compared to the separator-gas composition that was calculated from the GPM values (*cf* section “Estimating the separator-gas composition” above) (Figure 3.21).

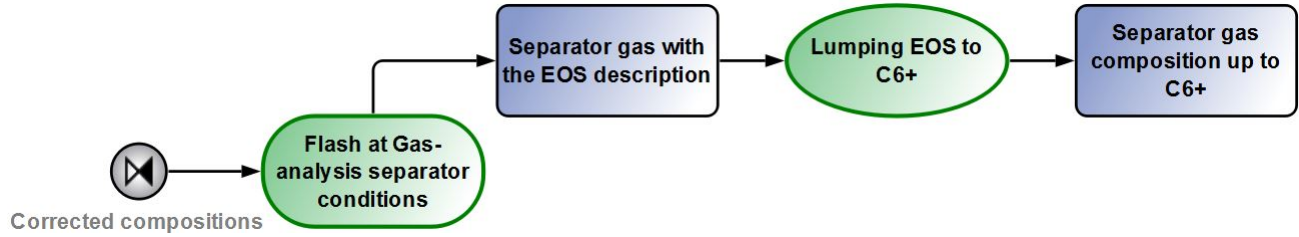

Figure 3.21: Calculation of the Separator Gas Composition

Consequently, the GPM values are used first to estimate the seed feed, and then to improve this first estimation, by a matching.

QC of the API

The wellstream is flashed at the reported condensate-analysis separator conditions, the resulting oil part is then flashed at standard conditions (60 F, 14.7 psia) (Figure 3.22).

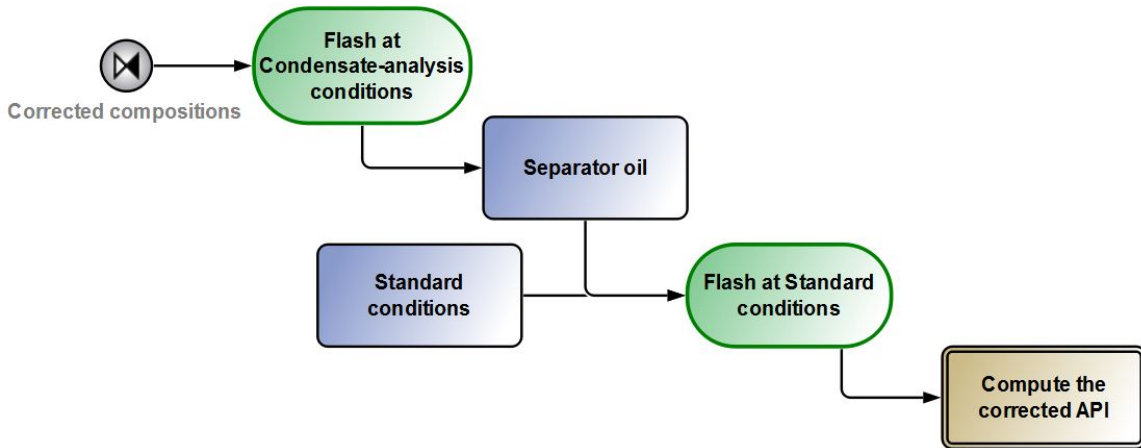

Figure 3.22: Calculation of the API density

A simultaneous conversion of these liquid molar rates (at standard conditions) into liquid and mass enables Pipe-It to calculate the density, hence the API gravity according to

$$\gamma_{API} = \frac{141.5}{\gamma_{oil}} - 131.5. \tag{3.10}$$

From both the oil flashed at standard conditions, and the oil flashed at condensate-analysis conditions, the shrinkage factor is also computed ($V_{o, std} / V_{o, sep}$), and compared to the reported

values. As stated above, the calculated SF values are not expected to match the reported SF:

- One of the reasons is that the way the SF is estimated by the laboratory company is not known (number of stages, release of gas); while the Pipe-It model uses a two-stage separation, as the processing conducted by the operator.
- Another reason is the slight difference between the estimated wellstream and the real wellstream.

The calculation of a two-stage GOR_{cond} is also implemented, even though the way it is reported by the laboratory company is uncertain. The data provider calls it a *Condensate Analysis Gas Oil Ratio*; therefore it was assumed as the *GOR* of the separator-oil, after flashing it at standard conditions. After these three QC, assuming the calculated values match with the measured values, the wellstream estimation can be considered as trustable, and it is legitimate using the molar wellstream for further processing.

3.5.3 Calculations at Common Separator Conditions

One of the requests of the Company is to be able to compare the measurements with each other. This means, flashing all the streams at a fix set of separator pressure and temperature, and then processing. With this method, the influence of the separator conditions will be removed, and the comparison will be consistent.

The compositional molar rates are input in a composite that defines the common conditions (Figure 3.23). Then, each stream is flashed at these conditions, using the same EOS than earlier in the processing:

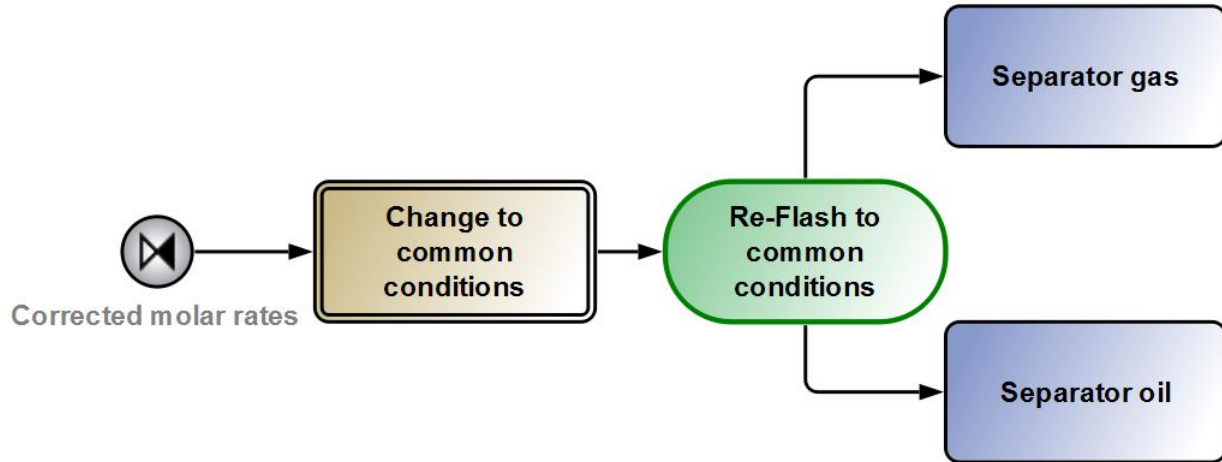

Figure 3.23: Changing the Separator Conditions to a Common Set

From this flash at fixed conditions, the gas and oil streams can be processed as above, in order to estimate the API (from the separator oil flashed at standard conditions) and the OGR_{sp} (from the separator gas and oil rates). These data are labelled as “corrected”, since the influence of the separator conditions was removed, and that they are all calculated in the exact same conditions (same EOS, same temperature, same pressure).

The same calculations are used for the continuous production data, but no correction is made (since no measurement was reported). Therefore, the API and separator-gas composition can be estimated from the wellstream composition, which was itself estimated from the OGR_{sp} measurements. Here is one of the major strengths of the method developed in this project.

3.5.4 Plots

The visual results are configured in PLOTZ, the plotting platform of Pipe-It (Figure 3.24).

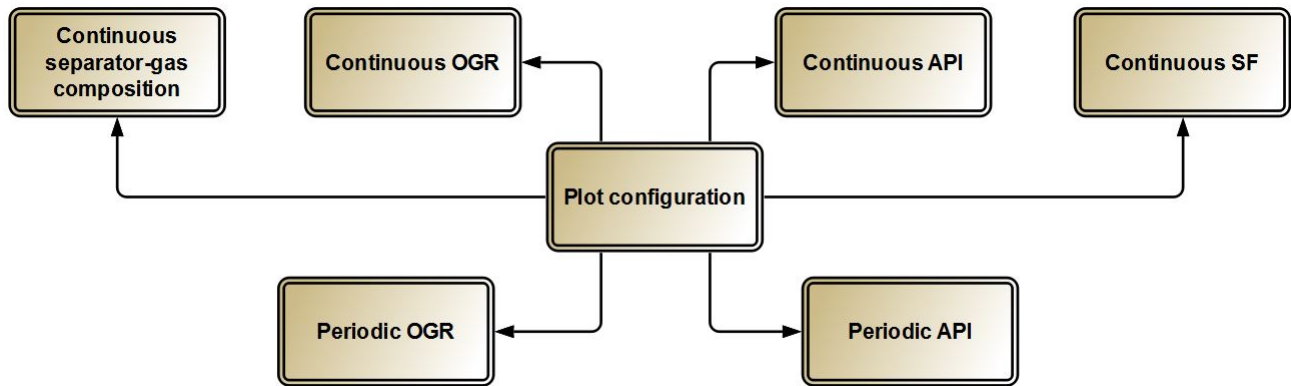

Figure 3.24: Template for the Plotting

Each run is associated with a given separator conditions, and the plots of each run are saved, for further discussions. The total time for one run (including PhazeComp iterations) is around twenty minutes.

3.6 Conclusion

Several attempts to estimate the wellstream composition are discussed in this section. The first approach is based on PVT reports (very limited amount of information), for a given time only. The composition of each well is constant throughout the production time, and is assumed identical for many wells. This approach was abandoned, for reliability reasons. A more-satisfying method is with an advanced use of the well tests and of the Well Test Conversion procedure. The WTC is used as a quality check; the actual corrections being done with PhazeComp iterations. Using PhazeComp reduces the non-uniqueness of the solution: the degree of uniqueness is reduced as more measurements are regressed to match. This match is physical: based on experiments and on the gamma-model.

The general Pipe-It template was presented; it has two main aims. Firstly, a periodic database can be generated, in order to estimate the wellstream composition of each well on a continuous basis (based on production data). Secondly, both the continuous and periodic streams can be reprocessed, at any separator conditions. The WTC is then applied to both the periodic data, and to the continuous data. Through these calculations, well tests measurements are simulated, at other conditions than those reported by the laboratory company.

Since no measurements of the API were made for the continuous production data, it is not possible to know whether the seed feeds match with measured data or not. That is why having trustable seed feeds is crucial for the continuous data.

Discussions on these calculations are made in the next chapter “Results” (4).

Chapter 4

Results

In this chapter, calculations are conducted on the incoming wellstream, to output several parameters representing the fluid. This wellstream is assumed as a reliable estimation of the real reservoir composition, and is input as compositional molar rates. It is first flashed at given separator pressure and temperature. Then the resulting gas and oil rates are used to calculate the API and OGR_{sp} , according to the procedure explained above.

The conclusions made in this section are based on API and OGR_{sp} interpretations. It could be interesting –and a complementary task- implementing other calculations (such as gas specific gravity, critical properties, dew point, bubble point) enhancing these first interpretations. Indeed, the more parameters are known, the better is the knowledge of the reservoir fluid.

4.1 First Method to Estimate the Wellstream

The wellstream was first estimated using PVT reports allocated to the wells of interest (see the chapter 3). For several reasons detailed in the previous section, this method was rejected. One of the reasons was the obvious lack of accuracy in the API-density calculations. From now on, the method used to generate seed feeds uses well tests and PhazeComp iterations.

4.2 Actual Estimation of the Wellstream

As stated, it is important that the most accurate seed feed library is built.

4.2.1 Discussion over the Incomplete Set of Data

The wellstream is assumed using PhazeComp convergences that are required to match the API, OGR_{sp} and separator-gas composition up to C_{6+} . Such a wellstream is considered reliable enough for further processing and calculations.

One of the inputs PhazeComp requires is the initial guess of the wellstream, which is estimated using both the gas analysis and the condensate analysis from the periodic well tests. Since gas- and condensate analysis are not always reported at the same time, two methods are discussed:

1. Use only the streams with both gas analysis and condensate analysis available (*complete* well test). 63 streams are generated using this method and the available data. This case is called “*case 63*” in the following.
2. Use all the streams, and assume that lacking data are equal to the previously-reported data (*incomplete* well test). 370 streams are generated using this method; this case is called “*case 370*” in the following.

It may seem better to extend the available data, by completing all well tests. More data is available, and no information is lost. All the analyses available (gas and condensate) are used to generate wellstreams, which sounds correct as a first approach. But when reprocessing the streams, it is clear that extending the data is not a trustable method, since it creates non-physical well tests, and requests non-physical compositions. These compositions can hardly be matched using PhazeComp, since PhazeComp uses a PVT background for the calculations (and not matching a stream, if this stream is non-physical).

After calculations, the wellstream is reprocessed for Quality checks. The average Root Mean Square (RMS) is more than a hundred times higher when using the incomplete well tests, than when using the complete well tests. The comparisons of calculated API *vs* reported API, and calculated separator-gas composition *vs* measured separator-gas composition also suggest to select the case 63.

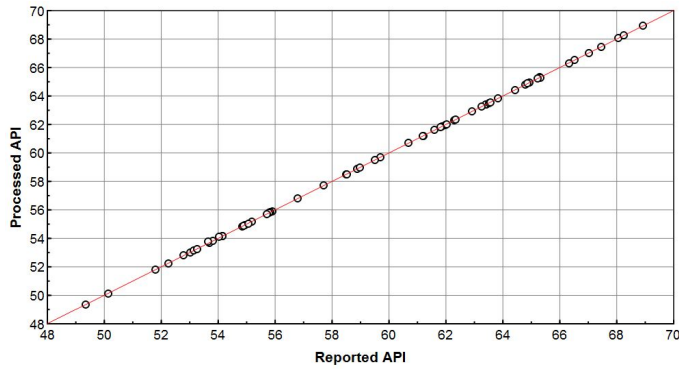

Figure 4.1: API Matching using *case 63*

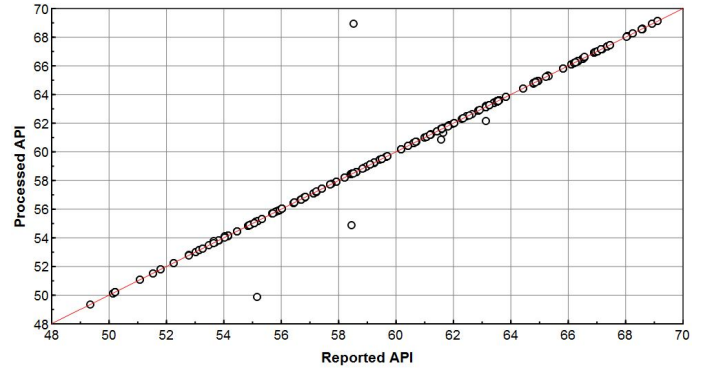

Figure 4.2: API Matching using *case 370*

The calculated API values accurately match the measured data for the case 63 (Figure 4.1); while some outliers can be seen on the case 370 (Figure 4.2). These non-matchings come from incomplete sets of data only, *i.e.* when either gas analysis or condensate analysis was lacking. The error in API estimation is up to 18%, which is not acceptable, because then the wellstream estimation cannot be considered as a correct estimation of the real reservoir composition.

The better-accuracy of case 63 is also noticeable on the separator-gas compositions. Figures 4.3 and 4.5 show the separator-gas molar composition, for the components iC_4 and nC_4 , for the case 63.

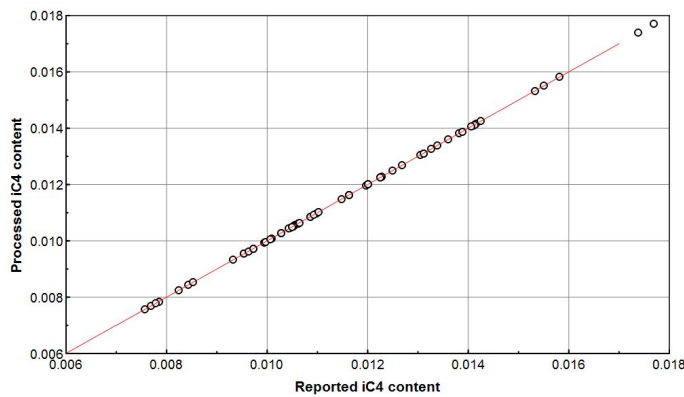

Figure 4.3: Sep-gas iC_4 matching using *case 63*

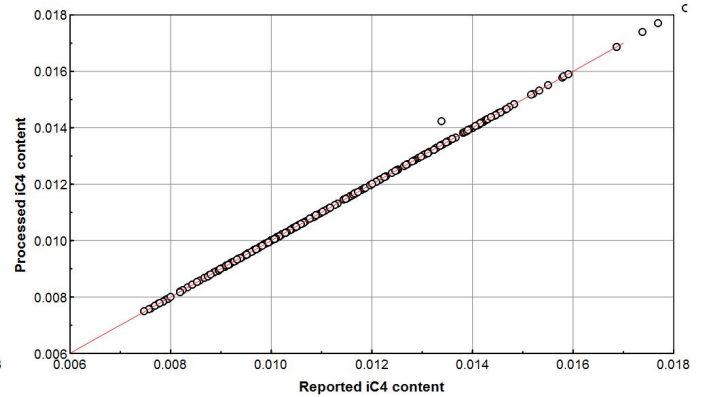
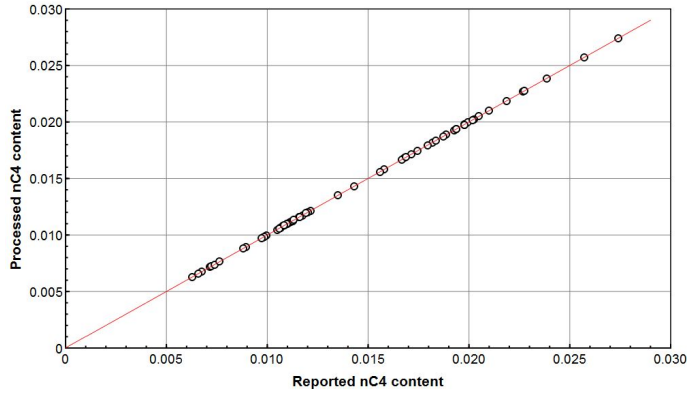
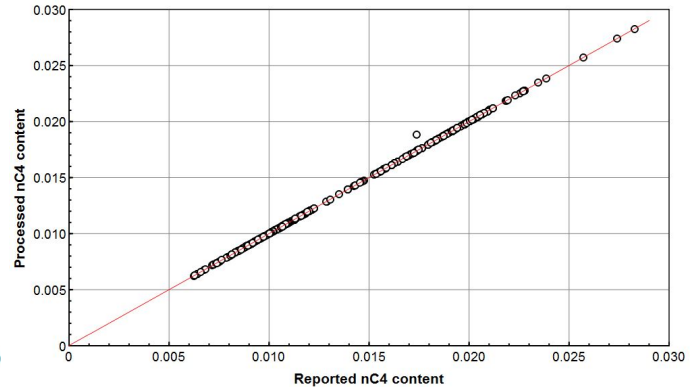

Figure 4.4: Sep-gas iC_4 matching using *case 370*

Figure 4.5: Sep-gas nC_4 matching using *case 63*Figure 4.6: Sep-gas nC_4 matching using *case 370*

All the dots perfectly match for the *case 63*, which shows that all the measurements can be matched with one real composition, physically acceptable.

The deviations are more significant for the *case 370* (Figures 4.4 and 4.6).

Some of the compositions are not matched. The most obvious example is for the Well ID 12, for the date 42072: there was no gas analysis available on day 42072, hence the values were taken from the previous gas analysis conducted on day 42051 (see the method described above).

When inputting these data in PhazeComp, the RMS is huge: 2886. This means that the convergence cannot be achieved, which is visible on Figures 4.4 and 4.6 (the only dot that does not follow the trend). The well test is theoretically acceptable (created from a gas analysis on day 42051 and a condensate analysis on day 42072), but nothing warrants that it is physically consistent (*i.e.* that one stream could fit both analyses on the same day).

For some of the incomplete streams, the convergence is not satisfying, as some variables hit their pre-defined boundaries. Even when enlarging the interval, the boundaries are still hit. This also reveals that mighty non-physical streams cannot be fit by the PhazeComp convergence procedure.

This study emphasizes the fact that simultaneous gas analysis and condensate analysis are required for correct wellstream estimations. Otherwise, the convergence may not be satisfying or reliable. This can be explained as follows: completing an incomplete well test forces PhazeComp to try to generate a composition that may not be physically possible.

In summary, the case 63 is selected for all the calculations below. It is based on physical samples only (with simultaneous gas analysis and condensate analysis), and does not generate

such non-convergences as the case 370 in PhazeComp.

4.2.2 Discussion over the Generation of the Continuous Composition

A table was generated from the periodic estimations of the wellstream. For a given well and a given date, a composition is suggested (with the same characterization as the EOS in use).

In between two dates for the same well, two methods were discussed above:

1. Keep the composition constant until next update;
2. Interpolate the composition using the previously-reported composition and the one reported later.

Contrary to the section above, it is not possible to base the selection (interpolation or no interpolation) on comparison with recorded data, since the method discussed here is used to generate continuous streams, for which properties have not been measured.

Non-interpolating assumes that a well is producing the exact same fluid until the next update (which might be months later), hence that the reservoir conditions stay identical for months. This assumption is, of course, wrong. The interpolation-based wellstream generation takes the real reservoir behaviour into account, by modelling a daily change of the producing fluid. It avoids such big gaps due to sudden updates, with much smoother (and most of the time more real) changes:

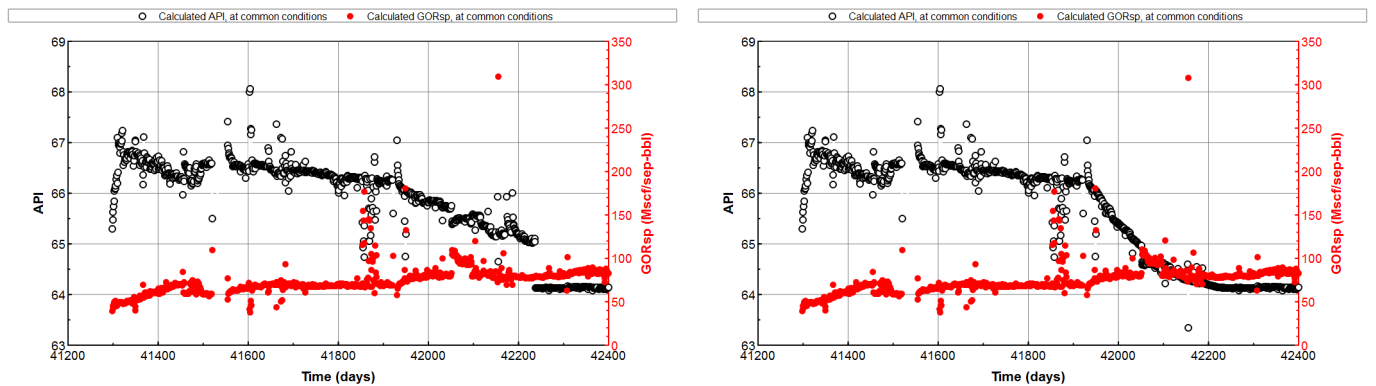

Figure 4.7: Continuous Calculations without Interpolation Figure 4.8: Continuous Calculations with Interpolation

In Figure 4.8 the gaps in API after day 42200 is avoided, by interpolation (well ID 30, p_{sp} 180.7 psia, T_{sp} 73.18 F). The decrease in API is smoother than without interpolation (Figure 4.7), indicating that the produced fluid becomes heavier with time. This makes more sense than a sudden increase of the density.

It is legitimate thinking that a wellstream interpolated from two real wellstreams will be physically consistent. Indeed, while constrained at each end by the two known wellstreams, the interpolation cannot go as wrong as a non-physical stream.

4.2.3 Summary of the Available Data

According to the advices above and with the available data, 63 streams in the periodic well tests database are used, to generate 24,074 streams in the continuous database. All the well tests compositions are calculated from PhazeComp convergences, with a satisfying reliability regarding the RMS (Figure 4.9). When the RMS value is high (greater than 10^{-6}), the error propagates in the reprocessing.

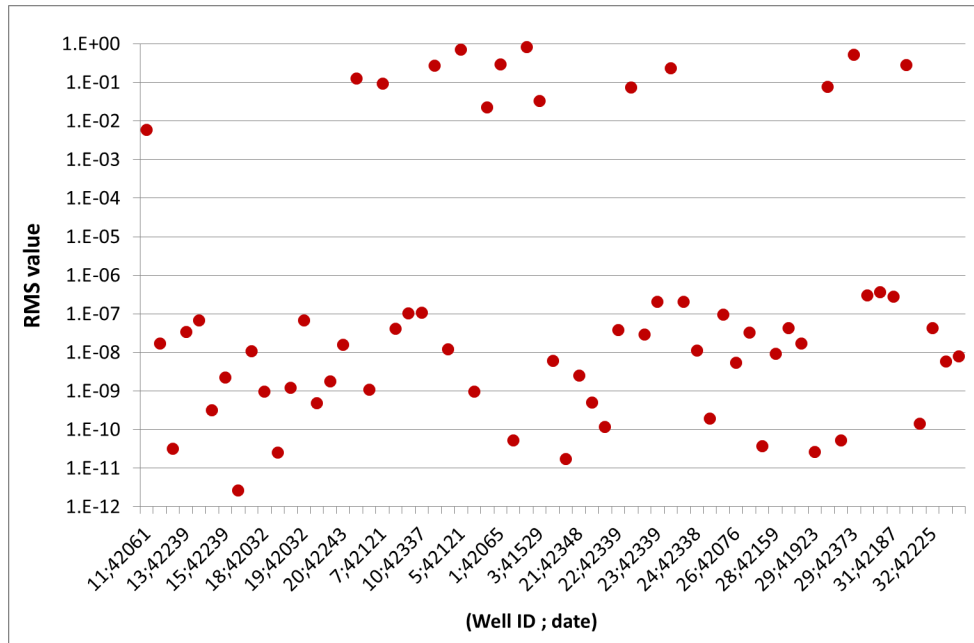

Figure 4.9: RMS Values for each Periodic Stream, after PhazeComp Convergence

4.2.4 Conclusions

Before any processing, the method to generate the wellstream (both in the periodic database and in the continuous database) had to be set up. It is suggested that the periodic wellstream is generated from a complete set of gas analysis and condensate analysis; and that the continuous wellstream is estimated by interpolating the periodic compositions.

The Pipe-It model developed is flexible, and the four options (the case 63 or the case 370, with or without interpolation) can be changed before each run.

4.3 EOS Selection for Reprocessing

Several Equations of State (EOS) were available for streams characterization, and for flash calculations. As stated above, the EOS is used both for the wellstream generation (PhazeComp iterations) and for any flash calculation (at production conditions, at condensate- or gas-analysis separator conditions, at common conditions). The EOS selected for the wellstream generation chosen is PERA2013, as stated in Chapter 2. It is available on request.

The chosen EOS has a direct impact on the calculations. It was sought which EOS to select, in order to have the most accurate results, *i.e.* which EOS outputs values closest to the reported ones (at the reported separator conditions), *i.e.* which EOS is the most representative of the wells at stake.

Since API or OGR_{sp} are matched during the iterations, a sensitivity analysis of EOS on these variables would be meaningless. The SF can be chosen for such study: a given stream is flashed at the exact same conditions for different EOS's. The one giving values closest to the reported ones will be selected as EOS for this Pipe-It model. It is discussed (see "Analysis with shrinkage factor") that the SF modelled in Pipe-It and the one provided by the laboratory company are probably not calculated in the same way. Nevertheless, comparing them to a common reference supports the selection of the EOS.

In this section, such sensitivity analysis is conducted. The same wellstream is processed (two-stage separation) in order to determine the SF value, with different EOS's used in the flash calculations (called PERA2013, PERA2015 and EOS19). All other parameters are kept constant:

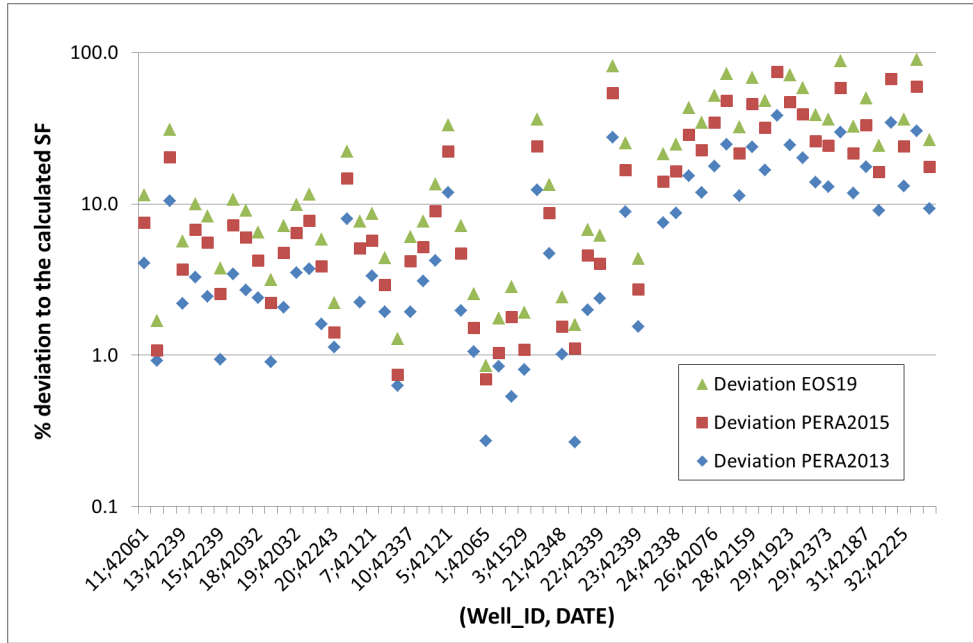

Figure 4.10: SF Calculations using different EOS

The deviation calculated-to-measured-SF has the same trend using the different EOS's (Figure 4.10). Though, it is clear on the plot that PERA2013 is the EOS proposing the best SF estimation. Therefore, PERA2013 was selected for the reprocessing (so was PERA2013 selected for PhazeComp iterations).

Regarding the difference between the EOS's estimations, the three could be used in this model, for the calculations. This means that they all depict the Eagle Ford area quite accurately. Defining and tuning an EOS according to all the available PVT reports in the Eagle Ford area could be interesting, and using this tuned EOS would certainly give more accurate results.

Remark: For the sake of consistency, the same EOS has to be used for the wellstream generations and for their reprocessing. A better EOS selection would integrate the wellstream generation. Then the wellstreams would be generated from different EOS, and flashed by these different EOS (while here the wellstream generation uses PERA2013 EOS).

From now on, the wellstream generation uses the EOS PERA2013, only complete sets of well test data, and the continuous streams generations with interpolation.

4.4 Processing at the reported conditions

The molar compositional wellstream is reprocessed at the reported separator conditions (varying for each stream). Since the exact same conditions as the time of the sampling are simulated, the calculated values are expected to match the reported values.

4.4.1 Quality Check on OGR_{sp} Calculations

In Figure 4.11 it is shown how the calculated OGR_{sp} perfectly matches the reported OGR_{sp} . The seed feed was initially created to fit the OGR_{sp} (in PhazeComp), then the WTC module in Pipe-It refreshes this wellstream, and recombines the gas and oil in order to match the OGR_{sp} . In summary, two consecutive corrections are applied to the stream to match the OGR_{sp} , that is why it is not surprising having a perfect overlap.

Since the OGR_{sp} are already matched in PhazeComp, the WTC module itself is not of significant correction. It is mostly used as a QC (see 3.4.1).

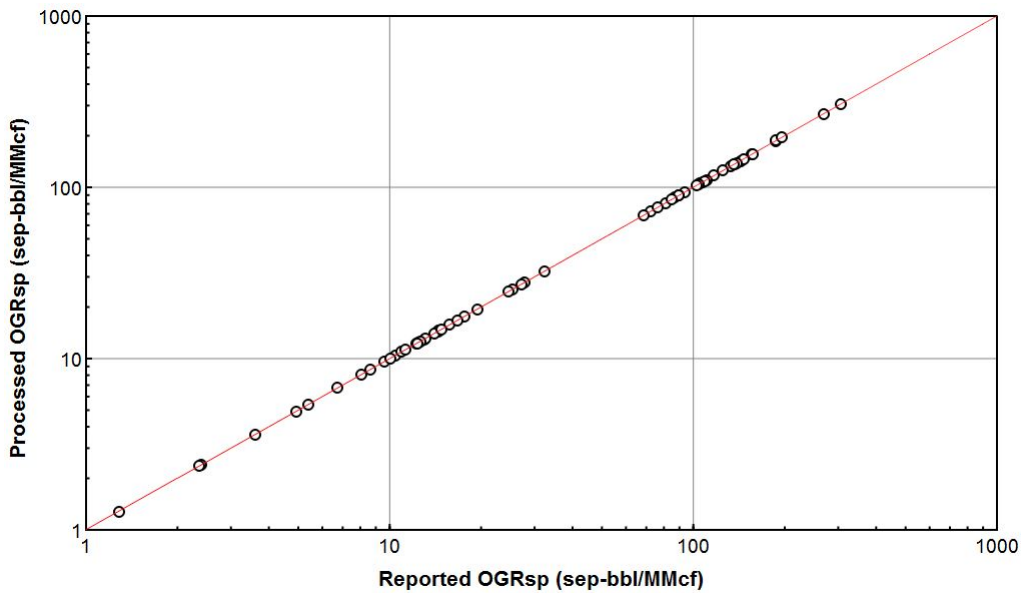

Figure 4.11: OGR_{sp} Matching

4.4.2 Quality Check on API Calculations

The API calculations are also satisfying, and match the measured data (Figure 4.12).

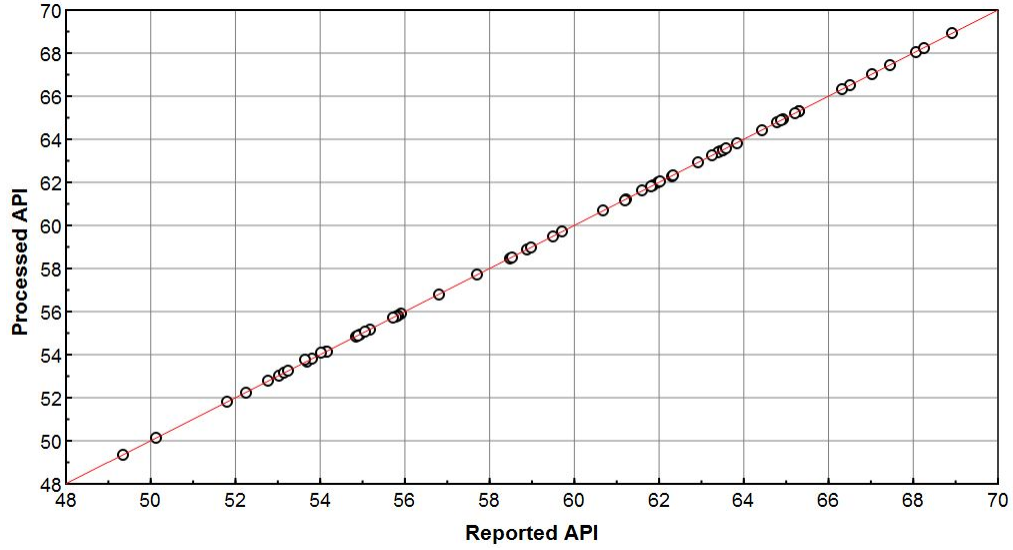

Figure 4.12: API Matching

4.4.3 Quality Check on Separator-gas Composition Calculations

The separator-gas composition, obtained from the GPM measurements, is also matched for components N_2 (Figure 4.13), CO_2 (Figure 4.14), C_2 (Figure 4.15), C_3 (Figure 4.16), iC_4 (Figure 4.17), nC_4 (Figure 4.18), iC_5 (Figure 4.19) and nC_5 (Figure 4.20):

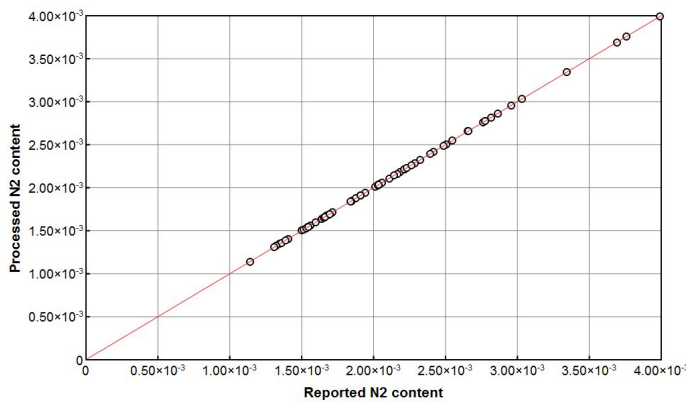

Figure 4.13: Sep-gas N_2 matching

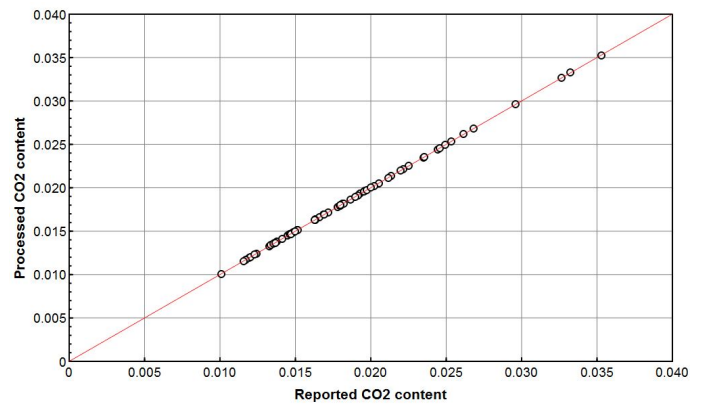

Figure 4.14: Sep-gas CO_2 matching

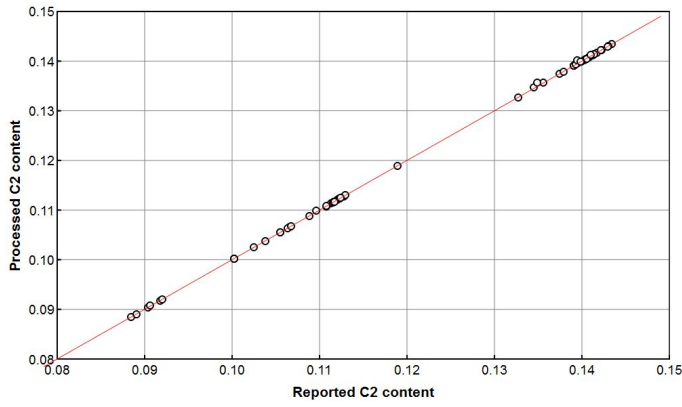

Figure 4.15: Sep-gas C₂ matching

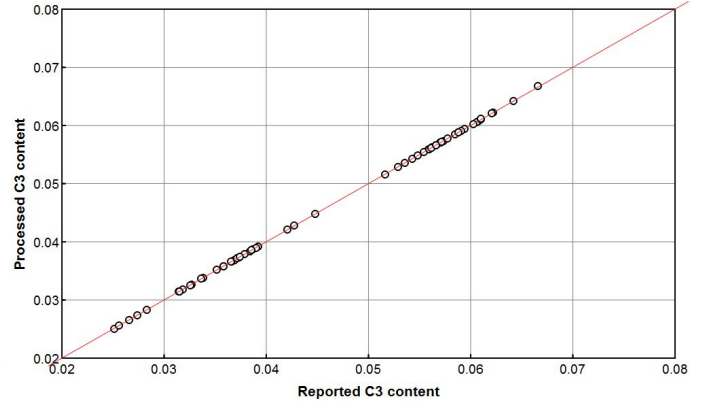

Figure 4.16: Sep-gas C₃ matching

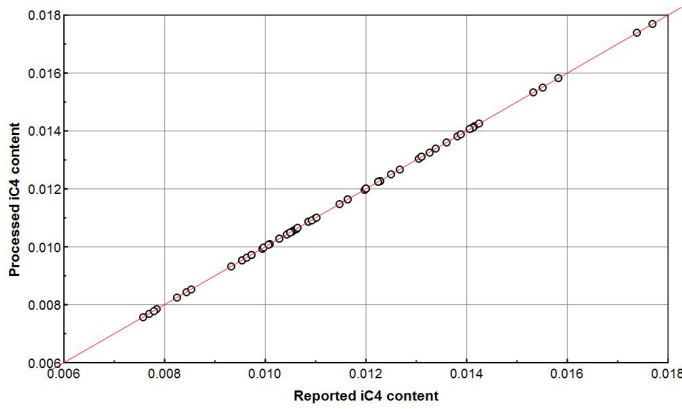

Figure 4.17: Sep-gas *i*C₄ matching

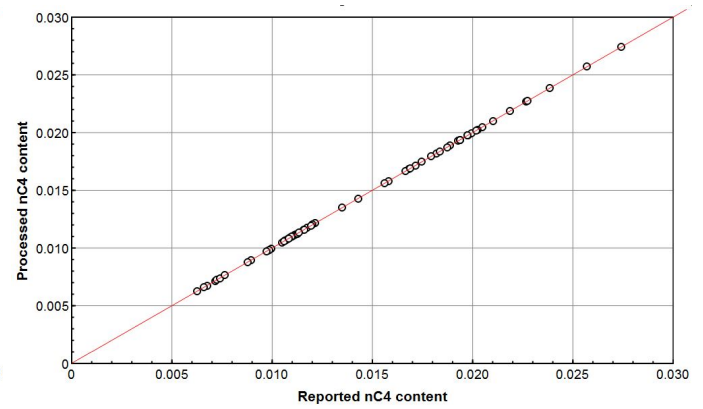

Figure 4.18: Sep-gas *n*C₄ matching

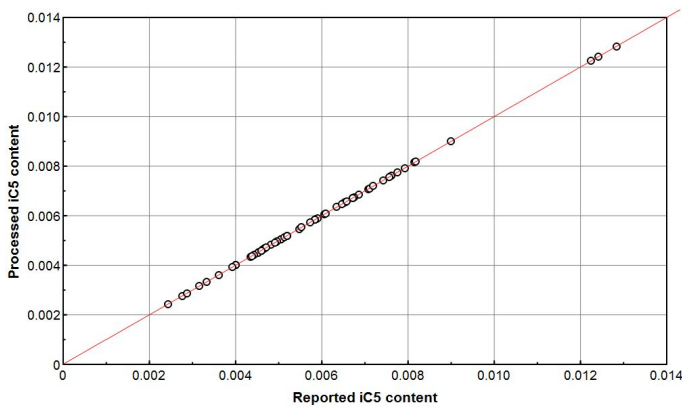

Figure 4.19: Sep-gas *i*C₅ matching

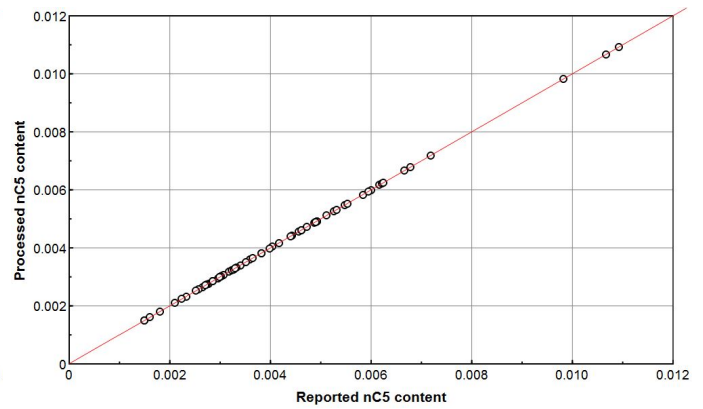

Figure 4.20: Sep-gas *n*C₅ matching

Nevertheless, for low C₁-content or for high C₆₊-content, the convergence is not fully achieved by the algorithm (Figures 4.21 and 4.22).

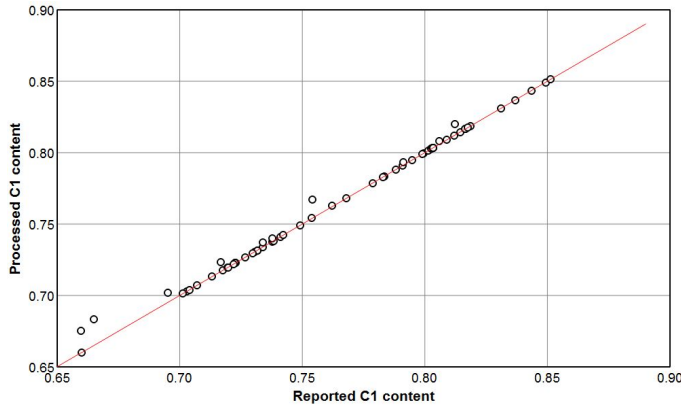

Figure 4.21: Sep-gas C_1 matching

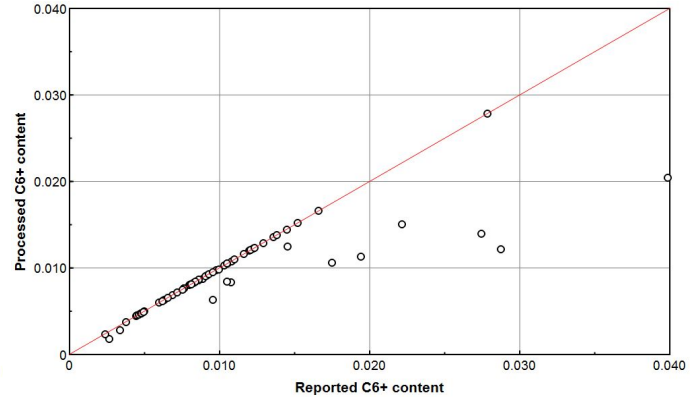

Figure 4.22: Sep-gas C_{6+} matching

It was sought whether the C_1 - and C_{6+} outliers come from the same streams, by plotting the deviation calculated-content to reported-content of the component, C_{6+} vs C_1 (Figure 4.23).

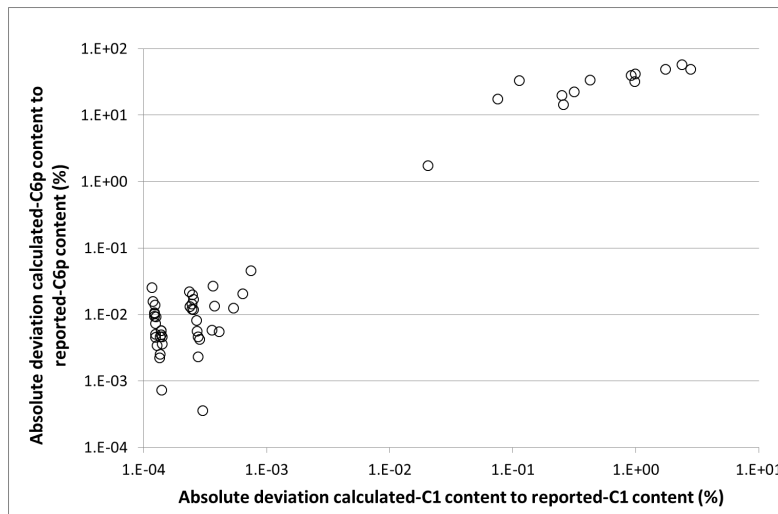

Figure 4.23: Separator Gas composition Matching

When the C_1 content matches, the C_{6+} content does as well (low values in Figure 4.23). When the C_1 content does not match, neither does the C_{6+} content (high deviation values in the plot). Therefore, **the same** streams converge in both C_1 - and C_{6+} -contents, and those that do not converge in C_1 -content do not converge in C_{6+} -content. These are the streams with a poor RMS in the PhazeComp iterations (RMS higher than 10^{-6}).

Remark: The deviation is much smaller for the C_1 -content, as this fraction is requested to match

in PhazeComp iterations. The Weighting Factor of the C_{6+} content being 0, it is not requested to match. Therefore, the C_{6+} content is imposed by the other components ($1 - \text{sum}(y_i)$). Since C_1 is tried to be matched, and since it already contains some deviations to the reported values, C_1 deviations are linked to those of the C_{6+} content.

With the method used for wellstream estimations, the convergence in PhazeComp cannot be fully satisfying. For some streams, it will result in outliers (processed value *vs* measured value) in both C_1 - and C_{6+} contents. The deviation in the C_{6+} calculations seems linked to that in the C_1 calculations, which gives information about PhazeComp iterations algorithm. Indeed, it shows how a variable not requested to match (C_{6+}) is iterated from a set of matching variables, among which only one does not match (C_1).

4.4.4 Analysis with Shrinkage Factor

The accuracy of the estimated wellstream (regarding the real reservoir composition) cannot be proven with the above, as the wellstream was generated in order to match the API, OGR_{sp} and separator gas composition. Matching the data while reprocessing at the reported conditions only illustrates that the method was *implemented correctly*, but does not give any information on whether the wellstream is accurate or not.

SF are barely matched while reconstituting streams, unless a very limited amount of data is available. The main reason is, the laboratory measurement of the SF is hardly known. In the current project, the SF values provided from the laboratory company were calculated. Since the method used to report data is not known (the EOS calculations for example), it would not be relevant trying to match the reported SF while using the EOS used in this project.

The calculated SF are plotted *vs* the reported SF, for all periodic well tests, in Figure 4.24. The SF are calculated using a two-stage separation (*cf* the section 3), while it is uncertain how the SF was reported by the laboratory company.

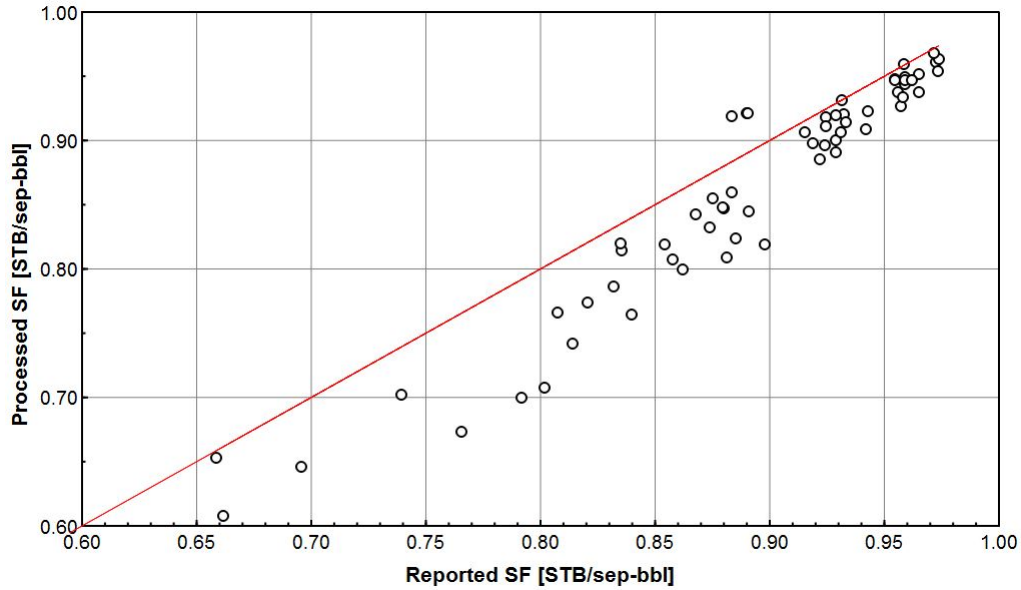

Figure 4.24: SF Matching for a two-stage Separation, from Separator Conditions to Standard Conditions

The values do not match; suggesting that at least one of the two values is not estimated correctly:

- The calculated SF might be wrong, because of a bad wellstream estimation.
- The reported SF might be influenced by varying separator conditions (Figure 4.25): if the separator pressure decreases, more gas comes out of the oil. Therefore, the oil volume after flashing to standard conditions is lower, so is the SF. If the separator temperature increases, more gas comes out of the oil and the SF increases.

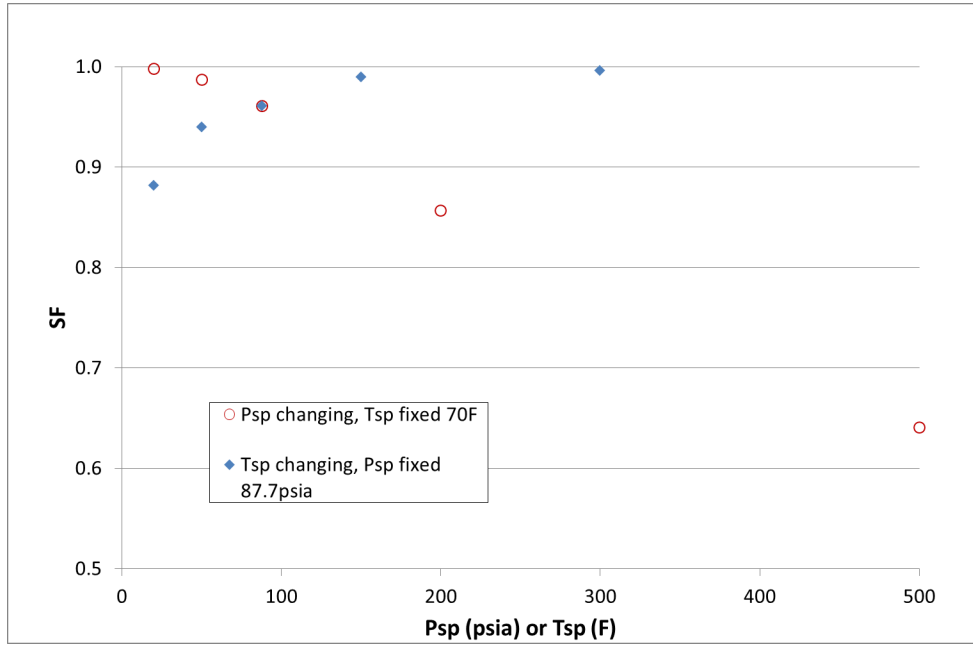

Figure 4.25: SF Variations with Separator Conditions. Stream from (Well ID 16, date 42072)

- The reported SF might be wrong, because of erroneous procedure. The laboratory company calculates the SF from samples. The method is uncertain (EOS used, number of stages among others), and can hardly be modelled in the Pipe-It project.

The average deviation is of 3.9%. Calculated SF tend to better match the reported SF for high values *i.e.* when the oil volume at separator conditions is similar to that at standard conditions, *i.e.* when little gas come out of the oil (when processing to standard conditions).

A low SF means that the volume of oil when flashed at standard conditions is significantly lower than its volume at separator conditions. This is due to gas that has come out of the oil during the flash to standard conditions. In other words, a low SF means that a great part of the oil is not stabilized. The more unstable the separator oil, the more gas is released when flashing from separator conditions to standard conditions. Since gas is much more sensitive to a cut in pressure and/or temperature than oil, unstable oil (*i.e.* with low SF) is more sensitive to the processing than stable oil (*i.e.* with high SF).

Consequently, the method to generate a wellstream is more accurate for high values of reported SF (the average deviation decreases to 1.8% only for SF values greater than 0.9). High SF indicates that the separator oil is close to being stable (only a bit of gas will be released when

bringing it to standard conditions).

In the following, the SF calculations use a two-stage separation. On the one hand, this is the true procedure used by the operator: the pressure is decreased from separator conditions to standard conditions at once. No gas is released during the depressurization; the fluid keeps the same composition until the calculation of the ratio. On the other hand, the SF calculations by the laboratory company are very uncertain:

- It might be a different processing, assuming successive pseudo-equilibriums and depressurization by bleeding off gas at each stage. Hence, the composition of the fluid might change, and would end up not representing the actual wellstream.
- The calculations are not known, hence they cannot be modelled in the separator-oil processing.

In a nutshell, a difference between the calculated SF (using a two-stage separation) and the reported SF is noticed. A plausible explanation is that the laboratory-reported SF is not really reliable. Indeed, while generating the wellstream, the API in the condensate analysis is matched. Therefore, one could expect that other properties of the condensate analysis such as SF would also match.

4.4.5 Analysis with Condensate Oil-Gas Ratio

The condensate-OGR is also very uncertain measurement. It is unclear, how the laboratory company measures or calculates it (two, three or more stages, whether the gas is released at standard pressures) and to which ratio it refers to. By analysing the values, it was assumed that the condensate-OGR is calculated the way described in the Chapter 3.

While being aware of its high uncertainty, a study on the condensate-OGR was conducted. A two-stage separation was assumed for OGR_{cond} calculations (Figure 4.26).

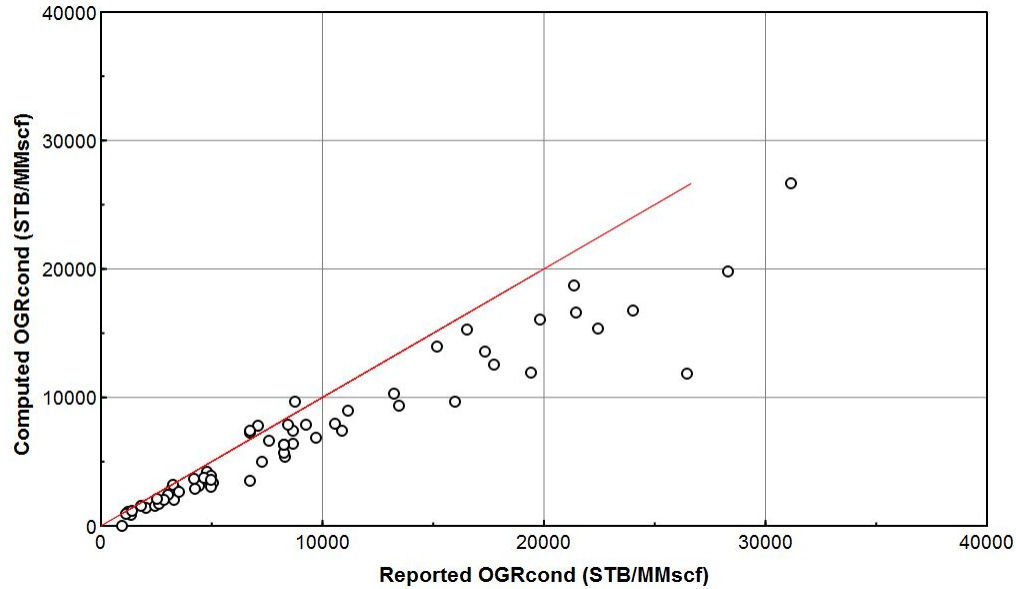

Figure 4.26: OGR_{cond} Matching for a two-stage Separation, from Separator Conditions to Standard Conditions

The values do not match, but the trend of the dots is similar to that of the SF: the measurements are greater than the calculated values. This suggests that the values may deviate for the same reason than the SF (a multi-stage structure).

For each well, and each date, the deviation in SF and the deviation in OGR_{cond} are represented (Figure 4.27).

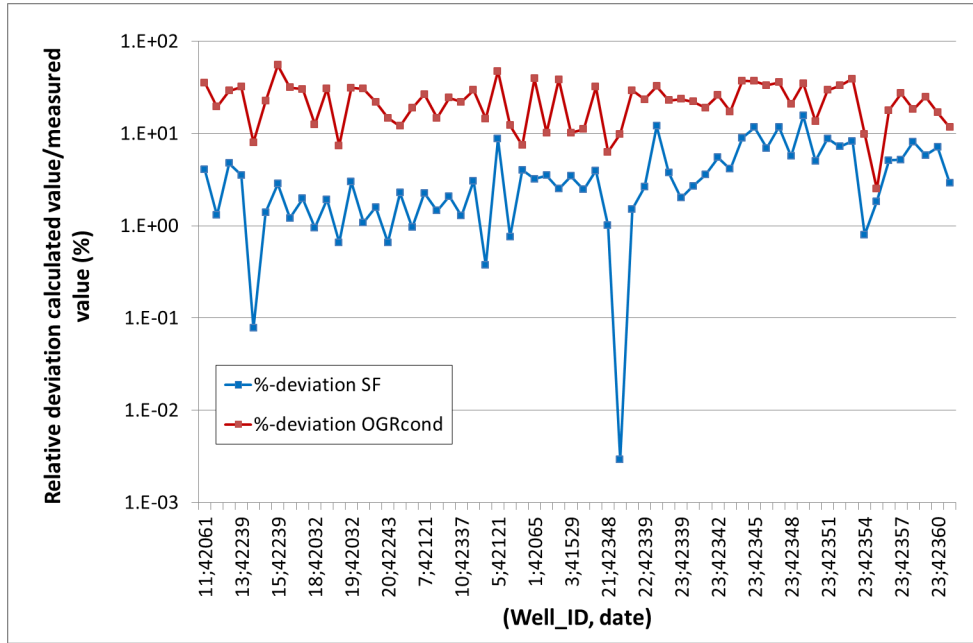

Figure 4.27: Errors in the Reprocessed SF and OGR_{cond}

Both deviations follow the same trend. Therefore, it is probable that OGR_{sp} were measured (or calculated) following the same procedure than the SF.

The deviation is more important concerning the OGR_{cond} than the SF:

- The SF is calculated after two consecutive flashes of the wellstream. It uses one volumetric calculation from the first flash (at separator conditions), and one volumetric calculation from the second flash (at standard conditions).
- The OGR_{cond} is calculated after the same two flashes, but both volumetric calculations used come from the second flash (at standard conditions).

The more flashes, the more uncertainties (due to the poor accuracy of the EOS, and to the uncertainty for the wellstream estimate). Since OGR_{cond} calculations are conducted after two flashes (*i.e.* two uses of the EOS), the deviation is greater than that of the SF.

4.4.6 Conclusion

The generated wellstream is built in order to match the API, OGR_{sp} and separator-gas composition. It does not iterate to match the SF or condensate-GOR values, and their deviations are

highlighted in this section.

It would not be consistent validating or not the reliability of the wellstream according to a SF or GOR_{cond} analysis, as the measurement itself is uncertain. The deviations in SF and GOR_{cond} are similar, suggesting that both are evaluated in the same way.

If available, very accurate SF measurements could be compared to calculated values, which would give information on the quality of the wellstream reconstitution. From the limited amount of data available, the wellstream can be considered reliable enough. Still, it is important noting that none of the calculated values truly represents the reservoir properties. The so-called “generated molar wellstream” is an accurate estimation of the real reservoir composition, but it is not the real reservoir composition. Evidences are that the SF values do not match when reflashing at the reported separator conditions.

4.5 Influence of the Separator Conditions

When testing a given well, the operator in the Eagle Ford field noticed some significant OGR_{sp} variations with time. The operator wants to know whether these variations are due to varying separator conditions, or if they depict actual changes in the reservoir.

In this section, the influence of the separator pressure and temperature on the OGR_{sp} is studied. The results do not apply to a single well; it is rather general theoretical concepts.

The wellstream is available as molar compositional rates. It is flashed at either fixed pressure and varying temperature, or fixed temperature and varying pressure, in order to see the effect of both parameters on the calculations.

The wellstream used for the sensitivity analyses is defined in Tables [4.1](#) and [4.2](#).

Table 4.1: Measurements of the Wellstream used

EOS	-	PERA2013
Well ID	-	16
Date ID	-	42072
$Q_{o_{sp}}$	bbl/d	42.01
$Q_{g_{sp}}$	Mscf/d	380.22
Measured API	°	54.85 at 87.7 psia and 70 F
Measured OGR	sep-bbl/MMscf	110.489 at 101.7 psia and 65.76 F

Table 4.2: Composition of the Wellstream used

Seed feed	Fractions	Seed feed	Fractions
H_2S	1.49169E-154	C_{12}	0.00222
N_2	0.00215	C_{13}	0.00190
CO_2	0.01910	C_{14}	0.00164
C_1	0.66597	C_{15}	0.00142
C_2	0.13049	C_{16}	0.00123
C_3	0.05813	C_{17}	0.00108
iC_4	0.01505	C_{18}	0.00094
nC_4	0.02306	C_{19}	0.00082
iC_5	0.01120	C_{20}	0.00072
nC_5	0.00963	C_{21}	0.00064
C_6	0.02743	C_{22}	0.00056
C_7	0.00533	C_{23}	0.00049
C_8	0.00505	C_{24}	0.00044
C_9	0.00381	C_{25}	0.00039
C_{10}	0.00312	C_{26+}	0.00335
C_{11}	0.00261		

OGR_{sp} and API are calculated from the incoming wellstream, as seen in Figure 4.28.

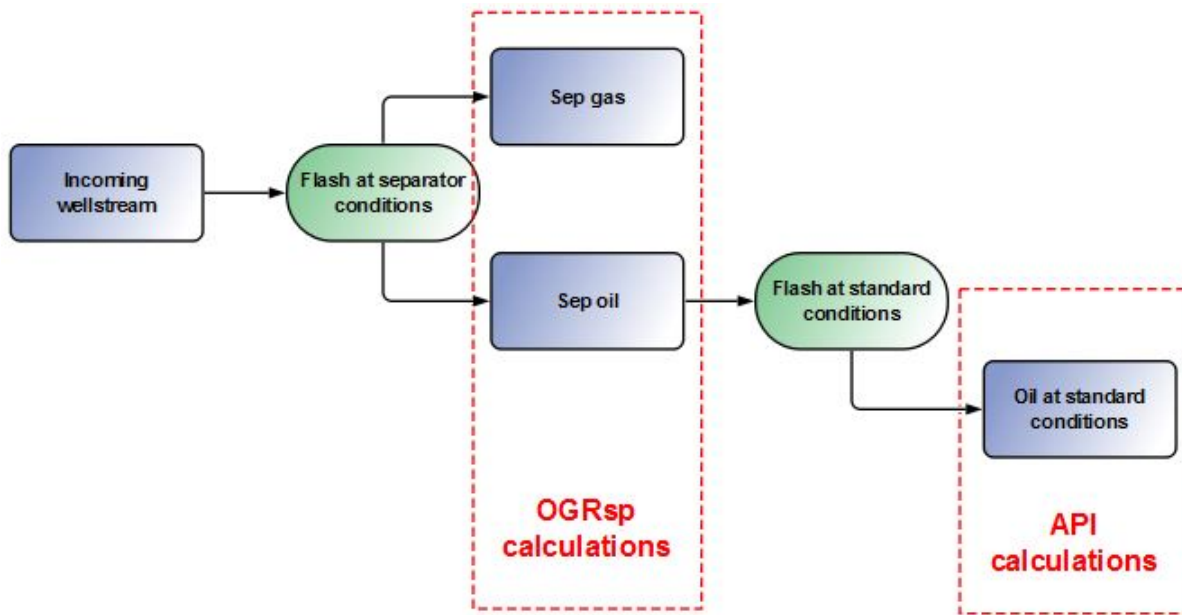

Figure 4.28: OGR_{sp} and API Calculations

Both the API and the OGR_{sp} are deeply affected by changes in the separator conditions.

4.5.1 Influence of the Separator Pressure

The sensitivity analysis is conducted both on the API and on the OGR_{sp} :

1. The API calculations are made at the fixed condensate-analysis recorded temperature, with varying pressures;
2. The OGR_{sp} calculations are made at the fixed production recorded temperature, with varying pressures.

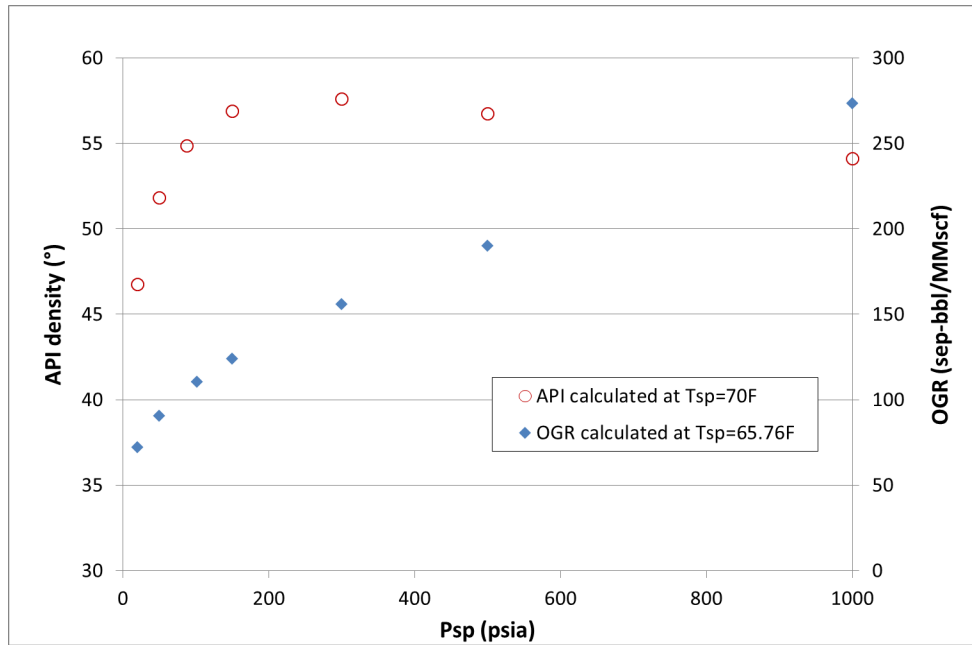

Figure 4.29: Influence of the Separator Pressure on OGR_{sp} and API. Stream from (Well ID16, date 42072)

If the separator pressure decreases, more gas is released out of the wellstream. Hence, the OGR_{sp} decreases. Besides, the remaining oil becomes heavier, therefore its API decreases as well (Figure 4.29). The changes in API and OGR_{sp} are quite significant, even for small changes of the separator pressure.

4.5.2 Influence of the Separator Temperature

The sensitivity analysis is conducted on both the API and the OGR_{sp} :

1. The API calculations are conducted at the fixed condensate-analysis recorded pressure, with varying temperatures;
2. The OGR_{sp} calculations are conducted at the fixed production recorded pressure, with varying temperatures.

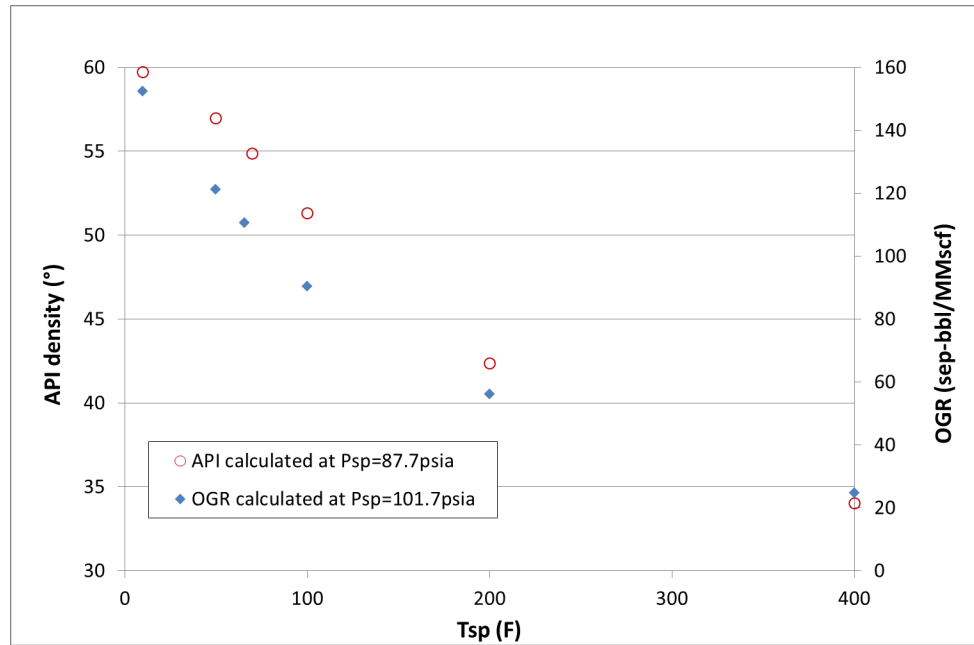

Figure 4.30: Influence of the Separator Temperature on OGR_{sp} and API. Stream from (Well ID16, date 42072)

When the separator temperature increases, more gas is released out of the fluid. Therefore, the OGR_{sp} decreases, so does the API (Figure 4.30). Once again, a small difference in separator temperature might induce an important change in API or in OGR_{sp} .

4.5.3 Conclusion

This study illustrates that, all other parameters fixed, a varying separator temperature and/or a varying separator pressure can lead to significant fluctuations in both the API and the OGR_{sp} measurements. The section 4.6.3 suggests a correlation of the OGR_{sp} or of the API density to the separator pressure and temperature, for a given wellstream. Before any interpretation, the measurements must be corrected to common separator conditions.

Apart from varying separator conditions, uncertainties can also come from the measurement tools and methods (especially if different laboratory companies conduct the well tests, as they have different procedures). For these two reasons, the company might notice API or OGR_{sp} variations that are not due to actual changes in the reservoir (and even if the exact same fluid is produced).

In the next section, all the molar wellstreams are flashed under the same conditions, so that these uncertainties are counteracted. The fluctuations that are obtained in the following are real variations of the parameters, due to reservoir or production changes, and can be discussed consistently.

4.6 Processing at Other Conditions

The periodic database is processed, and the API density and the OGR_{sp} are calculated, in order to obtain a consistent set of measurements (*i.e.* at the same set of separator conditions).

Continuous wellstreams are also generated from the periodic database. The continuous database is used to understand the behaviour of the reservoir and to discuss about the production.

4.6.1 Selection of the Common Separator Conditions

Figures 4.31 and 4.32 show the distribution of separator pressures and temperatures, including all wells, and all three measurements (production, gas-analysis, condensate-analysis). The obvious great variations of these conditions suggest that any measurement will be influenced by the separator conditions.

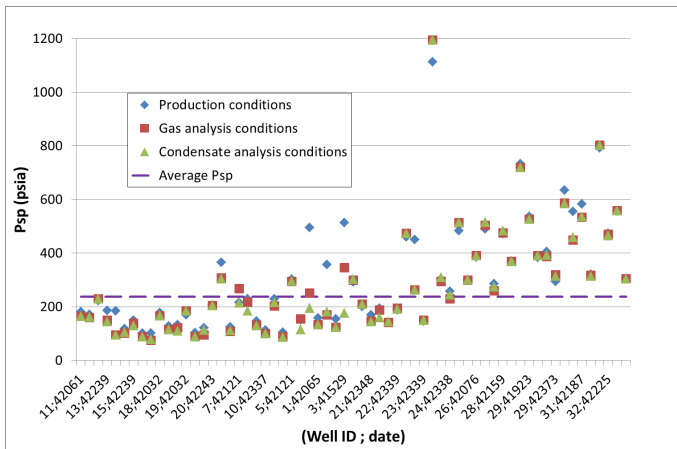

Figure 4.31: Pressure Range for All Data

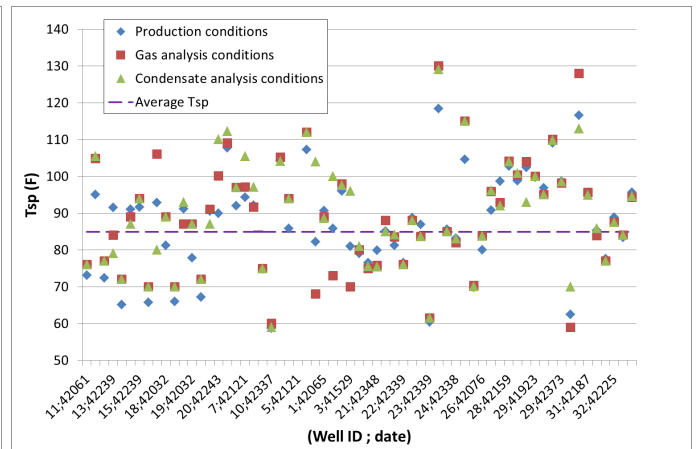

Figure 4.32: Temperature Range for All Data

For the sake of consistency, the molar compositional wellstreams, obtained after Phaze-

Comp iterations and WTC adjustments, have to be flashed at common separator conditions. The average separator pressure and temperature are selected as common conditions: **237.25 psia and 84.94 F**.

A more-individualized reprocessing could use other separator conditions, depending upon the well (*e.g.* the initial separator conditions for each well, kept constant). Another way of obtaining common conditions would be from the request of the operator.

It is shown in 4.6.4 that the correction depends upon the choice of common conditions (Figure 4.61).

4.6.2 Periodic Data

For a given well, the calculated values (at common conditions) are compared to those reported (at separator conditions). Only API and OGR_{sp} are studied in this section. Comparing the calculated SF to the reported SF would not be very relevant here, as two major uncertainties would be at stake:

- The wellstream does not match the SF (see above), and was not built with this purpose (=implementation inaccuracy of the SF);
- The measurements are influenced by varying separator conditions (=measurement uncertainty of the SF).

Since API and OGR_{sp} values are matched during the wellstream generation, the only deviations to the reported values come from the varying separator conditions. Since the selection of data is limited to 63 streams, each well has very few streams available. As discussed above, it still seems to be the most reliable method; but it would be advisable conducting more well tests.

API

All Wells Included The calculated API values (at the common conditions defined above) are compared to the reported API values (Figure 4.33). Few dots are close to the main diagonal, which indicates that the measurements were biased by the separator conditions. Most of the dots (65%) are in the left side of the diagonal, which means that the calculated API is greater than

the reported API. Hence, in most of the reported cases studied here, the API was underestimated while testing a well. This means that the fluid is seen heavier than it is in reality, and can lead to wrong production management decisions.

There is no apparent link between the distance of common separator conditions to the reported separator conditions, and whether the API is over- or underestimated.

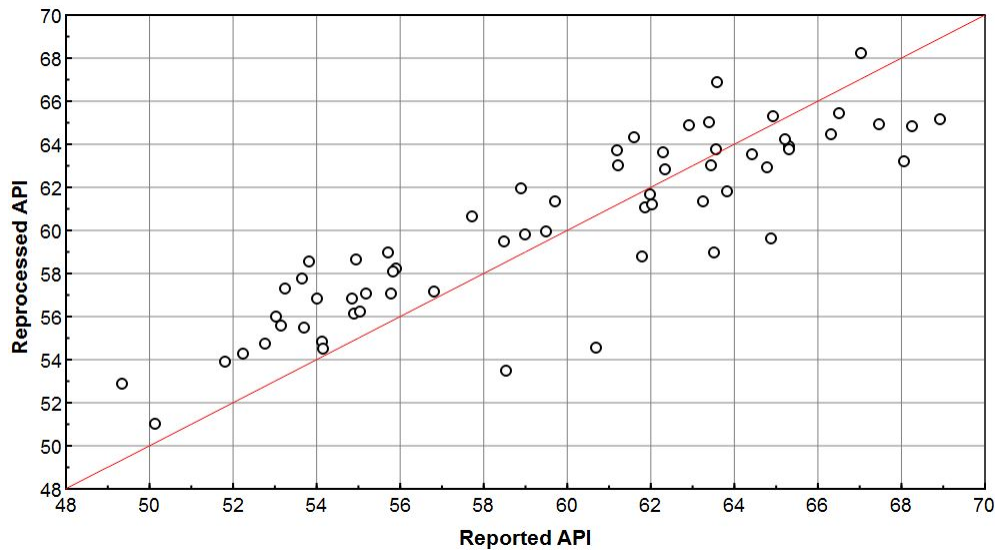

Figure 4.33: Reprocessed API at Common Conditions

A correlation was sought, in order to determine the corrected API from the measured API, and the separator conditions. This is discussed in [4.6.3](#).

For Individual Wells Both the calculated API (at common separator conditions) and the measured API (at reported separator conditions) are plotted; together with the reported separator conditions. Knowing the effect of the separator temperature and/or of the separator pressure on measurements (section [4.5](#)), a better comparison between the measured and the calculated data is suggested.

Three wells are selected to illustrate the actual API variations, and the variations due to the varying separator conditions: well ID 18, well ID 29, well ID 31.

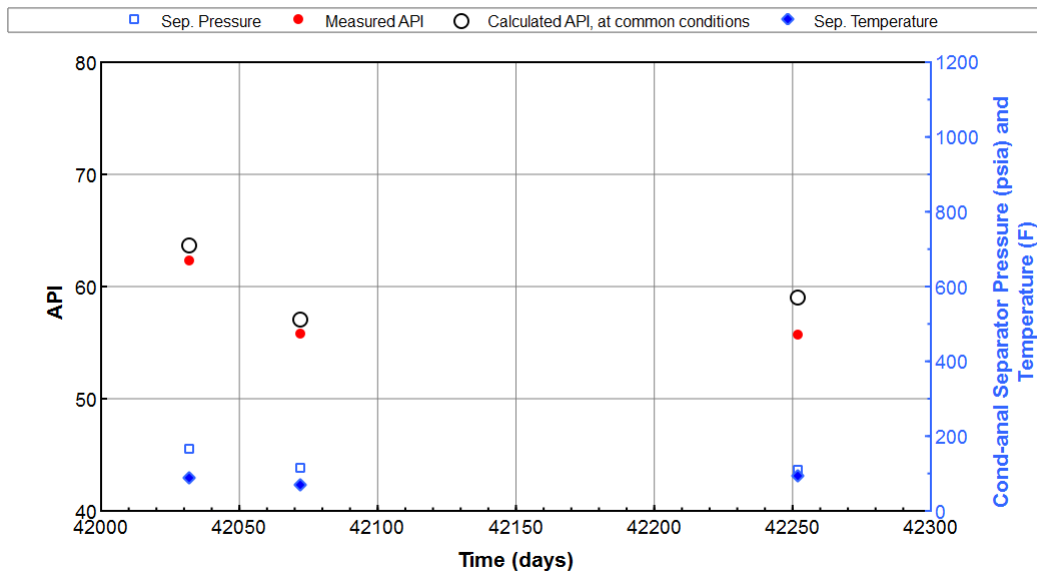

Figure 4.34: API vs time for Periodic Measurements, Well ID 18

Well ID 18 In Figure 4.34, the reported API (red dots) and calculated API (white circles) have different behaviour from the second to the third dates: while the reported API remains constant, the calculated API increases. According to the calculated API, the produced fluid became slightly lighter (from 57° API to 59° API), but this trend is not shown by the recorded API. The API increase was counteracted by the increase in temperature (which involves a decrease of the API).

Remark: The periodic dots do not represent the real density evolution, as shown in the Continuous study.

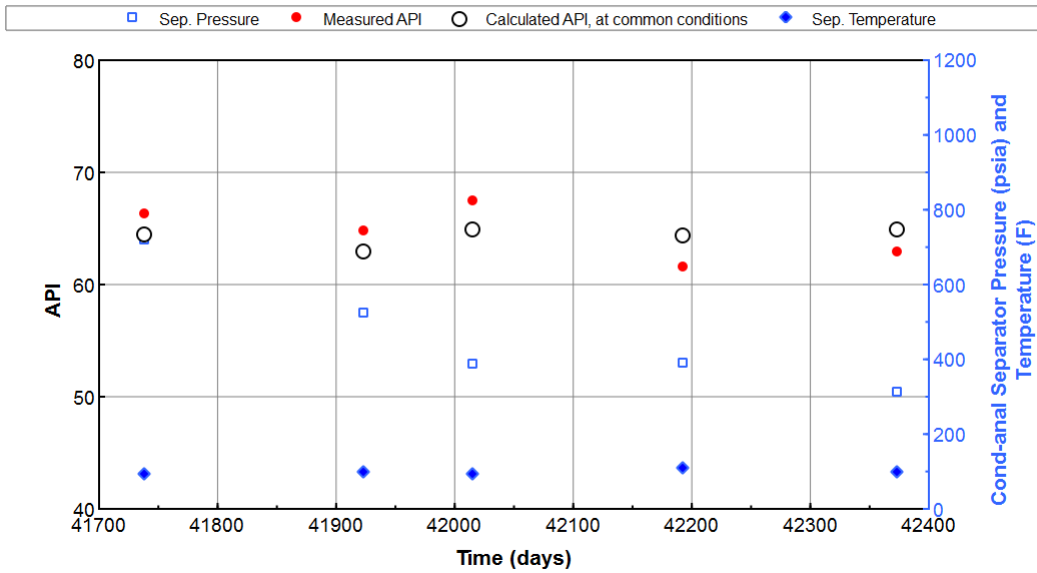

Figure 4.35: API vs time for Periodic Measurements, Well ID 29

Well ID 29 While the separator temperature remains constant (Figure 4.35), the separator pressure varies a lot for the well tests of well ID 29. The corrected API is more stable than the reported API, as it is not influenced by fluctuating separator pressure. The variations are the same for both API. Hence, even though the values of the reported API are wrong by 3-4°API, its evolution with time is correct (it follows the trend of the correct value). Since the actual changes are within 2 °API, the density of the wellstream can be assumed constant.

While for day 42015, the corrected API was lower than the reported API, the opposite occurs for day 42192. Since the only difference between the two dots is the separator conditions, this reveals its huge impact on the API measurements.

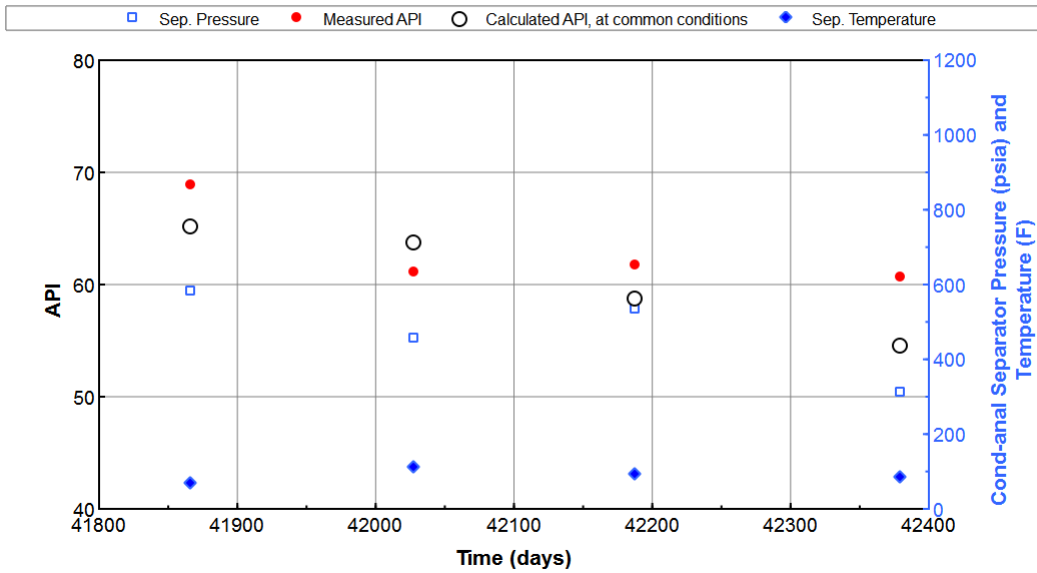

Figure 4.36: API vs time for Periodic Measurements, Well ID 31

Well ID 31 The reported-API variations follow the variations of the separator pressure (Figure 4.36), decreasing when the pressure decreases, and increasing when it increases.

The real API density is decreasing, which means that the fluid becomes heavier with time. Relying on the reported API, the fluid would be interpreted as heavier (day 42027), then lighter (day 42187), then heavier again (day 42379), which is erroneous.

It is clear from these plots that wrong decisions could be made, if relying on the reported API. Indeed, a supposed-increasing API might be, after correction, decreasing.

OGR_{sp}

All Wells Included For low values ($<40\text{sep-bbl/MMcf}$), the calculated OGR_{sp} is smaller than the reported OGR_{sp} ; while for bigger values, it is greater (Figure 4.37). In other words, the measured OGR_{sp} is overestimating the real value for low OGR_{sp} (wet gas, Whitson and Brulé (2000) figure 2.19), and it is underestimating the OGR_{sp} for high OGR_{sp} (gas condensate).

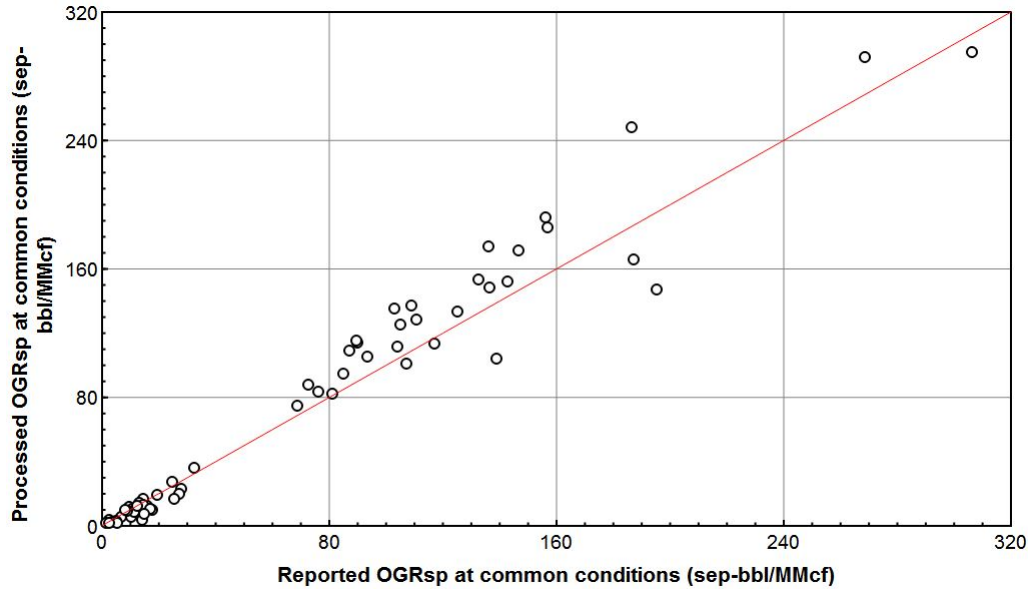

Figure 4.37: Reprocessed OGR_{sp} at Common Conditions

In order to estimate the corrected OGR_{sp} from the measured OGR_{sp} , a correlation was sought. It is discussed in 4.6.3.

For Individual Wells The exact same wellstream is computed, with the same EOS. Depending on the separator conditions, it results in the red dot (measured OGR_{sp} , the value reported from the well test) or in the white circle (calculated OGR_{sp}). It is expected that the values are not overlapping, as they are flashed at different separator conditions, which are of importance (section 4.5). From t_n to t_{n+1} , the variation in the difference “reported *vs* processed” shows the influence of the separator conditions.

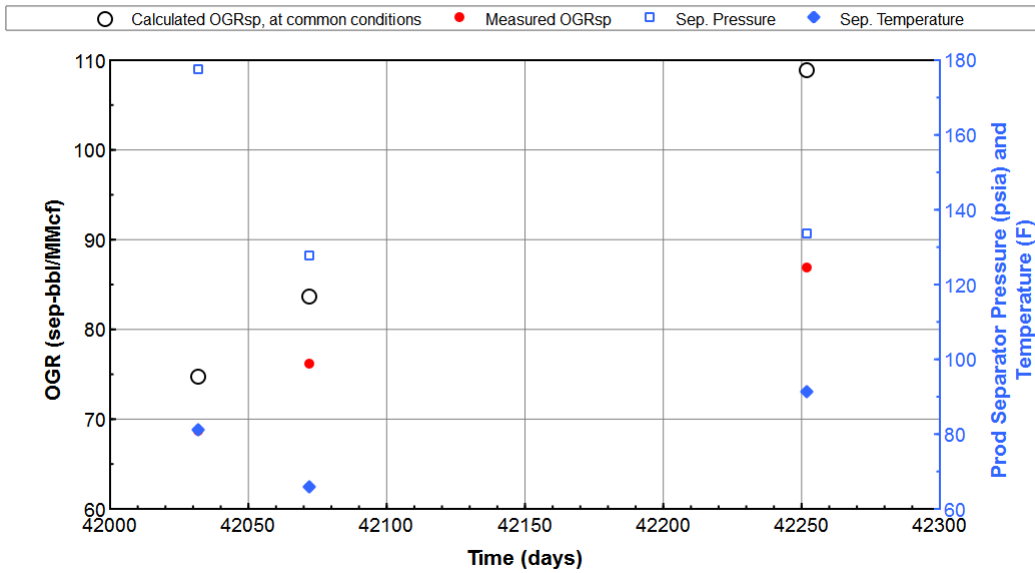

Figure 4.38: OGR_{sp} vs time for Periodic Measurements, Well ID 18

Well ID 18 The reported OGR_{sp} and recalculated OGR_{sp} have the same evolution (Figure 4.38). The actual increase is more important than it appears on the measurements; this is due to the increase in separator temperature: its change from day 42072 to day 42252 tends to decrease the OGR_{sp} value. This is why the increase in OGR_{sp} is less apparent.

The operator might consider that the OGR_{sp} increase is not important enough for a change in the production and treatment, but this decision is biased by the changes in separator conditions. The actual OGR_{sp} changes are important (an increase of 20% in six months). Having consistent data available would help to take better decisions.

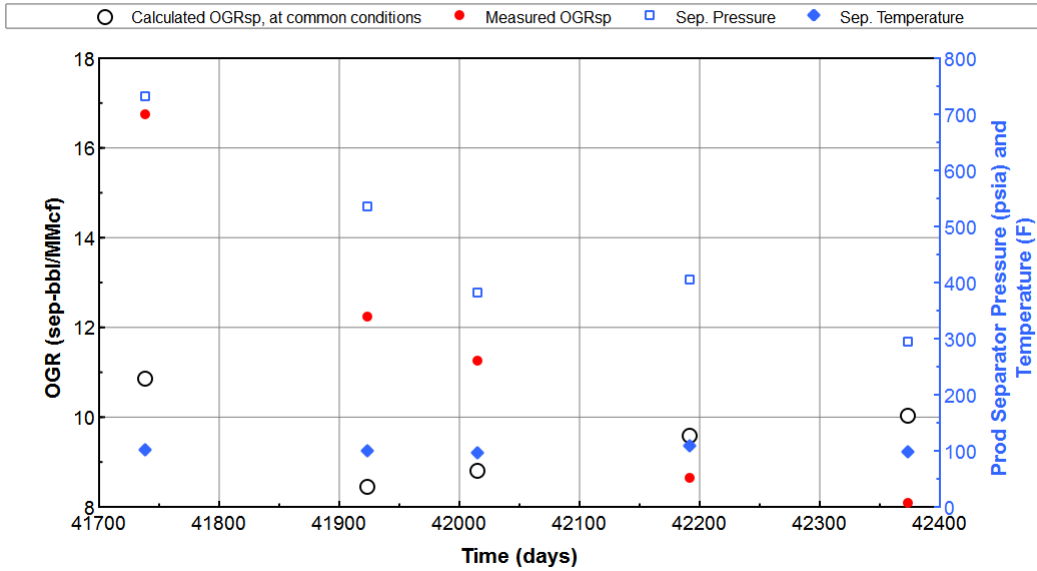

Figure 4.39: OGR_{sp} vs time for Periodic Measurements, Well ID 29

Well ID 29 The OGR_{sp} study of well ID 29 illustrates the typical use of such a correction (Figure 4.39). From the measurements, the OGR_{sp} is monotonously decreasing with time, which means that more and more gas is produced for the same amount of oil. The important decrease in separator pressure must also impact the OGR_{sp} measurements (inducing the OGR_{sp} values to decrease).

Indeed, the corrected OGR_{sp} values, at constant separator conditions, have a very different behaviour. While the recorded OGR_{sp} is decreasing from day 41923, the actual value starts increasing, *i.e.* more oil is produced from the same amount of gas.

Wrong interpretation could lead to a wrong treatment of the incoming fluid on surface, or to wrong management of the production. Once again, it is crucial having a consistent evolution of the well test measurements, in order to take correct decisions and to optimize incomes.

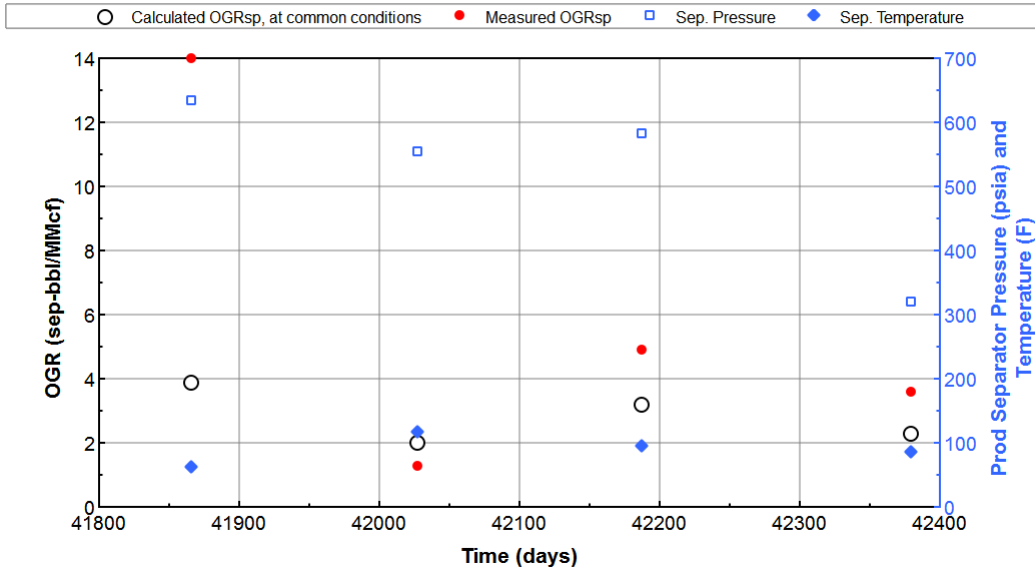

Figure 4.40: OGR_{sp} vs time for Periodic Measurements, Well ID 31

Well ID 31 From Figure 4.40, it is possible to see that the global variations of the measured OGR_{sp} agree with the actual variations (regarding the corrected values). Nevertheless, they are way less significant than those reported: while the real OGR_{sp} varies between 2 and 4 sep-bbl/MMcf, the reported OGR_{sp} is varying from 1 to 14 sep-bbl/MMcf. The reported- OGR_{sp} variations are the results from the combined variations of separator pressure and temperature, together with the real OGR_{sp} changes.

For example, the huge fall in the measured OGR_{sp} value from day 41866 to day 42027 is a combination of an actually-decreasing OGR_{sp} (as can be seen on the processed- OGR_{sp}), a decreasing separator pressure, and an increasing separator temperature.

4.6.3 Suggestions of Correlations from Periodic Well Tests

From Figure 4.37, it is clear that some measurements overestimate the real OGR_{sp} value, while some other measurements underestimate it. In this section, it is sought whether the reprocessed OGR_{sp} can be estimated from the set of common conditions, the set of reported conditions and the reported OGR_{sp} . A similar study is then conducted on the API density.

One stream (Well ID 16, day 42072) is used to illustrate the study: the OGR_{sp} (resp. API

density) is reprocessed at varying separator temperatures (resp. pressures) with a fixed pressure (resp. temperature).

Correlating the OGR_{sp}

- The plot of the reprocessed OGR_{sp} vs $\sqrt{p_{sp}}$ suggests a linear trend, with a very good coefficient of determination (R^2) (Figure 4.41).

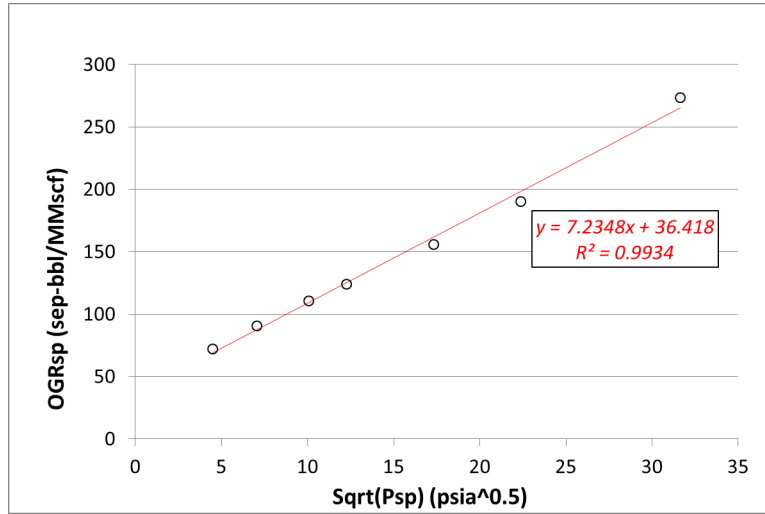

Figure 4.41: OGR_{sp} vs $\sqrt{p_{sp}}$, $T_{sp}=65.76$ F, Well ID 21, date 42072

- The plot OGR_{sp} vs an exponential in T_{sp} also suggests a linear trend (Figure 4.42).

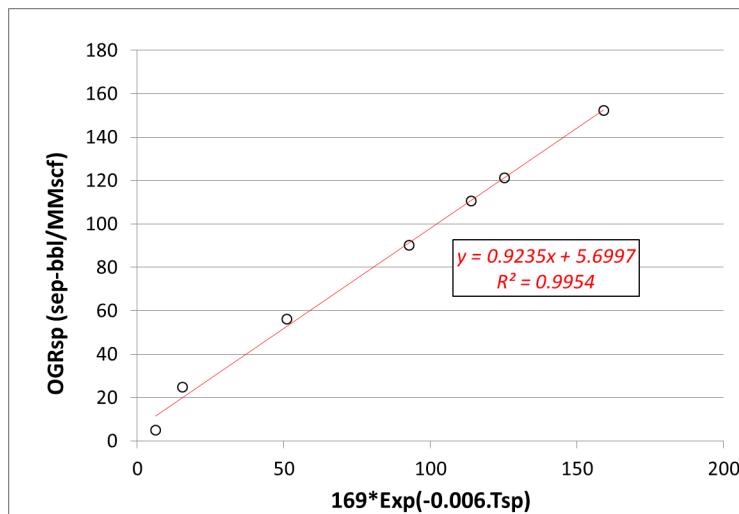

Figure 4.42: OGR_{sp} vs $\exp(-0.006.T_{sp})$, $p_{sp}=101.7$ F, Well ID 21, date 42072

From these two plots, it is suspected that a correlation between OGR_{sp} , T_{sp} and p_{sp} can be established:

$$OGR_{sp}(T_{sp}, p_{sp}) = \alpha(T_{sp})\sqrt{(P_{sp})} + \beta(T_{sp}) \tag{4.1}$$

The correlation between OGR_{sp} and p_{sp} was established assuming a constant T_{sp} , but it does not warranty that such correlation exists for other temperatures. An identical study was conducted, for different temperatures (*i.e.* the OGR_{sp} was calculated when varying both pressure and temperature). The interval for temperature is 50 F to 200 F, and for pressure from 20 psia to 1,000 psia.

For each temperature, a relationship $OGR_{sp} = \alpha \cdot \sqrt{(P_{sp})} + \beta$ was sought (Figure 4.43), the coefficients α , β and R^2 are summarized in Table 4.3.

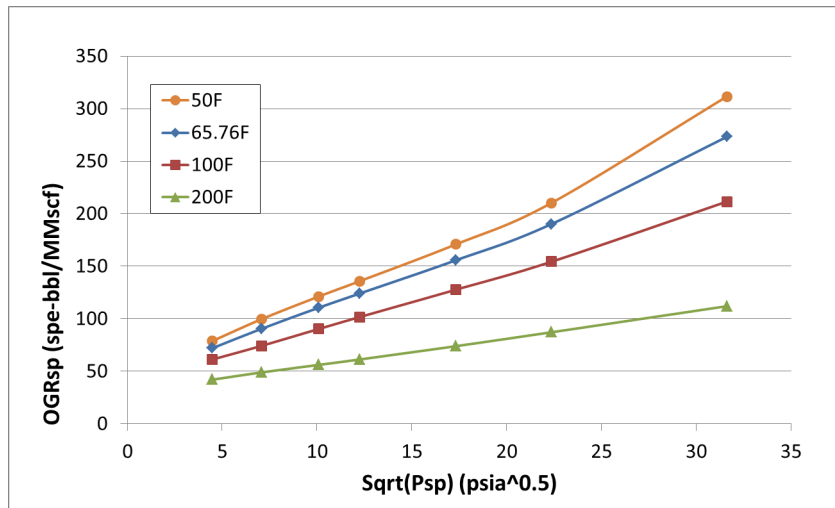

Figure 4.43: Influence of T_{sp} on OGR_{sp}

Table 4.3: Coefficients study for the correlation

$T_{sp}(F)$	50	65.76	100	200
Alpha	8.3222	7.2348	5.4883	2.5629
Beta	36.065	36.418	34.791	30.284
R^2	0.9883	0.9934	0.9982	0.9995

R^2 being very close to 1, a linear correlation can legitimately be assumed.

The evolution of both α and β with the temperature is then studied (Figure 4.44).

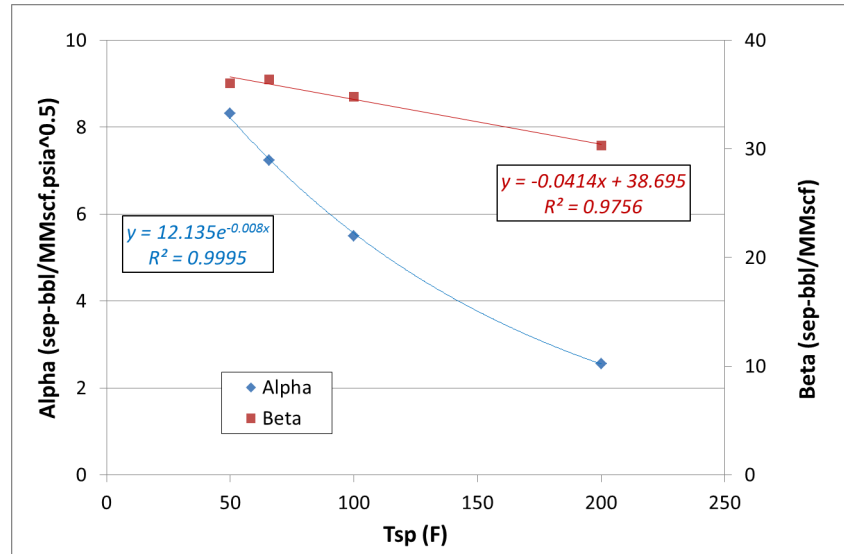

Figure 4.44: Correlation Factors vs T_{sp}

From this last plot, an exponential (resp. linear) correlation can be found, between α (resp. β) and T_{sp} :

$$\alpha(T_{sp}) = 12.135e^{-0.008T_{sp}} \quad (4.2)$$

$$\beta(T_{sp}) = -0.0414T_{sp} + 38.695 \quad (4.3)$$

Using 4.1, 4.2 and 4.3, the OGR_{sp} dependency on the separator pressures can be expressed as:

$$OGR_{sp}(T_{sp}, p_{sp}) = (12.135e^{-0.008T_{sp}} \cdot \sqrt{P_{sp}} - 0.0414T_{sp} + 38.695) \quad (4.4)$$

Formula for a range of pressures [20 psia ; 1,000 psia] and of temperatures [50 F ; 200 F]. This was developed for a given, fixed stream.

QC

The correlation is used to estimate a value of the OGR_{sp} at reported separator conditions, and to compare these values to the actual OGR_{sp} measurements in continuous (Figure 4.45).

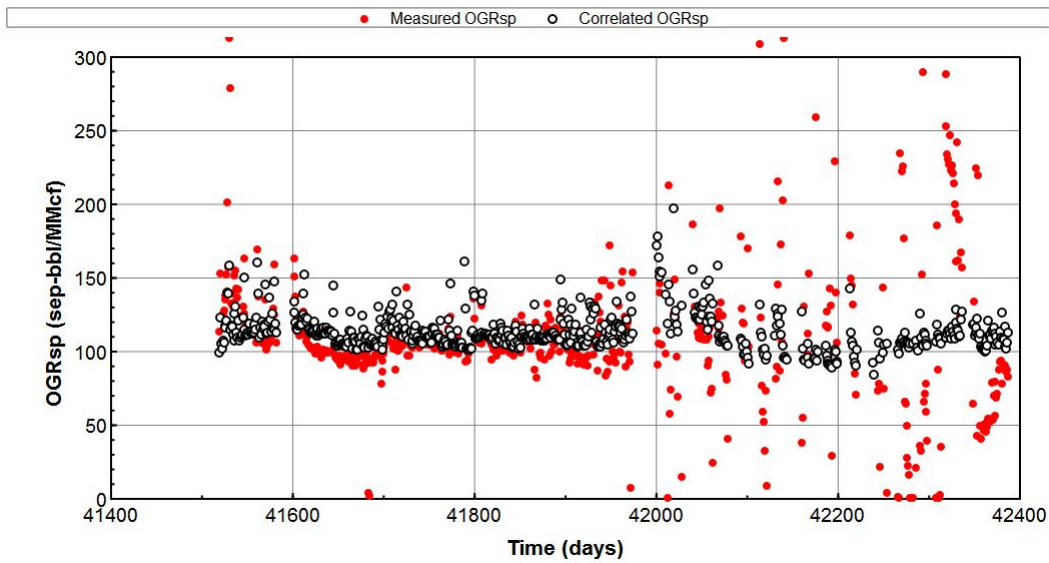

Figure 4.45: Correlation applied to OGR_{sp} Calculations of Well ID 16

The correlation tends to follow the trend of the measured OGR_{sp} , but the match is not satisfying, even for little fluctuations. The correlation was developed for one well at a given time, but it does not seem that it can be extended and used for other times, for this same well.

This plot suggests that the OGR_{sp} cannot be correlated from separator conditions only, but the stream composition must also be considered. Further studies are recommended, (developing correlations from other wellstreams and other wells). Developing such a correlation could be extremely useful, provided the wellstream is known at some point. Indeed, the OGR_{sp} could be converted from a set of separator conditions (T_{sp1}, p_{sp1}) to another set (T_{sp2}, p_{sp2}) . This represents a huge gain in consistency.

Correlating the API

The same procedure is followed: correlations are suggested after trial-and-errors.

- The relationship between calculated API and T_{sp} can be approximated by an exponential (Figure 4.46).

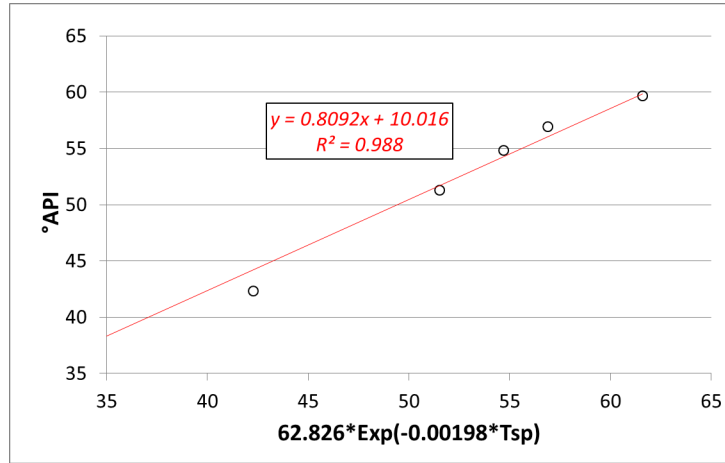

Figure 4.46: API vs $\exp(-x.T_{sp})$

- Though, a simple approximation of API vs p_{sp} cannot be found.

Since API vs p_{sp} is not trivial, discussion is based on formula 4.5, with a linear dependency on the pressure.

$$API(T_{sp}, p_{sp}) = \alpha(p_{sp}) \cdot e^{\gamma(p_{sp})T_{sp}} + \beta(p_{sp}) \tag{4.5}$$

Varying separator pressures are used to calculate the API density correlations. Assuming an exponential dependency upon T_{sp} , the coefficients α , β and γ are studied with varying p_{sp} (Figure 4.47).

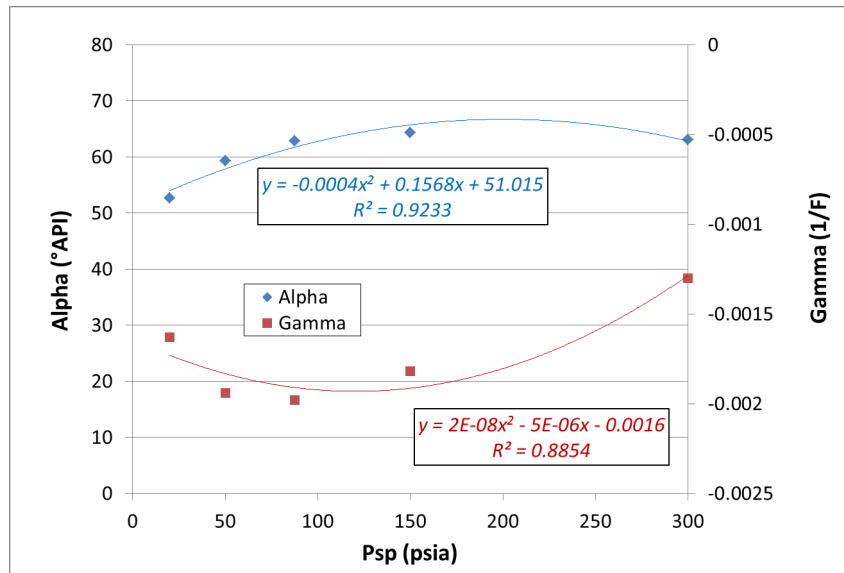

Figure 4.47: Correlation Factors vs p_{sp}

β is 0 for all the runs.

No clear correlation can be seen, the best fit being with second-order polynomials. Since the coefficient of determination is low, the match is not really satisfying.

Nevertheless, from 4.5 and 4.47, an approximation of the API density from the separator conditions can be suggested:

$$API(T_{sp}, p_{sp}) = (-0.0004p_{sp}^2 + 0.1568p_{sp} + 51.015)e^{(2 \cdot 10^{-8}p_{sp}^2 - 5 \cdot 10^{-6}p_{sp} - 0.0016)T_{sp}} \quad (4.6)$$

The approximation is valid only for the range [20 psia ; 300 psia] and [50 F ; 200 psia], and for the given stream.

QC

The production separator conditions are the only set of conditions reported on a continuous basis. From these data, the API densities can be reprocessed continuously. These values are compared to the correlated estimate of the API density (which comes from the separator conditions only), developed for Well ID 16 (Figure 4.48).

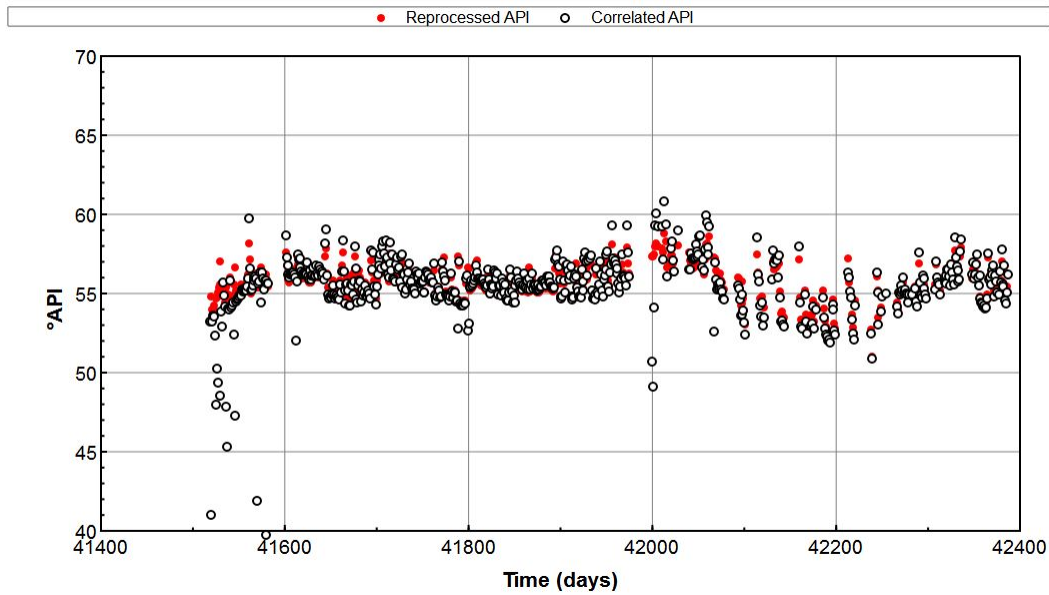

Figure 4.48: API Correlation applied on Well ID 16

Despite the relatively poor match and the low R^2 values, the match between the calculated API values and the correlation is satisfying.

It also gives satisfying matches for the API values of other wells (than the one it was developed from) (Figures 4.49 and 4.50).

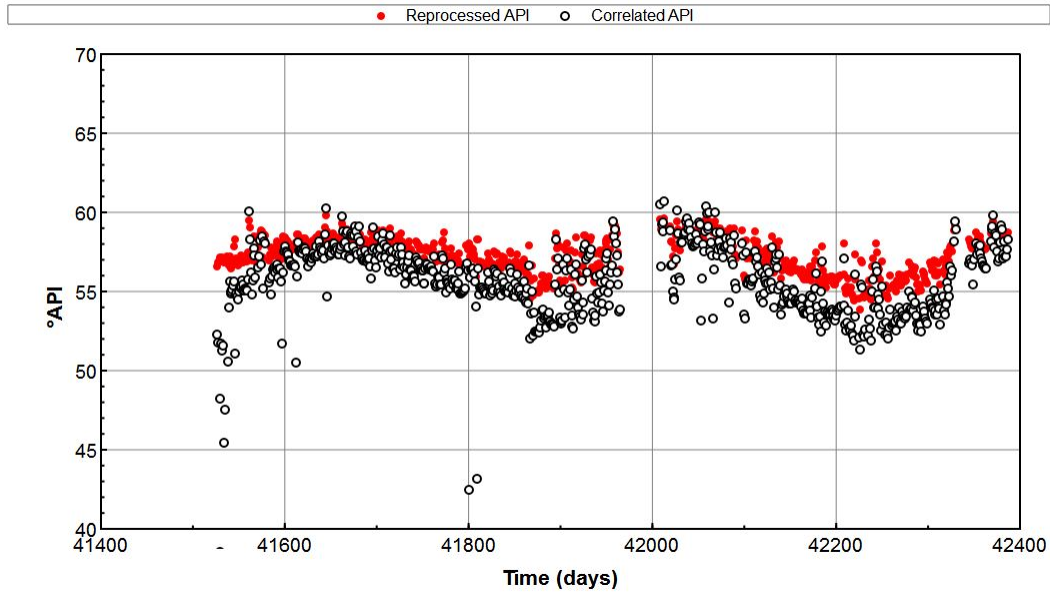

Figure 4.49: API Correlation applied on Well ID 15

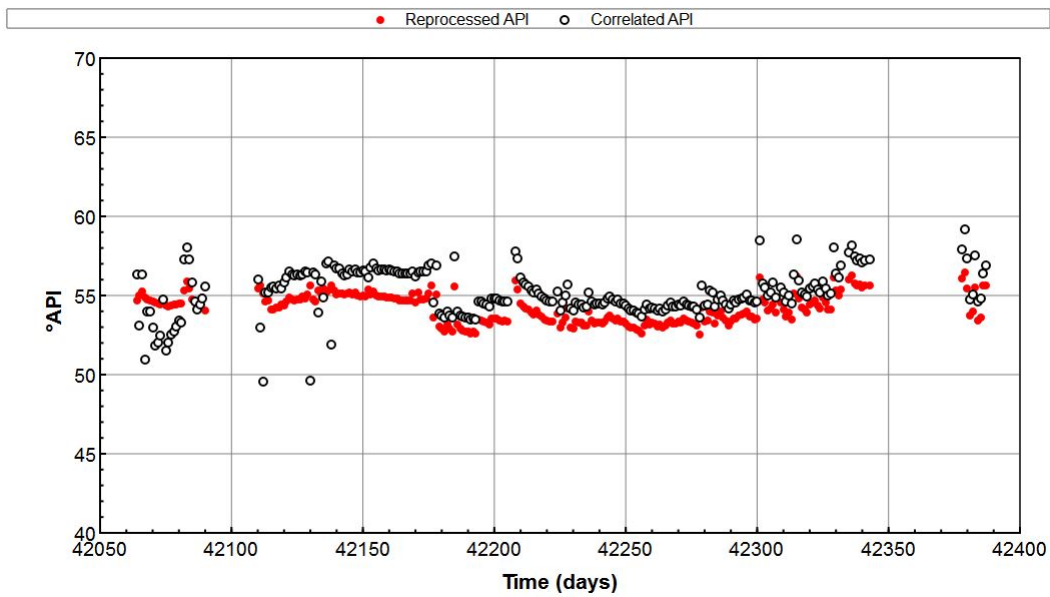

Figure 4.50: API Correlation applied on Well ID 7

For other wells, the API correlation follows the trend of the reported API, with a constant difference. A constant factor per well can be applied to the correlation, to adjust the values to the reported values. This depicts that the density of the liquid produced by the wells 7, 15 and 16 can be approximated in a similar way. Such correlations are one more way to study whether wells might be producing from the same hydrocarbon pocket, or at least from the same reservoir: if the correlation is very similar for two wells, this suggests that the streams themselves have similar time variations.

Nevertheless, this API density correlation cannot be applied to all the wells of the studied areas (Figure 4.51).

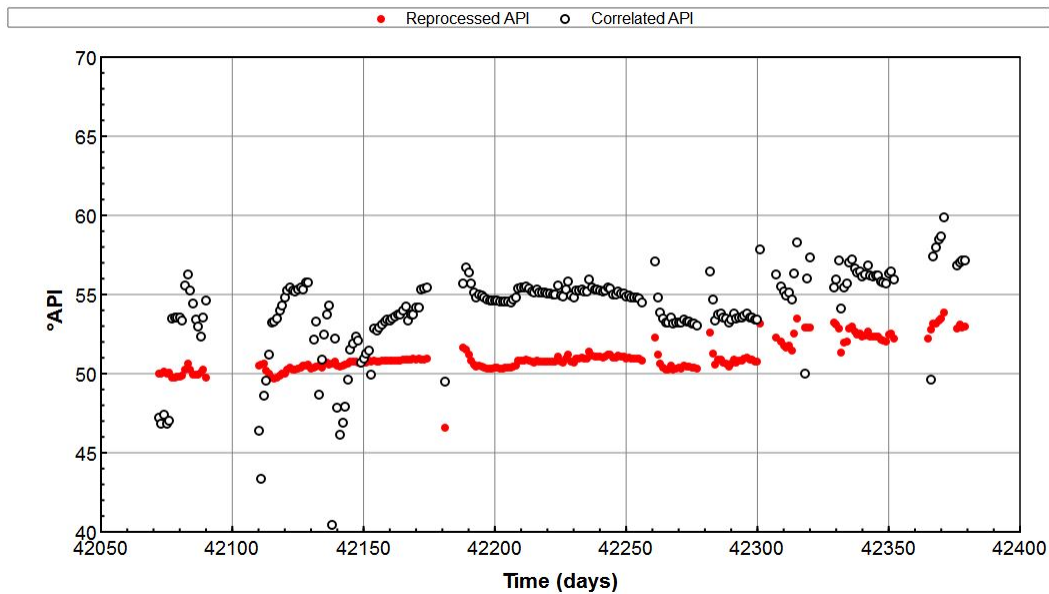

Figure 4.51: API Correlation applied on Well ID 4

Therefore, a correlation has to be developed per well, and it should take the wellstream composition into account. The location of the wells might help deciding whether an API correlation can be used for another well.

Few streams were analysed in this section. As discussed for the OGR_{sp} , the correlation for API would need further development to be more consistent. Results depend on which well the correlation is based on.

Conclusion

In this section, it is attempted to establish a dependency of the OGR_{sp} (resp. API density) on the separator conditions. For the range of separator pressure and temperature selected, the formulas are quite simple, and result in satisfying matches for the studied wellstreams for the API correlation. Nevertheless, a general OGR_{sp} correlation based on separator conditions only seems harder to find. It is not surprising, as the OGR_{sp} is much more dependent upon the composition, than the API density. Therefore, an OGR_{sp} correlation developed from a fixed composition is not expected to fit the actual values.

Even though the separator conditions impact the measurements (as seen above), the PVT properties are strongly dependent upon the wellstream composition. Therefore, unless the exact same fluid is produced for each well, it is not really consistent using the same correlation for a whole asset. A more into-detail attempt should correlate per well. Besides, the correlations are developed from a chosen wellstream.

The study here illustrates that the strong link between separator conditions and OGR_{sp} (or API density) can actually be correlated. This is useful for a better understanding of the measurements, and to convert measurements to other sets of separator conditions.

4.6.4 Continuous Data

Introduction

The wellstreams generated by the convergence are used to build an interpolation table: from a couple (Well ID, Date), a wellstream is associated to the corresponding set of separator conditions and OGR_{sp} measurement. This method assigns an estimate of the reservoir composition for each well, each time step.

The Well Test Conversion module is then applied to the wellstream, with the corresponding conditions. This recombination refines the reservoir composition estimate, and makes it reliable (see previous sections).

Therefore, from a limited database (periodic well tests) and continuous OGR_{sp} measurements, it is possible to reconstruct the molar compositional rates for each well, on a continuous basis. A good knowledge of the molar wellstreams has significant impacts on the reservoir and

production management, as the global understanding of the asset is enhanced, and much more information can be collected. Among others, the time evolution of OGR_{sp} (characterizing the produced fluid), separator-gas composition (characterizing the vapour part) and API (characterizing the liquid part) can be found. All the plots for all the wells can be obtained on request to the author.

Uncertainties

Several properties of the produced fluid have been discussed up to now:

- OGR_{sp} , separator-gas composition and API are requested to be matched while estimating the wellstream: the values in the periodic processing are very close to the actual values. But since wellstreams are interpolated from very limited sets of complete data (24,074 continuous streams from 63 periodic streams), uncertainties have to be considered.
- SF and OGR_{cond} are not requested to match in the algorithm, and a detailed study (see above) reveals that they do not match with the provided values, probably because of the number of stages used for separation. The SF and GOR_{cond} are calculated after a two-stage separation, as in reality. Besides, values are calculated from wellstreams that have been interpolated; this is another uncertainty to consider.

Therefore, for the sake of consistency, only OGR_{sp} , separator-gas composition and API are discussed in the following. SF and OGR_{cond} are more uncertain, and consequently they were rejected from a continuous analysis.

There is a fundamental difference between the data reprocessed in the continuous Pipe-It model. On the one hand, OGR_{sp} measurements are available; on the other hand, neither separator-gas composition nor API is available:

- On a continuous basis, only gas and oil rates are measured. Hence, only the OGR_{sp} is available. Reprocessing the streams and estimating the OGR_{sp} shows how a measurement needs to be corrected (to be “scaled” to common conditions).
- Since the separator-gas composition and the API are not measured, estimating them on a continuous basis furnishes the operator with extra data, which were not available before.

Wellstream Composition

Generating the composition of the produced fluid by each well, on a continuous basis, was the main purpose of the work above. The whole processing relies on it; some analysis can also be conducted from the composition variations.

Molar composition rates are assigned to each well, on a continuous basis (every day). This wellstream is corrected in two ways:

1. A “loose” correction on a continuous basis (every day, a GOR_{sp} is measured)
2. A “tight” correction on a periodic basis (every time the composition is updated from the well test).

Most likely, the main composition changes will take place when the periodic stream is updated, but the composition changes continuously, due to the WTC correction and the daily GOR_{sp} changes.

Generating accurate wellstream compositions is extremely important, as the whole processing (fluid properties calculations, processing in the facilities, back-allocation) relies on it. The need of very frequent well tests is highlighted: the more well tests, the more compositions input in the interpolation table, hence the better the accuracy of the continuous wellstream estimation.

Two wells are given as examples; a few molar compositions are plotted for each:

- Well ID 18, from area B, with three well tests (hence three seed feed updates);
- Well ID 29, from area A, with five well tests (hence five main updates of the continuous composition).

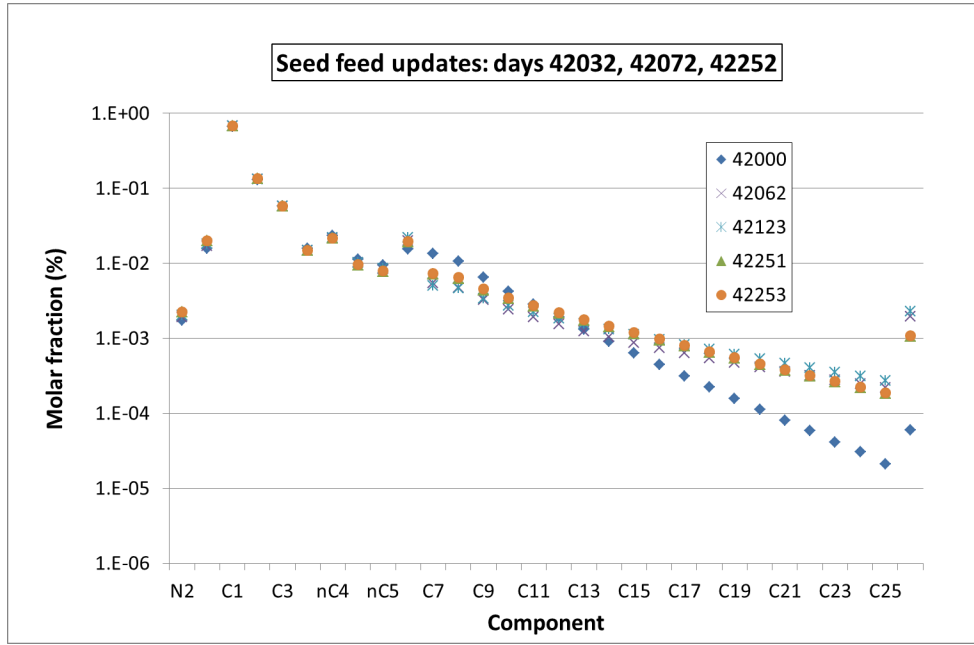

Figure 4.52: Continuous Composition of the Production of Well ID 18

Well ID 18 The first update (day 42032) is clearly visible in Figure 4.52: the slope of the heavy-components distribution is lower; consequently the heavier components have a bigger fraction. Between days 42251 and 42253, the seed feed has been changed. Though, there is no significant change in the corrected reservoir composition: this reveals that the method is consistent. Indeed, huge composition changes from day D to day D+2, because of periodic updates, would not make physical sense.

Generally speaking, the produced fluid tends to be richer in heavy components. As the API tends to decrease (Figure 4.53), the liquid part also becomes heavier.

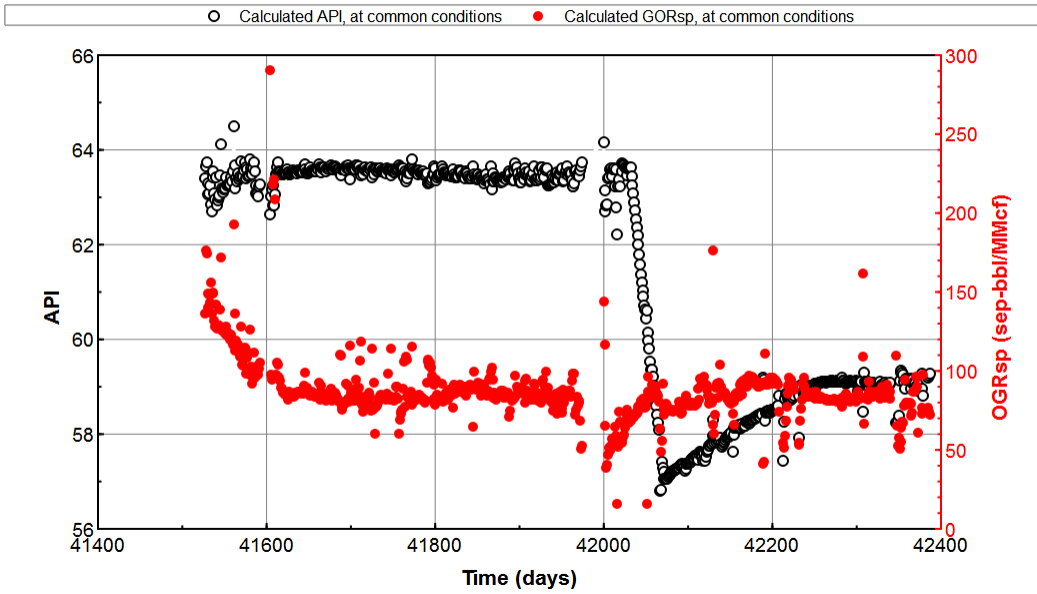

Figure 4.53: Continuous API Variations of the Production of Well ID 18

Nevertheless, from the separator-gas composition, the gas part of the fluid (after flash at 237.25 psia and 84.94 F) keeps the same content throughout the whole time of the study (Figures 4.54 and 4.55).

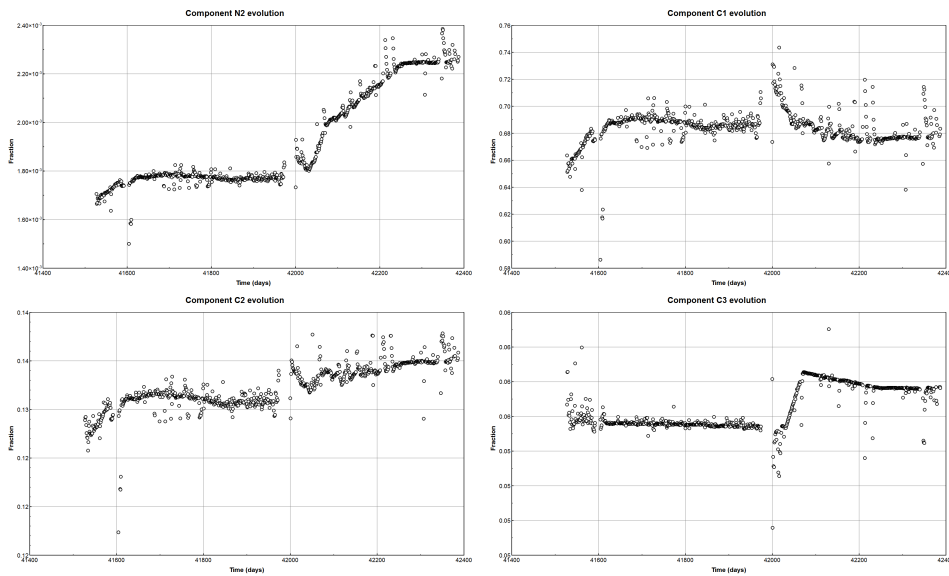

Figure 4.54: Continuous Light Components Variations of the Gas Production of Well ID 18

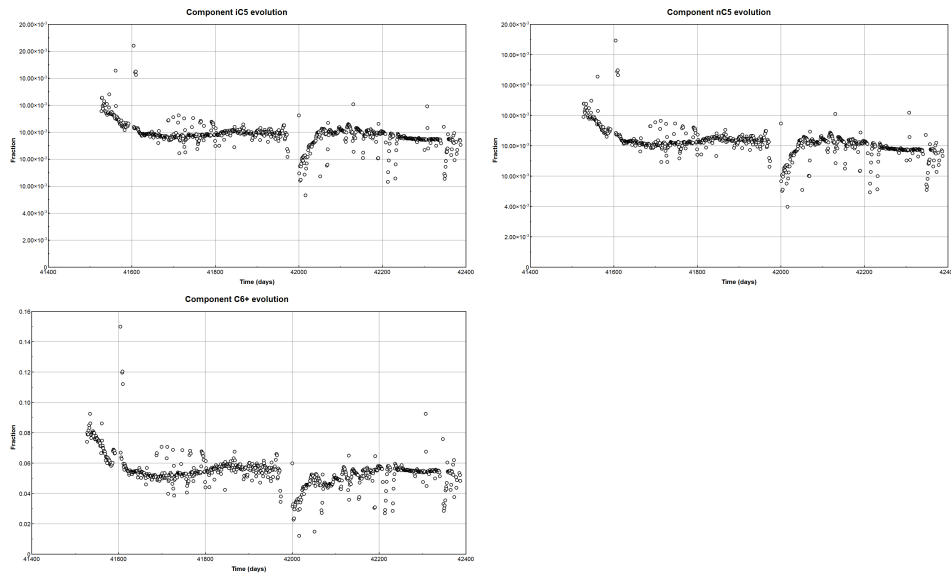

Figure 4.55: Continuous Heavy Components Variations of the Gas Production of Well ID 18

As the OGR_{sp} slightly fluctuates around 100 sep-bbl/MMcf, the relative rates of oil and gas are the same. Therefore, the heavier produced fluid seems to be transmitted to the oil; which makes sense: during the flash, heavy components are transferred to the liquid phase. More heavy components in the two-phase fluid means more heavy components in the liquid phase.

Well ID 29 Almost three years lasted between the first two compositions plotted in Figure 4.56. Two seed feed updates took place between the compositions of days 41187 and day 42000. The change is noticeable, suggesting that the reservoir composition has changed over the three years. But then, the composition is very similar over more than a year.

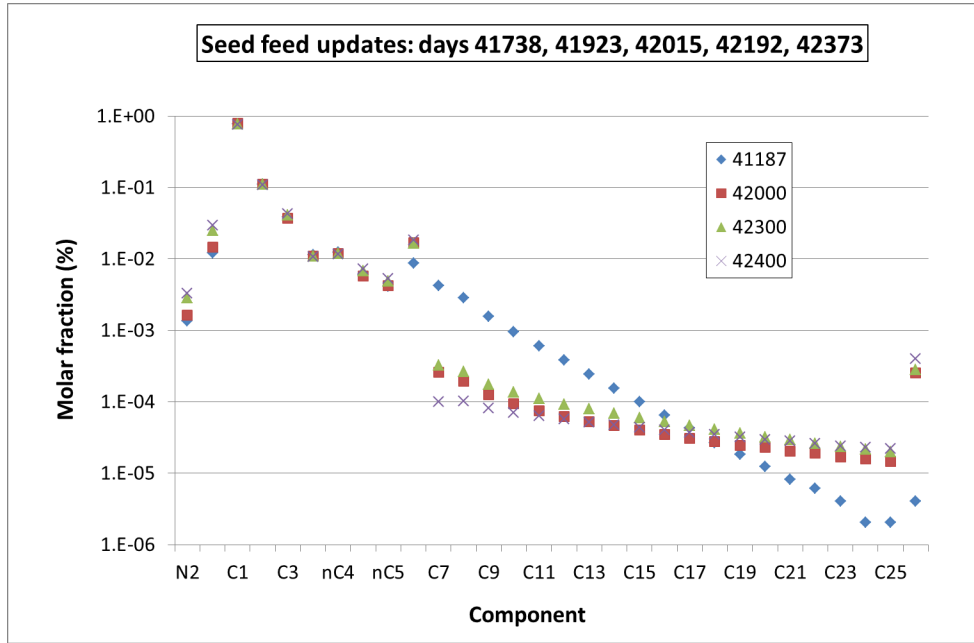

Figure 4.56: Continuous Composition of the Production of Well ID 29

The relatively-constant API (from 64° to 66°) suggests that the change in the fluid composition is not enough to impact the liquid density (Figure 4.57).

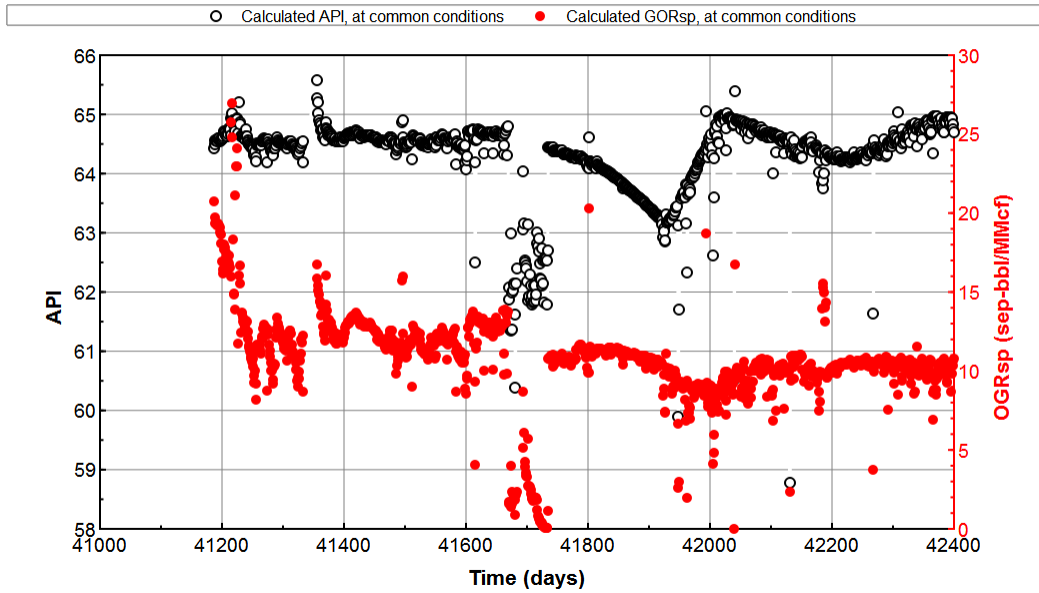

Figure 4.57: Continuous API Variations of the Production of Well ID 29

The seed feed updates are also clearly noticeable in the API plot, so is the linear interpolation method.

Remark: After selection of the complete well tests only, two wells (Well ID 8 and Well ID 12) have no well test available. The whole processing on these two relies on interpolation from other wells, and makes no sense. Therefore, it is advised that the processing of these two wells is removed, and no analysis is conducted on them; until complete well tests are available. This is the main limit of selecting only complete well tests: the few available data provided for Well IDs 8 and 12 are not used.

OGR_{sp}

Robust measurements at high OGR_{sp} values For all the wells, and all the dates, the OGR_{sp} is reprocessed at common separator conditions (237.25 psia, 84.94 F). They are then compared to the reported OGR_{sp} , which were reported at different separator conditions (Figure 4.58).

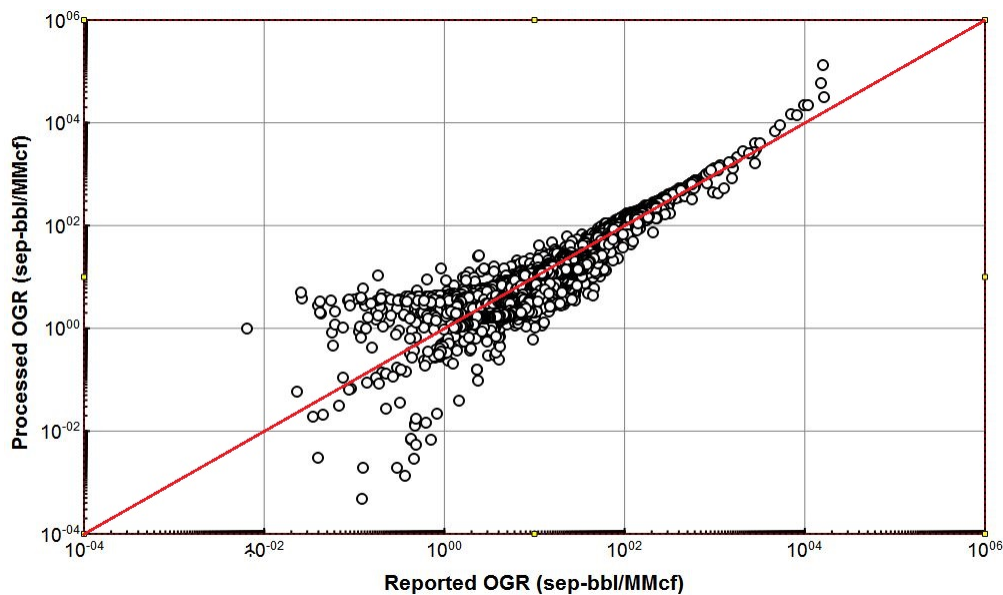

Figure 4.58: Continuous OGR_{sp} Variations, All Wells Included

Fluids with high OGR_{sp} (*i.e.* with high oil production relative to the gas production) are more robust to varying separator conditions, regarding the measurement of the OGR_{sp} .

Indeed, for high OGR_{sp} (more than 100 sep-bbl/MMcf), the calculated values tend to match

with the reported values; while for low OGR_{sp} there is a high fluctuation of the values due to varying separator conditions. Low- OGR_{sp} fluids have high gas content, and the gas behaviour is really dependent upon the pressure and temperature conditions, more than oil.

In other words, a correction needs to be applied to the OGR_{sp} if its value is low, but the measurement can be trusted if it is high. This is more obvious on the plots well-by-well: the calculated OGR are close to the measured OGR for Well ID 6, despite a pressure and temperature fluctuation (Figure 4.59). Values are more corrected for low OGR_{sp} values such as for Well ID 29 (up to a 100% correction) (Figure 4.60).

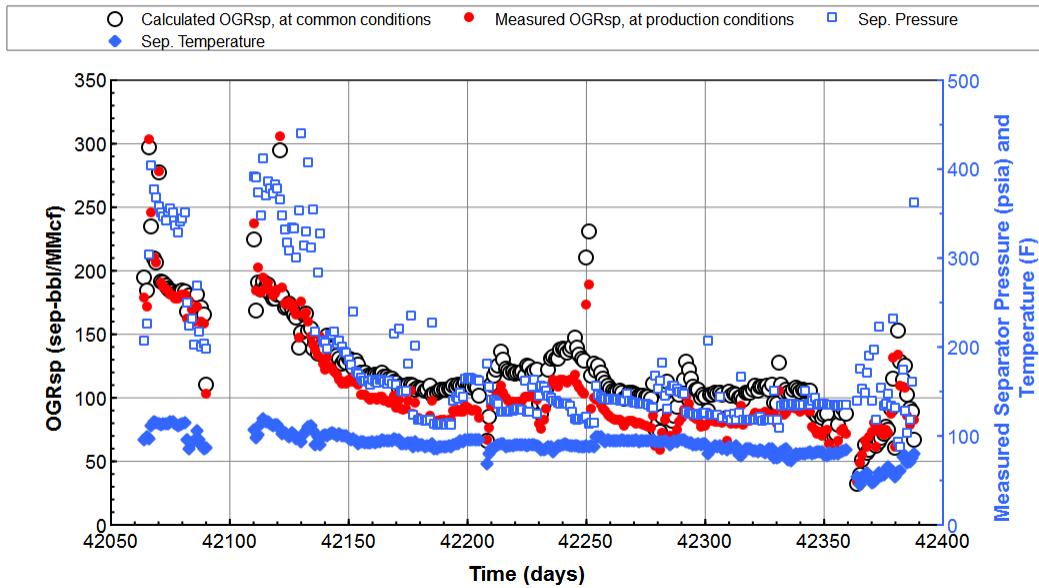

Figure 4.59: Continuous OGR_{sp} Variations, Well ID 6

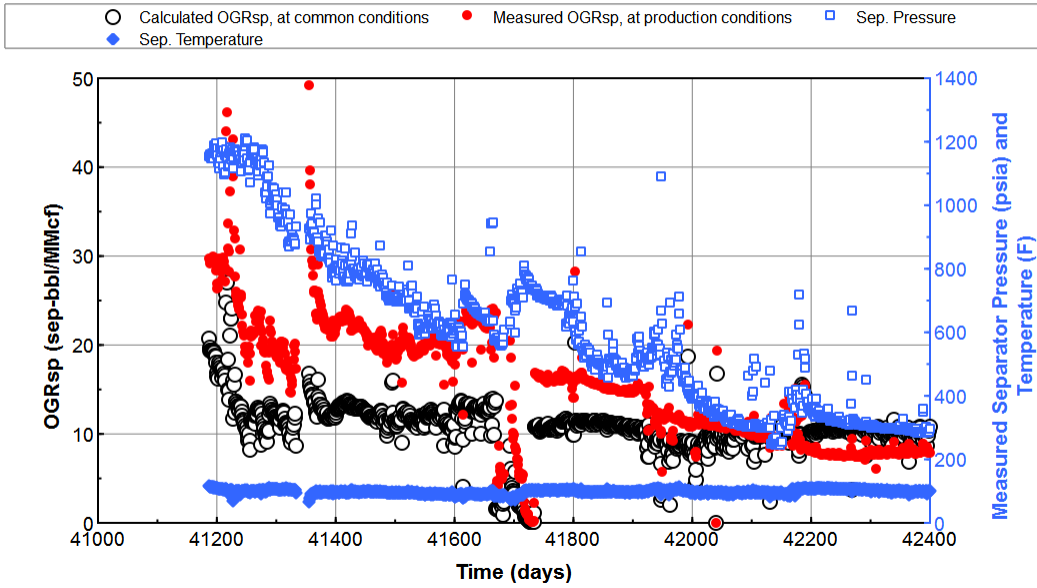

Figure 4.60: Continuous OGR_{sp} Variations, Well ID 29

In the section 4.5, it was discussed that the OGR_{sp} decreases when the separator pressure decreases. This effect is visible if reprocessing the same well, at a fixed separator temperature, but for two different separator pressures (Figure 4.61).

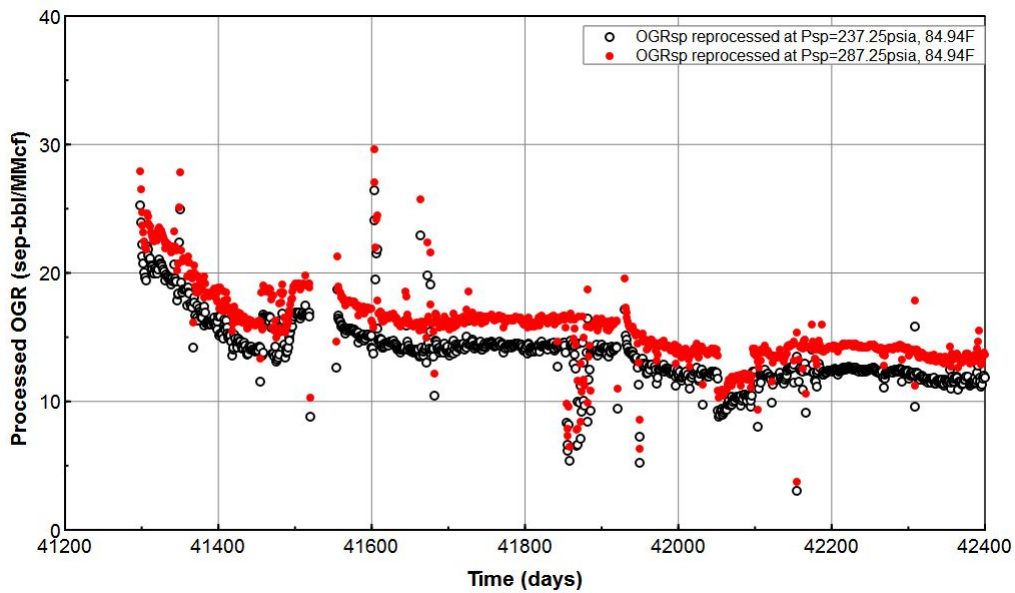

Figure 4.61: OGR_{sp} Variations for two different Separator Pressures

For a higher separator pressure, the OGR_{sp} values are higher, and the curve is shifted to the top. This also reveals that the correction is really dependent upon the chosen separator conditions (*cf* section “Selection of the common conditions”). The choice of the set of common conditions at which the operator wants to discuss corrected data, is critical.

Correction The correction to apply to the measured OGR_{sp} depends upon the separator pressure and temperature variations.

- For Well ID 18, the temperature and pressure hardly vary. Hence, the difference between the reported OGR_{sp} and the calculated OGR_{sp} is also almost constant (Figure 4.62).

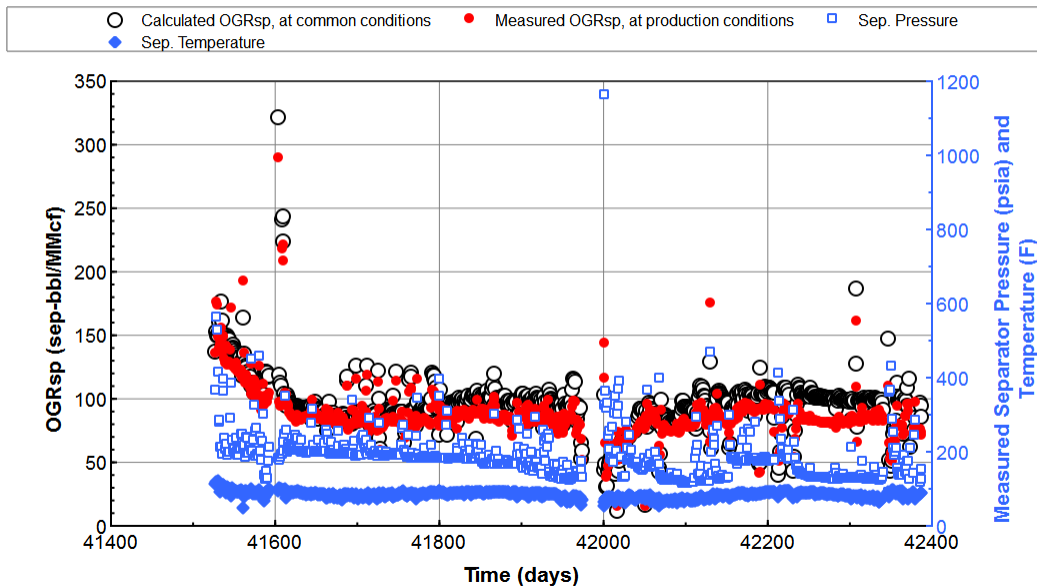

Figure 4.62: Continuous OGR_{sp} Variations, Well ID 18

- For Well ID 26, despite a constant temperature, the separator pressure varies a lot (from 250psia to more than 1,000psia), which affects the deviation of the measurement (red dots) to the actual OGR_{sp} (white circles). From day 42300, neither pressure nor temperature vary, hence the correction applied is constant.

Besides, while at the beginning (from days 41900 to days 41950) the measured OGR_{sp} increases, the actual OGR_{sp} decreases. The interpretation can be totally wrong because of

varying separator conditions. The vapour—phase analysis shows that the produced gas is lighter, while the increasing API suggests a heavier produced oil.

For wells 26, 6 and 29 above, the OGR_{sp} decreases, meaning that less oil is produced for a given volume of gas. Hence, less revenue will be generated from the relative oil production. This is the expected behaviour of the OGR_{sp} , throughout the life of a well.

- For Well ID 10, the measured OGR_{sp} varies around 140 sep-bbl/MMcf until the day 42300, with stable separator conditions. Then, the separator conditions fluctuate significantly, with chaotic variations. As a consequence, the measured OGR_{sp} varies in a chaotic way, and no OGR_{sp} -tendency can be inferred. The corrected OGR_{sp} also fluctuates, proving that the real produced fluid has varying properties from the day 42300 (Figure 4.63).

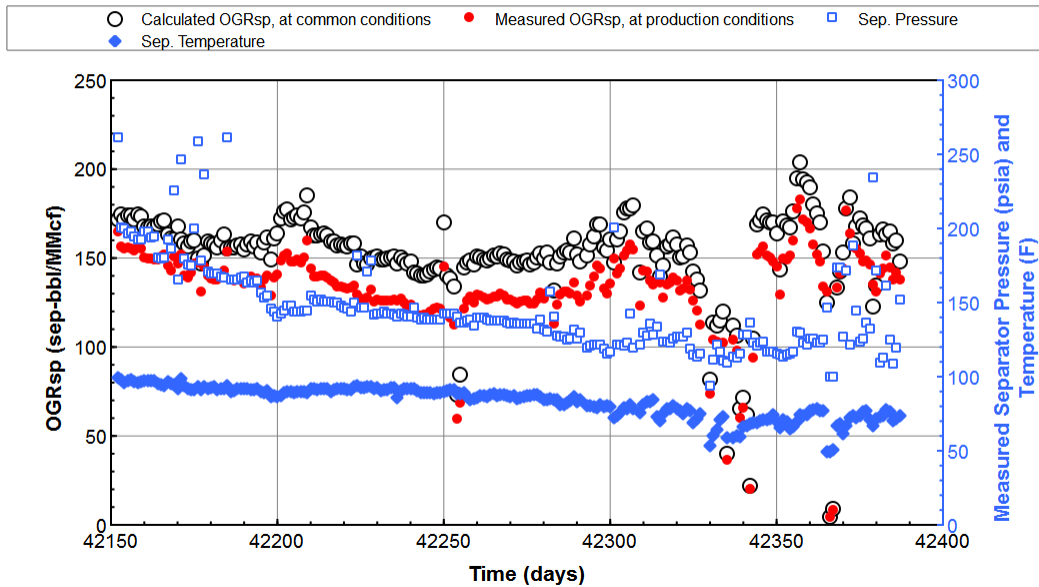

Figure 4.63: Continuous OGR_{sp} Variations, Well ID 10

Despite a constant temperature and a decreasing pressure, the measured OGR_{sp} (red dots) tends to increase. Based on this, actual OGR_{sp} must be increasing enough to counteract the decreasing separator pressure (that tends to decrease the OGR_{sp} measurement). Also, these high OGR_{sp} measurements are slightly affected by varying separator conditions.

Smoother OGR_{sp} Evolution The corrected OGR_{sp} can behave differently than the reported OGR_{sp} . When flashed at common separator conditions, the gain in consistency is enormous, as unphysical OGR_{sp} fluctuations are removed.

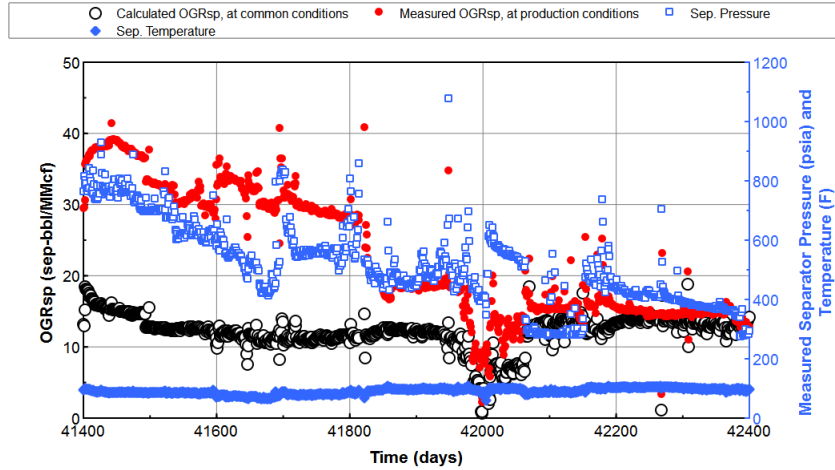

Figure 4.64: Continuous OGR_{sp} variations, Well ID 28

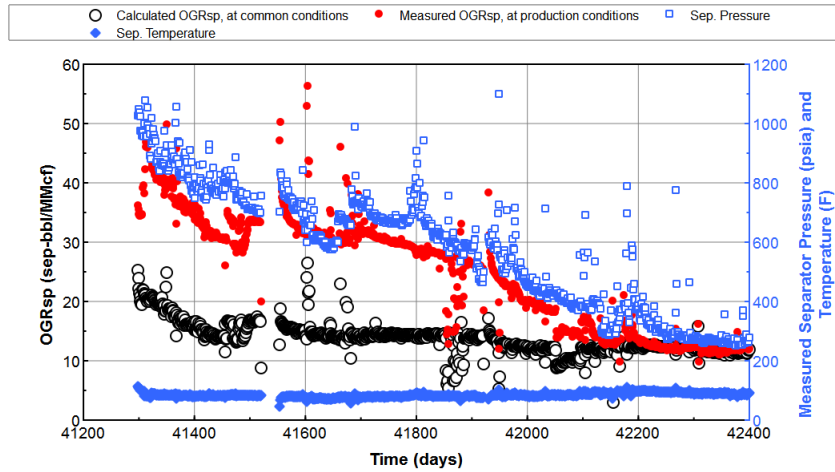

Figure 4.65: Continuous OGR_{sp} Variations, Well ID 30

For both Well ID 28 (Figure 4.64) and Well ID 30 (Figure 4.65), the pressure decrease causes OGR_{sp} to look like it is decreasing a lot, which is not due to real reservoir changes at all. The reprocessed wellstreams show that the OGR_{sp} behaviour is actually much smoother, and does

not vary as much as the measurements suggest. For Well ID 28, after correction, the OGR_{sp} decreasing is very gently.

While the OGR_{sp} seemed high for both wells, it is actually smaller (reduced by half), therefore the production is not as good as it seems. Indeed, less oil is produced from the same amount of gas (oil production is the most profitable).

Separator-gas Composition

Well ID 28 The separator-gas composition up to C_{7+} is matched during the wellstream generation. It can be reprocessed for the continuous data, indeed knowing the composition evolution can explain the behaviour of other PVT properties.

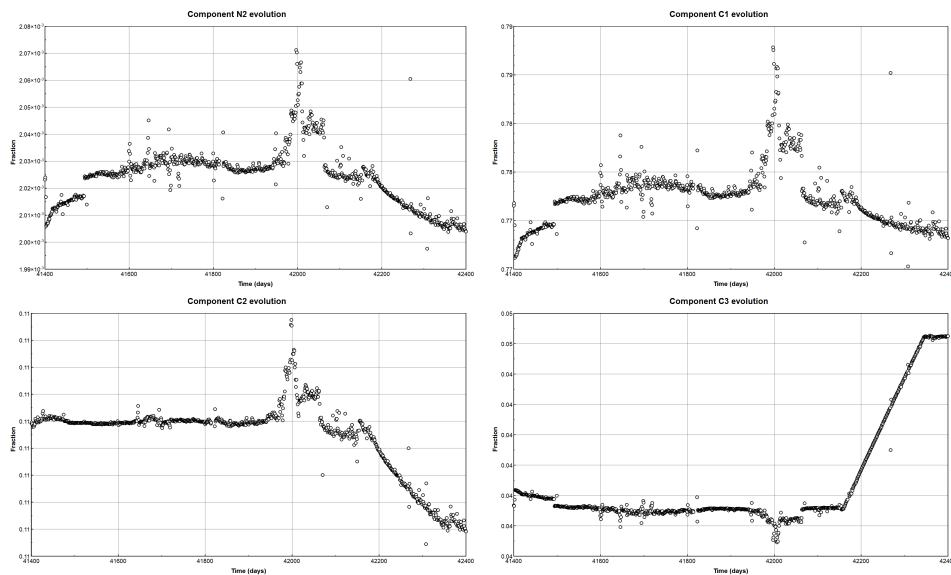

Figure 4.66: Continuous Separator Gas Light Composition Variations, Well ID 28

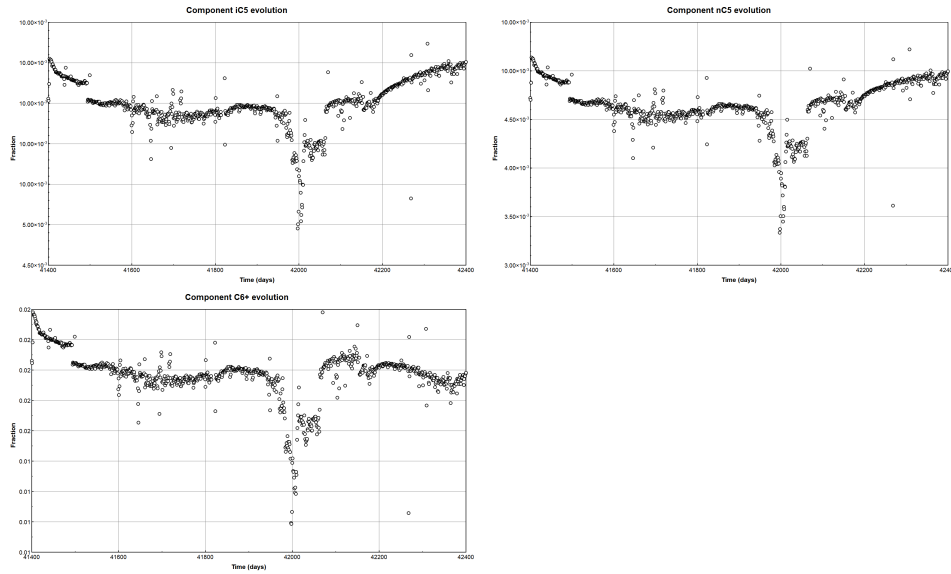

Figure 4.67: Continuous Separator Gas Heavy Components Variations, Well ID 28

Most of the component's molar fractions are constant; hence the composition does not evolve much for Well ID 28. This corresponds to the OGR_{sp} behaviour, which does not fluctuate much. The gas part “peaks” for a few months, near the day 42000: the fractions of the light components increase (Figure 4.66), and those of the heavy components decrease (Figure 4.67). Since the gas composition returns soon to its original status, it can be suggested that the peak is due to wrong measurements during a few months. For example, the flow meter may have been replaced or badly-calibrated for a few months, before the operator notices the error.

Even though the wellstream composition is reasonably correct, since it is adjusted to the continuous OGR_{sp} measurement, such an error in OGR_{sp} estimation propagates in all the re-processing, including the separator-gas composition. This is illustrated with the “peak” in the curves above.

Regarding the OGR_{sp} , the change might be due to the measurements and uncertainties, rather than due to an actual change in the reservoir.

The API variation for the produced oil of Well ID 28 confirms that the change near the day 42000 is not physical, but rather due to measurement uncertainties: API is strongly decreasing, suggesting that the produced oil is heavier.

All in all, for a short period of time, the oil would be heavier, the gas lighter, and more gas would be produced. Since all these data recover their original behaviour after a few months,

including the measured data, these changes seem to be non-physical (Figure 4.68).

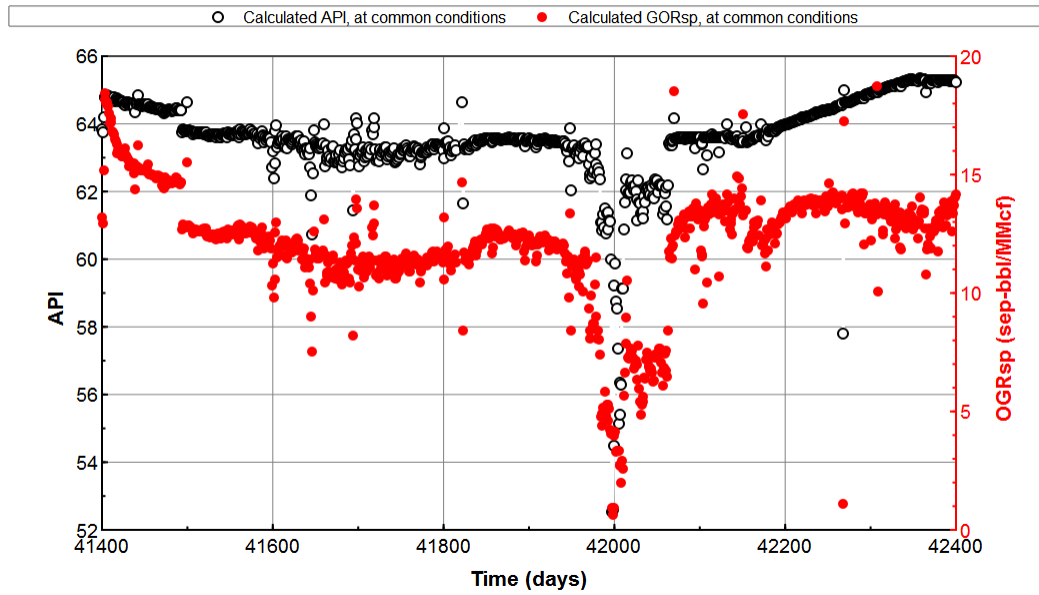

Figure 4.68: Continuous API Variations, Well ID 28

Well ID 6 Concerning the vapour phase of the produced fluid, the lighter components have increasing fractions with time (Figure 4.69); while the fractions of the heavier components decrease (Figure 4.70). This depicts a lighter gas.

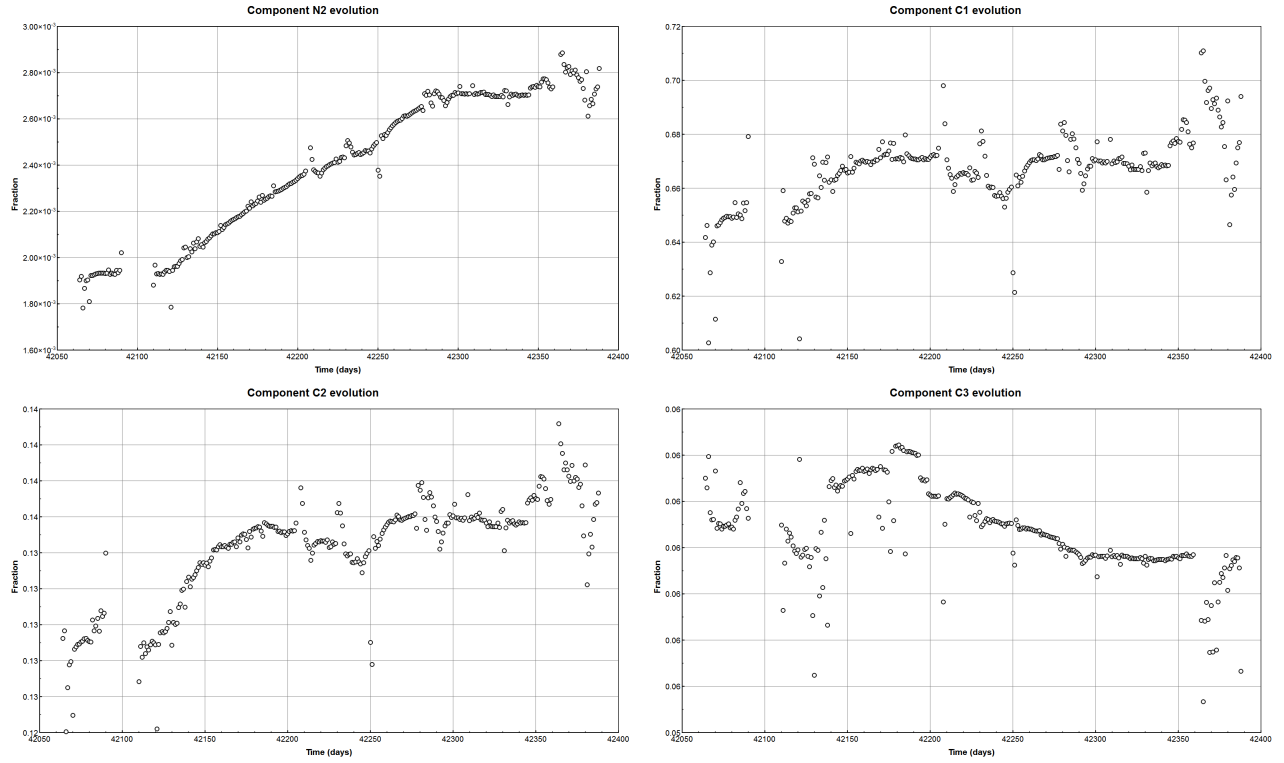

Figure 4.69: Continuous Separator Gas Light Composition Variations, Well ID 6

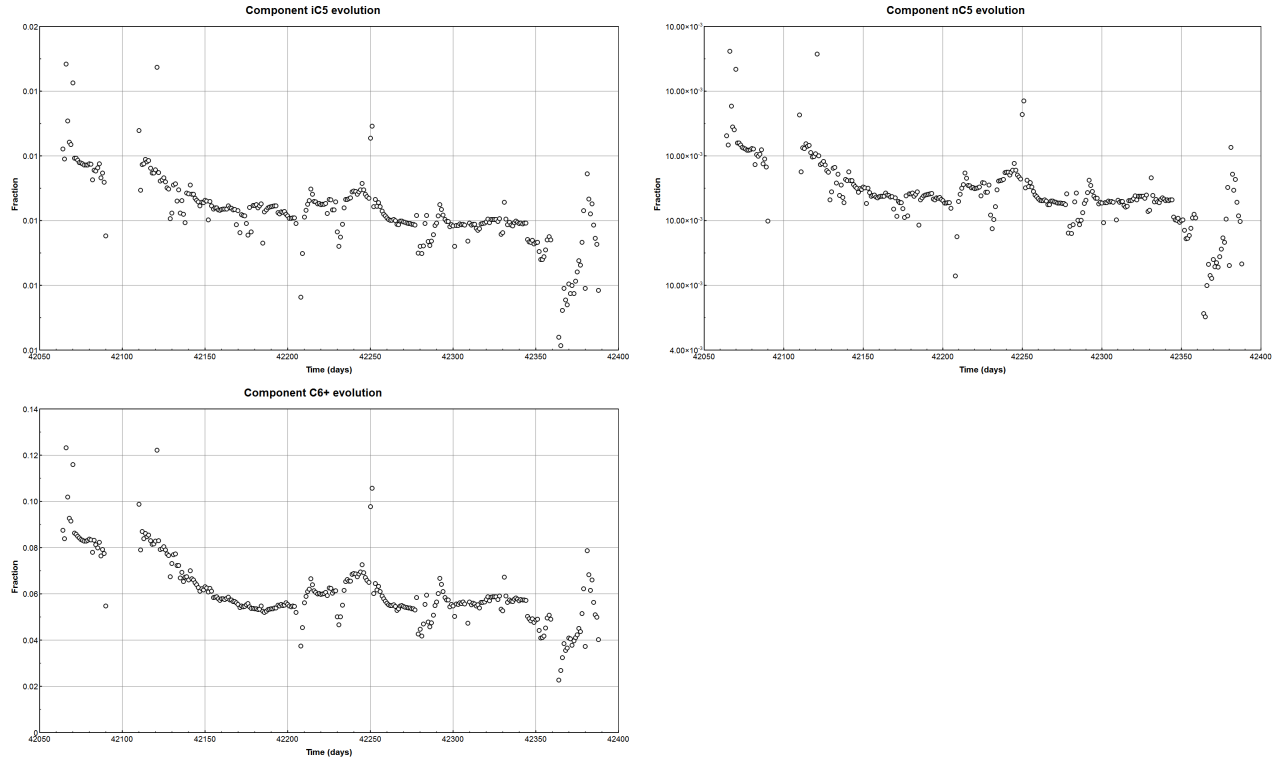

Figure 4.70: Continuous Separator Gas Heavy Components Variations, Well ID 6

The API density increases, meaning that the produced oil also becomes lighter. Since both the vapour part and the liquid part of the fluid are lighter, the produced fluid is lighter with time. This implies that the reservoir fluid becomes heavier, and that recovery might become challenging in the future (Figure 4.71).

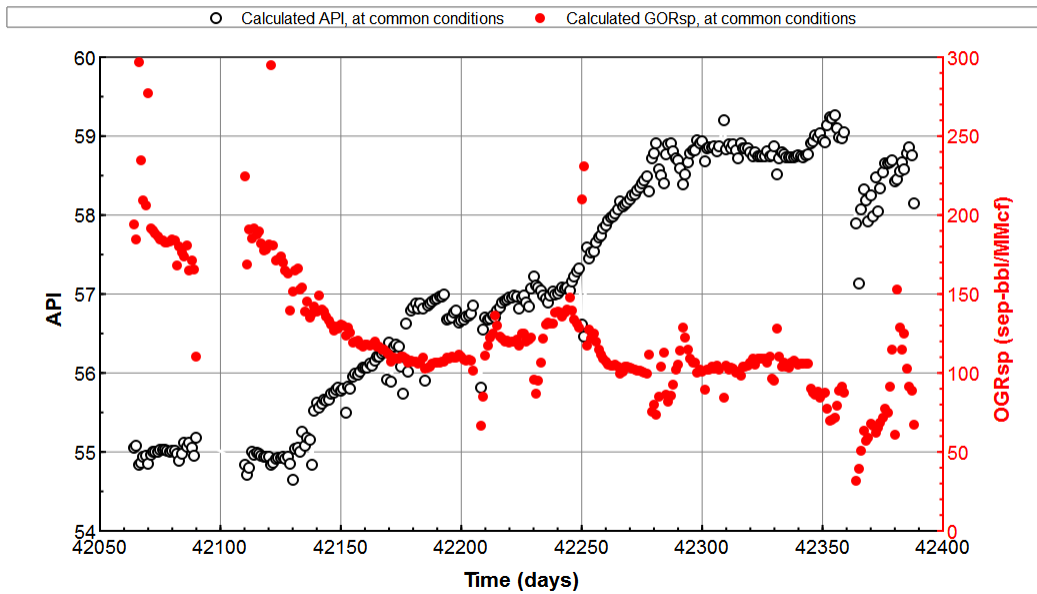

Figure 4.71: Continuous API Variations, Well ID 6

API

The API tendency reflects the evolution of the oil density: an increasing API means that the density decreases, hence that the produced fluid becomes lighter; a decreasing API depicts a heavier production.

Constant Oil Density Some wells have a constant API (± 1 °API): the oil density does not change with time. This makes the treatments on the surface easier, but does not mean that the exact same fluid is being produced. As seen above, the produced fluid from the Well ID 10 varies significantly from the day 42300 (Figure 4.72), together with the OGR_{sp} and the gas composition (Figures 4.73 and 4.74). This chaotic behaviour may reflect transient effects, due to break-through, fluid injection, or the start of any EOR (Enhanced Oil Recovery) technique.

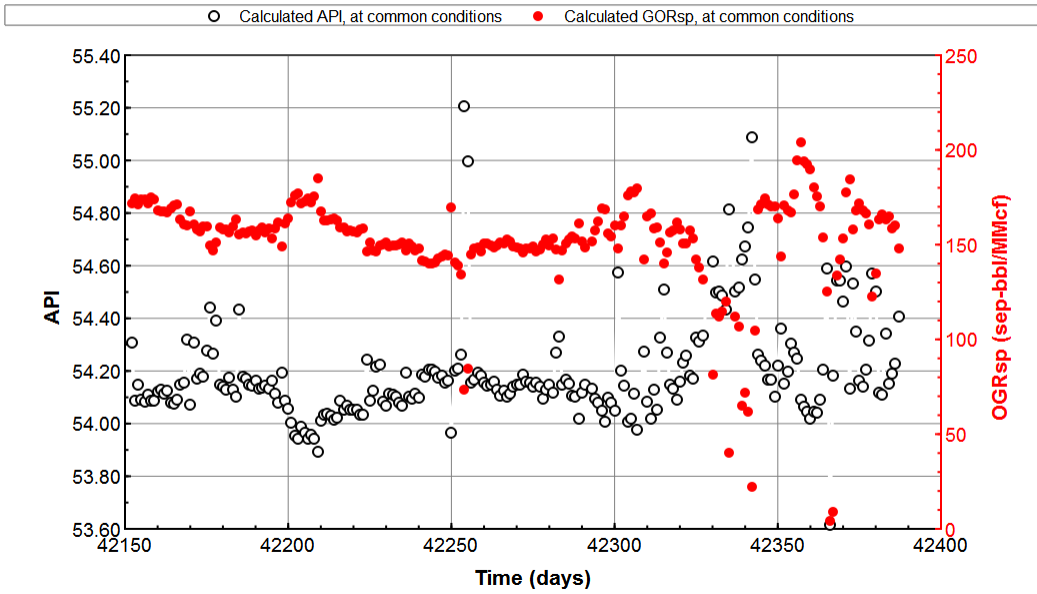

Figure 4.72: Continuous API Variations, Well ID 10

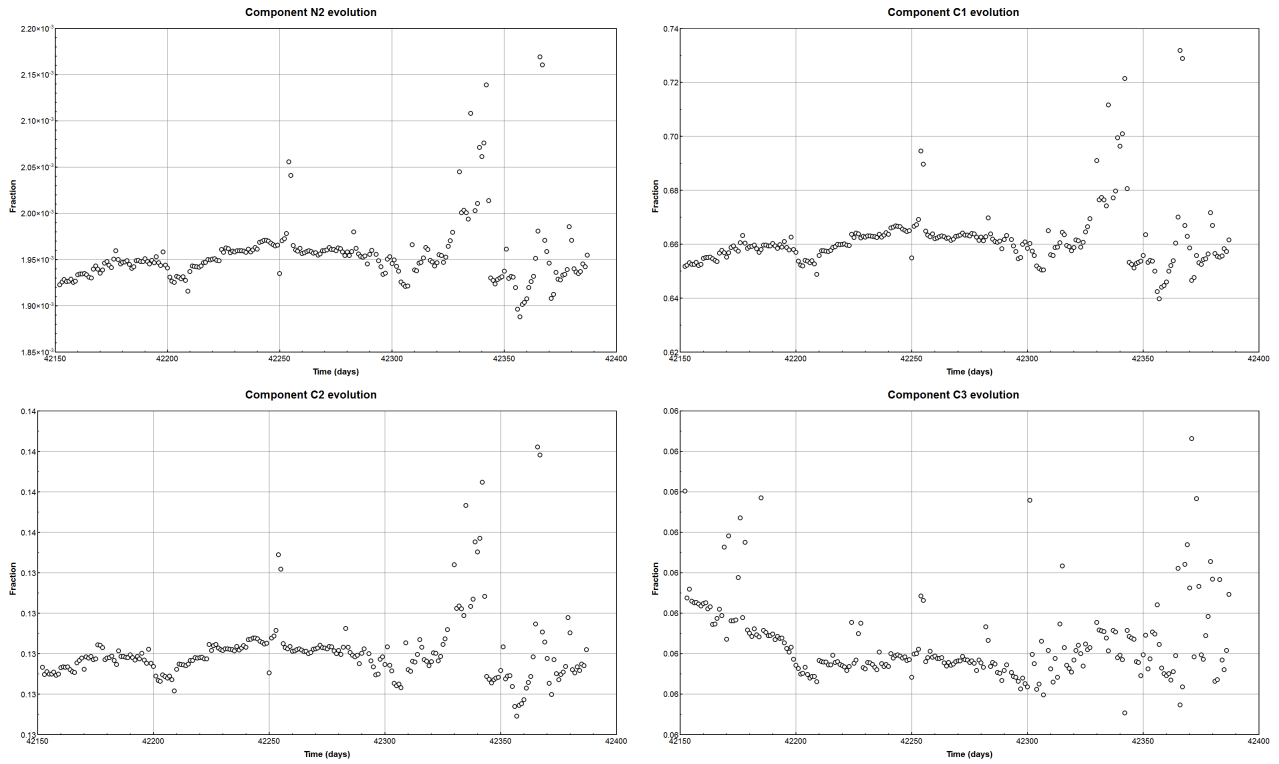

Figure 4.73: Continuous Separator Gas Light Composition Variations, Well ID 10

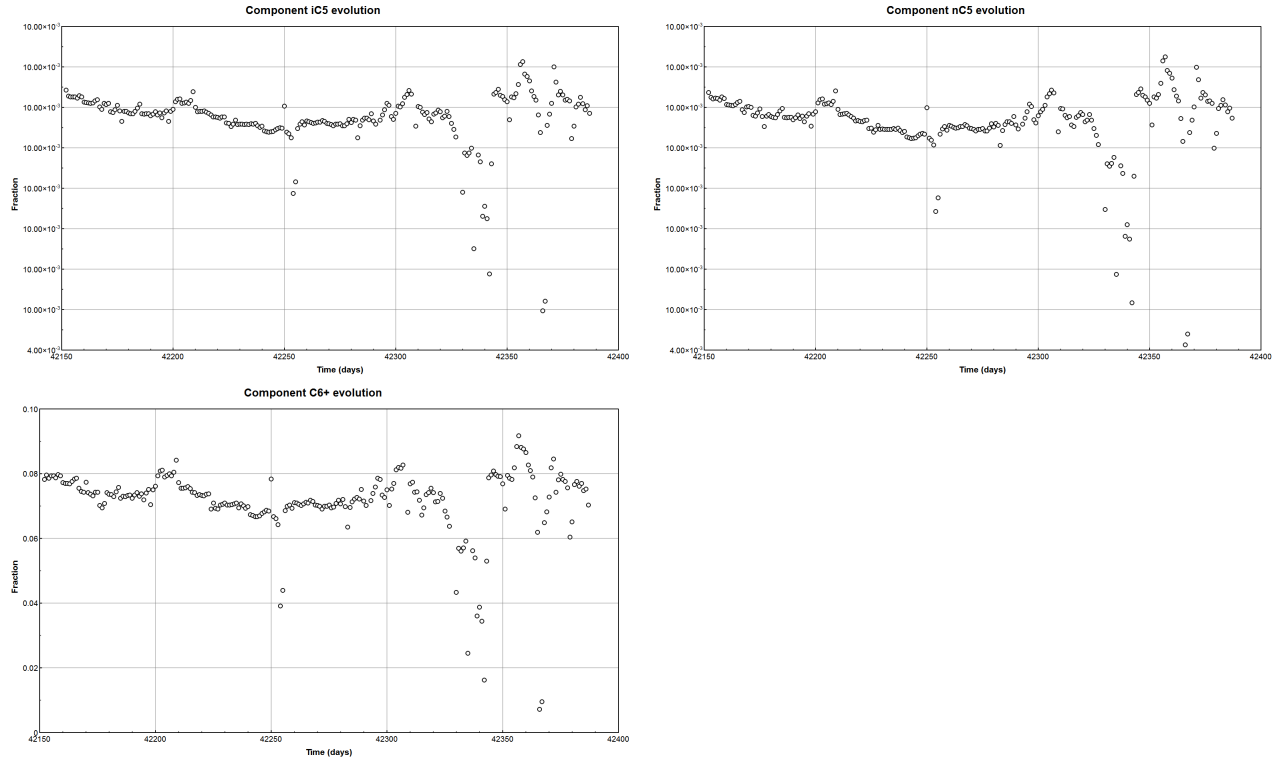

Figure 4.74: Continuous Separator Gas Heavy Components Variations, Well ID 10

This can be noted from several other wells.

Decreasing Oil Density The fluid produced by some wells becomes lighter, as can be seen on both the API evolution (for the liquid) and the separator-gas composition (for the gas) (Figure 4.75).

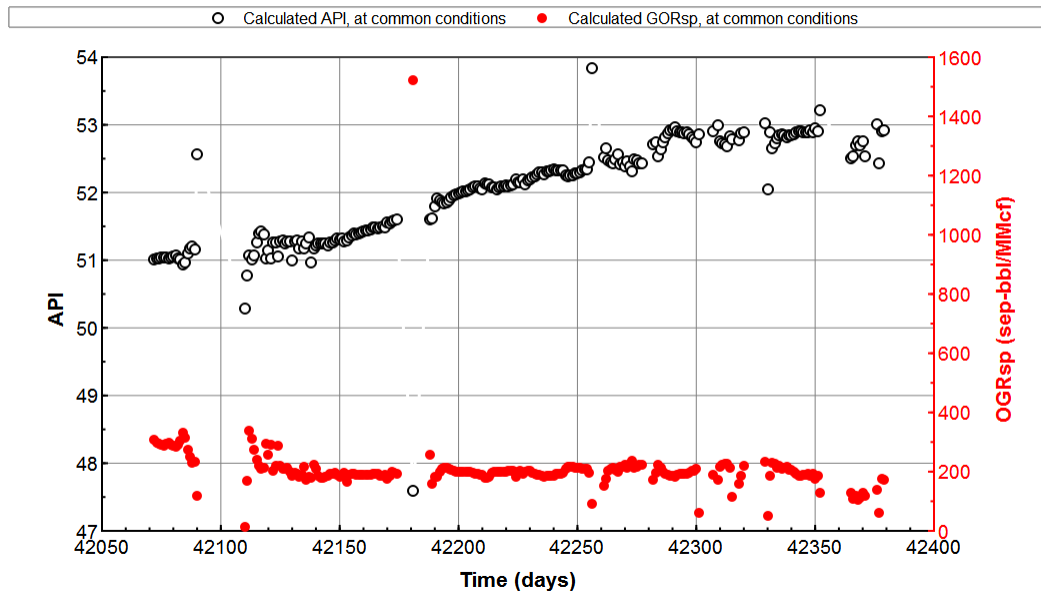

Figure 4.75: Continuous API Variations, Well ID 4

The light-components fractions tend to increase, while the heavy-components fractions diminish (Figures 4.76 and 4.77).

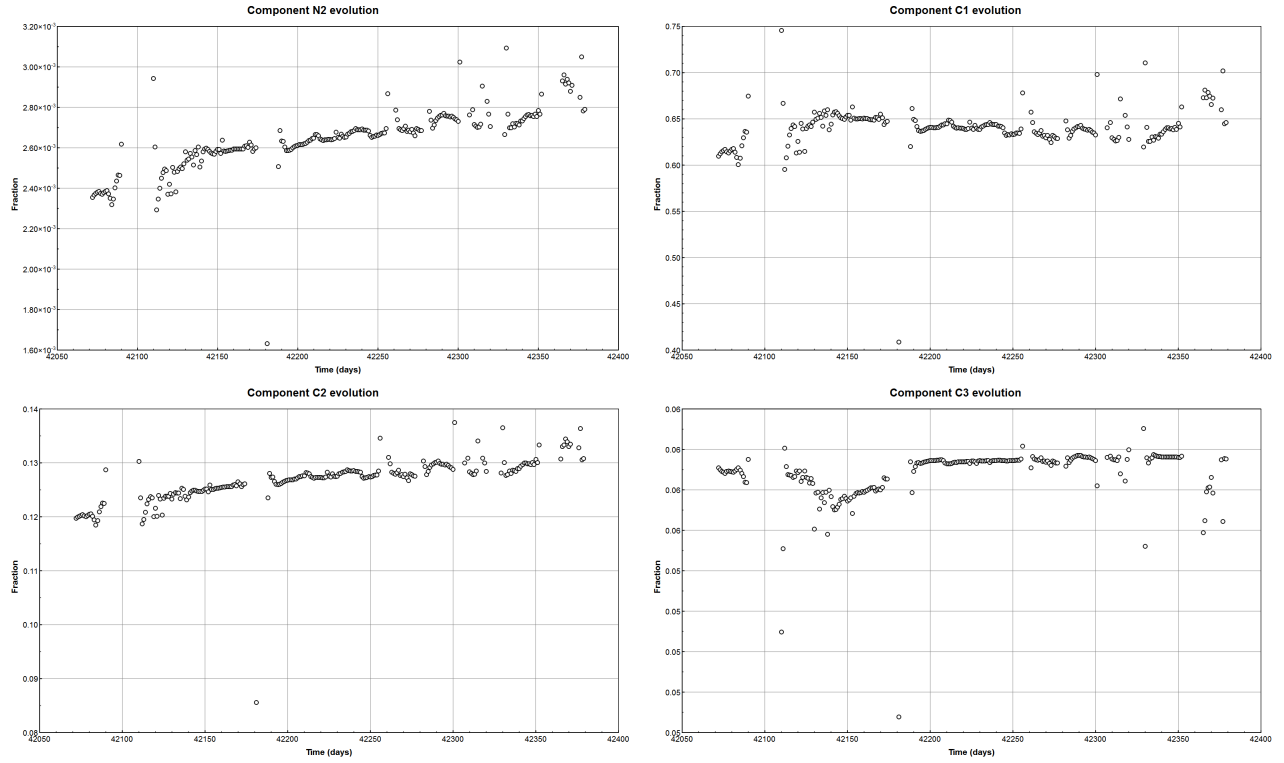

Figure 4.76: Continuous Separator Gas Light Composition Variations, Well ID 4

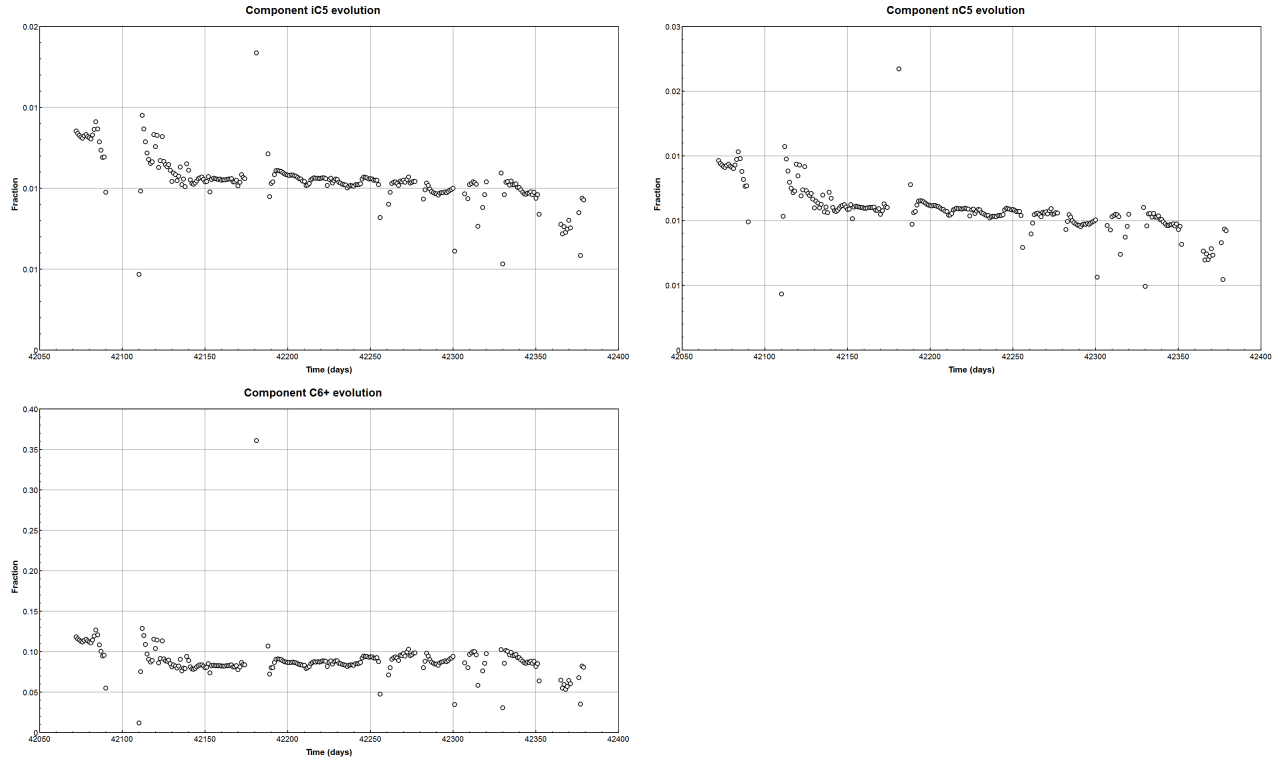

Figure 4.77: Continuous Separator Gas Heavy Components Variations, Well ID 4

It is important to remind that the composition represented here is the vapour part of the wellstream sample; while the API refers to the density of the liquid part.

At the beginning of the production, the most-mobile fluid is transported through the well. After some time, the fluid remaining in the reservoir is less mobile, and mostly its lightest part tends to travel to the surface (also for gravity reasons). This is why the density of the produced oil decreases, and it reveals that the fluid remaining in the reservoir becomes heavier. Some techniques might be needed in order to recover this heavy part. It will most likely consist of liquid, which generates more revenue.

Increasing Oil Density A similar API behaviour can be acknowledged from some wells (Figures 4.78 and 4.79).

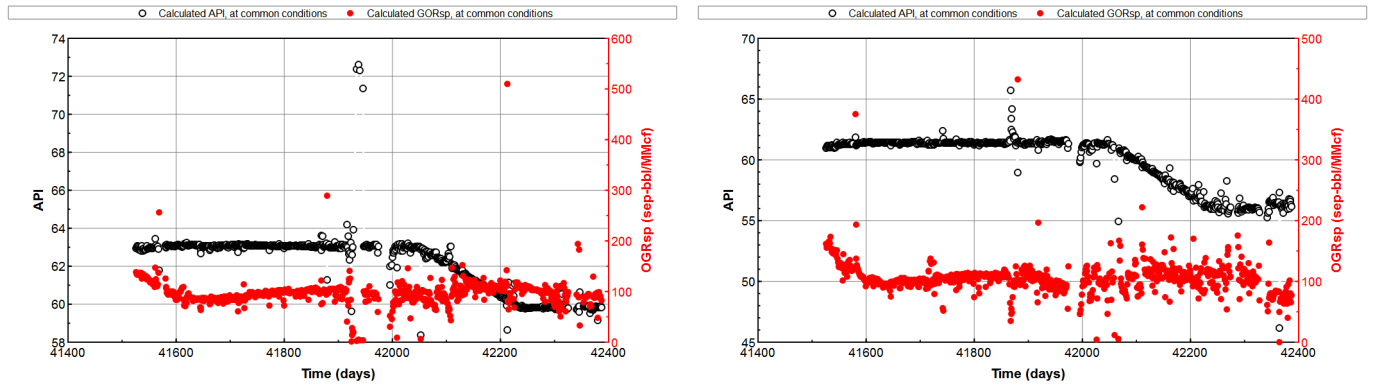

Figure 4.78: Continuous API Variations, Well ID 13 Figure 4.79: Continuous API Variations, Well ID 14

Around the same date (day 42050), the API decreases, revealing a heavier produced oil from both wells 13 and 14. The method used for continuous streams generation is noticeable here, with a linear interpolation. Both wells (Well IDs 13 and 14) also have the same separator-gas composition evolution. Since these two wells have been drilled close to each other, it is suggestive that they produce from the same hydrocarbon pocket.

From the explanation in the previous section, one may wonder why the density of the produced fluid increases with time. This is contradictory to a natural flow; and suggests that either the wellstream generation is not reliable (more periodic data would be necessary), or that the production has already been enhanced for the concerned wells. Enhancing the production means producing more oil, recovering the heavy components in the reservoir, and consequently producing heavier fluids.

Shrinkage Factor

From the continuous wellstreams, a two-stage separation computes the Shrinkage Factor of the oil, flashed from the common separator conditions (237.25 psia, 84.94 F) to the standard conditions (14.7 psia, 60 F). The reported SF (from the laboratory company) are represented on the same figure, at their reported separator conditions. As studied above, the method used by the laboratory company to estimate the SF is uncertain: the separation seems to be in several stages (four or five), while the real operations consist of two stages only.

In the industry, the classical procedure concerning the SF measurements is that the operator

considers it constant, until next update. Following are plot of the SF, both measured (hence assumed as a constant piecewise function) and calculated (continuous variations).

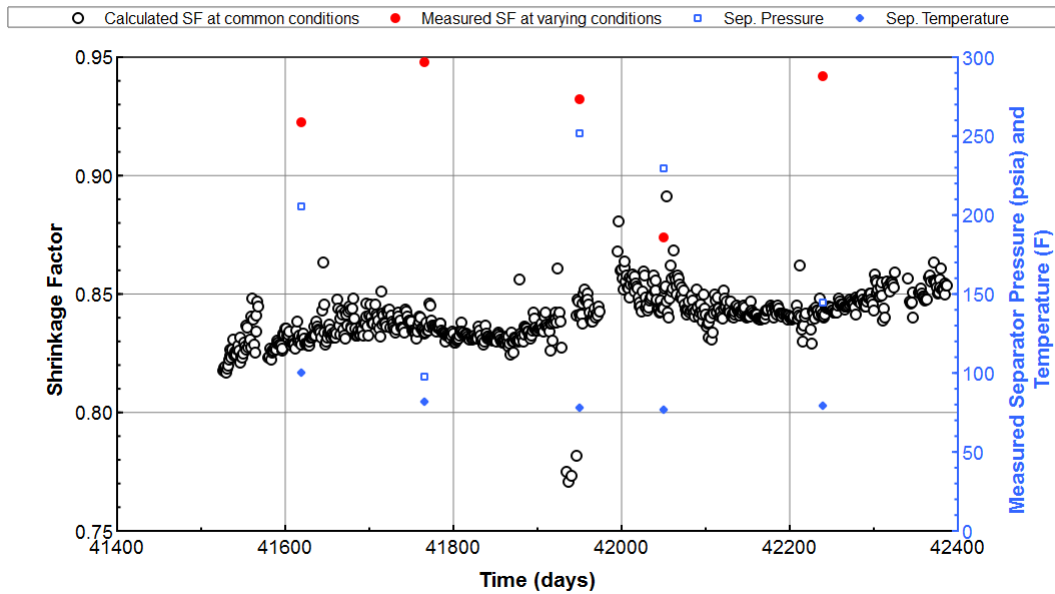

Figure 4.80: Continuous SF Variations, Well ID 13

Well ID 13 As seen in the section “Analysis with shrinkage factor”, the calculated SF’s have lower values than the values reported by the laboratory company (Figure 4.80). While the actual SF stays near 0.84 for the Well ID 13, the reported values fluctuate more, from 0.87 to 0.95.

For the date 41950, 42050, 42239, the separator temperature is the same. The separator pressure decreases significantly, which tends to increase the SF. But the reported SF decreases from the day 41950 to the day 42050, despite the decreasing pressure. This reveals that the real SF is decreasing in this period, which can actually be seen while studying the calculated SF at common conditions.

Despite the uncertainties, the general trend of the SF is captured in the reported SF (*i.e.* the reported SF increases when the real SF increases), but the variations and the values are wrongly estimated.

The real SF slightly increase over the three years studied: from the separator conditions to the standard conditions, less gas is released out of the oil, hence the produced oil is slightly more

stable. Using constant piecewise variations, the SF changes and interpretations would be much sharper.

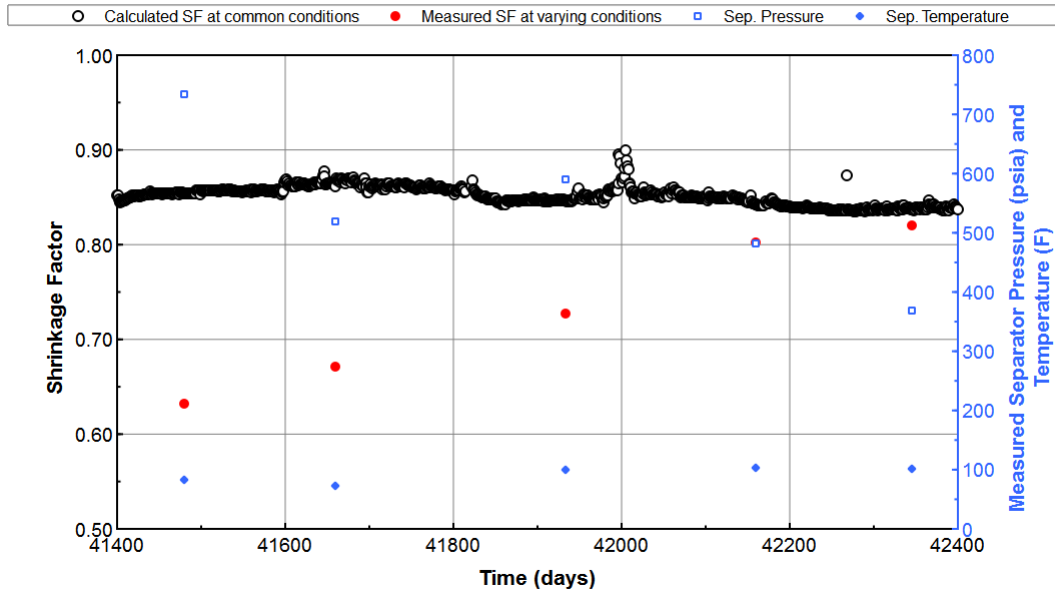

Figure 4.81: Continuous SF Variations, Well ID 28

Well ID 28 The reported SF evolution in Figure 4.81 suggest a highly-increasing SF (starting very low: 0.64), hence the produced oil would be more stable with time. While the separator temperature is almost constant, it does not impact the SF measurements. But the separator pressure decreases, which tends to push the SF up. When operating at constant separator conditions, and with a clearly-defined two-stage separation, the output SF is constant. Interpretations are biased by the varying separator conditions, and probably also by the procedure used for the laboratory SF estimations.

Assuming the exact same procedure is used to calculate the SF from Pipe-It and from the laboratory company, the SF values would still not match perfectly. Indeed, as stated above, the generated wellstream is not a perfect representation of what actually flows in the pipes. It has an intrinsic uncertainty, which spreads out when processing and calculating the SF.

Reservoir Behaviour

Having a compositional description of the wellstream on a daily basis is the most reliable support to interpret the reservoir behaviour, and to take the best decisions regarding the production and the asset management.

In addition, properties characterizing the reservoir fluid are calculated; these observations are another support for decisions:

- Wells producing from the same area are expected to produce a fluid with the same properties. If they vary significantly, faults or bad communication may be suspected. As an example, if the PVT properties of the produced fluid by a well are changing, while the fluids produced in the surrounding wells are not, this well might be producing from an isolated zone, or from several zones. The geometry around the wellbore can be discussed in this way.
- As discussed above, such a study documents the decision whether stimulating the reservoir or not. From a very limited amount of measurements, the API evolution can be estimated and forecast, therefore the density of the fluid in the bottomhole can be approached. According to this density, it may or may not be necessary to set up some EOR methods (gas lift for example) to produce the remaining fluid.
- Using the approach suggested here, both a thorough study of the production of a well, or of the production of a bunch of wells, is possible. Comparing the production of the wells, better understanding the behaviour of each well, and managing them individually becomes more consistent (*example*: if some are producing heavier fluid with time, the equipment may be adapted to keep optimizing the production).
- In theory, the OGR_{sp} and the API density are not correlated: the API describes the oil part of the fluid, independently from the proportions gas / oil (*i.e.* independently from the OGR_{sp}). No matter the amount of gas in the fluid, only the oil part is used to estimate the API density.
- While producing, the reservoir pressure decreases. Due to the gas compressibility, its density decreases. Hence, a lighter fluid is expected on surface.

4.6.5 Conclusion for the Continuous Streams Generation

From periodic well tests and limited sets of continuous measurements, it is possible to generate continuous reservoir wellstreams. Flashing them at common separator conditions provides the user with consistent and continuous sets of reservoir compositions. These sets are the basis for any production analysis.

The output OGR_{sp} and API variations depend upon the reservoir behaviour, and upon the production. Since the OGR_{sp} are measured, the variations can be compared to those of the calculated OGR_{sp} . It is not the case for the API values or the separator-gas composition, which are calculated only.

The API applying to the liquid part, and the separator-gas composition to the gas phase, it could be useful studying the compositional wellstream variations as well. The OGR_{sp} and API values confirm (Whitson and Brulé (2000)) that the wells produce from a retrograde gas-condensate reservoir in the Eagle Ford field.

The continuous OGR_{sp} measurements are used to refine the wellstream estimate; hence they impact the API and composition estimations. If these three parameters bring the same conclusions regarding the behaviour of the fluid, this behaviour can be assumed as physical. In case the conclusions are different (e.g. API suggesting a heavier fluid and separator-gas composition suggesting a lighter fluid), uncertainties and errors during the measurements must be even more considered.

Reflashing a stream at common separator conditions suggests a correction of the OGR_{sp} . Both oil rate and gas rates are affected by varying separator conditions, and their ratio is corrected. Though, it does not seem possible knowing to what extent each flow measurement was affected by varying conditions. Only the effect on their ratio is available.

Reservoir conditions are not used in this approach. Collecting them, and inputting them in the Pipe-It model would bring more consistency and would enhance the global understanding.

4.7 Uncertainties

Throughout the whole procedure, from well testing to reprocessing and back-allocating, the procedure is affected by multiple uncertainties. These propagate and may be of huge impact on

final results. As stated above, it is crucial having as-low-as-possible tolerances hence errors, and meanwhile being able to conduct measurements and calculations.

- The wellstream estimation is based on well tests. One must make sure that the wells are tested very periodically; three to six times a year is advised in the literature. The more frequent the tests, the better they catch up fluid behaviour.
- For the sake of the method developed here, well tests should provide both a gas analysis and a condensate analysis. In the example discussed above, 63 well tests are used to generate more than 24,000 streams, which is obviously not of best accuracy. The more well tests, the more updates of periodic streams, the better the estimation of continuous data. Besides, the analysis of two wells is not possible, as no complete well test was provided for any of these. In the above, interpolation is sometimes conducted between two very far dates (several months), which might not make lots of sense. During these months, a well may have been shut-in, water may have been injected, *etc*, and all this would not be taken into account.
- The Well Test Conversion technology is used to reflash the molar compositional rates. All its inputs are uncertain, to different extents:
 - The separator temperature and pressure are measured by tools, with a margin error;
 - The gas and oil rates (hence the OGR_{sp}) are flow-metered (tool acknowledged as uncertain);
 - The Equation of State PERA2013 used in this project is not optimum for the concerned wells. It is developed for the Eagle Ford area, but it is not expected to represent the reservoir accurately, as the wells of interest here were not used to develop the EOS.
 - The wellstream cannot be exactly reconstituted. PhazeComp iterates until a satisfying wellstream (regarding OGR_{sp} , API, separator-gas composition), but other properties such as SF are not matched. This approximation spreads out in any further processing, on all the data (*e.g.* the calculated API are slightly different from the actual ones). The stream used for processing is generated then refined by an OGR_{sp}

adjustment (recombination of gas and oil in different proportions). Despite the uncertainties discussed, it is still expected to represent the actual reservoir fluid quite accurately. The degree of freedom for this stream is considerably reduced by matching the three parameters.

- The reprocessing uses an EOS that has to be the same as for PhazeComp iterations. Since PERA2013 is not optimum, its poor accuracy impacts the procedure twice (streams generations and reprocessing).

4.8 Conclusion

In this section, the theory discussed in the previous chapters was implemented. While well tests report data at different separator conditions, the Well Test Conversion technology is used to convert them to common conditions, improving the consistency. The WTC requires several inputs, which influence is studied here. The separator conditions are of great impact on the measurements, so is the Equation of State. It is also crucial that the wellstream estimation is as accurate as possible. The method selected uses only complete well tests to generate a composition, and linear interpolation regarding time. Even with a high accuracy for the WTC inputs, the wellstream generation is not fully satisfying.

Reprocessing the periodic wellstreams at defined separator conditions highlights the fact that interpretations can be erroneous, if data are reported at changing separator conditions. An OGR that seems to be increasing may actually be decreasing; hence decisions for production optimization may be contradictory.

Generating a continuous wellstream database enables the tracking of each molar component on a continuous basis, and makes it possible to estimate some fluid properties from very limited data (periodic well tests and continuous flow rate measurements only). The degree of knowledge is considerably increased. Further processing, such as back-allocation, can then be conducted on these wellstreams. Hence, the accuracy of the compositional wellstreams generation is fundamental.

The flexibility of Pipe-It is highlighted in this project: the Equation of State can easily be changed for all the calculations; the estimation of the seed feeds can be switched from one

method (using complete well tests) to another (using incomplete well tests), so are separator conditions.

Nevertheless, the method proposed here is not optimum: some uncertainties remain regarding the wellstream estimation (the match is not perfect for all the available parameters, and the measurements themselves hold uncertainties and errors). Since the wellstream could not be exactly reconstructed:

- The OGR_{sp} , the API and the separator-gas compositions are not the very exact same values than the reported values.
- The SF and OGR_{cond} from condensate analysis estimations are even more uncertain, as the procedure for the measurement is not known. Consequently, any processing of the SF will consist in some intrinsic uncertainties. A better knowledge of how these values were measured is necessary, for an extended use of them in the wellstreams generations.

Chapter 5

Illustration of the Use of a Compositional Infrastructure

5.1 Issues

Both onshore and offshore, several HC streams can be commingled and share the process and transport facilities. While the properties of the total flow (sold) can be measured, those of each individual flow are unknown. For different reasons (reservoir management, production management, revenue sharing (Dahl)), it is useful to determine the production of each incoming source. Indeed, the relevance of the decisions strongly depends upon the quality of allocation (L. Saputelli, 2011). The results of allocation can also support other measurements or simulations, to better understand some behaviours of the field (which wells are still producing, what are the different gas-oil ratios, the water-cuts, *etc*) (Smith and Catto, 2015).

5.2 Proportional Allocation

The general procedure is that a total HC production is measured, together with individual well tests from the stream, before and after separation (oil rate, gas rate, density among others). Allocation consists in conciliating these measurements, to determine how much is coming from each contributing source (either well, formation, reservoir) Q_i , so that, when all flows are commingled (to the process facility, to the pipeline, to a tanker), $\sum_{i=1}^n Q_i = Q_{total}$ (MilanStanko).

Different methods are used, to allocate in the oil and gas industry. They depend upon the available data: pressure, temperature, well tests (Forrester).

The *proportional* allocation (Wikipedia) takes into account the fact that measuring the rate from each well is difficult (given the harsh temperature and pressure conditions, and the high uncertainties with flow meters).

From an estimate of each well production (theoretical, from reservoir simulation, or using well test rates) and an actual measurement of the total production, the flow rate of each well (either gas or oil) is normalized by:

$$Q_i = Q_{i,estimated} \cdot AF_i \quad (5.1)$$

The Allocation Factor of well i (AF_i) is calculated differently with the method.

Consequently, proportional allocation assumes that the exact same fluid is produced from all the sources, no matter if different fluids are produced from each well. Besides, the uncertainty of each flow meter is assumed identical.

Also, if one well rate estimation is wrong (*e.g.* due to a slight measurement error), it impacts the whole allocation estimation (R. J. Lorentzen, 2010).

5.3 Case when Continuous Well Test Data are not available

The original template is made of numerous wells, in the Eagle Ford area. The wells do not flow necessarily to the same gathering facility (called “CDP”: Central Delivery Point), but they flow to a pipeline that might distribute the flow to more than one CDP. Here is the main challenge for the allocation in this asset: the flows are not unidirectional but depend on the pressure differential. This study focusses on one specific zone of the Eagle Ford field acreage, with twenty wells flowing to one isolated CDP (Area B, presented above). Since all the wells flow to the same CDP, the process was easier to implement.

The Company ordered PVT studies of the wells. These consist of a gas analysis, and a condensate analysis (the problem is described in 3.4.2). The Company also measures the production data, *i.e.* gas and oil rates every day, with the separator conditions. The challenge in this study is that well tests are available *periodically* only, while the production data was measured

continuously. Two other industry standards for such a back-allocation are presented in the Appendix.

5.3.1 Petrostreamz Back-allocation: Using WTC and Integrating the Processes for each AF calculation

Background and Motivations

The allocation methods often proposed in the industry (see the Appendix) assume that the exact same fluid is produced from each well, which is not true in most of the cases. Indeed, even though wells can be producing from the same reservoir or pocket, they might be more or less influenced by nearby injection wells, by different EOR techniques, by fractures *etc* that will all affect the produced-fluid composition. DrillingInfo Services and IHS distribute the total reported production, with splitting factors varying according to the available data. The method proposed by Petrostreamz uses a compositional modelling of the produced wellstreams, which is obviously more consistent and makes a better use of the well test data.

Besides, in the classical proportion-based allocation approach, the several processes on surface are not taken into account for the calculations. The well test rates are immediately used to calculate the allocation factors, together with the total fiscal production rate.

Moreover, well tests were conducted at different separator conditions (temperature and pressure), which can lead to wrong interpretations. A well can seem to be a good oil producer (high OGR_{sp}) at given conditions, but it is actually a poor oil producer at a common set of separator conditions. Hence, it seems necessary to “correct” the measurements regarding the separator conditions.

Description of the Method

Proportional-based allocation is used, but the allocation factors are calculated in a different way, using more data from the well tests (Figure 5.1).

The procedure for allocation is as follows:

1. The most accurate seed feed library is generated.

2. The seed feed is flashed at common separator conditions. Separator-oil and gas rates are then recombined to compute the molar rates per component, per well.
3. These molar rates from each source (wells) are commingled, according to the processing of the facility, using a simulation software (such as HYSYS). The commingling can be achieved either before the processing (summing the molar rates per well) or after processing (summing the gas rates per well, and the oil rates per well).
4. The final outputs of the model are the sales gas rate and oil gas rate. These are the ones used for the AF calculation.
5. The oil and gas rates of each well are then back-calculated from both the AF and the fiscal oil and gas rates.

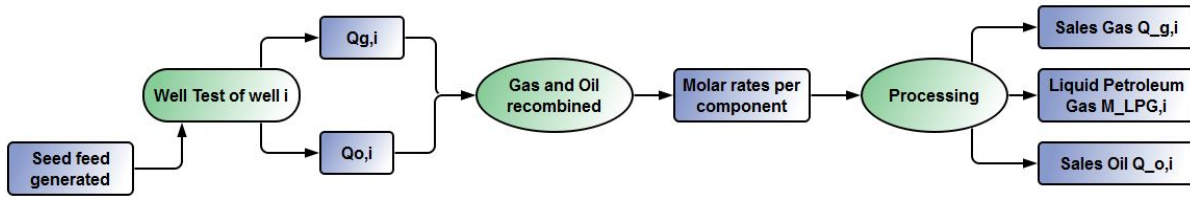

Figure 5.1: Back-allocation Method

IHS method (5.5) is based on well tests only:

$$AF_{oil,i} = \frac{Q_{oil,i}}{\sum_{i=1}^n Q_{oil,i}} \quad (5.2)$$

$$Q_{oil,i,allocated} = AF_{oil,i} Q_{oil,total} \quad (5.3)$$

Petrostreamz uses moles, simulates the actual processes and considers the sales oil, for each AF calculation (Petrostreamz).

$$AF_{oil,i,processed} = \frac{Q_{oil,i,processed}}{\sum_{i=1}^n Q_{oil,i,processed}} \quad (5.4)$$

$$Q_{oil,i,allocated} = AF_{oil,i} Q_{oil,total,fiscal} \quad (5.5)$$

This compositional analysis is based on the quantitative and qualitative information provided in the well tests: they are used for both rates and composition information. Therefore, it is extremely crucial that well tests are frequent enough and reliable.

To sum up, the proportion-based allocation proposed by Petrostreamz uses more-consistent AF calculations than the methods described above, since they take the processing into account, and are made at common conditions.

5.3.2 Conclusions

- Back-allocation is crucial for better knowledge of the production facilities. By determining the production at a lower level, it is possible to enhance the reservoir management and to optimize the production, by allowing each well to produce more or less.
- Back-allocating the production on a continuous basis can be achieved using periodic well tests. Several methods can be found in the industry. Petrostreamz proposes an improved back-allocation, taking the processing into account, and working with molar rates. The results of the back-allocation are then more consistent.

Chapter 6

Suggestions and Conclusion

6.1 Suggestions for Further Work

- The whole model relies on well tests. They need to be collected with better accuracy: an increased frequency and tests conducted by the same laboratory company are suggested. All wells must be sampled, and all the well tests need to be complete (simultaneous gas analysis and condensate analysis for all samples). Seed feeds would then be more reliable.
- The processing and calculations can be significantly improved, by improving the quality of the WTC inputs. An available EOS was used, which is assumed to represent the Eagle Ford area. A more-adapted EOS can be used:
 - The operator could input its own EOS, if such EOS was developed specifically for the studied wells.
 - If such EOS is not available, a theoretical one can be developed, based on PVT information. A sensitivity analysis on properties such as API, *GOR*, or SF would reveal a better or worse match, hence whether it is a more-adapted EOS for this field.
- Forecasting the production of each well (from rates only) can be conducted, using this compositional infrastructure.
- The correlations between API density and separator conditions show encouraging results. The wellstream composition can be taken into account, to make this correlation more

consistent. Such work does not seem relevant on OGR_{sp} .

- A reliable QC of the method would be building the actual CDP, commingling the streams, and comparing the total gas and oil rates to the total rates reported.
- A complete study of the back-allocation methods could be conducted, when only periodic data are available. This would estimate the degree of improvement brought by Petrostreamz approach, from the reservoir to the sales.

6.2 Conclusions

- A compositional infrastructure was built, from periodic well tests. It enhances the understanding of the flows and of the reservoir behaviour. The generation of compositional wellstreams is crucial, as it dictates the processing and calculations. Efforts were put to build the seed feed library as accurate as possible.
- The Company reports variations in the OGR_{sp} , and wants an accurate interpretation of these variations. It was shown that part of the OGR_{sp} fluctuations is due to varying separator temperature and pressure, at the time of the test. These variations are not expected, and might lead to wrong judgment and wrong decisions on the production. Other measurements (API, SF among others) are also influenced by varying separator conditions.
- The software Pipe-It and the Well Test Conversion technology developed by Petrostreamz make it possible to estimate the molar compositional rates from the periodic well tests, a very into-detail view of the stream. A first estimation of the wellstream is corrected, matching several measurements. This corrected wellstream can be reprocessed at varying separator conditions and through any surface facility, to reproduce the conditions of the well test, or to have data at another set of separator conditions. Obtaining the OGR_{sp} variations with fixed separator conditions enables a consistent comparison, and efficient reservoir and production management. The results are positive (regarding the reported data), validating the suggested procedure.
- The continuous production database is generated from periodic wellstreams. Before any

processing, studying the variations of the fluid composition per well is substantial. For a given well, an OGR_{sp} measurement and the date are enough to assign molar compositional rates, that are updated according to the periodic database generated.

Therefore, it is possible to estimate different fluid parameters (the API density, the composition of the wellstream or of the separator gas among others) from very limited information, and on a continuous basis. This avoids major spending for continuous and not-reliable measurements.

When forecasting the gas and oil rates, the OGR_{sp} is known, hence the API and other properties (composition of the separator-gas, Shrinkage Factor) can be forecast. A correlation is suggested for the API density variations, with separator conditions.

Wrong decisions may be taken if relying only on the measured OGR_{sp} . The OGR_{sp} behaviour is different once the influence of the varying separator conditions is removed. Suggestions over the mighty communication between the drained areas, and conclusions over the reservoir behaviour can be made. For most of the wells studied, the density of the produced fluid decreases along the production, which reveals a heavier fluid remaining in the reservoir. EOR techniques might be needed to recover it.

- Allocating the production, using the proportional-based method, can be enhanced if using such a compositional infrastructure. The allocation factor integrates the whole processing, and molar rates (generated from periodic well tests) are used. This makes the back-allocation to a well-level more consistent.
- To sum up, having accurate well tests measurements is essential for the sake of consistency and accuracy. Nevertheless, some measurements can be avoided and instead, experiments conducted on models. The results are more accurate, and not influenced by the same uncertainties. Additionally, they are quicker and cheaper to obtain.

Appendix A

Acronyms

AF Allocation Factor

API Liquid density in °API (American Petroleum Institute)

BTU British Thermal Unit

CCE Constant Composition Expansion

CDP Central Delivery Point

Cf Cubic feet

CVD Constant Volume Depletion

DLE Differential Liberation Expansion

EOR Enhanced Oil Recovery

EOS Equation Of State

f_g Gas molar fraction

GOR_{cond} Gas-Oil Ratio of the separator oil flashed at standard conditions (Mscf/STB)

GOR_{sp} Gas-Oil Ratio of the wellstream flashed at separator conditions (Mscf/sep-bbl)

HC HydroCarbons

IAM Integrated Asset Modelling

MM Million

MPFM MultiPhase Flow Meter

MTS Multiphase Test Separation

OGR_{cond} Oil-Gas Ratio of the separator-oil flashed at standard conditions (STB/MMscf)

OGR_{sp} Oil-Gas Ratio of the wellstream flashed at separator conditions (sep-bbl/MMscf)

Oil-Gas ratio or Gas-Oil Ratio are used indifferently in the project. GOR were reported by the company, while regressions in PhazeComp are conducted on OGR.

p_{sc} Standard Pressure (14.7 psia)

PR Peng-Robinson Equation of State

p_{sp} Separator Pressure

PVT Pressure, Volume, Temperature

QC Quality Check

RK Redlich-Kwong Equation of State

RMS Root Mean Square

Scf Standard Cubic feet

SCN Single Carbon Number

SF Shrinkage Factor

SG Specific Gravity

SRK Soave-Redlich-Kwong Equation of State

STB Stock-Tank Barrel

T_{sc} Standard Temperature (60 F)

T_{sp} Separator Temperature (60 F)

WTC Well Test Conversion

Appendix B

PVT data

B.1 Extract from a PVT Report

Well tests are often conducted by oil and gas services companies (called “Laboratory Company”). They are provided to the operator as PVT reports. These are used for two purposes in this project:

- The recombined reservoir composition of wells from areas A and B are used to estimate the seed feed, as first attempt (3.3.1)
- The recombined reservoir composition of wells from the Eagle Ford field (including those from Areas A and B) are used to estimate the ratio molecular weight/density, used in 3.3.2

The composition is described up to C_{7+} , C_{11+} and C_{31+} for most of the available reports (from the same laboratory company).

Figure B.1 is an example of the different streams, with a C_{11+} description of the well ID 21 (Area A).

B.1.1 GPM Conversion to Separator-gas Composition

A .stm macro is used to calculate the composition of the separator gas up to C_{6+} , from the GPM values given in the gas analysis of the well test (3.3.2):

```
INSERT VARIABLE M_d_C2 END real
```

**COMPOSITIONAL ANALYSIS OF THE SEPARATOR GAS, OIL
AND MATHEMATICALLY RECOMBINED WELLSTREAM THROUGH C₇₊**

SEPARATOR GOR.....: 71537 Scf/Sep Bbl
SEPARATOR PRESSURE.....: 1200 psig
SEPARATOR TEMPERATURE.....: 116 °F

Component	SEPARATOR GAS		SEPARATOR OIL		WELLSTREAM	
	Mole%	* GPM	Mole %	Liquid Volume %	Mole %	* GPM
Hydrogen Sulfide	0.002	0.000	0.000	0.000	0.002	0.000
Nitrogen	0.066	0.000	0.039	0.013	0.066	0.000
Carbon Dioxide	0.754	0.000	0.344	0.176	0.747	0.000
Methane	80.718	0.000	28.622	14.601	79.792	0.000
Ethane	11.143	2.964	11.919	9.596	11.157	2.968
Propane	3.824	1.047	8.866	7.344	3.914	1.071
Iso-butane	1.044	0.340	4.155	4.090	1.099	0.358
N-butane	1.054	0.330	5.395	5.117	1.131	0.354
2-2 Dimethylpropane	0.022	0.008	0.064	0.073	0.023	0.009
Iso-pentane	0.452	0.164	3.907	4.304	0.513	0.187
N-pentane	0.286	0.103	3.502	3.819	0.343	0.124
2-2 Dimethylbutane	0.024	0.010	0.282	0.355	0.029	0.012
Cyclopentane	0.003	0.001	0.000	0.000	0.003	0.001
2-3 Dimethylbutane	0.016	0.007	0.270	0.334	0.021	0.008
2 Methylpentane	0.098	0.040	1.421	1.775	0.122	0.050
3 Methylpentane	0.054	0.022	0.898	1.103	0.069	0.028
Other Hexanes	0.000	0.000	0.000	0.000	0.000	0.000
n-Hexane	0.107	0.044	1.929	2.388	0.139	0.057
Heptanes Plus	0.333	0.143	28.385	44.912	0.832	0.405
TOTAL	100.000	5.223	100.000	100.000	100.000	5.631

Figure B.1: Example of a PVT Report

```
SET FORMULA M_d_C2=1.348028226
INSERT VARIABLE M_d_C3 END real
SET FORMULA M_d_C3=1.388079959
INSERT VARIABLE M_d_iC4 END real
SET FORMULA M_d_iC4=1.647204157
INSERT VARIABLE M_d_nC4 END real
SET FORMULA M_d_nC4=1.585254691
INSERT VARIABLE M_d_iC5 END real
SET FORMULA M_d_iC5=1.796899401
INSERT VARIABLE M_d_nC5 END real
SET FORMULA M_d_nC5=1.833108041
INSERT VARIABLE M_d_C6p END real
SET FORMULA M_d_C6p=2.109749789
```

```
INSERT VARIABLE y_C2_from_GPM END real
SET FORMULA y_C2_from_GPM= GPM_C2/(19.73*M_d_C2)
INSERT VARIABLE y_C3_from_GPM END real
SET FORMULA y_C3_from_GPM= GPM_C3/(19.73*M_d_C3)
INSERT VARIABLE y_iC4_from_GPM END real
```

```

SET FORMULA y_iC4_from_GPM= GPM_iC4/(19.73*M_d_iC4)
INSERT VARIABLE y_nC4_from_GPM END real
SET FORMULA y_nC4_from_GPM= GPM_nC4/(19.73*M_d_nC4)
INSERT VARIABLE y_iC5_from_GPM END real
SET FORMULA y_iC5_from_GPM= GPM_iC5/(19.73*M_d_iC5)
INSERT VARIABLE y_nC5_from_GPM END real
SET FORMULA y_nC5_from_GPM= GPM_nC5/(19.73*M_d_nC5)
INSERT VARIABLE y_C6p_from_GPM END real
SET FORMULA y_C6p_from_GPM= GPM_C6p/(19.73*M_d_C6p)

```

```

INSERT VARIABLE BTU_C1 END real
SET FORMULA BTU_C1=1012
INSERT VARIABLE BTU_C2 END real
SET FORMULA BTU_C2=1783
INSERT VARIABLE BTU_C3 END real
SET FORMULA BTU_C3=2557
INSERT VARIABLE BTU_iC4 END real
SET FORMULA BTU_iC4=3354
INSERT VARIABLE BTU_nC4 END real
SET FORMULA BTU_nC4=3369
INSERT VARIABLE BTU_iC5 END real
SET FORMULA BTU_iC5=4001
INSERT VARIABLE BTU_nC5 END real
SET FORMULA BTU_nC5=4009
INSERT VARIABLE BTU_C6p END real
SET FORMULA BTU_C6p=5503

```

;these gross heating values come from Appendix A of the
SPE Phase Behavior Monograph

```

INSERT VARIABLE y_C1_from_GPM END real
SET FORMULA y_C1_from_GPM = (Dry_Gas_BTU - (y_C2_from_GPM * BTU_C2) -
(y_C3_from_GPM * BTU_C3) - (y_iC4_from_GPM * BTU_iC4) -
(y_nC4_from_GPM * BTU_nC4) - (y_iC5_from_GPM) * BTU_iC5) -
(y_nC5_from_GPM * BTU_nC5) - (y_C6p_from_GPM) * (BTU_C6p)) / BTU_C1

```

```

INSERT VARIABLE y_H2S_from_GPM END real
SET FORMULA y_H2S_from_GPM= 0

```

```

INSERT VARIABLE y_N2_from_GPM END real
SET FORMULA y_N2_from_GPM= (1 - y_C1_from_GPM - y_C2_from_GPM - y_C3_from_GPM
- y_iC4_from_GPM - y_nC4_from_GPM - y_iC5_from_GPM - y_nC5_from_GPM
- y_C6p_from_GPM) * 0.101592142632367

```

;0.101592142632367 is the average yN2/ynon-HC from the separator-gas analysis

```

INSERT VARIABLE y_CO2_from_GPM END real

```

```
SET FORMULA y_CO2_from_GPM= 1 - y_C1_from_GPM - y_C2_from_GPM - y_C3_from_GPM
- y_iC4_from_GPM - y_nC4_from_GPM - y_iC5_from_GPM -
y_nC5_from_GPM - y_C6p_from_GPM - y_N2_from_GPM
```

B.1.2 EOS PERA2013

The Equation of State is used (.chr format) in the wellstream generation and during the reprocessing (4.3). The other EOS used in this project (PERA2015 and EOS19) are also available on request.

B.1.3 PhazeComp Software

PhazeComp is a state-of-the-art software for PVT calculations, phase behaviour modelling and fluid characterization (Hoda and Whitson (2013)). It can simulate several PVT experiments (CCE, CVD, DLE among others), tune the EOS parameters and iterate a composition, in order to optimize the predictions of the experimental data (Technologies).

In the Pipe-It project discussed in this report, PhazeComp is integrated for a correct seed feed estimation that matches several parameters input, through three consecutive experiments (3.3.2). For each input stream, the PhazeComp template is updated, and iterations are run. The parameters are matched by experiment (according to Weighting Factors, see PhazeComp documentation) using multiplying factors, and the final converged composition is output.

Following are some parts of an example input and output file. The whole code can be provided on request.

B.1.4 Gawk Algorithms

Compiling the Streams

After PhazeComp iterations, a new wellstream has been generated. It is compiled to the list of already-existing streams using this procedure (section “Corrected wellstream composition available”):

```

BEGIN {
FS="\t" #how to separate each field (tab)
status=999
datenum = 42061
wellid = 11
k = 0
for (i=1; i<ARGC; i++) { #count of the arguments: 2
print "*** ", ARGV[i] #printed in the cmd line
}
outputfile = ARGV[2]
}

status==999 {
k= k+1
streamz[k] = $0
}

#Until the line "DATA", the lines are all saved in the vector "streamz"
(they are the headers of the STR file)

status==999 && $0=="DATA" {
getline
k= k+1
streamz[k] = $0
getline
k= k+1
streamz[k] = $0
for (i=1; i<=NF; ++i) header_index[$i]=i
status=0
}

#Status switched to 0 when we start reading the data
status==0 && $header_index["DATE"] == datenum &&
$header_index["WELL_ID"] == wellid {
for (i=1; i<=k; i++) {
print streamz[i] > outputfile #> outputfile
}
print >> outputfile #>> outputfile
status=1
next
}

#Adding all the other well tests

```

```

status==0 {
print >> outputfile
status=1
next
}

```

Generating a Continuous Compositional Rates Database

This procedure creates a table to assign a composition to any set of well + date (“Extended data”):

```

BEGIN {
FS="\t"
k=0
status=999
interpolate=1 #0 means no interpolation; to be chosen at the beginning
wellid=0
for (i=1; i<ARGC; i++) {
print ";*** ", ARGV[i], "\n"
}
print "; CNV file automatically created from the WTC of Well Tests data,
to feed the production database \n"
print "RESTORE DUMMY"
print "RESTORE EOS"
print "VARIABLE WELL_ID integer"
print "VARIABLE DATE integer \n"
print "CONVERT DUMMY FROM AMOUNT TO MOLES"

}

```

```

status==999 && $0=="DATA" {
status=1
getline
getline
for (i=1; i<=NF; ++i) header_index[$i]=i
getline
}

```

#interpolate = 1 : interpolation. The initial date of production for each well needs to be set, with the composition assumed as it is for first date of the well test

```

status==1 && interpolate==1 && $header_index["WELL_ID"]==wellid {
#the code reads the same well than previous line
#printing the current composition, with the current date
print "SET WELL_ID =" , $header_index["WELL_ID"] , " DATE =",
$header_index["DATE"]
printf("%s\t%s\t%s\t" ,"SPLIT","COMP01","H2S");
for(i=header_index["Moles H2S"]; i<=header_index["Moles C26+"];
i++) {printf("%s " , $i)}
print "\n"
wellid = $header_index["WELL_ID"]
}

status==1 && interpolate==1 && $header_index["WELL_ID"]!=wellid {
#the code reads a new well
#the initial date is set as 01/01/2000 = 36526
#printing the current composition, with the date 36526
print "SET WELL_ID =" , $header_index["WELL_ID"] , " DATE = 36526"
printf("%s\t%s\t%s\t" ,"SPLIT","COMP01","H2S"); for(i=header_index["Moles H2S"];
i<=header_index["Moles C26+"]; i++) {printf("%s " , $i)}
print "\n"
#printing the current composition, with the current date
print "SET WELL_ID =" , $header_index["WELL_ID"] , " DATE =",
$header_index["DATE"]
printf("%s\t%s\t%s\t" ,"SPLIT","COMP01","H2S");
for(i=header_index["Moles H2S"]; i<=header_index["Moles C26+"];
i++) {printf("%s " , $i)}
print "\n"
wellid = $header_index["WELL_ID"]
}

#interpolate = 0: no interpolation. The same composition is kept until next update
status==1 && interpolate==0 && $header_index["WELL_ID"]==wellid {
#the code reads the same well than previous line
#printing the previous composition, with the current date -1
print "SET WELL_ID =" , $header_index["WELL_ID"] , " DATE =",
$header_index["DATE"]-1
printf("%s\t%s\t%s\t" ,"SPLIT","COMP01","H2S"); for(i=header_index["Moles H2S"];
i<=header_index["Moles C26+"]; i++) {printf("%s " , vect_components[i])}
print "\n"
#printing the current composition, with the current date
print "SET WELL_ID =" , $header_index["WELL_ID"] , " DATE =",
$header_index["DATE"]
printf("%s\t%s\t%s\t" ,"SPLIT","COMP01","H2S");
for(i=header_index["Moles H2S"]; i<=header_index["Moles C26+"];
i++) {printf("%s " , $i)}

```

```

print "\n"
wellid = $header_index["WELL_ID"]
for(i=header_index["Moles H2S"]; i<=header_index["Moles C26+"];
i++) {vect_components[i]=$i}
}

status==1 && interpolate==0 && $header_index["WELL_ID"]!=wellid {
#the code reads a new well
#the initial date is set as 01/01/2000 = 36526
#printing the current composition, with the date 36526
print "SET WELL_ID =" , $header_index["WELL_ID"] , " DATE = 36526"
printf("%s\t%s\t%s\t" , "SPLIT","COMP01","H2S"); for(i=header_index["Moles H2S"];
i<=header_index["Moles C26+"]; i++) {printf("%s ", $i)}
print "\n"
#printing the current composition, with the current date
print "SET WELL_ID =" , $header_index["WELL_ID"] , " DATE =",
$header_index["DATE"]
printf("%s\t%s\t%s\t" , "SPLIT","COMP01","H2S");
for(i=header_index["Moles H2S"]; i<=header_index["Moles C26+"];
i++) {printf("%s ", $i)}
print "\n"
#saving this composition to keep it constant until next update
for(i=header_index["Moles H2S"]; i<=header_index["Moles C26+"];
i++) {vect_components[i]=$i}
wellid = $header_index["WELL_ID"]
}

END {
print "END"
}

```

Appendix C

Industry Standards for Back-allocation

The issue of back-allocation is discussed in Chapter 5. Different industry standards conduct the continuous back-allocation, from periodic well tests. The method used by Petrostreamz is presented in 5; here two other standards are introduced (DrillingInfo and IHS).

C.1 DrillingInfo Services: an upgraded proportion-based allocation

DrillingInfo Services is a global provider of data and technologies that helps solving challenging projects in the oil and gas industry ((DrillingInfo, a)). Each month, the Railroad Commission of Texas provides DrillingInfo Services with data (production data, pending data and well tests), that are input in an internal algorithm described below. These information, associated with an existing database of wells and lease, allocate the production. The database of wells and leases is constantly updated with the state of each well (coming into production, producing, shut-in, under maintenance, plugged).

Well tests (and pending rates) are used quantitatively only. In fact, like for the proportion-based allocation described above, allocated rates are normalized according to the well tests and pending rates. Well tests measure the amounts of gas, oil and water produced in 24 hours, and extrapolate it to a monthly estimation of the production (R. A. Gallun, 1993).

The total production is provided, so is the state of each well. According to the data provided

for a given well at a given month, different allocation methods can be used ([DrillingInfo](#), b):

- If only one well is in production, its production is that of the whole asset (red case)
- If the pending production is available, the monthly production of the well is assumed equal to it (purple case)
- If a well test is available, the monthly production is assumed equal to it (light orange case)
- If no updated information is provided (i.e. if no well test has been done on this well over the past month), the monthly production is assumed using the previous month allocation factor and the current month total production (dark blue case)
- If a jump in the total production is noticed, it is assumed that this difference is due to the new well in production (light blue case)
- If all wells have well tests, the monthly production is normalized, according to the proportional-based method introduced above
- An even allocation can also be implemented

The allocation proposed by DrillingInfo Services assumes that the same fluid is produced from each well, and relies on monthly updates (well tests, production and pending rates). This is a very discontinuous allocation. Within a month, the bottomhole conditions may vary significantly, and this method is not robust enough to account for short-time reservoir variations. Also, it strongly depends upon the previous month allocation, which is not the case in reality. The main advantage of this allocation procedure, though, is its flexibility in terms of input information: the allocation differs according to the provided data (pending rate, well test rate or nothing).

C.2 IHS

IHS (company giving critical information) is a provider of technical solutions for the oil and gas industry, with expertise in delivering accurate data. They propose an allocation routine for Texas and Louisiana (there are other regulations in the other states). The main target is the

conservation of volume: the total volume after allocation should be equal to the total volume before allocation (Smith and Catto, 2015).

It relies on periodic well tests (Initial Potential Tests for newly-producing wells), but as the method used by DrillingInfo Services, pending production data are used when well tests are not available. A well without well test or pending production is not taken into account in the allocation.

Like the method used above, IHS also has a database collecting the state of each well (producing or not, shut-in *etc*), that is called for allocation. Since Texan gas wells production already has to be reported per completion, allocation is only needed for oil wells in Texas.

The main asset of this monthly allocation procedure is that past results are also sensitive to updated changes: if the total unallocated production changes, or if new well tests are provided, or if new wells come into production, the rates of each well for previous months are corrected in order to fit with these new data.

IHS notices that small differences in the allocation might come from the well test data available, and not necessary from the actual reservoir performance. This shows how important it is, to have reliable and as-frequent-as-possible well tests; in order to limit the allocation deviations due to well test data. Allocation improves significantly with two well tests per year instead of one.

One of the weaknesses of such an allocation is the strong dependence upon the reservoir performance: the routine is more efficient with a stable production, while results deviate if new wells come into production.

IHS also acknowledges that production allocation is only a way of estimating the production at a lower level, but it cannot replace “good reservoir engineering practices” (Smith and Catto, 2015). In cases it is economically and technically possible to conduct all the measurements per well (or even per completion), these measurements should be done.

Once again for IHS allocation routine, like the method of DrillingInfo Services, periodic well tests are used only quantitatively, to scale up the production per well. The computed ratios are used, together with the total unallocated production, to allocate a global production per well, no matter the content of the fluid. All the potential information in the well test measurements (API, GOR, composition among others) are not used; while it could be of great help to gain significant

accuracy and understanding of the streams.

In a nutshell, the allocation routine used by IHS is similar to that used by DrillingInfo Services, in the sense that monthly well tests are crucial, and used only to split the total unallocated production, per well. Results are strongly dependent upon accurate well test data; and upon a stable reservoir behaviour. The main difference is that IHS routine focuses on oil wells, and is able to recalculate the prior allocation, according to new data.

Bibliography

Dahl, A. M. Multiphase Metering and Well Rate Estimation Methods for Field Allocation. <http://nfoqm.no/wp-content/uploads/2014/07/8-2014-06-05-Arne-Morten-Dahl-Kristin-Tyrihans-Field-Allocation.pdf>.

DrillingInfo. Services. <http://info.drillinginfo.com/services/>.

DrillingInfo. Texas allocated production data.

Forrester, D. Production allocation: Critical to the upstream energy industry but still mostly a manual process not well understood. <https://www.accenture.com/us-en/blogs/blog-production-allocation-critical-to-the-upstream-energy>.

Hoda, M. F. and Whitson, C. H. (2013). Well Test Rate Conversion to Compositional Wellstream. *Society of Petroleum Engineers, SPE 164334*.

KED Interests. Eagle Ford Shale. <http://eaglefordshale.com/>.

L. Saputelli, O. Oluwole, J. L. F. G. A. C. K. S. (2011). Infow Performance Identification and Zonal Rate Allocation from Commingled Production Tests in Intelligent Wells - Offshore West Africa. *Society of Petroleum Engineers, SPE 146991*.

Milan Stanko. TPG4230. Lectures of Field Development at NTNU, 2015.

Petrostreamz. Production allocation. <http://petrostreamz.com/portfolio/production-allocation/>.

R. A. Gallun, C. J. Wright, L. M. N. J. W. S. (1993). *Fundamentals of Oil and Gas Accounting*. Penn Well, 4th edition.

- R. J. Lorentzen, O. Sævareid, G. N. (2010). Soft Multiphase Flow Metering for Accurate Production Allocation. *Society of Petroleum Engineers, SPE 136026*.
- Smith, B. and Catto, D. (2015). *Allocated Production, White Paper*. IHS.
- Technologies, Z. Phazecom. <http://www.zicktech.com/phazecom.html>.
- Whitson, C. H. Molar Distribution. <http://www.ipt.ntnu.no/curtis/courses/PVT-Flow/Plus-Characterization/Molar-Distribution/>.
- Whitson, C. H. (1983). Characterizing Hydrocarbon Plus Fractions. *Society of Petroleum Engineers*.
- Whitson, C. H. and Brulé, M. R. (2000). *Phase Behavior Monograph*. Society of Petroleum Engineers.
- Whitson, C. H. and Sunjerga, S. (2012). PVT in Liquid-Rich Shale Reservoirs. *Society of Petroleum Engineers, SPE 155499*.
- Wikipedia. Allocation (oil and gas). [https://en.wikipedia.org/wiki/Allocation_\(oil_and_gas\)](https://en.wikipedia.org/wiki/Allocation_(oil_and_gas)).
- Wikipedia. Eagle Ford Group. https://en.wikipedia.org/wiki/Eagle_Ford_Group.