



NTNU – Trondheim
Norwegian University of
Science and Technology

Improved automated singulation of pelagic fish: Novel engineering and prior art construction

Design, Analysis and experiments

Aleksander Børresen Eilertsen

Master of Science in Engineering Cybernetics

Submission date: April 2012

Supervisor: Amund Skavhaug, ITK

Norwegian University of Science and Technology
Department of Engineering Cybernetics

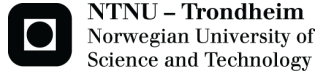

**IMPROVED AUTOMATED
SINGULATION OF PELAGIC FISH:**
NOVEL ENGINEERING and PRIOR ART CONSTRUCTION
DESIGN, ANALYSIS and EXPERIMENTS

ALEKSANDER EILERTSEN

MASTER THESIS in ENGINEERING CYBERNETICS
Trondheim, March 2012

Supervisor at NTNU: AMUND SKAVHAUG
Project support: SINTEF FISHERIES AND AQUACULTURE
Supervisor at SINTEF: BENDIK TOLDNES

NORWEGIAN UNIVERSITY OF SCIENCE AND TECHNOLOGY

Faculty: of Information Technology,

Mathematics and Electrical Engineering

Department: of Engineering Cybernetics

NTNU Norwegian University of Science and Technology

MASTER THESIS in ENGINEERING CYBERNETICS

**IMPROVED AUTOMATED
SINGULATION OF PELAGIC FISH:**
NOVEL ENGINEERING and PRIOR ART CONSTRUCTION
DESIGN, ANALYSIS and EXPERIMENTS

Faculty of Information Technology,
Mathematics and Electrical Engineering

Department of Engineering Cybernetics

Copyright © 2011/2012 Aleksander Eilertsen
All Rights Reserved NTNU and
SINTEF Fisheries and Aquaculture.

Master thesis written at NTNU, 2011/2012

Printed by TAPIR-trykk

Problem description

Today, anno 2012; weight estimation of fish at seas is a manual labor process. With the rapidly increasing use of technology and the economic benefits that automation brings - it is easy to conclude that the current solution of manual labor is not adequate: SINTEF Fisheries and Aquaculture has therefore started a research project on how to automate the process. As a part of this project has Aleksander Eilertsen, the institute for Engineering Cybernetics (at NTNU) and SINTEF Fisheries and Aquaculture joined efforts to construct a conceptual fish singulator. Fish singulation is more specifically a system used to orderly place all the individual fishes in a sample batch, readying them for weight estimation.

The task at hand will consist of a literature study - to understand the problems of fish weight-estimation at seas; an examination of established methods currently in use. Furthermore, this thesis will investigate novel methods for solving the challenge of weight distribution estimation aboard fishing vessels. A mechanical prototype and theoretical calculations will be included in the work conducted during this diploma.

Abstract

Automation: Reduce human interaction in processes or operations - so is the objective of this diploma. This thesis will examine a process within the fishing industry - where automation could be employed. In this project report the weight estimation of pelagic fish onboard trawling vessels is the focus.

A study of the current state-of-affairs is provided. Applicable solutions for automation of this process are discussed; and one part of the challenge of weight estimation at sea is addressed with a novel conceptual solution. Following this novel concept is the documentation of the design and realization of said idea. New concepts that have never been tried before are complicated to realize. Experiments on how to make the concept work has therefore taken place. A proof-of-concept has been constructed to test the hypothesis of the concept.

Final realizations of a scaled down prototype have been made. The prototype has been tested through experiments evaluating the performance of the novel solution. A discussion on what the next step in the process of creation should be, along with a reflection on the work conducted.

To ineffable dreams,
and their struggle for creation.

Digital-copy

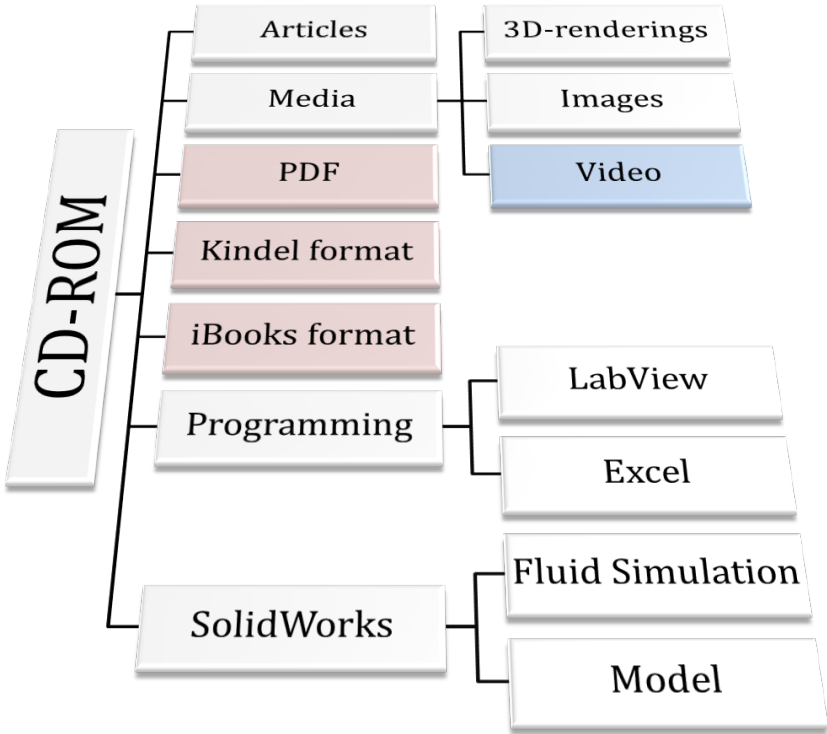

Acknowledgements

I want to acknowledge the help and support, as well as the belief in this project, shown by my supervisors: *Amund Skavhaug* at NTNU and *Bendik Toldnes* at SINTEF Fisheries and Aquaculture.

I express my appreciation for the research institute that has made this novel art investigation possible: Their willingness and support has made this project possible. I appreciate the discussions provided at *SINTEF Fisheries and Aquaculture* with: *Ida Grong Aursand*, *Morten Bondø*, *Ekrem Misimi*, *John André Fossum*, and *John Reidar Mathiassen*.

To my dad, *Knut Arne Børresen*, thank you for your advisements and support. My friends whom have provided valuable suggestions through reviews, as well as formidable editing - thank you: *Petter Norgren* and *Linn Ingrid Berggård*. *Hilde Ekrem*: Thank you for your support and encouragement through the long working nights, as well as advisory reviews.

Finally, I wish to thank the most important people of them all – my readers: Because without readers a project, or research paper, will never see the light of day.

Contents

Abstract	v
Dedication	vii
Digital-copy	ix
Acknowledgements	xi
Contents	xiii
List of Figures	xix
List of Tables	xxiii
I Introduction	1
1 Concept	5
1.1 Scope	6
1.2 Economy	6
1.3 State-of-art	10
1.4 Idea	11
1.5 Parameters	14
2 Motivation, aims and report outline	21
2.1 Aim of the Project	21

2.1.1	Preliminary aims	22
2.2	Outline	22
II	Concept idea	25
3	Concept overview	27
4	Weight estimation	37
4.1	Flow scale	37
4.2	Vision estimation	40
5	Singulator concepts	45
5.1	High-speed singulator conveyor belts	47
5.2	Other singulator systems	51
5.3	Pick-and-place	52
5.4	Novel ideas	54
5.4.1	Drop-in vision	54
5.4.2	The whirlpools	54
6	Concept choices and dicussion	59
6.1	The Estimator conclusion	59
6.2	Discussion of the Organizer	60
6.3	Conclusion of the Organizer	62
III	Hardware and Software	63
7	Hardware	65
7.1	Conveyor	65
7.2	Volumetric measurer	67

8	Software	69
8.1	SolidWorks	69
8.1.1	SolidWorks Fluid Simulation	70
8.2	Excel	70
IV	Design and Construction	71
9	Design - CAD	75
9.1	Fixed louver	79
9.2	Slide	81
9.3	Water injection	83
9.4	Whirlpool wall	85
9.5	Output funnel	87
9.6	Run-off	89
9.7	Summary	90
10	Cad - Simulation	91
10.1	Simulation of fluids	91
V	Realization and Experiments	97
11	Prior novel art	99
11.1	Prior arts functionality	100
12	Realization	117
12.1	Build	117
13	Experiments	121
13.1	Key questions	123

14 Results	131
14.1 Experiment setup	131
14.2 Experiments results	134
VI Aftermath	139
15 Discussion	141
15.1 Solutions	141
15.2 Experiments	143
15.2.1 Prior arts model	145
15.2.2 Conceptual solution	146
16 Further work	149
17 Summary and conclusion	153
Bibliography	155
Declaration	158
Reflection	159
Appendices	161
A Economic overview: Automated vs. manual labor	162
B Statistical data for prior arts model	171
C Statistical data for prior arts model	177

D Mid-way report	182
E Layout and first addition to an intended article	186

List of Figures

1.1	Localization of process	7
1.2	Price-weight-ratio of fish	9
1.3	Cost of automation versus manual labor	9
1.4	Vacuum pumping fish into storage tanks	12
1.5	Illustration of a fishing vessel's automated systems	13
1.6	The V-model	15
1.7	Sub-functions in the automated system	15
3.1	Process line overview	28
3.2	Estimation overview	29
3.3	Acreage used for estimation	30
3.4	Process block diagram	30
3.5	Manual weight estimation	33
a	Manual weight estimation process.[SINTEF (2010)]	33
b	A standard scale used in manual weight estimation.[Marel (2012b)]	33
4.1	Land-based flow scale	38
4.2	Flow scale	39
a	The motion of the flow scale.	39
b	The gyro function of the flow scale.[SINTEF (2011)]	39
4.3	Machine vision scanning	41
4.4	A vision scan result	42

5.1	Clocking system	46
5.2	The real clocking system	46
5.3	Applied Robotics High-speed conveyor belt system	48
5.4	Compact high-speed conveyor belt system	49
5.5	High-speed conveyor belt system	49
5.6	Fruit Singulator	50
5.7	Vibration feeder	50
5.8	Pick-and-place robot	53
5.9	Adept Quattro	53
5.10	Drop-in vision	55
5.11	‘The Cyclone’	55
5.12	‘The Screw’	56
5.13	‘The tower centrifuge’	56
7.1	Geppert-Band GAL-25	66
9.1	Segmented concept solution	77
9.2	The fixed louver	78
9.3	The slider	80
9.4	The water injection	82
9.5	The injection disc	82
a	Front of injection disc	82
b	Back of injection disc	82
9.6	The Whirlpool wall	84
9.7	The output funnel	86
9.8	The run-off	88
10.1	Comparisons of whirlpool wall	92
a	92
b	92

c	92
d	92
10.2 Comparisons of output funnel length	94
a	94
b	94
c	94
d	94
11.1 Prior art cyclone	101
11.2 Dummy fish	101
11.3 Four vortex formations	104
a	104
b	104
c	104
d	104
11.4 Continuous	105
11.5 Batch	105
11.6 Time consumption of fish in the system	110
11.7 Prior arts end terminal sections	110
a Large end terminal (LET)	110
b Small end terminal (SET)	110
11.8 Output speed of the prior arts model	111
a Input speed of 0,5 batches/second	111
b Input speed of 1,5 batches/second	111
11.9 Stirring rod	113
11.10 Guideline	113
12.1 The realized conceptual idea	118
13.1 General model of a process or system	122

13.2	System block diagram	124
14.1	Experiment setup	132
14.2	Output speed of the realized conceptual model	137
a	Input speed of 0,5 batches/second	137
b	Input speed of 1,5 batches/second	137
15.1	Prior arts model compared with CAD-designed ‘Cyclone’ and the realized ‘Cyclone’	144
a	CAD-modeled ‘Cyclone’	144
b	Prior arts model	144
c	The conceptual realization	144

List of Tables

- 1.1 **Total requirements** - This table lists the total requirements for the greater system needed for weight estimation at seas. This table lists the wants for the system alongside the have of the system, to illustrate what needs to be focused on in this and other coming projects. 18
- 1.2 **Requirement for the Singulator** - This table lists the requirements specified to the Singulator and its operation. The table lists how the work is currently conducted, and how the work should be in the automated process. 19
- 11.1 **Test plan for the prior arts model** - This table lists the factors which might play an important role in the design of that conceptual solution. The list starts with all the factors that were thought of before experiments, the last entries of the list at discoveries when work with the experiments. . . . 103
- 11.2 **Data from prior arts experiments** - In the table above some the results from the experiment on the prior arts model are listed. The results are a reflection of the output speed of the Singulator. 109
- 13.1 **Experiments/Variables to test** - This is a table showing all the variables of the system. It lists why a test on the specific variable should be done, as well as what the variable is. . . . 126

13.2	Experiments/Variables to test - This is a table show all the variables of the system. It lists why a test on the specific variable should be done, as well as what the variable is. . . .	127
13.3	List of equipment - This table lists the equipment needed to conduct the necessary tests and trials. The amount along with a reasoning for the equipment's use is given side-by-side the specified equipment.	128
14.1	Data from realized conceptual model experiments - In the table above some the results from the experiment on the realized conceptual model are listed. The results are a reflection of the output speed of the Singulator.	135

INTRODUCTION

Abstract – In this introductory Part the concept, the idea and the aims of this diploma are presented. Following these topics - subtopics such as, the economy of manual versus automated labor, as well as the parameters of the machine is presented. The last Chapter in this Part will give a short summary of the project, along with a walk-through of the diploma layout. However, first an introduction to the topic is in order.

Automation is often thought of as a concept from the modern age, however, automated solutions have been used for centuries; and can be dated as far back as the Greek inventor Ctesibius. Heron of Alexandria, whom lived over

two millennia ago, has described many automated constructions. His automated “programmable” devices are often seen as the first research into the subject of mechatronics, making him one of the forerunners of the world of cybernetics. The word cybernetics comes from the Greek word *kybernetes*, which loosely translated means *steersman*. The goal in cybernetics is essentially to understand and define functions or processes of physical systems; mimic natural phenomena and control them for the purpose of automation.

This diploma will focus on automation of a challenge within the fisheries industry. This master will use the phenomena of maelstroms in an effort of separating out the individual fish from batches. This concept of separation is called singulation. The concept of singulation is essential in this thesis. When using the term, *Singulation of fish*, we will hence forth understand this as taking a (large) bulk of fish and orderly position the individual fish in filed lines. This is of course a simplification of the solution; however, it illustrates the main idea of both the solution and the concept of cybernetics.

A Singulator is a machine preconditioning a bulk of objects for the next task in the automation line. A Singulator takes the bulk of objects and orderly position the individual objects in filed line.

□

Singulation of fish from batches is necessary as a preconditioning before weighing of individual fish. Individual weighing of fish is important for more than one reason. At sea a fishing trawl needs to know the weight class distribution of the fish that has just been pulled from the roaring sea. The aim is not to give an edification¹ to whether or not the fish is the “right” size. Far too often whole batches of fish, found not wanted, get illegally dumped.

¹Edification: it noun, to improve on knowledge, educate (6)

A machine telling the fisher if his catch is of the “right” size does not address misuse and easing of environmentally heinous crimes. These topics are not the goal for this project; however, a reflection on misuse should of course be given - food for thought, so to speak.

An ‘average-fish-size’-teller has different application areas than to ease illegal dumping. It will tell the fisher where to sell his catch, as different slaughter houses do different processes - an issue to be discussed later (see Section 1.2 [p.6]). Furthermore will singular weight estimation ensure better classification of the fish in both regards to areas and seasonal growth. Both these topics will increase economics and bring competition advances for the fisher that implements the system.

The data collected by fishers with improved classification does not just benefit them by increasing their revenues. Other parts of the fisheries industry would benefit from knowing the status of the fish population. Researches would be able to get more collected data, which in turn would give a better picture of the ecology at hand.

Working at seas can be a dangerous job. In Norway, EHS² is a reoccurring and central topic of discussion. By applying an automated workforce many lives have been saved in different industries. Automated works often results in higher efficiency and/or accuracy of processes. Automating simple, time consuming processes are the first steps for the fishing fleet in Norway. Removing laboring tasks at seas can improve on the EHS.

For Norway it is important *improve on* and *keep* our fishing industry at the highest competition level. The business cluster emanating from the fishery industry is vast, and is after oil the largest industry in Norway. The fishing industry is dependent on research from organizations such as SINTEF Fisheries and Aquaculture to keep their advances.

²EHS: *abbreviation*, stands for: Environment, health and safety (6)

With new ship designs and use of new technology, classification and packing of whole fish could be brought to oceans. That means more efficient classification of fish on board fishing vessels are needed, along with automated packing. Packed fish at seas can open for better product origin tagging, introducing geo-tagging, date and time classification along with the weight of the product. Is North Sea sea-bass from the North Sea? Or more importantly: Is fresh – fresh?

Chapter 1

Concept

Brought forth by the industrial revolution, automation has given birth to better and more efficient production lines. The industrial revolution has resulted in vast economic and social changes, bringing human society from hard manual labor over to the computerized world we know today. The construct for automation has multifarious¹ objectives: Improve product quality, reduce labor cost, improve work safety and reduce manufacturing lead-time.

Robots outperform humans in many jobs which require precision, speed, and continuity. In industries with prolongation-work², robot usage and automation is augmenting. The Norwegian fishery is one of the industries that are now seeing the benefits of robotic application. Automating the “fleet” of processing plants have the later years consumed a lot of attention. However, less consolidation of effort has been given to the actual fleet. Naturally this area of manual labor could not stay hidden. More and more complete-solution-models are idealized to lessen human interaction. Another focal point has been set in the horizon: Automation at seas.

¹Multifarious: *adjective*, many and of various types (6)

²Prolongation-work: Repetitive work over an extended amount of time. (6)

1.1 Scope

A part of the purpose for this project is to map out the different technologies that exist for singulation of fish at seas - and technology used to estimate the size of the individual fish in a catch. The efficiencies of the process are discussed, and the relevance between platforms and their performances is established. With this attained knowledge the aim is to build a prototype machine for the singulation of fish - with the possibility of attaching an automated weighing machine to remove human interaction completely.

In this project the main focus will be: ‘How to separate fish batches at seas’. The whole task from input throughout weight estimation and feedback will not be specifically in focus, since the prime goal is to make an innovative, efficient and novel singulator mechanism.

There has not, so far, been commercialized any automation with the purpose of removing the human link in the process of fish weight estimation aboard vessels. There are many methods of singulating fish; however, these are all built for land usage. The machines that exist for land usage tend to take a lot more physical space than is available on a vessel. Radical changes or new concepts are needed to address the challenge. In Figure 1.1 [p.7] the specific task of singulation is localized in the big picture.

1.2 Economy

The Norwegian fishing fleet pulls over one-point-seven-million metric tons of fish per year. However, the registration is only about one-and-a-half-million metric tons^[Norsk-sildesalgslag (2012)], which means that a lot of the catch is thrown overboard. “Why?”, you might ask: There are many reasons; when a trawler pulls fish the nets can often fill more than two vessels transport capabilities. Moreover, not all of the fish is within the right size, or even the

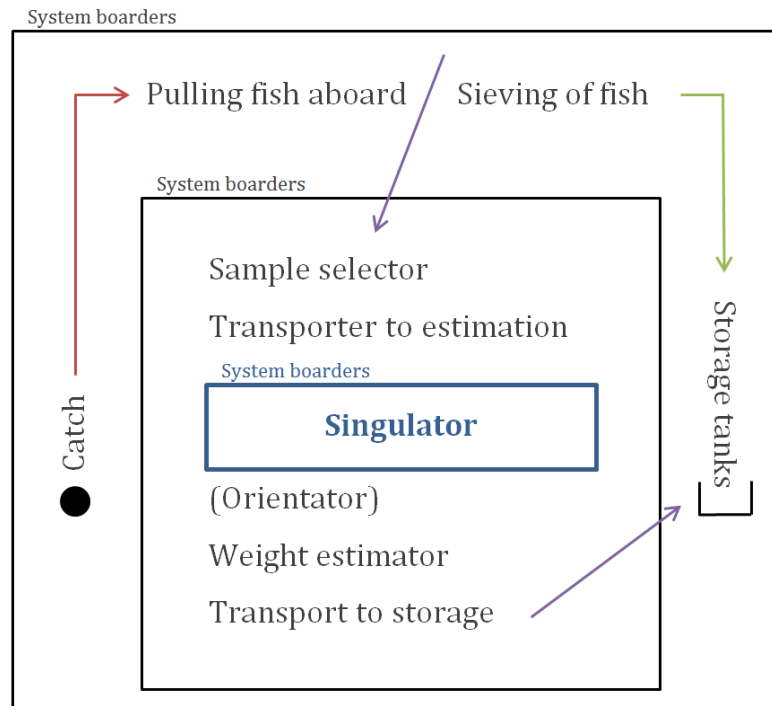

Figure 1.1: Localization of process - This illustration serves as an overview of the process at hand, and focuses in on the part that this research project is handling - the singulation of fish.

right species. And lastly the nets are hard to empty completely - leaving remnants that are dumped. This type of dumping is not classified as dumping, but as forfeited waste. Reasons for this type of loss can be: Too big of a catch, too much bycatch, and/or bad weather leaving the trawler no choice but to let go.

The fish that is not the right specie are often weeded-out and thrown overboard. Not a good use of resources. However, for the fisher - throwing the fish overboard could mean more storage space for the “right” fish: Which

in turn equals more money in the bank for the fisher. This is of course a bit off topic, but should be reflected on. Furthermore the same situation yields for the fish that are small: The size of the fish reflects on the price; however, not in the manor of two fish weighing 200 grams equals one fish of 400 grams. The fish weighing 400 grams get higher weight-to-value ratio. Ergo throwing out all the small fish and only collecting the big ones would bring in more cash - but contribute to a waste of natural resources. Fortunately dumping is illegal in Norwegian waters. But law enforcement is challenging. The weight-to-value ratio is illustrated in Figure 1.2 [p.9].

These concerns are relevant for this thesis in considering misuse or illegal use of the proposed technology. This is a machine telling the average size of the fish collected. It would be easy to think of making it look for all fish under a given weight and from there seclude them from the catch. However, the system estimates only samplings from the catch. (See Parameters Section 1.5 [p.14] for more.) My view is that the system at hand does not lend itself easily for exploiting unwanted actions or defining new.

As mentioned earlier, estimation of the average fish size is important for delivery to the right slaughter house. There are many fish processories strung along the winding coastline of Norway. However, not all of them are equipped equally nor are they equipped for all sorts of processing. Some processing plants need big fish for filleting; some only pack whole fish for human consumption, while others make fish meal³. Delivering small fish for filleting would only make for porridge. This means that it is important for the process-plants and the fishers to pick the right place, and due to situations like the porridging of fish - the factories subsequently pay more for the fish in *their* class.

³Fish meal: *noun*, a product made from both whole fish and fish bones. It is ground up into meal.

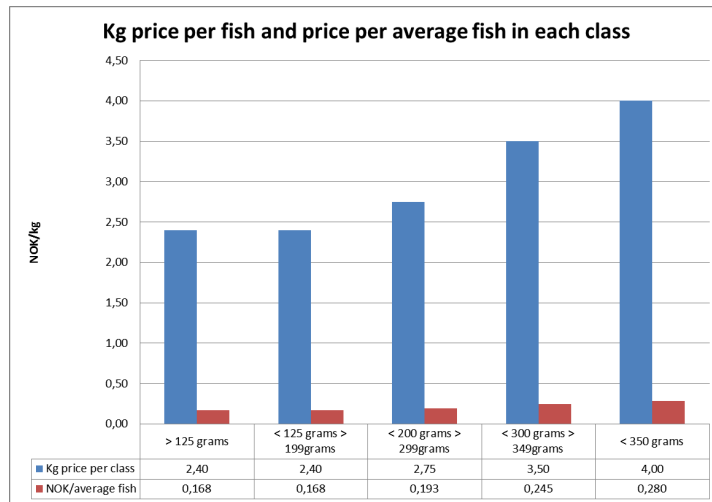

Figure 1.2: Price-weight-ratio of fish - This graph illustrates the price-weight-ratio for whole fish. It shows that the value of a bigger fish is not linear with the increase in weight. Ergo a catch with a greater average size fish will fetch more money.

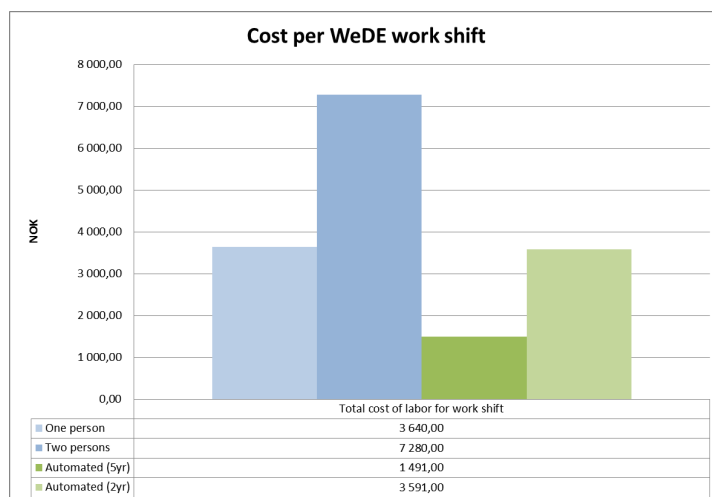

Figure 1.3: Cost of automation versus manual labor - The graph illustrates the cost of automation versus that of the manual labor. It is clear that automation this process which cut costs, and therefore become the next natural step in the automated workforce evolution.

In this project the goal is to make one part of a machine that will ease the work related to size calculation of single fishes in sample batches. This is a process that is done manually today. The manual weighing process is more thoroughly explained in Section 1.3 [p.10]. The manual labor process allocates one or even two sea men for the entire time of the pumping session. Freeing this allocation of personnel could potentially also free up some costs. In Figure 1.3 [p.9] it is apparent that - with the installation, the duty and the perpetuation - the automation of this process is cost efficient. All the affects to these estimations of cost can be found in Appendix A [p.162]. Furthermore, one might actually say this is wherewithal⁴ to keeping cost-efficiency as increased labor cost and other expenses hurdles away.

1.3 State-of-art

The current state-of-art, determining average fish weight, demands human interfacing. The fish is randomly pulled out into bins for control weighing as the fish is pumped aboard; these bins are handed over to a human operator whom picks and places fish on a scale. The human interface waits for the weight to stabilize, then plucks the fish off and throws it to the wastebasket. After the measurements are done the sample fish is dumped overboard.

For this project it is imperative to remove the human link, as well as to present possible automations that can return the fish to the vessel's cargo containers. Automating this prolongation process will release human work force at seas. A full depiction of the system and its setup will be presented in Part II [p.25] as a soft introduction to possible solutions.

⁴Wherewithal: *noun*, necessary means (economical) (6)

1.4 Idea

The idea is automating the prolongation-work of determining weight class distribution of fish trawled at seas. This diploma will not create a complete solution: However, the thesis will present the complete layout of the conceptual idea. This means the fully automated idea is given as a plan for what this project tries to achieve. The part focused on in this thesis is the preconditioning of the fish before weight estimation and other measurements are done.

The fish is pulled from the sea and pumped over the gunwale of the vessel into a fish sieve. From the fish sieve some of the fish are transported to the weight estimation area, while the main bulk of the catch is sent to the storage tanks (refrigeration tanks). In the weight estimation chambers the fish is delivered in bulks. Recaulking⁵ of the fish is necessary if separate weighing shall be attainable. The fish will via the Singulator be rearranged into single filed lines. After weight estimation the fish needs to be returned to the in-feed for the cargo containers (thus reducing waste).

There are multiple methods for solving this problem. On-shore a series of conveyers and shaking-boards are aligned such that the fish is singulated before reaching the filleting machines⁶. This is not space efficient and therefore not suitable on a vessel. New solutions must therefore be sought out. The solution presented here is to create a swirling drain, a maelstrom. This maelstrom will result in delivering individual fish into a drain. From the drain the individual fish can be distributed on a conveyer belt in an orderly manner ready for weight estimation. This process is named the singulation of fish.

⁵Recaulking: *verb*, making a radical change, stir-up (nautical term).(6)

⁶Weight estimation of fish is also manually conducted on-shore, however, total weight of a load can be done with batch weighing or continuous flow.

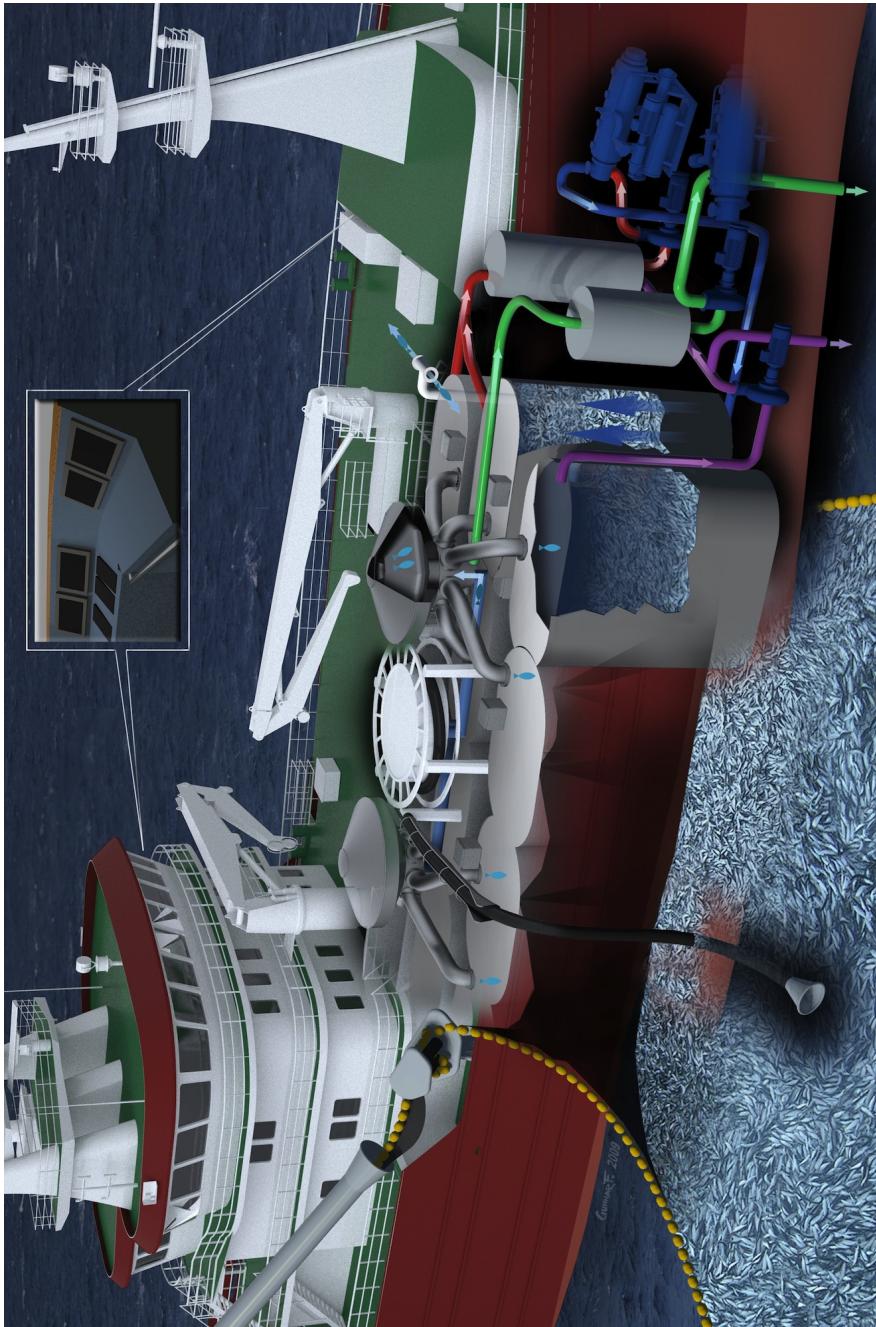

Figure 1.4: Vacuum pumping fish into storage tanks - This is an illustration of the system on which the automated fish weight estimation and feedback system may be attached. The illustration shows the position of the pump collecting the fish from the fishing net, and how the fish is lead either to the storage tanks or to the weight estimation chambers. [SINTEF (2011)]

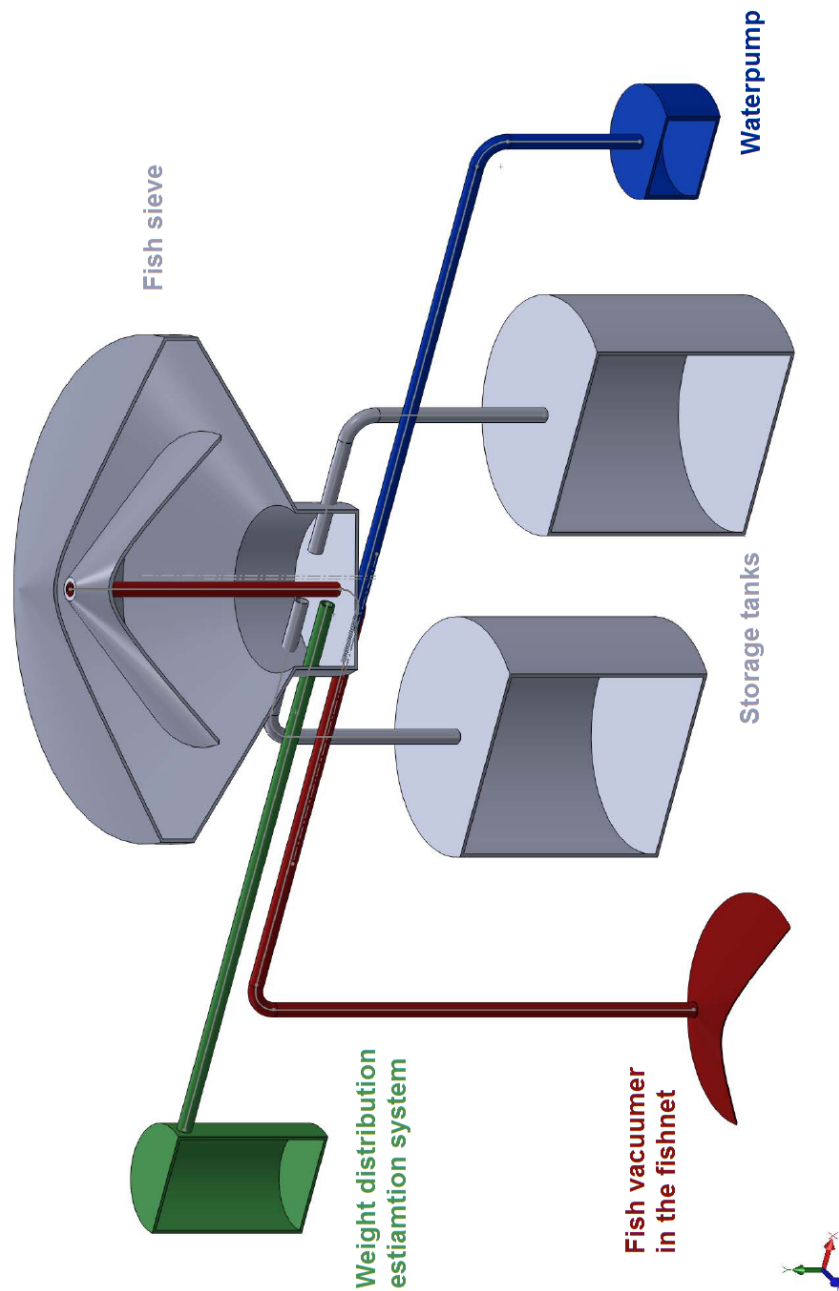

Figure 1.5: Illustration of a fishing vessel's automated systems - The illustration is a simpler depiction of the system used to collect fish from fishing nets. It illustrates how the new automated system would be included into the complete system.

1.5 Parameters

A mid-water trawling⁷ can in one trawling session pull for 200 metric tons to a staggering 1000 metric tons of fish.^[SINTEF (2011)] One such pull is typically around one-and-a-half-million fish⁸. To make *one* machine weigh each fish in the catch is today an improbable task, if not an impossible one, with the given in-feed-speed from the pumps. However, estimating the average size of the fish based on a representative sample selection from the catch is not such an excessive amount of input for a machine. A representative sample selection is commonly sat as low as 0.04 percent of the total catch.^[SINTEF (2011)] This means a minimum of 720 fish needs to be weighed⁹.

Predefined parameters are imperative in establishing what a machine shall be capable of as well as how efficient the machine is to be. The V-model is an important tool in these proceedings. The V-model demonstrates the relationships between each phase of a development's life cycle and how the phases are associated with testing and verification. The V-model was developed in the 1980's, and was constructed for use in software programming - however, the V-model also functions for an array of other platforms. The tool is used for verification between design and realization in a vast majority of industries.^[Storey (1996)] In this case we are going to use the V-model for the verification and analysis of a hardware system developed in this research. Figure 1.6 [p.15] is an illustration of the V-model that would apply in this case study. The concept is broken down into segments describing its behavior/requirements to behavior, and its physical design. When a design fitting the requirements a realization of the concept can be started: The im-

⁷Mid-water trawling: Also known as pelagic trawling. Mid-water trawling is when the trawl is conducted in the water column not hitting the ocean floor.

⁸Average fish \sim 280 grams, gives (500 tons of fish / 280 gram per fish = 1 785 000 fish).

⁹This is calculated with use of the average catch size in tons, and a selected average size of a herring. 0.04 percent of 500 tons divided by 280 grams per fish gives 715 fish.

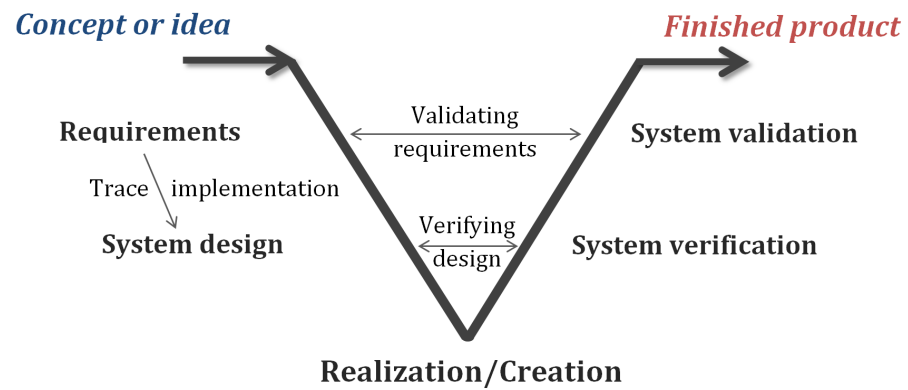

Figure 1.6: The V-model - An illustration of a generic V-model.

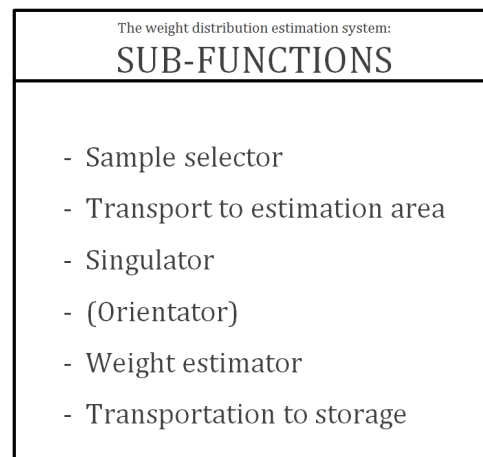

Figure 1.7: Sub-functions in the automated system - This is a list of the sub-functions that are needed in order to create a complete system for automated weight distribution estimation at sea.

portance of the V-model comes into play when the verification starts. The V-model illustrates the coherency between the verification and validation, and the requirements and design. If a realized concept passes all the trials set to verify and validate the build - the product moves into the finished product phase. However, most product developments swing back and forth sometimes in the V-model between the start and end phase before reaching the finished product phase.

The V-model states a list of requirements set for the parameters defining the design of the system. The parameters set for the machine must be such that all these rules are valid:

- All specifications shall be possible to fulfill.
- No factually wrong demands must be set.
- All demands must be contained in the description.
- All demands must be defined completely, no later fixes.
- No specification must conflict in description
or in functional demands.
- No demand shall exclude or contradict
any other demand.
- All demands shall be measurable and concrete.
- All specifications must be clear and unambiguous.

Today, the fish is picked from the pumping system of the trawler. The fish is weighed manually at a rate of 10-15 fish per min_[SINTEF (2010)]. This means that a machine estimating the individual fish size must operate at a minimum of 10-15 fish per min. Table 1.1 [p.18] is a list of the parameters that are set for the complete system. However, the parameters for the specific goal in this project are listed in Table 1.2 [p.19]. All concepts and ideas pre-

sented in this project are based on, and evaluated under the parameter-list: Specificities found in Table 1.2 [p.19].

In Table 1.1 [p.18] all the superficial wants and haves are listed. This table represent the main challenges that SINTEF Fisheries and Aquaculture are facing in their quest to automate weight estimation at seas. There are many aspects that can be focused on - subprojects such as: In-feed method for the weight estimation singulator, or the feedback to the systems storage tanks. The sub-functions of the automated weight distribution system is listed in Figure 1.7 [p.15]. The list of sub-functions is needed in order to create the wanted system and also suggests the agenda for the SINTEF Fisheries and Aquaculture project, as it highlights the main features that are/are not in place. This project handle but one of the challenges in creating the automated system.

Looking at the specific goals for this project, Table 1.2 [p.19], one can see that there is one a feature that depends on other concepts that are not yet created. The in feed of the singulation system is yet to be determined. The dependency is therefore made as small as possible: By allowing both continuous and batch in-feed to the Singulator. The output of the Singulator is set as individual fish at a given pace; however, the method of moving the individualized fish as well as the method of estimation is not yet created/chosen. But it is given that the weight estimation system will run continuously - i.e. the goal of the Singulator is to move as much fish through the system as possible, and the solution for handling the torrent will be left for later research.

The feedback of fish is an important element in improving the weight estimation system at seas. In the requirements table, Table 1.2 [p.19], a demand on the fish treatment is set, and it is imperative that the fish is not damaged during the process: Because if the fish were to be damaged

Options	Has	Wants
Human labor working on this process:	Yes, 1-2 people.	No, start and stop only.
Maintenance of machine	Low	Minimal interaction with machine, i.e. extremely low
Number of fish weighed per time instance	10-15 fish/minute ~0.2 fish/second	30-60 fish/minute ~0.75 fish/second
Amount of fish weighed in a catch:	~ 0.04 percentage	~ 1 percentage
Automatic in-feed to the estimation area:	No	Yes
Organizer for automatic weighing station:	No	Yes
Automatic weighing station:	No	Yes
Automatic feed-back to storage tanks:	No	Yes

Table 1.1: Total requirements - This table lists the total requirements for the greater system needed for weight estimation at seas. This table lists the wants for the system alongside the haves of the system, to illustrate what needs to be focused on in this and other coming projects.

Labor system

Requirements	Manually	Automated
Weight estimation speed:	10 - 15 fish/minute	30 - 60 fish/minute
Human interaction:	Continuously	Start/Stop
Robustness:	High, only reliant on the weight aboard. (human error)	High, no major error can delay the system.
Movement in vessel:	As much as the EHS allow for a trawler.	In excess of 15 degrees in ship rotation.
Species of fish:	Any species.	Mackerel, Herring and Capelin.
In-feed method:	Batches at regular intervals. Batches are collected between weighing sessions.	Batches or continuous in-feed. Speed or amount for in-feed determent by processing speed.
Cause damage to fish:	Yes, neck breakage is normal to ensure that the fish is still.	No damage must come to the fish if the fish is returned to storage.
Easy to clean:	Yes	Yes

Table 1.2: Requirement for the Singulator - This table lists the requirements specified to the Singulator and its operation. The table lists how the work is currently conducted, and how the work should be in the automated process.

during processing it cannot be fed to storage. Damaged fish are classified as unsuited/unwanted for human consumption; i.e. not of sufficient quality for human consumption¹⁰.

Table 1.2 [p.19] lists a want for the system to increase the speed. The want is a three to, as much as, six times the current operation speed. This is not an impossible task for an automated system; however, it will place a high demand on the Singulator.

¹⁰However, this is not completely true - the fish is edible, but cosmetically damaged fish is hard to sell and will fetch a lower price. They are therefore classified as not of sufficient quality.

Chapter 2

Motivation, aims and report outline

My interest in this project is the possibility of creating new innovations for the purpose of automating prolongation-work: To lessen human repetitive labor *is* the major goal for an ‘automation-kybernetes’. Through this project I will be able to get practical, hands-on experience of industrial processes and automatization. This project offers the possibility of exploring the physical world of cybernetics with experiments and innovations.

2.1 Aim of the Project

The aim of this project is to devise a machine with the sole purpose of separating and aligning fish for autonomous weighing at seas. This will be part of a completely autonomous system, estimating the weight distribution of fish. An automation of this work will increase the efficiency and accuracy of the sampling method used today.

Table 1.2 [p.19] lists the parameters needed to be fulfilled for this to be considered as an improvement to the current state-of-art. These specifications are set by the needs of the industry, and demand in the market.

[Tendons and SINTEF (2012)]

2.1.1 Preliminary aims

The main focus in this project will be the singulation and alignment of fish before the weight estimation module. In this project the goal is to create a conceptual model for fish singulation. However, studying the current state-of-affairs; understanding and design an overview of the situation, and give suggestions to how the whole process of fish weight distribution estimation on board vessels can be automated - will also be presented in the coming chapters and parts.

This project has many challenges, such as constructing a fast and efficient conceptual model; and keeping the unenviable repairs and corrective maintenance low. The machine must handle a lot of strain and harsh weather. There is also going to be singulated up to 60 fish per minute in the machine causing a lot of superficial tear. A lot of salt water will flush the system on the outside, and possibly on the inside - this means that the materials must be carefully chosen.

When constructing any machine for the purpose of automating prolongation work one must keep in mind that for high productivity it is imperative to have low maintenance. In other word, the system must be really robust.

2.2 Outline

Part II - Presents the ideas and concepts that are in existence along with novel thinking. An overview of the overall process is presented. At the end of this part, a discussion on choices is summarized and concluded.

Chapter 3 - Presents an overview of the task at hand, along with the current weight estimation systems.

Chapter 5 - The concepts of singulators are presented. They are explained and illustrated.

Chapter 6 - Discuss the ideas presented in previous chapters and conclude which of the idea that is to be realized.

Part III - Presents the hardware and software solutions that have been use in this project. The choices that are made are also explained.

Chapter 7 - Presents the hardware use in the project.

Chapter 8 -Presents the software use in the project.

Part IV - Present the design of the chosen concept. It will discuss how the different parts of the construct have been design, as well as why it is designed in such a specific way.

Chapter 9 - Goes through the design process and what has been taken into consideration.

Chapter 10 - Explains how fluid simulations have helped in concluding the final design.

Part V - Is a presentation of realized solution along with the results of the experiments. Both a prior arts model and a final conceptual solution are presented.

Chapter 12 - Presents the prior arts model system used for verification and edification of the principle and functions of the chosen conceptual idea.

Chapter 12 - Is a walk-through of the realized concept.

Chapter 14 - Contains both the experiments and its setups, as well as the results of the experiments.

Part VI - Summarizes the project, its results and what the next step could be. It ends with an opening for future research.

Chapter 12 - Discusses all the results throughout the report.

Chapter 12 - Suggests further work and aspects that could have been done differently.

Chapter 12 - Summarize the project in its entirety.

CONCEPT IDEA

Abstract – Through this Part, the concepts and ideas for automating fish weighing aboard vessels at seas will be presented. The first chapter is an introduction of the system that is needed. The second Chapter splits the process into Parts, a section for the singulation of fish and a section for weighing. At the end of the part the final Chapter discusses the choices that are available. A short conclusion along with a solution will be given. The solution will be further described in Part IV [p.71].

Cybernetics has split into many fields of study: Mechatronics, robotics, divisions of computer science and even anthropology. However, understanding that cybernetics is the study of processes with the goal of affectivity and effi-

ciency - it makes no difference whether the solution is electronically complex or mechanically complex, as long as the processes becomes more effective and efficient.

Concepts and ideas from all sides of the cybernetic world will be accessed in this project; everything from a conveyor-belt-system to a simple cone solution utilizing whirlpools.

Automation, relinquishing human interaction in a process will be highly important to provide a capable solution to the current state-of-affairs. In this Part a review of the different concepts along with an assessment of them will be given. An analysis of the system, its problems and needs is the first step in contemplating the task at hand. A complete overview is paramount; illustrations are therefore conjured alongside the explanations of the process.

Chapter 3

Concept overview

Available area on fishing vessels are limited and all equipment must therefore be compact. The area currently occupied for weight distribution estimation is also the space where the new automated system has to fit. The area has usually two meters head-height, and can vary in floor space from two-by-two to two-by-three meters. An example of the area where the system is to be placed is illustrated by Figure 3.3 [p.30].

A midway between the ‘cybernetic’ and the ‘mechatronic’ world is often the solution sought in real world automatization of industrial processes. However, in this process a different type of gap will be presented: A step bigger than between ‘mechatronics’ and ‘cybernetics’. Both these systems are often computer controlled. However, in this thesis both normal feedback systems with controllers and passive systems have been evaluated. For the singulation operation studied here, a passive mechanical system was found most applicable.

A presentation of the whole process is illustrated in Figure 3.1 [p.28]: The illustration shows the steps in the process, from the pull - to storage. In this schematic the weight distribution estimation(WeDE) is defined as a separate step branching from the main stem. Two things are ambitioned for this appendix: *a)* automate the process - the main focus of this project; *b)*

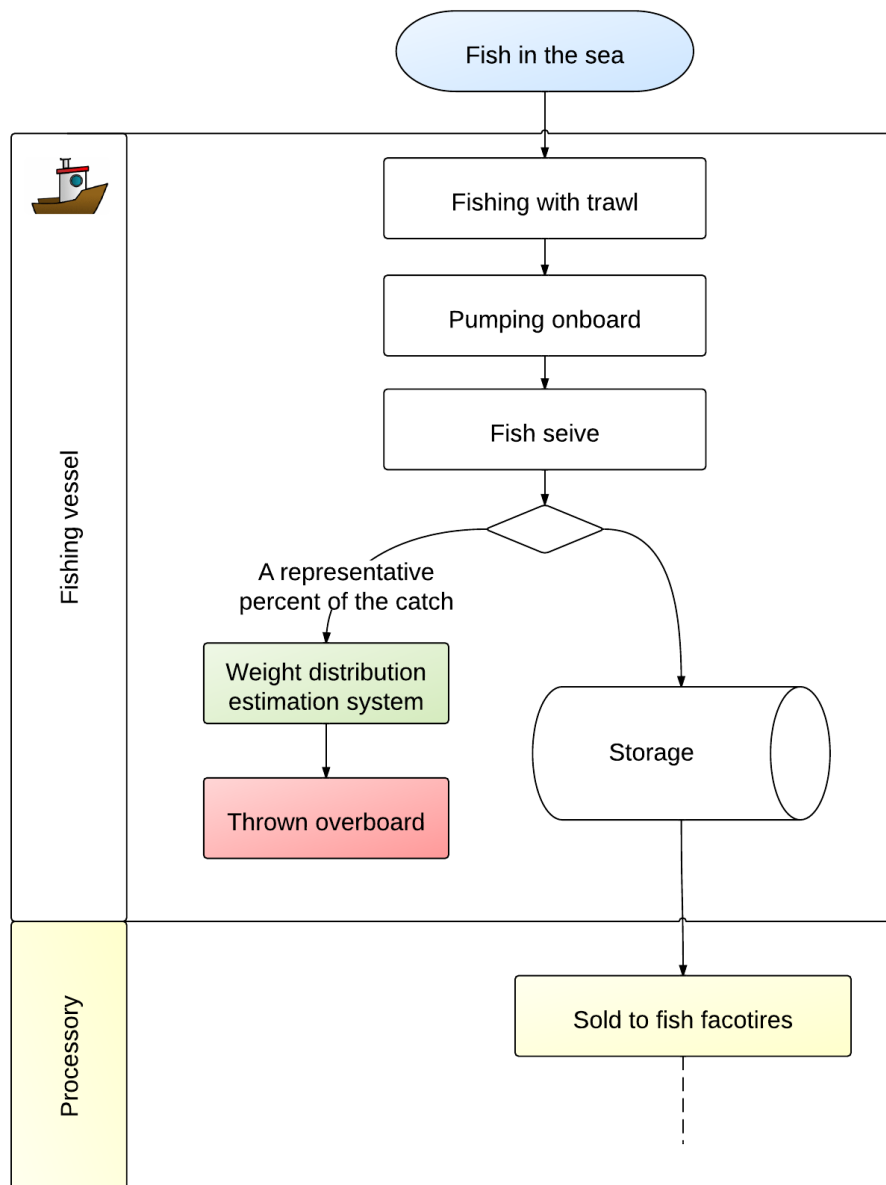

Figure 3.1: Process line overview - The figure gives an rough illustration of the whole process, for the fish in the sea to the product bought by the processories.

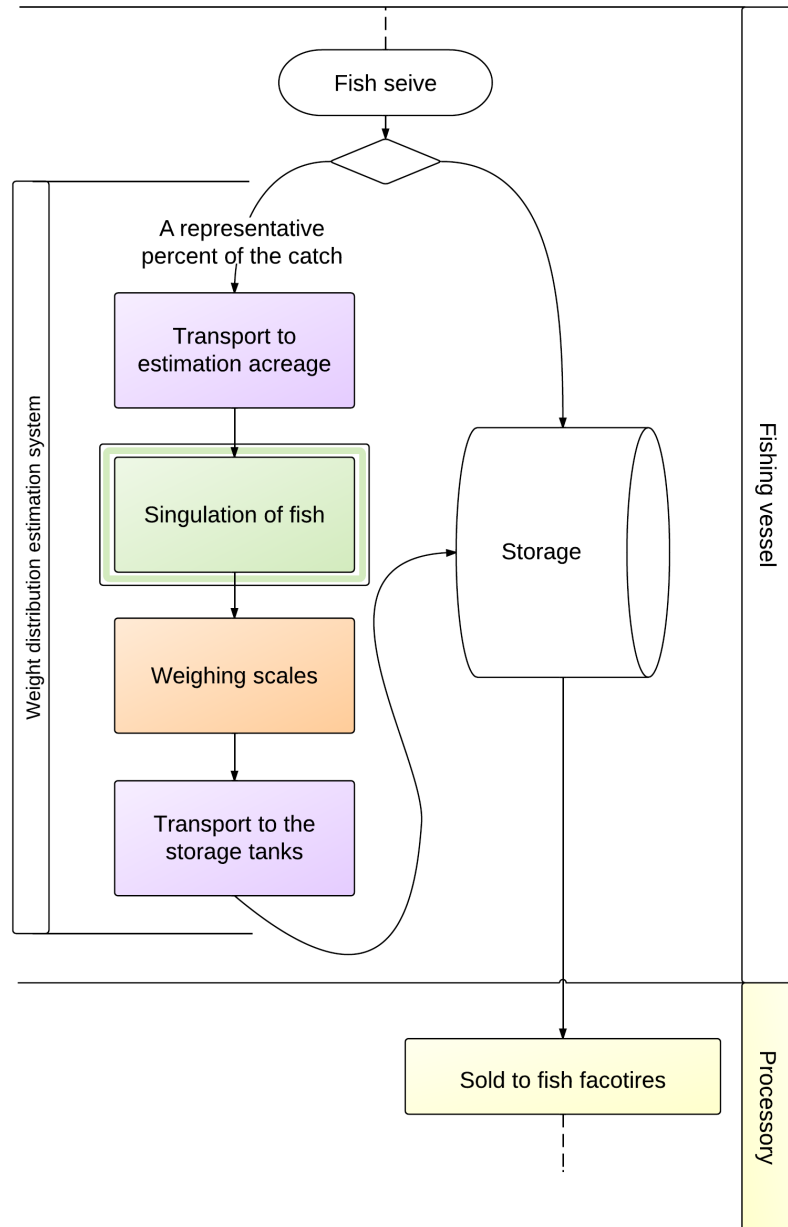

Figure 3.2: Estimation overview - An illustration of the different steps in the estimation process. The start of the estimation process as well as where the process ends is depicted. The segment in the weight distribution estimation system which this project focuses on is the singulation of fish.



Figure 3.3: Acreage used for estimation - An image illustration the acreage dedicated to weight estimation. [SINTEF (2010)]

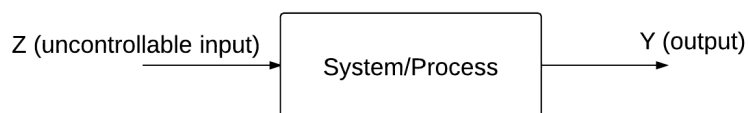

Figure 3.4: Process block diagram - This is a block diagram of the estimation process. The block diagram show how the input and output does not talk. The input Z is the uncontrollable input of fish to the sea men, while Y is the fish weighed by the sea men. For more on the block diagram look to Section 13.1 [p.123]. NOTE: Z must *not* be mistaken for a disturbance in the system, it is an input needed for the process to exist, however, it is not controllable for the process illustrated.

reconnecting the veering branch to the main stem.

Looking at the process overview in Figure 3.1 [p.28] it is easy to see that the veering branch of the WeDE can be compared to a SISO-system¹. In terms of control engineering the WeDE-system this would provide a block diagram with only one input, one output and no feed-back, i.e. an unregulated SISO. The system is illustrated in Figure 3.4 [p.30]. The feed rate and amount of fish delivered to the sailor is externally determined. The intervals are not deepened on the sailors work speed. In other words, the fish is delivered at regular intervals and the sailor tries to collect the fish when it is delivered. However, not all the fish is collected. The fish that has been measured along with the fish that did not get collected, but delivered for measurement, gets flushed over the gunwale. To get a better understanding of the action go to the Digital-copy/Media/Video/Vessel-process - where a movie illustrates the process.

The grander view of the trawling system shows a SIMO-system²: The fish is pumped up and divided into two run-offs, one to the storage tanks and one to the WeDE-system. This means that there is one input to the trawler; however, there are two outputs. A sub goal with the automation of the WeDE-process is to get the SIMO-system over to a SISO-system - where all processes aboard the vessel end at the storage tanks.

Figure 3.2 [p.29] illustrates the segmented WeDE-process, and how it connects back to the storage units. The main focus for this project is to create a concept for the singulation operation within the weight distribution estimation system. Below is a brief description of the various parts that make up the WeDE-system. The description explains what the different segments have to contribute to the weight distribution estimation process.

¹SISO: stands for single-input-single-output.

²SIMO: is a control theory term for single-input-multiple-outputs, just as SISO stands for single-input-single-output.

The Intake - Fish is pumped in from the trawl unto the deck of the vessel, where it is dumped into a fish sieve. From there batches of fish will be supplied to the weight estimation area where the Singulator must take over.

The Singulator - The Singulator takes in a steady supply of fish batches provided by the Intake step. The output of the Singulator is fish lined up and ready for individual measuring. This task can be done with many different ways. The most important requirement is that the fish must be lined up one by one, and that fish uses no longer than a given time through the system. The whole process must be compact due to the limited deck space.

The Estimator - This part will measure the weight of the fish to some set accuracy. Several measurement techniques exist: Computer vision, flow scales, and normal weighing stations. After weight estimation the fish goes to the Returner.

The Returner - This is the final part of estimating the fish sizes on board. The Returner will return the fish to the cargo tanks so that no fish is lost.



(a) Manual weight estimation process. [SINTEF (2010)]



(b) A standard scale used in manual weight estimation. [Marel (2012b)]

Figure 3.5: Manual weight estimation - These are illustrations of *a)* the manual weight estimation process and *b)* an image of a standard scale used in this process at seas.

All of these parts of the process, except for the Returner, has many possible functional existing solutions. The only reason to look at these other steps in the process is to grasp what technology already available, and what input can be expected as well as what output is needed. An overview provides an understanding of the completed system.

This project is conducted in cooperation with SINTEF Fisheries and Aquaculture and MMC Tendors. As far as the Intake and the Returner is concerned, MMC Tendors view this as a relatively uncomplicated part of the project and do not see the need for new innovation here. The Intake will deliver bulks of fish from the fish sieve to the localization of the Singulator and the Estimator; while the Returner will be capable of taking continuous feed from the Estimator and feed the fish into the storage tanks.

For individual automated estimation of weight there are many land-based methods to choose from, however, less so for the marine-based ones. Two of the most likely to provide satisfactory duty/through-put and accuracy are: Flow-scales and vision estimations.

Today, the weighing is done manually. The types of scales that are in use are similar to that of your bathroom weighing scale, only more advanced. All marine based scales can correct for motion. They are equipped with stabilizers and electrical computing systems taking into account the bank³ and pitch, sway and heave⁴ of the vessel. The accuracy of the scales can be as high as 97 percent, with a variation of 1,3 percent.[SINTEF (2012)] The largest challenge with these scales is that they use some time to stabilize for accurate measurements. This can take from 5 to 15 seconds. It does not seem like much, however, when trying to estimate 13-27 fish per second

³Boat rotation: *Roll* or *bank* is rotation about the bow-to-stern axis, *pitch* is when the bow rise and sink about center of the boat, *yaw* is rotation about the keel-to-mast axis.

⁴Boat translation: *Heave* is the boat moving vertically up and down, *sway* is linear motion side-to-side, *surge* linear movement back and forth.

- time is sparse. In Figure a [p.33] an illustration of a fisherman using a manual marine based scale is portrayed; while in Figure b [p.33] is an up close picture of the scale used by the fisherman. In the Digital-copy a video illustrating the weight estimation of the WeDE can be found. In the movie one can see how the fisherman breaks the neck of the fish to keep it still while weighing. The video illustrates also the speed of the weight estimation. The WeDE process time is of course longer than just the weighing of the fish as the fish has to be picked up by the sailor before weighing.

Chapter 4

Weight estimation

There are many methods of weight estimation. Two of the methods were picked out as the most viable concepts. These are depicted and tried to explain in the coming Sections. However, the weight estimation is not a prime part of this master thesis. SINTEF Fisheries and Aquaculture has done, and is developing an intricate weight estimation system based on vision. This system along with another concept of weight estimation called Flow scales are explained below.¹ But as mentioned, this is a part of the grander project, however, SINTEF Fisheries and Aquaculture is working on this problem; and it will be their choice to make when a weight estimation unit is selected.

4.1 Flow scale

There are several suppliers of gyro stabilized scales for manual use. There are so far no one delivering gyro stabilized flow scales. This is because the use of flow scales has not yet been assessed for usage at sea. On land-based operations there is no banking or pitching, so a gyro stabilization system would not be a cost-efficient installation.

But what is a flow scale? The flow scale is a set of gyro stabilized weight measurement units. That registers the differential suppression of the

¹For more concepts look to the Digital-copy, where other concepts are listed.

weighing-cells as an object flows over them. By logging change in the force in the gravitational direction the weight of an object can be transduced to an estimated by linking the multiple weight registration points. .

In Figure 4.2.a [p.39] the flow scale is illustrated. As the fish move along with the conveyor several weight cells register the exerted force of the fish passing over. The force exerted by gravity is measured. Combined with the knowledge of the conveyor belt's speed - each weight registration of the fish can be put together. An estimation of the actual weight of the fish is thereby made through mathematics

In Figure 4.2.a [p.39] a real flow weight system is depicted. It is a flow scale made by Marel.[Marel (2012a)] A problem with these types of weight estimation system is that they are susceptible to accumulated water. On a normal manual operation weight a slightly higher WeDE is measured that actually is correct. This is due to manual error, as one can forget to reset the weight between each *and every* fish. However, the flow scale system has the same type of problem, only with the flow scale the problem is not forgetting to reset the weight, but rather when and how without affecting the process speed.



Figure 4.1: Land-based flow scale - An illustration of the standard land-based flow scale.[Marel (2012a)]

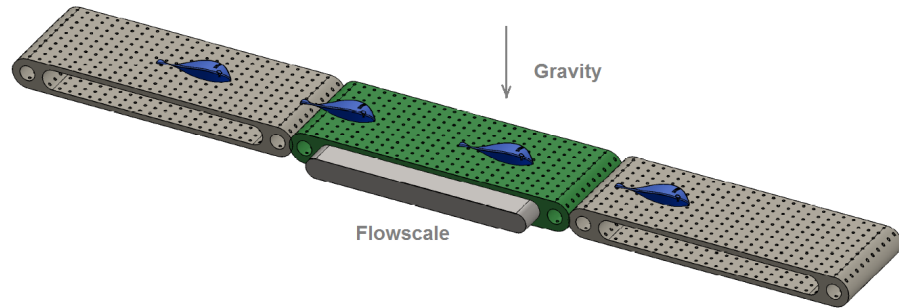

(a) The motion of the flow scale.

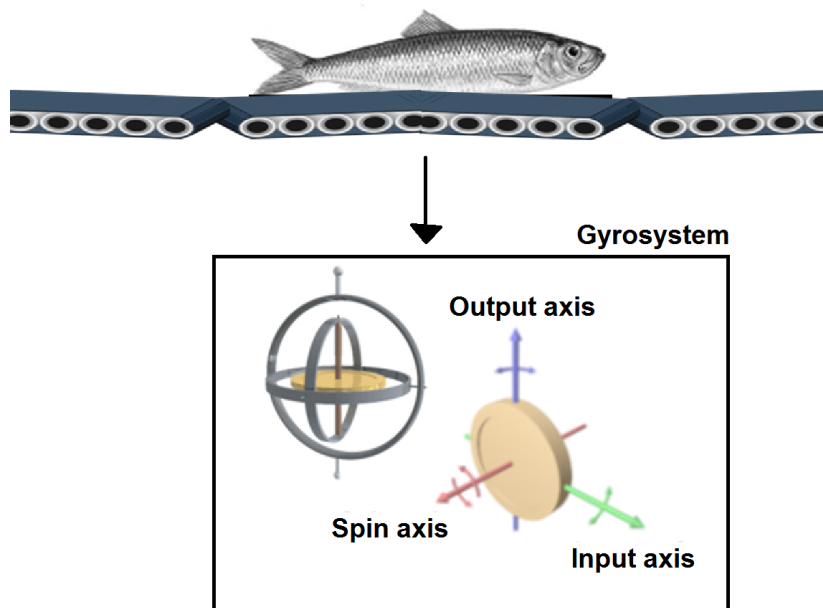

(b) The gyro function of the flow scale. [SINTEF (2011)]

Figure 4.2: Flow scale - In subfigure *a*) the motion of the flow scale is depicted. It illustrates how the weight is measured as the conveyor moves along. Subfigure *b*) is an illustration of the gyro function in the flow scales.

4.2 Vision estimation

There are many types of vision estimation techniques for determining weight of an object. The techniques can be 3D vision, 2D vision or X-ray. In an article written at SINTEF Fisheries and Aquaculture^[Misimi et al. (2011)] X-ray was used to estimate weight of the fish. The weight estimation was done by looking at the intensity of the X-ray reflections. The density of the echo reflects on the weight, as the weight of fish is approximately equal to the weight of muscle in the fish. The prediction error in estimations were documented to be for circa ± 2.5 percent, equaling about ± 7 grams² on an average size fish. In their research trials they established a maximum error of 4.4 percent.

The accuracy of the X-ray method is higher than the manual weighing stations. Another weight estimation technology SINTEF Fisheries and Aquaculture has studied combines 3D/2D vision systems. The accuracy of this new vision technique is of plus/minus 1 percent, equaling about plus/minus 2,7 grams on the average fish. The variance of the system have also become minimal, and lies in the 0,1 percentile. Toldnes et al. (2011) used in their experiments the new combined 3D/2D vision system is explained. The reason for changing from X-ray was to develop a system that was faster. The article by Misimi et al. (2011), mentioned above, estimated the time for one X-ray scan to be about two minutes - way to long for the speed needed in the industry.

In 1991 used Storbeck and Daan (1991) 3D machine vision for the weight estimation of plaice³. They used a laser triangulated 3D machine vision system. The triangulation made is possible to project the volumetric size of the fish. In the article from SINTEF Fisheries and Aquaculture, by

²The estimation of an average fish being about 280 grams is with the proviso of species dependency, here: Herring.

³Plaice: Most common name used on a group of flatfish. It is a group consisting of four species: Alaskan, American, European and scale-eye plaice.

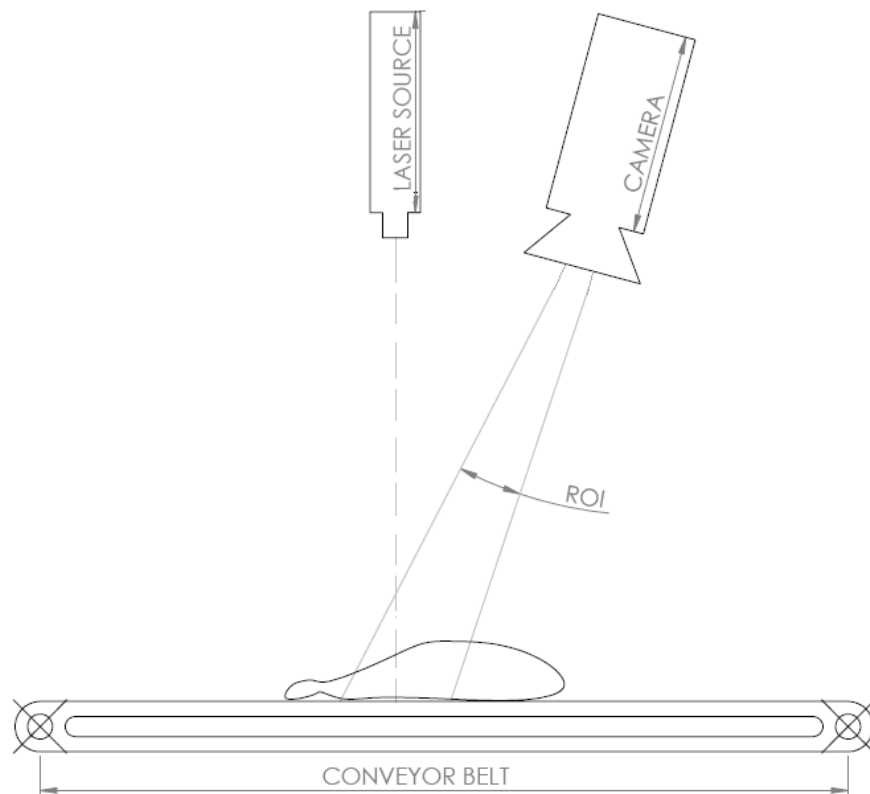

Figure 4.3: Machine vision scanning - An illustration of the imaging process, showing the relative position of the camera, laser source, and conveyor belt. The narrow region-of-interest (ROI) of the camera is also illustrated.

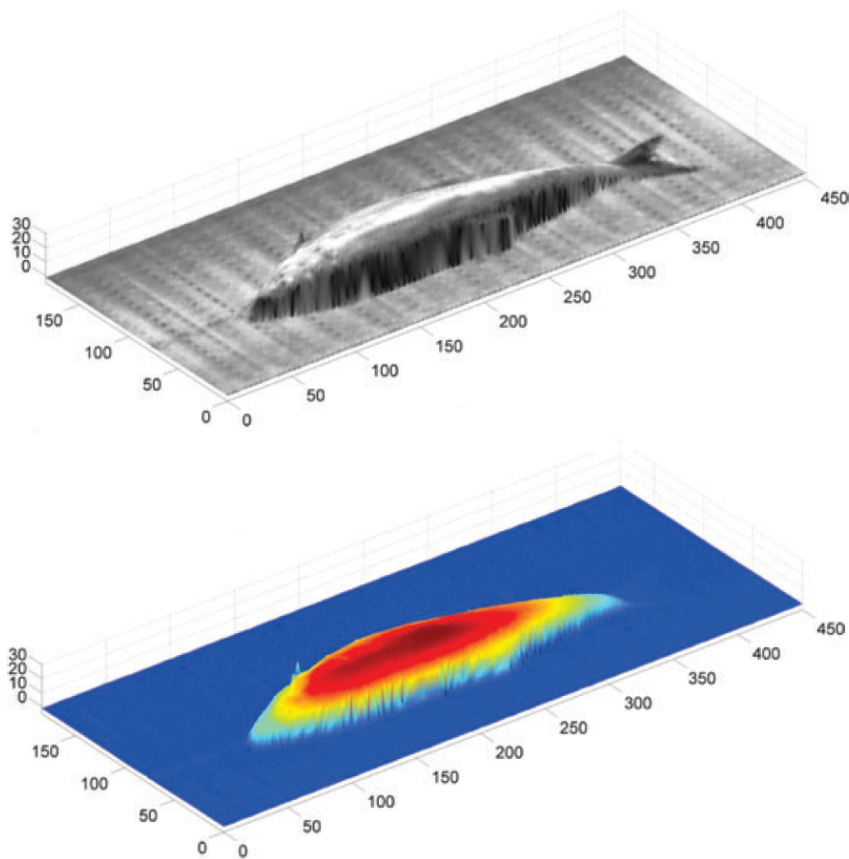

Figure 4.4: A vision scan result - An example of a geometrically calibrated intensity image (top) and 3D thickness map (bottom) obtained from a fresh herring. [Toldnes et al. (2011)]

Toldnes et al. (2011), the combining of 3D projections and 2D imaging is used to estimate the weight of herring.

The setup of the system used in this research is illustrated in Figure 4.3 [p.41]. There is one camera placed at an angle to the object, and then there is a laser placed centric to where the camera vision intersects the object. The angle between the camera and the laser is about 15 degrees. A conveyor moves the object through the line of sight. The results of an image capture for the setup is portrayed in Figure 4.4 [p.42]. The image capture is made and processed in LabView.

Chapter 5

Singulator concepts

Separators and singulators are also known as feeders. Land-based singulation of objects is used in a variety of industries. From the vibration singulator-output feeders used for nuts and bolts, to the larger conveyor belt systems often used in the fruit industry. In fish factories conveyors and shakers along with a clocking system are used to fashion the fish into filed lines.

The system described above is illustrated in Figure 5.1 [p.46] and Figure 5.2 [p.46]. The fish comes into the system with any type of orientation; it lands on a shaking-board. The shaking-board rocks back and forth to exploit the anatomy and friction of the fish. The fish has a significantly higher friction coefficient moving in the direction tail-to-head, than head-to-tail. Due to this physical attribute the shaking-board makes the fish “swim” in the direction of its head. At one end of the shaking-board the fish is fed over a grid leading to a clocking system. At the other end the fish is lead into a turning device which flips the fish around and spits it out on to the shaking-board again. Figure 5.1 [p.46] is an illustration pointing out the different components. As seen from the illustrations - the system is physically large, making it impossible to fit in the designated WeDE area on fishing vessels without serious downsizing. Compact solutions are important; however, for this system it will significantly reduce the system capacity.

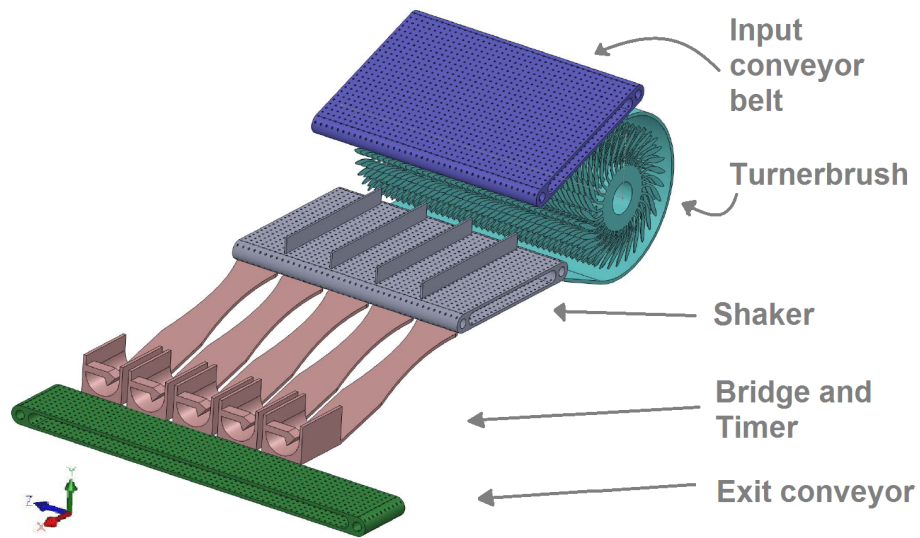

Figure 5.1: Clocking system - An illustration of the clocking system with a shaking-board and a flipper.



Figure 5.2: The real clocking system - An image capture of the real clocking system in use. [SINTEF (2011)]

5.1 High-speed singulator conveyor belts

Another method of singulation is to create space between objects by accelerating them. An assembly of conveyors running at different speeds is illustrated in Figure 5.5 [p.49]. Acceleration is the key in this system's function: By having conveyors running faster and faster after one another - the objects will be spaced as the relatively small starting gap is made greater for each time the piloting object is accelerated away from its followers.

As is illustrated in Figure 5.5 [p.49], this is a system using a lot of space; however, it is possible to make this system into a more compact solution. The system can be fitted to the designated area by looping it about. Dependent on the speed of the conveyor belts relative to each other, their lengths and how tight the in-feed of objects are, the number of turns can be calculated. An illustration of this is shown in Figure 5.4 [p.49] - an actually realized system for this exists as well, and is portrayed in Figure 5.3 [p.48]. As can be seen the example from Applied Robotics the system consists of two layers in order to ensure that the objects are sufficiently separated. A movie illustrating the Applied Robotics' system can be found in the [Digital-copy/Media/Video-files](#).



Figure 5.3: Applied Robotics High-speed conveyor belt system - This is an image for a high-speed singulator system created by Applied Robotics.

[Robotics (2012)]

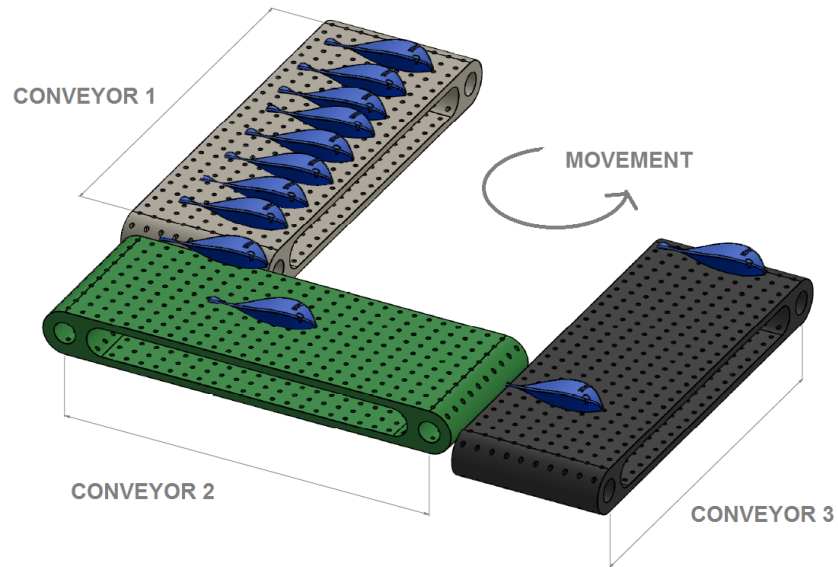

Figure 5.4: Compact high-speed conveyor belt system - This is an illustration of how the high-speed singulator conveyor belt system functions. It illustrates the movement of the conveyors along with how the separation of objects occurs.

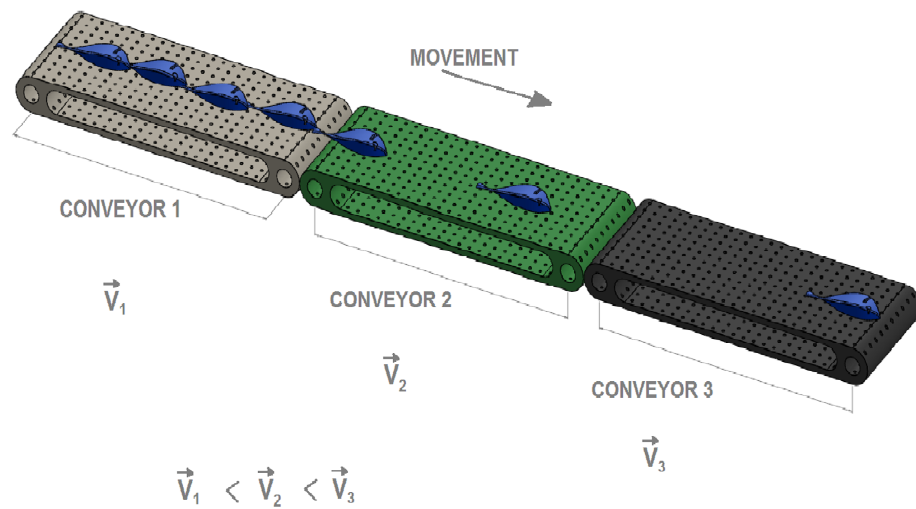

Figure 5.5: High-speed conveyor belt system - An example of how the different speeds of the conveyors belt system separates objects on a single filed line.



Figure 5.6: Fruit Singulator - Has a set of the conveyor belts moving at different speeds and angles. This machine is made by Burg Machinefabriek. It is defined as a V-belt singulator. [Machinefabriek (2012)]



Figure 5.7: Vibration feeder - This is a Singulator that vibrates the whole of its body to exploit friction. [Automation (2012)]

5.2 Other singulator systems

Other Singulator systems also exist; some of the systems that are in use in other industries are shown in Figure 5.6 [p.50] and Figure 5.7 [p.50]. Two of these singulators were picked out as mentionable. They are briefly explained in this following section.

In Figure 5.6 [p.50] the fruit Singulator from Burg Machinefabriek, Netherlands, is shown. The fruit Singulator use the method of acceleration explained in the ‘High-speed conveyor belt’ section, Section 5.1 [p.47]. The fruit enter on a slow moving conveyor belt. It is transported to a set of smaller conveyor belts, which are placed at an inclining angle. The angle make the fruit roll backwards if they lay on top of each other. This second set of conveyors moves faster than the first set: This accelerates the fruit - thereby separating them from the bulk. The V-shape of the belts helps the fruit from stacking on top of each other. After the V-shaped conveyor set another set of cleated belts makes sure that the fruit is absolutely singulated. A movie documenting this system by Burg Machinefabriek is attached in the Digital-copy.

A Syntron Vibratory Feeders is illustrated in Figure 5.7 [p.50]. The vibration feeder system works by exploitation of friction. The machine has a slowly inclining slope, as the machine vibrates the objects straddle up the slope. The objects are constantly pushed onto the entrance of the slope by a rotating plate turning. The new objects entering the slope help pushing the other object upwards as they straddle. All objects are dumped in the middle of the machine. And their orientation when entering the system is not important. There are place intricate obstacles to orientate the output. For a better understanding go to the Digital-copy/Media/Video and watch the movie provided by Homer City Automation.^[Automation (2012)]

5.3 Pick-and-place

This diploma work is done in co-operation with the institute for Technical Cybernetic at NTNU; pick-and-place robotics would be the first system to think of as it mimics the human motion and plays on the imagination of a robotic world view. However, another research project - conducted by this author and with help and support from SINTEF Fisheries and Aquaculture, [Eilertsen (2011)], found that pick-and-place handling of fish was not only highly complex - but rather harmful to the exterior of the fish.

The result and conclusion of the project was that pick-and-place is not a recommended solution with the current technology. The results from the research project clearly state the complexity of picking up a slippery fish. It was hard getting a grip on it laying still on a flat non-moving surface. Taking into account that the fish might be alive killed and the movement of the boat - this would not be an optimal choice today.

In Figure 5.8 [p.53] the machine made for the pick-and-place project is shown. As can be seen, the pick-and-place robot also demands a lot of space, making it a challenge to fit it in the area for weight estimation. There are smaller pick-and-place robots; however, they are still too large for the small space designated.

However, having said all this; the pick-and-place robot is still alluring as it aspires to similarities of the human movement. And a natural method of solving a problem is to look at the process currently used - copy it, and reproduce the action. It is important not to get too advanced, or too focused on how the process is currently handled. What is important is to keep in mind that the simpler the better. William of Ockham presented a statement to this affect: *Pluralitas non est ponenda sine necessitate* - or translated into the modern interpretation: *Whenever possible, shave away.*



Figure 5.8: Pick-and-place robot - This is the prior art pick-and-place robot created at SINTEF Fisheries and Aquaculture. [Eilertsen (2011)]



Figure 5.9: Adept Quattro - This is the Adept Quattro, a four legged robot made for high-speed pick-and-place work with high precision. [Quattro (2012)]

5.4 Novel ideas

In the preface of this project a brainstorming session was conducted at SINTEF Fisheries and Aquaculture. Along with the team at SINTEF Fisheries and Aquaculture, the author discussed possible novel solutions to the challenges this project would face. Many ideas were pitched and the best of them were written down. The best and most novel of these ideas are illustrated and explained below.

5.4.1 Drop-in vision

One of the solutions was a drop-in vision system. As can be seen for the illustration in Figure 5.10 [p.55], the drop-in vision idea consists of a ‘s’-curved conveyor pulling fish from a crate. The fish is then lifted to a desired high before it drops of the edge of the conveyor. The fish would then slide along a steep ramp, and flood passed a 2D/3D vision system. Since the conveyor is cleated only a limited amount of fish would be delivered at one time - ergo the vision system would not be deluge¹.

5.4.2 The whirlpools

Whirlpools have fascinated mankind ever since first discovered. The whirlpool is swirling body of water usually produced by ocean tides. A whirlpool with downdraft is called a vortex. The vortex is turbulent fluid flow with spiraling motion centered about a rapidly swirling center. A vortex is capable of pulling objects in its path toward its center of perturbation. The final solutions presented in this project are based on the whirlpool. Three possible solutions of the separation challenge was thought of, none of them had been tried before. The solutions came up when thinking of how to minimize

¹Deluge: *verb*, to overwhelm or flood something. (6)

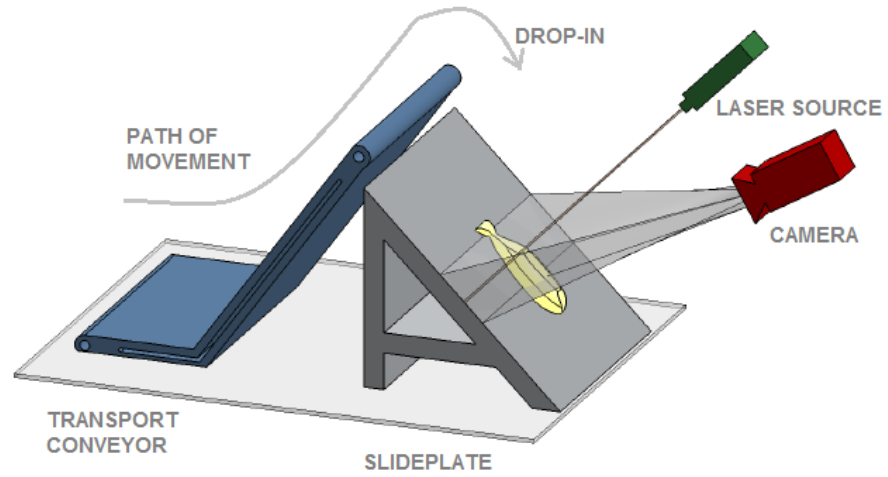

Figure 5.10: Drop-in vision - This is an illustration of a drop-in vision system. The illustration shows the camera, laser source, and the 's'-curved conveyor belt. The fish has fallen from the conveyor onto the slideplate.

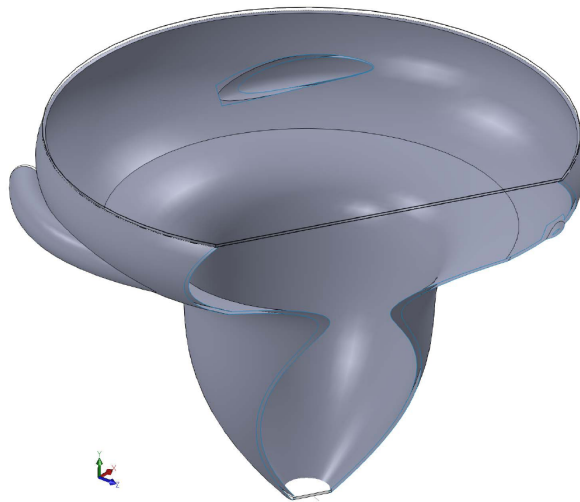

Figure 5.11: 'The Cyclone' - This is 'the Cyclone' system. A Whirlpool is created with water injections along the top.

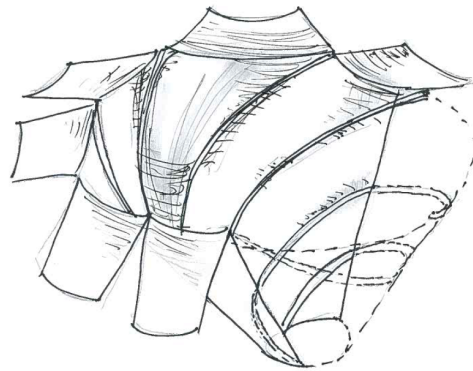

Figure 5.12: ‘The Screw’ - ‘The Screw’ operates somewhere in between the vibrators illustrated from Homer City Automation and ‘the Cyclone’. A Cyclone is created to force the fish into threads, and vibrated up along them to the exit.

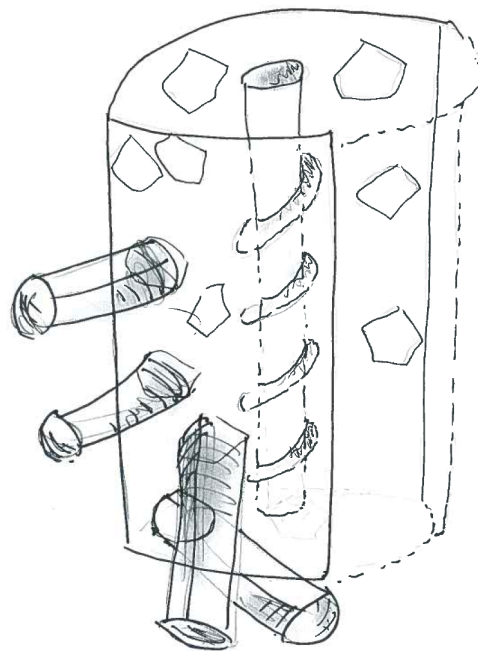

Figure 5.13: ‘The tower centrifuge’ - The ‘Tower centrifuge’ create a body of swirling water and push the objects to the wall. The wall is lined with holes letting the objects into pipes leading separate weighing stations.

the impact from the movement of the ship on singulation process. A vortex sucking in the fish would pull on the fish whether or not the system would be standing at an angle to gravity. This way the fish would be lines into tracks even in stormy waters.

The Cyclone

The first of the novel concepts are the ‘up-side-down-soda-bottle’-model. It is a funnel where water is added to create a whirlpool. When the objects, here the fish, are dropped into the whirlpool they will start swirling towards the center. However, while spinning about in the funnel the fish will start to spread. Only one object can occupy the center of the whirlpool at one given time, leaving the rest to “swim” about it. The center of the whirlpool leads to the end of the funnel. At the end of the funnel both the object and the introduced water will escape. The goal is then to get the objects to slide onto a conveyor leading them individualized to the estimation station.

In Figure 5.11 [p.55] a section view of ‘the Cyclone’ is illustrated. The fish is dropped in along the wall and swirl towards the center of the whirlpool. At the center of the whirlpool it drops to a conveyor along with the water.

Other swirling ideas

From this idea other concepts spired. One of the concepts was a water centrifuge with vibration and threading. It would utilize two different functions: The centrifuge would force the fish into the threads alongside the walls; while the vibrations would lead the fish up the threads - as in the example of the vibration-feeder, Section 5.2 [p.51]. The top of the centrifuge system, multiple run-offs would lead to separate weighing stations. We called the idea ‘the Screw’ and an illustration is shown in Figure 5.12 [p.56].

The other concept was a tower centrifuge - also here pushing the fish, into threads. However, these threads lead to holes in the side of the wall. These holes would, like 'the Screw', lead the objects to separate weighing stations. This 'Tower centrifuge' would potentially segregate the fish by size, as the larger fish would sink to a lower height than the small ones. In Figure 5.13 [p.56] the 'Tower centrifuge' is illustrated.

Chapter 6

Concept choices and dicussion

This chapter will conclude choices of the Estimator and its road ahead; suggestions to how SINTEF Fisheries and Aquaculture should move forward as well as how to fast trial their vision system for verification of function. Furthermore, the Singulator will be discussed thoroughly, along with a conclusion stating which concept to move forward with.

6.1 The Estimator conclusion

There are two main contenders for the role of Estimator: The hopper scale, and the vision system. The flow scale has yet to be made. There have been some talk about realizing this; however, nothing has happened yet. There is no marked for such a system yet.

The machine vision worked on by SINTEF Fisheries and Aquaculture is, however, already been tested at seas: And it works. There are still details to take care of, but work is progressing. The main challenge with using machine vision at seas is non-consistent vibrations of the motor, along with the heave. Tests for improved machine vision must therefore be conducted to establish whether or not the vision system will be able to function.

Suggested furtherer work on the Estimator is therefore as follow: A small experimental setup with the land-based vision system. Place a scaled-

up pager-vibrator on the vision-tower-box and run the usual tests. This should give conclusive information on whether or not a vision system will function while experiencing severe vibrations.

6.2 Discussion of the Organizer

In the previous chapters and sections, all types of singulation methods have been viewed. However, not all of them are possible to employ on fishing vessels. Systems like the larger conveyor belts and the pick-and-place robotics can be excluded on the bases of their space occupation alone. The more compact conveyor belt system could potentially fit on the acreage available. But there are other downsides to the conveyor belt system than size. If the boat has a lot of movement, the fish would slide back and forth on the conveyor belt with the potential of becoming unorganized again. This is not a wanting feature.

Back to the pick-and-place robotics: Space is but one factor rendering this solution disabled. A pick-and-place robot would need maintenance that the sea-man not necessarily has knowledge of. Meaning, if the machine would break during an expedition it could not be fixed before the vessel ported again. Furthermore, the movement of the robotic arm in an already dangerous work environment is not an EHS recommendation.

The vibration feeder made by Burg Machinefabriek would not function properly, as the machine has no hold of the fish when it balance along the wall - if a wave or other banking and heaves were to occur, the fish would by all likelihood fall of the desired path. A modification of the main feature in the machine is, however, redesigned into 'the Screw'. But before discussing the water based systems, let us look at the drop-in vision system. The drop-in visions system could work at seas. The system has taken into account the movement of the fish vessel. As stated by John Reidar Mathiassen from

SINTEF Fisheries and Aquaculture, under the conforming of the novel ideas, would the camera be able to conduct weight estimation of the fish at any drop-in angle - as long as the angle at all time is measured and convoyed back to the estimation system. However, there challenge with this system. The problem is that the drop-in system does not really have a Singulator. The drop-in system just uses the cleated belts from the input to create signulized fish. With the correct design, a cleated belt could ensure that not too many fish are plucked; however, there is no way of knowing exactly how many is grabbed each time. And even if one would say that the fish is separated enough with the cleated belt system, there is no telling if the fish will overlap when dropped in front of the camera. The overlapping fish problem would render the drop-in-vision-system none-functional.

There has been presented three water based systems: The ‘Tower centrifuge’, ‘the Screw’ and ‘the Cyclone. The water based systems are design with heave and bank in mind. A system where the fish is “suspended” in water, and it is the water movement separating the individual fish, the effect of vessel movement is theoretically eliminated. However, some of the concepts are more idealistic then practical. The ‘Tower centrifuge’ is very idealistic. It is built with many holes along its outer wall. The likelihood of these holes not getting jammed is small. This renders that solution unemployable. It would cause a lot of extra work unjamming the device and potentially dangerous situations trying to mend the problems that occur.

‘The Screw’ could function, there are little potential for jams or other problems causing the machine to hold-up the WeDE-process. However, the downside to ‘the Screw’ is the vibration. Having the vibrating part in the system means that there is *one more thing* that can go astray: This leaves one potential solution: ‘The Cyclone’.

‘The Cyclone’, just like the ‘Tower centrifuge’, could get constipated.

However, for ‘the Cyclone’ there is a simple solution to stop this from happening: *a)* Do not let the objects cover the outlet, *b)* do not let the objects stop swirling about. As long as these rules are employed to ‘the Cyclone’, ‘the Cyclone’ will deliver singulized fish. ‘The Cyclone’ system is also really robust, as it has no moving parts and is only controlled by the water injection. Robustness and simplicity is the key to durable prolongation automation.

6.3 Conclusion of the Organizer

In conclusion there are many methods of singulation. The possible options have been explained and discussed in the chapters before. Some of the singulation tools are designated for land-based processes only. However, others are capable of evolution: Such as the High-speed conveyor belt system redesigned to a compact solution (see Section 5.1 [p.47]); furthermore, among the novel concept solutions there where many innovation ideas.

During the discussion, most of the system solutions presented was shut-down. After reflecting on the discussion there was only one system that would work as needed under the given conditions: The conclusion must be that ‘the Cyclone’ will be the best choice to take into the design and experimental phase of the project.

HARDWARE AND SOFTWARE

Abstract - This Part III present the hardware and software used during this project. A presentation is given before the design Part - this is not because the process was limited by hardware; but rather to keep the software and hardware review in one collective Part. Knowing the hardware and software that is going to be applied in this project might give a better inside to the solution presented.

Both hardware and software have important roles in the realization of a conceptual idea. Hardware could be everything from the unit that materializes the concept to the physical controller. Software is just as important

and can be everything from the mathematical control algorithm employed in the physical controller - to the program used to design the concept before materialization.

In today's modern world, software and hardware spin an intricate web, interconnecting the two disciplines. The development of new hardware is most often done in software running on slightly older hardware. They push each other to strive for better technology.

Chapter 7

Hardware

In this project there have been utilized different types of hardware. It is the conveyors and the volumetric measurer, and the produced prior arts model and the 3D-renderd system.

To create the prior arts model the faculty workshop was utilized. The prior arts model, as well as parts of the finalized conceptual model was made in collaboration with *Terje Haugen* and *Per-Inge Snildal*, workshop-manager and chief-engineer, respectfully.

Some of the parts made for the final conceptual solution were produced by a 3D-printing company called Materialise. They produced and shipped the run-off section and the whirlpool wall section.

7.1 Conveyor

During this project there were used conveyor belts. The conveyor belts made an input/output system for the project. A conveyor liaised with fish gave a steady input compared to manually inputting the fish.

SINTEF Fisheries and Aquaculture provided a conveyor belt system from Geppert-Band. The model was a Geppert-Band GAL-25. It has an aluminum frame and is treated for use in wet conditions. This means that ‘the Cyclone’ system can be paired with these conveyors.

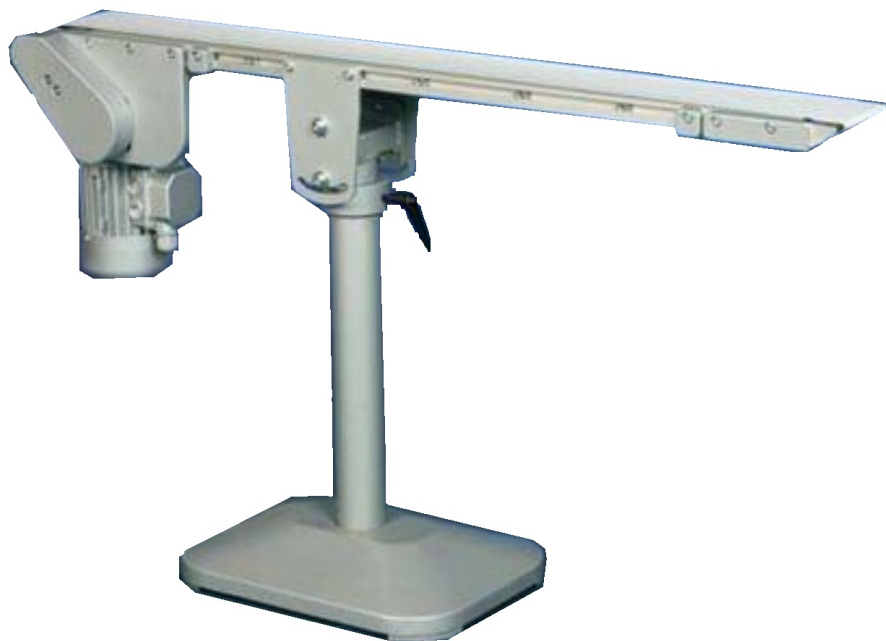

Figure 7.1: Geppert-Band GAL-25 - This is the conveyor belt system that was used in this research project.

The GAL-25 is a conveyor belt with a 300mm band width, and is 1500mm long. It is held by a pivotable single column support with an aluminum ground plate. The foot of the conveyor is placed to the far side so that one end of the conveyor can reach over objects. The manufacturer states that the speed of the system can be adjusted for about 1.6 to 5.7 meters per minute. Before testing the slowest speed of the conveyor was calculated to 1.8 meters per minute. Note that during the experiments only this setting of 1.8 m/min was used, and that it was the spacing between the objects that was changed.

7.2 Volumetric measurer

For the experiment in this master thesis a volumetric measurement unit would have been useful; and the intention was to use one. However, due to parsimony could not this wish be granted within the timetable of the master thesis. A less accurate method of measurement was used. A ten liter bucket was placed at the exit of the run-off segment when the vortex was fully developed. Since the system did not leak all the water entering the system had to come out this opening. Along with the bucket a stop watch was used. The filling of the bucket was timed, and the volume exiting the system was calculated. These calculations were done five times over, and the approximate average of the flow was calculated.

Chapter 8

Software

Software is the collection of computer programs and the related data, which provides a set of instructions telling the computer what to do, and how to do it. When programming software, the software can provide either a set of instructions directly to some computer hardware, or serve as an input in another software program.

When working with this project several programming languages were needed to reach the set goals. 3D-programming was used for design of the concept, while LabView were used to create a camera logger as well as an operation tool for the mechanisms involved in the concept.

8.1 SolidWorks

SolidWorks is a 3D mechanical computer-aided design (CAD) program, which was developed to make 3D-CAD programming easy-to-use, affordable and available on Windows desktops. This program has a graphical interface making it easy to understand and see what is being designed and built. The program makes it possible to utilize parametric modeling features. This means that objects easily can be resized and/or modified. SolidWorks is but one of many such 3D-rendering programs; other programs could be AutoCAD or Solid Edge, however, SolidWorks was chosen due to its many

addition features. Such as: Simulations tools, Motion tools and Flow Simulation tools.

8.1.1 SolidWorks Fluid Simulation

This is a tool that tests fluid-flow on 3D-renderings made in SolidWorks. This means that the concept can be tested in simulations before being produced. This helps with cutting costs as well as a lot of hang-time waiting for new parts each time a fault with the current prototype found. Eliminating many of the major mistakes or no-functional ideas helps the process procure a solution faster.

8.2 Excel

Microsoft Excel is a spreadsheet application. It is easy to use, and creating simulations are easy. Excel features calculation and graphing tools, pivot tables and a macro programming language called Visual Basic for Applications (VBA). Programming with VBA allows for spreadsheet manipulations that are impossible with standard spreadsheet techniques. A programmer may write code directly using the Visual Basic Editor (VBE), an appendix to Excel. Working in Excel provides a more visual control of values, thereby creating an easy and visual platform to work from.

DESIGN AND CONSTRUCTION

Abstract - Design and construction is important to all functional creations. In many ways is the design what defines that use. In this Part IV the design choices made in this research project are explained and discussed. The use of computer aided design along with the tools this brings to the table is summarized. The separate parts of the construction are explained and the reason for their particular design attributes is given.

Design is an allusive concept. Design is everything and at the same time very specific. Even the first creation (whether not you believe in religion) had a design, it functioned in a certain way. Design is, as trying to convey here,

in this project a manner of described function; and everything that exists can be found to have a function of some kind. In some simple manner have everything been designed for a “specific purpose” (or evolved or adapted or created to the surroundings).¹

Design is a specification of an object, manifested by an agent; intended to accomplish goals in a particular environment, using a set of primitive components satisfying a set of requirements that are subject to constraints. Lyytinen et al. (2007)

For any task there is more than *one* design, and such is the case in this project as well. There were multiple ways of designing and constructing the weight estimation process and its components - like the Singulator. However, one concept was chosen in the ingressional part of this diploma work, see Part II Section 6.3 [p.62].

The concept chosen for further indulgement was ‘the Cyclone’, see Figure 5.11 [p.55]. Prior to the final solutions presented in the coming sections there was made a prior art construction, which can be found in Chapter 11 [p.99]. The prior art has helped in procuring the final details of the design presented in this Part IV: It will therefore be referred to during the design analysis.

This project relied heavily on the CAD tools available, due to the desire of easy simulation of the system before materializing it. By using CAD, the conceptual design was easy to visualize, and a better understanding of the concept was attained. It made it possible to easily see small changes in design

¹Be aware, this is not coined for a discussion on religion - just an observation from the author.

along the way. With the use of simulation tools the effects of the changes in design was instantly visualized and made more culpable to comprehend.

Chapter 9

Design - CAD

Computer Aided Design can be used to create custom designs, not limited by shapes or sizes of existing materials. Designs can be planned with extreme accuracy, only limited by the milling that would be used when realizing the design. When it comes to designing structures, knowledge of materials and strain is not really within the education of cybernetics. However, with the CAD program that was used in this project, both materials and strain could be tested virtually. However, the project did not reach the stage where calculation of strain on materials were necessary.

In these next sections the chosen design's parts will be diverted into separate segments handling different sections employed in the conceptual solution. However, to get an overview and better understanding of how the interactions and positions of the different parts are, let us first look at the complete design. (Note that a lot of the design is based on findings during the prior arts trials - and it might be advised to read about it first, see Chapter 11 [p.99].)

In Figure 9.1 [p.77] the complete design of the Singulator is portrayed. As can be seen there are distinct parts composing the concept. These parts play separate and important roles in the machine. Along with the visual illustration a list explaining the different segments is given.

First segment - is the fixed louver. This fixed louver ensures that only the appropriate sized fish are allowed into the system. This means that the fish that is too big and would jam the system pass by and will not be measured at the weight estimation station.

Second segment - is a slide. It makes sure that the fish is not plumped into the middle of the system as this could invoke a jam. The fish is therefore led alongside the wall.

Third segment - is a water injection system, which creates the swirl of water that defines 'the Cyclone' system.

Fourth segment - is the defining walls of the whirlpool. It guides the fish to the exit, while allowing the fish to freely swirl about if it cannot get down the exiting hole strait away.

Fifth segment - is the output, or end, part of the fourth segment. This is a segment that narrows the exit into a tube section. The need and reason for this segment is thoroughly explained in Section 9.5 [p.87].

Sixth segment - is the run-off. This segment led the fish to the start of the weight estimation system. This tube is designed such that as much water as possible is let out before the fish reach the next system.

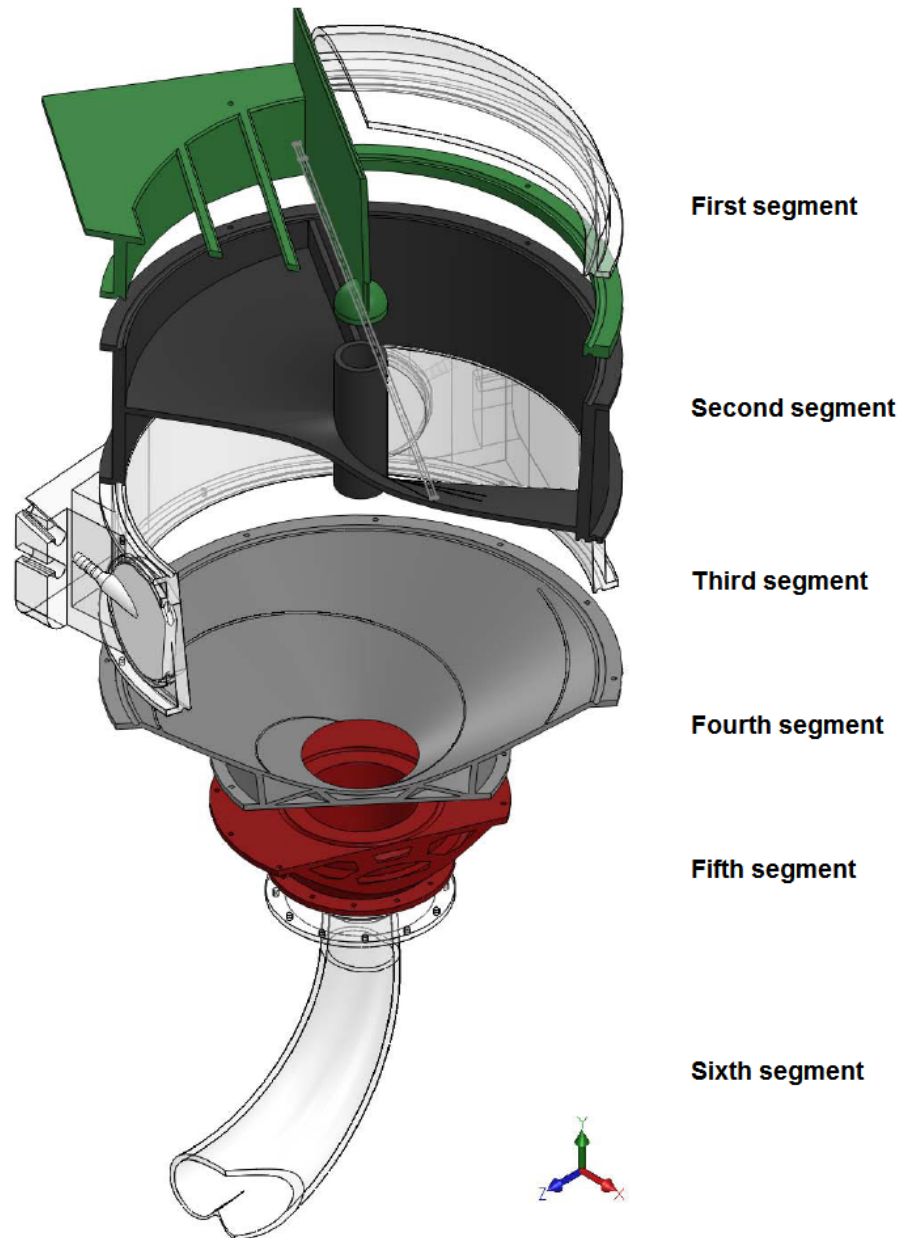

Figure 9.1: Segmented concept solution - The illustration is a simple drawing of the concepts different segments and their orderly placement in regard to each other.

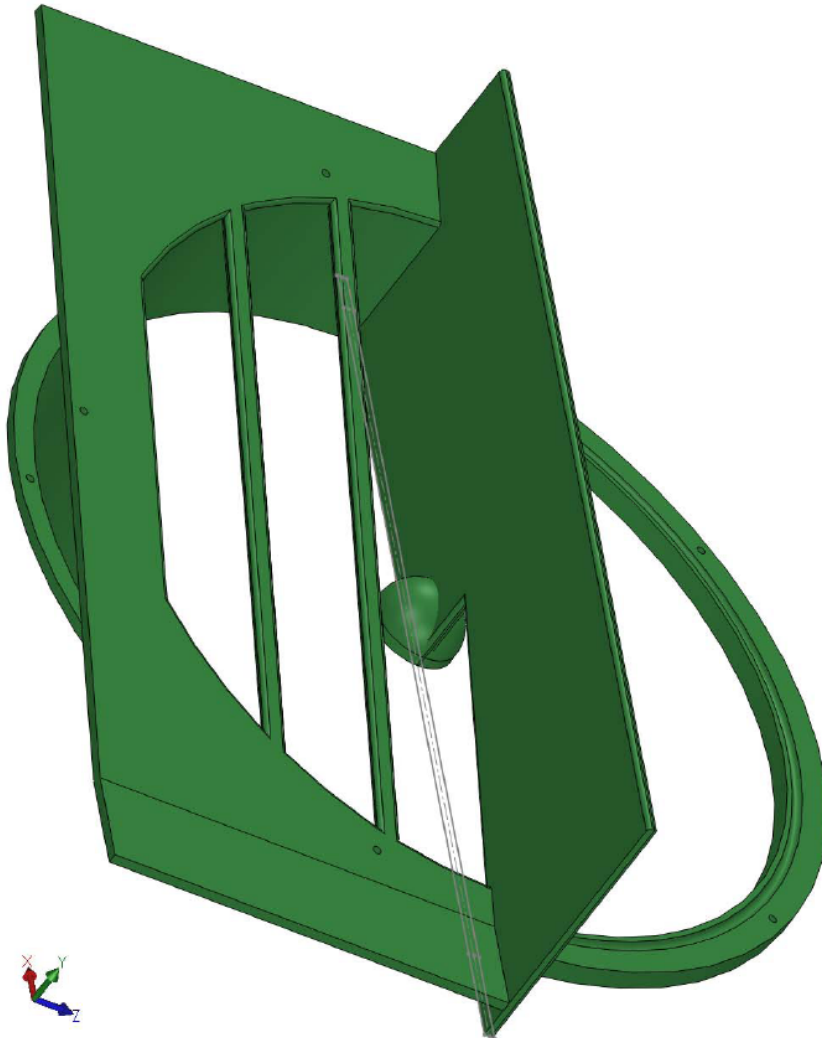

Figure 9.2: The fixed louver - This is an illustration of the fixed louver ensuring entrance to only the fish of the size which the system is capable of handling.

9.1 Fixed louver

The order of the segments listed in Figure 9.1 [p.77] is not the order the Singulators segments were thought of nor created in. However, it is more natural to explain the segments in such an order to ensure a better and easier overview. The first segment is therefore the fixed louver.

The fixed louver is a necessity for the system. Since the system is both closed and of ridged design with no moving parts, it is hard to correct any jamming in the system. In the prior arts model testing, made to prove the concepts functionality, the system had problems of jamming if fish were laying still; but it is pretty clear that it would also jam - if the fish entering the system were greater in diameter than the exiting hole at the bottom of the system. The fixed louver is the solution to such a problem. With the fixed louver only the fish that is smaller than the exiting hole may enter the system.

The spacing between the grid patterns in the fixed louver is made to be just slimmer than the diameter of the smallest exiting hole. This means that the fish entering the system will all ways be slim enough to get out.

But why is it a louver and not a perforated plate with square, diamante or round holes? As the fish slides with speed from the conveyor, the fish would just slide over holes; however, with the louver, the elongated gap lets the fish slide before it needs to enter the opening. This means that the input to the system is still easily accessible for the sliding fish, but limited for the fish that would constipate the system.



Figure 9.3: The slider - An illustration of the slider employed to ensure that the fish is not dropped into the middle of the system, causing it to jam.

9.2 Slide

This next segment is like the fixed louver put in place to hinder a simple action from causing a lot of trouble. Just like the fixed louver part the slide segment was found as a necessity when conducting the prior arts trials, Chapter 11 [p.99].

During the experiments with the prior arts model it was discovered that dropping multiple dummy fish in the middle of the whirlpool created a jam. The dummy fish had the tendency of clinging to each other as well as forcedly entering the exiting hole. The whirlpool sucked in the fish and pulled them along with the speed gained from the fall into the exit hole.

This is imperative to hinder the fish from getting dropped straight into the vortex. This is why the grid is position to one side of the cylindrical shape of 'the Cyclone'. However, just moving the input to one side of the cylinder did not help. The solution was to create a slide leading the fish, which entered the system, along the sidewall of the cylinder. The slide is designed to move the fish not only towards the sidewalls, but also so that the fish cannot drop into the middle. The cylinder placed in the middle of the slide, stiffens the plate the fish must slide along, but it also has a diameter big enough to make a center drop impossible.

The slide is also equipped with water injections; this is to ensure that the fish slides swiftly. It is also an insurance that the slide does not become a hold up in the systems speed.

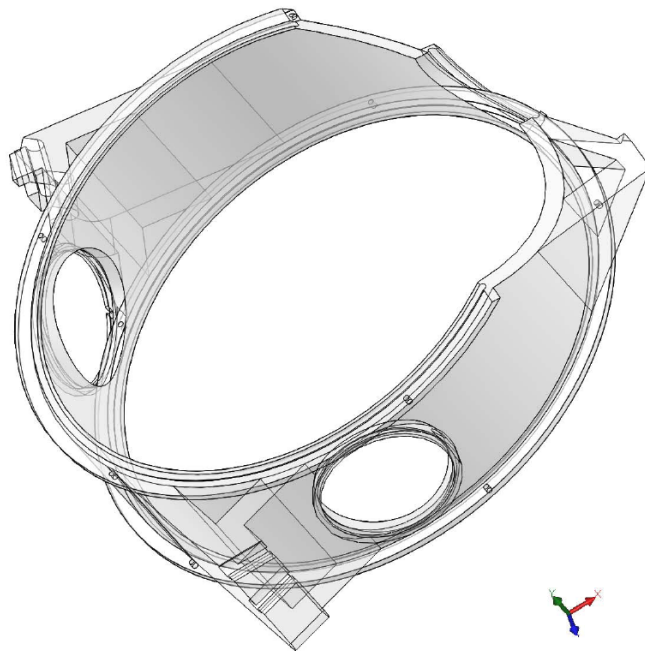
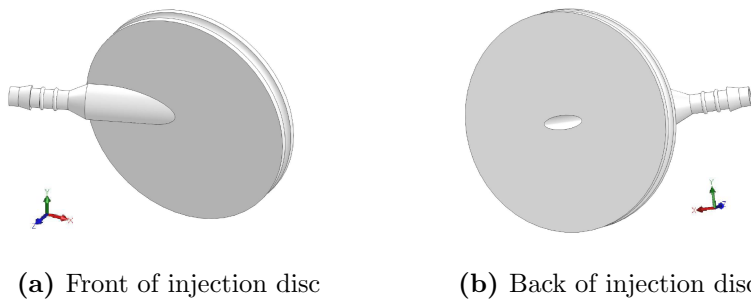

Figure 9.4: The water injection - The water injection illustrate in the picture above makes sure that water is entering the bowl and creating a whirlpool by its alignment of injections.



(a) Front of injection disc

(b) Back of injection disc

Figure 9.5: The injection disc - This is the front and back of the injection discs used in the injection unit. The discs are designed to move about its own center, which means that the water injection will only change direction in the injection chamber, not position.

9.3 Water injection

The water injection system is of course absolutely necessary for ‘the Cyclone’ to function. It is where the water that creates the whirlpool enters. In the prior arts model the water injection system was ridged, and were directing the water only along the sidewalls. In the CAD-model the water injection was made so that it can be directed, meaning they can be rotated upwards and downwards.

The possibility of directional water injection is important in the prototype experimental phase. With injection direction adjustments, different types of vortex formations can be tried. Water injection pointing downwards would most likely not create any vortex; however, a downward facing injection could create a higher pressure on the speed and direction of the water in the bowl. The whirlpool can become speedier with the downward injections. On the other hand, if the water were to point upwards the whirlpool would be slower, and the body of water higher as the water would be injected to the system as a showerhead. It is also fairly unlikely that an upwards injection would yield a vortex at all. In the case of the prior arts model, the water injection points horizontally along the sidewalls. Finding the right adjustment for the injection angle can play an important role in optimizing the time consumption for the total Singulator.

Figure 9.5 [p.82] is the illustration of adjustable disc that makes up the injection system. It fits in the openings in Figure 9.4 [p.82] with an O-ring seal to ensure that the injection segment does not leak.

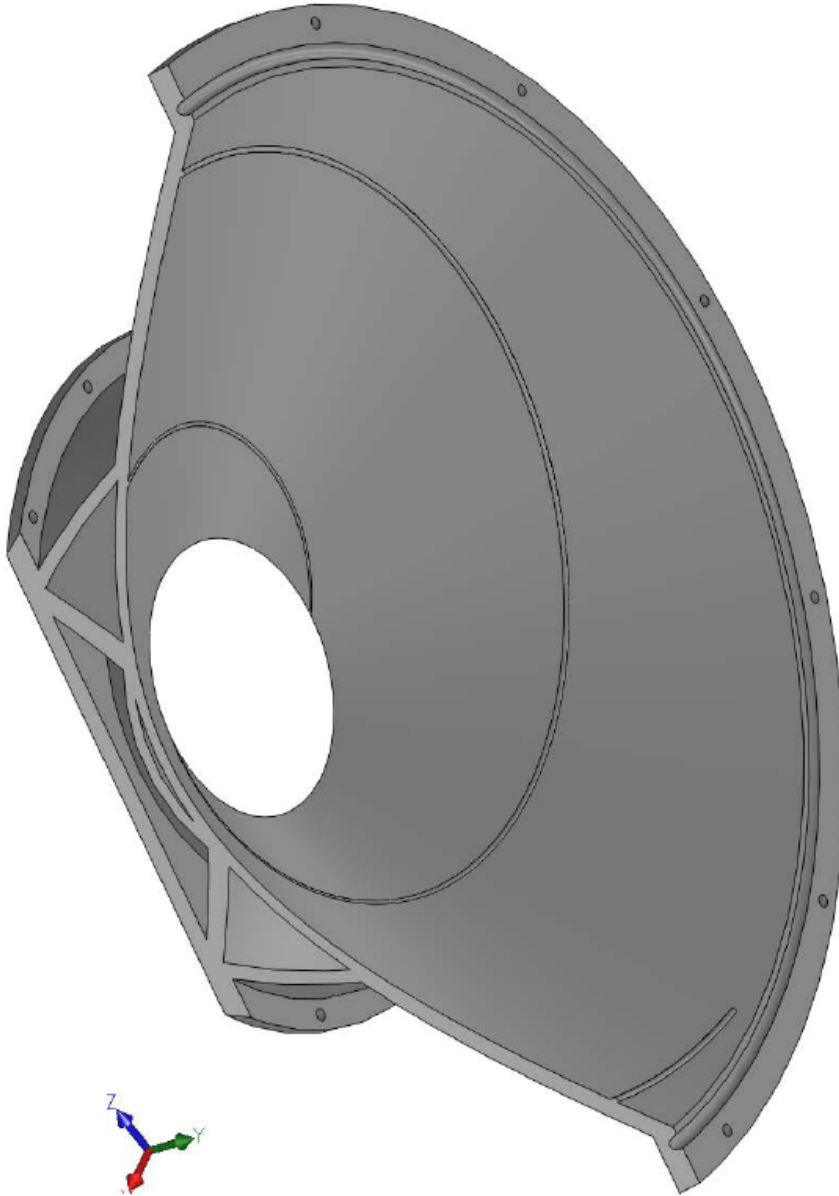

Figure 9.6: The Whirlpool wall - This funnel is the whirlpool wall ensuring that the fish has a direction towards the exit as well as allowing for delay in the fish output if there are many fish trying to move out at once.

9.4 Whirlpool wall

The whirlpool wall was made from an old lampshade in the prior arts model. In the CAD-model, illustrated in Figure 9.6 [p.84], the same principle of funneling is employed. The angle of on the wall was adjusted multiple times during the simulations. The final result of the dimensioning of the whirlpool wall was based on the size of the fish.

As can be seen in the illustration of the CAD-model there is designed in a wedge along the face of the wall. The reason for this is thoroughly discussed in Section 11.1 [p.114]. In the experiments with the prior arts model it was discovered that the fish tended to swirl about the exit using a long time reaching the exit. Employing guiding curves show itself as an effective method of leading the swirling objects faster towards the exit. The curves also affected the water speed. The guidelines increased the speed so much that the volumetric' input flow had to be reduced to ensure that the system did not flood.

The size of the whirlpool wall is designed so that fish while have enough space to swirl about without interfering with each other's paths to much. However, seen for the experiments on the prior art - interaction is enviable. The guidelines where therefore made small enough to let the fish float over them if colliding with other fish, but high enough to create an impact on the direction of the waters swirl and the fish's movement.

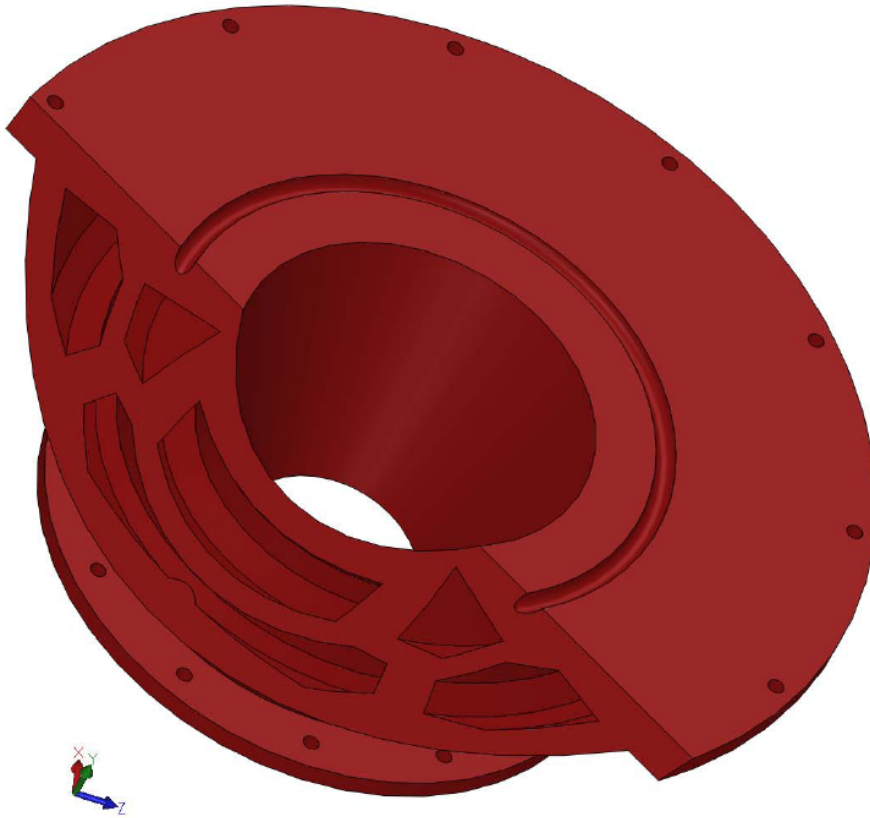

Figure 9.7: The output funnel - This is an illustration of the output funnel. It connects the whirlpool wall to the run-off. It also ensures that the water build up in the whirlpool does not happen while containing the whirlpool.

9.5 Output funnel

This is a segment that lives in sync with the whirlpool, and in reality the output funnel or end terminal is an elongation of the whirlpool wall. The end terminal (EnT) is design separate the whirlpool from the run-off, to ensure a more flexibly designed system where components could easily be changed in search of more optimized parts.

During the prior arts experiments two different EnTs were used. The experiments showed that the EnT had a profane effect on the whirlpool and its existence in the system. The length of the EnT affected the body of water in the system. With a short EnT the whirlpool was standing higher in the system compared with the long one. It was also shown that the EnT segment was easily influenced by the amount of fish flowing in it at a given time, with this we mean that the EnT easily jammed if there was too many fish entering at the same time.

The whirlpool was affected by the length of the EnT. If the EnT was virtually non-existent the creation of a whirlpool in the system was problematic. The system flooded along the whirlpool wall and the fish floated higher and the body of water in the system was so high that it reached the injection section. A sharper change in direction, created from the whirlpool wall to the longer EnT, seem to create a more perfect transition for the creation of a vortex.

However, letting the EnT becoming too long seem to create a body of water without swirling movement before the transition to the run-off. This stopped the fish's speed and created a bottle neck in the system which could potentially lead to constipation. The depth of the EnT was therefore made of allow for a vortex creation, but not still water; the length found through simulations of the system, see Chapter 10 [p.91].



Figure 9.8: The run-off - This is the run-off leading the fish to the input of the weight estimation system. It has a slight split in the middle to ensure that not two fish will lie on top of each other.

9.6 Run-off

This is the final segment in the Singulator system. The run-off is made to guide the singulated fish to their end destination. The entrance is dimensioned for the largest fish that the system must handle. The length of the pipe is constructed so that the largest fish will bend to its curve. In other words the stiffness of the upper body of the fish is calculated and accounted for so that the bend is not too sharp, as this would increase the possibility for fish getting stuck.

In the prior arts model the run-off was made from a gardening hose. The dimensions of the gardening hose were equal to that of the dummy fish. All the dummy fish in the prior arts experiments were of the same dimension. This is of course not a reflection of reality. Fish of different lengths have different thicknesses. This could cause problems in the piping: If two fish fit through the entrance it must be able to pass all the way through. But if there now is a possibility two fish exiting the system at one time, some solution must be found to avoid them for lying on top of each other.

The run-off is design as two intersecting pipes. The intersection starts to rise early inside the unit. The raised edge, from the merging of the two pipes, enforces the two fish in splitting. There is no room for the two fish to move along the same pipe section. In other word the fish is effectually separated. To ensure that no fish is gets stuck inside the pipe - the head height is raised some much that the largest fish many move smoothly through the tightest areas.

During the experiments the exiting fish had a very high exit velocity. There was also a lot of water flushing out along with the fish, since this was the only exit from the system. It was therefore found necessary to drill holes in the gardening hose. These holes are also added in the run-off unit, ensuring that most of the water is exiting the system before the fish.

9.7 Summary

The complete CAD-model is a creation of the conceptual idea: ‘the Cyclone’. The design of the Singulator have been heavily influenced by the findings in the prior arts experiments, Chapter 11 [p.99]. The prior art helped a lot when both defining dimension of the conceptual creation as well as developing needed attributes.

In the design of the CAD-model, the dimensions of the largest wanted fish where estimated. The model was built on coherent dimensions; this means that if the largest wanted fish changes, the model will scale to the dimensions of the new fish size.

All the parts designed are carefully thought through, with concern to easy adaptability for the dimensions and attributes such as the guidelines. The complete model is also designed so that each component can easily be taken out and substituted with a new designed segment. Such adaptability helps when working with prototypes in development.

Chapter 10

Cad - Simulation

Simulations are often very useful as an indicator of how a system will function in real life. Simulation of systems give way for more efficient productions, as many errors can be eliminated/removed before the unit is produced. This also means lower costs and less production design waste.

In this project the simulation tool was used to detect different types of whirlpool creations and their efficiencies. The simulation is also used to show how the angling of the whirlpool is important to ensure movement in the fish.

10.1 Simulation of fluids

During the simulations the whirlpool wall was changed. This was done to see the impact the guidelines had on the whirlpool. In Figure 10.1 [p.92] four different vortexes and whirlpool walls are illustrated. The illustrations show clearly the impact of obstructions in the flow path. The flow in a) marginally affected by the insertion, however, in illustration d) the affect is clear. The whirlpool is affected, and turns faster toward the exit.

During this simulation the whirlpool insertion where simulated from non-existent to highly invasive. In the illustrations shown in Figure 10.1 [p.92] the whirlpool's insertions were, of 4 millimeter, 12 millimeter, 21 millimeter,

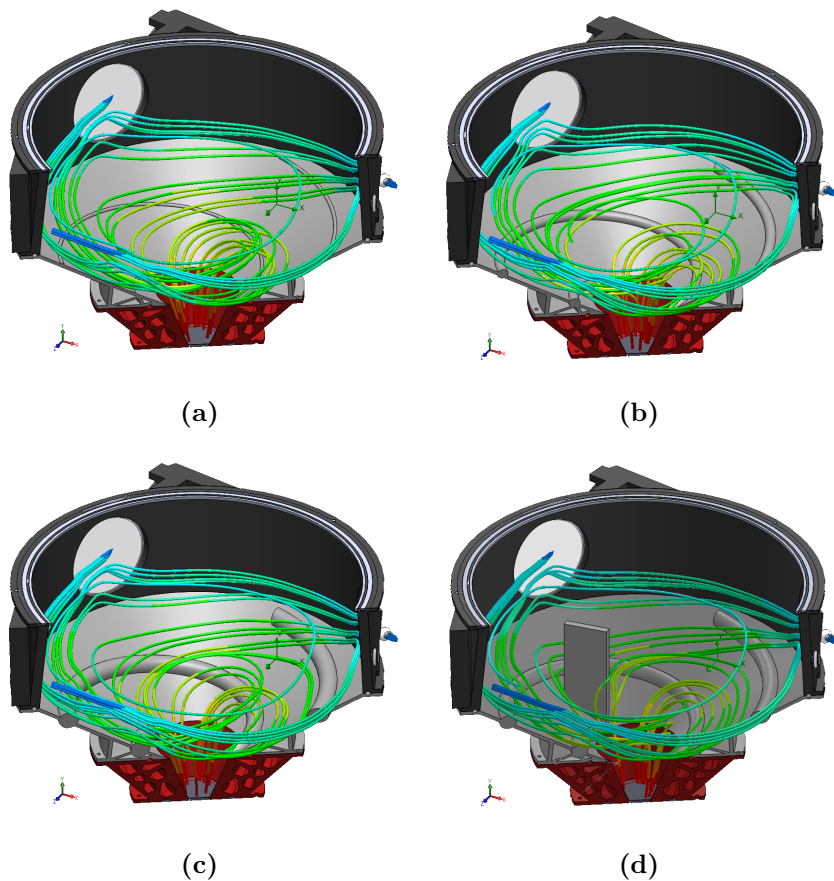

Figure 10.1: Comparisons of whirlpool wall - In this illustration of the whirlpool wall the angle is the subject for simulation. As can be seen in the top picture the “flat” wall funnel gets areas which does not have disturbance, while the lower illustration clearly states the turbulent movement created by the swirl is everywhere. The simulation in a) is with a 4mm raised edge, b) is 12mm, c) 21mm, and d) has a 21mm raised edge, and a inserted wedge. As illustrated the whirlpool is directionally affected by the insertions.

and 21 millimeter with a wall of 150x40x2 millimeter. These images are selected as they showed the most important differences in water activity. The input of the water is set to 16mL per second. This equals about one-sixth of the water supply from a regular water faucet, which normally delivers ten seconds per liter. The simulations were set to 16mL/s because this was the input needed in the prior arts model. Other values were also tested. And at maximum capacity of the regular water faucet the system was in the simulations completely flooded, and no vortex was created.

The simulations of the system had limits. There were problems simulating the system when it reached twice the injection volume speed of a normal faucet. The speed of the water injected in the system were in that case so high that it created a pressure differential between the two of the system and the vortex that the simulation failed to solve. This problem could partially be contributed to the method of simulation. To simulate the system all openings have to be closed off and defined so that the simulation knows where there is air and where there are walls - and so on. The simulation had some problems calculation the top opening to air. However, the simulation problems occurred with an injection volume that will not be replicated in during the experiments conducted in this thesis, and the simulations problems can therefore be ignored.

In Figure 10.1 [p.92] the significant vortexes are illustrated. In illustration a) the flow of the water is marginally affected by the guidelines; in fact so minimal that the speed of the output water was the same as without guidelines. However, as can be seen in the illustration the vortex is somewhat guided towards the exit.

Illustrations b) and c) show that the guidelines direct the flow of water faster into the exit. This is seen looking at the flow lines. The lines clearly show that the flow in b) cuts down earlier than in a) as well as less flow at

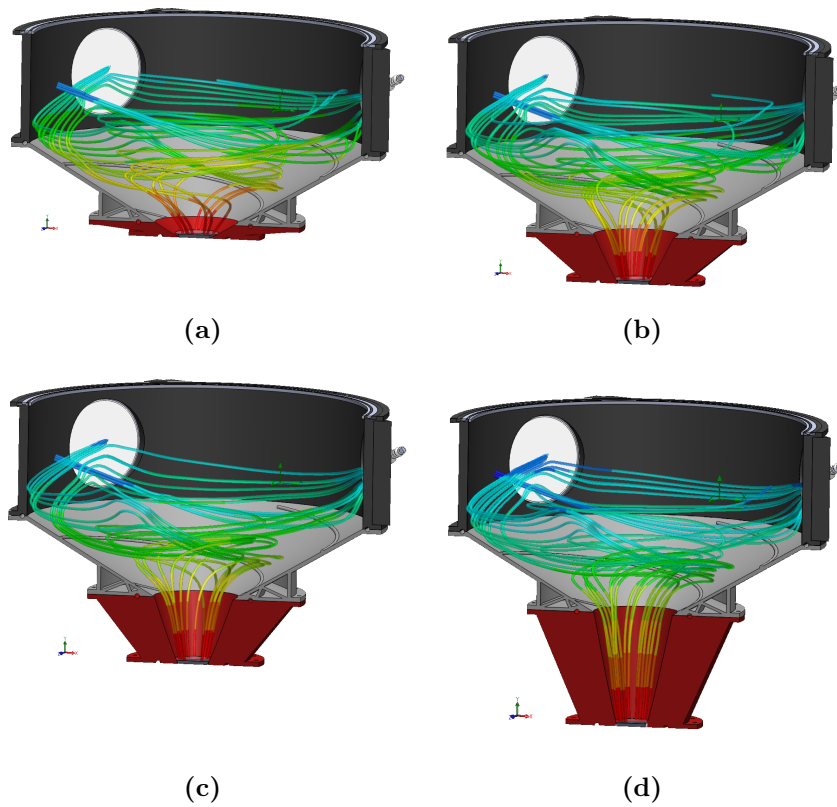

Figure 10.2: Comparisons of output funnel length - In this illustration of the output funnel is the subject for simulation, and the length of the funnel clearly affects the swell of the whirlpool in the whirlpool wall. The simulation in a) the EnT is 15mm, in b) 50mm, c) 70mm, and in d) 120mm.

the same points. This means that more water has left the system earlier, because all the illustrated simulations have the same input. In c) one can see that the vortex actually jump over and into other streams and binds with them. The effect of this is a narrower and higher vortex. It can also be read from the results the simulations that the speed of the output water has increased.

In d), the last of the whirlpool change simulations shown in this thesis, an object has been placed on the whirlpool wall. This was a simulation made to illustrate what happened if a wall was inserted. The results are clear, and the vortex is forced down and into the exit. The speed of the exiting water dramatically increased. However, such an insertion cannot be used as this would force the fish as well in a manner that is un-wanting. Such a harsh insertion could lead to a forced jamming of the system.

But looking that the prior arts experiments: Sometimes the whirlpool could build up a body of water that was not wanting. In such cases inserting a flat object, like the one in illustration d), the buildup of water swiftly exited the system. One could therefore argue that a levitating harsh insertion placed at the right height could prevent the system from getting a water buildup.

In Figure 10.2 [p.94] the EnT is changes. This was simulated because of the effect it had on the whirlpool. In the prior arts experiment it was established that the length of the EnT affected the ride height of the whirlpool in the whirlpool wall section. In the illustrations there are picked out four different lengths of EnTs; the lengths are 15mm, 50mm, 70mm, and 120mm, respectively.

Illustration a) is the 15 millimeter long EnT, and as the illustration shows the transition between EnT and the whirlpool wall is virtual linear. This means that the EnT just works as an elongation of the whirlpool wall

leading to the exiting hole. The illustration shows that the vortex that is riding high in the system. The whirlpool is so high that there is a body of water moving slower closer to the wall. This is not wanting. We wish of the whirlpool wall and the EnT to be as tight to the whirlpools from as possible, as this minimizes the amount of water used by the system.

The 50 and 70 millimeter EnT illustrated in subfigures b) and c) of Figure 10.2 [p.94] show a lower ride height for the vortex. This means that system is more fitted for the vortex is contains. The lower ride height also indicates that less water is in the system at one given instance, reducing the impact the body of water would have in banking and heaving. The banking and heaving from the boat is important to think of, as the body of water will be influenced more by the motion the bigger it is. The motion of the boat could also break the vortex if the body of water in the system is too large. With the body of water we are thinking of all the water that is not directly in the whirlpool. And have therefore a slower speed and less force on its movement, by force we refer to the centripetal force created by the swirling. The centripetal force will, up to a limit, keep the vortex from breaking up. In laymen's terms the forces we access in the vortex are the same that is used when twirling a bucket of water and the water sticks to the bottom.

In d) the EnT is set to 120mm, at this length the whirlpool does not get lower with a longer EnT. In other words the lowest ride height of the vortex is found. However, this ride high is not necessarily the idea ride height. The run-off with also contribute the ride height of the vortex. An in the complete system the run-off added about 30mm to the EnT. This means the EnT can be reduced to at least 90mm. But then back to the ride height; during the prior arts experiments was found that the water depth should be at about half of the fish diameter. The end results in the simulations led to the EnT being 60mm.

REALIZATION AND EXPERIMENTS

Abstract - This Part V will present the prior art used in this project to verify 'the Cyclone' system (Section 5.4.2 [p.57]). There will also be given a presentation on the realization of the finished concept. A chapter on experiments and their reasoning is a given, followed by a chapter presenting the findings and results. This part have a lot of attached videos, it is recommended that the Digital-copy is used while reading.

Realization of concepts and/or ideas can be hard to pursue. Often can ideas seem simple, however, the complexity of dreams are often far more vast than first grasped. Materialization of conceptual ideas has been made easier

as technology has developed. Now many of ideas are virtualized and/or simulated on computers before production. Realization is the final step in the process of creation. In this project there has been built two sets of models. Before going all out on an expensive 3D-printed model, this project constructed a prior arts proof-of-concept. In this Part V both the proof-of-concept and its more expensive big brother is illustrated and explained.

Experiments are vital to the investigation of performance in virtually all fields. An experiment is, bluntly put, a test; a test where purposeful changes to input variables of a process or a system. Along with the realization chapters, a chapter explaining the experimental trials that were done during this diploma is written.

Experiments always yields results, however, not all results are wanted. At the end of this Part V, a final chapter summarize the results of the tests completed in this project.

Chapter 11

Prior novel art

This diploma embarked on the creation of a novel concept. A concept never tried (documented) before. The idea was pulled into doubt - questioning whether or not it would work. In order to avoid wasting time and effort on designing and realizing a concept that *would not work*, a simple prior arts model was constructed. The model was built on the bases of the simple sketch show in Figure 5.11 [p.55].

The prior arts model was built from simple materials lying about in workshop for Engineering Cybernetics at NTNU. The cone creating the funnel is an old office lamp shade in metal. From the funnel a regular piece of gardening hose was attached to make a smooth transition over to the output area. The gardening hose was perforated to let out as much water as possible - so that the water would not flood the output area, and push the objects off the designated area for output. On top of the lamp shape an old PVC pipe was place and made into the water inlet of the system. In entirety, the created prior arts model is depicted in Figure 11.1 [p.101]. An additional movie of the model is found on the Digital-copy/Media/Videos.

Along with the prior arts model, dummy fish were creatively found. In Figure 11.2 [p.101] the dummy fish are shown. Many materials were tired; however, most of them either floated or sank. The dummy fish used in the

end was a simple foam tubing with plastic outer layer. The tubing was close to neutral in bouncy, and with a stiffness not far from a real fish at the same size. The dummy fish were cut to different lengths, twenty of each length. The lengths were from four centimeter to two centimeter with an increment of one centimeter.

11.1 Prior arts functionality

This prior arts model was fairly simple to construct, and making it functional was even simpler: Attach a water hose to the injection sockets and turn on. When the water was turned on the bowl started filling with water and a whirlpool emerged. The volume of water entering the bowl had to be tuned so the water did not flood the system; i.e. water escaping over the sides of the machine. (Movie added in Digital-copy/Media/Video.)

As the whirlpool was formed and the body of water was pulling toward the exit - small dummy fish were dropped in. When the dummy fish were entered into the system, the prior arts module showed that the fish did not immediately enter the vortex center and exit the system. The fish moved about the vortex wall and in some instances - with the correct water pressure/vortex speed the dummy fish kept on swirling until another dummy fish entered the stream. In other words the dummy fish were just swirling about the hole until it was interrupted in its path. While trying to pick up the swirling fish a discovery was made. If a guiding object was inserted in the whirlpool the flow immediately changed and the dummy fish promptly exited the system. To test this, different pieces of plastic was placed in the bowl. The insertion directed the body of water faster towards the exit, and pushing the dummy fish along with it. Of course are all of these experiments in need of documentation. A test plan for the system had to be made, both



Figure 11.1: Prior art cyclone - This is the prior art cyclone. It consists of a lamp shape, PVC water inlet pipe, and a gardening hose.

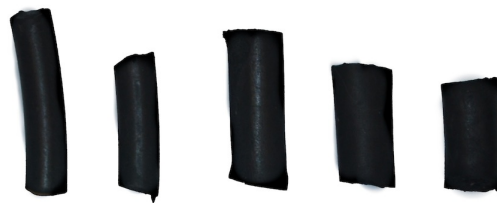

Figure 11.2: Dummy fish - These are the sizes of the dummy fish used in the prior arts experiments.

to clarify the challenges that were thought of - but also to establish a correct experimental procedure. Table 11.1 [p.103] lists all the factors that were thought as important. The table is split into two parts. One part handles all the factors realized prior to the trials, while the second part of the table describes the factors that were realized or discovered during the experiments. New factors came up as the trials were conducted it is quite natural as the trials were experiments documenting that the conceptual idea actually worked.

Body of water

As was written in the beginning of this chapter, the system was filled with water from a gardening hose attached to the house's water faucet. The tap was adjusted such that the volume of water entering the system differed - and gave way for different vortexes. On the gardening hose, a volumetric measurement unit was attached. With the use of this unit the amount of water flushing the system can be logged. The measurements that were registered were coincided with the vortex formation.

The pictures in Figure 11.3 [p.104] illustrates the vortexes that were of significant difference. One of the vortexes has not formed and is just trickling water, while another is flooding the system and spilling. During the testing of the system it was found that an input between 20mL/s and 30mL/s was desirable.

In subfigure a) of Figure 11.3 [p.104] the water input is minimal. The water input is in fact so little that no vortex can be formed. In both b) and c) the vortex is acceptable. b) is somewhat smaller than c) and one can notice that the guideline is just at the surface of the whirlpool. In c) the guidelines lay much lower. This would mean that the effect of the guidelines is less than they are in b) - both the whirlpool and the fish entering the system will be

TESTS NEEDING DOCUMENTATION

Tests	Why
Body of water	Measuring the volume of water that enters the system is important as this is what creates the vortex. With too much water the system would flood, too little the system would not get a vortex.
Fish entry	To learn how the vortex engulfs the fish is important. If too many fish are dropped into the middle of the vortex, the vortex collapses and the system gets jammed.
Amount of fish	An important factor telling the capacity of the system.
Time usage	The time usage from entry till exit is important, however, it is also important to register the rate of fish exiting the system.

DISCOVERED VARIABLES

Tests	Why
End terminal height	During the experiments the fish jammed in the long end terminal of the funnel system. The height and width of the end terminal had to be experimented with. When changing the height it was discovered that it had a profane effect on the vortex in the system.
“Guidelines”	The fish kept on swirling about the vortex, wasting a lot of time on its way to the exit. It was discovered that small imperfections in the surface of the whirlpool wall directed the fish faster to the exit.

Table 11.1: Test plan for the prior arts model - This table lists the factors which might play an important role in the design of that conceptual solution. The list starts with all the factors that were thought of before experiments, the last entries of the list at discoveries when work with the experiments.

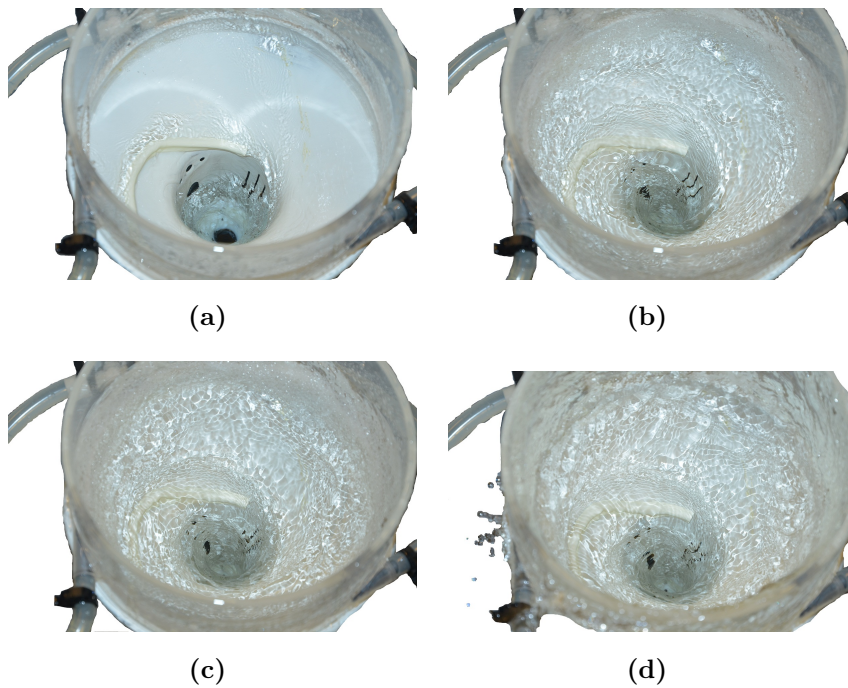

Figure 11.3: Four vortex formations - In this set of illustrations four different whirlpools are created. They are conformed from different amounts of water added into the system. (a) is an non-developed vortex, while (d) is an over stimulated one.



Figure 11.4: Continuous - This is a continuous line of fish ready for in-feeding.



Figure 11.5: Batch - The illustration shows the batched fish ready for in-feeding.

less affected. In subfigure d), the figure shows an over saturated whirlpool. The water injection is so high that the whirlpool torrents over the walls of the system. This is not ideal, and d) is over the wanted water injection limit.

Fish entry

When adding fish to the system it is important how/where the fish is added. If a fish is dropped into the middle of the vortex, the fish is flushed through the system. On the other hand, if more than *one* fish is dropped into the middle of the vortex at the same time - the vortex could react in three different manners: ONE, the vortex swallows the fish (best case); TWO, the vortex momentarily collapse; and THREE, the fish land such that they jam the exit. On that note, a collapse in vortex could also cause a jam as the fish could sink and block the exit.

During the tests, all this scenarios occurred - and the input point was therefore move about. The solution was to let the fish into the system along the side of the water injection wall - and just in front of the injection jets. This pushed the fish into the vortex at a greater speed.

In Figure 11.4 [p.105] and Figure 11.5 [p.105] the input formation of the dummy fish is illustrated. As can be seen the continuous input is a line of dummy fish, while the batch input are small batches of fish lined up. The batch input can be seen as a simulation of a cleated conveyer belt input. The continuous input could be the direct in-feed from the current dispenser system.

Amount of fish

The number of fish added to the system at one time, as briefly mentioned in the prior section, affects the systems probability of jamming severely. There was found a limit to the number of dummy fish the system could handle at

one time. This limit was not affected by change in the volume of water in the bowl. This means that nine fish entering the system at one time was the saturated limit for the systems input. This of course was the bulk input saturation, for the continues-feed it was found that no more than six fish could be in the bowl at one given time. It was therefore important to find the time the fish used through the system, as no new fish could enter the system before one of the presiding fish had left the bowl.

In the next section the time usage in the system is discussed, however, now let us look at the speed of the input of fish. The fish exiting the bowl used about three seconds to reach the exit when the input limit was placed in the system. However, all the fish exited within three seconds, meaning that the fish rapidly exited the system once in the vortex - about two fish per second. This gives an entry speed for continuous feeding of two fish per second. In Table 11.2 [p.109] these results are listed with the concrete parameters of the surrounding states.

Time consumption

How much time the fish use in the machine is important, however, just as important is the exiting rate. In these trials several parameters were adjusted to observe the change in time consumption. The exiting rate plays an important role in the success of this machine, since the goal for the singulation system was an output of 30-60 fish per minute, Table 1.1 [p.18].

When fish entered the bowl it took an average of three seconds to exit the system. This is not within the demands of the machine. However, if this is seen as a delay and continuous in-feed was used after an initialization the exiting rate would perform well within the given conditions.

With delay we mean that, a bulk of 10 fish will exit the system averagely within 6 seconds: This means an exit rate close to 2 fish per second, which

would make for about 120 fish per minute - well above expectation. If batch in-feed is used a new batch can be entered every sixth second. If continuous in-feeding is chosen the system should have an initialization process. A batch of 8 fish should be dumped into the system, than a delay of four seconds before the continuous in-feed of 2 fish per second should start. The results of findings in these trials are given in Table 11.2 [p.109], along with the table graphical illustrations of the statistical speed output of the Singulator is given in Figure 11.8.a [p.111] and Figure 11.8.b [p.111].

Figure 11.6 [p.110] illustrates the average time usage along with the amount of fish in the system. This shows the total time used in the system as well as the exiting rate. It is important to see how the exiting rate changes with the amount of fish in the body of water. As one fish enters the exiting face it is possible to add another fish at the input without flustering the system - this would make for continuous output.

The graph clearly states that the time consumption is at its lowest when 70 fish are supplied per minute, i.e. 1,6 fish per second. This is a time usage which falls within the criteria's of the wanted machine. In other word - the time consumption used through the prior arts model is acceptable, and further work on the concept is recommendable. With this said, a conclusion is not yet made and there are still two parts of the prior arts model that have major impacts on the systems operation.

End terminal

The end terminal, or better explained, the section between the whirlpool wall and the run-off/guiding section, works as the transfusion between the whirlpool and the exit. The design of this segment is important because it is shown to directly affect the whirlpool. With the prior arts model there where made two different sized end terminals, shown in Figure 11.7 [p.110].

FISH/SECOND OUTPUTTED BY THE SINGULATOR

No. of fish/batch	<i>Input speed for batches</i>			
	2 batches/sec	1.5 batches/sec	1 batches/sec	0.5 batches/sec
<i>Flow input 10mL/s</i>				
1	Jam		0.91	0.45
2		∴		0.93
3	∴			1.23
4			∴	
5		∴		
6				Jam
<i>Flow input 15mL/s</i>				
1	1.98	1.46	0.97	0.46
2	2.45	2.27	1.97	0.93
3	2.65	2.70	2.56	1.48
4	2.54	2.63	2.63	1.89
5	2.34	2.04	2.04	2.08
6	Jam	1.96	1.96	2.01
<i>Flow input 20mL/s</i>				
1	1.45	1.23	0.87	0.46
2	1.92	2.35	1.98	0.94
3	1.96	2.41	2.38	1.20
4	2.01	2.51	2.49	1.80
5	1.80	2.01	2.05	2.07
6	2.01	1.89	1.98	2.04

Table 11.2: Data from prior arts experiments - In the table above some the results from the experiment on the prior arts model are listed. The results are a reflection of the output speed of the Singulator.

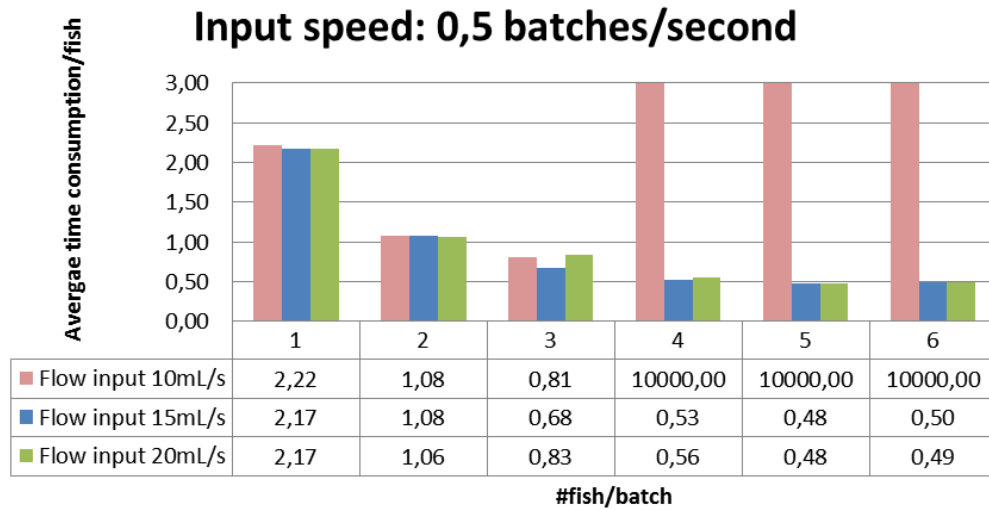
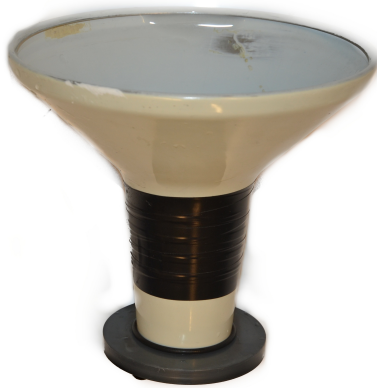

Figure 11.6: Time consumption of fish in the system - This graph illustrates the numbers listed in Table 11.2 [p.109]. It illustrates the spread of number of fish versus time consumption.



(a) Large end terminal (LET)



(b) Small end terminal (SET)

Figure 11.7: Prior arts end terminal sections - These pictures shows the two prior arts end terminals fabricated in this project.

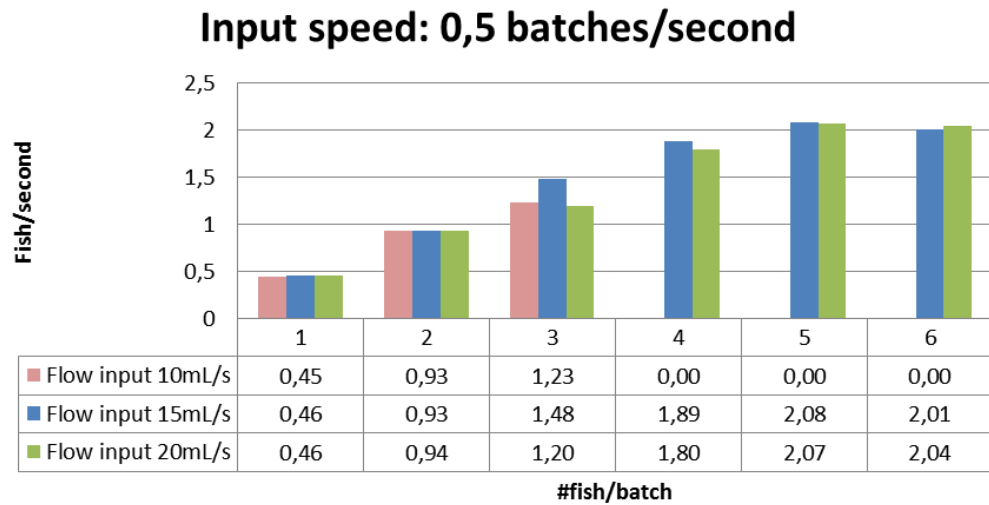

(a) Input speed of 0,5 batches/second

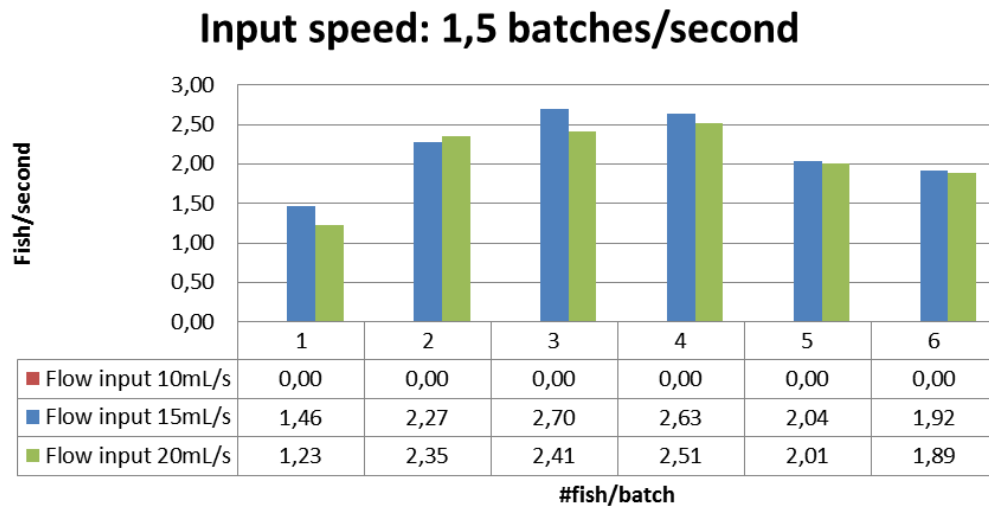

(b) Input speed of 1,5 batches/second

Figure 11.8: Output speed of the prior arts model - In these graphs the output speed of the Singulator is given with dependency on the water injection rate and the speed of new batches feed to the system. The different amount of fish per batch is also factored in. Subfigure *a)* illustrates three different water injection rates for six different sized batches. Subfigure *b)* illustrates the same only with a different input speed. For more see Appendix B [p. 171].

In Figure 11.7.a [p.110] the largest of the end terminals are shown (here forth is the largest end terminal called LET). The LET was in the prior arts testing's about twice as deep as the length of the longest dummy fish. When in use, the whirlpool dragged about half way down the LET. This means that there was a small body of water right before the run-off. The fish entered down the system and had minimal problems with exiting. However, some problems occurred. The shape of the LET was a bit swift in reduction of diameter from the entry size to the exiting size. This was due to the simple construction. The inlay creating the coned transition was only about one eighth of the whole LET. Since the transition happened so rapidly, and the diameter of the entry was as big as the smallest dummy fish - the smallest dummy fish had the unfortunate tendency to transverse the exit hole creating a jam as the other fish was pushed by the whirlpool into the LET.

To avoid this, two solutions where tried: One of the options where to reduce the length/depth of the LET; the second were to insert a device hindering the fish in both lying still, and trans-spanning the exit. The LET with reduced size is shown in Figure 11.7.b [p.110] - hence forth know as SET (small end terminal).

The SET was a large step from the LET, and it showed that the end terminal needed to be a funnel - not just an extension to the whirlpool wall, as the SET is. The problem with the SET was that the whirlpool flooded the system. In other words, to create the whirlpool the system needs a certain amount of water in movement. It is also imperative that there is an area where the whirlpool can move. The whirlpool walls are not in them self steep enough to hold the whirlpool that is wanted. This means that the shape of the whirlpool is not kept in *just* the whirlpool wall section. All whirlpools and tornados and other vortexes have the same shape, they are all wide



Figure 11.9: Stirring rod - A picture of the stirring rod used in the prior arts model to ensure no jams.



Figure 11.10: Guideline - This is a picture of the prior arts model's whirlpool wall with a guideline. The line helps the speed and direction of water injected in the system.

in the top - and from there rapidly narrows. The LET was long enough to accept a whirlpool. However, the run-off section does not except it. This is the definitive down fall of the SET. So to summarize - the SET showed that the EnT plays a vital role, and that it is necessary to the whirlpool and hindering a flood in the whirlpool wall section. The LET allows for the narrowing of the whirlpool, replacing the body of water otherwise needed to contain a vortex.

So understanding that the LET was more functional than its counterpart, the SET, a device to stop the system from jamming was required. The cardinal part showed is self as during one of the experiments, while trying to unjam the system a thin rod was used to stirring in the bowl. When this seem to work a simple stick swirling along the side of the edge of the exiting hole was introduce: This small rod insured that the fish did indeed not jam the system. In Figure 11.7 [p.110] the stirring rod is portrayed.

However, reducing the size of the LET might still be worth pursuing. Also increasing the angle of transition between entry and exit should be experimented with. But even if these options are pursued, the stirring rod is still believed to be of necessity. It will create greater chaos in the exiting phase ensuring that no fish lies still traversing the opening causing a jam. In the Digital-copy there are videos to illustrate the actions.

Guidelines

The final feature discovered during the experiments where the movement of the objects in the whirlpool and their slow progress towards the exit. The whirlpool had too much centrifugal force causing the object to swirl in the bowl for times in excess of seventeen seconds. However, the water injection force could not be reduced, as a reduction in injection caused the whirlpool to disrepair.

During one of the jams it was discovered that the speed and direction of the whirlpool dramatically increased and improved if a guide/wall was inserted - i.e. a guiding obstruction. This resulted in multiple tests with different types of insertions. In the prior arts model it was found that a small guide curve/line increased the speed and direction of the whirlpool so much that the initial injection volumetric flow could be reduced. This means not only more efficient exiting was achieved, but along with it a reduction of water usage was imposed.

In Figure 11.10 [p.113] the functional guideline attached to the whirlpool wall is shown. The guideline used in the prior arts model was a small caravan window sealer. The guideline was not so intrusive that the dummy fish were forced to follow the guideline. The caravan window sealer was not more intrusive than if two fish collided in the bowl one of the dummy fish would jump over the guideline. However, the guideline enforces a stricter direction to the fish movement, and the swirl was more efficient since the water injected now had some direction imposed on its movement.

Summary of prior art

In short, the prior art model revealed a lot of variables that needed to be registered and accounted for. The key features to the prior art was the guidelines on the whirlpool wall, and the end terminals design. Both these has profane effect on the time consumption of the system. However, it is also important to notice that the speed of the dummy fish was higher at higher density of fish in the bowl - up to a critical point. The prior arts tests have given hope and aspirations for a set of bigger and more extensive concept tests.

Chapter 12

Realization

Constructing and creating a concept, i.e. realizing it, can be hard. Not all concepts are functional to set into the world, however, in this chase we believe that the realization of ‘the Cyclone’ will deliver on its promise to automatize parts of the prolongation of the fish weight distribution estimation.

*All our dreams can come true, if we have the courage
to pursue them.*

– Walt Disney

12.1 Build

Multiple methods were used to create the end result - the more realistic model of ‘the Cyclone’. Some parts were hard to manufacture at NTNUs workshop. These parts were therefore special ordered from a 3D-printing company called Materialise. The parts that were shipped out had either an intricate design, or were simply too big to get made at NTNU. It was the run-off section with its difficult bend and merging pipes, and the whirlpool wall with its inlaid guidelines that were shipped off to 3D-rendering.



Figure 12.1: The realized conceptual idea - This picture shows the realized conceptual idea, 'the Cyclone'. It is made partially from 3D-printing, and partially by the IME-workshop at NTNU.

At NTNUs IME-workshop the top part of the system were created. Two PVC tubes were welded together in order to make the injection and slide platform. The injection system was created such that it could move about, creating the freedom of injection alignment. The inside slide and the top grid were also manufactured at the IME-workshop. The build was made as similar to the 3D-CAD drawings as possible. A lot of work was put into the realization of ‘the Cyclone’ concept. When putting the parts together the finished system was created, and ready for testing and experimenting.

The finished result of the conceptual idea, ‘the Cyclone’, can be seen in Figure 12.1 [p.118]. The top part of the system was made at the IME-workshop. It comprises the fixed louver, the slide and the water injection unit into one segment. The segment is created from the drawings provided though the 3D-CAD drawings. The bottom part of the system is made by Materialise. The printed parts are within 0.1mm of the given specifications in the 3D-CAD drawings. The system functions and is ready for testing.

Chapter 13

Experiments

From the beginning of the 1980s - continuing into this decade, an inordinate amount of attention has been awarded the *improvement of quality* in industrial production. The Japanese “industrial miracle” which began in the middle of the twentieth century has often been up for discussion: They were able to succeed where others failed - namely, to create an atmosphere that allows the productions of high-quality products. Much of the Japanese success has been attributed to their use of *statistical methods* and *statistical thinking* among the management personnel. The use of statistical methods in manufacturing, development of food production, computer science and many other areas involves the gathering of information, or more so scientific data.[Montgomery (1991)]

In order to collect the scientific data which is valuable for the investigator, experiments are specially crafted to suit the particular process or system. A process or system under study can be presented by the model shown in Figure 13.1 [p.122]. Usually we can visualize the process as a combination of machine, humans, and other resources transforming some input into an output that has one or more observable responses.[Montgomery (1991)]

Every system has process variables; some variable, x_1, x_2, \dots, x_p , are controllable; whereas others z_1, z_2, \dots, z_q are seen as uncontrollable. How-

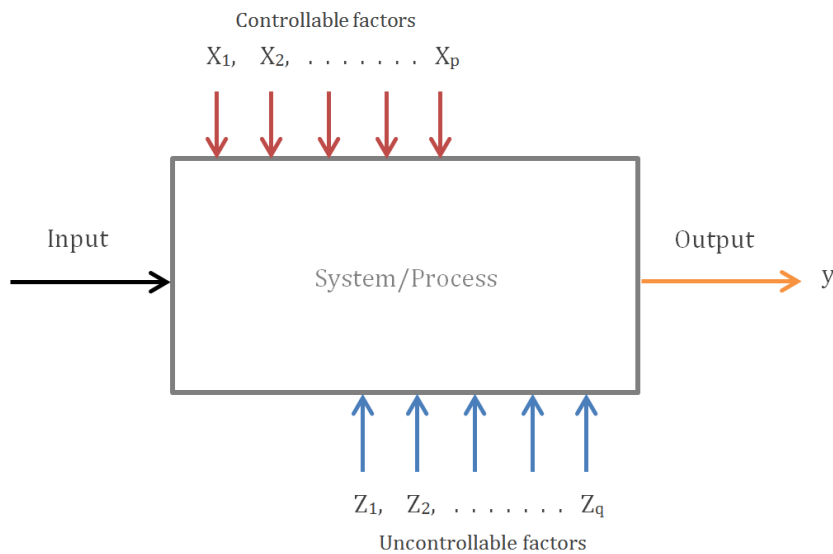

Figure 13.1: General model of a process or system - This is a model of a generalized process or system. The input variables are x , controllable, and z , uncontrollable, while the output response of the system is y .

ever, uncontrollable do not mean unreachable, often these uncontrollable variables are just not possible to reach during the current experiment: Variables such as surface roughness and/or shape of an object. The last variables are y_1, y_2, \dots, y_m , which are the response of the input and the controllable and uncontrollable variables. So, x represents the input/variables of a system, z are the uncontrollable variables, and y is the output.

In Figure 13.1 [p.122] the input is set separate and the output is just represented with one y , however, the input to a system is often referred to as x - and there is of course possible to have multiple outputs creating MIMO-systems¹ or SIMO-systems². The figure is based on the systems depicted in Balchen et al. (2003).

¹MIMO, multi-input-multi-output.

²SIMO, single-input-multi-output.

The objectives of an experiment may include these following observations (no inclination intended with the numeration)_[Montgomery (1991)]:

1. Determining which variables are most influential on the response, y .
2. Determining where to set the influential x 's so that y is almost always near the desired nominal value.
3. Determining where to set the influential x 's so that variability in y is small.
4. Determining where to set the influential x 's so that the effects of the uncontrollable variable z_1, z_2, \dots, z_p are minimized.

Experiments are a critically important for an engineer. A planned experiment sets up a realm in which the investigator is in control. Generally, we learn through series of activities in which we make conjecture about a process. These speculations lead to experiments generating data from which new conjectures are made. Having control over the experiments are important to get the data that is sought. If an experiment is *just* conducted, the observations that are done might be of no relevance to the challenge at hand. This means: Asking the *right* questions prior to execution is the key to success.

13.1 Key questions

In this research project the prior arts model gave many hints towards which parameters are important to observe. The simplistic trial and error conducted revealed parameters not thought to affect the system and situations not thought to occur in the system.

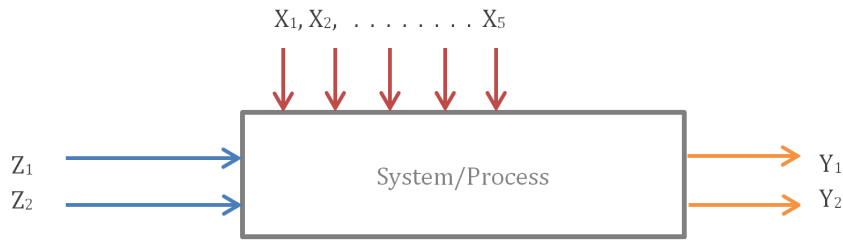

Figure 13.2: System block diagram - This is the specified process/system block diagram. The input variables are X , controllable, and Z , uncontrollable, while the output response of the system in Y .

To setup the experiment plan the first step is to draw the system diagram, the MIMO system - and classify the inputs and outputs as well as the uncontrollable variables. Defining a good process diagram make it easier to understand and see how the processes enter the system.

In Figure 13.2 [p.124], the MIMO system is drawn-up. It illustrates which variables and parameters that are expected in the system, these are variables and parameters based on the earlier inquiries. In Table 13.1 [p.126] and Table 13.2 [p.127] the specifics of these un/controllable inputs and outputs are stated. Along with each of the variables a description of them - and reasoning for the testing of said variable is given.

In particular, some variables are excessively more critical than others, such as: X_1 and X_2 , classified as the amount of fish feed into the system at one instance, and the speed of the input of the amount (defined in order). Compared with X_5 - the speed of the conveyor receiving the output of the system, X_1 and X_2 will have a direct effect. The X_5 is important for the end result, however, it is not an integral part in the research concerning the use of 'the Cyclone' system.

X_1 and X_2 , are variables that can be externally controlled or tuned. These two variables are capable of jamming the system if they are not

controlled or tuned. The prior arts model exhibits extreme susceptibility for the amount of fish in the system at a given instance; it can instantly jam the system rendering it immobile. The paralyzation of the system is imperative to avoid, however, if the system receiving the output of the system cannot handle its input - a new or improved system must be put in its place. Changing the system connected to 'the Cyclone' is much easier and faster than to change the inherited processes design into 'the Cyclone'.

'The Cyclone' system must be tested to the limits, i.e. X_1 and X_2 must be experimented with such that the system will get jammed. By testing the limits, the machine can be tuned such that the input of the system never affects the system in a negative manner.

Other variables that will have a direct effect on the system are X_3 and X_4 : The control of the flow of water, and the angle of its injection (in such order). The variation in X_3 will define the whirlpool, and its size. Depend on the volume of water injected into the system: X_3 could torrent the system into a flood, or reduce the injection rendering the system non-functioning. X_4 on the other hand has a less significant impact. The angle of the input will affect the systems performance; however, this is more in the manner of reduced speed.

X_4 is a variable which could give better direction to the flow of objects in the whirlpool. If the direction of the injection is pointed along the direction of gravity, i.e. downwards, the objects are more likely to move towards the exiting whirlpool faster. The reason for this is that the injections are pushing the objects toward the center. If the injection pipes pointed up in the air, the objects would only be left to the forces of the whirlpool. This would slow the objects, in comparisons to the downward directed water injection. However, the direction of the injection would also affect the whirlpool creation - as a fast swirling whirlpool is created with wall follow-

Variable	Description of variable	Why do test on this
X_1	Amount of fish fed into the system at once.	This is a test to see how much fish can get pushed into the system before it clogs up. It determines the maximum input of fish.
X_2	Speed of input conveyor, at what rate does the fish enter the system.	This is a test to see how fast the input can be. This would be a function dependent on X_1 , which must be taken into consideration.
X_3	Water injection, volumetric measurements.	Determining the flow of water in the system is important as the flow of water determines the vortex created, as well as affecting the speed of the fish movement.
X_4	Angle of water injection.	This could affect the vortex creation. At shallower angles of water injection one would expect a slower and higher body of water movement.
X_5	Speed of the receiving conveyor moving the fish away for the output.	This speed must match or go faster than the speed of fish fed out of the system. If it does not, the fish will not end up individually, but rather as a bulk.

Table 13.1: Experiments/Variables to test - This is a table show all the variables of the system. It lists why a test on the specific variable should be done, as well as what the variable is.

Variable	Description of variable	Why do test on this
Z_1	Inside of the cone, design.	The design of the inside wall surface of the whirlpool cone is important: If the cone is totally smooth the fish is more likely to move about inside the machine rather than follow the stream to the exit. Suggestions to ensure continues movement toward the exit is wedges along the inside wall.
Z_2	Length of the end terminal.	The length of the end terminal is important as this is where the fish is lead into the run-off section. If this transitional part is too wide too many fish will enter at the same time; if it is too short the body of water will make a buildup in the whirlpool cone (results for prior art).
Y_1	Picture of fish coming out, verification of singulation.	The picture of the fish going in and coming out will verify if the fish has in fact been singulized.
Y_2	Speed of the fish coming out, done with camera	This is an important factor to measure, as this will tell if the system is efficient enough and/or how efficient.

Table 13.2: Experiments/Variables to test - This is a table show all the variables of the system. It lists why a test on the specific variable should be done, as well as what the variable is.

Amount	Equipment	Use of equipment
1x	High-speed camera.	Ability to slow down action for use in measurement of time consumption in the system, and verification of singulation.
2x	Conveyor belts.	Need two small conveyor belts in order to get continuous in-feed and simulation of receiving system.
1x	Volumetric measurement.	Monitoring the flow of water into the system is one of the specific variables need to be controlled.
	Smolt or juvenile fish spawn.	Need fish fry in size 2-12 cm for real fish simulations.
	The system:	3D-printed special parts. Self-fabricated parts.

Table 13.3: List of equipment - This table lists the equipment needed to conduct the necessary tests and trials. The amount along with a reasoning for the equipment's use is given side-by-side the specified equipment.

ing injection; but a fast swirl is not equal a fast swallowing stream. If the water is directed strait toward the exit no whirlpool will exist, and furthermore the water rushing towards the exit would make a turbulent flood of the system. The ideal injection of water must lie between the horizontal and the vortical gravitational direction.

Understanding and comprehending the input variables are important and imperative to grasp and conduct experiments. However, realizing the outputs of a system, monitoring and documenting their behavior is just as vital for the contemplation of the systems behaviors and capabilities.

Y_1 and Y_2 are the registration and verification of the individualizing of the fish, and the speed of the exiting fish (respectively). These are two factors necessary to monitor in order to determine whether or not the system fulfills the criteria set for it.

There is one variable that is yet to be discussed, which is the sets of uncontrollable ones. Any system has uncontrollable variables, an important question for all systems are therefore: How much do these 'Uncontrollables' affect the system? In 'the Cyclone' there has been isolated two Uncontrollables that can be of importance. They are uncontrollable only in the sense that they are not possible to evoke any control over as the system is operating; they are on the other hand possible to adjust with fabrication and reconstructions. The variables in question are called Z_1 and Z_2 , and is the inside surface of the main cone and the length of the end terminal.

Changing or modifying the physical attributes of the system seems a tad radical. However, the prime testing showed that the construction of these two parts of the system had extreme impact on the performance. It is therefore important that they are included in the trials - as they could help to optimize the system.

In order to test these key questions, equipment is needed along with

the variable that wants to be tested. In Table 13.3 [p.128] the equipment needed/used in the experiments is listed. How test experiments are conducted and setup is illustrated and explained in the next chapter, Chapter 14 [p.131], Results.

Chapter 14

Results

Most of the experiments that are conducted are comparative. They consist of one change at the time, making it possible to understand how the variations affect the process or system. With a buildup of data where only one parameter is changing gives headway for statistical analysis. Statistical analysis is a tool used to get a better understanding of the collected results from experiments.

The broad term of statistics, which we know today, was not defined before the early 19th century. Today the term holds the meaning: collection or summary of analytical data. There are many ways of manipulating data sets, so it is important to clearly state how the data have been analyzed.

In this chapter all the results from the experiments design in Section 13.1 [p.123] are listed or illustrated. At the end of the chapter an analysis of the results and their meaning will be presented. In order to present the results properly are they presented as listed in Section 13.1 [p.123].

14.1 Experiment setup

In Figure 14.1 [p.132] an image depicts the setup used when conducting the experiments on the realized conceptual model. The conceptual model was placed on a table with a cutout for the model to slide into. The model was held in place by a latch attached to the table. The table was placed,

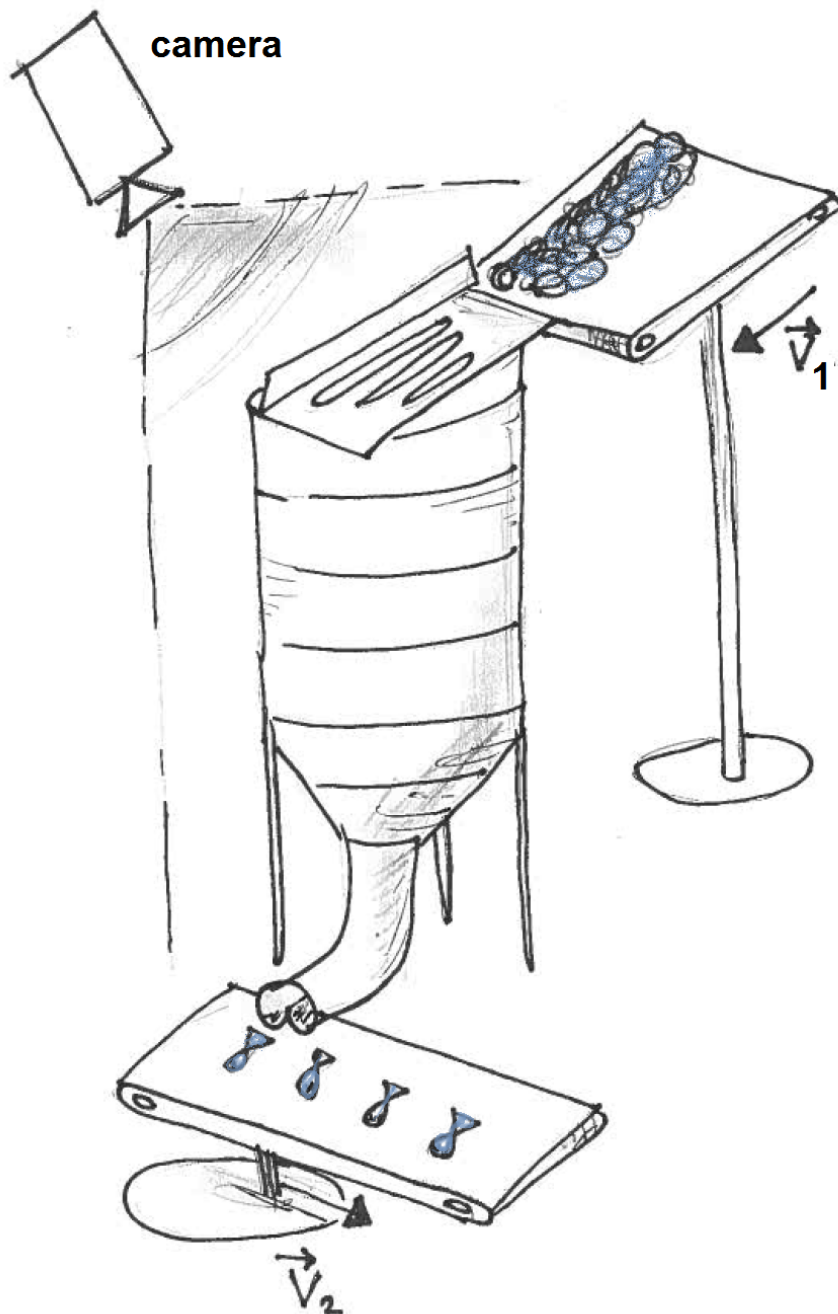

Figure 14.1: Experiment setup - The picture shows how the system was setup and made ready for experimentation.

as illustrated, with one input conveyor and a collection box for the output. It was initially thought that a second conveyor should lead away from the output. However, when rigging the experiment it was discovered that none of the conveyors could be lowered to less than 60cm. This meant that the singulation system had to get suspended higher: A minor technical difficulty. But there was another problem with using the second conveyor. There had to be built a wall along the conveyor so that the fish coming out of the Singulator would not get flushed strait over the conveyor belt. This would mean one more unit to build. The build of the conceptual model had come as an addition to the master - and time would sadly enough not allow for any more building.

The input conveyor was placed so that the fish would easily slide from the conveyor over the fixed lover and into the system. The output box was put in place to hinder the fish in flooding the floor. The water input was attached to the wall faucet. On the connecting gardening hose a butterfly valve was attached to control the water flow. It was intended that a volumetric flow measurement unit would be attached to the hose; however, due to insufficient funds where this not available during the experiments. The water measurement was conducted with buckets and the time used to fill them.

During the experiment three different formations of vortexes were tested. And during one vortex formation all the experiments were tested. Thereby did the vortex not change between with and without stirring rod for any of the experiments. The same yields for the experiments conducted on the angle of the water injection unit.

Due to time delays in production and costs was the stirring rod manually operated in the prototype experiments. The stirring rod was attached to a hand-drill. The drill was set to medium speed.

14.2 Experiments results

The results of the document experiments conducted during this master thesis are stated in this section. The results from the experiments are formalized in table below. Along with the tables are descriptions of the results - their explanations are conveying both in regards to the results and their actions and cause.

The in-feed mechanism was a conveyor. The conveyor moved at a rate of 1.6 meters per minute. The load for each experiment consisted of a batch of fish fry. The batch contained 22 fish and was spread on an area of 60x15 centimeters. The load was equal for every experiment. It was discovered that the Singulator could handle all of the 22 fish at once. Or rather, if all the fish were dumped on the slider at the same time, the system was found capable of handling the input.

The input speed of the batch varied, from 1.6 meters per second to 5.7 meters per second. It was found the speed of the input had little to say, as the system was able to handle the amount of fish pushed on it. Note that one batch of fish picked by the sailor are about two baskets worth of fish. In each basket there are about 25 fish. Which means that the input to the Singulator is high enough to handle the current input batches.

When the density of the fish batch changed it was not the Singulator's whirlpool that experienced problems. The fixed louver had problems letting the fish into the system. This happened if there was a layer of more than two fish. The fixed louver had no problem with fish overlapping of a double layer of fish. However, when the fish was compacted on a space of 30x15 centimeters the fish stacked so high that some of the fish ran over the fixed louver and not into the Singulator.

With or without the stirring rod answered itself relatively fast. The fresh fish was able to bend its tail up to its head, leading to a U-shaped fish.

FISH/SECOND OUTPUTTED BY THE SINGULATOR				
No. of fish/batch	<i>Input speed for batches</i>			
	2 batches/sec	1.5 batches/sec	1 batches/sec	0.5 batches/sec
<i>Flow input 20mL/s</i>				
9	2.70	2.56	2.1	1.98
15	2.81	2.61	1.98	2.01
22	2.82	2.62	2.07	2.05
<i>Flow input 25mL/s</i>				
9	2.91	2.81	2.87	2.43
15	2.71	2.12	2.05	2.41
22	2.85	2.51	2.08	2.51
<i>Flow input 30mL/s</i>				
9	2.62	2.56	1.78	1.65
15	2.74	2.61	1.87	1.87
22	2.58	2.62	1.98	2.04

Table 14.1: Data from realized conceptual model experiments - In the table above some the results from the experiment on the realized conceptual model are listed. The results are a reflection of the output speed of the Singulator.

The U-shape potential caused the system to jam, and when one fish jammed the exit the rest of the fish started pushing the first jammed fish further into the exit - causing an even more difficult jamming situation. The stirring rod solved this challenge of the U-shaped fish. The U-shape came when a fish traversed the exiting hole. However, U-shape was not allowed to occur when the stirring rod was activated. When ever a fish started traversing the hole, the stirring rod threw the fish back into the whirlpool.

From the experiments conducted the speed of the output of the system varied little from test to test with the same vortex. However, some vortexes where found to be more functional then others. The height of the vortex along the water injection wall was measured. At five centimeters ride height the speed of the system was the most efficient with the 22 fish input. With less than five centimeters ride height the vortex that problems containing and delivering the fish. The system had tendencies to jam due to too little movement in the vortex. On the other hand was not bigger necessarily better. When the rid height raised about eight centimeters the body of water started to become some great that is contained the fish for a longer period of time. In other word the output got slowed down due to time consumption inside the vortex. However, one should not that system was handling 22 fish per batch. With smaller batches of for example with batches of nine needed the system less water, i.e. smaller vortex. The would lead us to believe that size of the vortex can be optimized in regards to the amount of fish in the whirlpool.

The time consumption estimated for the optimal vortex is about 2 fish per second. The calculation of the speed is than based on the total time consumption for the batch of 22 fish. Time started when the front of the batch reached the input louver of the Singulator, time ended when last of the fish was released from the Singulator. From the batch entry to the batch exit

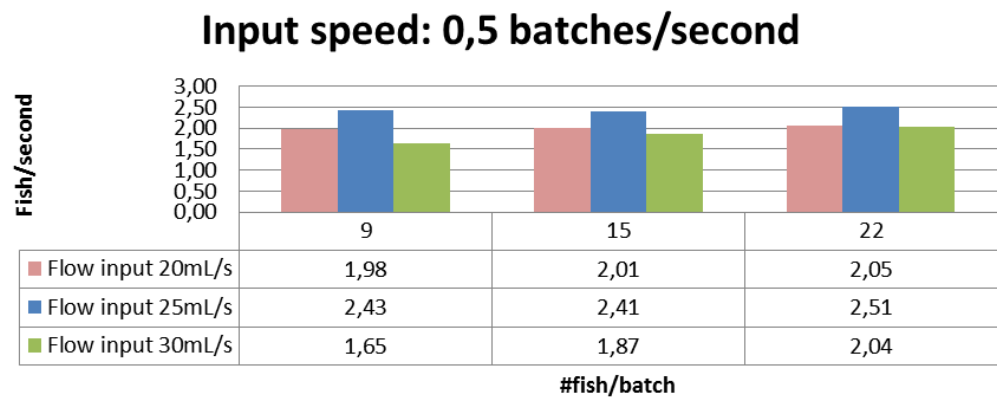

(a) Input speed of 0,5 batches/second

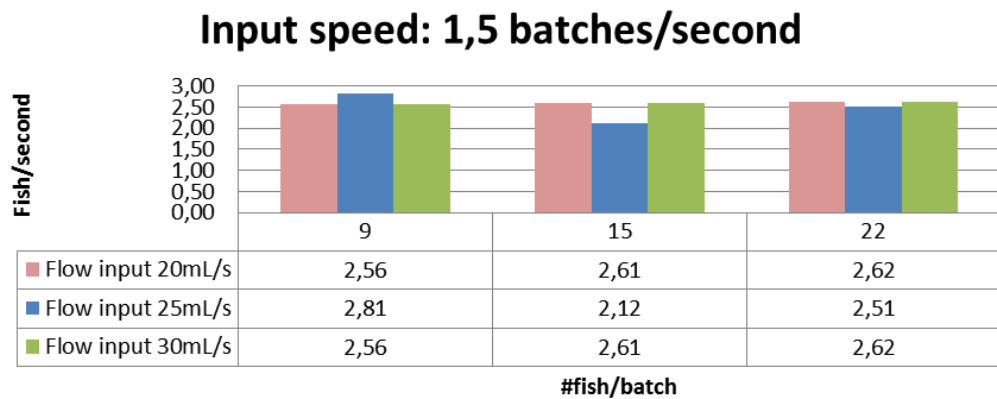

(b) Input speed of 1,5 batches/second

Figure 14.2: Output speed of the realized conceptual model - In these graphs the output speed of the Singulator is given with dependency on the water injection rate and the speed of new batches feed to the system. The different amount of fish per batch is also factored in. Subfigure *a)* illustrates three different water injection rates for six different sized batches. Subfigure *b)* illustrates the same only with a different input speed. For more see Appendix C [p. 177].

the average time consumption was 10 seconds. From the first fish entered onto the louver to the last fish entered onto the louver time consumption was five seconds. This suggest that the system should be fed that 10 second intervals with 22 fish per batch.

AFTERMATH

Abstract - In the following chapters the outcome of this research project on the singulation of fish at sea will be discussed. A chapter suggesting future direction and further work on the Singulator is also given. At the end of this part, a summary of this project is provided along with a definitive conclusion on the work conducted so far.

Chapter 15

Discussion

The discussion of a project is an important reflection not only on the choices that have been made, but also on literature study conducted prior to any choices was made. In this chapter the all the discussion made throughout this thesis are collected. A discussion on the results from the experiments on the prototype is made. The discussions chapter will look at pros and cons of the ideas that were pitched as well as the choices that have been made.

15.1 Solutions

In this research project inlays many hours of researching possible solutions. The most promising solutions have been selected and presented in this thesis. The picture possible solutions presented has been made a wide a possible. The goal in doing so is to create an image of the industries and the vast number of different used a singulation machine has. Automation is reaching the prolongation-work conducted on fishing vessels; however, it is long since the realization that automation is wanting reached other industries.

The possible solutions present are not necessarily directly employable to fisheries; however, they could be transduced into functional possibilities. A reoccurring problem with the systems that exists today is their space occupation. Many of the solution simply cannot fit on the space available

for the weight distribution estimation system. The solution made for weight distribution estimation must be compact. Some of the solutions suggested in this thesis could be reconstructed into more compact solutions. However, the solutions that can be made compact have a lot of moving part. Many moving part means high maintenance, which in turn can mean lower revenues. This is not wanting.

The more conventional cybernetic themes have been looked. With more conventional we mean robotic solutions. Pick-and-place robotics is used in many industries - such as chocolate packing, frozen chicken packing, and organization of nuts and bolts. For the fishing industries pick-and-place packing is relatively new, and the solutions that are made so far would not be capable of handling the motion of the vessel at sea. The pick-and-place robotic solution were excluded due to its current underdeveloped system - both in regard to the movement of the boat, but also due to the grabber, which picks up the fish.

In this master thesis the concept chosen, through discussion Chapter 15 [p.141], was a novel concept - not yet documented or tried in the pursuit of fish singulation of fish. The concept was called 'the Cyclone'.

'The Cyclone'

During the literature study on singulation machinery novel innovations were depicted and discussed. Through discussion 'the Cyclone' was found at the most promising singulation mechanism discovered. It was, however, pulled in to doubt. It was therefore suggested that a prior arts model of the concept should be built - and the theory could be proven or disproven. The results for the experiment of the prior arts model where promising. The current manual operation speed of the weight distribution estimation process is 10-15 fish per minute. The trail from the prior arts model showed a singulation

speed of 100-120 per minute. A significant improvement to the current state-of-affairs if the concept could be realized.

The decision was made: ‘The Cyclone’ should be tried in a bigger experiment with fish. A realization of the concept was to be made. The system was therefore constructed in 3D in a computer-aided-design program. The 3D-renderings were simulated in the same CAD-program. The results from the CAD-program help in the design of the finale realized singulator concept. The simulation illustrates the estimated flow of water in the system. The visualization of the flow is helpful for understanding the movement of the vortex, and how to control it.

In Figure a [p.144] the finalized 3D-design of the system is illustrated. The system has been split into multiple segments to ensure modularity in the construction. Since the system is design with different sections that are easy to remove, some of those parts can be redesigned if they are found not satisfactory. This means that the same system built in this master thesis can be used in further research and development of the system if so is wanting.

Figure b [p.144] and Figure c [p.144] are the models that were built during this masters. Figure b [p.144] is the prior arts model made to prove that the concept could in fact work. Figure c [p.144] on the other hand is the realized model which was used to conduct experiments with real fish. The realized model was not just made to prove the concept, but also be a foundation on which to build on. The realized model is a prototype of the suggested singulation system need in the automation of the weight distribution estimation of fish onboard fishing vessels.

15.2 Experiments

There were conducted several experiments during this master thesis. These experiments can be split into two groups: The experiments conducted on

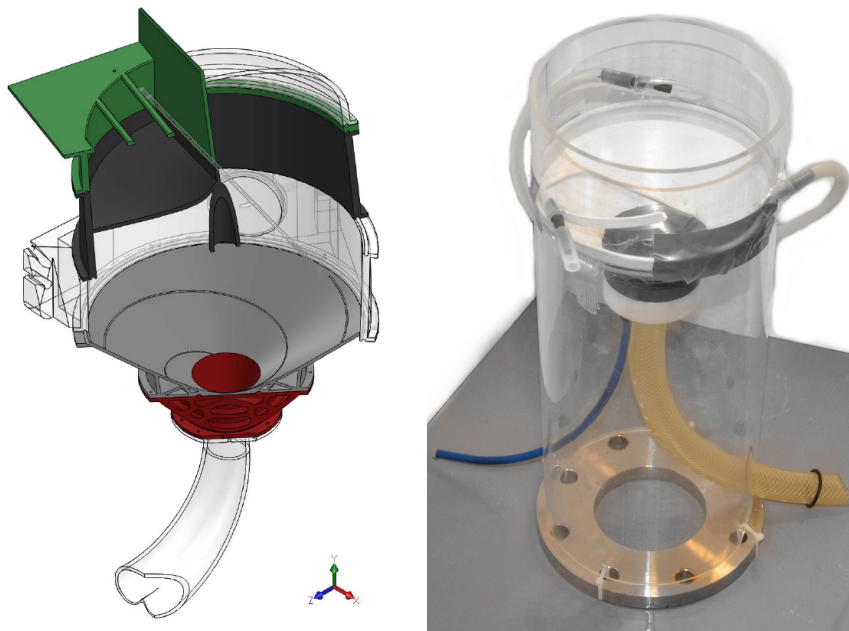

(a) CAD-modeled 'Cyclone'

(b) Prior arts model



(c) The conceptual realization

Figure 15.1: Prior arts model compared with CAD-designed 'Cyclone' and the realized 'Cyclone' - These pictures and illustrations depict: The prior art model, the CAD-model and the realized conceptual idea used in the trials with real fish.

the prior arts model, and the experiments conducted on the conceptual solution/prototype. Under this section of the discussion these to groups of experiments are separately handled.

15.2.1 Prior arts model

The prior arts model is illustrated in Figure b [p.144]. The experiment setup for the prior arts model consisted of one conveyor belt, a water input and the singulation system it self. The setup was simple, and right to the point. Could the idea be realized, was it functional. The results from the experiments were beyond expected. The prior arts model seemed to be capable of 10 folding the speed of the current operation.

The dummy fish created to test the given hypotheses were simple. However, they served their purpose. Different materials where looked at and a material almost neutral in water was chosen. The fish collected from the trawl while sink to the bottom of a bucket, however, not as fast as a stone.

During the experiments of the prior arts model different input methods and layout of the inputted dummy fish were tested. Both continuous and batch in-feed where tried. Reflection on the trails with continuous in-feed were these perhaps not as valuable as the batch in-feed. If the system was simulated as illustrated in the continuous experiments, the fish was all ready organized. However, having said that - did the continuous in-feed relay information on both how fast the system could handle ne fish in the system, as well as how fast could the fish move through the system. The batch tests consisted of batches with two, three, four, so on till nine fish. The tests showed that the prior arts model were capable of handling nine fish per batch. But this was also the limited amount of fish the system could handle at one time. In other words the prior arts model could not contain more

than nine dummy fish at a given time. Which means that the conceptual solution could suffer from the same failure: Non-compliance with greater batches of fish.

The results of the experiments on the prior arts model were so encouraging that it was made the decision of moving on to a bigger and more complex concept.

15.2.2 Conceptual solution

The conceptual solution was the next step toward the singulation machine wanted. The experiments conducted on the prior arts model had proved successful. The conceptual solution is portrayed through both Figure c [p.144] as well as Figure a [p.144]. Figure a [p.144] is an illustration of the concept wanted. And some complex SolidWorks flow simulations were conducted on it.

Figure c [p.144] depicts the realized system on which real fish were simulated. The experiments conducted on the concept were, due to time, restricted. More complex and advanced measurements and control would have been wanting. However, budget and time did not all for it. The decision actually realizing a complete system for testing on fish were made after the applications concerning budgets. Even so: The conceptual solution and the experiments conducted gave answer to many of the questions linked to the system. The realization of the principle has also made way for easier access to further experiment of ‘the Cyclone’ system.

In the experiments of the conceptual solution real fish were used. SINTEF Fisheries and Aquaculture manage to get some, 22, fish fry: A necessity for the Singulator concept to portray the real world handling of fish. The experiments were conducted over two days. The first day was the most successful one. On day two of the experiments the fish has dried-up. The mucus

on the outside of the fish had after one day of use disappeared. Which meant that the same experiments did not go as well. It could therefore be noted that fresh fish is of importance to the tests. Another important remark is to the amount of fish used in the experiments. In future endeavors more fish should be used, maybe as many as a 100 fish. During the experiments the input of 22 fish were placed on a conveyor, bulked together on an area of 60x15centimeters, the input were sent in to the system as one batch. The system handled this fine. All the 22 fish had entered the system within five seconds of the first fish reaching entry of the system. The batch used about ten seconds to get from the input and the output. It would have been nice to see how the system would fear - either with a continuous flow of such a batch or more compact batches.

The results for the experiments are about the same as for that of the prior arts model. This means that the singulation of fish with 'the Cyclone' have the potential of revolutionize the speed of the current weight distribution estimation system. The flow scale and/or visions systems are not the bottleneck in the system. They can both handle the amount of fish the Singulator can deliver. The bottleneck is definitively the Singulator. However, with the proven prototype and the results of about 2 singulized fish per second the Singulator system is catching up with the weight estimation systems.

Chapter 16

Further work

The prototype creation of the conceptual ‘Cyclone’ singulator is just that, a prototype: It is not a production model. With in that statement inlays the demand for further development. There is a set of multiple small tweaks need for the prototype to realize its full potential. In this chapter a suggested way forward is given in the form of points to improve on the prototype. All points have been reviled through the prior discussions, however, the further work chapter works as a conclusion to the discussions by formulating a plane for future progress.

In the prior discussion chapter all the aspects of this master thesis have been looked at: Form the idea to the prior arts model to the realization of the prototype and testing with real fish. Looking at the results form the testing and the discussion the conclusion must be: This is station worth stopping at, and take a dive into the sea of possibility. The challenge with the whirlpool system as now is: Controlling the water injection unit and keeping the whirlpool at a steady level; ensuring that there is *no* donut sandwiched between the whirlpool surface boundary and the fixed whirlpool wall feature; and enforcing a strict *no bending in the hole* law.

Suggested way forward for the water injection unit is: Find a water-valve that can be regulated through for example LabView. Along with water-

valve some sensors should be mounted inside the system. The sensor could be water high measurements relaying information to LabView on the current situation for the system. The water-valve and the sensors would thereby create a closed regulated system. Such systems are in them self not that complex; however, one needs to be aware of the fish entering the system - they could change the flow and the ride height of the water. It could also be useful create greater and more complex simulations of the process. With use of simulations one might get a new design for the whirlpool wall as well as the internal dimension ratios. For example would a change in distance between the slider and the whirlpool set new constraints on the size of the whirlpool.

Building of the current an available prototype might be the most cost effective way forward. However, simulation suggested improvement might save time in the trail and error phase of extending on the prototype. In the prototype, when the water injection were well defined and the fish move smoothly through the system, there was found a donut highly un susceptible to the movement of water and object about it. This donut was a slow moving body of water squeezed between the face of the whirlpool and the feature of the wall. There would often end up one fish inside this donut. If the fish ended up in the donut the fish would stay there until is manually picked up, or the system was drained. To hinder this phenomenon it is suggested that an object place along the wall of the system would break the donut - and push the fish towards the hole. Therefore is it now suggested that the next physical attribute added to the system should be a growth along the wall, one place.

The second attribute need, and is of extreme importance, is the stirring rod. The helter-skelter created and manifested through the stirring rod enforce chaos in at the center of the exit. It is imperative to hinder jamming. It

is suggested that the stirring rod should be water propelled. A water-turbine connected to the rod and the rest of the water input system could, render the system without the direct use of electricity - an EHS recommendation when working in water. However, for the prototype a simple automated stirring rod with an electrical motor connected to LabView could prove sufficient. Connecting the motor to LabView makes it easy to program, and can be embedded with the water-valves.

Chapter 17

Summary and conclusion

Through this masters thesis a lot of new innovation work has been conducted. The thesis starts with an introduction to the challenge of singulation along with an economic overview of the manual labor versus an automated process. In the suggested economic the automated process is well worth pursuing. The cost of an automated system will repay it self with easy within two fishing seasons. But not only does an automated weight distribution estimation system reduces costs - they also increase the amount of fish that can be estimated. An increase of almost 10 times that of manual labor.

A concept overview of the viable and no-viable solution has also been given. The overview looked at methods currently employed onboard fishing vessels, on-shore within both the fishing industry and other industries where automated singulation is used. New novel innovative ideas where also pitched in collaboration with SINTEF Fisheries and Aquaculture. A discussion on the use of the different systems was conducted, and the conclusion was to try out one of the novel concepts. The concept chosen for experiments was 'the Cyclone'. To ensure that the concept has merits a prior arts proof-of-concept was made from an old metal lamp shaped and some gardening hoses. The concept proved successful. It was therefore made an executive decision to pursue the concept. A model was built in SolidWorks

and simulated. When a suitable model was found the 3D-computer-aided-design drawings from SolidWorks was realized. Some of the parts making up the structure were made in the IME-faculty workshop, while the most difficult parts were sent to 3D-printing. The fully realized CAD-model was put together and tested. The prior arts model had just been tested with dummy fish; however, the final prototype was tested with fish fry. The tests were successful once again. The prototype took bulks of fish and separated them into individual components and feed them to the output area of the Singulator.

‘The Cyclone’ was a proven prototype worth research further. Some time constraints on the build, and some constraints on the budget for this project have been a part of the challenge. However, it has been a valuable insight to the cost of production and the limit of funding.

In conclusion: A novel innovation idea was design and realized. The results from the prototype was positive. The solution that was made handled the task of automated singulation of fish. The experiments suggests that the prototype is capable of delivering TWO fish per second, compared to the manual labor speed of 10-15 fish per minute is the automated system able to operate at almost 10 times the speed. The prototype has defiantly proved that it is up for the job. There are minor details that need some more work before the prototype can become a production model - but the end result of *this* master thesis is: Solution proven and ready for finalization.

All novel innovations have great potential, not all of the innovations get there day to shine - however, in this case an idea was materialized and proved to function as wanted.

Bibliography

- Automation, H. C. (2012), 'Syntron vibratory feeders', www.syntronpartsfeeders.com.
- Balchen, J. G., Andresen, T. and Foss, A. B. (2003), *Reguleringsteknikk (5. utgave)*, Institutt for Teknisk Kybernetikk, NTNU, Trondheim.
- Eilertsen, A. (2011), *Automated packing of pelagic fish: Cost-efficiency through application of robotics - design, analysis and experiments*, NTNU.
- Lyytinen, K., Loucopoulos, P., Mylopoulos, J. and Robinson, B. (2007), *Design Requirements Engineering: A Ten-Year Perspective*, Inbip14 edn, Springer.
- Machinefabriek, B. (2012), 'V-belt singulator', www.burgmachinefabriek.nl.
- Marel (2012a), 'Marel flow scale', www.marel.no.
- Marel (2012b), 'Marel manual weighing station', www.marel.no.
- Misimi, E., Bondø, M., Veberstad, P. A., Østvik, S. O. and Veliyulin, E. (2011), *A Simple Method for Weight Estimation of Whole Herring (Clupea harengus) Using Planar X-ray Imaging*.
- Montgomery, D. C. (1991), *Design and analysis of experiments*, Vol. 3rd edition, John Wiley & Sons.

- Norsk-sildesalgslag (2012), ‘Norsk sildesalgslag’, www.sildelaget.no.
- Quattro, A. (2012), ‘Adept quattro, pick-and-place robotics’, www.adept.com.
- Robotics, A. (2012), ‘High-speed singulator’, www.arobotics.com.
- SINTEF (2010), Video documentation of operations, Video, SINTEF Fisheries and Aquaculture.
- SINTEF (2011), Technical reports, found in the digital-copy., Video, SINTEF Fisheries and Aquaculture.
- SINTEF (2012), Meetings, found in the digital-copy. Notes from meetings concerning the project, weight distribution estimation onboard fishing vessels.
- Storbeck, F. and Daan, B. (1991), *Weight estimation of flatfish by means of structured light and image analysis*.
- Storey, N. (1996), *Safety Critical Computer Systems*, Vol. 1st edition, Pearson.
- Tendons, M. and SINTEF (2012), Video conferance with MMC TENDONS, Technical report.
- Toldnes, B., Misimi, E., Bondø, M., Østvik, S. O. and Mathiassen, J. R. (2011), *High-Speed Weight Estimation of Whole Herring (*Clupea harengus*) Using 3D Machine Vision*, Journal of Food Science.

Declaration

I herewith declare that I have produced this work without the prohibited assistance of third parties and without making use of aids other than those specified; notions taken over directly or indirectly from other sources have been identified as such. This paper has not previously been presented in identical or similar form to any other Norwegian nor foreign examination board.

The thesis work was conducted from Desember 2011 to April 2012 under the supervision of Amund Skavhaug associate professor at Norwegian University of Science and Technology, and SINTEF Fisheris and Aquaculture - Process technology.

TRONDHEIM - NORWAY, 23rd of April 2012

Reflection

Through this project I feel that I did not *just* learn new programming skills, or *just* improve and add to any pre-existing know-how on the subject of automation in the fishing industry: No, through this project I have learned how much there is to it, when creating and developing novel innovations; how much groundwork is needed, and that: “Just making it work”, *ain't* that easy.

In conclusion, I feel that the hick-ups and delays experienced in this project have left me *more* capable of handling such research and development in the future, as well as making me more aware of time constraints and costs associated with realization of conceptual ideas.

ALEKSANDER EILERTSEN

23rd of April 2011

APPENDICES

All appendices can be found on the digital-copy of the report, CD-ROM included on page ix. All MATLAB and MATLAB SIMULINK code can also be found on the CD-ROM, and can be run through MATLAB. All pictures shown in the appendices and elsewhere in the report, is included in digital form on the CD-ROM.

Appendix A

Economic overview:

Automated vs. manual labor

In this appendix all the economics calculated in this master thesis is illustrated. The accuracy of the economics is based on information gain for discussions at SINTEF Fisheries and Aquaculture, as well as in discussions with MMC Tendors. Other sources have been Norsk Sildeslagslag and Nofima Market. The excel computations are added in the Digital-copy.

The economics used in this master thesis are meant as a guide to the benefits of automation. Not all the numbers are easy to neither find nor calculate. The economics must be seen as a sketch of the land - and not definitive statement.

Figures from Survey on operating revenues in the fishing industry 2008 (by Nofima Market):		
	Mill. NOK	NOK/kg
Sales revenue	5 396,00	4,80
Commodity consumption	3 980,00	3,54
Salary costs	486,00	0,43
Other operating expenses	620,00	0,55
Depreication	82,00	0,07
Operating profits	228,00	0,20
Volume of raw materials 2008 (in 1000 tonnes)	1 125	

Parameters set for the calculation of the operation		
Duration of work shift	9,1 hours	
A work hour	50 min	
Down time for automation	1 %	
A work hour for the automated process	59,4 min	
NVG herring, average weight	260 gram	From SINTEF
Fish in a trawl "average" catch	700 000 kg	
<p>Note: These numbers are very hard to safely conclude anything with. The numbers are educated guesses on average values. The guesses are made in an effort to contemplate the value of estimation.</p>		

Price classes of fish 2011 from Norges Sildesalgslag		
Classes	NOK/kg	NOK/average fish
> 125 grams	2,40	0,168
< 125 grams > 199grams	2,40	0,168
< 200 grams > 299grams	2,75	0,193
< 300 grams > 349grams	3,50	0,245
< 350 grams	4,00	0,280

Human operator	
# of fish WeDEed (speed)	15 seconds per fish 4 fish per minute 0,07 fish per second
Hourly pay	300,00 NOK/hour
Extra cost with employment	100,00 NOK/hour
WeDE = weight distribution estimation	

Manual operation	Duration of work shift:	9,1 hours
	A work hour:	50 min
# of operators in the process	1 person	
# of fish WeDE (speed)	4 fish per minute 0,07 fish per second	
Total # of fish WeDEed in a work shift	1820 pcs. of fish	
Total weight of fish WeDEed in a work shift	473,2 kg	
Percentage of catch measured	0,07 % of catch measured	
Error in measurement on plus/minus	3 grams	
Error in measurement with manual labor	1,2 % error in measurements	
Salary cost for the work shift	2 730,00 NOK	
Extra cost of labor for the work shift	910,00 NOK	
Total summed cost of labor work shift	3 640,00 NOK	
Cost of labor per # of fish WeDEed	2,00 NOK/fish	
Cost of labor per kg of fish WeDEed	7,69 NOK/kg	

NOTE	
<p>Note that by increasing the amount of people the efficiency of weight estimation speed increases. This is due to the fact that while one collects the samples needed for the weight estimation another can weigh the fish already collected. The factor is a representation of less time spent of collection in the total picture.</p>	
Factor	10 % increase in speed

Manual operation multiple workers	Duration of work shift:	9,1 hours
	A work hour:	50 min
# of operators in the process	2 person	
# of fish WeDE (speed)	8,8 fish per minute 0,15 fish per second	
Total # of fish WeDEed in a work shift	4004 pcs. of fish	
Total weight of fish WeDEed in a work shift	1041,04 kg	
Percentage of catch measured	0,15 % of catch measured	
Error in measurement on plus/minus	3 grams	
Error in measurement with manual labor	1,2 % error in measurements	
Salary cost for the work shift	5 460,00 NOK	
Extra cost of labor for the work shift	1 820,00 NOK	
Total summed cost of labor work shift	7 280,00 NOK	
Cost of labor per # of fish WeDEed	1,82 NOK/fish	
Cost of labor per kg of fish WeDEed	6,99 NOK/kg	

Automated system		
# of fish WeDEed (speed)	0,7 seconds per fish 86 fish per minute 1,43 fish per second	
Investment sum	350 000,00 NOK	
Deprecation on investment per year	70 000,00 NOK	5 year
Number of WeDE shifts per year	1 400,00 NOK/work shift	50 work shifts
Hourly pay	153,85 NOK/hour	
Extra work cost the automated system	10,00 NOK/hour	

Automated operation	Duration of work shift:	9,1 hours
	A work hour:	59,4 min
# of operators in the process	1 person	
# of fish WeDE (speed)	85,71 fish per minute 1,43 fish per second	
Total # of fish WeDEed in a work shift	46332 pcs. of fish	
Total weight of fish WeDEed in a work shift	12046 kg	
Percentage of catch measured	1,72 % of catch measured	
Error in measurement on plus/minus	2,6 grams	
Error in measurement with automated system	1,0 % error in measurements	
Salary cost for the work shift	1 400,00 NOK	
Extra cost of labor for the work shift	91,00 NOK	
Total summed cost of labor for work shift	1 491,00 NOK	
Cost of labor per # of fish WeDEed	0,03 NOK/fish	
Cost of labor per kg of fish WeDEed	0,12 NOK/kg	

Automated system		
# of fish WeDEed (speed)	0,7 seconds per fish 86 fish per minute 1,43 fish per second	
Investement sum	350 000,00 NOK	
Deprecaition on investment per year	175 000,00 NOK	2 year
Number of WeDE shifts per year	3 500,00 NOK/work shift	50 work shifts
Hourly pay	384,62 NOK/hour	
Extra cost work the automated system	10,00 NOK/hour	

Automated operation	Duration of work shift:	9,1 hours
	A work hour:	59,4 min
# of operators in the process	1 person	
# of fish WeDE (speed)	85,71 fish per minute 1,43 fish per second	
Total # of fish WeDEed in a work shift	46332 pcs. of fish	
Total weight of fish WeDEed in a work shift	12046 kg	
Percentage of catch measured	1,72 % of catch measured	from SINTEF
Error in measurement on plus/minus	2,6 grams	
Error in measurement with automated system	1,0 % error in measurements	
Salary cost for the work shift	3 500,00 NOK	
Extra cost of labor for the work shift	91,00 NOK	
Total summed cost of labor for work shift	3 591,00 NOK	
Cost of labor per # of fish WeDEed	0,08 NOK/fish	
Cost of labor per kg of fish WeDEed	0,30 NOK/kg	

Profitability		Work shifts	50
One year of work estimates 50.			
	Cost per work shift	Total cost per year	
	in NOK	in NOK	
Automated (5yr)	1 491,00	74 550,00	
Automated (2yr)	3 591,00	179 550,00	
Manual operation	3 640,00	182 000,00	
Double manual operation	7 280,00	364 000,00	
This means that a Automated system with 2yr down payment is less than manual operation.			
Manual operation is more expensive in percentage			
Automated (5yr)	107 450,00 NOK		59 %
Automated(2yr)	2 450,00 NOK		1 %

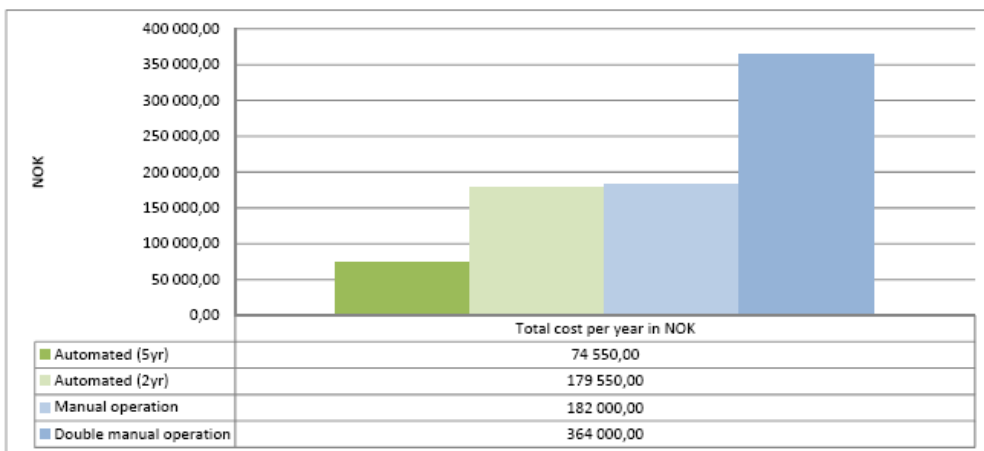

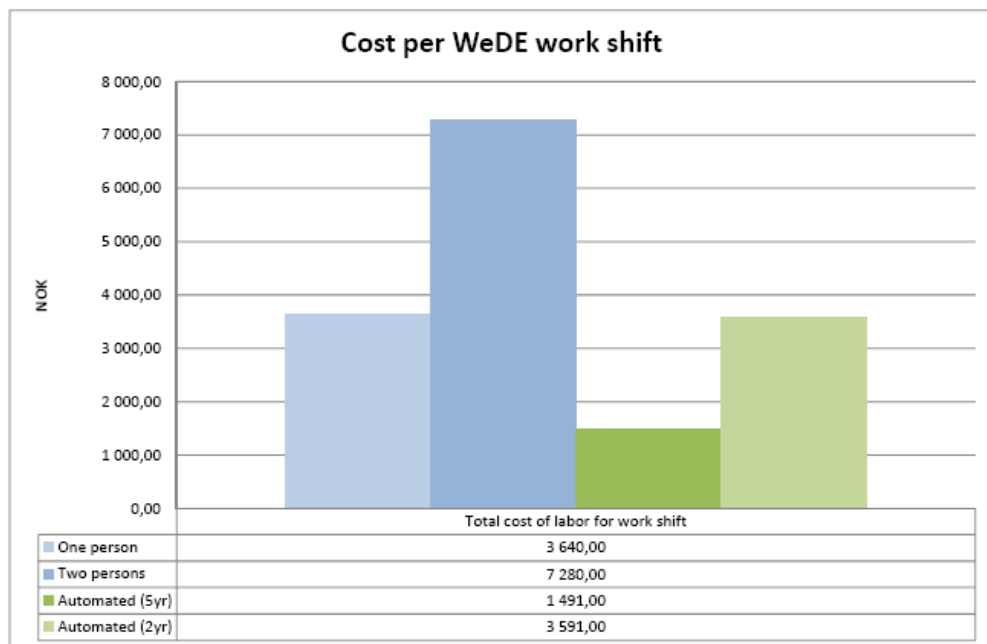

In this graph the cost per work shift is estimated. It compares the different options. As can be seen from the illustration the Automated system with 5 years down payment is the cheapest. However, it is also interesting to see that the 2 year down payment of the Automated system is also cheaper than the manual labor.

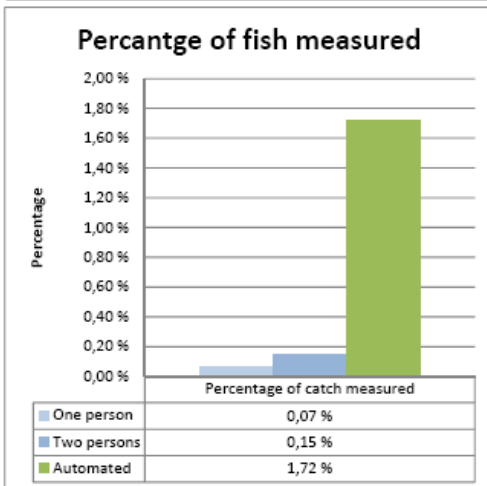
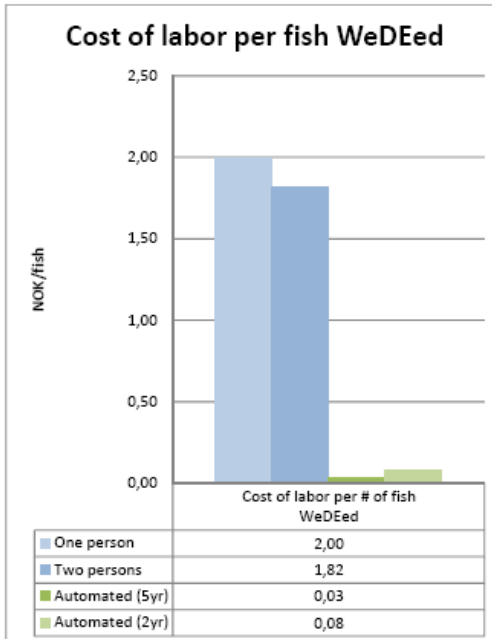
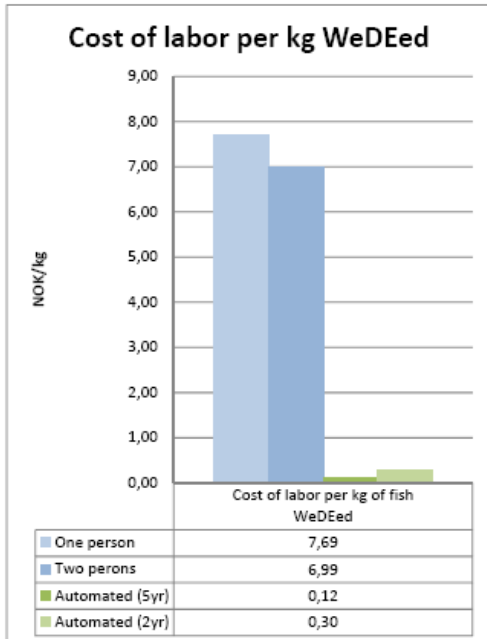

Appendix B

Statistical data for prior arts model

This appendix contains some of the statistical data logged during the prior arts model experiments. The excel computations for this data along with more statistical loggings can be found in the Digital-copy.

These logging tables illustrate the average time consumption per fish, and the average fish/second outputted by the singulator. When we talk about time consumption are we thinking of the average time a fish spends in the singulator. This is important to know if batches are to continuously fill the machine. Data on how many fish are in the system at one given time is not reflected in these logs. However in the Digital-copy, this data can be found.

Illustration of Average consumption time/per				
10mL/s				
	2	1,5	1	0,5
# of fish/batch	Input speed: 2 batch/sec	Input speed: 1,5 batch/sec	Input speed: 1 batch/sec	Input speed: 0,5 batch/sec
1	10000,00	10000,00	1,10	2,22
2	10000,00	10000,00	10000,00	1,08
3	10000,00	10000,00	10000,00	0,81
4	10000,00	10000,00	10000,00	10000,00
5	10000,00	10000,00	10000,00	10000,00
6	10000,00	10000,00	10000,00	10000,00
15mL/s				
	2	1,5	1	0,5
# of fish/batch	Input speed: 2 batch/sec	Input speed: 1,5 batch/sec	Input speed: 1 batch/sec	Input speed: 0,5 batch/sec
1	0,51	0,68	1,03	2,17
2	0,41	0,44	0,51	1,08
3	0,38	0,37	0,39	0,68
4	0,39	0,38	0,38	0,53
5	0,43	0,49	0,49	0,48
6	10000,00	0,52	0,51	0,50
20mL/s				
	2	1,5	1	0,5
# of fish/batch	Input speed: 2 batch/sec	Input speed: 1,5 batch/sec	Input speed: 1 batch/sec	Input speed: 0,5 batch/sec
1	0,69	0,81	1,15	2,17
2	0,52	0,43	0,51	1,06
3	0,51	0,41	0,42	0,83
4	0,50	0,40	0,40	0,56
5	0,56	0,50	0,49	0,48
6	0,50	0,53	0,51	0,49

Illustration of fish/sec singulised				
Flow input 10mL/s				
	2	1,5	1	0,5
# of fish/batch	Input speed: 2 batch/sec	Input speed: 1,5 batch/sec	Input speed: 1 batch/sec	Input speed: 0,5 batch/sec
1	0,00	0,00	0,91	0,45
2	0,00	0,00	0,00	0,93
3	0,00	0,00	0,00	1,23
4	0,00	0,00	0,00	0,00
5	0,00	0,00	0,00	0,00
6	0,00	0,00	0,00	0,00
Flow input 15mL/s				
	2	1,5	1	0,5
# of fish/batch	Input speed: 2 batch/sec	Input speed: 1,5 batch/sec	Input speed: 1 batch/sec	Input speed: 0,5 batch/sec
1	1,98	1,46	0,97	0,46
2	2,45	2,27	1,97	0,93
3	2,65	2,70	2,56	1,48
4	2,54	2,63	2,63	1,89
5	2,34	2,04	2,04	2,08
6	0,00	1,92	1,96	2,01
Flow input 20mL/s				
	2	1,5	1	0,5
# of fish/batch	Input speed: 2 batch/sec	Input speed: 1,5 batch/sec	Input speed: 1 batch/sec	Input speed: 0,5 batch/sec
1	1,45	1,23	0,87	0,46
2	1,92	2,35	1,98	0,94
3	1,96	2,41	2,38	1,20
4	2,01	2,51	2,49	1,80
5	1,80	2,01	2,05	2,07
6	2,01	1,89	1,98	2,04

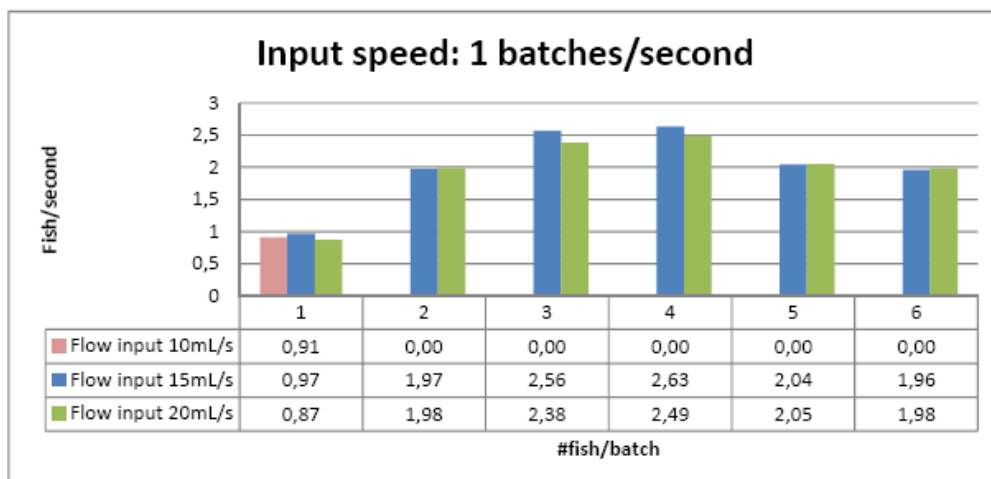
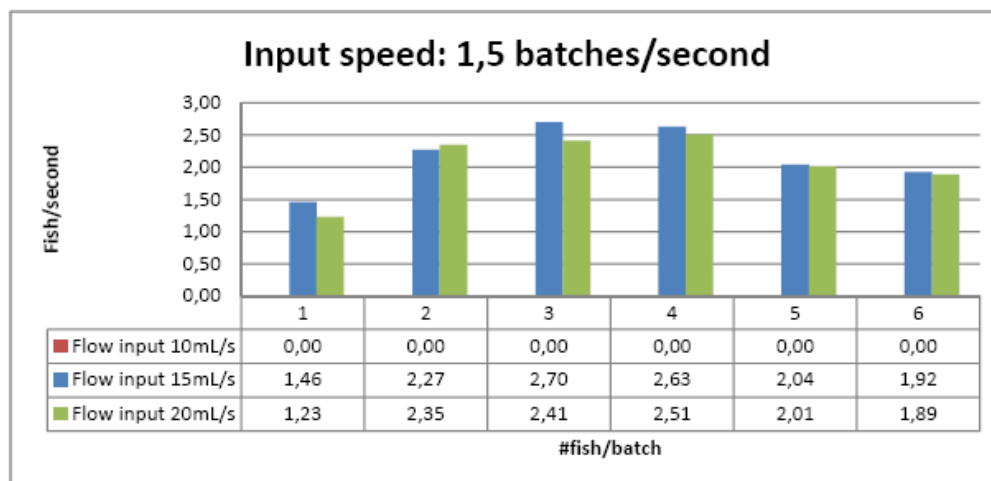
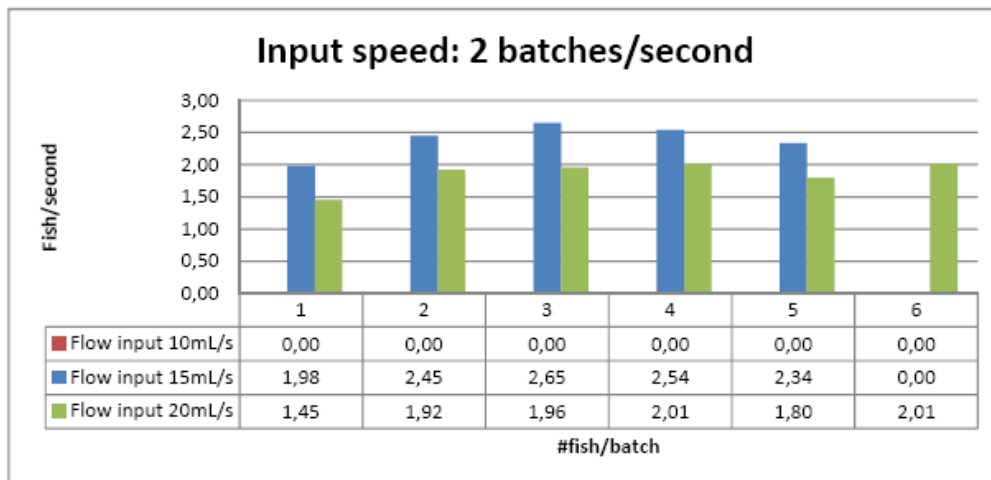

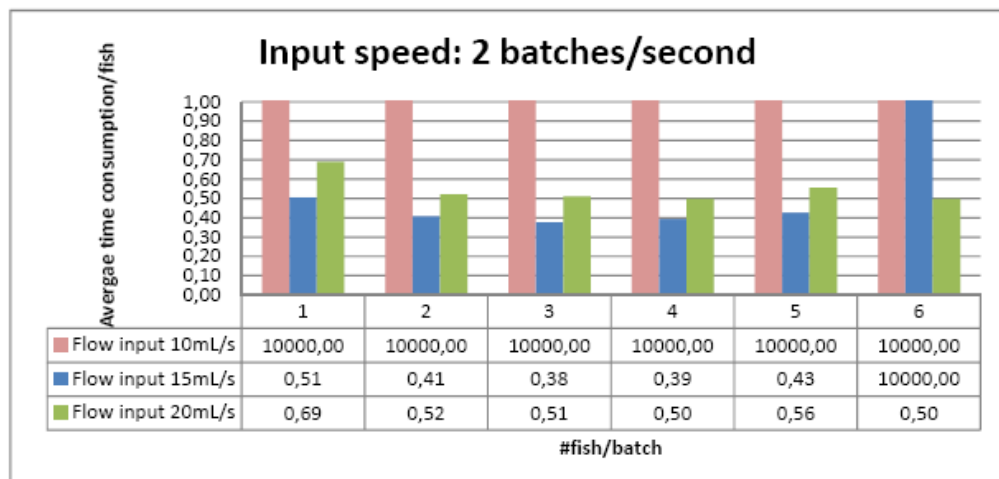
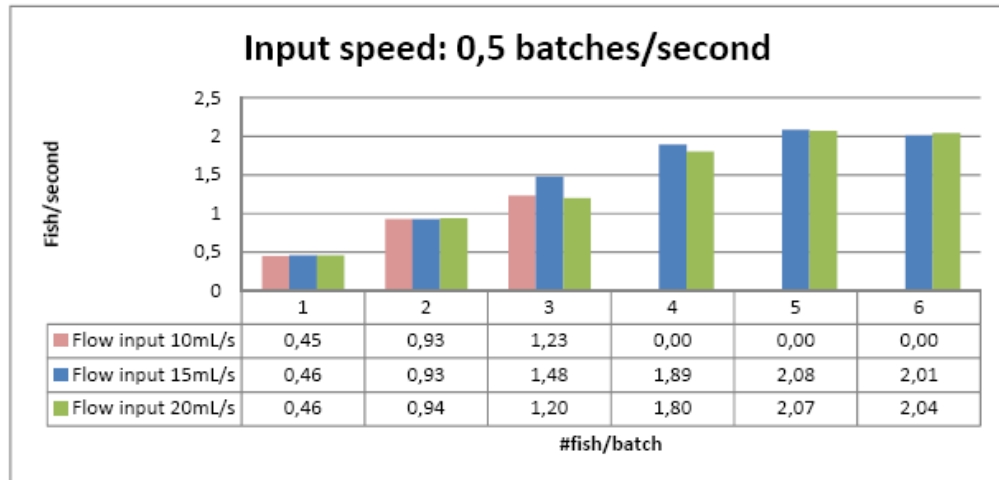

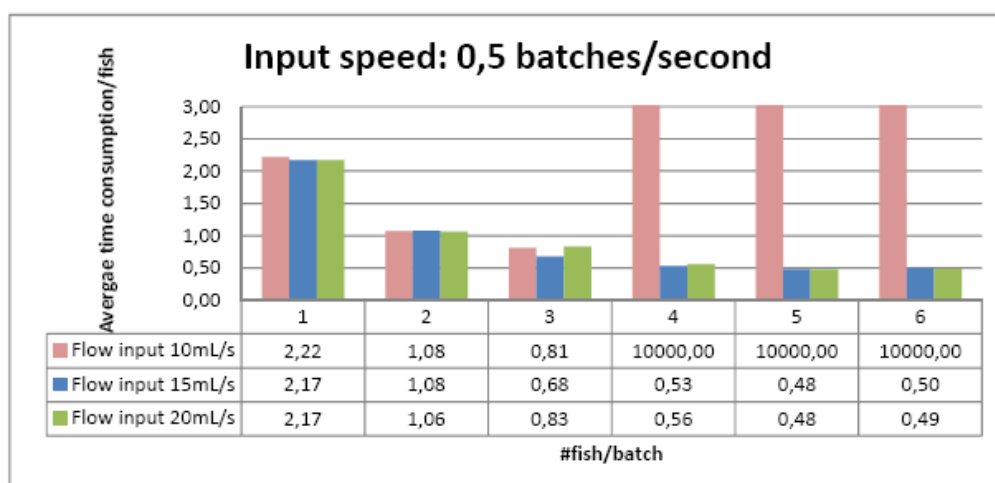
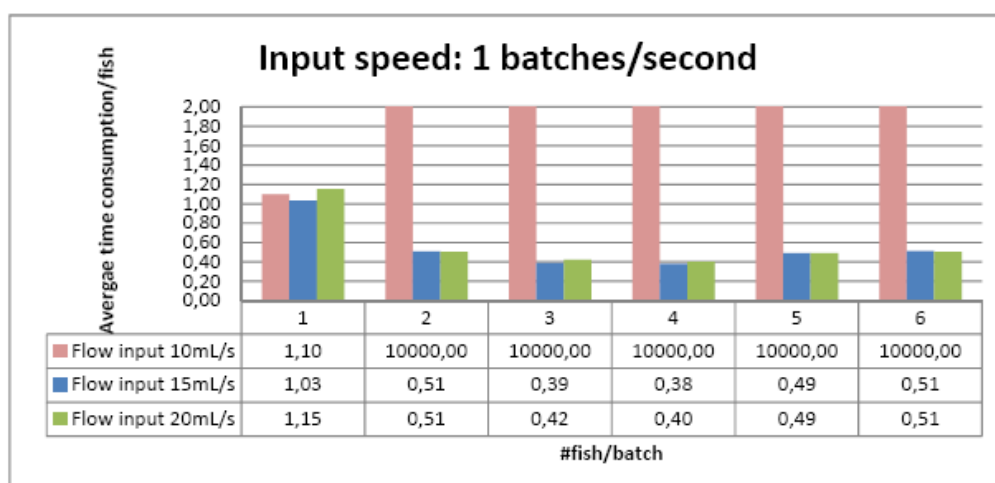
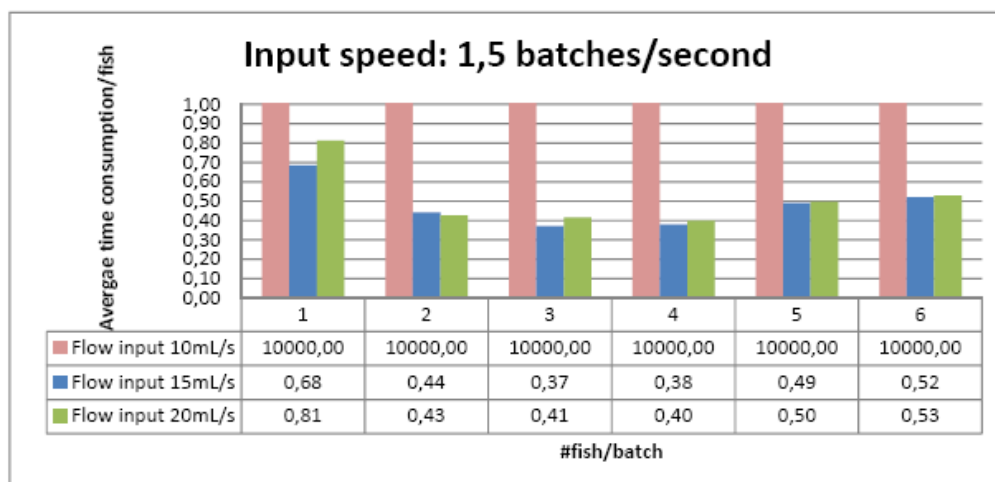

Appendix C

Statistical data for prior arts model

This appendix contains some of the statistical data logged during the realized conceptual model experiments. The excel computations for this data along with more statistical loggings can be found in the Digital-copy.

These logging tables illustrate the average time consumption per fish, and the average fish/second outputted by the singulator. When we talk about time consumption are we thinking of the average time a fish spends in the singulator. This is important to know if batches are to continuously fill the machine. Data on how many fish are in the system at one given time is not reflected in these logs. However in the Digital-copy, this data can be found.

Illustration of Average consumption time/per				
10mL/s				
	2	1,5	1	0,5
# of fish/batch	Input speed: 2 batch/sec	Input speed: 1,5 batch/sec	Input speed: 1 batch/sec	Input speed: 0,5 batch/sec
1	0,37	0,39	0,48	0,51
2	0,36	0,38	0,51	0,50
3	0,35	0,38	0,48	0,49
15mL/s				
	2	1,5	1	0,5
# of fish/batch	Input speed: 2 batch/sec	Input speed: 1,5 batch/sec	Input speed: 1 batch/sec	Input speed: 0,5 batch/sec
1	0,34	0,36	0,35	0,41
2	0,37	0,47	0,49	0,41
3	0,35	0,40	0,48	0,40
20mL/s				
	2	1,5	1	0,5
# of fish/batch	Input speed: 2 batch/sec	Input speed: 1,5 batch/sec	Input speed: 1 batch/sec	Input speed: 0,5 batch/sec
1	0,38	0,39	0,56	0,61
2	0,36	0,38	0,53	0,53
3	0,39	0,38	0,51	0,49

Illustration of fish/sec singulised				
Flow input 20mL/s				
	2	1,5	1	0,5
# of fish/batch	Input speed: 2 batch/sec	Input speed: 1,5 batch/sec	Input speed: 1 batch/sec	Input speed: 0,5 batch/sec
9	2,70	2,56	2,1	1,98
15	2,81	2,61	1,98	2,01
22	2,82	2,62	2,07	2,05
Flow input 25mL/s				
	2	1,5	1	0,5
# of fish/batch	Input speed: 2 batch/sec	Input speed: 1,5 batch/sec	Input speed: 1 batch/sec	Input speed: 0,5 batch/sec
9	2,91	2,81	2,87	2,43
15	2,71	2,12	2,05	2,41
22	2,85	2,51	2,08	2,51
Flow input 30mL/s				
	2	1,5	1	0,5
# of fish/batch	Input speed: 2 batch/sec	Input speed: 1,5 batch/sec	Input speed: 1 batch/sec	Input speed: 0,5 batch/sec
9	2,62	2,56	1,78	1,65
15	2,74	2,61	1,87	1,87
22	2,58	2,62	1,98	2,04

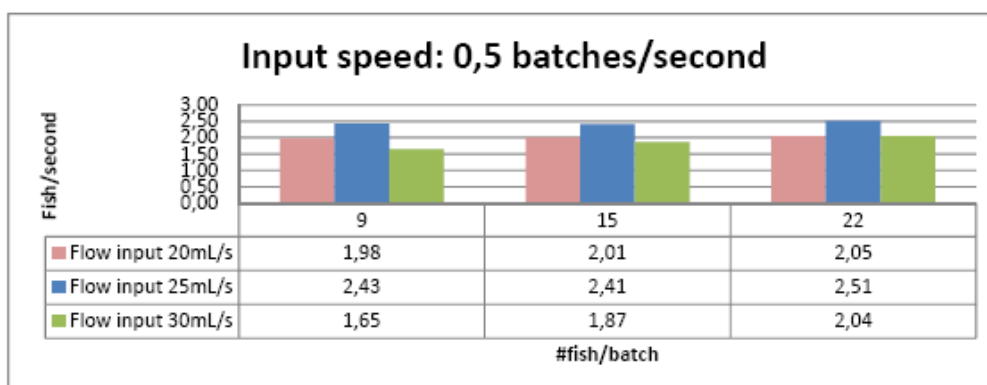
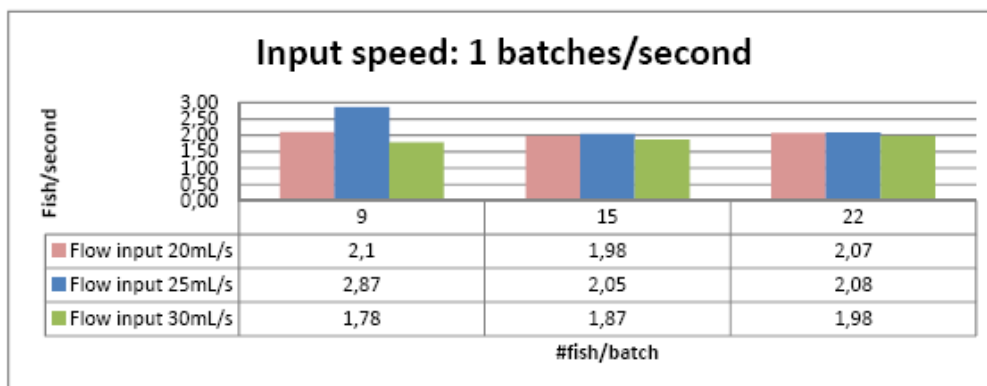
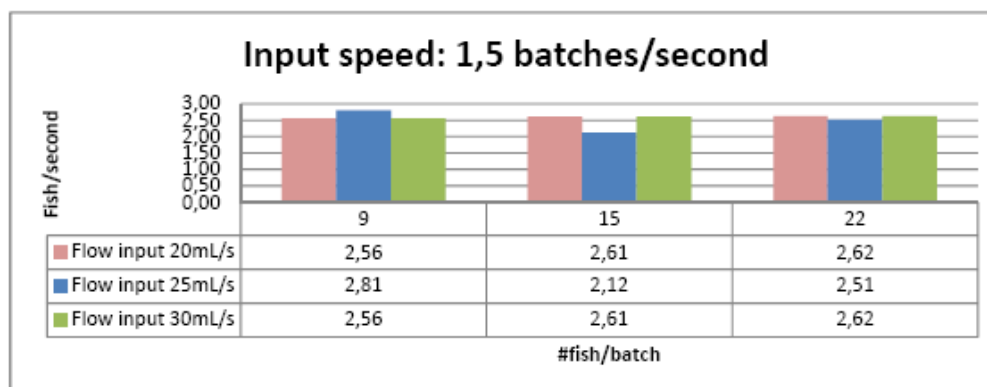
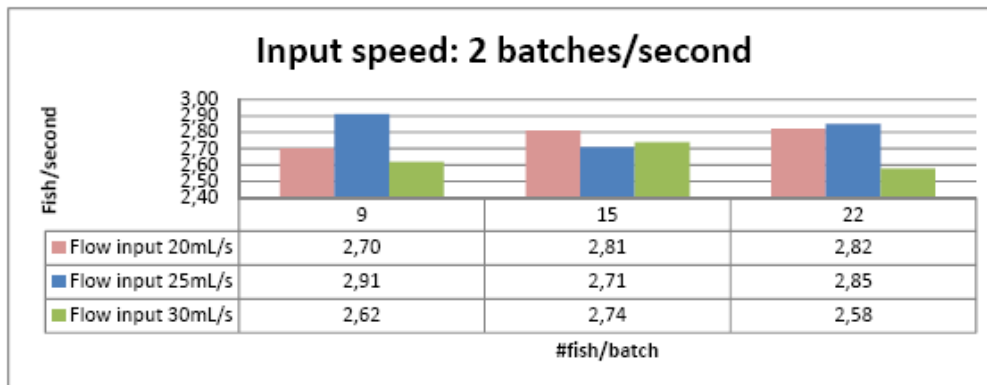

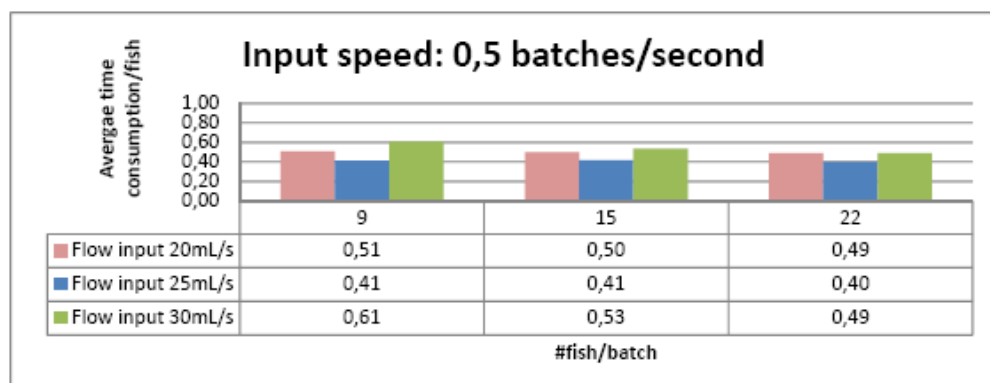
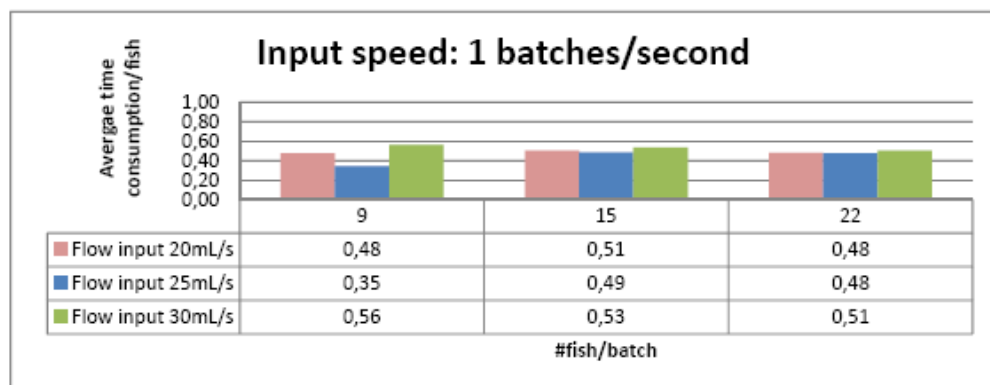
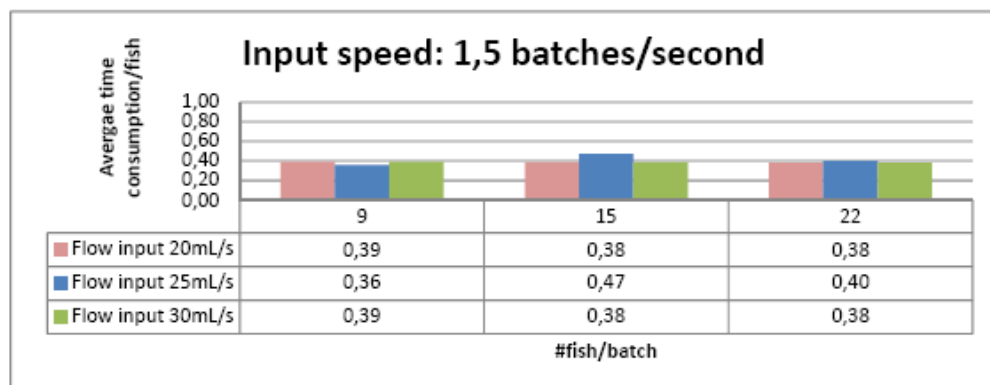
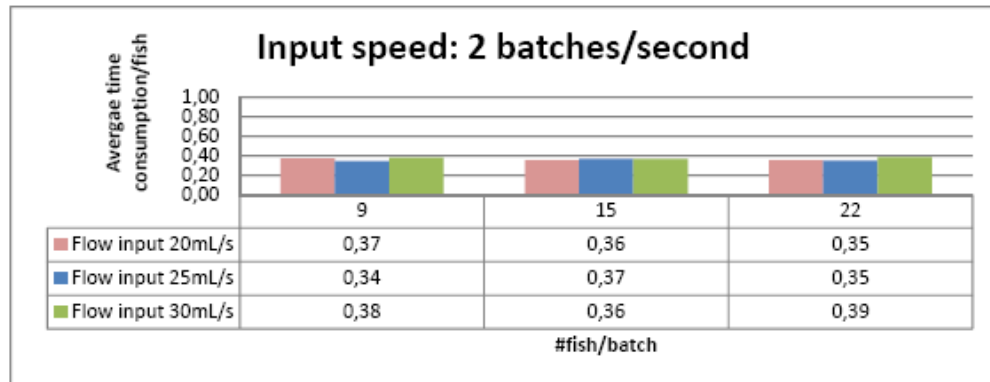

Appendix D

Mid-way report

During this project there was written a mid-way report on the progress of the master thesis. The report is added here as an illustration - however, the real report is recommended to read on the Digital-copy. In the report the project is summarized and further work is planned. The report was made to document SINTEF Fisheries and Aquaculture's progress in their project - supported and funded through the Norwegian Research Council.

Progress report on: Automated Singulation of Whole Fish at Sea for Use in Weight Distribution Estimation of Catch.

Aleksander Eilertsen

Abstract: Weight distribution estimation of a catch is an important parameter by which the captain determines where to sell his catch. Within the fishing industry the price of the catch is set by the estimated sizes of fish in one load. Enabling for greater accuracy by automating the process, as well as removing the human link in the process of estimation, is wanting. Automated system with lower cost than human labor means higher revenues for the fishing vessel. In this article a novel solution to the challenge is presented along with its results. Currently the operation speed of weight estimation is 10-15 fish per minute. The new concept provides more than 60 fish per minute, i.e. 5x as fast. In one catch the weight distribution estimation choose a representative amount of the fish, currently set at 1%. With the increase of speed – the amount of estimated fish can become as high as 5%, dramatically increasing the accuracy of weight distribution estimation.

Keywords: Fish singulation, fish bulk separation, weight distribution at sea.

Practical Applications: The machine system presented in this article enables automated singulation/pre-ordering of fish before automatically weight estimated. This system functions as the in-feeder to the weight estimation system Automating the process of weight distribution estimation of catch at seas removes the allocation of labor, thus increasing profits as well as EHS. Such an automated system will increase the speed of the process allowing for higher percentage of the catch to be estimated – increasing accuracy of the weight distribution estimation.

Introduction

This is a progress report on a master thesis conducted by Aleksander Eilertsen, NTNU - Engineering Cybernetics. The master thesis is conducted in collaboration with SINTEF Fisheries and Aquaculture. This article is written as a progress report on the master thesis, and the conclusions and discussions are only preliminary. The master thesis is a part of a research project connected at SINTEF Fisheries and Aquaculture. The research project is look into the automation of weight distribution estimation of catch.

Weight distribution estimation of a catch is an important parameter by which the captain determines where to sell his catch. Within the fishing industry the price of the catch is set by the estimated sizes distribution of fish in the catch. The price of fish is set by the size of the individual fish, and it varies greatly between the defined classes. The weight distribution estimation is not just conducted by the vessel, but also on-shore at the slaughterhouses. Both these processes are manually conducted: In the on-shore process a representative amount of fish is selected for weight distribution estimation

(WeDE). During the WeDE process fish are manually place on weight scales, the weight is logged and the WeDE is calculated. The same process is conducted at sea on the vessels. The captain chooses which slaughterhouse to deliver the catch to based on the price set by the slaughterhouse on the classes of fish. The different slaughterhouse conduct different processing of the fish, this is why the price of the fish classes varies – a filleting house cannot use fish under a given size. The filleting machines fed with too small fish will not deliver fillets.

Enabling for greater accuracy by automating the process, as well as removing the human link in the process of estimation, is wanting. Automated system with lower cost than human labor means higher revenues for the fishing vessel. Automated processing of WeDE can also relive some of the work conducted at the slaughterhouses. An automated WeDE process would be beneficial for both the slaughterhouse and the fishing vessels.

In this research project a novel solution, created by Aleksander Eilertsen, is presented. The conceptual idea is based on the physical principles of a whirlpool. In this progress report a prior art proof-of-concept is made, and the preliminary results shows that the WeDE process can be dramatically

Authors are with NTNU - Trondheim, and SINTEF Fisheries and Aquaculture AS – Trondheim. Project conducted by Master Student, Aleksander Eilertsen, within the field of Engineering Cybernetic at NTNU. Direct inquiries to author Aleksander Eilertsen (lillienskiold@gmail.com)

APRIL 2012 - MASTER THESIS BY: ALEKSANDER EILERTSEN

SUPERVISOR AT NTNU: AMUND SKAVHAUG
SUPERVISOR AT SINTEF: BENDIK TOLDNES

PG. 1 OF 2

increased. Currently the operation speed of weight estimation is 10-15 fish per minute. The new concept provides more than 60 fish per minute, i.e. 5x as fast. In one catch the representative amount of the fish set at about 1% of the entire catch. With the increased speed – the amount of estimated fish can become as high as 5%, dramatically increasing the accuracy of weight distribution estimation.

Progress

Where is the research project at? A lot of the work so far has been focused on the established methods of singulation of fish. Processes conducted both at off- and on-shore have been looked at, as well as systems used in other singulation processes.

It has been established that the research project will focus on pelagic fish. The size of the fish has also been established. Along with these parameter MMC Tendons, a collaborator in the project, have helped define a set of demands for the automated WeDE process. In Table 1 [p.2] all the demands are written down.

The research into the already existing singulation technics has shown that much of the system currently in use are not applicable for the singulation process at sea. Many of the system are massive and contain many moving part. The system sough for maritime usage have to be quite compact, as well as robust. The space designated for the WeDE process is no greater than 2x2x2 meters. The system employed has to be easy to maintain – and have high duty cycle. It must also be a

system that can cope with the movement of the vessel.

This is a project conducted at NTNUs Engineering Cybernetics department, so a robot might be the natural thought solution. Pick-and-place robots are often used in singulation of object in other industries. However, the maintenance on a robot is difficult, it demands a certain education, an education that sailors not necessarily have. This means that if the system goes down during a trawling session – the WeDE process cannot be conducted before vessel docks and the problem is fixed. Two other challenges with the usage of robotic arms are: ONE, the movement of the robotic arm in an already accident prone environment is not really a EHS recommendation; and TWO, the current state-of-art would have difficulty picking up and placing fish while all the objects are moving about. It is hard enough picking up fish while on-shore.

Conceptual Idea

Reaching the conclusion that robotic might not be the best way forward; another automated system must be developed. The idea proposed by this master thesis is: A whirlpool object separating centrifuge.

This is a novel invention was sought out as it has the potential of ignoring any vessel movement, as well as being simple and compact. The machine will be easy to understand and fixed or mend if anything should happen. A drawing of the prototype was made utilizing a 3D-computer-aided-design program called SolidWorks. An illustration is given in Figure 1 [p.3]. The drawings were taken to the IME-faculty Workshop, where a collaboration conceived a realized prototype. The prototypes were to be used in the verification of the principle.

Demands	State-of-affairs	Goals for automation
Placement on the vessel	Has it owns room/area	Same place as currently used
Size of area		2x2x2 meters in area
Labor	1-2 people during the whole process of pulling the catch	Captain starts and stops the system
Handling of fish	The neck is broken and the fish is thrown overboard afterwards	The fish is gently handled, and can be lead back to the storage containers.
Capacity of system	10-15 fish per minute per person	In excess of 60 fish per minute
Fish species		Pelagic fish: Herring, Mackerel, Capelin, and blue whiting
Fish sizes	All fish can be handle but only the wanted fish species are processed	Only fish smaller than 50 centimeter is allowed into the system. (This is virtually all pelagic fish.)
Input	The fish is dispensed from an outlet from the pump from the nets	Attached to the same system, transferred all the way to the singulation process.

Table 1: The demands for the automated process. Lists the current state-of-affairs along with the goals set for the automation process. The goals are set in collaboration with MMC Tendons.



Figure 1: This is a 3D-rendering of the novel innovation. The fish enters in the top of the «bowl». A whirlpool separates the objects that enter and lets them out one at the time.



Figure 2: This is the prior arts model made to verify concept and its functionality.

The realized prior arts proof-of-concept, illustrated in Figure 2 [p.3], even though it was just a rough model proved successful. The system showed during experiments that it was capable of handling batch in-feed of 8 fish at the time. Using about 4 seconds to align and produce an out-feed. This means that the prototype showed a singulation speed in excess of 2 fish per second, i.e. an output rate of about 120 fish per minute. If this results could be replicated in a real sized machine, there is an exceptional potential of increase in the speed of the process.

Further work

From these findings it was decided that a more accurate and bigger model were to be constructed. A new 3D-model of the system has to be constructed based on findings in the prior arts model. A simulation of the 3D-model will also be demanded in the next steps of the process.

The new 3D-model will be split into segments ensuring that the finished model is as modular as possible. If the system is modular it makes it easier to change small segments of the system rather than rebuilding the whole thing. Some of the parts needed in the creation of a new and more improved singulation model are difficult to make at NTNUs Workshop. Some of the parts are therefore necessary to order as 3D-prints.

The plane ahead is to create the 3D-model, simulate it, and realize it for the purpose of conducting experiments. During the realization of the 3D-model an experiment plane will be made.

Conclusion

A lot of work has been done. However, the research project on singulation of fish is still a long way from conclusion. When the new model has been built and the results from the experiments on it are in, a master thesis while be rewritten. In the master thesis a conclusion on the conceptual solution while be made; along with the solution will a suggested path be pointed out.

So far has the progress and results of the research been promising, and with support the next steps towards the goal will hopefully be as giving.

END OF PAPER

Appendix E

Layout and first addition to an intended article

A final paper for this master thesis is intended. This appendix is the first edition of the article intended, and is meant as an illustration for what is going to be sent in for publishing.

Automated Singulation of Whole Fish at Seas for Use in Weight Distribution Estimation of Catch.

Aleksander Eilertsen, Amund Skavhaug and Bendik Toldnes

Abstract: Weight distribution estimation of a catch is an important parameter by which the captain determines where to sell his catch. Within the fishing industry the price of the catch is set by the estimated sizes of fish in one load. Enabling for greater accuracy by automating the process, as well as removing the human link in the process of estimation, is wanting. Automated system with lower cost than human labor means higher revenues for the fishing vessel. In this article a novel solution to the challenge is presented along with its results. Currently the operation speed of weight estimation is 10-15 fish per minute. The new concept provides about 100 fish per minute, 10x as fast. In one catch the weight distribution estimation choose a representative amount of the fish, currently set at 1%. With the increase of speed – the amount of estimated fish can become as high as 10%, dramatically increasing the accuracy of weight distribution estimation.

Keywords: Fish singulation, fish bulk separation, weight distribution at seas.

Practical Applications: The machine system presented in this article enables automated singulation/pre-ordering of fish before automatically weight estimated. This system functions as the in-feeder to the weight estimation system. Automating the process of weight distribution estimation of catch at seas removes the allocation of labor, thus increasing profits as well as EHS. Such an automated system will increase the speed of the process allowing for higher percentage of the catch to be estimated – increasing accuracy of the weight distribution estimation.

At SINTEF Fisheries and Aquaculture a research project concerning weight distribution estimation onboard trawling vessels are conducted. In connection with this research project a master student, Aleksander Eilertsen, at the department of Engineering Cybernetics, NTNU, was challenged with the task of studying the process of singulation of fish; a sub-process in the weight distribution estimation system.

During the master thesis a study on the current operations onboard the vessels were made, along with a study into the singulation systems that exist with in the fishing industry and other industries. After some discussion on each of the systems and their pros and cons that choices was made to try a new a novel innovation in regards to fish singulation. The idea and concept was made by Aleksander Eilertsen, with input from his supervisors at both NTNU and SINTEF Fisheries and Aquaculture.

The article starts with an introduction to the challenge that was presented in the master thesis. It moves onto the economical impact automation could bring to the fishing vessels, and ends of with the results from the prototype that was built during the master thesis.

Authors are with NTNU - Trondheim, and SINTEF Fisheries and Aquaculture AS – Trondheim. Project conducted by Master Student, Aleksander Eilertsen, within the field of Engineering Cybernetic at NTNU. Direct inquiries to author Aleksander Eilertsen (lillienskiold@gmail.com)

Introduction

Weight distribution estimation (WeDE) of a catch is highly important for the fishing vessel to know. It is this estimation the fishing vessel negotiates their price. Within the fishing industry the price of the catch is set by the estimated sizes distribution of the fish in a catch. The price of the individual fish varies for weight class to weight class. The different fish processing plants needs different sized fish for their operations. Some weight classes are used in filleting and other classes are better to sell as whole fish. The weight distribution estimation is not just conducted by the vessel, but also on-shore at the slaughterhouses. Both these processes are currently manually conducted: In the on-shore process a representative amount of fish is selected for WeDE handling. During the WeDE process fish are manually place on weight scales, the weight is logged and the WeDE is calculated from the collective logged data. The same process and procedure is conducted onboard the vessels.

The WeDE process is time consuming. Onboard the vessels the catch is estimated while being pumped aboard. This is a process that can go on for hours: A process in dyer need of

APRIL 2012 - MASTER THESIS BY: ALEKSANDER EILERTSEN

SUPERVISOR AT NTNU: AMUND SKAVHAUG
SUPERVISOR AT SINTEF: BENDIK TOLDNES

PG. 1 OF 5

automations. The cost of having one to two men working can be lower with automation. The cost of an automated system will only be small maintenance issues and the general depreciation. Replacing the manual labor with an automated system would also reallocate resources. In Graph 1 [p. 2] the economic benefits of automation are illustrated. (All numbers used in these calculations are estimations based on information from the industry and SINTEF Fisheries and Aquaculture.)

During the WeDE process onboard fishing vessels, the fish selected often get their neck broken and are classified as not sellable fish. In other words, the fish used in the calculations of the WeDE is thrown overboard after logging. This means that 1% of the entire catch is wasted. With a gentle automated handling of the fish during the WeDE process one hopes to return the representative selection back the storage tank on the vessel: And thereby reduce the amount of waster resources.

Current Operations

The current operations for WeDE processing is said earlier manually conducted. A representative amount of the catch is selected for WeDE processing. The Selection is conducted will the fish is pumped aboard. Batches of fish are sent to an output area where a fisherman collects the fish in baskets. The baskets contain about 25 fish when filled. The fisherman collects to baskets before he returns to the weight distribution estimation post. At this post the fisherman picks up one fish at the time.

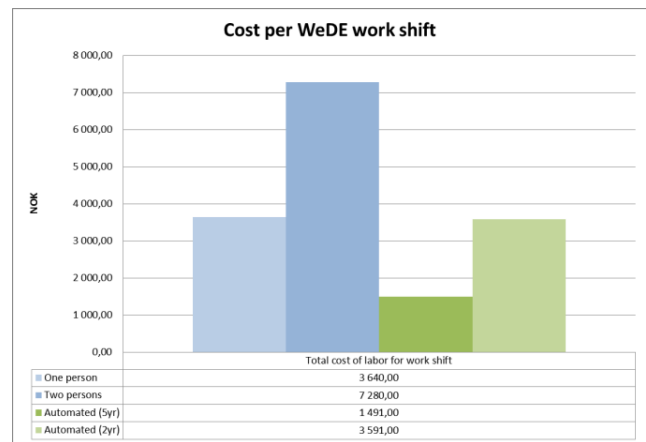

Graph 1: Cost of automation versus manual labor per work shift. By one work shift we mean one pulled catch.

Usually breaks its neck in order to keep it still while on the weighing scale. When the fish is placed on the scale it takes about 4-5 seconds before the scale stabilizes. When the scale is stable and the fish is logged, it is pick up by the fisherman and thrown overboard as waste.

It Table 1 [p. 2] the parameters for the current operation as well as for the automated operation is listed. These parameters are used to evaluate whether or not an automated system can be installed.

Demands	State-of-affairs	Goals for automation
Placement on the vessel	Has it owns room/area	Same place as currently used
Size of area	2x2x2 meters in area	
Labor	1-2 people during the whole process of pulling the catch	Captain starts and stops the system
Handling of fish	The neck is broken and the fish is thrown overboard afterwards	The fish is gently handled, and can be lead back to the storage containers.
Capacity of system	10-15 fish per minute per person	In excess of 60 fish per minute
Fish species	Pelagic fish: Herring, Mackerel, Capelin, and blue whiting	
Fish sizes	All fish can be handle but only the wanted fish species are processed	Only fish smaller than 50 centimeter is allowed into the system. (This is virtually all pelagic fish.)
Input	The fish is dispensed from an outlet from the pump from the nets	Attached to the same system, transferred all the way to the singulation process.

Table 1: The demands for the automated process. Lists the current state-of-affairs along with the goals set for the automation process. The goals are set in collaboration with MMC Tendons.

Wanted operation

The wanted operation for this process is to replace the human-link. Connecting the batch delivery system to an automated WeDE process.

The fish gets pumped all the way over to the estimation area. The batch input is attached to a fish separation mechanism called the singulator. In the singulator the fish gets from an input of 25 fish in a basket to 25 fish on a filled line. From the singulator a weight estimation process accrues, for example vision weight estimation. The fish then moves from the weight estimation into a system leading the fish back to the storage tanks.

In the master thesis connected to this article the singulation operation was the focus. The weight estimation system was SINTEF Fisheries and Aquacultures part, while the input and the output to and from the estimation area were handled by a sub-contractor.

Singulation of Fish

Singulation of objects are not necessarily an easy task. Humans have an extraordinary ability to operate with pick-and-placement. Developing robots reproducing the human motion and decision-making is extremely difficult. Often is human mimicking *not* the chosen method of operation. For humans to accept an automated way of life, it is easier to “communicate” and accept automations that look like, or are similar to humans. Even though the human body is able to adapt to all most any situation, does this not mean that the human body is the optimal solution of every specific task. When working with slippery fish, in motion prone environment pick-and-place robotics is not the most ideal operation tool. A more mechanical operating system, a set of slide-shafts and conveyor, could prove more efficient.

In this article a novel solution to fish singulation is

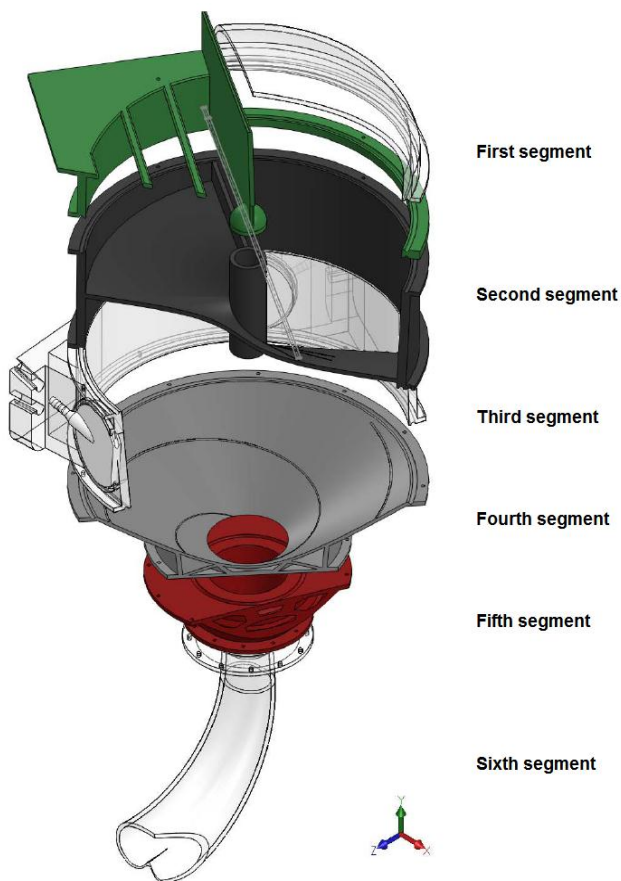

Figure 1: The CAD-model made in SolidWorks. The model was built so that segments could easily be interchange with others, so that the parts of the system could be saved for future experiments. The separate parts are listed her as segments.



Figure 2: Picture of the realization of the conceptual idea.

presented. The solution is in need of control regulation. But not in the same way as more complex robots need.

Conceptual Idea

By look at the behavior of vortexes, a singulation idea conformed. The idea is to construct a whirlpool in which the fish enter. It was discovered that with minor manipulation objects would that separated if placed in the vortex, and only one object was able to escape at the time.

Function of Concept

The idea pitched by Aleksander Eilertsen was first pulled into doubt – questioning whether or not it would work. In order to not wasting time and effort on designing and realizing a concept that *would not work* a simple prior arts model was constructed. The prior art proof-of-concept was successful, and lead to the creation of a prototype proving the concept.

The concept worked with small dummy fish and a metal lampshade. The objects entered the whirlpool and got separated and spread out along the surface of the whirlpool. Upon exiting the system the objects had to be manipulated so that they did not jam the system by trying to exit two and two. The solution to this challenge was to mimic a simple human action. When a system jams, the natural action it to gab in en remove the jam for the system. A stirring rod where there for

put in place. The stirring rod was made to follow the outskirts of the exiting hole – ensuring a certain amount of helter-skelter. The chaos created by the stirring rod was enough to hinder the fish form jamming.

Realization of Concept

Having proof-of-concept, it was decide to create a bigger and more advanced prototype. The prototype would be design to accommodate fish fry from 4-15 centimeters of length. The prototype was design using SolidWorks. SolidWorks was a great platform to utilize when looking at the possibility of designs. The three-dimension virtualization of the concept made it easier to understand and grasp. Along with SolidWorks follow a flow simulation program. This enabled for simulation of the whirlpool before realizing the concept. The simulations helped in the pursuit of shape. The design was made so that it was easy to change the separate parts if they were found not to be optimized.

The conceptual solution to the challenge of fish singulation was constructed in segments. Some of the parts were built at the IME-faculty's Workshop at NTNU, other parts were ordered for a 3D-printing company. Figure 1 [p. 3] illustrates the CAD-model made in SolidWorks, while in Figure 2 [p. 3] the realized conceptual model is portrayed.

Illustration of Average consumption time/per					
10mL/s					
	2	1,5	1	0,5	
# of fish/batch	Input speed: 2 batch/sec	Input speed: 1,5 batch/sec	Input speed: 1 batch/sec	Input speed: 0,5 batch/sec	
1	0,37	0,39	0,48	0,51	
2	0,36	0,38	0,51	0,50	
3	0,35	0,38	0,48	0,49	
15mL/s					
	2	1,5	1	0,5	
# of fish/batch	Input speed: 2 batch/sec	Input speed: 1,5 batch/sec	Input speed: 1 batch/sec	Input speed: 0,5 batch/sec	
1	0,34	0,36	0,35	0,41	
2	0,37	0,47	0,49	0,41	
3	0,35	0,40	0,48	0,40	
20mL/s					
	2	1,5	1	0,5	
# of fish/batch	Input speed: 2 batch/sec	Input speed: 1,5 batch/sec	Input speed: 1 batch/sec	Input speed: 0,5 batch/sec	
1	0,38	0,39	0,56	0,61	
2	0,36	0,38	0,53	0,53	
3	0,39	0,38	0,51	0,49	
Illustration of fish/sec singulised					
Flow input 20mL/s					
	2	1,5	1	0,5	
# of fish/batch	Input speed: 2 batch/sec	Input speed: 1,5 batch/sec	Input speed: 1 batch/sec	Input speed: 0,5 batch/sec	
9	2,70	2,56	2,1	1,98	
15	2,81	2,61	1,98	2,01	
22	2,82	2,62	2,07	2,05	
Flow input 25mL/s					
	2	1,5	1	0,5	
# of fish/batch	Input speed: 2 batch/sec	Input speed: 1,5 batch/sec	Input speed: 1 batch/sec	Input speed: 0,5 batch/sec	
9	2,91	2,81	2,87	2,43	
15	2,71	2,12	2,05	2,41	
22	2,85	2,51	2,08	2,51	
Flow input 30mL/s					
	2	1,5	1	0,5	
# of fish/batch	Input speed: 2 batch/sec	Input speed: 1,5 batch/sec	Input speed: 1 batch/sec	Input speed: 0,5 batch/sec	
9	2,62	2,56	1,78	1,65	
15	2,74	2,61	1,87	1,87	
22	2,58	2,62	1,98	2,04	

Table 2: These are the results from the experiments conducted with fish fry on the realized conceptual solution.

Setup for the experiments

The setup used for the experiments was fairly simple. A conveyor belt with adjustable speed where placed at the entrance of the realized model. A gardening hose with a butterfly valve was attached to the water faucet and to the water injection unit. A hand-held drill drove the stirring rod. A camera were placed above the system documenting the vortex and the movement of the fish, and a camera was place to the side of the system ensuring that the input speed and the output speed were documented. The camera filming form the side was also used to verifying that the fish was in fact singulated.

In the experiments there was used 22 fish fry. They were placed on the conveyor and the area they were places on was constant. The fish were used as a batch input bulked together on a 60x15 centimeter area.

Results & Discussion

In Table 2 [p. 4] the documented results from experiments are shown. As can be read, was the speed of the singulation approximately two fish per second. Two fish per second could provide an overall speed of 120 fish per minute: A 10 fold of the current operational speed. Graph 2 [p. 5] is a graphical illustration of the numbers given in Table 2.

Discussion

The results from the experiments suggest that the idea of singulating fish by using the phenomena of whirlpool can work. The experiments on the singulator concept should be more advanced, and the group of fish used in the experiments should be bigger. However, the concept has proven to work.

During the experiments the exact amount of water filling the system along with a controller for the input should be used. The experiments should also have an automated stirring rod.

It was also found that most fish should be used in the experiments, as the system currently design did not experience any extreme difficulties with handling the amount of input.

Conclusion

It is hard to give a conclusive answer to the exact operation speeds possible with the concept design during this master thesis. However, the concept has proven to work; and the preliminary results for the prototype is astonishing. Even if only half the speed of the suggested operating rate is achieved the singulator will improve on the current state-of-affairs by quintupling the speed.

The speed want from the industry is set at 30-60 fish per minute. With this speed the industry reckon that at these speeds the manual operation of the WeDE process will benefit

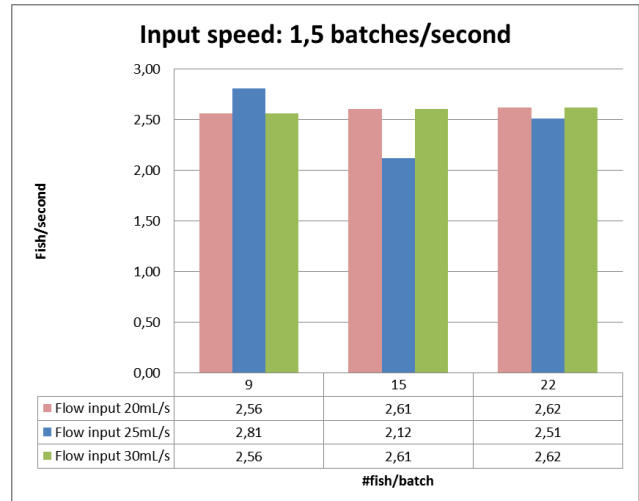

Graph 2: Illustration of the results given in Table 2 [p. 4].

from the automation. If the suggested speed of concept were halved the concept would still lie in the top layer of the wanted speeds.

The conclusion in this master thesis must be that: The prototype has proven that singulation of fish by utilizing the phenomena of whirlpool is possible, and that the singulation speed should reach an access of 120 fish per minute. Singulation of fish at sea is one step closer to a solution.

Acknowledgements

In during this master thesis the help from the supervisors have been of great importance. It is also important to acknowledge the help provide by the Workshop employees at NTNU, Terje Haugen and Per-Inge Snildal. I, Aleksander Eilertsen, would also like to thank all my friends and family that have supported me; and finally of course Hilde Ekrem for her love and support.

END OF PAPER