



Norwegian University of  
Science and Technology

# Ground Source Heat Pump in District Heating and Cooling System in Elverum

Grunnvannsbasert varmepumpe for  
fjernvarme og kjøling i Elverum

**Gian Maria Stradiotto**

Sustainable Energy

Submission date: January 2016

Supervisor: Trygve Magne Eikevik, EPT

Co-supervisor: Anna Stoppato, Università degli Studi di Padova

Norwegian University of Science and Technology  
Department of Energy and Process Engineering



EPT-M-2015-136

**MASTER THESIS**

for

Student Gian Maria Stradiotto

Fall 2015

Ground Source Heat Pump in District Heating and Cooling System in Elverum

*Grunnvannsbasert varmepumpe for fjernvarme og -kjøling i Elverum***Background and objective**

Groundwater is a renewable, but underutilized resource for heating and cooling in many populated areas. Limited expertise and inadequate mapping are among the major causes. Elverum has large groundwater resources, but the potential for using this technology with the use of groundwater source heat pumps is much higher than the present utilization. More challenges of technical, geological, organizational and legal nature have to be solved to ensure comprehensive and sustainable use.

The established plants in other municipalities has very good profitability compared with other energy sources. Value creation potential lies in further developing, by exploiting the resources and optimize already established solutions, and to develop alternative solutions and new business models for the delivery of heating and cooling. This can be as base load in the district heating or local heating and cooling systems. Increased expertise by sharing experience ensures the best ideas are disseminated and utilized and prevents that the same mistakes are repeated in new plants. The geological conditions must detail investigated and wells must be located, designed and operated so that undesirable operational problems avoided.

**The following tasks are to be consider:**

1. Literature review of ground source heat pump
2. Evaluate different working fluids for applications for ground based heat pumps for different heating and cooling applications
3. Develop a simulation model using EES for ground source heat pump application
4. Optimize the system for the Elverum case; ground water temperature, climate and temperature in the distribution system for heating and cooling, including system for tap water heating. More specific, the new district in Elverum called Ydalir with blocks, dwellings and a school should be considered.
5. Make a draft scientific paper of the results from the project
6. Make suggestion for further work

Within 14 days of receiving the written text on the master thesis, the candidate shall submit a research plan for his project to the department.

When the thesis is evaluated, emphasis is put on processing of the results, and that they are presented in tabular and/or graphic form in a clear manner, and that they are analyzed carefully.

The thesis should be formulated as a research report with summary both in English and Norwegian, conclusion, literature references, table of contents etc. During the preparation of the text, the candidate should make an effort to produce a well-structured and easily readable report. In order to ease the evaluation of the thesis, it is important that the cross-references are correct. In the making of the report, strong emphasis should be placed on both a thorough discussion of the results and an orderly presentation.

The candidate is requested to initiate and keep close contact with his/her academic supervisor(s) throughout the working period. The candidate must follow the rules and regulations of NTNU as well as passive directions given by the Department of Energy and Process Engineering.

Risk assessment of the candidate's work shall be carried out according to the department's procedures. The risk assessment must be documented and included as part of the final report. Events related to the candidate's work adversely affecting the health, safety or security, must be documented and included as part of the final report. If the documentation on risk assessment represents a large number of pages, the full version is to be submitted electronically to the supervisor and an excerpt is included in the report.

Pursuant to "Regulations concerning the supplementary provisions to the technology study program/Master of Science" at NTNU §20, the Department reserves the permission to utilize all the results and data for teaching and research purposes as well as in future publications.

The final report is to be submitted digitally in DAIM. An executive summary of the thesis including title, student's name, supervisor's name, year, department name, and NTNU's logo and name, shall be submitted to the department as a separate pdf file. Based on an agreement with the supervisor, the final report and other material and documents may be given to the supervisor in digital format.

- Work to be done in lab (Water power lab, Fluids engineering lab, Thermal engineering lab)  
 Field work

Department of Energy and Process Engineering, 14. January 2014

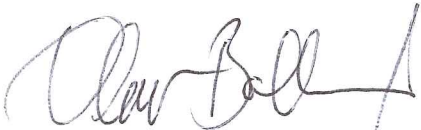

---

Prof. Olav Bolland  
Department Head



---

Prof Trygve M. Eikevik  
Academic Supervisor  
e-mail: Trygve.m.eikevik@ntnu.no

Research Advisor:  
Dr. Randi Kalskin Ramstad  
PhD Ignat Tolstorebrov

e-mails  
[randi.kalskin.ramstad@ntnu.no](mailto:randi.kalskin.ramstad@ntnu.no)  
[Ignat.tolstorebrov@ntnu.no](mailto:Ignat.tolstorebrov@ntnu.no)

**The following tasks are to be consider:**

1. Literature review of ground source heat pump
2. Evaluate different working fluids for applications for ground based heat pumps for different heating and cooling applications
3. Design and optimize the system for the Elverum case; ground water temperature, climate and temperature in the distribution system for heating and cooling, including system for tap water heating. More specific, the new district in Elverum called Ydalir with blocks, dwellings, a kindergarten and a school should be considered.
4. Develop a simulation model using EES for low-temperature district heating
5. Make a draft scientific paper of the results from the project
6. Make suggestion for further work

18/11 - 2016



---

Prof Trygve M. Eikevik  
Academic Supervisor  
e-mail: Trygve.m.eikevik@ntnu.no



# MASTERKONTRAKT

## - uttak av masteroppgave

### 1. Studentens personalia

Etternavn, fornavn <b>Stradiotto, Gian Maria</b>	Fødselsdato <b>14. feb 1991</b>
E-post <b>stradiotto.gm@hotmail.com</b>	Telefon <b>+393450364175</b>

### 2. Studieopplysninger

Fakultet <b>Fakultet for ingeniørvitenskap og teknologi</b>
Institutt <b>Institutt for energi- og prosessteknikk</b>
Studieprogram <b>Sustainable Energy</b>

### 3. Masteroppgave

Oppstartsdato <b>21. sep 2015</b>	Innleveringsfrist <b>14. feb 2016</b>
Oppgavens (foreløpige) tittel <b>Ground Source Heat Pump in District Heating and Cooling System in Elverum</b>	
Oppgavetekst/Problembeskrivelse 1. Literature review of ground source heat pump 2. Evaluate different working fluids for applications for ground based heat pumps for different heating and cooling applications 3. Develop a simulation model using EES for ground source heat pump application 4. Optimize the system for the Elverum case; ground water temperature, climate and temperature in the distribution system for heating and cooling, including system for tap water heating. More specific, the new district in Elverum called Ydalir with blocks, dwellings and a school should be considered. 5. Make a draft scientific paper of the results from the project 6. Make suggestion for further work	
Hovedveileder ved institutt <b>Professor Trygve Magne Eikevik</b>	Medveileder(e) ved institutt
Ekstern bedrift/institusjon <b>Università degli Studi di Padova</b>	Ekstern veileder ved bedrift/institusjon <b>Anna Stoppato</b>
Merknader <b>1 uke ekstra p.g.a jul.</b>	

#### 4. Underskrift

**Student:** Jeg erklærer herved at jeg har satt meg inn i gjeldende bestemmelser for mastergradsstudiet og at jeg oppfyller kravene for adgang til å påbegynne oppgaven, herunder eventuelle praksiskrav.

Partene er gjort kjent med avtalens vilkår, samt kapitlene i studiehåndboken om generelle regler og aktuell studieplan for masterstudiet.

30 September 2015  
.....  
Sted og dato

  
.....  
Student

  
.....  
Hovedveileder

Originalen lagres i NTNUs elektroniske arkiv. Kopi av avtalen sendes til instituttet og studenten.



## Acknowledgments

This paper was written abroad, during my Erasmus period at the Norwegian University of Science and Technology (NTNU) in Trondheim, Norway. Therefore, I'd first like to thank the people who made this possible: my supervisors and my parents.

I would like to thank my Norwegian supervisor Trygve Magne Eikevik, who offered me this thesis proposal, giving me the opportunity to confront myself with a real project, and offering support when I had doubts. I would also like to thank my supervisor at the University of Padova (Italy), Anna Stoppato, who allowed me to have this great experience.

During my stay at NTNU other people helped me by giving me advice and material. In particular I would like to thank the Project Manager Randi Kalskin Ramstad, for all the material and information related to the building site; the Associate Professor Georges Laurent, for the advices and the material related to the passive houses; Armin Hafner, Senior Research Scientist employee of SINTEF (Energy Research), for helping me with the weather simulation using Meteororm; and Ignat Tolstorebrov, Ph.D for the material related to the refrigerants.

I acknowledge Espen Aune and Harald Karlsen, employees of the "Johnson Controls" company, for having provided me the datasheets and the prices related to the Heat-packs.

I sincerely thank my family; my parents, Romeo and Luisa, and my brother Pierpaolo, for the patience to be always present during the years and giving me the best advice that they could in helping me choosing my path.

Finally, I have not forgotten all the friends and the other persons who make my life worth living and have supported me during these years. It is not possible to list all of their names here, because, starting with the precious friends of my childhood up to all the nice people that I have met in the last months, they are too many. I'll always remember the time we spent together.

Trondheim, January 2016

Gian Maria Stradiotto

## Abstract

The project presented in this master thesis work was evaluated from September 2015 - January 2016 under the supervision of Professor Trygve Magne Eikevik , Department of Energy and Process Engineering at the Norwegian University of Science and Technology, in collaboration with the Project Manager Randi Kalskin Ramstad, Department of Geology and Mineral Resources Engineering at the Norwegian University of Science and Technology.

The paper is divided into seven main chapters as follows:

Chapter 1 is a general introduction to the project.

Chapter 2 provides a quick summary of the origin of the geothermal energy with some historical data.

Chapter 3 reviews the actual state of the art regarding the Geothermal Heat Pumps, by providing a rapid overview of all the technologies (Surface Water Heat Pumps, Ground Water Heat Pumps and Ground Coupled Heat Pumps) and their possible applications.

Chapter 4 gives the reader some general data regarding the various typologies of heat exchangers that are used in these kind of applications.

Chapter 5 provides a quick overview of the legislation regarding the refrigerants and an introduction to some possible refrigerants that could be used during the heat pump cycle (according to the legislation), with some economic data related to heat pumps operated with those refrigerants.

Chapter 6 is the main chapter constituting the project itself. After a quick presentation of the main assumptions taken in this paper, the building site is analyzed using the planimetry and a system to fulfil the space heating/cooling and domestic hot water is designed (heat pumps and pipes). Afterwards the peak and simultaneous loads for each typology of building are evaluated to choose the shape of the distribution circuits; those in this paper are named "circuit A" for houses and row-houses and "circuit B" for all the other buildings. A first simple economical evaluation of the proposed heat pumps is then shown. In this chapter the needed electric heating to fulfil the peak load in each domiciles are also evaluated, after having chosen the dimension of the system, and the losses along the pipe network; in particular, adding the last ones to the chosen size of the system, the required size for the heat pump in each circuit was obtained, i.e. 131.56kW for circuit A and 726.30kW for circuit B. With these data , a simple economical evaluation was completed, using known information from the company "Johnson Controls", obtaining, with the chosen sizes and the chosen limits to the economic evaluation, a

simple payback period of 8.760 and 8.068 years respectively for circuit A and B. In the end, with data regarding some heat-packs furnished by “Johnson Controls”, a simulation of the heat pump systems was operated using EES to confirm that what was hypothesized is achievable in the reality and to see how some parameters changes with the decrease of the load. The results of the simulation show that the size of the intermediate heat exchanger between the brine and the groundwater is  $36.31\text{m}^2$  for the heat-pack of circuit A and  $102.4\text{m}^2$  for each of the two heat-pack of circuit B and that the size of the heat exchangers to produce the domestic hot water and the space heating water, in circuit B during the summer mode at full load, is  $2.853\text{m}^2$ . The mass flow rates (kg/s) of the brine and of the groundwater for the two circuits during the winter and the summer modes were also found. After this some simulations were run at a partial load only with the purpose to see how the COP varies.

Chapter 7 contains the conclusions and some suggestions for future works on the site and how the quality of the data to build the system could be improved.

After the list of the sources used to write this paper, the reader will find the appendix, containing some useful information discussed during the work.

## Abbreviations

Here is a list of the most commonly used abbreviations in this paper:

DHW Domestic Hot Water

SH Space Heating

HEX Heat Exchanger

GSHP Ground Source Heat Pump

SWHP SurfaceWater Heat Pump

GWHP GroundWater Heat Pump

GCHP Ground Coupled Heat Pump

DHSU District Heating Storage Unit (water tank)

IHEU Instantaneous Heat Exchange Unit

DH District Heating

COP Coefficient of performance

HVAC Heating and Ventilation Air Conditioning (system)

ASHRAE American Society of Heating, Refrigerating, and Air-Conditioning Engineers

If other abbreviations or symbols are used within the chapters, they will be introduced and explained there.

# Summary

Acknowledgments.....	1
Abstract .....	2
Abbreviations.....	4
1. Introduction .....	7
1.1 The site.....	7
2. Geothermal Energy .....	8
2.1 Historical background .....	11
3. State of the art.....	12
3.1 Surface-Water Heat Pumps (SWHP).....	12
3.2 Ground Coupled Heat Pumps (GCHP).....	14
3.3 GroundWater Heat Pumps (GWHP) .....	18
4. Heat Exchangers .....	21
5. Refrigerants .....	22
5.1 Ammonia-R717 (NH <sub>3</sub> ).....	24
5.2 Carbon Dioxide-R744 (CO <sub>2</sub> ).....	25
5.3 Propane-R290 (C <sub>3</sub> H <sub>8</sub> ) .....	26
5.4 Isobutane-R600a (C <sub>4</sub> H <sub>10</sub> ).....	26
5.5 Economics.....	27
6. The project .....	28
6.1 Guidelines and assumptions .....	28
6.2 Buildings .....	31
6.2.1 Heating terminals.....	31
6.3 System design .....	32
6.3.1 Main system.....	34
6.3.2 Secondary system .....	36
6.3.3 Pipe Distribution Network .....	39
6.4 Thermal load .....	41
6.4.1 Thermal Load Evaluation.....	43
6.4.2 Simultaneous factor.....	45
6.4.3 Peak Power.....	48
6.4.3.1 DHSUs .....	53
6.4.4 Reach the peak load .....	53
6.4.5 Pipes losses.....	54
6.4.6 Final estimation .....	61
6.5 Heat pumps modelling.....	62

6.5.1 Winter mode .....	64
6.5.2 Summer mode.....	67
6.5.3 Final Considerations.....	70
7 Conclusions and suggestions.....	71
References.....	74
Appendix .....	78
A. 3D draw of Ydalir in Elverum .....	78
B. Low temperature legionella treatment from [Annex X, Dalla Rosa et al., 2014] .....	79
C. From the rapid installation guide of Uponor.....	80
C.1 Pipe sizing and pressure drop.....	80
C.2 Heat loss coefficients .....	82
C.3 Prices.....	84
D. Heat-packs from Johnson Controls proposal .....	85
E. Calculations related to the compressors .....	87
E.1 Isoentropic and volumetric efficiency curves.....	87
E.2 Shaft Power at partial load .....	90

# 1. Introduction

In this paper the possibility to exploit the underground aquifer in the new district Elverum called Ydalir, in Norway, using ground water heat pumps, will be evaluated.

After giving a general overview about the various typology of geothermal heat pumps and about the geothermal energy itself, the usage of some different refrigerants will be evaluated and then the real evaluation of the project will be start.

## 1.1 The site

Elverum is a town and a municipality in the Hedmark country within Norway, that is located north of Oslo near the boundary with Sweden. It has a great historical background but it became the topic of this paper because of its large amount of underground water and surface rivers; indeed, for these reasons it was decided to use a groundwater heat pump system to cover the thermal load of the buildings. Doing a rapid estimation the surface of the whole building site has an extension of about 380000m<sup>2</sup>.



Figure 1. Geographical location [Wikipedia, 2015; Google Maps, 2015].

## 2. Geothermal Energy

Geothermal energy is the energy derived from the heat flux from the earth's deep interior, that actually is caused by the decay of long-lived radioactive isotopes of uranium, thorium and potassium, and from an uncertain portion of energy of the planetary creation [Dickson et al., 2004]. Furthermore for the European Union: ' geothermal energy ' means energy stored in the form of heat beneath the surface of solid earth [Banks, 2012]. The radioactive isotopes are mostly located in the surface crust and in the mantle, and it is also demonstrated that the mantle has cooled down only of 300-350 degrees in three billion years (now it stays around 4000 °C at its base) [Dickson, 2004], but unfortunately only a small fraction of this stored energy is usable for human purposes. However, with an average estimation of 0.06 W/m<sup>2</sup> of heat flux on the surface crust we can see that it is enough to fulfill 1,84 times the world energy demand of 2013 (12500 Mtoe), so the geothermal energy it must be taken in consideration for future development of industrial and residential energy plants.

The geothermal energy stored inside our planet could be exploited to directly produce electric energy or could be used to heat another working fluid in a power cycle (almost all the applications) [Dickson et al., 2004]. The method used depends on the temperature of the underground and on the presence, or not, of a water reserve in the underground. If the temperature is high enough the water will become steam and it can be used directly in a Rankine cycle. If its chemical properties are not suited for the cycle it can be used to heat another working fluid for a low-temperature Rankine cycle, like an ORC [Manente et al., 2015]. Depending on the size of the water reserve a reinjection of the underground water can be taken in consideration in the soil, paying attention at the return temperature to avoid the precipitation of some salts and avoid corrosion problems. Sometimes there is a large amount of heat that is stored in underground rocks but there isn't a water reserve, so the Hot Dry Rocks technology was developed, that, due to an hydraulic fracturing of the rocks, creates a water reserve at high temperature which can be exploited to produce electricity with the same pipes used for the fracturing (so it's very similar to close-loop cycle) [Wei et al., 2015].



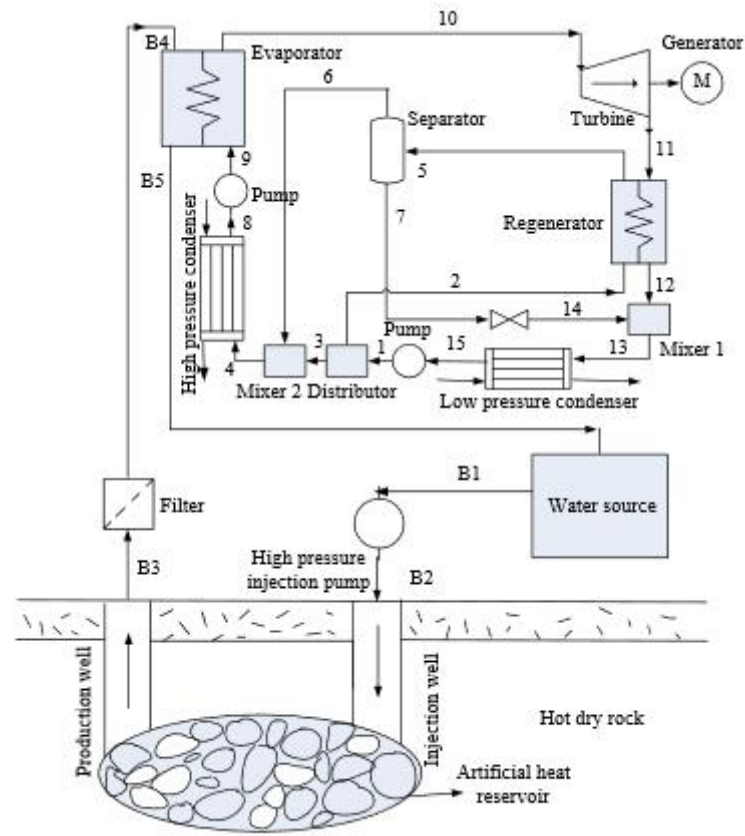

Figure 2. Sketch of a hot dry rock power generation system based on Kalina cycle [Wei et al., 2015].

Beyond these applications, if the temperature of the underground is not so high, and it's not possible to use the geothermal energy for a power cycle, it could be extracted from the underground using a Ground Source Heat Pump. It could also be injected, depending on whether the heat pump is working in heating or cooling mode. Moreover United States EPA (Environmental Protection Agency) has identified the GSHPs, especially the GCHP, as the most energy-efficient and environmentally friendly heating/cooling technology [Atam et al., 2015]. Indeed, when compared to their competitor air-source heat pumps (ASHPs), they have a better and stable efficiency due to their relatively higher-lower, respectively in winter and in summer, and stable ground temperature compared to the ambient air temperature [Atam et al. 2015; Granryd et al., 2011]. The GCHP could be used not only in residential air-conditioning systems but also to heat greenhouses and facilities for aquacultures [Dickson et al., 2004].

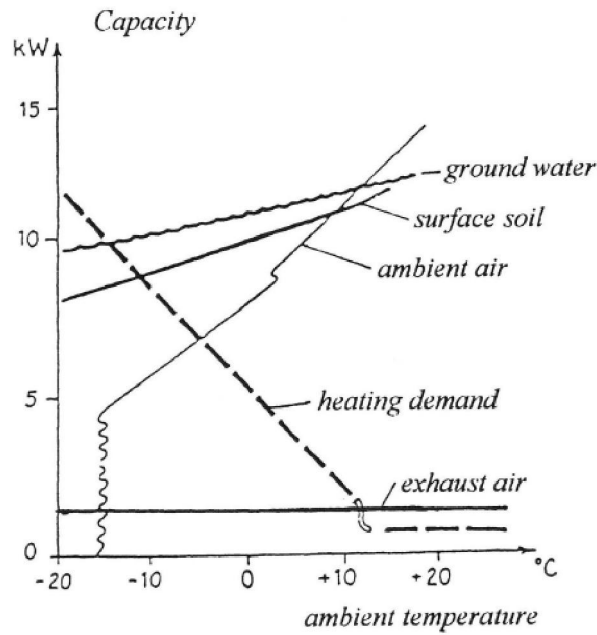

Figure 3. Capacity characteristics of heat pumps with different heat sources [Granryd et al., 2011].

Geothermal energy is very useful due to other several reasons: it is a clean energy, meaning it produces almost no pollution; it is sustainable; and can be used directly by extracting from hot springs and hot dry rocks, after the fracturing, for example. If well projected it also doesn't suffer from the intermittency issue as solar and wind energy do, and it reduces the dependency on foreign fuel markets for some energy-dependent countries (like European countries) [Atam et al, 2015].

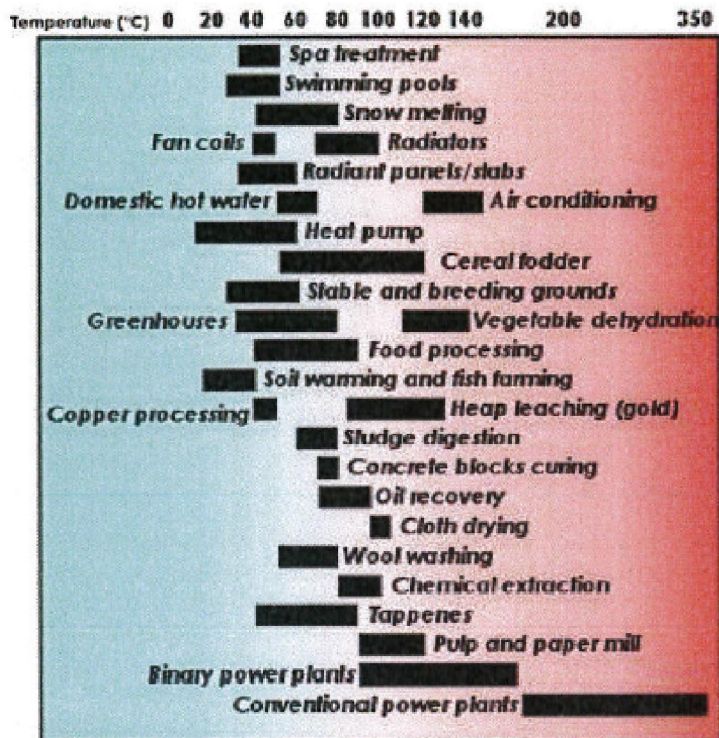

Figure 4. Utilization of geothermal fluids [Dickson et al, 2004]

## 2.1 Historical background

The first recorded use of geothermal energy for human purposes was in 1827 in Larderello (Italy), where hot steam was used to assist in extracting boric acid from the boric hot waters emerging naturally or from special drilled boreholes and after a short period of time the geothermal hydropower was used to obtain mechanical work, before hot spring waters were used only for bathing or to extract some dissolved salts. In 1904 for the first time the generation of electricity was obtained and after, in 1911, the first power plant was built, the sole electricity generation plant in the world until 1958. In 1892 the first geothermal district heating system was built in Idaho (USA) and in 1928 in Iceland the exploitation of geothermal fluids (hot water), for domestic heating purposes, began. After 1958 (New Zealand), more and more plants were built for both power generation and heating systems [Dickson et al., 2004; Banks, 2012; Wund et al., 2015].

	Capacity, MWt				
	2015	2010	2005	2000	1995
Geothermal Heat Pumps	49,898	33,134	15,384	5,275	1,854
Space Heating	7,556	5,394	4,366	3,263	2,579
Greenhouse Heating	1,830	1,544	1,404	1,246	1,085
Aquaculture Pond Heating	695	653	616	605	1,097
Agricultural Drying	161	125	157	74	67
Industrial Uses	610	533	484	474	544
Bathing and Swimming	9,140	6,700	5,401	3,957	1,085
Cooling / Snow Melting	360	368	371	114	115
Others	79	42	86	137	238
<b>Total</b>	<b>70,329</b>	<b>48,493</b>	<b>28,269</b>	<b>15,145</b>	<b>8,664</b>

Table 1. Summary of the various categories of low-temperature worldwide for the period 1995-2015 [Wund et al., 2015].

### 3. State of the art

There are three types of technologies that can be used to exploit the geothermal energy in heat pump systems: surface water heat pumps, ground-coupled heat pumps and ground water heat pumps. In this paper a brief introduction of the first two categories will be given, with some useful sources to go deeper into the arguments. I will spend more time discussing the third, which is the topic of this work.

Besides, before presenting them it has to be said that the first step to do is to make a depth research about the geology of the site, or at least, if it is a very small residential plant, is important to know if in the area there is underground water and of which kind of material the subsoil is composed. Only knowing this data it is possible to estimate the right size, or the maximum size, of the plant and decide if the project is achievable and how to proceed with it [Dickson et al., 2004; Banks, 2012; Kavanaugh et al., 2014]. Is really important to examine the local legislation regarding all the aspects of the plant: typology, limitations in power, limitations in size, ... [Kavanaugh et al., 2014]. Finally, it is very important to know the amount of the heating and cooling loads of the site, because only after knowing the heating/cooling demand is it possible to choose the most appropriate HVAC system for the owner, regarding both investment costs and maintenance costs [Kavanaugh et al., 2014].

#### 3.1 Surface-Water Heat Pumps (SWHP)

Surface-water heat pumps can be either close-loop system or open loop-systems. The first ones consist of water-to-air or water-to-water heat pumps located in a building and connected to a network of pipes placed in a river or in a lake; furthermore a pump circulates a brine trough the heat pump's water-to-refrigerant coils and the submerged loop of pipes (the recommended piping material is HDPE with ultraviolet protection) [Kavanaugh et al., 2014]. Larger-diameter (thicker-wall) tubing is recommended for areas in which damage from boats is a possibility. Closed-loop has some advantages, for example: a relatively low-cost, low pumping energy requirements, high reliability, low maintenance requirements and low operating costs; the disadvantages are the possibility of coil damage in public lakes and wide temperature variations with outdoor conditions if the lake is small or shallow (efficiency variations) [Kavanaugh et al., 2014].

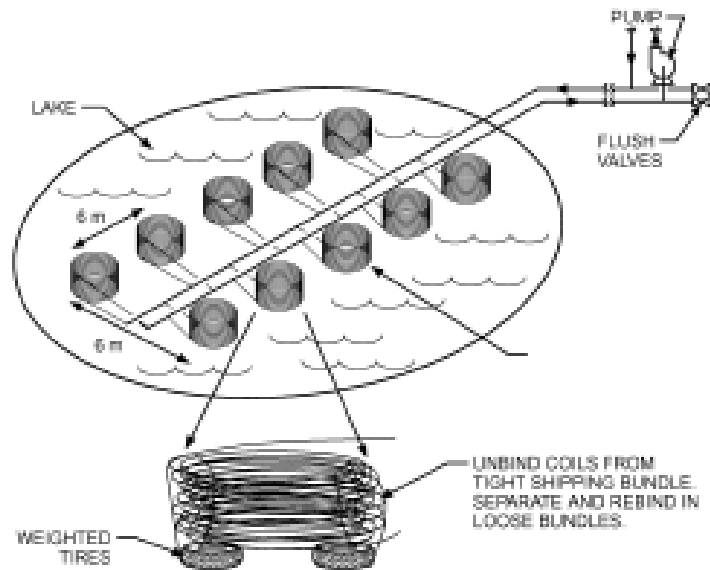

Figure 5. Configuration for a closed-loop application [ASHRAE Handbook 2011, HVAC Applications].

Open-loop SWHPs can use surface water bodies similarly to cooling towers, without the need for fan energy or frequent maintenance. Surface water can be pumped directly to water-to-air or water-to-water heat pumps or through an intermediate heat exchanger that is connected with a close loop to the units (this second solution is mostly adopted). If the lake is deep enough it is possible to profit by the thermal stratification and pumping the cold water from the bottom trough heat exchangers in the return air duct it can be obtained a total cooling effect, if the water is 10°C or less [Kavanaugh et al., 2014]; otherwise only a precooling can be obtained.

There are three categories of pump:

- above surface: must have low net positive suction head requirements, and precautions to ensure that water remains in the pump during the off cycles must be taken;
- vertical pumps with submerged impellers: connected to above-surface motors
- submersible pumps: single-stage can be used if the building is located near the lake, multistage units are used to provide waters for greater elevations and distances.

In warm climates lakes can also be used as heat source during the winter heating mode [Kavanaugh et al., 2014].

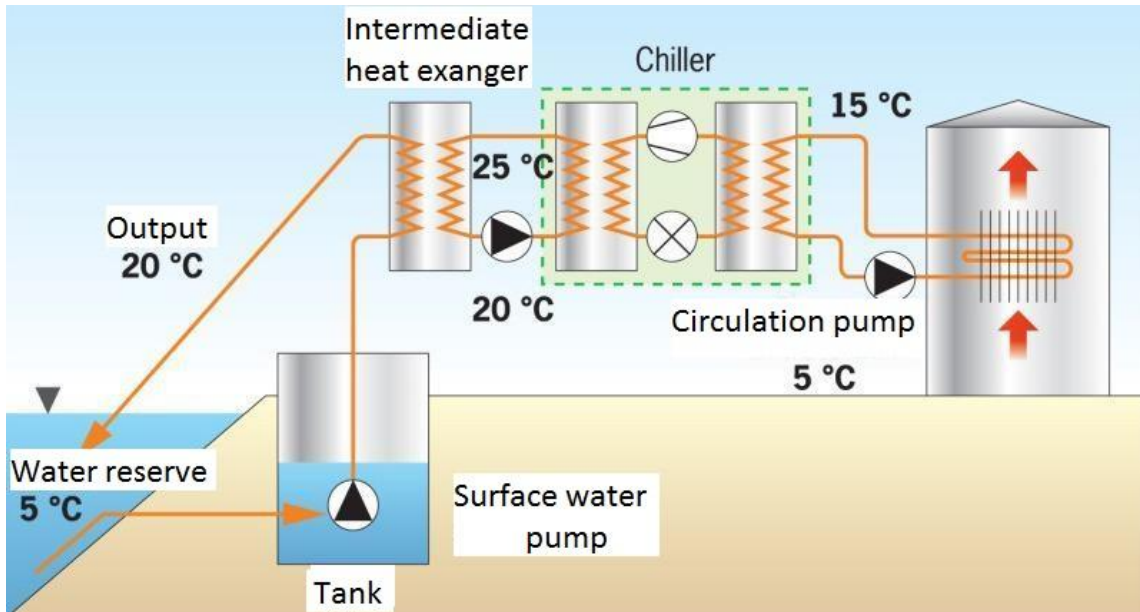

Figure 6. Example of open-loop SWHP [edilizianews.it, 24].

### 3.2 Ground Coupled Heat Pumps (GCHP)

This typology of heat pump takes advantage of the fact that the temperature of the ground, after 1 meter deep into the ground, isn't affected by the temperature difference between days and night, moreover after 10 meters deep into the ground it isn't affected by the seasonal variation of temperature and it's close to the yearly average temperature of the air in that location.

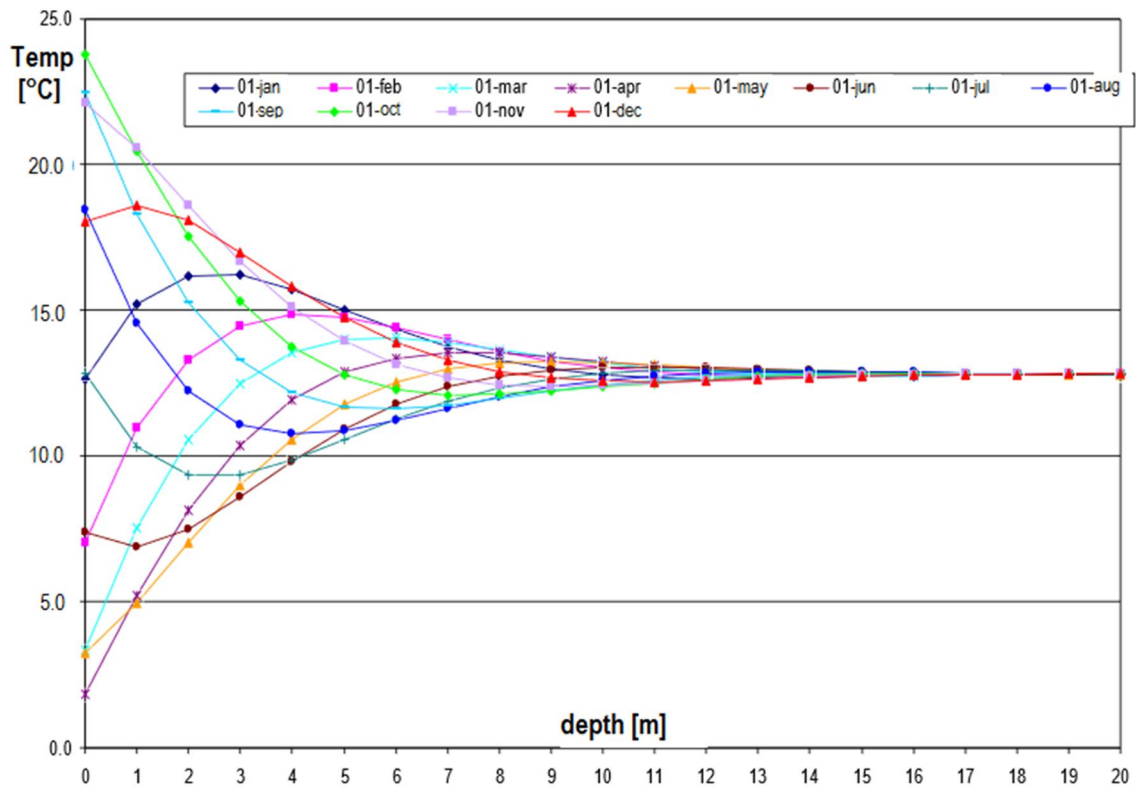

Figure 7. Monthly fluctuations in temperature at different depths underground in the location of Asolo, Italy. Every curve is referred to a month starting from January to December [Chinellato, 2013].

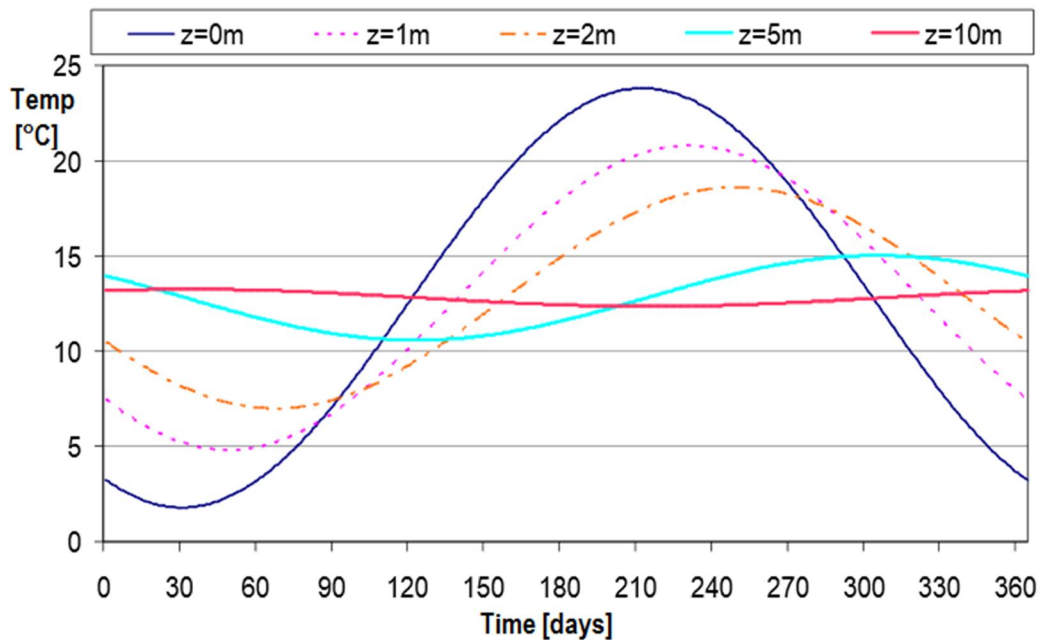

Figure 8. Temperature curves at different depths underground (z) during the year in the location of Asolo, Italy [Chinellato, 2013].

Often in literature people refers to them as closed-loop ground-source heat pumps, this is because the acronym GCHP refers to a system composed by a network of heat pumps that are linked to a closed ground heat exchanger buried in the soil. Furthermore GCHPs are subdivided according to the ground heat exchanger design [Kavanaugh et al., 2014].

The ground heat exchanger could be divided in two main categories: horizontal and vertical.

The first type is called horizontal because the heat exchanger is not buried so deep into the ground, it is about a couple of meters underground, and requires a big horizontal surface [Kavanaugh et al., 2014; Banks, 2012; Atam et al., 2015]. For this category several different geometries for the pipe network exist, for example: single pipe in parallel trenches, double pipes and helix pipes; obviously, if there is more than one pipe in the same hole in the ground, it must be studied the interference between them. To do this calculation during the project it is not mandatory to study every single case, indeed ASHRAE manuals provide useful coefficients to do an estimation of the interference [Kavanaugh et al., 2014]. The ASHRAE manuals also give to the engineer some construction criteria about the depths of the pipes and the distance between them. The following picture is taken from the book of Banks D. [Banks, 2012] and gives some visual explanation.

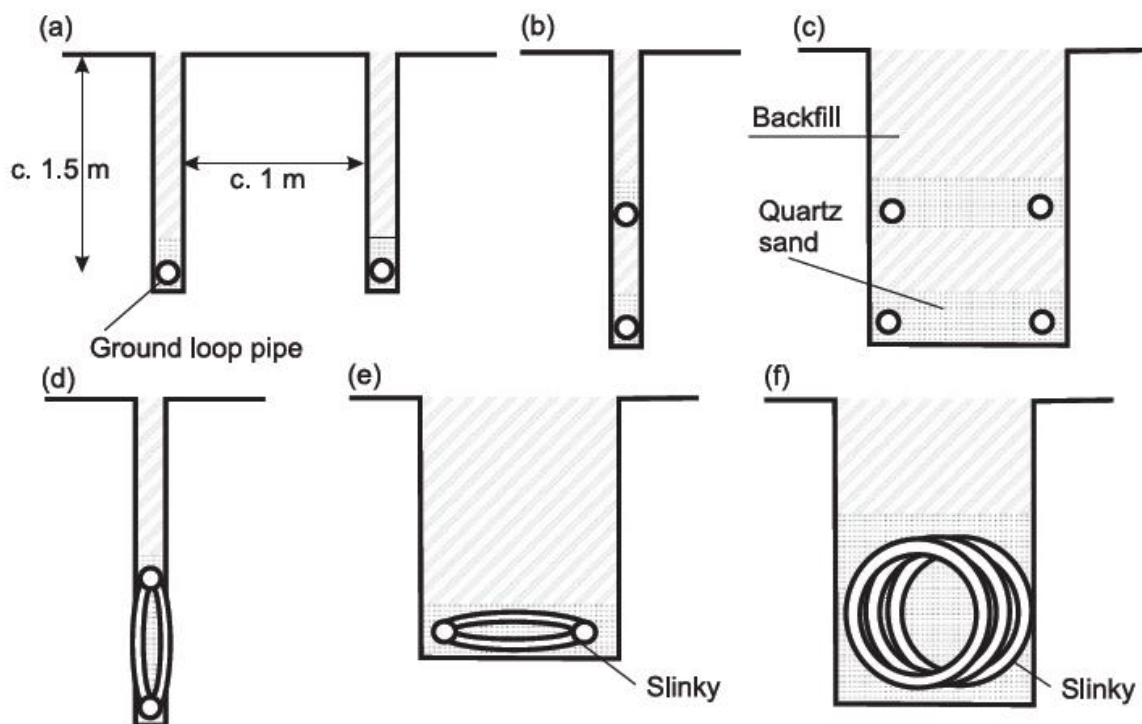

Figure 9. Examples of horizontal configuration.



Especially with this configuration a direct expansion cycle in the underground can also be used; in this case the pipe network must be of an appropriate material [Kavanaugh et al., 2014], but there aren't so many application like this. However this configuration presents some advantages like: the evaporator of the heat pump is in direct contact with the soil, so the exchange of heat between the refrigerant and the soil is done without an intermediate fluid (higher efficiency); no presence of the pump for the circulation of the secondary fluid; higher thermal conductivity of copper pipes compared to the plastic ones (and different diameters).

The second category is the vertical one, and, as suggested by the name itself, it consists in one (or more) vertical drill in which is placed the pipe network; usually it is composed by one or two U-tubes per drill or by a coaxial heat exchanger. As for the previous category some guidelines given by ASHRAE exist to estimate the needed length of the pipe (based on the cooling and heating load of the building), the coefficients of interference between one well and another and so on [Kavanaugh et al., 2014].

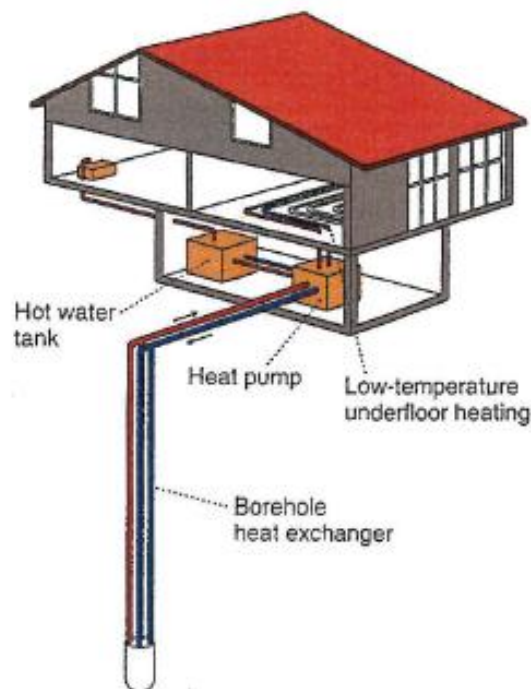

Figure 10. Example of vertical configuration [Dickson et al., 2004].

In both the applications, but especially for the vertical one, it is very important to know the physical composition and the properties of the underground to be able to estimate all the coefficients, those are used in the successive calculations. They can be estimated in the first sight using the ASHRAE manuals (and having a basic knowledge of the

underground of the site) but after that the first well is drilled, it can be used to know them in a more precise way [Kavanaugh et al., 2014].

If the heat pump has to work only during the heating season, a special application could be used which consist in a GCHP that utilizes CO<sub>2</sub> in the underground tubes. In particular the carbon dioxide will evaporate removing heat from the ground, it will condense on the top of the pipe giving the heat to the evaporator of the heat pump through a heat exchanger, and then it will return back down in the underground due to the gravity force; so it works like a huge gravity heat pipe [Eslami-Nejad, 2016].

The advantages of the vertical configuration are: less soil (surface) consumption; being in contact with a mean that has little variations in the seasonal temperature and in its thermo-physical properties; lower length of the pipe net, so less pumping consumption for the heat transfer fluid; higher energy efficiency. Instead, the advantages of the horizontal configuration are: lower installation cost and wider availability of technical means needed to implement it; the annual drift of the ground temperature is more limited, since that the heat exchange between the ground and the drills is small if compared with the normal heat exchange at the surface of the ground [Kavanaugh et al., 2014].

The drills can be also embedded in the foundations of the building. In this case the concrete foundations guarantee mechanical protection and a good heat contact with the soil; but it must be paid attention to the temperature of the external surface of the pipe, because if it is too low it could cause the formation of condensate in the structure.

### 3.3 GroundWater Heat Pumps (GWHP)

In the first period of its application, this typology of GSHP was responsible of some widespread water quality problems. For this reason after in the commercial sector the plate heat exchangers were used to solve this problem isolating the building loop from the exposure to groundwater. If properly designed, even if the maintenance of a GWHP is higher compared to a GCHP or closed-loop SWHP, the potential capital cost savings are higher.

Various applications can be realized. Often is used to put a water-to-water plate heat exchangers between the groundwater and the closed water loop, which is connected to the water-to-air heat pump inside the building; but, if the application is very small, it could be decided to pump the groundwater directly through the heat pumps system (evaporator) incurring in risk of corrosion and fouling of heat exchangers and valves. Another option is to circulate the groundwater through a central chiller (or heat pump)

and to heat and cool the building with a conventional chilled- and hot-water distribution system, in this case unitary designs are more efficient compared to central chiller systems.

In all the previous applications it is possible to use the cold underground water to cool or precool the outdoor air that is entering in the air conditioning system of the building; other advantages are that the water well is very compact and the use of a technology tested for decades.

There are also some disadvantages, indeed the local legislation may preclude the use or injection of groundwater, the water availability may be limited, the pumping energy may be excessive if the pump is oversized or if it hasn't a good regulation, and fouling precautions must be taken if the well is not properly developed or if the water quality is not so good [Kavanaugh et al., 2014].

With the acronym ATEs (Aquifer Thermal Energy Storage), a particular application of the GWHP systems is identified, which consists in a reversible GWHP; the main purpose of this solution is to realize a seasonal thermal storage in the aquifer itself, gaining great energetic and management benefits [Kavanaugh et al., 2014; Paksoy, 2004].

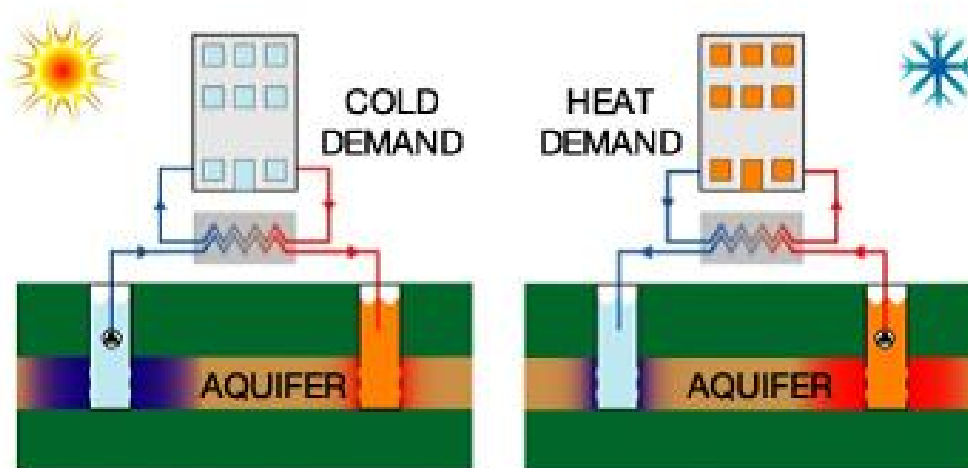

Figure 11. Example of GWHP with ATEs technology [26].

Before designing a GWHP system, besides having checked the local legislation and limitations, it is very important to study the underground. In particular, to be able to conceive a very good project, it's needed to know if the aquifers is confined, undergoing to a pressure higher than atmospheric one and this causes an increase of the piezometric level, or unconfined, the flow direction, the permeability (quantity of water that will pass through one square meter of the material in one day under a gradient of 100%), the transmissivity that is related to the thickness of the aquifer and the porosity

[Banks, 2012; Kavanaugh et al., 2014]. If there is an injection well it has to be placed down gradient, paying attention to create less thermal interferences as possible between the production and the injection wells. Furthermore well screens are used in water wells to control the entrance of sand into the well and stabilize unconsolidated formations; in unconfined aquifers the length of the screen is usually lower than  $\frac{1}{2}$  of the thickness but to select it several parameters must be considered like water entrance velocity, diameter, material,... [Kavanaugh et al., 2014].

In a closed loop system the specific capacity of the injection well varies with the working conditions. In particular under poor conditions, like low aquifer thickness, high potential for biofouling,... the specific capacity of the injection well may be 50-75% that of the production well; otherwise it will be 85-100% that of the production well if the conditions are good, i.e. sand-free injection, rock aquifer, nonscaling water chemistry,... [Kavanaugh et al., 2014; Banks, 2012].

Another GWHP application is the open-loop residential heat pump systems, whose particularity is the absence of an injection (or reinjection) well. If properly applied it can offer a huge advantage in terms of capital costs, while maintains a production performance comparable to the one of close-loop systems; the disadvantage of this configuration compared to the other is the higher maintenance cost, but it is relatively little if compared to the reduction of capital investment [Kavanaugh et al., 2014]. During the years several issues were encountered but some solutions were also found, for example: to face the low groundwater quality, and the relative maintenance costs, now plate heat exchangers designed to be disassembled and cleaned are used between the well's circuit and the one of the heat pump and all the other pipes are in nonmetallic materials; or to prevent a lowering of the aquifer water level, going against some territorial legislations, reinjection technologies were developed (this depends on the geomorphology of the site and become a close-loop); to raise the efficiency of the system the designer must find the optimum flow rate to achieve the maximum performance for the whole system, so he must search the optimum working point considering together the working-curve of the heat pump and the one of the well pump [Kavanaugh et al., 2014; Banks, 2012].

## 4. Heat Exchangers

Usually in the geothermal heat pumps applications compact heat exchangers are used, like “plate” HEX and “Shell and Plate” heat exchangers, those allow a refrigerant charge reduction. The second ones are more expensive and can resist to higher pressure and temperature, that’s why they are used in applications with high pressure (temperature) CO<sub>2</sub>.

They could be made of different materials depending on the compatibility with the working fluid and the brine that are used. Simplifying the structure they’re composed by several parallel channels in which the fluids flow in the same or in the opposite direction (depending on the chosen configuration) and each channel is confined between two plates; the surface of the plates could have several different corrugations to promote the heat exchange. The plates could be braised (or welded) together or simply putted in contact with a gasket in the middle (perimeter) and kept in contact with the pressure of some tying screws fixed between the two frontal plates; one of these is removable, so that it is easy to open the HEX to clean it if needed.

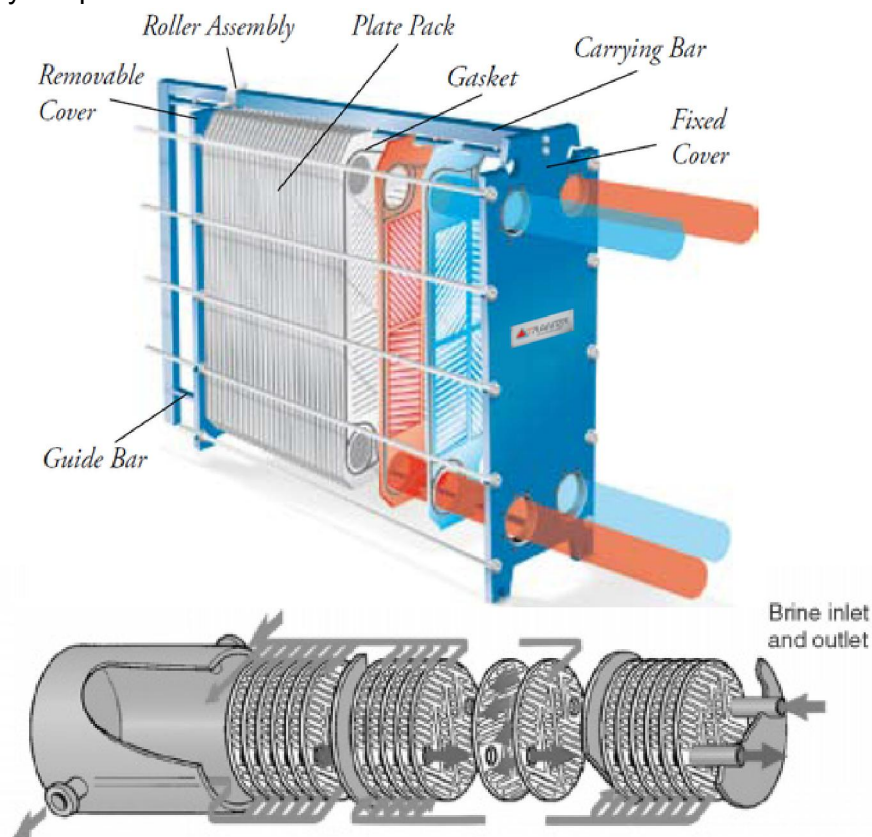

Figure 12. On the top the sketch of a plate HEX taken from the web site of “mcd plate heat exchanger gaskets Venezuela” [41]. On the bottom a sketch of a shell and plate HEX from the site “www.ref-wiki.com” [42].

The aim of this little chapter is not to explain all the the construction details and sizing procedures, but to give to the reader an overview of the possible applicable technologies before starting the design of the system.

The reader should also be informed that HEX with mini-channel are studied to obtain a further reduction of the refrigerant charge (see chapter 5.3); their application is really interesting on the condensation side, but actually they are not really used in a commercial scale.

## 5. Refrigerants

A very important design specification during the evaluation of the possible installation of a refrigeration/heat pump cycle is which kind of refrigerant will be used inside it, because, knowing the working fluid, it is possible to know the range of temperature in which the machine can work and if there are some compatibility problems between it and some construction materials.

The working fluid in a refrigeration system has to satisfy some requirements, in particular: it should not cause any risk of injuries, panic, fire or property damage in case of leakage; furthermore the chemical, physical and thermodynamic properties of the refrigerant have to be suitable for the system and the working condition (i.e. low freezing point, high thermal conductivity, satisfactory oil solubility, ...) at the lowest cost. In addition to that it must be taken in consideration, during the system design, the behavior of the working fluid, so if it is a pure fluid or a mixture, and if the mixture has an azeotropic, similar to a pure fluid, or zeotropic behavior (presence of bubble and dew temperature, so with a glide that can be seen in a temperature- composition graphic, at a fixed pressure) [5]. Unfortunately the perfect refrigerant, so the one that fulfil all the previous characteristics, was not found until now, so basically the designer has to follow some rules of the thumb to achieve a better performance in efficiency and cost-effectiveness like not have a too high pressure (excessively heavy construction) nor to low (lower COP), and it is better if it never goes below the atmospheric value, because it can cause problems due to the suction of air inside the system [Granryd et al., 2011]. But the designer in the last years has to face other problems related to the legislation, because first with the Montreal Protocol, that is focused to the reduction of the usage of substances those can damage the ozone layer of the planet, and after with the Kyoto Protocol, focused on the reduction of the emission of the substances responsible of the anthropic greenhouse effect (and so of the global warming). To be able to estimate the greenhouse effect of every substance was given to it a GWP value (Global Warming

Potential), based on 100 years of permanence in the atmosphere, taking the carbon dioxide as reference (GWP=1); after that it was estimated another index, called TEWI (Total Equivalent Warming Impact), to help the designers to find an optimum solution between using a refrigerant with low GWP and the decrease of efficiency that usually occurs (that means more energy consumption, and often the energy production is characterized by not-negligible CO<sub>2</sub> emissions). To substitute the previous working fluids new ones were developed [Cavallini et al., 2007], and this process is still going on, but according with the European legislation every year increasingly restricted emission will be allowed and the maximum admitted value of GWP will be decreased, so now are gaining round very interesting application with natural fluids due to their low GWP index, and this category will be taken in consideration in this paper.

Refrigerant	GWP	ODP
CFC-12	10,900	1
R-502	4,657	0.334
R-507A	3,985	0
R-404A	3,922	0
R-407A	2,107	0
HCFC-22	1,810	0.055
R-407C	1,774	0
HFC-134a	1,430	0
Propane (R-290)	3.3	0
CO <sub>2</sub> (R-744)	1	0
Ammonia (R-717)	0	0

Table 2. Some commercial refrigerants with GWP and ODP (Ozone Depletion Potential) values [EPA].

Refrigerant	GWP	ODP
CFC-12	10,900	1
HFC-134a	1,430	0
HFC-152a	124	0
Isobutane (R-600a)	3	0

Table 3. Some domestic refrigerants with GWP and ODP (Ozone Depletion Potential) values [EPA].

As we can see from the tables 2 and 3 the Montreal Protocol was successfully applied, and now the challenge is The Kyoto's and the European directives (as UE Regulation No 517/2014 [Mota-Babiloni, 2015]) regarding the reduction of greenhouse gas. To win this challenge new fluids were/developed, the HFOs (fluids without chlorine and carbon), but it is still not clear how they and the natural refrigerants will replace the old ones. Some authors suggest to simply replace the actual refrigerant with mixtures of them with

the new ones in the already existing systems (lowering the GWP), but this should be evaluated very carefully, because, even if a retrofit is totally viable, the consequent reduction in the performance could be not negligible, affecting the TEWI index [Devecioğlu, 2015; Mota-Babiloni, 2015]. So it is mandatory for a designer to think about using new (or natural) fluids in new built systems; keeping in mind that the natural fluids can achieve very good performance if the system is well designed.

### 5.1 Ammonia-R717 ( $\text{NH}_3$ )

Ammonia is an old refrigerant but it is still very interesting. Its normal boiling temperature is  $-33.3^\circ\text{C}$  and it has a GWP and an ODP equal to zero. It is easy to manufacture and not expensive. The main disadvantages of ammonia are its toxicity and that it forms a flammable mixture with the air, indeed it is classified as B2L by the ASHRAE hazard nomenclature system. To avoid the detonation/deflagration hazard in a built-in system there must be a ventilation system on the ceiling, because ammonia is lighter than air; besides its characteristic smell can be perceived in much lower concentration than the hazardous level. A low level exposure can cause irritation of the mucous membranes and a higher may cause coughing, vomiting and other complications. As said before another disadvantage of ammonia is that it is not compatible with copper, so it should be avoided in the system, indeed steel is often used.

Ammonia has good thermodynamic properties because its heat of vaporization is large, favoring the heat transfer.

With ammonia can be used immiscible oils that are heavier than it and they can be easily drained from the evaporator (shell-and-tube for example).

The new studied applications in the refrigeration field use ammonia in an ammonia-water absorption and hybrid absorption-compression cycle [He Mao-Gang, 2014]. The last one was founded that can supply heat to  $150^\circ\text{C}$  with a temperature lift of 60K using commercially available components, and with an economic benefit compared to gas combustion; furthermore it was demonstrated that for operating conditions over  $80^\circ\text{C}$  the present value of this technology is higher of the one of the vapor compression heat pump (that for high temperature implies a technology with isobutane) [Jensen et al., 2014].



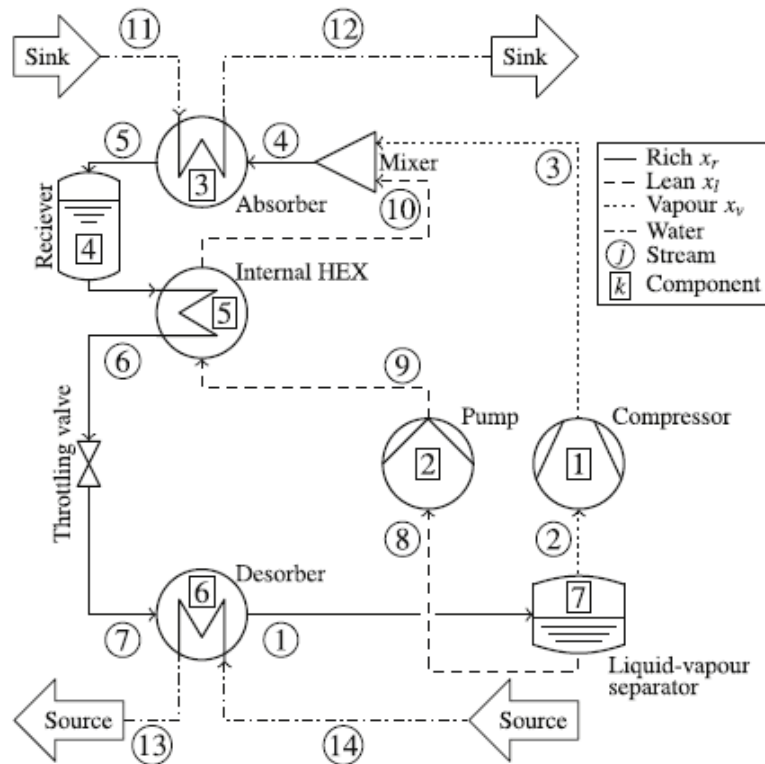

Figure 13. Hybrid absorption-compression ammonia cycle [Jensen et al., 2014].

## 5.2 Carbon Dioxide-R744 (CO<sub>2</sub>)

It is the most common pollutant that is produced during the combustion of a hydrocarbons or of another carbon compound. It was used a lot in maritime industry for refrigeration application until the fifties years of the twentieth century and it was dismissed due to the low efficiency of the cycle, that was caused by the critical temperature, that is very low (31°C). But now higher pressure values can be achieved inside the system, so the CO<sub>2</sub> cycle can be exploited in a better way, using for example cascade cycles, gas coolers and “shell and plate” heat exchangers instead of plate heat exchangers; this is possible especially because the carbon dioxide has very good thermodynamic properties, like a high volumetric latent heat and high vapor density. In particular in a refrigeration cycle if the temperature of the cooling fluid is lower than 15-20°C, it can be operated a subcritical cycle; otherwise if the temperature of the cooling fluid is higher than 15-20°C, a transcritical cycle can be operated, still obtaining high cycle performance. As said before in the refrigerant introduction (chapter 5), the carbon dioxide has a GWP equal to one, so it will be a very good solution looking at the possible leakages in the atmosphere due to the complexity of the pipe net especially for some commercial, industrial, dryers and heat pumps application. Actually the real limit regarding the CO<sub>2</sub> technologies is the discharge temperature both in low pressure and in high pressure applications [Ommen et al., 2015].

### 5.3 Propane-R290 (C<sub>3</sub>H<sub>8</sub>)

Propane is a hydrocarbon and it is classified in class A3 (extremely flammable) by ASHRAE, however it has very good thermal properties and a very high volumetric refrigeration capacity [He Mao-Gang et al., 2014]. This means that less refrigerant charge is required in the refrigeration cycle and this follows both the European guideline, that impose to reduce the amount of used refrigerant, and the safety requirements (less risk related to explosions) [Colbourne et al., 2015]. The amount of refrigerant charge can be further reduced, without a significant reduction of the coefficient of performance, using mini-channel heat exchangers [Fernando, 2004; Cavallini et al., 2009; Del Col et al., 2012]. Furthermore propane has a high solubility with conventional lubricants and esters oil, and this means a reduction in viscosity. To avoid it can be used an oil with a higher basic viscosity and other measures can be adopted, for example using an internal heat exchanger to supply a superheat in the suction line, because at a fixed pressure the solubility of propane is inversely proportional to the temperature variation [Cavallini et al., 2009].

Unlike the carbon dioxide, for hydrocarbons, especially the one in class A3, the European legislation set tight directives regarding the amount of refrigerant allowed in the system, the maximum temperature and the pressure that can be achieved due to their flammability, above all regarding the civilian applications. These limitations are mainly function of area and/or volume of occupancy, of the typology of the system (direct or indirect) and of the presence or not of a mechanical ventilation system. [Eikevik et al., 2014]

### 5.4 Isobutane-R600a (C<sub>4</sub>H<sub>10</sub>)

Isobutane is a hydrocarbon of the same hazard class of propane (using ASHRAE classification), and as propane it has good thermal properties and a high volumetric refrigeration capacity, with the same benefits regarding legislation and hazard risk. Also, unlike propane, with isobutane can be achieved good performances even working at higher temperature in a vapor compression cycle [Ommen et al., 2015].

Regarding the European directives about the use of isobutane in a refrigeration system, being a refrigerant in class A3, it follows the same of propane.

## 5.5 Economics

In literature several works are published regarding this topic; in this part of the paper it was decided to report the results of *Ommen et al.* [19]. In that work some vapour compression heat pumps, those runs with different refrigerants, are compared together, in particular they utilize: R744 (transcritical), R290, high pressure R717, low pressure R717, R600a and R134a (this one to make some comparisons). The study is operated only regarding a simple configuration of the thermodynamic cycle and it is based on prices from intermediate Danish trade business and individual manufactures.

The final conclusions are very interesting, because it was found that, from variations of operation hours and heat production of a heat pump, the net present value and the payback period show the feasibility of the solution with higher detail, compared to the use of semi-economic parameters as COP and volumetric heat capacity. All the six heat pumps considered in the work show working domains where the net present value is positive, when compared to the fuel cost of a natural gas burner. Furthermore was found that can be achieved sink temperatures up to 115°C and temperature lifts up to 40K by four common heat pump systems.

## 6. The project

As mentioned in the introduction (chapter 1), in this project it will be evaluated how it would be possible to fulfill the heating and cooling demand of the new building site of Ydalir in Elverum, utilizing Ground Water Heat Pumps.

After a briefly exposition of the guidelines used in this project the heating and cooling demand of the site will be evaluated; starting from them, a possible solution will be proposed and implemented.

### 6.1 Guidelines and assumptions

The main guidelines regarding the heat pumps adopted in this paper can be summarized as follow:

- Utilize a low-temperature pipe network to supply the heating demand in the district heating system
- Utilize natural refrigerants in heat pump internal cycle according to European directives for the reduction of the greenhouse gasses emissions, as UE Regulation No 517/2014
- Utilize commercial components
- Simple management of the system

Furthermore in this work other important assumptions are done regarding the site itself:

- All the buildings respect the Norwegian passive houses standards (NS3700, 2013; NS3701, 2012) as declared by the designers
- The dimensioning of the wells, the evaluation of the aquifer and the analysis of the groundwater are not objects of this thesis, so it will be assumed that in the site is present as much groundwater as it is needed
- All the floor areas, number of floors and number of apartment per floor are estimated<sup>2</sup> on the project release signed and dated 28/10/2014 (see figure 14)

If during the work other assumptions or simplifications will be adopted, they will be reported.

In this chapter in all the tables almost all the values are rounded as appropriate.

---

<sup>2</sup> Actually nothing is built, so this is still a preliminary project that could be modified



Figure 14. Project site of Ydalir in Elverum. The identification numbers are referred to table 4, in particular to indicate the single dwellings (light yellow on the bottom-right) the correspondent number was spread around the whole zone.

Identification	Typology	Color	Number of Buildings	Floor area [m <sup>2</sup> ]	Floors	Total Floor Area [m <sup>2</sup> ]	Apt. per Floor	Apt. Area [m <sup>2</sup> ]	Number of Apartment
1	Flat	Orange	7	576	6	3456	6	96	252
2	Flat	Orange	5	576	5	2880	6	96	150
3	Flat	Orange	6	576	4	2304	6	96	144
4	Flat	Brown	3	784	8	6272	4	196	96
5	Dwelling	Light-yellow	73	96	1.5	144	N/A	144	73
6	Row House	Yellow	41	72	1.5	108	N/A	108	41
a	2fl. Blocks	Yellow	1	488	2	976	N/A	122	8
b	2fl. Blocks	Yellow	1	650.2	2	1300.5	N/A	118.2	11
c	2fl. Blocks	Yellow	1	950	2	1900.2	N/A	135.7	14
d	2fl. Blocks	Yellow	1	615.8	2	1231.7	N/A	123.2	10
e	2fl. Blocks	Yellow	1	240	2	480	N/A	80	6
f	2fl. Blocks	Yellow	1	633.6	2	1267.2	N/A	126.7	10
g	2fl. Blocks	Yellow	1	326.4	2	652.8	N/A	108.8	6
h	2fl. Blocks	Yellow	1	339.2	2	678.4	N/A	135.7	5
i	2fl. Blocks	Yellow	1	371.2	2	742.4	N/A	123.7	6
m	2fl. Blocks	Yellow	1	532.48	2	1065	N/A	118.3	9
7	School	Red	1	6536	3	19608	N/A	19608	1
8	Kindergarten	Red	1	1576	2	3152	N/A	3152	1
<b>Total</b>									<b>841</b>

Table 4. Evaluation of the typology and number of buildings based on the project release of 28/10/2014.

## 6.2 Buildings

As shown in figure 14 several typologies of buildings are going to be built in the site according with the last project release; in particular they consist in: singular dwellings, row houses, flats, one school and one kindergarten. The floor areas are estimated with a direct physical measurement on the planimetry and the obtained results are reported in the table 4.

In the table the number of floors for the flats was estimated comparing the project release dated 28/10/2014 with a very similar 3D draw (Appendix A); besides, using the same strategy, it was decided that the yellow buildings a ,b,..., m are blocks of houses with two floors each and it was established the number of domiciles for each block.

For the single houses and the row houses it was used 1.5 as number of floors to emphasize the fact that they are buildings composed by two floors, but that the second floor has a smaller area compared to the first one.

The houses and the public buildings, those are composed of more than one floor, report N/A as number of apartments per floor, because it is improper to utilize this definition if the domicile is developed in two floors.

Finally it has to be noticed that, with these approximations, were obtained 841 domiciles, that agrees with the estimation on the Elverum commune website (800-1000 domiciles, <http://www.elverumvekst.no/boligtomter/tomteomrader/ydalir> ).

### 6.2.1 Heating terminals

As previously said, in the Ydalir site passive houses will be built; it is not the purpose of this work to argue about them, but it has to be clear that they are very well insulated, so the space heating demand could be satisfied with a low-temperature heating system. Furthermore this heating system has to be quick in the response, to meet the needs of the occupants; so in this work it has be hypothesized to install low-temperature radiators with an appropriate mass flow regulation system.

The working range of the low-temperature radiators is between 50 and 25°C; the mass flow of water that enters inside them is regulated firstly with an outdoor temperature sensor, from which it can be derived a curve (temperature compensation curve), on the variable speed pump of the water distribution network, and locally, in each terminal, with a thermostatic valve that is in contact with the indoor environment.

During the dimensioning of the space heating system it is considered that in the worst case scenario, so with an external air temperature equal to the DOT, the maximum (nominal) mass flow of water is going through the radiators.

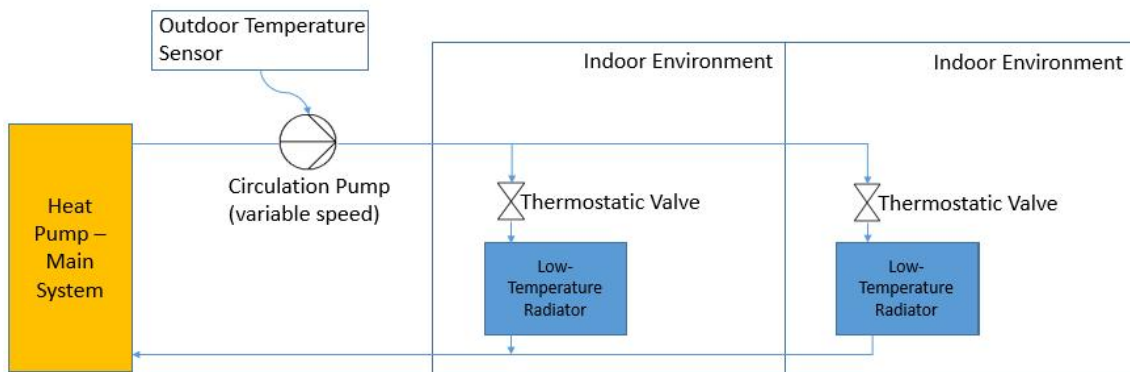

Figure 15. Sketch of how the space heating system should be.

In the sketch above are represented only low-temperature radiators, but according to the “Guidelines for Low-Temperature District Heating” [Dalla Rosa et al., 2014] it is better to heat the bathrooms with a floor heating system; this is irrelevant at this state of the project for the next points, design of the system and thermal evaluation, but it has to be taken into consideration by the final designers of the buildings.

### 6.3 System design

Starting from the previous evaluations, to fulfil the heating demand of the site it was decided to split the site in two circuits:

- Circuit A: single houses and row houses
- Circuit B: all the other buildings

This was done because the buildings in circuit A are small, so it was supposed that they will have a heating demand or a cooling demand (depending on the outdoor temperature), not both of them simultaneously. On the other hand the other buildings could have both of them so they were connected to the same circuit.





Figure 16. Sketch of circuit A in green; the circle on the top symbolizes the heat pump.

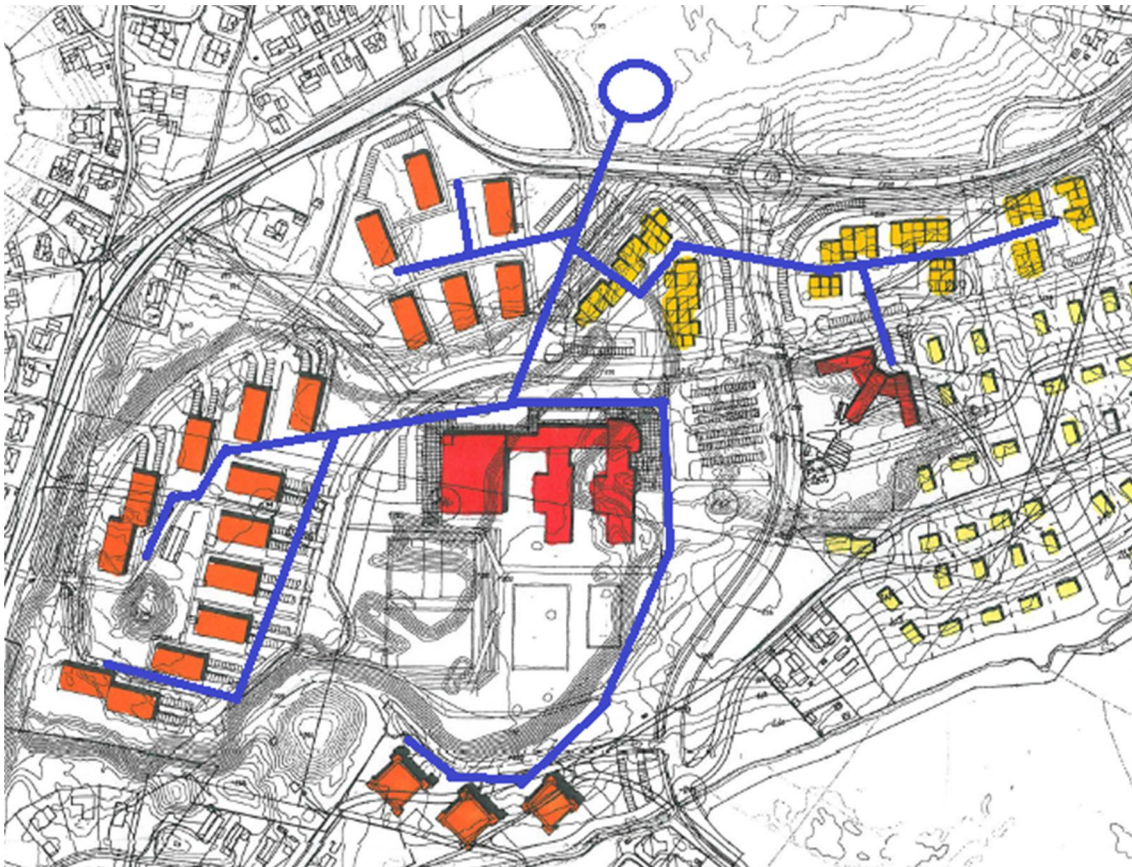

Figure 17. Sketch of circuit B in bleu; the circle on the top symbolizes the heat pump.

Both the heat pumps were placed in the northern area of the site, outside the inhabited area.

Anyway both the circuits can be divided in two systems, because both of them use ammonia heat pumps (part of main system) to generate low-temperature water in the distribution system, to provide the hot water for the space heating (or cold water for space cooling). The domestic hot water (DHW), will be produced using Instantaneous Heat Exchanger Units (IHEUs) connected to a District Heating Storage Unit (DHSU) in the secondary system.

### 6.3.1 Main system

Using figure 18 as reference, the main system could be divided in two main sections:

- i) Groundwater-brine HEX, brine-ammonia HEX and two circulation pumps
- ii) Brine-ammonia HEX, screw compressor, ammonia-water HEX, lamination valve, four way valve, HEX for hot water production during summer and circulation pumps on the water side, this sub-system is the ammonia heat pump

The intermediate heat exchanging sub-system is used to avoid problems on the heat pump evaporator, related to the chemical properties of the groundwater, like corrosion and scaling; some of this issues are discussed on the ASHRAE manual “Geothermal Heating and Cooling: Design of Ground-Source Heat Pump Systems” [Kavanaugh et al., 2014].

All the heat exchangers that are present in the main system are plate heat exchangers. A four way valve will be used to switch the system from the winter to the summer mode; doing this the functions of evaporator and condenser will be reversed, so the groundwater and the water of the distribution system must enter in heat exchanger in the opposite way compared to the winter mode, to maintain the counter flow (better heat exchange coefficients). This seasonal modification will be operated in both the heat pumps. However in this climate zone it could happen that in the same time a heating and a cooling demand are present in the opposite sides of a building in spring or fall and furthermore during summer there is still a DHW demand, therefore only in circuit B is added an extra HEX with which is produced hot water to send in the tanks when needed (see secondary system, chapter 6.3.2).

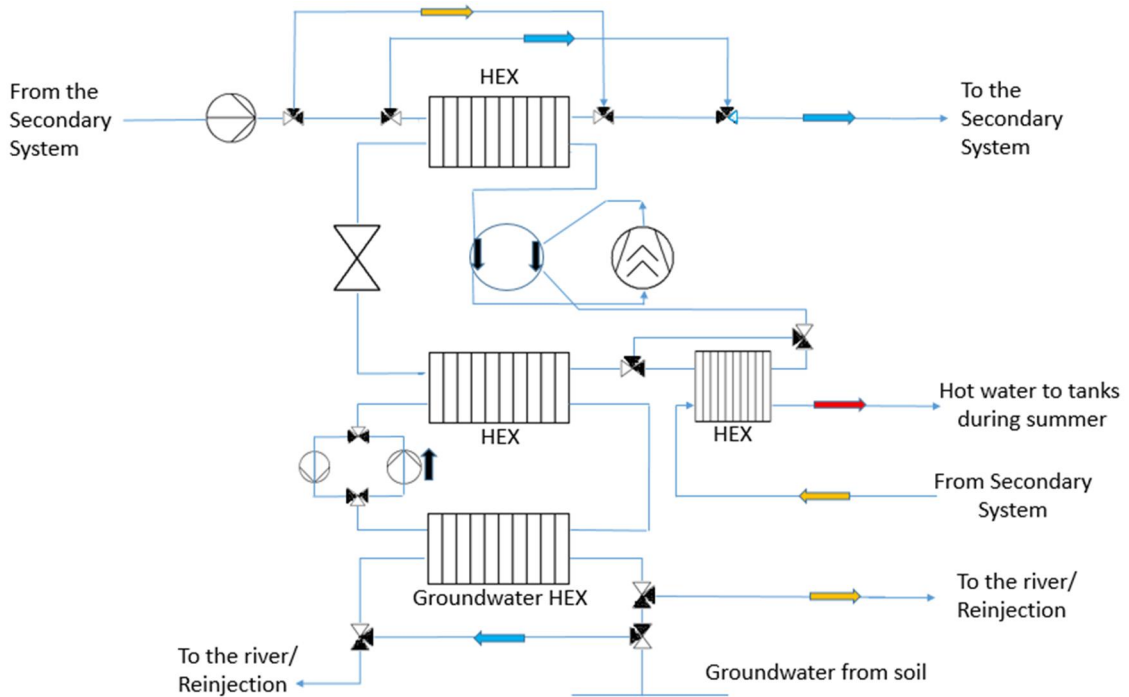

Figure 18. Main Heat Pump System: summer mode. The blue arrows indicate cold flow (ground water and supply pipes), the red hot flow (DHW) and the orange flows at an intermediate temperature (return pipes and reinjection).

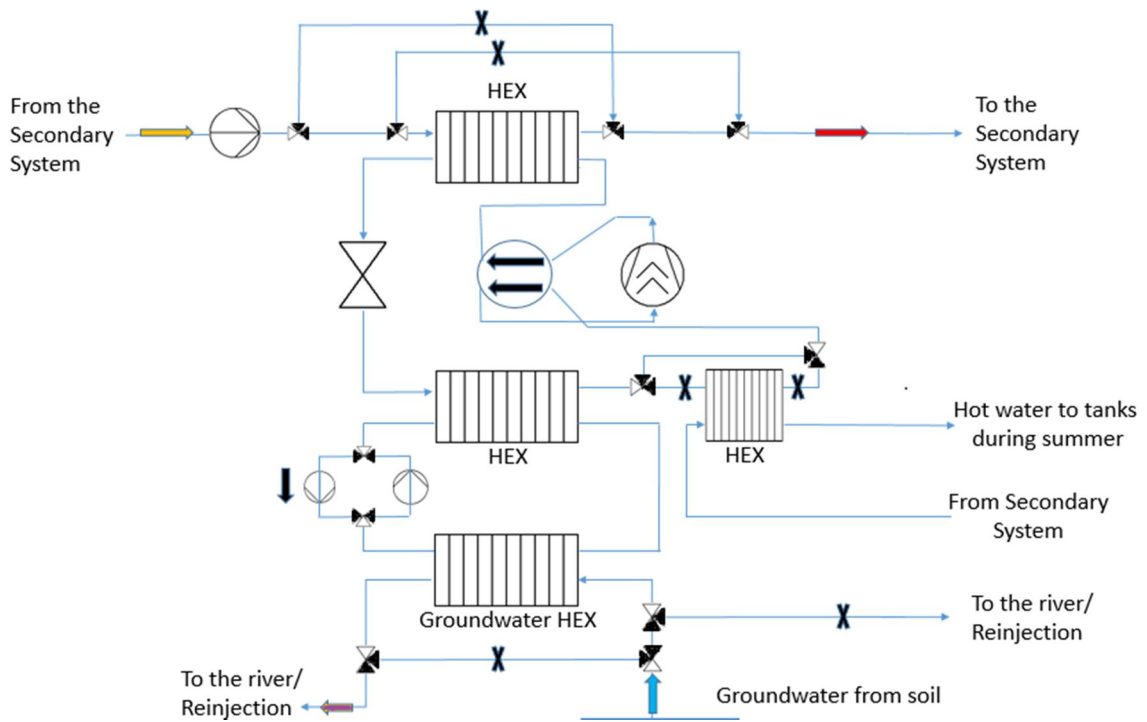

Figure 19. Main Heat Pump System: winter mode. The blue arrows indicate cold flow (ground water), the red hot flow (supply pipes), the violet a very cold flow (reinjection) and the orange flows at an intermediate temperature (return pipes); the black "X" are included to tell to the reader that those portions of the system aren't used.

It is wise, to obtain a proper control of the system, to put pressure and temperature sensors (and other components); this is done to obtain, for example, a regulation of the output temperature from the heat pump in the piping network (setpoint value). This and other controls are not present in the pictures above. This was done to maintain a certain neatness and clearness in the in the system explanation, but they have been considered.

### 6.3.2 Secondary system

Using figure 21 as reference, the secondary system is the association of three sub-systems:

- i) The heating/cooling terminals inside the houses where the hot water or the cold water from the main system arrives
- ii) Water tank connected to several IHEU and to the low-temperature radiators
- iii) Mechanical ventilation system

It was decided that the DHW will be produced locally in each domicile. Some tanks (DHSUs) will be used to accumulate the hot water that comes from the district heating circuit, and through some valves it will be send to a IHEU that will produce instantly the DHW at a temperature that is only 3°C less than the one on the DH side through a 3 liters tank [Annex X, Dalla Rosa et al. 2014; Annex 40 task1, J. Alonso M., 2013]. Furthermore, producing the DHW in this way, thus reaching a maximum temperature that it is closer to the usage temperature (50°C), it is demonstrated that there isn't any proliferation of legionella. The only exceptions are the single houses and the row houses, because they are too much spread in the area, so the DHW will be provided using an electrical boiler in each domicile.

As will be explained better in chapter 6.4.1 it is possible that there will be the simultaneous presence of a heating and a cooling demand during some seasons in all the buildings except for single houses and row houses. So when circuit B is switched to the summer mode, the hot water, after being produced, will be stored in the DHSUs and it will be sent, when needed, to the low-temperature radiators to provide space heating or to the IHEUs for the DHW.

During the summer mode the principle that controls the cooling demand is the same of the space heating for the low-temperature radiators, so an outdoor temperature sensor on the pump and an indoor temperature sensor in the room. Furthermore in figure 20, 21, 22 it is not outlined the heat exchangers between the cold water and the mechanical ventilation system. This is because the design of the mechanical ventilation system will be decided by the project designer of the buildings, so it will be left for a future evaluation.

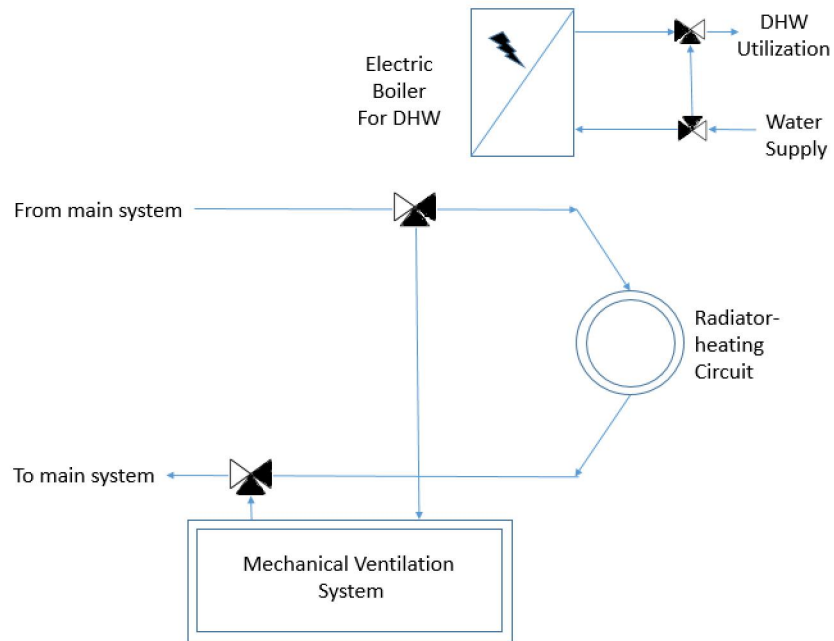

Figure 20. Secondary System in single houses and row houses (circuit A).

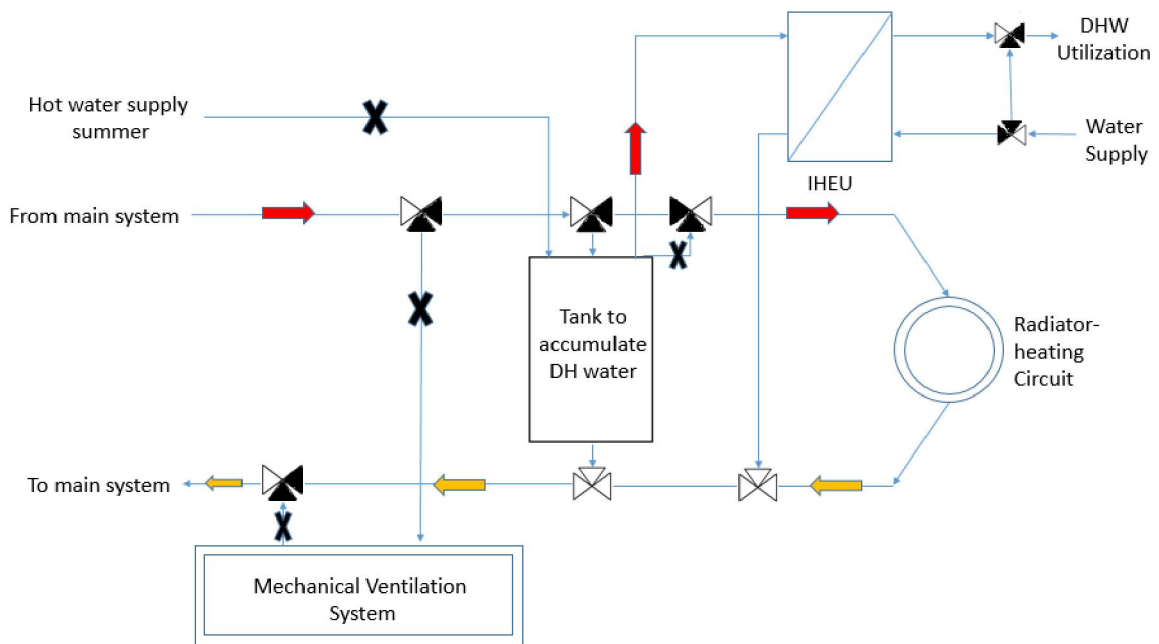

Figure 21. Secondary System in other buildings: winter mode (circuit B). The red arrows indicate a hot flow (supply pipes and DHW) and the orange flows at an intermediate temperature (return pipes); the black "X" are included to tell to the reader that those portions of the system aren't used.

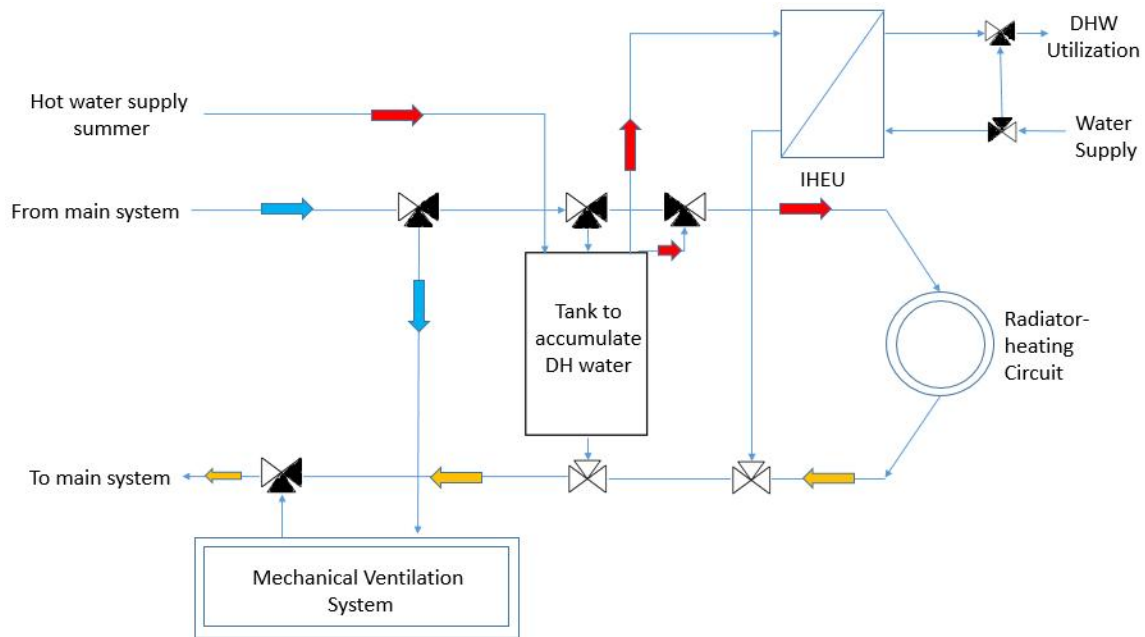

Figure 22. Secondary System in other buildings: summer mode. The blue arrows indicate cold flow (supply pipes), the red hot flow (DHW) and the orange flows at an intermediate temperature (return pipes).

In the valves under the DHSU and the one before (output of low-temperature heating system) it is not indicated how they work, because in the reality they are a group of control valves and collectors to drive the return flow out of the buildings to the main system.

As for the main system here there are also pressure and temperature controls on the heat pump cycle and other components in the system; for example at 1/3 of the distance from the bottom [Guidelines for Low-Temperature District Heating, 2014[39]] of the last tank should be installed a temperature sensor calibrated on a setpoint temperature to start the heat pump cycle.

It has to be said that with recent research was demonstrated that in a new-built system legionella could be avoided with an oxidation pretreatment of the water and a DHW temperature of 48°C [Annex X, Dalla Rosa et al., 2014]; so theoretically it is possible to decrease of some degrees the temperature of the system, obtaining a reduction of the heat losses along the pipes (see Appendix B).

### 6.3.3 Pipe Distribution Network

An underground pipe distribution network must be used to distribute the water to supply the heating and cooling demand during the year. In particular this is a low-temperature distribution system, so the heat losses of the pipes into the underground are smaller if compared to a high-temperature distribution system, but, they are still not negligible in the peak load sizing of the system in the winter conditions.

Compared to the pipe the ground can be considered as an infinite material at a constant temperature; furthermore doing an approximation it can be assumed that the heat transfer between pipe and ground is obtained only by conduction.

In this work it was decided to adopt, where possible, twin pipes. These pipes are designed containing a supply and a return pipe of the same size together, in the same insulation envelope.

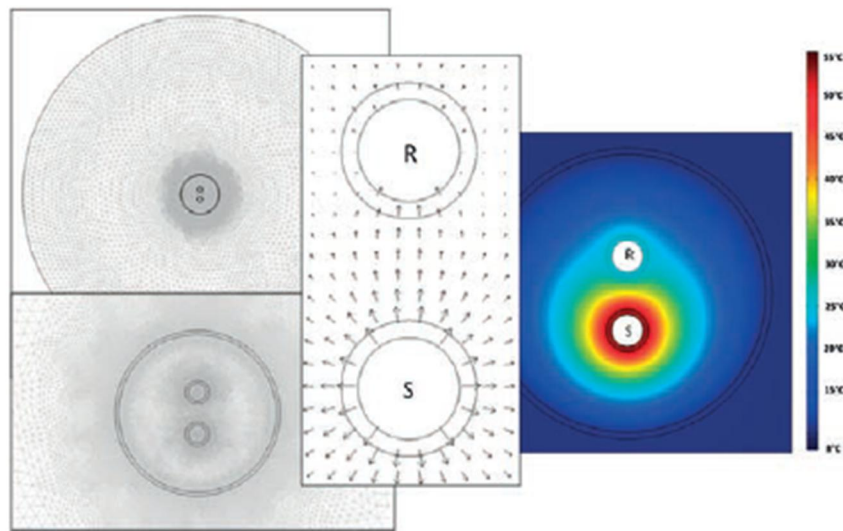

Figure 23. Sketch of a twin pipe analyzed with finite elements method [Dalla Rosa, 2012]. S=supply, R=return; colors scale in the picture: red=50°C(max), dark blue=0°C (min).

The advantages of these pipes are lower heat losses and lower investment costs (material and excavation) if compared to normal single insulated pipes [Kristjansson et al.,2006; Dalla Rosa, 2012].

DISTRIBUTION PIPE	HEAT LOSSES					RESOURCES			COST
	$U_{11}$ supply W /(m·K)	$U_{22}$ return W /(m·K)	$U_{12}$ W /(m·K)	$q_{tot}$ W/m	Relative loss %	Casing cm <sup>2</sup>	Insulation cm <sup>2</sup>	Gravel m <sup>2</sup>	Investment index %
A Single pair	0.2664	0.2664	0.0113	26.53	100%	31	270	0.480	100%
B Circular twin	0.2517	0.2534	0.0784	18.08	68%	31	360	0.370	90%
C Egg twin	0.2264	0.2735	0.0799	16.74	63%	31	310	0.320	88%

Table 5. Comparison of heat losses and costs between different pipe typologies taken from the technical paper of Danfoss [Kristjansson et al.,2006].

To evaluate the thermal losses of this typology of pipe it should be considered that the thermal conductivity of the insulation foam varies with the time-aging of the pipe and with the temperature, considering the one of the supply flow, of the return flow and of the ground outside; but from the engineering point of view only the variation due to the temperature can be considered during the dimensioning of the system [Dalla Rosa, 2012].

The pipe network can be considered in a steady state during the sizing; furthermore considering a constant temperature along the piping network in the heat losses evaluation, it is committed an error that is acceptable from the engineering point of view [Dalla Rosa, 2012].

For the supply and the return pipes respectively:

$$q_1 = U_{11} \cdot (T_1 - T_0) + U_{12} \cdot (T_2 - T_0) = (U_{11} + U_{12}) \cdot (T_1 - T_0) + U_{12} \cdot (T_2 - T_1)$$

$$q_2 = U_{22} \cdot (T_2 - T_0) + U_{21} \cdot (T_1 - T_0) = (U_{22} + U_{21}) \cdot (T_2 - T_0) + U_{21} \cdot (T_1 - T_2)$$

With  $T_1$ = supply temperature,  $T_2$ = return temperature and  $T_0$ = ground temperature.

So as can be seen in the two equations above the heat transfer ( $q_1$  and  $q_2$ ) from each pipe can be treated as the linear superimposition of two heat fluxes: the first one describes the heat transfer between the pipe and the ground ( $U_{11}$  and  $U_{22}$ ), the second one describes the heat transfer between the supply pipe and the return pipe ( $U_{12}$  and  $U_{21}$ , see figure 23). Furthermore, using the previous assumption regarding the steady state, the equations can be simplified:

$$q_1 = \left[ U_{11} + U_{12} \cdot \frac{(T_2 - T_0)}{(T_1 - T_0)} \right] \cdot (T_1 - T_0) = U_1 \cdot (T_1 - T_0)$$

$$q_2 = \left[ U_{22} + U_{21} \cdot \frac{(T_1 - T_0)}{(T_2 - T_0)} \right] \cdot (T_2 - T_0) = U_2 \cdot (T_2 - T_0)$$

Where  $U_1$  and  $U_2$  are some average linear conductivity those depends only on the temperature. Doing this operation as said before the error is negligible and the two  $U$ -values are evaluated with a hypothesized mean temperature of the insulation; however to do this and find a proper correlation to estimate the  $U$ -values, is necessary to do some test with some samples or a simulation with a software.

Regarding this work, considering the great level of uncertainty inside of it, it was decided to size the pipes and find the heat losses along them utilizing the sizing guide of a pipe manufacturer, Uponor (see Appendix C.1) [Uponor, 2012].



## 6.4 Thermal load

To estimate the thermal load of a passive house it is not possible to utilize the Degree-Day calculation method, because this typology of buildings is very well insulated; this means that the solar heat gains and the internal generated heating gains are as important as the heat demand that should be provided by the heating system.

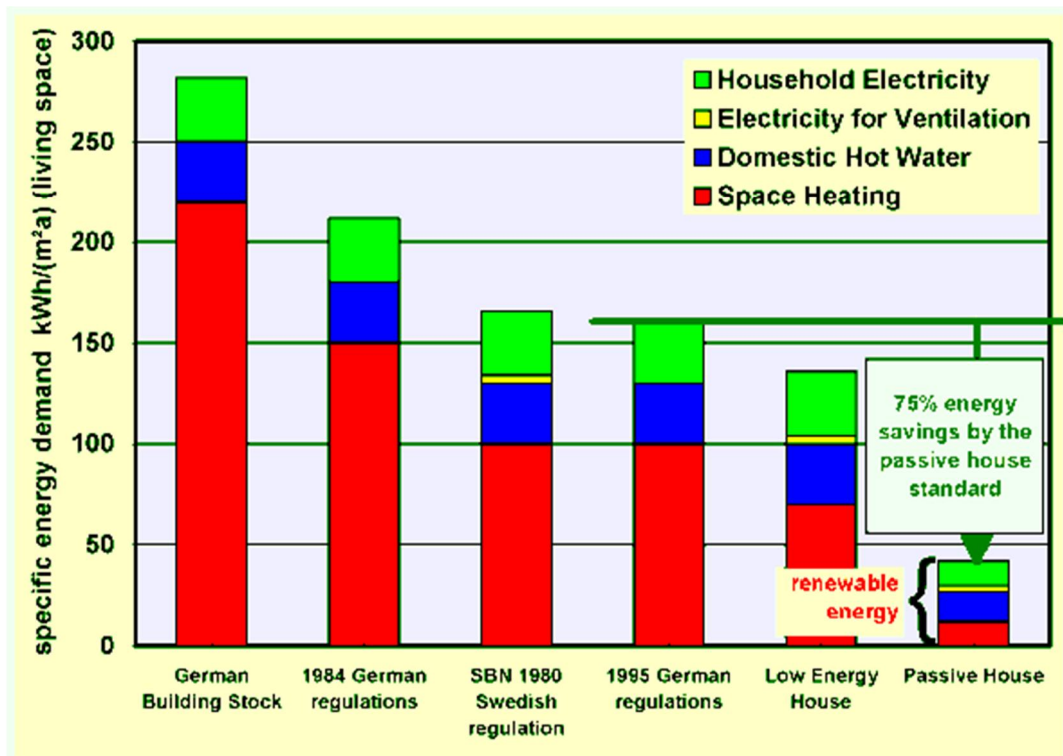

Figure 24. Comparison of the energy demand of a passive house with other previous typology of buildings, picture taken “from [www.nypassivehouse.org](http://www.nypassivehouse.org)” [43].

This problem could be avoided utilizing a simulation software that implements a quasi-steady state model or better a dynamic model, so very accurate methods that require a lot of data in input. One of these programs, that utilize a simplified method, is Simien [Programbyggerne, 2013]; it was developed already including the Norwegian standards for passive houses [NS3700, 2013 and NS3701, 2012], so it is perfect for the purposes of this work. Nevertheless, due to the high uncertainty of the building data, in this paper it was decided to utilize some results obtained in the IEA HPP Annex 40 task 2 [Justo Alonso M. et al., 2015] and some data from the Norwegian Standard 3701:2012 [37].

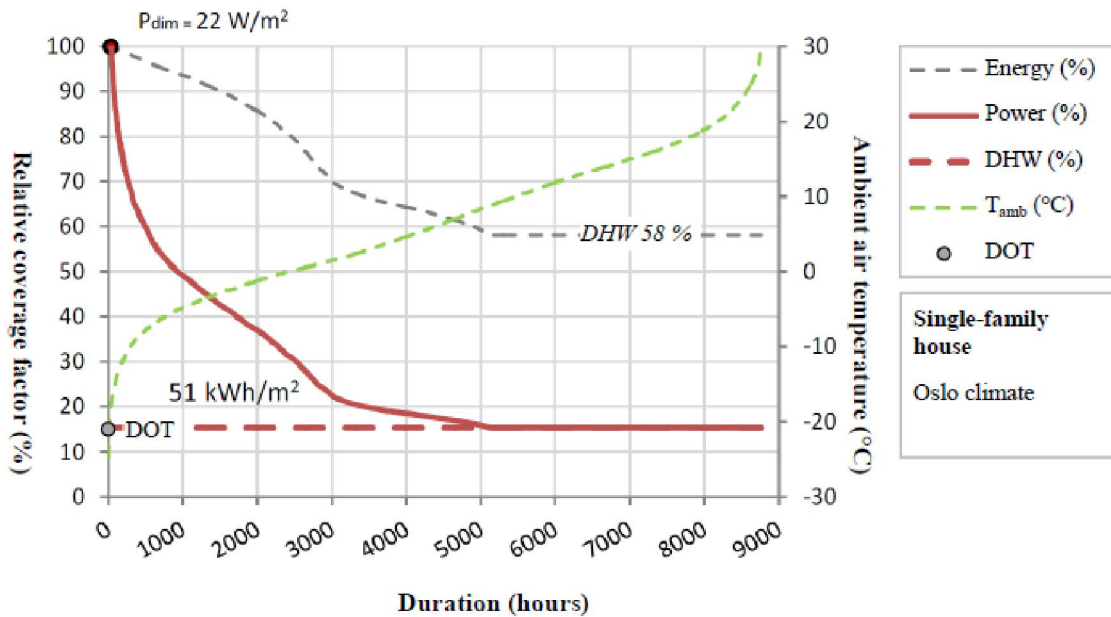

Figure 25. Calculated thermal power duration curve for a 2-storey 128m<sup>2</sup> single house using the passive standards in the Oslo climate; taken from IEA HPP Annex 40 task 2 [Justo Alonso M. et al., 2015].

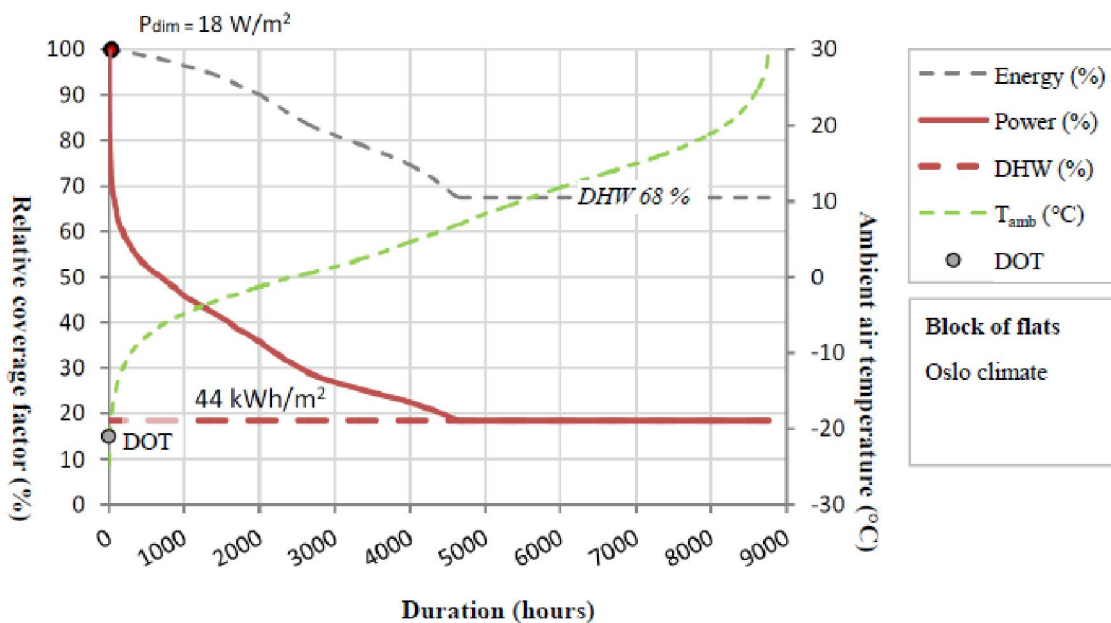

Figure 26. Calculated thermal power duration curve for a 4-storey 2240m<sup>2</sup> block of flats using the passive standards in the Oslo climate; taken from IEA HPP Annex 40 task 2 [Justo Alonso M. et al., 2015].

The results showed in the pictures above are evaluated in the Oslo climatic zone, so it is wise to think if they could be utilized also in Elverum.

To verify this, the climate data of Oslo were compared to the ones of Elverum. In particular, utilizing the database Meteonorm [Meteotest, 2015], weather and climate data were been interpolated between the weather stations of Oslo, Gardemoen and Røros,

because Elverum climatic data are not included in Simien, in the time period between 1991 and 2010.

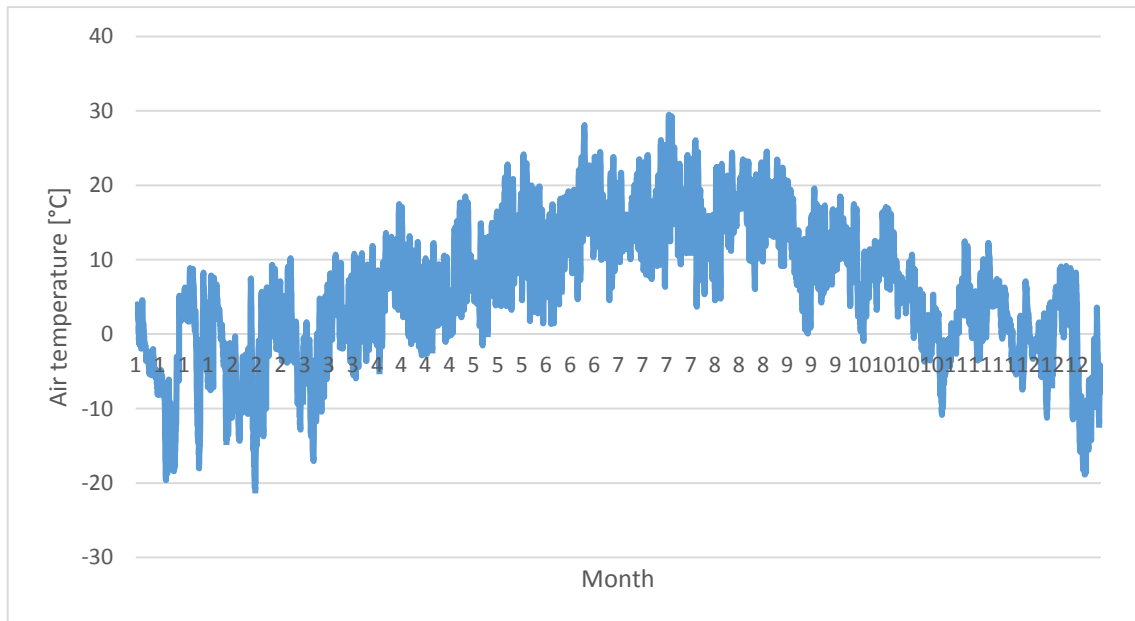

Figure 27. Hourly external air temperature trend in Elverum [Meteotest, 2015].

As evidenced in the Meteoronorm output in the figure above, it can be assumed that the DOT (design outdoor temperature) of Elverum is the same of Oslo (-20°C); so in this work can be utilized the values obtained through the simulations with Oslo climatic data.

#### 6.4.1 Thermal Load Evaluation

To evaluate the thermal load of the site some assumptions were adopted. In particular:

- For the space heating demand of the school and of the kindergarten data from the Norwegian Standard NS 3701:2012 [37] are used;
- Regarding the space heating demand of all the other buildings the values given in the IEA HPP Annex 40 task 2 are used [Justo Alonso M. et al., 2015]; besides the yellow buildings (table 4) a,b,...m are considered as flats in this estimation, due to the shape of the blocks.
- For the domestic hot water demand of every building it was used the value, in  $W/m^2$ , saved in the database of SIMIEN, that is obtained assuming a steady consumption during the time;
- The row houses aren't present in the SIMIEN database, so it was decided that they have the same DHW requirements of the single houses and for the SH an average value between the single houses and the flats.

- The values for the SH in W/m<sup>2</sup> for the school and the kindergarten are obtained assuming a total heat demand of 12 W/m<sup>2</sup> and subtracting the DHW value from it.

Some of these assumptions, especially the last ones, could seem very arbitrary, but it has to be considered that, at the actual state of the project, it is impossible to perform a complete simulation with a software; so to justify the choices that are adopted it has to be considered that the values given in the standards are obtained considering how the envelope should be, without taking in consideration local peculiarities and how the building will be used by the owners. The value of 12 W/m<sup>2</sup> can be justified by the fact that the energy demand of a school and a kindergarten (in average 21.4 and 26.44 kWh/m<sup>2</sup>) are almost the half of the one of the flats (44 kWh/m<sup>2</sup> [Justo Alonso M. et al., 2015]) and considering that the DHW request implemented in SIMIEN is lower, it is legit to assume that the peak value is a little more of the half of the one of the flats.

Identification	DHW [W/m <sup>2</sup> ]	DHW [kW]	DHW [kW] typology of building	SH [W/m <sup>2</sup> ]	SH [kW]	SH [kW] typology of building
1	3.4	11.750	82.253	14.6	50.456	353.203
2	3.4	9.792	48.960	14.6	42.048	210.240
3	3.4	7.834	47.002	14.6	33.638	201.830
4	3.4	21.325	63.974	14.6	91.571	274.714
5	3.4	0.489	35.741	18.6	2.678	195.523
6	3.4	0.367	15.055	16.6	1.7928	73.505
a	3.4	3.318	3.318	14.6	14.250	14.250
b	3.4	4.422	4.422	14.6	18.987	18.987
c	3.4	6.460	6.460	14.6	27.742	27.742
d	3.4	4.188	4.188	14.6	17.983	17.983
e	3.4	1.632	1.632	14.6	7.008	7.008
f	3.4	4.308	4.308	14.6	18.501	18.501
g	3.4	2.219	2.219	14.6	9.531	9.531
h	3.4	2.306	2.306	14.6	9.905	9.905
i	3.4	2.524	2.524	14.6	10.839	10.839

m	3.4	3.621	3.621	14.6	15.548	15.548
7	1.9	37.255	37.255	10.1	198.041	198.041
8	1.6	5.043	5.043	10.4	32.781	32.781
<b>Total</b>			<b>370.283</b>			<b>1690.130</b>

Table 6. Space nominal heating and domestic hot water calculation. The identification column corresponds to the one of table 4.

The usage of the building by the owners is almost impossible to be predicted (how often the windows are opened, usage of shading devices on windows, utilization of the rooms, habits,...); therefore, even if theoretically a passive house well build could have a cooling demand close to zero, in this paper it is considered that it is necessary to fulfil a certain cooling demand, that is evaluated, arbitrary, as 10 W/m<sup>2</sup>.

#### 6.4.2 Simultaneous factor

The site is composed by different typologies of buildings with a different number of domiciles; so sizing the system it should have to be taken into account that statistically not all the people will utilize at the same time the nominal capacity of their domicile regarding the space heating and the domestic hot water system. To do this a simultaneous factor was estimated for each typology of building utilizing a formula from the literature [Li et al., 2012].

For the space heating:

$$SF_{SH}(N_i) = K + \frac{1 - K}{N_i}$$

Where K=0.62 and N<sub>i</sub> is the number of domiciles after that node in the network.

For the domestic hot water:

$$SF_{DHW} = \frac{1}{Q_{DHW}} \cdot \left( A + \frac{B}{N_i^{0.5}} + \frac{C}{N_i} \right)$$

Where Q<sub>DHW</sub> is the demand per house and the coefficients A, B, C are different if the system works only with IHEU or also with a DHSU; in the first case A=1.19 B=18 C=13.1, in the second one (the one of this paper) A=1.19 B=1.5 C=0.3.

It is obtained:

	<b>Building</b>	<b>Simultaneous Factor SH</b>	<b>Simultaneous Factor DHW</b>
Circuit A			
	Single house - 5	0.625205	
	Row house - 6	0.629268	
Circuit B			
	Flat - 1	0.630556	0.123258
	Flat - 2	0.632667	0.150517
	Flat - 3	0.635833	0.192592
	Sq. Flat - 4	0.631875	0.068678
	Flat – a	0.667500	0.529722
	Flat – b	0.654545	0.377585
	Flat – c	0.647143	0.249564
	Flat – d	0.658000	0.404980
	Flat – e	0.683333	1
	Flat - f	0.658000	0.393257
	Flat –g	0.683333	0.834582
	Flat –h	0.696000	0.832764
	Flat - i	0.683333	0.733857
	Flat - m	0.662222	0.475945
	School - 7	1	0.080257
	Kindergarten - 8	1	0.592878

Table 7. Simultaneous factors for SH and DHW.

To estimate a simultaneous factor for the cooling load it's necessary to know the orientation of the facades of the buildings and how are disposed the rooms inside them. It was not possible to do it because this particulars are still uncertain in the site, so it was decided to adopt during the space cooling mode the same simultaneous factor of the space heating.

	<b>Building</b>	<b>Simultaneous Cooling Load [kW]</b>	
Circuit A			
	Single house - 5	65721.6	
	Row house - 6	27864.0	
		TOT	93585.6
Circuit B			
	Flat - 1	152.54	
	Flat - 2	91.10	
	Flat - 3	87.90	
	Sq. Flat - 4	118.90	
	Flat – a	6.52	
	Flat – b	8.51	
	Flat – c	12.30	
	Flat – d	8.11	
	Flat – e	3.28	
	Flat - f	8.34	
	Flat –g	4.46	
	Flat –h	4.72	
	Flat - i	5.07	
	Flat - m	7.05	
	School - 7	0	
	Kindergarten - 8	31.52	
		TOT	550.32

Table 8. Simultaneous cooling load.

It has to be noticed that the cooling load for the school is assumed equal to zero kW. That's because without knowing the internal disposition and usage of the rooms is almost impossible to predict the peak load in  $W/m^2$ ; indeed, using the NS 3701:2012, is only possible to evaluate the energy needed, that is equal to  $7.125 \text{ kWh}/m^2$ . Anyway denying the presence of the cooling load of the school, at this point in the project, can be accepted, because typically the cooling load is present when the outdoor temperature is

over 25°C, and, according with Meteonorm data, this happens mostly between June and August, so when the school is closed for vacation.

### 6.4.3 Peak Power

Besides the load contemporaneity it has to be considered that only for a few hours in a year, as can be seen clearly in figure 25 and 26, the system has the nominal space heating power demand (the DHW is a basic load that has to be taken into account all year long). So, to avoid to oversize it and sustain meaninglessly higher investment costs, it has been operated a simple economic analysis to try to find the optimum size of the heat pump. It was not considered the whole system, but only the heat pump.

So starting from the nominal simultaneous power and after decreasing it of a certain percentage, the expected specific energy price (SE) in NOK/kWh and the simple payback time (SPB) in years using the correlations were simulated:

$$SE = \frac{SI \cdot a}{\tau} + \frac{E_{el}}{COP_{HP}}$$

$$SPB = \frac{SI}{\left( \tau \cdot \left( E_{el} - \left( \frac{E_{el}}{COP_{HP}} \right) \right) \right)}$$

Where:

SI: Specific Investment cost (NOK/kW)

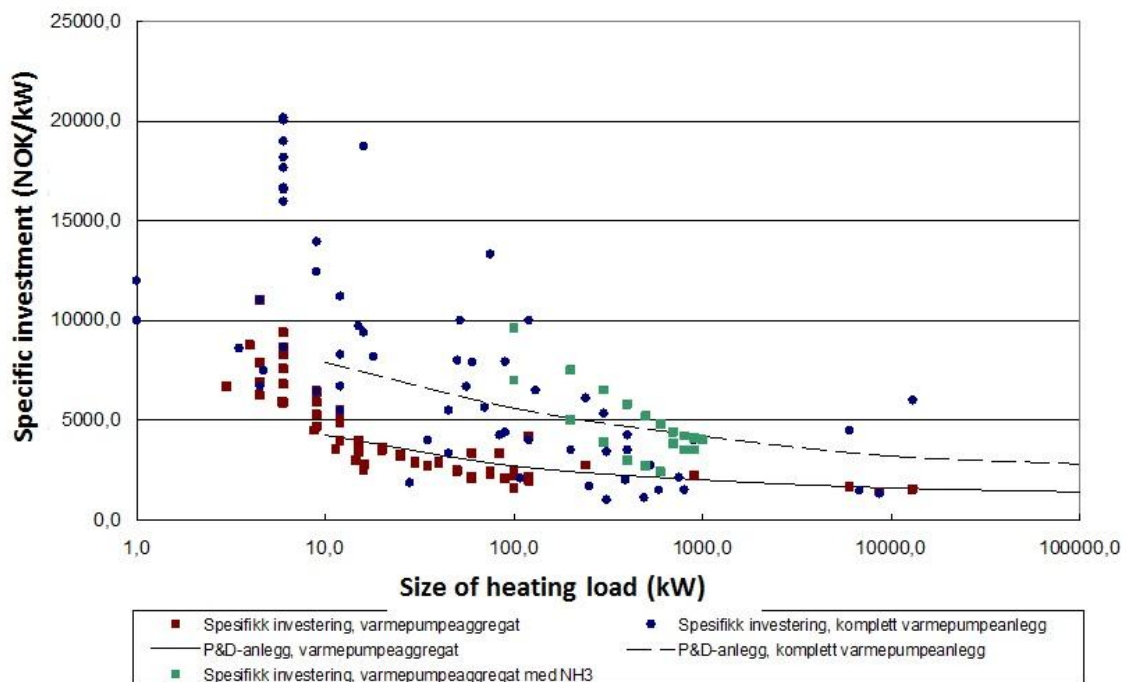

Figure 28. Specific investment for heat pumps based on the size.



$\tau$ : equivalent running time (hours)

a: amortization (%), assumed with a value of 10%

$E_{el}$ : Electricity price (NOK/kWh), evaluated doing the arithmetic mean between the electricity price of the last four years [Nordpool.com, 2015] and adding 0.35NOK/kWh as basic tax to be connected to the power grid, the final value is around 0.64 NOK/kWh.

$COP_{HP}$ : coefficient of performance of the heat pump (-), obtained in a first approximation using the Carnot COP multiplied by an efficiency factor [Granryd et al., 2011]

$$COP_{HP} = 1 + \eta_{Carnot} \cdot \frac{T_2}{T_1 - T_2}$$

With  $T_2$ = temperature of evaporation, estimated around 265 Kelvin, and  $T_1$ = temperature of condensation, estimated for circuit A around 318K and for circuit B around 333K.

Assuming in both cases a compressor consumption around 100 kW, the Carnot efficiency is around 0.58 for circuit A and 0.48 for circuit B. So the  $COP_{HP}$  is 3.85 for circuit A and 2.87 for circuit B. These values take into account only the winter mode; in the summer mode the temperature difference between condenser and evaporator will be smaller, so the COP will be higher, in particular for circuit B where is taken advantage of the double effect.

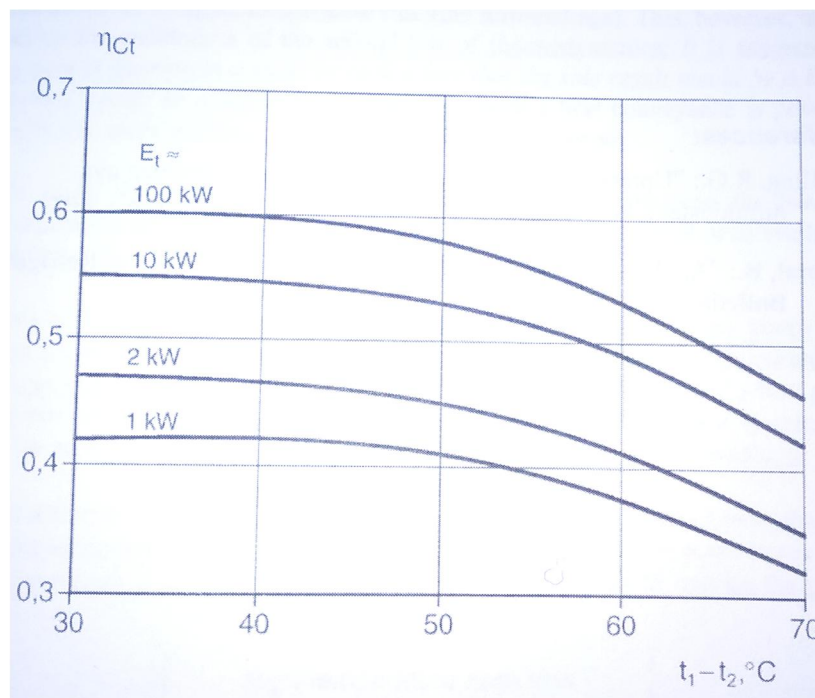

Figure 29. Carnot efficiency based on the compressor consumption and the temperature difference between cold and hot source [Granryd et al., 2011].

The preliminary results that were obtained are:

	Percentage	Power [kW]	Equivalent time [h]	SE [NOK/kW]	SPB [y]
Circuit A					
	1	168.4964	1128.76	0.698	11.22
	0.7	117.9475	1612.514	0.538	7.85
	0.65	109.5227	1736.554	0.512	7.29
	0.6	101.0978	1881.267	0.485	6.73
	0.55	92.67303	2052.291	0.459	6.17
Circuit B					
	1	1042.6028	787.490	0.756	12.79
	0.7	746.1248	1100.404	0.605	9.15
	0.65	696.7118	1178.448	0.579	8.55
	0.6	647.2987	1268.408	0.554	7.94
	0.55	597.8857	1373.237	0.529	7.33

Table 9. SE and SPB for different capacities of the system.

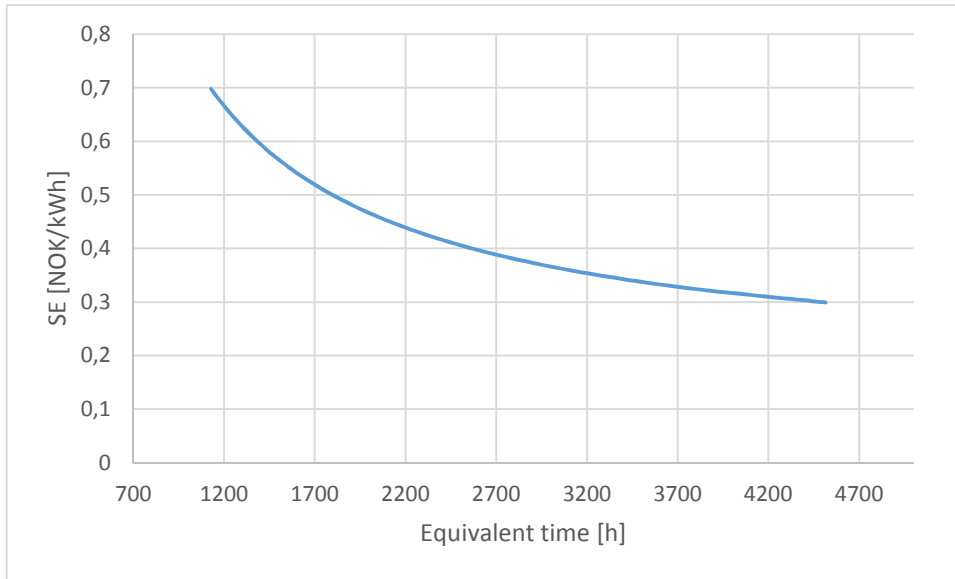

Figure 30. SE in function of Equivalent time for circuit A.

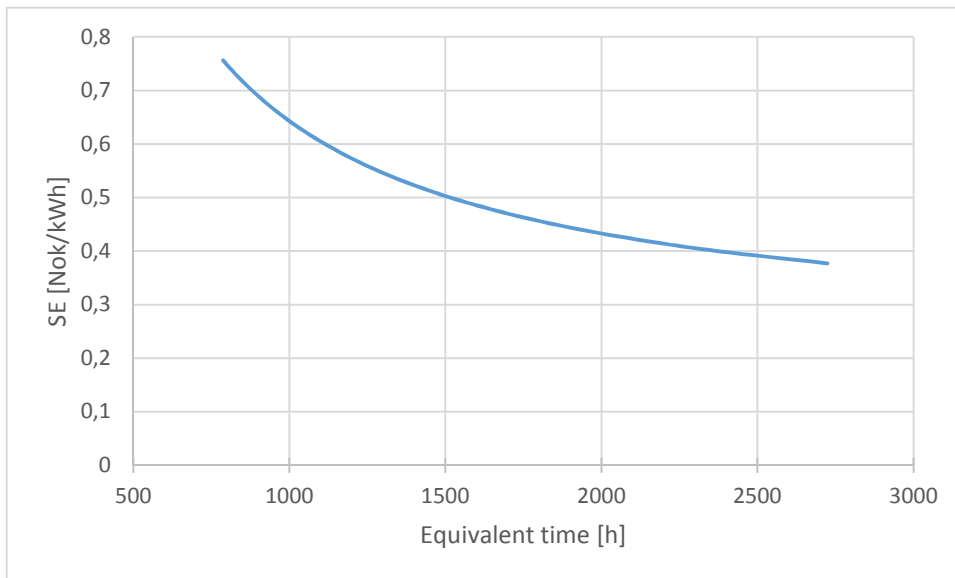

Figure 31. SE in function of Equivalent time for circuit B.

Analyzing the output data above, it was decided to size circuit A with the 55% of the nominal power and circuit B with the 65% of the nominal power; decreasing more the percentages doesn't affect significantly the specific energy price, because the curve becomes flat.

	<b>Building</b>	<b>Simultaneous Peak SH and DHW Load [kW]</b>	
Circuit A			
	Single house - 5	67.23	
	Row house - 6	25.44	
		TOT	92.67
Circuit B			
	Flat - 1	154.90	
	Flat - 2	93.83	
	Flat - 3	92.47	
	Sq. Flat - 4	117.22	
	Flat – a	7.94	
	Flat – b	9.75	
	Flat – c	13.28	
	Flat – d	9.38	
	Flat – e	4.75	
	Flat - f	9.61	
	Flat –g	6.09	
	Flat –h	6.40	
	Flat - i	6.67	
	Flat - m	8.42	
	School - 7	131.72	
	Kindergarten - 8	24.30	
		TOT	696.72

Table 10. Simultaneous peak load for SH and DHW. The values for single houses and row houses don't include the DHW demand.

With the DHSUs theoretically it is possible to decrease the peak value of the DHW thanks to the storage volume.

#### 6.4.3.1 DHSUs

As said in the previous chapters, in circuit B it have been decided to use the DHSUs to lower the peak load and to store the DHW (and a little portion of the SH water) during the summer mode, and in the final project this should be done. Indeed when there will be more data related to the buildings (number of domiciles and their floor area) the average daily DHW consumption could be evaluated, and afterwards it is possible to size the tanks and decrease the corresponding peak value. In this work all the data are not known with a lot of precision, so this procedure cannot be considered; therefore it was decided to assume the DHW as a constant load (in circuit B), that is estimated using the “Simien” values for DHW, which don’t represent a peak value but something similar to an average consumption during the day.

#### 6.4.4 Reach the peak load

After all these evaluations regarding the simultaneous peak load of the system, the heat to fulfil the peak load for the winter worst conditions has to be provided in every building. After an analysis of the mix of sources used for the electric energy production in Norway, it was decided to use electric resistance heaters inside the buildings. This because the electric energy is mostly produced by hydropower plants, those have really low CO<sub>2</sub> emissions, and because the heating demand of the passive buildings is not so high. Thus it is meaningless to install a combustion boiler for such a low singular load (except for the school and kindergarten, but there depends of the usage and the disposition of the internal spaces), emitting more CO<sub>2</sub> in the atmosphere.

<b>Building</b>	<b>Electric Power installed* [kW]</b>	<b>Percentage of peak load [%]</b>
Flat - 1	0.491	35
Flat - 2	0.491	35
Flat - 3	0.491	35
Sq. Flat - 4	1.002	35
Single house - 5	1.205	45
Row house - 6	0.807	45
Flat – a	0.623	35

Flat – b	0.604	35
Flat – c	0.694	35
Flat – d	0.629	35
Flat – e	0.409	35
Flat - f	0.648	35
Flat –g	0.556	35
Flat –h	0.693	35
Flat - i	0.632	35
Flat - m	0.605	35
School - 7	69.314	35
Kindergarten - 8	11.473	35

Table 11. Electrical Power required for each typology building and percentage respect the peak load. \*The values are given for each domicile.

#### 6.4.5 Pipes losses

Even if the district heating is realized with low temperature water and very well insulated pipes the thermal losses cannot be denied. As said in chapter 6.3.3 due to the particular geometry of the twin pipes the heat losses are estimated using a product guide delivered by the manufacturer Uponor.

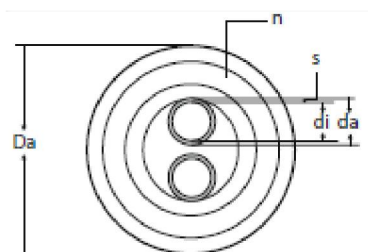

Figure 32. On the left example of twin pipe; on the right sketch of the twin pipe [Uponor,2012].

In particular some nodes were identified in the two circuits and the mass flow of water (kg/s) that is required between two of them to fulfil the thermal load was evaluated, assuming to be in steady-state condition and using the formula:

$$q = \dot{m}c_p\Delta T$$

Where:

q= heat flux [kW]

$\dot{m}$ = mass flow rate [kg/s]

$c_p$ = specific heat capacity [kJ/kg K]

$\Delta T$ = temperature difference between supply and return pipe [°C]

At this point, to use the equation above and select an appropriate pipe, some assumptions were done in addition to the one of chapter 6.3.3:

- The specific heat capacity of the water will be constant in the temperature interval considered
- The supply and return temperature will be respectively 55 and 30 °C for circuit B and 45 and 30°C for circuit A;

The supply temperature in circuit B is higher because it has to be provided the DHW due the IHEUs as said in 6.3.2; furthermore the set return temperature could be compatible with the working temperature of the low-temperature radiators.

Afterwards the mass flow rate in the pipe between each node was converted in kg/h and, together with the heating demand (expressed in kW) sustained by that portion of the net, using the guide for rapid installation of Uponor (Appendix C.1) the possible pipes that could be utilized were found. Always using the guide for rapid installation some expected values were found for the twin and single pipes in those working conditions. The external underground temperature was set to 0°C for the winter calculation. To size the single pipe that will provide the DHW and the 10% of the thermal load (if necessary) in circuit B, the external underground temperature was set to 10°C.

Moreover during the summer season, considering the selected supply and return temperature (8°C and 25°C, see 6.5.2), the mean temperature is really close to the ground temperature; this allows to don't consider any thermal loss from the circuits when they're operated in the summer-mode. The only losses during the summer mode are from the DHW pipe, which still has a great difference between its mean temperature and the ground one.



Figure 33. Sketch of circuit A with nodes. The green lines correspond to the primary circuit and the orange ones to the terminals into the houses.

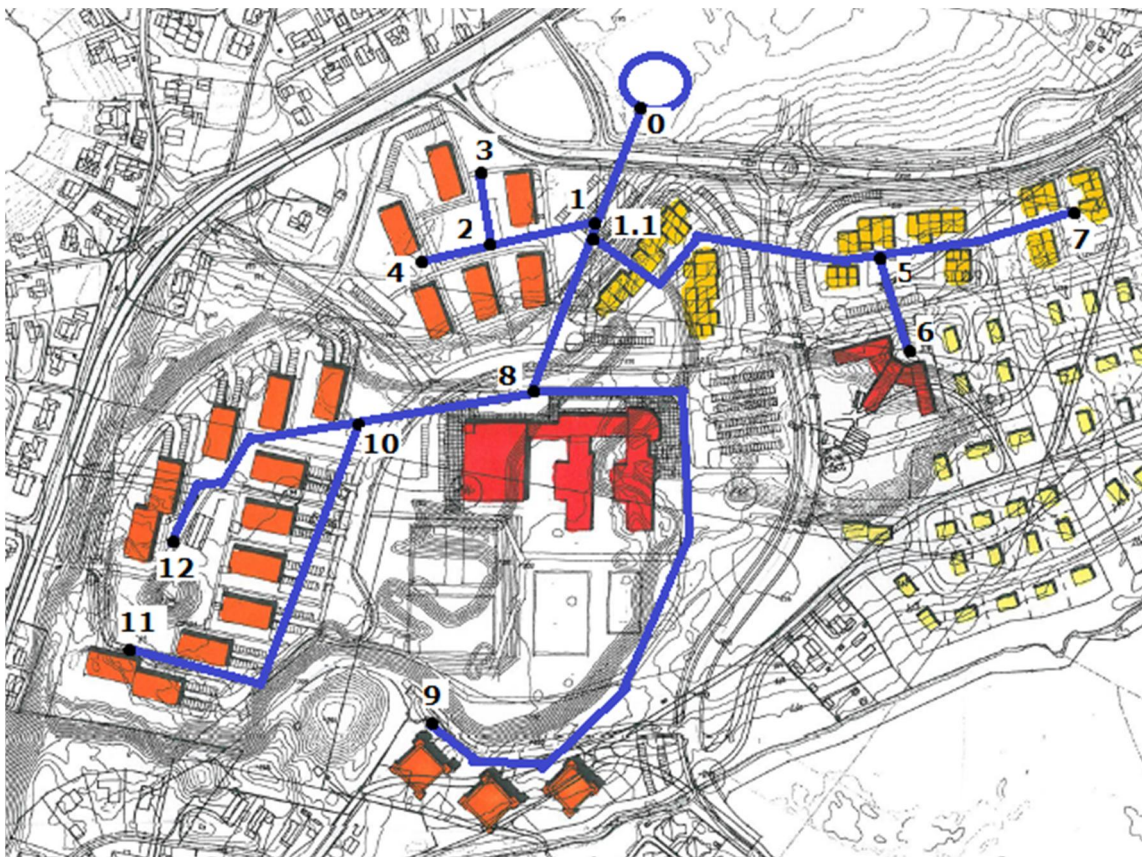

Figure 34. Sketch of circuit B with nodes.



Path	Heat Flux [kW]	$\dot{m}$ [kg/h]	Estimated length [m]	Typology	da*	Heat loss [kW]	Pressure drop [kPa]	Price [NOK]
0-1	101.10	5796.34	100	Twin	50	1.25	69.88	121780
1-2	27.75	1591.16	280	Twin	32	2.52	--	189097
1-3	73.35	4205.18	120	Twin	50	1.50	46.18	146136
3-4	25.12	1440.13	320	Twin	32	2.88	210.67	216111
3-5/6	46.22	2649.84	720	Twin	40	8.64	--	69638
terminals	--	--	1600	Twin	25	13.67	--	927827
					TOT	30.82	326.72	2263910

Table 12. Total heat loss and pressure drop along circuit A. \*da= external diameter of the pipe (inside insulation) using the nomenclature of figure 32.

Path	Heat Flux [kW]	$\dot{m}$ [kg/h]	Estimated length [m]	Typology	da*	Heat loss [kW]	Pressure drop [kPa]	Price [NOK]
0-1	696.71	23967.15	100	Single	110	2.28+1.25	19.13	296281
1-2	92.47	3180.90	80	Twin	40	1	--	73662
2-3	30.82	1060.30	60	Twin	32	0.6	--	40521
2-4	61.65	2120.60	60	Twin	32	0.6	--	40521
1.1-5	106.57	3666.22	244	Twin	50	3.172	--	295610
5-6	24.30	835.84	80	Twin	25	0.68	--	46161
5-7	46.56	1601.78	156	Twin	32	1.56	--	105354
1.1-8	497.67	17120.03	128	Single	90	2.24+1.22	35.04	350336
8-9	117.22	4032	520	Twin	50	6.76	--	632017
8-10	248.73	8556.39	120	Twin	63	2.1	52.66	163534
10-11	138.08	4750.17	284	Twin	50	3.69	150.18	345179
10-12	110.65	3806.22	188	Twin	50	2.44	--	228498
TOT						29.59	257.01	2617676

Table 13. Total heat loss and pressure drop along circuit B. \*da= external diameter of the pipe (inside insulation) using the nomenclature of figure 32.

Path	Heat Flux [kW]	$\dot{m}$ [kg/h]	Estimated length [m]	Typology	da*	Heat loss [kW]	Pressure drop [kPa]	Price [NOK]
0-1	153.17	5269.06	100	Single	50	0.9	60	67801
1-2	17.39	598.35	80	Twin	25	0.56	--	30837
2-3	5.80	199.45	60	Twin	25	0.42	--	23128
2-4	11.60	398.90	60	Twin	25	0.42	--	23128
1.1-5	33.66	1157.82	244	Twin	40	1.95	--	137863
5-6	6.27	215.62	80	Twin	25	0.56	--	30837
5-7	16.25	558.98	156	Twin	25	1.09	--	60132
1.1-8	97.63	3358.37	128	Single	50	1.152	33.33	86786
8-9	21.75	748.28	520	Twin	32	3.9	--	234996
8-10	53.08	1825.98	120	Twin	40	0.96	48.00	67801
10-11	29.93	1029.62	284	Twin	32	2.13	113.60	128344
10-12	26.05	896.01	188	Twin	32	1.41	--	84960
TOT						15.46	254.93	976613

Table 14. Total heat loss and pressure drop along the DHW pipe for the summer mode of circuit B. \*da= external diameter of the pipe (inside insulation) using the nomenclature of figure 32.

In circuit A (table 12), the heat loss and pressure drop are the result of the final choices operated between the possible pipes that the technical manual of Uponor suggested (see Appendix C.2 for thermal losses); operating these choices it has been taken into account that the pipes are built with a maximum working pressure of 6 bar. There are other conditions regarding the pressure that have to be taken into account: the internal resistance in the buildings, that now is unpredictable and that could be estimated around 0.5 bar [Guidelines for Low-Temperature District Heating, 2014[39]], and the minimum static pressure at the beginning of the plant, that should be around 1.5 bar [Dalla Rosa, 2012]. Even if the pressure drops present in the catalogue could be slightly higher compared to the one of this case, the estimation is still good because it has not taken into account the presence of the connections between the pipes. According with the geometry only the path with more resistance was used to evaluate the pressure drop. Regarding the terminals that connect the main pipes to the houses, their length was estimated and even connecting together more domiciles the water mass flow is still so small that the pipes with an external diameter of 25mm (smallest in the catalogue) are oversized. That's why some values are not reported and they're not considered in the evaluation of the pressure drop, which anyway will not change a lot since the small amount of mass flow in the farthest points from the heat pump.

In the table is given a price estimation of the pipes based on the Uponor price catalogue of 2015 [40, reported in Appendix C.3]; the original prices are in Euro, to convert them was adopted a changing value that is the average of the last five days, so with the reference day of 23/12/2015 the change €:NOK is 1:9,52.

Even for circuit B (table 13 and 14) the same considerations of circuit A are valid regarding heat loss, pressure drop and economic cost estimation. Even in the case of table 14 almost all the pipes with a "da" equal to 25 are oversized (more heat loss and less pressure drop), but they are the smallest one in the catalogue (Appendix C.1).

In particular the DHW pipe for the summer mode of circuit B was sized for the sum of the full load of DHW and the 10% of the thermal load. As said before the DHSUs allow to decrease the peak load of the DHW but this is not taken into consideration in this work because of the uncertainty related to the buildings' area and to the number of domiciles; furthermore in this configuration the hot water is used to fulfill also the simultaneous heat load, that cannot be estimated precisely in this phase of the project. It was decided to size the pipe of the DHW adding the 10% of the SH demand, because it was thought that if the cooling load is simultaneous with the heating load, the heating load should not be so big; obviously it is only a supposition, but it is not possible to evaluate the simultaneous cooling and heating load at this point of the project.

It has to be noticed that for the cooling mode it is better to size the peak power to the 100% of the load, to be sure to fulfil the cooling load without installing other cooling systems. Furthermore pipe losses are not evaluated in the summer mode because the mean temperature in the pipes are close to the ground temperature, so they can be neglected; having a look to the obtained cooling loads it can be seen that they're lower compared to the heat loads, so it is clear that the pipes, being sized with the heating load, are able to sustain the cooling load without any problem.

#### 6.4.6 Final estimation

Taking into account all the consideration related to the heat losses along the pipes, maintaining the same percentage of peak load, the real size of the heat pump is around 131kW for circuit A and 726kW for circuit B.

Knowing this, the specific energy price and the Simple payback time could be evaluated again, obtaining:

	<b>SE [NOK/kWh]</b>	<b>SPB [years]</b>	<b>Pump size</b>	<b>Percentage peak load</b>
Circuit A	0.58125	8.760	131.56	0.781
Circuit B	0.59449	8.908	726.30	0.696

Table 15. New evaluation of SE and SBP considering the thermal losses.

Considering these pump sizes and the working temperatures, some economical and technical data were asked to the company "Johnson Controls" about some of their "heat package", those could suite for this work.

To reach the objective could be used (see chapter 6.5 for the description):

- 2x HeatPAC108SV-C for circuit B (maximum power 387kW)
- 1x HeatPAC28V-C

So adjourning another time the values of SE and SPB with the data made available by the "Johnson Controls" company it is obtained:

	SE [NOK/kWh]	SPB [years]	Pump size	Percentage peak load
Circuit A	0.58125	8.760	131.56	0.781
Circuit B	0.55946	8.068	726.30	0.696

Table 16. New evaluation of SE and SBP considering the economical data of “Johnson Controls”.

The economical data furnished don't includes pumps, pipes, valves (on the brine sides), transport, refrigerant, intermediate HEX, HEX for DHW in summer mode (circuit B) and work on the site, so, including only the cost of the heat pump itself, they can be used to directly compare the new SE and SBP with the previous ones. For circuit A the initial investment cost estimation was right so it SE and SPB weren't modified in the last table, but in circuit B there is a sensible difference on the investment cost (NOK/kW) and this makes the SE and the SPB significantly lower.

## 6.5 Heat pumps modelling

It was decided to build a model on EES [F-Chart Software, 2015] to evaluate the surface of the intermediate HEX, the DWH HEX and to know the mass flow of the groundwater; so to do it and run it, some assumptions were done related to the site itself and to the scope of this work. They can be summarized as follows:

- a) Absence of any pressure drop inside the HEX
- b) The suction line and the liquid line are already optimized
- c) Groundwater temperature assumed constant as 7°C
- d) Plate heat exchangers with high number of plates
- e) Heat transfer coefficient of the intermediate HEX as the lower between evaporator and condenser
- f) Supply and return temperature are constant
- g) Know the isoentropic and the volumetric efficiency curves of the compressor
- h) Intermediate HEX with a brine of Ethyl Alcohol (35% vol.)
- i) 0.82 and 2 °C of subcooling out of the condenser respectively in winter and summer mode
- j) The maximum pressure difference from inlet and outlet of the compressor is 20 bar
- k) Two HeatPAC108SV-C will be used for circuit B and the load will be divided equally

- l) Absence of heat exchange and pressure drops in the 4-way valve
- m) 35°C as minimum condensing temperature

So it was not modelled with an extreme precision the heat pump itself (HEXs, lamination device and compressor), but it was searched to describe what happen when the load of the system change. Some of these assumptions are related to the documentation sent by “Johnson Controls” (*d, b, g, h, i, j, m*), others have geological (*c*) and operating (*a, e, f, l*) motivations. In particular the curves for the efficiencies of the compressor (*g*) were built interpolating six values for each one of them, which were obtained analyzing the output data of the two compressors in three different working conditions (see Appendix E.1).

This assumptions imply other constrains to the system:

- Combining *c, d, e, l* and *a*, the temperature levels in the intermediate HEX and in the HEX between the brine and the working fluid can be assumed, so the working fluid temperature can be fixed too (evaporation temperature in winter).
- Combining *f, d, l, l* and *a*, the temperature levels in the HEX between the water circuit and the working fluid can be assumed (condensation temperature in winter).
- Considering the previous two points, the temperature levels of the cycle are fixed and with them is fixed the pressure ratio (remembering to don't go against *j*).
- Combining *d* and *e* with the heat exchange coefficients in the data sheet furnished by “Johnson Controls” it is possible to estimate the surface area that is needed to dissipate/acquire the heat (high number of plates, i.e. more than 50, means perfect counter-flow), obviously the useful data for the dimensioning of the intermediate HEX is the one at the nominal load.

Running the simulations the needed mass flows of groundwater and brine to fulfill the heating/cooling request and the COP of the system in different conditions (fixed pressure ratio) will be obtained.

This is not a dynamic simulation where the thermal load varies with the external air temperature, because now in the site there aren't enough data regarding the behavior of the passive buildings related to the external temperature and solar radiation exposure, especially during the summer period (for the reason said in chapter 6.4.2). Furthermore in the evaluation of all the COPs the required power from the brine pumps, the well pumps and the circuit water pumps are not considered.

Another assumption is that in all the pipes that are inside the heat pump and between the heat pump and the surface of the soil there aren't thermal losses and pressure drops.

During the following simulations the main components for each of the two heat-packs are:

- 1x Single stadium ammonia compressor
- 1x Plate HEX evaporator (in winter mode)
- 1x Plate HEX condenser (in winter mode)
- 1x Isoenthalpic Throttling device
- 1x Intermediate HEX

In Appendix D all the data regarding the Heat-packs could be found, except for the Intermediate HEXs, which will be defined during the simulation itself.

As said before during the simulations the total isentropic efficiency will be used, which take as reference the shaft power; but it has to be said that the electric efficiency of the motor of the compressors for circuit B is 95% and the one of the motor of the compressor for circuit A is 94%.

#### 6.5.1 Winter mode

To estimate the temperature in the HEX the method presented in chapter 6.5 is used, paying attention that the groundwater cannot freeze in the HEX, so it was decided to set 1.5°C as outlet temperature; moreover it has been decided to use 1°C as temperature difference, to guarantee the heat exchange, at both the two sides of the HEX, even if, having a look to the datasheet of “Johnson Controls” it could be reduced. The supply and the return temperature are the same of chapter 6.4.5 and it is supposed that the intermediate HEX in both the circuits has a U-value of 958 W/m<sup>2</sup>K, like the condenser in circuit A.

	$T_2$ [°C]	$P_{cond}$ [bar]	$P_{evap}$ [bar]	$r_p$	$T_{cond}$ [°C]	$T_{evap}$ [°C]	$\eta_{iso,tot}$	$\eta_{vol}$
Circuit A	138.5	18.31	4.06	4.509	46	-1.5	0.7458	0.7572
Circuit B	160.8	23.69	4.06	5.835	56	-1.5	0.7787	0.7363

Table 17. In the table are reported for the nominal working conditions of the two circuits in sequence: temperature output compressor, condensation pressure (inlet condenser), evaporation pressure, pressure ratio, condensation temperature (inlet of condensed, remember of subcooling on outlet), evaporation temperature, total isentropic efficiency of the compressor (related to shaft power), volumetric efficiency of the compressor.



	$\dot{m}_{amm}$ [kg/s]	$\dot{m}_{eth}$ [kg/s]	$\dot{m}_{gw}$ [kg/s]	$A_{intHEX}$ [m <sup>2</sup> ]	$A_{Cond}$ [m <sup>2</sup> ]	$A_{Evap}$ [m <sup>2</sup> ]	$COP_{HEAT}$
Circuit A	0.1337	4.732	3.972	36.31	26.46	19.71	3.311
Circuit B	0.3033	13.35	11.21	102.4	49.08	63.41	3.489

Table 18. In the table are reported for the nominal working conditions of the two circuits in sequence: mass flow of ammonia, mass flow of ethyl alcohol (35%) brine, mass flow of groundwater, estimated heat exchange surface of the intermediate HEX, theoretical areas of condenser and evaporator (with U-values from datasheets) and COP heating mode.

In the simulation the specific heat of the ethyl alcohol brine was evaluated (fixing the pressure) as:

$$c_{p,brine} = c_{p,water@277K} \times 0.65 + (c_{p,eth@inlet\ temp} + c_{p,eth@outlet\ temp})/2 \times 0.35$$

Anyway it is interesting to see how the obtained nominal COPs are similar to the ones adopted for the economical evaluation of the previous chapter; in particular the previous value was about 0.54 points higher in the case of circuit A and 0.62 points lower in the case of circuit B.

Only with the scope of showing how the COP of the systems will change working at a partial load, that is a typical condition during the year, some simulations were done decreasing the loads and the work of the compressors, according to the correlation between swept volume and shaft power in Appendix E.2, after having fixed the shaft power, the cooling capacity and the heating capacity obtained from this first simulation as nominal values. Since each compressor have 8 pistons, it was decided to decrease the nominal load, from the maximum to zero, in eight steps with the same amplitude, i.e. switching off one piston more in the compressor each time.

$\text{Load}_{\text{HEAT}}$ [kW]	Percentage	$W_{\text{comp}}$ [kW]	$\text{COP}_{\text{HEAT}}$	$\dot{m}_{\text{amm}}$ [kg/s]	$\dot{m}_{\text{eth}}$ [kg/s]	$\dot{m}_{\text{gw}}$ [kg/s]
131.6	100	39.74	3.311	0.1337	4.732	3.972
116.1	88.26	35.77	3.246	0.1204	4.14	3.476
100.7	76.51	31.79	3.166	0.107	3.549	2.979
85.21	64.77	27.82	3.063	0.09362	2.957	2.483
69.75	53.02	23.84	2.925	0.08025	2.366	1.986
54.3	41.28	19.87	2.733	0.06687	1.774	1.49
38.85	29.53	15.9	2.444	0.0535	1.183	0.9931
23.4	17.79	11.92	1.963	0.04012	0.5915	0.4965

Table 19. Partialization of the load of Circuit A in winter conditions.

It has to be noticed that in Circuit A there are 30.46kW of thermal losses, so the system will never work on a partial load lower than 23.15%; this means that the last value for the COP while the compressor is working is around 2.

$\text{Load}_{\text{HEAT}}$ [kW]	Percentage	$W_{\text{comp}}$ [kW]	$\text{COP}_{\text{HEAT}}$	$\dot{m}_{\text{amm}}$ [kg/s]	$\dot{m}_{\text{eth}}$ [kg/s]	$\dot{m}_{\text{gw}}$ [kg/s]
363.2	100	104.1	3.489	0.3033	13.35	11.21
320.4	88.23	93.69	3.42	0.273	11.68	9.808
277.6	76.44	83.28	3.333	0.2426	10.01	8.407
234.8	64.66	72.87	3.222	0.2123	8.345	7.006
192	52.87	62.46	3.074	0.182	6.676	5.605
149.2	41.09	52.05	2.867	0.1517	5.007	4.203
106.4	29.30	41.64	2.556	0.1213	3.338	2.802
63.62	17.52	31.23	2.037	0.09099	1.669	1.401

Table 20. Partialization of the load of Circuit B in winter conditions.

It has to be kept in mind that in circuit B there are two compressors working together, so if one is switched off it is possible to work with a higher COP with small loads. In particular

here the thermal losses are 29.594kW, so the compressor will work only until the 4.08% of the nominal load.

What said just before regard the load to switch-on and off the compressor is only an example to explain the working range. In reality there are a lot of controls in this system that will be decided in agreement with the designers of the system, doing an optimization between the operative and the investment costs. For example could be implemented some controls to have a more precise regulation of the swept volume during the partial load or decide a minimum load to turn on the system (in this case the low heating load could be fulfilled by the electric radiators installed in the buildings and the DHSUs will give some time of autonomy for the DHW in circuit B).

### 6.5.2 Summer mode

During the simulation it is assumed that for both the circuits the supply and the return temperatures are respectively 8°C and 25°C. It has to be noticed that these temperatures depend on which kind of cooling system will be installed, but assuming temperature differences of 5°C at the inlet and the outlet of the final heat exchangers these values are reasonable. Furthermore, even if it is not clear if the groundwater will be reinjected or not, it was decided that the maximum outlet temperature for the groundwater from the intermediate HEX it has to be 5°C more than the inlet, so 12°C. Furthermore the condensing temperature was set to 35°C, the minimum value for the Heat-packs according with the assumptions of chapter 6.5, and the supply temperature of the DHW is 55°C (as in chapter 6.5.1).

In these simulation the thermal characteristics (W/K) of the heat exchangers are fixed equal to the one obtained in the winter simulation, doing so it is maintained the same geometry and dimension of the already modelled HEXs; obviously in the reality this is not true, because even if the heat exchange surfaces are the same the U-values will change a little according with the new working temperatures of the HEXs, but this could be neglected. Doing this operation are obtained the ethyl alcohol temperatures and evaporation temperature.

Another time the load of circuit B was divided equally between the two heat pumps. Furthermore it was decided to utilize in the DHW production a HEX with the same global heat exchange coefficient of the HEX between ammonia and ethyl alcohol 35%vol (so 981.85 W/m<sup>2</sup>K).

	$T_2$ [°C]	$P_{\text{cond}}$ [bar]	$P_{\text{evap}}$ [bar]	$r_p$	$T_{\text{cond}}$ [°C]	$T_{\text{evap}}$ [°C]	$\eta_{\text{iso,tot}}$	$\eta_{\text{vol}}$
Circuit A	124.5	13.51	3.174	4.256	35	-7.828	0.745	0.7653
Circuit B (DHW)	119	13.51	3.262	4.141	35	-7.139	0.7694	0.802
Circuit B (DHW+SH)	119	13.51	3.262	4.141	35	-7.139	0.7694	0.802

Table 21. In the table are reported for the nominal working conditions of the two circuits in sequence: temperature output compressor, condensation pressure (inlet condenser), evaporation pressure, pressure ratio, condensing temperature (inlet of condensed, remember of subcooling on outlet), evaporation temperature, total isentropic efficiency of the compressor (related to shaft power), volumetric efficiency of the compressor.

	$\dot{m}_{\text{amm}}$ [kg/s]	$\dot{m}_{\text{eth}}$ [kg/s]	$\dot{m}_{\text{gw}}$ [kg/s]	$\text{COP}_{\text{COLD}}$
Circuit A	0.1071	1.687	5.885	3.111
Circuit B (DHW only)	0.2686	4.248	14.84	4.328
Circuit B (DHW+0.05SH)	0.269	3.563	12.49	5.018

Table 22. In the table are reported for the nominal working conditions of the two circuits in sequence: mass flow of ammonia, mass flow of ethyl alcohol (35%) brine, mass flow of groundwater and COP cooling mode.

In circuit B the COP in cooling mode is affected positively by the production of hot water on the condenser side, indeed when the production of the hot water for SH is not considered, the COP decreases.

Furthermore it is obtained that in circuit B to fulfil the DHW and SH demand (full load) it is necessary a heat exchange surface of 2,853 m<sup>2</sup>, assuming that the ammonia exits from it with a temperature of 36°C, so one degree more of the condensation temperature.

It has to be remembered that the results for circuit B are done on half of the cooling and DHW/SH loads, because are used two heat-packs to fulfil the total load, therefore two DHW HEX will be present in the real system.

As it was done in the previous chapter now a simulation fixing the same nominal parameters will be operated (using the correlation in Appendix E.2), to see how the COPs change running the system at a partial load.

Furthermore the same assumptions to vary the nominal load will be done, i.e. switching off one piston per time.

<b>Load<sub>COLD</sub> [kW]</b>	<b>Percentage</b>	<b>W<sub>comp</sub> [kW]</b>	<b>COP<sub>COLD</sub></b>	<b><math>\dot{m}_{amm}</math> [kg/s]</b>	<b><math>\dot{m}_{eth}</math> [kg/s]</b>	<b><math>\dot{m}_{gw}</math> [kg/s]</b>
93.59	100	30.08	3.111	0.1071	1.687	5.885
81.89	87.5	27.07	3.025	0.09613	1.445	5.185
70.19	75	24.06	2.917	0.0853	1.215	4.486
58.49	62.5	21.06	2.778	0.07458	0.9973	3.786
46.79	50	18.05	2.593	0.06391	0.7893	3.086
35.09	37.5	15.04	2.334	0.05325	0.4937	2.386
23.4	25	12.03	1.945	0.0426	0.4032	1.686
11.7	12.5	9.024	1.296	0.03195	0.1646	0.9862

Table 23. Partialization of the load of Circuit A in summer conditions.

<b>Load<sub>COLD</sub> [kW]</b>	<b>Percentage</b>	<b>W<sub>comp</sub> [kW]</b>	<b>COP<sub>COLD</sub></b>	<b><math>\dot{m}_{amm}</math> [kg/s]</b>	<b><math>\dot{m}_{eth}</math> [kg/s]</b>	<b><math>\dot{m}_{gw}</math> [kg/s]</b>
275.2	100	71.51	4.328	0.2686	4.248	14.84
240.8	87.5	64.48	4.275	0.2397	3.579	12.86
206.4	75	57.31	4.210	0.2114	2.945	10.89
172	62.5	50.15	4.125	0.1841	2.343	8.91
137.6	50	42.98	4.013	0.1574	1.77	6.932
103.2	37.5	35.82	3.855	0.131	1.225	4.954
68.79	25	28.66	3.618	0.1048	0.7101	2.976
34.39	12.5	21.49	3.224	0.07859	0.2382	0.9987

Table 24. Partialization of the load of Circuit B (only DHW) in summer conditions.

Load <sub>COLD</sub> [kW]	Percentage	W <sub>comp</sub> [kW]	COP <sub>COLD</sub>	$\dot{m}_{amm}$ [kg/s]	$\dot{m}_{eth}$ [kg/s]	$\dot{m}_{gw}$ [kg/s]
275.2	100	71.51	5.018	0.2686	3.575	12.49
240.8	87.5	64.48	5.042	0.2397	2.925	10.51
206.4	75	57.31	5.072	0.2114	2.309	8.535
172	62.5	50.15	5.111	0.1841	1.725	6.558
137.6	50	42.98	5.162	0.1574	1.169	4.58
103.2	37.5	35.82	5.235	0.131	0.6435	2.602
68.79	25	28.66	5.343	0.1048	0.149	0.6245
34.39	12.5	21.49	--	--	--	--

Table 25. Partialization of the load of Circuit B (DHW+0.05SH) in summer conditions.

As can be seen in the previous table in Circuit B the COP is really high because to produce the hot water is used the residual heat of the condenser. It must be noticed that if the sum of cooling load and shaft power is not enough it is not possible to cover all the SH demand; so, as said before, according to the selected controls the system will solve this. For example it could be decided to run the pump without fulfilling the SH demand and to reach it with the electric radiators, but this should be decided in the next stages of the project. Another control, that could be implemented to save energy, is to use free-cooling if the external air temperature allows it, so using the air temperature as cold sink where reject the heat during the night in the summer mode.

It is also to be said that is improbable that in the site there will be the 100% of the cooling load and simultaneously the 10% of the heating load, so the COP of the two heat-pack that work together at the nominal condition is not properly the one evaluated here; but this could be accepted at this point of the project.

### 6.5.3 Final Considerations

In addition to all the considerations related to the COP, the system controls and the heat exchangers, which were done in chapter 6.5.1 and 6.5.2, after the simulation of both the working modes it could be said that the well-pump(s) of both the circuits have to be sized to fulfil the summer-mode mass flow rate at the nominal load, because they are the highest values. Regarding the circulation pump(s) of the intermediate brine (ethyl alcohol

35%) nothing was said regarding them, so it is left to a future work to choose the right ones, paying attention that they will be able to fulfill the mass flow rate needed in the winter-mode at the nominal load for the same reason of the well-pump(s).

## 7 Conclusions and suggestions

With this work it was evaluated the possibility to fulfil the heating and cooling load of the Ydalir passive house district using a low-temperature district heating system operated with groundwater ammonia heat pumps. From the environmental point of view it is a very good choice, because it prevents the CO<sub>2</sub> emissions related to the consumption of fossil fuels and moreover using a natural refrigerant as working fluid all the environmental direct impact (GWP and OPD) is negligible; obviously, if an LCA from cradle to grave will be operated, some emissions will be founded during the production, the construction and the dismantling, but in this work the comparison should be done only during the working life-time. With these assumptions a system design was proposed and sized, obtaining some economic outputs justifying the investments; it has to be noticed that even if the simple payback period, evaluated in a simplify way (using only heat pumps specific investment cost) is around 10 years, the certified life-time of the pipes is around 50 years. In the end it was operated a simulation to quantify the needed groundwater mass flow and see how the COPs change working in a partial load conditions, both of them to give an order of magnitude for future works.

The results of this work are affected by some necessary assumptions, which were made to proceed with the analysis. So was thought about some suggestions to improve the accuracy of the calculations for further works:

- Know precisely the buildings data: in this work some values were guessed starting from the planimetry, so to have a more accurate thermal evaluation it is mandatory to know more precisely the buildings (typology, floor areas, number of floors, apartment per floor,...).
- Thermal and DHW demand: as consequence of the previous suggestion, if the data of the site are more precise, the space heating/cooling and DHW demand could be evaluated with more precision and the real DHW peak power (based on the real demand and not on the “Simien” values) could be lowered significantly due to the DHSUs (those now can be sized).
- Heat pumps location: it was assumed that the heat pumps are located on the north region of the site out of the building area, but it has to be investigated where really is the aquifer; if it is inside the building area probably the pipes will be smaller (lower investment cost and heat loss), but the heat pump must be sealed

in a room with some scrubbers to avoid the ammonia contamination of the public spaces, related to a possible leakage (more investment costs).

- Borehole and well pump: in this work was only evaluated the groundwater mass flow rate that is needed by the system to work, so the designing of the underground system and the fulfilling of the groundwater demand is left for future works.
- Return temperatures: the return temperatures were chosen arbitrarily according to the working conditions of the heating and cooling systems hypothesized, so it is suggested to set them according to the constructor's desires (very important on the pipe sizing).
- Supply temperatures: in circuit B the supply temperature is related the minimum DHW temperature to avoid legionella threats; by the way in a future work the system could be sized using a low-temperature treatment for legionella (see Appendix B), lowering the supply temperature.
- Pipes: it was chosen a manufacture to obtain some data for the estimation, so the suggestion is to search more commercial proposals from other manufactures; in particular it can be searched some pipes to substitute the oversized "da25" (see chapter 6.4.5), it could be evaluated the possibility of a triple pipe insulated tube to provide the DHW in circuit B during the summer season and could be estimated the number of the connection devices. Moreover it could be evaluated with more precision the thermal loss and the pressure drop in the pipes (and connections), allowing a proper sizing of the circulation pumps, and, according to the position of the heat pumps in the site, the pipes used have to be evaluated another time, maybe changing the shape of the circuits.
- Exergy analysis: summing all the previous suggestion the site and the system will be evaluated in a better way, so more components could be described, and with this knowledge an exergy analysis could be operated, to see where the losses are and try to improve the performance of the system.
- Dynamic simulation of the buildings thermal behavior: the loads in the sizing procedure are assumed at their peak, but during the year they will assume different values; so could be interesting to have a correlation between the outdoor temperature and the thermal load (behavior of the envelope) for passive buildings. In particular, since that the solar gains are as important as the heating load, to have a very precise evaluation it should be evaluated properly the effect of the shading factor between the flats and in the same flat the difference between apartments on the north and on the south facade.



- System controls: in this paper it was only assumed their existence, so the next step is to choose and implement them to optimize the system after knowing its dynamics.
- Economic evaluation: in this paper was assumed a static COP and only the heat pump investment cost (according to what said in chapter 6.4.6) and obviously both of them don't correspond to the reality; by the way, taking into consideration all the suggestions, it will be possible to evaluate a seasonal performing factor instead of the COP (especially with the dynamic simulation and the controls implementation) and, knowing the system with a higher level of detail, it could be possible to estimate the real specific investment price (NOK/kW); an example of this calculation could be founded in the "Annex X" [Dalla Rosa et al., 2014]. Probably the SPB will be more than 10 years, so it is suggested to use the "discounted payback", because it has to be taken into consideration the inflation (value of money related to the time).

## References

- [1] Dickson M. H., Fanelli M. 2004. What is Geothermal Energy? Istituto di Geoscienze e Georisorse, CNR, Pisa, Italy [http://www.geothermal-energy.org/what\\_is\\_geothermal\\_energy.html](http://www.geothermal-energy.org/what_is_geothermal_energy.html)
- [2] Banks D. 2012. An Introduction to Thermology. Wiley. Second Edition. ISBN: 978-0-470-67034-7
- [3] Kavanaugh S., Rafferty K. 2014. Geothermal Heating and Cooling: Design of Ground-Source Heat Pump Systems. ASHRAE. ISBN: 9781936504855
- [4] Atam E., Helsen L. 2015. Ground-coupled heat pumps: Part2—Literature review and research challenges in optimal design. Renewable and Sustainable Energy Reviews (<http://www.sciencedirect.com/science/article/pii/S1364032115006565> )
- [5] Granryd E. et al. 2011. Refrigeration Engineering Part. Royal Institute of Technology, KTH, Stockholm, Sweden. ISBN 978-91-7415-415-3
- [6] Eslami-Nejad P., Ouzzane M., Aidoun Z. 2013. Modeling of a two-phase CO<sub>2</sub>-filled vertical borehole for geothermal heat pump applications. Applied Energy 114 (2014) 611–620
- [7] Vivian J., Manente G., Lazzaretto A. 2015. A general framework to select working fluid and configuration of ORCs for low-to-medium temperature heat sources. Applied Energy 156 (2015) 727–746
- [8] Wei G. et al. 2015. Performance analysis on a hot dry rock geothermal resource power generation system based on Kalina cycle. The 7th International Conference on Applied Energy – ICAE2015. Energy Procedia [Volume 75](#) ( 2015 ) 937 – 945
- [9] Lund J.W., Boyd T.L, 2015. Direct Utilization of Geothermal Energy 2015 Worldwide Review. Proceedings World Geothermal Congress 2015
- [10] Paksoy H.O. et al. 2004. Aquifer thermal storage (ATES) for air-conditioning of a supermarket in Turkey. Renewable Energy 29 (2004) 1991–1996
- [11] Cavallini A., Del Col D., Doretti L., Zillio C. 2007. I fluidi frigoriferi: processi di sostituzione e nuove frontiere tecnologiche. <http://hdl.handle.net/11577/2429143>
- [12] US Environmental Protection Agency (EPA) <http://www.epa.gov/ozone/snap/subsqwps.html>

- [13] Devecioğlu A. G., Oruç V. 2015. Characteristics of Some New Generation Refrigerants with Low GWP. The 7th International Conference on Applied Energy – ICAE2015. Energy Procedia 75 ( 2015 ) 1452 – 1457
- [14] Mota-Babiloni et al. 2015. Analysis based on EU Regulation No 517/2014 of new HFC/HFO mixtures as alternatives of high GWP refrigerants in refrigeration and HVAC systems. International Journal of Refrigeration 52 ( 2015 ) 21e31
- [15] He Mao-Gang et al. 2014. Application of natural refrigerant propane and propane/isobutene in large capacity chest freezer. Applied Thermal Engineering 70 (2014) 732e736
- [16] D. Colbourne, K.O. Suen, Comparative evaluation of risk of a split air conditioner and refrigerator using hydrocarbon refrigerants, *International Journal of Refrigeration* (2015), <http://dx.doi.org/doi:10.1016/j.ijrefrig.2015.06.026>
- [17] Fernando P. et al. 2004. Propane heat pump with low refrigerant charge: design and laboratory tests. International Journal of Refrigeration 27 (2004) 761–773
- [18] Jensen J.K. 2014. Technical and economic working domains of industrial heat pumps: Part 2 e Ammonia-water hybrid absorption-compression heat pumps. International Journal of Refrigeration 55 ( 2015 ) 183e200
- [19] Ommen T. et al. 2015. Technical and economic working domains of industrial heat pumps: Part 1 e Single stage vapour compression heat pumps. International Journal of Refrigeration 55 ( 2015 ) 168e182
- [20] Cavallini A., Da Riva E., Del Col D. 2009. Performance of a large capacity propane heat pump with low charge heat exchangers. International journal of refrigeration 33 ( 2010 ) 242–250
- [21] Eikevik T.M., Tolstorebov I. 2014. Next Generation of Heat Pumps working with Natural fluids: Review of standards for Hydrocarbones and CO<sub>2</sub>
- [22] Cavallini A., Del Col D., Rossetto L. 2012. Heat transfer and pressure drop of natural refrigerants in minichannels (low charge equipment). International journal of refrigeration 36 ( 2013 ) 287e300
- [23] Chinellato M. 2013. Master Thesis. Supervisor: De Carli M., Zarrella A.; University of Padova. Title: Effetto del congelamento del terreno sulle prestazioni delle pompe di calore geotermiche
- [24] <http://www.edilizianews.it/articolo/20277/gli-impianti-con-acqua-di-superficie>

[25] ASHRAE Handbook 2011, HVAC Applications, Chapter 34 – Geothermal Energy, ASHRAE, Atlanta, GA, 2011

[26] [http://www.whitepavilion.com.cn/?page\\_id=186](http://www.whitepavilion.com.cn/?page_id=186)

[27] <https://en.wikipedia.org/wiki/Elverum>

[28] J. Alonso M., Stene J., Bantle M., Georges L., 2015, Simulations of Heat Pumps for Nearly Zero Energy Buildings Country Report IEA HPP Annex 40, Task 2 – NORWAY. It will be published soon on ZEB (<http://www.zeb.no>)

[29] Meteotest, 2015: Meteonorm v7.1.X. Meteonorm is a database for weather and climate data that utilizes a worldwide net of weather stations.

[30] <https://www.google.no/maps/@60.8901312,11.5697312,14.13z> , Ydalir geographical position

[31] <http://www.elverumvekst.no/boligtomter/tomteomrader/ydalir> , Elverum commune website

[32] Kristjansson H., Bøhm B. 2006. Optimum Design of Distribution and Service Pipes, Danfoss, EH&P IV/2006, (Presented at 10th International Symposium District Heating and Cooling 2006, Hanover) [http://heating.danfoss.com/pcmpdf/technical\\_article\\_optimumdesign\\_lores.pdf](http://heating.danfoss.com/pcmpdf/technical_article_optimumdesign_lores.pdf)

[33] Dalla Rosa A., 2012. The Development of a new District Heating Concept: Network Design and Optimization for Integrating Energy Conservation and Renewable Energy Use, PhD Thesis, DTU Civil Engineering Report R-269 (UK)

[34] Uponor, 2012. Pre-Insulated Piping Systems Installation and Technical Guide <https://www.uponor.co.uk/~media/countryspecific/uk/download-centre/general/preinsulated-pipe-tech-guide.pdf?version=1>

[35] Li H., Svendsen S. 2012. Energy and exergy analysis of low temperature district heating network. Energy 45 (2012) 237e246

[36] <http://www.nordpoolspot.com/Market-data1/Elspot/Area-Prices/SYS1/Yearly/?view=table>

[37] Norsk Standard NS 3701:2012, Kriterier for passivhus og lavenergibygninger Yrkesbygninger – Criteria for passive houses and low energy buildings Non-residential buildings

[38] Dalla Rosa A., Li H., Svendsen S., Werner S., Persson U., Ruehling K., Felsmann C., Crane M., Burzynski R., Bevilacqua C. , Date of Publication: 2014-09-01, Annex X

Final report, Toward 4th Generation District Heating: Experience and Potential of Low-Temperature District Heating short title: Toward 4th Generation District Heating, IEA DHS/CHP [http://energia.fi/sites/default/files/iea\\_annex\\_x\\_final\\_report\\_2014\\_-\\_toward\\_4th\\_generation\\_district\\_heating.pdf](http://energia.fi/sites/default/files/iea_annex_x_final_report_2014_-_toward_4th_generation_district_heating.pdf)

[39] Guidelines for Low-Temperature District Heating, 2014, Editors of the guidelines, Olsen P.K., COWI A/S (Project Manager); Christiansen C. H., Danish Technological Institute; Hofmeister M., Danish District Heating Association; Svendsen S. / (Dalla Rosa A.), Technical University of Denmark; Thorsen J.E. / Gudmundsson O./ Brand M., Danfoss District Energy [https://setis.ec.europa.eu/energy-research/sites/default/files/project/docs/Guidelines%20for%20LTDH-final\\_rev1.pdf](https://setis.ec.europa.eu/energy-research/sites/default/files/project/docs/Guidelines%20for%20LTDH-final_rev1.pdf)

[40] <https://www.uponor.fr/~media/countryspecific/france/services/tarifuponor20151.pdf?version=1>

[41] <http://mcdp hegaskets.weebly.com/>

[42] <http://www.ref-wiki.com/content/view/31188/28/>

[43] <http://nypassivehouse.org/why-passive-house/>

[44] J. Alonso M., Stene J., 2013, State-of-the-Art Analysis of Nearly Zero Energy Buildings Country Report IEA HPP Annex 40 Task 1 – NORWAY, <http://www.zeb.no/index.php/reports/item/406-state-of-the-art-analysis-of-nearly-zero-energy-buildings-country-report-iea-hpp-annex-40-task-1-norway>

[45] EES, 2015, F-Chart Software <http://www.fchart.com/ees/> , (Engineering Equation Solver) is a general equation-solving program that can numerically solve thousands of coupled non-linear algebraic and differential equations (contains NASA and REFPROP databases)

## Appendix

In this section could be found some documents used for the calculations in the work.

### A. 3D draw or Ydalir in Elverum

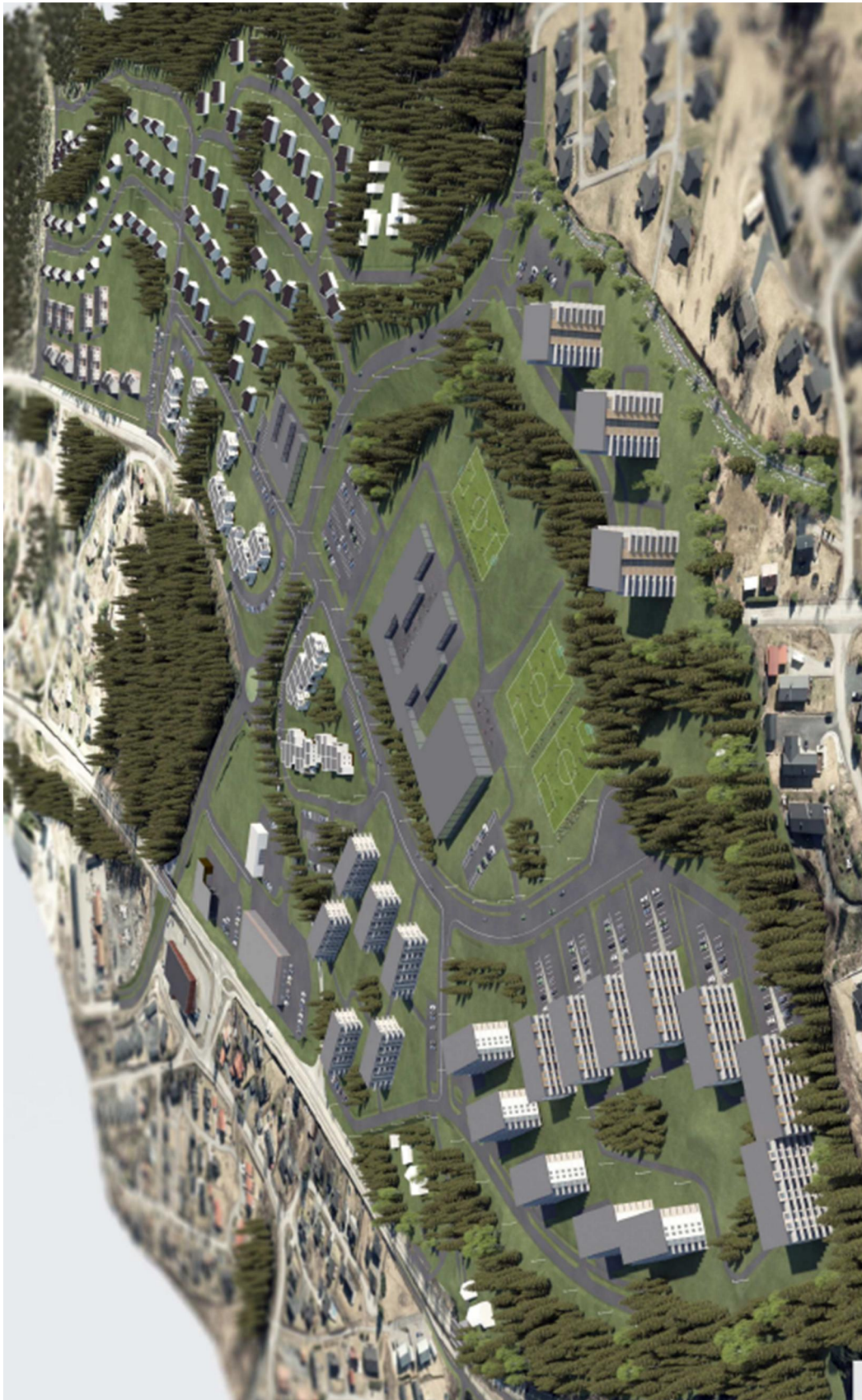

B. Low temperature legionella treatment from [Annex X, Dalla Rosa et al., 2014]

It was demonstrated that a combination of reduced tap water temperatures and bactericidal technology can save energy and enhance protection against Legionella. In the “Annex X” it is reported also that bactericidal effect enabled DHW temperatures to be reduced below 50°C. The technology complements conventional bactericidal methods (based on thermal treatment), with a chemical-free bactericidal methodology.

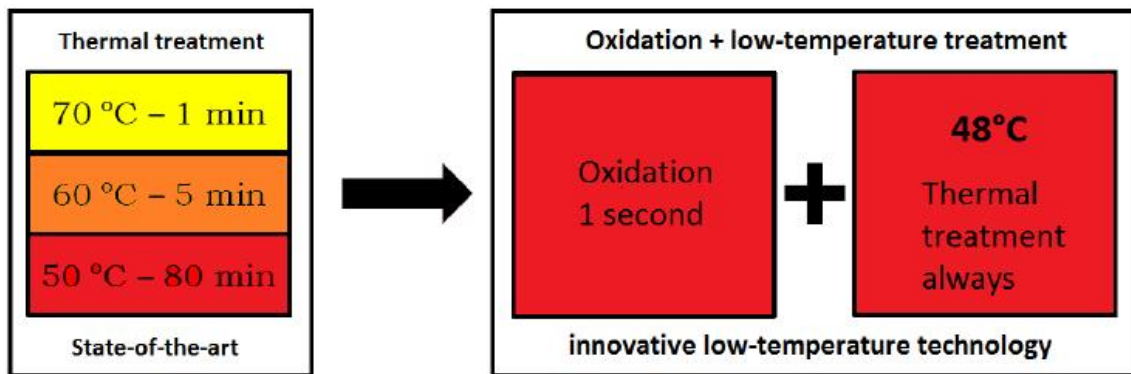

Figure 35. Comparative scheme between different Legionella treatments.

The technology consists of a combination of oxidation technology – in which a bactericidal effect of up to 99.999% (“log 5-barrier”) is achieved at every barrier protection with regard to Legionella and amoebae – with a DHW temperature of 48°C in the DHW system. Biological substances that form biofilm are also broken down, reducing the build-up of biofilm in the pipes, which creates the optimal environment for Legionella. The health issues connected with Legionella bacteria and amoebae are eliminated, even at temperatures below 50°C; this means that the supply temperature could be lowered to 50-52°C. The chemical-free barrier for legionella is installed on the cold water supply line, so it is possible to have first a treatment of the cold water, and after another one due to the temperature rising.

A limitation of this process is that if the building has a secondary pipe systems, such as dead-end pipes, the water is stationary and there the oxidation technology cannot reach. Thus, while the protective oxidation barrier effectively treats the incoming and circulating DHW, it has no access to external system components, like dead-end pipes and shower heads. Legionella colonies which survive in these parts can grow and even spread to other parts of the system due to the system temperatures of <50°C. It was shown that in the buildings where Legionella was already present in the DHW circulation system before the installation of the oxidation equipment, the technology did not reduce the bacteria concentration; so it is important that a system is cleared of bacteria before the installation of the low-temperature oxidation barrier, and special measures can be taken to prevent the proliferation of Legionella in those places.

C. From the rapid installation guide of Uponor

C.1 Pipe sizing and pressure drop

The following table enables approximation of pipe size for a given heat load (kW) and design temperature drop ( $\Delta T$ ). Generally, pipe dimensions are selected according to the available pressure.

Spread							Mass flow	Pipe type		Pipe type	
$\Delta T=10K$	$\Delta T=15K$	$\Delta T=20K$	$\Delta T=25K$	$\Delta T=30K$	$\Delta T=35K$	$\Delta T=40K$		$\Delta p.v$	$\Delta p.v$	$\Delta p.v$	$\Delta p.v$
10 kW	15 kW	20 kW	25 kW	30 kW	35 kW	40 kW	860 kg/h	25/20.4 0.30974 kPa/m 0.74962 m/s	32/26.2 0.09786 kPa/m 0.46148 m/s		
20 kW	30 kW	40 kW	50 kW	60 kW	70 kW	80 kW	1720 kg/h	32/26.2 0.32917 kPa/m 0.92296 m/s	40/32.6 0.11240 kPa/m 0.58708 m/s	50/40.8 0.03872 kPa/m 0.37481 m/s	
30 kW	45 kW	60 kW	75 kW	90 kW	105 kW	120 kW	2580 kg/h	32/26.2 0.66923 kPa/m 1.38445 m/s	40/32.6 0.22851 kPa/m 0.88062 m/s	50/40.8 0.07872 kPa/m 0.56221 m/s	
40 kW	60 kW	80 kW	100 kW	120 kW	140 kW	160 kW	3440 kg/h	40/32.6 0.37806 kPa/m 1.17416 m/s	50/40.8 0.13023 kPa/m 0.74962 m/s	63/51.4 0.04348 kPa/m 0.47232 m/s	
50 kW	75 kW	100 kW	125 kW	150 kW	175 kW	200 kW	4300 kg/h	50/40.8 0.19244 kPa/m 0.93702 m/s	63/51.4 0.06425 kPa/m 0.59040 m/s	75/61.2 0.02805 kPa/m 0.41646 m/s	
60 kW	90 kW	120 kW	150 kW	180 kW	210 kW	240 kW	5160 kg/h	50/40.8 0.26445 kPa/m 1.12443 m/s	63/51.4 0.08859 kPa/m 0.70848 m/s	75/61.2 0.03859 kPa/m 0.49975 m/s	
70 kW	105 kW	140 kW	175 kW	210 kW	245 kW	280 kW	6020 kg/h	50/40.8 0.34945 kPa/m 1.31183 m/s	63/51.4 0.11513 kPa/m 0.82656 m/s	75/61.2 0.05053 kPa/m 0.58304 m/s	
80 kW	120 kW	160 kW	200 kW	240 kW	280 kW	320 kW	6880 kg/h	63/51.4 0.14654 kPa/m 0.94464 m/s	75/61.2 0.06334 kPa/m 0.66633 m/s	90/73.6 0.02657 kPa/m 0.46072 m/s	
90 kW	135 kW	180 kW	225 kW	270 kW	315 kW	360 kW	7740 kg/h	63/51.4 0.18133 kPa/m 1.06272 m/s	75/61.2 0.07836 kPa/m 0.74962 m/s	90/73.6 0.03266 kPa/m 0.51831 m/s	
100 kW	150 kW	200 kW	250 kW	300 kW	350 kW	400 kW	8600 kg/h	63/51.4 0.21940 kPa/m 1.18080 m/s	75/61.2 0.09480 kPa/m 0.83291 m/s	90/73.6 0.03905 kPa/m 0.57590 m/s	
110 kW	165 kW	220 kW	275 kW	330 kW	385 kW	440 kW	9460 kg/h	63/51.4 0.26071 kPa/m 1.29888 m/s	75/61.2 0.11263 kPa/m 0.91620 m/s	90/73.6 0.04639 kPa/m 0.63349 m/s	
120 kW	180 kW	240 kW	300 kW	360 kW	420 kW	480 kW	10320 kg/h	75/61.2 0.13183 kPa/m 0.99949 m/s	90/73.6 0.05429 kPa/m 0.69108 m/s	110/90.0 0.02064 kPa/m 0.46217 m/s	
130 kW	195 kW	260 kW	325 kW	390 kW	455 kW	520 kW	11180 kg/h	75/61.2 0.15238 kPa/m 1.08278 m/s	90/73.6 0.06274 kPa/m 0.74867 m/s	110/90.0 0.02385 kPa/m 0.50068 m/s	
140 kW	210 kW	280 kW	350 kW	420 kW	490 kW	560 kW	12040 kg/h	75/61.2 0.17427 kPa/m 1.16608 m/s	90/73.6 0.07174 kPa/m 0.80626 m/s	110/90.0 0.02727 kPa/m 0.53919 m/s	
150 kW	225 kW	300 kW	375 kW	450 kW	525 kW	600 kW	12900 kg/h	75/61.2 0.19746 kPa/m 1.24937 m/s	90/73.6 0.08129 kPa/m 0.86385 m/s	110/90.0 0.03089 kPa/m 0.57771 m/s	
160 kW	240 kW	320 kW	400 kW	480 kW	560 kW	640 kW	13760 kg/h	75/61.2 0.22196 kPa/m 1.33266 m/s	90/73.6 0.09136 kPa/m 0.92144 m/s	110/90.0 0.03472 kPa/m 0.61622 m/s	
170 kW	255 kW	340 kW	425 kW	510 kW	595 kW	680 kW	14620 kg/h	90/73.6 0.10196 kPa/m 0.97903 m/s	110/90.0 0.03874 kPa/m 0.65473 m/s		



180 kW	270 kW	360 kW	450 kW	540 kW	630 kW	720 kW	15480 kg/h	90/73.6 0.11308 kPa/m 1.09662 m/s	110/90.0 0.04296 kPa/m 0.69325 m/s
190 kW	285 kW	380 kW	475 kW	570 kW	665 kW	760 kW	16340 kg/h	90/73.6 0.12472 kPa/m 1.09421 m/s	110/90.0 0.04738 kPa/m 0.73176 m/s

Spread										
$\Delta T=10K$	$\Delta T=15K$	$\Delta T=20K$	$\Delta T=25K$	$\Delta T=30K$	$\Delta T=35K$	$\Delta T=40K$	Mass flow	Pipe type $\Delta p.v$	Pipe type $\Delta p.v$	Pipe type $\Delta p.v$
200 kW	300 kW	400 kW	500 kW	600 kW	700 kW	800 kW	17200 kg/h	90/73.6 0.13687 kPa/m 1.15180 m/s	110/90.0 0.05199 kPa/m 0.77028 m/s	
210 kW	315 kW	420 kW	525 kW	630 kW	735 kW	840 kW	18060 kg/h	90/73.6 0.14953 kPa/m 1.20939 m/s	110/90.0 0.05680 kPa/m 0.80879 m/s	
220 kW	330 kW	440 kW	550 kW	660 kW	770 kW	880 kW	18920 kg/h	90/73.6 0.16269 kPa/m 1.26698 m/s	110/90.0 0.06179 kPa/m 0.84730 m/s	
230 kW	345 kW	460 kW	575 kW	690 kW	805 kW	920 kW	19780 kg/h	90/73.6 0.17635 kPa/m 1.32457 m/s	110/90.0 0.06697 kPa/m 0.88582 m/s	
240 kW	360 kW	480 kW	600 kW	720 kW	840 kW	960 kW	20640 kg/h	90/73.6 0.19051 kPa/m 1.38216 m/s	110/90.0 0.07234 kPa/m 0.92433 m/s	
250 kW	375 kW	500 kW	625 kW	750 kW	875 kW	1000 kW	21500 kg/h	110/90.0 0.07790 kPa/m 0.96285 m/s		
260 kW	390 kW	520 kW	650 kW	780 kW	910 kW	1040 kW	22360 kg/h	110/90.0 0.08364 kPa/m 1.00136 m/s		
270 kW	405 kW	540 kW	675 kW	810 kW	945 kW	1080 kW	23220 kg/h	110/90.0 0.08956 kPa/m 1.03987 m/s		
280 kW	420 kW	560 kW	700 kW	840 kW	980 kW	1120 kW	24080 kg/h	110/90.0 0.09567 kPa/m 1.07839 m/s		
290 kW	435 kW	580 kW	725 kW	870 kW	1015 kW	1160 kW	24940 kg/h	110/90.0 0.10196 kPa/m 1.11690 m/s		
300 kW	450 kW	600 kW	750 kW	900 kW	1050 kW	1200 kW	25800 kg/h	110/90.0 0.10843 kPa/m 1.15541 m/s		
310 kW	465 kW	620 kW	775 kW	930 kW	1085 kW	1240 kW	26660 kg/h	110/90.0 0.11507 kPa/m 1.19393 m/s		
320 kW	480 kW	640 kW	800 kW	960 kW	1120 kW	1280 kW	27520 kg/h	110/90.0 0.12190 kPa/m 1.23244 m/s		
330 kW	495 kW	660 kW	825 kW	990 kW	1155 kW	1320 kW	28380 kg/h	110/90.0 0.12890 kPa/m 1.27096 m/s		
340 kW	510 kW	680 kW	850 kW	1020 kW	1190 kW	1360 kW	29240 kg/h	110/90.0 0.13608 kPa/m 1.30947 m/s		
350 kW	525 kW	700 kW	875 kW	1050 kW	1225 kW	1400 kW	30100 kg/h	110/90.0 0.14344 kPa/m 1.34798 m/s		

## C.2 Heat loss coefficients

### Uponor Thermo Single

Thermal conductivity ground: 1.0 W/mK  
Ground coverage: 0.8 m



#### Note!

Heat loss data in the diagram are calculated with a safety factor of 1,05, according to the requirements of the German "VDI-AG Gütesicherung". Depending on production related tolerance.

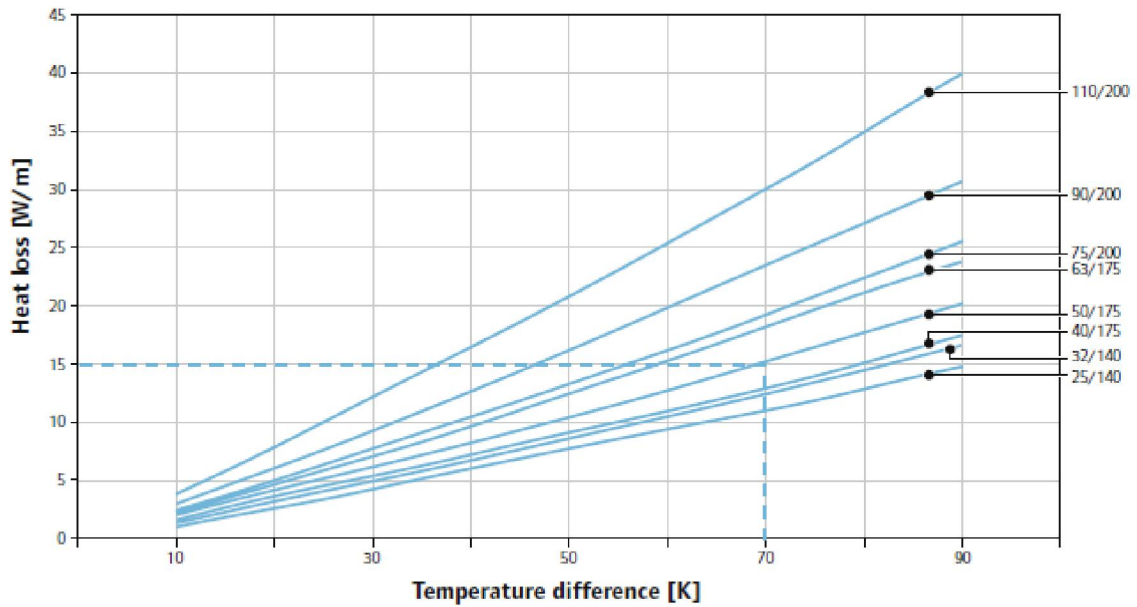

### Example for Uponor Thermo Single 50/175

$T_M$  = Medium temperature  
 $T_E$  = Ground temperature  
 $\Delta T$  = Temperature difference (K)

$\Delta T = T_M - T_E$   
 $T_M = 75\text{ °C}$   
 $T_E = 5\text{ °C}$   
 $\Delta T = 75 - 5 = 70\text{ K}$   
Heat loss: 15.1 W/m



## Uponor Thermo Twin

Thermal conductivity ground: 1.0 W/mK  
Ground coverage: 0.8 m



### Note!

Heat loss data in the diagram are calculated with a safety factor of 1,05, according to the requirements of the German "VDI-AG Gütesicherung". Depending on production related tolerance.

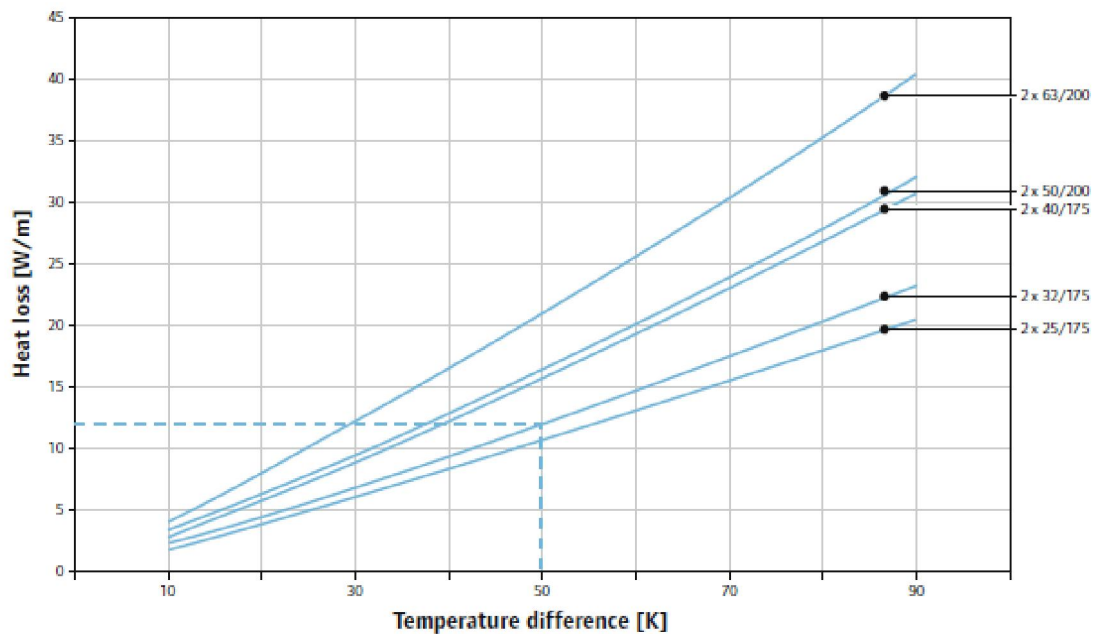

### Example for Uponor Thermo Twin 2 x 32/175

$T_V$  = Flow temperature  
 $T_R$  = Return temperature  
 $T_E$  = Ground temperature  
 $\Delta T$  = Temperature difference (K)  
 $\Delta T = (T_V + T_R)/2 - T_E$   
 $T_V = 70 \text{ }^\circ\text{C}$   
 $T_R = 40 \text{ }^\circ\text{C}$   
 $T_E = 5 \text{ }^\circ\text{C}$   
 $\Delta T = (70 + 40)/2 - 5 = 50 \text{ K}$   
**Heat loss: 12 W/m**











### C.3 Prices



#### Thermo Single

Livraison sur demande avec câble chauffant  
par couronne complète uniquement : nous consulter.







Codes	Diamètres de/di/ep. (mm)	DN	Dimensions ext. Gaine (mm)	Longueurs couronne (m)	Rayons de courbure (m)	Prix H.T. €/m
 1018109	25 / 20,4 / 2,3	20	140	200	0,25	40,49
 1018110	32 / 26,2 / 2,9	25	140	200	0,30	47,47
 1018111	40 / 32,6 / 3,7	32	175	200	0,35	59,35
 1018112	50 / 40,8 / 4,6	40	175	200	0,45	71,22
 1018113	63 / 51,4 / 5,8	50	175	200	0,55	112,09
 1018114	75 / 61,4 / 6,8	65	200	100	0,80	127,92
 1018115	90 / 73,6 / 8,2	80	200	100	1,10	143,75
 1018116	110 / 90,0 / 10,0	100	200	100	1,20	155,61



#### Thermo Twin



Codes	Diamètres de/di/ep. (mm)	DN	Dimensions ext. Gaine (mm)	Longueurs couronne (m)	Rayons de courbure (m)	Prix H.T. €/m
 1018134	25 / 20,4 / 2,3 (x2)	20	175	200	0,50	60,61
 1018135	32 / 26,2 / 2,9 (x2)	25	175	200	0,60	70,94
 1018136	40 / 32,6 / 3,7 (x2)	32	175	200	0,80	96,72
 1018137	50 / 40,8 / 4,6 (x2)	40	200	100	1,00	127,67
 1018138	63 / 51,4 / 5,8 (x2)	50	200	100	1,20	143,15

D. Heat-packs from Johnson Controls proposal

Proposal for circuit B (utilize two of this):

**Johnson Controls proposals**

<i>ID</i>	<i>Description</i>	<i>Pc</i>
<b>High stage unit</b>		
HPC108S-H229	Compressor unit VSD for HeatPAC (A121,B112-115,B120,B150-154,B230,B231,OVUR,C621,G100)	1
HPAC108X-B131	Basic unit for HeatPAC	1
ESRE-702241.PED	Evaporator ESRE, 224 cassettes, 1 pass at secondary side	1
HPSH-C517	Condenser HPSH 5, 126 cassettes (one cassette=two plates)	1
HPAC108X-G100	PED Design according to EC- PED Documentation: GX40,41,53/GX01,02,27/GX60,62,84/GX88,89	1
PACXX-D608	Electrical VSD panel, 132 kW, 400V, max 260 Amp, with build-in Frequency inverter, including RFI-filter and additional p	1
1568.1559	Motor ABB IE3 IP55 131kW 4P 400V 252A B35 500-1500rpm FF600 Accessories	1
HPAC108X-B213	Vibration dampers	1
HPAC-E700	Insulation of evaporator and cold pipes	1
HeatPAC-E710	Evaporator manifold for double brine connection steel	1
HeatPAC-E685	Electronic flow switch for condenser	1
HeatPAC-E686	Electronic flow switch for evaporator	1
	Parts	
HPCXX-A631	Oil charging pump, hand operated (R717)	1

Proposal for circuit A:

**Johnson Controls proposals**

<i>ID</i>	<i>Description</i>	<i>Pc</i>
<b>High stage unit</b>		
HPO28-H151	Compressor unit for HeatPAC (A121,B101,B102,B103,B322,C621,C623)	1
HPAC28X-B131	Basic unit for HeatPAC	1
ESRE-700801.PED	Evaporator ESRE, 80 cassettes, 1 pass at secondary side	1
HPSH-C527	Condenser HPSH 4, 84 cassettes (one cassette=two plates)	1
PACXX-D605	Electrical VSD panel, 75 kW, 400V, max 147 Amp, with build-in Frequency inverter, including RFI-filter and additional pa	1
HPAC28X-G100	PED Design according to EC- PED Documentation: GX40,41,53/GX01,02,27/GX60,62,84/GX88,89	1
1568.045	Motor ABB IE2 IP55 61kW 4P 400V 123A B3 500-1500rpm	1
	Accessories	
HPAC28X-B213	Vibration dampers	1
HPAC-E700	Insulation of evaporator and cold pipes	1
HeatPAC-E705	Evaporator pipe extension for single brine connection steel (easy installation)	1
HeatPAC-E685	Electronic flow switch for condenser	1
HeatPAC-E686	Electronic flow switch for evaporator	1
	Parts	
HPOXX-A631	Oil charging pump, hand operated (R717)	1

## E. Calculations related to the compressors

### E.1 Isoentropic and volumetric efficiency curves

The curves that are founded here are applicable only in the working range (pressure ratios) of this project, they cannot describe properly the behavior of the compressor out of it.

#### Circuit A: HPO28-H151

Test	tev [°C]	tcond [°C]	pev [bar]	pcond [MPa]	rp	h1 [kJ/kg]	h2,is[kJ/kg]	mr [kg/s]
1	-1,8	55,2	4,02	23,6	5,870647	1603,5	1871,8	0,1258
2	0	55	4,29	23,1	5,384615	1605,4	1858,8	0,1376
3	5	60	5,16	26,14	5,065891	1610,6	1854,8	0,1684
4	-10	35	2,91	13,5	4,639175	1593,9	1816,9	0,0948
5	-5	35	3,55	13,5	3,802817	1599,8	1791,4	0,1209
6	0	40	4,29	15,55	3,624709	1605,4	1790,6	0,1479

q,ev [kW]	q,cond [kW]	P,comp [kW]	eta,is tot	vol swept th [m^3/s]	v spec 1 [m^3/kg]	eta vol
125,8	163,3	45,5	0,741805	0,053877778	0,30795	0,719037
139,1	178,1	46,1	0,756352	0,053877778	0,28958	0,739567
167	213,2	53,4	0,770099	0,053877778	0,24293	0,7593
104	128	28,3	0,747011	0,053877778	0,41792	0,735346
133,2	160,1	30,2	0,767034	0,053877778	0,34641	0,777333
160,4	192,2	35	0,782602	0,053877778	0,28954	0,794817

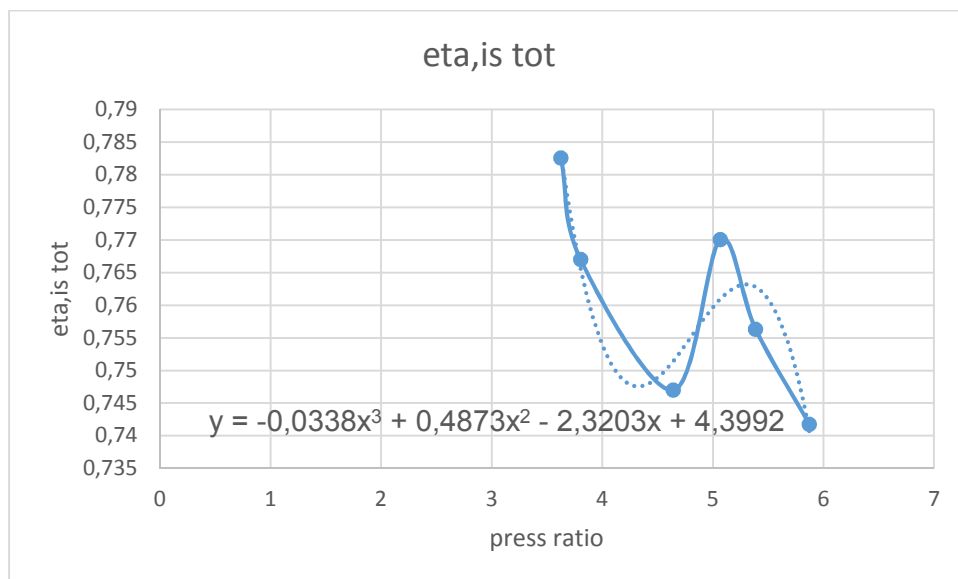

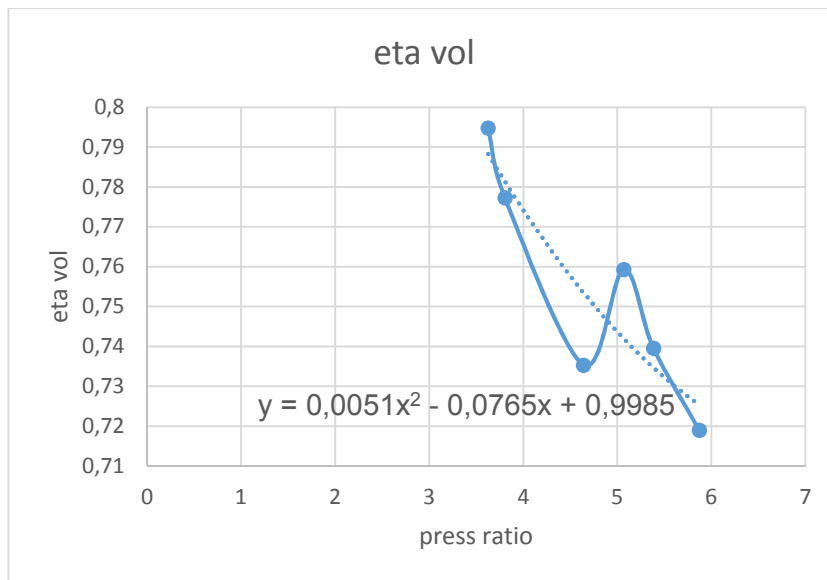

**Circuit B: HPC108S-H229**

Test	tev [°C]	tcond [°C]	pev [MPa]	pcond [MPa]	rp	h1 [kJ/kg]	h2,is[kJ/kg]	mr [kg/s]
1	-1,5	55,2	4,03	23,2	5,756824	1604	1869	0,3013
2	0	55	4,29	23,1	5,384615	1605,4	1858,8	0,3269
3	5	60	5,16	26,14	5,065891	1610,6	1854,8	0,3974
4	-10	35	2,91	13,5	4,639175	1593,9	1816,9	0,2328
5	-5	35	3,55	13,5	3,802817	1599,8	1791,4	0,2968
6	0	40	4,29	15,55	3,624709	1605,4	1790,6	0,3613

q,ev [kW]	q,con[kW]	P,comp [kW]	eta,is tot	vol swept th [m^3/s]	v spec 1 [m^3/kg]	eta vol
302,3	387,6	102	0,782789	0,125661111	0,3075	0,737299
330,6	419,8	104,9	0,789671	0,125661111	0,28958	0,753325
394,1	500	122	0,795451	0,125661111	0,24293	0,76826
255,3	312,5	67,2	0,772536	0,125661111	0,41792	0,774239
327,2	392	72,6	0,78329	0,125661111	0,34641	0,818189
391,6	468,1	83,9	0,79753	0,125661111	0,28954	0,832484



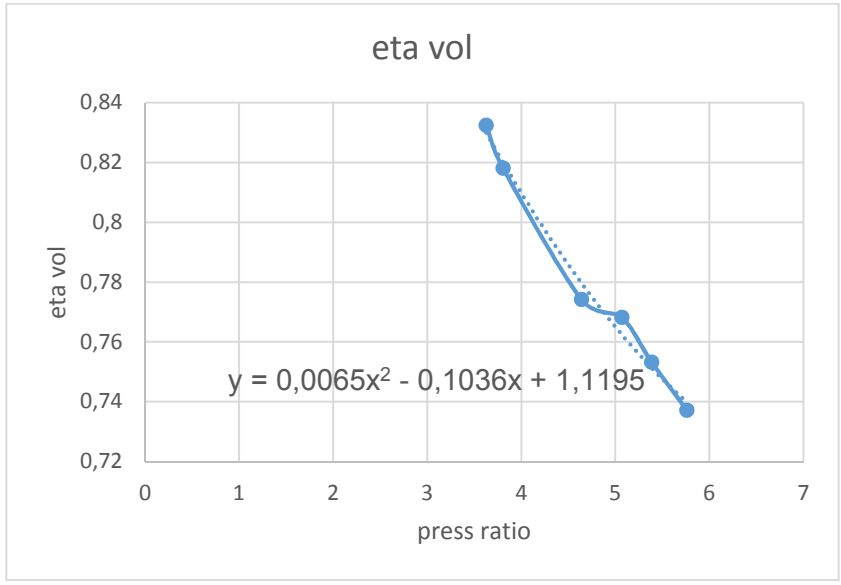
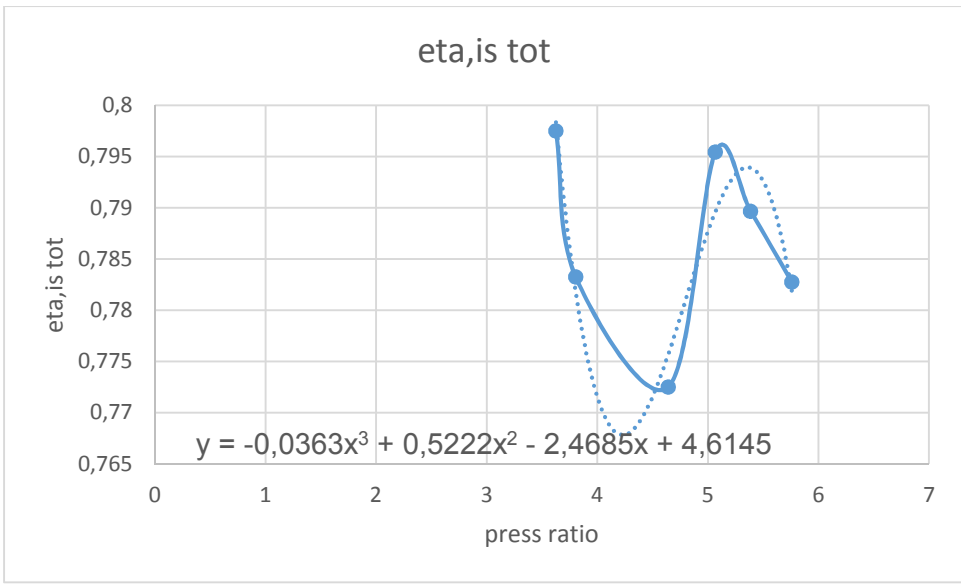

## E.2 Shaft Power at partial load

When the heating/cooling, depends on the working mode, load is decreased, the swept volume of the compressor decrease within it. So in ideal conditions the shaft power in a piston compressor decreases linearly with the cooling capacity (and swept volume), but in the reality there are other losses (like friction,...). Starting from this concept and knowing that usually a piston compressor still requires at 25% of his swept volume the 40% of the shaft power, it was obtained a simple curve to obtain the shaft power in partial load conditions.

The curve is done only to give an output in the simulation similar to the reality and it is not built with data related to the compressors used in this project.

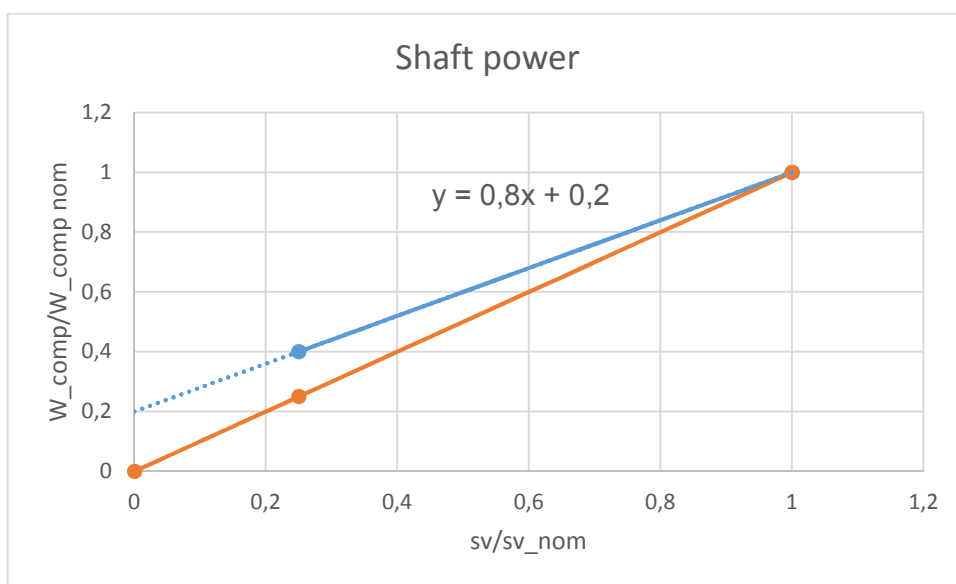

In the graphic is plotted the ratio between shaft power and shaft power in the nominal conditions, against the ratio between the swept volume and the swept volume in nominal condition; the orange curve is the ideal case and in blue is the real case.



