



NTNU – Trondheim
Norwegian University of
Science and Technology

Dynamic Response of Flexible Pipes During Installation

Xin Lu

Marine Technology

Submission date: June 2013

Supervisor: Svein Sævik, IMT

Norwegian University of Science and Technology
Department of Marine Technology



MASTER THESIS SPRING 2013

for

Stud. tech. Lu Xin

Dynamic Response of Flexible Pipes during Installation

Dynamisk respons av fleksible rør under installasjon

The background for this project is related to the behavior of flexible pipes during installation. The dynamic curvature at the touch down point is governed by the bending stiffness of the flexible pipe. Normal practice has been to perform installation analysis using the plastic layer elastic bending stiffness without taking into account the bi-linear contribution from the tensile armour layers. The purpose of this project is to investigate the effect of applying different moment-curvature assumptions with regard to the dynamic response at TDP. The thesis work is to be carried out as follows:

1. Literature study, including flexible pipe technology in general i.e. pipe manufacture, design, pipe-soil interaction, installation methods and associated design criteria. This is also to include the techniques used to perform response analysis during installation (ensuring that the relevant design criteria are met) including non-linear finite element methods and non-linear time-domain analysis techniques with focus on the methods applied in computer programs such as ORCAFLEX, RIFLEX, SIMLA and BFLEX.
2. Define relevant lay scenarios in terms of water depth, vessel geometry, vessel RAO, pipe cross-section properties, hydrodynamic coefficients and environmental conditions.
3. Define a cross-section model in Bflex to calculate the cross-section characteristics in terms of axial-force versus strain, torque versus torsion and moment versus curvature as a function of water depth.
4. Establish alternative models in SIMLA assuming different moment-curvature relations and perform non-linear, regular wave dynamic analysis to investigate the dynamic response at TDP (Curvature and tension). Will the bi-linear assumption tolerate less static bottom tension? (Thus predicting the inherent conservatism in applying the linear moment-curvature assumption).
5. Perform irregular wave analysis for the same cases to investigate the same differences in response measured in terms of the standard deviations.
6. Conclusions and recommendations for further work



The work scope may prove to be larger than initially anticipated. Subject to approval from the supervisors, topics may be deleted from the list above or reduced in extent.

In the thesis the candidate shall present his personal contribution to the resolution of problems within the scope of the thesis work.

Theories and conclusions should be based on mathematical derivations and/or logic reasoning identifying the various steps in the deduction.

The candidate should utilise the existing possibilities for obtaining relevant literature.

Thesis format

The thesis should be organised in a rational manner to give a clear exposition of results, assessments, and conclusions. The text should be brief and to the point, with a clear language. Telegraphic language should be avoided.

The thesis shall contain the following elements: A text defining the scope, preface, list of contents, summary, main body of thesis, conclusions with recommendations for further work, list of symbols and acronyms, references and (optional) appendices. All figures, tables and equations shall be numerated.

The supervisors may require that the candidate, in an early stage of the work, presents a written plan for the completion of the work.

The original contribution of the candidate and material taken from other sources shall be clearly defined. Work from other sources shall be properly referenced using an acknowledged referencing system.

The report shall be submitted in two copies:

- Signed by the candidate
- The text defining the scope included
- In bound volume(s)
- Drawings and/or computer prints which cannot be bound should be organised in a separate folder.

Ownership

NTNU has according to the present rules the ownership of the thesis. Any use of the thesis has to be approved by NTNU (or external partner when this applies). The department has the right to use the thesis as if the work was carried out by a NTNU employee, if nothing else has been agreed in advance.



Thesis supervisor(s): Prof. Svein Sævik, NTNU

Deadline: June 10, 2013

Svein Sævik

January, 2013
Trondheim, Norway





Preface

This report presents the master thesis work done by Xin Lu in 2013 at NTNU. All the tasks listed on the thesis description are performed with discussions and comments on relevant contents. The thesis is written in accordance with NTNU's standard for master thesis and all the additional requirements for this particular case.

This thesis cannot be completed without support from my supervisor Prof. Svein Sævik, who has provided guidance on the thesis content, help with computation tools and discussions on the results throughout the process of this thesis work.

Special thanks to Dr. Naiquan Ye from Marintek, who provided significant help with the computation codes, especially during the late stage of the thesis work.

Gratitude is also given to students Boyang Zhao and Rui Zhang from Marine Technology Department, for the discussions with me on various issues.

Xin Lu

June 2013

Trondheim, Norway





Abstract

This paper is referring to performing dynamic analysis for an installation scenario with the bi-linear assumption for the bending moment stiffness, which is the governing component stiffness for the curvature at the touching down point. The dynamic analysis model is set up with SIMLA and both regular and irregular wave loads are applied. The case with linear assumption is also performed to make a comparison with the bi-linear case.

A 3-dimensional pipe element with axial stiffness, torsional stiffness and bending stiffness required is applied in SIMLA. For the missing stiffness information, a BFLEX flexible pipeline cross section model is also set up. Both intact case and damaged case are performed and comments are given.

Relevant literature studies are also made. Theories are also discussed for the modelling.

Key words:

Flexible pipeline, dynamic analysis, bending moment-curvature, none-linear FEM, SIMLA, BFLEX



List of Symbols and Acronyms

| Parameter | Symbol | Unit |
|-----------------------------|----------|------|
| Pipeline Outside Diameter | D_e | m |
| Pipeline Inside Diameter | D_i | m |
| Elastic Displacement | ν_e | m |
| Plastic Displacement | ν_p | m |
| Elastic Soil Stiffness | k_s | N/m |
| Axial Stiffness | EA | N/m |
| Bending Stiffness | EI | kNm |
| Torsional Stiffness | GI | kNm |
| Significant Wave Height | H_s | M |
| Peak Period | T_p | s |
| Zero-up Crossing Period | T_z | s |
| Lay Angle | α | rad |
| Wave Elevation | η | m |
| Submerged Weight | w | kg |
| Young's modulus | E | Mpa |
| Response Amplitude Operator | RAO | |



Contents

| | |
|---|----|
| Contents | I |
| 1 Literature Study | 1 |
| 1.1. Key Consideration Flexible Pipeline | 1 |
| 1.2. Design of Flexible Pipeline | 2 |
| 1.3. Pipe and Soil Interaction Modes..... | 3 |
| 1.4. Installation Methods | 5 |
| 1.5. Design Criteria..... | 8 |
| 1.6. Response Analysis | 9 |
| 1.7. Relative Software | 10 |
| 2 Flexible Pipeline Installation Scenario | 12 |
| 2.1. Vessel Geometry..... | 12 |
| 2.2. Vessel Element Property | 12 |
| 2.3. Vessel RAO | 12 |
| 2.4. Pipe Cross-Section Properties | 12 |
| 2.5. Hydrodynamic Coefficients..... | 13 |
| 2.6. Environmental Conditions | 13 |
| 3 BFLEX Model | 14 |
| 3.1. Theory..... | 14 |
| 3.2. Model Setting | 22 |
| 3.3. Results | 28 |
| 4 SIMLA Model..... | 38 |
| 4.1. Theory..... | 38 |
| 4.2. Model Setting | 41 |
| 4.3. Results | 50 |
| 5 Irregular Wave Analysis | 58 |
| 5.1. Input Data | 58 |
| 5.2. Results | 59 |
| 5.3. Response Deviation Comparison..... | 61 |



| | | |
|------|---|----|
| 6 | Conclusions and Recommendations for Further Work..... | 63 |
| 6.1. | Conclusion | 63 |
| 6.2. | Further Work | 63 |
| | Bibliography | 64 |
| | Appendix A BFLEX CODE | 65 |
| | Appendix B SIMLA Model | 69 |
| | Appendix C Pipe Data | |

1 Literature Study

With a history of no longer than 5 decades, flexible pipe is kind of technical and industrial product in its blooming age but with many blind areas needs to be uncovered too. In 1970s, companies like Technip started to put the flexible pipe into practice which was a milestone of subsea oil and gas industry. (Technip, 2013)

After decades development, the contemporary unbounded flexible pipes is designed as a structure that addresses the specific environmental requirements and characteristics of transported fluids with concentric layers of metallic wires, tapes and extruded polymers.

1.1. Key Consideration Flexible Pipeline

(Clevelario, 2012)

Faced with both internal and external loadings, the flexible pipes have many key points to be taken into considerations during design and installation. These key considerations and main failure modes are illustrated in the following figure.

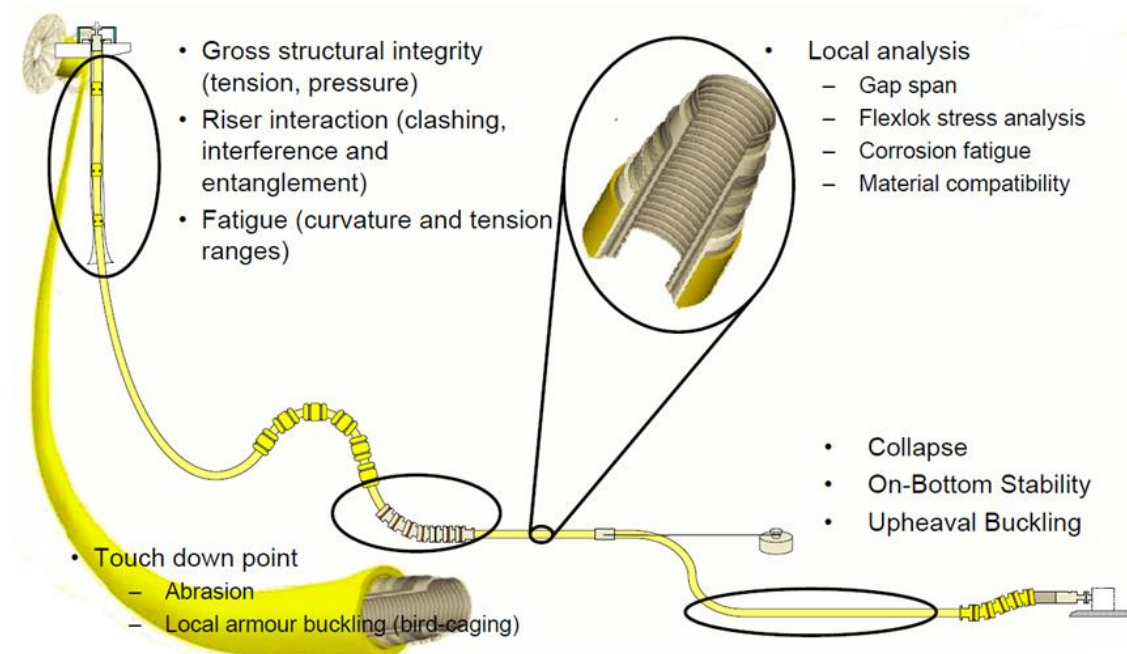

Figure 1-1 Key Consideration in Flexible Pipeline

1.2. Design of Flexible Pipeline

(Clevelario, 2012)

Here by a typical design of flexible pipeline is illustrated and the usages of different layers are also described briefly.



Figure 1-2 Flexible Pipeline Layers

1.2.1. Internal Carcass

The Carcass is a corrugated metallic tube with a specified internal diameter. The Carcass supports the extruded fluid barrier and prevents collapse from hydrostatic pressure or crushing loads applied during pipe operation.

1.2.2. Internal Pressure Sheath

The Internal Pressure Sheath is a polymer layer extruded over the Carcass to form a boundary for the conveyed fluid. The Internal Pressure Sheath material is selected to be chemically resistant to the conveyed fluid and unaffected by its service conditions.

1.2.3. Pressure Armour

The Pressure Armour is a steel hoop strength layer consisting of circumferentially wound profiled wire to resist to internal pressure and bending. The Z-shaped wire is profiled to allow interlocking of the edges as they are formed around the pipe.

1.2.4. Tensile Armour

The Tensile Armour layer is a helical steel armour layer that resists internal pressure and axial tension.

1.2.5. Anti-wear Layer

The Anti-wear Layer is a thin polymer tape layer applied between any two adjacent metallic layers, and such prevents metal-to-metal contact between the layers to prevent wear.

1.2.6. Tape Layer

Tape layers are applied over the tensile armours as a manufacturing aid to prevent “bird caging”.

1.2.7. Insulation

Insulation is a thermal insulation layer used to limit heat loss through the pipe wall to the surrounding environment.

1.2.8. External Sheath

External Sheath is an external polymer barrier applied to resist mechanical damage and intrusion of seawater.

1.3. Pipe and Soil Interaction Modes

(Sævik, Simla- Theory Manual, 2008)

1.3.1. Forces

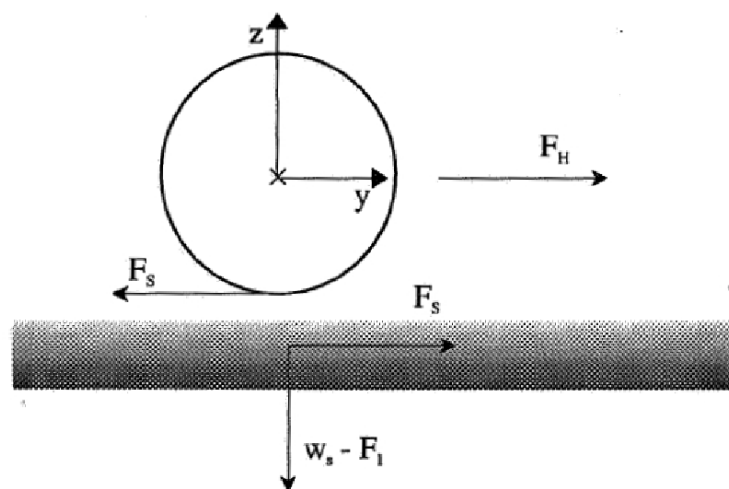

Figure 1-3 External forces per unit length



Figure 1-3 shows a submerged pipe laid on seabed. Dynamic external forces per unit length acting on the pipe are illustrated and the positive directions are also pointed out.

Forces per unit length:

- lift force
- horizontal hydrodynamic force
- submerged weight
- soil force

1.3.2. Elastic or Plastic Soil Force

The displacement of pipeline can be obtained by summing up the elastic and plastic displacement of soil material:

$$v = v_e + v_p \quad (1)$$

where v_e is elastic displacement and v_p is plastic displacement.

In the elastic domain, the soil force is expressed as:

$$F_s = k_s v_e + \alpha_s k_s \dot{v} \quad (2)$$

where k_s is elastic soil stiffness (per unit length) and α_s is a soil damping constant. The damping force is included only in the linear range to damp out transient oscillations in the elastic soil displacement.

In the plastic range the soil force is expressed as a sum of a friction type force and a soil remaining force as follows:

$$\begin{aligned} F_s &= F_f + F_r \\ F_f &= \mu(\omega_s - \hat{F}_l) \frac{\dot{v}}{|\dot{v}|} \\ F_r &= D_s \frac{\dot{v}}{|\dot{v}|} \end{aligned} \quad (3)$$

where \min is a function selecting the smallest of its arguments, μ is the constant friction coefficient and D_s is the remaining force function.

1.4. Installation Methods

(kaskus, 2010)

Pipeline Installation Methods include:

- S-lay
- J-lay
- Reel-lay
- Tow-In

1.4.1. S-lay

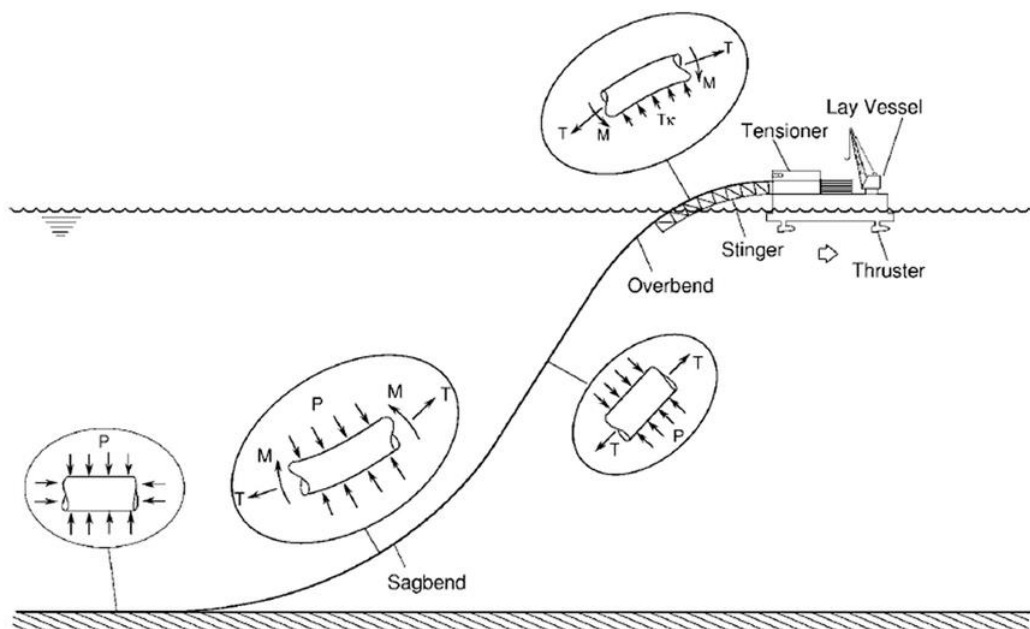

Figure 1-4 S-lay Configuration

- Method-Description

S-lay installation method is usually used for shallow water (water depth 0 to 300m). Deep water application (0-2000m) is also possible for some vessels. The diameters of installed pipelines are from 8 inch up to 60 inch.

The pipeline is expected to be associated with high stress at over-bend and sag-bend. For maintain bending curvature at over-bend and sag-bend, stinger and tensioner are used. During the installation process, pipelines also needed to be in un-flooded condition.

1.4.2. J-lay

- Method-Description

J-lay method is suitable for deep water and ultral deep water. is held by hang off system/collar or clamp system is needed to hold the pipe cantenary. The suitable diameter is up to 32 inch for maximum. Compared with S-lay method, J-lay can result in lower bottom tension and shorter production time. For the given project, since the water depth is set at a large number of 2000 m, J-lay method is chosen.

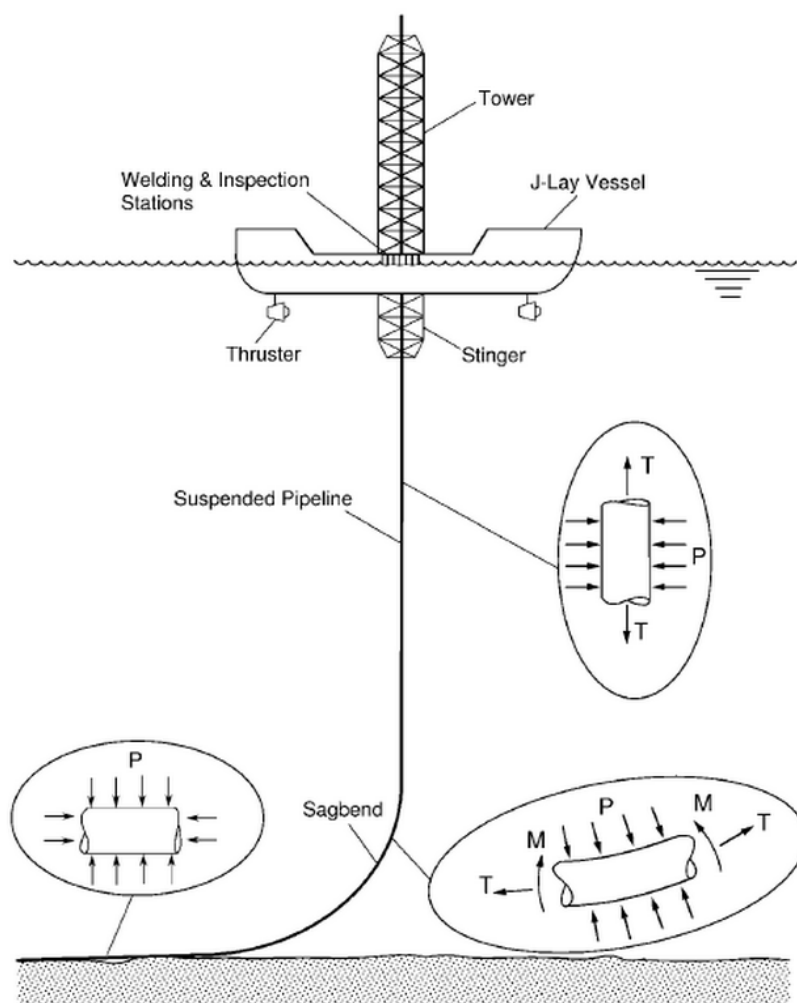

Figure 1-5 J-lay configuration

1.4.3. Reel-lay

The reel-lay method is an application using coiled pipe on a spool. By using this method it is possible to lay the pipe in a continuous manner by unwinding it from the reel. This will then reduce the cost due to lower number of personnel required and lower the risk of accidents at the same time.

The condition for using this method is when the diameter of pipe is from 2 inch to 12 inch and the operating depth is from 100 to 1000 m.

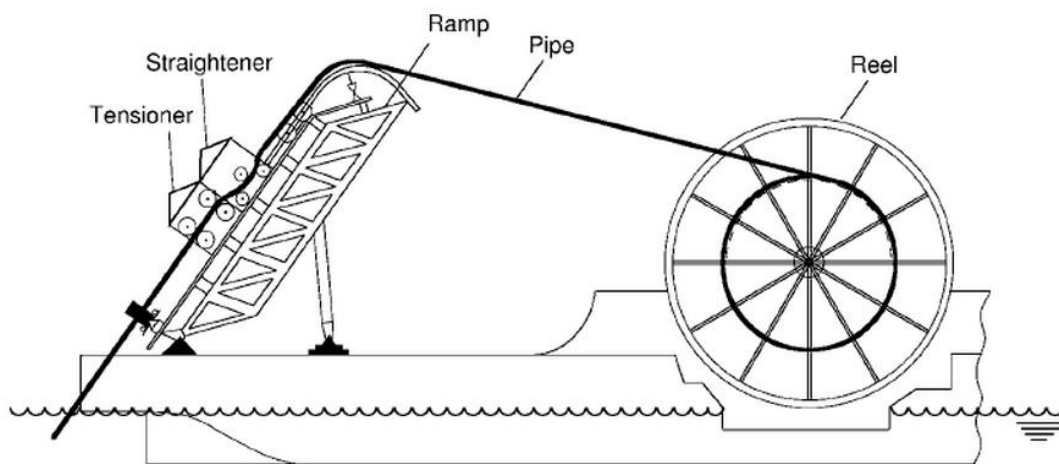

Figure 1-6 Reel-lay configuration

1.4.4. Tow-In Method

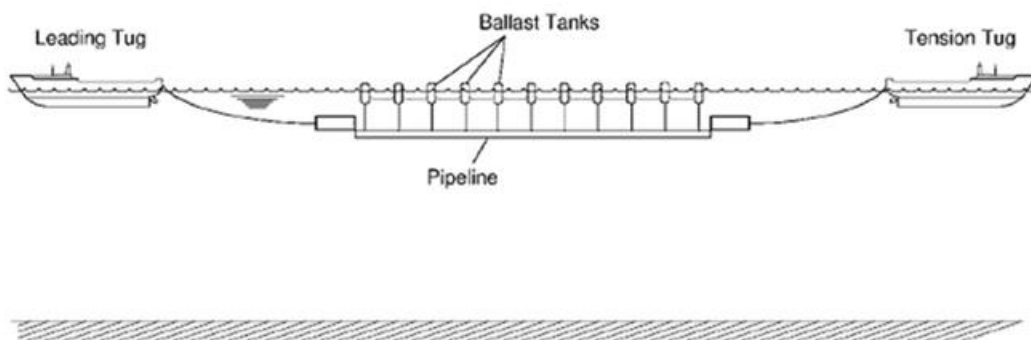

Figure 1-7 Tow-In Method Configuration

As the name implies, with tow-in method, the pipe is suspended in the water via buoyancy modules, and one or two tug boats tow the pipe into place. When it is in



location, the buoyancy modules are removed or flooded with water, and the pipe sinks gradually to the seafloor.

The tow-in pipeline installation can be divided into four main types.

For the first type, the surface tow involves towing on the water surface. With this method, a tug tows the pipe on the water surface, and buoyancy modules help to keep it on the water surface.

Instead of using pure buoyancy modules like in the surface tow, the second method, the mid-depth tow uses forward speed of the tug boat to keep the pipeline at a certain submerged level. Once the forward motion has stopped, the pipeline settles to the seafloor.

The third type of tow-in method is the off-bottom tow. The off-bottom tow uses buoyancy modules and chains as added weight acting against each other to keep the pipe just above the sea bed. Once it is towed into the right position, the buoyancy modules are removed, and the pipe sinks to the seafloor.

In the bottom tow method, the pipe is dragged along the sea bed with no buoyancy modules. This is only performed in shallow-water installations, and the sea floor must be soft and flat for this type of installation.

1.5. Design Criteria

(Sævik, Lecture Notes in Offshore Pipeline Technology, 2013)

During installation throughout operation that may trigger other failure modes as well. Include:

- Excessive yielding and in the longitudinal direction
- Plastic straining
- Local buckling due to bending and external pressure
- Buckle propagation
- Impact load denting
- Ovalization
- Fracture
- Fatigue
- Corrosion



In relevant standards for pipeline design there are two different design principles in use:

- Load Factored Resistance Design (LRFD)
- Allowable Stress Design (ASD)

The LRFD design principle is applied in the pipeline standard DNV-OS-F101 [DNV, 2007b], whereas ASD was applied in the previous DnV pipeline standard [DNV, 1982] and is still applied in the flexible pipe standard [API, 2008b].

The LRFD format applied in [DNV, 2007b] is formulated as:

$$L_F\gamma_F + L_E\gamma_E + L_A\gamma_A \leq \frac{R_C}{\gamma_m\gamma_{SC}} \quad (4)$$

where L_i and γ_i are characteristic load effects and associated load factors for Functional (F), Environmental (E), Interaction (I) and Accidental (A) loads. R_C is the characteristic resistance, γ_m is the material factor whereas γ_{SC} represents a factor considering the safety class.

The ASD format is formulated as:

$$\sigma \leq \eta\sigma_y \quad (5)$$

Here the safety factor is applied on the resistance side only.

1.6. Response Analysis

(Sævik, Lecture Notes in Offshore Pipeline Technology, 2013)

In order to determine the installation forces and associated stresses, there are several techniques available:

- Analytical calculations based on the catenary equation
- Finite differences solution of the stiffened catenary equation
- Finite differences solution of the full non-linear beam equation
- The Finite Element Method (FEM)

The structural analysis of pipeline installation includes a number of non-linearity such as:



- Non-linear loads
- Non-linear geometry
- Plastic material behaviour
- Interaction between pipe, stinger and tensioner machinery
- Pipe-soil interaction

Only the FEM method is capable of handling all the above items in a consistent way and full time domain integration of the non-linear equation of motion is normally needed to capture all relevant effects related to dynamic behaviour and fatigue. However, in order to determine the main lay parameters such as the required lay tension, simplified analysis based on analytical formula' s or finite differences as stated above can be performed.

In the following three items that relates to the above will be addressed:

- The effective tension concept
- The catenary equation
- Minimum horizontal lay radius

1.7. Relative Software

1.7.1. BFLEX

(Marintek, Software-developed-at-MARINTEK, 2010)

The BFLEX Program System is a special-purpose computer tool for analysis of extreme stresses and fatigue in the tensile- and pressure armour layers of flexible pipes.

The BFLEX Analysis Modules currently include the following functionality:

- The BFLEX module, reading and controlling all input data needed for all modules, and performing tensile armour stress analysis
- The PFLEX module, performing pressure spiral bending stress analysis
- The LIFETIME module, performing fatigue analysis
- The BOUNDARY module, performing transverse cross-sectional stress analysis of the pressure armour layer
- The TEMPERATURE module, performing temperature analysis



1.7.2. SIMLA

(Marintek, SIMLA, 2008)

SIMLA is a computer tool for analysis of offshore pipelines in deep waters and rough environments. Currently available functionality includes pipe laying and inspection of free spans.

A special-purpose finite element solver has been developed to calculate the structural response of the pipe being laid.

The special purpose numerical engine is based on integrating several levels of response resolution into one finite element solver, including the following features:

- Catenary solution
- Stiffened catenary solution
- 2D FEM solution with both four and six degrees of freedom per element, in a linear and elastoplastic material mode
- 3D FEM solution with both eight and twelve degrees of freedom per element, in a linear and elastoplastic material mode

2 Flexible Pipeline Installation Scenario

In this chapter, a virtual pipe laying scenario is defined. The laying depth is set as 2000 meters, at which depth the dynamic response of pipeline will be definitely very important.

2.1. Vessel Geometry

The laying vessel geometry will be imported to the model in an input file naming “vessel.txt”. In the SIMLA, the vessel model will be set up as the Figure 2-1.



Figure 2-1 Vessel Model in SIMLA

2.2. Vessel Element Property

| ITEM | VALUE | UNIT |
|---|-------|------------------|
| Submerged mass = dry mass - buoyancy mass | 3058 | MN |
| Dry mass | 3600 | MN |
| Dry mass of rotation, x-rotation | 3675 | MNM ² |
| Dry mass of rotation, y-rotation | 9975 | MNM ² |
| Dry mass of rotation, z-rotation | 6075 | MNM ² |
| Dry mass of rotation, z-rotation | 6075 | MNM ² |

Figure 2-2 Vessel Element Property

2.3. Vessel RAO

The vessel RAO information is given in RAO data sheet in Appendix.

2.4. Pipe Cross-Section Properties

The pipe cross-section properties are given in the pipe data sheet in Appendix.



2.5. Hydrodynamic Coefficients

| ITEM | VALUE |
|-----------------------------|-------|
| Radial drag coefficient | 0.8 |
| Tangential drag coefficient | 0.1 |
| Radial mass coefficient | 2.0 |
| Tangential mass coefficient | 0.2 |

Figure 2-3 Hydrodynamic Coefficients

2.6. Environmental Conditions

(Wikipedia, 2013)

For this laying scenario, the depth of operation water is 2000 meters. The wind load and current load will be ignored. Only wave load will be concerned. The significant wave height (H_s) is 7 meters and peak period (T_p) is 10 seconds. For the wave load, both regular and irregular wave load will be considered. In the irregular wave load condition, two parameters Pierson Moskowitz spectrum will be selected.

$$\frac{S(\omega)}{H_{1/3}^2 T_1} = \frac{0.11}{2\pi} \left(\frac{\omega T_1}{2\pi}\right)^{-5} \exp\left[-0.44\left(\frac{\omega T_1}{2\pi}\right)^4\right] \quad (6)$$

The equation (6) is the spectrum for fully developed sea (modified Pierson-Moskowitz spectrum) recommended by International Towing Tank Conference (ITTC).

3 BFLEX Model

Before establishing SIMLA model, a cross-section model in BFLEX should be set up since material information required in SIMLA model is missing. In this chapter, three terms of the cross-section characteristics are given which are axial-force versus strain, torque versus torsion and moment versus curvature as a function of water depth. The stiffness of pipeline in damaged condition will also be calculated.

3.1. Theory

(Sævik, Lecture Notes in Offshore Pipeline Technology, 2013)

According to chapter 1, the unbounded flexible pipe is made of a layered structure where each layer is free to slide relative to each other. In this case, the steel tendon cross-section of pipeline consists of the following layers.

- Carcass
- Flar spiral
- Z-spiral
- Tensile Armour

Generally speaking, the stress components in the cross-section of pipeline consist of 3 normal stress components σ_{11} , σ_{22} , σ_{33} and 3 shear stress components σ_{13} , σ_{23} , σ_{12} , as is shown in Figure 3-1.

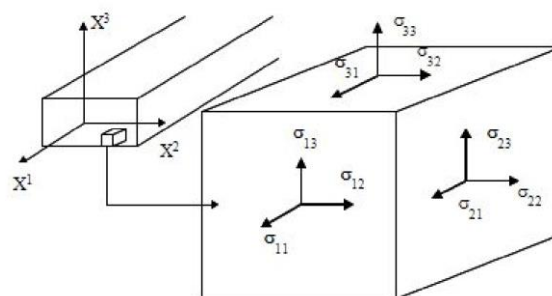

Figure 3-1 General components of stress

The pipeline is made of steel layers and plastic layers. Generally speaking, the steel layers will basically govern the load response. But the plastic layers will have an influence on the loads sharing between different steel layers.

Naturally speaking, the stress state is 3-dimensional in each layer. However, since the governing steel layers are made of long slender helical beams, the longitudinal stresses will be the primary stress components in strength calculations.

In Figure 3-2, the governing stress resultants in wires are defined. The loading scenario will be divided by the following two cases.

- Axisymmetric loads
- Bending

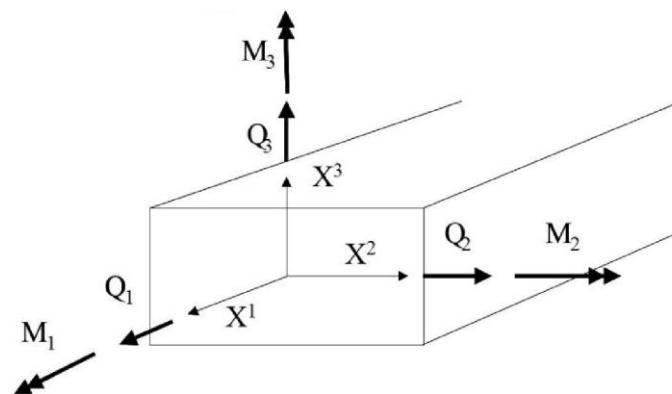

Figure 3-2 Wire stress resultants

3.1.1. Behaviour due to axisymmetric loads

Assume the cylindrical shape is unchanged during deformation. Then the behaviour caused by axisymmetric loads, which are tension, torsion, internal and external pressure loads will be described.

- Axial loading

Neglect the contribution of plastic layers and consider all the steel layers, then the pure axial equilibrium is obtained:

$$\sum_{j=1}^{N_a} n_j \sigma_{11j} A_j \cos \alpha_j = T_\omega = T_e + \pi p_{\text{int}} R_{\text{int}}^2 - \pi p_{\text{ext}} r_{\text{ext}}^2 \quad (7)$$

Where T_ω is the true wall tension, n_j is the number of wires in layer j , σ_{11j} is the axial stress in the layer, A_j is the cross-section area, T_e is the effective tension (the total cross-section resultant), p_i is the internal pressure and p_e is the external pressure. R is the taken to be the mean radius.

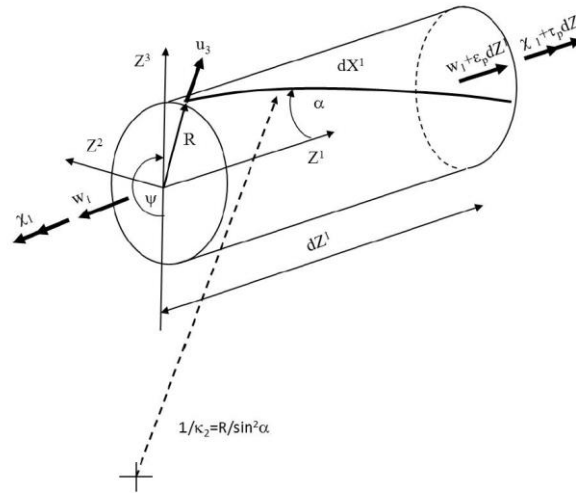

Figure 3-3 Kinematic quantities for axisymmetric deformation

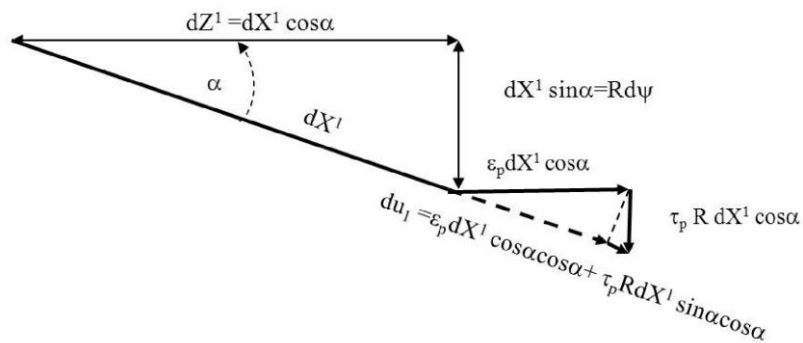

Figure 3-4 Infinitesimal segment strain

Referring to Figure 3-3 and Figure 3-4, with respect to standard beam quantities at the cross-section centre and the radial motion u_3 of each layer, in the helix the axial strain can be described by as:

$$\varepsilon_{11} = \cos^2 \alpha \varepsilon_p + \frac{\sin^2 \alpha}{R} u_3 + R \sin \alpha \cos \alpha \tau_p \quad (8)$$

where ε_p and τ_p are the overall pipe strain and torsion at the pipe centre. By assuming no torsion coupling the axial stiffness of the two layered pipe can then be obtained. Neglecting the last term in Eq. 6 and using energy principles as:

$$EA = nEA_f \cos \alpha (\cos 2\alpha - \nu_\alpha \sin 2\alpha) = 2\pi R t_{tot} F_f E \cos 2\alpha (\cos 2\alpha - \nu_\alpha \sin 2\alpha) \quad (9)$$

In equation 7, the first term describes the stiffness contribution from the tensile armour, while the second term describes the softening effect of the radial contraction associated with the helix.

ν_α is the apparent Poisson's ratio defined by the relation between axial straining and radial contraction:

$$\nu_\alpha = -\frac{u_3}{R\varepsilon_p} \quad (10)$$

- Torsion

Exceeding the critical torsion may give lock-up of the wires and cause “bird caging” or structural damage to the pipe. This failure mode is not very likely to be happened under normal operational conditions where the torsional loads are small. But the cases at which a pipe's structure failure caused by excessive torsion during pipe installation have happened.

The torsional resistance from all N_a resisting layers must equal to the torsional moment M_t given as:

$$\sum_{i=1}^{N_a} n_i \sigma_{11i} A_i R_i \sin \alpha_i = M_t \quad (11)$$

Helically wound tensile armours are the main contribution to the torsional resistance

For an approximate evaluation of the torsional stiffness of the pipe equation 12 might be used.

$$GI_t = nA_t E R_2^2 \sin 2\alpha \cos \alpha = 2\pi R t_{tot} F_f \sin 2\alpha \cos 2\alpha \quad (12)$$

The above formulas are based on assuming that all layers remain in contact.

3.1.2. Bending

Compared with the axisymmetric load case, the bending behaviour of flexible pipes is a more complex phenomenon to analyse. The flexural response shows a pronounced hysteretic behaviour. This is illustrated by the moment/curvature relation in Figure 3-5.

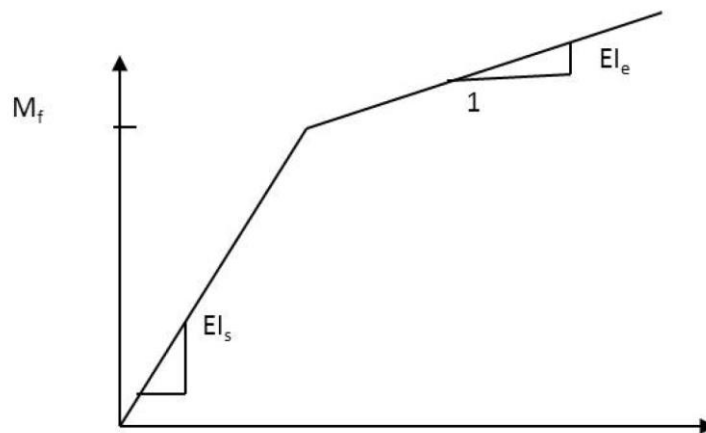

Figure 3-5 Typical moment curvature relation for non-bonded flexible pipe

The internal slip mechanism might be used in explaining the hysteretic behaviour of non-bonded pipes. There are a number of helical reinforcing layers in such pipes. When the pipe is bent, these layers tend to slip relative to each other. For the two cross wound tensile layers, it is particularly the case. The slip between layers will be prevented due to the internal friction between each layer when the friction is small. And this gives a high initial tangent stiffness, EI_s , corresponding to the sum of contributions from all layers when assuming plane surfaces remain plane as for standard beam theory. The moment which is required to overcome the friction forces, M_f , is called the friction moment. M_f depends on the contact pressure between pipe layers, and consequently on the loads applied to the pipe. The curvature will vary linearly with the moment variation when the friction moment is exceeded. The slope of this line corresponds to the elastic bending stiffness EI_e represented by the sum of contributions from elastic bending of the plastic layers and each individual wire. This stiffness is rather low and the main part of it is due to the stiffness of the plastic sheaths. It should also be noted that when the direction of the curvature is changed, the change in moment has to exceed twice the friction moment before reversed slip behaviour occurs.

- Stresses and stress resultants related to the tensile armour

For the tensile armour layers, the dynamic stresses will consist of an axial friction stress associated to the slip between layers and local torsion and bending stresses resulting from the components of global pipe curvature along each wire. For the pressure armour, the axial friction and elastic bending stresses will be small.

- Local wire bending stresses in tensile armour

In the stressed state, the local bending behaviour can be described by assuming that each wire follows an assumed path along the curved pipe surface and application of differential geometry. With regard to which path each wire will follow, there are two assumptions that have been commonly used.

- a. The Geodesic
- b. The Loxodromic

The loxodromic curve represents the curve that would represent the initial path of each wire on the circular cylinder as if it was fixed relative to the surface. The geodesic represents the shortest distance between two points, respectively on the tensile and compressive sides of the pipe along the same helix. It has no transverse curvature and as such represent a straight line in the cylinder plane. Both longitudinal and transverse slip relative to the loxodromic is needed to reach the geodesic path as illustrated in Figure 3-6.

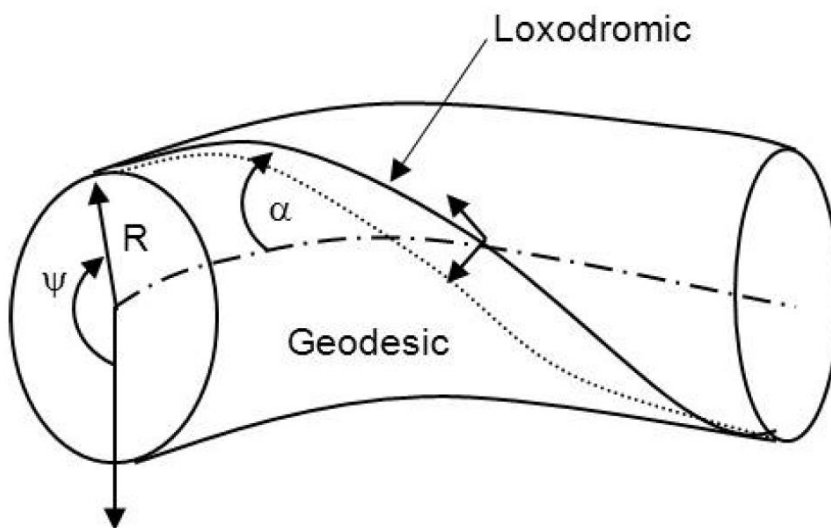

Figure 3-6 Definition of curve paths

The transverse wire displacements towards the geodesic will be restrained by transverse friction forces. Hence, the dynamic bending torsion and curvature in each wire, ω_{ip} , will result in between the solution given by the above limit curves. If no slip

is assumed, the loxodromic curve applies and the torsion and curvature quantities can be determined with reference to Figure 3-7 as:

$$\omega_{1p} = \sin \alpha \cos 3\alpha \cos \psi \beta_2 \quad (13)$$

$$\omega_{2p} = -\cos 4\alpha \cos \psi \beta_2 \quad (14)$$

$$\omega_{3p} = (1 + \sin 2\alpha) \cos \alpha \cos \psi \beta_2 \quad (15)$$

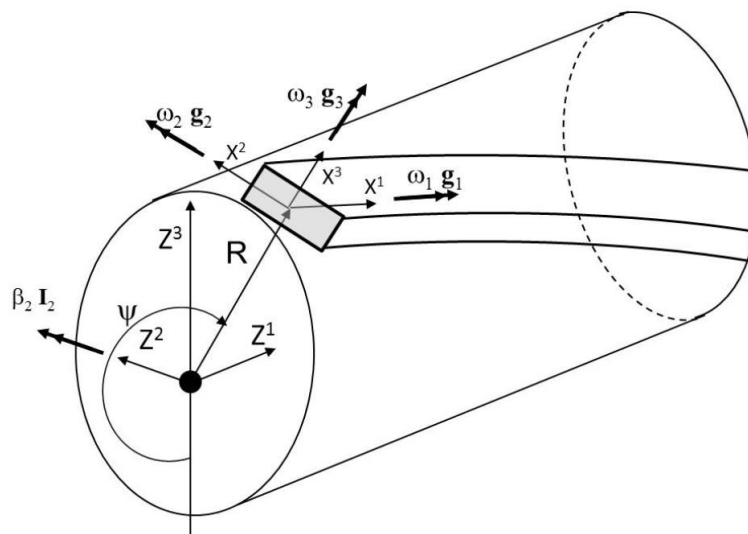

Figure 3-7 Definition of curvature quantities

Where β_2 is the global curvature at the cross-section centre and ψ is the angular coordinate starting from the lower side of the pipe.

Total bending stiffness relation for the flexible pipe:

$$EI = EI_e + \sum_{i=1}^{N_i} F_{fi} \cos^4 \alpha_i \pi R_i^3 t_i f(\beta_2, \beta_{2ci}) \quad (16)$$

where f is a function that is zero whenever the global curvature β_2 is larger than the defined slip curvature β_{2ci} for each layer i . It is noted that for dynamic loading the slip curvature range will be twice the amplitude limits described above. EI_e represents the sum of elastic contributions from the plastic layers and local wire bending. The local wire bending contribution is also influenced by the wire tension which increases the geometric stiffness against bending. By assuming the loxodromic curve representation for the tensile armour, the following expression may be applied to estimate EI_e :

$$\begin{aligned}
 EI_e = & \sum_{i=1}^{N_{pl}} \frac{\pi}{4} E_i \left[(R_i^o)^4 - (R_i^i)^4 \right] \\
 & + \frac{1}{2} \sum_{i=1}^{N_i} G_i I_{1i} \sin^2 \alpha_i \cos^5 \alpha_i + E_i I_{2i} \cos^7 \alpha_i + E_i I_{3i} \left[\cos \alpha_i + 2 \sin^2 \alpha_i \cos \alpha_i + \sin^4 \alpha_i \cos \alpha_i \right] \quad (17) \\
 & + \sum_{i=1}^{N_i} F_{fi} \sigma_{11i} \pi R_i^3 t_i \left[9 \cos^5 \alpha_i \sin^2 \alpha_i + 6 \cos^7 \alpha_i + \frac{\cos^9 \alpha_i}{\sin^2 \alpha_i} + \frac{\cos^5 \alpha_i}{\sin^2 \alpha_i} + 4 \cos \alpha_i \right]
 \end{aligned}$$

Since, the behaviour of the plastic layers are sensitive to temperature and the geometric stiffness and slip limit depend on pressure and tension, several moment-curvature relations may have to be used in strength calculations, depending on the condition to be evaluated.

3.1.3. Stress relations obtained by the Principle of Virtual Displacements

(Sævik, BFLEX-Theory Manuel , 2010)

By excluding volume forces and assuming the spiral to be thin in the metric sense, the principle of virtual work in an arbitrary equilibrium state reads:

$$\int_V \sigma : \delta \varepsilon dX^1 dX^2 dX^3 - \int_s t \cdot \delta u ds = 0 \quad (18)$$

The above gives stress resultants defined by:

$$Q_1 = C_\sigma A \varepsilon_1 + C_\sigma \kappa_1 \beta \quad (19)$$

$$Q_2 = C_\tau A (\varepsilon_2 - \theta_3) \quad (20)$$

$$Q_3 = C_\tau A (\varepsilon_3 + \theta_2) \quad (21)$$

$$M_1 = C_\tau I_t \beta + C_\tau I_p (\omega_1 - \beta) \quad (22)$$

$$M_2 = C_\sigma I_2 \omega_2 \quad (23)$$

$$M_3 = C_\sigma I_3 \omega_3 \quad (24)$$

Q_i represents the force along axes X_i , and M_i the moments acting about the respective axes X_i . A is the area of the cross-section, D , Γ , I_t , I_p are torsion constants and I_2 , I_3 are inertia moments about the respective cross-section axes.

3.2. Model Setting

(Svein Sævik O. D., 2012)

According to the theory mentioned above, a FEM static analysis model is set up to obtain axial stiffness (EA), torsional stiffness (GI) and bending stiffness (EI), which will be required as the material information in SIMLA model in next chapter.

The FEM model is set up in BFLEX which consists of the following parts:

- Control Data
- Nodal Coordinates of Model
- Element Connectivity and Properties
- Orientation of Elements
- Definition of Flexible Pipe Cross-Section
- Cross-Section Boundary Data
- Boundary condition data
- Constraint Input
- History Data
- Material Data

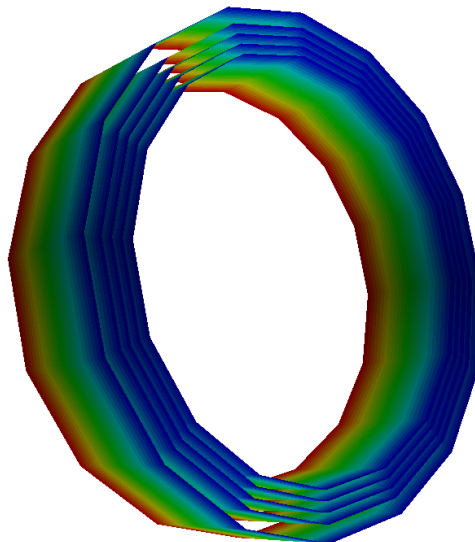

Figure 3-8 Pipeline Cross-Section Model



Figure 3-9 Pipeline Cross-Section Model

3.2.1. Control Data

In this section, basic information of the cross section model is given. The simulating time is also defined. Since we want to get stiffness information, static analysis is selected. The initial configuration is stress free.

3.2.2. Nodal Coordinates of Model

In this section, the nodal coordinates are given in a global coordinates system. Pipe model is set with a length of 200 mm.

In XPOST, visual presentation is enabled. All required results will be listed in the VISRES card in XPOST. The result presentation mode is set as INTEGRATION which means FEM results that includes consistent representation of all numerical elements.

Three types of results will be required in this model as followed; with the condition that PIPE52 model is chosen.

- Axial stress in tendon
- Longitudinal stress due to bending about weak axis
- Longitudinal stress due to bending about strong axis

3.2.3. Element Connectivity and Properties

In this section, element group, references to element and material types as well as element connectivity are defined.

According to the PIPE data, five element groups are defined which consist of one core part and four tensile layers. For all the five groups, pipe52 element is applied and that is the premise of obtaining results mentioned above.

According to the Table 2.1 in BFLEX user manual, pipe 52 is a 3D element with linear or elastic material.

3.2.4. Orientation of Elements

In this model, the initial orientation of the element coordinate systems needs to be defined. This command is accomplished by order ELORIENT and must be given.

For the pipe element which is chosen for this model, specifying the positions of the xy-plane in local element system relative to the global coordinate system can define the orientations, see Figure 3-10. This process is accomplished by defining the position vector R one point in the plane of the local y-axis.

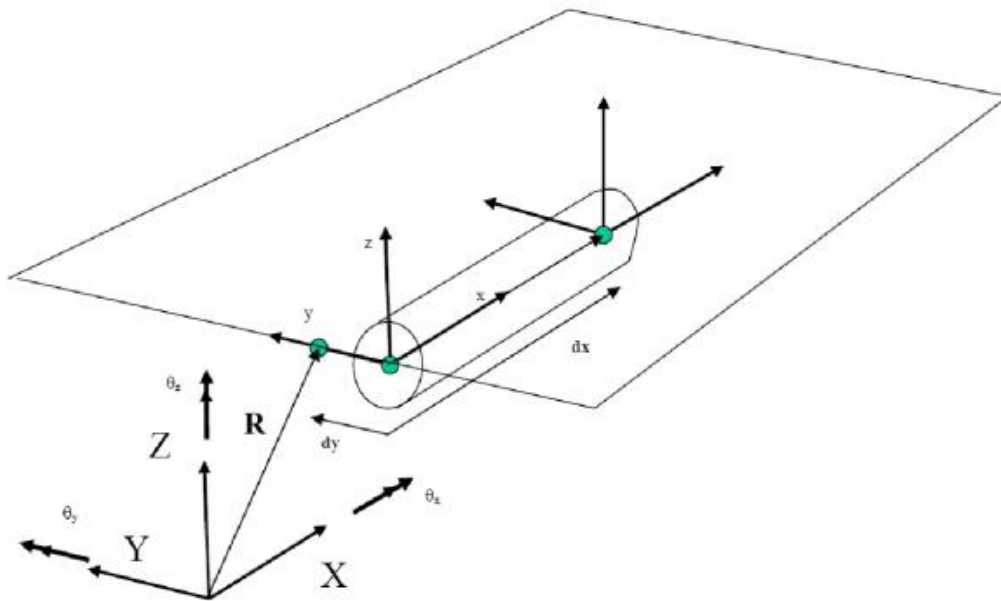

Figure 3-10 Element Orientation



3.2.5. Definition of Flexible Pipe Cross-Section

This section is based on the given pipe data.

Since the required pipeline is flexible. The type of cross-section is also set as FLEXCROSS. Only friction from axisymmetric effects is included when solving equilibrium equations.

For the solution algorithm to be used in this model, ITCODE 31 is recommended which applies one curve for each layer in order to modelling the slip process in a more correct way. By iterating with respect to moment balance the stress are calculated. Compared with full equilibrium iteration of the entire cross-section at each load step, this method will give less stress in extreme cases. However, it has shown a best fitting compared with FBG full scale test stress data when comes to fatigue.

For the modelled pipe, there are 13 layers in total, and 5 element groups are set related to core and tension armour layers. It is normal for the pipe to get broken in out sheath layer. If the out sheath is damaged, the most out-side tension armour will lose friction with it and will surely influence the bending moment. So in this model, the intact and damaged condition will be both considered. And for the damaged condition, the external loading position is at the layer 5. And that means the outer 8 layers are not water tight any more.

The lay angle of the helices can be calculated out by the following equating with given layer weights in combination with the density and cross-section area.

Lay angle equation (Referring to Appendix Pipe Data):

$$\alpha = \cos^{-1}\left(\frac{\rho_{layer} A}{m_{layer}}\right) \quad (25)$$

For Z-spiral, the filled ratio is 85% according to experience.

| Item | ρ_{layer} (kg/m ³) | A(mm ²) | m_{layer} (kg/m) | Filled Ratio | α (°) |
|----------|-------------------------------------|---------------------|--------------------|--------------|--------------|
| Carcass | 7850 | 55×1.4 | 23.786 | 100% | 88.553 |
| Z-sprial | 7850 | 26.8×12 | 68.762 | 85% | 88.201 |

Table 3-1 Cross Section Information

3.2.6. Cross-Section Boundary Data

In this section, the cross section control code denoted in above section for the tensile armour layers is defined.

Relative to the global pipe coordinate XYZ system as shown in Figure 3-11, the cross section is defined by a local right handed Cartesian xyz coordinate system. Assuming the tendon to be installed at a positive lay angle relative to geometric orientation, the X-axis's positive direction is defined.

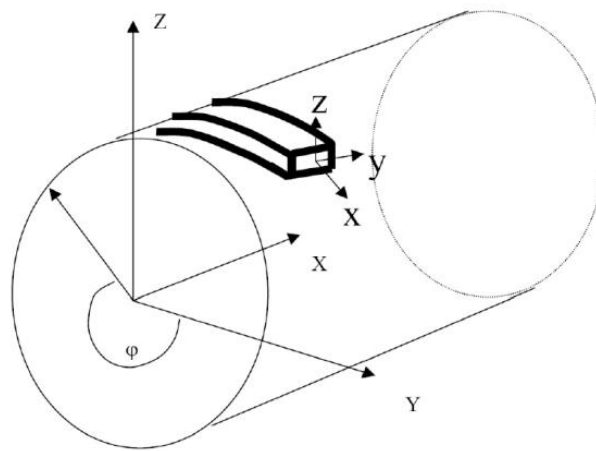

Figure 3-11 Axis systems

3.2.7. Boundary condition data

The specified DOF is fixed in the global coordinates system, so global boundary condition is set.

Three types of prescribed displacement will be defined for different cases, which are longitudinal axial displacement, rotation about X-axis, and bending curvature about Y-axis. So the pipe element is fixed from DOF 1 to DOF 5 at one end and from DOF 2 to DOF 3 at the other. See Figure 3-12.

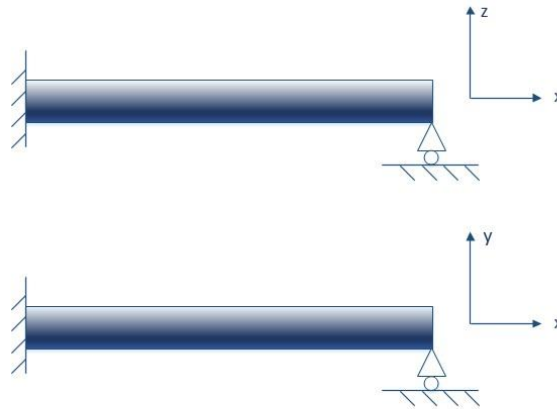

Figure 3-12 Boundary Condition

3.2.8. Constraint Input

As mentioned in the above part, 3 types of constraint inputs will be given with respect to different results required respectively.

| Results Item | DOF | Value |
|--------------------------|-----|-------|
| Stress-Strain | 1 | 0.4 |
| Torque-Torsion | 4 | |
| Bending moment-Curvature | 5 | |

Table 3-2 Constraint Input

3.2.9. Loading Input

For this static BFLEX cross section analysis, the gravity is ignored and only concentrated nodal load and external pressure are considered.

In the water, the pipeline will be faced with high water pressure, but the water pressure can be variable according to the water depth. So for the external pressure load, two different conditions are considered, which are that the pipeline is at the bottom and the pipe line is at the middle.

For the two cases, loading inputs are listed in Table 3-3

| Pipe Position | External Pressure (MPa) |
|---------------|-------------------------|
| Bottom | 20 |
| Middle | 10 |

Table 3-3 Loading Input



3.2.10. History Data

For both prescribed displacement and loading cases, the relative loading steps should be defined in this section.

Linear interpolation is applied between the time steps. For time between T1 and T2 the load factor will then be:

$$F = \frac{FAC2(t - T1) + FAC1(T2 - t)}{T2 - T1} \quad (26)$$

where FACn is Load factor for time tn and is multiplied with the load level given in the relevant load definition.

3.2.11. Material Data

Three types of material information are required in the cross section part. To perform the analysis, the material information card needs to be full filled. But only the following information in Table 3-4 and Table are important concerned with given case.

| ITEM | Plastic layers | Steel |
|-----------------|----------------|-------|
| Poisson's ratio | 0.4 | 0.3 |
| Young's modulus | 300 | 2E5 |

Table 3-4 Linear material mechanical properties

| Strain | Stress (MPa) |
|-----------|-----------------|
| 1.691E-03 | 350 |
| 0.005 | 450 |
| 0.0998 | 835 |

Table 3-5 Stress-Stress relation of none-linear steel material

3.3. Results

The model is visually shown in XPOST as Figure 3-8 and Figure 3-9 above. The relationship of Stress-Strain, Torque-Torsion and Bending moment-Curvature will be illustrated in Matrix Plot for different layers respectively. In the Cross-Section Definition Part, the layers are already separated by core part and tensile layer part. In the Matrix, the results will also be shown by layers. To obtain the stiffness for entire pipeline cross section, the results of different layers shall be add up. In the following part, from section 3.3.1 to section 3.3.3, the results are under the assumption that the pipeline is at the position of seabed, which means the external pressure is 20Mpa. The

section 3.3.4 shows the results under the assumption that the pipeline is at the position of mid-sea, which means the external pressure is 10 Mpa. And in the SIMLA model the results in 3.3.4 are used for model PIPE31 which needs linear material information.

3.3.1. Axial Stiffness

From the Figure 3-13 and Figure 3-14, it is seen that the axial stiffness will not change significantly due to damage.

- Intact condition

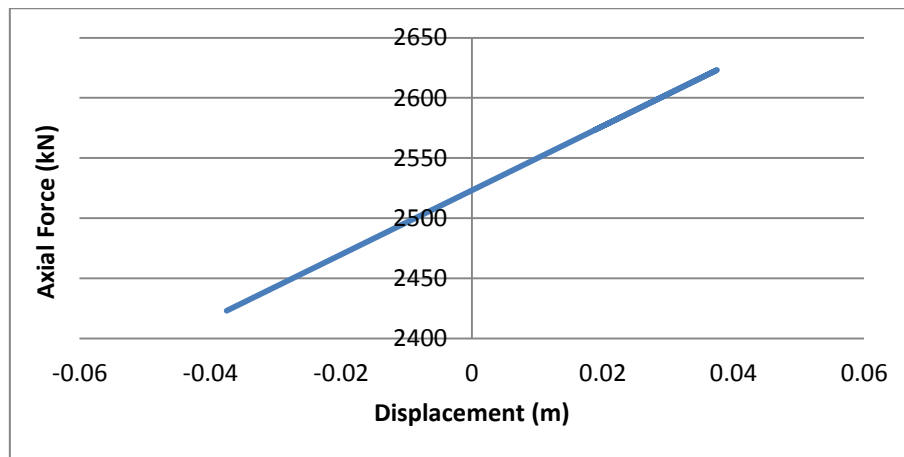

Figure 3-13 Axial Stiffness Relationship of Flexible Pipeline

- Damaged Condition

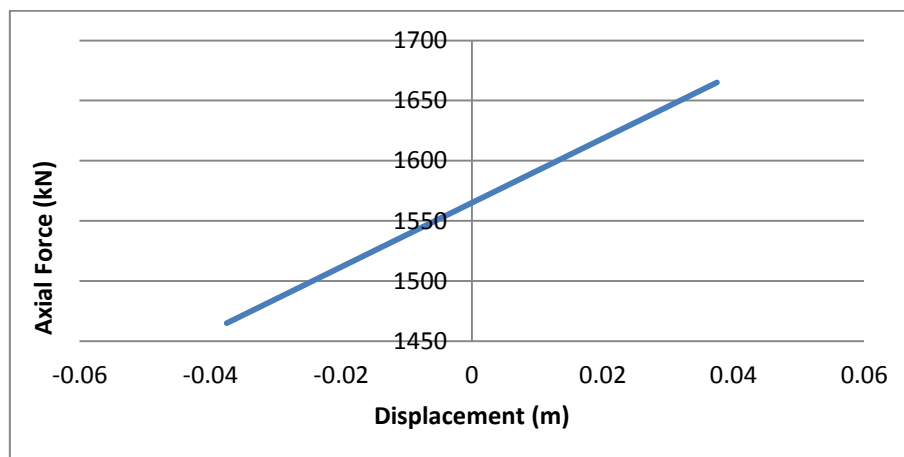

Figure 3-14 Axial Stiffness Relationship of Flexible Pipeline

3.3.2. Torque-Torsion

From the Figure 3-13 and Figure 3-14, it is seen that the torsional stiffness does not change due to damage.

- Intact Condition

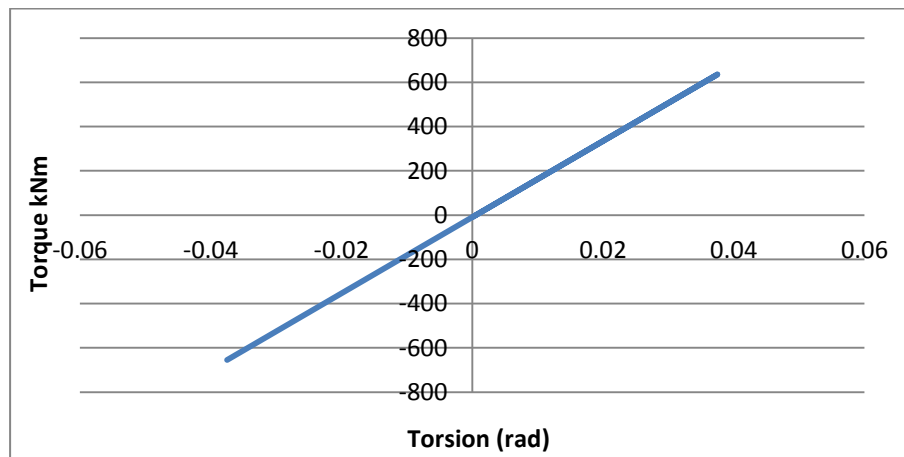

Figure 3-15 Torsional Stiffness Relationship of Flexible Pipeline

- Damaged Condition

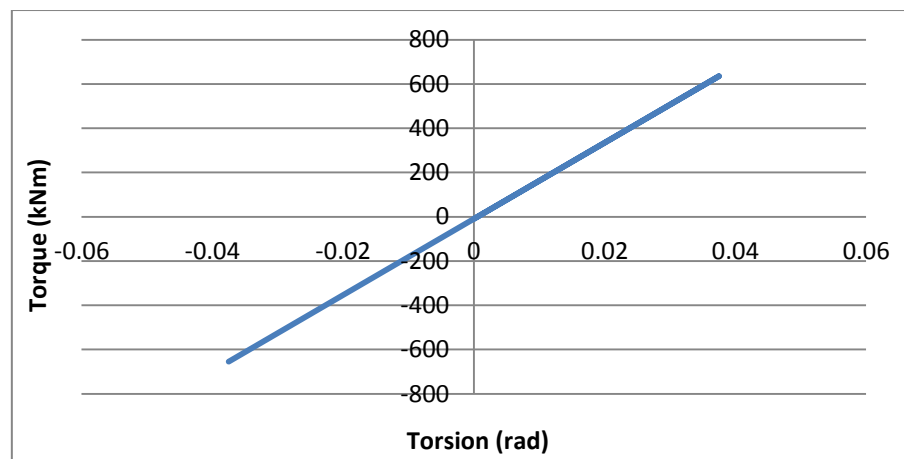

Figure 3-16 Torsional Stiffness Relationship of Flexible Pipeline

3.3.3. Bending Moment-Curvature

For the Bending Moment –Curvature relationship, each layer's contribution will be listed up, i.e. core part, and tensile layer1 to tensile layer4. Both intact condition and damaged condition will be shown below. Analysis and conclusion will be given in Chapter 6.

- Intact Condition

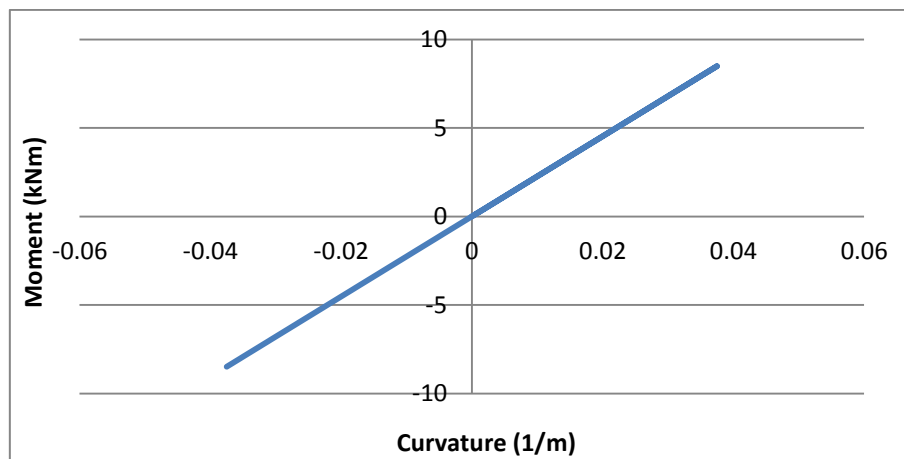

Figure 3-17 Bending Moment-Curvature (Core)

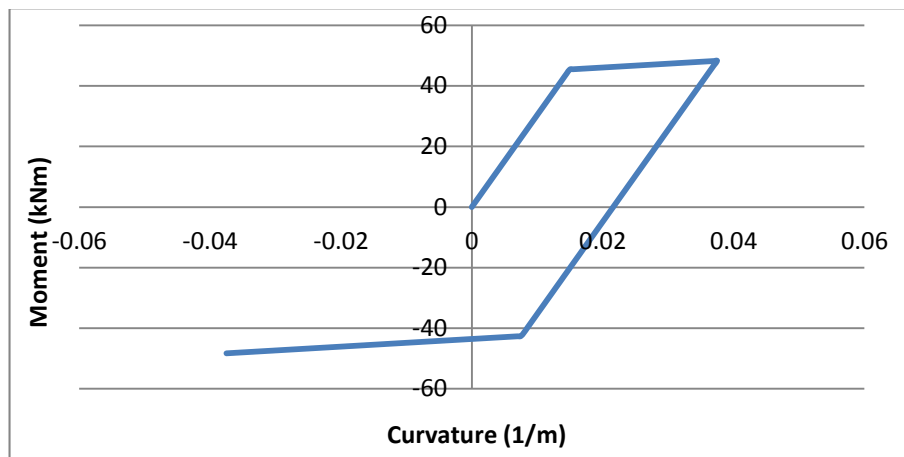

Figure 3-18 Bending Moment-Curvature (Tensile Layer 1)

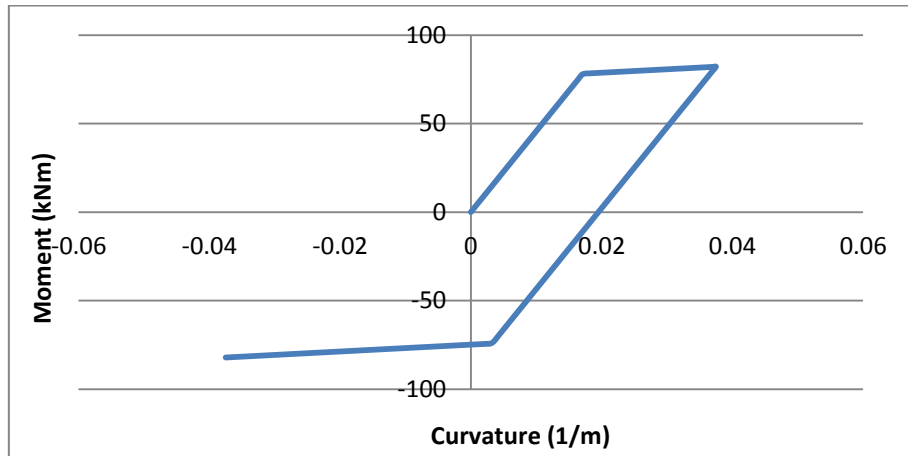

Figure 3-19 Bending Moment-Curvature (Tensile Layer 2)

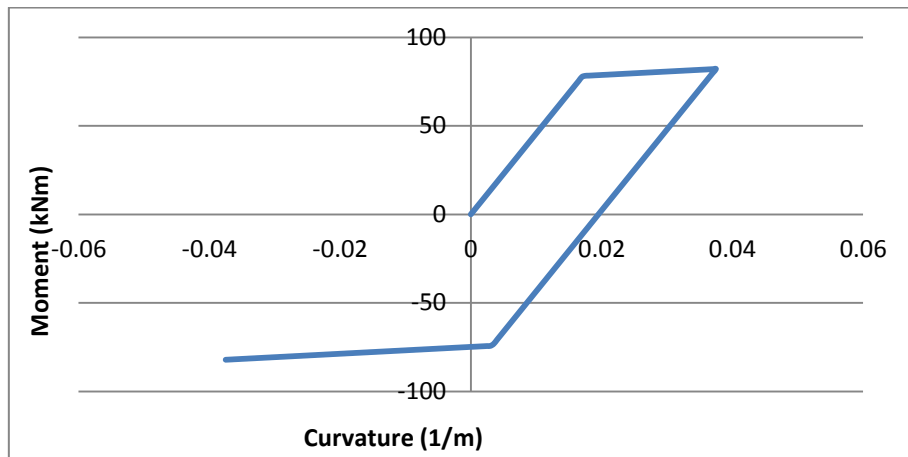

Figure 3-20 Bending Moment-Curvature (Tensile Layer 3)

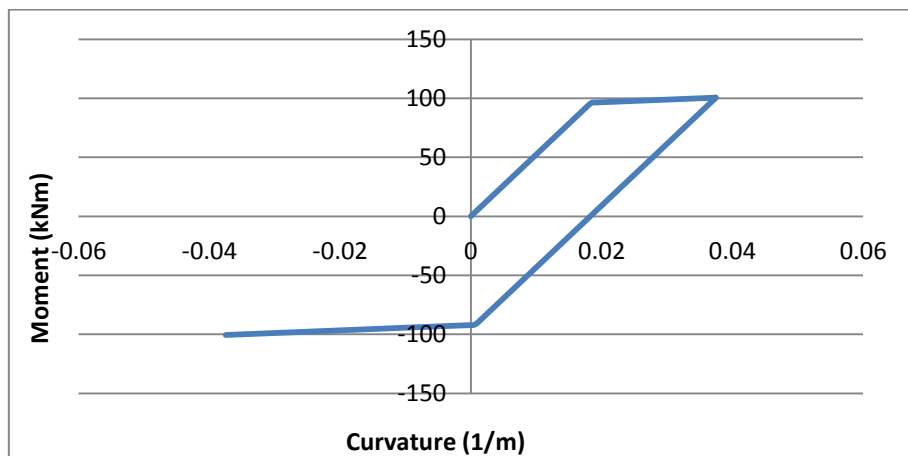

Figure 3-21 Bending Moment-Curvature (Tensile Layer 4)

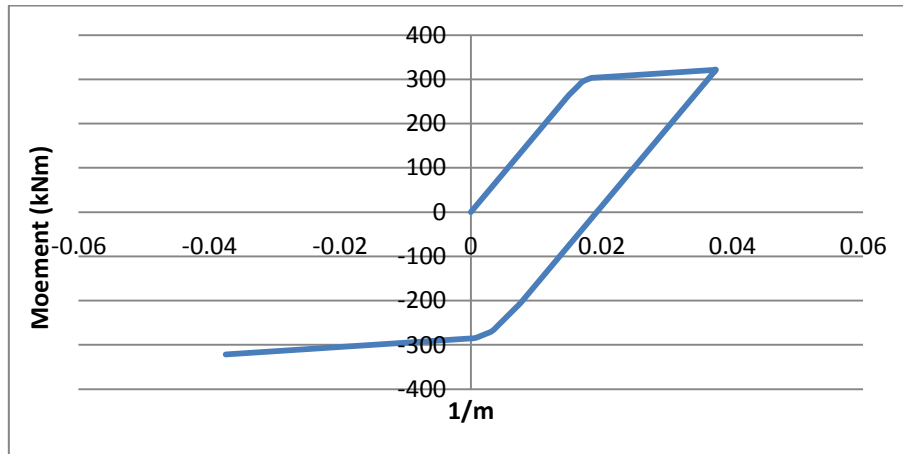

Figure 3-22 Bending Moment-Curvature

- Damaged Condition

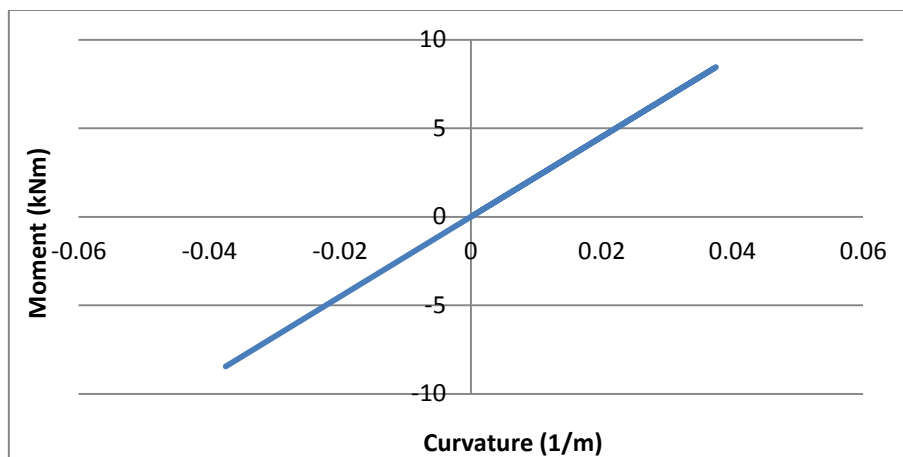

Figure 3-23 Bending Moment-Curvature (Core)

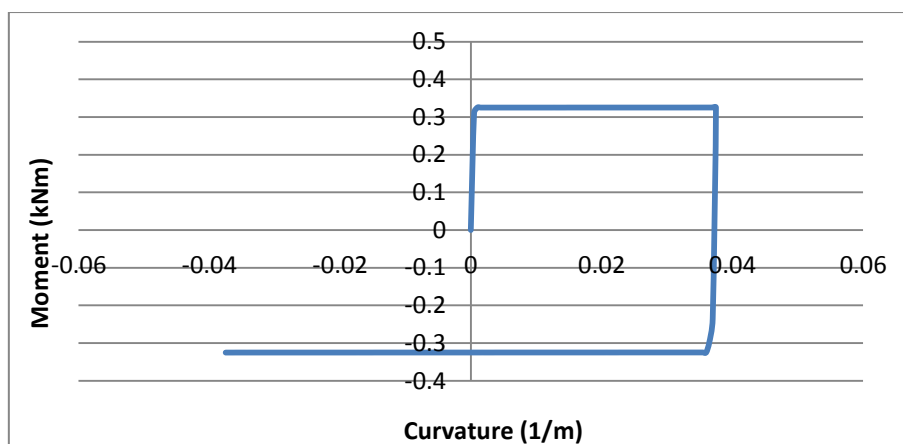

Figure 3-24 Bending Moment-Curvature (Tensile Layer1)

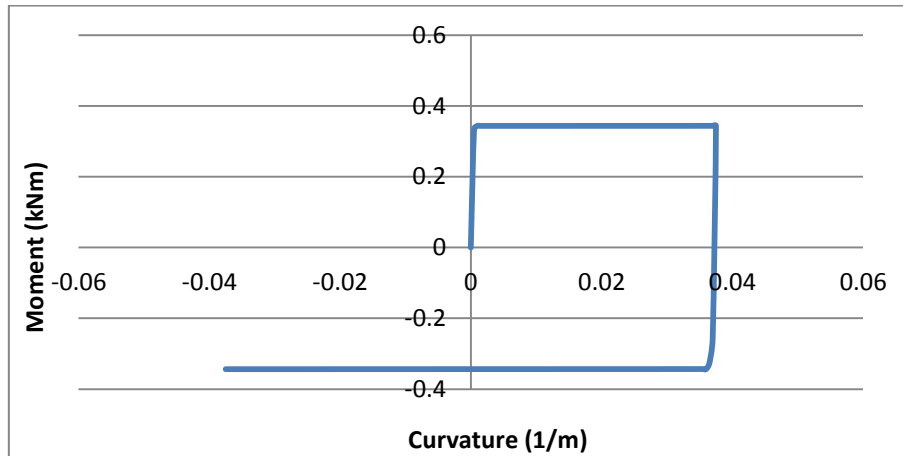

Figure 3-25 Bending Moment-Curvature (Tensile Layer2)

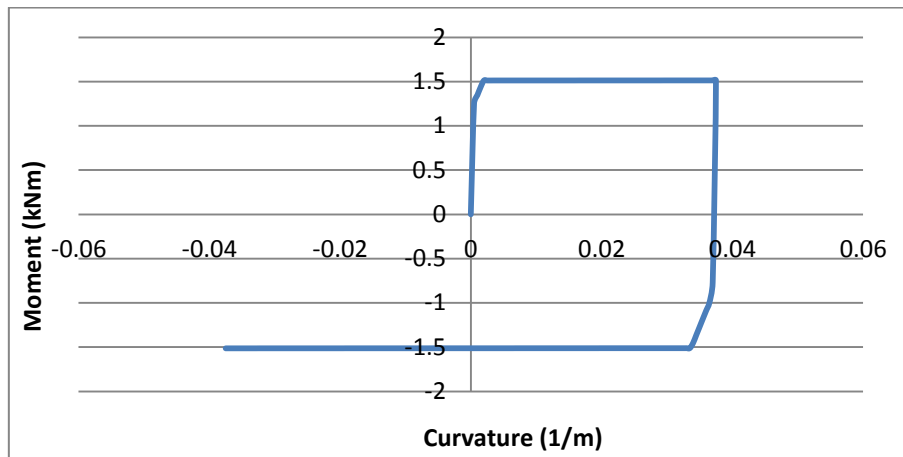

Figure 3-26 Bending Moment-Curvature (Tensile Layer3)

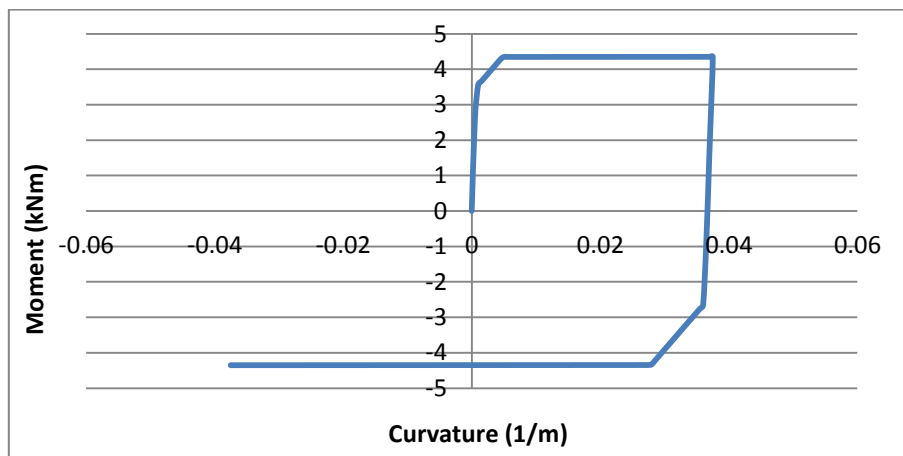

Figure 3-27 Bending Moment-Curvature (Tensile Layer 4)

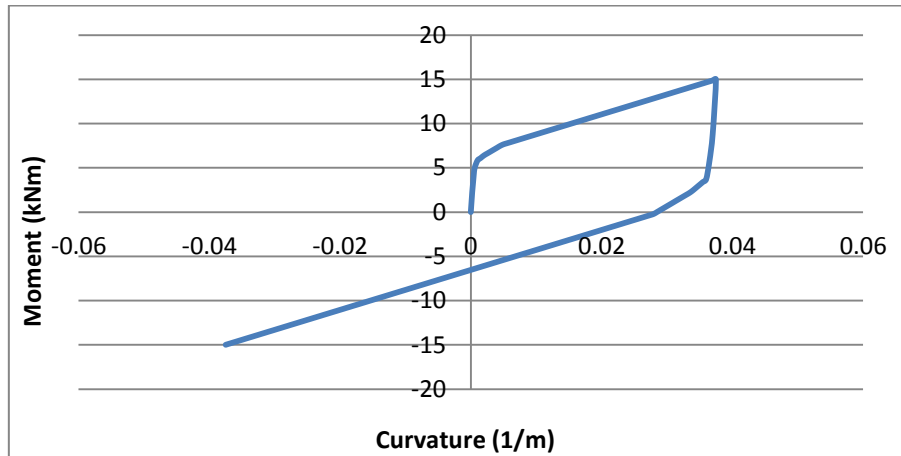

Figure 3-28 Bending Moment-Curvature

3.3.4. Pipe31

- Intact Condition

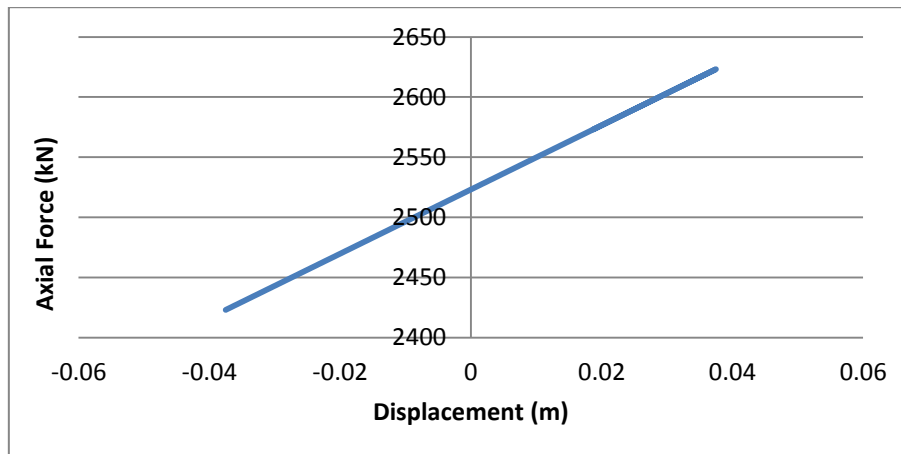

Figure 3-29 Axial Stiffness Relationship of Flexible Pipeline

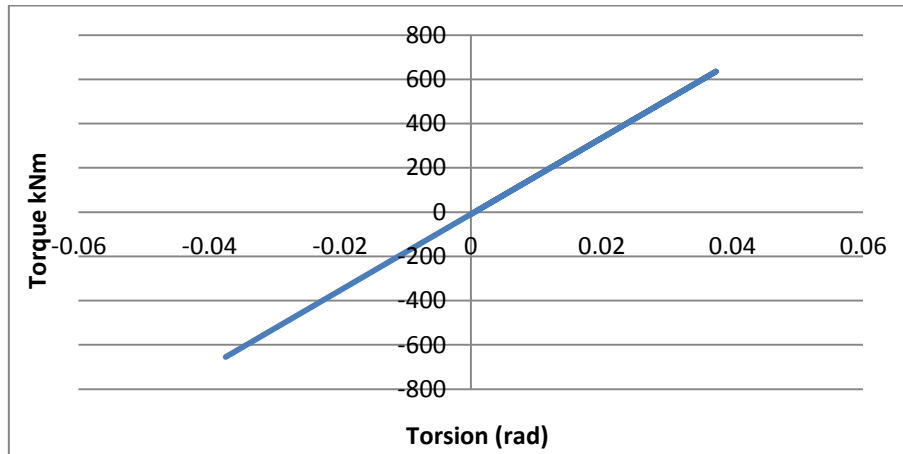

Figure 3-30 Torsional Stiffness Relationship of Flexible Pipeline

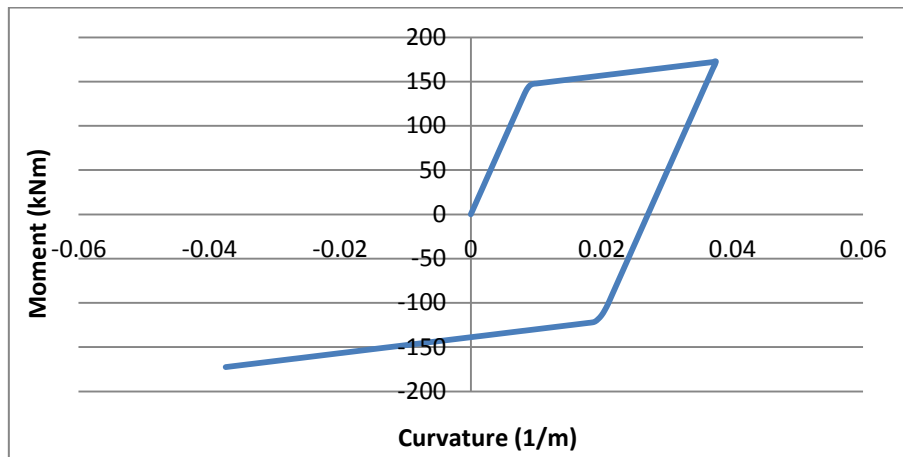

Figure 3-31 Bending Stiffness Relationship of Flexible Pipeline

- Damaged Condition

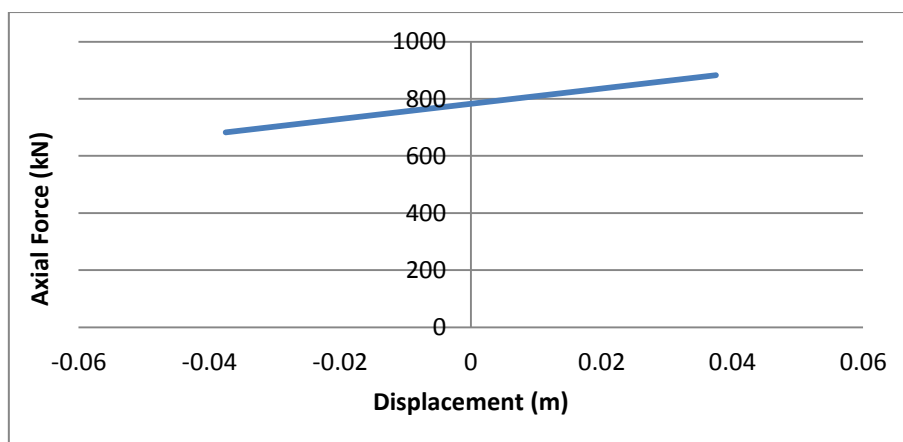

Figure 3-32 Axial Stiffness Relationship of Flexible Pipeline

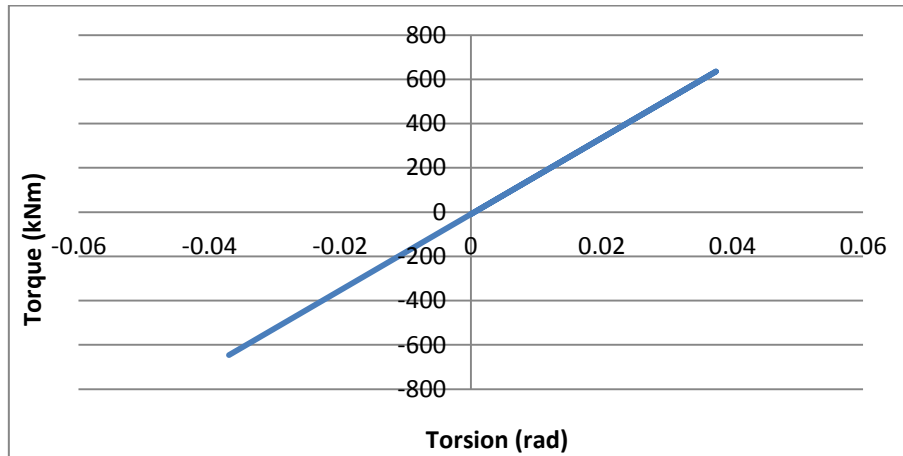

Figure 3-33 Torsional Stiffness Relationship of Flexible Pipeline

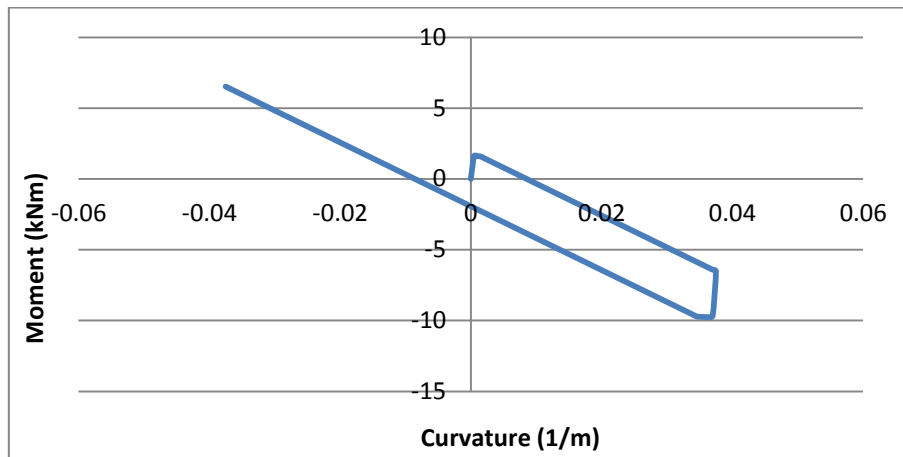

Figure 3-34 Bending Stiffness Relationship of Flexible Pipeline



4 SIMLA Model

In this section, a SIMLA model is set up. The model simulates a J-lay process in a water depth of 2000 meters.

4.1. Theory

(Sævik, Simla- Theory Manual, 2008)

4.1.1. Principle of virtual displacements

The principle is not a real energy principle, since the computed work is actions work done by a set of (statically admissible) forces and stresses on a set of kinematically admissible displacements and strains. The stresses and displacements need not be the actual distribution in the deformed body, and they may be independently prescribed.

Excluding volume forces, the principle of virtual work in an arbitrary equilibrium state reads:

$$\int_V (\rho \ddot{u} - f) \cdot \delta u dV + \int_V (\sigma - \sigma_0) : \delta \varepsilon dV - \int_S t \cdot \delta u dS = 0 \quad (27)$$

where ρ is the material density, \ddot{u} is the acceleration field, f is the volume force vector, σ is the stress tensor of Cauchy stress, σ_0 is the initial stress tensor, ε is the strain tensor of natural strain, t is the surface traction and u is the displacement vector. σ_0 may be obtained from the initial strain tensor by applying the material law.

4.1.2. Incremental form of the Principle of Virtual Displacements

In finite element analysis of large deformation problems in solid mechanics, there are two different formulations widely used. These are the Total Lagrangian (TL) and the Updated Lagrangian (UL) formulations. The difference between them is the choice of reference configuration. In a TL formulation, all static and kinematic variables are referred back to the initial (C_0) configuration, while in the UL formulation these are referred to the last obtained equilibrium configuration, i.e. the current (C_n) configuration.

The present work has been based on the Co-rotational formulation referring all quantities to the C_0 configuration. In the Co-rotational formulation, the last obtained reference configuration is adequately described by the current strains and the equation

of incremental stiffness is obtained by making use of Eq. (25) and study the virtual work in an infinitesimal increment as follows when including static terms only:

$$\int_V C : (\varepsilon + \Delta E) : (\varepsilon + \Delta E) dV_0 - \int_s (t + \Delta t) \cdot \delta u dS_0 = 0 \quad (28)$$

4.1.3. Implementation into finite element equations

Looking at Equations. (25) and (26), the following is needed in order to develop finite element equations that can be implemented into a numerical code:

- Kinematics description, i.e. a relation between the displacements and rotation and the strains at a material point.
- A material law connecting the strain with resulting stresses.
- Displacement interpolation, describing the displacement and rotation fields by a number of unknowns on matrix format.

4.1.4. Solution Algorithms

- Static Solution Procedure

The static solution procedure is based on user defined load control with Newton-Raphson equilibrium iteration at each load step. This is illustrated in Figure 4-1 below.

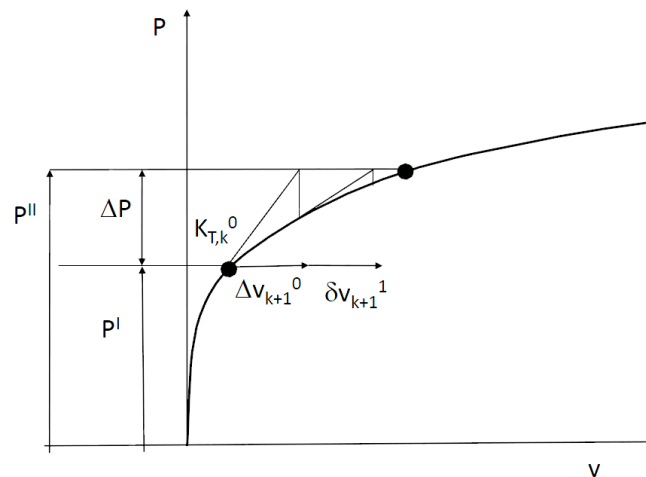

Figure 4-1 Illustration of Newton Raphson iteration

The procedure can be written as:

$$\Delta r_{k+1}^i = K_{T,k+1}^{-li} \Delta R_{k+1}^i \quad (29)$$

- Dynamic Solution Procedure

Nonlinear dynamic problems cannot be solved by modal superposition and therefore direct time integration of the equation of motion is necessary. This can be performed either by an explicit method or an implicit method. Explicit methods can typically be expressed as in Eq. (28).

$$r_{k+1} = f(\ddot{r}_{k+1}, \ddot{r}_k, \dot{r}_{k+1}, \dot{r}_k, r_k, \dots) \quad (30)$$

In SIMLA the HHT- α method is used in the time integration scheme. In the HHT- α method the modified equilibrium equation for the system is given as:

$$M\ddot{r}_{k+1} + (1 + \alpha)C\dot{r}_{k+1} - \alpha C\dot{r}_k + (1 + \alpha)R_{k+1}^I - \alpha R_k^I = (1 + \alpha)R_{k+1}^E - \alpha R_k^E \quad (31)$$

Here M is the mass matrix, C the damping matrix, R^I the internal force vector and R^E the external force vector. Subscript $k + 1$ refers to next time step and subscript k to current time step. The total damping matrix includes both Rayleigh-damping and a diagonal damping matrix:

$$C = C_0 + \alpha_1 M + \alpha_2 K \quad (32)$$

4.1.5. Convergence Criteria

The iteration algorithm is terminated by means of a vector norm when equilibrium at a given tolerance level is achieved. Such a norm can for instance be based on total displacements as given below equations.

$$\|\delta r_{k+1}^{i+1}\| < \varepsilon_D \|r_{k+1}^{i+1}\| \quad (33)$$

$$\|r_{k+1}^{i+1}\| = \frac{1}{N} \sqrt{\sum_{j=1}^N (r_j^{i+1})^2} \quad (34)$$

$$\|r_{k+1}^{i+1}\| = \|r_{k+1}^{i+1}\| - \|r_{k+1}^i\| \quad (35)$$

In the tolerance criteria given in Eq. (31) the accuracy of the solution is governed by the ε_D -parameter. Reasonable values for the ε_D -parameter is usually in the order of 10^{-2} to 10^{-6} .



4.2. Model Setting

(Svein Sævik O. D., 2010)

The FEM model is set up in BFLEX which consists of the following parts:

- Control Data
- Analysis Time Control
- Nodal Coordinates
- Element Connectivity
- Element Orientation
- Element Eccentricity
- Contact Interface
- Element Property
- Loading
- Boundary Conditions
- Constraint Input
- RAO Property
- Material Data
- Envelope Results

The material mechanic information obtained in BFLEX will be input in the Material Data part.

The model shown in XPOST is as following illustration, where the blue section is sea surface, the green box is lay vessel, red string is pipeline and green section at the bottom is seabed.

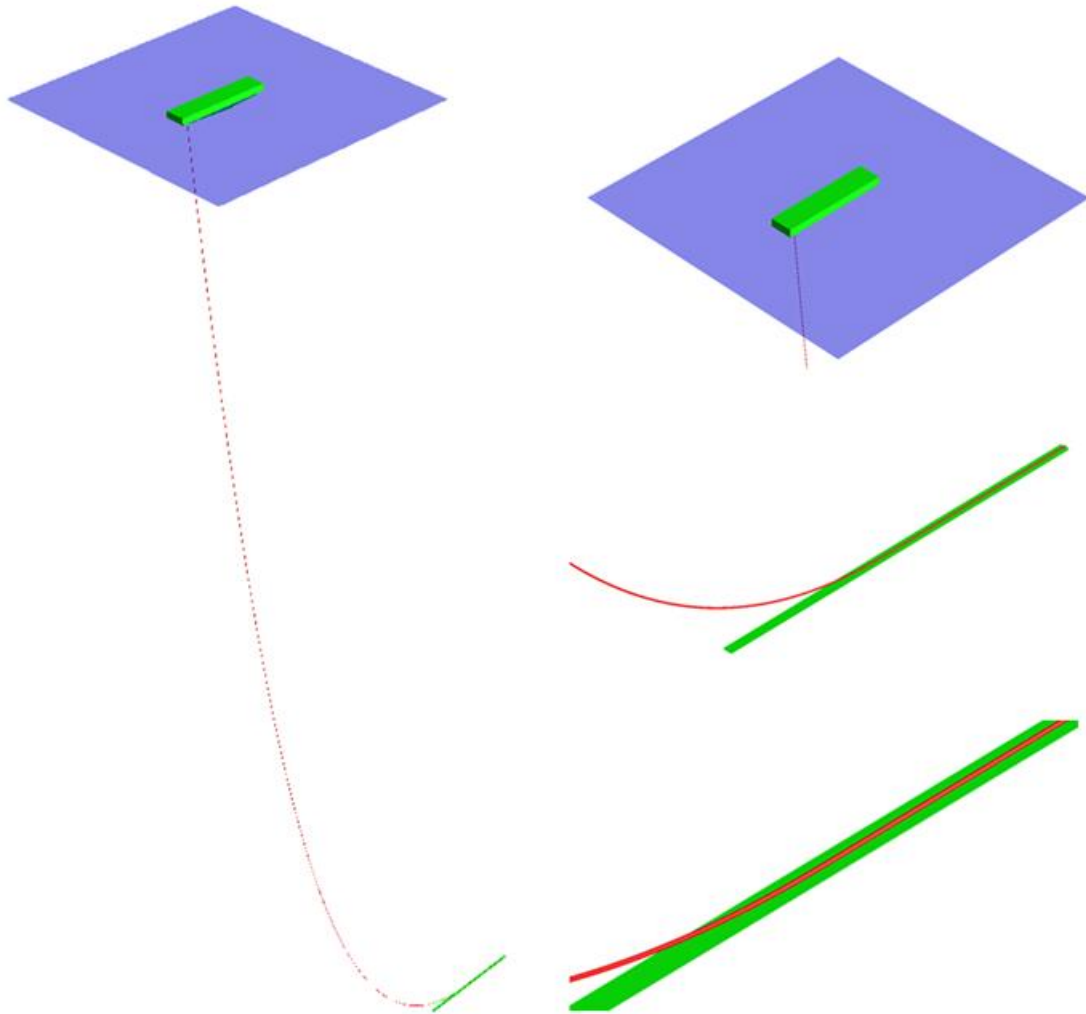

Figure 4-2 J-lay SIMLA Model in XPOST

4.2.1. Control Data

This model is 3-dimensional and the start procedure parameter is set as AUTOSTART, which means that an initial configuration assuming the weight at step 1 is determined by the program automatically. It assumes that the pipeline is installed on a seabed defined by the COSURFPR card.

Since the J-lay method is chosen, no roller and no stinger.

In this case, the departure angle is 85 ° and equals to 1.484 rad.

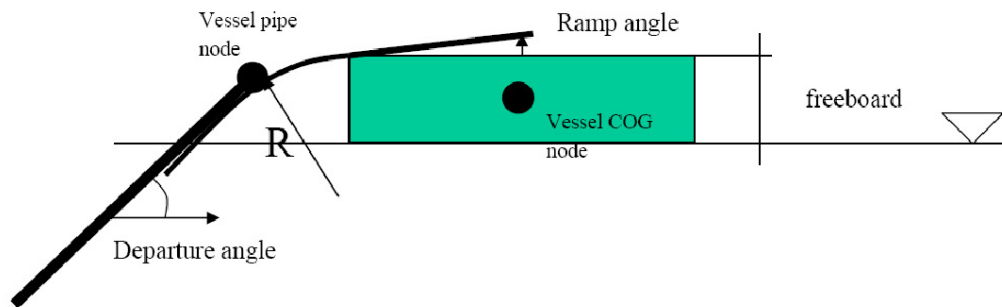

Figure 4-3 Laying Vessel Configuration

In the part of control parameters for dynamic analysis, mass matrix is set as concentrated one. Damping factors are also set.

In XPOST, three types of results will be presented with scaling factor of 1.

- σ_{xx} Longitudinal stress at mean surface
- Contact element local y-force
- Contact element local z-force

Since dynamic response analysis is required in this paper, the DYNRES cards are needed in SIMLA, which will enable direct use of the XPOST time history plot functionality.

The results of Vessel COG and the element which contact to vessel are mostly interested by us.

4.2.2. Analysis Time Control

Both static analysis and dynamic analysis is required in time control.

4.2.3. Nodal Coordinates

Hereby neglecting the bending stiffness, catenary theory is applied. Under the catenary theory, the length of suspended line is given by: (Nielsen, 2007)

$$L = \frac{H}{W} \left\{ \left[\frac{Dw}{H} + 1 \right]^2 - 1 \right\}^{1/2} \quad (36)$$

Where D is the water depth, H is the horizontal component of the tension at upper end. W is the submerged weight and can be defined by:



$$w = mg + (\rho_i A_i - \rho_o A_o)g \quad (37)$$

m is the mass of dry pipe per unit length, ρ is the fluid density, and A is the cross-sectional area. Index I refers to interior of the pipeline, while o refers to the external.

According to the results obtained by applying equation of catenary, the minimum installation length of pipeline is 2021 m. Since the departure angle is set as 85 ° and it can be changeable during installation, the real installation length will be surely larger than the calculated result. Since we need several elements to be laid on the seabed with no response at all, a length of 2300 m is chosen for the SIMLA model.

To get accurate result, the bottom part of pipeline is simulated with element COMPIPE42. For accuracy, COMPIPE42 element length is set as 0.5 m. The first 800 elements are COMPIPE42 and the left 1900 m pipeline is meshed up by 900 PIPE31 elements. So in total, the pipeline is meshed with 1700 elements. The nodal coordinates of pipe and COG of laying vessel is given according to the geometry of pipe and laying vessel then.

The sea surface is also simulated with several nodal coordinates.

4.2.4. Element Connectivity

In SIMLA, the elements are organised into element groups which have a specific name respectively. In this case, 5 groups of elements are defined. They are:

| Group name | Element type | Simulating |
|------------|--------------|-------------|
| ormpipe1 | COMPIPE42 | pipe |
| ormpipe2 | PIPE31 | pipe |
| vessel1 | SPRING137 | Lay vessel |
| seabed | CONT126 | seabed |
| sea1 | SEA150 | sea surface |

Table 4-1 Element Type

4.2.5. Element Orientation

Same as the BFLEX model, the initial orientation of element coordinate system is supposed to be defined. For the pipe elements, the orientations are defined by specifying of the xy-plane in local element system relative to the global coordinate system. See Figure 3-10



4.2.6. Element Eccentricity

Element eccentricity of the contact element between lay vessel and pipeline should be defined. The element type is BEAM and the eccentricity is defined according to the vessel geometry and nodal coordinate information of the contact pipeline element.

4.2.7. Contact Surface Property

The contact surface properties are defined by input profile “levold.txt” which is added to the Appendix.

The material properties along a route on KP basis which contact with the pipeline are also defined.

4.2.8. Contact Interface Data

The contact interfaces shall be defined, in order to optimize the contact search. Hereby the master element group and slave element group will be denoted.

4.2.9. Element Property

Element property card is the alternative part in this SIMLA code case. The following cases can be listed. RADE is the external radius where external pressure acts on.

| Element Property Type | Condition | Changeable Term |
|-----------------------|----------------|-----------------|
| Pipe31 | Intact/Damaged | None |
| Compipe42 | Intact | RADE |
| | Damaged | RADE |

Table 4-2 Element Property Cases

The hydrodynamic coefficients are defined in Chapter 2 as the Table 4-3.

| ITEM | VALUE |
|-----------------------------|-------|
| Radial drag coefficient | 0.8 |
| Tangential drag coefficient | 0.1 |
| Radial mass coefficient | 2.0 |
| Tangential mass coefficient | 0.2 |

Table 4-3 Hydrodynamic coefficients

For the lay vessel, the element property type is selected as GENSPRING according to the element type of lay vessel namely SPRING137.



4.2.10. Loading

Concentrated load, external pressure and gravity shall be considered here. The loading history numbers are also denoted which will be listed out in the time history card.

Wave load shall be divided by two cases, which are regular wave and irregular wave. For the irregular wave case, it will be discussed in detail in chapter 5. Here the regular wave loading parameters are listed in Table 4-4.

| Item | Value | Unit |
|--|---------|------|
| x-coordinate where the wave is generated | 1667.27 | M |
| y-coordinate where the wave is generated | 0 | M |
| Wave direction angle | 0 | Rad |
| Wave period | 10 | S |
| Wave height | 7 | M |
| Water depth | 2000 | M |
| Phase angle | 0 | Rad |

Table 4-4 Regular Wave Load

The wave elevation at any point x,y along the sea surface is calculated as:

$$\eta(x, y, t) = \frac{H}{2} \sin(\omega t - k(x - x_0) \cos(\varphi_\omega) - k(y - y_0) \sin(\varphi_\omega) + \phi) \quad (38)$$

where $k = 2\pi / L_\omega$ is the wave number and $\omega = 2\pi / T$ is the wave circle frequency. The above means that the waves propagate along the positive x-axis at direction angle $\varphi_\omega = 0$.

4.2.11. Boundary Condition

Boundary conditions at the sea bottom and sea surface shall be defined.

4.2.12. Constraint Input

Two types of prescribed displacements are defined, which are vessel and sea surface prescribed displacements. The vessel prescribed displacements are defined according to the RAO property, which will be defined in next section.

4.2.13. RAO Property

The RAO property card is following the Table 4-5. The DIRn is the direction angles of the n-th transfer function.

| Item | DIR1 | DIR2 | DIR3 | DIR4 | DIR5 |
|-------|------|------|------|------|------|
| Surge | 0 | 1.57 | 3.14 | 4.71 | 6.28 |
| Sway | 0 | 1.57 | 3.14 | 4.71 | 6.28 |
| Heave | 0 | 1.57 | 3.14 | 4.71 | 6.28 |
| Roll | 0 | 1.57 | 3.14 | 4.71 | 6.28 |
| Pitch | 0 | 1.57 | 3.14 | 4.71 | 6.28 |
| Yaw | 0 | 1.57 | 3.14 | 4.71 | 6.28 |

Table 4-5 RAO Property

The RAO curve information for single direction will be listed in the Appendix.

For a given wave frequency the response quantity is calculated according to the following procedure:

- Calculate the angle $\varphi_{rao} = \varphi_{\omega} - \varphi_h$ which is the wave heading angle in the RAO vessel system, see Figure 4-4.

- The unit response amplitude and associated phase are given as:

$$\beta_{rao} = f_{amp}(\omega, a_i)(1 - \zeta) + f_{amp}(\omega, a_{i+1})\zeta \quad (39)$$

$$\phi_{rao} = f_{phase}(\omega, \phi_i)(1 - \zeta) + f_{phase}(\omega, \phi_{i+1})\zeta \quad (40)$$

Where ζ is a non-dimensional interpolation scaling parameter = $\frac{\varphi_{rao} - \varphi_i}{\varphi_{i+1} - \varphi_i}$

- The response is then calculated as:

$$r(x, y, t) = \frac{H}{2} \sin(\omega t - k(x - x_0) \cos(\varphi_{\omega}) - k(y - y_0) \sin(\varphi_{\omega}) + \phi_{rao}) \quad (41)$$

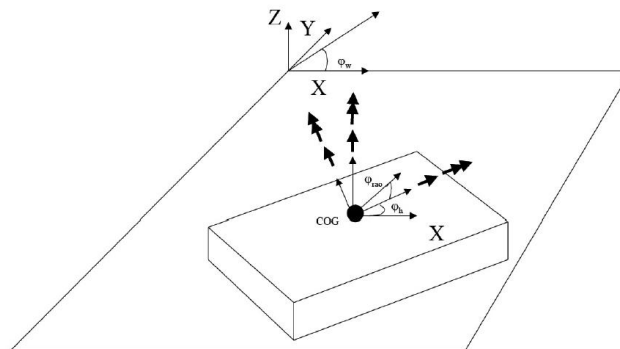

Figure 4-4 Vessel RAO coordinate system in relation to global system

4.2.14. Material Data

For the laying scenario under regular wave, three cases shall be performed. They are given the following names respectively as the list below.



- Bi-linear case
- None bi-linear case A
- None bi-linear case B

For all the cases, since there are two parts of pipeline, the material information is also given for two element parts respectively.

a. Bi-linear Case

In this case, compipe42 element is selected for the pipeline of the bottom part while for the upper part is element pipe31. For the compipe42 element, axial stiffness, torsional stiffness and bending stiffness shall be given in material information type of HY-curve or EP curve.

For the pipe31 element, since the element is linear in material property, the axial stiffness, torsional stiffness and bending stiffness shall be input directly in the material card.

Both of the elements' material information is obtained from the BFLEX model in chapter 3.

For element compipe42, it is assumed to be kinematic hardening. The stiffness in different DOFs are given from Table 4-6 to Table 4-8.

| HY-Curve | X-Axis (m) | Y-Axis (MN) |
|----------|------------|-----------------------|
| | -1.000 | -2.6688×10^4 |
| | 1.000 | 2.6688×10^4 |

Table 4-6 Axial material information

| HY-Curve | X-Axis (m) | Y-Axis (MNM) |
|----------|------------|--------------------------|
| | -1.000 | -549.26×10^{-3} |
| | 1.000 | 2.6688×10^{-3} |

Table 4-7 Torsional material information

| EP-Curve | X-Axis (m) | Y-Axis (MNM) |
|----------|------------|-------------------------|
| | 0.008 | 141.03×10^{-3} |
| | 0.0185 | 303.21×10^{-3} |
| | 0.026 | 310.44×10^{-3} |
| | 0.0375 | 321.54×10^{-3} |

Table 4-8 Bending material information

For element pipe31, the material information is given in Table 4-9

| EA (MN/M) | GI (MNM) | EI (MNM) |
|----------------------|---------------------|--------------------|
| 2.6688×10^4 | 1.658×10^2 | 1.69×10^3 |

Table 4-9 Material information for pipe31

b. None Bi-linear Case A

As is mentioned in the thesis scope, the dynamic curvature at the touch down point is governed by the bending stiffness of the flexible pipe. Normal practice has been to perform installation analysis using the plastic layer elastic bending stiffness without taking into account the bi-linear contribution from the tensile armour layers. The purpose of this project is to investigate the effect of applying different moment-curvature assumptions with regard to the dynamic response at TDP.

In the bi-linear case A, the normal practice shall be performed, which means the elastic bending stiffness will be used. So hereby the blue line in Figure 4-5 shall be taken for the material information.

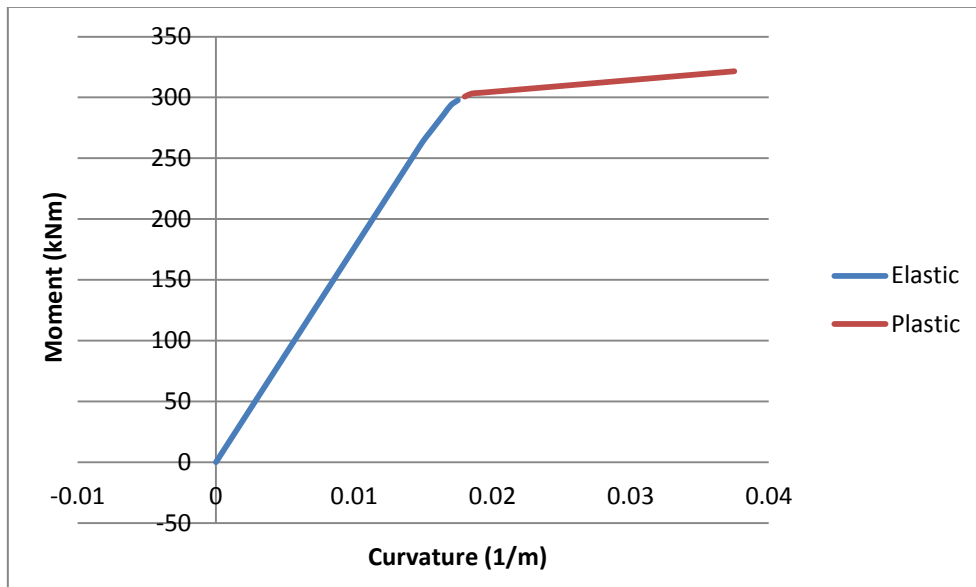

Figure 4-5 Bending Moment-Curvature

The pipe31 element used in the bi-linear case does not need to be replaced, but the compipe42 element shall be replaced by a new pipe31 element. So does the relative element property card.

For the new pipe31 element, the stiffness information is given in Table 4-10.

| EA (MN/M) | GI (MNM) | EI (MNM) |
|----------------------|---------------------|--------------------|
| 2.6688×10^4 | 1.658×10^2 | 1.69×10^3 |

Table 4-10 Material information for pipe31

c. None bi-linear Case B

This case shall be made to make comparison with the other two. It is almost same as the None Bi-linear Case A. But the new pipe31's bending stiffness is obtained from the red line in Figure 4-5. So it is in the plastic range.

4.2.15. Envelope Results

Here the nodal displacement in DOF1 and DOF3 will be required.

For the element result, axial force on DOF 1 direction, moment to DOF 2 and curvature will also ordered.

The final result will be plotted in Matrix Plot and the illustrations are shown in next section.

4.3. Results

4.3.1. Bi-linear Case

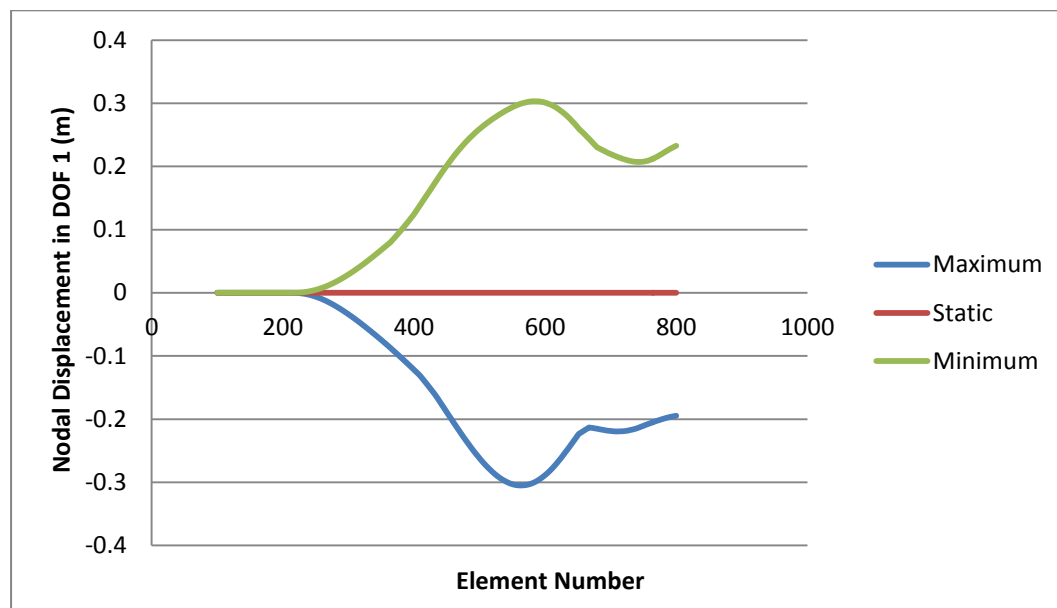

Figure 4-6 Nodal Displacement in DOF 1

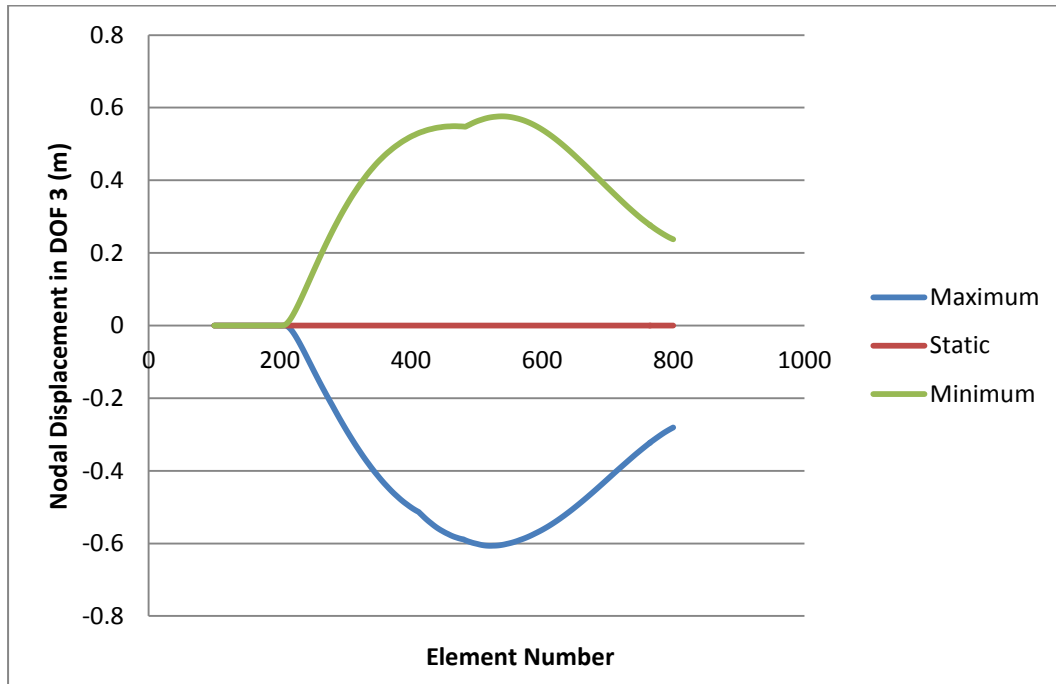

Figure 4-7 Nodal Displacement in DOF 2

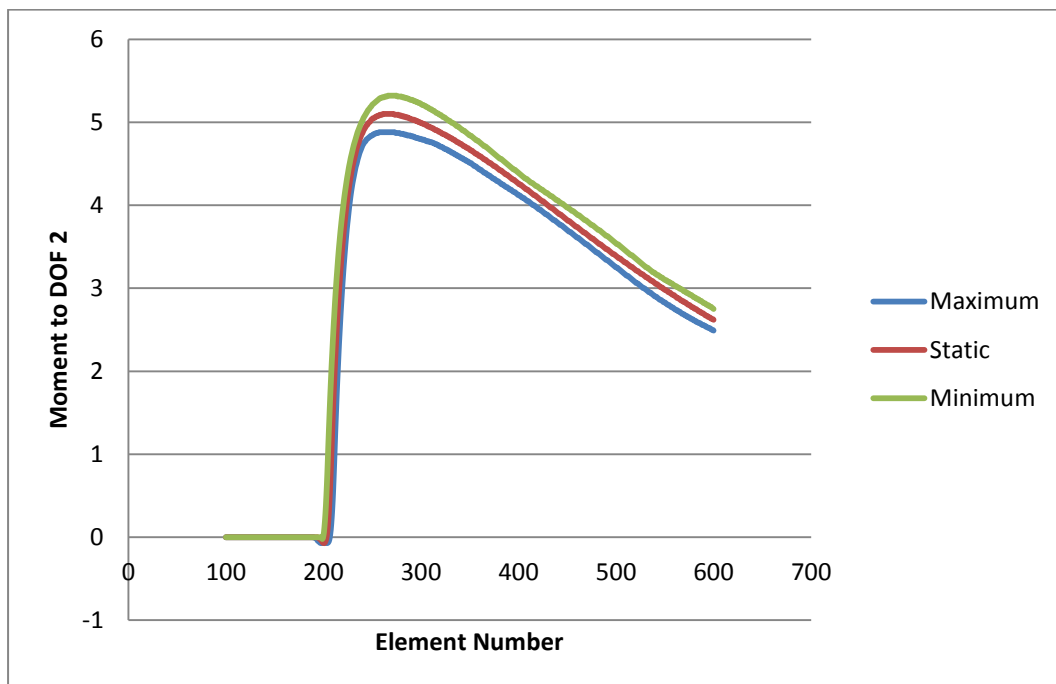

Figure 4-8 Moment to DOF2

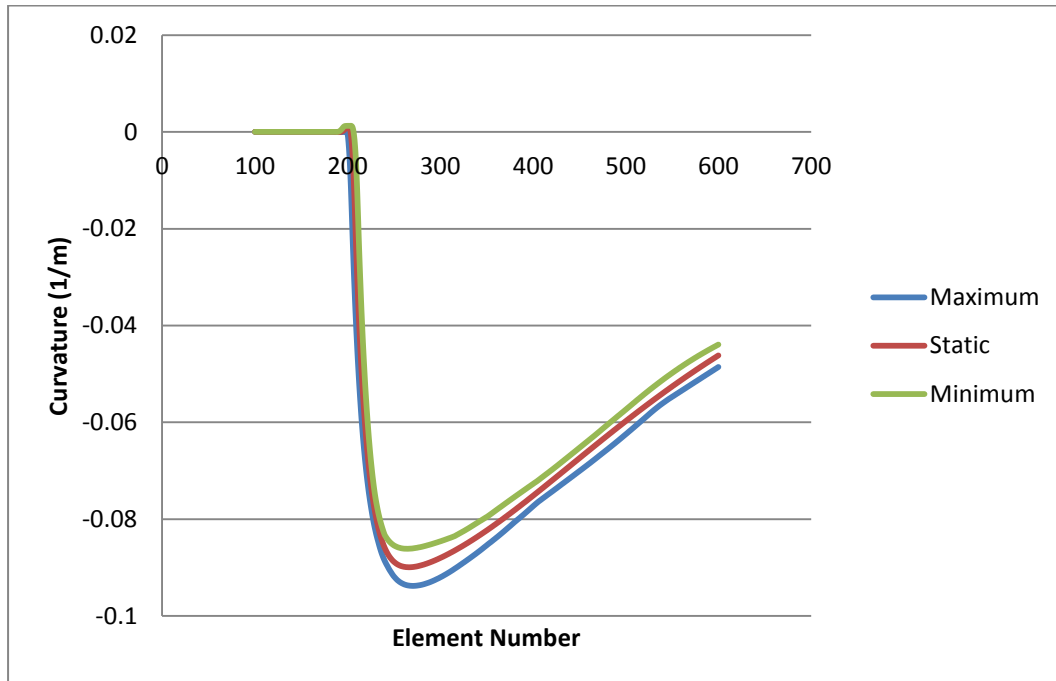

Figure 4-9 Curvature

4.3.2. None Bi-linear Case A

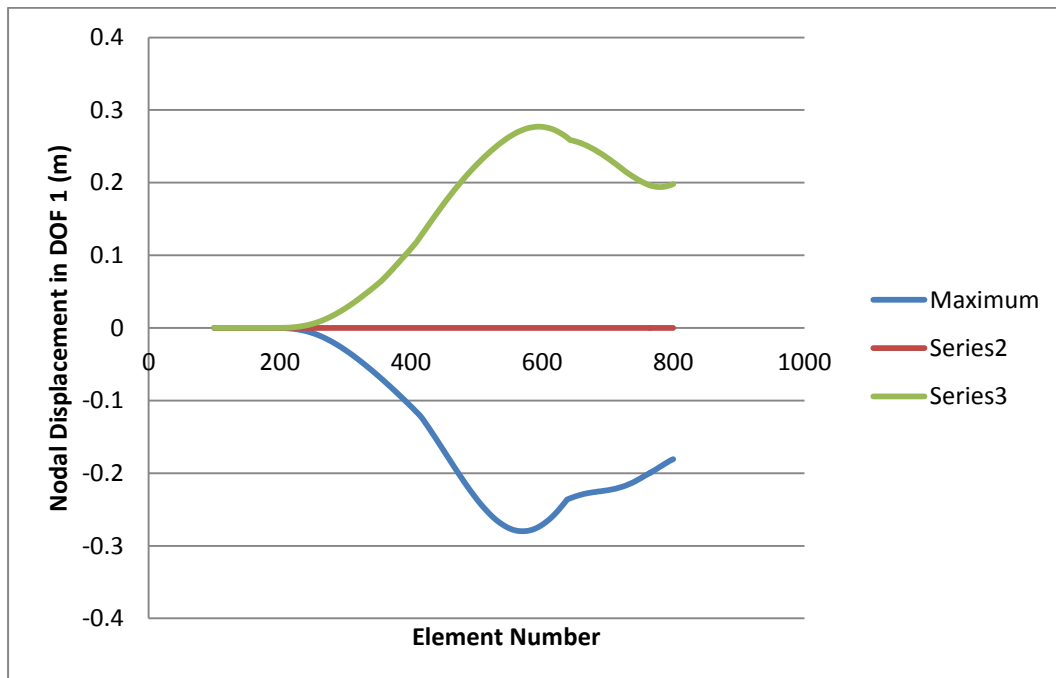

Figure 4-10 Nodal Displacement in DOF1

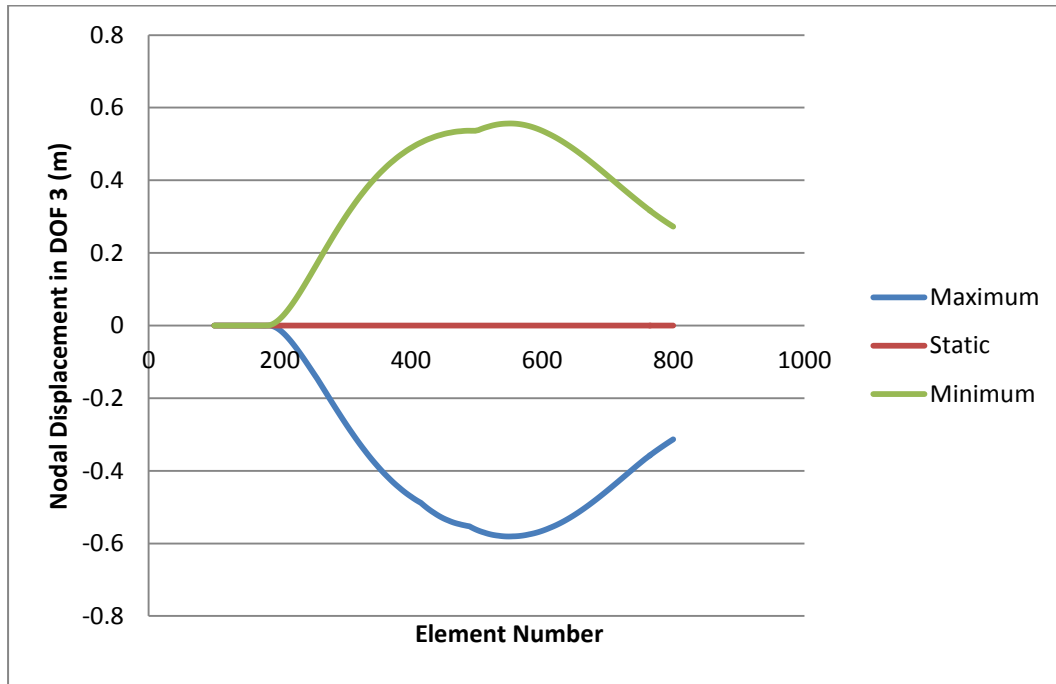

Figure 4-11 Nodal Displacement in DOF3

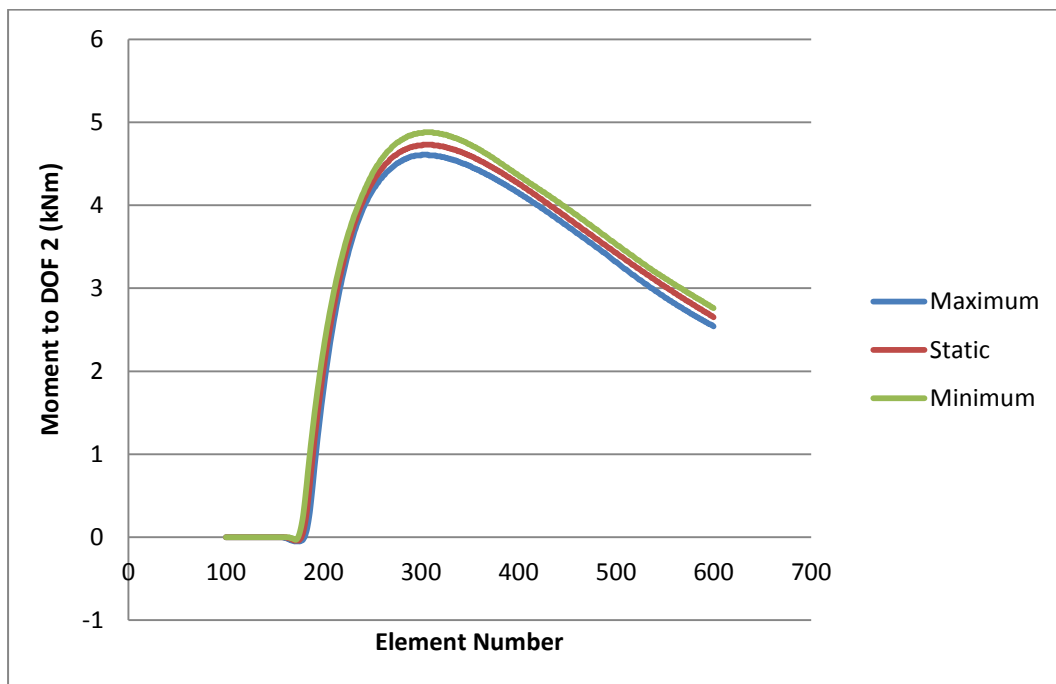

Figure 4-12 Moment to DOF2

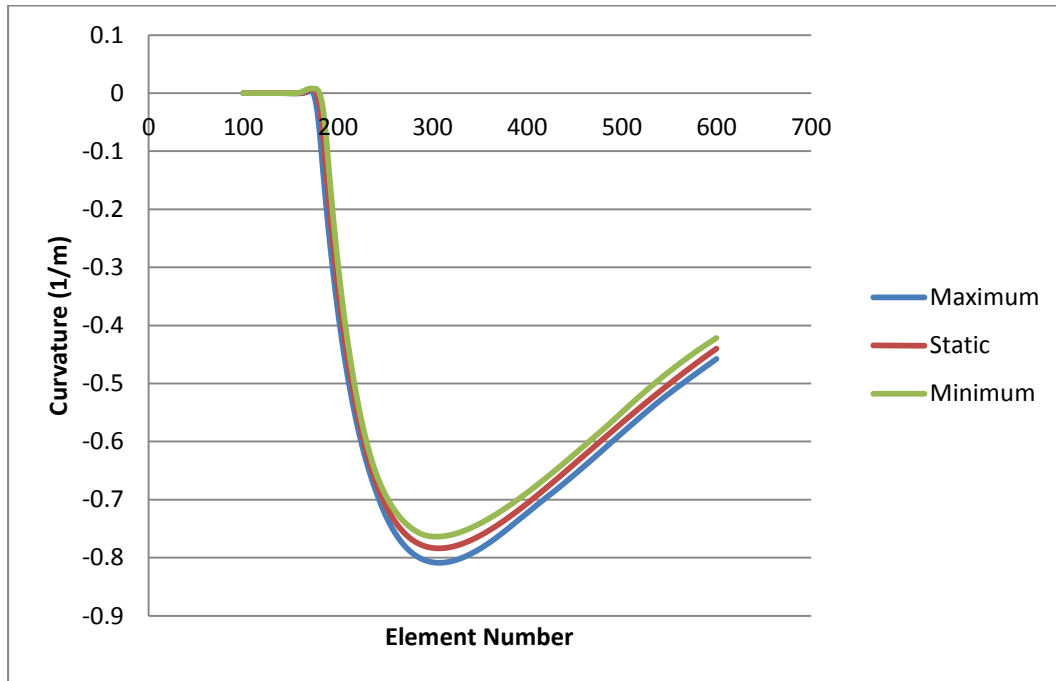

Figure 4-13 Curvature

4.3.3. None Bi-linear Case B

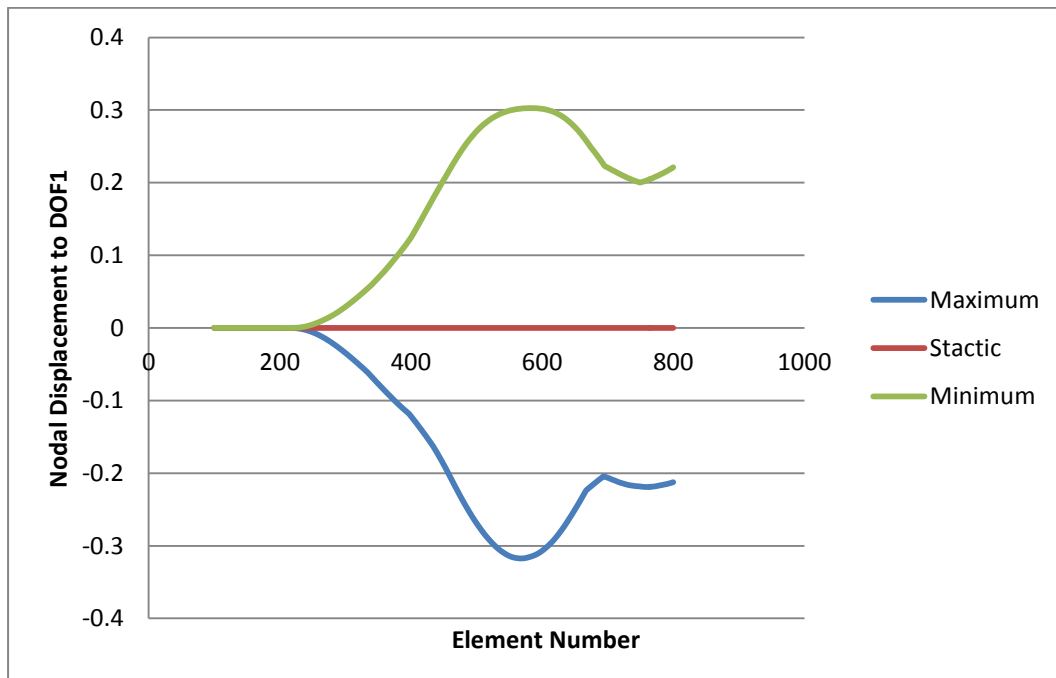

Figure 4-14 Nodal Displacement to DOF1

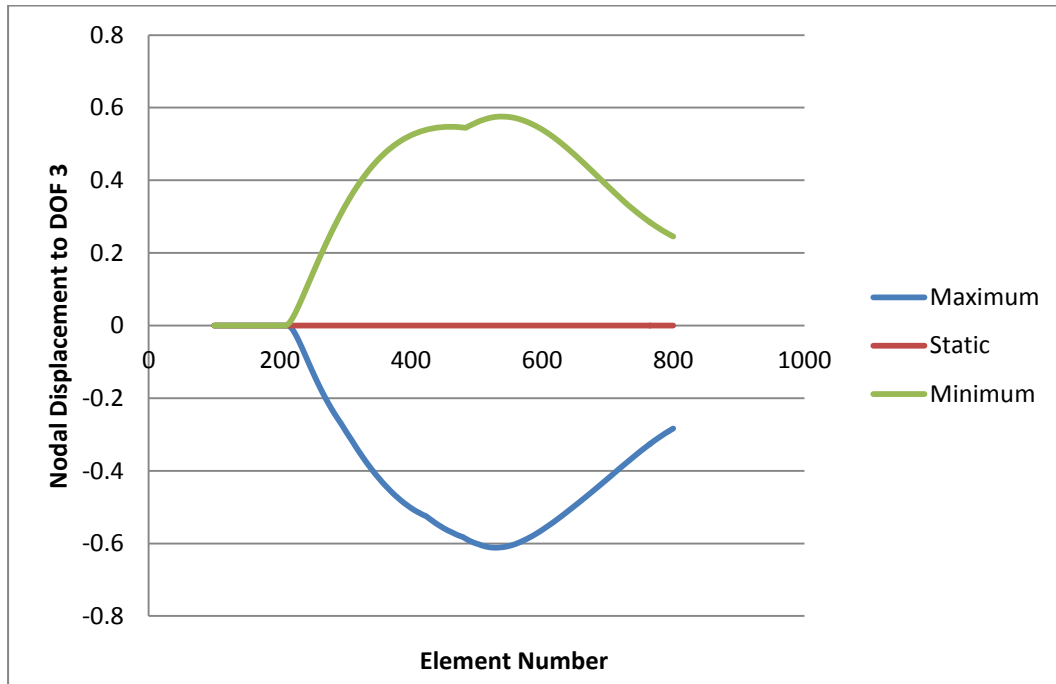

Figure 4-15 Nodal Displacement to DOF3

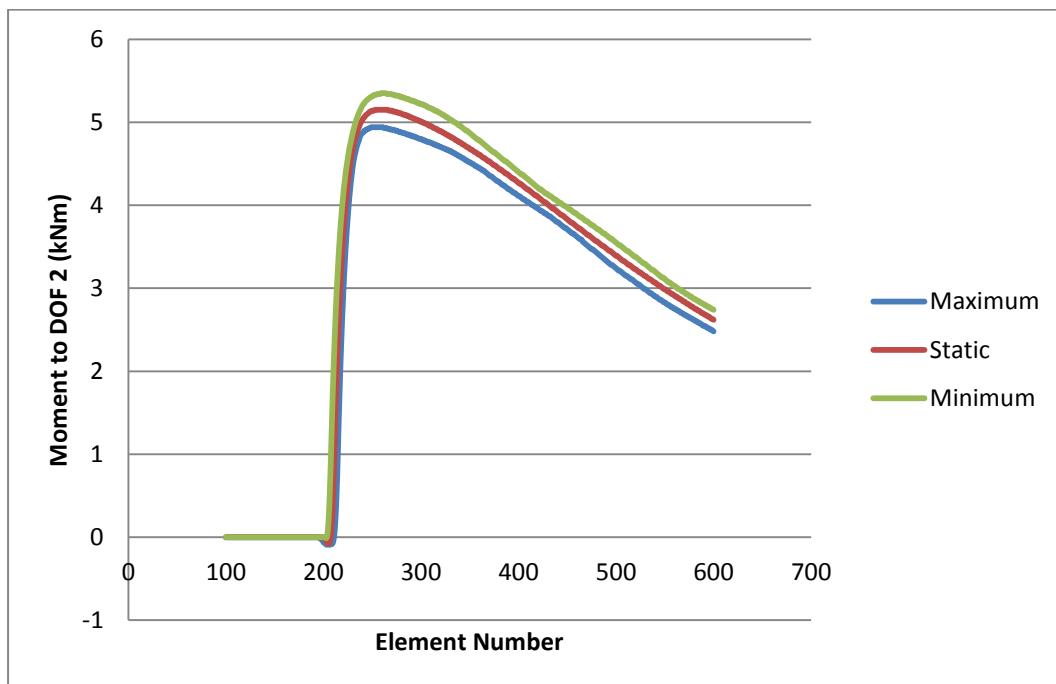

Figure 4-16 Moment to DOF2

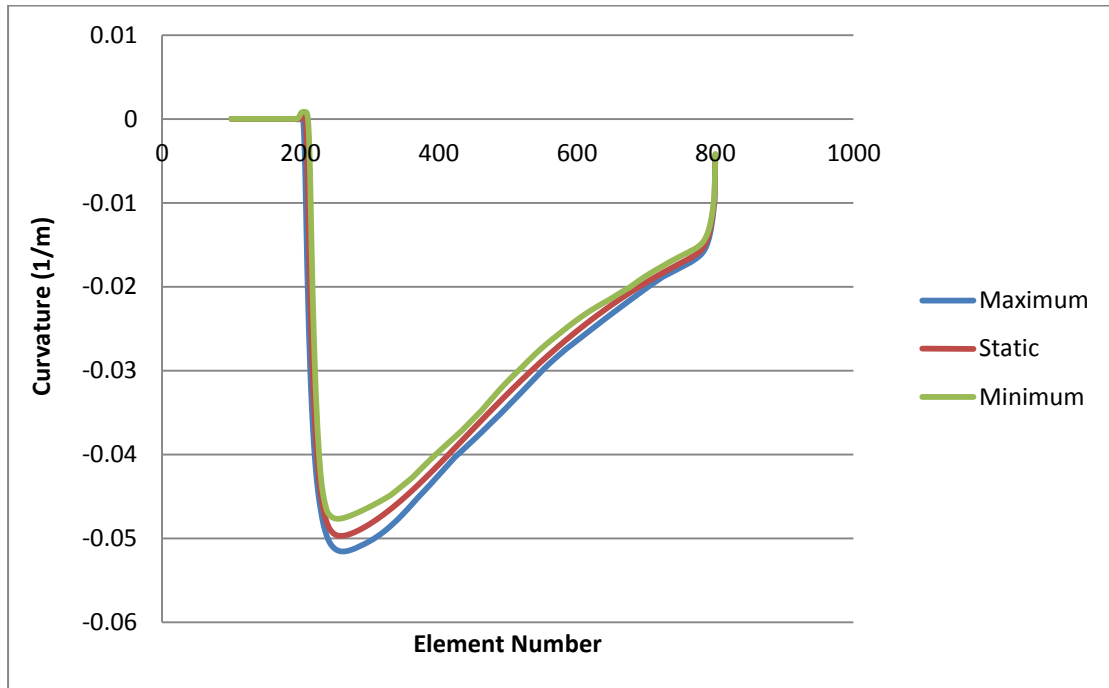

Figure 4-17 Curvature

4.3.4. Bottom Tension

With referring to the bending moment and curvature illustrations above, the touch down point is at element number 270 to 280 where it shows the largest curvature and bending moment.

So we shall chose the elements from number 250 to number 350, and plot the static tension of different case for these elements in the same figure. See Figure 4-18. Conclusion will be given in Chapter 6.

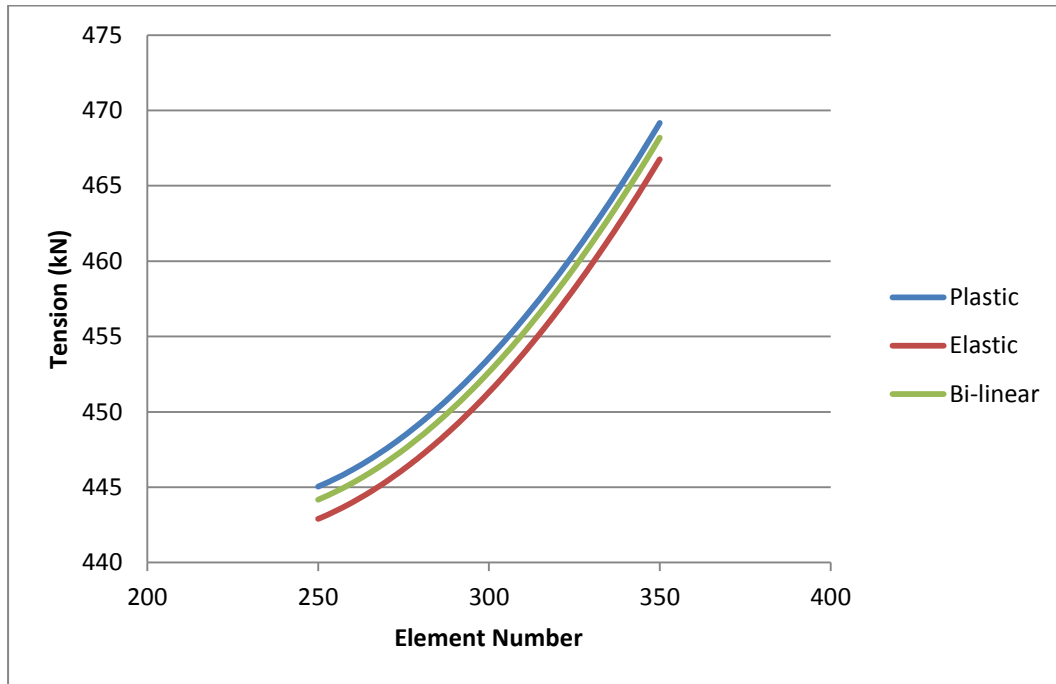

Figure 4-18 Bottom Tension Comparison



5 Irregular Wave Analysis

5.1. Input Data

| Item | DIR1 | DIR2 | DIR3 | DIR4 | DIR5 |
|-------|------|------|------|------|------|
| Surge | 0 | 1.57 | 3.14 | 4.71 | 6.28 |
| Sway | 0 | 1.57 | 3.14 | 4.71 | 6.28 |
| Heave | 0 | 1.57 | 3.14 | 4.71 | 6.28 |
| Roll | 0 | 1.57 | 3.14 | 4.71 | 6.28 |
| Pitch | 0 | 1.57 | 3.14 | 4.71 | 6.28 |
| Yaw | 0 | 1.57 | 3.14 | 4.71 | 6.28 |

Table 5-1 RAO Property

The RAO information in single direction is referred to Appendix.

For this case the two-parameter Pierson Moskowitz spectrum is chosen. Under this condition, the wave elevation is expressed as:

$$\eta(t, x, y) = \sum_{k=1}^{N_{\omega}} A_k \sin(\omega_k t + \phi_k^p + \phi_k) \quad (42)$$

Where ϕ_k is the random phase angle sampled from a uniform distribution over $[-\pi, \pi]$. A_k is the wave component amplitude and ϕ_k^p is the position dependent phase angle given as

$$A_k = \sqrt{s S_{\eta}(\omega) \Delta \omega} \quad (43)$$

The two-parameter Pierson Moskowitz spectrum is defined as

$$S_{\eta}(\omega) = A \omega^{-5} e^{-\frac{B}{\omega^4}}, 0 < \omega < \infty \quad (44)$$

$$A = 124.2 \frac{H_s}{T_z^4} \quad (45)$$

$$B = \frac{496}{T_z^4} \quad (46)$$

where H_s is the significant wave height and T_z is the zero-up crossing frequency. The relation between the zero-up crossing frequency and the peak period T_p is $T_p = 1.408T_z$.

5.2. Results

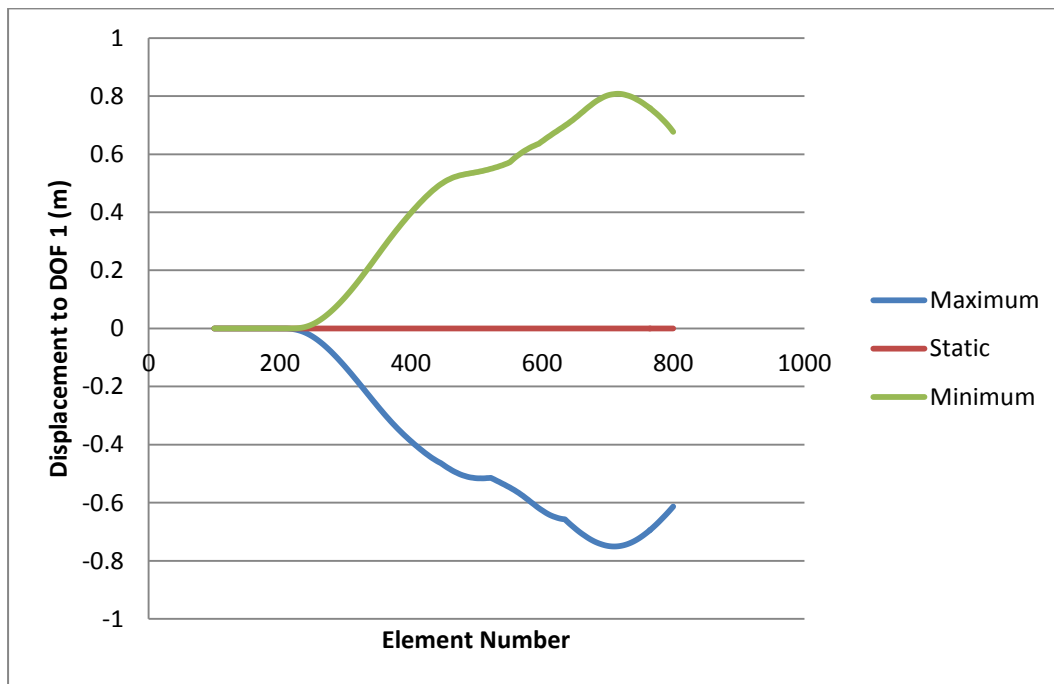

Figure 5-1 Displacement to DOF1

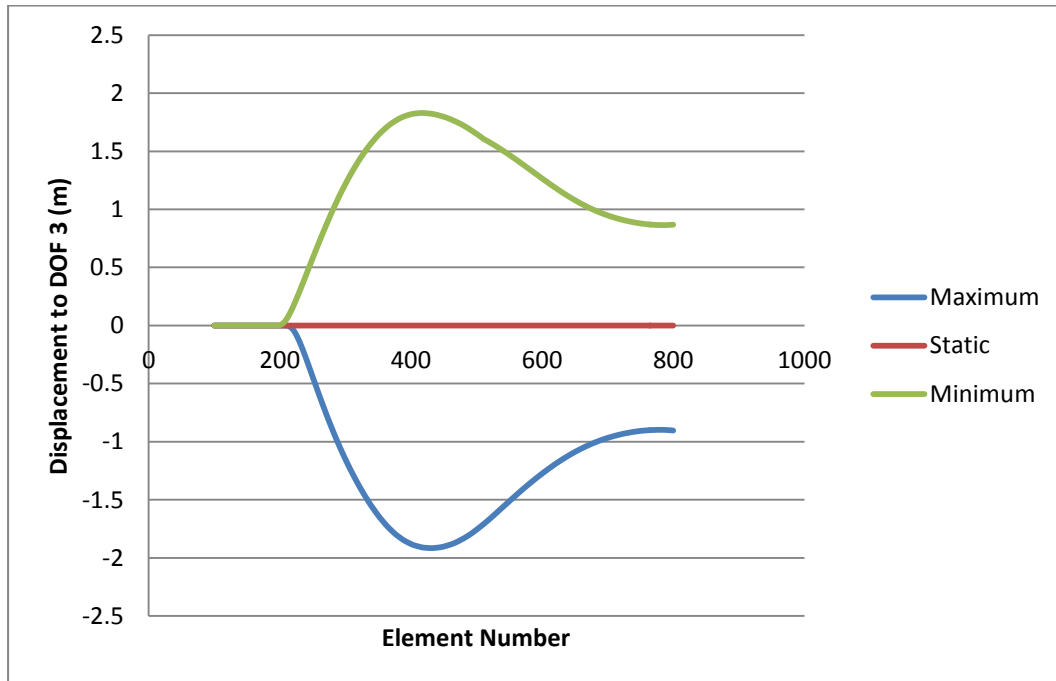

Figure 5-2 Displacement to DOF3

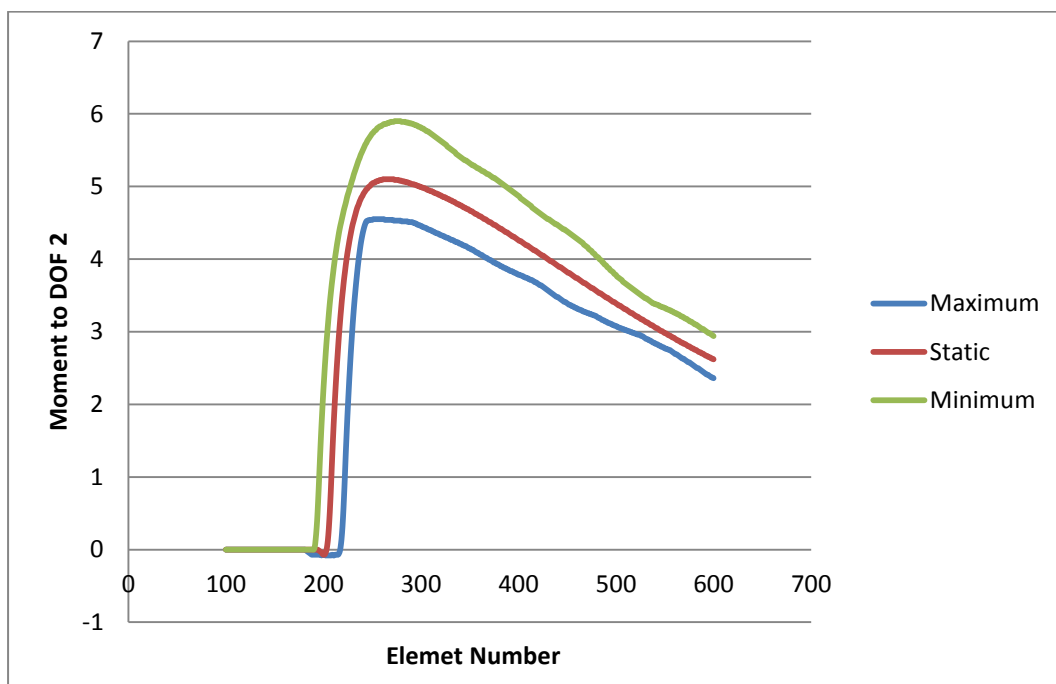

Figure 5-3 Moment to DOF2

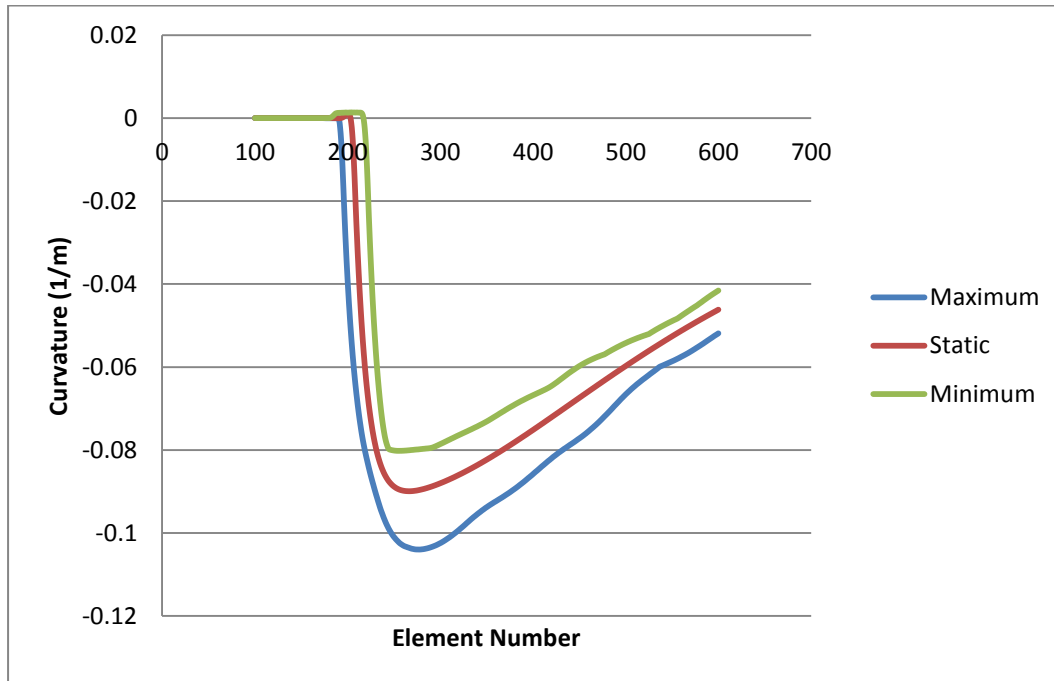

Figure 5-3 Curvature

5.3. Response Deviation Comparison

Comparing the curvature and moment results of cases under two different types of wave loads, number 271 to 273 elements are selected, where the moment and curvature are largest, which means these elements are believed as touch down point.

Take the dynamic curvature response in time domain in a sequence, and calculate the average value and standard deviation for each loading case. The results are listed in Table 5-1 and Table 5-2.

| ITEM | Mini | Static | Max | Average | Standard Deviation |
|-------------|---------|---------|---------|----------|--------------------|
| Element 271 | 0.00454 | 0.0051 | 0.00589 | 0.005215 | 0.000395552 |
| Element 272 | 0.00453 | 0.0051 | 0.00589 | 0.00521 | 0.000683321 |
| Element 273 | 0.00453 | 0.00509 | 0.0059 | 0.005215 | 0.000688355 |

Table 5-1 Dynamic Response Under Irregular Wave

| ITEM | Mini | Static | Max | Average | Standard Deviation |
|-------------|---------|---------|---------|---------|--------------------|
| Element 271 | 0.00488 | 0.0051 | 0.00532 | 0.0051 | 0.000128921 |
| Element 272 | 0.00488 | 0.0051 | 0.00532 | 0.0051 | 0.000221075 |
| Element 273 | 0.00488 | 0.00509 | 0.00532 | 0.0051 | 0.000221076 |

Table 5-2 Dynamic Response Under Regular Wave

Plot the standard deviation versus element number in Figure 5-4 with a 10000 scale factor on the response. Conclusion will be given in Chapter 6.

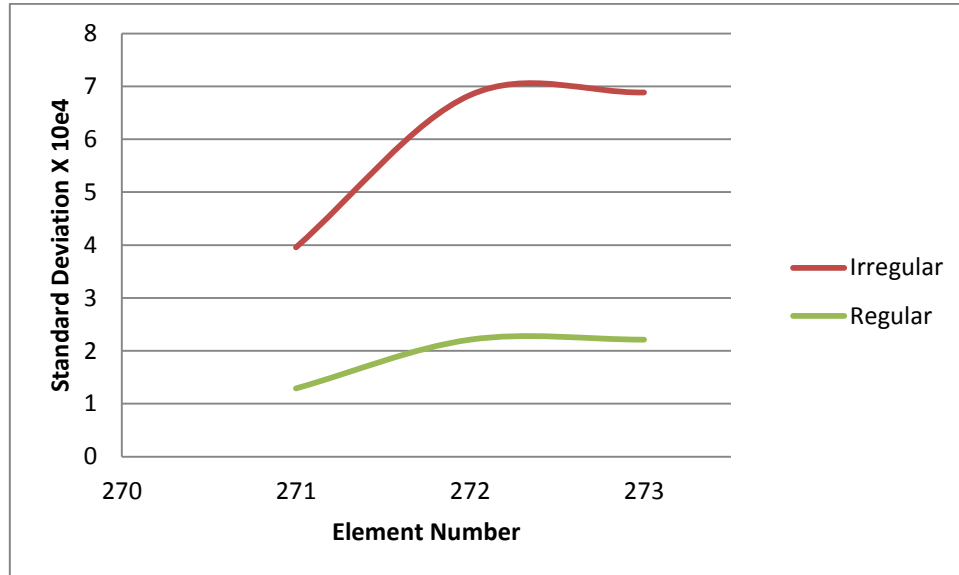

Figure 5-4 Standard Deviation



6 Conclusions and Recommendations for Further Work

6.1. Conclusion

6.1.1. BFLEX

From the results illustrated in section 3.3, it can be seen that the axial stiffness and torsional stiffness will change little if damage happens in the middle part of the thickness. While for the bending stiffness, which we already know governs the dynamic curvature response at the touch down point, will show a significant drop for the bending moment and very short elastic range. The reason is because when the pipeline is damaged, several layers will lose most of the friction between layers, which as we already discussed in section 3.1.2 will cause a friction moment. When the friction moment is exceeded, the curvature varies linearly with the moment variation. Since the friction moment is very small at the damaged condition, so the bending moment required to overcome it is small too and will overcome it very fast then enter the plastic range fast.

6.1.2. SIMLA

- Regular Wave Load

From the results in section 4.3, it is seen that, the model with bilinear assumption will show larger curvature and larger static bottom tension with reference to Figure 4-9 Figure 4-13, and Figure 4-18.

So the normal practice which applies the linear moment-curvature assumption has an inherent conservatism.

- Irregular Wave Load

The curvature response under irregular wave load has larger deviation compared with the one under regular wave load with reference to Figure 5-4.

6.2. Further Work

In this thesis, only two external pressure loads have been applied on the pipe. Because the external pressure, i.e. the water pressure, changes with water depth, so it is accurate to set up a model with variable external pressure. More sea conditions are also recommended to be applied on this mode.



Bibliography

- Clevelario, J. (2012, July 03). *LABORATÓRIO DE ESTRUTURAS E MATERIAIS ESTRUTURAIS*. Retrieved from <http://www.lem.ep.usp.br/pef418/wellstream.pdf>
- kaskus. (2010). *Offshore Pipeline Installation*. Retrieved from kaskus: http://www.kaskus.co.id/show_post/282224862/51installation
- Marintek. (2008). *SIMLA*. Retrieved from sintef: <http://www.sintef.no/upload/MARINTEK/PDF-filer/Sofware/SIMLA.pdf>
- Marintek. (2010). *Software-developed-at-MARINTEK*. Retrieved from sintef: <http://www.sintef.no/home/MARINTEK-old/Software-developed-at-MARINTEK/BFLEX/>
- Nielsen, F. G. (2007). *Lecture Notes in Marine Operations*. Trondheim/Bergen: Faculty of Marine Technology.
- Sævik, S. (2008). *Simla- Theory Manual*. Trondheim: MARINTEK.
- Sævik, S. (2010). *BFLEX-Theory Mannuel* . Trondheim: Marintek.
- Sævik, S. (2013). *Lecture Notes in Offshore Pipeline Technology*. Trondheim: NTNU.
- Svein Sævik, O. D. (2010). *SIMLA Version 3.15.0 User Manual*. Trondheim: Marintek.
- Svein Sævik, O. D. (2012). *BFLEX 2010 Version 3.0.7 User Mannuel* . Trondheim: Marintek.
- Technip. (2013). *Flexible Pipeline*. Retrieved from Technip: http://www.technip.com/sites/default/files/technip/publications/attachments/Flexible_pipe_April_2013_Web.p
- Wikipedia. (2013). *Sea state*. Retrieved from Wikipedia: http://en.wikipedia.org/wiki/Sea_state



Appendix A BFLEX CODE

```
# Trying input to simla
HEAD BFLEX2010 - Cross Section Model
#-----
# Control data
#
#   maxit ndim isolvr npoint ipri  conr  gacc  iproc
CONTROL  100  3  2   16  22 1.e-8  9.81  stressfree
TIMECO   1.0 1.0 1.0  201.0 STATIC
TIMECO   2.0 1.0 1.0  201.0 STATIC auto none all 100 5 1e-6
TIMECO  227.0 1.0 1.0  201.0 STATIC auto none all 100 5 1e-6
#
#-----
# Nocoor input
#
#       no   x   y   z
Nocoor Coordinates 1   0   0   0
                3  200  0   0
#
Visres Integration 2 Sigma-xx-ax sigma-xx-my sigma-xx-mz
#
#-----
# Elcon input
#
#
# The core
#
# GRO: this info is no longer required
#  group  elty  material no n1  n2 n3  n4
Elcon core  pipe52  mypipe 1  1  2
#  n  elinc nodinc
Repeat 2 1  1
#
#
# Tensile Layers
#  group  elty  crossname elid  n1  n2 n3  n4
Elcon tenslayer1 pipe52  mypipe 1001  1  2
#  n  elinc nodinc
Repeat 2 1  1
# Tensile Layers
#  group  elty  crossname elid  n1  n2 n3  n4
Elcon tenslayer2 pipe52  mypipe  2001  1  2
#  n  elinc nodinc
Repeat 2 1  1
#
#  group  elty  crossname elid  n1  n2 n3  n4
Elcon tenslayer3 pipe52  mypipe  3001  1  2
#  n  elinc nodinc
Repeat 2 1  1
# Tensile Layers
#  group  elty  crossname elid  n1  n2 n3  n4
Elcon tenslayer4 pipe52  mypipe  4001  1  2
#  n  elinc nodinc
```



```

Repeat 2 1 1
#-----
# Orient input
#
# The core
#      no  x  y  z
Elorient Coordinates  1  0 1e3  0
                    2  0 1e3  0
#      no  x  y  z
# Tensile Layer 1
#      no  x  y  z
Elorient Coordinates 1001  0 1e3  0
                    1002  0 1e3  0
# Tensile Layer 2
#      no  x  y  z
Elorient Coordinates 2001  0 1e3  0
                    2002  0 1e3  0
#      no  x  y  z
# Tensile Layer 3
#      no  x  y  z
Elorient Coordinates 3001  0 1e3  0
                    3002  0 1e3  0
# Tensile Layer 4
#      no  x  y  z
Elorient Coordinates 4001  0 1e3  0
                    4002  0 1e3  0
#-----
#
# Definition of flexible pipe cross-section
# GRO: the cloadnode and cloadhistno is no longer required
#      name  type  ifric  disfac  forfac  geofac  dummy  ID  Timeini  itcode  layernumb  ielbfl
#      fimod
CROSSSECTION MYPIPE FLEXCROSS 1  10000.0 10.0  0.0  2.0  228.6  2.0  31  13
1  0
content nelgr  e11  e12
1000e-9  5  core  tenslayer1  tenslayer2  tenslayer3  tenslayer4
#
#CTYPE  TH  matname  FRIC  LAYANG  RNUM  TEMP  nlmat  CCODE  CFATFL  AREA
IT  INY  IKS  WIDTH
CARC  7.00  steel  0.15  88.553  1  0.0  none  MANUAL  NONE  77.00  0  0  0  0
THER  17.01  plastic  0.15  0.000  0  0.0  none  NONE  NONE  0.00  0  0  0  0
ZETA  12.00  steel  0.25  88.201  1  0.0  nl_steel  MANUAL  fi09  273.36  0  0  0  0
SPIR  5.99  steel  0.15  88.936  1  0.0  nl_steel  MANUAL  fi09  96.00  0  0  0  0
THER  1.52  plastic  0.15  0.000  0  0.0  none  NONE  NONE  0.00  0  0  0  0
TENS  5.99  steel  0.15  44.000  54  0.0  nl_steel  T203_3247  fi09  72.00  0  0  0  0
THER  1.93  plastic  0.15  0.000  0  0.0  none  NONE  NONE  0.00  0  0  0  0
TENS  5.99  steel  0.15  -44.000  57  0.0  nl_steel  T203_3247  fi09  72.00  0  0  0  0
THER  1.93  plastic  0.15  0.000  0  0.0  none  NONE  NONE  0.00  0  0  0  0
TENS  5.99  steel  0.15  42.000  61  0.0  nl_steel  T203_3247  fi09  72.00  0  0  0  0
THER  1.93  plastic  0.15  0.000  0  0.0  none  NONE  NONE  0.00  0  0  0  0
TENS  5.99  steel  0.15  -42.000  64  0.0  nl_steel  T203_3247  fi09  72.00  0  0  0  0
THER  12.82  plastic  0.15  0.000  0  0.0  none  NONE  NONE  0.00  0  0  0  0
#
#CROSS-SECTION BOUNDARY DATA
#      NAME  type  X0  Y0  CCURV  P1  P2  P3  P4  NINTER  ICODE

```



```
#
CROSSGEOM TENS-T203_3247 BFLEX 0 0 S 6.00 90.000 0.0 0.0 5 0
          S 12.00 180.00 0.0 0.0 10 1
          S 6.00 270.00 0.0 0.0 5 0
          S 12.00 0.0000 0.0 0.0 10 0
#-----
#
# Element property input
#-----
# Boundary condition data
# Loc node dir
BONCON GLOBAL 1 1
BONCON GLOBAL 1 2
BONCON GLOBAL 1 3
BONCON GLOBAL 1 4
BONCON GLOBAL 3 2
BONCON GLOBAL 3 3
#-----
#
# Constraint input
CONSTR PDISP GLOBAL 1 5 -0.1 100
CONSTR PDISP GLOBAL 3 5 0.1 100
#
#-----
# Load input
#
# hist dir no1 r1 no2 r2 n m
#
CLOAD 200 1 3 1000000.00
#-----
PILOAD 500 -1 20.0 -2 20.0
#-----
# History data
#
# pdisp
#
# no istp fac
THIST 100 0 0.00
      1 0.0
      2 0.0
      77.0 0.0375
      227.0 -0.0375
#
# cload
#
THIST 200 0 0.0
      1 0.4
      2 0.4
#
# int pres
#
THIST 500 0 1.0
      1 1.0
      20 1.0
#-----
```



```
# Material data
# name type poiss talfa tecond heatc beta ea eiy eiz
MATERIAL plastic linear 0.4 11.7e-6 50 800 0 1.02e6 3.210e3 3.210e3
MATERIAL steel linear 0.3 11.7e-6 50 800 0 1.02e6 3.210e3 3.210e3
git em gm den tem
3.210e3 300 60 1800 300
3.210e3 2E5 0.8e5 7850 2E5
# name type alfa poiss ro talfa tecond heatc eps sigma
MATERIAL nl_steel elastoplastic 1 0.3 7850 1.17e-5 50 800 0 0
1.691E-03 3.50E+02
0.005 450
0.0998 835
```



Appendix B SIMLA Model

```
# Trying input to simla
HEAD This is a J- lay test example comparing OFFPIPE, RIFLEX and SIMLA
HEAD Regular wave H=7m T = 10s - Elastic material model - 1700 pipe elems
# Unit m MN
#-----
# Control data:
#-----
#   maxit ndim isolvr npoint ipri  conr  gacc  iproc
CONTROL  120  3  1  16  1 1e-5  9.81  autostart
#
#   ie1pip  ie2pip  incpip  nrolls  icaten  ivsnod
#   1    1700    1    0    1    1701
#
#   tens0  depang  freeb  rampan  rample  stirad  kp
#   0    1.484  10.0  0.1745  0    0  50000
#
#   seabedgrp  stingergrp  vesselgrp  vessel  cog  node
#   seabed    none    vessell    3001
#
#
DYNCONT 1 0.0 0.095 -0.05
#
#
VISRES  INTEGRATION 1 SIGMA-XX  VCONFOR-Z  VCONFOR-Y
#VISRES  nodal 1 SIGMA-XX
DYNRES_E  2  2  1  1
DYNRES_E  2 1700 1  1
DYNRES_E  2 1699 1  1
DYNRES_N  1 3001 1
DYNRES_N  2 3001 1
DYNRES_N  3 3001 1
DYNRES_N  1 3001 2
DYNRES_N  2 3001 2
DYNRES_N  3 3001 2
DYNRES_N  1 3001 3
DYNRES_N  2 3001 3
DYNRES_N  3 3001 3
DYNRES_N  1 3001 4
DYNRES_N  2 3001 4
DYNRES_N  3 3001 4
DYNRES_N  1 3001 5
DYNRES_N  2 3001 5
DYNRES_N  3 3001 5
#-----
# Analysis time control:
#-----
#   t  dt  dtvi  dtdy  dt0  type  hla? [STEPTYPE ITERCO ITCRIT MAXIT MAXDIV CONR]
TIMECO  1.0 1.0 1.0  1.0 201.0  STATIC  NOHLA  auto  none  all 400 5 1e-5
TIMECO 120.0 0.10 1.0  1.0 201.0  DYNAMIC  NOHLA  auto  none  disp 20 5 1e-5
#
#-----
# Nocoor input
#-----
```



```

#
# no x y z
NOCOOR coordinates 1 1245.309 0 10.0000
      2 1245.809 0 10.0000
      800 1644.809 0 10.0000
      801 1646.809 0 10.0000
      1700 3544.809 0 10.0000
      1701 3546.809 0 10.0000
NOCOOR coordinates 3001 3475.249 0 -15.0
NOCOOR coordinates 2101 10400 -200 0
      2111 10800 -200 0
repeat 11 11 0.0 40.0 0.0
#-----
#
#
# Elcon input:
#-----
# group elty material ID n1 n2 n3 n4
ELCON ormpipe1 pipe31 pipemat1 1 1 2
# n j
REPEAT 800 1 1
#
# group elty material ID n1 n2 n3 n4
ELCON ormpipe2 pipe31 pipemat2 801 801 802
# n j
REPEAT 900 1 1
# Lay-vessel
# group elty material ID n1 n2
ELCON vessel1 spring137 vessel1 3000 3001 1701
#
# name of surface ID n1
ELCON seabed cont126 cosurf1 4001 1
# n j
REPEAT 400 1 1
#
# TRAWL BOARD
ELCON myvessel body502 none 60001 3001
ELORIENT eulerangle 60001 0.0 0.0 0.0
# name type geoname ws wd wdtx wdthz cdx cdy cdz
ELPROP myvessel body rectangle 3058.103976 3600 3675 9975 6075 0.0 0.0

cdTx cdTy cdTz cmx cmy cmz cmthx cmthy cmthz xcog ycog zcog [phist mhist]
0.0 0.0 0.0 0.0 0.0 0.0 0.0 0.0 0.0 0.0 0.0 0.0 0.0
# name nplates type name r0x r0y r0z tetax tetay tetaz
GEOM rectangle 1 from_file "vessel1.txt" 0.0 0.000 15.0 0.00 0.00 0.0
#
ELCON seal sea150 seamat 2101 2101 2102 2113 2112
# 2110 2110 2111 2122 2121
REPEAT 10 1 1
REPEAT 10 10 11
#
# orient elements elid x y z
#
ELORIENT COORDINATES 1 0.0 1000.0 10.0000
      1700 0.0 1000.0 10.0000

```



```

ELORIENT EULERANGLE 3000 0 0 0
ELORIENT EULERANGLE 4001 0 0 0
      4400 0 0 0
#
# Elecc data:
#-----
ELECC beam 3000 1 71.56 0 25.000
#-----
#
# Cosurfpr data
#-----
#
# name data file nlines kpstart x0 y0 fi route id
COSURFPR cosurf1 "levold.txt" 1 0 0 0 0 100
# route id kp1 kp2 matname
COSUPR 100 -0.1 60000 soil1
#
#
# Contact interface data:
#-----
# groupn mname name is1 isn istx isty istz gt1 gt2
CONTINT seabed ormpipe1 cosurf1 1 401 1.1 1.0 1 60 1.0
CONTINT sea1 sea1 ormpipe1
CONTINT sea1 sea1 ormpipe2
#
#
# Element property input:
#-----
#
# elgoupe elprop Ro Ri Cdr Cdt CMr CMt wdry wsub ODp OD external
# name type pipe wrap wrapfrac
#ELPROP ormpipe1 compipe 0.38683 0.2286 0.8 0.1 2.0 0.2 0.3647e-3 0.2366e-3 0.38683
0.38683 0.5
# name type rad th CDr Cdt CMr CMt wd ws ODp ODw rks
ELPROP ormpipe1 pipe 0.3017 0.1462 0.8 0.1 2.0 0.2 0.3647e-3 0.2366e-3 0.39883 0.39883
0.5
ELPROP ormpipe2 pipe 0.3017 0.1462 0.8 0.1 2.0 0.2 0.3647e-3 0.2366e-3 0.39883 0.39883
0.5
# name type ix iy iz irx iry irz
ELPROP vessell genspring 1 1 1 1 1 1 1
#
#
# Concentrated nodal loads:
#-----
# hist dir no1 r1 no2 r2 n m
CLOAD 50 1 3001 1.18
#
# External pressure and gravity:
#-----
PELOAD 100 100
#
#TLOAD 200 100 100 200 100
#
#PILOAD 200 100 20 200 20
#

```



```
# Current and wave loads:
#-----
#
# seagrp type wav hist x0 y0 phi T H D Phase
WAVELO seal REGULAR 100 250 1667.270 0 0.000 10 7.0 2000 0
#
#-----
# Boundary condition data
#-----
#
# Loc node dir
BONCON GLOBAL 1 1
BONCON GLOBAL 1 2
BONCON GLOBAL 1 3
#
#
#
BONCON GLOBAL 2101 1
REPEAT 121 1
BONCON GLOBAL 2101 2
REPEAT 121 1
#-----
# CONSTRAINT INPUT:
#-----
#
# sn dof mn fi1 fi2 fi3 ex ey ez
CONSTR PDISP SPECIAL 1701 1 3001 0 0.0 0 71.56 0 25.000
CONSTR PDISP SPECIAL 1701 2 3001 0 0.0 0 71.56 0 25.000
CONSTR PDISP SPECIAL 1701 3 3001 0 0.0 0 71.56 0 25.000
CONSTR PDISP SPECIAL 1701 4 3001 0 0 0 71.56 0 25.000
#CONSTR PDISP SPECIAL 441 5 3001 0 0 0 71.56 0 25.000
CONSTR PDISP SPECIAL 1701 6 3001 0 0 0 71.56 0 25.000
#
# sn df head
CONSTR PDISP RAO 3001 1 0 100 surge
CONSTR PDISP RAO 3001 2 0 100 sway
CONSTR PDISP RAO 3001 3 0 100 heave
CONSTR PDISP RAO 3001 4 0 100 roll
CONSTR PDISP RAO 3001 5 0 100 pitch
CONSTR PDISP RAO 3001 6 0 100 yaw
#
#
# Wave elevation:
#-----
CONSTR PDISP WAVE 2101 3 100
REPEAT 121 1
#
#-----
# History data
#
# no istp fac
THIST 50 0 0.0
360 0.0
#
THIST 100 0 1.0
```



```

360 1.0
#
# no istp fac
THIST 250
    0 0.0
    10 0.0
    40 1.0
    120 1.0
    360 1.0
#
THIST 300 0 0.0
    360 0.0
#
THIST 400 0 0.0
    360 0.0
THIST 500 0 0.0
    360 0.0
THIST 999 0 0.0
    360 0.0
#
#
#-----
# Material data:
#-----
#
#      name  type  poiss  talfa  tecond  heatc  beta  ea   eiy  eiz  git  em  gm
#      name  type  poiss  talfa  tecond  heatc  beta  ea   eiy  eiz  git  em  gm
MATERIAL pipemat1 linear 0.3 1.17e-5 50 800 0 2.6688e4 16.58e1 16.58e1 16.9e2 2e5 8e4
#      name  type  alfa  eps  sig
#      name  type  poiss  talfa  tecond  heatc  beta  ea   eiy  eiz  git  em  gm
MATERIAL vessel2 linear 0.3 1.17e-5 50 800 0 1.4e6 7.65e4 7.65e4 5.88e4 2e5 8e4
#      name  type  poiss  talfa  tecond  heatc  beta  ea   eiy  eiz  git  em  gm
MATERIAL pipemat2 linear 0.3 1.17e-5 50 800 0 2.6688e4 16.58e1 16.58e1 16.9e2 2e5 8e4#
# name  type  density
MATERIAL seamat sea 1000e-6
# name  type  rmyx  rmyy  xname  yname  zname
MATERIAL soil1 contact 0.5 1.0 soilx soily soilz
MATERIAL soil2 contact 0.5 1.0 soilx soily soilz2
MATERIAL roller1 contact 0.3 0.3 soilx soily soilz3
# name  type  eps  sig
MATERIAL dumpx hycurve -1000 -1
                1000 1
# name  type  eps  sig
MATERIAL dumpy hycurve -1000 -1
                1000 1
# name  type  eps  sig
MATERIAL dumpz hycurve -1000 -1
                1000 1
# name  type  alfa  eps  sig
MATERIAL soilx epcurve 1 0 0
                0.005 1
                100.00 1
# name  type  eps  sig
MATERIAL soily epcurve 1 0 0
                0.10 1

```



```

100.00 10
# name type eps sig
MATERIAL soily1 hycurve -10000 -10000
10000 10000
# name type eps sig
MATERIAL soilz hycurve -10000 -100000
10000 100000
#
# name type eps sig
MATERIAL soilz2 hycurve -10000 -1000000
10000 1000000
#
# name type eps sig
MATERIAL soilz3 hycurve -10000 -240000
10000 240000
MATERIAL soilz4 hycurve -10000 -220000
10000 220000
MATERIAL soilz5 hycurve -10000 -200000
10000 200000
MATERIAL soilz6 hycurve -10000 -170000
10000 170000
MATERIAL soilz7 hycurve -10000 -142000
10000 142000
MATERIAL soilz8 hycurve -10000 -116000
10000 116000
MATERIAL soilz9 hycurve -10000 -82000
10000 82000
MATERIAL soilz10 hycurve -10000 -58000
10000 58000
MATERIAL soilz11 hycurve -10000 -48000
10000 48000
MATERIAL soilz12 hycurve -10000 -40000
10000 40000
MATERIAL soilz13 hycurve -10000 -30000
10000 30000
MATERIAL soilz14 hycurve -10000 -20000
10000 20000
MATERIAL soilz15 hycurve -10000 -200000
10000 200000
#
# name type apr1 spr2 spr3 spr4 spr5 spr6
MATERIAL vessel1 genspring surgesp2 yawsp heavesp rollsp pitchsp swaysp
# tensioner
MATERIAL surgesp epcurve 1
0.00 0.0
1.00 0.05
23.00 0.20
MATERIAL surgesp1 hycurve -10000 -50
-24.00 -40
-23.00 -0.200
-1.00 -0.050
1.00 0.050
23.00 0.200
24.00 40
10000 50

```



MATERIAL surgesp2 hycurve -1000 0
1000 0
MATERIAL yawsp hycurve -1000 0
1000 0
MATERIAL heavesp hycurve -1000 0
1000 0
MATERIAL rollsp hycurve -1000 0
1000 0
MATERIAL pitchsp hycurve -1000 0
1000 0
MATERIAL swaysp hycurve -1000 0
1000 0

#-----
RAO definitions:
#-----

RAOPROP surge DEF 0 1.57 3.14 4.71 6.28 surge1 surge2 surge3 surge4 surge5
RAOPROP sway DEF 0 1.57 3.14 4.71 6.28 sway1 sway2 sway3 sway4 sway5
RAOPROP heave DEF 0 1.57 3.14 4.71 6.28 heave1 heave2 heave3 heave4 heave5
RAOPROP roll DEF 0 1.57 3.14 4.71 6.28 roll1 roll2 roll3 roll4 roll5
RAOPROP pitch DEF 0 1.57 3.14 4.71 6.28 pitch1 pitch2 pitch3 pitch4 pitch5
RAOPROP yaw DEF 0 1.57 3.14 4.71 6.28 yaw1 yaw2 yaw3 yaw4 yaw5
#

RAOPROP surge1 CURVE 0 0 0.000000000
0.314159265 1.1908 3.129375349
0.34906585 1.0798 3.127630020
0.369599136 1.0253 3.127630020
0.392699082 0.9693 3.124139361
0.41887902 0.909 3.122394032
0.448798951 0.8391 3.125884690
0.483321947 0.7541 3.127630020
0.502654825 0.7029 3.132866007
0.523598776 0.6435 -3.136356666
0.54636394 0.5734 -3.111922056
0.571198664 0.4888 -3.061307508
0.598398601 0.3833 -2.954842424
0.628318531 0.2414 -2.696533694
0.661387927 0.0802 -1.642354826
0.698131701 0.1581 0.322885912
0.785398163 0.1889 0.895353906
0.897597901 0.1167 -1.162389282
1.047197551 0.0337 -1.956514091
1.256637061 0.0581 0.497418837
1.570796327 0.0143 -2.651155134
1.770796327 0 0

RAOPROP surge2 CURVE 0 0 0.000000000
0.314159265 0 0.000000000
0.34906585 0 0.000000000
0.369599136 0 0.000000000
0.392699082 0 0.000000000
0.41887902 0 0.000000000
0.448798951 0 0.000000000
0.483321947 0 0.000000000
0.502654825 0 0.000000000
0.523598776 0 0.000000000



| | | | |
|----------------|-------------|---------|--------------|
| | 0.54636394 | 0 | 0.000000000 |
| | 0.571198664 | 0 | 0.000000000 |
| | 0.598398601 | 0 | 0.000000000 |
| | 0.628318531 | 0 | 0.000000000 |
| | 0.661387927 | 0 | 0.000000000 |
| | 0.698131701 | 0 | 0.000000000 |
| | 0.785398163 | 0 | 0.000000000 |
| | 0.897597901 | 0 | 0.000000000 |
| | 1.047197551 | 0 | 0.000000000 |
| | 1.256637061 | 0 | 0.000000000 |
| | 1.570796327 | 0 | 0.000000000 |
| | 1.770796327 | 0 | 0.000000000 |
| RAOPROP surge3 | CURVE 0 | 0 | 0.000000000 |
| | 0.314159265 | -1.1908 | 3.129375349 |
| | 0.34906585 | -1.0798 | 3.12763002 |
| | 0.369599136 | -1.0253 | 3.12763002 |
| | 0.392699082 | -0.9693 | 3.124139361 |
| | 0.41887902 | -0.909 | 3.122394032 |
| | 0.448798951 | -0.8391 | 3.12588469 |
| | 0.483321947 | -0.7541 | 3.12763002 |
| | 0.502654825 | -0.7029 | 3.132866007 |
| | 0.523598776 | -0.6435 | -3.136356666 |
| | 0.54636394 | -0.5734 | -3.111922056 |
| | 0.571198664 | -0.4888 | -3.061307508 |
| | 0.598398601 | -0.3833 | -2.954842424 |
| | 0.628318531 | -0.2414 | -2.696533694 |
| | 0.661387927 | -0.0802 | -1.642354826 |
| | 0.698131701 | -0.1581 | 0.322885912 |
| | 0.785398163 | -0.1889 | 0.895353906 |
| | 0.897597901 | -0.1167 | -1.162389282 |
| | 1.047197551 | -0.0337 | -1.956514091 |
| | 1.256637061 | -0.0581 | 0.497418837 |
| | 1.570796327 | -0.0143 | -2.651155134 |
| | 1.770796327 | 0 | 0 |
| RAOPROP surge4 | CURVE 0 | 0 | 0.000000000 |
| | 0.314159265 | 0 | 0.000000000 |
| | 0.34906585 | 0 | 0.000000000 |
| | 0.369599136 | 0 | 0.000000000 |
| | 0.392699082 | 0 | 0.000000000 |
| | 0.41887902 | 0 | 0.000000000 |
| | 0.448798951 | 0 | 0.000000000 |
| | 0.483321947 | 0 | 0.000000000 |
| | 0.502654825 | 0 | 0.000000000 |
| | 0.523598776 | 0 | 0.000000000 |
| | 0.54636394 | 0 | 0.000000000 |
| | 0.571198664 | 0 | 0.000000000 |
| | 0.598398601 | 0 | 0.000000000 |
| | 0.628318531 | 0 | 0.000000000 |
| | 0.661387927 | 0 | 0.000000000 |
| | 0.698131701 | 0 | 0.000000000 |
| | 0.785398163 | 0 | 0.000000000 |
| | 0.897597901 | 0 | 0.000000000 |
| | 1.047197551 | 0 | 0.000000000 |
| | 1.256637061 | 0 | 0.000000000 |
| | 1.570796327 | 0 | 0.000000000 |



```
1.770796327 0 0
RAOPROP surge5 CURVE 0 0 0.000000000
0.314159265 1.1908 3.129375349
0.34906585 1.0798 3.127630020
0.369599136 1.0253 3.127630020
0.392699082 0.9693 3.124139361
0.41887902 0.909 3.122394032
0.448798951 0.8391 3.125884690
0.483321947 0.7541 3.127630020
0.502654825 0.7029 3.132866007
0.523598776 0.6435 -3.136356666
0.54636394 0.5734 -3.111922056
0.571198664 0.4888 -3.061307508
0.598398601 0.3833 -2.954842424
0.628318531 0.2414 -2.696533694
0.661387927 0.0802 -1.642354826
0.698131701 0.1581 0.322885912
0.785398163 0.1889 0.895353906
0.897597901 0.1167 -1.162389282
1.047197551 0.0337 -1.956514091
1.256637061 0.0581 0.497418837
1.570796327 0.0143 -2.651155134
1.770796327 0 0
RAOPROP sway1 CURVE 0 0 0.000000000
0.314159265 0 0.000000000
0.34906585 0 0.000000000
0.369599136 0 0.000000000
0.392699082 0 0.000000000
0.41887902 0 0.000000000
0.448798951 0 0.000000000
0.483321947 0 0.000000000
0.502654825 0 0.000000000
0.523598776 0 0.000000000
0.54636394 0 0.000000000
0.571198664 0 0.000000000
0.598398601 0 0.000000000
0.628318531 0 0.000000000
0.661387927 0 0.000000000
0.698131701 0 0.000000000
0.785398163 0 0.000000000
0.897597901 0 0.000000000
1.047197551 0 0.000000000
1.256637061 0 0.000000000
1.570796327 0 0
1.770796327 0 0
RAOPROP sway2 CURVE 0 0 0.000000000
0.314159265 1.1908 3.129375349
0.34906585 1.0798 3.127630020
0.369599136 1.0253 3.127630020
0.392699082 0.9693 3.124139361
0.41887902 0.909 3.122394032
0.448798951 0.8391 3.125884690
0.483321947 0.7541 3.127630020
0.502654825 0.7029 3.132866007
0.523598776 0.6435 -3.136356666
```



| | | | |
|---------------|-------------|---------|--------------|
| | 0.54636394 | 0.5734 | -3.111922056 |
| | 0.571198664 | 0.4888 | -3.061307508 |
| | 0.598398601 | 0.3833 | -2.954842424 |
| | 0.628318531 | 0.2414 | -2.696533694 |
| | 0.661387927 | 0.0802 | -1.642354826 |
| | 0.698131701 | 0.1581 | 0.322885912 |
| | 0.785398163 | 0.1889 | 0.895353906 |
| | 0.897597901 | 0.1167 | -1.162389282 |
| | 1.047197551 | 0.0337 | -1.956514091 |
| | 1.256637061 | 0.0581 | 0.497418837 |
| | 1.570796327 | 0.0143 | -2.651155134 |
| | 1.770796327 | 0 | 0 |
| RAOPROP sway3 | CURVE 0 | 0 | 0.000000000 |
| | 0.314159265 | 0 | 0.000000000 |
| | 0.34906585 | 0 | 0.000000000 |
| | 0.369599136 | 0 | 0.000000000 |
| | 0.392699082 | 0 | 0.000000000 |
| | 0.41887902 | 0 | 0.000000000 |
| | 0.448798951 | 0 | 0.000000000 |
| | 0.483321947 | 0 | 0.000000000 |
| | 0.502654825 | 0 | 0.000000000 |
| | 0.523598776 | 0 | 0.000000000 |
| | 0.54636394 | 0 | 0.000000000 |
| | 0.571198664 | 0 | 0.000000000 |
| | 0.598398601 | 0 | 0.000000000 |
| | 0.628318531 | 0 | 0.000000000 |
| | 0.661387927 | 0 | 0.000000000 |
| | 0.698131701 | 0 | 0.000000000 |
| | 0.785398163 | 0 | 0.000000000 |
| | 0.897597901 | 0 | 0.000000000 |
| | 1.047197551 | 0 | 0.000000000 |
| | 1.256637061 | 0 | 0.000000000 |
| | 1.570796327 | 0 | 0 |
| | 1.770796327 | 0 | 0 |
| RAOPROP sway4 | CURVE 0 | 0 | 0.000000000 |
| | 0.314159265 | -1.1908 | 3.129375349 |
| | 0.34906585 | -1.0798 | 3.12763002 |
| | 0.369599136 | -1.0253 | 3.12763002 |
| | 0.392699082 | -0.9693 | 3.124139361 |
| | 0.41887902 | -0.909 | 3.122394032 |
| | 0.448798951 | -0.8391 | 3.12588469 |
| | 0.483321947 | -0.7541 | 3.12763002 |
| | 0.502654825 | -0.7029 | 3.132866007 |
| | 0.523598776 | -0.6435 | -3.136356666 |
| | 0.54636394 | -0.5734 | -3.111922056 |
| | 0.571198664 | -0.4888 | -3.061307508 |
| | 0.598398601 | -0.3833 | -2.954842424 |
| | 0.628318531 | -0.2414 | -2.696533694 |
| | 0.661387927 | -0.0802 | -1.642354826 |
| | 0.698131701 | -0.1581 | 0.322885912 |
| | 0.785398163 | -0.1889 | 0.895353906 |
| | 0.897597901 | -0.1167 | -1.162389282 |
| | 1.047197551 | -0.0337 | -1.956514091 |
| | 1.256637061 | -0.0581 | 0.497418837 |
| | 1.570796327 | -0.0143 | -2.651155134 |



```

1.770796327 0 0
RAOPROP sway5 CURVE 0 0 0.000000000
0.314159265 0 0.000000000
0.34906585 0 0.000000000
0.369599136 0 0.000000000
0.392699082 0 0.000000000
0.41887902 0 0.000000000
0.448798951 0 0.000000000
0.483321947 0 0.000000000
0.502654825 0 0.000000000
0.523598776 0 0.000000000
0.54636394 0 0.000000000
0.571198664 0 0.000000000
0.598398601 0 0.000000000
0.628318531 0 0.000000000
0.661387927 0 0.000000000
0.698131701 0 0.000000000
0.785398163 0 0.000000000
0.897597901 0 0.000000000
1.047197551 0 0.000000000
1.256637061 0 0.000000000
1.570796327 0 0
1.770796327 0 0
RAOPROP heave1 CURVE 0 0 0
0.314159265 1.0639 0.829031395
0.34906585 1.0692 0.753982237
0.369599136 1.0767 0.706858347
0.392699082 1.0844 0.654498469
0.41887902 1.0906 0.596902604
0.448798951 1.0907 0.53581608
0.483321947 1.0688 0.464257581
0.502654825 1.0455 0.424115008
0.523598776 1.01 0.380481777
0.54636394 0.963 0.333357887
0.571198664 0.9081 0.277507351
0.598398601 0.8551 0.240855437
0.628318531 0.7643 0.298451302
0.661387927 0.5216 0.521853446
0.698131701 0.1095 0.773180859
0.785398163 0.2618 -1.987930018
0.897597901 0.0802 1.628392192
1.047197551 0.1258 1.256637061
1.256637061 0.1161 -2.605776573
1.570796327 0.0291 -1.436405974
1.770796327 0 0
RAOPROP heave2 CURVE 0 0 0
0.314159265 1.0639 0.829031395
0.34906585 1.0692 0.753982237
0.369599136 1.0767 0.706858347
0.392699082 1.0844 0.654498469
0.41887902 1.0906 0.596902604
0.448798951 1.0907 0.53581608
0.483321947 1.0688 0.464257581
0.502654825 1.0455 0.424115008
0.523598776 1.01 0.380481777

```



| | | | |
|----------------|-------------|--------|--------------|
| | 0.54636394 | 0.963 | 0.333357887 |
| | 0.571198664 | 0.9081 | 0.277507351 |
| | 0.598398601 | 0.8551 | 0.240855437 |
| | 0.628318531 | 0.7643 | 0.298451302 |
| | 0.661387927 | 0.5216 | 0.521853446 |
| | 0.698131701 | 0.1095 | 0.773180859 |
| | 0.785398163 | 0.2618 | -1.987930018 |
| | 0.897597901 | 0.0802 | 1.628392192 |
| | 1.047197551 | 0.1258 | 1.256637061 |
| | 1.256637061 | 0.1161 | -2.605776573 |
| | 1.570796327 | 0.0291 | -1.436405974 |
| | 1.770796327 | 0 | 0 |
| RAOPROP heave3 | CURVE 0 | 0 | 0 |
| | 0.314159265 | 1.0639 | 0.829031395 |
| | 0.34906585 | 1.0692 | 0.753982237 |
| | 0.369599136 | 1.0767 | 0.706858347 |
| | 0.392699082 | 1.0844 | 0.654498469 |
| | 0.41887902 | 1.0906 | 0.596902604 |
| | 0.448798951 | 1.0907 | 0.53581608 |
| | 0.483321947 | 1.0688 | 0.464257581 |
| | 0.502654825 | 1.0455 | 0.424115008 |
| | 0.523598776 | 1.01 | 0.380481777 |
| | 0.54636394 | 0.963 | 0.333357887 |
| | 0.571198664 | 0.9081 | 0.277507351 |
| | 0.598398601 | 0.8551 | 0.240855437 |
| | 0.628318531 | 0.7643 | 0.298451302 |
| | 0.661387927 | 0.5216 | 0.521853446 |
| | 0.698131701 | 0.1095 | 0.773180859 |
| | 0.785398163 | 0.2618 | -1.987930018 |
| | 0.897597901 | 0.0802 | 1.628392192 |
| | 1.047197551 | 0.1258 | 1.256637061 |
| | 1.256637061 | 0.1161 | -2.605776573 |
| | 1.570796327 | 0.0291 | -1.436405974 |
| | 1.770796327 | 0 | 0 |
| RAOPROP heave4 | CURVE 0 | 0 | 0 |
| | 0.314159265 | 1.0639 | 0.829031395 |
| | 0.34906585 | 1.0692 | 0.753982237 |
| | 0.369599136 | 1.0767 | 0.706858347 |
| | 0.392699082 | 1.0844 | 0.654498469 |
| | 0.41887902 | 1.0906 | 0.596902604 |
| | 0.448798951 | 1.0907 | 0.53581608 |
| | 0.483321947 | 1.0688 | 0.464257581 |
| | 0.502654825 | 1.0455 | 0.424115008 |
| | 0.523598776 | 1.01 | 0.380481777 |
| | 0.54636394 | 0.963 | 0.333357887 |
| | 0.571198664 | 0.9081 | 0.277507351 |
| | 0.598398601 | 0.8551 | 0.240855437 |
| | 0.628318531 | 0.7643 | 0.298451302 |
| | 0.661387927 | 0.5216 | 0.521853446 |
| | 0.698131701 | 0.1095 | 0.773180859 |
| | 0.785398163 | 0.2618 | -1.987930018 |
| | 0.897597901 | 0.0802 | 1.628392192 |
| | 1.047197551 | 0.1258 | 1.256637061 |
| | 1.256637061 | 0.1161 | -2.605776573 |
| | 1.570796327 | 0.0291 | -1.436405974 |



| | | | |
|----------------|-------------|-------------|--------------|
| | 1.770796327 | 0 | 0 |
| RAOPROP heave5 | CURVE 0 | 0 | 0 |
| | 0.314159265 | 1.0639 | 0.829031395 |
| | 0.34906585 | 1.0692 | 0.753982237 |
| | 0.369599136 | 1.0767 | 0.706858347 |
| | 0.392699082 | 1.0844 | 0.654498469 |
| | 0.41887902 | 1.0906 | 0.596902604 |
| | 0.448798951 | 1.0907 | 0.53581608 |
| | 0.483321947 | 1.0688 | 0.464257581 |
| | 0.502654825 | 1.0455 | 0.424115008 |
| | 0.523598776 | 1.01 | 0.380481777 |
| | 0.54636394 | 0.963 | 0.333357887 |
| | 0.571198664 | 0.9081 | 0.277507351 |
| | 0.598398601 | 0.8551 | 0.240855437 |
| | 0.628318531 | 0.7643 | 0.298451302 |
| | 0.661387927 | 0.5216 | 0.521853446 |
| | 0.698131701 | 0.1095 | 0.773180859 |
| | 0.785398163 | 0.2618 | -1.987930018 |
| | 0.897597901 | 0.0802 | 1.628392192 |
| | 1.047197551 | 0.1258 | 1.256637061 |
| | 1.256637061 | 0.1161 | -2.605776573 |
| | 1.570796327 | 0.0291 | -1.436405974 |
| | 1.770796327 | 0 | 0 |
| RAOPROP roll1 | CURVE 0 | 0 | 0.000000000 |
| | 0.314159265 | 0 | 0.000000000 |
| | 0.34906585 | 0 | 0.000000000 |
| | 0.369599136 | 0 | 0.000000000 |
| | 0.392699082 | 0 | 0.000000000 |
| | 0.41887902 | 0 | 0.000000000 |
| | 0.448798951 | 0 | 0.000000000 |
| | 0.483321947 | 0 | 0.000000000 |
| | 0.502654825 | 0 | 0.000000000 |
| | 0.523598776 | 0 | 0.000000000 |
| | 0.54636394 | 0 | 0.000000000 |
| | 0.571198664 | 0 | 0.000000000 |
| | 0.598398601 | 0 | 0.000000000 |
| | 0.628318531 | 0 | 0.000000000 |
| | 0.661387927 | 0 | 0.000000000 |
| | 0.698131701 | 0 | 0.000000000 |
| | 0.785398163 | 0 | 0.000000000 |
| | 0.897597901 | 0 | 0.000000000 |
| | 1.047197551 | 0 | 0.000000000 |
| | 1.256637061 | 0 | 0.000000000 |
| | 1.570796327 | 0 | 0 |
| | 1.770796327 | 0 | 0 |
| RAOPROP roll2 | CURVE 0 | 0 | 0.000000000 |
| | 0.314159265 | 0.00996583 | -0.027925268 |
| | 0.34906585 | 0.0108926 | -0.027925268 |
| | 0.369599136 | 0.011477285 | -0.026179939 |
| | 0.392699082 | 0.012126548 | -0.02443461 |
| | 0.41887902 | 0.012821189 | -0.02443461 |
| | 0.448798951 | 0.013494886 | -0.013962634 |
| | 0.483321947 | 0.014060372 | -0.005235988 |
| | 0.502654825 | 0.014254104 | 0.003490659 |
| | 0.523598776 | 0.014327408 | 0.019198622 |



| | | | |
|---------------|-------------|--------------|--------------|
| | 0.54636394 | 0.014241887 | 0.04712389 |
| | 0.571198664 | 0.013894566 | 0.097738438 |
| | 0.598398601 | 0.013158037 | 0.193731547 |
| | 0.628318531 | 0.011445869 | 0.39618974 |
| | 0.661387927 | 0.007897615 | 0.799360797 |
| | 0.698131701 | 0.003136357 | 1.736602606 |
| | 0.785398163 | 0.004256858 | -2.331759881 |
| | 0.897597901 | 0.000949459 | 1.123992038 |
| | 1.047197551 | 0.001469567 | 1.052433539 |
| | 1.256637061 | 0.001350885 | -2.686061719 |
| | 1.570796327 | 0.000439823 | -1.466076572 |
| | 1.770796327 | 0 | 0 |
| RAOPROP roll3 | CURVE 0 | 0 | 0.000000000 |
| | 0.314159265 | 0 | 0.000000000 |
| | 0.34906585 | 0 | 0.000000000 |
| | 0.369599136 | 0 | 0.000000000 |
| | 0.392699082 | 0 | 0.000000000 |
| | 0.41887902 | 0 | 0.000000000 |
| | 0.448798951 | 0 | 0.000000000 |
| | 0.483321947 | 0 | 0.000000000 |
| | 0.502654825 | 0 | 0.000000000 |
| | 0.523598776 | 0 | 0.000000000 |
| | 0.54636394 | 0 | 0.000000000 |
| | 0.571198664 | 0 | 0.000000000 |
| | 0.598398601 | 0 | 0.000000000 |
| | 0.628318531 | 0 | 0.000000000 |
| | 0.661387927 | 0 | 0.000000000 |
| | 0.698131701 | 0 | 0.000000000 |
| | 0.785398163 | 0 | 0.000000000 |
| | 0.897597901 | 0 | 0.000000000 |
| | 1.047197551 | 0 | 0.000000000 |
| | 1.256637061 | 0 | 0.000000000 |
| | 1.570796327 | 0 | 0 |
| | 1.770796327 | 0 | 0 |
| RAOPROP roll4 | CURVE 0 | 0 | 0.000000000 |
| | 0.314159265 | -0.00996583 | -0.027925268 |
| | 0.34906585 | -0.0108926 | -0.027925268 |
| | 0.369599136 | -0.011477285 | -0.026179939 |
| | 0.392699082 | -0.012126548 | -0.02443461 |
| | 0.41887902 | -0.012821189 | -0.02443461 |
| | 0.448798951 | -0.013494886 | -0.013962634 |
| | 0.483321947 | -0.014060372 | -0.005235988 |
| | 0.502654825 | -0.014254104 | 0.003490659 |
| | 0.523598776 | -0.014327408 | 0.019198622 |
| | 0.54636394 | -0.014241887 | 0.04712389 |
| | 0.571198664 | -0.013894566 | 0.097738438 |
| | 0.598398601 | -0.013158037 | 0.193731547 |
| | 0.628318531 | -0.011445869 | 0.39618974 |
| | 0.661387927 | -0.007897615 | 0.799360797 |
| | 0.698131701 | -0.003136357 | 1.736602606 |
| | 0.785398163 | -0.004256858 | -2.331759881 |
| | 0.897597901 | -0.000949459 | 1.123992038 |
| | 1.047197551 | -0.001469567 | 1.052433539 |
| | 1.256637061 | -0.001350885 | -2.686061719 |
| | 1.570796327 | -0.000439823 | -1.466076572 |



| | | | |
|----------------|-------------|-------------|--------------|
| | 1.770796327 | 0 | 0 |
| RAOPROP roll5 | CURVE 0 | 0 | 0.000000000 |
| | 0.314159265 | 0 | 0.000000000 |
| | 0.34906585 | 0 | 0.000000000 |
| | 0.369599136 | 0 | 0.000000000 |
| | 0.392699082 | 0 | 0.000000000 |
| | 0.41887902 | 0 | 0.000000000 |
| | 0.448798951 | 0 | 0.000000000 |
| | 0.483321947 | 0 | 0.000000000 |
| | 0.502654825 | 0 | 0.000000000 |
| | 0.523598776 | 0 | 0.000000000 |
| | 0.54636394 | 0 | 0.000000000 |
| | 0.571198664 | 0 | 0.000000000 |
| | 0.598398601 | 0 | 0.000000000 |
| | 0.628318531 | 0 | 0.000000000 |
| | 0.661387927 | 0 | 0.000000000 |
| | 0.698131701 | 0 | 0.000000000 |
| | 0.785398163 | 0 | 0.000000000 |
| | 0.897597901 | 0 | 0.000000000 |
| | 1.047197551 | 0 | 0.000000000 |
| | 1.256637061 | 0 | 0.000000000 |
| | 1.570796327 | 0 | 0 |
| | 1.770796327 | 0 | 0 |
| RAOPROP pitch1 | CURVE 0 | 0 | 0.000000000 |
| | 0.314159265 | 0.00996583 | -0.027925268 |
| | 0.34906585 | 0.0108926 | -0.027925268 |
| | 0.369599136 | 0.011477285 | -0.026179939 |
| | 0.392699082 | 0.012126548 | -0.02443461 |
| | 0.41887902 | 0.012821189 | -0.02443461 |
| | 0.448798951 | 0.013494886 | -0.013962634 |
| | 0.483321947 | 0.014060372 | -0.005235988 |
| | 0.502654825 | 0.014254104 | 0.003490659 |
| | 0.523598776 | 0.014327408 | 0.019198622 |
| | 0.54636394 | 0.014241887 | 0.04712389 |
| | 0.571198664 | 0.013894566 | 0.097738438 |
| | 0.598398601 | 0.013158037 | 0.193731547 |
| | 0.628318531 | 0.011445869 | 0.39618974 |
| | 0.661387927 | 0.007897615 | 0.799360797 |
| | 0.698131701 | 0.003136357 | 1.736602606 |
| | 0.785398163 | 0.004256858 | -2.331759881 |
| | 0.897597901 | 0.000949459 | 1.123992038 |
| | 1.047197551 | 0.001469567 | 1.052433539 |
| | 1.256637061 | 0.001350885 | -2.686061719 |
| | 1.570796327 | 0.000439823 | -1.466076572 |
| | 1.770796327 | 0 | 0 |
| RAOPROP pitch2 | CURVE 0 | 0 | 0.000000000 |
| | 0.314159265 | 0 | 0.000000000 |
| | 0.34906585 | 0 | 0.000000000 |
| | 0.369599136 | 0 | 0.000000000 |
| | 0.392699082 | 0 | 0.000000000 |
| | 0.41887902 | 0 | 0.000000000 |
| | 0.448798951 | 0 | 0.000000000 |
| | 0.483321947 | 0 | 0.000000000 |
| | 0.502654825 | 0 | 0.000000000 |
| | 0.523598776 | 0 | 0.000000000 |



| | | |
|------------------------|--------------|--------------|
| 0.54636394 | 0 | 0.000000000 |
| 0.571198664 | 0 | 0.000000000 |
| 0.598398601 | 0 | 0.000000000 |
| 0.628318531 | 0 | 0.000000000 |
| 0.661387927 | 0 | 0.000000000 |
| 0.698131701 | 0 | 0.000000000 |
| 0.785398163 | 0 | 0.000000000 |
| 0.897597901 | 0 | 0.000000000 |
| 1.047197551 | 0 | 0.000000000 |
| 1.256637061 | 0 | 0.000000000 |
| 1.570796327 | 0 | 0 |
| 1.770796327 | 0 | 0 |
| RAOPROP pitch3 CURVE 0 | 0 | 0.000000000 |
| 0.314159265 | -0.00996583 | -0.027925268 |
| 0.34906585 | -0.0108926 | -0.027925268 |
| 0.369599136 | -0.011477285 | -0.026179939 |
| 0.392699082 | -0.012126548 | -0.02443461 |
| 0.41887902 | -0.012821189 | -0.02443461 |
| 0.448798951 | -0.013494886 | -0.013962634 |
| 0.483321947 | -0.014060372 | -0.005235988 |
| 0.502654825 | -0.014254104 | 0.003490659 |
| 0.523598776 | -0.014327408 | 0.019198622 |
| 0.54636394 | -0.014241887 | 0.04712389 |
| 0.571198664 | -0.013894566 | 0.097738438 |
| 0.598398601 | -0.013158037 | 0.193731547 |
| 0.628318531 | -0.011445869 | 0.39618974 |
| 0.661387927 | -0.007897615 | 0.799360797 |
| 0.698131701 | -0.003136357 | 1.736602606 |
| 0.785398163 | -0.004256858 | -2.331759881 |
| 0.897597901 | -0.000949459 | 1.123992038 |
| 1.047197551 | -0.001469567 | 1.052433539 |
| 1.256637061 | -0.001350885 | -2.686061719 |
| 1.570796327 | -0.000439823 | -1.466076572 |
| 1.770796327 | 0 | 0 |
| RAOPROP pitch4 CURVE 0 | 0 | 0.000000000 |
| 0.314159265 | 0 | 0.000000000 |
| 0.34906585 | 0 | 0.000000000 |
| 0.369599136 | 0 | 0.000000000 |
| 0.392699082 | 0 | 0.000000000 |
| 0.41887902 | 0 | 0.000000000 |
| 0.448798951 | 0 | 0.000000000 |
| 0.483321947 | 0 | 0.000000000 |
| 0.502654825 | 0 | 0.000000000 |
| 0.523598776 | 0 | 0.000000000 |
| 0.54636394 | 0 | 0.000000000 |
| 0.571198664 | 0 | 0.000000000 |
| 0.598398601 | 0 | 0.000000000 |
| 0.628318531 | 0 | 0.000000000 |
| 0.661387927 | 0 | 0.000000000 |
| 0.698131701 | 0 | 0.000000000 |
| 0.785398163 | 0 | 0.000000000 |
| 0.897597901 | 0 | 0.000000000 |
| 1.047197551 | 0 | 0.000000000 |
| 1.256637061 | 0 | 0.000000000 |
| 1.570796327 | 0 | 0 |



```

1.770796327 0 0
RAOPROP pitch5 CURVE 0 0 0.000000000
0.314159265 0.00996583 -0.027925268
0.34906585 0.0108926 -0.027925268
0.369599136 0.011477285 -0.026179939
0.392699082 0.012126548 -0.02443461
0.41887902 0.012821189 -0.02443461
0.448798951 0.013494886 -0.013962634
0.483321947 0.014060372 -0.005235988
0.502654825 0.014254104 0.003490659
0.523598776 0.014327408 0.019198622
0.54636394 0.014241887 0.04712389
0.571198664 0.013894566 0.097738438
0.598398601 0.013158037 0.193731547
0.628318531 0.011445869 0.39618974
0.661387927 0.007897615 0.799360797
0.698131701 0.003136357 1.736602606
0.785398163 0.004256858 -2.331759881
0.897597901 0.000949459 1.123992038
1.047197551 0.001469567 1.052433539
1.256637061 0.001350885 -2.686061719
1.570796327 0.000439823 -1.466076572
1.770796327 0 0
RAOPROP yaw1 CURVE 0 0 0.000000000
1.570796327 0 0
1.770796327 0 0
RAOPROP yaw2 CURVE 0 0 0.000000000
1.570796327 0 0
1.770796327 0 0
RAOPROP yaw3 CURVE 0 0 0.000000000
1.570796327 0 0
1.770796327 0 0
RAOPROP yaw4 CURVE 0 0 0.000000000
1.570796327 0 0
1.770796327 0 0
RAOPROP yaw5 CURVE 0 0 0.000000000
1.570796327 0 0
1.770796327 0 0
# type nod1 nod2 dof statstep
ENVRES_N 1 1 1701 1 1
ENVRES_N 1 1 1701 3 1
# I1 EL1 EL2 ELNODE DOF TIME0
ENVRES_E 2 1 1700 2 5 1
ENVRES_E 2 1 1700 2 1 1
ENVRES_E 3 1 1700 2 2 1

```

1. DESCRIPTION OF PIPE DATA

1.1 Pipe data sheet

The pipe data sheet is presented below:

| Inside diameter | 228.6 mm | Service | Sour dynamic | Max Fluid Temp | 130.0 °C | |
|-------------------|--------------|----------------|--------------|-----------------|-----------|---------------|
| Design pressure | 50.07 MPa | Conveyed Fluid | Oil | Water Depth (m) | 300.0 m | |
| Layer | Material | Strength (MPa) | I.D. (mm) | Thick (mm) | O.D. (mm) | Weight (kg/m) |
| Carcass | Steel | 689 | 228.60 | 7.00 | 242.60 | 23.786 |
| Antiwear | PVDF | | 242.60 | 3.99 | 248.60 | 4.097 |
| Barrier | PVDF | | 248.60 | 12.00 | 272.60 | 17.389 |
| Antiwear | PVDFc | | 272.60 | 1.02 | 274.63 | 0.873 |
| Z-spiral | Carbon Steel | 758 | 274.63 | 12.00 | 298.63 | 68.762 |
| Flat spiral | Carbon Steel | 758 | 298.63 | 5.99 | 310.62 | 40.835 |
| Antiwear | PA11 (nylon) | | 310.62 | 1.52 | 313.67 | 1.569 |
| Tensile_armour_ 1 | Carbon Steel | 758 | 313.67 | 5.99 | 325.66 | 43.049 |
| Antiwear | PA11(nylon) | | 325.66 | 0.41 | 326.47 | 0.425 |
| Antiwear | PA11(nylon) | | 326.47 | 1.52 | 329.52 | 1.649 |
| Tensile_armour_ 2 | Carbon Steel | 758 | 329.52 | 5.99 | 341.51 | 45.400 |
| Antiwear | PA11(nylon) | | 341.51 | 0.41 | 342.32 | 0.445 |
| Antiwear | PA11(nylon) | | 342.32 | 1.52 | 345.37 | 1.729 |
| Tensile_armour_ 3 | Carbon Steel | 758 | 345.37 | 5.99 | 357.36 | 46.991 |
| Antiwear | PA11(nylon) | | 357.36 | 0.41 | 358.17 | 0.466 |
| Antiwear | PA11(nylon) | | 358.17 | 1.52 | 361.22 | 1.808 |
| Tensile_armour_ 4 | Carbon Steel | 758 | 361.22 | 5.99 | 373.21 | 49.265 |
| Antiwear | PA11(nylon) | | 373.21 | 0.41 | 374.02 | 0.487 |
| Antiwear | PA11(nylon) | | 374.02 | 0.41 | 374.83 | 0.319 |
| Protective sheath | PA11(nylon) | | 374.83 | 12.00 | 398.83 | 15.312 |

Table 3.1 Pipe Data Sheet

The steel tendon cross-section details are summarised below. Details on the geometry is provided by separate text input file in Bflex format for the Z-spiral.

| Layer | Dimension (mm) | Pitch (mm) | Wires | Angle (°) | Filled (%) |
|-------------------|----------------|------------|-------|-----------|------------|
| Carcass | 55 × 1.4 | - | - | - | - |
| Z-spiral | 26.8 × 12 | - | - | - | - |
| Flar spiral | 16 × 6 | - | 1 | - | - |
| Tensile_armour_ 1 | 12 × 6 | 1039.9 | 54 | 44 | 91.3 |
| Tensile_armour_ 2 | 12 × 6 | 1091.5 | 57 | 44 | 91.8 |
| Tensile_armour_ 3 | 12 × 6 | 1225.9 | 61 | 42 | 90.7 |
| Tensile_armour_ 4 | 12 × 6 | 1281.2 | 64 | 42 | 91.0 |

Densities to be based on data sheet values using the combined weight and thickness values provided. The overall pipe mass in empty condition is 364.65 kg/m. During operation (oil filled condition – oil density = 800 kg/m³) the mass increases to 399.1 kg/m³. In the laboratory test condition, the mass will be 407.7 kg/m³. The buoyancy mass to be calculated based on the external diameter and a sea water density of 1025 kg/m³.

Note that the layer weights in combination with the density and cross-section area given can be used to calculate the lay angle of the helices by the simple formula:

$$\alpha = \cos^{-1} \left(\frac{\rho_{layer} A}{m_{layer}} \right)$$

The geometry of the carcass can be handled according to an example input provided and the basic principles outlined in below figure utilizing the layer thickness and the thin plate (dimension 1.4*55 mm) used to form the carcass.

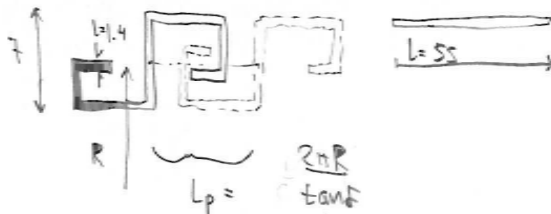

Mechanical properties are given below.

| Material | Young's modulus (MPa) | Poisson's ratio (-) |
|----------------|-----------------------|---------------------|
| Steel | 2e5 | 0.3 |
| Plastic layers | 300 | 0.4 |

1.2 Description of bend stiffener

The pipe bending stiffener is normally made of polyurethane (PU). The Young's modulus of elasticity during operation is taken to be 68.5 MPa. During testing at room temperature ((23 °C), the stress strain curve given below governs

| Strain (%) | Stress (MPa) |
|------------|--------------|
| 1 | 2 |
| 2 | 4 |
| 3 | 5.2 |
| 4 | 6.4 |
| 5 | 7.2 |
| 6 | 8 |
| 7 | 8.6 |
| 8 | 9.2 |
| 9 | 9.7 |
| 10 | 10.2 |

It is seen that the tangential modulus of elasticity is 200 MPa up to 2% strain.

The geometry of the pipe and bending stiffener to be used for test specimen modelling in Bflex is shown in Figure 3.1 below. The figure also includes the position of the specimen relative to the test rig pivot point in the laboratory test rig (for the riser model project only the bend stiffener geometry is relevant).

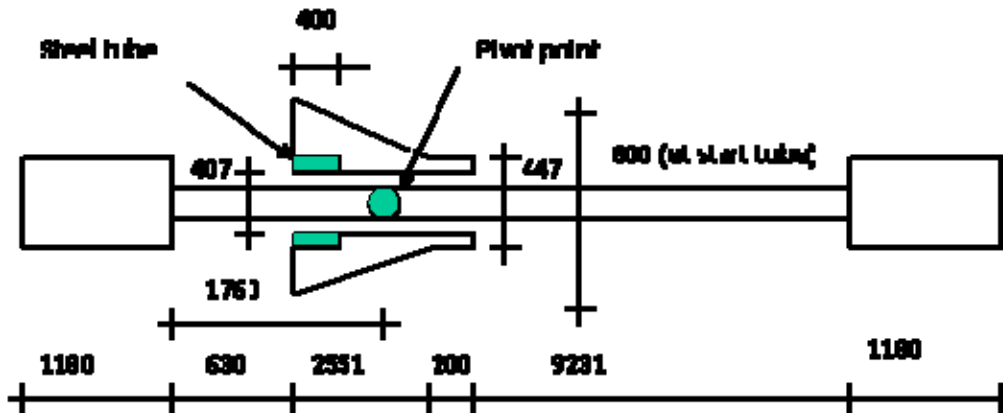

1.3 Fatigue data

With regard to the fatigue calculation, example input files are provided on Bflex format. The fatigue data to be used are specified below:

$$\lg N = \lg a - n \lg s - m \lg \Delta \sigma$$

where $\lg a$ is a constant, $\lg s$ is the standard deviation, n is the number of standard deviations used to construct the fatigue curve and m is the slope parameter where:

| Layer | $\lg a$ | n | m |
|-----------------|---------|-----|------|
| Tensile_armour_ | 23.89 | 0 | 6.53 |
| Z-spiral | 12.5 | 0 | 3 |

1.4 Operational data

Internal pressure to be applied is 475 bar (47.5 MPa).

1.5 Load cases to be applied for the test rig case (not relevant for the full riser analysis)

For the test rig case, the following load sequence is to be assumed:

LC1 – 400 000 cycles at variable rocking angle +/- 7.5 degrees and constant tension 725 kN

LC2 – 200 000 cycles at variable rocking angle +/- 12.5 degrees and constant tension 750 kN

1.6 Friction coefficients

Between steel and plastic – 0.15

Between steel and steel (for Z-spiral) – 0.25