



NTNU – Trondheim
Norwegian University of
Science and Technology

Motion analysis of Semi-Submersible

Emil Aasland Pedersen

Marine Technology

Submission date: June 2012

Supervisor: Bjørnar Pettersen, IMT

Norwegian University of Science and Technology
Department of Marine Technology



HOVEDOPPGAVE I MARIN HYDRODYNAMIKK

VÅR 2012

FOR

Stud.techn. Emil Aasland Pedersen

BEVEGELSESANALYSE AV SEMI-SUBMERSIBLE (Motion analysis of Semi-Submersible)

Kandidaten skal bruke programmet ANSYS/AQWA og gjøre analyser av bevegelsene til en semi-submersible i forskjellige tilstander. Beregningene gjøres i regulære bølger. Riggeren som skal brukes i analysen er en GG5000 (Grenland Group), og bevegelsen skal undersøkes i forskjellige last- og flytetilstander, med spesiell fokus på hiv, stamp og rull. Kandidaten skal redegjøre for antagelser og begrensninger som gjøres og som kan ha betydning for vurdering av resultatene. Overføring av modellen til et visualiseringsprogram kan være til stor hjelp og utnyttes i den grad tiden tillater det.

Kandidaten skal i besvarelsen legge frem sitt personlige bidrag til løsning av de problemer som oppgaven stiller. Påstander og konklusjoner som legges frem, skal underbygges med matematiske utledninger og logiske resonnementer der de forskjellige trinn tydelig fremgår. I besvarelsen skal det klart fremgå hva som er kandidatens eget arbeid, og hva som er tatt fra andre kilder.

Kandidaten skal utnytte de muligheter som finnes til å skaffe seg relevant litteratur for det problemområdet kandidaten skal bearbeide.

Besvarelsen skal være oversiktlig og gi en klar fremstilling av resultater og vurderinger. Det er viktig at teksten er velskrevet og klart redigert med tabeller og figurer. Besvarelsen skal gjøres så kortfattet som mulig, men skrives i klart språk.

Besvarelsen skal inneholde oppgaveteksten, forord, innholdsfortegnelse, sammendrag, hoveddel, konklusjon med anbefalinger for videre arbeid, symbolliste, referanser og eventuelle vedlegg. Alle figurer, tabeller og ligninger skal nummereres.

Det forutsettes at Institutt for marin teknikk, NTNU, fritt kan benytte seg av resultatene i sitt forskningsarbeid, da med referanse til studentens besvarelse.

Besvarelsen leveres innen 27. juni 2012.

Bjørnar Pettersen
Professor



1 Preface

A semi-submersible is a specialized marine vessel with good sea keeping and stability characteristics, of which the first one was built in 1961.

The semi-submersible vessel design is commonly used in a number of specific offshore roles such as for offshore drilling rigs, safety vessels and oil production platforms.

Offshore drilling in water depth greater than around 120 meters requires that operations are carried out from a floating vessel, as fixed structures are not practical. Initially in the early 1950s, monohull ships were used, but these were found to have significant heave, pitch and yaw motions in large waves, and the industry needed more stable drilling platforms.

A semi-submersible obtains its buoyancy from watertight pontoons located below the ocean surface, which have the possibility of ballasting if the draft needs to be changed. With its hull structure submerged at a deep draft, the semi-submersible is less affected by wave loadings than a normal ship. With a small water-plane area, however, the semi-submersible is sensitive to load changes, and therefore must be carefully trimmed to maintain stability.

Only a handful of the studies done are dedicated to how a semi-submersible will be affected when damaged. This thesis studies the movement of a semi-submersible in regular waves. Two damage cases are included as well as a shallow draft case. What would be the best way to preserve the buoyancy when damaged?

The work has been both demanding and time consuming over an entire semester. The main reason for this is the meshing process and the computational time required for each run. The meshing has been demanding. This is due to the fact that the unit is modeled without simplifications in order to maintain geometric accuracy; so the geometry is quite detailed. The run times for the different models have varied from 6 minutes to over 19 hours. And to check the results it has been necessary to run them over and over again. The damage cases especially have been demanding. Here it has been necessary to divide the model manually and redo the entire mesh for both cases. AQWA is also very restrictive on this field, as it does not have a general setup for damage cases, so several days have been used to accomplish this task. The data calculated has been presented in the form of response amplitude operators for the different translations and rotations, which shows the response at a given wave period. For the shallow water condition there are, in addition to the response amplitude operators, also presented graphs for added mass and damping as well as excitation forces, as these are interesting parameters to consider in such a condition.



NTNU

The Norwegian University of Science and Technology

Department of Marine Technology

I would like to take this opportunity to thank Grenland Group Technology for their cooperation. They have given me clearance to many classified and sensitive documents, drawings and reports from the COSLProspector (GG5000 design). This includes their own motion analysis report (Global Maritime (2011)), done by Global Maritime AS, and a stability analysis report (Henriksen (2011)), done by Grenland Group Technology. I would also like to thank my main supervisor at NTNU, Professor Bjørnar Pettersen, for his guidance and motivation, and my co-supervisor at Grenland Group Technology, Sime Kolic (Senior Naval Architect), for his patience and ability to assist me in all kinds of problems which has occurred. In addition I would like to thank the principal lead for the department of structure and marine technology at Grenland Group Technology, Kristen Amundrød, for sending me to a three day intensive AQWA course at Teknisk Data AS as this saved me valuable time in the learning process of the software.

Emil Aasland Pedersen

Stud. techn.

2 Index and tables

2.1 Table of contents

1	Preface	I
2	Index and tables	III
2.1	Table of contents	III
2.2	Nomenclature	IV
2.3	Abbreviations	V
2.4	Table list	V
2.5	Figure list	VI
3	Summary	VIII
4	Introduction	1
4.1	Environmental conditions	2
4.1.1	Waves	2
4.2	Description of hydrodynamic model	3
4.3	Description of coordinate system	5
4.4	Software and hardware setup	6
4.5	Hydrodynamic assumptions in AQWA	9
5	Pre processing	10
5.1	Creating the model in SolidWorks	10
5.2	Mesh generation	11
5.3	Element analysis	15
5.3.1	Element analysis setup	15
5.3.2	Time consumption	17
5.3.3	Element analysis results	18
5.3.3.1	Element convergence	22
5.3.4	Verification of obtained results	24
5.3.4.1	Resonance period in heave	24
5.3.4.2	Comparison to RAOs from Global Maritime (2011)	25
5.3.5	Element analysis conclusion	29
6	Analysis of abnormal floating conditions	30
6.1	Analysis of GG5000 in damaged condition	30
6.1.1	Setup of model	33
6.1.2	Damage case setup in AQWA	34
6.2	Analysis of GG5000 in shallow draft condition	35
7	Post processing	36
7.1	Animation in AQWA GS	36
7.2	Results damage case 1	37
7.3	Results damage case 2	41
7.4	Results shallow draft case	44
8	Conclusion and further work	53
9	References	54
10	Appendix	I
10.1	Appendix notes	I
10.2	AQWA script	II
10.3	Draft of stability analysis report (Henriksen (2011))	V
10.4	CAD-schematics	XIII



2.2 Nomenclature

ρ	-	Density of water
η_1	-	Translation in surge
η_2	-	Translation in sway
η_3	-	Translation in heave
η_4	-	Rotation in roll
η_5	-	Rotation in pitch
η_6	-	Rotation in yaw
λ	-	Wave length
θ	-	List angle
a	-	Length of arm in the Steiner theorem
A_{ij}	-	Added mass in i – direction due to movement in j – direction
$A_{ij\ 2D}$	-	Two dim. added mass in i – direction due to movement in j – direction
A_{WL}	-	Water plane area
b	-	Pontoon/column breadth
BM_T	-	Distance from centre of buoyancy to metacentre (transverse direction)
BM_L	-	Distance from centre of buoyancy to metacentre (longitudinal direction)
GM_T	-	Distance from centre of gravity to metacentre (transverse direction)
GM_L	-	Distance from centre of gravity to metacentre (longitudinal direction)
KB	-	Distance from keel/baseline to centre of buoyancy
KG	-	Distance from keel/baseline to centre of gravity
I_{44}	-	Mass moment of inertia around x-direction
I_{55}	-	Mass moment of inertia around y-direction
d	-	Draft of unit
g	-	Gravitational acceleration
m_{tot}	-	Total mass
T_{n3}	-	Resonance period in heave
T_{n4}	-	Resonance period in roll
T_{n5}	-	Resonance period in pitch
r_{xx}	-	Radius of gyration around x-direction
r_{yy}	-	Radius of gyration around y-direction
r_{zz}	-	Radius of gyration around z-direction



LCG	-	Longitudinal (x-direction) Centre of Gravity
TCG	-	Transverse (y-direction) Centre of Gravity
VCG	-	Vertical (z-direction) Centre of Gravity
X_b	-	Longitudinal (x-direction) Centre of buoyancy
Y_b	-	Transverse (y-direction) Centre of buoyancy
Z_b	-	Vertical (z-direction) Centre of buoyancy

2.3 Abbreviations

BWT ST	-	Ballast water tank starboard side
CAD	-	Computer Aided Design
CoB	-	Centre of Buoyancy
CoG	-	Centre of Gravity
COSL	-	China Oilfield Services Limited
CPU	-	Central Processing Unit
DNV	-	Det Norske Veritas
DP	-	Dynamic Positioning
FR	-	Frame
FWD	-	Forward
GB	-	Gigabyte
GG	-	Grenland Group
MT	-	Metric Ton
RAM	-	Random Access Memory
RAO	-	Response Amplitude Operator
SYMX	-	Symmetry about X-axis
WADAM	-	Wave Analysis by Diffraction And Morrison theory

2.4 Table list

Table 1: Weight of water for flooded tanks	IX
Table 2: Main dimensions of GG5000	1
Table 3: Main particulars of GG5000	4
Table 4: Number of diffracting elements VS processing time.....	17
Table 5: Sea water weight for the different units' total volume.....	31
Table 6: Sea water weight for the different units' available volume	31
Table 7: Data for damage cases.....	33



2.5 Figure list

Figure 1: CAD picture of COSLProspector (GG5000)(Photo: GG archive).....	1
Figure 2: SolidWorks model	3
Figure 3: Translation- and rotation motions (Figure: www.wikipedia.org).....	5
Figure 4: Model assembly in SolidWorks.....	6
Figure 5: Meshed model from Mechanical APDL.....	7
Figure 6: AQWA Graphical Supervisor interface window	8
Figure 7: Plan on pontoons with main dimensions (from CAD-schematics)	10
Figure 8: Main Menu in Mechanical APDL	11
Figure 9: Mesh before modifications	12
Figure 10: Mesh after number of divisions are changed	13
Figure 11: Mesh after mapping the panels	14
Figure 12: RAO heave in head sea.....	18
Figure 13: RAO heave in beam sea.....	18
Figure 14: RAO pitch in head sea	19
Figure 15: RAO roll in beam sea	19
Figure 16: Pitch in head sea w/higher periods	20
Figure 17: Roll in beam sea w/higher periods.....	20
Figure 18: Loss of area in model due to insufficient curvature.....	21
Figure 19: Element convergence in heave, head sea.....	22
Figure 20: Element convergence in heave, beam sea.....	22
Figure 21: Element convergence in pitch, head sea	23
Figure 22: Element convergence in roll, beam sea	23
Figure 23: RAO heave, wave headings 0° to 180° (from Global Maritime (2011))	26
Figure 24: RAO pitch, wave headings 0° to 180° (from Global Maritime (2011)).....	27
Figure 25: RAO roll, wave headings 0° to 180° (from Global Maritime (2011)).....	28
Figure 26: Tank layout in pontoons for the two damage scenarios	30
Figure 27: Damage case 1-WBT ST-8 flooded.....	32
Figure 28: Damage case 2-WBT ST-2 flooded.....	32
Figure 29: Sketch with rotated heel axis for damage case 2	33
Figure 30: Shallow draft condition.....	35
Figure 31: AQWA GS frame from animation.....	36
Figure 32: RAO heave, head sea (damage case 1 VS operational draft)	37
Figure 33: RAO heave, beam sea (damage case 1 VS operational draft)	38
Figure 34: RAO roll, head sea (damage case 1 VS operational draft)	38
Figure 35: RAO roll, beam sea (damage case 1 VS operational draft).....	39
Figure 36: RAO pitch, head sea (damage case 1 VS operational draft).....	39
Figure 37: RAO pitch, beam sea (damage case 1 VS operational draft).....	40
Figure 38: RAO heave, head sea (damage case 2 VS operational draft)	41
Figure 39: RAO heave, beam sea (damage case 2 VS operational draft)	42
Figure 40: RAO roll, head sea (damage case 2 VS operational draft)	42
Figure 41: RAO roll, beam sea (damage case 2 VS operational draft).....	43
Figure 42: RAO pitch, head sea (damage case 2 VS operational draft).....	43
Figure 43: RAO pitch, beam sea (damage case 2 VS operational draft).....	44
Figure 44: RAO heave, head sea (shallow draft VS operational- and survival draft).....	45
Figure 45: RAO heave, beam sea (shallow draft VS operational- and survival draft).....	45



Figure 46: RAO roll, beam sea (shallow draft VS operational- and survival draft)	46
Figure 47: RAO pitch, head sea (shallow draft VS operational- and survival draft).....	46
Figure 48: Added mass variation heave (shallow draft VS operational- and survival draft)...	47
Figure 49: Added mass variation roll (shallow draft VS operational- and survival draft).....	48
Figure 50: Added mass variation pitch (shallow draft VS operational- and survival draft) ...	48
Figure 51: Damping variation heave (shallow draft VS operational- and survival draft).....	49
Figure 52: Damping variation roll (shallow draft VS operational- and survival draft)	49
Figure 53: Damping variation pitch (shallow draft VS operational- and survival draft).....	50
Figure 54: Excitation force variation heave, head sea (shallow draft VS operational- and survival draft)	50
Figure 55: Excitation force variation heave, beam sea (shallow draft VS operational- and survival draft)	51
Figure 56: Excitation force variation roll, beam sea (shallow draft VS operational- and survival draft)	51
Figure 57: Excitation force variation pitch, head sea (shallow draft VS operational- and survival draft)	52



3 Summary

In this thesis the response variables (RAOs) of a semi submersible unit are inspected. Both operational and survival condition as well as a shallow draft are inspected. The survival condition is inspected with respect to an element analysis. And both operational- and shallow draft condition are case studies, where the operational condition is inspected for two different damage cases.

The unit in question is a four column semi submersible, based on the GG5000 design. This is a relatively new design, and the first vessel to get this design is in its final engineering stage. Construction start is planned to be in August this year (2012). This unit will get the name COSLProspector and will be built in CIMC Yantai Raffles shipyard in China.

The unit is symmetrical about the centre line and close to symmetrical about the vertical transverse plane, only pontoon tips are different. Because of this, no significant simplifications have been necessary in order to simplify the calculation due to computational time. Another reason for not doing any simplifications to the geometry is due to the fact that the results are desired to be the most realistic. However, to reduce computational time, only half the unit has been modelled due to symmetry about centre line.

To find the appropriate element size for the mesh, an element analysis has been carried out. The results from this analysis resulted in a chosen element size of 2.5m. This element size both gives accurate results, and requires a relatively short computational time.

The units' resonance periods has been investigated, and verified by help of hand calculations and comparison with RAOs done by Global Maritime (2011). However not all the values were identical to each other, but many factors can influence on that result. The GM value was not changed in this thesis, but was in Global Maritime (2011), in addition the additional damping was in this thesis taken as 3% of critical damping, while in Global Maritime (2011), Morrison elements were taken into account. These factors, and perhaps a few shortenings are assumed to be the reason for the small difference in the responses, they are however small differences for most of the periods.

Two damage cases have been modelled by flooding two different water ballast tanks. These damages will give an angle of list for the unit. Damage case 1 gives an angle of list of 13.18° with a rotation of heel axis of 7° forward. Damage case 2 gives a list angle of 11.68° with a rotation of the heel axis of 39° forward. An earlier study like this one is done by Henriksen (2011), found in Grenland Groups internal archive. AQWA does not give out the tilt angles in damage cases as this is not the main purpose of this program. Therefore, the list angles for the different cases have been obtained from the report done by Henriksen (2011). However, AQWA will be used to obtain the RAOs for both cases, as well as confirm floating equilibrium in such conditions.

It is assumed that the tanks are completely emptied for air, and that seawater is filling the entire volume. A table showing the different tanks flooded and its weight with seawater is shown in table 1.



<i>Unit</i>	<i>Volume [m³]</i>	<i>Sea water weight [MT]</i>
BWT ST-2	692.51	709.82
BWT ST-8	616.83	632.25

Table 1: Weight of water for flooded tanks

When it comes to the RAOs in the damage cases, they are very hard to read. This is mainly due to the fact that the motions in these cases are highly dependent on each other due to coupled motions. Due to an angle of list, the unit is no longer symmetric. As a consequence of this a RAO for a specific degree of freedom can no longer be read like it is only this degree of freedom which is affecting the responses, but one or more of the other degrees of freedom are strongly influencing. This makes some of the peaks appear where not normally expected.

It is also noticeable that the highest motions are encountered for damage case 1, which is natural because this case has the highest list angle. The resonance periods are lower in the damage cases compared to the normal operational condition, however not to a degree which is dangerously low. The lowest resonance period is still in heave.

From the RAOs in the shallow draft case, it can be noticed that the highest responses in heave are encountered for the shallow condition (14.5m) compared to the survival condition (15.5m) and operational condition (17.5m), however only up to about 18s, where after that it has the smallest response, and the operational condition has the highest.

In roll and pitch the trends are fairly similar. The graphs are a little uneven until the first cancellation period, and then the shallow draft gives a higher response until reaching the resonance period. In the resonance region, the operational condition has the highest response for both roll and pitch, same as for the heave.

As a conclusion, the optimal approach in a situation where the unit is heavily tilted is to try to ballast the unit to an even keel. But of course risks of doing this are a possibility, such as slamming problems and the fact that the resonance periods will be shorter.

4 Introduction

The COSLProspector (GG5000 design) is a deep water semi submersible DP drilling unit, equipped and suitable for year round operations worldwide. It will be built in Yantai Raffles shipyard in China, starting in August this year (2012). When COSLProspector is finished, it will be the only one with this design.

The units' main dimensions are listed below in table 2.

Length of pontoon	104.50m
Height of pontoon	10.05m
Width of pontoon	16.50m
Overall width	70.50m
Height (box bottom)	29.50m
Height (main deck)	37.55m
Survival draft	15.50m
Operational draft	17.50m

Table 2: Main dimensions of GG5000



Figure 1: CAD picture of COSLProspector (GG5000)(Photo: GG archive)

The objective of this thesis has been to study the motions of the GG5000 using computer tools. SolidWorks Premium has been used to make the model geometry. For the analysis itself the ANSYS package has been used, and then especially the part of ANSYS called AQWA. The mesh has been done in ANSYS Mechanical APDL. A description on how the mesh is made, including choice of panel size has also been done. The unit has been modelled in two conditions, survival and operational, with 15.5 m and 17.5 m draft respectively, as well as a shallow draft condition of 14.5m. A similar analysis is done by Global Maritime (2011) for Grenland Group in SESAM, so some of the parameters have been taken from that report, and the results have been used for comparison.



4.1 Environmental conditions

The unit is intended for worldwide operation and shall operate on a given location for a limited period of time.

For the global structural strength of the vessel, the wind and current loads are negligible for the overall structural integrity of the hull, and therefore only the wave conditions are of concern.

4.1.1 Waves

Regular waves are used for the analysis.

Wave headings from 0° to 180° with steps of 15° will be checked for the global response analysis. However, only head and beam sea are considered and given in the RAO curves because these directions will cause the highest responses.

The unit is meant to be operating in Norwegian continental shelf area. Extreme sea states are expected to occur at a water depth of approximately 300m. In areas closer to shore where depth is less than 300m it is evident that the maximum waves sea states decreases (ref. NORSOK– N003). This is most likely due to wave breaking. Hence a depth of 300m has been used for establishing the hydrodynamic databases. Water density is set to 1025 kg/m^3 .

4.2 Description of hydrodynamic model

The semi submersible GG5000 design has been modelled in this project. As mentioned earlier, no simplifications to the geometry has been applied as the results are desired to be the most realistic. Only half the unit have been modelled due to symmetry about centre line¹. Then a feature in AQWA, which uses symmetry to analyse the whole unit, has been applied.

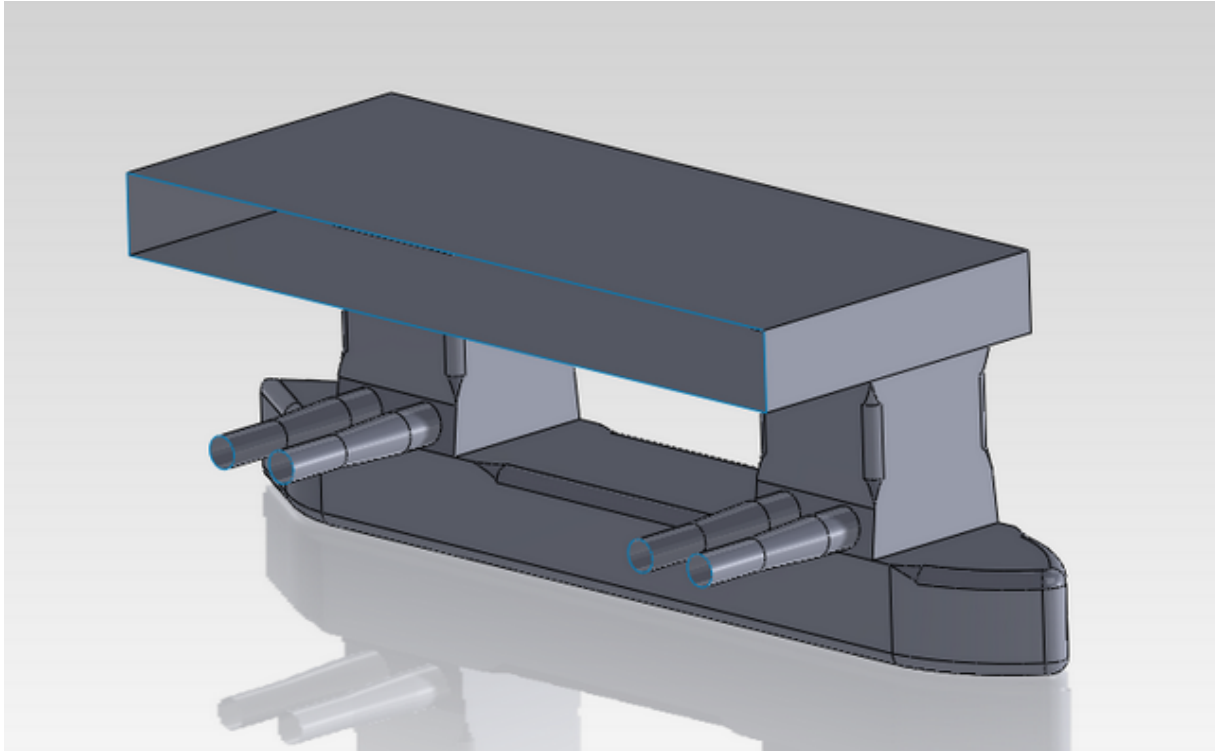

Figure 2: SolidWorks model

The unit is modelled with the same operation- and survival draught as the GG5000 unit, 17.5 m and 15.5 m respectively, where the operation draught has been used for damage cases. In addition, a shallow draught of 14.5 m has been modelled to see how this affects the stability of the vessel. We also need several other data to complete the analysis, as radii of gyration and CoG. In addition, as mentioned earlier, some of the parameters have been taken from a previous analysis done in SESAM by Global Maritime (2011). However most of the results are calculated in AQWA. It gives out all these values according to geometry and input, and after processing the only change needed is the vertical CoG. A table describing these values is shown below in table 3.

¹ Note that symmetry exists on even keel only



	Shallow draft condition	Survival condition	Operational condition
Draft [m]	14.5	15.5	17.5
Displacement [m ³]	36556100	37726800	39443900
Center of Gravity: LCG(x) [m]	0.0539	0.0575	0.0571
TCG(y)	0.0	0.0	0.0
VCG(z)	23.46 ²	23.05 ²	22.23 ²
Metacentric height: GM _T [m]	2.80	2.55	2.70
GM _L	3.96	3.25	3.47
Center of Buoyancy: X _b [m]	0.053	0.053	0.053
Y _b	0.0	0.0	0.0
Z _b	-8.30	-9.07	-10.59
Radii of gyration: r _{xx} [m]	30.20	29.90	29.40
r _{yy}	31.80	31.50	31.00
r _{zz}	34.80	34.80	34.80
Water plane area [m ²]	999.6	960.9	955.8
Water depth [m]	300	300	300

Table 3: Main particulars of GG5000

Table 3 gives the values which is the basis of all the calculations that have been done.

² Note that VCG is expressed from baseline and not from WL

4.3 Description of coordinate system

The coordinate system used in this thesis is right handed and defined with the z-axis as the zero line at the bottom of the units' pontoons, with positive direction upwards. The x- and y-axis has their origin in the geometrical centre of the unit, and are positive, to the forward and to port side respectively. This coordinate system is used by default in AQWA. The different translations and rotations are shown in figure 3 below.

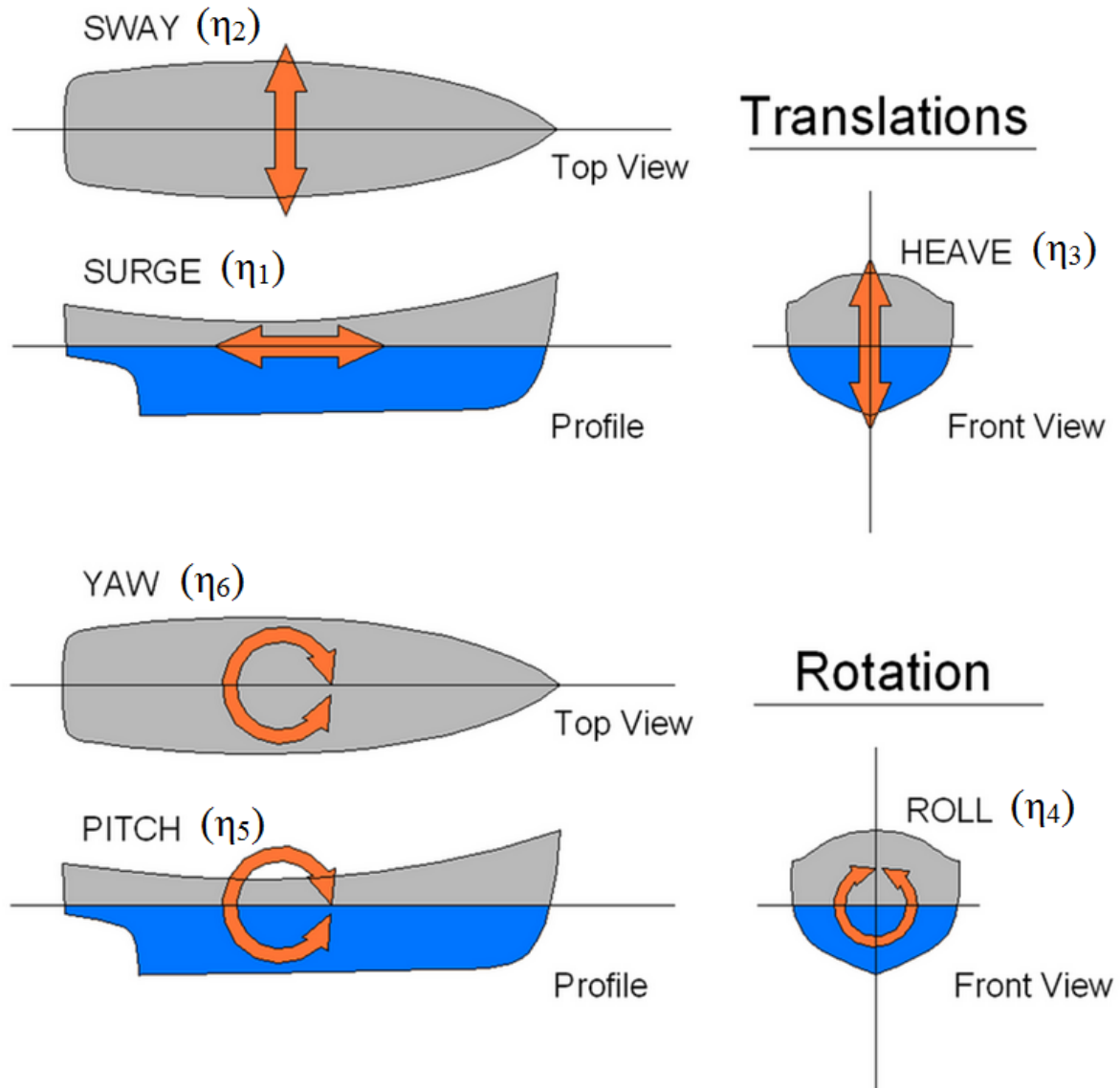

Figure 3: Translation- and rotation motions (Figure: www.wikipedia.org)

4.4 Software and hardware setup

All computations done in this thesis have been done using an Intel Xeon CPU W3565 @ 3.20GHz with 4 cores and 6GB RAM. To make sure that the performance is optimized, most of the computations have been done after hours. This makes sure that the computer can work undisturbed because no other programs are working simultaneously. The computer has been running on a Microsoft Windows 64-bit operating system.

SolidWorks Premium – 2011

SolidWorks is the program where the model has been created. It is a 3D modelling program which is intuitive and easy to use. The program has an interface that is used to make the model, so no scripting is used. In this project only half the unit is modelled in order to maintain simplicity, and then it has been mirrored later in the process.

The model is made by making sketches in different planes and further to apply the many different features such as: Extrude, split, fillet, body-move and combine to mention some. After all these operations are done, the model will look like the one shown in figure 4.

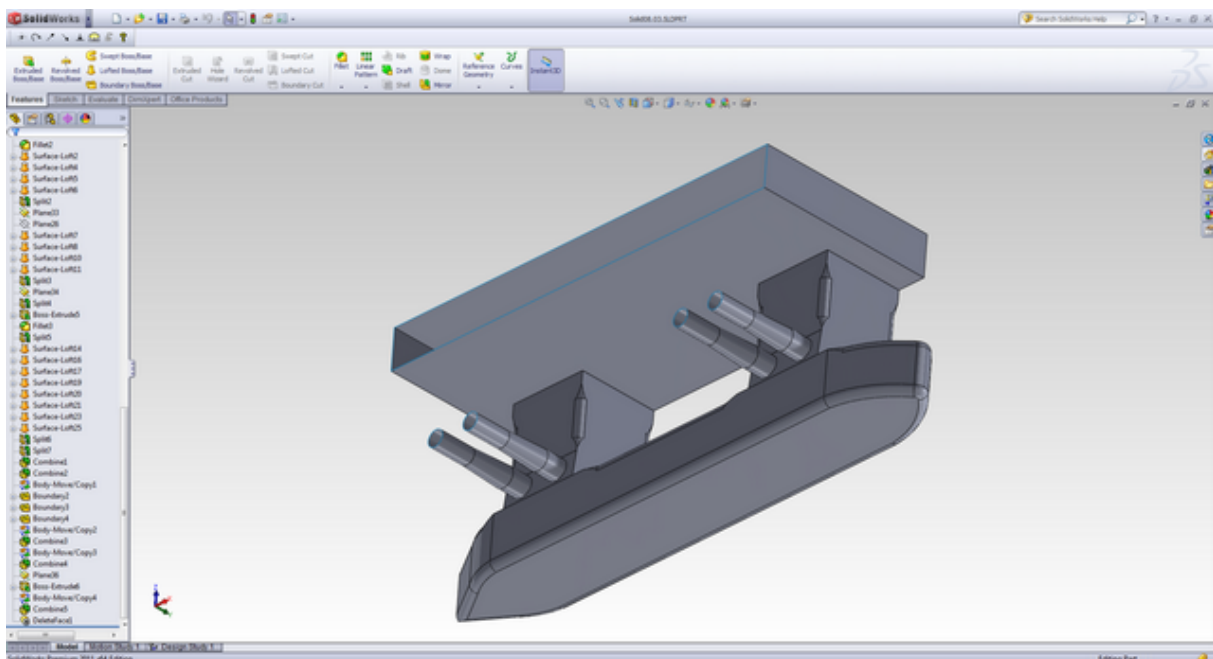

Figure 4: Model assembly in SolidWorks

AutoCAD Mechanical – 2011

AutoCAD Mechanical is primarily used for 2D drawings like general arrangements, layout drawings etc. But it is also useful for some 3D operations. In this thesis the sea surface for the damage cases (see chapter 6.1) are made with this program. This has been done to obtain the angle of list with respect to the unit



Mechanical APDL – Version 14.0

Mechanical APDL is the part of the ANSYS package where the mesh has been made and the hydrodynamic problem is set up.

Mechanical APDL is a very nice feature to make the mesh, because there are more possibilities for changing the mesh than in DesignModeler, which is a newer and more intuitive interface in the ANSYS package. In DesignModeler the choices for mesh generation are more or less automatic, but harder to adjust. In Mechanical APDL you can easily change the mesh in areas of choice to make it more refined and uniform.

After the mesh is satisfying, a function called “execute macro” is used. Draft, gravity and density of the fluid are chosen. All these can however be changed after the macro file is made. The model is also mirrored in Mechanical APDL, using the “use SYMX” function implemented. A file called “file.aqwa” is created and this file can be opened with a normal text editor. In figure 5, a completed mesh is shown.

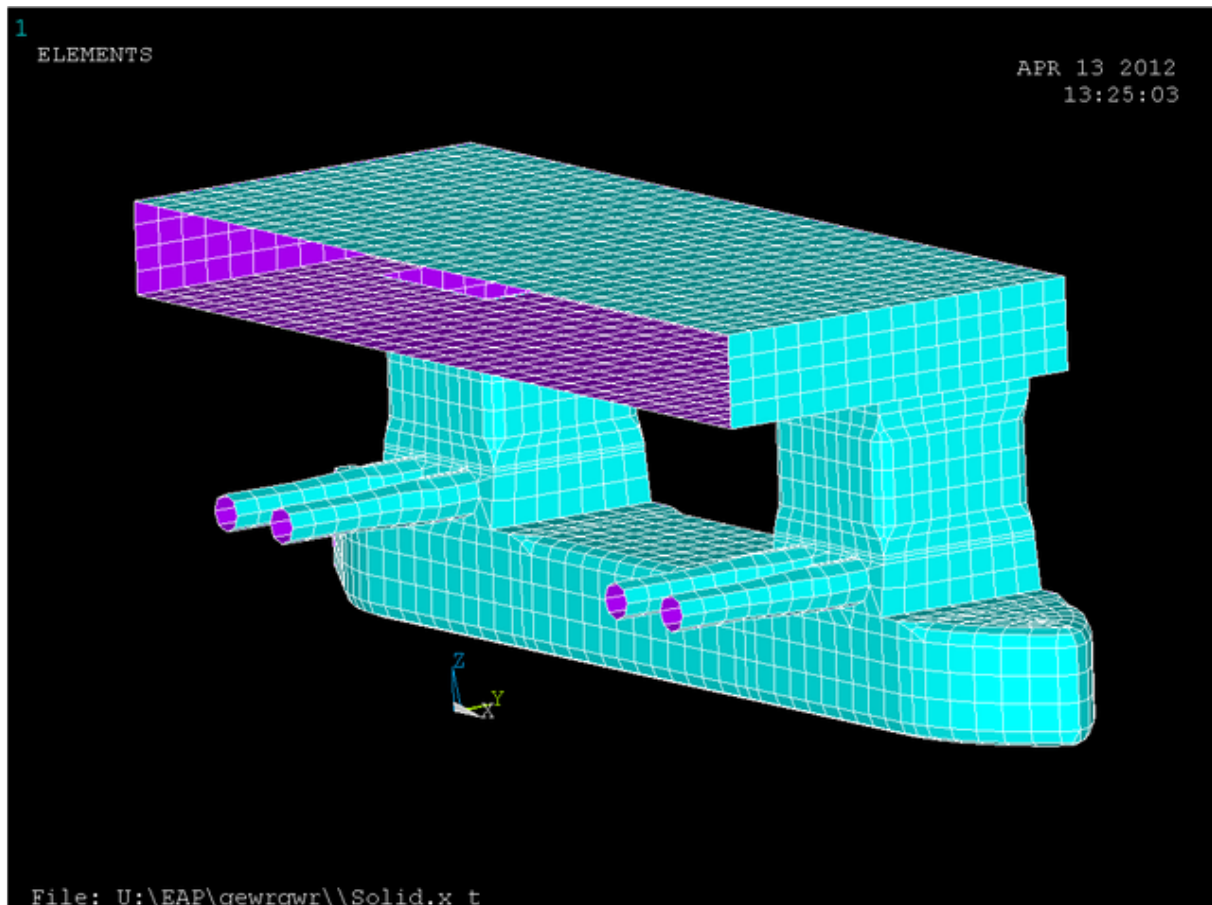

Figure 5: Meshed model from Mechanical APDL

AQWA Classic – Version 14.0

AQWA Classic, hereby denoted AQWA, is the actual solver implemented in the ANSYS package. When the editing in textpad is finished, the file generated from Mechanical APDL can simply be opened in AQWA using drag and drop. It might be hard to understand why the mirroring is done before running AQWA. But AQWA “reads” that this has been done in APDL, so only half the model is actually solved, and then it is mirrored automatically. To store relevant input data, AQWA creates a file called “FILE.LIS”. This file contains both input and output data, and can be accessed with a normal text editor. The coding language is FORTRAN. AQWA consists of several sub modules where AQWA-LINE and AQWA-NAUT are the ones used in this thesis, for the analyses and the animation respectively.

AQWA Graphical Supervisor (AQWA GS) – Version 14.0

AQWA GS is the interface in the ANSYS package where the results can be visualized.

Graphs and animations are among the features that can be found here.

AQWA makes a file called “FILE.RES”. This file is used for animation in the frequency domain. In addition AQWA makes a file called “FILE.PLT”, which is used by AQWA GS to visualize the graphs of significance. However not many options to the graphs are available, so in this thesis the graphs from AQWA have only been used to verify results, and then they have been plotted in Microsoft Excel.

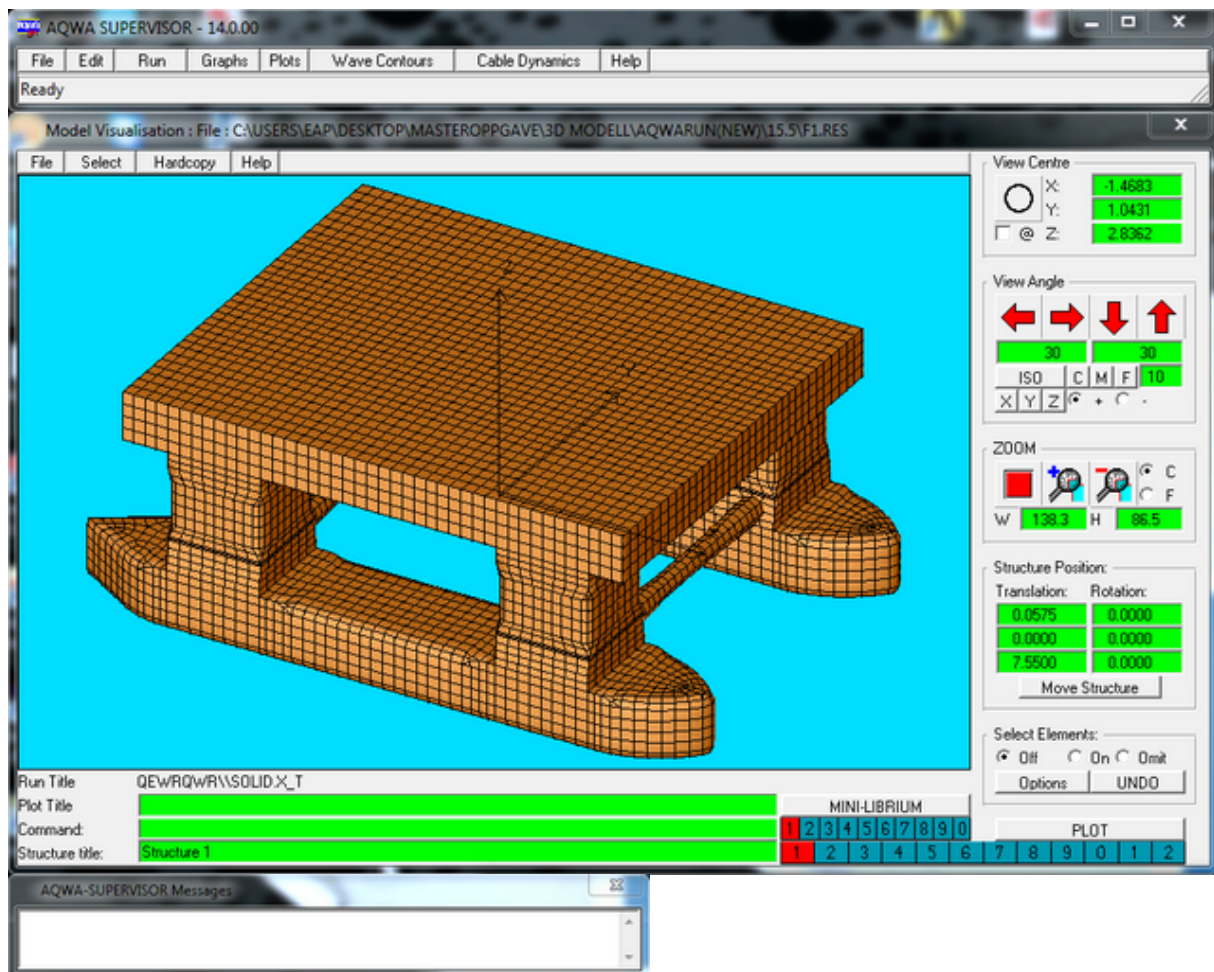

Figure 6: AQWA Graphical Supervisor interface window



4.5 Hydrodynamic assumptions in AQWA

Waves have been added in range from 0 to 180 degrees with an increment of 15 degrees. Period increments are unevenly distributed. AQWA is restricted to running a maximum of 50 periods. This makes it very hard to get a good resolution around the resonance periods; especially for the roll- and pitch motions which have longer resonance periods than the heave motion. Because of this, a separate run for roll and pitch has been done, and then been combined with the first run with all motions included to get a better overview.

Additional damping has also been included. This is due to the fact that AQWA neglects the viscous effects around corners and edges. Normally additional damping is assumed to be between 3% and 7% of critical damping. In this thesis, 3% of critical damping has been applied. This is a very conservative assumption and will in general give a higher response than expected from the actual full size unit.

In addition to these assumptions AQWA also operates with certain restrictions. This is because the solver is based on potential theory. The required assumptions are listed below.

- Potential flow (hence inviscid flow and irrotational flow)
- Incompressible
- Kinematic free surface condition
- Dynamic free surface condition
- No particle flow through the hull surface
- Constant source strength over each panel
- Laplace equation is fulfilled

All these assumptions and boundary conditions combined give a desired result. These assumptions and boundary conditions have been found in the AQWA user manual.

5 Pre processing

The first step in the pre processing is the creation of the model. In this project this has been done in SolidWorks. After the model was created, it was imported into Mechanical APDL for meshing (panel generating process). Furthermore an element sensitivity analysis has been carried out for the model. In addition some of the values from this analysis have also been verified with simple hand calculations. These processes are described in detail in the following chapters.

5.1 Creating the model in SolidWorks

The model used in AQWA was made with SolidWorks. Since only the model itself was made here, no scripting was necessary, so the SolidWorks interface was used. As mentioned earlier no simplifications have been done. This is to make the analysis as reliable as possible. However, since only the hydrodynamic aspects are of interest, the units' superstructure has not been implemented.

To reduce the computational time, only half of the model has been created for the purpose of the element analysis. As mentioned earlier, this part was defined as symmetrical about the center line in Mechanical APDL, which then instructs AQWA to run half the model and "mirror" the results such that the entire unit is included in the results.

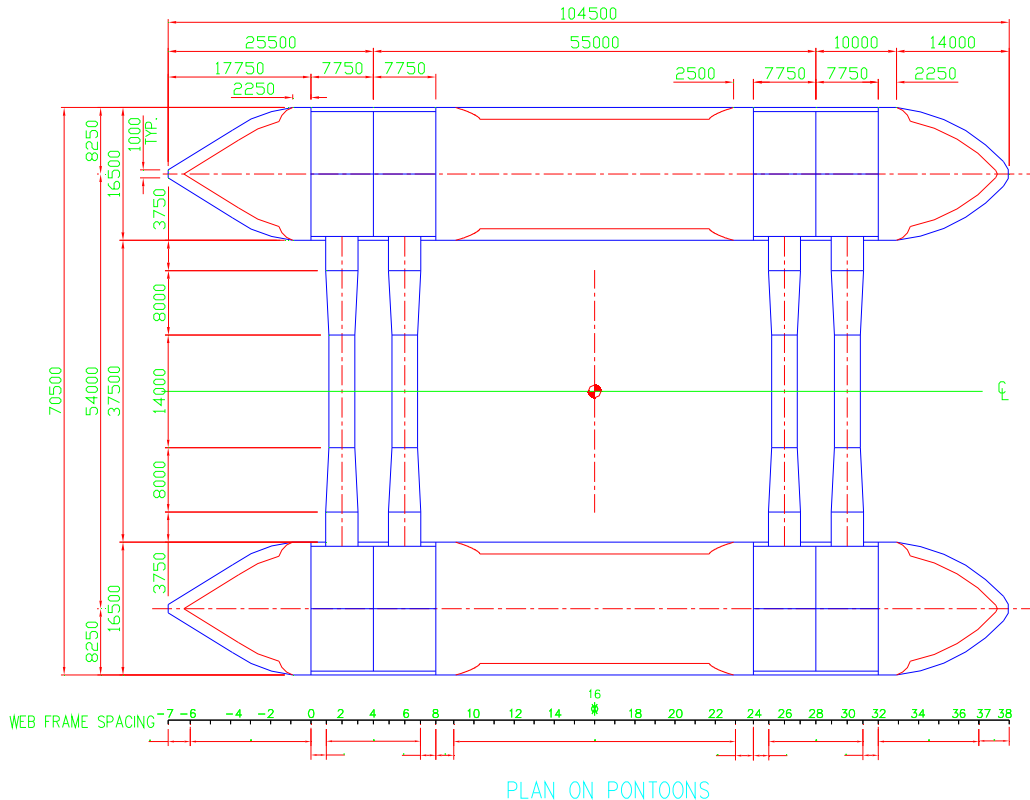

Figure 7: Plan on pontoons with main dimensions (from CAD-schematics)

5.2 Mesh generation

The mesh used on the model was generated in Mechanical APDL. The model was exported from SolidWorks and imported into APDL as a parasolid. This file format is one of the possibilities, where each has their advantages and disadvantages.

When the model is imported, APDL sketches the unit with lines automatically. So the first step is to divide areas with new lines to get the mesh as smooth as possible. Then when the mesh is generated, the lines get divided again to make the mesh fit with the size that has been chosen. Note that these line divisions do not create new areas.

When a free mesh has been generated, it is important to make sure that all area normals are pointing outwards because these areas are the ones considered as the wetted surface. APDL shows which way the normals are pointing with colour codes, purple for inwards and turquoise for outwards.

Mechanical APDL has an ANSYS main menu. In this menu there are a lot of different options. One of them, and the one used here, is the “Preprocessor”. Under this we find a several submenus as shown on figure 8.

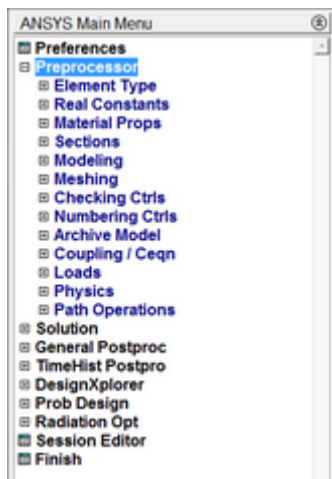

The “Meshing” option in the menu (see figure 8) contains a useful sub option called “MeshTool”, which is both used to make the mesh, and to make several different modifications to it. Some of the features used in this thesis are:

- Global size control (This feature is used to set initial element size).
- Division number change along the lines. (This feature is used because when the free mesh is generated, there will be a mismatch in some areas, and some triangular elements will be generated to make up for lack of connection points on one side. See figure 9 and 10 to see the difference between respectively before and after this feature has been applied).
- Mapped meshing on certain areas. (This feature makes the panels within an area to be with the most similar in size as possible, but is restricted in the manner that the lines on the opposite side of each other must have the same number of divisions. See figure 10 and 11 to see the difference between before and after this feature has been applied).

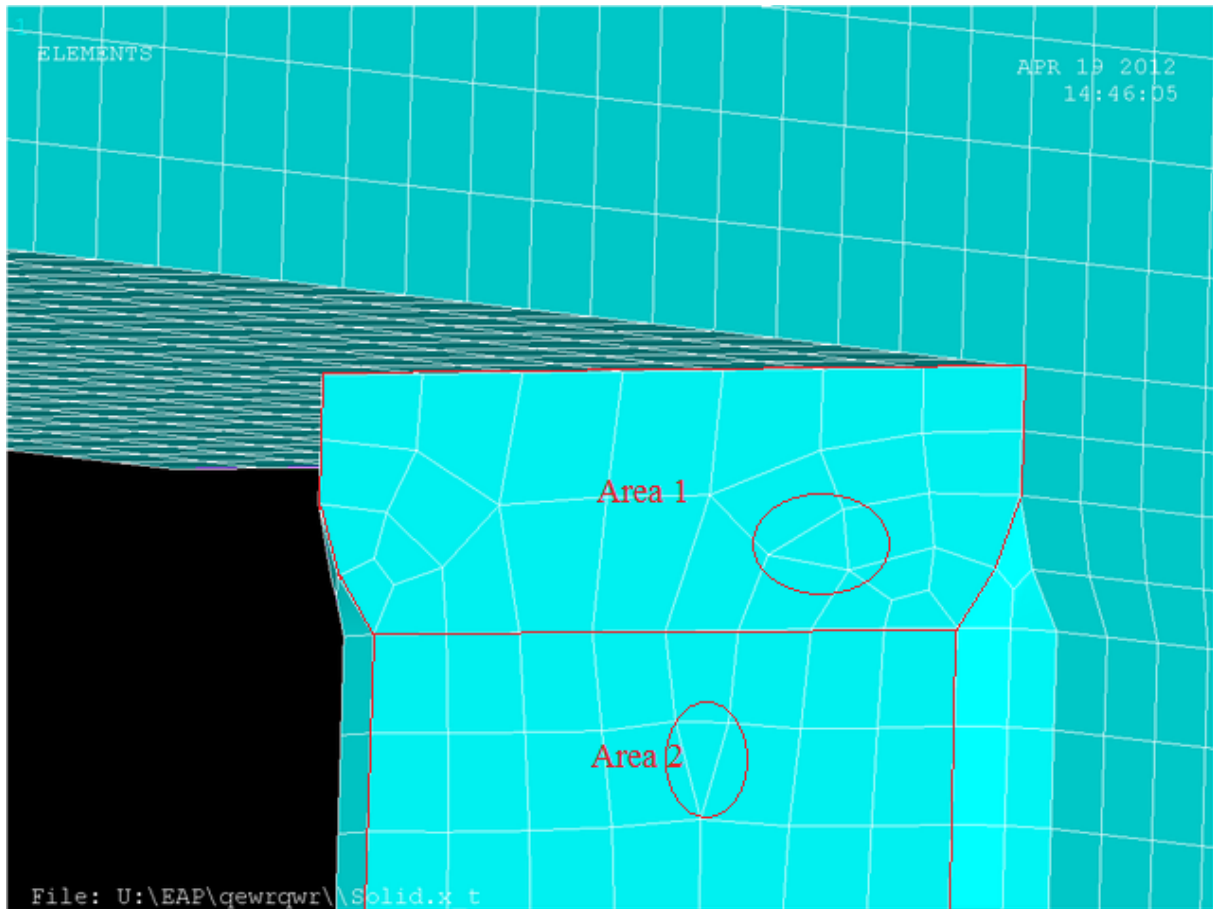

Figure 9: Mesh before modifications

In figure 9 we can see that one of the elements in area 1 and one of the elements in area 2 is a triangular one (marked with a red circle). In area 1 there are also a lot of different sizes, and some of them are quite misshaped. Because area 1 and area 2 share one line, the number of divisions on this line will affect both areas. The necessity of the modifications done in the following is not of big significance for the results for the hydrodynamic model, but a uniform mesh is preferable. However, available meshing tools are developed to suite structural mesh as well.

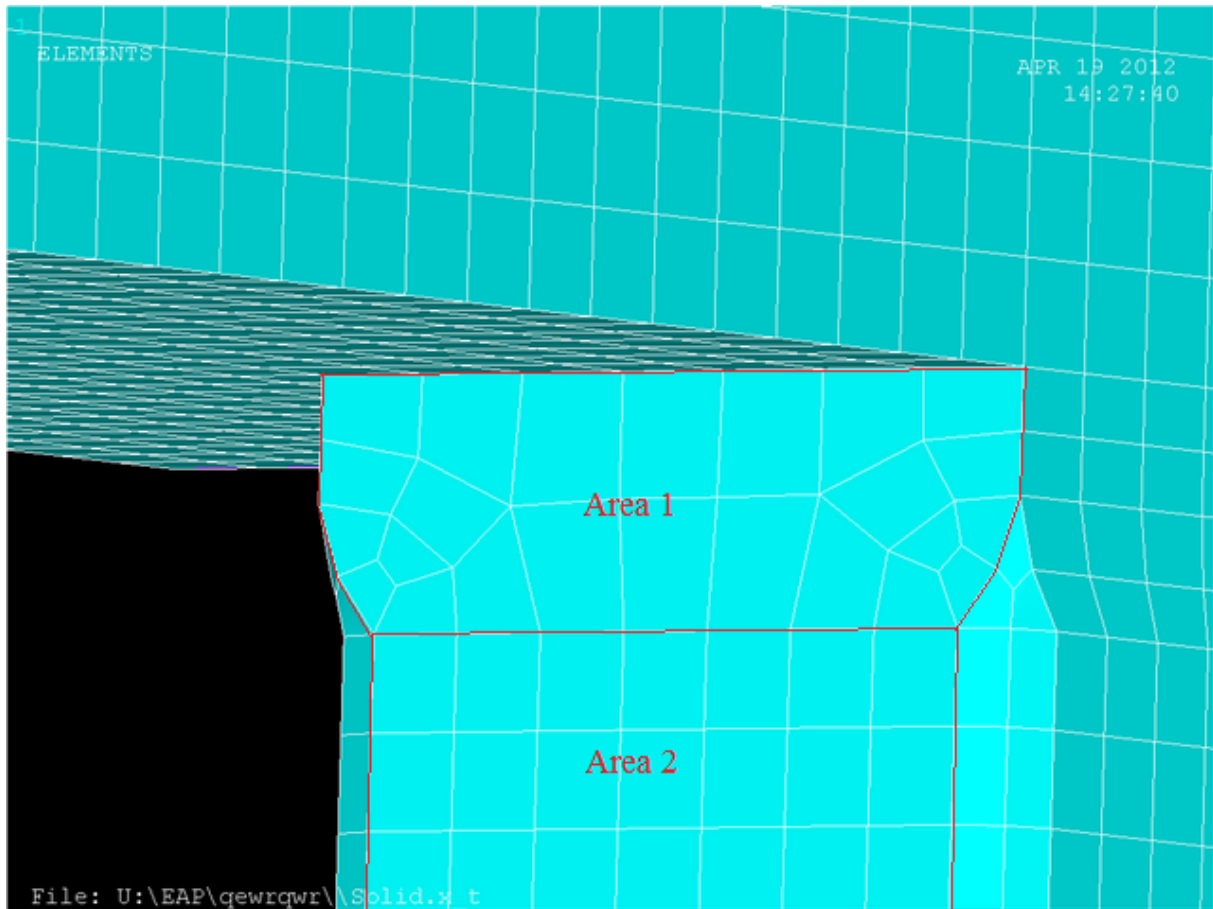

Figure 10: Mesh after number of divisions are changed

In figure 10 we can see that no elements in area 1 or area 2 are triangular. However the elements in area 1 are still misshaped and have a big difference in size. The reason that area 2 now looks uniform is that it is a square area, so that when the number of divisions on the line on the top matches the number of divisions on the line on the bottom, it will automatically make square elements. Here the number of divisions on the sides has also been modified to make the panels as quadratic as possible, but they still match each other.

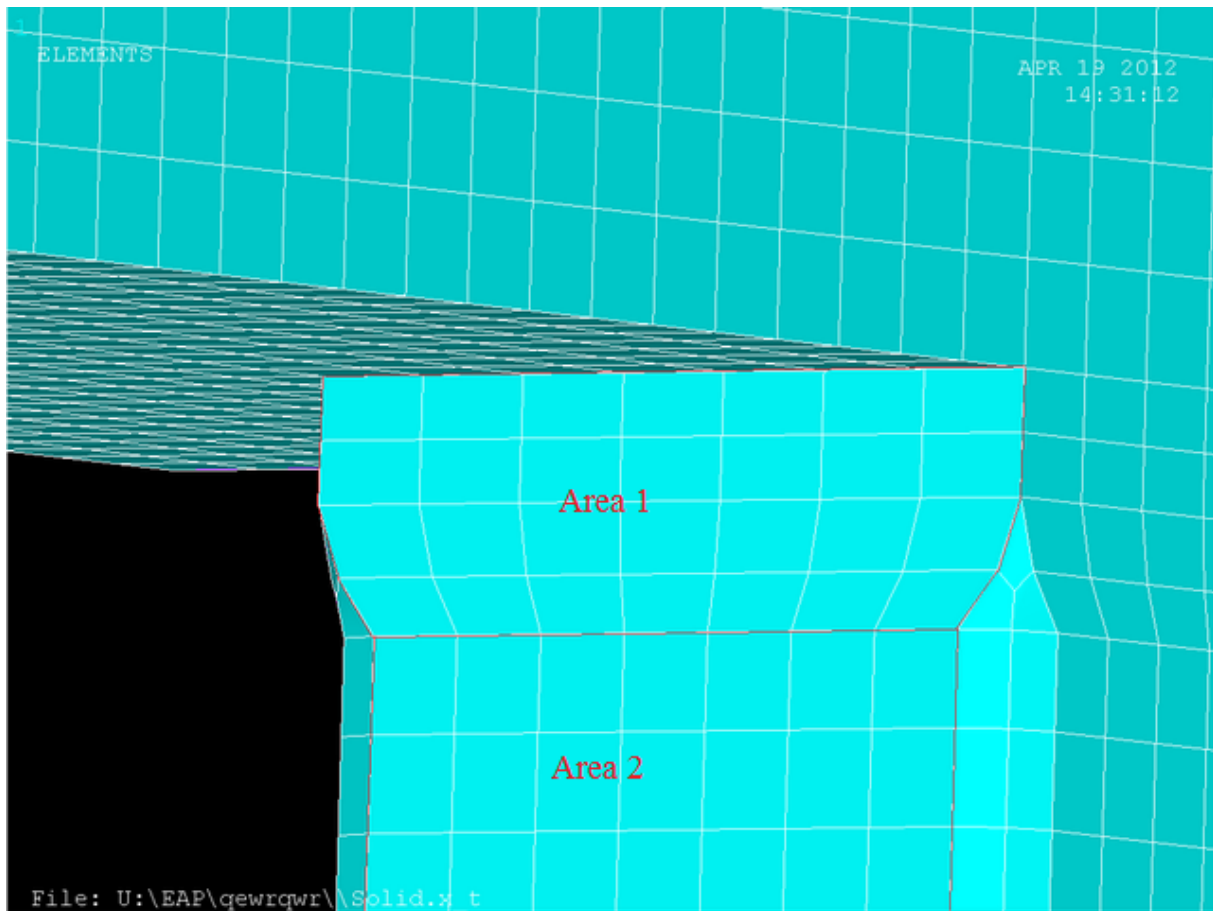

Figure 11: Mesh after mapping the panels

In figure 11 we can see that both area 1 and area 2 looks uniform. The area mapping feature has here been applied to area 1 to make the panels as similar as possible in size and shape.

Note that the mesh shown in figure 9, 10 and 11 are above the water line, while the mesh that is of significance is actually those elements that are below the water line, the so-called diffracting elements. Hence these figures are for illustration of the mesh generation options only, but the same process has been applied to the areas with the diffracting elements.



5.3 Element analysis

The initial phase of this project was to evaluate the element size with respect to obtain reasonable results. This evaluation has been carried out to optimize the element size with regard to both the platform length and the wave length. In this thesis, the whole unit has been meshed, even though only the diffracting elements (below water surface) are used in hydrodynamic runs. An initial first estimate would be to have at least 10 elements per wave length.

The element analysis has been carried out with three different element sizes; from 1m to 4 m, with increments of 1.5m. The unit has been modelled in with waves with periods from 3.5s to 30s, except the model with the coarsest mesh; this has been modelled with waves with periods from 4.5s to 30s. This is because AQWA fails to compute such low periods for such a coarse mesh since it is way outside the criteria. The periods correspond to a wave length of 19m to 1405m and 32m to 1405m respectively. With respect to the initial criteria of 10 elements per wavelength, only the finest mesh meets the criteria. However AQWA allows some less than 10 per wavelength, and comparison of the different RAOs shows that in this region the differences are fairly small (see chapter 5.3.3).

For the element convergence test both heave and roll as well as pitch has been considered.

Note that only the survival condition with 15.5m draft has been included in the element analysis.

5.3.1 Element analysis setup

The unit has been analyzed in regular waves. A short description on the setup in the AQWA textfiles follows.

Location

As mentioned earlier, the unit has been analyzed at a water depth at where it is likely that it shall be located when completed, approximately 300m. The water density has been left to the default value of 1025kg/m³.

The AQWA scripting of the global data are as follows:

```
*-----  
* GLOBAL DATA - DECK 5  
*-----  
      GLOB * Global analysis parameters  
      DPTH  300.0  
      DENS 1025.000  
      ACCG  9.81000  
END
```



Directions and frequencies

As described earlier, a total of 13 sea states have been considered; from 0° to 180° with increments of 15° . The reason for not including the ratio from 180° to 360° is because of symmetry. However in this analysis only head sea (0°) and beam sea (90°) will be considered as these headings will give the highest response for heave, pitch and roll.

The wave frequencies are unevenly distributed, with a concentration around the cancellation period and the natural period. In these areas the increment of the periods are 0.25, and in the other areas the increment varies from 0.5s to 3s, where the highest increments of 2s and 3s are only from periods 25s to 30s. This has been done to get the best resolution in the areas of highest importance. In addition a run from 30s to 90 s is done for roll and pitch. This is to obtain the natural period in these motions. Increments here are evenly distributed with smaller steps around the resonance period.

The AQWA scripting of the directions and frequencies is as follows (only a few frequencies and directions are presented due to the large magnitude in the actual analysis):

```
*-----  
* FREQUENCIES AND DIRECTIONS DATA - DECK 6  
*-----
```

```
FDR1 * Frequencies and directions  
1PERD 13 13 19.25  
1PERD 14 14 19.00  
1PERD 15 15 18.50  
1PERD 16 16 18.00  
1DIRN 4 4 045.  
1DIRN 5 5 060.  
1DIRN 6 6 075.  
1DIRN 7 7 090.
```

END

Panel model

As described earlier in this chapter, three different models have been created, each with different mesh size. It is in this step that the different models have been chosen.

Mass model

A homogenous density of the unit has been assumed. AQWA can from that calculate the mass, centre of buoyancy and inertia moments. The values for the radii of gyration and the CoG are found in Global Maritime (2011), and are assumed to be valid estimates.



5.3.2 Time consumption

There are big differences in computational time with different element sizes. Time consumption when using computer programs to perform analyses are often an important factor in a design process. However, it is important that the model has a sufficient number of panels to make the results reliable.

The calculations in this thesis have, as mentioned earlier, been carried out using an Intel Xeon CPU W3565 @ 3.20GHz with 4 cores and 6GB RAM. Time consumption for the different element sizes are shown in table 4. All times includes off body points.

“Initial” element size [m]	Number of diffracting elements	Time consumption [s]
1.0	7784	69583
2.5	2395	3376
4.0	772	369

Table 4: Number of diffracting elements VS processing time

From table 4 it is seen that the computational time increases drastically with number of elements. It increases approximately 10 times from the element size of 4.0m to 2.5m and 20 times from 2.5m to 1.0m. The element size of 2.5m uses a computational time close to 1 hour, while the element size of 1.0m uses over 19 hours. This is a difference of over 18 hours.

The reason that the table notes “initial” element size is that in the meshing process, this is the desired value set by the user. However, when the mesh is adjusted, not all elements will have exactly the same size. Hence it is more important to know number of diffracting elements, as two meshes with the same initial element size may, if the drafts are different, have a slightly difference in number of diffracting elements.

5.3.3 Element analysis results

The results from the element analysis are shown in the following figures as RAOs. All element sizes are represented with their own colour.

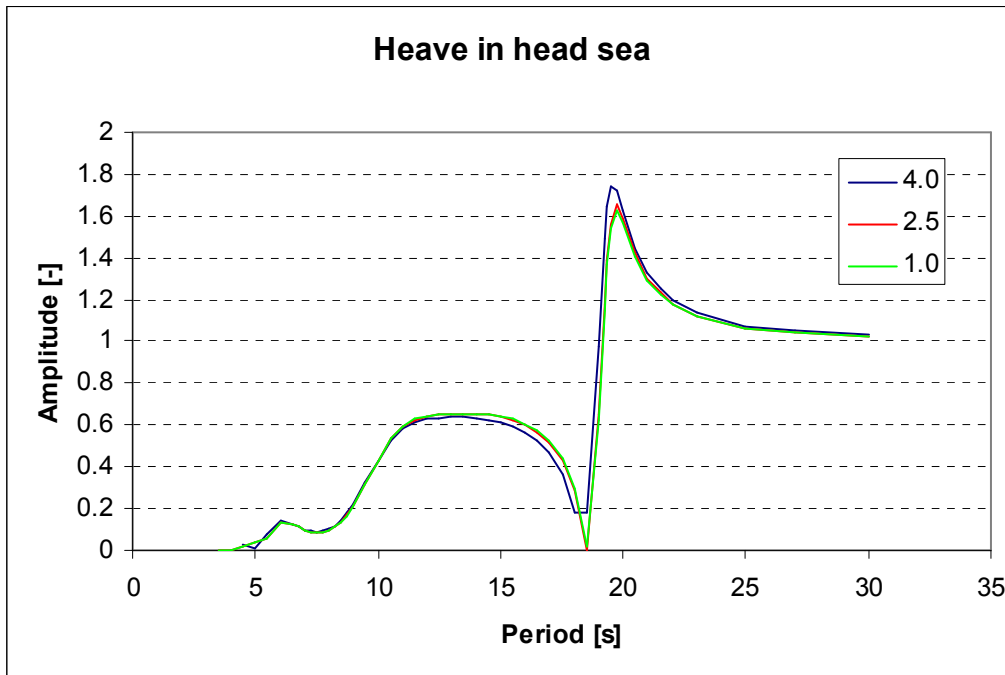

Figure 12: RAO heave in head sea

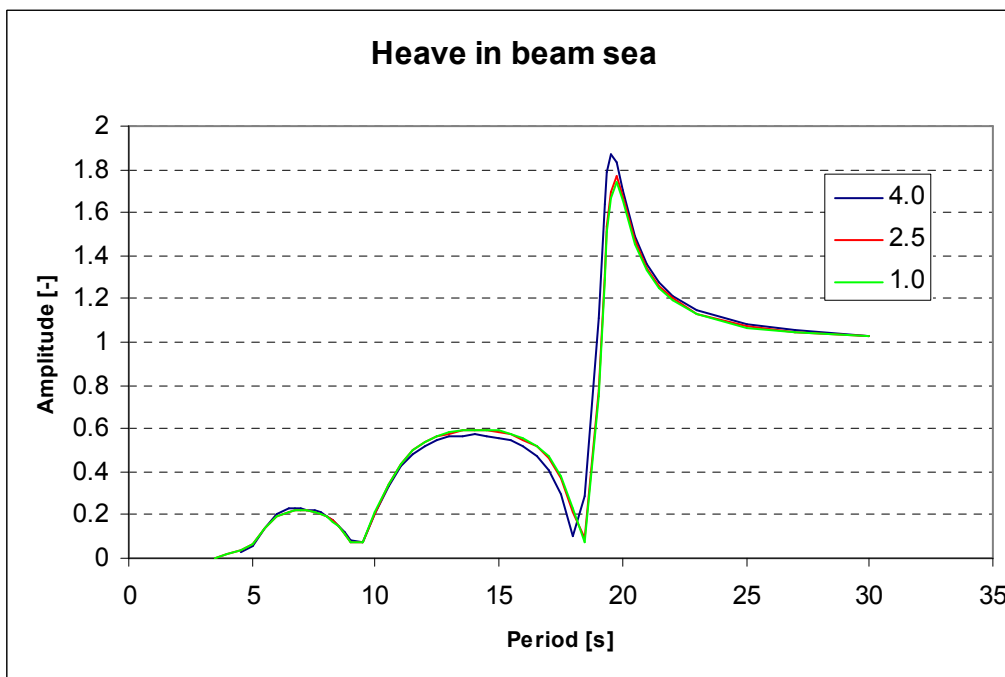

Figure 13: RAO heave in beam sea

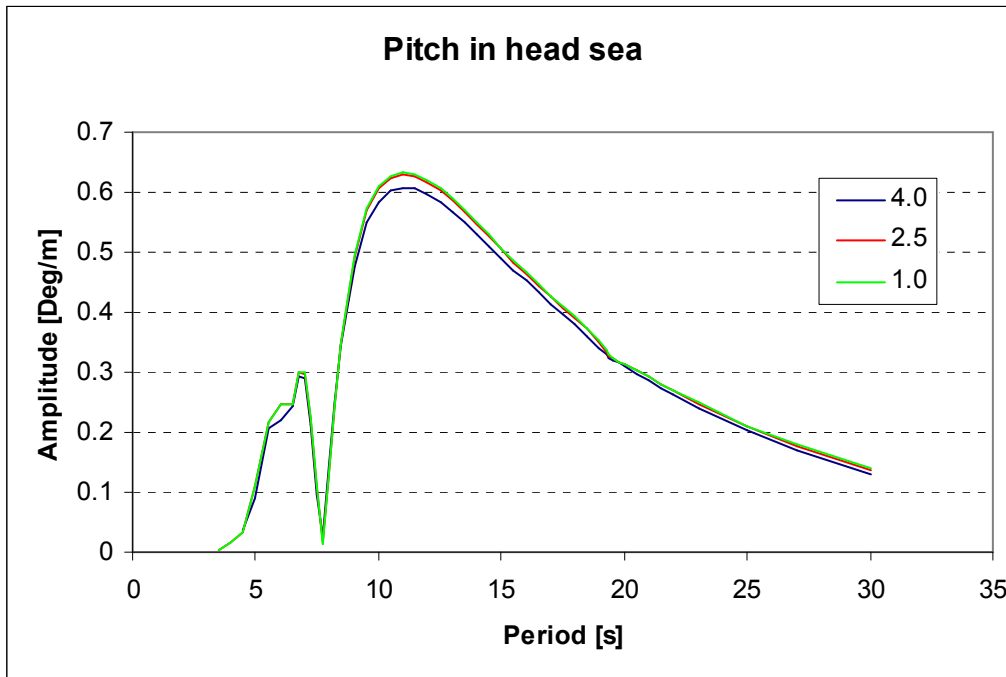

Figure 14: RAO pitch in head sea

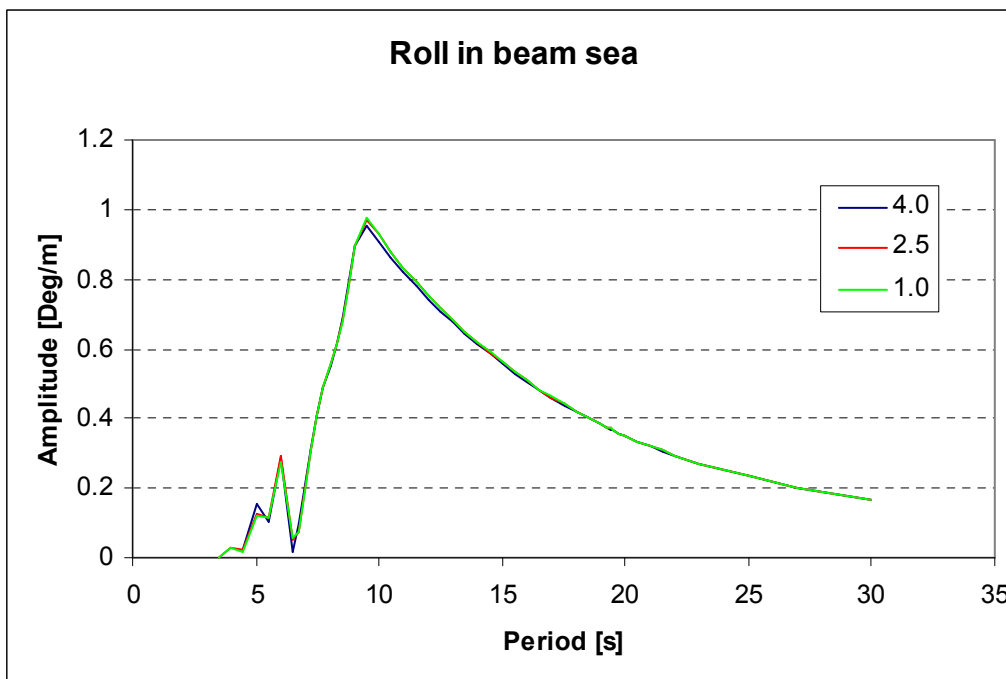

Figure 15: RAO roll in beam sea

When looking at the RAOs in heave, it can be seen that the resonance period is within the time interval chosen. However, the resonance period in roll and pitch has not yet been reached with a maximum of 30s. Because of this, a second run is done to verify this. In this run, periods from 30s to 90s is included. However in the RAO graphs, the entire interval from 3.5s to 90s is included. These graphs are shown in figure 16 and 17.

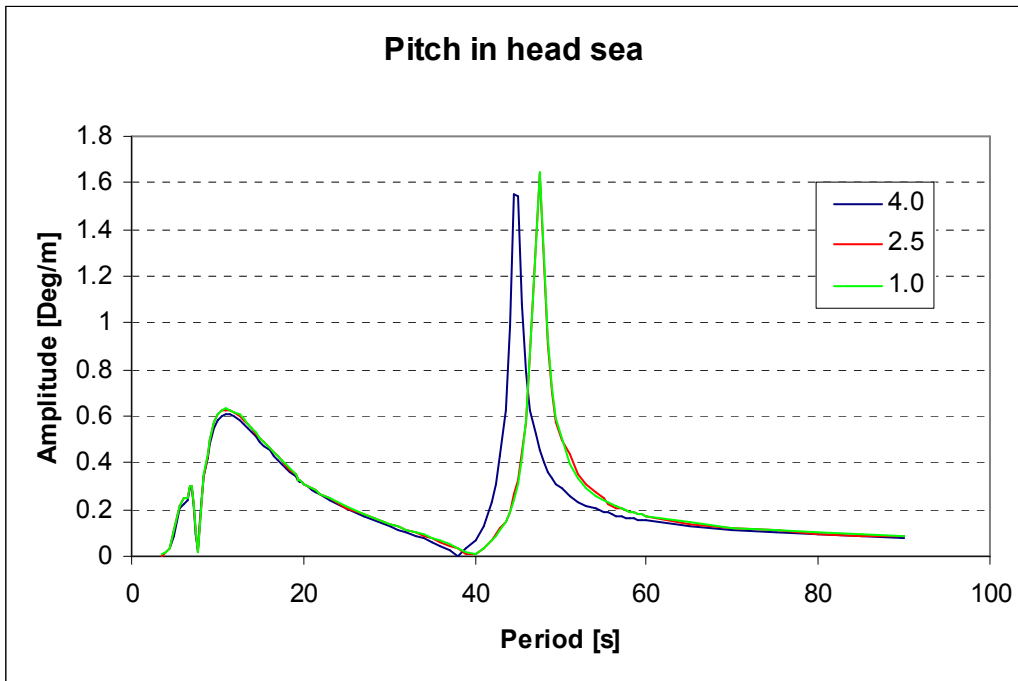

Figure 16: Pitch in head sea w/higher periods

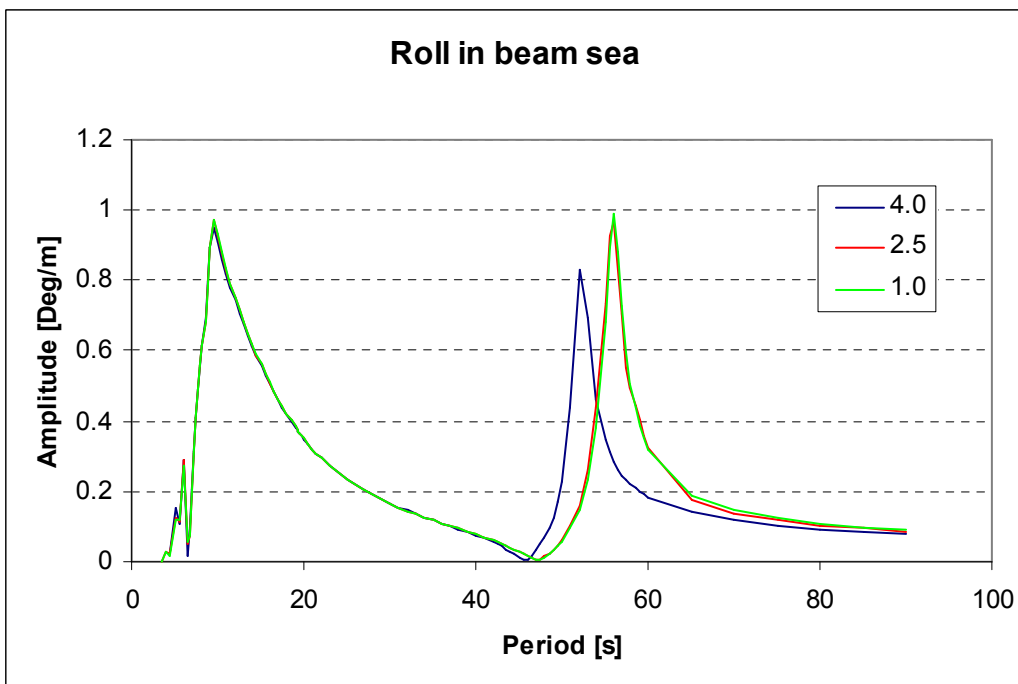

Figure 17: Roll in beam sea w/higher periods

If we look at the graphs in figure 16 and 17 we can see that from a period of approximately 40s, the RAO for the model with 4.0m panels deviates very much with respect to the other two. We can already here assume that this model can not be used as a good estimate for the analysis.

The pontoons, columns and the bracings on GG5000 have a curvature; and due to lack of panels to represent this curvature, a “loss” of a 1000 tonnes is given in the AQWA output file for the mesh based mass. Only one element per 90° is used in the coarsest mesh model (panel size of 4.0m). See figure 18 to visualize this issue.

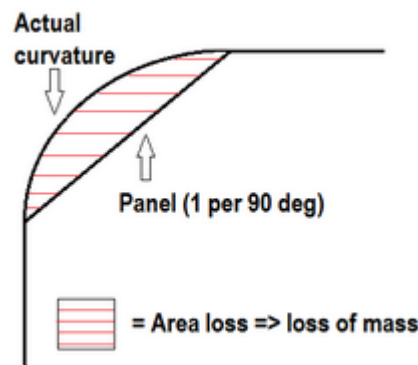

Figure 18: Loss of area in model due to insufficient curvature

If we look at the lower periods, a larger deviation of the RAO for the coarsest mesh model (4.0m panels) would be expected with respect to the other two models. This is because it is very close or outside the interval that gives 10 elements per wave length. However some differences can also be noticed in this lower period region. We can finally conclude that this model is far too coarse to represent the real unit. In spite of this, the model will even though be taken into account in the element convergence test to see the effects.

5.3.3.1 Element convergence

The element convergence in heave has been done by picking six different periods. A plot of the three element sizes for the six chosen periods are shown in the following figures.

The periods selected are spread over the entire interval, with the first close to the start of the interval and the last close to the end of the interval. The remaining periods are distributed around the cancellation and the resonance period of the unit.

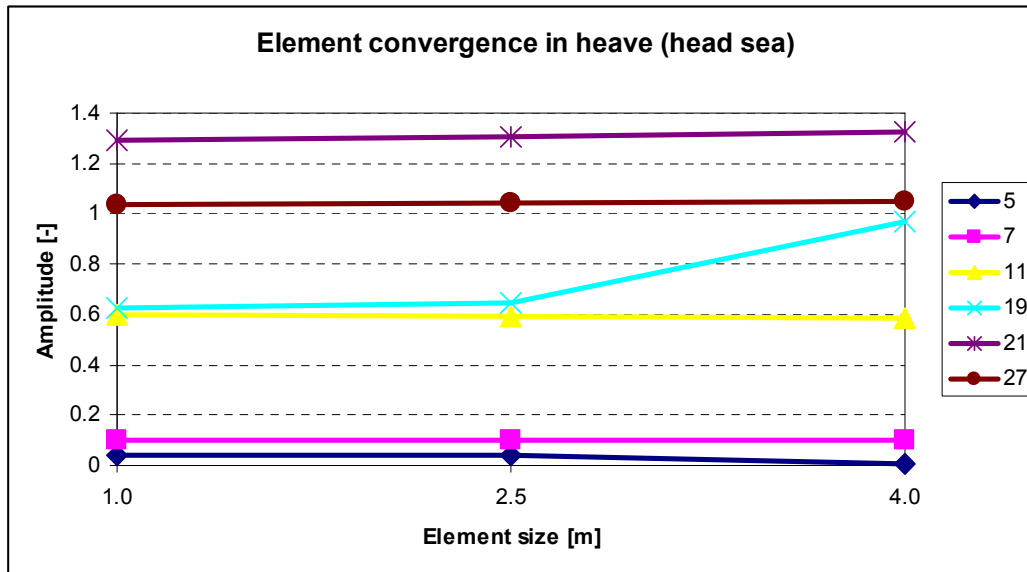

Figure 19: Element convergence in heave, head sea

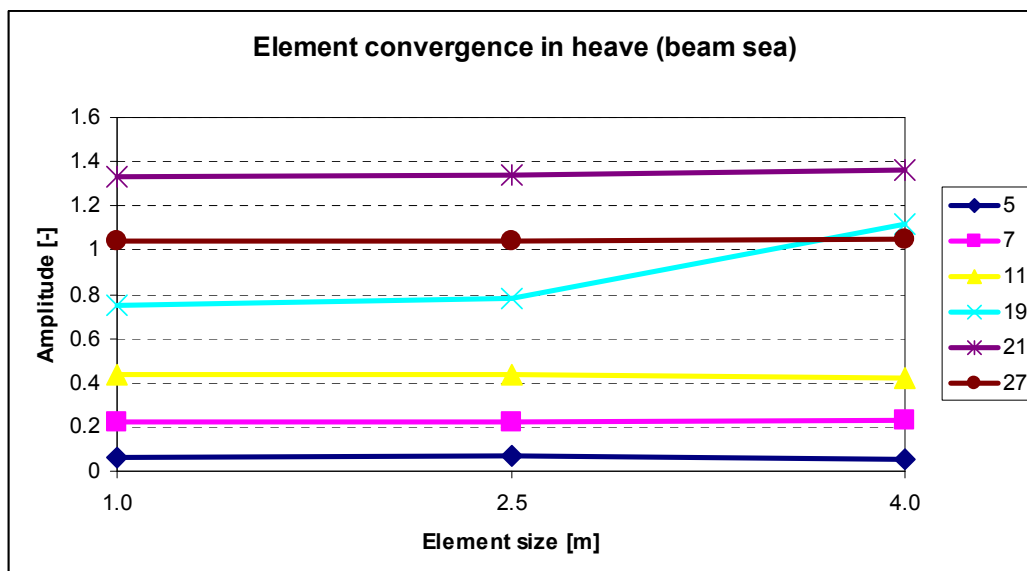

Figure 20: Element convergence in heave, beam sea.

From figure 19 and 20, for heave in head and beam sea respectively, it can be seen that the largest discrepancies are encountered for the period of 19s. However this is expected because this is very close to the maximum resonance period³ in heave. For all other frequencies the differences are small, and convergence is assumed from approximately 2.5m.

The element convergence in roll and pitch has been done by picking ten different periods. A plot of the three element sizes for the ten chosen periods are shown in the following figures. The periods selected are spread over the entire interval, with the first close to the start of the interval and the last close to the end of the interval. The remaining periods are distributed around the cancellation and the resonance period of the unit.

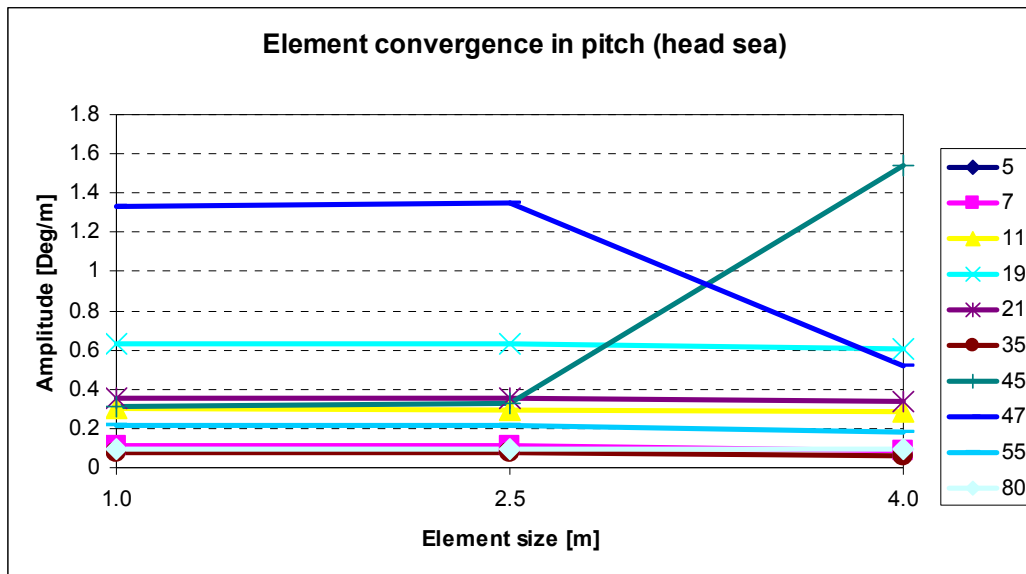

Figure 21: Element convergence in pitch, head sea

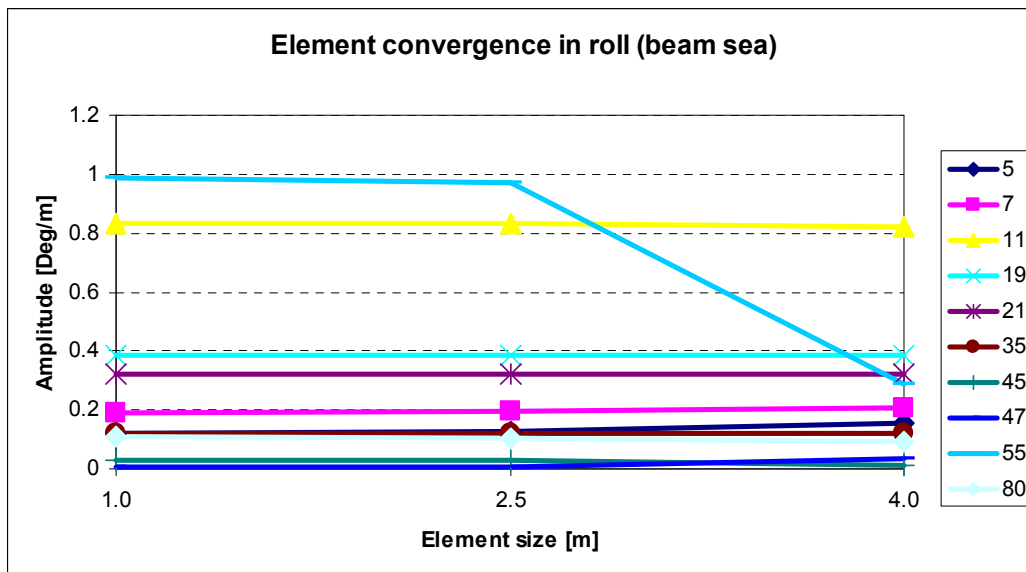

Figure 22: Element convergence in roll, beam sea

³ Note that due to geometry deviation for the coarsest mesh model, it is in fact most likely that such model has a slightly different natural period.



From figure 21, for pitch, it can be seen that the largest discrepancies are encountered for the periods of 45s and 47s. Again, this is expected because they are both very close to the maximum resonance period in pitch, they are however significantly large. For all other frequencies the differences are fairly small. From figure 22, for roll, the trend is similar. The only difference is that the largest discrepancies are encountered for the period of 55s because this is very close to the maximum resonance period in roll, but also here extremely large differences. Convergence is therefore assumed from approximately 2.5m.

5.3.4 Verification of obtained results

To verify that the parameters in the element analysis are correct, hand calculations have been carried out to be certain of the obtained results. Because of the difficulties of calculating the added mass in pitch and roll for a unit with the given geometry, these calculations of the resonance periods have only been done for the heave motion. In addition RAOs obtained from model tests has been used for verification.

5.3.4.1 Resonance period in heave

The resonance period in heave for head and beam sea is calculated to verify that the peak in figure 12 and 13 is at the correct period. The mass is calculated on the basis of submerged volume, and the added mass, with additional assumptions for the pontoon tips and braces, is found from appendix 1, table 5 in Pettersen (2004).

Pontoons

From appendix 1, table 5 in Pettersen (2004) a width to height ratio of $16.5/10.05=1.64$ for the pontoons is obtained. This value is in the middle of two suggested values of 1 and 2. To use the value of 2 would give a too inaccurate result, so an interpolation is done to get more accuracy. With an interpolation we get that the added mass for the pontoons is given as:

$$A_{332DPontoon} = 1.414 \cdot \pi \cdot \rho \cdot b^2 = 1.414 \cdot 3.14 \cdot 1025 \cdot \left(\frac{16.5}{2}\right)^2 = 309750 \left[\frac{kg}{m}\right]$$

$$A_{33Pontoon} = A_{332DPontoon} \cdot PontoonLength$$

$$\text{Added mass square parts of pontoons: } A_{33Pontoon} = 309750 \cdot 141 \cdot 1.0 = 43674750 [kg]$$

Since the pontoon tips are not squares, it is assumed that these only give approximately 75% of added mass from the result of this formula. We get:

$$\text{Added mass of pontoon tips: } A_{33PontoonTip} = 309750 \cdot 68 \cdot 0.75 = 15797250 [kg]$$

$$\text{Total added mass pontoons: } A_{33PontoonTot} = A_{33Pontoon} + A_{33PontoonTip} = \underline{59472000 [kg]}$$



Braces

From appendix 1, table 5 in Pettersen (2004) a width to height ratio of 1.0 is obtained (circular cylinder). The formula for a circle is therefore used. A middle value of 3.5m for the diameter is used. The added mass for the braces is given as:

$$A_{332DBraces} = \pi \cdot \rho \cdot \left(\frac{d}{2}\right)^2 = 3.14 \cdot 1025 \cdot \left(\frac{3.5}{2}\right)^2 = 9857 \left[\frac{kg}{m}\right]$$

$$A_{33 Braces} = A_{332 DBraces} \cdot BracingLen_{gth} = 9857 \cdot 75 = \underline{739275 [kg]}$$

Total added mass in heave is:

$$A_{33Tot} = A_{33PontoonTot} + A_{33Braces} = 59472000 + 739275 = \underline{60211275[kg]}$$

, where b is the breadth of the pontoons, d is the diameter of the bracing, A_{332D} is the added mass per length and A_{33} is the total added mass.

We calculate the mass, and the following resonance period for the unit is obtained:

$$m_{totunit} = Vol_{displacement} \cdot \rho = 37726.8 \cdot 1025 = 38669970[kg]$$

$$T_{n3} = 2\pi \sqrt{\frac{m_{totunit} + A_{33Tot}}{\rho \cdot g \cdot A_{WLunit}}} = 2\pi \sqrt{\frac{38669970 + 60211275}{1025 \cdot 9.81 \cdot 960.9}} = 20.1[s]$$

The value of 20.1s for the resonance period in heave is slightly off. The reason for this could probably be the assumptions made to calculate the added mass on pontoon tips and bracings are with minor errors. The assumptions were in fact quite coarse. From figure 12 and 13 we would expect a value of 19.5s. This gives an initial error of 0.6s.

5.3.4.2 Comparison to RAOs from Global Maritime (2011)

The motion has also been compared to an analysis performed by Global Maritime (2011). Their analysis was done in WADAM, which is a part of the SESAM package and contains sea keeping abilities of GG5000. The main difference between this analysis and their analysis is that they have taken Morrison elements into account instead of including additional damping, as done here. Another difference is the water depth which in Global Maritimes analysis is set to 150m, as apposed to this report where water depth is set to 300m. Because of this discrepancies are expected. However, the RAOs from Global Maritime (2011) should give a general idea of how the RAOs should look like.

Heave (η_3)

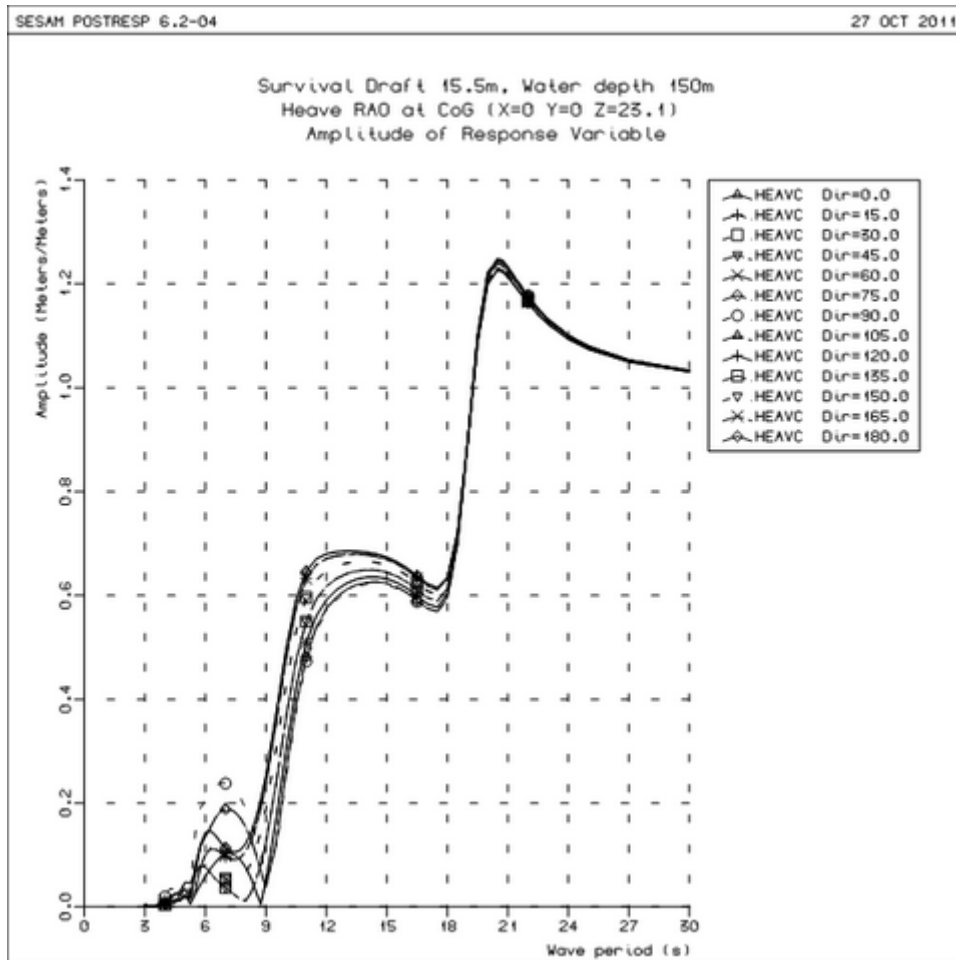

Figure 23: RAO heave, wave headings 0° to 180° (from Global Maritime (2011))

Comparison of figures 12 and 13 with figure 23 shows that the resonance period in heave match very well for both head and beam sea, only a small difference is noticeable. The maximum response in figures 12 and 13 is however significantly larger. However as mentioned earlier, the analysis by Global Maritime have Morrison elements taken into account, and in this analysis additional damping is applied.

Also only 3% of critical damping, which is very conservative, has been applied as additional damping in this report. That can explain the big difference in maximum response.

Pitch (η_3)

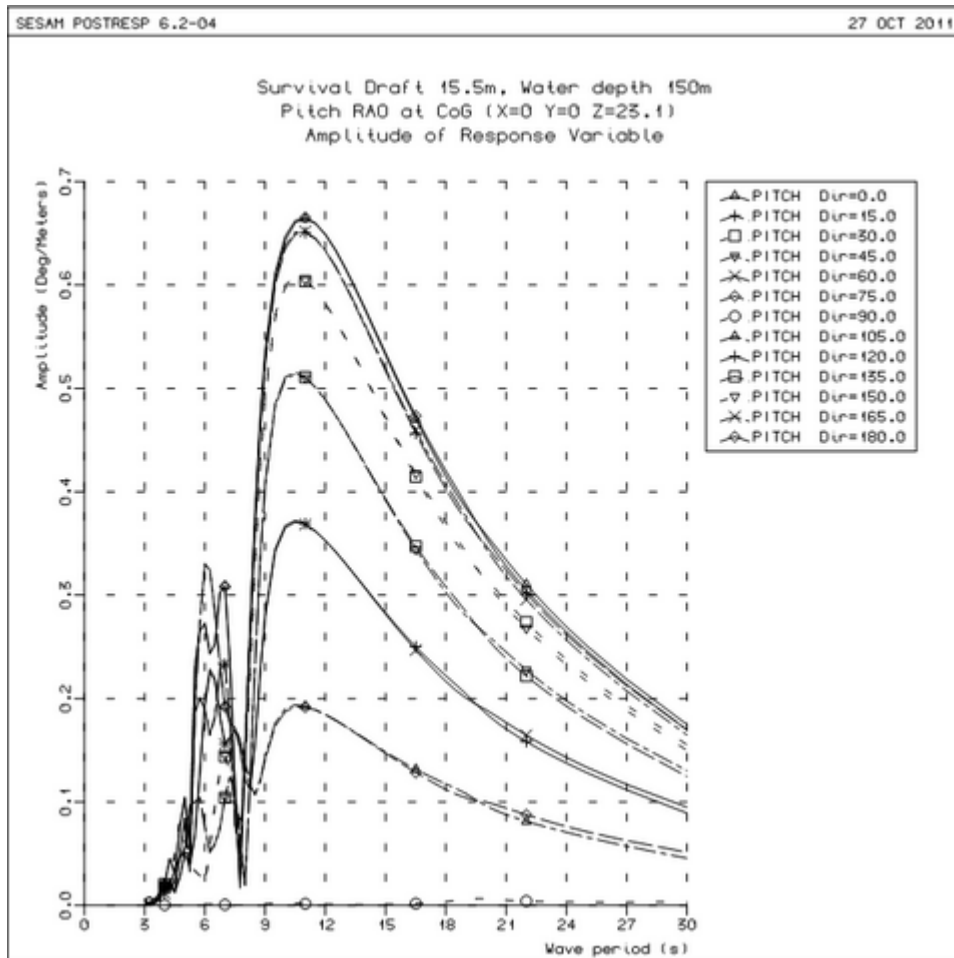

Figure 24: RAO pitch, wave headings 0° to 180° (from Global Maritime (2011))

When comparing figure 14 with figure 24, we find that they are really alike. Only from the period of about 23s or 24s, some discrepancies are noticeable.

Roll (η_4)

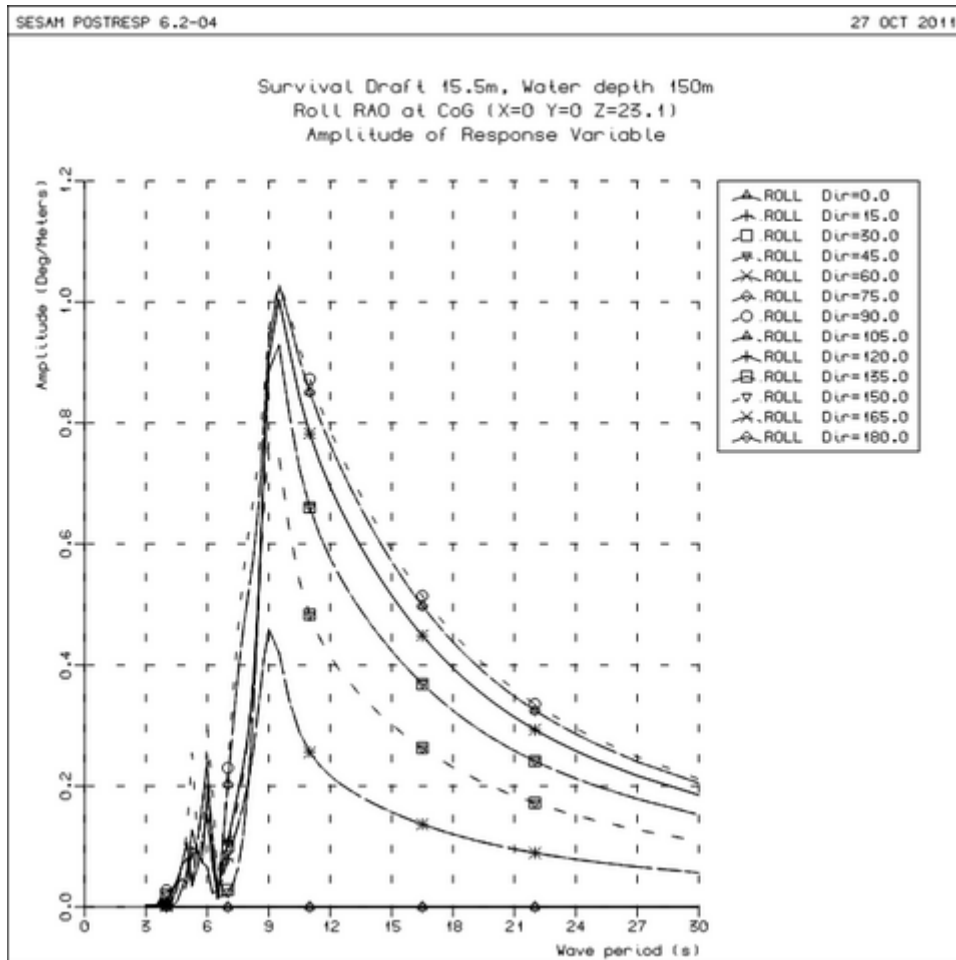

Figure 25: RAO roll, wave headings 0° to 180° (from Global Maritime (2011))

Also in roll the trend continues from pitch. When comparing figure 15 with figure 25 we see that they are almost identical. It can be quite difficult to read figure 25 from period 4s to 7s, because the different wave headings are all in one graph. However a close look shows a big resemblance.



5.3.5 Element analysis conclusion

As a conclusion for the element analysis, the two smallest sizes are fairly accurate, and discrepancies are small. However the biggest size of 4.0m is far too coarse. When using this size, the mesh will not represent the real unit in a good manner. As seen in the element convergence test, it gives maximum resonance at a different period than the two others. It still makes it hard to choose between the other two sizes because they are very similar, but due to the extremely large computational time required for calculating the element size of 1.0m, the element size of 2.5m is chosen in this thesis and has been used for all further calculations.

This element size matches fairly well with regard to the resonance period. And when comparing the obtained RAOs to the ones calculated by Global Maritime (2011), the values match very well. The RAOs from Global Maritime (2011) have smaller response for the resonance period, and at about 18s, the response does not fall as much. The reason for these differences are assumed to be that Global Maritime (2011) modelled their unit taking Morrison elements into account, whilst this thesis has taken additional damping into account. Also the additional damping is quite conservative, with only 3% of critical damping, which can explain the difference in response at the resonance period.

Normally it is expected that motion response analyses are followed by a model test, which will be used to confirm/adjust analytical model.

6 Analysis of abnormal floating conditions

In this chapter it will be shown how the unit behaves when in different abnormal floating conditions. Two damage conditions and one shallow draft condition will be presented. In the damage case part of this chapter, initial draft will be as for the units' operational condition (17.5m), and RAOs retrieved for this condition are also presented to compare with the damaged conditions. In the shallow draft case, the draft is set to be 14.5m, and will be compared to both survival draft (15.5m) and operational draft (17.5m).

6.1 Analysis of GG5000 in damaged condition

The two damage scenarios studied are as follows:

- **Damage case 1 – BWT ST-8 damaged (FR 17-21)**
- **Damage case 2 – BWT ST-2 damaged (FR 32-36)**

These cases are different damage scenarios to starboard pontoon due to a collision. It is assumed that a collision will result in a puncturing of either a pontoon tank or a column tank; however in this analysis only damage to the pontoon will be presented. It is further assumed to happen on the top or near the top of the pontoon, so that the entire tank is filled with sea water. An analysis for two different angles of list has been done, one on the side of the pontoon, and one in the pontoon tip. Damage case 1 will therefore result in mostly heel (η_4) and Damage case 2 will result in a combination of heel (η_4) and trim (η_5). Both damage cases have been modelled with increased displacement in addition to the angle of list. The tanks that are punctured in the two scenarios are shown below on the pontoon tank layout (figure 26). Note that the tanks run all the way from top to bottom of the pontoon.

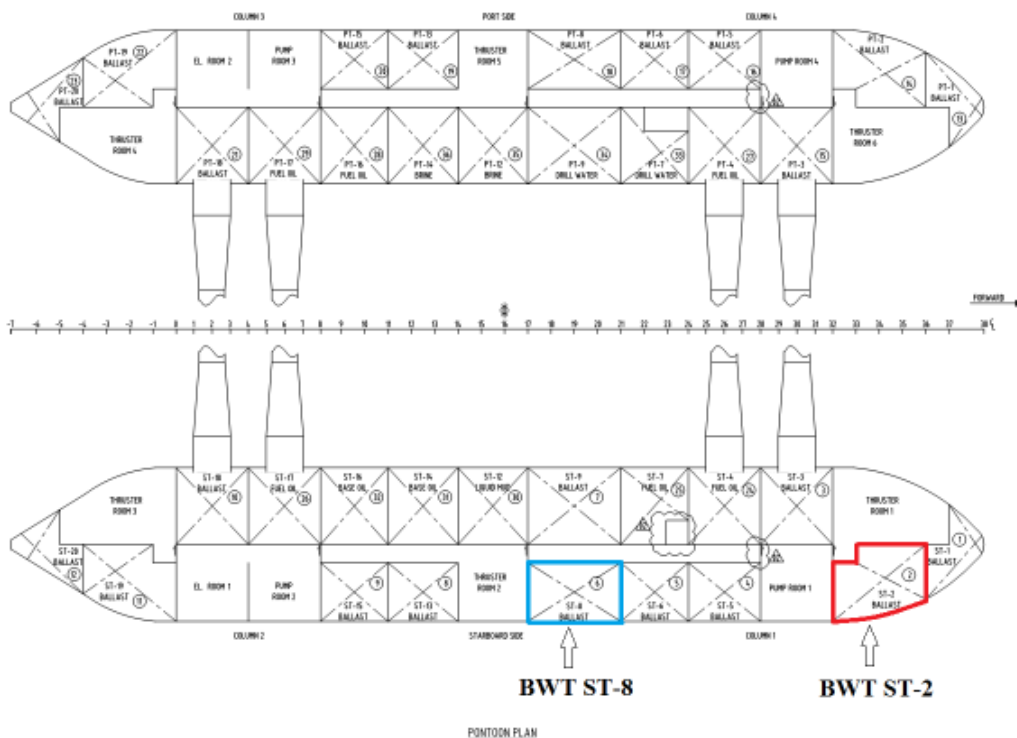

Figure 26: Tank layout in pontoons for the two damage scenarios

The blue outline here represents the punctured pontoon tank in damage case 1 and the red outline represents the punctured pontoon tank in damage case 2.

It is assumed that the holes in the tanks are large enough such that the water can flow freely between them and the sea. The loss of buoyancy when fully flooded has been simulated by adding weights to the pontoons. To find the added weight, the tank volume has been used as a basis to find the weight of water for the two different angles. The tank volumes have been found from the CAD-schematic which lists all these. These values are presented in table 5 below, with the respective calculated weight of the added water. The weights have been calculated by multiplying the volume with the density of water. AQWA does not have a feature for damage calculations, the list angles for the different damage cases are therefore taken from a previous stability analysis report on GG5000 (Henriksen (2011)) (A draft of this report is found in appendix 10.3). Note that the displacement in the report done by Henriksen (2011) has a slightly higher displacement than the one used in this report. This is due to the fact that thrusters and shell are taken into account. In addition not the entire volumes of the damaged tanks are filled with sea water. This is due to the fact that the structure itself and pipes inside takes up space such that not the entire tank volume will be available for flooding. Usually 1-5% is an estimate used, depending on whether it is a tank or a room or other places in the unit. The differences are however quite small and the results are assumed to be adequate. See adjusted values in table 6.

<i>Unit</i>	<i>Volume [m³]</i>	<i>Sea water weight [MT]</i>
BWT ST-2	692.51	709.82
BWT ST-8	616.83	632.25

Table 5: Sea water weight for the different units' total volume

<i>Unit</i>	<i>Volume [m³]</i>	<i>Sea water weight [MT]</i>
BWT ST-2	667.90	684.60
BWT ST-8	594.92	609.79

Table 6: Sea water weight for the different units' available volume

To illustrate how the different damage cases looks like, they have been shown in figure 27 and 28. The illustration is taken from AQWA GS showing the diffracting elements (submerged elements) in blue. Figure 27 illustrates damage case 1, whilst figure 28 illustrates damage case 2.

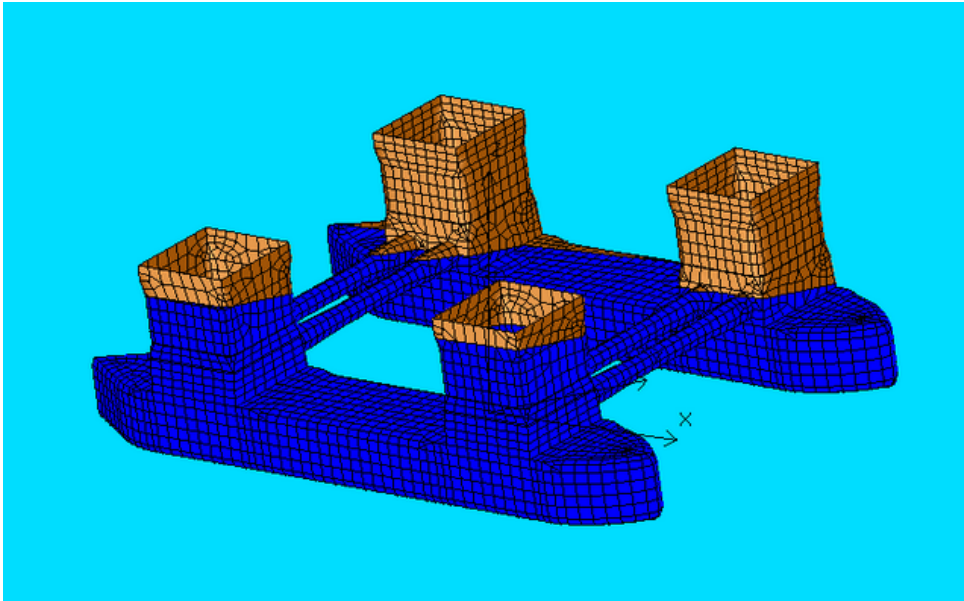

Figure 27: Damage case 1-WBT ST-8 flooded

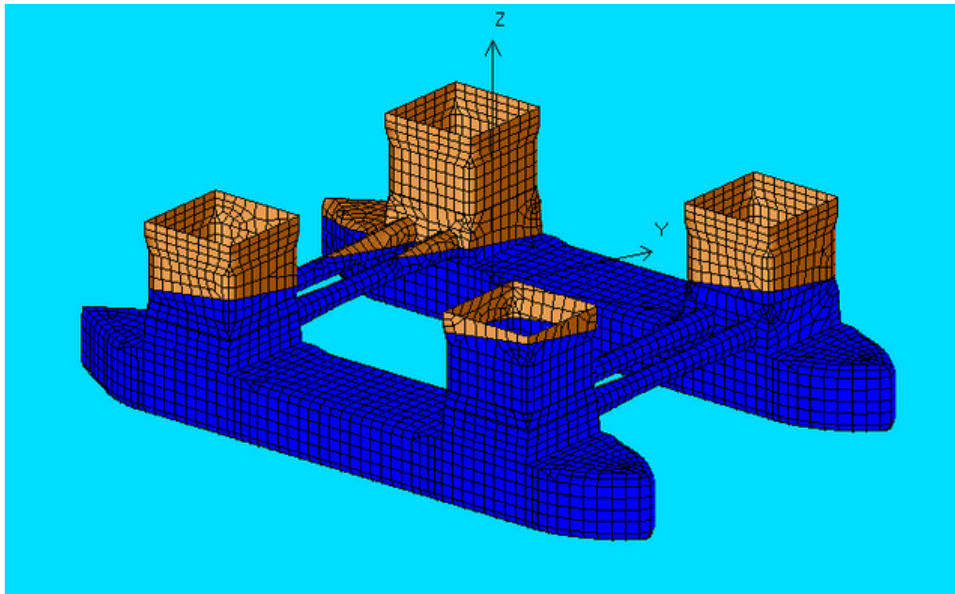

Figure 28: Damage case 2-WBT ST-2 flooded

6.1.1 Setup of model

The model is first modelled in the same way as for the model with survival draft discussed in earlier chapters. A box is generated in AutoCAD Mechanical. This box is the basis for both damage cases. For each case the draft amidships when damaged is placed as a work plane. Further a line with the rotated heel axis is placed and so the plane is tilted about the rotated heel axis to achieve the inclination desired. The plane is imported into Mechanical APDL and is placed to its right position by choosing three reference points. Further the mesh is generated, as earlier in Mechanical APDL. The model is then run in AQWA to get out hydrostatic data. A table showing the angles and other data for the two damage cases are presented below in table 7.

	<i>Initial condition</i>	<i>Damage case 1</i>	<i>Damage case 2</i>
Draft amidships [m]	17.5	17.759	18.224
Displacement [MT]	40430	41040	41115
Max inclination [deg]	0	13.18	11.68
Heel axis rotation [deg]	0	FWD 7.0	FWD 39.0

Table 7: Data for damage cases

As mentioned earlier, the list angles are taken from Henriksen (2011). How these values are obtained by means of one single angle will be explained in the following.

Max inclination means the inclination obtained when the unit is tilted in both heel and trim. The value for this inclination is then obtained by rotation of the axis system, in this case heel axis, with respect to where the damaged tank is in relation to centre of the axis system. In figure 29 this is visualized by a simple sketch for damage case 2. Note that figure 29 is for illustration only and is not to scale nor exact.

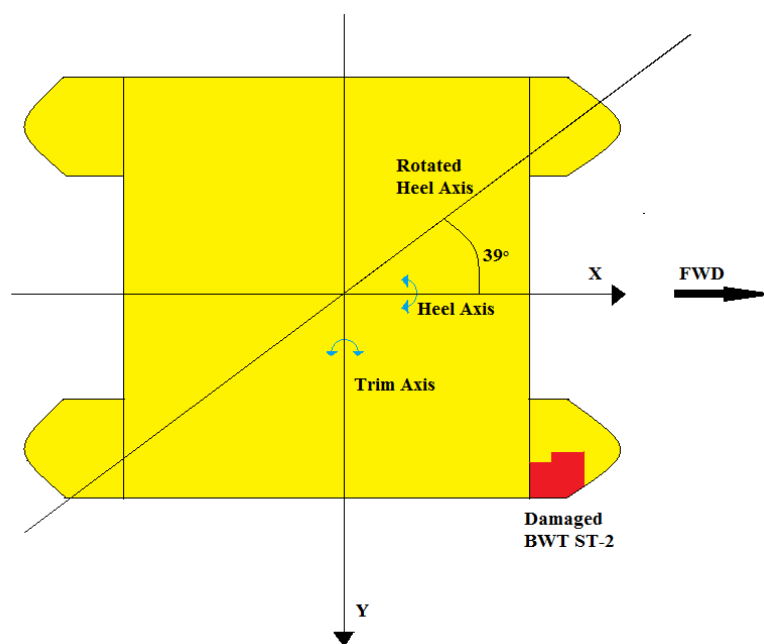

Figure 29: Sketch with rotated heel axis for damage case 2

6.1.2 Damage case setup in AQWA

When setting up the analysis in AQWA, several choices have been made. A description of the steps done is described in the following.

Wave directions

In this step, the wave propagation direction is set. As earlier a total of 13 directions is from 0° to 180° is run in the analysis. However only head sea (0°) and beam sea (90°) are considered in the report.

Frequencies

The same set of frequencies used in element analysis is also used here (see chapter 5.3), however AQWA requires that also the directions from -180° to 0° are included since not only half the unit is modelled at this point.

Location

It is in this step possible to set the different environmental conditions. This includes the density and viscosity of the water, specific gravity and water depth. All values have been left to default except for the water depth which is set to be 300m.

To be able to assume deep water, the general rule is that depth should be at least half as deep as the length of the longest wave. However in this case this is not satisfied. A deep water assumption can be done when considering waves up to 19.6s, ref calculations done below.

$$T = \sqrt{\frac{2 \cdot 2\pi \cdot \lambda_{\text{waterdepth}}}{g}} \approx \sqrt{\frac{2 \cdot \lambda_{\text{waterdepth}}}{1.56}} = \sqrt{\frac{2 \cdot 300}{1.56}} = \underline{19.6s}$$

This does however not influence the calculations done, because AQWA automatically takes this effect into account.

Panel model

The panel model created in Mechanical APDL is selected. However as opposed to the non damaged case, it is here necessary to use the complete panel model and not only half the model. This is due to the fact that the unit will not be symmetrical with a list angle. A consequence of this is that the computational time increases by quite much. In this case it actually took approximately three times as long.

Mass model

A homogenous density of the unit has been assumed. This means that the mass inside the panel model is homogenous. This is not entirely accurate, but it is a good approximation. AQWA can from that calculate the mass, centre of buoyancy and inertia moments.

Note that the same input values for the radii of gyration and the CoG as for the non damaged unit is used; these values will of course change, but are assumed to be only slight changes.

6.2 Analysis of GG5000 in shallow draft condition

As mentioned in the first section of this chapter, a draft of 14.5m is chosen, and again the model is created in the same way as for the survival draft discussed in earlier chapters. The reason for choosing a draft of 14.5m is that for this draft the braces are only just emerged from the sea surface, and at the same time the pontoons will be closer to the sea surface and will thus cause a change of the vessels properties, in terms of added mass and damping as well as the excitation forces, which is a combination of Froude-Krylov- and diffraction forces. This is what is meant to be shown here. This condition is indeed a hypothetic case as the unit would never be in a situation where it would be a danger attached when in this condition. The results are given in chapter 7.4. Below in figure 30, the draft can be seen in means of diffracting elements.

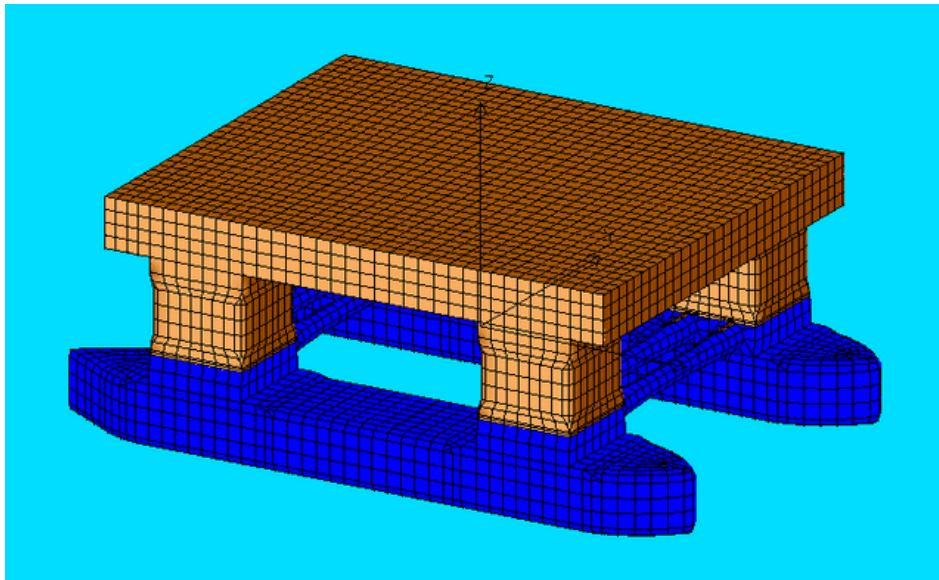

Figure 30: Shallow draft condition

7 Post processing

When the setup was initiated and all runs completed, the obtained results were copied to spreadsheet in Microsoft Office. The datasets were also animated in AQWA GS. This chapter describes the results obtained in order of graphs and animation (animation found on separate electronical transmitted folder marked DamAni in Appendices folder).

7.1 Animation in AQWA GS

As stated earlier, the model was created in SolidWorks Premium. The model was then imported into Mechanical APDL for meshing, and further run in AQWA. The results could then be used in AQWA GS. AQWA GS is a graphical supervisor implemented in the ANSYS package where it is possible, amongst other features, to animate the unit with values calculated by AQWA. This does not give any concrete results that can be used for comparison, but gives a general indication about the units' movement. The animation is from damage case 2 in head sea, and one of the frames is shown in figure 31.

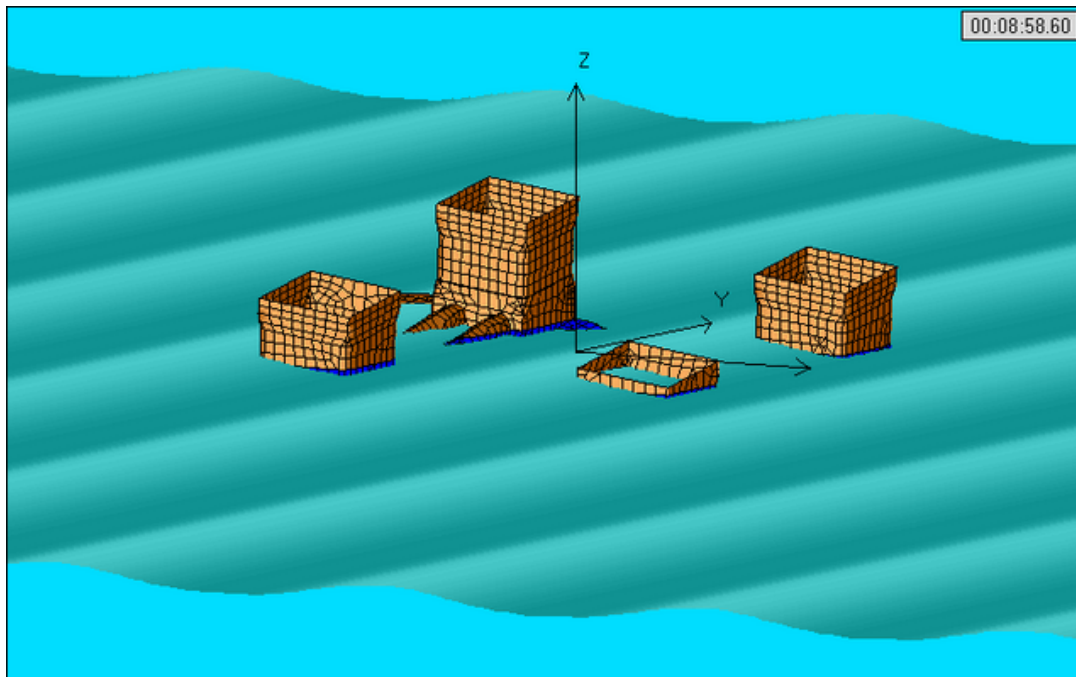

Figure 31: AQWA GS frame from animation

7.2 Results damage case 1

This damage case is, as stated earlier, due to rupturing of BWT-ST8, located in starboard pontoon in between frame 17 and 21, shown in figure 26. The list angle presented in table 7 is the maximum angle when the heel axis is rotated. In this case the tank at question is almost in the middle of the starboard pontoon, so the rotation is only 7° fwd and the maximum angle is 13.18°. The RAOs for heave, roll and pitch are shown below in figures 32-37. To refresh the mechanics of what is dominating the resonance frequencies, the equations for resonance periods in heave, roll and pitch respectively are listed below.

$$T_{n33} = 2\pi \sqrt{\frac{m_{totunit} + A_{33}}{\rho \cdot g \cdot A_{WL}}}$$

$$T_{n44} = 2\pi \sqrt{\frac{I_{44} + A_{44}}{\rho \cdot g \cdot vol.displacement \cdot GM_T}}$$

$$T_{n55} = 2\pi \sqrt{\frac{I_{55} + A_{55}}{\rho \cdot g \cdot vol.displacement \cdot GM_L}}$$

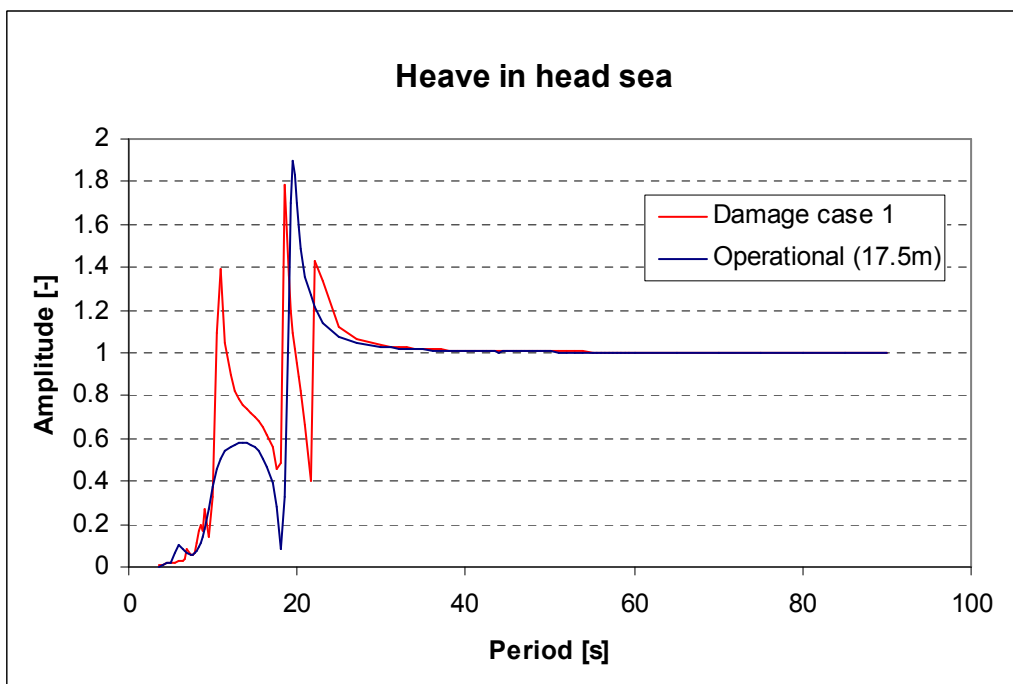

Figure 32: RAO heave, head sea (damage case 1 VS operational draft)

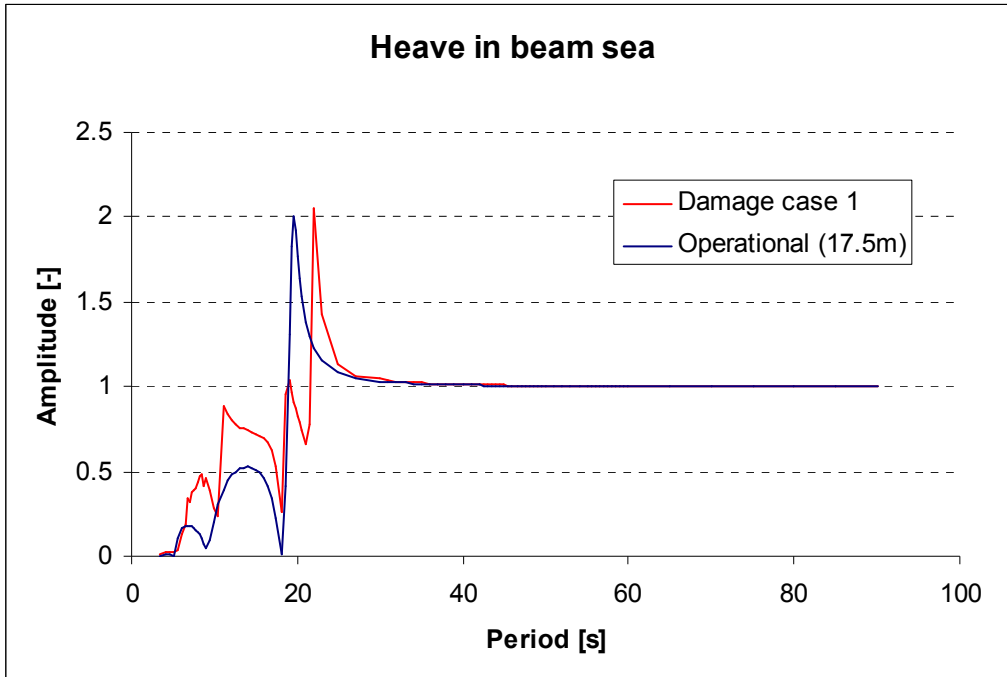

Figure 33: RAO heave, beam sea (damage case 1 VS operational draft)

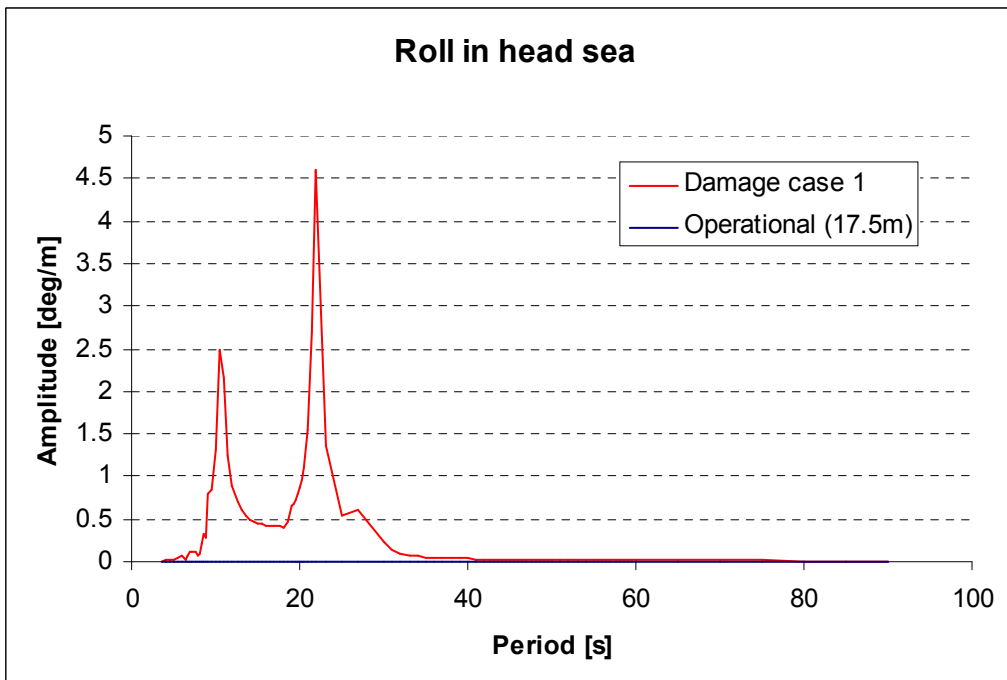

Figure 34: RAO roll, head sea (damage case 1 VS operational draft)

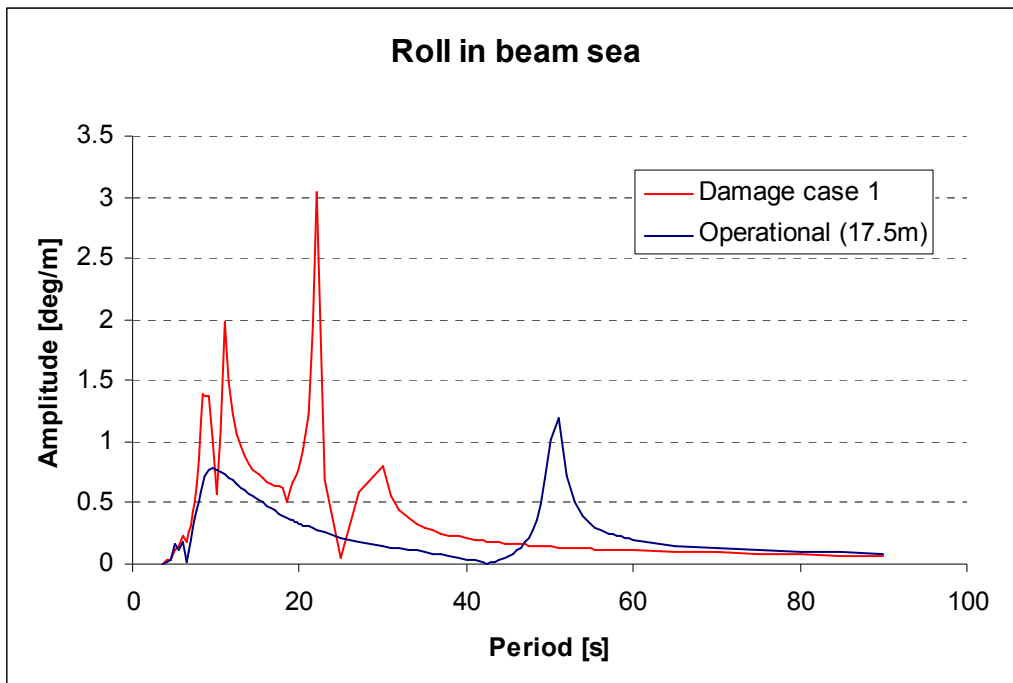

Figure 35: RAO roll, beam sea (damage case 1 VS operational draft)

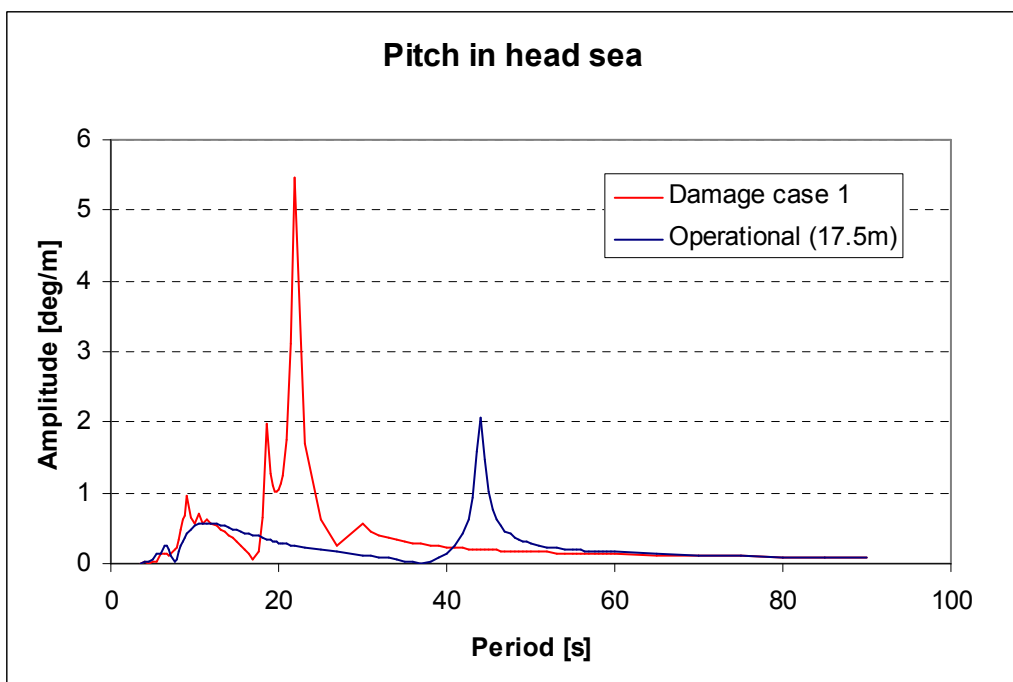

Figure 36: RAO pitch, head sea (damage case 1 VS operational draft)

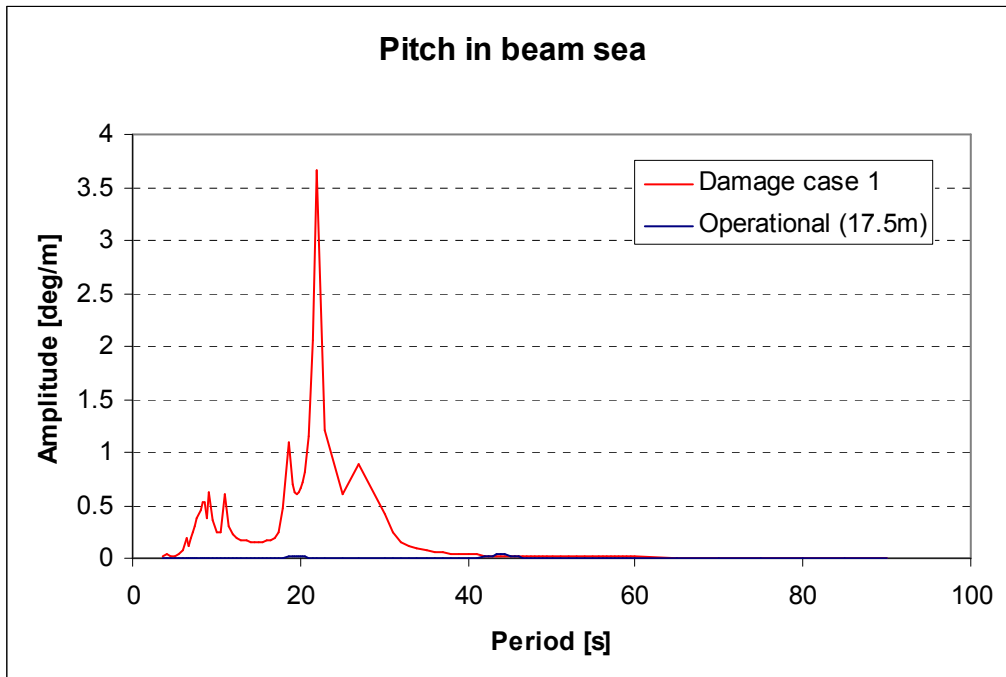

Figure 37: RAO pitch, beam sea (damage case 1 VS operational draft)

When looking at the RAOs in heave for damage case 1 (figures 32 and 33), it is clear that they are not a consequence of the heave motion alone. It could be that other motions are influencing due to coupling. The trends, with respect to the operational draft RAO, are similar at some places at the curve but all together quite big deviations are seen.

For the roll and pitch RAOs the story is also that the differences are big, but here there are no trends what so ever compared to the operational condition. The motions are extremely high especially around 22s. It could be easy to assume that this is a consequence of a coupled movement with the heave motion, which has a natural period in this region in normal operational condition. However the natural period of the heave motions are expected to be lower in the damage case, so it is more likely to be opposite, that either roll or pitch contributes this jump in the heave RAO due to coupled motions. It is very hard to predict without further analyses because the different RAOs are no longer only dependent on one degree of freedom, but one or more of the other five (See figure 3 to get a better picture of the different degrees of freedom).

One would expect to observe a shift in the resonance period. This is assumed to come from the increased water plane area, which again gives a higher stiffness. Also the BM value will increase as a result of the increased water plane area. This change will be reduced by the increase in displacement, but the stiffness from water plane area will be larger, and thus dominate. The KG value will also be reduced while the KB will increase slightly. These factors will contribute to an overall increase in the GM value, which also will reduce the resonance frequency.

The RAOs for roll in head sea and pitch in beam sea are as expected, zero, in the operational condition. Due to the fact that the unit is not tilted in only one degree of freedom in damage case 1, it is normal that the RAOs for these directions have some responses. However the motions are very big, and are assumed to come from the fact that all motions are coupled and will highly influence on each other.

The best way to check if the peaks in the RAOs are a consequence of irregular frequencies would be to see if there are any discontinuities in the added mass/damping curves at considered frequencies. An additional reason for the high peaks may be the fact that additional damping in roll/pitch, which so far had no reason to be specially adjusted (because it has been on even keel), now start to play a significant role due to the fact that the natural periods change.

7.3 Results damage case 2

This damage case is due to rupturing of BWT-ST2, located in starboard pontoon in between frame 32 and 36, shown in figure 26. Also here the angle presented in table 7 is the maximum angle when the heel axis is rotated. In this case the tank at question is in the fore tip of the starboard pontoon. This gives a rotation of 39° fwd and maximum angle of 11.68° . The RAOs for heave, roll and pitch are presented below in figures 38-43.

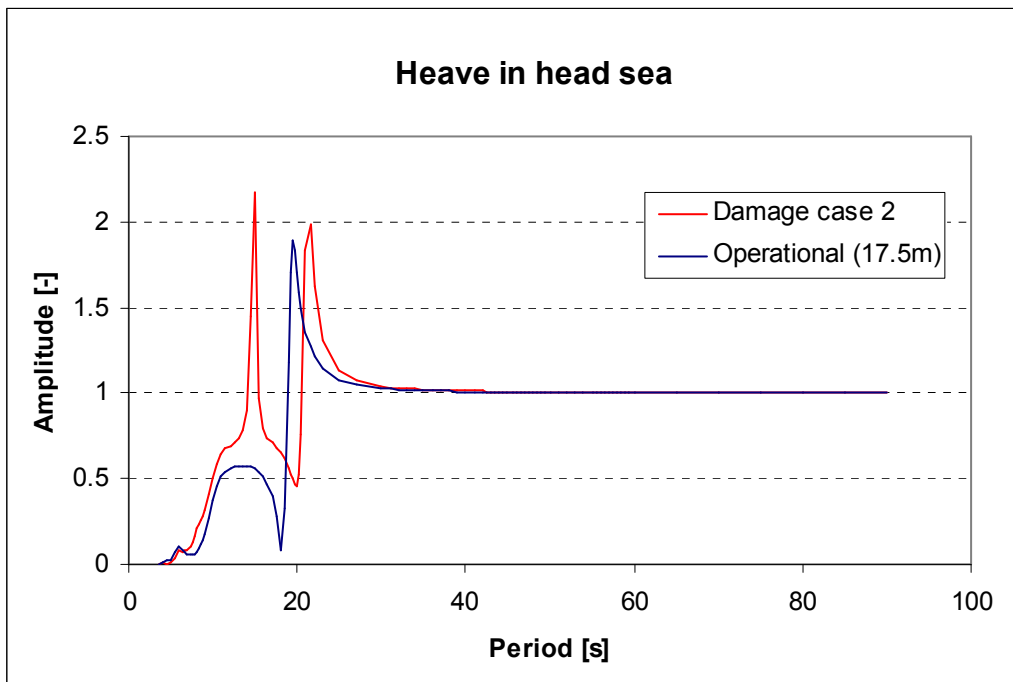

Figure 38: RAO heave, head sea (damage case 2 VS operational draft)

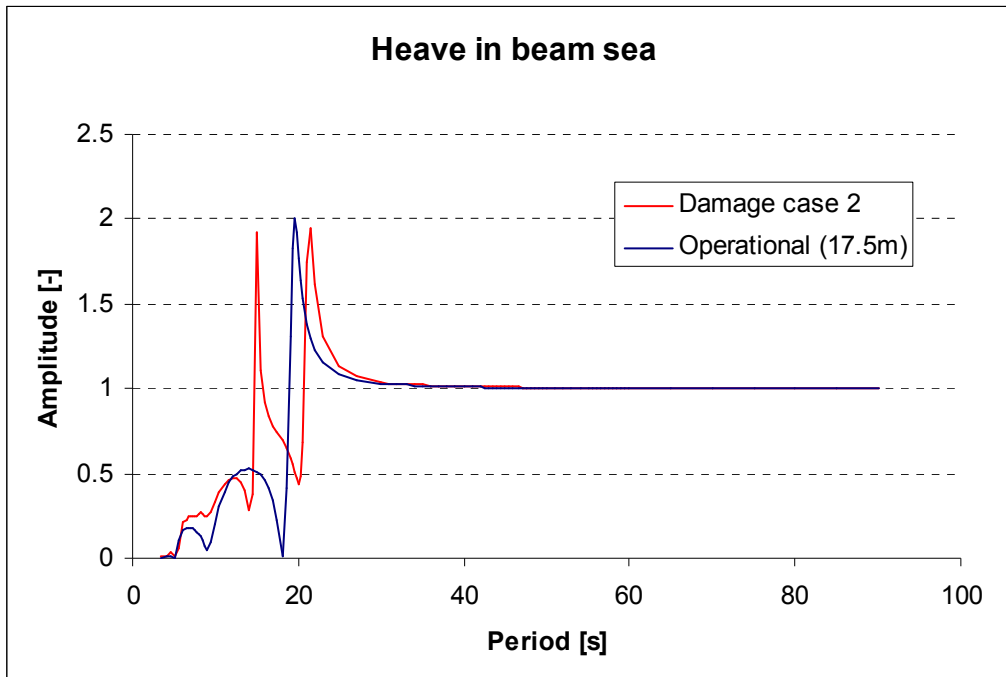

Figure 39: RAO heave, beam sea (damage case 2 VS operational draft)

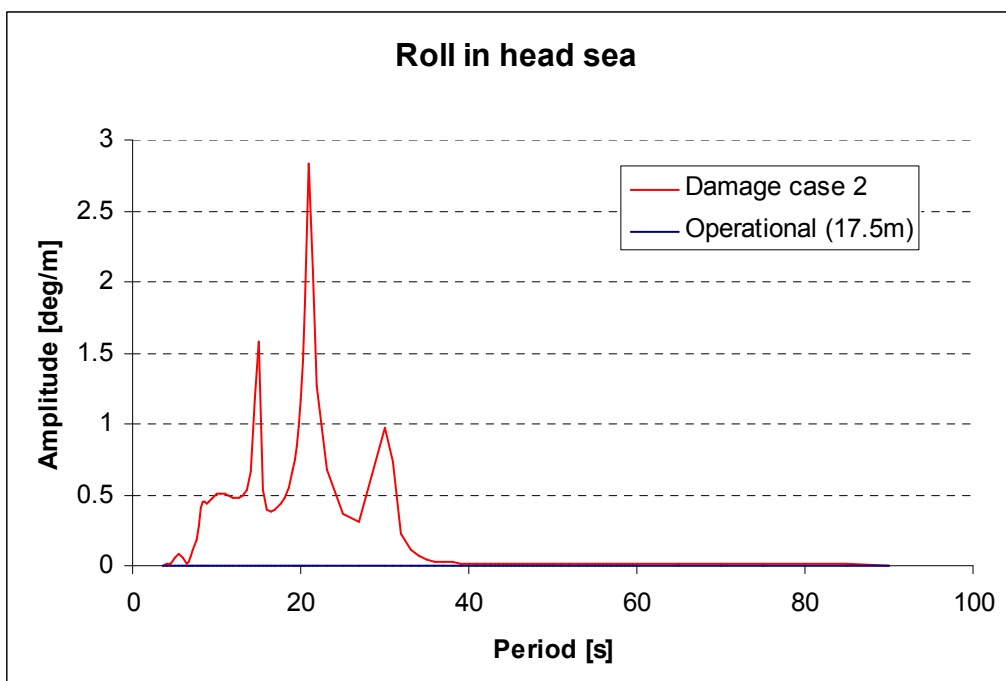

Figure 40: RAO roll, head sea (damage case 2 VS operational draft)

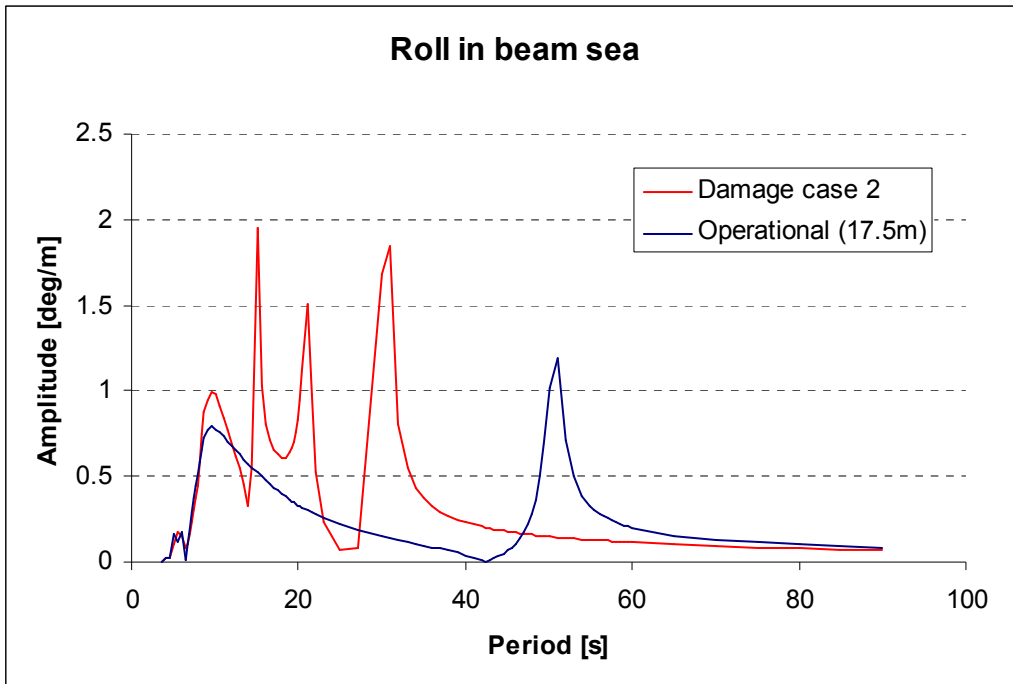

Figure 41: RAO roll, beam sea (damage case 2 VS operational draft)

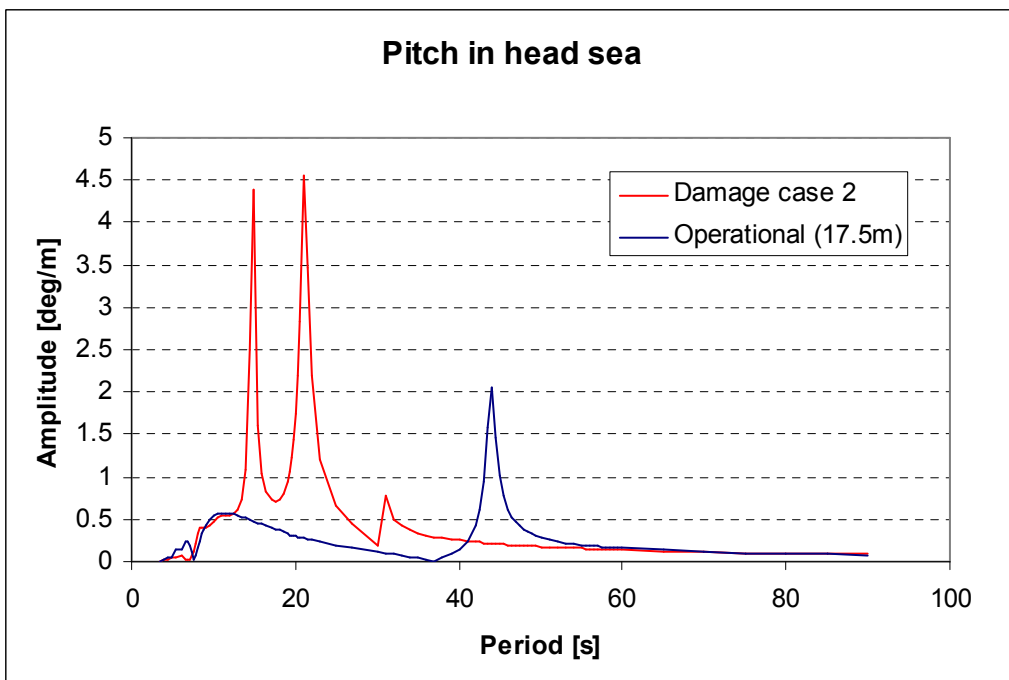

Figure 42: RAO pitch, head sea (damage case 2 VS operational draft)

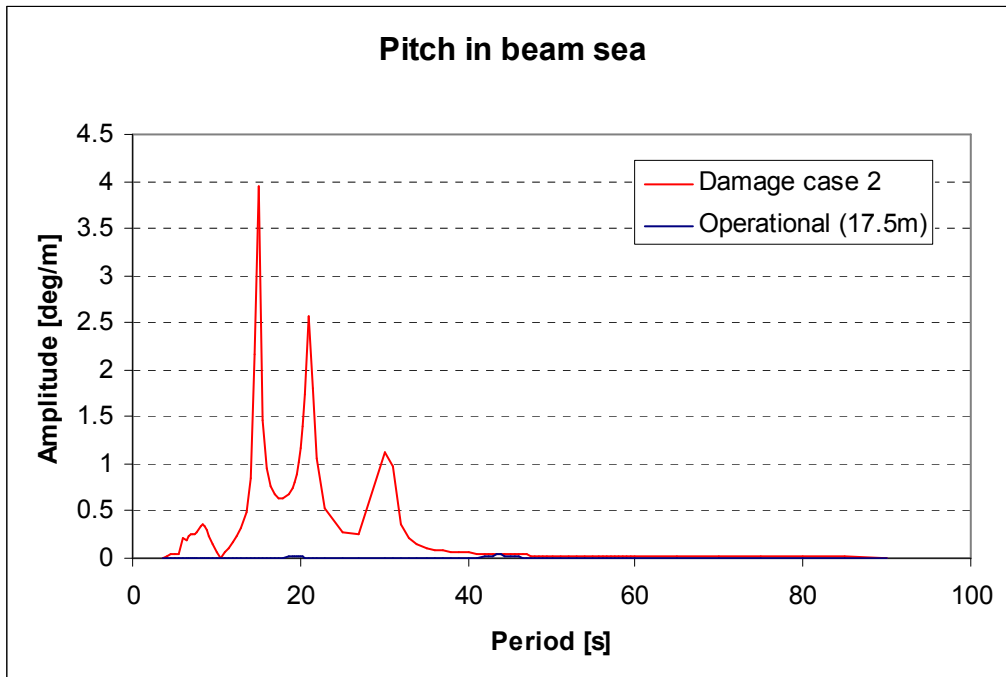

Figure 43: RAO pitch, beam sea (damage case 2 VS operational draft)

To start off with the heave, it can be seen that it follows the same trend as in damage case 1, only with a higher peak in the 15s region. This is assumed to be due to coupled motions from one of the other degrees of freedom.

In roll and pitch it can be seen that the resonance period is reduced. This is assumed to be caused by the same changes as damage case 1. An increase in the water plane area then increases the BM, which in turn increases the GM. The increase in GM will then result in a decreased resonance period.

The RAOs for roll head sea and pitch beam sea are also included here. This is to show that the unit will have responses in both these cases due to the fact that it is tilted both forward and to starboard side. In addition the high responses in these cases show how much the coupled motions influences on the different RAOs.

7.4 Results shallow draft case

This case is a study to see how the forces in terms of excitation, added mass and damping are changing when the pontoons gets closer to the surface, and the braces are just emerging from the sea surface. These parameters are quite interesting in such a condition and will be presented in terms of graphs in the following with comparison to survival draft (15.5m) and operational draft (17.5m). RAOs in heave, roll and pitch will also be presented.

The RAOs for heave, roll and pitch are shown below in figures 44-47, whilst the graphs for added mass, damping and excitation forces are shown in figures 48-57.

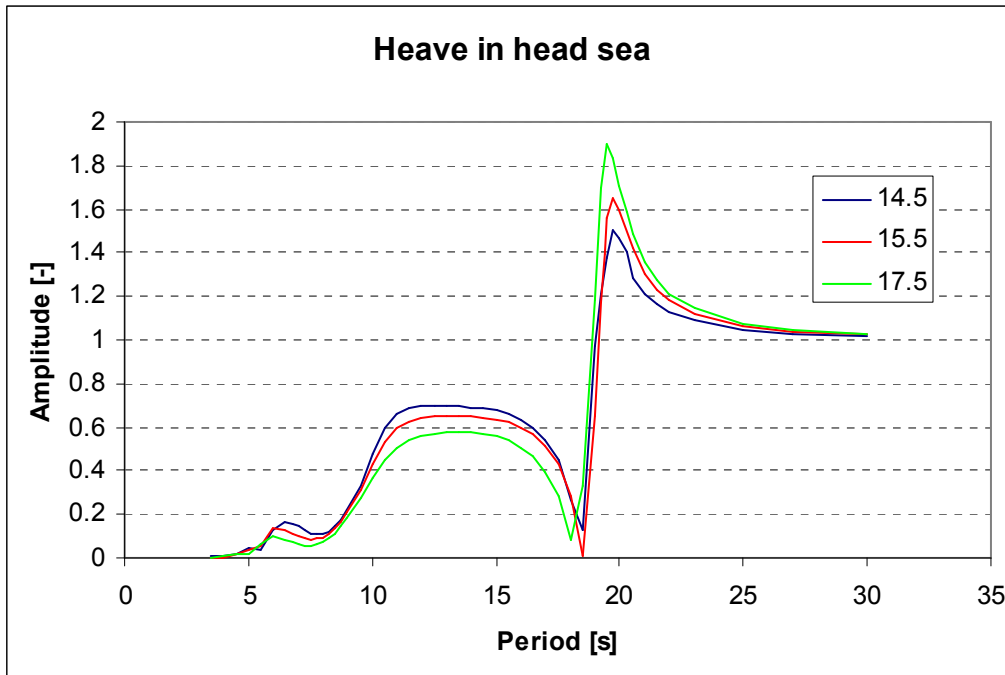

Figure 44: RAO heave, head sea (shallow draft VS operational- and survival draft)

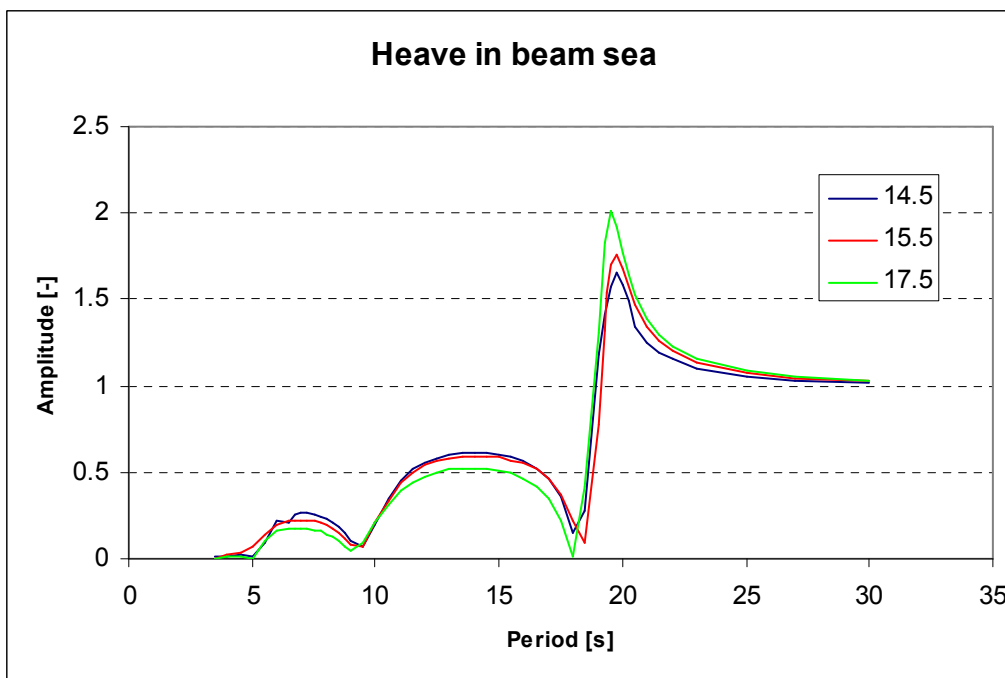

Figure 45: RAO heave, beam sea (shallow draft VS operational- and survival draft)

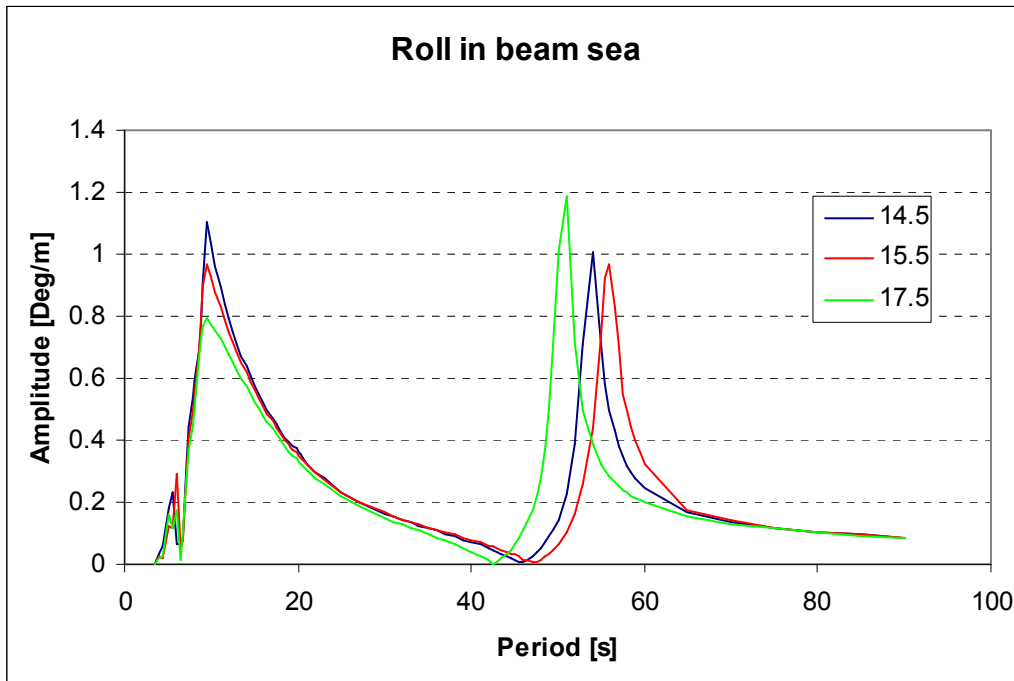

Figure 46: RAO roll, beam sea (shallow draft VS operational- and survival draft)

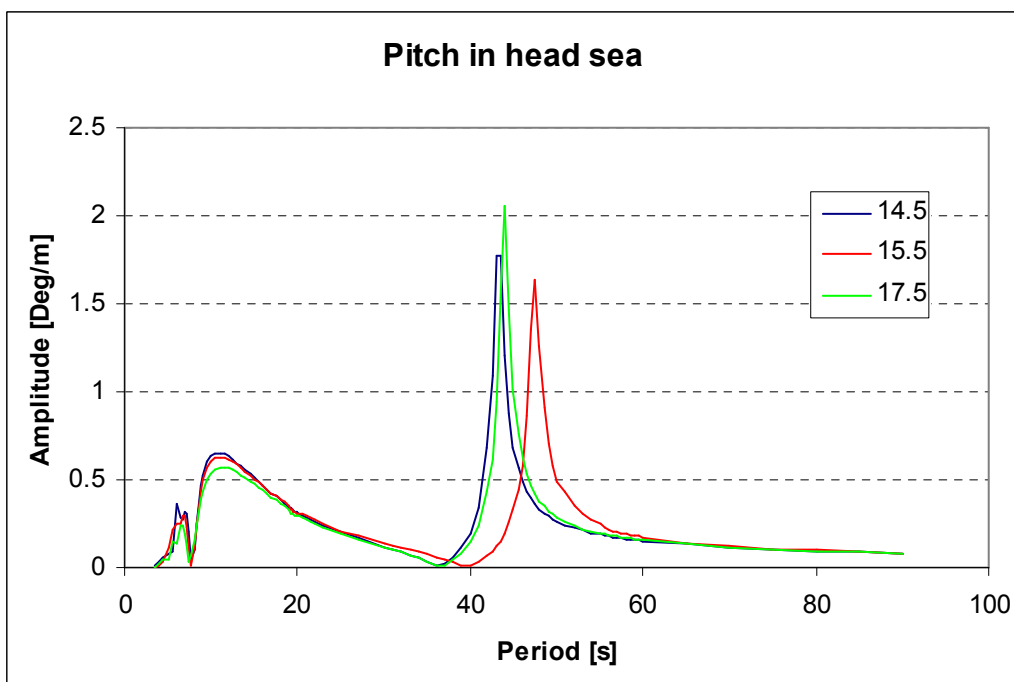

Figure 47: RAO pitch, head sea (shallow draft VS operational- and survival draft)

To start of with the heave, it is seen that the response is the highest for the shallow draft (14.5m) followed by the survival draft (15.5m) and finally the operational draft (17.5m). However when the unit reaches its natural period it can be seen that the trend is opposite, and the responses are getting more and more alike towards 30s. This is only to be expected, and no discontinuities are detected for the shallow draft condition.

For the roll and pitch the same trends as for the heave is seen. However a difference in the resonance period is clearly seen for the three drafts. As explained in chapter 7.2 and 7.3, it is to be expected that the condition with the highest draft, hence largest displacement, will have the lowest resonance period. This is the case from the 15.5m draft to the 17.5m draft but not for the 14.5m draft. The 14.5m draft actually has a lower resonance period than the 15.5m draft in roll, and in pitch it has the lowest resonance period. In addition, in the resonance period region, the 14.5m draft has a higher response than the 15.5m draft.

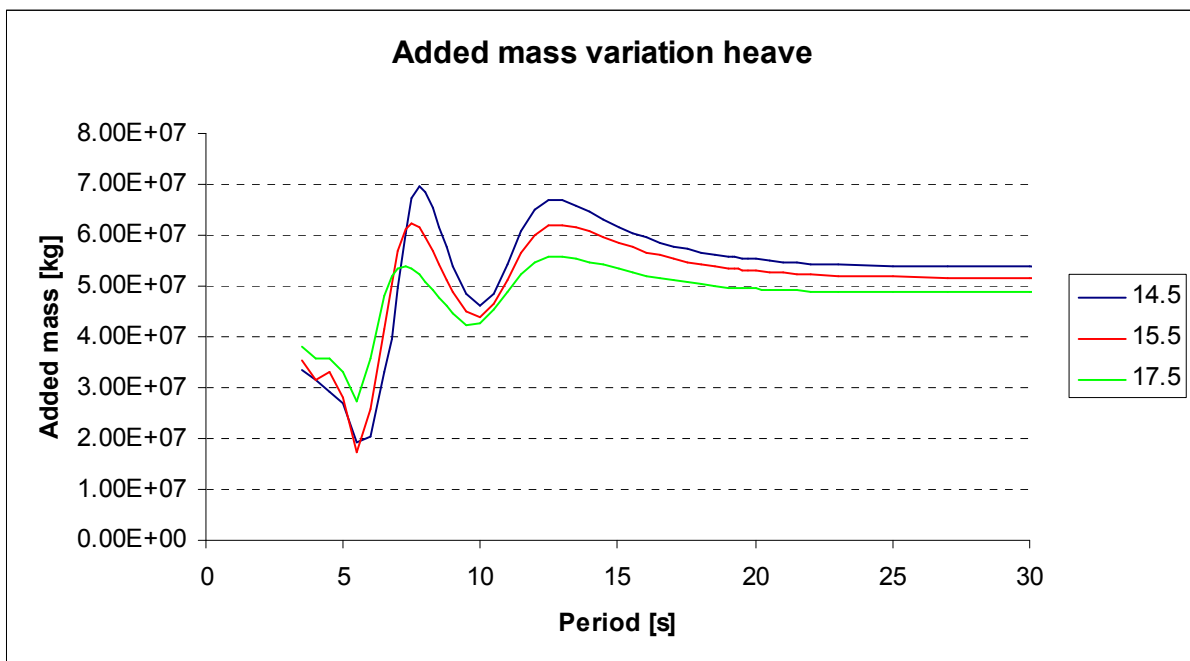

Figure 48: Added mass variation heave (shallow draft VS operational- and survival draft)

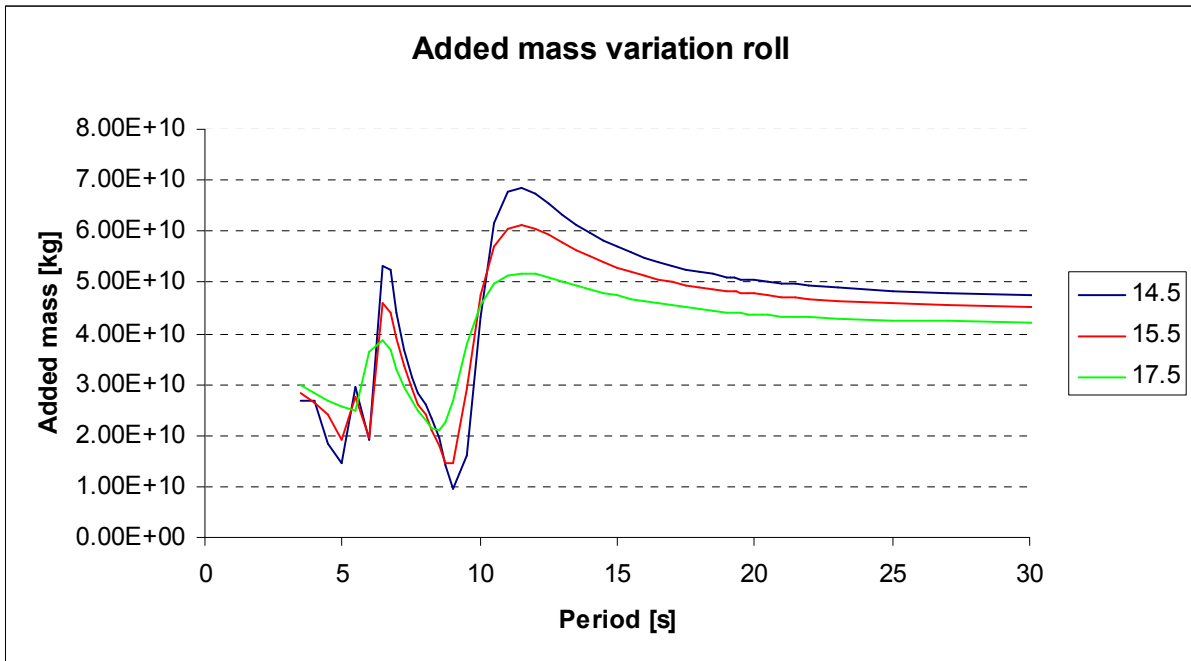

Figure 49: Added mass variation roll (shallow draft VS operational- and survival draft)

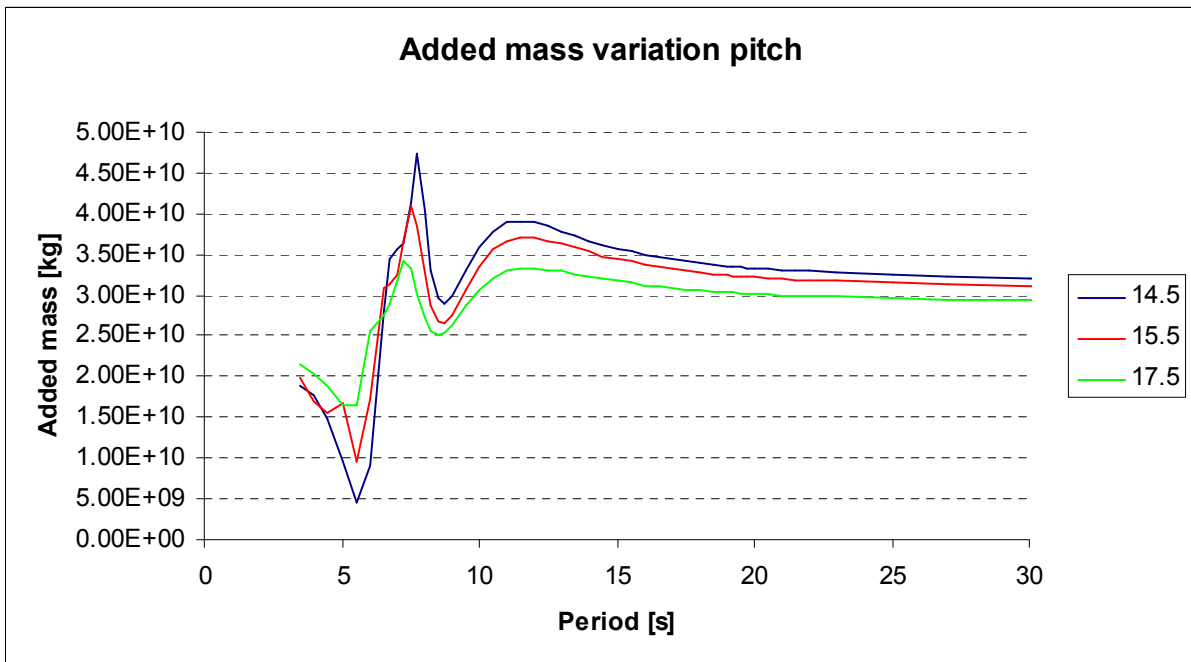

Figure 50: Added mass variation pitch (shallow draft VS operational- and survival draft)

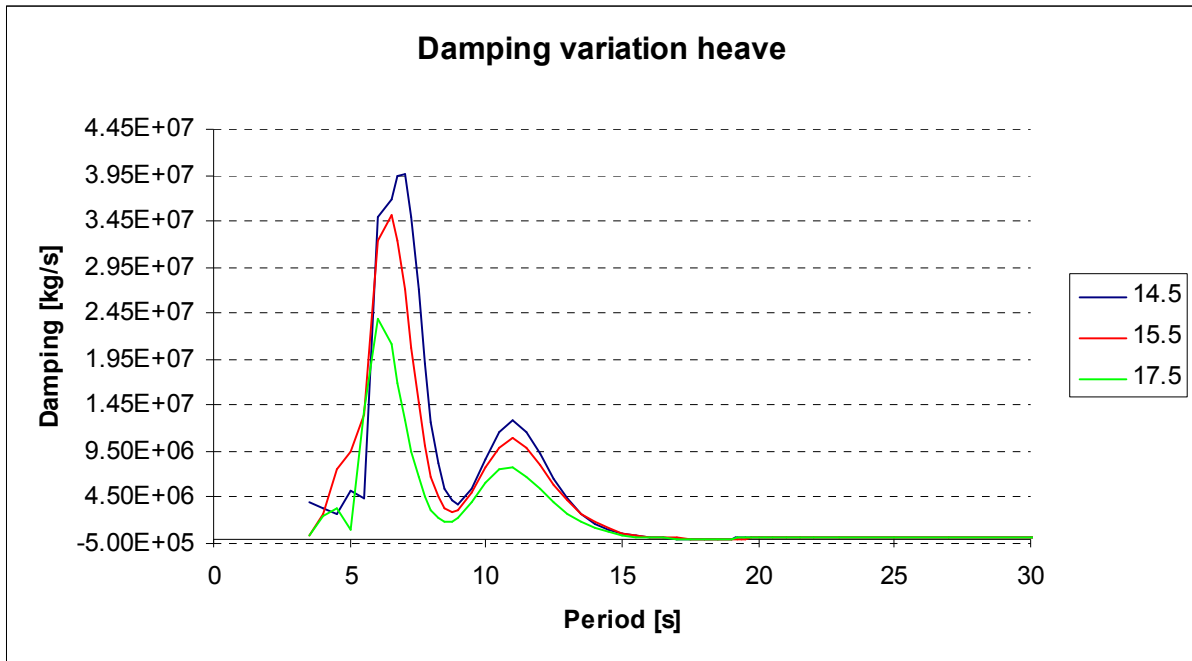

Figure 51: Damping variation heave (shallow draft VS operational- and survival draft)

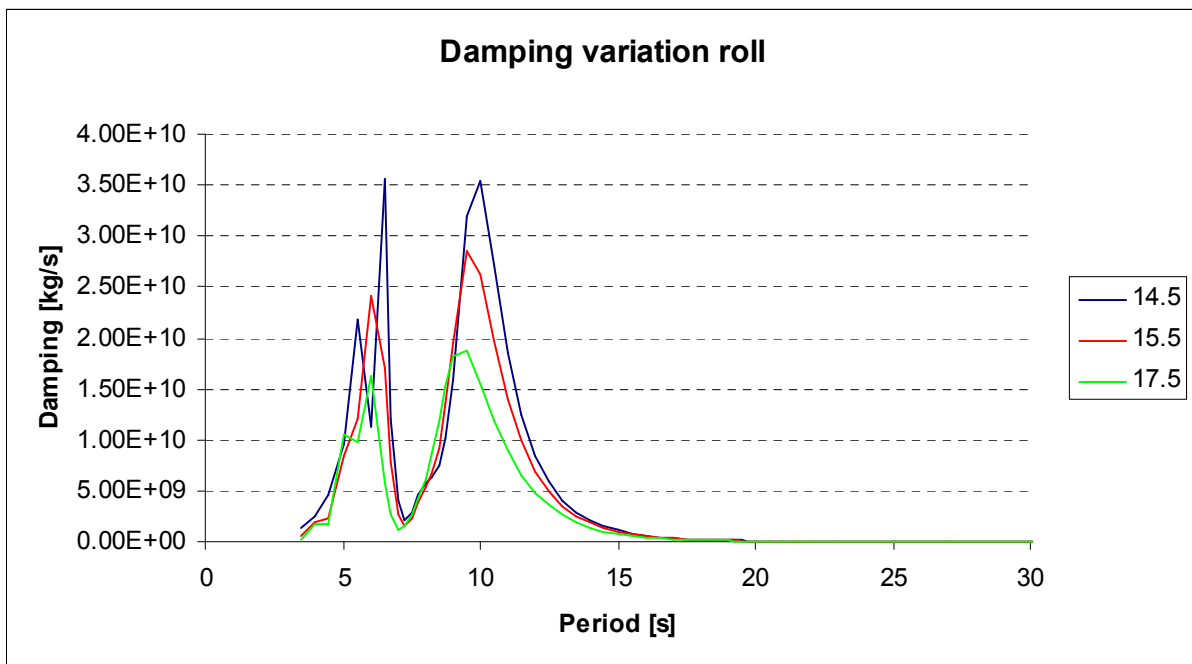

Figure 52: Damping variation roll (shallow draft VS operational- and survival draft)

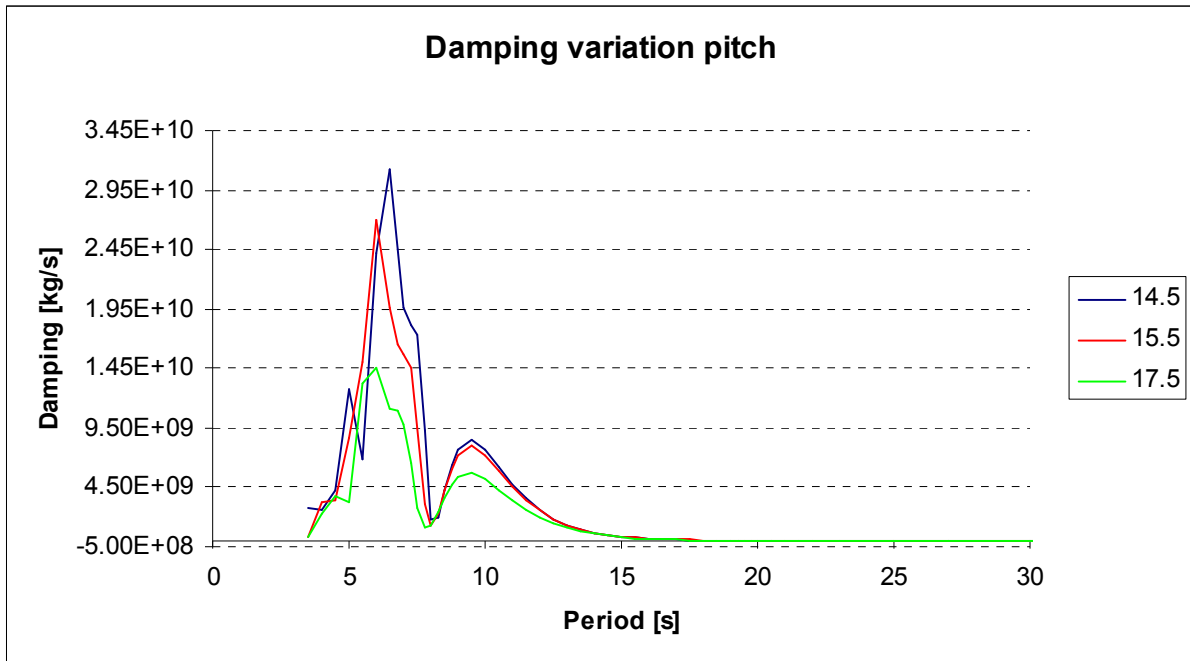

Figure 53: Damping variation pitch (shallow draft VS operational- and survival draft)

In the added mass and damping variations the curves for the three drafts are expected to “follow” each other more than they do in these figures 48-53, at least the 15.5m draft and the 17.5m draft. They should of course differ in value, but have the same trend. However it is clear from the peaks that the 14.5m draft has the highest values for both added mass and damping in all three degrees of freedom: heave, roll and pitch, followed by the 15.5m draft and the 17.5m draft.

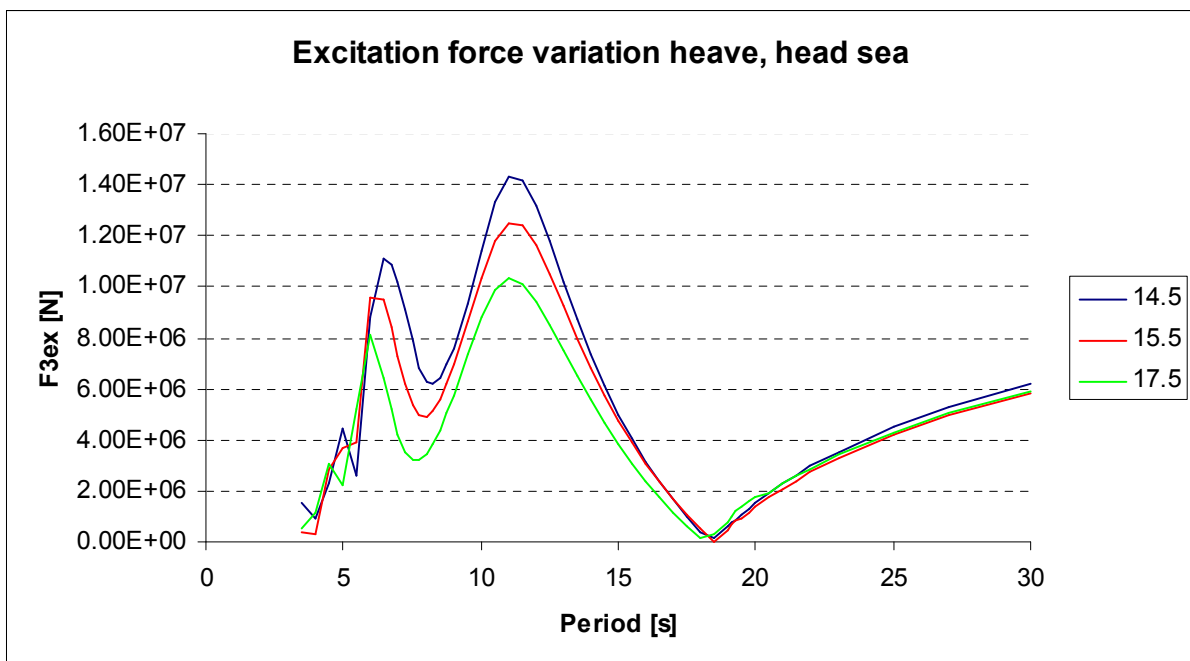

Figure 54: Excitation force variation heave, head sea (shallow draft VS operational- and survival draft)

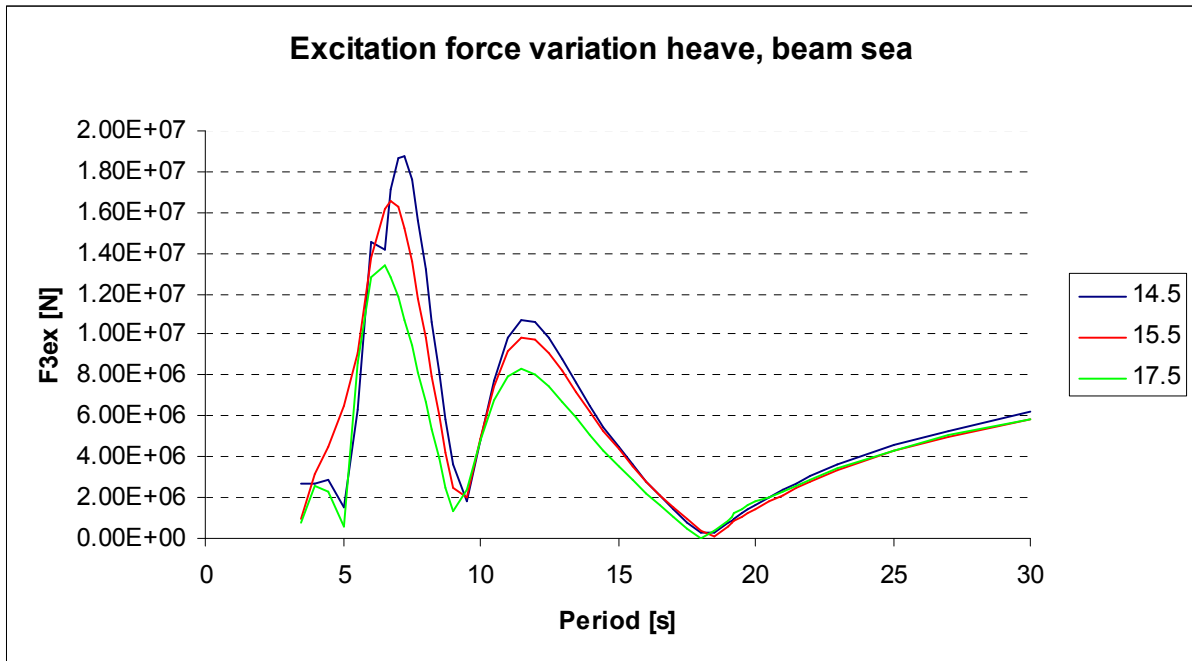

Figure 55: Excitation force variation heave, beam sea (shallow draft VS operational- and survival draft)

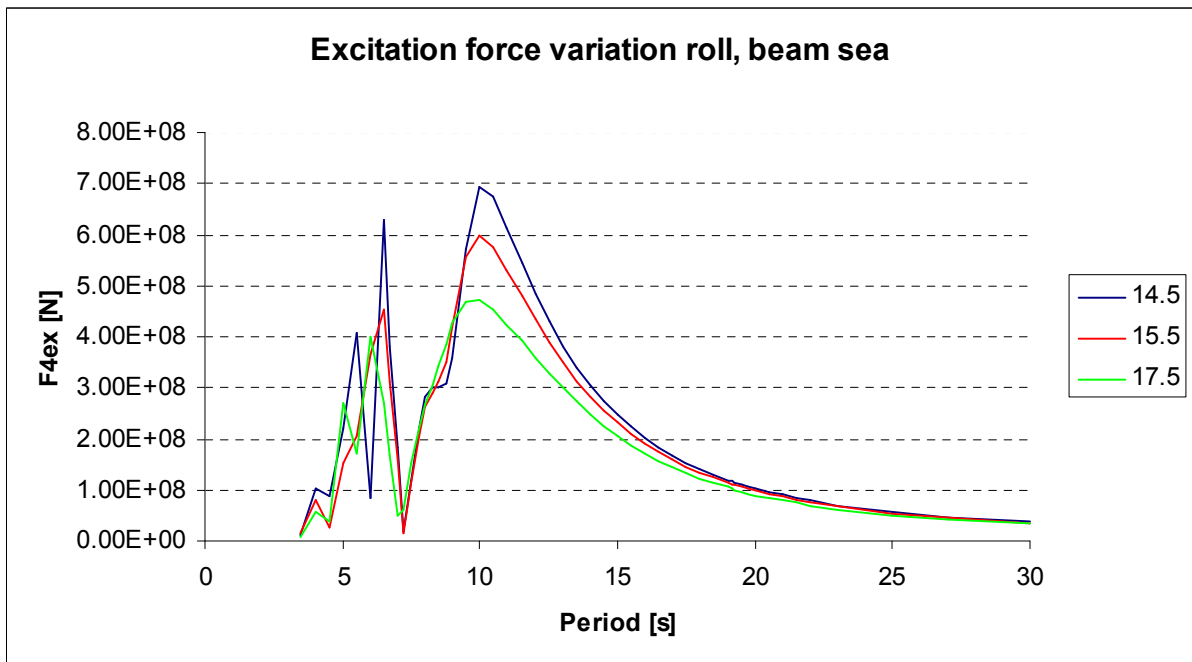

Figure 56: Excitation force variation roll, beam sea (shallow draft VS operational- and survival draft)

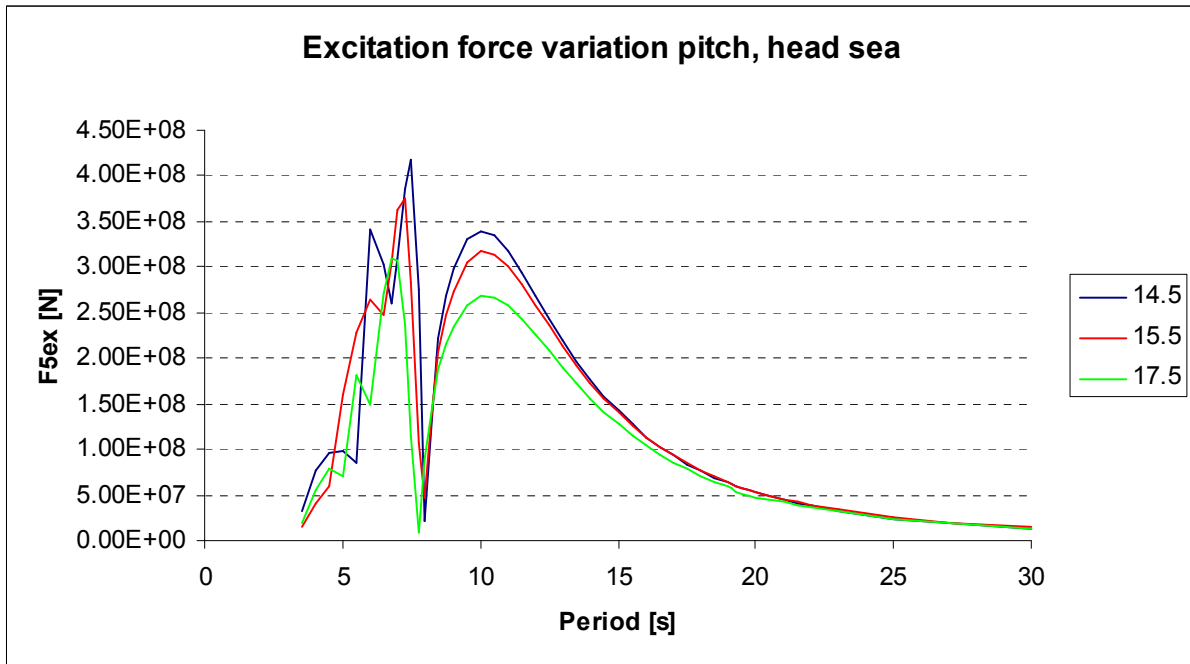

Figure 57: Excitation force variation pitch, head sea (shallow draft VS operational- and survival draft)

Also here in the excitation force variations, the curves for the three different drafts are expected to “follow” each other more. But again, in the peaks it is clearly seen that the 14.5m draft gives the largest forces. This is due to the fact that the columns are much closer to the sea surface, and that the bracings are travelling in and out of the sea surface.



8 Conclusion and further work

From what can be extracted from the RAOs in the damage cases, the optimal thing to do in a situation where the unit is tilted heavily is to try to ballast the unit to an even keel. This can be done by filling the tanks on the opposite side from the damaged tank. A risk of doing this can be that the rig will have a draft much higher than usual, so wave slamming (pile up on the columns) is a possibility. This can produce large forces on the deck and jeopardize the structural integrity and stability of the hull. The pontoons and columns are however reinforced to achieve an ICE-T notation. This means that the unit is fitted for travelling through ice. So to have full penetration through these tanks will be unlikely at best.

Another downside by ballasting the unit to an even keel is a lower resonance period for the unit. However, the resonance period will be sufficiently large to avoid severe resonance due to the fact that the incoming waves need a length of approximately 600m which corresponds to the lowest resonance period for heave to achieve resonance.

This thesis has not taken the structural integrity of the unit into account. A collision of such a character as here could result in more severe damages such as structural collapse. It is therefore proposed as further work to do a structural analysis to verify that the vessel will be kept intact. Proposed background information is Videiro, Cyranka and Nunes (2002)

To verify the data calculated, a model test is proposed as further work. This has been done several times in the past for a damaged unit. Proposed background information is De Souza (1978), Huang (1982) and Stone (1990)

A surface elevation analysis with respect to the draft should also have been done. This is to see if amongst others slamming will be a major issue, and how this will affect the unit over time.

The shallow draft case is merely a case study to see how the RAOs and forces are affected. This case does not represent a real danger scenario, as one can either drain the tanks more to achieve the transit draft of 9,75m or fill them more to achieve the survival draft of 15.5m or operational draft of 17.5m



9 References

Literature and software

Pettersen, Bjørnar (2004) – *Marin hydrodynamikk og konstruksjonsteknikk grunnkurs 1*.
NTNU Department of marine technology.

Fuglerud, Geir (2003) – *Marin teknikk intro + marin teknikk 1*.
NTNU Department of marine technology.

Faltinsen, O.M. (1990) – *Sea loads on ships and offshore structures*.
Cambridge university press.

Irgens, Fridtjov (1999) – *Formelsamling i mekanikk*.
NTNU Department of marine technology.

SolidWorks Software (2011) – *SolidWorks user manual*.
Dassault Systèmes S.A. company

ANSYS AQWA software (2011) – *AQWA user manual*.
ANSYS Inc.

ANSYS AQWA GS software (2011) – *AQWA GS user manual*.
ANSYS Inc.

ANSYS Mechanical APDL software (2011) – *Mechanical APDL user manual*.
ANSYS Inc.

AutoCAD Mechanical software (2011) – *AutoCAD user manual*.
AUTODESK.

Conversations

Professor Bjørnar Pettersen (26th of April 2012)

Volkert Oosterlaak (6th – 8th of March 2012, three day intensive course on AQWA)

Sime Kolic (1/2-12, 15/2-12, 21/3-12, 3/4-12, 19/4-12, 22/5-12)

Additional literature

Global Maritime (2011) – *Motion Response Analysis – COSLProspector*. (Confidential)

Henriksen, Reidar (2011) – *Stability Analysis Report – COSLProspector*. (Unpublished)

Internet

http://en.wikipedia.org/wiki/Ship_motions

-Figure 3 is obtained here

<http://en.wikipedia.org/wiki/Semi-submersible>

-Facts and history about semi-submersibles



10 Appendix

10.1 Appendix notes

Because of its great size all AQWA files are added electronically in a folder attached to this report marked “Appendices”. The folder also contains CAD-schematics and a draft from the stability analysis report done by Henriksen (2011).

A complete list of the sub folders that the “Appendices” folder contains is presented below.

Filename	Description
Element analysis	Contains AQWA text files (input and output) for the element analysis (survival draft)
Damage analysis	Contains AQWA text files (input and output) for the damage analysis and operational draft
Shallow draft analysis	Contains AQWA text files (input and output) for the shallow draft analysis
DamAni	Contains AQWA text files (input and output) for the animation. Also contains a video that shows the animation of damage case 2 done in AQWA GS
Stability analysis report	Outcast of the stability analysis report obtained from Grenland Group AS (noted “Henriksen (2011)” in the text)
CAD-schematics	All CAD schematics used in the thesis



10.2AQWA script

* Model from ANSYS v14.0 UP20111024
* Generated by the ans2aqwa macro, v1.7, on 20120411 at 17.35
* ANSYS jobname is file

JOB AQWA LINE

TITLE File: U:\EAP\qewrqrw\Solid.x_t

OPTIONS GOON REST

OPTIONS ALDB CRNM

OPTIONS END

RESTART 1 3

*-----

* NODE CO-ORDINATE DATA - DECK 1

*-----

COOR			
NOD5			
1	23.600000	15.000000	14.550000
2	23.600000	15.000000	10.550000
3	25.014214	15.000000	13.964214
4	25.600000	15.000000	12.550000
5	25.014214	15.000000	11.135786
40	31.400000	15.000000	10.550000
45	31.400000	15.000000	14.550000
46	32.814214	15.000000	13.964214
47	33.400000	15.000000	12.550000
48	32.814214	15.000000	11.135786
122	-31.400000	18.801546	10.550000
124	-29.401407	19.000000	12.475000
125	-30.010726	18.859410	11.111279
126	-31.400000	19.213918	14.550000

(due to the extremely long script, a break is placed here)

8155	-47.996219	30.103159	9.615222
8156	-46.372261	31.102101	9.618692
8157	-51.310033	25.947983	0.430859
8158	-49.642143	24.913537	0.434626
8159	-47.996219	23.896841	0.434778
8160	-46.372261	22.897899	0.431308
8161	-51.310033	28.052017	0.430859
8162	-49.642143	29.086463	0.434626

*-----CoG-----

90000	0.057132	0.000000	22.230000
-------	----------	----------	-----------

*-----

END



*-----

* ELEMENT DATA - DECK 2

*-----

```
      ELM1
      ZLWL      ( 17.50000)
      SYMX
      QPPL DIFF (1)( 470)( 471)( 477)( 476)          339
      QPPL DIFF (1)( 471)( 469)( 473)( 477)          340
      QPPL DIFF (1)( 476)( 477)( 475)( 474)          341
      QPPL DIFF (1)( 477)( 473)( 472)( 475)          342
      QPPL DIFF (1)( 478)( 480)( 488)( 487)          343
      QPPL DIFF (1)( 480)( 481)( 489)( 488)          344
      QPPL DIFF (1)( 481)( 479)( 483)( 489)          345
      QPPL DIFF (1)( 487)( 488)( 485)( 484)          346
      QPPL DIFF (1)( 488)( 489)( 486)( 485)          347
      QPPL DIFF (1)( 489)( 483)( 482)( 486)          348
      TPPL DIFF (1)( 494)( 491)( 492)                 349
      QPPL DIFF (1)( 493)( 494)( 492)( 490)          350
      QPPL DIFF (1)( 496)( 495)( 511)( 512)          351
```

(another break is placed here)

```
      QPPL DIFF (1)( 8163)( 540)( 541)( 8164)        8528
      QPPL DIFF (1)( 589)( 8164)( 584)( 583)        8529
      QPPL DIFF (1)( 8164)( 541)( 534)( 584)        8530
      PMAS      (1)(90000)( 1)( 1)                  4777
```

END

FINI

*-----

* MATERIAL DATA - DECK 3

*-----

```
      MATE * Material properties
      1 4.043E+07
```

END

*-----

* GEOMETRY DATA - DECK 4

*-----

```
      GEOM * Geometric properties
      PMAS      1 3.49461e10 0.00 0.00 3.88532e10 0.00 4.89623e10
```

END

*-----

* GLOBAL DATA - DECK 5

*-----

```
      GLOB * Global analysis parameters
      DPTH      300.0
      DENS      1025.000
      ACCG      9.81000
```

END



*-----
* FREQUENCIES AND DIRECTIONS DATA - DECK 6
*-----

FDR1 * Frequencies and directions (may need editing)

* 1PERD	1	1	90.00
* 1PERD	2	2	85.00
* 1PERD	3	3	80.00
* 1PERD	4	4	75.00
* 1PERD	5	5	70.00
* 1PERD	6	6	65.00
* 1PERD	7	7	60.00
* 1PERD	8	8	59.50
* 1PERD	9	9	59.00
* 1PERD	10	10	58.50
* 1PERD	11	11	58.00
* 1PERD	12	12	57.50

(another break here)

* 1PERD	48	48	32.00
* 1PERD	49	49	31.00
* 1PERD	50	50	30.00
* 1DIRN	1	1	000.
* 1DIRN	2	2	015.
* 1DIRN	3	3	030.
* 1DIRN	4	4	045.
* 1DIRN	5	5	060.
* 1DIRN	6	6	075.
* 1DIRN	7	7	090.
* 1DIRN	8	8	105.
* 1DIRN	9	9	120.
* 1DIRN	10	10	135.
* 1DIRN	11	11	150.
* 1DIRN	12	12	165.
* 1DIRN	13	13	180.

END

*-----
* GLOBAL DATA - DECK 7
*-----

WFS1 * Distance from waterline to COG (may need editing)

FIDP	3	0.0	0.0	1.76E+06	0.0	0.0	0.0
FIDP	4	0.0	0.0	0.0	2.83E+08	0.0	0.0
FIDP	5	0.0	0.0	0.0	0.0	2.34E+08	0.0

END

*-----
* DECK 8
*-----

NONE



10.3 Draft of stability analysis report (Henriksen (2011))

GG5000
DAMAGE CASE 1
 1 Compartment flooded.
 Operation draft 17.50 m. Wind 0 Knots
 Rig Intact

Rig Floating Status

Draft(origin)	17.500 m	Equil	Yes	GM(Solid)	1.000 m
Heel	zero	Wind	Off	F/S Corr	0.000 m
Trim	zero	Incl.Axis	0.00	GM(Fluid)	1.000 m
LCG	0.022f m	Wave	No	KMT	24.783 m
TCG	0.000 m	VCG ⁴	23.783 m	KMI	25.438 m

Hydrostatic Properties

Draft is from Baseline.
 No Trim, No heel, VCG = 23.783

LCF Draft (m)	Displ (MT)	LCB (m)	VCB (m)	LCF (m)	TPcm (MT/cm)	MTcm (MT-m/cm)	GML (m)	GM(Solid) (m)
17.500	40848.970	0.022f	6.918	0.000	9.751	10.699	1.655	1.000

Water Specific Gravity = 1.025.
 Trim is per 63.18m

RIG WITH DAMAGE

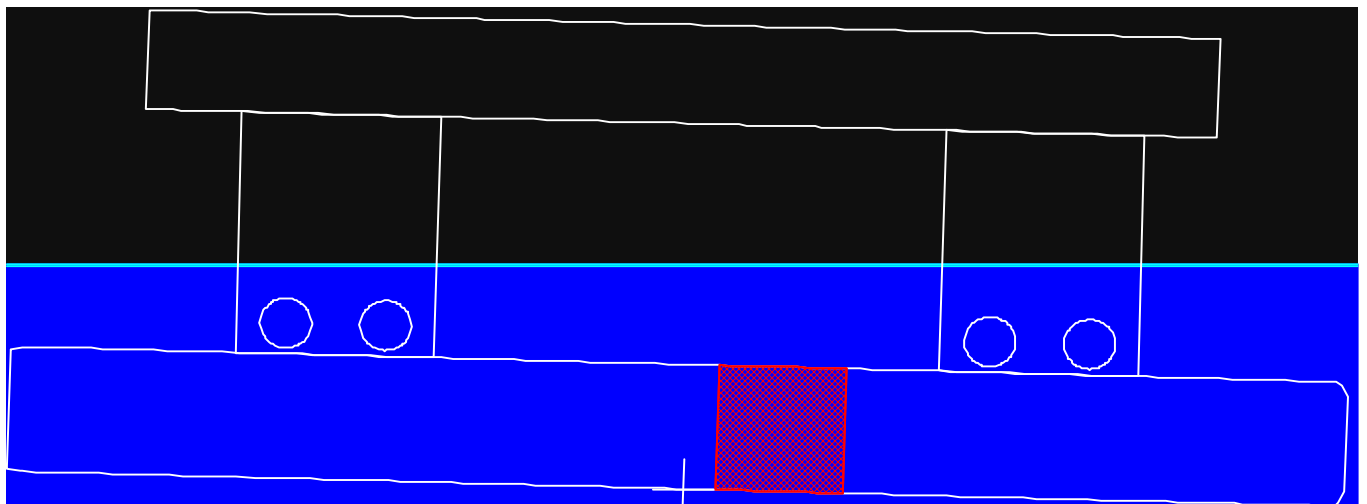

⁴ Note that the VCG here is the limiting VCG as a consequence of the rule requirement that the GM has to be at least 1m

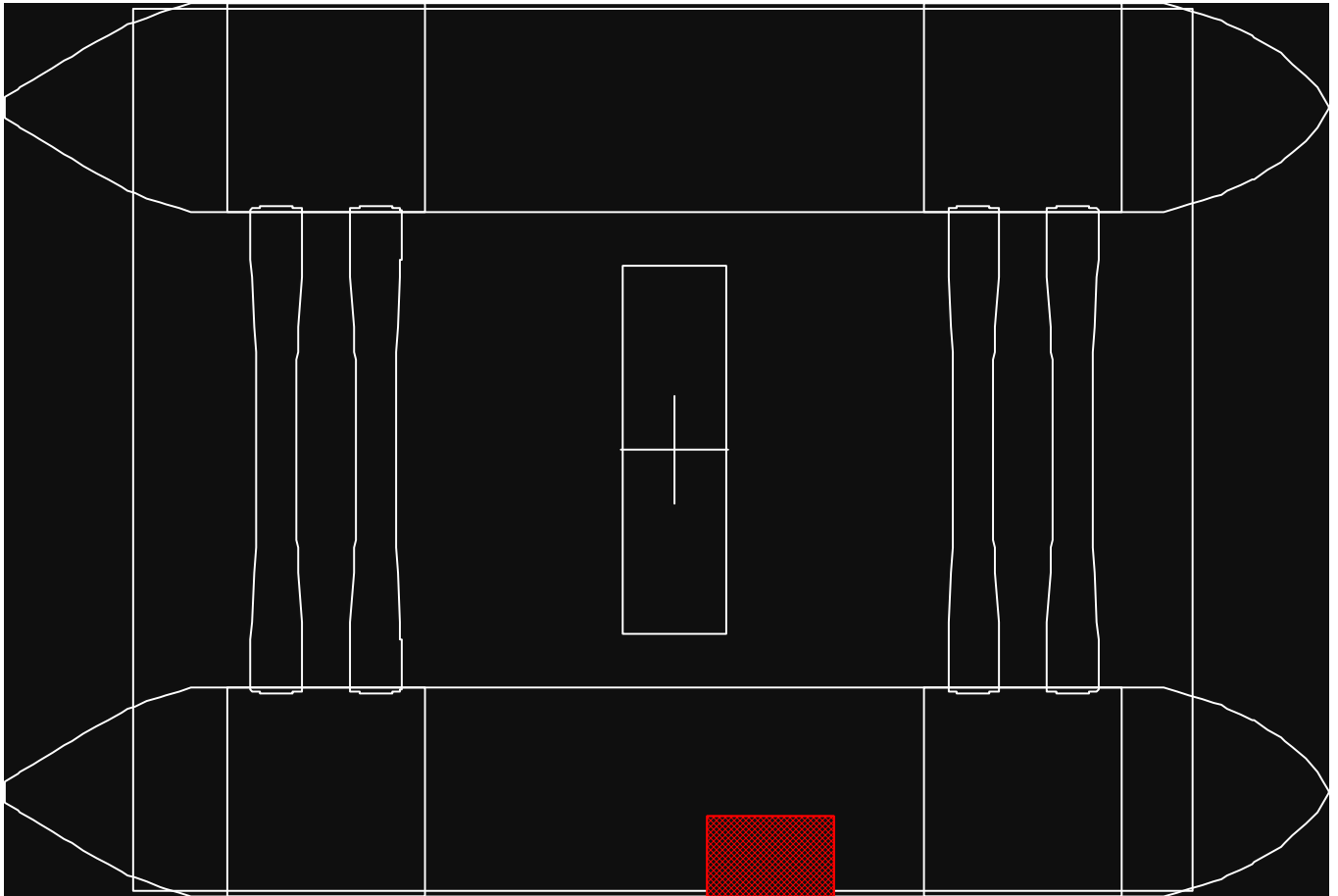

Displacer Status

Item	Status	Spgr	Displ (MT)	LCB (m)	TCB (m)	VCB (m)	Eff /Perm
HULL	Intact	1.025	41 458.77	0.575f	4.176s	7.578	1.000
ST8.S	Flooded	1.025	-609.79	7.500f	32.063s	5.027	0.950
SubTotals:			40 848.97	0.472f	3.760s	7.616	

Unprotected Flood Points

Name	L,T,V (m)	Height (m)
(1) DOOR AFT maindk. stb	27.700a, 29.000s, 37.600	13.029
(2) DOOR FORW maindk. stb	28.700f, 30.000s, 37.600	11.281

Hydrostatic Properties with Damage

No Trim, heel: stbd 13.18 deg.
Heel axis rotated Fwd 7.0 degrees

Depth (m)	Displ (MT)	LCB (m)	TCB (m)	VCB (m)	WPA (m ²)	LCF (m)	BMI (m)	BMt (m)
17.759	40848.970	0.472f	3.760s	7.616	1097.9	2.758a	21.984	21.708

Water Specific Gravity = 1.025.

Righting Arms vs Heel Angle with Damage

Heel axis rotated Fwd 7.0 degrees

Heel Angle (deg)	Trim Angle (deg)	Origin Depth (m)	Righting Arm (m)	Area (m-Rad)	Flood Pt Height (m)
0.00	1.66f	18.118	-0.486	0.000	18.749 (2)
2.00s	1.54f	18.108	-0.444	-0.016	17.627 (2)
4.00s	1.39f	18.077	-0.397	-0.031	16.496 (2)
6.00s	1.20f	18.029	-0.342	-0.044	15.362 (2)
8.00s	0.99f	17.963	-0.276	-0.055	14.206 (2)
10.00s	0.73f	17.886	-0.193	-0.063	13.045 (2)
12.00s	0.35f	17.802	-0.087	-0.068	11.905 (2)
13.06s	0.02a	17.762	-0.011	-0.069	11.352 (2)
14.00s	0.42a	17.740	0.078	-0.068	10.875 (2)
16.00s	0.99a	17.824	0.409	-0.060	9.574 (2)
18.00s	1.36a	17.979	0.912	-0.038	8.080 (2)
20.00s	1.55a	18.011	1.851	0.010	6.603 (2)
22.00s	1.62a	17.950	3.158	0.097	5.141 (2)
24.00s	1.64a	17.831	4.741	0.235	3.687 (2)
26.00s	1.63a	17.664	6.554	0.432	2.241 (2)
28.00s	1.53a	17.469	8.486	0.694	0.767 (2)
28.99s	1.44a	17.378	9.388	0.849	0.000 (2)
30.00s	1.31a	17.288	10.221	1.022	-0.799 (2)
32.00s	0.94a	17.088	11.592	1.403	-2.428 (2)
34.00s	0.34a	16.823	12.568	1.825	-4.110 (2)
36.00s	0.62f	16.447	13.143	2.273	-5.858 (2)

Unprotected Flood Points

Name	L,T,V (m)	Height (m)
(2) DOOR FORW maindk. stb	28.700f, 30.000s, 37.600	18.749

NMD AND IMO DAMAGE STABILITY FOR SEMI-SUBMERSIBLE

Limit	Min/Max	Actual	Margin	Pass
(1) Absolute Angle at Equilibrium	<17.00 deg	13.06	3.94	Yes
(2) Angle from Equilibrium to Flood	>10.00 deg	15.93	5.93	Yes
(3) RA Ratio between Equilibrium and RAzero or Flood	>2.000		<und>	No
(4) Absolute Area Ratio from Equilibrium to Flood	>1.000		<large>	Yes
(5) Righting Arm at PFlood	>2.500 m	13.143	10.643	Yes

Righting Arms vs. Heel

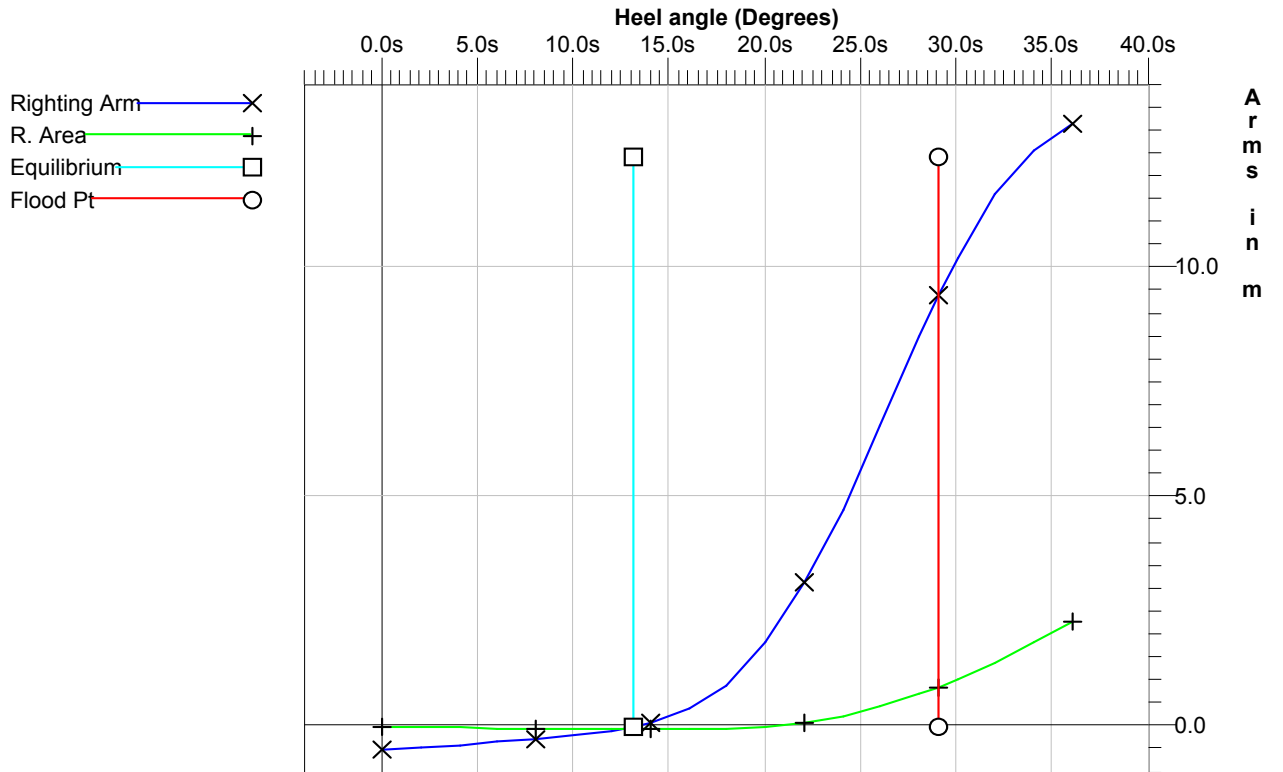



GG5000
DAMAGE CASE 2
1 Compartment flooded.
Operation draft 17.50 m.Wind 0 Knots
Rig Intact

Rig Floating Status

Draft(origin)	17.500 m	Equil	Yes	GM(Solid)	1.000 m
Heel	zero	Wind	Off	F/S Corr	0.000 m
Trim	zero	Incl.Axis	0.00	GM(Fluid)	1.000 m
LCG	0.022f m	Wave	No	KMT	24.783 m
TCG	0.000 m	VCG ⁵	23.783 m	KMI	25.438 m

Hydrostatic Properties

Draft is from Baseline.
 No Trim, No heel, VCG = 23.783

LCF Draft (m)	Displ (MT)	LCB (m)	VCB (m)	LCF (m)	TPcm (MT/cm)	MTcm (MT-m/cm)	GML (m)	GM(Solid) (m)
17.500	40848.970	0.022f	6.918	0.000	9.751	10.699	1.655	1.000

Water Specific Gravity = 1.025.
 Trim is per 63.18m

RIG WITH DAMAGE

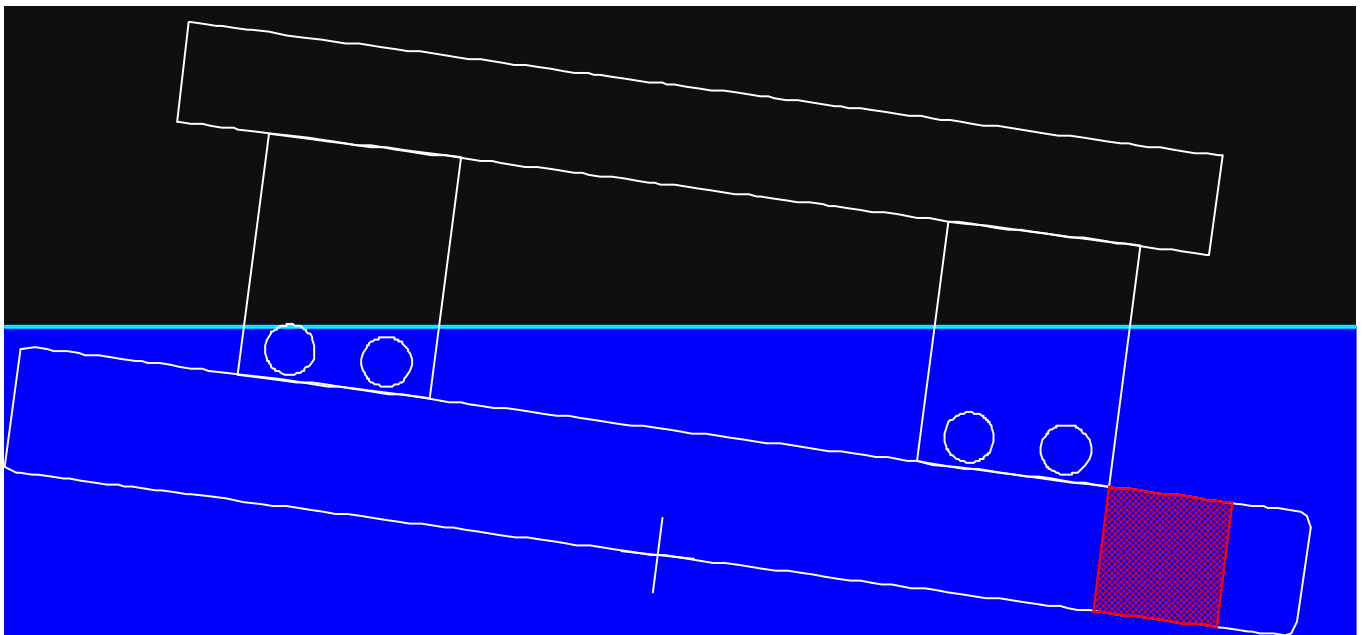

⁵ Note that the VCG here is the limiting VCG as a consequence of the rule requirement that the GM has to be at least 1m

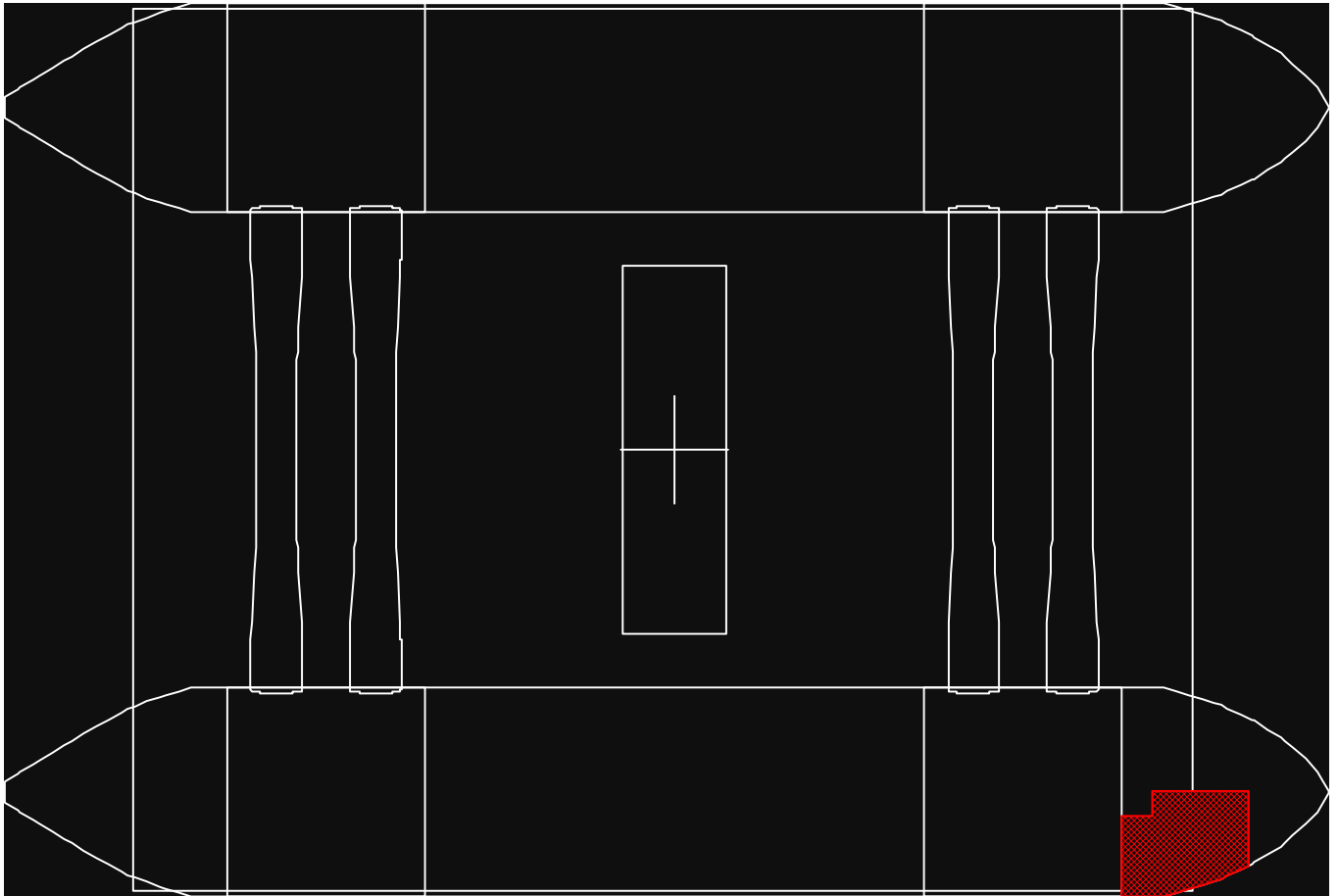

Displacer Status

Item	Status	Spgr	Displ (MT)	LCB (m)	TCB (m)	VCB (m)	Eff /Perm
HULL	Intact	1.025	41 533.53	2.741f	3.081s	7.554	1.000
ST2.S	Flooded	1.025	-684.60	40.211f	30.971s	5.039	0.950
SubTotals:			40 848.93	2.113f	2.614s	7.596	

Unprotected Flood Points

Name	L,T,V (m)	Height (m)
(1) DOOR AFT maindk. stb	27.700a, 29.000s, 37.600	17.521
(2) DOOR FORW maindk. stb	28.700f, 30.000s, 37.600	10.225

Hydrostatic Properties with Damage

No Trim, heel: stbd 11.68 deg.
Heel axis rotated Fwd 39.0 degrees

Depth (m)	Displ (MT)	LCB (m)	TCB (m)	VCB (m)	WPA (m ²)	LCF (m)	BMI (m)	BMt (m)
18.224	40848.930	2.113f	2.614s	7.596	1251.4	8.193a	27.410	22.475

Water Specific Gravity = 1.025.



Righting Arms vs Heel Angle with Damage

Heel axis rotated Fwd 39.0 degrees

Heel Angle (deg)	Trim Angle (deg)	Origin Depth (m)	Righting Arm (m)	Area (m-Rad)	Flood Pt Height (m)
0.00	6.21f	18.105	-0.789	0.000	18.904 (2)
2.00s	5.85f	18.103	-0.735	-0.027	17.492 (2)
4.00s	5.38f	18.085	-0.678	-0.051	16.063 (2)
6.00s	4.68f	18.073	-0.599	-0.074	14.607 (2)
8.00s	3.63f	18.083	-0.482	-0.093	13.113 (2)
10.00s	1.77f	18.154	-0.255	-0.105	11.570 (2)
11.63s	0.03f	18.224	-0.006	-0.109	10.265 (2)
12.00s	0.37a	18.237	0.056	-0.109	9.960 (2)
14.00s	2.53a	18.273	0.473	-0.100	8.326 (2)
16.00s	4.33a	18.306	1.102	-0.073	6.621 (2)
18.00s	5.39a	18.311	2.060	-0.019	4.883 (2)
20.00s	5.84a	18.241	3.344	0.075	3.178 (2)
22.00s	5.97a	18.095	4.856	0.218	1.519 (2)
23.87s	5.77a	17.893	6.182	0.399	-0.002 (2)
24.00s	5.74a	17.877	6.261	0.412	-0.102 (2)
26.00s	5.19a	17.569	7.342	0.650	-1.667 (2)
28.00s	4.41a	17.169	8.089	0.920	-3.172 (2)
30.00s	3.51a	16.680	8.547	1.211	-4.618 (2)
32.00s	2.56a	16.120	8.790	1.515	-6.016 (2)
34.00s	1.87a	15.665	8.879	1.823	-7.379 (2)
34.51s	1.41a	15.344	8.882	1.903	-7.725 (2)
36.00s	0.77a	14.860	8.855	2.133	-8.715 (2)

Unprotected Flood Points

Name	L,T,V (m)	Height (m)
(2) DOOR FORW maindk. stb	28.700f, 30.000s, 37.600	18.904

NMD AND IMO DAMAGE STABILITY FOR SEMI-SUBMERSIBLE

Limit	Min/Max	Actual	Margin	Pass
(1) Absolute Angle at Equilibrium	<17.00 deg	11.63	5.37	Yes
(2) Angle from Equilibrium to Flood	>10.00 deg	12.25	2.25	Yes
(3) RA Ratio between Equilibrium and RAzero or Flood	>2.000		<und>	No
(4) Absolute Area Ratio from Equilibrium to Flood	>1.000		<large>	Yes
(5) Righting Arm at PFlood	>2.500 m	8.883	6.383	Yes

Righting Arms vs. Heel

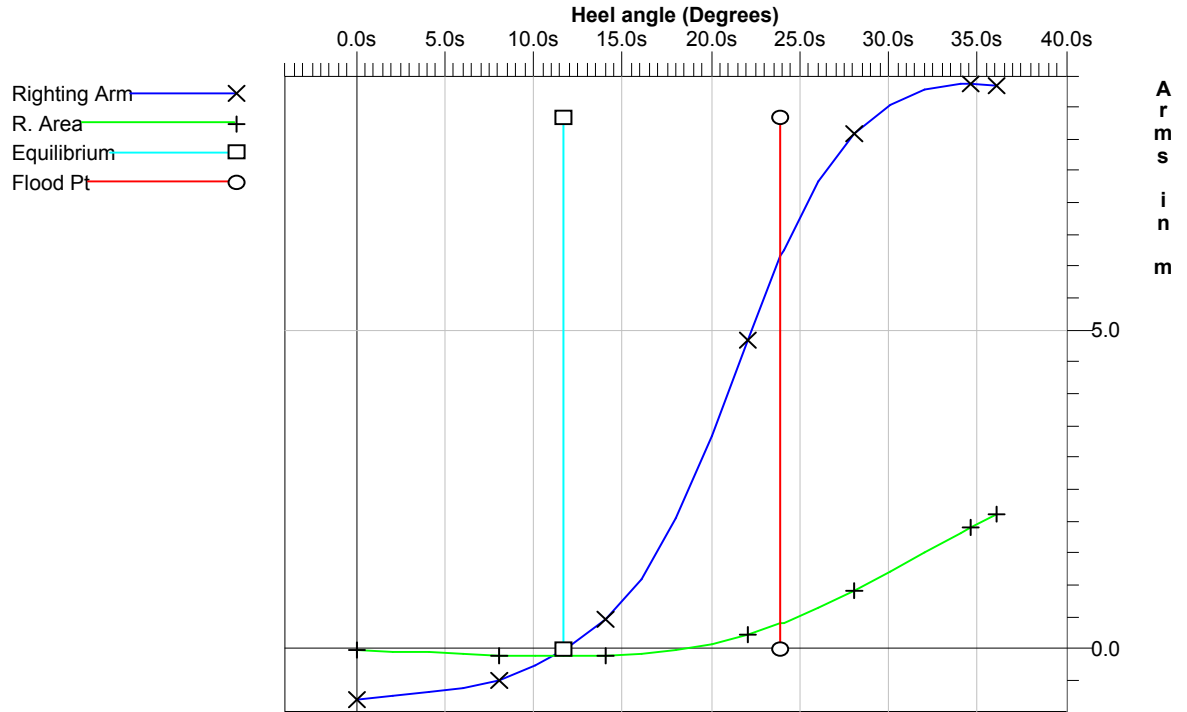

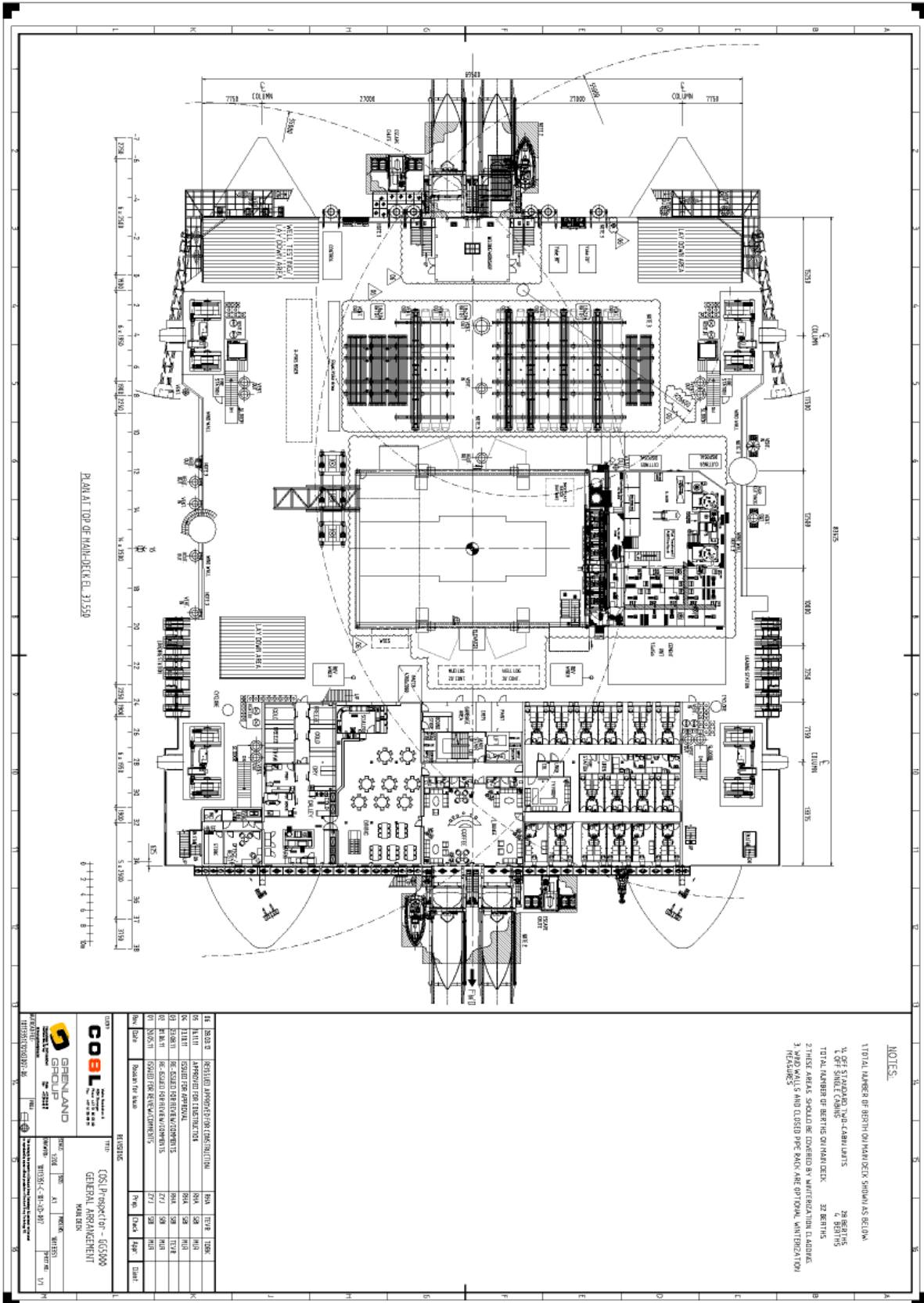

NOTES:

- TOTAL NUMBER OF BERTHS ON MAIN DECK SHOWN AS BELOW
- 4 SET STATIONS, 2 PAID CABINETS
- 2 BERTHS
- 27 BERTHS
- TOTAL NUMBER OF BERTHS ON MAIN DECK 37 BERTHS
- THREE AREAS SHOULD BE COVERED BY WATERPROOF LAMINATE
- 3 WIND WALLS AND CLOSED PER. WIND ARE OPTIONAL, WATERPROOF MEASURES

NO.	DESCRIPTION	NO.	TYPE	TOTAL
1	BERTH	37	TYPE 1	37
2	STATION	4	TYPE 2	4
3	CABINET	2	TYPE 3	2
4	WATERPROOF LAMINATE	3	TYPE 4	3
5	WIND WALL	3	TYPE 5	3
6	CLOSED PER. WIND	3	TYPE 6	3

COBL GROUP
 GENERAL ARRANGEMENT
 NUMBER: 065900

DATE: 2008
 DRAWN: AT
 CHECKED: WIKEN
 PROJECT: 171

