



NTNU – Trondheim
Norwegian University of
Science and Technology

An economic transport system of the next generation integrating the northern and southern passages

Anette Omre

Marine Technology

Submission date: June 2012

Supervisor: Soren Ehlers, IMT

Norwegian University of Science and Technology
Department of Marine Technology

MASTER THESIS 2012
for
Stud. Techn. Anette Omre

An economic transport system of the next generation – integrating the northern and southern passages

The global climate change continues to increase the marine transport in the Arctic Sea as a result of decreasing ice extends. However, the distinct conditions of the Arctic Sea, such as remoteness or the lack of marine infrastructure, represent a challenge to be surpassed in order to ensure safe and economic feasibility.

Additionally, the Arctic Sea may not be seen as a substitute for marine transport, but as an integral member of new transport systems as part of a global fleet- and supply chain management system. Therefore, the purpose of this work is to identify an assessment framework to integrate the northern and southern passages together in an economically feasible transport system. Hence, the methodology needs to be capable to assess this economic feasibility for the different routing and scheduling options to be made considering the distinct requirements of the Arctic sea. This assessment shall include the assessment of the feasibility of different ice classed vessels for the possible ice conditions to be encountered. The results shall be presented both on a generally applicable level as well as with the use of a case study, also discussing the assumptions and limitations of the study.

Ownership

NTNU has according to the present rules the ownership of the thesis. Any use of the thesis has to be approved by NTNU (or external partner when this applies). The department has the right to use the thesis as if a NTNU employee carried out the work, if nothing else has been agreed in advance.

Thesis supervisors

Prof. Sören Ehlers

Additionally, the Arctic laboratory manager Rüdiger von Bock und Polach (Dipl.-Ing.) from the Aalto University acted as a Co-supervisor.

Deadline: 10th of June 2012

Trondheim, 16th of September, 2011



Sören Ehlers

Preface

The purpose of this master thesis is to identify an assessment framework to integrate the northern and southern passages together in an economically feasible transport system. In addition the constraints of the NSR, both in terms of route limitations as well as vessel restriction for the most common transport system, will be investigated.

A model that simulates the transport systems has been developed. The development of the model has been more time consuming than first expected and much time has been used to alter the model and verify the results.

The report was written in the spring semester of 2012 and is the finalization of the Master of Science degree in Marine Systems Design at the Norwegian University of Science and Technology, NTNU. The thesis is weighted as 30 credits.

The author would like to express her gratitude to her thesis advisor Professor Sören Ehlers for valuable input, quick response to inquiries and constructive criticism. The author would also like to thank Professor Kaj Riska for his assistance and good advice.

Friday 8th June 2012

Stud. techn. Anette Omre

Abstract

The ice cap surrounding the Arctic Ocean has been significantly reduced during the last decades. As the ice continues to diminish the economic potential of the NSR is becoming stronger. However there are still challenges and uncertainties connected to navigation in the Arctic. Among these are the lack of marine infrastructure, the uncertainties regarding the regulations and length of the ice free season.

The purpose of this master thesis is therefore to develop a transport simulation model to investigate the economic feasibility of a NSR transport system. The route has not been evaluated as a year-round substitute for the traditional route through the Suez Canal, but has been integrated with the southern passage. As a result the Northern Sea Route is only used as an alternative in the navigation season between August and the end of November.

In order to investigate the feasibility of the route a case study is developed. Container cargo is evaluated as the most suitable shipping cargo; therefore the case study presents a possible container transport between Rotterdam in the Netherlands and Yokohama in Japan. The shorter distance of the NSR is exploited in two ways, either by slow steaming or increasing the number of transits a year. In addition the transport systems are evaluated for 4 different ice classes, 7 different ice scenarios and a fleet consisting of 6 or 7 vessels.

The transport simulation model calculates the speed and fuel consumption in ice with the use of an ice thickness-speed curve (h-v curve). The h-v curve is found by calculating the ice resistance of the vessel for variable ice thicknesses and the corresponding net thrust available to overcome this resistance. Further the model simulates the schedules and calculates the total fuel consumption for the entire fleet. The output of the model is the required freight rate (RFR) for the NSR transport systems and the Suez Canal route.

The simulation results indicate that:

- The optimal fleet size consist of 7 vessels
- The slow steaming schedule is more profitable than the maximum transits schedule
- The optimal ice class for the less severe ice scenarios are IC, while IB is better when the ice conditions harshen
- All ice classes are more profitable than the SCR if the ice conditions are less severe than ice scenario 5

Table of Contents

PREFACE	III
ABSTRACT	IV
TABLE OF CONTENTS	VI
LIST OF FIGURES	VII
LIST OF TABLES	VIII
1 INTRODUCTION	1
1.1 FEATURES OF THE NSR	2
1.2 CURRENT REGULATIONS AND VESSEL REQUIREMENTS ON THE NSR	7
1.3 RECENT BENCHMARK NSR TRANSITS	7
2 THE SUEZ CANAL ROUTE	9
3 BACKGROUND FOR THE TRANSPORT SYSTEM	10
4 COMBINING THE SOUTHERN ROUTE WITH THE NSR	12
4.1 THE CASE STUDY	12
4.2 THE ICE SCENARIOS	17
4.3 SHIP DIMENSIONS	18
5 METHODOLOGY	20
5.1 ICE RESISTANCE	20
5.2 THE NET THRUST CONCEPT.....	22
5.3 H-V CURVE	23
5.4 TRANSPORT SIMULATION MODEL	24
6 RESULTS	29
6.1 FLEET OF 6 OR 7 VESSELS.....	30
6.2 SLOW STEAMING VERSUS MAXIMUM TRANSITS A YEAR	31
6.3 NSR VERSUS SCR	34
7 FINAL DISCUSSION	36
7.1 EVALUATION OF THE RESULTS.....	36
7.2 BUNKER PRICE.....	37
7.3 INCREASING CARGO CAPACITY	38
7.4 OPERATIONAL DAYS A YEAR	40
7.5 EVALUATION OF THE SIMULATION MODEL.....	41
7.6 THE SUSTAINABILITY OF THE TRANSPORT SYSTEM.....	42
8 CONCLUSION AND FUTURE WORK	44
BIBLIOGRAPHY	45

List of Figures

FIGURE 1 SEA ICE EXTENT IN THE ARCTIC OCEAN (JAXA AND IARC, 2011).....	3
FIGURE 2 ARCTIC - ANNUAL AVERAGE SURFACE AIR TEMPERATURE ANOMALIES (RICHTER-MENGE, 2010).....	5
FIGURE 3 NEW ROUTE (YELLOW).....	8
FIGURE 4 FLEET SIZE AND CORRESPONDING TRANSIT TIME AND SPEED.....	13
FIGURE 5 THE VARIABLES IN THE NSR TRANSPORT SYSTEM.....	14
FIGURE 6 CURRENT AND PREDICTED OPERATIONAL DAYS ALONG THE NSR FOR DIFFERENT ICE CLASSES.....	14
FIGURE 7 INFLUENCE OF SPEED ON FUEL CONSUMPTION (NOTTEBOM, 2011).....	15
FIGURE 8 NAVIGATION CHANNEL, (JUVA AND RISKA, 2002).....	16
FIGURE 9 AVERAGE BRASH ICE THICKNESS OF THE 7 ICE SCENARIOS	18
FIGURE 10 ILLUSTRATION OF SHIP DIMENSIONS.....	19
FIGURE 11 H_F AND δ	21
FIGURE 12 ICE RESISTANCE CURVES	21
FIGURE 13 NET THRUST CURVE.....	23
FIGURE 14 THE H-V CURVE	23
FIGURE 15 MATLAB MODEL.....	24
FIGURE 16 RFR FOR THE SCR AND THE NSR FOR A SLOW STEAMING SCHEDULE WITH A FLEET CONSISTING OF 6 VESSELS	29
FIGURE 17 RFR FOR THE SCR AND THE NSR FOR A SLOW STEAMING SCHEDULE WITH A FLEET CONSISTING OF 7 VESSELS	29
FIGURE 18 RFR FOR THE SCR AND THE NSR FOR A MAXIMUM TRANSITS SCHEDULE WITH A FLEET CONSISTING OF 6 VESSELS.....	30
FIGURE 19 RFR FOR THE SCR AND THE NSR FOR A MAXIMUM TRANSITS SCHEDULE WITH A FLEET CONSISTING OF 7 VESSELS.....	30
FIGURE 20 SAVINGS PER TEU FOR THE SLOW STEAMING SCHEDULE COMPARED TO THE MAXIMUM TRANSITS SCHEDULE FOR DIFFERENT ICE CLASSES AND ICE SCENARIOS	32
FIGURE 21 MAXIMUM NUMBERS OF TRANSITS THROUGH THE NSR PER VESSEL FOR THE SLOW STEAMING SCHEDULE FOR DIFFERENT ICE SCENARIOS AND ICE CLASSES	33
FIGURE 22 MAXIMUM NUMBERS OF TRANSITS THROUGH THE NSR PER VESSEL FOR THE MAXIMUM TRANSITS SCHEDULE FOR DIFFERENT ICE SCENARIOS AND ICE CLASSES	33
FIGURE 23 SAVINGS PER TEU FOR THE NSR COMPARED TO THE SCR FOR THE DIFFERENT ICE SCENARIOS AND ICE CLASSES	35
FIGURE 24 INFLUENCE OF BUNKER PRICE ON ICE CLASS IB	37
FIGURE 25 INFLUENCE OF BUNKER PRICE ON ICE CLASS IC.....	37
FIGURE 26 RFR FOR DIFFERENT VESSEL SIZES.....	39
FIGURE 27 SAVINGS PER TEU FOR THE NSR COMPARED TO THE SCR FOR DIFFERENT CARGO CAPACITIES	40
FIGURE 28 REQUIRED TRANSITS A YEAR ON THE NSR IN ORDER FOR THE ROUTE TO BE PROFITABLE.....	41
FIGURE 29 REQUIRED OPERATIONAL DAYS A YEAR ON THE NSR IN ORDER FOR THE ROUTE TO BE PROFITABLE	41
FIGURE 30 REDUCTION IN EMISSIONS A YEAR FOR THE NSR COMPARED THE THE SCR	43
FIGURE 31 REDUCTION IN EMISSION OF SO _x , NO _x AND CO ₂ FOR THE NSR COMPARED TO THE SCR	43

List of Tables

TABLE 1 METEOROLOGICAL CHARACTERISTICS FOR NSR AREAS	4
TABLE 2 HAZARDOUS WEATHER ALONG THE NSR.....	4
TABLE 3 NSR TRANSITS IN 2009 AND 2010	8
TABLE 4 NSR AND SCR DETAILS	9
TABLE 5 EU-CHINA TRADE 2011	10
TABLE 6 EU-JAPAN TRADE 2011	10
TABLE 7 EU-SOUTH KOREA TRADE 2011	10
TABLE 8 SCHEDULE DETAILS SCR.....	13
TABLE 9 SCHEDULE DETAILS NSR	15
TABLE 10 MAXIMUM CHANNEL ICE THICKNESS FOR ICE CLASSES (JUVA AND RISKÅ, 2002)	16
TABLE 11 ICE SCENARIOS FOR THE NSR.....	17
TABLE 12 MAIN DIMENSIONS.....	19
TABLE 13 SCHEDULE.....	26
TABLE 14 COST BASIS FOR A 3800 TEU VESSEL (LEVANDER, 2009)	27
TABLE 15 INCREASE IN CAPITAL COST FOR ICE CLASSED VESSELS (ERIKSTAD AND EHLERS, 2012)	27
TABLE 16 RFR FOR THE SLOW STEAMING AND MAXIMUM TRANSITS SCHEDULE FOR A FLEET CONSISTING OF 6 AND 7 VESSELS	31
TABLE 17 RFR FOR THE SLOW STEAMING AND MAXIMUM TRANSITS SCHEDULE FOR A FLEET OF 7 VESSELS OF ICE CLASS IAS	32
TABLE 18 TRANSIT NUMBERS AND NUMBER OF DELIVERED TEUS FOR THE SLOW STEAMING SCHEDULE	34
TABLE 19 TRANSIT NUMBERS AND NUMBER OF DELIVERED TEUS FOR THE MAXIMUM TRANSITS SCHEDULE	34
TABLE 20 VESSEL DETAILS.....	39
TABLE 21 THE YEAR THE OPERATIONAL REQUIREMENT ON THE NSR IS FULFILLED FOR DIFFERENT ICE SCENARIOS AND ICE CLASSES	41

List of nomenclature

CO ₂	Carbon dioxide
FESCO	Far Eastern Shipping Company
FSICR	Finnish Swedish Ice Class Rules
EU	European Union
GSSDS	Global Sea Salvage Distress System
IAS	IA Super
MOHQ	Marine Operation Headquarters
MSCO	Murmansk Shipping Company
NO _x	Nitrogen oxide
NSR	Northern Sea Route
RFR	Required freight rate
SCR	Suez Canal Route
SFC	Specific fuel consumption
SO _x	Sulphur oxides

1 Introduction

The principal commercial maritime routes have had few changes since the beginning of the 20th century. However, global warming and technological progress have opened up a possible pathway between Asia and Europe on the Northern Sea Route (NSR). The NSR is defining the different fairways going from Novaya Zemlya in the west to the Bering Strait in the east. The length of the route depends on the ice conditions and the choice of different stretches of the route, but is generally considered as 2100 to 2900 nautical miles. Russia has claimed ownership of the route and has controlled the traffic since the beginning of the 20th century. The first commercial transit was completed in 2009.

Today there is a growing interest in the NSR as a transit route. The distance between Northern Europe and Northeast Asia can be reduced with as much as 50 % compared to the traditionally route through the Suez Canal. The presence of thick ice has been the main reason for not considering this pathway as an option, but as the ice continues to diminish the economic potential of using the route is becoming stronger. Therefore, DNV expects 480 container transit voyages across the Arctic Sea in 2030 (DNV, 2010). However there are some risks and uncertainties related to shipping in the remote Arctic areas such as issues with the regulation of the route, unstable weather and lack of sufficient infrastructure.

Hence, this thesis presents the constraints of the NSR, both in terms of route limitations as well as vessel restriction for the most common transport system. Furthermore, a comparison to and integration of the Suez Canal route and the NSR will be presented for a range of ice conditions and resulting vessel speeds and different ice classes. Hence, this paper will therefore not evaluate the route as a replacement for the route through the Suez Canal but rather look at the economic feasibility of a vessel using both routes. As a result required freight rate (RFR) will be presented for the life span of the vessel, which amortizes the capital expenditure while comparing the operational expenditure to the Suez Canal route (SCR). In conclusion, the RFR for the NSR can be discussed in contrast to the current climate and ice extent developments and thereby allow for an evaluation of the feasibility of the NSR as a transit route.

A case study will be developed in order to be able to compare the different transport systems. Similar NSR transport systems have been developed and analysed by others. (Liu and Kronbak, 2009) have analysed a year-round NSR transport system and found that the NSR is unprofitable compared to the Suez Canal route. However global climate models indicate that the winter sea ice cover will decline, but not disappear during this century, hence this report will only regard the NSR as a feasible option in the navigation season between August and the end of November. Further (Verny and Grigentin, 2009) describes a transport system where the navigable days a year, bunker price and NSR fees are variables. The calculations are done for the ice class IB. The results that reflects the current amount of navigable days, indicates that the route will be more profitable than the SCR if the NSR fees are reduced to 3 USD per net tonnage and the level of the bunker price is 700 USD per ton. However the speed in the ice infested areas are not calculated but are assumed to be constant at 10 knots and the calculations are only done for a single vessel. In conclusion, there are many factors that must be included in a route evaluation so that the results are somewhat realistic or feasible. In order to increase the accuracy of the analysis a transport simulation model will be made. The model will calculate the resistance in ice for a given ice thickness and ship size, simulate the schedule for an entire fleet and calculate the cost per TEU. In addition this will be done for 7 different ice scenarios and 4 ice classes.

1.1 Features of the NSR

The NSR lies in a remote area where the environment imposes significant challenges for navigation compared to the SCR. In this section the area along the NSR will be presented, looking into the bathymetry, ice and weather conditions and infrastructure. These are all factors that may set restrictions to the transport system and must be evaluated and included in the feasibility study.

1.1.1 Bathymetry and ice and weather conditions on the NSR

The NSR follows the Arctic Ocean, passing from west to east, the Barents Sea, Kara Sea, Laptev Sea, East Siberian Sea and Chukchi Sea. All seas are dominated by shallow waters that set certain draft restrictions for the vessels. The draft restriction depends on the route choice which is dependent on the ice conditions. In September the ice concentration along the route is small and the vessels are able to navigate farther offshore where the depths increases.

One may encounter several types of ice at sea in the Arctic. The dominant ice type along the NSR is thick first year level ice, but this depends on the time of year. First year ice is relatively soft due to inclusions of brine cells and air pockets. It will in general not damage an ice-strengthened ship operated with caution. The merchant vessels transiting through the NSR will never navigate independently in level ice when ice breaker support is currently mandatory. When an ice breaker breaks the level ice a channel of brash ice is created. This type of ice is easier for the vessels to navigate in than the first year level ice.

The maximum extent of sea ice is found in March, while the minimum is found in September. From an operational view, the season is short and varies every year; it stretches from late July to late November. In September, the end of the melting season, usually only the multi-year ice at the centre of the Arctic Ocean remains (Kon, 2001). How the sea ice extent is changing throughout the year is illustrated in Figure 1. Additionally, (J, 2008) presents the rapid decline of sea ice in the Russian Arctic based on summer ice extent measures as low as 10% and winter measures as low as 60%. Also (NSIDC, 2010) reports that the ice cap has diminished 40% between 1979 and 2010. The sea ice extent has a great influence on the operational season in the Arctic, and with the decreasing ice cover it is evident that the operational season has become longer over the last decade.

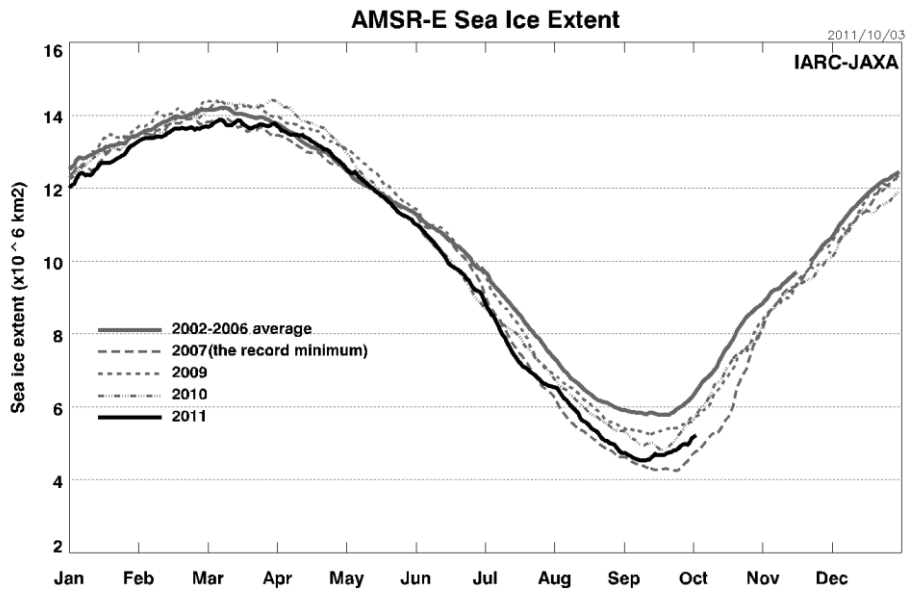

Figure 1 Sea ice extent in the Arctic Ocean (JAXA and IARC, 2011)

Several Global Climate Models have been used to simulate the decline in sea ice cover of the Arctic Ocean. Perhaps one of the most interesting findings in these simulations is that none of them indicate that the winter sea ice cover will disappear during this century (Arctic Council, 2006). With this in mind it is clear that all year transport in the Arctic region will remain a challenge in the near future.

Navigation is among others affected by wind, air temperatures and visibility. Polar stations are the main regular data source for these meteorological data on the NSR. However, data from the coast stations do not always reflect meteorological conditions on the NSR. The main factors influencing the arctic seas meteorological conditions are solar radiation, atmospheric circulation and inhomogeneous underlying surfaces. The inhomogeneous underlying surfaces are caused by the presence of inland and drift ice, influence of warm waters from the Atlantic and Pacific Oceans, water inflow from Siberian rivers and topography.

There are three different climate areas along the NSR; the Atlantic area, the Siberian area and the Pacific area. The Atlantic Area consists of the Barents Sea, western part of the Kara Sea and part of the Arctic Ocean. The Siberian area is the area of eastern Kara Sea, Laptev Sea and the western part of the East Siberian Sea. The Pacific area consists of eastern part of the East Siberian Sea and the Chukchi Sea. In Table 1 the meteorological characteristics for each area is listed.

Table 1 Meteorological characteristics for NSR areas

Area	Winter	Summer
Atlantic	Low atmospheric pressure and disturbed weather	Frequent fogs and rain
Siberian	Colder air temperatures than in surrounding areas. High pressure	Temperatures rises considerably in the southern parts, remains cold in northern parts
Pacific	Higher temperatures, greater wind strength and more rain than surrounding areas.	Lowest atmospheric pressure on the NSR, considerable air temperature amplitudes. Frequent fogs in southern parts

Throughout the year hazardous meteorological phenomena may occur on the NSR. Strong winds often appear during the winter, while in the summer fog can worsen the horizontal visibility to dangerous limits. In the Arctic seas the levels of the hazardous weather phenomena are as listed in Table 2.

Table 2 Hazardous weather along the NSR

Hazardous	Very hazardous
Wind speed of 15 m/s and more	Wind speed of 35 m/s and more
Fog, snowstorm or rain reducing the visibility to 50-500m	Thick fog, snowstorm or rain reducing the visibility to 50m or less
Sticking of melting snow with a layer thickness of 11mm and more	Intensive sticking of melting snow with a layer thickness of 35mm and more
Slow icing with ice accumulation rate of 0,6 cm per hour and more	Very fast icing with ice accumulation rate 1,4 cm per hour and more

The conditions mentioned in Table 2 may appear fast and are sometimes difficult to predict. To avoid the hazardous weather conditions in the summer season, ships often have to change the course, leading to a less optimal route. In the winter season it can be more difficult to change the course due to thick ice layers on alternative routes, hence dangerous situations can occur. Furthermore, the temperature in the Arctic has increased significantly over the recent years. Figure 2 shows the annual average air temperature anomalies relative to the 1961-90 mean based on land stations over 60°N. As a result, it has been documented that the Arctic sea ice extent has been declining for the past five decades together with the thickness of the sea ice cover (AMSA, 2009).

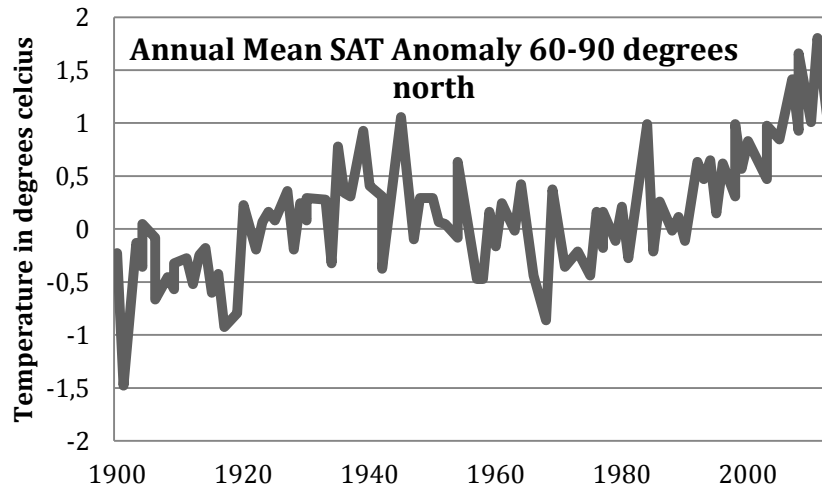

Figure 2 Arctic - Annual average surface air temperature anomalies (Richter-Menge, 2010)

1.1.2 Infrastructure

To create an efficient and safe transport system it is important to have a functional vessel, but it is also essential to invest and construct good basic facilities and services that are required for shipping activities.

When navigating in ice infested waters adequate ice information is essential. The ice information is needed to design an optimum route that will reduce the fuel consumption, transit time, as well as reducing the risk of ending up in dangerous areas or getting stuck in ice. The NSR is equipped with visual and radio aids to help navigation. Coastal navigation is ensured mainly by light and day beacons fitted with passive radar reflectors and racons. The lighted aids only operate from mid-August to the termination of navigation. Radio aids to navigation are also widely used. These are radio navigational and satellite systems, as well as marine radio beacons. The ship radar is in most cases a reliable tool for position fixing when navigating near the coast. The range of radar horizon varies with the weather conditions (Dodd, 1985).

When looking at the different parameter of ice data, the thickness is the least documented one. The satellites have difficulties with measuring the ice thickness and most data comes from in situ observations. Considering the large area the NSR covers, it will be impossible to collect up to date thickness measurements by in situ observation. (Arctic Council, 2006) also highlights the need of more navigational data to secure safe Arctic marine shipping. There are measures that have taken place within this field the recent years and the access to information is constantly increasing. One of the most interesting developments within this field is the new global navigation satellite system Glonass. The system can track an objects speed and location and is therefore equivalent to the U.S. GPS navigation system. Glonass will increase the access to radio aids on the NSR when it will provide continuous year-round navigation support, regardless of the weather conditions (Pettersen, 2011c).

There are more than 50 ports along the NSR, but only 41 are open to foreign vessel. Among these there are only 8 ports that are capable of handling merchant ships, but the quality and the operational status are limited (Vanebo, 2011). Due to lack in investments and maintenance services, only the ports in Dudinka and Zelëny Mys are reported to be in a satisfactory state (Ragner, 2000). At an Arctic conference in Arkhangelsk in 2011, Russia's Prime Minister Vladimir Putin stated:

"We intend to turn it (NSR) into one of the key trade routes of international significance and scale, which will be able to compete with traditional international corridors"

"To support the shipping via the northern seas, Russia plans to develop infrastructure in the Arctic, including the construction and modernization of roads, railroads, airports and seaports and the expansion of its icebreaking fleet that currently includes 10 nuclear ice-breakers" (Blackseagrain, 2011)

It is unknown if any concrete investments have been made with respect to the ports, but these statements are a positive sign regarding the future development.

The NSR has been criticised for the lack of sufficient rescue facilities. As of today the Marine Operation Headquarters (MOHQ) are responsible for the search and rescue operations. The ice-class salvage tugs operate from Dikson and Pevek. In these ports there are stand-by salvage and repair teams working in the navigation season. Besides the salvage tugs the MOHQs also operate the icebreakers working along the NSR. If an accident occurs the icebreaker closest to the location of the accident will be routed to the vessel. The Global Sea Salvage Distress System (GSSDS) covers all of the NSR regions. The emergency radio watch routine is unknown. When it comes to positioning of the accident it is likely that it have improved with the new Glonass satellite system in place.

One of the main reasons for the criticism of the rescue facilities is the response time. The distance between the two rescue ports is considerable; hence a vessel being stuck in ice in the Laptev Sea can expect to wait several days for rescue. Russia has responded to the criticism and is now investing 910 billion roubles (€21.8 million) in the development of ten centres for search and rescue along the Northern Sea Route. In the ten centres there will be working a total of 980 persons. The construction of the centres is planned to finish in 2015 and the locations will be in Murmansk, Arkhangelsk, Naryan-Mar, Vorkuta, Nadym, Tiksi, Pevek, Provideniya and Anadyr (Pettersen, 2011b). The rescue centre in Tiksi, located in Laptev Sea, is maybe the most needed. With this centre up and running the response time is significantly decreased for accidents occurring in the Laptev Sea.

The icebreaking fleet operating in the Arctic can be divided into two groups; the nuclear icebreakers and the diesel-electric icebreakers. The nuclear icebreakers are operated by the Rosatomflot. They have a fleet of 7 atomic icebreakers (Atomflot, 2011). The Russian company Far Eastern Shipping Company (FESCO) controls 4 diesel –electric icebreakers and Murmansk Shipping Company (MSCO) has one. The nuclear icebreakers are the biggest and most powerful icebreakers in the world and were built to assist the traffic along the NSR (FESCO, 2011). Only three of the icebreakers are built after 1990, the rest is built in the period 1975-1990 and will soon be out of service. The amount of needed icebreaker assistance depends on the ice conditions and the state of the ship transiting. Until now no foreign ship has sailed the entire route without any help from icebreakers. The icebreakers can handle the current level of traffic, but will have problems with handling an increase in traffic. Based on this prospect the Russian government has decided to allocate 20 billion RUB to the building of new icebreaking vessels. 3 diesel-electric icebreakers and one nuclear icebreaker are to be constructed in the near future. By 2020 the aim is to have in total three new nuclear icebreakers and six new diesel-electric icebreakers (Barentsnova, 2011).

In addition to the size of the fleet of icebreakers the size and performance of the icebreakers also sets certain restrictions for the ship being assisted. The maximum speed and the breadth of the icebreaker set the maximum speed and allowable breadth for the ship. The open water speeds of the Russian icebreakers are around 20-21 knots. The icebreaker breaks up a channel that is slightly wider than its own beam. If the breadth of the ship exceeds this width it will result in higher ice resistance. Most of

the Russian icebreakers have a beam around 30 m and breaks up a channel that is 32-33 m, hence this will be the breadth restrictions for the NSR with the current conditions.

1.2 Current regulations and vessel requirements on the NSR

During navigation season all shipping on the NSR is under the control of the MOHQ. Having at their disposal data from aircraft ice reconnaissance and ice patrol, as well as ice hydro meteorological forecasts, the MOHQ determines dates of beginning and termination of navigation on different route stretches. They also provide optimum routes for shipping, icebreaker support and aircraft ice reconnaissance support. To enter the route and get the support from MOHQ, everyone has to pay a certain fee. The fee depends on different criterions; time of year, navigation on the entire path or parts of the NSR and the ship size. Furthermore, according to Dodd (1985) no model for calculating the fee exists; so far the amount has been established through negotiation. Hence, (Vanebo, 2011) concludes consistently that in order to make shipping in the NSR a commercial success it is important that the fees don't erase the advantages of the reduced transit time and fuel costs. The large fees have been looked upon by many as one of the major obstacles of making the NSR a commercial pathway. The MOHQ have recently reduced the fees (Vanebo, 2011). Christian Bonfils, CEO of Nordic Bulk Carriers, the operator of the MV Nordic Barents which in 2010 sailed along the NSR, has stated that the cost for icebreaker service was 210.000 USD. He further stated that this was comparable to transit fees for the Suez Canal (Mahony, 2011). The manager of Rosatomflot, Vyacheslav Ruksha, stated in 2010 at an international maritime conference that the fee, in the future, would be slightly above the Suez Canal rate (Vanebo, 2011). However the level of the fees are highly uncertain and difficult to predict when they are a function of traffic volume, development rate of infrastructure and political factors (Erikstad and Ehlers, 2012). In this report the fee is assumed to be 5 USD/net tonnage.

To get a permit to sail the NSR the ship owner has to apply 2 months in advance, with the potential reduction of 1 month for the subsequent journey (Erikstad and Ehlers, 2012). All documents are written in Russian and are time consuming to fill out for non-Russian companies. If the MOHQs accepts the application the ship and its equipment needs to be inspected by agents from MSCO or FESCO. The MSCO run the western MOHQ while FESCO run the eastern MOHQ. The inspectors evaluate the ice worthiness of the ship to estimate how much escort the ship needs from icebreakers and to clarify that all other requirements are satisfied. If the ship is approved the MOHQs will schedule a date and route based on the capabilities of the ship and the availability of icebreakers (Liu and Kronbak, 2009).

1.3 Recent benchmark NSR transits

Only recently have companies begun to find the route profitable, as the receding polar ice cap has opened paths further offshore that allows larger ships with deeper drafts the routing. 2009 was marked as a test year for commercial ships sailing the entire NSR from Europe to Asia. In 2009, two vessels from Beluga Shipping Group sailed on the NSR as a part of a small convoy escorted by a Russian nuclear-powered icebreaker. In 2010 the traffic increased and 8 vessels completed the journey. More detailed information can be found in Table 3 (Vanebo, 2011).

Table 3 NSR transits in 2009 and 2010

Owner	Vessel	Dwt	Cargo	Comments
Beluga Shipping Group	MV Foresight	12000	Power plants components	First transit made by foreign vessel (2009)
	MV Fraternity	12000		
Beluga Shipping Group	MV Houston	12000	Power plants components	Parts of NSR used (2010)
	MV Fortitude	20000		
Murmansk Shipping Company	Indiga	16000	Fuel (diesel)	First transit in 2010
	Varzuga	16000		
Sovcomflot	Baltica	100000	Natural gas condensate	Biggest shipping of gas through NSR (2010)
Nordic Bulk Carriers	MV Nordic Barents	41000	Iron ore	First transit made by foreign bulk carrier (2010)
Norilsk Nikkel	Monchegorsk	18000	Concentrate of metal	First transit without icebreaker support (2010)
Russian state-owned	Georg Ots	12600	Passenger ship	First transit made by a passenger ship (2010)

In 2011, 34 vessels went through the NSR and the sailing season was extended by a month. Among these ships was the Panamax-class tanker STI Heritage that set a speed record on the NSR. STI Heritage sailed from Murmansk to Map Ta Phut in Thailand, spending six and a half days on the NSR with an average speed of 14 knots. The previous record was eight days.



Figure 3 New route (yellow)

The normal pack-ice surrounding the New Siberian Islands had vanished in 2011, allowing larger oil tankers to enter the NSR because of the deeper waters around the islands, see Figure 3. This resulted in an increase in gas condensate transport. Nine large tankers transported in total 600.000 tons of gas condensate along the route, during the four months sailing season. They sailed the new ice free pathway north of the Novo Siberian Island. This route has a draft restriction of 13-15 meter, while the old route

through the Sannikov Strait sets stricter requirements to both draft and speed. In total 820 000 ton of cargo was transported along the NSR this year. 15 of the 34 vessels transported liquid cargo (682 000 ton), three carried bulk (110 000 ton), four refrigerator ships transported salmon (27 500 ton), two vessels transported general cargo and ten vessels sailed with only ballast (Pettersen, 2011a).

2 The Suez Canal route

In contrast to the NSR, the Suez Canal runs north to south across the Isthmus of Suez in Egypt and connects the Mediterranean Sea and the Red Sea. The canal length is 103.7 nm and most of the canal is limited to a single lane of traffic. The vessels pass through in convoys and for joining a certain convoy the ship has to send an arrival notice at least 48 hours in advance. As for the NSR the vessels also have to be inspected before entering the canal, but after being inspected the vessel is handed a certificate that can be used for future transits (Authority, 2012).

The Suez Canal fee can easily be calculated. The Suez Canal Authority has made a model which is based on the tonnage of the vessel, where the fees decreases per ton with increasing tonnage. The size restrictions in the canal are mainly the draft and the height of the ship because of the Suez Canal Bridge which is situated 70 m above the water. The draft restriction is 20.1 m and there is also a deadweight restriction of 240 000 ton, meaning that the largest super tankers are not submitted if fully loaded (Authority, 2012). The Suez Canal is located in an area with the highest frequency of pirate attacks. The piracy and the fact that the Suez Canal passes conflicting areas has been a big concern for shipowners the recent years. Furthermore, the shipping of cargo at sea is increasing 6% per year (Valkonen, 2011). This may lead to a capacity problem in the Suez Canal being one of the busiest shipping lanes in the world. A summarizing table of differences for the Suez and NSR is presented in Table 4.

Table 4 NSR and SCR details

	NSR	Suez	Comments
Distance	7280	11180	Rotterdam-Yokohama
Transit time [days]	Depends on the ice conditions	20*	*with an average speed of 24 knots
Uncertainties	Ice and weather conditions, Russian regulations.	Piracy	Russian administration is often considered as unreliable
Transit notice	4 months	48 hours	
Insurance	No model exists	Yes	
Probability of delays	High	Low	
Fees	5 USD/net tonnage*	Depends on net tonnage	*assumed value in this report
Max draft	13 m	20.1 m	
Max breadth	32-33 m *	50 m	*Depends on the breadth of the icebreaker
Infrastructure	Not sufficient	Good	

3 Background for the transport system

In the process of evaluating the most suitable and economic sustainable commodity to be transported along the route, the current cargo flow between the Far East and Europa has been used. In order to benefit from the potential reduction of routing by using the NSR, the route should be from Northern Europe to countries in the Far East such as China, Japan and South Korea. All three countries are among the top 10 trading partners of the European Union (EU), hence the potential market is significant. The main imports and exports between Europe and the Far East are machinery and transport equipment as seen in Table 5-7, i.e. containerized cargo (Commission, 2011).

Table 5 EU-China trade 2011

	Imports	Exports
Total	€292.1 billion	€136.2 billion
Machinery and transport equipment	49 %	60 %
Others*	30%	14 %
Textile and clothing	13 %	1 %

*Non-agricultural, chemicals or fuel and mining products

Table 6 EU-Japan trade 2011

	Imports	Exports
Total	€65 billion	€44 billion
Machinery and transport equipment	67 %	31 %
Chemical products	7 %	14 %
Agriculture products	< 1 %	11 %

Table 7 EU-South Korea trade 2011

	Imports	Exports
Total	€36.1 billion	€32.4 billion
Machinery and transport equipment	64 %	50 %
Others*	20 %	19 %
Chemicals	6 %	16 %

*Non textile, agricultural or fuel and mining products

As is shown in table 5-7, there is an imbalance in import and export between Europe and Asia. Europe imports more than twice as much as it exports to China. The result is that about two TEUs leave Asia for every TEU leaving Europe (OECD, 2006), resulting in a decrease in the total utilization factor of the vessels.

The container ships usually operate in the liner market. In liner shipping a ship follows a regular scheduled service that is similar to a bus line. The cargo transported by the liner market is often too small to fill a single ship and needs to be shipped with other types of cargo. The mix of cargo makes the planning and administration of the ships more complex and the timeframe is strict. This means that the vessels operate on a given schedule where they are granted certain slot times in each port to do the loading/unloading. If the vessels arrive outside this timeframe they receive fines from the port administration or the cargo owner or both. The unpredictable weather and ice conditions in the Arctic will impose challenges for Arctic container shipping in contrary to vessels using non-arctic routes.

However, cost is also crucial because the whole manufacturing business depends on cheap transport and the NSR could reduce the shipment cost.

Vessels navigating the high north will be exposed to icing. In areas where the sea is ice covered the problem of icing is less than when there is no ice as the ice cover prevents water from being blown up in the air. With a decrease of the ice extent the risk of icing might grow in the future. Icing will affect a container vessel heavily because of the topside cargo, which is exposed to spray, particularly in the bow section of the vessel. Due to the stacking of topside containers, it will also become more difficult to remove ice. Another aspect is that the topside cargo is located high above the metacentre of the vessel, resulting in larger impact on the stability of the vessel if the topside cargo becomes packed with ice.

As pointed out by the (AMSA, 2009) report, the low temperatures along the route might further affect the cargo transported along the NSR. For a container vessel this might mean that not all types of cargo can be transported and thus setting restrictions to what types of cargo that can be transported in containers. This thesis however assumes that the NSR transit days will not be affected by weather influences other than the sea ice extent.

When strengthening a vessel to operate in ice the strengthening primarily involves an increase in plate thickness and frame scantlings. This strengthening result in a higher steel weight, and thus the payload compared to similar vessels without ice strengthening becomes less. However, container vessels, are generally more sensitive to volume rather than weight and hence it can be concluded that a container carrier is less sensitive to the increased steel weight and the ice strengthening of the structure would have a minor impact on the operations.

4 Combing the southern route with the NSR

For a liner shipping company running a container shipping service between ports in Europe and in the Far East, the benefit of using the NSR could be significant. But how to combine and fit shipments through the NSR into the regular liner service can be a challenging task with numerous solutions. In this chapter a case study is presented to investigate some of the transport options.

4.1 The Case Study

The incentive for the case study is to investigate the economic feasibility of shipping through the NSR for a fleet operating between the ports of Rotterdam and Yokohama. The purpose is not to clarify if the route is optimal compared to the traditional SCR today or in the near future, but rather to investigate under what conditions it may be profitable to use. In addition the influence of the choice of ice class is evaluated to find the optimal ice class for navigation in both open water and ice infested waters.

The case study presents a possible container transport between Rotterdam in the Netherlands and Yokohama in Japan. It is assumed that only these two ports are visited during the round-trip and one ship leaves each port ones a week. Shipping is only a part of a larger transport system build-up of roads, railways, airfreight etc. that also competes to some degree with each other, and there are large support systems running the business such as ports etc. (Stopford, 2009). These support systems will not be dealt with in this paper. The transport system will be compared with an equal transport system going through the Suez Canal year-round. Cargo owners that operate in the liner segment considers the frequency of sailings as an important factor of the freight service (Stopford, 2009), hence a weekly schedule service has been set as a requirement. The number of vessels in the fleet must then be decided based on a competitive one way transit time and the corresponding speed. A traditional liner service between Europe and the Far East visits 7-10 ports during a roundtrip and the one-way transit time is rarely more than 45 days. This is of course dependent on the type of cargo and the size of the vessel. The transport system in the case study will only visit two ports so it is reasonable to assume that the one way transit time will be much lower, hence the maximum one way transit time has been set as 25 days. Further it is assumed that the vessels spend two days loading/off-loading in each port and that the average transit and waiting time on the Suez Canal is 20 hours. The length of the Suez Canal Route (SCR) is 11180 nm. The one way transit time for varying fleet sizes can now be calculated with the vessel speed as a variable. The fleet sizes and the corresponding transit time and speed is illustrated in Figure 4. As seen in Figure 4, the only applicable numbers of vessel in the fleet are 5, 6 and 7. If the fleet consist of only 5 vessels the required average speed in order to keep the weekly schedule will be 31.8 knots which is an unreasonable high speed for a container vessel. As a result the number of vessels in the fleet evaluated in this case study are 5 and 6. Scheduling details are found in Table 8.

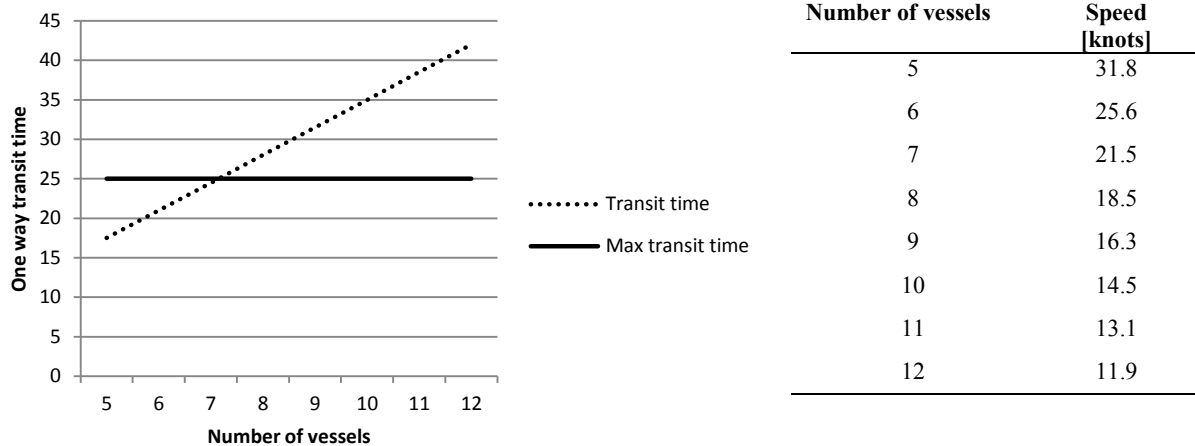

Figure 4 Fleet size and corresponding transit time and speed

The vessels will not operate 365 days a year. Each year the vessels will have 2 days off-hire, each 5th year 15 days of docking and after the first 5 years 11 days of docking each 2.5 years (Klaveness, 2012). With an expected lifetime of 20 years the average operational days per year are 358 days.

Table 8 Schedule details SCR

	Fleet 1	Fleet 2
Numbers of vessels	6	7
Distance [nm]	11180	11180
Time in port [hours]	47.5	47.5
Waiting and sailing time		
Suez Canal [hours]	20	20
Average speed [knots]	25.6	21.5
Round-trip time [days]	42	49

The route through the NSR is 35 % shorter than the route through the Suez Canal, so it is reasonable to assume that 6 and 7 vessels will satisfy the weekly service requirement for both routes. Further each fleet will either exploit the shorter distance through the NSR by slow steaming the rest of the route or increasing the number of transits a year. In order to see how the ice conditions will affect the competitiveness of the NSR, 7 ice scenarios are set up. In addition these options will be tested for 4 different ice classes, see Figure 5. More information about the schedule options will be found in the next sections.

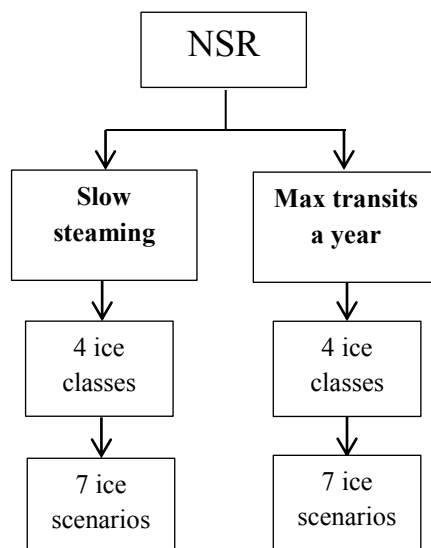

Figure 5 The variables in the NSR transport system

4.1.1 Slow steaming versus maximum transits a year

The Arctic is still covered with heavy ice during the winter and navigation throughout the year on the NSR is not viable. The transport system in this case study will therefore combine the use of the Suez Canal in the winter with the use of the NSR in the summer season. The NSR is only open for navigation between August and end of November, hence the route will only be regarded as an option during these 4 months, even though it is likely to believe that the navigation season will increase due to the diminishing ice cap as illustrated in the figure x from the paper (Erikstad and Ehlers, 2012).

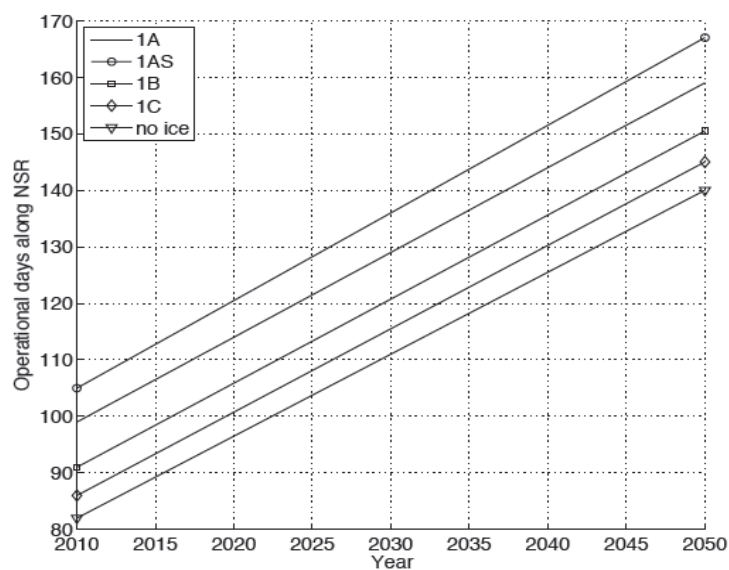

Figure 6 Current and predicted operational days along the NSR for different ice classes

The benefits of the shorter sailing distance the NSR offers can be exploited in two ways:

1. Slow steaming through NSR
2. Increasing the transits a year

Slow steaming means reducing vessel speed through the NSR in the navigational season, and thereby utilizing the shorter distance. By doing so, the operator will consume less fuel by steaming slower, as speed and consumption is directly connected as shown in Figure 6. Slow steaming is a usual strategy for shipping operators to save costs in market lows, in addition to decreasing transport capacity and emissions (Cariou, 2011, Stopford, 2009). Using this alternative, the operator can fit the use of the NSR without altering the existing schedule.

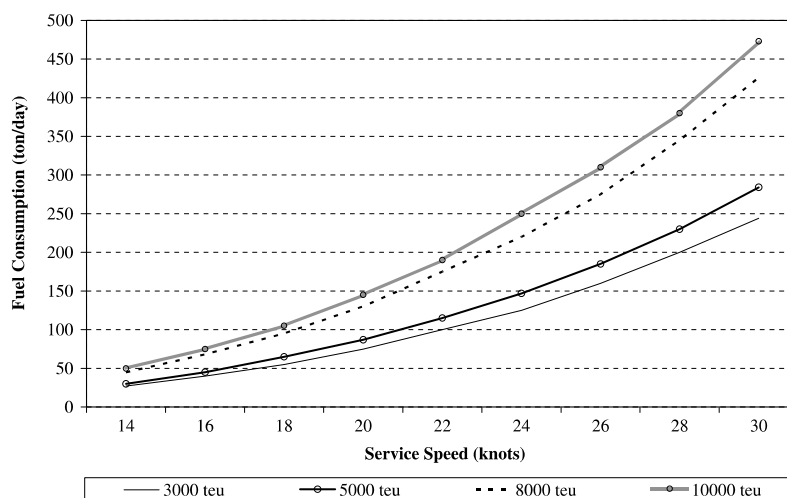

Figure 7 Influence of speed on fuel consumption (Nottebom, 2011)

The second alternative is to use utilize the reduced distance by increasing the amount of transits a year. That way one could use the NSR as a way to increase cargo capacity due to the shorter distance, and thus increasing the transits a year. In periods with high demand, this alternative could be used. Although, fitting alternative two into the regular operation will be more demanding than slow steaming as in alternative one. Schedule information for the two options follows in Table 9.

Table 9 Schedule details NSR

Schedule details:	Option 1 Slow Steaming		Option 2 Max transits	
	Fleet 1	Fleet 2	Fleet 1	Fleet 2
Numbers of vessels	6	7	6	7
Distance [nm]	7280	7280	7280	7280
NSR [nm]	2500	2500	2500	2500
Time in port [hours]	47.5	47.5	47.5	47.5
Waiting time NSR [hours]	20	20	20	20
Average speed [knots]	-	-	25.6	21.5
Round-trip time [days]	42	49	-	-

4.1.2 Ice class

The merchant vessels operating in ice covered areas must compete with the open water vessels during the winter season when the NSR isn't navigable. It is a challenge to find a design solution that optimizes the performance in both open sea and ice infested waters. The ice classed vessels will have less payload capacity than the open water vessels because of the additional weight of the ice strengthening on the hull. Normally an ice strengthened ship will also need more propulsion power to satisfy the ice class requirements, but this is not necessary for vessels with an open water speed of more than 20 knots, when reaching high speeds requires a great deal of power and therefore the power requirement is automatically fulfilled (Riska, 2012). To reduce the additional weight from the required ice strengthening one can use icebreaker escort. If a ship is being escorted by an icebreaker the ice strengthening requirements decreases as opposed to a ship navigating independently without assistance. In this case study ice breaker assistance is a requirement and it is assumed that the Russian ice breaker fleet has the capacity to offer a regular ice breaker service, even though this is not true for the current situation, see chapter 1.1.2. The ice classes evaluated are:

- 1A Super
- 1A
- 1B
- 1C

The most important factors that separate these ice classes are the building cost and the ice thickness restrictions. The difference in building costs will be evaluated in chapter 5.4.4. In Table 10 the ice restriction for each ice class is presented.

Table 10 Maximum channel ice thickness for ice classes (Juva and Riska, 2002)

Ice Class	Channel thickness, H_m [m]
IA Super	1
IA	1
IB	0.8
IC	0.6

H_m represents the thickness of the brash ice in the middle of the channel, see Figure 8. IA Super (IAS) and IA have the same brash ice restriction.

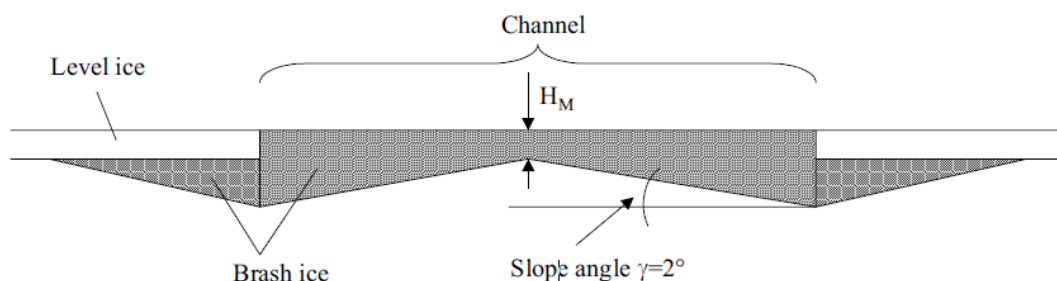

Figure 8 Navigation channel, (Juva and Riska, 2002)

As of today it is required to have an ice class equivalent to 1A to enter the NSR. This paper is assuming that the requirement will disappear in the future and investigates the influence of choosing other ice classes. To lower the ice class will reduce the weight and building cost, but it may also reduce the transit days on the NSR. It is important to have a transport system that can compete with others both in the winter and in the summer season. To fulfil this requirement one need to find the most economical balance between the open water and the ice performance. In general a good ice performance is defined as low ice resistance, high thrust when going in ice, the ability to avoid being stuck in ice and the ability to get out if stuck in ice (Kaj Riska, 1997). However in this report the speed in ice is the only parameter that is of importance for the transport system.

4.2 The ice scenarios

The ice coverage on the route will greatly influence the schedule and the economical aspect. Different ice alternatives have therefore been made to investigate the influence of the ice thickness. The NSR has been divided into ten equal legs and it is assumed that the vessels will only encounter ice along these ten legs in the navigation period, see Appendix 1 for the map of the legs. The ice alternatives are not a prediction of the future ice condition but are made to analyse the effect of the ice thickness on the economic feasibility. The maximum ice thickness has been set as 1 m because of the restriction for the highest ice classes. The 14 ice alternatives are listed in Table 11. The first ice alternative has no ice, in the second the ice starts accumulating along the route according to the video (NASA, 2011), which shows the propagation and melting pattern of the ice in the Arctic Ocean. The growth in thickness per alternative is an assumption when up to date numbers has been difficult to find.

Table 11 Ice Scenarios for the NSR

Ice alternatives	Ice thickness									
	leg 1	leg 2	leg 3	leg 4	leg 5	leg 6	leg 7	leg 8	leg 9	leg 10
1	0	0	0	0	0	0	0	0	0	0
2	0	0	0	0.1	0	0	0	0	0	0
3	0	0	0	0.2	0	0	0.1	0	0	0
4	0	0	0	0.3	0.1	0.1	0.2	0	0	0
5	0	0	0.1	0.4	0.2	0.2	0.3	0	0	0
6	0.1	0.1	0.2	0.5	0.3	0.3	0.4	0.1	0.1	0.1
7	0.2	0.2	0.3	0.6	0.4	0.4	0.5	0.2	0.2	0.2
8	0.3	0.3	0.4	0.7	0.5	0.5	0.6	0.3	0.3	0.3
9	0.4	0.4	0.5	0.8	0.6	0.6	0.7	0.4	0.4	0.4
10	0.5	0.5	0.6	0.9	0.7	0.7	0.8	0.5	0.5	0.5
11	0.6	0.6	0.7	1	0.8	0.8	0.9	0.6	0.6	0.6
12	0.7	0.7	0.8	1	0.9	0.9	1	0.7	0.7	0.7
13	0.8	0.8	0.9	1	1	1	1	0.8	0.8	0.8
14	0.9	0.9	1	1	1	1	1	0.9	0.9	0.9

One of the challenges of this paper has been to simulate somewhat realistic ice conditions. The ice alternatives in Table 11 only illustrates how the ice thickness can be when 1 trip is made, but how to combine these ice alternatives when several numbers of trips are made during one season has been a challenge. The result was that 7 new ice scenarios were made with the 14 already existing alternatives. These 7 ice scenarios are called ice 1-7 and have the variable x in the MATLAB script. In ice 1 the first transit through the NSR will be ice free, the second time the same vessel enters the NSR the ice thickness has increased to ice alternative 2 and the third time ice alternative 3 and so on. The variable i represents the number of trips in the MATLAB script. In ice 2 the vessel encounters ice alternative 2

on the first trip on the NSR and ice alternative 3 on the second trip and so it continues for ice 3 to ice 7. The average thickness on the route for the 7 new ice scenarios is shown in Figure 9.

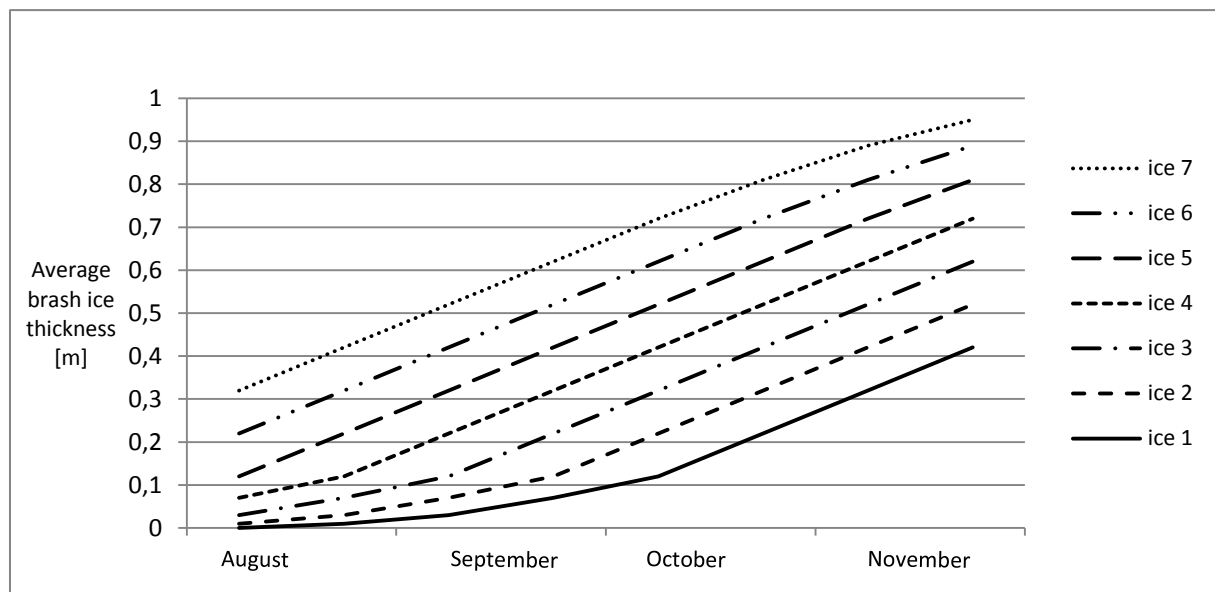

Figure 9 Average brash ice thickness of the 7 ice scenarios

It's difficult to discuss the accuracy of the ice scenarios when there has been hard to find numbers on the thickness propagation for each month, but as mentioned earlier the aim of the model is not to predict future ice scenarios, but rather to analyse the influence of the ice thickness. However, portraying the ice conditions in such a manner will give more conservative results for the maximum transits option when the vessel in this fleet will have more trips through the NSR than the slow steaming alternative when the ice thickness increases with each trip. As a result a 'slow steaming' ship and a 'maximum transits' ship may enter the NSR the same day, but the ice thickness will be thicker for the 'maximum transits' ship because she has had more trips through the NSR prior to the current trip.

The 4 ice classes have different ice restrictions and this is implemented in the model. If the ice thickness is greater than the restrictions for IB or IC the model will assign the vessel a speed of 0.01 knots. The model has a NSR entering limit and this will be surpassed with a speed of 0.01 knots so the model stops entering NSR and goes through the Suez Canal instead.

4.3 Ship dimensions

The dimensions of the ship have been based on the vessel restrictions on the NSR. As mentioned in chapter 1.1, the area along the NSR are mostly shallow waters, hence a draft restriction of 13 m has been set. In addition there is also a restricted breadth of 33 m because of the size of the ice breakers. The dimensions of the ship is listed in Table 12 (Sørstrand, 2012).

Table 12 Main dimensions

	3800 TEU
L	250 m
L_{PAR}	130 m
B	32.2 m
T	12 m
Propulsion power	35 000 kW
Power delivered P_D (80 % MCR)	19 600 kW
K_e	0.78
A_{wf}	806.5 m ²
Deadweight	50 000 ton
Payload	3800 TEU
Design speed open water	24 knots
α	23 °
φ	90 °
Bulb	yes
Propeller	1
D_p	7.5

All 4 ice classes will have the same main dimensions except the lightship weight. The lengths and angles are illustrated in Figure 10. $\varphi=90$ because of the bulb. K_e describes the efficiency of the propeller when power is converted into bollard pull and changes with the number of propellers (Juva and Riska, 2002). The difference in lightweight will be compensated by increasing the fuel consumption for the higher ice classes.

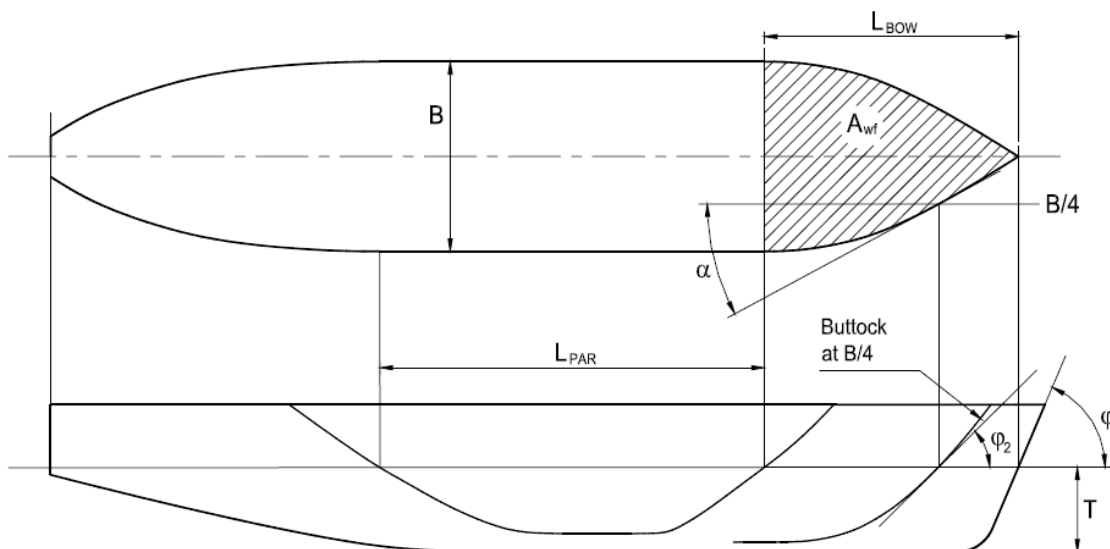

Figure 10 Illustration of ship dimensions

5 Methodology

The model has been made with MATLAB as a tool to run the simulations for the different transport systems. In this chapter the development of the transport system will be explained in addition to the theory used.

5.1 Ice resistance

The ice resistance must be calculated in order to find the h-v curve and hence the transit time and fuel consumption in the different ice conditions. The h-v curve gives the relation between the ice thickness and the ship speed. To find the h-v curve one must calculate the ice resistance for different ice thicknesses and the net thrust available to overcome the resistance. In this section the ice resistance is calculated.

The superposition principle separates the ice resistance into two parts, the open water resistance and the brash ice resistance. The open water resistance will not be calculated in this report because it is not included in the net thrust concept which will be used together with the brash ice resistance to calculate the h-v curve. The brash ice resistance can be divided into two components, one breaking and one friction part. The breaking component comes from breaking the brash ice and pushing it down while the friction component is due to the friction from the broken ice along the hull. A speed dependent equation from (Juva and Riska, 2002) has been used to calculate the resistance and is given by the following formula:

$$R_{ch} = 0.5\mu_B\rho_\Delta g H_F^2 K_p \left[\frac{1}{2} + \frac{H_M}{2H_F} \right]^2 \left[B + 2H_F \left(\cos\delta - \frac{1}{\tan\psi} \right) \right] (\mu_h \cos\phi + \sin\psi \sin\alpha) \quad (1)$$

$$+ \mu_B\rho_\Delta g K_0 \mu_h L_{par} H_F^2 + \rho_\Delta g \left[\frac{LT}{B^2} \right]^3 H_M A_{WF} F n^2$$

where μ_B is 0.8 [-], ρ_Δ is 150 [kg/m³], K_p is 6.5, μ_h is 0.02 and K_0 is 0.68.

μ_B represents the porosity factor of ice, ρ_Δ is the difference in densities of water and ice, A_{WF} is the waterline area of the foreship, $F n$ is Froudes number, L_{par} the length of the parallel midbody at waterline, L is the length, B the breadth and T is the draft of the ship. Both μ_B , the porosity factor of ice, and ρ_Δ , changes with the temperature of the ice, but the value has been set to be constant. K_p is a mechanical factor of ice and has been found in (Kujala and Sundell, 1992). μ_h , the friction coefficient, is also a variable that varies with the temperature and other mechanical properties of ice and it is difficult to measure the exact value. The value of K_0 is taken from (Kujala and Sundell, 1992) where it has been calculated for the ice in the Baltic Sea. The value may be a bit conservative as the Baltic Sea ice is very hard.

H_F represents the thickness of the brash ice that is pushed down and to the side by the bow, sees Figure 11. The thickness H_F is given by the following formula:

$$H_F = H_M + \frac{B}{2} \tan\gamma + (\tan\gamma + \tan\delta) \sqrt{\frac{B[H_M + \frac{B}{4} \tan\gamma]}{\tan\gamma + \tan\delta}} \quad (2)$$

Both γ and δ are slope angles of the brash ice and have a value of respectively 2° and 22.6° . If $B > 10$ m and the brash ice thickness $H_M > 0.4$ m, the equation can be modified to:

$$H_F = 0.26 + (BH_M)^{0.5} \quad (3)$$

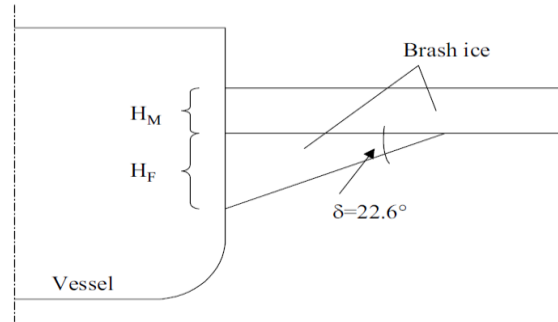

Figure 11 H_F and δ

The flare angle ψ in equation 1 can be calculated with the bow angles ϕ and α :

$$\psi = \arctan \left[\frac{\tan \phi}{\sin \alpha} \right] \quad (4)$$

The results of the calculations are shown in Figure 12.

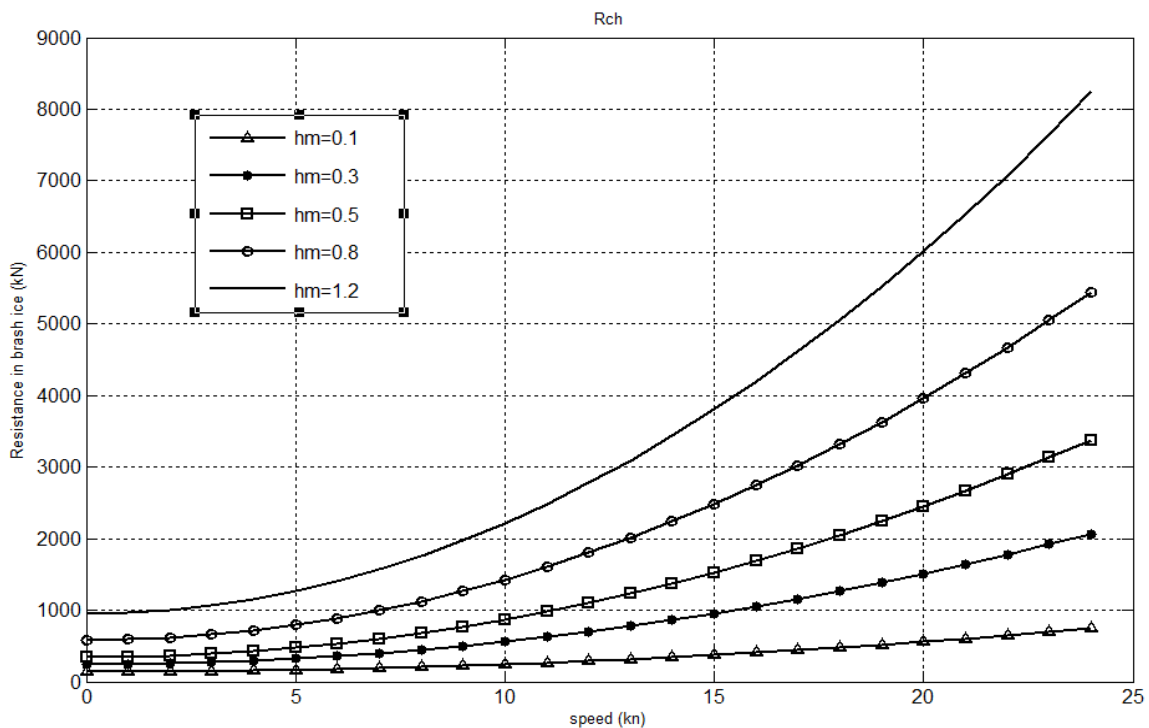

Figure 12 Ice resistance curves

5.2 The net thrust concept

For the calculation of the available propulsion power the net thrust concept has been used. The net thrust concept T_{net} is defined as:

“the thrust available to overcome the ice resistance after the thrust used to overcome the open water resistance is taken into account” (Juva and Riska, 2002)

The formula for T_{net} is as follows:

$$T_{tot}(v)(1 - t) = R_{ow}(v) + R_i(v) \quad (5)$$

$$T_{net}(v) = T_{tot}(v)(1 - t) - R_{ow}(v) = R_i(v) \quad (6)$$

where $(1-t)$ is the thrust deduction factor, $R_{ow}(v)$ the open water resistance and $R_i(v)$ the ice resistance.

Equation 6 can be expressed further by using the bollard pull T_B

$$T_{net}(v) = \left(1 - \frac{1}{3} \frac{v}{v_{ow}} - \frac{2}{3} \left(\frac{v}{v_{ow}}\right)^2\right) T_B \quad (7)$$

$$T_B = K_e (P_D D_P)^{2/3} \quad (8)$$

where v is the speed in brash ice while v_{ow} is the open water trial speed, K_e is the bollard pull quality factor, D_P the propeller diameter and P_D is the actual power delivered.

See Table 12 to find the values of the constants. Equation 7 has been achieved by making a parabolic curve between the two points where T_{net} is known, $T_{net} = T_B$ when $v=0$ and $T_{net} = 0$ when $v = v_{ow}$. In (Juva and Riska, 2002) it has been shown that the calculated T_{net} - curve is somewhat conservative compared to the full scale trials. The T_{net} curve follows in Figure 13.

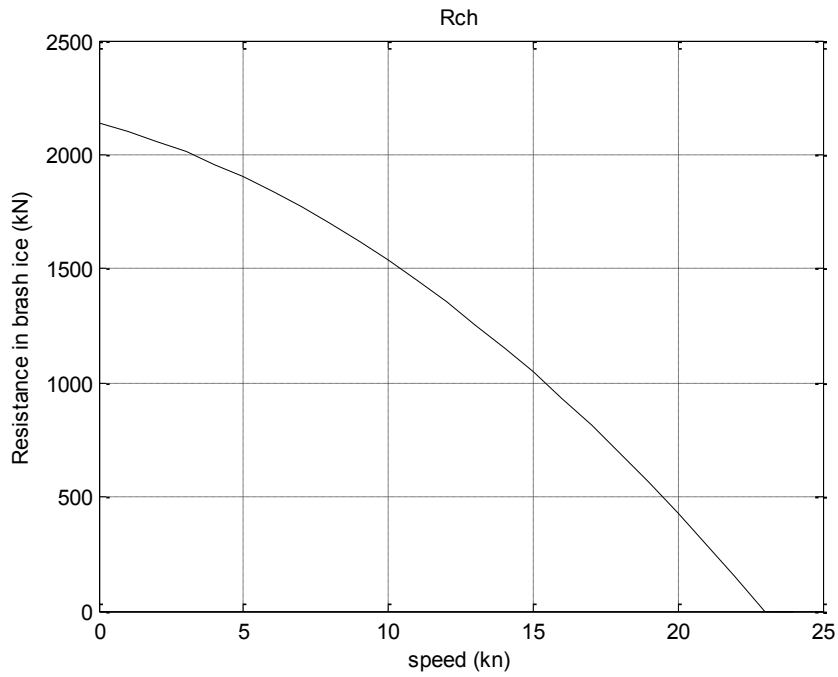

Figure 13 Net thrust curve

5.3 H-v curve

When the ice resistance R_{ch} for the different ice thicknesses and the T_{net} curve has been calculated, the results are plotted in the same graph. The intersecting points in the graph where $R_{ch} = T_{net}$ are then found and plotted in a new graph that gives the relation between ice thickness h and speed v . The h - v curve for the 3800 TEU vessel is found in Figure 14.

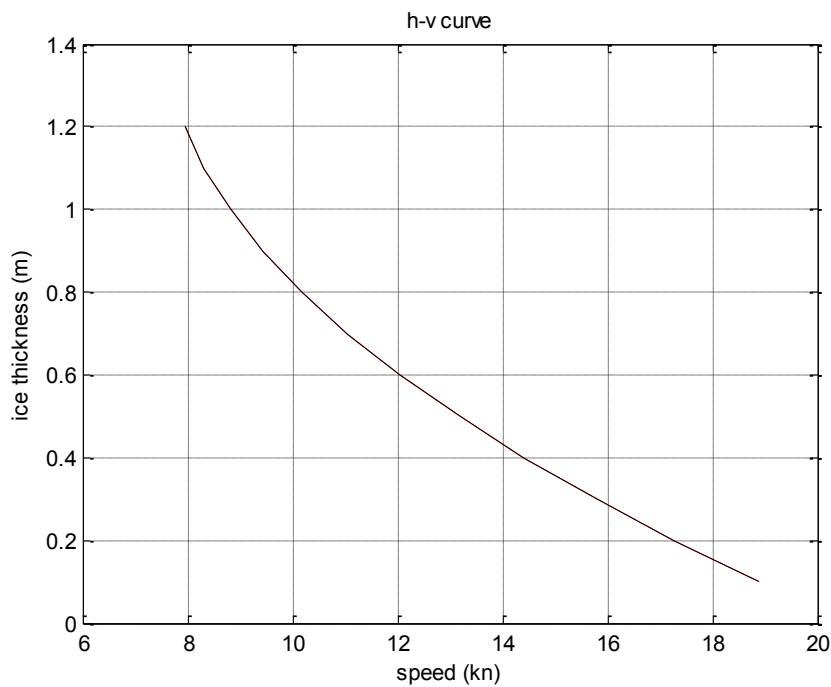

Figure 14 The h-v curve

5.4 Transport simulation model

Figure 15 presents a simplified step by step illustration of the MATLAB model. The MATLAB codes can be found in Appendix 6.

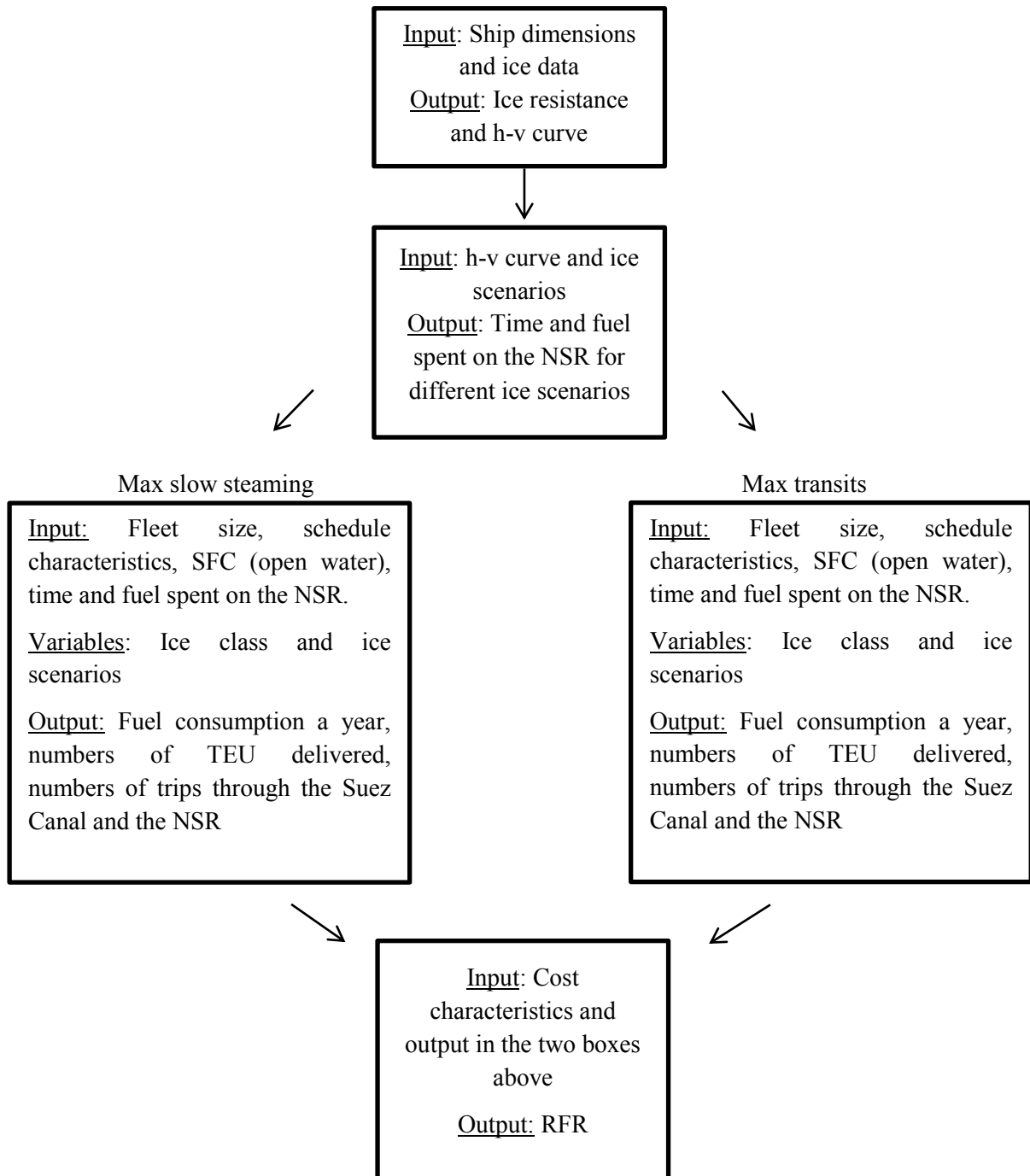

Figure 15 MATLAB model

5.4.1 Step 1- H-v curve

In the first step of the model the h-v curve is calculated. All ice classes will have the same curve even though it is reasonable to believe that it will be slightly different for the higher ice classes. Since the main focus of this report is the transport system and not the design this has not been implemented in the model.

5.4.2 Step 2- Transit time and fuel consumption

Time and fuel consumption on the NSR is calculated in the next step. The model finds the equation for the h-v curve and uses the ice thickness from the ice scenarios as a variable and returns the speed for a specific ice thickness. In the cases where the ice thickness is 0 the speed is set to be 18 knots when it is assumed that there will be a speed limit on the NSR because of the risk of hitting ridges and such. When the speed is known the time is calculated by dividing the distance with the speed. The fuel consumption calculations are also a function of the speed. An assumption that 80 % MCR is used whenever the ship encounters ice has been made, while the fuel consumption in no ice corresponds to the fuel consumption in 18 knots. The fuel consumption graph in Figure 7 has been used to calculate the specific fuel consumption (SFC) [tons/day] by doing an interpolation between the results for 5000 TEU and 3000 TEU. Further the results have been plotted in MATLAB and an equation for the SFC for a 3800 TEU vessel has been found. The graph can be found in Appendix 2 and the equation follows:

$$SFC = 0.6 * v^2 - 12 * v + 84 \quad (9)$$

Equation 9 is only valid when the speed is more than 12 knots. At last the fuel consumption is calculated with equation 9

$$fc = SFC * t \quad (10)$$

where fc is the fuel consumption and t represents time and is given in days. The time and fuel calculations are done separately for each leg of the route and for each ice scenario.

The ice classes have different fuel consumption. The fuel consumption depends on the hull form. Usually at the lower ice classes IB and IC the hull form doesn't deviate from the open water hull form and the fuel consumption is almost the same. An increase in fuel consumption of 2 % and 3 % for respectively IC and IB has been assumed. In higher ice classes the fuel consumption depends on how much the hull has been modified for ice performance. If the hull form has been modified slightly, but still has a bulbous bow one can assume that the fuel consumption increases with 10 % (Riska, 2012). To divide the highest ice classes the fuel consumption has been set as 8 % increase for IA and 10 % increase for IA Super.

5.4.3 Step 3 - Schedule

When the speed and time in ice is calculated the schedule for each ship in the fleet can be simulated. The schedule for the slow steaming option will have the same roundtrip time as the comparison fleet going through the Suez Canal. This roundtrip time is therefore calculated to begin with. As mentioned in chapter 3, the cargo flow between Europe and the Far East is not equal. Europe imports more than twice as much as it exports to the Far East, one can therefore not assume a fully loaded vessel going both ways, hence a utilization factor of 0.75 has been assumed, i.e. the vessels carry 2850 TEUs. The time in port is a function of the numbers of cranes available, the capacity of the cranes and the amount of TEUs being loaded and off-loaded. The number of cranes is 4 for both ports and the capacity of the cranes is set as 30 [TEU/hour]. The values are based on numbers from the port in Oslo, but are slightly increased when it is reasonable to believe that the major container hubs in Rotterdam and Yokohama have a greater capacity than Oslo (Agerup, 2012). The average transit time through the Suez Canal is 16 hours (Authority, 2012), in addition an average waiting time of 4 hours has been assumed. The

average waiting time for the NSR is assumed to be higher, 20 hours, when the vessels may need to wait for ice breaker assistance or the unstable weather may create delays.

The roundtrip time for the NSR options with 6 and 7 vessels are respectively 42 and 49 days. Since the NSR is only open for navigation from August these options will follow the same schedule as the comparison transport system through Suez before this month. To fulfil the weekly schedule requirement vessel 1 starts day 1 in Rotterdam and vessel 2 starts day 1 in Yokohama, the next week vessel 3 and 4 leaves the ports and so on as illustrated in Table 13.

Table 13 Schedule

	week 1	week 2	week 3
Vessel 1	Leaves Y		
Vessel 2	Leaves R		
Vessel 3	-	Leaves Y	
Vessel 4	-	Leaves R	
Vessel 5	-	-	Leaves Y
Vessel 6	-	-	Leaves R

When the NSR is open for navigation the vessels starts going through the NSR instead of the Suez Canal. The model then calls the first transit time through the NSR calculated in step 2, and subtracts this time from the available total sailing time. Then the distance outside the NSR (the slow steaming distance) is divided with the residual time and the slow steaming speed is found, see equation 11.

$$v_s = \frac{dist_{outsideNSR}}{tmax_{NSR} - t_{port} - w_{NSR} - t_{NSRscen}} \quad (11)$$

where v_s represents the slow steaming speed, $dist_{outsideNSR}$ is the transit distance when going through the NSR minus the distance of the NSR, $tmax_{NSR}$ is the total transit time, t_{port} is time in port, w_{NSR} is waiting time on the NSR and $t_{NSRscen}$ is the time spent on the NSR.

The slow steaming speed is dependent on knowing the transit time through the NSR before the vessel has gone through. This is not a problem for the model when the ice conditions is already known, but in a real situation one does not have the same detailed ice information and the weather or other unforeseen situation may occur and delay the vessel. In this case the ship operator may slow steam before entering the NSR but have to increase the speed when leaving the route in order to keep the schedule, resulting in higher fuel consumption.

The vessels will continue going through the NSR until the navigation season ends in the end of November. For the max transits option the speed outside the NSR will not be necessary to calculate, this speed is the same as when the vessels use the Suez Canal.

5.4.4 Step 4 - Budget

In step 4 all the costs are calculated. The required freight rate (RFR) will be used to evaluate the feasibility of the transport options. The RFR is the freight rate per container that is required to cover all expenses when looking at the life cycle cost. In Table 14 the basic costs are listed. Only the main costs have been included in the calculations when the aim is not to calculate the most realistic RFR, but rather to compare the RFR for the NSR and the SCR transport systems.

Table 14 Cost basis for a 3800 TEU vessel (Levander, 2009)

Costs:	Suez	NSR
Capital cost	60 000 000	Depends on ice class
Maintenance [per year]	1 % of capital cost	2 % of capital cost
Administration [per employee]	40 000	40 000
Insurance [per year]	1 % of capital cost	1 % of capital cost
Fee [per trip]	134 764	171 000
Cargo handling [per TEU]	150	150
Interest rate [%]	8	8
Equity of capital cost[%]	40	40
Loan	36 000 000	Depends on ice class
Term of loan	20	20
Bunker price [USD]	700	700

The capital cost of the vessels will depend on the ice class and is mostly a function of increased steel weight and winterization of the vessel. Winterization is a term for the extra outfitting an ice classed vessel is required to have, such as ballast water heating and heating of equipment on the deck (Riska, 2011). In Table 15 the increase in cost compared to an open water vessel is listed for the 4 ice classes.

Table 15 Increase in capital cost for ice classed vessels (Erikstad and Ehlers, 2012)

Ice class	Increase in capital cost [%]
IAS	12
IA	9.5
IB	7.5
IC	6.5

The Suez Canal fee has been calculated based on the tonnage of the vessel (Service, 2012). It is assumed that the ice classed vessels will have higher maintenance expenses because of the navigation in ice infested waters. The insurance cost for the NSR will be high due to the remoteness of the area, lack of infrastructure and presence of ice. Further no insurance policy for the NSR has been established when these policies are based on the collision or accident frequencies of the given route. Since vessel operators have just recently begun to exploit the route there are no numbers on the possibility of collisions. However the rules and regulations of the route are strict and one may assume that the risk of accidents is reduced when the vessels have ice breaker support. In addition the insurance premium for vessels on the SCR has increased because of pirate attacks and is now quite high, therefore the insurance is put equal for the SCR and the NSR.

In order to find the RFR the lifecycle cost must be calculated. The lifecycle includes the following factors

$$L_{CC} = C + M + O - S \quad (12)$$

where L_{CC} is the lifecycle cost, M is the maintenance cost, O is operational cost and S is the salvage value, that is the value of the ship at the end of the lifecycle.

The lifecycle is set to be 20 years. The operational cost includes fuel cost, wages, cargo handling in ports and fees. The shipowners have rarely enough equity to cover the capital cost of the vessels therefore an equity of 40 % of the capital cost has been assumed and the residual amount must be

financed through a loan. The interest rate has been set to be 8 % and the equation for the yearly cost R of the loan follows:

$$R = C * (1 - eq) * \frac{(1 + r)^i * r}{(1 + r)^i - 1} \quad (13)$$

where eq is the equity, r the interest rate and i the term of loan.

The RFR can then be calculated with equation 14:

$$RFR = \frac{L_{CC}}{c_{TEU} * n} \quad (14)$$

where c_{TEU} is the number of delivered TEUs a year and n is the lifecycle.

An example of the budget for ice condition 1 and 7 can be found in Appendix 3.

6 Results

The results from the simulation model for the different transport systems are found in Figures 16-19. The charts show the RFR for the different ice classes and ice scenarios and the RFR for the SCR. The solid black line represents the RFR for the SCR, while the stippled lines represent the RFR for the four ice classes evaluated. The RFR for the SCR is naturally not dependent on the ice conditions thus it is constant. These results are the basic outputs from the model and they will be further processed in the next sections.

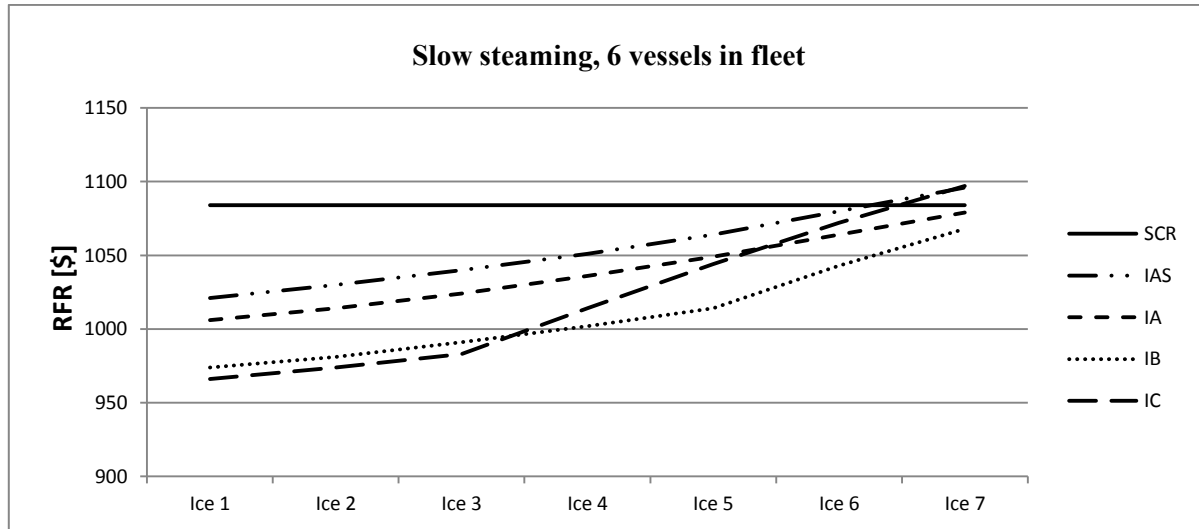

Figure 16 RFR for the SCR and the NSR for a slow steaming schedule with a fleet consisting of 6 vessels

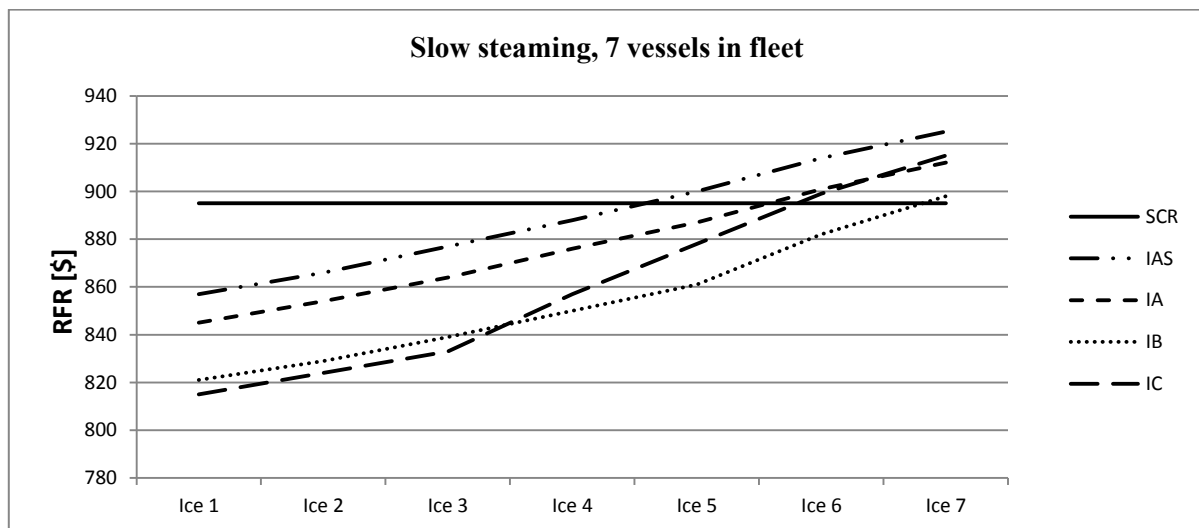

Figure 17 RFR for the SCR and the NSR for a slow steaming schedule with a fleet consisting of 7 vessels

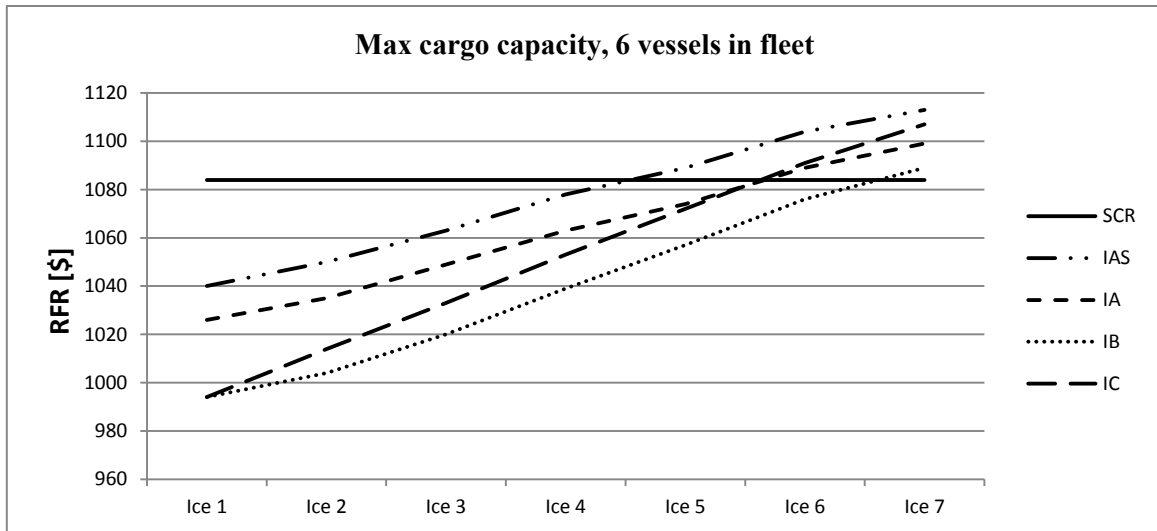

Figure 18 RFR for the SCR and the NSR for a maximum transits schedule with a fleet consisting of 6 vessels

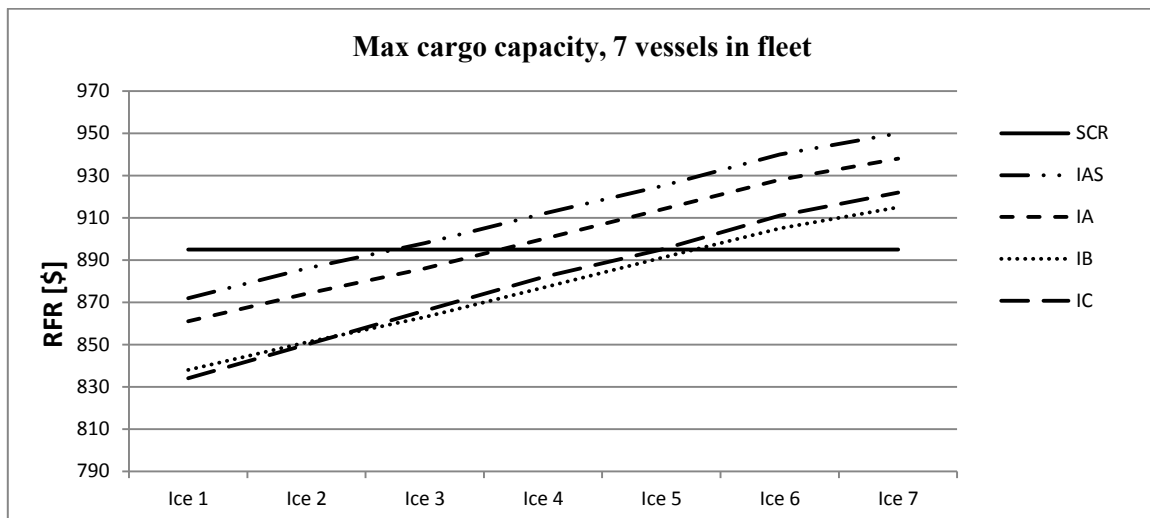

Figure 19 RFR for the SCR and the NSR for a maximum transits schedule with a fleet consisting of 7 vessels

6.1 Fleet of 6 or 7 vessels

In this case study the weekly schedule requirement resulted in a fleet consisting of 6 and 7 vessels. The fleet with 6 vessels would have to have a higher average speed and hence higher fuel consumption, however the capital cost will be less. The aim was to evaluate if the reduction in capital cost would make up for the increased fuel consumption. As is seen in Table 16, in both the slow steaming and the maximum transits schedule the fleet consisting of 7 vessels has a lower RFR than the 6 vessel fleet. The table only represents the results for the IAS ice class, but the other ice classes show the same trend.

Table 16 RFR for the slow steaming and maximum transits schedule for a fleet consisting of 6 and 7 vessels

	<u>IAS -Slow steaming</u>		<u>IAS - Maximum transits</u>	
	6 vessels [RFR]	7 vessels [RFR]	6 vessels [RFR]	7 vessels [RFR]
ice 1	1021	857	1040	872
ice 2	1030	866	1050	886
ice 3	1040	877	1063	898
ice 4	1051	888	1078	912
ice 5	1064	900	1089	925
ice 6	1080	914	1104	940
ice 7	1096	925	1115	950

6.2 Slow steaming versus maximum transits a year

In Table 17 the RFR for the slow steaming and maximum transits schedule is listed for a fleet consisting of 7 vessels of ice class IAS. In addition the difference in RFR between the two schedules is calculated in the last column. The difference in RFR between the two schedules has also been calculated for the other ice classes and the results are plotted in Figure 20. The RFR for the slow steaming schedule is found in Figure 17 while the RFR for the maximum transits schedule is found in Figure 19.

Both the chart for IC and IB in Figure 20 increases toward a peak value at respectively ice 3 and ice 5 and then decreases evenly. The peaks illustrate the last ice scenario for the slow steaming schedule where the IC and IB classed vessels are not restricted by the ice thickness. After this point the number of transits on the NSR decreases, therefore the difference between the two schedules also decreases because more transits through the Suez Canal are made and on this route the two schedules have the same transit time and fuel consumption. The number of transits through the NSR per vessel for each ice scenario and ice class can be found in Figure 21 and 22. The plots have been adjusted in order to make all charts visible, i.e. in Figure 21 all the ice classes have the value 5 for the first ice scenarios. The same applies for Figure 22. The number of transits does not reflect the required transits on the NSR in order to make the route profitable; they only show the maximum possible transits with the given schedule, ice condition and ice class. The black square indicates where the SCR is more profitable. In these areas the NSR will never be profitable for the relevant ice class. In addition the total number of transits for the entire fleet through the Suez Canal and the NSR is listed in Table 18 and 19 together with the total number of delivered TEUs.

As is shown in Table 18 and 19 the number of transits through the NSR is constant for IAS and IA in the slow steaming schedule, while this number decreases for the maximum transits alternative. This is because the time it takes to transit through the NSR increases with the increasing ice scenarios but also with the number of trips through the NSR, resulting in thicker ice and longer transit times for the maximum transits schedule when these vessels have a higher number of transits through the NSR. As mentioned in chapter 4.2 this way of simulating the ice conditions gives a more conservative result for the maximum transits schedule, but the influence on the RFR is rather small. The numbers of transits through the NSR for the IB and IC classed vessels decreases more rapidly than for the higher classes because of their brash ice thickness restrictions of respectively 0.8 m and 0.6 m.

Table 17 RFR for the slow steaming and maximum transits schedule for a fleet of 7 vessels of ice class IAS

7 vessel fleet - IAS			
	Slow steaming [RFR]	Maximum transits [RFR]	$RFR_{max t} - RFR_{slow s}$
ice 1	857	872	15
ice 2	866	886	20
ice 3	877	898	21
ice 4	888	912	24
ice 5	900	925	25
ice 6	914	940	26
ice 7	925	950	25

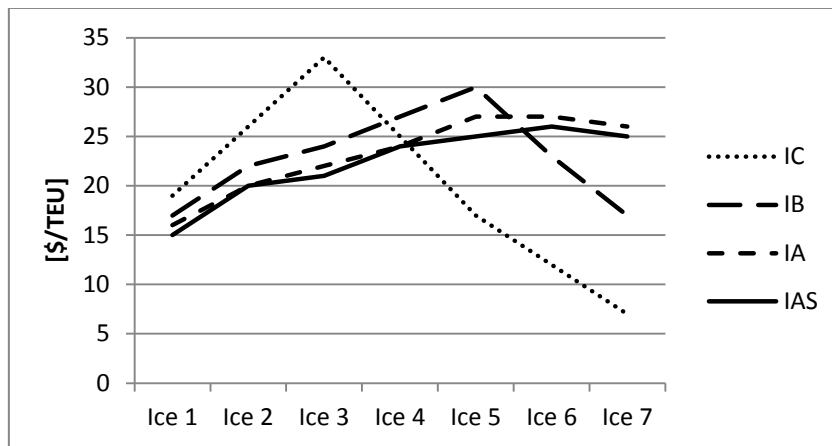

Figure 20 Savings per TEU for the slow steaming schedule compared to the maximum transits schedule for different ice classes and ice scenarios

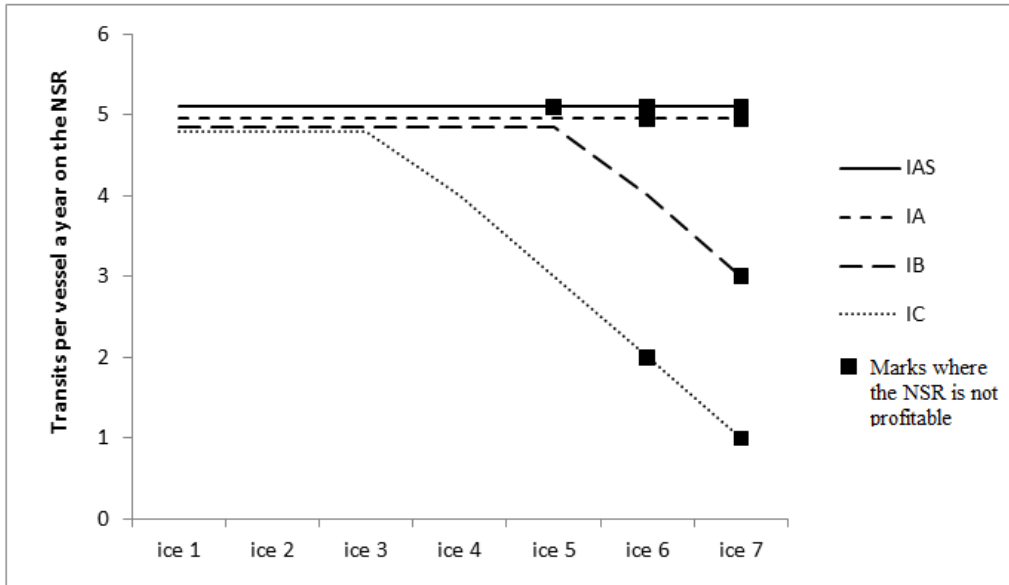

Figure 21 Maximum numbers of transits through the NSR per vessel for the slow steaming schedule for different ice scenarios and ice classes

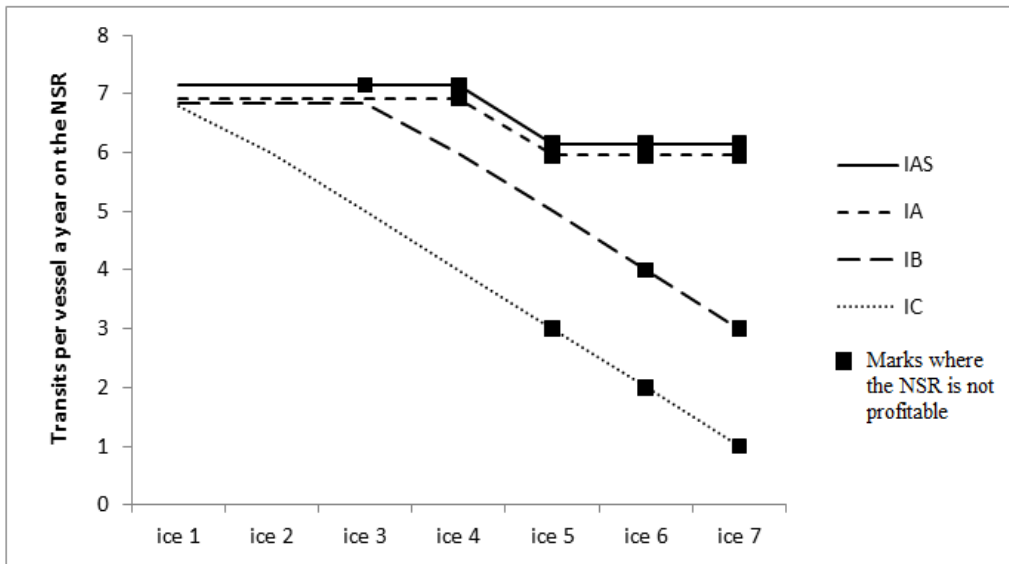

Figure 22 Maximum numbers of transits through the NSR per vessel for the maximum transits schedule for different ice scenarios and ice classes

Table 18 Transit numbers and number of delivered TEUs for the slow steaming schedule

	<u>Slow steaming IAS</u>			<u>Slow steaming IA</u>			<u>Slow steaming IB</u>			<u>Slow steaming IC</u>		
	Trips NSR	Trips Suez	TEUs	Trips NSR	Trips Suez	TEUs	Trips NSR	Trips Suez	TEUs	Trips NSR	Trips Suez	TEUs
Ice 1	35	62	276 450	35	62	276 450	35	62	276 450	35	62	276 450
Ice 2	35	62	276 450	35	62	276 450	35	62	276 450	35	62	276 450
Ice 3	35	62	276 450	35	62	276 450	35	62	276 450	35	62	276 450
Ice 4	35	62	276 450	35	62	276 450	35	62	276 450	28	69	276 450
Ice 5	35	62	276 450	35	62	276 450	35	62	276 450	21	76	276 450
Ice 6	35	62	276 450	35	62	276 450	28	69	276 450	14	83	276 450
Ice 7	35	62	276 450	35	62	276 450	21	76	276 450	7	90	276 450

Table 19 Transit numbers and number of delivered TEUs for the maximum transits schedule

	<u>Maximum transits IAS</u>			<u>Maximum transits IA</u>			<u>Maximum transits IB</u>			<u>Maximum transits IC</u>		
	Trips NSR	Trips Suez	TEUs	Trips NSR	Trips Suez	TEUs	Trips NSR	Trips Suez	TEUs	Trips NSR	Trips Suez	TEUs
Ice 1	51	63	324 900	51	63	324 900	51	63	324 900	49	65	324 900
Ice 2	49	62	316 350	49	62	316 350	49	62	316 350	42	69	316 350
Ice 3	47	64	316 350	47	64	316 350	47	64	316 350	35	74	310 650
Ice 4	47	62	310 650	47	62	310 650	42	67	310 650	28	77	299 250
Ice 5	44	63	304 950	44	63	304 950	35	72	304 950	21	83	296 400
Ice 6	44	61	299 250	44	61	299 250	28	76	296 400	14	86	285 000
Ice 7	42	62	296 400	42	62	296 400	21	81	290 700	7	91	279 300

6.3 NSR versus SCR

The RFR for the different ice classes for the slow steaming schedule and the RFR for the traditional SCR can be found in Figure 17. These results have been used to calculate the savings per TEU for the NSR compared with the SCR by subtracting the RFR for the NSR from the RFR for the SCR, for the different ice classes and ice scenarios. The results are found in Figure 23 and illustrate the savings per TEU for the NSR compared to the traditional SCR.

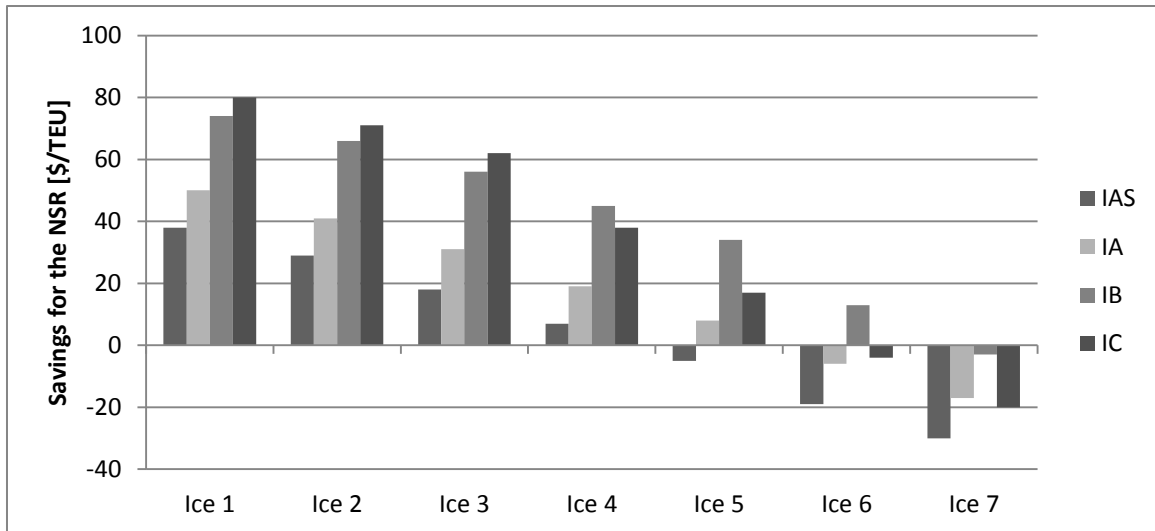

Figure 23 Savings per TEU for the NSR compared to the SCR for the different ice scenarios and ice classes

7 Final discussion

The main results are discussed in this chapter. In addition the influence of a variable bunker price and different cargo capacities will be analyzed and the number of required operational days is calculated. At the end the simulation model is evaluated and the potential reduction in emissions is calculated.

7.1 Evaluation of the results

The main findings that have been presented in the previous chapter are:

- A fleet consisting of 7 vessels is more profitable than a fleet with 6 vessels
- Slow steaming is more profitable than increasing the transits a year
- The NSR is profitable for all ice classes if the ice conditions is less severe than ice scenario 5
- Ice class IB and IC is the most profitable for all ice scenarios, except ice scenario 7 where all the ice classes are unprofitable

The results from the comparison of the optimal numbers of vessels in the fleet show the impact of the speed and hence fuel consumption on the total costs when looking at high speed vessels. The 6 vessel fleet has an average speed of 25.6 knots that results in an SFC of 170 tons fuel per day which is an increase of 40 % compared to the 103 tons fuel per day for the 7 vessel fleet. Even though one vessel has a new build price of 60 million dollars and the insurance, crew wages and maintenance costs increases with the fleet size, this does not make up for the increase in fuel costs.

In addition to the more profitable RFR, the slow steaming schedule also provides the possibility to maintain a more regular schedule, i.e. if the vessel is delayed because of the weather or other unforeseen events, the vessel operator can make up for the lost time by increasing the speed. This is of course dependent on the magnitude of the delay. The punctuality of the transport system is substantial in liner shipping, hence the mitigating measures the slow steaming schedule offers may be an important factor for shipowners considering the use of the NSR.

All ice classes are profitable for the ice scenarios 1-4. The most interesting finding is that the extra operational days the IAS and IA provide will not have a positive effect on the profitability because the NSR is not profitable when the ice thickness in the ice scenarios is thicker than 0.8 meters. As a result the IAS and IA ice classed vessels transits through the NSR when the ice is thicker than 0.8 meter consuming more fuel than the IB and IC classed vessels transiting through the Suez Canal. The additional operational days for the IAS and IA will therefore be manifested as a drawback in the simulation. A ship operator would never use the NSR if it was well-known that the SCR was more profitable, hence the model is somewhat conservative for the IAS and IA ice class for the most severe ice scenarios ice 5, ice 6 and ice 7. On the other hand, the additional operational days the IB provides compared to the IC ice class is an advantage. As is seen in Figure 17 the RFR for IC is the lowest until it reaches ice scenario 4 where the RFR for IB is less. In ice scenario 4 the ice thickness is more than 0.6 m in November, hence IC is restricted to enter and reduces the amount of transits through the NSR from five in ice scenario 3 to four in scenario 4 and the number continues to decrease with 1 for each increase in ice scenario. Consequently ice class IC is the best option if the ice conditions are less severe than ice scenario 3, after this IB is the optimal choice for navigation on the NSR.

The evaluation of the results is highly dependent on the RFR. The freight cost is of great importance for the cargo owners but there are also other influencing factors. The reliability of the schedule has already been mentioned as an important property. Another factor is the transit time. The cargo owners with high-value commodities may be willing to pay a higher freight cost to reduce the transit time and save money on inventory. In this case the maximum transits schedule would be preferable. In addition

high-value commodities shippers may prioritize a secure transportation where the risk of damage is low. The NSR will not be competitive with the SCR when it comes to the risk of damage because of the presence of ice and the lack in rescue facilities.

7.2 Bunker price

In all the previous calculation a bunker price of 700 USD has been used. However the bunker price varies over time and it is often difficult to estimate the variation in price. In order to look at the influence of the bunker price on the profitability, two more price levels of 400 USD and 550 USD has been calculated for the slow steaming schedule. Figure 24 and 25 illustrates the change in RFR for the different bunker price for the SCR and the NSR with ice class IB and IC. As can be seen from the charts, the NSR becomes less profitable for a decreasing fuel price. This is not a surprising result because the advantage of the NSR lies solely in the reduced fuel consumption.

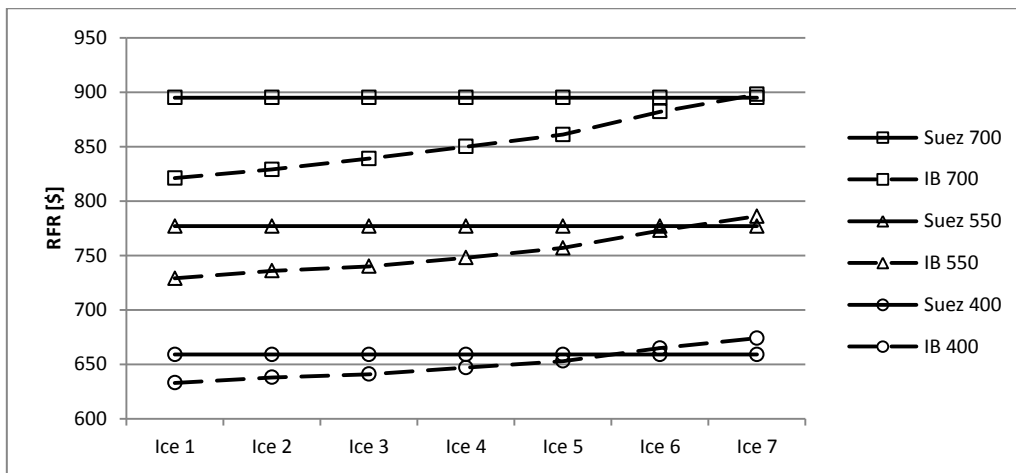

Figure 24 Influence of bunker price on ice class IB

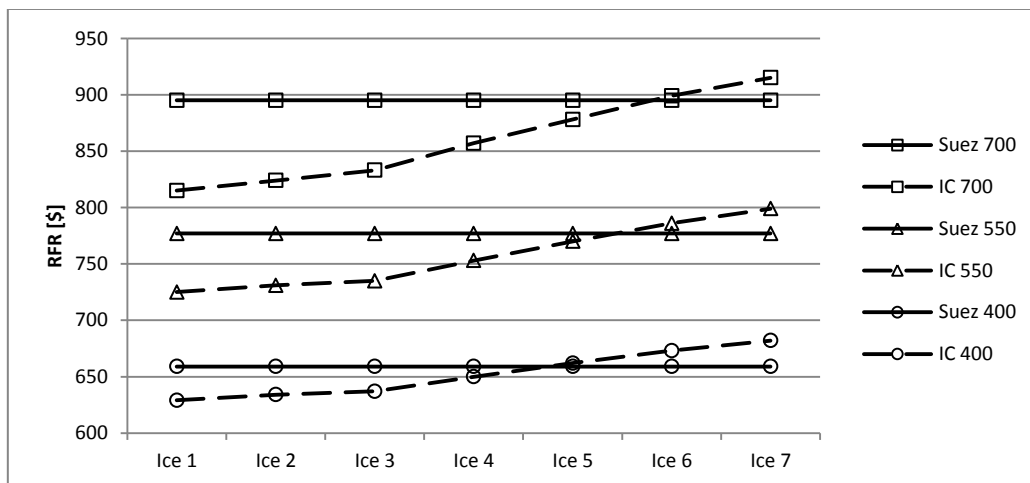

Figure 25 Influence of bunker price on ice class IC

7.3 Increasing cargo capacity

One of the benefits of containerization is that it allows bigger ships to be used and therefore the size of the container ships has increased steadily (Stopford, 2009). The shallow waters of the Arctic Ocean set restrictions to the draft of the vessel, while the ice breakers restrict the breadth. However with the diminishing ice cap and new wider ice breakers these restrictions may disappear in the future, allowing bigger vessels to use the route. A simulation for vessels with variable cargo capacity has therefore been done to evaluate the ship size sensitivity of the NSR. The vessels sizes evaluated are 3000 TEUs, 5000 TEUs, 8000 TEUs and 10 000TEUs. The simulation has been done for a slow steaming schedule with a fleet consisting of 7 vessels with ice class IB. The vessel dimensions and other details can be found in Table 20. The dimensions have been found by using the vessels listed in Table 20 as comparisons vessels (Sea-web, 2012). L_{PAR} and A_{wf} were not given for the comparison ships and have been calculated by regarding their values as a function of the length and breadth of the ship. The angles α and φ has been set as equal to the 3800 TEU ship when it is reasonable to assume that the bow will keep the same shape.

The simulation model has been adapted to the new size of the vessels by changing the SFC according to Figure 7 and the dimensions of the ship has been changed in the MATLAB input file. In addition the available cranes in the port have been altered to keep the schedule somewhat equal. The vessels h-v curve can be found in Appendix 4 and 5. In Figure 26 the RFR is presented for all the vessel sizes. The decrease in RFR for the increasing cargo capacity is an expected result when the economies of scale have been well proven by others. However Figure 26 does not illustrate the reduction in the RFR for the SCR for the same vessel sizes. This rate will naturally also be reduced when the cargo capacity is increased. The charts in Figure 27 has therefore been plotted to show the change in the savings per TEU for the NSR compared to the SCR for the variable ship sizes and ice scenarios. The plots has been extrapolated for the 12 000-16 000 TEUs based on the gradient between 8000-10 000 TEUs. The results show a significant reduction in profit per TEU, hence the influence of the economies of scale becomes less evident when the ice cap increases and is therefore not applicable for the NSR. When the cargo capacity increases the fuel costs constitutes a smaller percentage of the total costs, hence the profit for the NSR compared to the SCR decreases for the larger vessels. It is difficult to set a restriction on the cargo capacity in order for the NSR to be feasible when the exact ice conditions are not known. However this uncertainty may suggest that a smaller vessel should be chosen so the profit per TEU has a larger buffer in case the ice conditions should be more severe than expected or other unexpected costs arises, such as an increase in insurance premium or the NSR fees.

Table 20 Vessel details

	3000	5000	8000	10000
Vessel name:	Ottawa Express	Maersk Drummond	MSC Charleston	Hanjin Korea
TEU	2992	5041	8034	9954
L [m]	232	283,2	285	334
Lpar [m]	120,6	147,3	148,2	173,7
B [m]	32,2	32,2	45,6	45,6
T [m]	10,8	12	13,5	15
Awf [m2]	747	911,9	1299,6	1523
P [kW]	25416	41000	43610	68640
Pd [kW]	14233	22960	24422	38438
Dwt [ton]	40879	54058	94526	118800
Propeller	1	1	1	1
Dp [m]	6,5	7,5	8,0	8,0
Cranes in port	3	5	8	10
Capital cost	50000000	75000000	100000000	115000000
SFC (ice)	123,3	148	220	250
SFC equation	$0.61v^2-14v+108$	$0.59*v^2-11v+75$	$0.94v^2-19v+120$	$1.05v^2-23v+160$

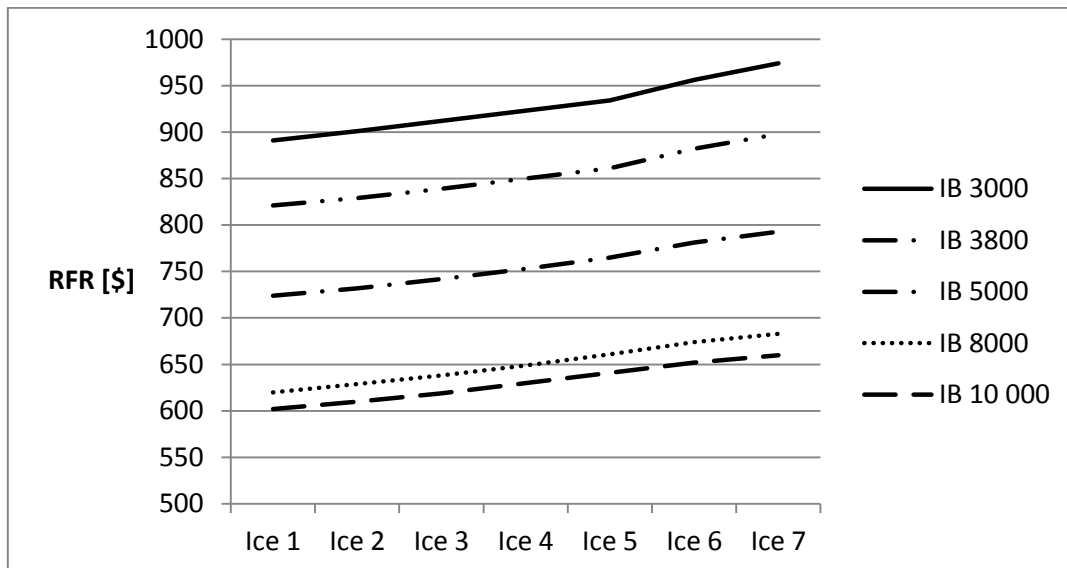

Figure 26 RFR for different vessel sizes

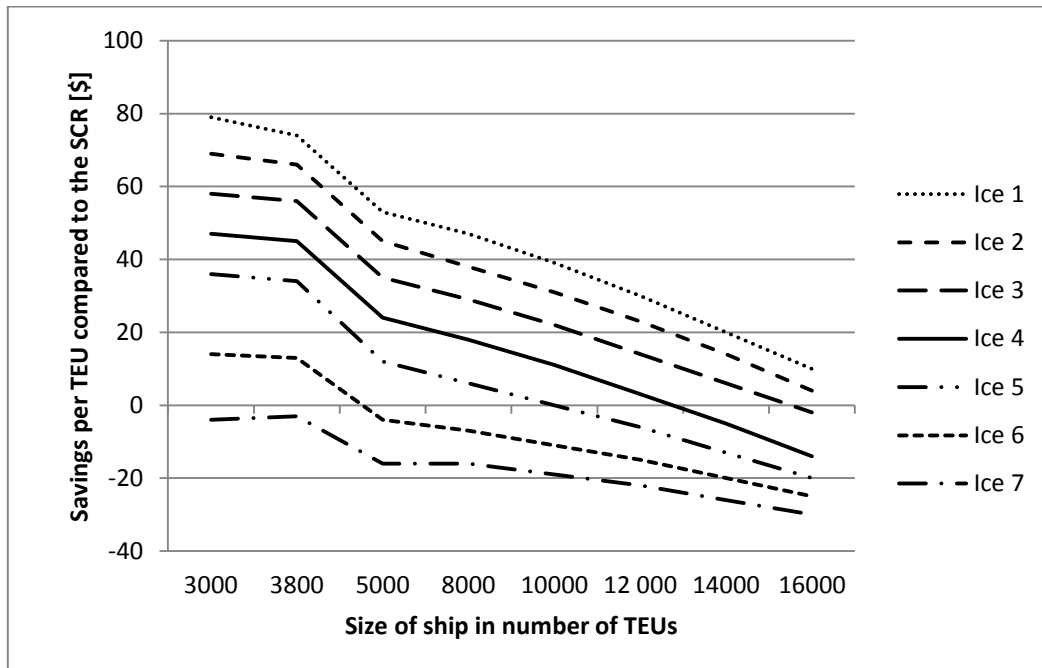

Figure 27 Savings per TEU for the NSR compared to the SCR for different cargo capacities

7.4 Operational days a year

The main results from the simulation show that the ice class IC is the best option for the 3 first ice scenarios while IB is better when the ice conditions harshen. As of today the NSR is only open for vessels with ice class IA or higher, hence the results for ice class IB and IC is not applicable with the current regulations. However as seen in Figure 6, the predicted operational days a year will increase, implying that the severity of the ice conditions will decrease, hence opening up for the use of lower ice classes. In Figure 28 the required transits a year in order for the NSR to be profitable is plotted for all ice classes. The number of transits has been converted to days a year in Figure 29. The results for ice scenario 7 are not given when none of the ice classes are profitable under these conditions. When a bar is missing in the plot this implies that the route is not feasible for this option. If the required operational days in figure 29 are compared to the prediction of operational days a year in Figure 6, all the ice classes are economic feasible for the first three ice scenarios with the current conditions. In scenario 4, it is only the conditions for IAS, 120 operational days a year that will not be fulfilled until year 2020. The rest of the results are listed in Table 21 which illustrates in what year the route is economic feasible for the results in the case study according to Figure 6..

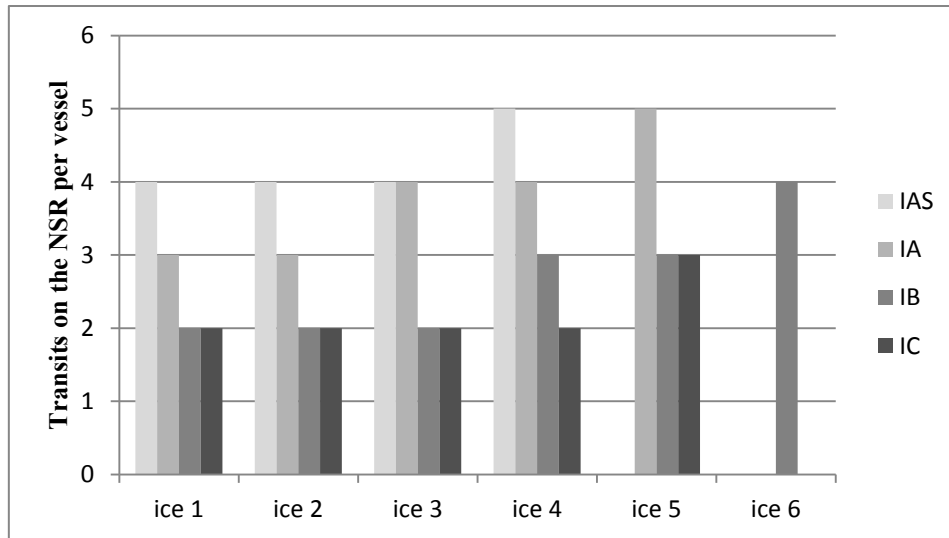

Figure 28 Required transits a year on the NSR in order for the route to be profitable

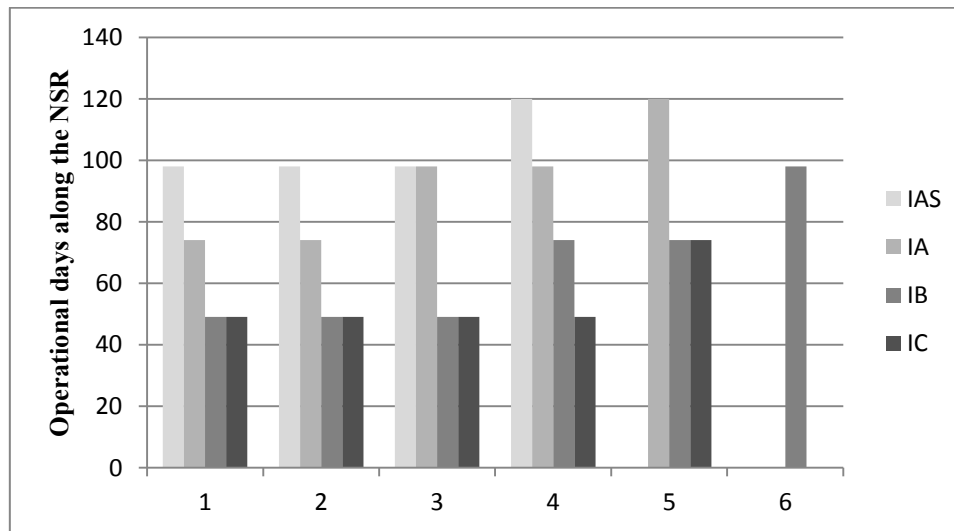

Figure 29 Required operational days a year on the NSR in order for the route to be profitable

Table 21 The year the operational requirement on the NSR is fulfilled for different ice scenarios and ice classes

	Ice 1	Ice 2	Ice 3	Ice 4	Ice 5	Ice 6
IAS	2012	2012	2012	2020	-	-
IA	2012	2012	2012	2012	2024	-
IB	2012	2012	2012	2012	2012	2020
IC	2012	2012	2012	2012	2012	-

7.5 Evaluation of the simulation model

The results are highly dependent on the construction of the model and the input values. In this section the input values and the methods and theory used in the construction of the model will be discussed in order to evaluate the accuracy and reliability of the results.

7.5.1 Weaknesses in the simulation model

As mentioned in chapter 4.2, the model assigns the vessel a specific ice condition based on the ice scenario, but also according to how many transits through the NSR the vessel already have completed. As a result the maximum transits schedule and the 6 vessels fleet will have more conservative results than the slow steaming schedule. However this weakness in the model is more influential in the most severe ice scenarios where most of the different ice classes for both schedules are unprofitable.

The vessels in the slow steaming schedule will slow steam on the stretch from the port to the NSR and from the end of the NSR to the port. The speed in both cases is dependent on the transit time through the NSR. The simulation model knows the transit time on the NSR and can therefore assign the vessel a minimum speed on the stretch from the port to the NSR. It is however not realistic to assume that the ship operator will know the transit time before the transit through the NSR is completed. As a result the vessels may only be able to slow steam after leaving the NSR so the risks of delays are reduced, hence the RFR will be reduced.

The theory used for the calculations of the h-v curve are solely based on one source, (Juva and Riska, 2002), and the correctness of the curve has not been verified when similar curves with corresponding vessel dimensions has been difficult to find. The formulas for the ice resistance and the net thrust are all semi empirical and it is reasonable to believe that full scale trial results for the same vessel will be slightly different

7.5.2 The input values

The ice scenarios are by far the most uncertain input values. The aim has not been to simulate the current or future ice conditions; however the reliability of the results is dependent on the accuracy of the ice conditions. The accumulation of the ice along the route is based on actual observations from satellites, but the increase in ice thickness is an assumption. Another approach to the ice cap simulation could have been to have no ice in the start of all ice scenarios and then vary the increase in thickness per week for the different scenarios.

The waiting time on the NSR has been set as 20 hours. With the current Russian regulation and approval process this is not realistic. In addition the assumed level of the NSR fee does not correspond to the current level. In order for this level to be realistic the traffic on the NSR must increase together with the ice breaker capacity.

The SFC is solely based on the plots in Figure 7 that shows the average fuel consumption per day for different cargo capacities. The SFC of newly build vessels is constantly decreasing because of new technology. When the fuel consumption decreases the profitability for the NSR compared to the SCR also decrease.

7.6 The sustainability of the transport system

IMO has clearly stated that more environment-friendly shipping is high on their agenda. Speed reduction or slow steaming is one of the most important operational methods to reduce emissions as there is a cube law between speed and fuel consumption per day, as seen in Figure 7. Container vessels are characterized as fast vessels and the potential in reduced emissions through slow steaming is significant.

The main pollutants in shipping emissions are nitrogen oxides (NO_x), sulphur oxides (SO_x) and the greenhouse gas carbon dioxide (CO_2). Emissions from ship are mainly influenced by the engine type and fuel type. SO_x and CO_2 are solely determined by respectively the contents of sulphur (S) and carbon (C) in the fuel. The average content of carbon in marine diesel oil is 86.7 %. When the fuel is

burned in the combustion process the carbon is combined with the oxygen and results in approximately 3.17 kg CO₂ per kg burned fuel. The emission of SO_x on the other hand is about 0.46 kg SO_x per ton consumed fuel (Cooper, 2002). The NO_x emission depends on the combustion condition, but has an average value of 55 kg NO_x per ton fuel (Lindstad, 2011). Some basic calculations are made to show the possible reduction in emissions for a NSR transport system. A fleet consisting of 7 vessels with ice class IB is used in the calculation. The results are illustrated in Figure 30 and show the reduction in emissions a year compared to the SCR. In addition the reduction of each pollutant is shown in Figure 31.

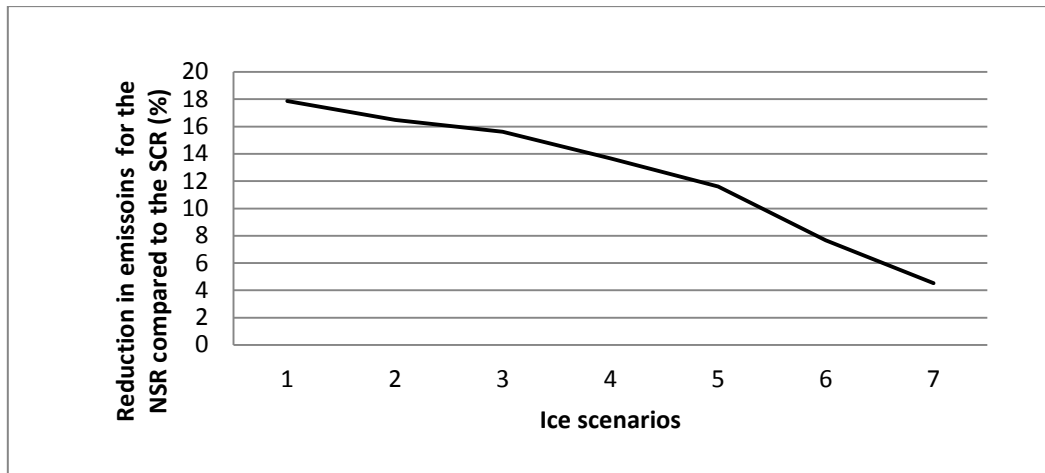

Figure 30 Reduction in emissions a year for the NSR compared the the SCR

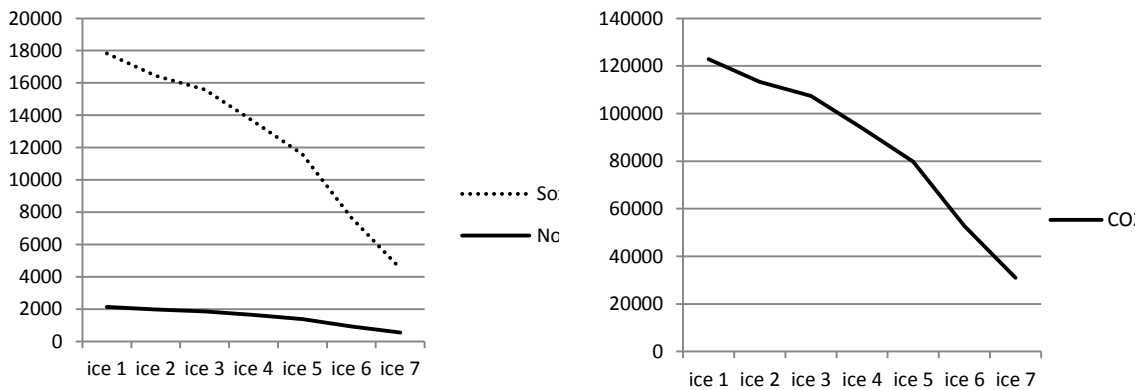

Figure 31 Reduction in emission of SO_x, NO_x and CO₂ for the NSR compared to the SCR

8 Conclusion and future work

In this thesis a transport simulation model has been presented. The model has been used to compare the profitability of two shipping routes: the Suez Canal route (SCR) and the Northern Sea Route (NSR). Further the shorter distance of the NSR has been exploited in two different ways by assigning one fleet a slow steaming schedule while the other fleet increases the number of transits a year. The transport systems have been evaluated for different ice scenarios in order to look at the influence of the ice conditions. In addition the optimal fleet size and ice class has been found. The comparison of the transport systems has been based on the required freight rate (RFR). The results indicate that:

- The optimal fleet size consist of 7 vessels
- The slow steaming schedule is more profitable than the maximum transits schedule
- The optimal ice class for the less severe ice scenarios are IC, while IB is better when the ice conditions harshen
- All ice classes are more profitable than the SCR if the ice conditions are less severe than ice scenario 5

In addition it has been proven that the NSR can reduce the emissions a year with as much as 18 percent compared to the Suez Canal route.

The development of the NSR and the access to relevant information has increased significantly the recent years and will very likely continue to increase in the future. Relevant information such as up to date ice data should always be implemented in the model. In addition the weaknesses in the simulation model should be corrected if the model is used in future work.

With some adjustments the simulation model could be used for other transport systems or by shipowners considering the use of the NSR. Further the model could be used in an iterative process together with a NSR ship design model in order to find the optimal schedule and ship design.

Bibliography

- AGERUP, J. 2012. *RE: Employee at Port of Oslo*.
- AMSA 2009. Arctic Marine Shipping Assessment 2009 Report. *Arctic Council, April 2009, second printing*.
- ARCTIC COUNCIL 2006. Arctic Marine Shipping Assessment 2009 Report. *Arctic Council*. PAME - Arctic Council.
- ATOMFLOT, F. 2011. Available: <http://www.rosatomflot.ru/?lang=en>.
- AUTHORITY, S. C. 2012. Available: <http://www.suezcanal.gov.eg/>.
- BARENTSNOVA. 2011. Northern Sea Route gaining cargo turnover. Available: <http://barentsnova.com>.
- BLACKSEAGRAIN. 2011. Russia wants Northern Sea Route to become major trade route: Putin. Available: www.blackseagrains.net.
- CARIOU, P. 2011. Is slow steaming a sustainable means of reducing CO2 emissions from container shipping? . Transportation Research Part D: Transport and Environment.
- COMMISSION, E. 2011. Available: <http://ec.europa.eu/trade/creating-opportunities/bilateral-relations/>.
- COOPER, D. 2002. Representative emission factors for use in "Quantification of emissions from ships associated with ship movements between port in the European Community". IVL Swedish Environmental Research Institute Ltd.
- DNV 2010. Shipping Across the Arctic Ocean. A feasible option in 2030-2050 as a result of global warming? *Position Paper 04-2010*.
- DODD, G. J. 1985. *Arctic Pilot*.
- ERIKSTAD, S. O. & EHLERS, S. 2012. A Decision Support Framework for Exploiting Northern Sea Route Transport Opportunities.
- J, R. 2008. The rapid decline of the sea ice in the Russian Arctic. *Cold Regions Science and Technology*, 54, 124-142.
- JAXA, J. A. E. A. & IARC, I. A. R. C. 2011. *Ice Extent in the Arctic Ocean* [Online]. Available: www.ijis.iarc.uaf.edu.
- JUVA, M. & RISKKA, K. 2002. ON THE POWER REQUIREMENT IN THE FINNISH-SWEDISH ICE CLASS RULES.
- KAJ RISKKA, M. W., KIM EGLUND, TOPI LEIVISKA 1997. *Performance of merchant vessels in ice in the Baltic*, Espoo, December 1997, Helsinki University of Technology.
- KLAVENESS, E. A. T. 2012. *RE: Discussion of average off-hire and docking days during the lifetime of a vessel*.
- KON, Y. 2001. *The Northern Sea Route - The shortest sea route linking East Asia an Europe*, Tokyo, JAPAN, Yoshio Kon.
- KUJALA, P. & SUNDELL, T. 1992. Performance of ice strengthened ships in the northern Baltic Sea in winter 1991.
- LEVANDER, K. 2009. *System Based Ship Design*.
- LINDSTAD, H. 2011. LECTURED material for course Sustainable Ship Desig and Operations. Institute of Marine Technology, Norwegian University of Science and Technology.
- LIU, M. & KRONBAK, J. 2009. The potential economic viability of using the Northern Sea Route (NSR) as an alternative route between Asia and Europe.
- NASA. 2011. Available: http://eoimages.gsfc.nasa.gov/images/imagerecords/53000/53108/npseai_ams_2011252.mov.
- OECD 2006. Transport link between Europe and Asia. Paris: OECD.
- PETTERSEN, T. 2011a. 34 vessels in transit on Northern Sea Route. Available: www.barentsobserver.com.

- PETTERSEN, T. 2011b. Russia to have ten Arctic rescue centers by 2015. Available: www.barentsobserver.com.
- PETTERSEN, T. 2011c. Russian GPS finally global. Available: www.barentsobserver.com.
- RAGNER, C. L. 2000. Northern Sea Route Cargo Flows and Infrastructure-Present State and Future Potential.
- RICHTER-MENGE, J. A. J. E. O., EDS, 2010. Arctic Report Card 2010.
- RISKA, K. 2011. Lecture material for course ICE 2 Institute of Marine Technology, Norwegian University of Science and Technology.
- RISKA, K. 2012.
- SEA-WEB. 2012. Available: http://www.seaweb.com/authenticated/seaweb_subscriber_welcome.aspx.
- SERVICE, I. M. 2012. *Calculation of Suez fee* [Online]. Available: http://www.imsalex.com/suez_canal.html.
- STOPFORD, M. 2009. *Maritime Economics*.
- SØRSTRAND, S. 2012. A Decision Support System for Merchant Ships Operating on the Arctic Sea.
- VANEBO, N. 2011. Analyserer Nordøstpassasjen. *Knutepunkt*.
- VERNY, J. & GRIGENTIN, C. 2009. Container shipping on the Northern Sea Route.

Appendix 1: Map of the ten legs



Appendix 2: Specific fuel consumption for the 3800 TEU vessel

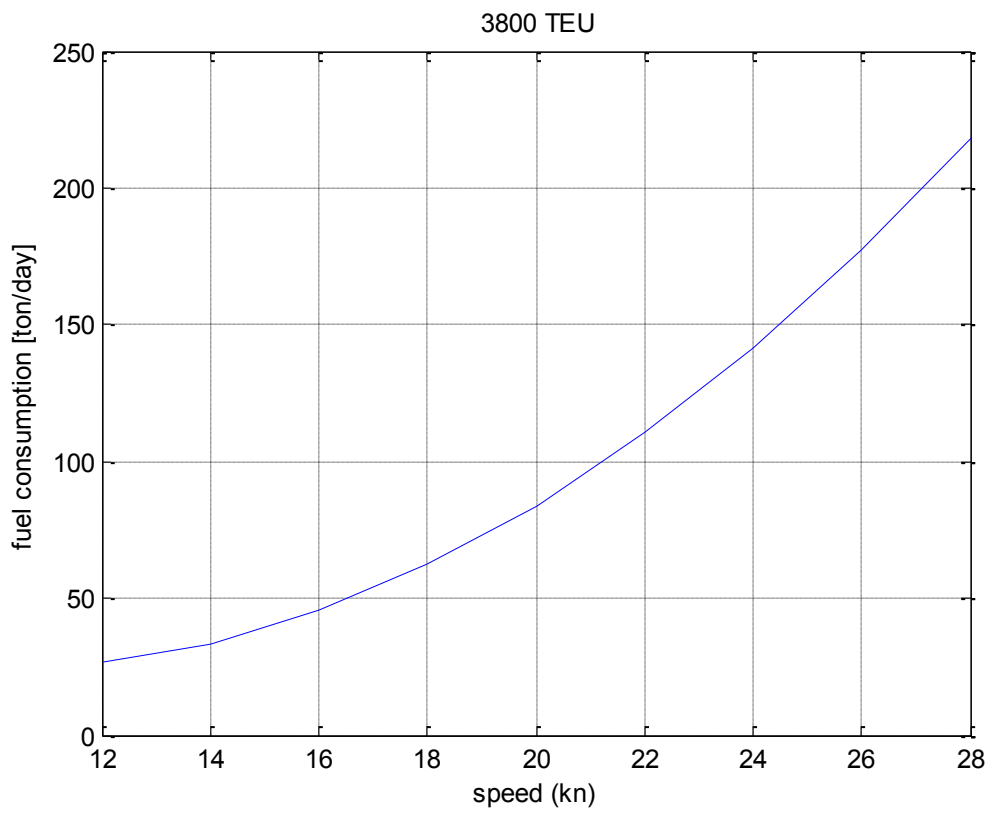

Appendix 3: Budget for ice scenario 1 and 7

Ice scenario 1	Suez	IAS	IA	IB	IC
<u>Operational cost per year:</u>					
Wages crew	6 300 000	6 300 000	6 300 000	6 300 000	6 300 000
Administration	680 000	680 000	680 000	680 000	680 000
Port handling	41 467 500	41 467 500	41 467 500	41 467 500	41 467 500
Fuel	151 770 000	133 120 000	130 700 000	124 650 000	123 440 000
<u>Fee per year:</u>					
Suez	13 072 108	8 625 000	8 625 000	8 625 000	8 625 000
NSR	-	5 643 000	5 643 000	5 643 000	5 643 000
Maintenance per year	4 200 000	9 408 000	9 198 000	9 030 000	8 946 000
Insurance per year	4 200 000	4 704 000	4 599 000	4 515 000	4 473 000
<u>Financial cost:</u>					
Capital cost	420 000 000	470 400 000	459 900 000	451 500 000	447 300 000
Equity	168 000 000	282 240 000	183 960 000	180 600 000	178 920 000
Loan	252 000 000	40 320 000	275 940 000	270 090 000	268 380 000
Yearly cost of loan	25 667 000	28 750 000	28 105 000	27 592 000	27 335 000
Lifecycle	20	20	20	20	20
Value of ship at end of lifecycle	84 000 000	94 080 000	91 980 000	90 300 000	89 460 000
LCC [millions]:	5 031	4 962	4 798	4 660	4 628

Ice scenario 7	Suez	IAS	IA	IB	IC
<u>Operational cost per year:</u>					
Wages crew	6 300 000	6 300 000	6 300 000	6 300 000	6 300 000
Administration	680 000	680 000	680 000	680 000	680 000
Port handling	41 467 500	41 467 500	41 467 500	41 467 500	41 467 500
Fuel	151 770 000	150 190 000	147 460 000	144 920 000	150 500 000
<u>Fee per year:</u>					
Suez	13 072 108	8 625 000	8 625 000	10 242 000	12 129 000
NSR	-	5 643 000	5 643 000	3 591 000	1 197 000
Maintenance per year	4 200 000	9 408 000	9 198 000	9 030 000	8 946 000
Insurance per year	4 200 000	4 704 000	4 599 000	4 515 000	4 473 000
<u>Financial cost:</u>					
Capital cost	420 000 000	470 400 000	459 900 000	451 500 000	447 300 000
Equity	168 000 000	282 240 000	183 960 000	180 600 000	178 920 000
Loan	252 000 000	40 320 000	275 940 000	270 090 000	268 380 000
Yearly cost of loan	25 667 000	28 750 000	28 105 000	27 592 000	27 335 000
Lifecycle	20	20	20	20	20
Value of ship at end of lifecycle	84 000 000	94 080 000	91 980 000	90 300 000	89 460 000
LCC [millions]:	5 031	5 304	5 134	5 057	5 150

Appendix 4: H-v curve 3000 TEU and 5000 TEU

3000 TEU

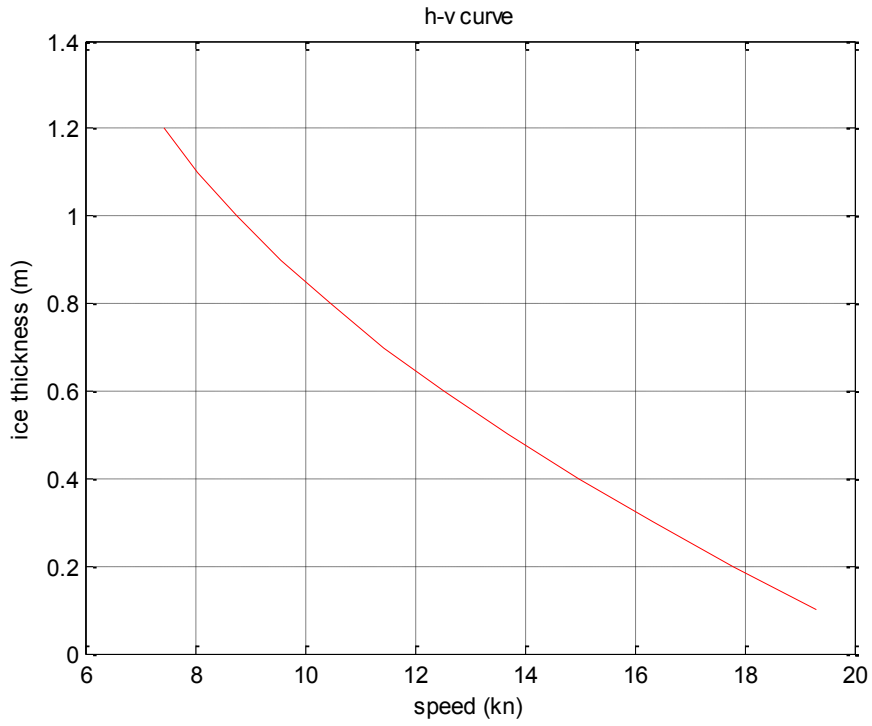

5000 TEU

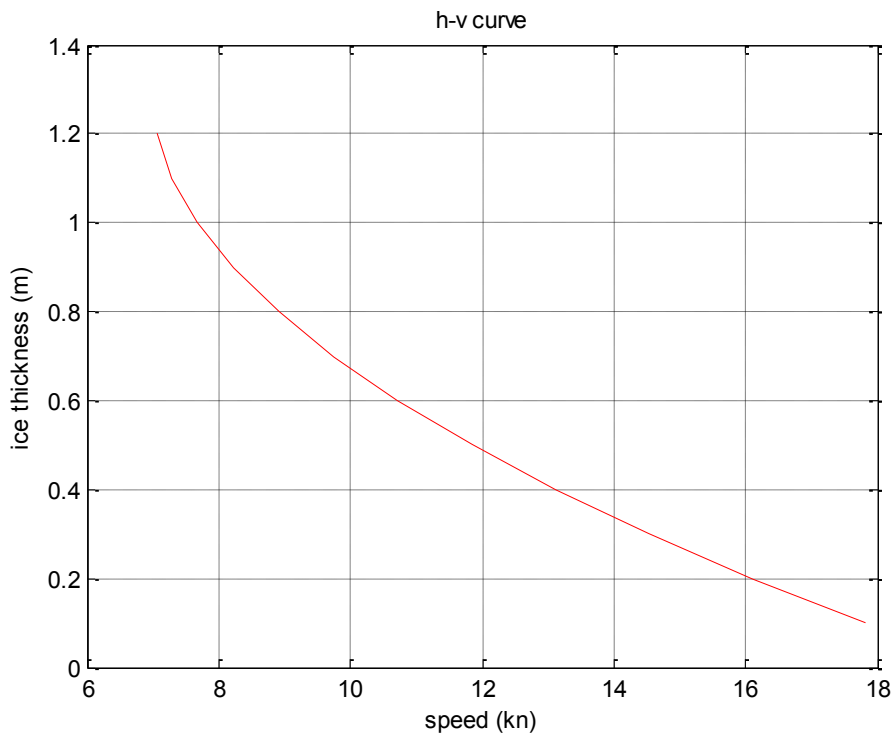

Appendix 5: H-v curve 8000 TEU and 10 000 TEU

8000 TEU

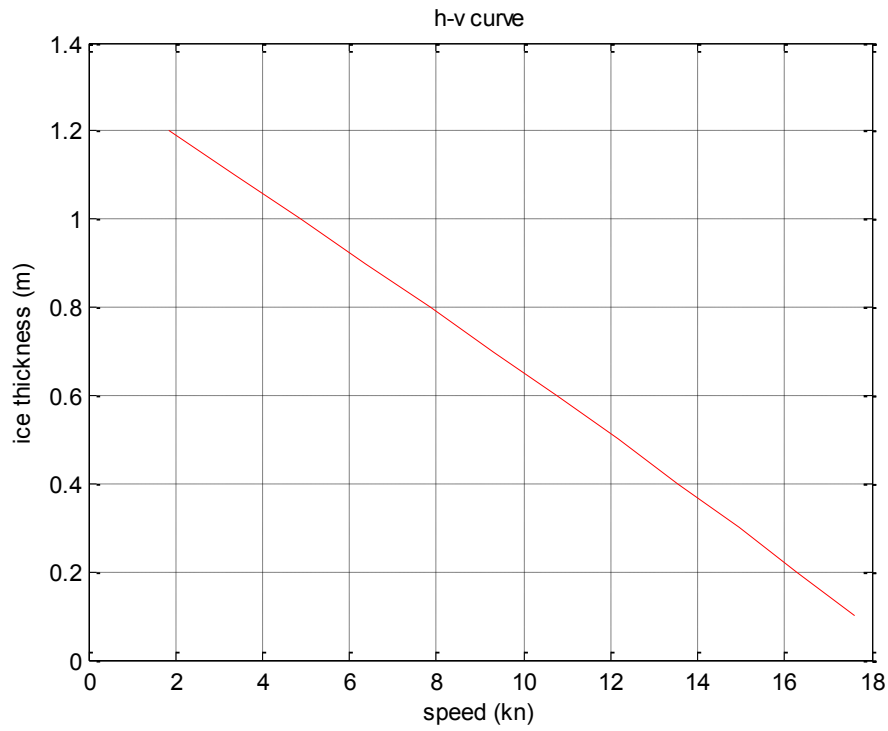

10 000 TEU

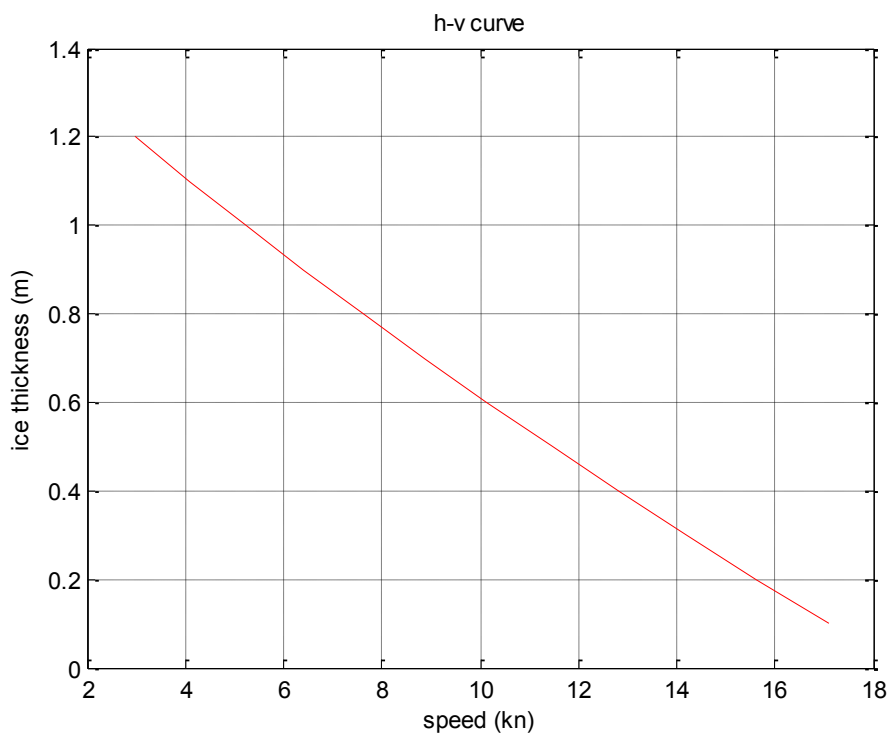

Appendix 6: MATLAB scripts

The model consists of 4 main MATLAB scripts.

- input1.m (input variables)
- brashiceristance.m (calculates h-v curve, NSR transit time and fuel consumption)
- slowsteaming_schedule.m (calculates RFR for the slow steaming schedule)
- maxtransits_schedule.m (calculates RFR for max transits schedule)

Model tutorial

The input values must first be given to MATLAB

Then the brashiceristance.m can be run

Then either the slowsteaming_schedule.m or maxtransits_schedule.m can be run. The ice class and different costs must be filled in manually in these scripts.

Each time the slowsteaming_schedule.m or maxtransits_schedule.m are run, the brashiceristance.m must be run first.

input1.m script

```
%input values
clear all
clc

%% -----brashiceristance-----

B=input('B '); % 32.2
phi=input('phi '); % 90
alpha=input('alpha '); %23
uh=input('uh '); %0.02
Kp=input('Kp '); %6.5
K0=input('K0 '); % 0.68
Lpar=input('Lpar '); % 130
L=input('L '); % 250
T=input('T '); % 12
Awf=input('Awf '); % 806.5

%%-----net_thrust-----
K=input('K '); % 0.78 ,describes the ability of the propeller to convert delivered power
into bollard pull
Pd=input('Pd '); % 19600 ,installed power
Dp=input('Dp '); % 7.5 ,propeller diameter
vow=input('vow ');% 24 ,open water speed

%% -----schedule details-----
dNSR=input('length NSR [nm]'); %2500
tot_distNSR=input('total distance NSR [nm] '); %7280
wNSR=input('Waiting time NSR [hours] '); %20 hours
dist_SUEZ=input('distance of route through Suez [nm] '); %11180
avg_speedSUEZ=input('average speed on the Suez route [knots] '); %24
wait_timeSUEZ=input('transit and waiting time on the Suez Canal [hours] '); %20 [hours]
TEU_full=input(' # TEU '); %3800
crane=input(' # cranes in harbour '); %4
t_crane=input(' efficiency of cranes, [TEU/hour] '); %30
utilf=input('utilization factor '); %0.75
save input1.mat
```

brashiceristance.m script

```

clear all

clc
load input1.mat

%% ----- Brash ice resistance ----- %
Tnet=zeros(1,vow+1); b=zeros(1,vow+1); c=[];
psi=atan(tand(phi)/sind(alpha));
for hm=[0.1,0.3,0.5,0.8,1.2]
    for v=(0:1:vow);
        if B>10 && hm>0.4
            Hf=0.26+(B*hm)^0.5;
            Rch=0.5*0.8*135*9.81.*Hf.^2...
            *Kp.*(0.5+(hm./(2.*Hf))).^(2).*(B+(2.*Hf).*(...
            (cosd(22.6)-(1./tand(psi))))).*(uh.*cosd(phi)+sind(psi)...
            *sind(alpha))+0.8*135*9.81.*K0.*uh.*Lpar.*Hf.^2...
            +135*9.81.*((L.*T./B.^2)).^3.*hm.*Awf.*(v./sqrt(9.81.*L)).^2;
        else
            Hf=hm+(B./2).*tand(2)+(tand(2)+tand(22.6)).*sqrt((B.*(hm+(B./4)...
            *tand(2))./(tand(2)+tand(22.6))));
            Rch=0.5*0.8*135*9.81.*Hf.^2.*Kp.*(0.5+(hm./(2.*Hf))).^(2).*(B+(2.*Hf).*(...
            (cosd(22.6)-(1./tand(psi))))).*(uh.*cosd(phi)+sind(psi).*sind(alpha))...
            +0.8*135*9.81.*K0.*uh.*Lpar.*Hf.^2+135*9.81.*...
            ((L.*T./B.^2)).^3.*hm.*Awf.*(v./sqrt(9.81.*L)).^2;
        end
        b(v+1)=Rch/1000;
    end
    c=[c;b];
end

%% ----- Tnet ----- %
for v=(1:vow-1);
    Tnet(v)=K*((Pd*Dp)^(2/3))*(1-((1/3)*(v/vow))-((2/3)*(v/vow)^(2)));
end

figure(1); r=0:1:vow; plot(r,c,r,Tnet) %r,Tnet
grid on; xlabel('speed (kn)'); ylabel('Resistance in brash ice (kN)')
title('Rch and Tnet') % fill inn resistance

c1=c(1,:); c2=c(2,:); c3=c(3,:); c4=c(4,:); c5=c(5,:);
t=polyfit(r,Tnet,2); t1=t(1); t2=t(2); t3=t(3);

d=polyfit(r,c1,2); d1=d(1); d2=d(2); d3=d(3); syms x;
dx=solve('d1*x^2 + d2*x + d3 = t1*x^2 + t2*x + t3'); cd1=subs(dx);
e=polyfit(r,c2,2); e1=e(1); e2=e(2); e3=e(3);
ex=solve('e1*x^2 + e2*x + e3 = t1*x^2 + t2*x + t3'); ce1=subs(ex);
f=polyfit(r,c3,2); f1=f(1); f2=f(2); f3=f(3);
fx=solve('f1*x^2 + f2*x + f3 = t1*x^2 + t2*x + t3'); cf1=subs(fx);
g=polyfit(r,c4,2); g1=g(1); g2=g(2); g3=g(3);
gx=solve('g1*x^2 + g2*x + g3 = t1*x^2 + t2*x + t3'); cg1=subs(gx);
h=polyfit(r,c5,2); h1=h(1); h2=h(2); h3=h(3);
hx=solve('h1*x^2 + h2*x + h3 = t1*x^2 + t2*x + t3'); ch1=subs(hx);

hh=[0.1,0.3,0.5,0.8,1.2]; vhice=[cd1(1),ce1(1),cf1(1),cg1(1),ch1(1)]; figure(2)
hh2=0.1:1:1.2; vh=spline(hh,vhice,hh2);
hvi=polyfit(hh2,vh,2); vice=hvi(1).*hh2.^2+hvi(2).*hh2+hvi(3);
plot(vice,hh2,'r'); hold on; grid on; title('h-v curve');
xlabel('speed (kn)'); ylabel('ice thickness (m)');

%% ----- ice scenarios ----- %

leg_dist=dNSR/10; %distance of one leg

hm1=[0 0 0 0 0 0 0 0 0];
hm2=[0 0 0 0.1 0 0 0 0 0];
hm3=[0 0 0 0.2 0 0 0.1 0 0];
hm4=[0 0 0 0.3 0.1 0.1 0.2 0 0];
hm5=[0 0 0.1 0.4 0.2 0.2 0.3 0 0];

```

```

hm6=[0.1 0.1 0.2 0.5 0.3 0.3 0.4 0.1 0.1 0.1];
hm7=[0.2 0.2 0.3 0.6 0.4 0.4 0.5 0.2 0.2 0.2]; %max 1C
hm8=[0.3 0.3 0.4 0.7 0.5 0.5 0.6 0.3 0.3 0.3];
hm9=[0.4 0.4 0.5 0.8 0.6 0.6 0.7 0.4 0.4 0.4]; %max 1B
hm10=[0.5 0.5 0.6 0.9 0.7 0.7 0.8 0.5 0.5 0.5];
hm11=[0.6 0.6 0.7 1 0.8 0.8 0.9 0.6 0.6 0.6];
hm12=[0.7 0.7 0.8 1 0.9 0.9 1 0.7 0.7 0.7];
hm13=[0.8 0.8 0.9 1 1 1 1 0.8 0.8 0.8];
hm14=[0.9 0.9 1 1 1 1 1 0.9 0.9 0.9];

%% calculation of transit time and fuel consumption for the 14 different ice alternatives

sfc=zeros(1,10); %specific fuel consumption
hm1_t=zeros(1,10);hm1_f=zeros(1,10);

    for i=1:10;
        if hm1(i)==0 %if there is no ice the speed is 18 knots
            vhice(i)=18;
            sfc(i)=0.6*vhice(i)^2-12*vhice(i)+84;
        else
            vhice(i)=hvi(1)*hm1(i)^2 + hvi(2)*hm1(i) + hvi(3); %calculates the speed
            sfc(i)=135; %fuel consumption in ice
        end
        hm1_t(i)=leg_dist/vhice(i);
        hm1_f(i)=sfc(i)*hm1_t(i)/24;
    end
    hm1_time=sum(hm1_t);
    hm1_fuel=sum(hm1_f);

hm2_t=zeros(1,10);
hm2_f=zeros(1,10);

    for i=1:10;
        if hm2(i)==0
            vhice(i)=18;
            sfc(i)=0.6*vhice(i)^2-12*vhice(i)+84;
        else
            vhice(i)=hvi(1)*hm2(i)^2 + hvi(2)*hm2(i) + hvi(3);
            sfc(i)=135;
        end
        hm2_t(i)=leg_dist/vhice(i);
        hm2_f(i)=sfc(i)*hm2_t(i)/24;
    end
    hm2_time=sum(hm2_t);
    hm2_fuel=sum(hm2_f);

hm3_t=zeros(1,10);
hm3_f=zeros(1,10);

    for i=1:10;
        if hm3(i)==0
            vhice(i)=18;
            sfc(i)=0.6*vhice(i)^2-12*vhice(i)+84;
        else
            vhice(i)=hvi(1)*hm3(i)^2 + hvi(2)*hm3(i) + hvi(3);
            sfc(i)=135;
        end
        hm3_t(i)=leg_dist/vhice(i);
        hm3_f(i)=sfc(i)*hm3_t(i)/24;
    end
    hm3_time=sum(hm3_t);
    hm3_fuel=sum(hm3_f);

hm4_t=zeros(1,10);
hm4_f=zeros(1,10);

```

```

for i=1:10;
    if hm4(i)==0
        vhice(i)=18;
        sfc(i)=0.6*vhice(i)^2-12*vhice(i)+84;
    else
        vhice(i)=hvi(1)*hm4(i)^2 + hvi(2)*hm4(i) + hvi(3);
        sfc(i)=135;
    end
    hm4_t(i)=leg_dist/vhice(i);
    hm4_f(i)=sfc(i)*hm4_t(i)/24;
end
hm4_time=sum(hm4_t);
hm4_fuel=sum(hm4_f);

hm5_t=zeros(1,10);
hm5_f=zeros(1,10);

for i=1:10;
    if hm5(i)==0
        vhice(i)=18;
        sfc(i)=0.6*vhice(i)^2-12*vhice(i)+84;
    else
        vhice(i)=hvi(1)*hm5(i)^2 + hvi(2)*hm5(i) + hvi(3);
        sfc(i)=135;
    end
    hm5_t(i)=leg_dist/vhice(i);
    hm5_f(i)=sfc(i)*hm5_t(i)/24;
end
hm5_time=sum(hm5_t);
hm5_fuel=sum(hm5_f);

hm6_t=zeros(1,10);
hm6_f=zeros(1,10);

for i=1:10;
    if hm6(i)==0
        vhice(i)=18;
        sfc(i)=0.6*vhice(i)^2-12*vhice(i)+84;
    else
        vhice(i)=hvi(1)*hm6(i)^2 + hvi(2)*hm6(i) + hvi(3);
        sfc(i)=135;
    end
    hm6_t(i)=leg_dist/vhice(i);
    hm6_f(i)=sfc(i)*hm6_t(i)/24;
end
hm6_time=sum(hm6_t);
hm6_fuel=sum(hm6_f);

hm7_t=zeros(1,10);
hm7_f=zeros(1,10);

for i=1:10;
    if hm7(i)==0
        vhice(i)=18;
        sfc(i)=0.6*vhice(i)^2-12*vhice(i)+84;
    else
        vhice(i)=hvi(1)*hm7(i)^2 + hvi(2)*hm7(i) + hvi(3);
        sfc(i)=135;
    end
    hm7_t(i)=leg_dist/vhice(i);
    hm7_f(i)=sfc(i)*hm7_t(i)/24;
end
hm7_time=sum(hm7_t);
hm7_fuel=sum(hm7_f);

hm8_t=zeros(1,10);
hm8_f=zeros(1,10);

for i=1:10;
    if hm8(i)==0
        vhice(i)=18;
        sfc(i)=0.6*vhice(i)^2-12*vhice(i)+84;
    else
        vhice(i)=hvi(1)*hm8(i)^2 + hvi(2)*hm8(i) + hvi(3);
        sfc(i)=135;
    end

```

```

        end
        hm8_t(i)=leg_dist/vhice(i);
        hm8_f(i)=sfc(i)*hm8_t(i)/24;
    end

    hm8_time=sum(hm8_t);
    hm8_fuel=sum(hm8_f);

    hm9_t=zeros(1,10);
    hm9_f=zeros(1,10);

    for i=1:10;
        if hm9(i)==0
            vhice(i)=18;
            sfc(i)=0.6*vhice(i)^2-12*vhice(i)+84;
        else
            vhice(i)=hvi(1)*hm9(i)^2 + hvi(2)*hm9(i) + hvi(3);
            sfc(i)=135;
        end
        hm9_t(i)=leg_dist/vhice(i);
        hm9_f(i)=sfc(i)*hm9_t(i)/24;
    end
    hm9_time=sum(hm9_t);
    hm9_fuel=sum(hm9_f);

    hm10_t=zeros(1,10);
    hm10_f=zeros(1,10);

    for i=1:10;
        if hm10(i)==0
            vhice(i)=18;
            sfc(i)=0.6*vhice(i)^2-12*vhice(i)+84;
        else
            vhice(i)=hvi(1)*hm10(i)^2 + hvi(2)*hm10(i) + hvi(3);
            sfc(i)=135;
        end
        hm10_t(i)=leg_dist/vhice(i);
        hm10_f(i)=sfc(i)*hm10_t(i)/24;
    end
    hm10_time=sum(hm10_t);
    hm10_fuel=sum(hm10_f);

    hm11_t=zeros(1,10);
    hm11_f=zeros(1,10);

    for i=1:10;
        if hm11(i)==0
            vhice(i)=18;
            sfc(i)=0.6*vhice(i)^2-12*vhice(i)+84;
        else
            vhice(i)=hvi(1)*hm11(i)^2 + hvi(2)*hm11(i) + hvi(3);
            sfc(i)=135;
        end
        hm11_t(i)=leg_dist/vhice(i);
        hm11_f(i)=sfc(i)*hm11_t(i)/24;
    end
    hm11_time=sum(hm11_t);
    hm11_fuel=sum(hm11_f);

    hm12_t=zeros(1,10);
    hm12_f=zeros(1,10);

    for i=1:10;
        if hm12(i)==0
            vhice(i)=18;
            sfc(i)=0.6*vhice(i)^2-12*vhice(i)+84;
        else
            vhice(i)=hvi(1)*hm12(i)^2 + hvi(2)*hm12(i) + hvi(3);
            sfc(i)=135;
        end
        hm12_t(i)=leg_dist/vhice(i);
        hm12_f(i)=sfc(i)*hm12_t(i)/24;
    end
end

```

```

hm12_time=sum(hm12_t);
hm12_fuel=sum(hm12_f);

hm13_t=zeros(1,10);
hm13_f=zeros(1,10);

    for i=1:10;
        if hm13(i)==0
            vhice(i)=18;
            sfc(i)=0.6*vhice(i)^2-12*vhice(i)+84;
        else
            vhice(i)=hvi(1)*hm13(i)^2 + hvi(2)*hm13(i) + hvi(3);
            sfc(i)=135;
        end
        hm13_t(i)=leg_dist/vhice(i);
        hm13_f(i)=sfc(i)*hm13_t(i)/24;
    end
hm13_time=sum(hm13_t);
hm13_fuel=sum(hm13_f);

hm14_t=zeros(1,10);
hm14_f=zeros(1,10);

    for i=1:10;
        if hm14(i)==0
            vhice(i)=18;
            sfc(i)=0.6*vhice(i)^2-12*vhice(i)+84;
        else
            vhice(i)=hvi(1)*hm14(i)^2 + hvi(2)*hm14(i) + hvi(3);
            sfc(i)=135;
        end
        hm14_t(i)=leg_dist/vhice(i);
        hm14_f(i)=sfc(i)*hm14_t(i)/24;
    end
hm14_time=sum(hm14_t);
hm14_fuel=sum(hm14_f);

%% -----transit time for the 7 ice sceanrios-----
t_NSR_scen=...
[hm1_time hm2_time hm3_time hm4_time hm5_time hm6_time hm7_time hm8_time hm9_time hm10_time
hm11_time hm12_time
hm2_time hm3_time hm4_time hm5_time hm6_time hm7_time hm8_time hm9_time hm10_time hm11_time
hm12_time hm13_time
hm3_time hm4_time hm5_time hm6_time hm7_time hm8_time hm9_time hm10_time hm11_time hm12_time
hm13_time hm14_time
hm4_time hm5_time hm6_time hm7_time hm8_time hm9_time hm10_time hm11_time hm12_time hm13_time
hm14_time 2000
hm5_time hm6_time hm7_time hm8_time hm9_time hm10_time hm11_time hm12_time hm13_time hm14_time
2000 2000
hm6_time hm7_time hm8_time hm9_time hm10_time hm11_time hm12_time hm13_time hm14_time 2000
2000 2000
hm7_time hm8_time hm9_time hm10_time hm11_time hm12_time hm13_time hm14_time 2000 2000 2000
2000];

%% -----fuel consumption for the 7 ice scenarios -----
fuel_scen=...
[hm1_fuel hm2_fuel hm3_fuel hm4_fuel hm5_fuel hm6_fuel hm7_fuel hm8_fuel hm9_fuel hm10_fuel
hm11_fuel hm12_fuel
hm2_fuel hm3_fuel hm4_fuel hm5_fuel hm6_fuel hm7_fuel hm8_fuel hm9_fuel hm10_fuel hm11_fuel
hm12_fuel hm13_fuel
hm3_fuel hm4_fuel hm5_fuel hm6_fuel hm7_fuel hm8_fuel hm9_fuel hm10_fuel hm11_fuel hm12_fuel
hm13_fuel hm14_fuel
hm4_fuel hm5_fuel hm6_fuel hm7_fuel hm8_fuel hm9_fuel hm10_fuel hm11_fuel hm12_fuel hm13_fuel
hm14_fuel 1000
hm5_fuel hm6_fuel hm7_fuel hm8_fuel hm9_fuel hm10_fuel hm11_fuel hm12_fuel hm13_fuel hm14_fuel
1000 1000
hm6_fuel hm7_fuel hm8_fuel hm9_fuel hm10_fuel hm11_fuel hm12_fuel hm13_fuel hm14_fuel 1000
1000 1000
hm7_fuel hm8_fuel hm9_fuel hm10_fuel hm11_fuel hm12_fuel hm13_fuel hm14_fuel 1000 1000 1000
1000];

%%-----
-----

```

slowsteaming_schedule.m script

```

clc

load input1.mat
ice_class=1; %1=ice class IAS, 2=IA, 3=IB, 4=IC
n=20; %lifecycle
fuel_price=700;

TEU=TEU_full*utilf;      %utilf=utilization factor

days_year=358;
t_port=(TEU./(crane.*t_crane))*2; % time in port [hours],*2 for off-loading/loading
t_SUEZ=(dist_SUEZ./avg_speedSUEZ)+wait_timeSUEZ; %time from port to port [hours]
roundtrip_SUEZ=(t_SUEZ.*2+t_port*2); %hours

% SUEZ-route

%S1=SCR, 6 vessels
%S2=SCR, 7 vessels
n_S1=floor(roundtrip_SUEZ/7/24); %number of vessels in fleet
n_S2=ceil(roundtrip_SUEZ/7/24); %number of vessels in fleet

tmax_S1=n_S1*7/2; %time one transit, including time in port
tmax_S2=n_S2*7/2;

trips_S1=zeros(1,3);% number of trips within a year for ship 1-7, 1 & 2 representing i=1, 3 &
4 i=2, 5 & 6 i=3 and ship 7 equals to i=4
for i=(1:3)
    trips_S1(i)=floor((days_year-(i*7)+7)/tmax_S1);
end
tot_trips_S1=sum(trips_S1)*2;

trips_S2=zeros(1,4);
for i=(1:4)
    trips_S2(i)=floor(((days_year-(i*7)+7))/tmax_S2);
end
tot_trips_S2=sum(trips_S2)*2-(trips_S2(4));

tot_TEU_deliveredS1=tot_trips_S1*TEU;
tot_TEU_deliveredS2=tot_trips_S2*TEU;

v_avgS1=((dist_SUEZ*2)/((tmax_S1*2*24)-2*t_port-2*wait_timeSUEZ)); %average speed for fleet S1
v_avgS2=((dist_SUEZ*2)/((tmax_S2*2*24)-2*t_port-2*wait_timeSUEZ)); %average speed for fleet S2

t_transitS1=dist_SUEZ/v_avgS1/24 ; %transit time
t_transitS2=dist_SUEZ/v_avgS2/24 ; %transit time

fuel_S1=(0.6*v_avgS1^2-12*v_avgS1+84)*t_transitS1 ;%fuel consumption, one transit, minus fuel
consumed in the Suez Canal
fuel_S2=(0.6*v_avgS2^2-12*v_avgS2+84)*t_transitS2 ;%fuel consumption, one transit

fuelconsumpS1=fuel_S1*tot_trips_S1;%fuel consumption a year
fuelconsumpS2=fuel_S2*tot_trips_S2 ;%fuel consumption a year

r1=(fuelconsumpS1/tot_TEU_deliveredS1); %fuel per TEU
r2=(fuelconsumpS2/tot_TEU_deliveredS2);

%building cost
%operational cost
%suez fee
%insurance

%SUEZ and NSR route
%n1=NSR, 7 vessel
%n2=NSR, 6 vessels

```

```

n1=ceil(roundtrip_SUEZ/(7*24)) ; %number of vessels in fleet
n2=floor(roundtrip_SUEZ/(7*24)); %number of vessels in fleet

tmax_NSRn1=n1*7/2 ; %max time one transit
tmax_NSRn2=n2*7/2 ; %max time one transit

dist_outsideNSR=tot_distNSR-dNSR; %distance outside NSR

trips_n1=zeros(1,4); % number of trips within a year for ship 1-7, 1 & 2
representing i=1, 3 & 4 i=2, 5 & 6 i=3 and ship 7 equals to i=4
for i=(1:4)
    trips_n1(i)=floor((days_year-(i*7)+7)/tmax_NSRn1);
end

trips_n2=zeros(1,3);
for i=(1:3)
    trips_n2(i)=floor(((days_year-(i*7)+7))/tmax_NSRn2);
end

tottrips_NSR_n1_12=zeros(1,7);tottrips_NSR_n1_34=zeros(1,7);tottrips_NSR_n1_56=zeros(1,7);
tottrips_NSR_n1_7=zeros(1,7);tottrips_NSR_n2_12=zeros(1,7);tottrips_NSR_n2_34=zeros(1,7);
tottrips_NSR_n2_56=zeros(1,7);tottrips_SUEZ_n1_12=zeros(1,7);tottrips_SUEZ_n1_34=zeros(1,7);
tottrips_SUEZ_n1_56=zeros(1,7);tottrips_SUEZ_n1_7=zeros(1,7);tottrips_SUEZ_n2_12=zeros(1,7);
tottrips_SUEZ_n2_34=zeros(1,7);tottrips_SUEZ_n2_56=zeros(1,7);ttn1_12=zeros(1,7);
rn1=zeros(1,7);rn2=zeros(1,7);total_f_n1_12=zeros(1,7);b=zeros(1,7);tsn1_12=zeros(1,7);
tsn1_34=zeros(1,7);tsn1_56=zeros(1,7);tsn1_7=zeros(1,7);tsn2_12=zeros(1,7);tsn2_34=zeros(1,7);
tsn2_56=zeros(1,7);fuel_SUEZ_n1_12=zeros(1,7);fuel_NSR_n1_12=zeros(1,7);tot_f_outsNSR_n1_12=ze
ros(1,7);
fuel_SUEZ_n1_34=zeros(1,7);fuel_NSR_n1_34=zeros(1,7);tot_f_outsNSR_n1_34=zeros(1,7);
total_f_n1_34=zeros(1,7);fuel_SUEZ_n1_56=zeros(1,7);fuel_NSR_n1_56=zeros(1,7);tot_f_outsNSR_n1
_56=zeros(1,7);
total_f_n1_56=zeros(1,7);fuel_SUEZ_n1_7=zeros(1,7);fuel_NSR_n1_7=zeros(1,7);tot_f_outsNSR_n1_7
=zeros(1,7);
total_f_n1_7=zeros(1,7);fuel_SUEZ_n2_12=zeros(1,7);fuel_NSR_n2_12=zeros(1,7);tot_f_outsNSR_n2
_12=zeros(1,7);
total_f_n2_12=zeros(1,7);fuel_SUEZ_n2_34=zeros(1,7);fuel_NSR_n2_34=zeros(1,7);tot_f_outsNSR_n2
_34=zeros(1,7);
total_f_n2_34=zeros(1,7);fuel_SUEZ_n2_56=zeros(1,7);fuel_NSR_n2_56=zeros(1,7);tot_f_outsNSR_n2
_56=zeros(1,7);
total_f_n2_56=zeros(1,7);ttn1_7=zeros(1,7);ts12=zeros(1,7);ts34=zeros(1,7);ts56=zeros(1,7);
tot_tripsNSR_fleetn1=zeros(1,7);tot_tripsNSR_fleetn2=zeros(1,7);
tot_tripsSUEZ_fleetn1=zeros(1,7);tot_tripsSUEZ_fleetn2=zeros(1,7);
total_fuel_n1=zeros(1,7);total_fuel_n2=zeros(1,7);TEU_delivered_n1=zeros(1,7);
TEU_delivered_n2=zeros(1,7);
a=zeros(1,7);trips_SUEZ_n1_12=zeros(1,7);trips_SUEZ_n1_34=zeros(1,7);
trips_SUEZ_n1_56=zeros(1,7);trips_SUEZ_n1_7=zeros(1,7);

for x=1:7; % ice scenario, ice 1-7

%calculates the slow steaming speed when it is possible to go through NSR
vN1=zeros(1,12);
vN2=zeros(1,12);

vN1(i)=((dist_outsideNSR)./(tmax_NSRn1*24-t_port-wNSR-t_NSR_scen(x,i)));
vN2(i)=((dist_outsideNSR)./(tmax_NSRn2*24-t_port-wNSR-t_NSR_scen(x,i)));
%i is the number of trip through NSR, if i=3, it is the 3rd trip through NSR for the current
vessel
for i=1:12

    if vN1(i)>26 %if the slow steaming speed is greater than 26 it is no longer feasible to
go through the NSR
        vN1(i)=0.01;
    else
        vN1(i)=((dist_outsideNSR)./(tmax_NSRn1*24-t_port-wNSR-t_NSR_scen(x,i)));
        if ice_class==4 && t_NSR_scen(x,i)>hm7_time % hm7 is the ice thickness restriction
    for IC
        vN1(i)=0.01;
        elseif ice_class==3 && t_NSR_scen(x,i)>hm9_time ;

```

```

        vN1(i)=0.01;
    end

end

if vN2(i)>26
    vN2(i)=0.01;
else
    vN2(i)=((dist_outsideNSR)./(tmax_NSRn2*24-t_port-wNSR-t_NSR_scen(x,i)));
    if ice_class==4 && t_NSR_scen(x,i)>hm7_time
        vN2(i)=0.01;
    elseif ice_class==3 && t_NSR_scen(x,i)>hm9_time ;
        vN2(i)=0.01;
    end
end

end

%calculates the specific fuel consumption [tons/day] the ice classes,
sfc_n1=zeros(1,12);
sfc_n2=zeros(1,12);
for i=1:12
    if ice_class==1
        sfc_n1(i)=(0.6*vN1(i)^2-12*vN1(i)+84)*1.1;
        sfc_n2(i)=(0.6*vN2(i)^2-12*vN2(i)+84)*1.1;
        sfc_SUEZ_n1=(0.6*v_avgS2^2-12*v_avgS2+84)*1.1;
        sfc_SUEZ_n2=(0.6*v_avgS1^2-12*v_avgS1+84)*1.1;
        fuel_scen(x,i)=fuel_scen(x,i)*1.1;
    elseif ice_class==2
        sfc_n1(i)=(0.6*vN1(i)^2-12*vN1(i)+84)*1.08;
        sfc_n2(i)=(0.6*vN2(i)^2-12*vN2(i)+84)*1.08;
        sfc_SUEZ_n1=(0.6*v_avgS2^2-12*v_avgS2+84)*1.08;
        sfc_SUEZ_n2=(0.6*v_avgS1^2-12*v_avgS1+84)*1.08;
        fuel_scen(x,i)=fuel_scen(x,i)*1.08;
    elseif ice_class==3
        sfc_n1(i)=(0.6*vN1(i)^2-12*vN1(i)+84)*1.03;
        sfc_n2(i)=(0.6*vN2(i)^2-12*vN2(i)+84)*1.03;
        sfc_SUEZ_n1=(0.6*v_avgS2^2-12*v_avgS2+84)*1.03;
        sfc_SUEZ_n2=(0.6*v_avgS1^2-12*v_avgS1+84)*1.03;
        fuel_scen(x,i)=fuel_scen(x,i)*1.03;
    elseif ice_class==4
        sfc_n1(i)=(0.6*vN1(i)^2-12*vN1(i)+84)*1.02;
        sfc_n2(i)=(0.6*vN2(i)^2-12*vN2(i)+84)*1.02;
        sfc_SUEZ_n1=(0.6*v_avgS2^2-12*v_avgS2+84)*1.02;
        sfc_SUEZ_n2=(0.6*v_avgS1^2-12*v_avgS1+84)*1.02;
        fuel_scen(x,i)=fuel_scen(x,i)*1.02;
    end
end

%%-----
% MAX SLOW STEAMING

enter_NSR=212; %first enetering date NSR
last_NSR=334 ; %last entering date NSR

%N1
%schedule n1, ship 1 & 2

schedn1_start12=zeros(1,14);
for i=1:(trips_S2*2)
    schedn1_start12(i)=tmax_S2*i-tmax_S2; %start day for ship 1 and 2,
    if (schedn1_start12(i)+(dist_outsideNSR/((2*vN1(1))*24))>=enter_NSR
        tsn1_12(x)=i;
        break
    end
end

trips_SUEZ_n1_12(x)=tsn1_12(x)-1;

trips_NSR_n1_12=zeros(1,6);
enter_NSR_n1_12=zeros(1,6);

```



```

f_NSR_n1_12=zeros(1,6);
f_outsNSR_n1_12=zeros(1,6);
for i=1:trips_n1(1)

    enter_NSR_n1_12(i)=schedn1_start12(tsn1_12(x))+((tmax_S2*i-tmax_S2))+...
    ((dist_outsideNSR)/((2*vN1(i)*24))) ;%calculates entering day on the NSR
    f_NSR_n1_12(i)=fuel_scen(x,i); % fuel consumption on the NSR
    f_outsNSR_n1_12(i)=sfc_n1(i)*(dist_outsideNSR/vN1(i)/24); % fuel consumed from the port to
    the NSR and from the end of NSR to the other port
        if enter_NSR_n1_12(i)>last_NSR %checks if the entering day has passed last
entering day
            tnn1_12(x)=i;

                break %stops the loop if the last entering day on the NSR is surpassed
            end
        end
end
tottrips_NSR_n1_12(x)=(tnn1_12(x))-1; % total trips NSR, one vessel
tottrips_SUEZ_n1_12(x)=trips_n1(1)-tottrips_NSR_n1_12(x) ; % total trips Suez, one vessel
fuel_SUEZ_n1_12(x)=sfc_SUEZ_n1*t_transitS2*tottrips_SUEZ_n1_12(x); %one vessel
fuel_NSR_n1_12(x)=sum(f_NSR_n1_12)-fuel_scen(x,tnn1_12(x)); %one vessel
tot_f_outsNSR_n1_12(x)=sum(f_outsNSR_n1_12)-(f_outsNSR_n1_12(tnn1_12(x)));% fuel consumed
outside NSR, one vessel
total_f_n1_12(x)=2*(fuel_SUEZ_n1_12(x)+fuel_NSR_n1_12(x)+tot_f_outsNSR_n1_12(x)); %total fuel,
one vessel

%%-----
%n1 vessel 3 & 4
schedn1_start34=zeros(1,14);

for i=1:(trips_S2*2)
    schedn1_start34(i)=tmax_S2*i-tmax_S2+7;
    if (schedn1_start34(i)+(dist_outsideNSR/((2*vN1(1))*24)))>=enter_NSR;
        tsn1_34(x)=i;
        break
    end
end

trips_SUEZ_n1_34(x)=tsn1_34(x)-1;

trips_NSR_n1_34=zeros(1,6);
enter_NSR_n1_34=zeros(1,6);
f_NSR_n1_34=zeros(1,6);
f_outsNSR_n1_34=zeros(1,6);
for i=1:trips_n1(2)

    enter_NSR_n1_34(i)=schedn1_start34(tsn1_34(x))+((tmax_S2*i-tmax_S2))+...
    ((dist_outsideNSR)/((2*vN1(i)*24)));
    f_NSR_n1_34(i)=fuel_scen(x,i);
    f_outsNSR_n1_34(i)=sfc_n1(i)*(dist_outsideNSR/vN1(i)/24);
        if enter_NSR_n1_34(i)>last_NSR
            tnn1_34=i;

                break
            end
        end
end
tottrips_NSR_n1_34(x)=tnn1_34-1;
tottrips_SUEZ_n1_34(x)=trips_n1(2)-tottrips_NSR_n1_34(x);
fuel_SUEZ_n1_34(x)=sfc_SUEZ_n1*t_transitS2*tottrips_SUEZ_n1_34(x);
fuel_NSR_n1_34(x)=sum(f_NSR_n1_34)-fuel_scen(x,tnn1_34);
tot_f_outsNSR_n1_34(x)=sum(f_outsNSR_n1_34)-(f_outsNSR_n1_34(tnn1_34));
total_f_n1_34(x)=2*(fuel_SUEZ_n1_34(x)+fuel_NSR_n1_34(x)+tot_f_outsNSR_n1_34(x));

%%-----

%n1 vessel 5 & 6
schedn1_start56=zeros(1,14);

```

```

for i=1:(trips_S2*2)
    schedn1_start56(i)=tmax_S2*i-tmax_S2+14;
    if (schedn1_start56(i)+(dist_outsideNSR/((2*vN1(1))*24)))>=enter_NSR;
        tsn1_56(x)=i;
        break
    end
end

trips_SUEZ_n1_56(x)=tsn1_56(x)-1;

trips_NSR_n1_56=zeros(1,6);
enter_NSR_n1_56=zeros(1,6);
f_NSR_n1_56=zeros(1,6);
f_outsNSR_n1_56=zeros(1,6);
for i=1:trips_n1(3)

    enter_NSR_n1_56(i)=schedn1_start56(tsn1_56(x))+((tmax_S2*i-tmax_S2))+...
        ((dist_outsideNSR)/((2*vN1(i))*24));
    f_NSR_n1_56(i)=fuel_scen(x,i);
    f_outsNSR_n1_56(i)=sfc_n1(i)*(dist_outsideNSR/vN1(i)/24);
        if enter_NSR_n1_56(i)>last_NSR
            tnn1_56=i;

                break
            end

end

tottrips_NSR_n1_56(x)=tnn1_56-1;
tottrips_SUEZ_n1_56(x)=trips_n1(3)-tottrips_NSR_n1_56(x);
fuel_SUEZ_n1_56(x)=sfc_SUEZ_n1*t_transitS2*tottrips_SUEZ_n1_56(x);
fuel_NSR_n1_56(x)=sum(f_NSR_n1_56)-fuel_scen(x,tnn1_56);
tot_f_outsNSR_n1_56(x)=sum(f_outsNSR_n1_56)-(f_outsNSR_n1_56(tnn1_56));
total_f_n1_56(x)=2*(fuel_SUEZ_n1_56(x)+fuel_NSR_n1_56(x)+tot_f_outsNSR_n1_56(x));

%%-----
%n1 vessel 7
schedn1_start7=zeros(1,14);

for i=1:((trips_S2-1)*2)
    schedn1_start7(i)=tmax_S2*i-tmax_S2+21;
    if (schedn1_start7(i)+(dist_outsideNSR/((2*vN1(1))*24)))>=enter_NSR;
        tsn1_7(x)=i;
        break
    end
end

trips_SUEZ_n1_7(x)=tsn1_7(x)-1;

trips_NSR_n1_7=zeros(1,6);
enter_NSR_n1_7=zeros(1,6);
f_NSR_n1_7=zeros(1,6);
f_outsNSR_n1_7=zeros(1,6);
for i=1:trips_n1(4)

    enter_NSR_n1_7(i)=schedn1_start7(tsn1_7(x))+((tmax_S2*i-tmax_S2))+...
        ((dist_outsideNSR)/((2*vN1(i))*24));
    f_NSR_n1_7(i)=fuel_scen(x,i);
    f_outsNSR_n1_7(i)=sfc_n1(i)*(dist_outsideNSR/vN1(i)/24);
        if enter_NSR_n1_7(i)>last_NSR
            tnn1_7(x)=i;

                break
            end

end

tn7=i;
tottrips_NSR_n1_7(x)=tnn1_7(x)-1;

```

```

tottrips_SUEZ_n1_7(x)=trips_n1(4)-tottrips_NSR_n1_7(x);
fuel_SUEZ_n1_7(x)=sfc_SUEZ_n1*t_transitS2*tottrips_SUEZ_n1_7(x);
fuel_NSR_n1_7(x)=sum(f_NSR_n1_7)-fuel_scen(x,tnn1_7(x));
tot_f_outsNSR_n1_7(x)=sum(f_outsNSR_n1_7)-(f_outsNSR_n1_7(tnn1_7(x)));
total_f_n1_7(x)=(fuel_SUEZ_n1_7(x)+fuel_NSR_n1_7(x)+tot_f_outsNSR_n1_7(x));

%%-----

%N2
%schedule n2, ship 1 & 2

schedn2_start12=zeros(1,14);
for i=1:(trips_S2*2)
    schedn2_start12(i)=tmax_S1*i-tmax_S1;
    if (schedn2_start12(i)+(dist_outsideNSR/((2*vN2(1))*24))>=enter_NSR;
        ts12(x)=i;
        break
    end
end

trips_SUEZ_n2_12=ts12(x)-1;

trips_NSR_n2_12=zeros(1,6);
enter_NSR_n2_12=zeros(1,6);
f_NSR_n2_12=zeros(1,6);
f_outsNSR_n2_12=zeros(1,6);
for i=1:(trips_n2(1)-trips_SUEZ_n2_12)

    enter_NSR_n2_12(i)=schedn2_start12(ts12(x))+((tmax_S2*i-tmax_S2))+...
        ((dist_outsideNSR)/((2*vN2(i))*24))
    f_NSR_n2_12(i)=fuel_scen(x,i);
    f_outsNSR_n2_12(i)=sfc_n2(i)*(dist_outsideNSR/vN2(i)/24);
    if enter_NSR_n2_12(i)>last_NSR
        tn12=i;
        break
    else tn12=i;
    end

end
tottrips_NSR_n2_12(x)=tn12-1;
tottrips_SUEZ_n2_12(x)=trips_n2(1)-tottrips_NSR_n2_12(x);
fuel_SUEZ_n2_12(x)=sfc_SUEZ_n2*t_transitS1*tottrips_SUEZ_n2_12(x);
fuel_NSR_n2_12(x)=sum(f_NSR_n2_12)-fuel_scen(x,tn12);
tot_f_outsNSR_n2_12(x)=sum(f_outsNSR_n2_12)-(f_outsNSR_n2_12(tn12));
total_f_n2_12(x)=2*(fuel_SUEZ_n2_12(x)+fuel_NSR_n2_12(x)+tot_f_outsNSR_n2_12(x));

%%-----

%ship 3 & 4

schedn2_start34=zeros(1,14);
for i=1:(trips_S2*2)
    schedn2_start34(i)=tmax_S1*i-tmax_S1;
    if (schedn2_start34(i)+(dist_outsideNSR/((2*vN2(1))*24))>=enter_NSR;
        ts34(x)=i;
        break
    end
end

trips_SUEZ_n2_34=ts34(x)-1;

trips_NSR_n2_34=zeros(1,6);
enter_NSR_n2_34=zeros(1,6);
f_NSR_n2_34=zeros(1,6);
f_outsNSR_n2_34=zeros(1,6);
for i=1:(trips_n2(2)-trips_SUEZ_n2_34)

```

```

enter_NSR_n2_34(i)=schedn2_start34(ts34(x))+((tmax_S1*i-tmax_S1))+...
    ((dist_outsideNSR)/((2*vN2(i)*24)));
f_NSR_n2_34(i)=fuel_scen(x,i);
f_outsNSR_n2_34(i)=sfc_n2(i)*(dist_outsideNSR/vN2(i)/24);
    if enter_NSR_n2_34(i)>last_NSR
        tn34=i;
        break

    else tn34=i;

end

end

tottrips_NSR_n2_34(x)=tn34-1;
tottrips_SUEZ_n2_34(x)=trips_n2(2)-tottrips_NSR_n2_34(x);
fuel_SUEZ_n2_34(x)=sfc_SUEZ_n2*t_transitS1*tottrips_SUEZ_n2_34(x);
fuel_NSR_n2_34(x)=sum(f_NSR_n2_34)-fuel_scen(x,tn34);
tot_f_outsNSR_n2_34(x)=sum(f_outsNSR_n2_34)-(f_outsNSR_n2_34(tn34));
total_f_n2_34(x)=2*(fuel_SUEZ_n2_34(x)+fuel_NSR_n2_34(x)+tot_f_outsNSR_n2_34(x));

%% -----

%ship 5 & 6
schedn2_start56=zeros(1,14);
for i=1:(trips_S2*2)
    schedn2_start56(i)=tmax_S1*i-tmax_S1;
    if (schedn2_start56(i)+(dist_outsideNSR/((2*vN2(1))*24)))>=enter_NSR;
        ts56(x)=i;
        break
    end
end

trips_SUEZ_n2_56=ts56(x)-1;

trips_NSR_n2_56=zeros(1,6);
enter_NSR_n2_56=zeros(1,6);
f_NSR_n2_56=zeros(1,6);
f_outsNSR_n2_56=zeros(1,6);
for i=1:(trips_n2(3)-trips_SUEZ_n2_56)

    enter_NSR_n2_56(i)=schedn2_start56(ts56(x))+((tmax_S1*i-tmax_S1))+...
        ((dist_outsideNSR)/((2*vN2(i)*24)));
    f_NSR_n2_56(i)=fuel_scen(x,i);
    f_outsNSR_n2_56(i)=sfc_n2(i)*(dist_outsideNSR/vN2(i)/24);
        if enter_NSR_n2_56(i)>last_NSR
            tn56=i;
            break

        else tn56=i;

end

end

tottrips_NSR_n2_56(x)=tn56-1;
tottrips_SUEZ_n2_56(x)=trips_n2(3)-tottrips_NSR_n2_56(x);
fuel_SUEZ_n2_56(x)=sfc_SUEZ_n2*t_transitS1*tottrips_SUEZ_n2_56(x);
fuel_NSR_n2_56(x)=sum(f_NSR_n2_56)-fuel_scen(x,tn56);
tot_f_outsNSR_n2_56(x)=sum(f_outsNSR_n2_56)-(f_outsNSR_n2_56(tn56));
total_f_n2_56(x)=2*(fuel_SUEZ_n2_56(x)+fuel_NSR_n2_56(x)+tot_f_outsNSR_n2_56(x));

%% -----

tot_tripsNSR_fleetn1(x)=(tottrips_NSR_n1_12(x)+tottrips_NSR_n1_34(x)+...
    tottrips_NSR_n1_56(x))*2+tottrips_NSR_n1_7(x); % total trips NSR

tot_tripsNSR_fleetn2(x)=(tottrips_NSR_n2_12(x)+tottrips_NSR_n2_34(x)+tottrips_NSR_n2_56(x))*2;

tot_tripsSUEZ_fleetn1(x)=(tottrips_SUEZ_n1_12(x)+tottrips_SUEZ_n1_34(x)+...
    tottrips_SUEZ_n1_56(x))*2+tottrips_SUEZ_n1_7(x); %total trips SCR
tot_tripsSUEZ_fleetn2(x)=(tottrips_SUEZ_n2_12(x)+tottrips_SUEZ_n2_34(x)+tottrips_SUEZ_n2_56(x))
    *2;

```

```

total_fuel_n1(x)=total_f_n1_12(x)+total_f_n1_34(x)+total_f_n1_56(x)+total_f_n1_7(x);
total_fuel_n2(x)=total_f_n2_12(x)+total_f_n2_34(x)+total_f_n2_56(x);

TEU_delivered_n1(x)=TEU*(tottrips_NSR_n1_12(x)+tottrips_NSR_n1_34(x)+...
    tottrips_NSR_n1_56(x)+(tottrips_NSR_n1_7(x)/2)+tottrips_SUEZ_n1_12(x)+...
    tottrips_SUEZ_n1_34(x)+tottrips_SUEZ_n1_56(x)+(tottrips_SUEZ_n1_7(x)/2))*2;

TEU_delivered_n2(x)=TEU*(tottrips_NSR_n2_12(x)+tottrips_NSR_n2_34(x)+...

tottrips_NSR_n2_56(x)+tottrips_SUEZ_n2_12(x)+tottrips_SUEZ_n2_34(x)+tottrips_SUEZ_n2_56(x))*2;

rn1(x)=total_fuel_n1(x)/TEU_delivered_n1(x) %fuel consumption per TEU
rn2(x)=total_fuel_n2(x)/TEU_delivered_n2(x)

end

%% -----
% BUDGET

%% -----
%SUEZ
%per vessel
capital_costS=60000000; %investment cost of 1 ship
mS_S1=0.01*capital_costS*n_S1; %maintenance & repair
mS_S2=0.01*capital_costS*n_S2 ;

wage_adm=40000;
adm_S1=(10+(n_S1))*wage_adm; %administration costs
adm_S2=(10+(n_S2))*wage_adm;
insur_S1=0.01*capital_costS*n_S1; %insurance
insur_S2=0.01*capital_costS*n_S2;

%suez fee (per transit)
one_TEU=12; %tonnage
tot_net_tonnage=TEU*one_TEU;
if tot_net_tonnage>20000
    suez_feeS1=(5000*7.21+5000*6.13+10000*3.37+((tot_net_tonnage-20000)*2.42))*tot_trips_S1;
    suez_feeS2=(5000*7.21+5000*6.13+10000*3.37+((tot_net_tonnage-20000)*2.42))*tot_trips_S2;
elseif tot_net_tonnage>10000
    suez_feeS1=(5000*7.21+5000*6.13+((tot_net_tonnage-10000)*3.37))*tot_trips_S1;
    suez_feeS2=(5000*7.21+5000*6.13+((tot_net_tonnage-10000)*3.37))*tot_trips_S2;
end

%operation
portS1=150*tot_TEU_deliveredS1;
portS2=150*tot_TEU_deliveredS2;

wage=30000;
crew_sea=30;
wage_crewS1=crew_sea*wage*n_S1 ; %http://www.itfglobal.org/
wage_crewS2=crew_sea*wage*n_S2;
%financial cost
tl=n; %term of loan
int_rate=0.08; %interest rate
eq=0.4; %equity
loanS1=capital_costS*(1-eq)*n_S1;
loanS2=capital_costS*(1-eq)*n_S2;
cost_loanS1=loanS1*((1+int_rate)^(tl))*int_rate/(((1+int_rate)^(tl))-1);
cost_loanS2=loanS2*((1+int_rate)^(tl))*int_rate/(((1+int_rate)^(tl))-1);
scS1=0.2*capital_costS*n_S1 ; %value of ship after n years, todays value assumed to be
20% of capital cost
scS2=0.2*capital_costS*n_S2 ;

%LCC

fu=fuelconsumpS2*fuel_price;

lccS1=((cost_loanS1+(fuelconsumpS1*fuel_price)+wage_crewS1+portS1+suez_feeS1+mS_S1+adm_S1)*n)-
scS1+capital_costS*n_S1*eq

```

```

rfrS1=lccS1/(tot_TEU_deliveredS1*n)

lccS2=((cost_loanS2+(fuelconsumpS2*fuel_price)+wage_crewS2+portS2+suez_feeS2+mS_S2+adm_S2)*n)-
scS2+capital_costS*n_S2*eq
rfrS2=lccS2/(tot_TEU_deliveredS2*n)

%% -----
-----

%NSR

%SLOW STEAMING

if ice_class==1
    capital_costN=capital_costS*1.12;
elseif ice_class==2
    capital_costN=capital_costS*1.095;
elseif ice_class==3
    capital_costN=capital_costS*1.075;
elseif ice_class==4
    capital_costN=capital_costS*1.065;
end

%financial cost
tl=n; %term of loan
int_rate=0.08; %interest rate
eq=0.4; %equity
loan_n1=capital_costN*(1-eq)*n1;
loan_n2=capital_costN*(1-eq)*n2;
cost_loan_n1=loan_n1*((1+int_rate)^(tl))*int_rate/(((1+int_rate)^(tl))-1);
cost_loan_n2=loan_n2*((1+int_rate)^(tl))*int_rate/(((1+int_rate)^(tl))-1);
scn1=0.2*capital_costN*n1 ; %value of ship after n years, todays value assumed
to be 20% of capital cost
scn2=0.2*capital_costN*n2 ;

mS_n1=0.02*capital_costN*n1 ; %maintenance &
repair
mS_n2=0.02*capital_costN*n2;
wage_adm=40000;
adm_n1=(10+(n1))*wage_adm ; %administration
costs
adm_n2=(10+(n2))*wage_adm;
insur_n1=0.01*capital_costN*n1; %insurance
insur_n2=0.01*capital_costN*n2;

rfr_n1=zeros(1,7);
rfr_n2=zeros(1,7);
for x=1:7
%Suez fee (per transit)

one_TEU=12; %tonnage
tot_net_tonnage=TEU*one_TEU;

if tot_net_tonnage>20000

    suez_fee_n1(x)=(5000*7.21+5000*6.13+10000*3.37+((tot_net_tonnage-
20000)*2.42))*tot_tripsSUEZ_fleetn1(x);
    suez_fee_n2(x)=(5000*7.21+5000*6.13+10000*3.37+((tot_net_tonnage-
20000)*2.42))*tot_tripsSUEZ_fleetn2(x);
elseif tot_net_tonnage>10000
    suez_fee_n1(x)=(5000*7.21+5000*6.13+((tot_net_tonnage-
10000)*3.37))*tot_tripsSUEZ_fleetn1(x);
    suez_fee_n2(x)=(5000*7.21+5000*6.13+((tot_net_tonnage-
10000)*3.37))*tot_tripsSUEZ_fleetn2(x);
end

% NSR fee
fee=5 ; %per tonnage [$]
nsr_fee_n1(x)=tot_net_tonnage*fee*tot_tripsNSR_fleetn1(x);
nsr_fee_n2(x)=tot_net_tonnage*fee*tot_tripsNSR_fleetn2(x);
%operation

```

```
wage=30000;
crew_sea=30;
wage_crewn1=crew_sea*wage*n1 ;      %http://www.itfglobal.org/
wage_crewn2=crew_sea*wage*n2;

cargo_hand=150 ;      %cost of cargo handling per TEU
port_n1(x)=cargo_hand*TEU_delivered_n1(x);
port_n2(x)=cargo_hand*TEU_delivered_n2(x);

lcc_n1(x)=(cost_loan_n1+(total_fuel_n1(x)*fuel_price)+wage_crewn1+port_n1(x)+suez_fee_n1(x)+m
S_n1+adm_n1+nsr_fee_n1(x))*n)-scn1+capital_costN*eq*n1;
rfr_n1(x)=lcc_n1(x)/(TEU_delivered_n1(x)*n);

lcc_n2(x)=(cost_loan_n2+(total_fuel_n2(x)*fuel_price)+wage_crewn2+port_n2(x)+suez_fee_n2(x)+m
S_n2+adm_n2+nsr_fee_n2(x))*n)-scn2+capital_costN*eq*n2;
rfr_n2(x)=lcc_n2(x)/(TEU_delivered_n2(x)*n);

end
```

maxtransits_schedule.m

```

%max transits schedule
clc
load input1.mat

ice_class=1; %1=ice class IAS, 2=IA, 3=IB, 4=IC
fuel_price=700;
n=20 %lifecycle

f1=7; %number of vessels in fleet 1
f2=6; %number of vessels in fleet 2

days_year=358;
TEU=TEU_full*utilf;
t_port=(TEU./(crane.*t_crane))*2; % time in port [hours],*2 for off-loading/loading

%% -----
--
% SUEZ ROUTE

t_SUEZ=(dist_SUEZ./avg_speedSUEZ)+wait_timeSUEZ; %time from port to port [hours]
roundtrip_SUEZ=(t_SUEZ.*2+t_port*2);
n_S1=floor(roundtrip_SUEZ/7/24); %number of vessels in fleet
n_S2=ceil(roundtrip_SUEZ/7/24); %number of vessels in fleet

tmax_S1=n_S1*7/2; %time one transit, including time in port
tmax_S2=n_S2*7/2;

trips_S1=zeros(1,3); % number of trips within a year for ship 1-7, 1 & 2 representing i=1, 3 &
4 i=2, 5 & 6 i=3 and ship 7 equals to i=4
for i=(1:3)
    trips_S1(i)=floor((days_year-(i*7)+7)/tmax_S1);
end
tot_trips_S1=sum(trips_S1)*2;

trips_S2=zeros(1,4);
for i=(1:4)
    trips_S2(i)=floor(((days_year-(i*7)+7))/tmax_S2);
end
tot_trips_S2=sum(trips_S2)*2-(trips_S2(4));

tot_TEU_deliveredS1=tot_trips_S1*TEU;
tot_TEU_deliveredS2=tot_trips_S2*TEU;

v_avgS1=((dist_SUEZ*2)/((tmax_S1*2*24)-2*t_port-2*wait_timeSUEZ));
v_avgS2=((dist_SUEZ*2)/((tmax_S2*2*24)-2*t_port-2*wait_timeSUEZ));

t_transitS1=dist_SUEZ/v_avgS1/24 ; %transit time
t_transitS2=dist_SUEZ/v_avgS2/24 ; %transit time

fuel_S1=(0.6*v_avgS1.^2-12*v_avgS1+84)*t_transitS1 ;%fuel consumption, one transit
fuel_S2=(0.6*v_avgS2.^2-12*v_avgS2+84)*t_transitS2 ;%fuel consumption, one transit

fuelconsumpS1=fuel_S1*tot_trips_S1;%fuel consumption a year
fuelconsumpS2=fuel_S2*tot_trips_S2 ;%fuel consumption a year

r1=(fuelconsumpS1/tot_TEU_deliveredS1);
r2=(fuelconsumpS2/tot_TEU_deliveredS2);

%% -----
%NSR ROUTE

%ice_class=1 is IA Super, ice_class=2 is IA, ice_class=3 is IB, ice_class=4
%is IC

enter_NSR=212; %first entering date NSR
last_NSR=334 ; %last entering date NSR
dist_outsideNSR=tot_distNSR-dNSR; %distance outside NSR

```



```

vmaxf1=((dist_SUEZ)/((tmax_S2*24)-t_port-wait_timeSUEZ));
vmaxf2=((dist_SUEZ)/((tmax_S1*24)-t_port-wait_timeSUEZ));

t_transit_Sf1=(dist_SUEZ/(vmaxf1*24)+(wait_timeSUEZ/24)+(t_port/24)); %total time [days] one
transit, including time in port
t_transit_Sf2=(dist_SUEZ/(vmaxf2*24)+(wait_timeSUEZ/24)+(t_port/24));
t_sail_Sf1=(dist_SUEZ/(vmaxf1*24)); %sailing time [days] SUEZ, excluding waiting and transit
time through SUEZ
t_sail_Sf2=(dist_SUEZ/(vmaxf2*24));
t_sail_Nf1=dist_outsideNSR/vmaxf1/24; %sailing time [days] outside NSR
t_sail_Nf2=dist_outsideNSR/vmaxf2/24;

f1=7 ; %numbers of vessel in fleet
f2=6 ;

tnf1_34=zeros(1,7); last_Sf1_34=zeros(1,7);tnf1_56=zeros(1,7);last_Sf1_56=zeros(1,7);
tnf1_7=zeros(1,7);last_Sf1_7=zeros(1,7);tsf2_12=zeros(1,7);tnf2_12=zeros(1,7);
last_Sf2_12=zeros(1,7);tsf2_34=zeros(1,7);tnf2_34=zeros(1,7);last_Sf2_34=zeros(1,7);
tsf2_56=zeros(1,7);tnf2_56=zeros(1,7);last_Sf2_56=zeros(1,7);
tot_fuel_f1_12=zeros(1,7);tsf1_12=zeros(1,7);tnf1_12=zeros(1,7);
last_Sf1_12=zeros(1,7);rf1=zeros(1,7);rf2=zeros(1,7);tottrips_SUEZ_f1_12=zeros(1,7);
tottrips_NSR_f1_12=zeros(1,7);fuel_SUEZ_f1_12=zeros(1,7);fuel_NSR_f1_12=zeros(1,7);
fuel_outsNSR_f1_12=zeros(1,7);trips_Sf1_12=zeros(1,7); trips_Sf1_34=zeros(1,7);
tottrips_SUEZ_f1_34=zeros(1,7);tottrips_NSR_f1_34=zeros(1,7);fuel_SUEZ_f1_34=zeros(1,7);
fuel_NSR_f1_34=zeros(1,7);fuel_outsNSR_f1_34=zeros(1,7);tot_fuel_f1_34=zeros(1,7);
tsf1_34=zeros(1,7);
trips_Sf1_56=zeros(1,7);tottrips_SUEZ_f1_56=zeros(1,7);tottrips_NSR_f1_56=zeros(1,7);fuel_SUEZ
_f1_56=zeros(1,7);
fuel_NSR_f1_56=zeros(1,7);fuel_outsNSR_f1_56=zeros(1,7);tot_fuel_f1_56=zeros(1,7);
tsf1_56=zeros(1,7);
trips_Sf1_7=zeros(1,7);tottrips_SUEZ_f1_7=zeros(1,7);tottrips_NSR_f1_7=zeros(1,7);fuel_SUEZ_f1
_7=zeros(1,7);
fuel_NSR_f1_7=zeros(1,7);fuel_outsNSR_f1_7=zeros(1,7);tot_fuel_f1_7=zeros(1,7);
tsf1_7=zeros(1,7);
trips_Sf2_12=zeros(1,7);trips_Sf2_34=zeros(1,7);trips_Sf2_56=zeros(1,7);
tottrips_SUEZ_f2_12=zeros(1,7);tottrips_NSR_f2_12=zeros(1,7);fuel_SUEZ_f2_12=zeros(1,7);
fuel_NSR_f2_12=zeros(1,7);fuel_outsNSR_f2_12=zeros(1,7);tot_fuel_f2_12=zeros(1,7);
tottrips_SUEZ_f2_34=zeros(1,7);tottrips_NSR_f2_34=zeros(1,7);fuel_SUEZ_f2_34=zeros(1,7);
fuel_NSR_f2_34=zeros(1,7);fuel_outsNSR_f2_34=zeros(1,7);tot_fuel_f2_34=zeros(1,7);
tottrips_SUEZ_f2_56=zeros(1,7);tottrips_NSR_f2_56=zeros(1,7);fuel_SUEZ_f2_56=zeros(1,7);
fuel_NSR_f2_56=zeros(1,7);fuel_outsNSR_f2_56=zeros(1,7);tot_fuel_f2_56=zeros(1,7);
tottrips_NSR_f1=zeros(1,7);tottrips_NSR_f2=zeros(1,7);tottrips_SUEZ_f1=zeros(1,7);
tottrips_SUEZ_f2=zeros(1,7);total_fuel_f1=zeros(1,7);total_fuel_f2=zeros(1,7);
TEU_delivered_f1=zeros(1,7);TEU_delivered_f2=zeros(1,7);

for x=1:7 %ice scenario 1-7
% specific fuel consumption and fuel consumption on the NSR
if ice_class==1
sfc_f1=(0.6*vmaxf1^2-12*vmaxf1+84)*1.1;
sfc_f2=(0.6*vmaxf2^2-12*vmaxf2+84)*1.1;
fuel_scen(x,i)=fuel_scen(x,i)*1.1;
elseif ice_class==2
sfc_f1=(0.6*vmaxf1^2-12*vmaxf1+84)*1.08;
sfc_f2=(0.6*vmaxf2^2-12*vmaxf2+84)*1.08;
fuel_scen(x,i)=fuel_scen(x,i)*1.08;
elseif ice_class==3
sfc_f1=(0.6*vmaxf1^2-12*vmaxf1+84)*1.03;
sfc_f2=(0.6*vmaxf2^2-12*vmaxf2+84)*1.03;
fuel_scen(x,i)=fuel_scen(x,i)*1.03;
elseif ice_class==4
sfc_f1=(0.6*vmaxf1^2-12*vmaxf1+84)*1.02;
sfc_f2=(0.6*vmaxf2^2-12*vmaxf2+84)*1.02;
fuel_scen(x,i)=fuel_scen(x,i)*1.02;

end

%schedule f1, ship 1 & 2

schedf1_startl2=zeros(1,i);

```

```

    for i=1:20
        schedf1_start12(i)=t_transit_Sf1*i-t_transit_Sf1; % calculates when the vessel leaves
the ports
        if ((schedf1_start12(i)+(dist_outsideNSR/((2*vmaxf1)*24)))>=enter_NSR
            tsf1_12(x)=i;

                break
            end
        end
        trips_Sf1_12(x)=tsf1_12(x)-1;
        f_N_f1_12=zeros(1,20);
        enter_NSR_f1_12=zeros(1,7);
        for i=1:20

enter_NSR_f1_12(i)=schedf1_start12(tsf1_12(x))+((dist_outsideNSR)/(vmaxf1*24))+...
        ((t_NSR_scen(x,i))/24))*i-(((dist_outsideNSR)/(vmaxf1*24))+...
        ((t_NSR_scen(x,i))/24))+((dist_outsideNSR)/(2*vmaxf1*24))%calculates the entering
day on the NSR
            f_N_f1_12(i)=fuel_scen(x,i);

                if enter_NSR_f1_12(i)>last_NSR %checks if last entering date is surpassed
                    tnfl_12(x)=i;

                        break %stops the loop if the last entering day has been surpassed

                elseif ice_class==3 && t_NSR_scen(x,i)>(hm9_time)
                    tnfl_12(x)=i;

                        break % stops the loop if the ice class is IB and the ice thickness is
thicker than 0.8m

                elseif ice_class==4 && t_NSR_scen(x,i)>(hm7_time)
                    tnfl_12(x)=i;

                        break % stops the loop if the ice class is IC and the ice thickness is
thicker than 0.6m

                else
                    tnfl_12(x)=i;

                end
            end

            schedule_lastSUEZf1_12=zeros(1,10);
            for i=1:10
                schedule_lastSUEZf1_12(i)=enter_NSR_f1_12(tnfl_12(x)-1)+t_transit_Sf1*i-
t_transit_Sf1+...
                (((t_NSR_scen(x,tnfl_12(x)))/24))+((dist_outsideNSR)/(2*vmaxf1*24))) ;%calculates how
many transits through Suez the vessel takes after the NSR is closed

                    if schedule_lastSUEZf1_12(i)+t_transit_Sf1>days_year
                        last_Sf1_12(x)=i-1;
                    break % stops loop if the operational days a year is surpassed
                end
            end

            end

            tottrips_SUEZ_f1_12(x)=trips_Sf1_12(x)+last_Sf1_12(x) ;
            tottrips_NSR_f1_12(x)=tnfl_12(x)-1;
            fuel_SUEZ_f1_12(x)=sfc_f1*((tottrips_SUEZ_f1_12(x))*t_sail_Sf1;
            fuel_NSR_f1_12(x)=sum(f_N_f1_12)-fuel_scen(x,tnfl_12(x));
            fuel_outsNSR_f1_12(x)=tottrips_NSR_f1_12(x)*sfc_f1*(dist_outsideNSR)/(vmaxf1*24);
            tot_fuel_f1_12(x)=2*(fuel_SUEZ_f1_12(x)+fuel_NSR_f1_12(x)+fuel_outsNSR_f1_12(x));

            %% -----
            %schedule f1, ship 3 & 4

schedf1_start34=zeros(1,i);

        for i=1:20
            schedf1_start34(i)=t_transit_Sf1*i-t_transit_Sf1+7;
            if ((schedf1_start34(i)+(dist_outsideNSR/((2*vmaxf1)*24)))>=enter_NSR
                tsf1_34(x)=i;

```

```

        break
    end
end
trips_Sf1_34(x)=i-1;

enter_NSR_f1_34=zeros(1,7);
f_N_f1_34=zeros(1,7);
for i=1:20

enter_NSR_f1_34(i)=schedf1_start34(tsf1_34(x))+(((dist_outsideNSR)/(vmaxf1*24))+...
(((t_NSR_scen(x,i))/24)))*i-(((dist_outsideNSR)/(vmaxf1*24))+...
(((t_NSR_scen(x,i))/24)))+((dist_outsideNSR)/(2*vmaxf1*24));
f_N_f1_34(i)=fuel_scen(x,i);

        if enter_NSR_f1_34(i)>last_NSR
            tnfl_34(x)=i;

            break

        elseif ice_class==3 && t_NSR_scen(x,i)>(hm9_time)
            tnfl_34(x)=i;

            break

        elseif ice_class==4 && t_NSR_scen(x,i)>(hm7_time)
            tnfl_34(x)=i;

            break

        else
            tnfl_34(x)=i;

        end

    end

    schedule_lastSUEZf1_34=zeros(1,7);
    for i=1:10
        schedule_lastSUEZf1_34(i)=enter_NSR_f1_34(tnfl_34(x)-1)+t_transit_Sf1*i-
t_transit_Sf1+...
        (((t_NSR_scen(x,tnfl_34(x)))/24)+((dist_outsideNSR)/(2*vmaxf1*24)));

        if schedule_lastSUEZf1_34(i)+t_transit_Sf1>days_year
            last_Sf1_34(x)=i-1;
            break
        end

    end

    tottrips_SUEZ_f1_34(x)=trips_Sf1_34(x)+last_Sf1_34(x) ;
    tottrips_NSR_f1_34(x)=tnfl_34(x)-1;
    fuel_SUEZ_f1_34(x)=sfc_f1*tottrips_SUEZ_f1_34(x)*t_sail_Sf1;
    fuel_NSR_f1_34(x)=sum(f_N_f1_34)-fuel_scen(x,tnfl_34(x));
    fuel_outsNSR_f1_34(x)=tottrips_NSR_f1_34(x)*sfc_f1*(dist_outsideNSR)/(vmaxf1*24);
    tot_fuel_f1_34(x)=2*(fuel_SUEZ_f1_34(x)+fuel_NSR_f1_34(x)+fuel_outsNSR_f1_34(x));

%% -----

%schedule f1, ship 5 & 6

schedf1_start56=zeros(1,7);
for i=1:20
    schedf1_start56(i)=t_transit_Sf1*i-t_transit_Sf1+14;
    if ((schedf1_start56(i))+((dist_outsideNSR)/((2*vmaxf1)*24)))>=enter_NSR
        tsf1_56(x)=i;

        break
    end
end
trips_Sf1_56(x)=i-1;
enter_NSR_f1_56=zeros(1,7);
f_N_f1_56=zeros(1,7);
for i=1:20

enter_NSR_f1_56(i)=schedf1_start56(tsf1_56(x))+(((dist_outsideNSR)/(vmaxf1*24))+...

```

```

(((t_NSR_scen(x,i))/24)))*i-(((dist_outsideNSR)/(vmaxf1*24))+...
(((t_NSR_scen(x,i))/24))+((dist_outsideNSR)/(2*vmaxf1*24)));
f_N_f1_56(i)=fuel_scen(x,i);

    if enter_NSR_f1_56(i)>last_NSR
        tnf1_56(x)=i;

        break

    elseif ice_class==3 && t_NSR_scen(x,i)>(hm9_time)
        tnf1_56(x)=i;

        break

    elseif ice_class==4 && t_NSR_scen(x,i)>(hm7_time)
        tnf1_56(x)=i;

        break

    else
        tnf1_56(x)=i;

    end

end

schedule_lastSUEZf1_56=zeros(1,7);
for i=1:10
    schedule_lastSUEZf1_56(i)=enter_NSR_f1_56(tnf1_56(x)-1)+t_transit_Sf1*i-
t_transit_Sf1+...
    (((t_NSR_scen(x,tnf1_56(x)))/24)+((dist_outsideNSR)/(2*vmaxf1*24)));

    if schedule_lastSUEZf1_56(i)+t_transit_Sf1>days_year
        last_Sf1_56(x)=i-1;
        break
    end

end

tottrips_SUEZ_f1_56(x)=trips_Sf1_56(x)+last_Sf1_56(x) ;
tottrips_NSR_f1_56(x)=tnf1_56(x)-1;
fuel_SUEZ_f1_56(x)=sfc_f1*tottrips_SUEZ_f1_56(x)*t_sail_Sf1;
fuel_NSR_f1_56(x)=sum(f_N_f1_56)-fuel_scen(x,tnf1_56(x));
fuel_outsNSR_f1_56(x)=tottrips_NSR_f1_56(x)*sfc_f1*(dist_outsideNSR)/(vmaxf1*24);
tot_fuel_f1_56(x)=2*(fuel_SUEZ_f1_56(x)+fuel_NSR_f1_56(x)+fuel_outsNSR_f1_56(x));

%% -----
---
%schedule f1, ship 7
schedf1_start7=zeros(1,7);
for i=1:20
    schedf1_start7(i)=t_transit_Sf1*i-t_transit_Sf1+21;
    if ((schedf1_start7(i))+((dist_outsideNSR)/((2*vmaxf1)*24)))>=enter_NSR
        tsf1_7(x)=i;

        break
    end
end
trips_Sf1_7(x)=i-1;
enter_NSR_f1_7=zeros(1,7);
f_N_f1_7=zeros(1,7);
for i=1:20
    enter_NSR_f1_7(i)=schedf1_start7(tsf1_7(x))+(((dist_outsideNSR)/(vmaxf1*24))+...
    (((t_NSR_scen(x,i))/24)))*i-(((dist_outsideNSR)/(vmaxf1*24))+...
    (((t_NSR_scen(x,i))/24))+((dist_outsideNSR)/(2*vmaxf1*24)));
    f_N_f1_7(i)=fuel_scen(x,i);

    if enter_NSR_f1_7(i)>last_NSR
        tnf1_7(x)=i;

        break

    elseif ice_class==3 && t_NSR_scen(x,i)>(hm9_time)
        tnf1_7(x)=i;

        break

```

```

elseif ice_class==4 && t_NSR_scen(x,i)>(hm7_time)
    tnf1_7(x)=i;

    break

else
    tnf1_7(x)=i;

end

end

schedule_lastSUEZf1_7=zeros(1,7);
for i=1:10
    schedule_lastSUEZf1_7(i)=enter_NSR_f1_7(tnf1_7(x)-1)+t_transit_Sf1*i-
t_transit_Sf1+...
    (((t_NSR_scen(x,tnf1_7(x)))/24)+((dist_outsideNSR)/(2*vmaxf1*24)));

    if schedule_lastSUEZf1_7(i)+t_transit_Sf1>days_year
        last_Sf1_7(x)=i-1;
        break
    end
end

tottrips_SUEZ_f1_7(x)=trips_Sf1_7(x)+last_Sf1_7(x) ;
tottrips_NSR_f1_7(x)=tnf1_7(x)-1;
fuel_SUEZ_f1_7(x)=sfc_f1*tottrips_SUEZ_f1_7(x)*t_sail_Sf1;
fuel_NSR_f1_7(x)=sum(f_N_f1_7)-fuel_scen(x,tnf1_7(x));
fuel_outsNSR_f1_7(x)=tottrips_NSR_f1_7(x)*sfc_f1*(dist_outsideNSR)/(vmaxf1*24);
tot_fuel_f1_7(x)=(fuel_SUEZ_f1_7(x)+fuel_NSR_f1_7(x)+fuel_outsNSR_f1_7(x));

%% -----

%schedule f2, ship 1 & 2

schedf2_start12=zeros(1,7);

for i=1:20
    schedf2_start12(i)=t_transit_Sf2*i-t_transit_Sf2;
    if ((schedf2_start12(i))+((dist_outsideNSR)/((2*vmaxf2)*24)))>=enter_NSR
        tsf2_12(x)=i;

        break
    end
end
trips_Sf2_12(x)=i-1;
enter_NSR_f2_12=zeros(1,12);
f_N_f2_12=zeros(1,12);
for i=1:20
enter_NSR_f2_12(i)=schedf2_start12(tsf2_12(x))+(((dist_outsideNSR)/(vmaxf2*24))+...
(((t_NSR_scen(x,i))/24)))*i-(((dist_outsideNSR)/(vmaxf2*24))+...
(((t_NSR_scen(x,i))/24)))+((dist_outsideNSR)/(2*vmaxf2*24));
f_N_f2_12(i)=fuel_scen(x,i);

if enter_NSR_f2_12(i)>last_NSR
    tnf2_12(x)=i;

    break

elseif ice_class==3 && t_NSR_scen(x,i)>(hm9_time)
    tnf2_12(x)=i;

    break

elseif ice_class==4 && t_NSR_scen(x,i)>(hm7_time)
    tnf2_12(x)=i;

    break

else
    tnf2_12(x)=i;

end
end

```

```

end

schedule_lastSUEZf2_12=zeros(1,7);
for i=1:10
    schedule_lastSUEZf2_12(i)=enter_NSR_f2_12(tnf2_12(x)-1)+t_transit_Sf2*i-
t_transit_Sf2+...
    (((t_NSR_scen(x,tnf2_12(x)))/24)+((dist_outsideNSR)/(2*vmaxf2*24)));

    if schedule_lastSUEZf2_12(i)+t_transit_Sf2>days_year
        last_Sf2_12(x)=i-1;
        break
    end
end

tottrips_SUEZ_f2_12(x)=trips_Sf2_12(x)+last_Sf2_12(x) ;
tottrips_NSR_f2_12(x)=tnf2_12(x)-1;
fuel_SUEZ_f2_12(x)=sfc_f2*tottrips_SUEZ_f2_12(x)*t_sail_Sf2 ;
fuel_NSR_f2_12(x)=sum(f_N_f2_12)-fuel_scen(x,tnf2_12(x)) ;
fuel_outsNSR_f2_12(x)=tottrips_NSR_f2_12(x)*sfc_f2*(dist_outsideNSR)/(vmaxf2*24) ;
tot_fuel_f2_12(x)=2*(fuel_SUEZ_f2_12(x)+fuel_NSR_f2_12(x)+fuel_outsNSR_f2_12(x)) ;

%% -----
-----

%schedule f2, ship 3 & 4

schedf2_start34=zeros(1,7);

for i=1:20
    schedf2_start34(i)=t_transit_Sf2*i-t_transit_Sf2+7;
    if ((schedf2_start34(i))+((dist_outsideNSR)/((2*vmaxf2)*24)))>=enter_NSR
        tsf2_34(x)=i;

        break
    end
end
trips_Sf2_34(x)=i-1;
enter_NSR_f2_34=zeros(1,7);
f_N_f2_34=zeros(1,7);
for i=1:20

enter_NSR_f2_34(i)=schedf2_start34(tsf2_34(x))+(((dist_outsideNSR)/(vmaxf2*24))+...
(((t_NSR_scen(x,i))/24)))*i-(((dist_outsideNSR)/(vmaxf2*24))+...
(((t_NSR_scen(x,i))/24)))+((dist_outsideNSR)/(2*vmaxf2*24));
f_N_f2_34(i)=fuel_scen(x,i);

    if enter_NSR_f2_34(i)>last_NSR
        tnf2_34(x)=i;

        break

    elseif ice_class==3 && t_NSR_scen(x,i)>(hm9_time)
        tnf2_34(x)=i;

        break

    elseif ice_class==4 && t_NSR_scen(x,i)>(hm7_time)
        tnf2_34(x)=i;

        break

    else
        tnf2_34(x)=i;

    end

end

schedule_lastSUEZf2_34=zeros(1,7);
for i=1:10
    schedule_lastSUEZf2_34(i)=enter_NSR_f2_34(tnf2_34(x)-1)+t_transit_Sf2*i-
t_transit_Sf2+...
    (((t_NSR_scen(x,tnf2_34(x)))/24)+((dist_outsideNSR)/(2*vmaxf2*24)));

    if schedule_lastSUEZf2_34(i)+t_transit_Sf2>days_year
        last_Sf2_34(x)=i-1;

```

```

        break
    end
end

tottrips_SUEZ_f2_34(x)=trips_Sf2_34(x)+last_Sf2_34(x) ;
tottrips_NSR_f2_34(x)=tnf2_34(x)-1;
fuel_SUEZ_f2_34(x)=sfc_f2*tottrips_SUEZ_f2_34(x)*t_sail_Sf2;
fuel_NSR_f2_34(x)=sum(f_N_f2_34)-fuel_scen(x,tnf2_34(x));
fuel_outsNSR_f2_34(x)=tottrips_NSR_f2_34(x)*sfc_f2*(dist_outsideNSR)/(vmaxf2*24);
tot_fuel_f2_34(x)=2*(fuel_SUEZ_f2_34(x)+fuel_NSR_f2_34(x)+fuel_outsNSR_f2_34(x));

%% -----

%schedule f2, ship 5 & 6

schedf2_start56=zeros(1,7);

for i=1:20
    schedf2_start56(i)=t_transit_Sf2*i-t_transit_Sf2+14;
    if ((schedf2_start56(i)+(dist_outsideNSR/((2*vmaxf2)*24)))>=enter_NSR
        tsf2_56(x)=i;

        break
    end
end
trips_Sf2_56(x)=i-1;
enter_NSR_f2_56=zeros(1,7);
f_N_f2_56=zeros(1,7);
for i=1:20

enter_NSR_f2_56(i)=schedf2_start56(tsf2_56(x))+(((dist_outsideNSR)/(vmaxf2*24))+...
    (((t_NSR_scen(x,i))/24)))*i-(((dist_outsideNSR)/(vmaxf2*24))+...
    (((t_NSR_scen(x,i))/24)))+(dist_outsideNSR)/(2*vmaxf2*24));
    f_N_f2_56(i)=fuel_scen(x,i);

    if enter_NSR_f2_56(i)>last_NSR
        tnf2_56(x)=i;

        break

    elseif ice_class==3 && t_NSR_scen(x,i)>(hm9_time)
        tnf2_56(x)=i;

        break

    elseif ice_class==4 && t_NSR_scen(x,i)>(hm7_time)
        tnf2_56(x)=i;

        break

    else
        tnf2_56(x)=i;

    end
end

    schedule_lastSUEZf2_56=zeros(1,7);
    for i=1:10
        schedule_lastSUEZf2_56(i)=enter_NSR_f2_56(tnf2_56(x)-1)+t_transit_Sf2*i-
t_transit_Sf2+...
        (((t_NSR_scen(x,tnf2_56(x)))/24))+((dist_outsideNSR)/(2*vmaxf2*24));

        if schedule_lastSUEZf2_56(i)+t_transit_Sf2>days_year
            last_Sf2_56(x)=i-1;
            break
        end
    end

tottrips_SUEZ_f2_56(x)=trips_Sf2_56(x)+last_Sf2_56(x) ;
tottrips_NSR_f2_56(x)=tnf2_56(x)-1;
fuel_SUEZ_f2_56(x)=sfc_f2*tottrips_SUEZ_f2_56(x)*t_sail_Sf2;
fuel_NSR_f2_56(x)=sum(f_N_f2_56)-fuel_scen(x,tnf2_56(x));
fuel_outsNSR_f2_56(x)=tottrips_NSR_f2_56(x)*sfc_f2*(dist_outsideNSR)/(vmaxf2*24);
tot_fuel_f2_56(x)=2*(fuel_SUEZ_f2_56(x)+fuel_NSR_f2_56(x)+fuel_outsNSR_f2_56(x));

```

```

tottrips_NSR_f1(x)=(tottrips_NSR_f1_12(x)+tottrips_NSR_f1_34(x)+tottrips_NSR_f1_56(x))*2+tottrips_NSR_f1_7(x);
tottrips_NSR_f2(x)=(tottrips_NSR_f2_12(x)+tottrips_NSR_f2_34(x)+tottrips_NSR_f2_56(x))*2;

tottrips_SUEZ_f1(x)=(tottrips_SUEZ_f1_12(x)+tottrips_SUEZ_f1_34(x)+tottrips_SUEZ_f1_56(x))*2+tottrips_SUEZ_f1_7(x);
tottrips_SUEZ_f2(x)=(tottrips_SUEZ_f2_12(x)+tottrips_SUEZ_f2_34(x)+tottrips_SUEZ_f2_56(x))*2;

total_fuel_f1(x)=tot_fuel_f1_12(x)+tot_fuel_f1_34(x)+tot_fuel_f1_56(x)+tot_fuel_f1_7(x);
total_fuel_f2(x)=tot_fuel_f2_12(x)+tot_fuel_f2_34(x)+tot_fuel_f2_56(x);
TEU_delivered_f1(x)=TEU*(tottrips_NSR_f1_12(x)+tottrips_NSR_f1_34(x)+tottrips_NSR_f1_56(x)...
+(tottrips_NSR_f1_7(x)/2)+tottrips_SUEZ_f1_12(x)+tottrips_SUEZ_f1_34(x)...
+tottrips_SUEZ_f1_56(x)+(tottrips_SUEZ_f1_7(x)/2))*2
TEU_delivered_f2(x)=TEU*(tottrips_NSR_f2_12(x)+tottrips_NSR_f2_34(x)+tottrips_NSR_f2_56(x)...
+tottrips_SUEZ_f2_12(x)+tottrips_SUEZ_f2_34(x)+tottrips_SUEZ_f2_56(x))*2;

rf1(x)=total_fuel_f1(x)/TEU_delivered_f1(x);
rf2(x)=total_fuel_f2(x)/TEU_delivered_f2(x);

end
r1=(fuelconsumpS1/tot_TEU_deliveredS1);
r2=(fuelconsumpS2/tot_TEU_deliveredS2);

%% -----
%%BUDGET

capital_costS=60000000;

if ice_class==1
    capital_costN=capital_costS*1.12;
elseif ice_class==2
    capital_costN=capital_costS*1.095;
elseif ice_class==3
    capital_costN=capital_costS*1.075;
elseif ice_class==4
    capital_costN=capital_costS*1.065;
end

%financial cost
tl=n; %term of loan
int_rate=0.08; %interest rate
eq=0.4; %equity
loan_f1=capital_costN*(1-eq)*f1;
loan_f2=capital_costN*(1-eq)*f2;
cost_loan_f1=loan_f1*((1+int_rate)^(tl))*int_rate/(((1+int_rate)^(tl))-1);
cost_loan_f2=loan_f2*((1+int_rate)^(tl))*int_rate/(((1+int_rate)^(tl))-1);
scf1=0.2*capital_costN*f1; %value of ship
after n years, assumed 20% of capital cost
scf2=0.2*capital_costN*f2;

mS_f1=0.02*capital_costN*f1; %maintenance &
repair
mS_f2=0.02*capital_costN*f2;
wage_adm=40000;
adm_f1=(10+(f1))*wage_adm; %administration
costs
adm_f2=(10+(f2))*wage_adm;
insur_f1=0.01*capital_costN*f1; %insurance
insur_f2=0.01*capital_costN*f2;

rfr_f1=zeros(1,7);
rfr_f2=zeros(1,7);
for x=1:7
    %suez fee (per transit)

one_TEU=12; %tonnage
tot_net_tonnage=TEU*one_TEU;
suez_fee_f1(x)=(5000*7.21+5000*6.13+10000*3.37+20000*2.42+((tot_net_tonnage-40000)*2.42))*tottrips_SUEZ_f1(x);
suez_fee_f2(x)=(5000*7.21+5000*6.13+10000*3.37+20000*2.42+((tot_net_tonnage-40000)*2.42))*tottrips_SUEZ_f2(x);

```



```

% NSR fee
fee=5 ;           %per tonnage [$]
nsr_fee_f1(x)=tot_net_tonnage*fee*tottrips_NSR_f1(x);
nsr_fee_f2(x)=tot_net_tonnage*fee*tottrips_NSR_f2(x);
%operation

wage=30000; %http://www.itfglobal.org/
crew_sea=30;
wage_crewf1=crew_sea*wage*f1;
wage_crewf2=crew_sea*wage*f2;

cargo_hand=150 ;      %cost of cargo handling per TEU
port_f1(x)=cargo_hand*TEU_delivered_f1(x);
port_f2(x)=cargo_hand*TEU_delivered_f2(x);

lcc_f1(x)=(cost_loan_f1+(total_fuel_f1(x)*fuel_price)+wage_crewf1+port_f1(x)+suez_fee_f1(x)+m
S_f1+adm_f1+nsr_fee_f1(x))*n)-scf1+capital_costN*eq*f1;
rfr_f1(x)=lcc_f1(x)/(TEU_delivered_f1(x)*n);

lcc_f2(x)=(cost_loan_f2+(total_fuel_f2(x)*fuel_price)+wage_crewf2+port_f2(x)+suez_fee_f2(x)+m
S_f2+adm_f2+nsr_fee_f2(x))*n)-scf2+capital_costN*eq*f2;
rfr_f2(x)=lcc_f2(x)/(TEU_delivered_f2(x)*n);

end

```

graph_fuelconsumption.m script

```

%graph fuel consumption 3800 TEU

x=[12 14 16 18 20 22 24 26 28];
g=zeros(1,9);

for i=1:9
    g(i)=0.6*x(i)^2-12*x(i)+84;
end
plot(x,g); axis([12 28 0 250]);grid on ;title(' 3800 TEU'); xlabel('speed (kn)');
ylabel('fuel consumption [ton/day]')

```