



Norwegian University of  
Science and Technology

# Optimizing the directivity index of a two-way loudspeaker

Diego Ivars Morón

Master of Science in Electronics  
Submission date: June 2010  
Supervisor: Peter Svensson, IET

Norwegian University of Science and Technology  
Department of Electronics and Telecommunications



# Problem Description

The directivity index is a performance indicator of a loudspeaker which is often overlooked. There are indications that a largely frequency-independent directivity index is preferable for loudspeakers in an ordinary stereo setup. The directivity index at higher frequencies is quite sensitive to the mounting and orientation of the tweeter element, and the purpose of this project is to study this aspect through simulation, prototype building, measurements, and informal listening tests.

Assignment given: 02. February 2010  
Supervisor: Peter Svensson, IET



---

## Optimizing the Directivity Index of a Two-way loudspeaker

**Abstract:** Performance of the loudspeaker in a common living room is analyzed in this project. Moreover, directivity parameters like Directivity Index and polar Directivity Diagram are studied taking as example one specific tweeter construction. Some writers suggest that largely frequency-independent Directivity Index is preferable for loudspeakers in an ordinary indoor stereo setup. To achieve this goal, variation of the original radiation diagram of the studied tweeter is performed including reflectors in the system. A measurement protocol is designed and used. Obtained data is processed by developed software that presents the results.

---

## Acknowledgments

I would like to thank Peter Svensson for the help to develop this project. I thank Tim Cato and Øyvind Lervik for providing all the necessary equipment and for their invaluable comments. I also thank the people from the workshop, especially Tore Landsem for the great work making the reflectors and stands.

# Contents

<b>1</b>	<b>Introduction</b>	<b>1</b>
<b>2</b>	<b>Theory</b>	<b>3</b>
2.1	Stereo . . . . .	3
2.1.1	Setup . . . . .	4
2.1.2	Stereo seat . . . . .	4
2.2	Loudspeaker Directivity “Radiation in Anechoic Environment” . . . . .	4
2.2.1	Anechoic Environment . . . . .	4
2.2.2	Loudspeaker Directivity Descriptors . . . . .	5
2.2.3	Directivity Index . . . . .	6
2.2.4	Radiation in Anechoic Environment . . . . .	7
2.3	Room Characteristics “Loudspeaker in a room” . . . . .	7
2.3.1	Reverberant sound parameters . . . . .	7
2.3.2	Reverberant sound . . . . .	8
2.3.3	Loudspeaker in a room . . . . .	8
2.4	Relationship between anechoic data and room curves . . . . .	8
2.5	Forcing the similarity of reflected and direct sound . . . . .	10
2.5.1	Problem . . . . .	11
2.5.2	Approximation . . . . .	11
2.6	Loudspeakers constructions with “wide dispersion” . . . . .	11
2.6.1	Linkwitz Pluto DIY Solution . . . . .	11
2.6.2	Reflectors. Analyzing the market . . . . .	13
<b>3</b>	<b>Directivity Index measurement techniques</b>	<b>17</b>
3.1	Description of the test loudspeaker . . . . .	17
3.2	Number of microphones . . . . .	18
3.2.1	Problem . . . . .	18
3.2.2	Solution . . . . .	18
3.3	2D vs. 3D measurement. Decision . . . . .	18
3.3.1	2D . . . . .	18
3.3.2	3D . . . . .	19
3.3.3	Comparison of the two methods. Pros and cons . . . . .	19
3.3.4	Decision of the method to follow . . . . .	20
3.4	Acoustic center . . . . .	21
3.5	Develping software . . . . .	21
3.5.1	Program needs . . . . .	21
3.5.2	Brief description of functions . . . . .	21
3.6	Possible problem solutions . . . . .	24
3.6.1	Problem recapitulation . . . . .	24
3.6.2	Why just in mid-high frequencies? What about low frequencies? . . . . .	24

3.6.3	Solution . . . . .	24
<b>4</b>	<b>Experiments</b>	<b>25</b>
4.1	Radiation of the Loudspeaker . . . . .	25
4.2	Radiation of the Loudspeaker with reflector . . . . .	25
4.2.1	Reflectors . . . . .	25
<b>5</b>	<b>Results</b>	<b>31</b>
5.1	Radiation of the test loudspeaker . . . . .	31
5.2	Radiation of the test loudspeaker with reflector . . . . .	35
5.2.1	Cone $82^\circ$ . . . . .	35
5.2.2	Cone $88^\circ$ . . . . .	39
5.2.3	Parabola placed at 8.3 cm from the surface of the transducer . . . . .	43
5.2.4	Parabola placed at 2 cm from the surface of the transducer . . . . .	47
5.2.5	Sphere placed at 2 cm from the surface of the transducer . . . . .	51
<b>6</b>	<b>Discussion</b>	<b>55</b>
6.1	Radiation of the test loudspeaker . . . . .	55
6.2	Radiation of the test loudspeaker with reflector . . . . .	55
6.2.1	Cone $82^\circ$ . . . . .	55
6.2.2	Cone $88^\circ$ . . . . .	56
6.2.3	Parabola placed at 8.3 cm from the surface of the transducer . . . . .	56
6.2.4	Parabola placed at 2 cm from the surface of the transducer . . . . .	56
6.2.5	Sphere placed at 2 cm from the surface of the transducer . . . . .	57
<b>7</b>	<b>Conclusion</b>	<b>59</b>
<b>A</b>	<b>Parabola Description</b>	<b>61</b>
<b>B</b>	<b>Equipment used</b>	<b>65</b>
<b>C</b>	<b>Reflector assembly</b>	<b>67</b>
<b>D</b>	<b>Measurement Protocol</b>	<b>69</b>
D.1	Calibration . . . . .	69
D.2	Setup . . . . .	69
D.3	Measuring . . . . .	69
D.4	Storing . . . . .	69
D.5	Next measuring state . . . . .	71
<b>E</b>	<b>Software description</b>	<b>73</b>
E.1	SETUP . . . . .	73
E.2	Frequency Response . . . . .	74
E.3	Directivity Diagram . . . . .	75
E.4	Directivity Index . . . . .	76



---

<b>F Flow Diagrams and Code of Matlab Functions</b>	<b>79</b>
F.1 Graphic User Interface . . . . .	79
F.2 center . . . . .	81
F.3 Frequency Response . . . . .	85
F.4 Radiation Diagram . . . . .	93
F.5 Directivity Index . . . . .	101
<b>Bibliography</b>	<b>107</b>



# Introduction

---

Stereo reproduction in small rooms constitutes most of the listening experience time during the day. Home or car environment are the more often listening places. However, scientific research is mostly dedicated to understand sound propagation and psychoacoustics in big concert halls or workspaces. Reproduction in small rooms seems often unrealistic. It is easy for listeners to differentiate between a real instrument playing inside this room and an instrument record played into the same place by a pair of loudspeakers. This fact is due to several reasons, like microphone techniques in recording, mixing subjectivity, reproduction setup . . .

There is some controversy about the loudspeaker setup inside this kind of rooms. In the listening experience performed inside this, the listener will receive sound from the loudspeaker but in two different ways. The direct sound is the first one that reaches the listener and arrives via the shortest path. The pressure of it depends on the power of the source, the directivity index in that direction and the distance between the source and the listener. The reverberant sound comes after the direct sound. It is formed by the sound due to resonances, reverberation and reflections caused by the boundaries of the room [2]. The reverberant sound depends on the power of the source and one room-absorbing factor. Some studies defend that the frequency response of the direct sound should be as flat as possible setting up the system with the loudspeaker axis aimed towards the listener. It is supported by the commercials and publicity of sound systems that show this on-axis frequency response as main parameter on the loudspeaker datasheet. But, it is well known that when the reproduction is performed in a room, reverberant sound is added to the direct sound and due to this, final frequency response in the listener position is varied from the original showed in the loudspeaker datasheet.

The radiation diagram of a commercial loudspeaker depends on the frequency. That means that the energy the transducer is emitting is spread in a different way for each frequency. This fact makes the room a non-neutral factor in the reproduction adding some coloration to the received sound.

In the other hand, some studies defend flatness in the room frequency response. This is followed in a mixing control room or a recording studio construction. Flat room frequency response is difficult to reach because it depends on the room geometry and the objects placed in. That is why the changes in this frequency response are achieved with changes in the boundaries or elements inside the room.

One solution in between could be the one suggested by Toole. In his paper [5] it is affirmed that important for localization, and very interesting from the perspective of

sound reproduction, is the observation that the precedence effect appears to be most effective when the spectra of the direct and reflected sounds are similar. That is what he claims that this appears to be an argument for constant-directivity loudspeakers and frequency-independent (that is, broad-band) reflectors, absorbers, and diffusers.

Forcing the similarity of reflected and direct sound is a difficult task due to the diversity of rooms the stereo sound system is placed in. That is why an approximation where Directivity Index should be close to zero in the listening direction over the audible frequency range is taken. This idea is supported by Linkwitz in his commercial Pluto DIY. In it, the low-mid loudspeaker (20-1000 Hz.) is faced upwards, varying the classical loudspeaker orientation in the stereo sound system setup. Horizontal plane is proposed as the listening plane because the zero Directivity Index has been measured on it. However, transducer in charge of mid-high frequency (1k-22kHz.) has been designed aimed towards the listener.

This solution for mid-high frequency produces the classical problems in small-rooms reproduction where changes in the radiation diagram make the room participate in the final result [8].

Apparently, varying loudspeaker orientation like woofer solution is difficult due to the changes in the diagram make uncertain the possibility to find one direction that keeps  $DI=0$  in all the range. Moreover, solution in the horizontal plane ( $\theta=90^\circ$ ) would be suitable. This solution entails the variation of the radiation diagram. It can be solved facing the loudspeaker towards a reflector.

That is why,  $DI$  as descriptor parameter of loudspeaker radiation becomes fundamental in this thesis. The software lack about  $DI$  calculation makes a new goal in this work developing a software tool to make it possible.

In a pilot study, 2D measurement techniques have been studied [13].

In this project, measuring techniques all around the loudspeaker (2D/3D) are further developed, explained and compared. Reflector shapes and materials are studied and manufactured. The different solutions are discussed helped by the results in Frequency Response, Radiation Diagram and Directivity Index obtained from the developed software.

In the first part of this thesis, theoretical concepts are presented. Issues like loudspeaker radiation characteristics in an indoor or anechoic environment are treated. It is also explained the goal of this study and the publications that support it.

Second part treats about the appropriate measuring method to follow and a brief description of the developed software. In this section is also discussed which solution could be valid.

In the third part, results are presented and discussed.

Several appendices are attached containing exhaustive information about measuring protocol, software manual, . . .

# Theory

## Contents

<b>2.1 Stereo</b> . . . . .	<b>3</b>
2.1.1 Setup . . . . .	4
2.1.2 Stereo seat . . . . .	4
<b>2.2 Loudspeaker Directivity “Radiation in Anechoic Environment”</b> . . . . .	<b>4</b>
2.2.1 Anechoic Environment . . . . .	4
2.2.2 Loudspeaker Directivity Descriptors . . . . .	5
2.2.3 Directivity Index . . . . .	6
2.2.4 Radiation in Anechoic Environment . . . . .	7
<b>2.3 Room Characteristics “Loudspeaker in a room”</b> . . . . .	<b>7</b>
2.3.1 Reverberant sound parameters . . . . .	7
2.3.2 Reverberant sound . . . . .	8
2.3.3 Loudspeaker in a room . . . . .	8
<b>2.4 Relationship between anechoic data and room curves</b> . . . . .	<b>8</b>
<b>2.5 Forcing the similarity of reflected and direct sound</b> . . . . .	<b>10</b>
2.5.1 Problem . . . . .	11
2.5.2 Approximation . . . . .	11
<b>2.6 Loudspeakers constructions with “wide dispersion”</b> . . . . .	<b>11</b>
2.6.1 Linkwitz Pluto DIY Solution . . . . .	11
2.6.2 Reflectors. Analyzing the market . . . . .	13

## 2.1 Stereo

This sound system is used to reproduce two audio channels using two loudspeakers symmetrically placed in front of the listener. The goal is to produce the sensation that the sound is heard from different directions.

The mechanism that ear uses to locate the source is different for high and low frequencies. Low frequencies correspond to wavelength large in comparison with the head. This minimum difference in intensity arrives to the two ears and this fact points out that directional location at low frequencies is not possible.

Above 1 kHz directional location is achieved because wavelength is short compared with the head dimension. Head-masking effect produces differences in the intensity reached in each ear and directional location can be performed by the brain [7].

### 2.1.1 Setup

Stereo system in a domestic living room could be set in many different ways. The most used position of the two loudspeakers is around  $\pm 30^\circ$ . It is shown in the Figure 2.1.

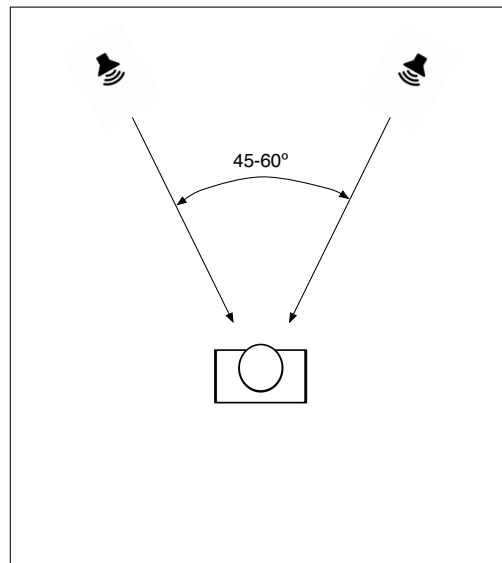

Figure 2.1: Most often stereo setup

### 2.1.2 Stereo seat

Stereo reproduction causes that only one listener can hear the played sound as it should be heard. That is why, some writers define it as an antisocial system because no one would listen the same out of the main seat. Moreover, sound quality is altered because of the acoustical crosstalk [6].

## 2.2 Loudspeaker Directivity “Radiation in Anechoic Environment”

### 2.2.1 Anechoic Environment

For this project, anechoic chamber is the place chosen for developing the measurements. Inside this anechoic environment the listener receives just the radiation that

comes directly from the loudspeaker simulating free-field radiation conditions. As it is known for all, it consists in a test room in which all surfaces are lined with a sound-absorbing material (like rock wool) to reduce reflections of sound to a minimum [10].

### 2.2.2 Loudspeaker Directivity Descriptors

**Directivity Diagram. Polar representation.** Directivity diagram is the most important directivity descriptor. It consists in the graphic description of the transducer response in far field related with the sound waves direction in a spherical plane at one frequency. It shows the way the radiation is spread on the space around the source [1].

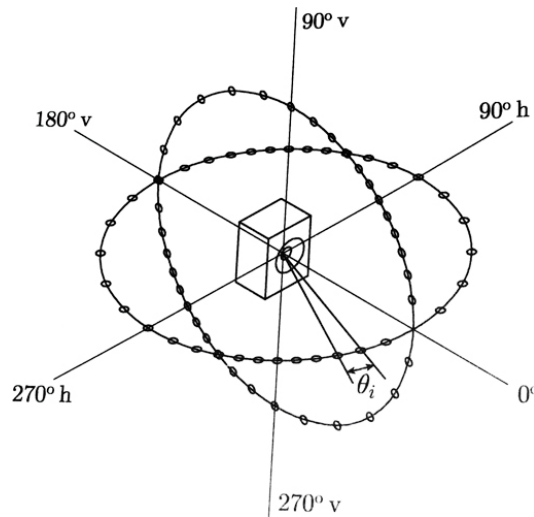

Figure 2.2: Points for measurement of directivity.[1]

This representation consists in the source placed in the center of a sphere ( $r$  radio). Sound pressure in function of elevation  $\theta$  and azimuth  $\phi$  is represented either linear scale or dB.

It is usual to find the pressure normalized with the maximum. Radiation is often a volume of revolution. That is why, measurements are taken the way that  $z$  is the symmetry axis of the radiation [1].

#### Dispersion (6 dB):

Directivity diagram shows the pressure normalized with the maximum pressure. This value is usually on  $z$  axis (broadside radiation, on-axis). The dispersion is the coverage angle between -6 dB points including the maximum pressure within the interval.

“In general, high frequency dispersion of  $\pm 15^\circ$  at a -6 dB point is considered

acceptable,  $\pm 30^\circ$  at a -6 dB point is considered to be good performance, and  $\pm 45^\circ$  at -6 dB is considered to be excellent in conventional loudspeaker performance. Generally, no modifications to the transducer itself are undertaken to modify driver dispersion” [9].

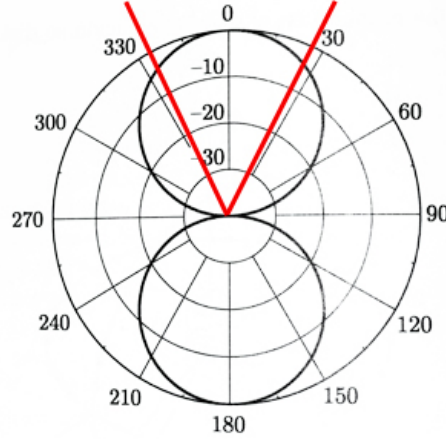

Figure 2.3: Dispersion of the a source at one specific frequency.

### 2.2.3 Directivity Index

Directivity Index in the direction  $(\theta_0, \phi_0)$  shows the relationship between acoustic intensity on this direction and the intensity produced by an isotropic source radiating the same power as this source. This difference in dB could reach 12 or 13 dB in high frequencies. This means that if the listener varies the position from the loudspeaker axis to another, high frequencies information would probably fall.

It is known that in low frequency, the loudspeaker acts like an omni-directional source. This makes the  $DI = 0$  within this frequency range.

$$DI(\theta_0, \phi_0) = 10 \log \frac{I(\theta_0, \phi_0)}{I_{iso}} \quad (2.1)$$

This isotropic intensity is defined as the power emitted by the source over the surface of a sphere around it with radio  $r$  [1].

$$I_{iso} = \frac{W}{4\pi r^2} \quad (2.2)$$

The sound power ( $W$ ) is defined as the sum of intensities on any surface  $S$  around the source.

$$W = \int_S I(\theta, \phi) dS \quad (2.3)$$

If the sphere is chosen ( $dS = r^2 \sin \theta d\theta d\phi$ )



$$DI(\theta_0, \phi_0) = 10 \log \frac{I(\theta_0, \phi_0)}{\int_S I(\theta, \phi) dS} 4\pi r^2 = 4\pi \frac{I(\theta_0, \phi_0)}{\int_S I(\theta, \phi) \sin \theta d\theta d\phi} \quad (2.4)$$

**2D approximation** If radiation forms a volume of revolution around  $z$  axis, it means that the expression could be modified getting the discretized formula [1]:

$$DI(\theta_0) = 10 \log \frac{1}{\frac{1}{2} \sum_{i=1}^{72} \frac{I(\theta_i)}{I(\theta_0)} \sin \theta_i \Delta \theta_i} \quad (2.5)$$

Equation 2.5 belongs to a discretized measurement around the loudspeaker where  $\theta$  step is  $5^\circ$ .

### 2.2.4 Radiation in Anechoic Environment

It should be clear that directivity descriptors of the loudspeaker do not depend on the room the transducer is placed in. Radiation diagram and Directivity Index are measured under anechoic conditions. Pressure the listener receives does vary depending on this place. But the radiation characteristics of the loudspeaker are the same as measured in anechoic chamber.

Anechoic chamber pretends to be a free field environment. There, listener would receive direct sound coming from the source and reaching him through the shortest path. Pressure level of a spherical source decreases 6 dB every time the distance is doubled.

Pressure of the direct sound generated by the source on the listener is:

$$L_p(d) = L_W + 10 \log \frac{Q(\theta, \phi)}{4\pi r^2} \quad (2.6)$$

Note that  $Q$  is the Directivity Factor and it is one for omni-directional sources.

## 2.3 Room Characteristics “Loudspeaker in a room”

### 2.3.1 Reverberant sound parameters

**Absorptivity** Absorptivity is the parameter that includes the properties of the whole room. This includes the sum of the absorption coefficients weighted by their areal contribution to the room. This parameter is frequency dependent [11].

$$A = S\bar{\alpha} \quad (2.7)$$

**Reverberation time** When the sound source stops emitting, there is a slot of time between the loudspeaker disconnection and the sound disappearance. This is called reverberation time and is defined as the time that the intensity takes to decrease 60 dB respect the stationary level.

$$T_{60} = 0.163 \frac{V}{A} \quad (2.8)$$

$V$  is the Volume of the room and  $A$  the Absorptivity.

**Room constant** It quantifies the total absorption of sound in a room [1]:

$$R = \frac{S\bar{\alpha}}{1 - \bar{\alpha}} = \frac{S}{\frac{0.163S}{V} - 1} m^2 \quad (2.9)$$

### 2.3.2 Reverberant sound

Indoors, reverberant sound is added to the direct sound. This sound comes from the multiple reflexions of the signal on the surfaces of the enclosure. This reverberant sound is uniformly spread in the room. That is why it is taken as independent of the listener position [1].

The formula that defines this sound is:

$$L_p(r) = L_W + 10 \log \frac{4}{R} \quad (2.10)$$

### 2.3.3 Loudspeaker in a room

Indoors, the combination of the direct pressure and the reverberant pressure makes the total pressure received by the listener:

$$L_p = L_W + 10 \log \left( \frac{Q(\theta, \phi)}{4\pi r^2} + \frac{4}{R} \right) \quad (2.11)$$

**Constructive and destructive interference** It is known that the sum of a single frequency sound and a delayed replica of itself yields a result that depends on the delay, the period of the signal and the amplitude of both [6].

## 2.4 Relationship between anechoic data and room curves

Toole analyzes it and affirms that “It may seem absurd to use anechoic data to predict what happens in real rooms, but connection is not a loose one. . . However, the on-axis frequency response by itself is not a useful indicator of how this loudspeaker will perform in a room” [6].

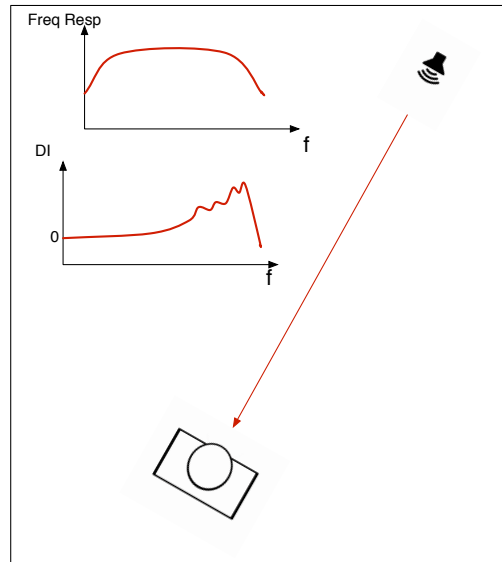

Figure 2.4: Frequency Response of a normal source and its DI.

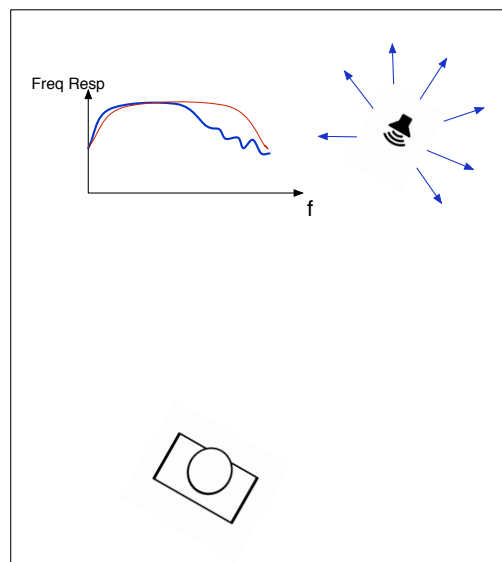

Figure 2.5: Average of the radiation in the rest of directions.

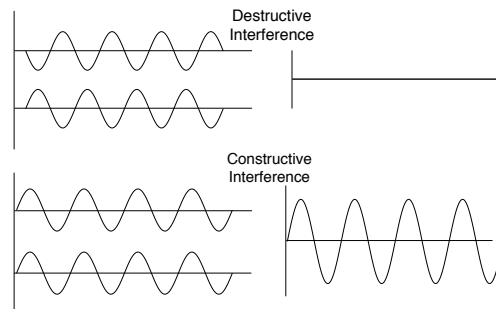

Figure 2.6: Constructive and destructive interference.

## 2.5 Forcing the similarity of reflected and direct sound

As seen in 1, Toole explains in his Paper [5] that “important for localization, and very interesting from the perspective of sound reproduction, is the observation that the precedence effect appears to be most effective when the spectra of the direct and reflected sounds are similar. This appears to be an argument for constant-directivity loudspeakers and frequency-independent (that is, broad-band) reflectors, absorbers, and diffusers.”

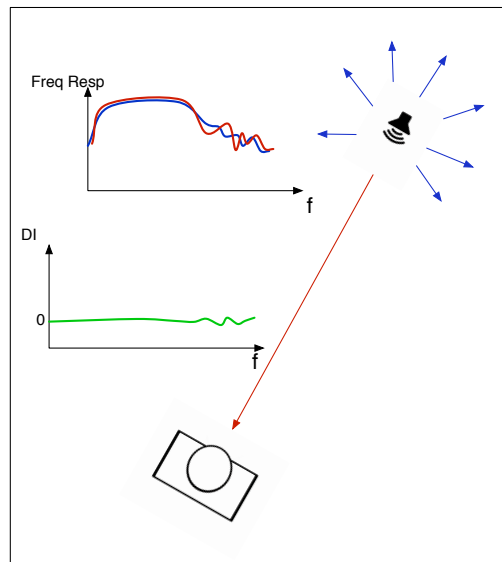

Figure 2.7: Suggestion of Toole.

It is well known that the pressure of the direct sound follows the formula 2.6 and the pressure of the reverberant sound 2.10. If similarity is wanted:

$$L_p(d) = L_p(r) \rightarrow \frac{Q(\theta, \phi)}{4\pi r^2} = \frac{4}{R} \quad (2.12)$$

### 2.5.1 Problem

The problem is that  $R$  varies markedly in frequency and in every different room the stereo sound system is placed in. Moreover,  $Q(\theta, \phi)$  also varies.

That means that a unique solution is not valid for all the listening rooms.

### 2.5.2 Approximation

A good approximation is to have  $DI$  constant all the listening range long and equal to zero.  $DI$  zero means that the intensity of the direct sound is equal to the average of the intensity radiated in all directions by the source. This intensity spread all around the driver contributes to form the reverberation sound that reaches the listener. That is why, loudspeakers with wide dispersion are optimal for this purpose.

## 2.6 Loudspeakers constructions with “wide dispersion”

### 2.6.1 Linkwitz Pluto DIY Solution

In this solution, transducer orientation has been taken as solution for 20-1000 Hz range. Driver (5.25” woofer) is faced upwards. Suitable listening plane is the horizontal. That means that  $DI$  in this plane ( $\theta=90^\circ$ ) is close to zero all the range long.

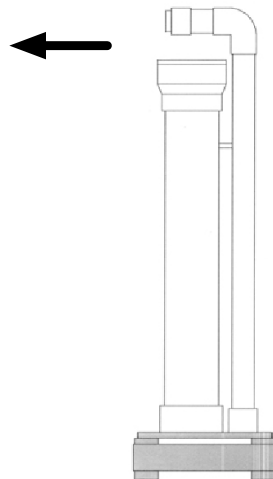

Figure 2.8: Linkwitz Pluto [12]. Suitable direction  $\theta=90^\circ$  for woofer.

For 1-22 kHz range the solution is different. Driver (1.7” tweeter) is aimed towards the listener like the classical stereo sound system setup. Dispersion of this

range is almost  $80^\circ$  ( $\pm 40^\circ$ ) at 9 kHz.

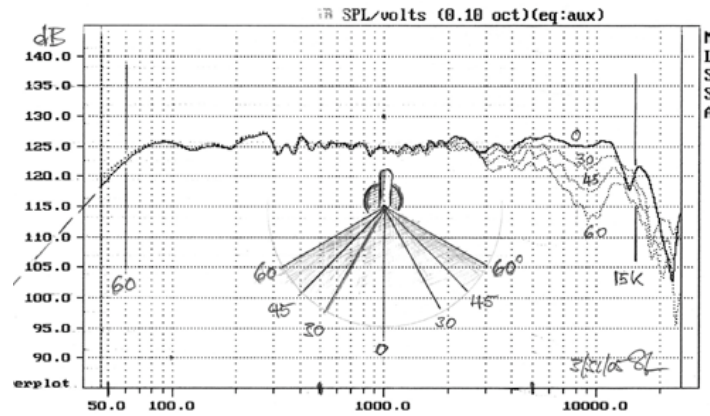

Figure 2.9: “Frequency response in the horizontal plane. At frequencies above 3 kHz the tweeter becomes directional which is indicated by the increase in response roll-off with larger off-axis angle. Above 10 kHz the concave tweeter dome brings up the off-axis response somewhat. Included in the data, and not corrected for, is the high frequency roll-off of the measuring microphone. Thus the high frequency response corner is at about 15 kHz. Some of the response ripple is due to reflections from objects in the measurement environment” [12].

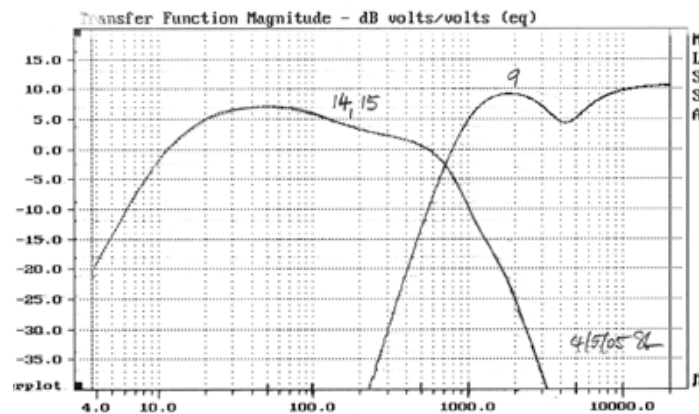

Figure 2.10: The frequency response of the final electronics, when measured at the amplifier outputs [12].

### 2.6.2 Reflectors. Analyzing the market

**Bang & Olufsen BeoLab 5** This stereo sound system uses reflectors to increase the dispersion of the drivers varying the radiation diagram. No reflector used in low frequencies and the reason why will be explained in Section 3.6.2.

The other two drivers are faced towards reflectors called ALT (Acoustic Lens Reflectors).

#### Acoustic Lens Technology. ALT.

Technology patented by Sausalito Audio. It is based on the idea that in the ellipse, distance from one focus to the other is the constant (reflecting on the figure first). In one of the focus the center of the loudspeaker is placed. It affects to high frequencies [9].

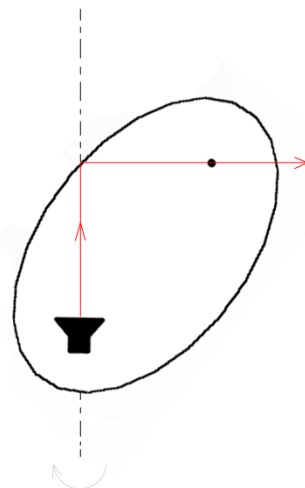

Figure 2.11: ALT thechnology based on ellipse characteristic.

Theoretically, if the main radiation spot is desired horizontally, the configuration should be like Figure 2.11. But it is not possible to get all the reflections from the walls of the ellipse (Figure 2.11) because of physical limitations. This contributes to an unbalanced radiation respect the main spot. That is why in the studied example (ALT in BeoLab 5, Bang & Olufsen), the orientation of the ellipse (tilted up) corrects this unbalanced radiation. With this design it is possible to get virtual sources all around, but is not possible to go further than  $180^\circ$  around. It is a valid solution if the goal is to increase the dispersion [13].

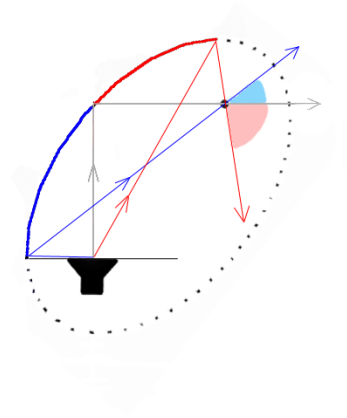

Figure 2.12: ALT technology based on ellipse characteristic.

**Nacsound** This Italian enterprise develops the sound system based on reflectors as well. The reflector is a cone made of ceramic. As in the B&O case, the reflector works on the mid-range and treble drivers. The company called this model Omni because of the omni-directional behaviour but no test has been found about this [13].



Figure 2.13: Nacsound reflector [34].



**Mirage** This company has a part of the production about loudspeakers equipped with reflectors. The axis of the driver is not placed vertically as before. The reflector is tilted respect the driver as well. That is the reason why it is very difficult to analyze it. However, no test has been found about the directivity of this system to corroborate the omni-directional behaviour the company says it performs.



Figure 2.14: Mirage reflector [35].



# Directivity Index measurement techniques

---

## Contents

---

<b>3.1</b>	<b>Description of the test loudspeaker</b> . . . . .	<b>17</b>
<b>3.2</b>	<b>Number of microphones</b> . . . . .	<b>18</b>
3.2.1	Problem . . . . .	18
3.2.2	Solution . . . . .	18
<b>3.3</b>	<b>2D vs. 3D measurement. Decision</b> . . . . .	<b>18</b>
3.3.1	2D . . . . .	18
3.3.2	3D . . . . .	19
3.3.3	Comparison of the two methods. Pros and cons . . . . .	19
3.3.4	Decision of the method to follow . . . . .	20
<b>3.4</b>	<b>Acoustic center</b> . . . . .	<b>21</b>
<b>3.5</b>	<b>Developing software</b> . . . . .	<b>21</b>
3.5.1	Program needs . . . . .	21
3.5.2	Brief description of functions . . . . .	21
<b>3.6</b>	<b>Possible problem solutions</b> . . . . .	<b>24</b>
3.6.1	Problem recapitulation . . . . .	24
3.6.2	Why just in mid-high frequencies? What about low frequencies? . . . . .	24
3.6.3	Solution . . . . .	24

---

Measuring experience is performed in the anechoic chamber (Acoustics Department, NTNU)

## 3.1 Description of the test loudspeaker

The loudspeaker used for measuring  $DI$  is similar to the one used in the commercial Linkwitz Pluto DIY. It consists in a 1.7" tweeter mounted into a PVC pipe. This driver is an AURA NSW2-326-8A.

The frequency response of the driver provided by the company is showed in Figure 3.1.

In Linkwitz Pluto, tweeter is in charge of frequencies higher than approximately 800 Hz where filter band starts. Behind it woofer driver is responsible.

Linkwitz attaches this frequency response in the Specifications (Figure 2.9).

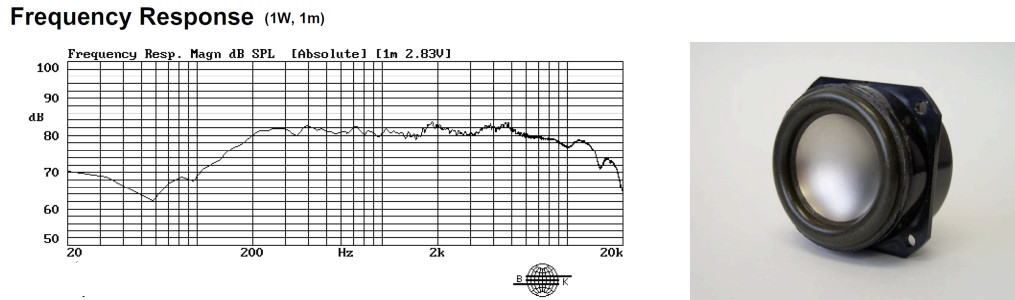

Figure 3.1: Frequency Response of the AURA NSW2-326-8A [14].

## 3.2 Number of microphones

Number of microphones needed for a multipoint measurement is huge. If the measurements are taken one by one instead of all at the same time, number of microphones could be reduced. But the number of microphones is a critical factor in the measurement. The more microphones the loudspeaker is measured with, the better *DI* calculation accuracy is obtained.

### 3.2.1 Problem

It is needed to measure all around the source. Building a sphere up with distributed microphones on it is an expensive solution.

### 3.2.2 Solution

Changing the relative position between the microphone and the loudspeaker every measurement could be the solution. Measuring protocol should be created and tested. In the beginning, two solutions are thought: 2D and 3D. 2D solution only measures in one plane. This plane contains the loudspeaker axis and the microphone axis. And the 3D solution pretends a measuring sphere around the source.

## 3.3 2D vs. 3D measurement. Decision

### 3.3.1 2D

**Theory** Directivity Index formula is calculated taking into account all the directions around the loudspeaker. In this case, some modifications must be introduced to get similar results but in one measuring plane. For this, method explained in [1] is followed. Discrete measuring is desired so, equation 2.5 is followed. The shorter the  $\theta$  step is, the more accurate the result is given.

**Practice** Measuring protocol design, implementation and bill of materials is explained in-depth in [13]. Briefly, it consists in the microphone fixed horizontally on a pole aligned with the axis of the loudspeaker in the position  $\phi=0$ . Loudspeaker is oriented horizontally as well but turning with the movement of the turntable. Measurement in every step is taken.

### 3.3.2 3D

**Theory** No change for the original formula in this case. The number of files increases. Discrete measuring is performed so, the formula 2.4 becomes:

$$DI(\theta_0, \phi_0) = 10 \log \frac{I(\theta_0, \phi_0)}{\sum_{i=1}^{72} \sum_{j=1}^{17} I(\theta_j, \phi_i) \sin \theta_j} \frac{4\pi}{\Delta\theta \Delta\phi} \quad (3.1)$$

**Practice** Equipment used is sorted in Appendix B. Measuring protocol design and how to use it is explained in Appendix D. Briefly, it consists in a fixed arc where microphones are placed on the different holes aiming the center of the arc. Movement of the loudspeaker (on the turntable pole but this time faced upwards) makes the relative position between microphones and source change. Measure for each channel (microphone) is taken every step.

### 3.3.3 Comparison of the two methods. Pros and cons

**2D** Pros and cons are sorted:

Pros:

- Fast
- Easy setup inside the anechoic chamber
- Few files to work on
- Not necessary to calibrate a group of microphones

Cons:

- Low precision in  $DI$  results due to small amount of files
- Loudspeaker radiation is theoretically symmetric, but actually is not. This is not taken into account in this measurement

**3D** Pros and cons are sorted:

Pros:

- Higher precision in  $DI$  result
- Using the original formula of  $DI$ , radiation all around is taken into account

Cons:

- Calibration of a group of microphones
- Setup is a hard task
- Slow measuring method
- Program running with a big amount of files

### 3.3.4 Decision of the method to follow

Precision in the computation of the  $DI$  is crucial in this project. Radiation in all directions around is also wanted to take into account. That is why, even if the 3D measuring is actually a hard task and time-consuming, is the method followed in this study.

**Ideal isotropic source result** Isotropic source is the one that emits radiation equally in all directions.  $DI$  should be zero in all directions around it but in fact discretizing the measurement produces that it is not.

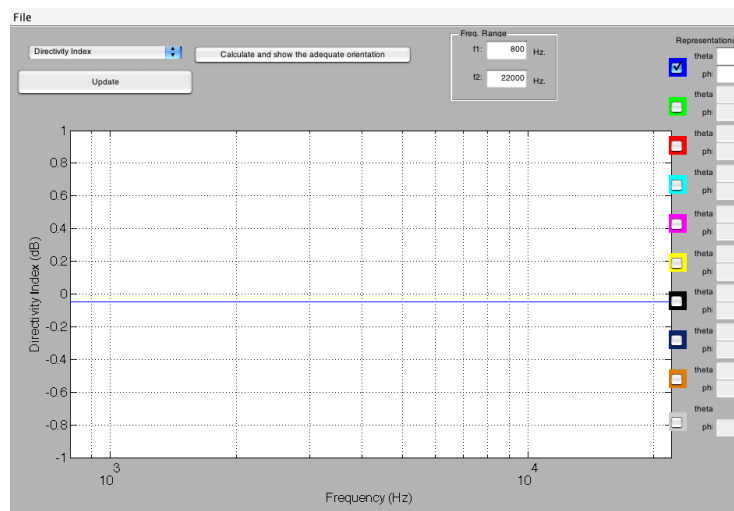

Figure 3.2: Computed Directivity Index of an ideal isotropic source. 3D method.

## 3.4 Acoustic center

Acoustic center of a source changes with the frequency, but this variation is not always predictable [15]. The acoustic center is just the center of curvature of acoustic waves. Sound does not actually radiate from it [16].

Analyzing the test loudspeaker pulses and applying signal processing, acoustic center due to the group delay (within the frequency range) could be approximately known. This value (7cm) is taken as a valid approximation within frequency range to place the reflector according to it.

## 3.5 Developing software

### 3.5.1 Program needs

The program should be able to show some of the directivity descriptors that have been commented before. The needs of the program are:

- Read multiple impulse response files. In this case, WinMLS is the chosen measurement system. These files contain the  $IR$  in every measured direction. The program must be aware of the microphones the measurement was taken with. So, calibration must be performed before every time measurements are taken.
- Calculate Frequency Response of each file.
- Show the impulse response.
- Directivity diagram either selecting  $\phi$  for 2D representation or 3D representation. Possibility to change the point of view.
- Calculate Directivity Index. Possibility to show results of several directions at the same time.
- Calculate the suitable position. It is based on the idea of Toole. Direction with  $DI$  close to zero in all the range is the winner.

### 3.5.2 Brief description of functions

To explain the task of the functions the main program (GUI) is calling to, flow diagrams are used. They are attached in the Appendix F. The code of the main program is not included in it because of the length of it but flow diagram of it is attached.

**Calibration** In the beginning of this project, work with 1 kHz calibrator was performed. In this method, similar frequency responses of the microphones are

assumed. The only difference is the offset between them and it has to be compensated. For this, 1 kHz signal calibrator was faced towards the microphones. Offset between them in this frequency is used to calculate the compensation.

After some discussions, it was decided the change of the way the system was calibrated. This new way is called relative calibration.

It consists in every microphone recording the same spectrum, no matter if it is not flat response. For this, four measurement rounds are done placing the microphone in the same place and orientation as the last round microphone.

After this, frequency responses are compared. It is possible to check that the offset is not the only difference between them. So calibrating this way seems to be more accurate.

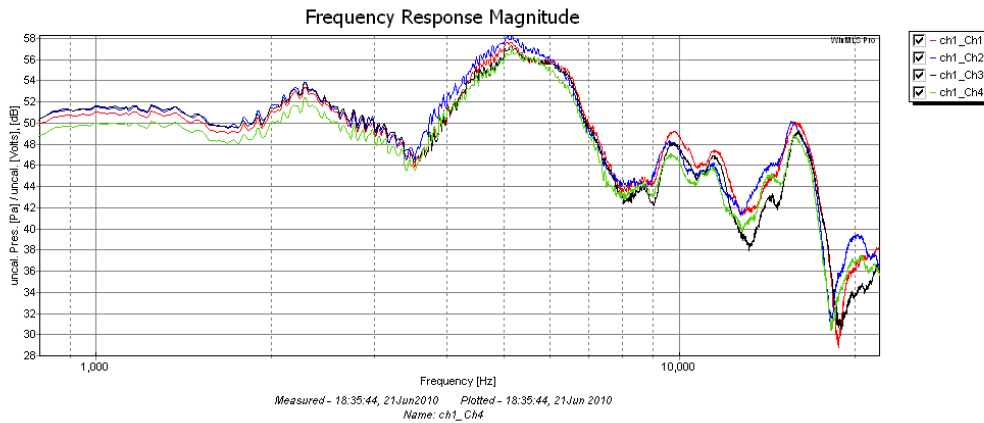

Figure 3.3: Plot of the same spectrum recorded by four different microphones

**Center** The other functions call this one. Impulse responses contained in the files are not centered in the same sample and they must be. If do not, impulses that are registered afterwards, would disturb the results because the amplitudes are diminished.

#### Time shifting

One direction  $(\theta, \phi)$  must be introduced as reference for centering the rest of them. The sample where the impulse appears is stored like the reference sample. The rest of the impulse responses will be centered in this sample. Centering makes one part of the impulse response disappear. This empty slot is filled up with zeros.

#### Amplitude compensation

The amplitude of the impulse response must be varied when the centering is produced. It is known that the pressure is inversely proportional to the distance.



$P \propto \frac{1}{r}$ . The variation of the distance can be calculated from the difference of samples between the reference and the impulse response it is being processed. This amplitude compensation must be only performed with the loudspeaker radiating without reflector.

Performing polar response measurements in this manner therefore involves some complicated balancing acts [21].

Compensation of the pulse pressure is defined by the instant the Impulse Response issued and the reference one (selected in the SETUP menu of the software) are recorded. With these values, compensation can be calculated.

$$P_i \propto \frac{1}{r_i}; r_i = vt_i \quad (3.2)$$

$$P_{ref} \propto \frac{1}{r_{ref}}; r_{ref} = vt_{ref} \quad (3.3)$$

So,

$$P_i(comp) \propto \frac{1}{r_i} \frac{r_i}{r_{ref}} \quad (3.4)$$

$$P_i(comp) = P_i \frac{t_i}{t_{ref}} \quad (3.5)$$

**Frequency Response** This representation is useful either one direction is desired to be shown or a group of them. Variation of the impulse response in determined frequency range and phi as theta increases could be observed. In the other hand, variation as  $\phi$  increases could be observed if  $\theta$  value is introduced. Frequency response for one direction could be observed if theta and phi values are introduced.

**Radiation Diagram** 2D: This representation shows the Directivity Diagram of the source but in a plane specified by  $\phi$  coordinate. This plane is chosen because of the volume of revolution respect  $z$  axis of the radiation diagram of the loudspeaker faced upwards.

3D: Complete radiation diagram representation. Azimuth and elevation of the point of view must be introduced.

**Directivity Index** Directivity Index is calculated with all the files measured. The amount of files to be read makes this function slow.  $\phi$  step is  $5^\circ$  and  $\theta$  step is  $11.25^\circ$ . These steps produce 1224 to be analyzed every time  $DI$  calculation is required.

**Suitable Orientation** Suitable orientation is defined as the direction with  $DI$  closer to zero in all the frequency range.

#### GUI creation

The Graphic User Interface is the tool to call functions intuitively. Four different pages have been decided: Setup, Frequency Response, Directivity Diagram and Directivity Index. To know more about how to use the GUI Appendix E should be consulted.

## 3.6 Possible problem solutions

### 3.6.1 Problem recapitulation

In section 2.5 has been explained that direct sound pressure and the reverberant sound pressure are desired to be similar. Decided approximation is that  $DI$  close to zero is desired in all the frequency range on the listening direction. This would be the suitable orientation the software is looking for. In reflectors design, getting horizontal radiation for final radiation is taken as goal.

### 3.6.2 Why just in mid-high frequencies? What about low frequencies?

“We shall consider the case of relatively high frequencies, i.e. we shall neglect interference and diffraction effects which are typical wave phenomena and which only appear in the immediate vicinity of reflecting walls or when obstacle dimensions are comparable with the wavelength” [20].

So, i.e. for a frequency of 800 Hz, obstacle dimensions should be 45 cm approximately.

### 3.6.3 Solution

Radiation at high frequencies are stronger onaxis. Therefore, changing this directivity pattern increasing the radiation on the rest of directions around the test loudspeaker is desired. This could make both (direct and average sound) similar at high frequencies. And if so,  $DI$  would decrease reaching values close to zero.

Solutions with reflectors are designed to increase the dispersion all around the test loudspeaker. Therefore, driver is fixed upwards and faced towards the reflector. Geometric characteristics make some of them a priori suitable. But it is important to say that the acoustic beams that will follow these characteristics will be in high frequency. Resultant radiation on horizontal plane is desired.

# Experiments

## Contents

<b>4.1 Radiation of the Loudspeaker</b> . . . . .	<b>25</b>
<b>4.2 Radiation of the Loudspeaker with reflector</b> . . . . .	<b>25</b>
4.2.1 Reflectors . . . . .	25

Six different loudspeaker constructions are tested and described below. All experiments are developed following the 3D measurement protocol designed and explained in Appendix D. The results are with  $\theta$  step of  $11.25^\circ$  and  $\phi$  step of  $5^\circ$ . Equipment used in Appendix B.

## 4.1 Radiation of the Loudspeaker

It is useful to know the original directivity diagram of the loudspeaker for comparing with the one created with the reflector in the end.

Moreover, suitable direction (defined in E.5) is sought. This seems to be a weak candidate for reaching the goal of the project. Significant changes in the directivity diagram for high frequencies are the characteristic of the transducer itself. Therefore, finding one direction where the intensity emitted is the same of the average of intensities of all directions around the loudspeaker (in all frequency range) seems to be more than difficult.

## 4.2 Radiation of the Loudspeaker with reflector

When loudspeaker is faced towards a reflector, pressure compensation related with the pulse delay should not be performed. The reason is that the beam (at high frequency) that hits on the reflector surface gets new orientation and reaches the microphone in a different instant from the beam that travels directly to the microphone. But no compensation should be applied because the system itself is defined this way.

### 4.2.1 Reflectors

**Material** Wooden reflectors were the first choice. Light and handy are the main characteristics. Surface porosity becomes a problem, but can be solved painting it with plastic. The same case is ceramics like used in Nacsound OMNI. The final

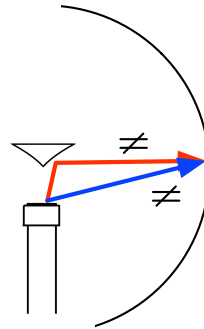

Figure 4.1: No compensation due to pulse delay in loudspeaker with reflector.

choice was metallic (aluminium). Even if heavier and uncomfortable, it is considered as a perfect acoustic wall.

The NTNU acoustics workshop facilities make possible the construction of them. Loudspeaker is equipped with a stand designed for holding reflectors made out of aluminum. Stand makes the speaker axis coincident with the turntable rotation axis. Different reflectors must be analyzed so, attaching system is designed as well. It is explained graphically in the Assembling Manual, Appendix C.

**Shape** Three reflector shapes are considered for increasing the dispersion.

#### Cone

It is widely used by reflector-based loudspeakers companies like Nacsound (section 2.6.2). In this project, two cone shapes are constructed. Both of them are right circular cones but with different angle. The first one is  $88^\circ$  and the second is  $82^\circ$ .

It is easy to see that when a vertical beam hits the surface of the almost  $90^\circ$  reflector, it is orientated horizontally. This characteristic makes it a priori suitable. If the reflector is taken as an acoustic wall (high frequencies), Figure 4.4 shows what would happen if vertical radiation hits on the  $90^\circ$  cone.

$80^\circ$  cone is chosen as alternative because some companies are using it. Theoretically, this angle seem to be non appropriate for radiation in horizontal because main spot will be reflected upwards in high frequency.

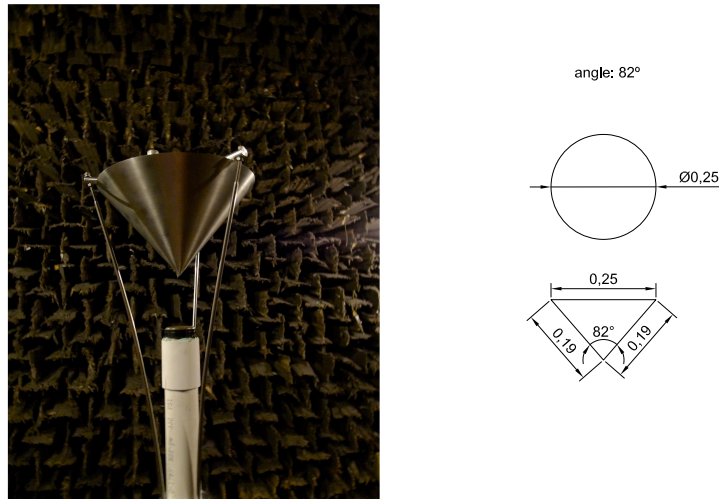
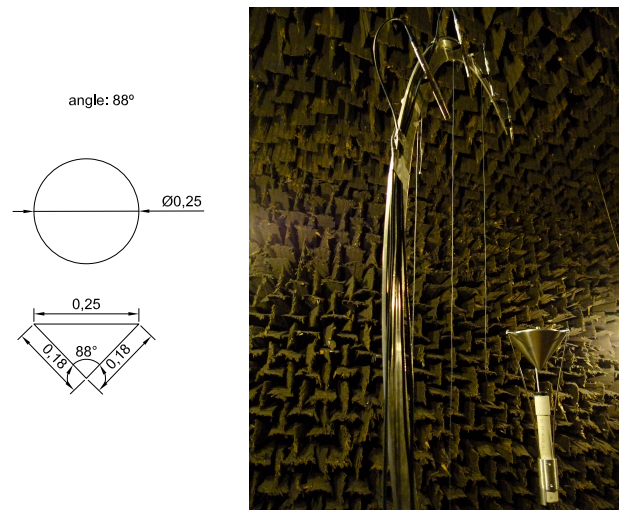
Figure 4.2: Conical  $82^\circ$  reflector.Figure 4.3: Conical  $88^\circ$  reflector.

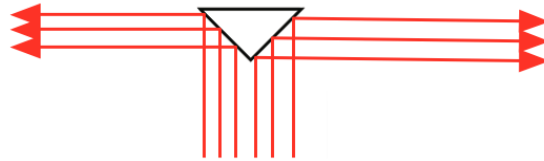

Figure 4.4: Vertical beams hitting on the reflector and redirected.

### Parabola

The geometrical characteristics of the parabola are used in several fields. In telecommunications, parabolic antenna is used to drive the plane waves reaching its surface to the focus where the LNB is placed.

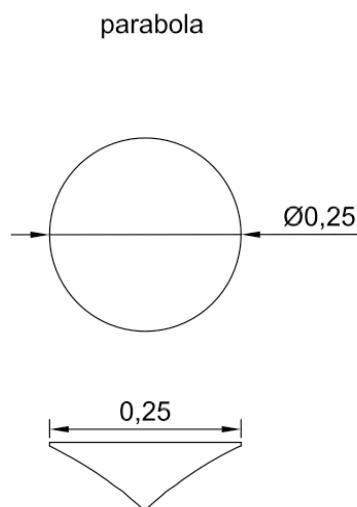

Figure 4.5: Parabolic reflector.

This model could be used inversely. If the loudspeaker is placed in the focus, radiation will be horizontally redirected. If the parabolic reflector is made with volume of revolution, the radiation diagram could be modified aiming the on-axis radiation of the single loudspeaker to horizontal and  $360^\circ$  around. Exhaustive analysis of the parabola characteristics in Appendix A.

### Sphere

This reflector is chosen out of curiosity. Almost no company has invested in this kind of reflector shape. This one is built with a billiard ball. Smooth and hard surface makes it a perfect candidate for this reflector shape.



Figure 4.6: Spherical reflector.





---

**Contents**

<b>5.1</b>	<b>Radiation of the test loudspeaker . . . . .</b>	<b>31</b>
<b>5.2</b>	<b>Radiation of the test loudspeaker with reflector . . . . .</b>	<b>35</b>
5.2.1	Cone 82° . . . . .	35
5.2.2	Cone 88° . . . . .	39
5.2.3	Parabola placed at 8.3 cm from the surface of the transducer	43
5.2.4	Parabola placed at 2 cm from the surface of the transducer .	47
5.2.5	Sphere placed at 2 cm from the surface of the transducer . .	51

---

Large amount of results could be shown. It is decided to show just the main parameters like frequency response in the listening direction, polar directivity diagram ( $\theta$ ) and Directivity Index. It is also shown the suitable direction and the impulse response on it. Radiation characteristics of  $\theta=90^\circ$  plane are shown as well.

Measurements for many different relative position between the loudspeaker and the reflector are taken. In this chapter, only the most interesting plots are shown.

For polar directivity diagram frequencies spaced logarithmically from 800 Hz to 22 kHz has been presented. It is plotted the average of directivity diagrams on all  $\phi$  values.

## 5.1 Radiation of the test loudspeaker

**Frequency Response on-axis** Figure 5.1

**Polar Directivity Diagram** Figure 5.2

**On-axis Directivity Index** Figure 5.3

**Suitable Orientation:** Figure 5.4

**Frequency response on suitable direction:** Figure 5.5

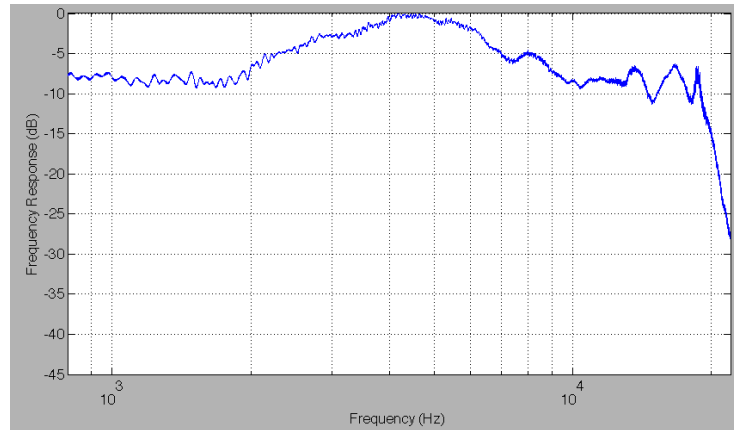

Figure 5.1: On-axis Frequency Response of the test loudspeaker.

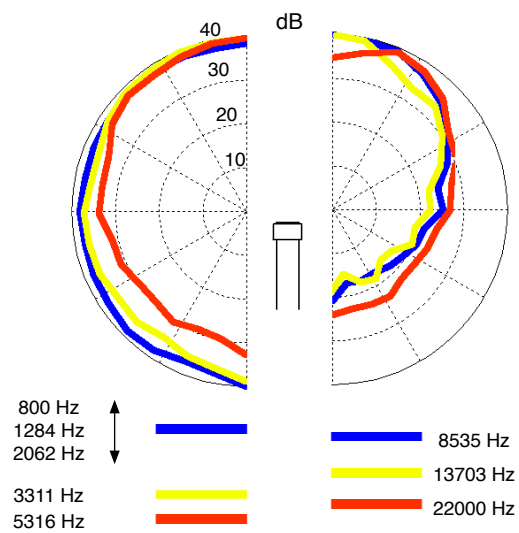

Figure 5.2: Directivity Diagram of the test loudspeaker.

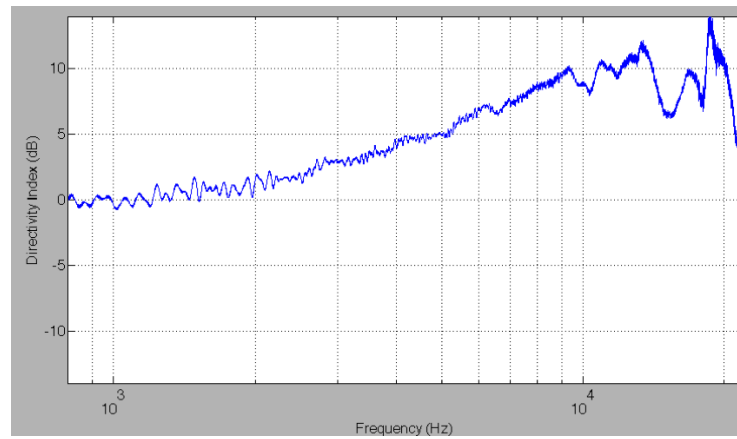

Figure 5.3: On-axis Directivity Index of the test loudspeaker.

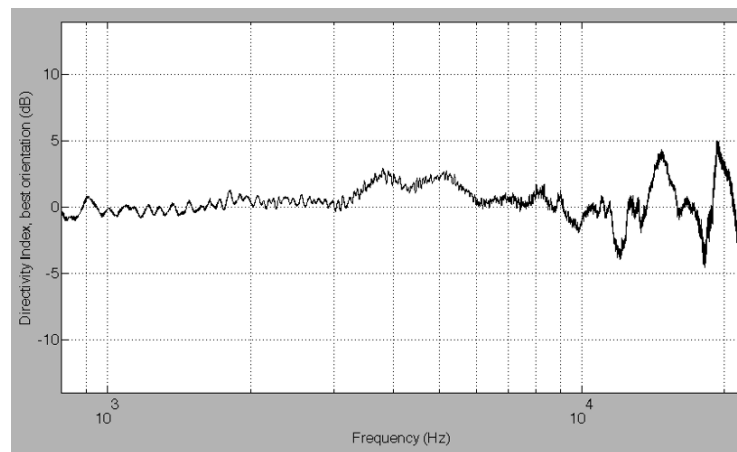

Figure 5.4: Directivity Index on the suitable orientation ( $\theta=56^\circ$ ) of the test loudspeaker.

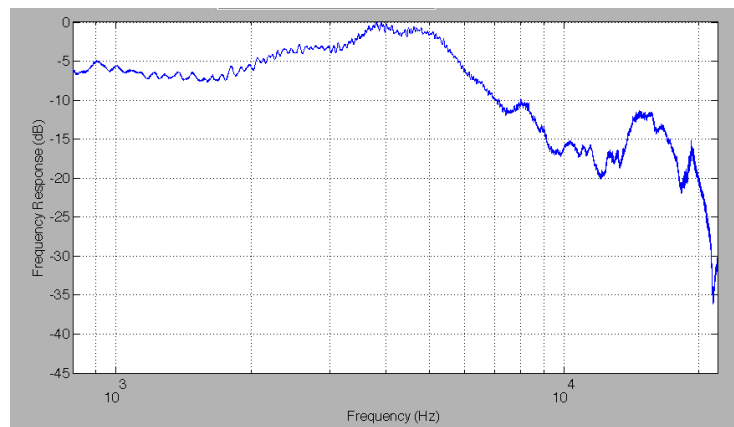

Figure 5.5: Directivity Index on the suitable orientation ( $\theta=56^\circ$ ) of the test loudspeaker.

## 5.2 Radiation of the test loudspeaker with reflector

### 5.2.1 Cone 82°

Frequency Response on  $\theta=90^\circ$  Figure 5.6.

Polar Directivity Diagram Figure 5.7.

DI( $\theta = 90^\circ$ ) Figure 5.8.

Suitable orientation Figure 5.9.

Frequency response on suitable direction Figure 5.10.

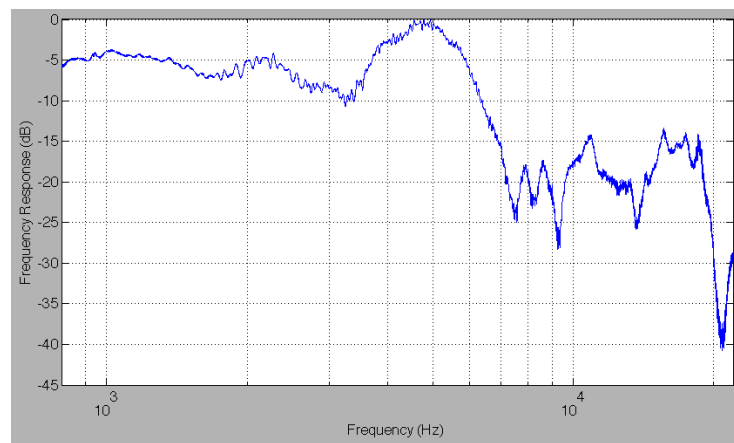

Figure 5.6: Frequency Response of the 82° cone on  $\theta=90^\circ$ .

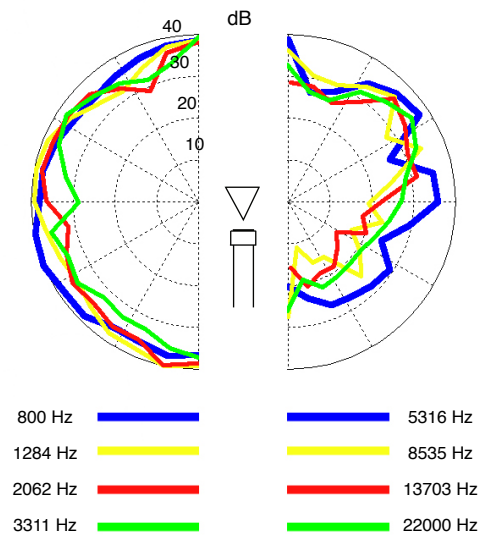
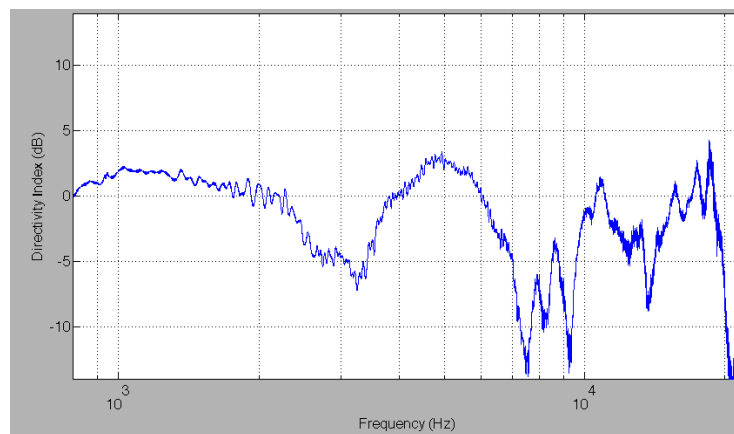

Figure 5.7: Directivity Diagram of the 82° cone.

Figure 5.8: Directivity Index on  $\theta=90^\circ$  of the 82° cone.

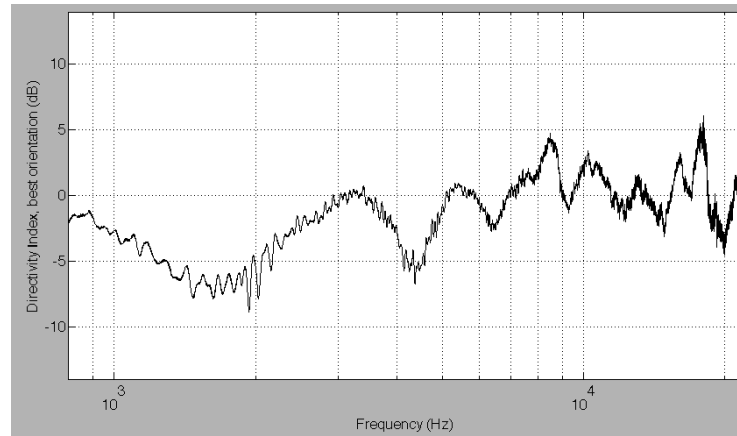

Figure 5.9: Directivity Index on the suitable orientation ( $\theta=34^\circ$ ) of the  $82^\circ$  cone.

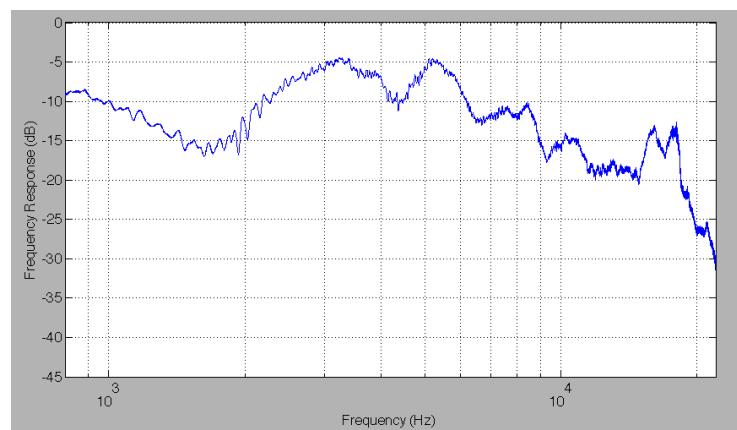

Figure 5.10: Frequency Response on suitable orientation ( $\theta=34^\circ$ ) of the  $82^\circ$  cone.





### 5.2.2 Cone 88°

Frequency Response on  $\theta=90^\circ$  Figure 5.11.

Polar Directivity Diagram Figure 5.12.

DI( $\theta = 90^\circ$ ) Figure 5.13.

Suitable Orientation Figure 5.14.

Frequency response on suitable direction Figure 5.15.

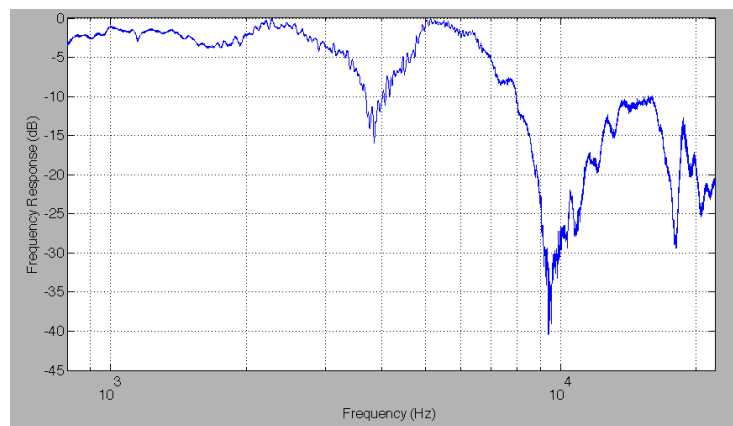

Figure 5.11: Frequency Response of the 88° cone on  $\theta=90^\circ$ .

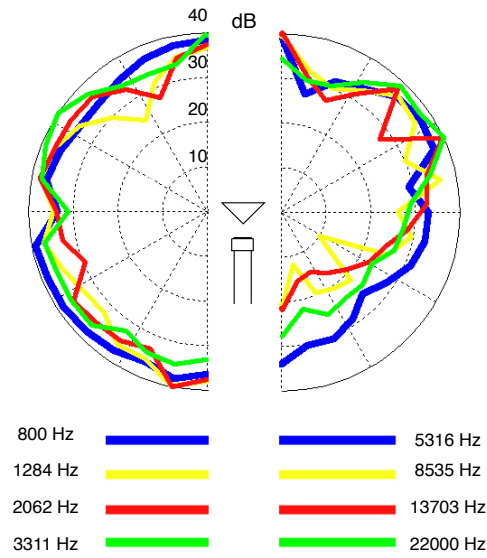

Figure 5.12: Directivity Diagram of the 88° cone.

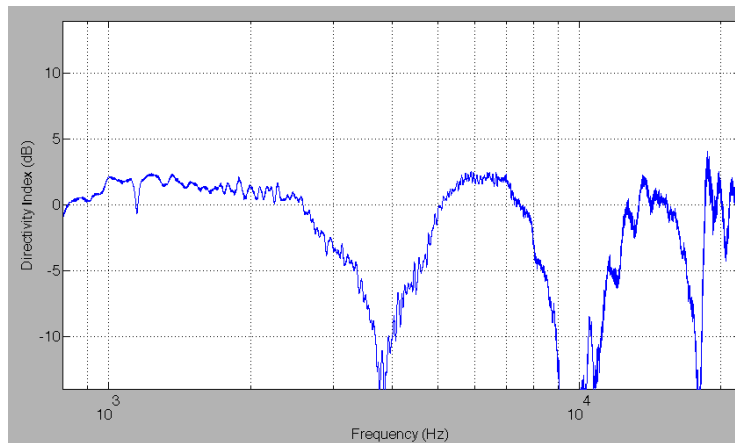

Figure 5.13: Directivity Index on  $\theta=90^\circ$  of the 88° cone.

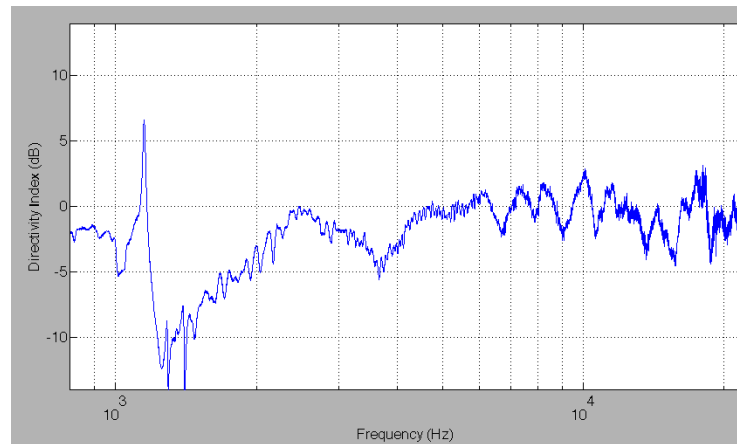

Figure 5.14: Directivity Index on the suitable orientation ( $\theta=34^\circ$ ) of the  $88^\circ$  cone.

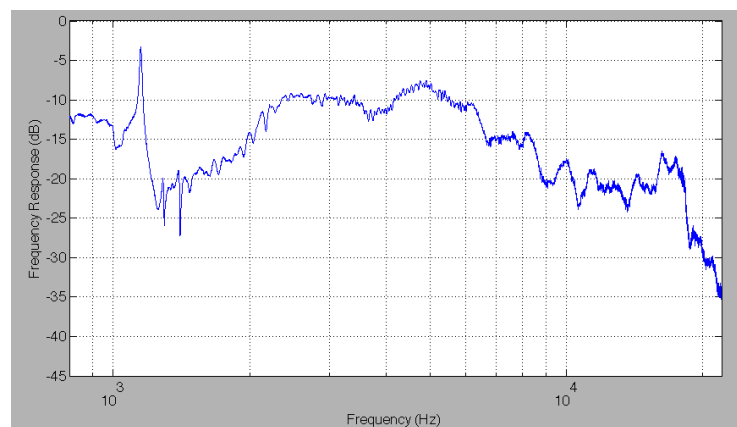

Figure 5.15: Frequency Response on suitable orientation ( $\theta=34^\circ$ ) of the  $88^\circ$  cone.



### 5.2.3 Parabola placed at 8.3 cm from the surface of the transducer

Frequency Response on  $\theta=90^\circ$  Figure 5.16.

Polar Directivity Diagram Figure A.1.

DI( $\theta = 90^\circ$ ) Figure 5.18.

Suitable Orientation Figure 5.19.

Frequency response on suitable direction Figure 5.20.

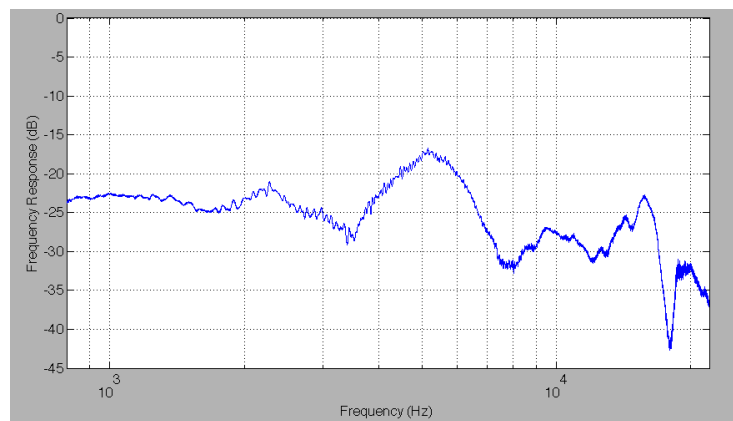

Figure 5.16: Frequency Response of the parabolic reflector on  $\theta=90^\circ$  at 8.3.

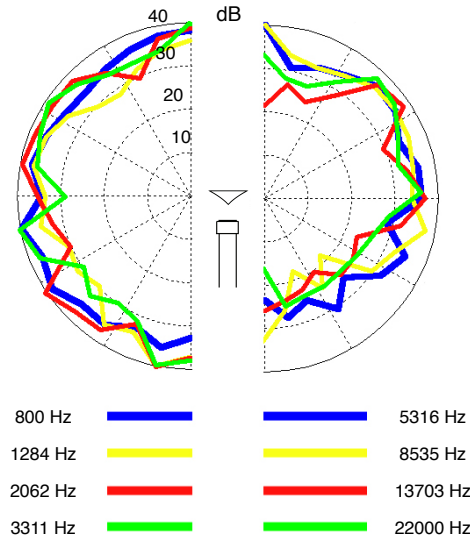

Figure 5.17: Directivity Diagram of the parabola at 8.3 cm.

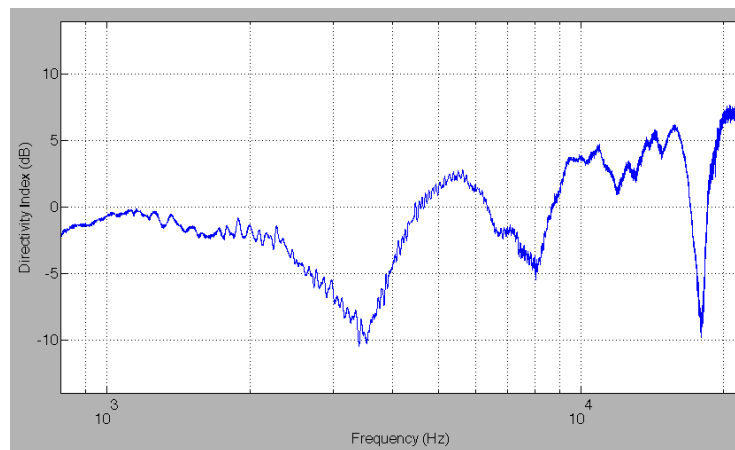

Figure 5.18: Directivity Index on  $\theta=90^\circ$  of the parabolic reflector placed at 8.3 cm.

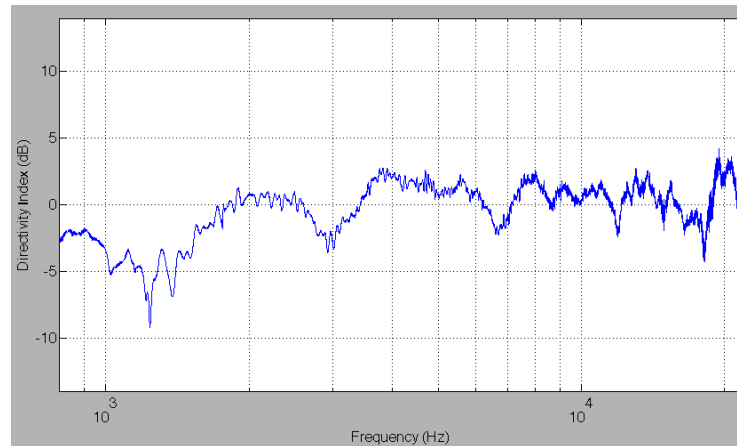

Figure 5.19: Directivity Index on the suitable orientation ( $\theta=45^\circ$ ) of the parabolic reflector placed at 8.3 cm.

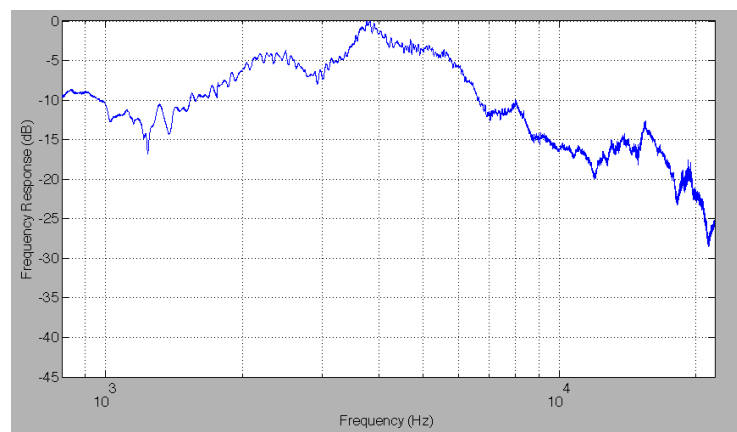

Figure 5.20: Frequency Response on suitable orientation ( $\theta=45^\circ$ ) of the parabolic reflector placed at 8.3 cm.





### 5.2.4 Parabola placed at 2 cm from the surface of the transducer

Frequency Response on  $\theta=90^\circ$  Figure 5.21.

Polar Directivity Diagram Figure 5.22.

DI( $\theta = 90^\circ$ ) Figure 5.23.

Suitable Orientation Figure 5.24.

Frequency response on suitable direction Figure 5.25.

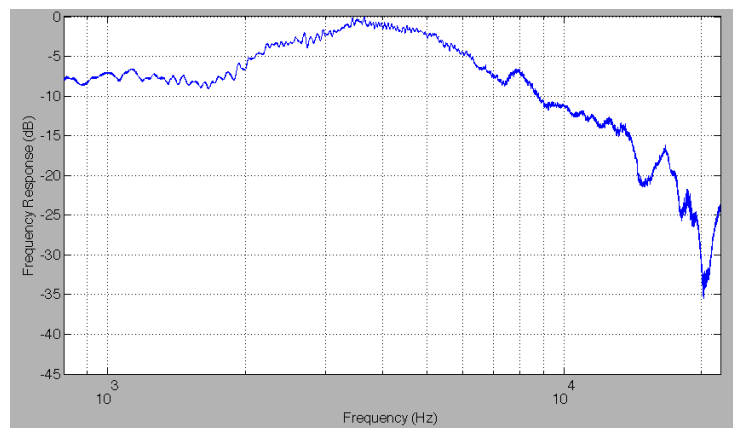

Figure 5.21: Frequency Response of the parabolic reflector on  $\theta=90^\circ$  at 2 cm.

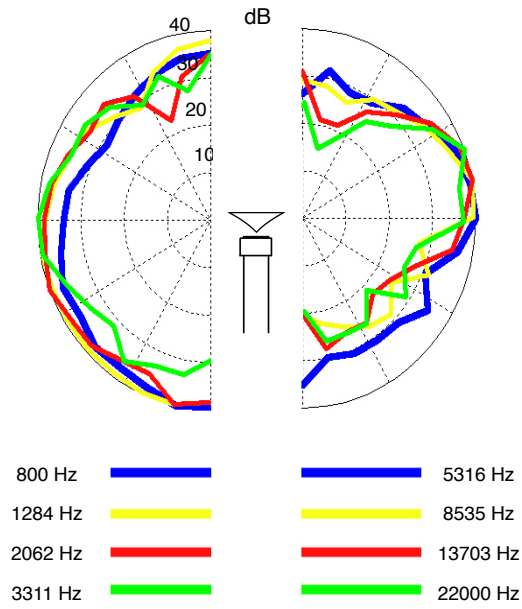

Figure 5.22: Directivity Diagram of the parabola at 2cm.

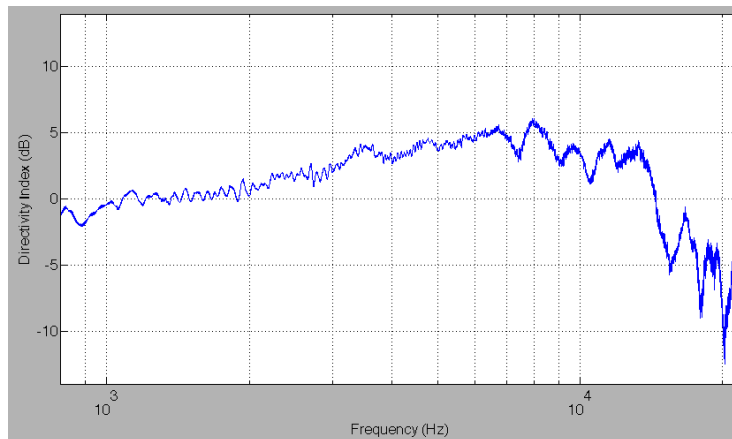

Figure 5.23: Directivity Index on  $\theta=90^\circ$  of the parabolic reflector placed at 2 cm.

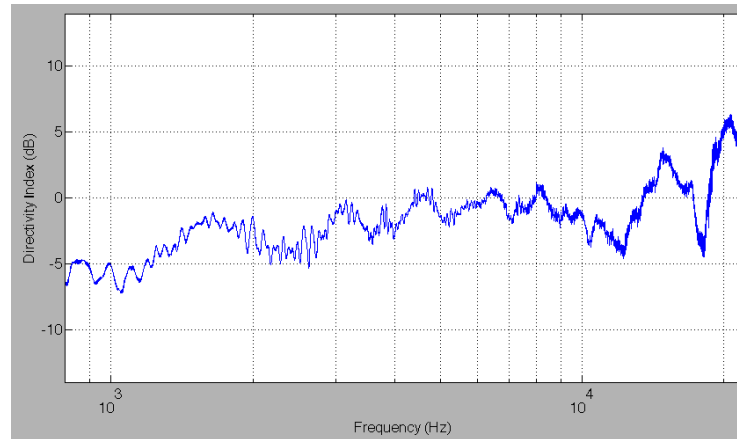

Figure 5.24: Directivity Index on the suitable orientation ( $\theta=56^\circ$ ) of the parabolic reflector placed at 2 cm.

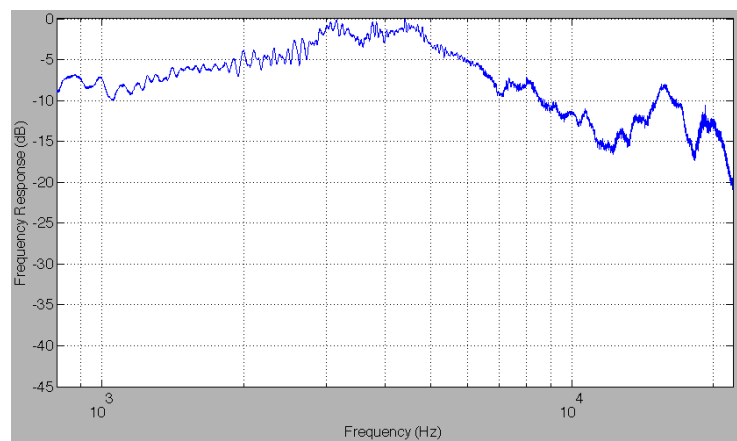

Figure 5.25: Frequency Response on suitable orientation ( $\theta=56^\circ$ ) of the parabolic reflector placed at 2 cm.



### 5.2.5 Sphere placed at 2 cm from the surface of the transducer

Frequency Response on  $\theta=90^\circ$  Figure 5.26.

Polar Directivity Diagram Figure 5.27.

DI( $\theta = 90^\circ$ ) Figure 5.28.

Suitable Orientation Figure 5.29.

Frequency response on suitable direction Figure 5.30.

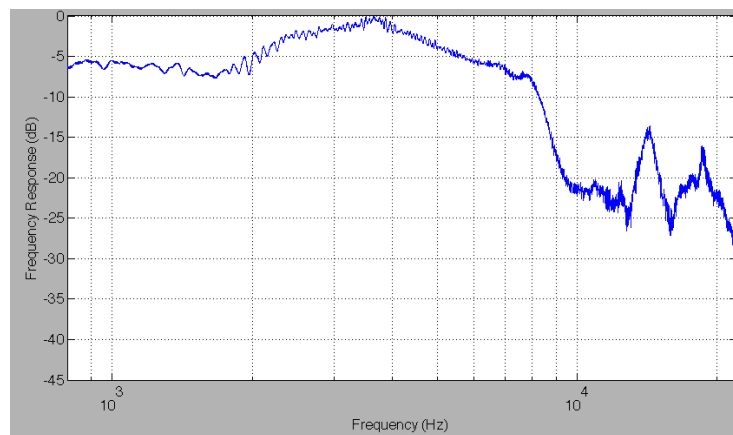

Figure 5.26: Frequency Response of the spherical reflector on  $\theta=90^\circ$  at 2 cm.

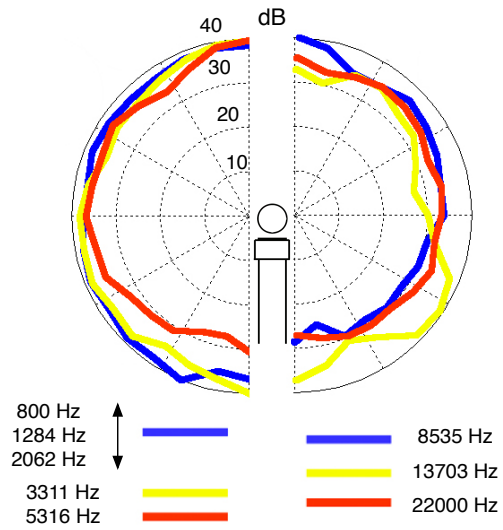

Figure 5.27: Directivity Diagram of the sphere at 2 cm.

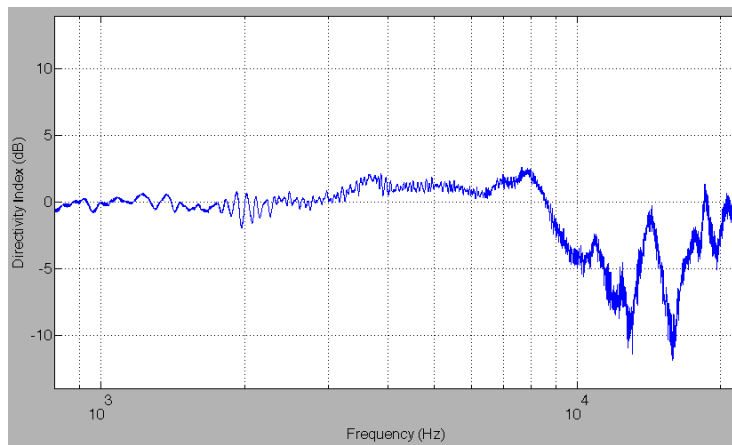

Figure 5.28: Directivity Index on  $\theta=90^\circ$  of the spherical reflector placed at 2 cm.

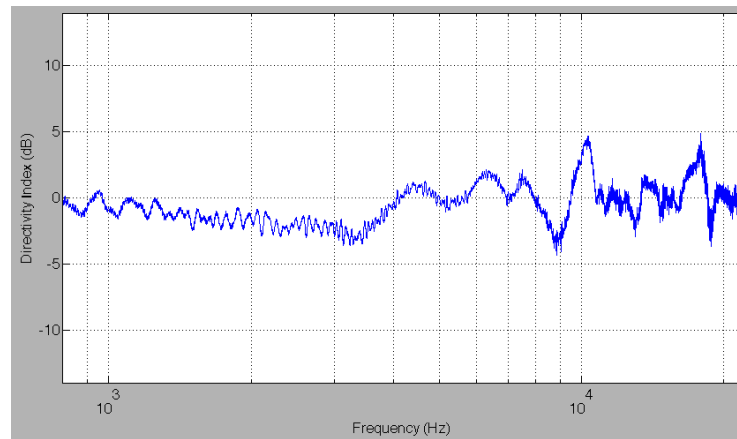

Figure 5.29: Directivity Index on the suitable orientation ( $\theta=68^\circ$ ) of the spherical reflector placed at 2 cm.

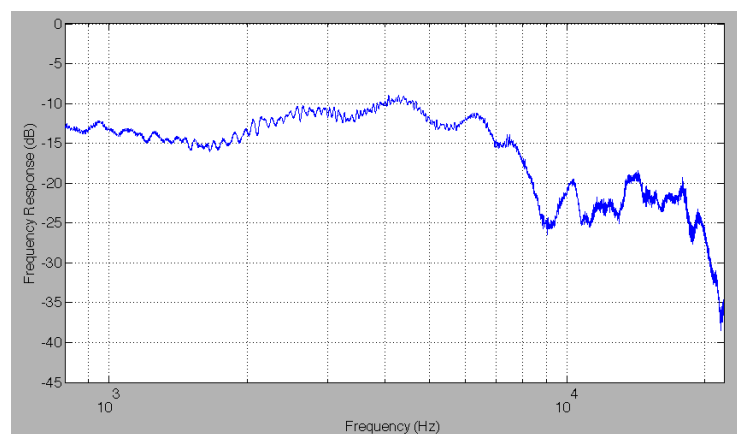

Figure 5.30: Frequency Response on suitable orientation ( $\theta=68^\circ$ ) of the spherical reflector placed at 2 cm.





# Discussion

## Contents

<b>6.1</b>	<b>Radiation of the test loudspeaker . . . . .</b>	<b>55</b>
<b>6.2</b>	<b>Radiation of the test loudspeaker with reflector . . . . .</b>	<b>55</b>
6.2.1	Cone 82° . . . . .	55
6.2.2	Cone 88° . . . . .	56
6.2.3	Parabola placed at 8.3 cm from the surface of the transducer	56
6.2.4	Parabola placed at 2 cm from the surface of the transducer .	56
6.2.5	Sphere placed at 2 cm from the surface of the transducer . .	57

## 6.1 Radiation of the test loudspeaker

On-axis frequency response of the test loudspeaker is similar to the one showed in Figure 2.9 but not the same. The differences are that this figure is the frequency response of the system formed by amplifier and loudspeaker given in the Pluto specs. The one shown in this result is only the frequency response of the loudspeaker. Therefore, frequency response of the Linkwitz Amplifier causes mainly this difference and looking it up (Figure 2.10), seems to be coherent.

The polar diagram shows a little increment in  $\theta=180^\circ$  due to reflections on the turntable. Polar diagram follows the directivity tendency on a normal loudspeaker increasing the on-axis radiation ( $\theta=0$ ) as frequency increases.

The same for the  $DI$ , it increases in high frequency reaching 14 dB that is known it happens in most of the tweeters. But, it is remarkable that on the suitable orientation ( $\theta=56^\circ$ )  $DI$  is close to zero ( $\pm 2\text{dB}$ ) until 10 kHz. Above this, the variation is stronger ( $\pm 4\text{dB}$ ) but still acceptable compared with  $DI(\theta=0)$ . The frequency response of the suitable orientation shows how the average sound curve looks like. It is possible to notice the difference in high frequencies compared with the on-axis frequency response.

## 6.2 Radiation of the test loudspeaker with reflector

### 6.2.1 Cone 82°

Frequency Response on  $\theta=90^\circ$  seems to be similar to the original loudspeaker response until 7 kHz where falls dramatically. In higher frequencies, the plot reaches

40 dB difference from the original.

Polar representation shows that for high frequencies, main part of the radiation is emitted upwards. This results produce scepticism about the suitable orientation on  $\theta=90^\circ$ .

*DI* on this direction confirms it with variations of 16 dB. In contrast, the *DI* on the suitable orientation ( $\theta=34^\circ$ ) is similar to the one of the loudspeaker at high frequencies ( $\pm 4$ dB). But in the range 1-2 kHz, a decrease is produced and it is corroborated by the frequency response on this suitable orientation.

### 6.2.2 Cone 88°

Frequency Response on  $\theta=90^\circ$  looks better than the 82° cone. 9-11 kHz frequency range suffers a decrease of 15 dB.

But, polar representation shows that at high frequencies the radiation is still mainly reflected upwards like in the last case.

The decrease commented before within 9-11 kHz frequency range produces a fall in the *DI* representation up to -25 dB. Suitable orientation for this cone coincides with the 82° one ( $\theta=34^\circ$ ). *DI* in frequencies above 2 kHz seems to be close to zero fluctuating less than in the other cone. Below 2 kHz, markedly fluctuation is observed and it could be caused by the reflector attaching system.

### 6.2.3 Parabola placed at 8.3 cm from the surface of the transducer

Frequency Response on  $\theta=90^\circ$  is more than acceptable within all the frequency range. Dome tendency appears from 3-7 kHz but just 5 dB difference. It is really similar to the original test loudspeaker on-axis radiation.

In the polar representation 30-60° range seems to be stronger in high frequencies. This is not convenient.

At  $\theta=90^\circ$  *DI* varies markedly getting some dips at around 3.3k, 8k and 18 kHz. Except these three dips that seem to be a kind of resonances of the reflector, the curve follows the same trend of the original loudspeaker. Suitable orientation on  $\theta=45^\circ$  shows an extraordinary *DI* plot where frequency range from 1.7k to 18 kHz is bounded between  $\pm 2$  dB. But at lower frequencies, the reflector adversely affects to the result.

### 6.2.4 Parabola placed at 2 cm from the surface of the transducer

Frequency Response in  $\theta=90^\circ$  seems to be similar to the original except in high frequencies where significant attenuation is observed.

Polar representation is similar to the last case. But high frequencies are emitted closer to the horizontal plane. This could bring the suitable orientation closer to 90°.

In the *DI* curve for  $\theta=90^\circ$ , acceptable behaviour until 11 kHz where the curve falls dramatically. Suitable orientation *DI* ( $\theta=56^\circ$ ) seems to be acceptable but big fluctuations are observed at high frequencies exceedind 6 dB at 22 kHz.

### 6.2.5 Sphere placed at 2 cm from the surface of the transducer

Frequency Response on  $\theta=90^\circ$  contains big attenuation at high frequencies and some dips that suggest us that it is difficult that this direction is the suitable.

Low frequencies do not seem to be affected. The most interesting aspect of this reflector is that directivity pattern of the original loudspeaker has been modified, getting kind of omni-directivity (compared with the original radiation) even at high frequencies. But this result could be coincidentally enhanced by the selected frequencies to be represented.

$DI$  in  $\theta=90^\circ$  do not seem to be that good. High frequencies contains some dips that reach -11 dB. Suitable direction ( $\theta=68^\circ$ ) shows a better aspect. The curve is bounded between  $\pm 4$  dB.



# Conclusion

---

Polar representation is a good tool to check how the radiation is spread out. But actually it depends on the chosen frequencies to plot. The peaks in the polar responses in Chapter 5 indicate that sampling in elevation ( $\theta$  step) does not seem to be enough. For future measurements, decreasing this step should be considered.

Observing the frequency response on the suitable direction of every measured system it is obvious to guess how the average sound curve for this test loudspeaker looks like.  $DI$  close to zero (suitable direction) means that this curve is similar to the average one. Of course, no equalization allowed to make the curve similar to this.

With these measurements and postprocessing several solutions are obtained in this project. The goal of increasing the dispersion and largely frequency-independent Directivity Index is reached using reflectors. However, suitable listening plane at  $\theta=90^\circ$  is not achieved even if it is enhanced like in the parabola case.

At first thoughts, test loudspeaker orientation was almost discarded due to markedly changes of the radiation diagram as frequency increases. But surprisingly it is one of the best results in this work.

Some of the constructions offer interesting results like the parabolic reflector at 8.3 cm which its frequency response all around at  $\theta=90^\circ$  is close to the on-axis frequency response of the test loudspeaker, or the spherical reflector that behaves almost omnidirectional in all the plotted frequencies.

Other constructions were expected to give better results at  $\theta=90^\circ$  like the cones. Strong dips in the frequency response make them disposable for the listening at this elevation angle.

It is also arguable the fact that the frequency range used for this study is too wide, and it could be interesting a second study which uses an actual audible frequency range for an adult person.

Moreover, the other two goals of the project are achieved as well. On the one hand, measuring protocol is developed and used. It is an efficient protocol but it cannot avoid the long time measurement process. On the other hand, software to compute the Directivity Index and the rest of the parameters is programmed. This Graphic User Interface is efficient as well but the amount of files to process (1224 files per construction) makes it slower than desired.



# Parabola Description

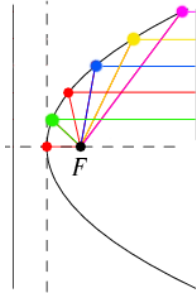

Figure A.1: Main parabola characteristic

The parabola is a figure that could be interesting as a reflector at high frequencies. The main interesting characteristic is that the path that starts in the focus and reflects in the figure changes its direction to horizontal. Every beam runs the same distance from the focus to a perpendicular plane respect the reflected beam direction (vertical). This fact is represented in the picture on the right hand side.

The vertical line that cross the focus, where the virtual center of the loudspeaker is placed, is used as an axis of revolution. With this method the dispersion of the radiation pattern is considerably rised bringing the possibility to radiate all around the  $360^\circ$ . This configuration is represented in the Figure A.2.

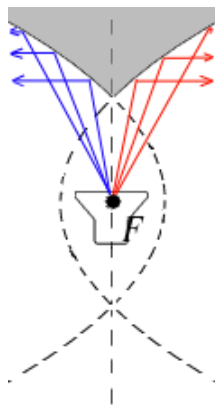

Figure A.2: Parabola with volume of revolution

The equation of the parabola with focus located in the  $(0,0)$  is:

$$y = 2\sqrt{p}\sqrt{x+p} \quad (\text{A.1})$$

And the equation of the line that represents -6dB SPL respect the maximum (defined as dispersion).

$$y = \frac{x}{\tan \alpha} \quad (\text{A.2})$$

$\alpha$  is the angle between the axis of the loudspeaker and the -6dB SPL direction.

It would be useful to know the relationship between the parameter of the  $p$  parameter of the parabola and  $\alpha$ .

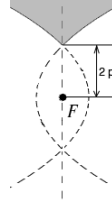

Figure A.3: Distance from the focus

The distance from the focus to the point of the figure vertically upwards is  $2p$ . This conclusion is obtained calculating  $y|_{x=0}$  in (A.1). As  $p$  increases, the shape section of the reflector seems to be closing. This could be interesting because if  $p$  increases, the V shape is tightened and the dispersion increases vertically. But the problem is that if  $p$  increases, the distance from the tweeter to the reflector increases and that means that the size of the system increases as well.

Linkwitz Pluto specifications [12] show the tweeter diagram almost omni-directional from 1 kHz. to 3 kHz. After 3 kHz the diagram has a low point in  $60^\circ$  for 10 kHz of 13 dB respect the direct beam.

It could be interesting to find out the relationship between (A.1) and (A.2).

$$\begin{aligned} 2\sqrt{p}\sqrt{x+p} &= \frac{x}{\tan \alpha} \rightarrow \\ \rightarrow 4p(x+p) &= \frac{x^2}{\tan^2 \alpha} \rightarrow \\ \rightarrow 4px + 4p^2 &= \frac{x^2}{\tan^2 \alpha} \end{aligned} \quad (\text{A.3})$$

This second degree equation is solved taking the positive result of the  $x$ :

$$x = 2p \tan \alpha \left( \tan \alpha + \frac{1}{\cos \alpha} \right) \quad (\text{A.4})$$

And substituting this value in (A.2):



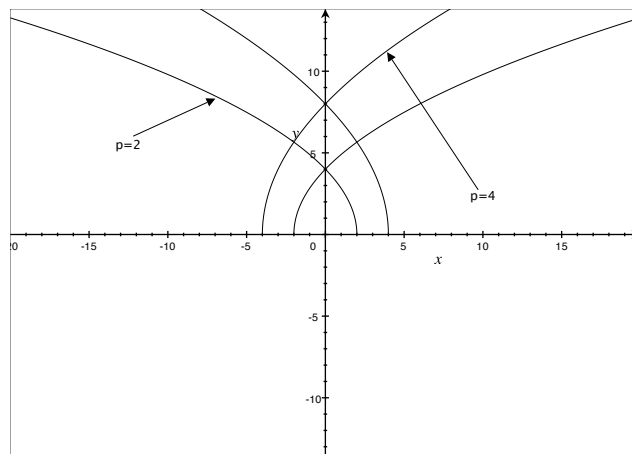

Figure A.4: Shape of the parabola depending on  $p$

$$y = 2p\left(\tan \alpha + \frac{1}{\cos \alpha}\right) \quad (\text{A.5})$$

With this relationship, it is easy to find the shape of the reflector knowing the  $p$  parameter and the angle of coverage this project is made for. It is important to decide the angle of coverage. The source has different radiation patterns for different frequencies. Pluto specifications analysis shows that if the source (tweeter) is radiating at 1 kHz., the source could be approximately a omni-directional source. In this case, the parabolic reflector is not going to reflect all the energy the loudspeaker is radiating out. In the other hand side, the thinnest beam is produced approximately at 9 kHz. At this frequency the dispersion is  $\pm 40^\circ$  (-6dB related with the maximum ( $0^\circ$ )). This should be the minimum coverage angle of the design.

The designed parabolla follows the equations:

$$y = 2\sqrt{3.5}\sqrt{\pm x + 3.5}; y = 14. \quad (\text{A.6})$$

The flat part on top is 25 cm. This diameter makes  $p=8.3$  cm.

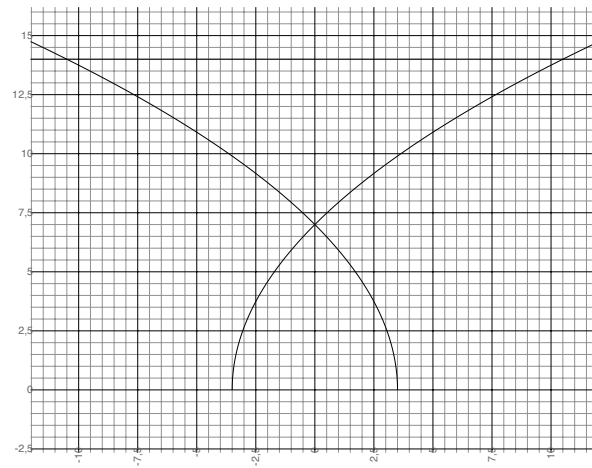

Figure A.5: Designed parabola

# Equipment used

---

The bill of materials is:

- 4 Brüel & Kjær condenser microphones. Cartridge Type 4149.
- 2 (X2 channels) Norsonic Front End preamplifiers. Type 336. Flat filtering.
- 1 Brüel & Kjær microphone calibrator. Type 4231. 94 dB SPL at 1 kHz. (Not used in the second part of the project)
- Turntable Norsonic connected to the serial port.
- WinMLS software.
- Loudspeaker explained in [3.1](#)
- Metallic arc. It consist in an arc made out of aluminium drilled every 22.5 degrees to place the microphones in. The arc contains other three groups of drills used to attach the arc to its stand. The arc can be turned respect the centre screwing the arc into another group of drills. Depending on the group the arc is screwed in, different angles can be measured.



# Reflector assembly

---

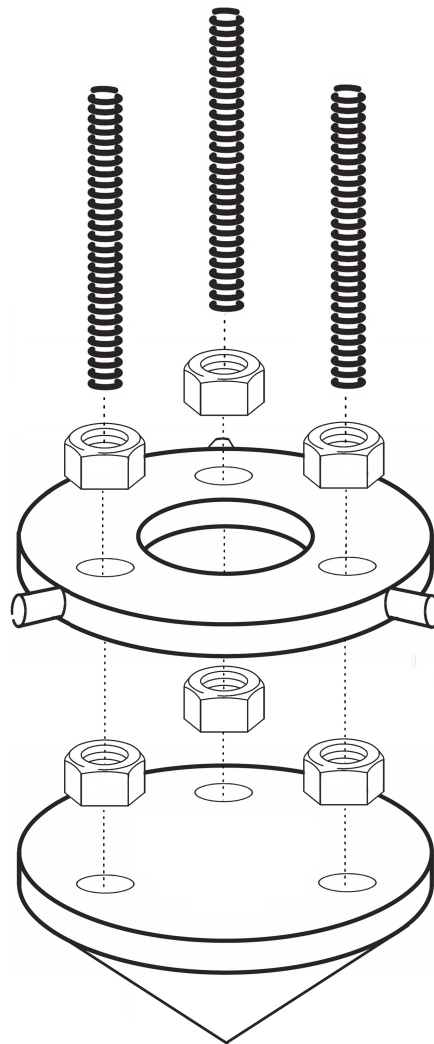

Figure C.1: How to attach reflector to the holder

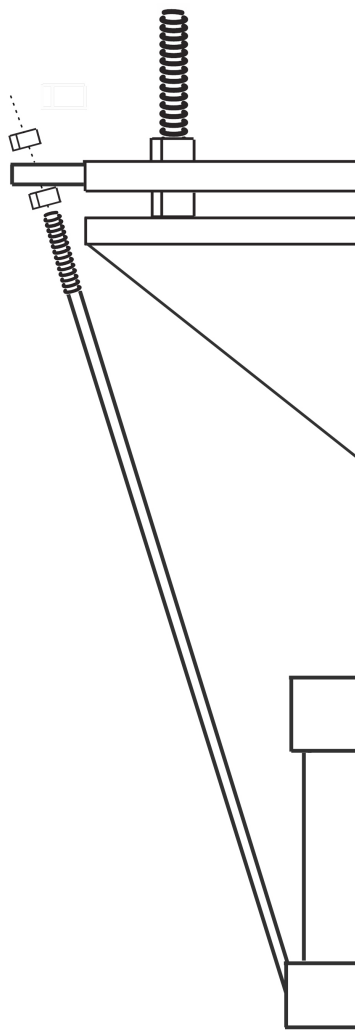

Figure C.2: How to attach both to the loudspeaker stand

# Measurement Protocol

---

Protocol followed to get and store the files is explained here. Following this, all measurements all of the project are taken. The result is  $\theta$  step of  $11.25^\circ$  and  $\phi$  step of  $5^\circ$ .

## D.1 Calibration

To get the files used for calibrate the measurements, the microphones must be placed one by one in the same position and orientation respect the loudspeaker. The result should be similar to Figure 3.3. Resultant calibration files of all channels must be placed in the same folder named with an intuitive label like calibration.

## D.2 Setup

Amplifier warm up time must be respected as well.

This method has 5 measuring states showed in Figure D.1. In each state, measurements for every  $\phi$  are taken but belonging to just four angles of  $\theta$  (four microphones). Changing either the arc position or the microphones position is needed in the transition from one state to the next one.

## D.3 Measuring

The task of controlling the turntable and calling WinMLS (loading a determined user setup) from Matlab has been solved with DoTurntableMeasurement.m explained in [13]. Five degrees of  $\phi$  step has been decided to use in this project. Measuring starts with the command:

```
DoTurntableMeasurement(0,5,72,30,5,1,1,'filename','SetupFile');1
```

WinMLS user setup must be configured with Impulse/Frequency Response with 4 input channels,  $F_s=48000$  and simple sweep as impulse generator.

## D.4 Storing

Once the files of this state have been created, they should be stored in a known labelled folder. New folder for each state must be created. Naming the folders that contain the files is actually an important step. Developed software is able to rename

---

<sup>1</sup> MATLAB file developed by Dirk Schröder

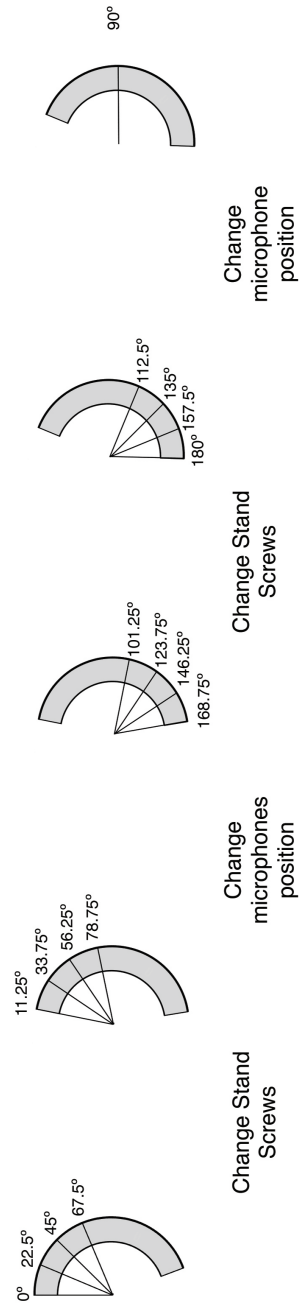

Figure D.1: Arc measurement states



---

and store all them in a new folder. It is useful to name the folders with an intuitive label. E.g. Folder of measuring *state 1* where  $\theta=0, 22.5, 45, 67.5$  named as *0to68*

## D.5 Next measuring state

Changing either the stand screws or the microphones position is needed to advance to the next state. Changing the microphones position is a critical step because careful variations in the orientation have to be done for aiming them towards the center of the circumference the arc belongs to. After this, back to the step Measuring (D.3) until state 5.



# APPENDIX E

## Software description

---

This appendix contains a brief explanation about the fields in the program and how to use it.

### E.1 SETUP

This step is unavoidable. In this, parameters for the following computation must be entered. Even if it is not intuitive, it is important to know that calibration must be performed before renaming. If do not, error will be shown. All the folders created in every step of Appendix D will be in the same folder level.

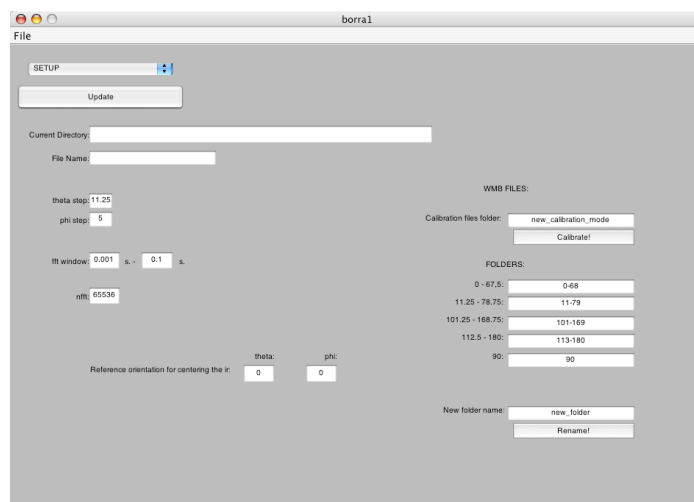

Figure E.1: SETUP window

- Current Directory: this field contains the measurements folder path. This folder contains all the folders with the measures taken in each step and the calibration folder as well.
- File Name: name of the measurements specified in D.3
- Theta Step: this is the theta step followed in the measurements. For the measurements obtained with the arc this is  $11.25^\circ$  step.

- Phi Step: It is defined in D.3 as well. For developing this project,  $5^\circ$  step has been set.
- fft window: start and end in seconds of the time window used in the fft calculation. This time window can be checked in the Frequency Response menu pushing *Show fft window over ir* button.
- nfft: points of the fft. Power of two should be used if faster computation is desired. E.g.  $nfft=65536$  ( $2^{16}$ ).
- Reference orientation for centring the ir: in this field, orientation used as reference to centre and compensate the rest of the ir measurements is introduced.

On the right side of the window: WMB FILES

- Calibration files folder: name of the folder contained in *Current Directory* where the Calibration files are stored.
- Folders: these fields contain the name of the folders that contain the measurements taken in every state.
- New folder name: this is the name of the folder that will be created to store the renamed files in.
- Rename! Button: pressing this button, renaming of the files contained in every folder is performed. All renamed files are stored together in the New Folder.

## E.2 Frequency Response

In this window, Frequency Resopnse can be shown. It can be shown for one direction or several.

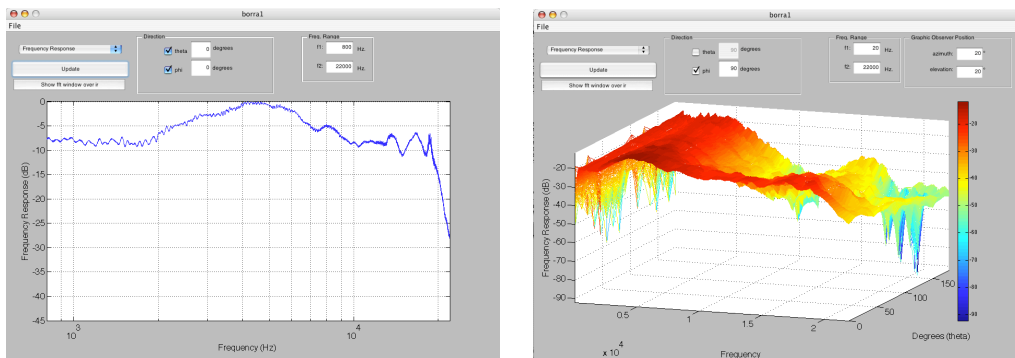

Figure E.2: Frequency Response window.  $FR$  on  $(\theta=0, \phi=0)$  and  $FR$  variation respect  $\theta$

- Direction: Frequency response of just one direction can be represented ticking both checkboxes. It is also possible to represent how frequency response changes with theta or alpha ticking only one of the checkboxes.
- Frequency Range: range of frequencies to be analyzed.
- Graphic Observer Position: azimuth and elevation angle to observe the 3D representation. Obviously, it is not available for representation of one direction.
- Show fft window over ir button: this button shows the impulse response of the orientation introduced. It also represents the limits of the window the fft is going to be calculated with.

### E.3 Directivity Diagram

Here, directivity diagram for a introduced frequency is plotted. The user can choose either 2D or 3D representation.

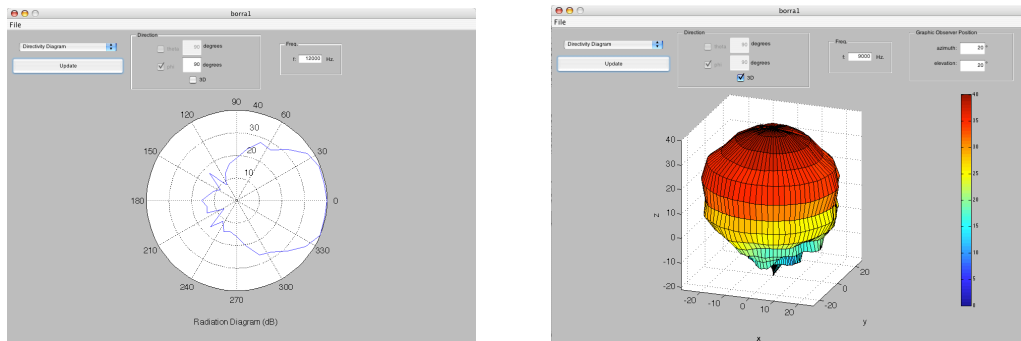

Figure E.3: Directivity Diagram window. Directivity Diagram in one  $\phi$  plane or 3D representation.

- Direction: this represents classic directivity diagram representation (2D). Due to this radiation is almost volume of revolution respect the axis of the loud-speaker radiation (coincident with  $z$  axis), value of phi has to be introduced. It indicates the plane it is going to be shown.
- 3D checkbox: if it is ticked, 3D representation of the radiation is performed. If so, Graphic Observer Position appears to show the orientation of the view.
- Frequency: both representations are just for one frequency. It has to be introduced as well.

## E.4 Directivity Index

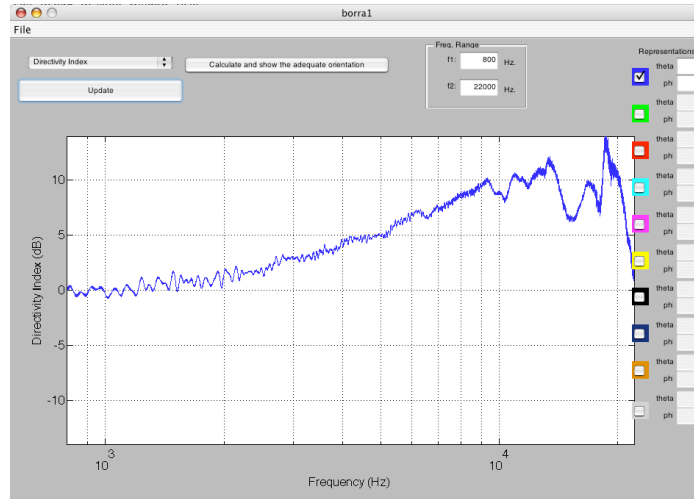

Figure E.4: Directivity Index window. Directivity Index on ( $\theta=0$   $\phi=0$ )

- Frequency Range: range of frequencies to be analyzed.
- Representations: representations of the  $DI$  in multiple orientations can be performed at the same time.
- Calculate and show the adequate orientation button: this button starts the function that looks for the orientation that is closer to zero  $DI$  in the specified frequency range.

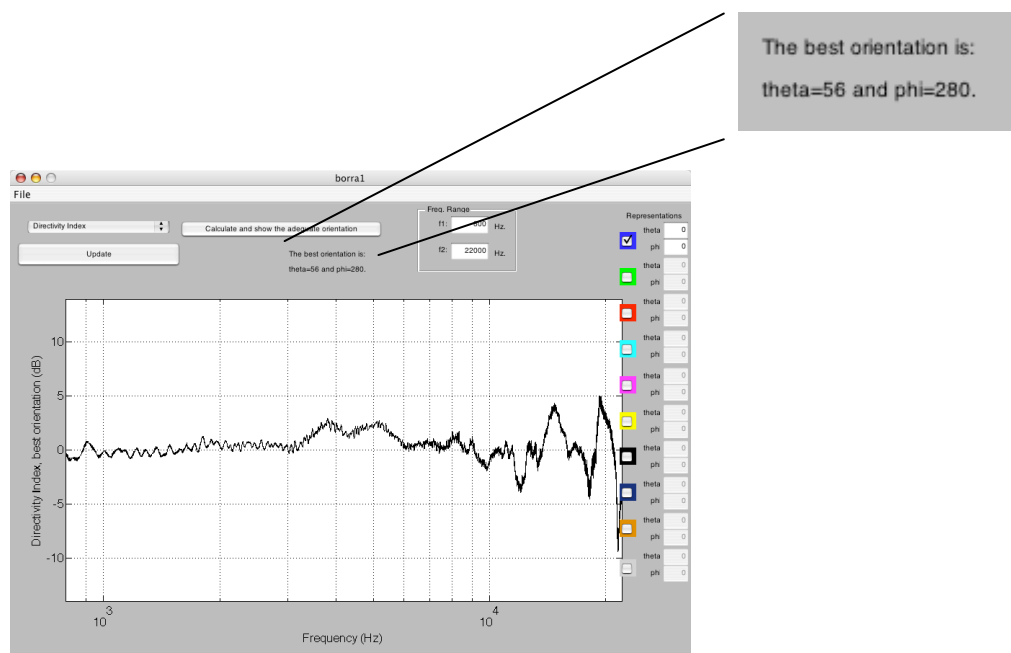

Figure E.5: Directivity Index window. Suitable direction computed.





# Flow Diagrams and Code of Matlab Functions

---

## F.1 Graphic User Interface

Due to the length of the code, only flow diagram is presented in [Figure F.1](#)

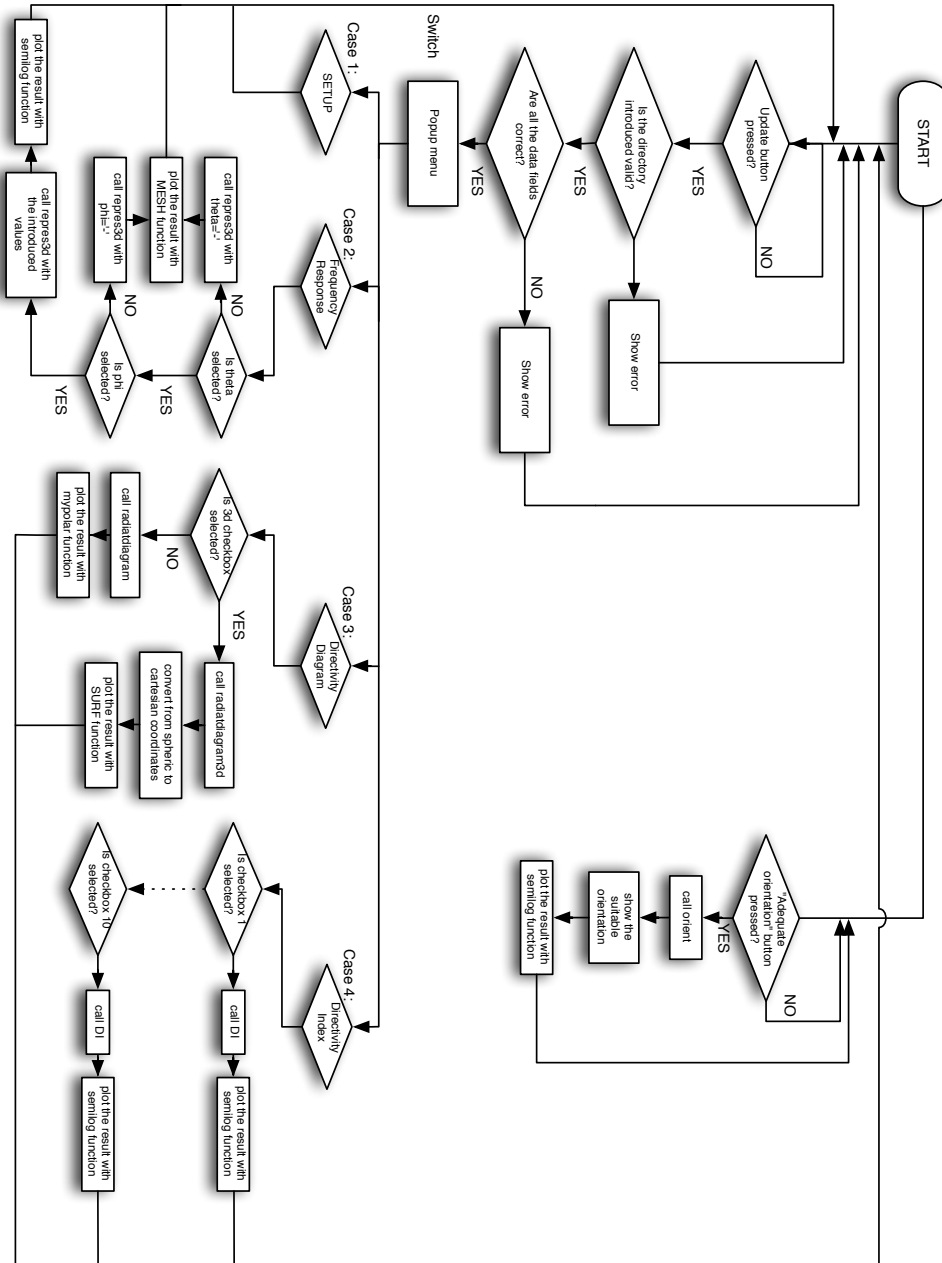

Figure F.1: Flow diagram of the Graphic User Interface.

## F.2 center

```

function [ir2]=center(ir,pos)
%-----
%
%returns ir2 that is is a copy of ir but shifted until the maximus is placed
%in the position pos:
%
%[ir2]=center(ir,pos)
%
%
%
%   Diego Ivars
%
%-----

[m,posit]=max(abs(ir));
dist=posit-pos;

if dist>0

    ir2=[ir(dist+1:end)',zeros(1,dist)];
    %Impulse response has to be compensated due to variation of the
    %distance.
    %the delay produced by the soundcard is 2.208ms;
    %fs=48000;

    %%%%%%%%%%Uncomment for plots of loudspeaker without reflector

    Rref=343*(2.208*10^(-3)+pos/48000);
    Rprop=343*(2.208*10^(-3)+posit/48000);
    ir2=ir2*Rref/Rprop;
    %%%%%%%%%%

else
    if dist==0
        ir2=ir;

    else

        ir2=[zeros(1,abs(dist)),ir(1:end+dist)'];
        %Impulse response has to be compensated due to variation of the
        %distance.

```



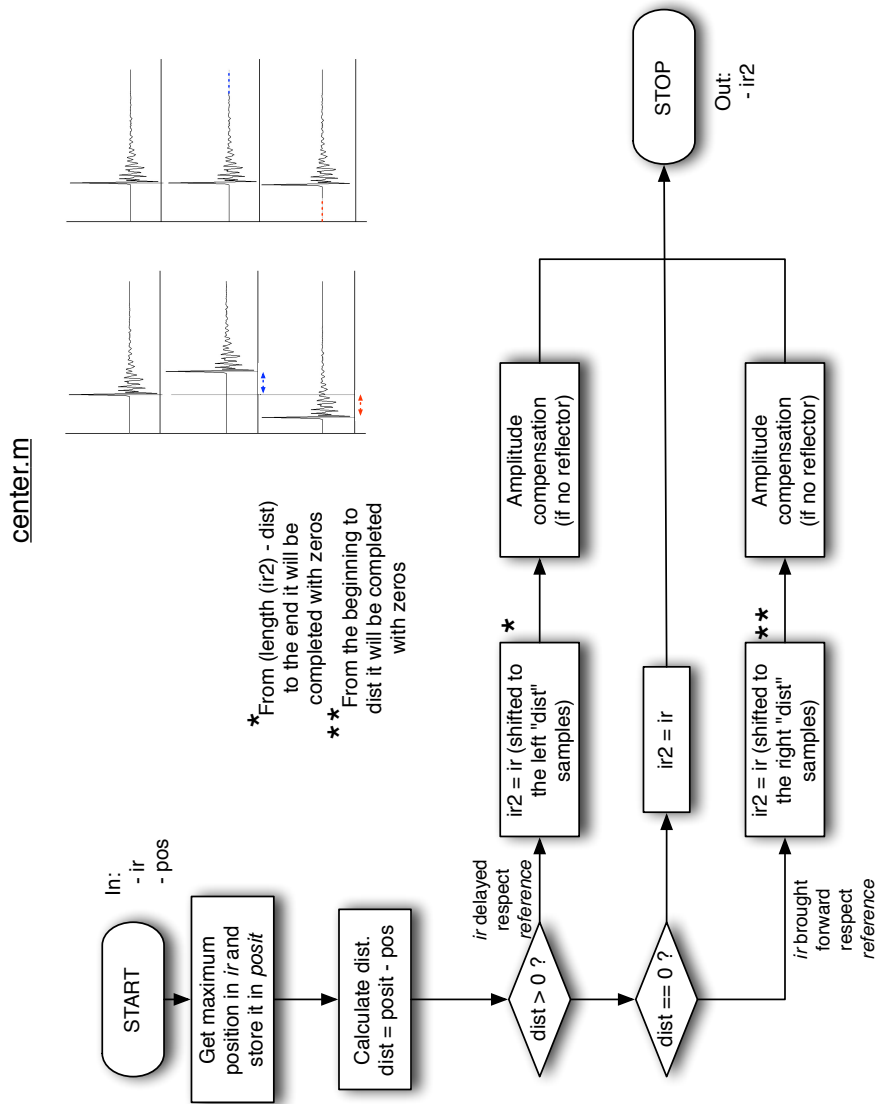

Figure F.2: Flow diagram of center.m.



## F.3 Frequency Response

```

function [represmatrix,fs]= repres3d (varargin)
%-----
%
%repres3d:
%This function gets the frequency response of one or several orientations.
%The calling of this function should be:
%    [represmatrix]=repres3d(filename,degreestheta,degreesphi,t1,t2,theta,phi)
%
%- Before and after the filename: '
%- degreestheta and degreesphi are the steps in the measurements.
%- t1 and t2 mean start and end of the window within the fft is calculated
%- theta and phi represent the direction which the frequency response
%will be calculated on
%
%
%It works in three different ways:
%
% - phi introduced, theta not defined('-'). The result is a matrix of
% (180/degreestheta+1,fs/2) where all the frequency responses are stored.
% The first row contains the frequency response of theta=0, second
% theta=degreestheta, third theta=2*degreestheta,... last theta=180.
%
% - theta introduced, phi not defined('-'). The result is a matrix of
% (360/degreesphi+1,fs/2) where all the frequency responses are stored.
% The first row contains the frequency response of phi=0, second
% phi=degreesphi, third phi=2*degreesphi,... last phi=360-degreesphi.
%
% - Both are introduced. The result is a vector of length fs/2 that
% contains the frequency response in that direction.
%
%
%
%    Diego Ivars
%
%-----

[cax,args,nargs] = axescheck(varargin{:});
error(nargchk(10,10,nargs,'struct'));

if nargs < 10 || nargs > 10
    error('MATLAB:repres3d:InvalidInput', 'Requires 10 data arguments.')
```

```

else
    filename = args{1};
    degreestheta = args{2};
    degreesphi = args {3};
    t1 = args{4};
    t2 = args{5};
    theta=args{6};
    phi=args{7};
    nfft=args{8};
    pos=args{9};
    a=args{10};

    if (strcmp(theta,'-')) %Representation with theta variable
        nfiles = 180/degreestheta+1;
        filenamestart = [filename,'_'];

        for ii = 1:nfiles
            filenumb=(ii-1)*degreestheta;

            filename1 = [filenamestart,int2str(phi),'_',int2str(filenumb),
'_Ch1.wmb'];
            filename2 = [filenamestart,int2str(phi),'_',int2str(filenumb),
'_Ch2.wmb'];
            filename3 = [filenamestart,int2str(phi),'_',int2str(filenumb),
'_Ch3.wmb'];
            filename4 = [filenamestart,int2str(phi),'_',int2str(filenumb),
'_Ch4.wmb'];

            if(exist(filename1))
                commandstr = ['[ir,fs] = loadimp('','',filename1,'','',')'];
                f=1;
            elseif(exist(filename2))
                commandstr = ['[ir,fs] = loadimp('','',filename2,'','',')'];
                f=2;
            elseif(exist(filename3))
                commandstr = ['[ir,fs] = loadimp('','',filename3,'','',')'];
                f=3;
            elseif(exist(filename4))

```



```
        commandstr = ['[ir,fs] = loadimp(''',filename4,''',');'];
        f=4;
    end

    eval(commandstr)

    fclose('all'); % Close all open files

    ir=center(ir,pos);

    h1=ir./(20*10(-6));
    try
        h1=h1(round(t1*fs)+1:round(t2*fs)+1);
    catch
        errordlg('Error. It could be caused by the File name (check
SETUP)', 'Error');
    end

    y=abs(fft(h1,nfft));
    reprod=y(1:nfft/2);

    %Calibration

    reprod=reprod(:);
    reprod=reprod';
    if f==1
        reprod=reprod./a(1,:);
    elseif f==2
        reprod=reprod./a(2,:);
    elseif f==3
        reprod=reprod./a(3,:);
    elseif f==4
        reprod=reprod./a(4,:);
    end

    reprod=20*log10(reprod);
```

```

    if ii==1
        represmatrix=zeros(nfiles,length(reprod));
    end

    represmatrix(ii,:)=reprod;

end

else
    if(strcmp(phi,'-')) %Representation with phi variable
        nfiles = 360/degreesphi;
        filenamestart = [filename,'_'];

        for ii = 1:nfiles
            filenumb=(ii-1)*degreesphi;

            filename1 = [filenamestart,int2str(filenumb),'_',int2str(phi),
'_Ch1.wmb'];
            filename2 = [filenamestart,int2str(filenumb),'_',int2str(phi),
'_Ch2.wmb'];
            filename3 = [filenamestart,int2str(filenumb),'_',int2str(phi),
'_Ch3.wmb'];
            filename4 = [filenamestart,int2str(filenumb),'_',int2str(phi),
'_Ch4.wmb'];

            if(exist(filename1))
                commandstr = ['[ir,fs] = loadimp('','',filename1,'','',')'];
                f=1;
            elseif(exist(filename2))
                commandstr = ['[ir,fs] = loadimp('','',filename2,'','',')'];
                f=2;
            elseif(exist(filename3))
                commandstr = ['[ir,fs] = loadimp('','',filename3,'','',')'];
                f=3;
            elseif(exist(filename4))
                commandstr = ['[ir,fs] = loadimp('','',filename4,'','',')'];
                f=4;
            end
        end
    end
end

```

```
eval(commandstr)

fclose('all'); % Close all open files

ir=center(ir,pos);

h1=ir./(20*10^(-6));
try
    h1=h1(round(t1*fs)+1:round(t2*fs)+1);
catch
    error('Error. It could be caused by the File name (check
SETUP)', 'Error');
end

y=abs(fft(h1,nfft));
reprod=y(1:nfft/2);

%Calibration
reprod=reprod(:);
reprod=reprod';

if f==1
    reprod=reprod./a(1,:);
elseif f==2
    reprod=reprod./a(2,:);
elseif f==3
    reprod=reprod./a(3,:);
elseif f==4
    reprod=reprod./a(4,:);
end

reprod=20*log10(reprod);
```

```

        if ii==1
            represmatrix=zeros(nfiles,length(reprod));
        end

        represmatrix(ii,:)=reprod;

    end

else %both coordinates are introduced
    filenamestart = [filename,'_'];

    filename1 = [filenamestart,int2str(phi),'_',int2str(theta),
'_Ch1.wmb'];
    filename2 = [filenamestart,int2str(phi),'_',int2str(theta),
'_Ch2.wmb'];
    filename3 = [filenamestart,int2str(phi),'_',int2str(theta),
'_Ch3.wmb'];
    filename4 = [filenamestart,int2str(phi),'_',int2str(theta),
'_Ch4.wmb'];

    if(exist(filename1))
        commandstr = ['[ir,fs] = loadimp('','',filename1,'','',')'];
        f=1;
    elseif(exist(filename2))
        commandstr = ['[ir,fs] = loadimp('','',filename2,'','',')'];
        f=2;
    elseif(exist(filename3))
        commandstr = ['[ir,fs] = loadimp('','',filename3,'','',')'];
        f=3;
    elseif(exist(filename4))
        commandstr = ['[ir,fs] = loadimp('','',filename4,'','',')'];
        f=4;
    end
end

```

```
eval(commandstr)
fclose('all'); % Close all open files

ir=center(ir,pos);

h1=ir./(20*10(-6));
try
    h1=h1(round(t1*fs)+1:round(t2*fs)+1);
catch
    error(dlg('Error. It could be caused by the File name (check
SETUP)', 'Error'));
end

y=abs(fft(h1,nfft));
reprod=y(1:nfft/2);

%Calibration
reprod=reprod(:);
reprod=reprod';

if f==1
    reprod=reprod./a(1,:);
elseif f==2
    reprod=reprod./a(2,:);
elseif f==3
    reprod=reprod./a(3,:);
elseif f==4
    reprod=reprod./a(4,:);
end

reprod=20*log10(reprod);

represmatrix=reprod;

end
end
end
```

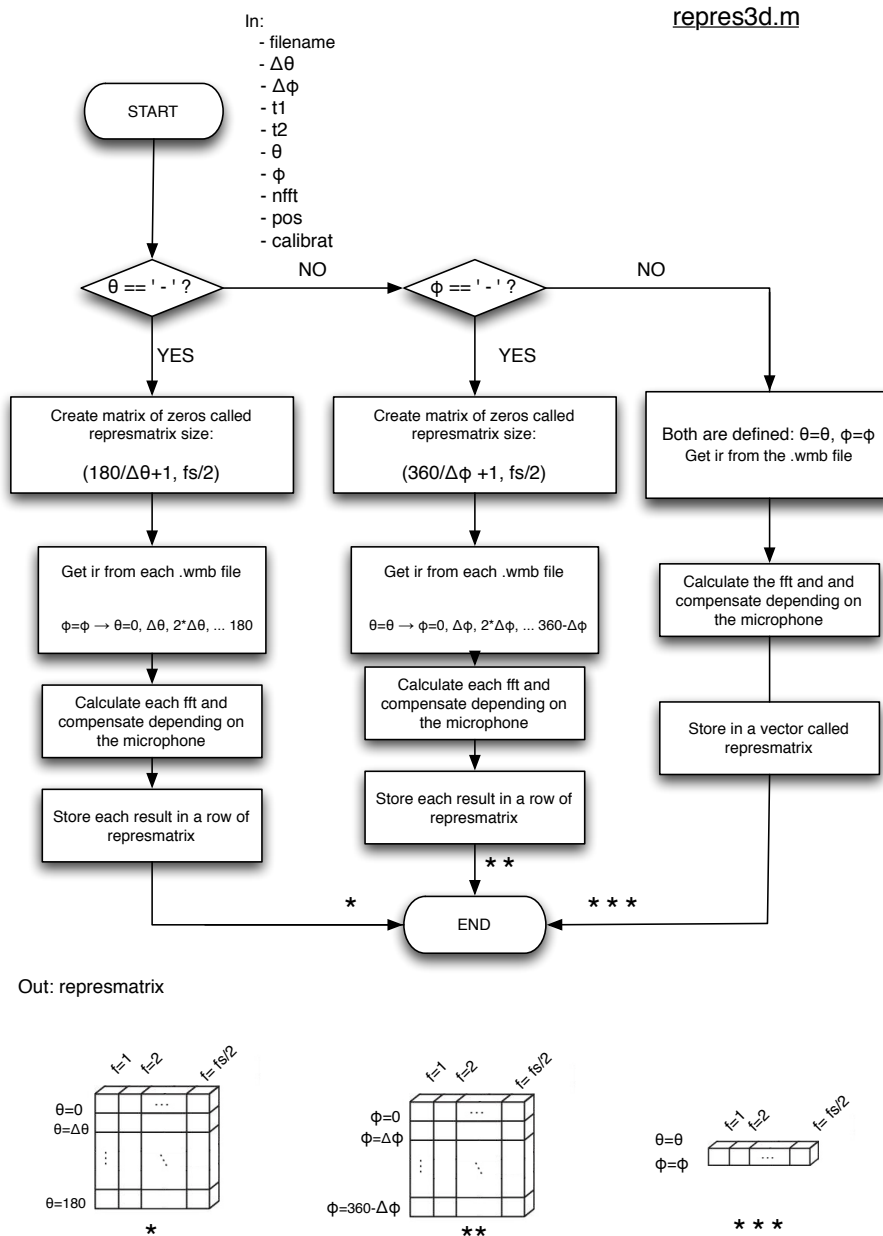

Figure F.3: Flow diagram of repres3d.m.

## F.4 Radiation Diagram

```

function [represmatrix,fs]= radiatdiagram
(filename,degreestheta,anglephi,t1,t2,freq,nfft,pos,a)
%-----
%
%"radiatdiagram" is a program developed to get the frequency response of a
% loudspeaker in different directions in one specific frequency. It could
% be used to represent polar diagrams.
%
%It works with the measurements (files .wmb) obtained with WinMLS.
%
%
%The way to call it:
%
%[represmatrix]= radiatdiagram(filename,degreestheta,anglephi,t1,t2,freq)
%
%
%- Before and after the filename: '
%- degreestheta is the step advanced in every measurement
%- anglephi is the plane where the representation will be made
%- t1 and t2 mean start and end of the window within the fft is calculated
%- freq is the frequency desired
%
%
%-represmatrix will contain a vector. The size of the vector will be
%(2*180/degreestheta+1,1).
%represmatrix(1,1) contains the dB(SPL) of theta=0,phi=anglephi and f=freq
%represmatrix(2,1) contains the dB(SPL) of theta=degreestheta,phi=anglephi
%           and f=freq
%represmatrix(3,1) contains the dB(SPL) of theta=2*degreestheta,phi=anglephi
%           and f=freq
% ...
%
%
%
%
%   Diego Ivars
%
%-----

```

```

nfiles = 180/degreestheta ;
filenamestart = [filename, '_'];
%theta is defined from 0 to 180.

%with this for, files with phi=anglephi and
%theta=0,degreestheta,2*degreestheta... 180-degreestheta will be read.
for ii = 1:nfiles
    filenumb=(ii-1)*degreestheta;

    filename1 = [filenamestart,int2str(anglephi),'_',int2str(filenumb),
'_Ch1.wmb'];
    filename2 = [filenamestart,int2str(anglephi),'_',int2str(filenumb),
'_Ch2.wmb'];
    filename3 = [filenamestart,int2str(anglephi),'_',int2str(filenumb),
'_Ch3.wmb'];
    filename4 = [filenamestart,int2str(anglephi),'_',int2str(filenumb),
'_Ch4.wmb'];

    if(exist(filename1))
        commandstr = ['[ir,fs] = loadimp(''',filename1,''',');'];
        f=1;
    elseif(exist(filename2))
        commandstr = ['[ir,fs] = loadimp(''',filename2,''',');'];
        f=2;
    elseif(exist(filename3))
        commandstr = ['[ir,fs] = loadimp(''',filename3,''',');'];
        f=3;
    elseif(exist(filename4))
        commandstr = ['[ir,fs] = loadimp(''',filename4,''',');'];
        f=4;
    end

    eval(commandstr)

```



```
fclose('all'); % Close all open files

ir=center(ir,pos);

h1=ir./(20*10(-6));
try
    h1=h1(round(t1*fs)+1:round(t2*fs)+1);
catch
    error('Error. It could be caused by the File name (check
SETUP)', 'Error');
end

y=abs(fft(h1,nfft));
reprod=y(1:nfft/2);
reprod=reprod(:);
reprod=reprod';

%Calibration
if f==1
    reprod=reprod./a(1,:);
elseif f==2
    reprod=reprod./a(2,:);
elseif f==3
    reprod=reprod./a(3,:);
elseif f==4
    reprod=reprod./a(4,:);
end

reprod=20*log10(reprod);

%vertical vector is needed
[c,b]=size(reprod);
if c==1
    reprod=reprod';
end
```

```

    if ii==1
        represmatrix=zeros((nfiles*2+1),1);
    end

    %to make the values under 60dB equal to 60 dB because of the
    %representation

    for kk=1:length(reprod)
        if reprod(kk,1)<60
            reprod(kk,1)=60;
        end
    end

    reprod=reprod-60;

    represmatrix(ii,1)=reprod(round(freq*nfft/fs),1);

end

%now from 180 to 360

%with this for, files with phi=anglephi+180 and
%theta=180,180-degreestheta,180-2*degreestheta... 0 will be read.
for ii = 1:nfiles
    filenumb=180-(ii-1)*degreestheta;
    if anglephi<180
        filename = [filenamestart,int2str(anglephi+180),'_',int2str(
filenumb)];
    else
        filename = [filenamestart,int2str(anglephi-180),'_',int2str(
filenumb)];
    end

    filename1 = [filename,'_Ch1.wmb'];
    filename2 = [filename,'_Ch2.wmb'];
    filename3 = [filename,'_Ch3.wmb'];
    filename4 = [filename,'_Ch4.wmb'];

```

```

if(exist(filename1))
    commandstr = ['[ir,fs] = loadimp(''',filename1,''',');'];
    f=1;
elseif(exist(filename2))
    commandstr = ['[ir,fs] = loadimp(''',filename2,''',');'];
    f=2;
elseif(exist(filename3))
    commandstr = ['[ir,fs] = loadimp(''',filename3,''',');'];
    f=3;
elseif(exist(filename4))
    commandstr = ['[ir,fs] = loadimp(''',filename4,''',');'];
    f=4;
end

eval(commandstr)

ir=center(ir,pos);

h1=ir./(20*10(-6));
try
    h1=h1(round(t1*fs)+1:round(t2*fs)+1);
catch
    errordlg('Error. It could be caused by the File name (check
SETUP)', 'Error');
end

y=abs(fft(h1,nfft));
reprod=y(1:nfft/2);
reprod=reprod(:);
reprod=reprod';

%Calibration
reprod=reprod(:);
reprod=reprod';

if f==1
    reprod=reprod./a(1,:);

```

```
elseif f==2
    reprod=reprod./a(2,:);
elseif f==3
    reprod=reprod./a(3,:);
elseif f==4
    reprod=reprod./a(4,:);
end
```

```
reprod=20*log10(reprod);
```

```
[ac,b]=size(reprod);
if ac==1
    reprod=reprod';
end
```

```
%to make the values under 60dB equal to 60 dB because of the
%representation
```

```
for kk=1:length(reprod)
    if reprod(kk,1)<60
        reprod(kk,1)=60;
    end
end
```

```
reprod=reprod-60;
```

```
represmatrix(ii+nfiles,1)=reprod(round(freq*nfft/fs),1);
```

```
end
```

```

represmatrix((2*nfiles+1),1)=represmatrix(1,1);%if this is not placed,
%the curve in the representation
%is not completely closed.
    
```

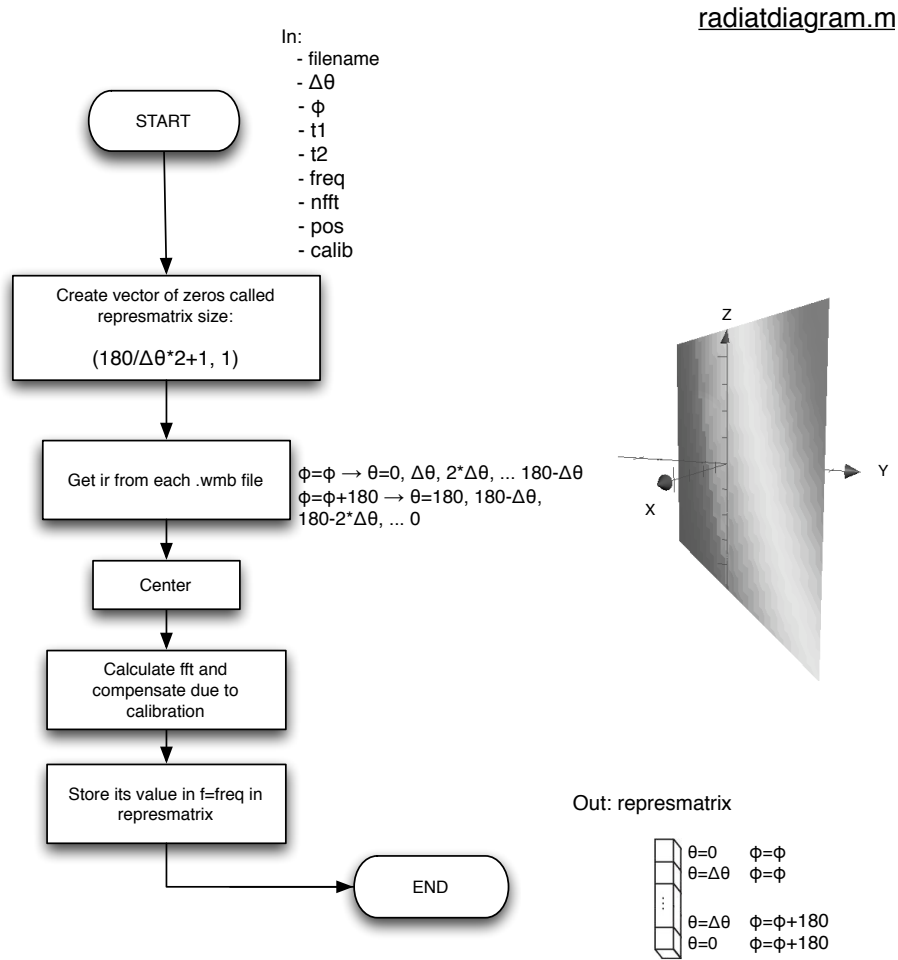

Figure F.4: Flow diagram of radiatdiagram.m.



## F.5 Directivity Index

```

function [DImatrix,fs]= DI (filename,degreestheta,degreesphi,theta,
phi,t1,t2,f1,f2,nfft,pos,a)
%-----
%
%This function calculates the Directivity Index in one direction. For this
%calculation, the rest of the measured orientations should be loaded.
%
%The instruction has to be like:
%[DImatrix]= DI (filename,degreestheta,degreesphi,theta,phi,t1,t2)
%
%- Before and after the filename: '
%- degreestheta and degreesphi are the steps in the measurements.
%- theta and phi form the direction where the DI is desired to be calculated
%- t1 and t2 mean start and end of the window within the fft is calculated
%
% DImatrix is a vector of length fs/2 (usually 24000 due to fs=48000)
%
%
%
%    Diego Ivars
%
%-----

nfiles = 360/degreesphi;
nfiles2 = 180/degreestheta+1;
represmatrix=zeros(nfiles2,nfiles+1,nfft/2);
filenamestart = [filename,'_'];
%theta is defined from 0 to 180
for ii = 1:nfiles
    filenumb=(ii-1)*degreesphi;
    for jj=1:nfiles2
        filenumb2=(jj-1)*degreestheta;

        filename1 = [filenamestart,int2str(filenumb),'_',int2str(filenumb2),
'_Ch1.wmb'];
        filename2 = [filenamestart,int2str(filenumb),'_',int2str(filenumb2),
'_Ch2.wmb'];

```

```

        filename3 = [filenamestart,int2str(filenumb),'_',int2str(filenumb2),
'_Ch3.wmb'];
        filename4 = [filenamestart,int2str(filenumb),'_',int2str(filenumb2),
'_Ch4.wmb'];

        if(exist(filename1))
            commandstr = ['[ir,fs] = loadimp(''',filename1,''',');'];
            f=1;
        elseif(exist(filename2))
            commandstr = ['[ir,fs] = loadimp(''',filename2,''',');'];
            f=2;
        elseif(exist(filename3))
            commandstr = ['[ir,fs] = loadimp(''',filename3,''',');'];
            f=3;
        elseif(exist(filename4))
            commandstr = ['[ir,fs] = loadimp(''',filename4,''',');'];
            f=4;
        end

        eval(commandstr)

        ir=center(ir,pos);

        h1=ir./(20*10(-6));
        try
            h1=h1(round(t1*fs)+1:round(t2*fs)+1);
        catch
            errordlg('Error. It could be caused by the File name (check
SETUP)', 'Error');
        end

        y=abs(fft(h1,nfft));
        reprod=y(1:nfft/2);
        reprod=reprod(:);
        reprod=reprod';

        if f==1
            reprod=reprod./a(1,:);
        elseif f==2
            reprod=reprod./a(2,:);
        elseif f==3
            reprod=reprod./a(3,:);

```



```

elseif f==4
    reprod=reprod./a(4,:);
end

fclose('all'); % Close all open files

represmatrix(jj,ii,:)=reprod.^2;

end

end

represmatrix(:,(nfiles+1),:)=represmatrix(:,1,:);%if this is not placed,
%the curve is not completely closed.

%calculation of the double summatory (it is the same sum for each frequency)
B=(round(f2*nfft/fs)-round(f1*nfft/fs))/3;

disp('0%...');
Isum=zeros(1,length(reprod));
for i=round(f1*nfft/fs):round(f2*nfft/fs)

    if(i==round(f1*nfft/fs)+round(B))
        disp('33%...');
    elseif(i==round(f1*nfft/fs)+2*round(B))
        disp('66%...');
    elseif(i==round(f2*nfft/fs))
        disp('100%...');
    end

    for j=1:nfiles+1
        for k=1:nfiles2
            Isum(1,i)=Isum(1,i)+represmatrix(k,j,i)*sin((k-1)*degreestheta*
pi/180);
        end
    end
end
Isum(1,i)=Isum(1,i)/(4*pi)*(degreestheta*(pi/180)*degreesphi*(pi/180));

```

```
end
DImatrix=zeros(1,length(reprod));

for i=round(f1*nfft/fs):round(f2*nfft/fs)
    DImatrix(1,i)=10*log10(represmatrix((theta/degreestheta+1),(phi/degreesphi
+1),i)/Isum(1,i));
end
```

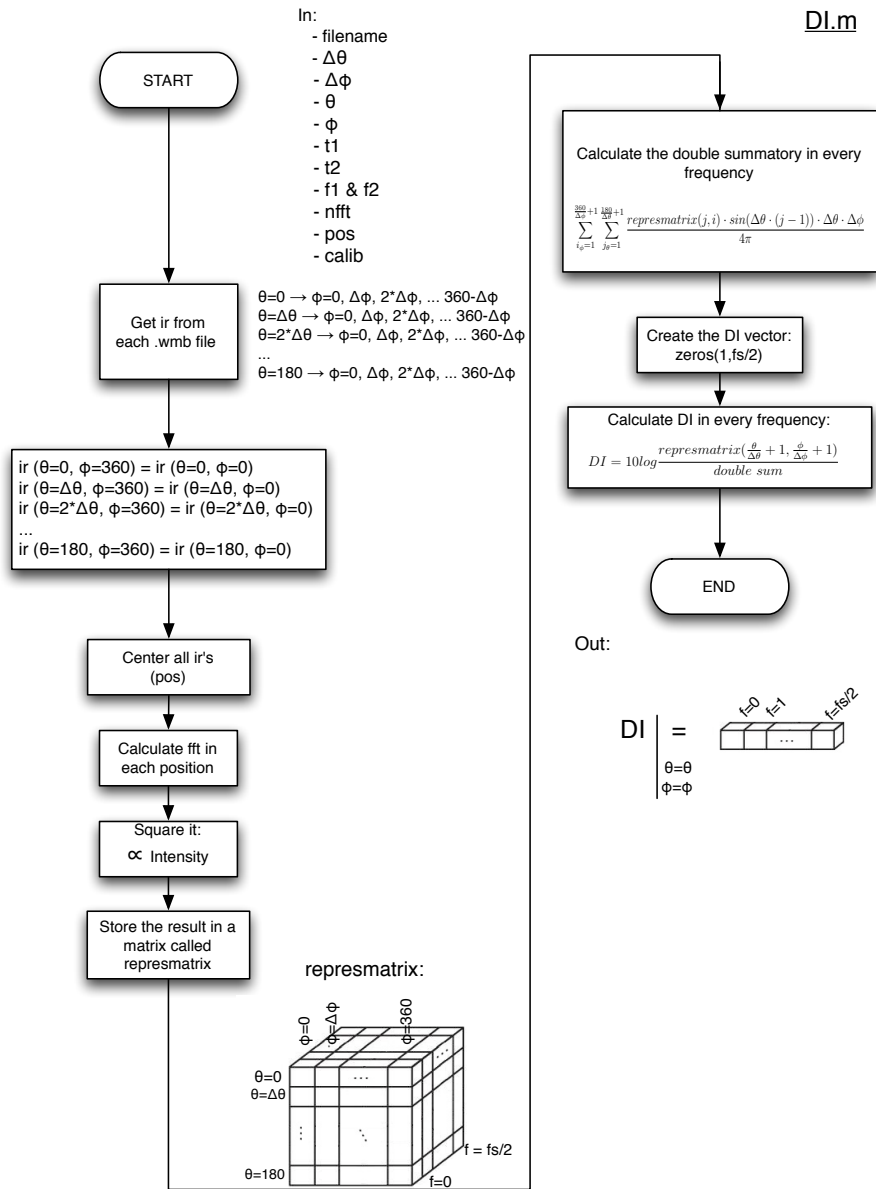

Figure F.5: Flow diagram of DI.m.



# Bibliography

- [1] Basilio Pueo y Miguel Romá, *Electroacústica, Altavoces y Micrófonos*, Pearson Prentice Hall, 2003. Referenced in page: 5, 6, 7, 8, 18
- [2] Siegfried Linkwitz, *Accurate Reproduction and Recording of Auditory Scenes*, <http://www.linkwitzlab.com> (available in december 2009). Referenced in page: 1
- [3] Leo L. Beranek, *Acoustics*, American Institute of Physics, Inc, 1954.
- [4] Josef Merhaut, *Theory of Electroacoustics*, McFraw-Hill, 1981.
- [5] Floyd E. Toole, “Loudspeakers and Rooms for Sound Reproduction. A Scientific Review”, *J. Audio Eng. Soc.*, Vol. 54, No. 6, pp.451–476 (2006). Referenced in page: 1, 10
- [6] Floyd E. Toole, *Sound Reproduction, Loudspeakers and Rooms*, Focal Press, 2008. Referenced in page: 4, 8
- [7] G. R. Jones and others, *Acoustics* The English Universities Press LTD, 1967. Referenced in page: 4
- [8] Siegfried Linkwitz, *Accurate performance of a stereo sound system*, <http://www.linkwitzlab.com/accurate%20stereo%20performance.htm> (available in may 2010). Referenced in page: 2
- [9] David Moulton, “The Use of an Acoustic Lens to Control the High Frequency Dispersion of Conventional Soft Dome Radiators”, presented at the American Loudspeaker Manufacturers Association Symposium, Las Vegas, NV (1998). Referenced in page: 6, 13
- [10] Sybil P. Parker, *McGraw-Hill dictionary of scientific and technical terms*, McGraw-Hill, c1994 5th ed. Referenced in page: 5
- [11] Accucal Comapany, *Topics in Room Acoustics*, <http://accucalhd.com/documents/audio/Acoustics%20Short%20Course.pdf> (available in may 2010). Referenced in page: 7
- [12] Siegfried Linkwitz, *Pluto specs*, <http://www.linkwitzlab.com/Pluto/specs.htm> (available october 2009). Referenced in page: 11, 12, 62
- [13] Diego Ivars, *Specialization Course Project Acoustics Department*, NTNU (2009). Referenced in page: 2, 13, 14, 19, 69
- [14] Aurasound, *Transducer specs*, <https://www.madisound.com> (available december 2009). Referenced in page: 18

- [15] Elliot Sound Products, *Phase, Time and Distortion in Loudspeakers*, <http://sound.westhost.com/> (available may 2010). Referenced in page: 21
- [16] Mark S. Ureda, “On the Movement of a Horns Acoustic Center”, presented at the 106th Convention of the Audio Engineering Society (1999), preprint 4986. Referenced in page: 21
- [17] Moulton D, “On the Significance of Early High–Frequency Reflections from Loudspeakers in Listening Rooms”, presented at the 99th Convention of the Audio Engineering Society, preprint 4094 (1995).
- [18] Richard C. Heyser, “Determination of Loudspeaker Signal Arrival Times”, *J. Audio Eng. Soc.*, vol. 19, pp. 734-743 (1971).
- [19] George L. Augspurger, “More Accurate Calculation of the Room Constant”, *J. Audio Eng. Soc.*, vol. 23, pp. 381-385 (1975).
- [20] Heinrich Kuttruff, *Room acoustics*, Taylor & Francis Group, 1973. Referenced in page: 24
- [21] Stereophile magazine, *Measuring Loudspeakers* <http://www.stereophile.com/features/103/index6.html> (available may 2010). Referenced in page: 23
- [22] David Moulton, Sausalito Audio, *The Subjective Qualities of Wide-Dispersion Acoustic Lens Technology Loudspeakers*, [http://www.sausalitoaudio.com/pdf/SAU\\_ALT\\_Subj\\_Qualities\\_WPaper\\_R1.pdf](http://www.sausalitoaudio.com/pdf/SAU_ALT_Subj_Qualities_WPaper_R1.pdf) (available in december 2009).
- [23] Manny LaCarrubba, Sausalito Audio, “Making Loudspeakers And Control Rooms That Make Music “Sound Good” ”, Mix Magazine, November 1999.
- [24] Beat Stamm, *Off-Axis Response (Crossovers, Beaming, and Lobing Errors)*, <http://www.beatstamm.com/> (available in december 2009).
- [25] Beyma Loudspeakers, *Curso: El Altavoz electrodinámico*, [http://profesional.beyma.com/download/Apuntes\\_del\\_Altavoz.pdf](http://profesional.beyma.com/download/Apuntes_del_Altavoz.pdf) (available in december 2009).
- [26] James. A. S. Angus & Michael J. Evans, “Loudspeaker Polar Pattern Measurement and Representation with Surface Spherical Harmonics”, presented at the 104th Convention of the Audio Engineering Society, preprint 4717 (1998).
- [27] John Vanderkooy, “The Acoustic Center: A New Concept for Loudspeakers at Low Frequencies”, presented at the 121st Convention of the Audio Engineering Society, Convention Paper 6912 (2006).

- [28] Moulton Laboratories, *Panoramic Power Response: A Fresh Approach To Loudspeaker Dispersion and Control Room Design*, <http://www.moultonlabs.com/> (available in december 2009).
- [29] Moulton Laboratories, *A new loudspeaker design: a case study of an effort to more fully integrate the loudspeaker into the playback room in a musical way*, [http://www.moultonlabs.com/images/pdfs/new\\_loudspeaker\\_design.pdf](http://www.moultonlabs.com/images/pdfs/new_loudspeaker_design.pdf) (available in december 2009).
- [30] The Audio Critic, *Bang & Olufsen BeoLab 5*, <http://theaudiocritic.com/plog/index.php?op=ViewArticle&articleId=34&blogId=1> (available in december 2009).
- [31] Egidijus Jakulis, *Ribbon Wavefront Patterns*, <http://phy6.net/audio/papers/> (available in december 2009).
- [32] Nacsound, *Catalog 2007*, [http://www.nacsound.it/download/catalogo\\_2007.pdf](http://www.nacsound.it/download/catalogo_2007.pdf) (available in december 2009).
- [33] Bang & Olufsen, *BeoLab 5 Specifications*, [http://www.bang-olufsen.com/graphics/bogo/media/LOUDSPEAKERS/BeoLab5/BeoLab\\_5\\_Technology.pdf](http://www.bang-olufsen.com/graphics/bogo/media/LOUDSPEAKERS/BeoLab5/BeoLab_5_Technology.pdf) (available in december 2009).
- [34] Nacsound, *Description of the products*, <http://www.nacsound.it/eng/indexeng.html> (available in december 2009).  
Referenced in page: 14
- [35] Mirage, *Description of the products*, <http://www.nacsound.it/eng/indexeng.html> (available in december 2009).  
Referenced in page: 15





