



**NTNU – Trondheim**  
Norwegian University of  
Science and Technology

Challenges of the future Danish energy scenario with 50 % wind integration and how electric vehicles adaptive charging can help to mitigate.

**Adrian Sanchez Garcia**

Wind Energy

Submission date: July 2015

Supervisor: Elisabetta Tedeschi, ELKRAFT

Co-supervisor: Pavol Bauer, Delft University of Technology  
Peter Bach Andersen, Danmarks Tekniske Universitet  
Henk Polinder, Delft University of Technology

Norwegian University of Science and Technology  
Department of Electric Power Engineering



**Challenges of the future Danish energy  
scenario with 50% wind integration and  
how electric vehicles adaptive charging  
can help to mitigate**

July 28, 2015

Denmark aims for a 50% wind integration in 2020. In the current scenario, where wind represents around 34% of domestic consumption, mothballing of conventional power plants and heavy dependency in interconnection lines is already the trend. One of the strategies from the Transmission System Operator is to integrate a big volume of flexible loads to adapt to wind production and mitigate some of its draw backs. EVs, even when a significant increase is expected in the following years, will not represent a volume of consumption that can really impact the load curve by 2020 and this type of response will rely in the short term in other flexible loads like Heat Pumps.

Due to its configuration and advanced technology, EVs can participate to other services vital to the correct operation of the Electric Power System as it is provision of frequency reserves to maintain balance between consumption and generation.

This work presents a solution using the adaptive charging capabilities of an EV to get the best respond in both the day-ahead market and the regulation market. The adaptive scheme will achieve: lower price for purchased electricity in the day-ahead market, with higher levels of wind energy penetration, and the possibility to participate to the frequency regulation market and get revenues. All this features are gained without affecting the normal operation of the vehicle. Two different configurations for the battery of the EV are compared in this work: unidirectional and bidirectional.

A fleet of 400 EVs have been modeled based on statistical survey data for EVs users driving profiles in weekdays and weekends. This fleet is managed by the figure of an aggregator who purchases electricity in the day-ahead market and bid on the frequency regulation market. The reference charging profile is a non-controlled consumption scheme of plug-and-charge. This reference model is compared first with a basic adaptive models based on weight coefficients varying according to the State of Charge of the battery and the level of wind penetration. Later on, the adaptive model is optimized, following the same indicators, seeking to maximize wind penetration while bidding to frequency regulation market the most number of times. The optimization algorithms used are Gradient Search, Genetic and Differential Evolution. The decision factor for the adaptive charging strategies is the forecast wind penetration signal with is the coefficient between the level of forecast wind production and the level of forecast consumption. The idea behind using this signal is that it will yield typically lower cost of electricity and high net wind penetration. Allowing high net wind penetration will reduce the presence of energy from other generation facilities and thus the  $CO_2$  content in the battery charge.

Results show that the owner of an EV with bi-directional capabilities and Genetic Algorithm can reduce the final expenses on the EV by 20% in one year. If GSA is used instead, 36% more wind energy will be integrated in the vehicle. In addition, because currently upward regulation is provided by coal and gas fired units, 60% of the current emissions by providing this service could be cut with a GSA charging scheme.





# Contents

<b>1</b>	<b>Introduction</b>	<b>1</b>
1.1	The transition of the danish energy system	2
1.2	Introduction to Wind Energy in Denmark	2
1.3	Introduction to Electric Vehicles	3
<b>2</b>	<b>Background</b>	<b>5</b>
2.1	System Operation	5
2.1.1	Stakeholders	6
2.1.2	The Aggregator	7
2.1.3	Regulation capability	7
2.1.3.1	How reserves are currently allocated in DK1	9
2.1.3.2	Energinet.dk's strategy for individual ancillary services	10
2.2	Wind Energy in Denmark	11
2.2.1	Wind Energy and prices	12
2.2.2	Wind Energy and Exports	13
2.2.3	Wind Energy and CO2	15
2.3	Evolution of Denmark's consumption: Flexible loads	16
2.3.1	Electric Vehicles	16
2.3.2	Heat Pumps	19
2.4	EVs for provision of regulating reserves: Conclusions	19
2.5	Problem statement	21
2.6	Project Objective, Research Questions and Approach	21
2.7	Thesis Outline	22
<b>3</b>	<b>Simulation Setup</b>	<b>25</b>
3.1	Electric Vehicles Modeling	25
3.1.1	Variables definition	25
3.1.2	Fleet of Electric Vehicles profile	26
3.1.3	The aggregator (Cluster of EVs)	29
3.2	Market Operation: Real Time constraints	30
3.3	Provision of Ancillary Services	31
3.4	Charging Schemes	34
3.4.1	Non-controlled charging	35
3.4.2	Basic Adaptive Charging	36
3.4.3	Optimal Adaptive Charging	37

3.4.3.1	Optimization algorithms . . . . .	39
3.4.3.2	Constraints vs Penalties . . . . .	41
<b>4</b>	<b>Simulation Results . . . . .</b>	<b>47</b>
4.1	Non controlled Scheme . . . . .	48
4.2	Adaptive schemes . . . . .	49
4.2.1	Basic adaptive charging . . . . .	49
4.2.2	Optimized results . . . . .	50
4.3	Comparison of results . . . . .	52
4.3.1	Week long results . . . . .	52
4.3.2	Year long results . . . . .	54
4.4	Economic Impact . . . . .	56
4.4.1	Savings: Purchase of Electricity . . . . .	56
4.4.1.1	Price of electricity . . . . .	59
4.4.1.2	Costs relative to consumption of electricity . . . . .	60
4.4.2	Earnings: Participating to Regulating Market . . . . .	61
4.4.3	Final Cost . . . . .	64
4.5	Socioeconomic Impact . . . . .	65
4.5.1	Net wind energy penetration . . . . .	65
4.5.2	$CO^2$ Reduction . . . . .	66
<b>5</b>	<b>Conclusions and future work . . . . .</b>	<b>71</b>
<b>A</b>	<b>Energy Content in Ancillary Services . . . . .</b>	<b>73</b>
A.1	The Energy Market . . . . .	74
A.1.1	Day-Ahead Market . . . . .	74
A.1.2	Intra-Day . . . . .	75
A.1.3	Regulation market . . . . .	75
A.2	Regulation Capability Response . . . . .	75
A.3	Interconnections to neighboring countries . . . . .	78
A.4	Reserves: Regulating and balancing . . . . .	81
A.4.1	Balancing reserves . . . . .	81
A.4.2	Regulating reserves . . . . .	82
A.5	The Nikola Project . . . . .	83
<b>B</b>	<b>Matlab Script . . . . .</b>	<b>85</b>
	<b>Bibliography . . . . .</b>	<b>91</b>

# List of Tables

2.2.1 Comparison of capacity level in DK1 and DK2. Values at the end of the year. . . . .	12
2.2.2 List of future wind farms to be built in Denmark. [23] . . . . .	12
2.1.1 Table summarizing Ancillary Services to be provided in Denmark . .	23
2.3.1 Distribution of electricity consumption in GWh. Source [16] . . . . .	24
3.3.1 Regulating power to be made available per EV depending on battery capability (Bid refers to each individual EV) . . . . .	31
3.3.2 Percentile 20th for Upward Regulation and 80th for Downward . . .	33
3.3.3 Percentile 50th for Upward Regulation and Downward Regulation .	33
4.3.1 Adaptive charging schemes using unidirectional capability for a week with high wind penetration . . . . .	53
4.3.2 Whole year performance for an adaptive scheme using different optimization algorithms and unidirectional capability . . . . .	55
4.3.3 Whole year performance for an adaptive scheme using different optimization algorithms and bidirectional capability . . . . .	55
4.4.1 electricity bill . . . . .	58
4.4.2 Average price of electricity for a whole year for the fleet of EVs if unidirectional capability . . . . .	60
4.4.3 Costs applied to the energy consumed . . . . .	60
A.3.1 Transmission capacity between Denmark and neighboring countries .	78

## List of Abbreviations

<b>Abbreviation</b>	<b>Meaning</b>
BRP	Balance Responsible Party
DE	Differential Evolution
DK1	West Denmark area
DK2	East Denmark area
EPS	Electric Power System
EV	Electric Vehicle
EVSE	Electric Vehicle Supply Equipment
GA	Genetic Algorithm
GSA	Gradient Search Algorithm
HVDC	High Voltage Direct Current
SOC	State of Charge
TSO	Transmission System Operator
V2G	Vehicle to grid

# Chapter 1

## Introduction

Energy is one of the key elements for any country growth and future prosperity but also international authorities have the task to find solutions to mitigate the global warming. A key question for energy planners in grown countries is whether today's investments in energy infrastructure should be based on traditional fossil fuels or on the emerging renewable energies.

The traditional fossil fuel oriented approach may still be cost-efficient in the shorter run compared to some of the more costly renewable energy sources but is clearly unsustainable in the longer run. The alternative and more sustainable approach is that of energy efficiency and renewables. Introducing larger shares of wind power into the grid is a great opportunity as it can improve energy security through diversification of the energy mix and through decentralisation and geographic scattering of power generators but naturally it also poses challenges.

In the case of Denmark, moving down to a single day, the 21th of December 2014, wind covered an impressive 102 % of the energy demand (surplus energy had to be exported to neighboring countries). A different day the same year, March 11th, only an average of 9 MW wind power was generated out of the installed capacity of 4900 MW.

How can a transmission System Operator deal with this situation and move from stable but polluting and outsourcing dependent traditional units to the unpredictable but local wind? The danish government has elaborated a series of tool kits focus on key aspects and challenges with regards to increasing the amount of wind energy. System operation and the power market represent the two central pillars on which the successful Danish integration of wind power has been build:

- System operation with accurate wind forecasts and adequate reserve capacity for periods with little wind and a demand side response that automatically adapts in situations where there is too little or excess production from wind power.

- A well-functioning power market – in which players can adapt to changes in forecast production and consumption (intra day market) and a global market for balancing power (the regulating power market) that allows shared reserves between larger areas.

## 1.1 The transition of the danish energy system

The power system has traditionally been based on a limited number of large thermal power stations. Before 1990 most of the electricity was delivered from few large scale power plants. As a result of a consecutive policy, pursuing higher efficiency through increased cogeneration of power and heat (CPH) and deployment of wind power, an increasing share of demand is met by small scale CHP and wind. In particular during the 1990s huge investments took place in these new technologies leading to a much more decentralised production and an increase in the number of producing units.

Along the last years of the 20th century wind quadruplicate its installed capacity initiating an unstoppable development of the wind energy sector in Denmark that will change the whole energy scenario. One of the consequences is that the electricity sector has much more electricity capacity than demand so that small scale CHP plants, which had a remarkable share in production for the past years, will be mostly mothballed or fully dedicated to District Heating provision as they cannot find it economical to keep producing electricity. Central power stations though some of them will be mothballed, are expected to turn into biofuel in the period up to 2035. They will still have a presence in the next years as they are among the only contributors to system stability and capable of restoring the system after a black out.

To understand the other particularity of the danish energy sector is worth looking at figure 1.1.1. It shows the historical of the electricity consumption for the years 1990 to 2013 and a development of the consumption until 2023. Due to the close relation of the danish and Norwegian market, there are some peaks in production in 1996, 2003 and 2006 due to dry years with low reservoirs in Norway and high prices in electricity. The opposite is seen in years like 2000 and 2012 where high imports were seen. This explains clearly how Denmark and Norway relies on each other and how their energy development is closely interrelated.

## 1.2 Introduction to Wind Energy in Denmark

In the late 1970's the first batch-produced Danish wind turbines were produced with an output of 22 kW. They were gradually scaled up to 55, 75 and 95 kW through the course of the 1980s. Alongside this commercial production, a government-funded development programme was undertaken by the electricity companies to test considerably larger pilot wind turbines. Since the 1980s, the wind turbine industry's commercial products have become increasingly larger-scale to arrive at the new

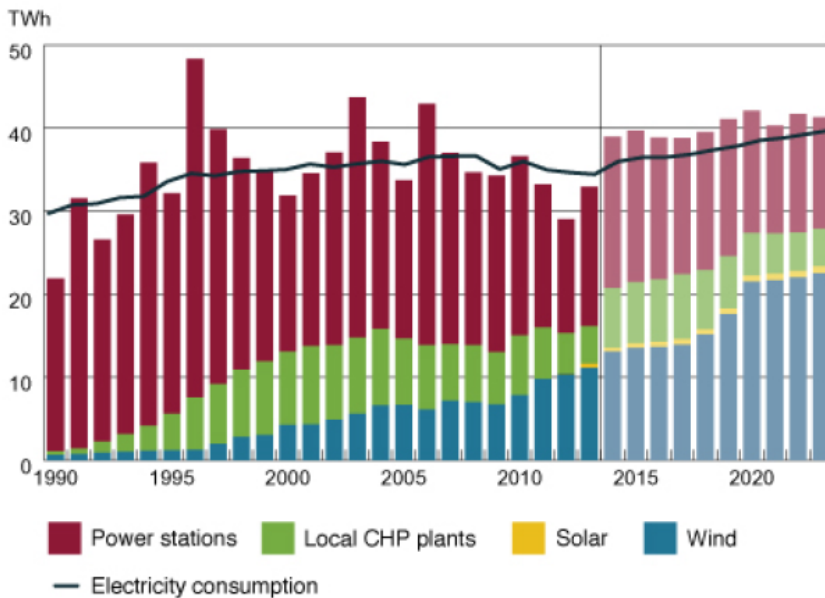

Figure 1.1.1: Evolution of the electricity production sector in Denmark [12]

models of 8 MW from Vestas (V164 - 8.0). In 1991 Denmark became the first country in the world to take wind turbines out to sea with 11 x 450 kW turbines in the Vindeby offshore wind farm and the aim for 2020 is to achieve 2,7 GW of installed offshore wind power. In the offshore industry, a total of 90% of the world's turbines are either Danish produced or have Danish developed foundations and components.

Strong public involvement, together with excellent wind conditions and a strong political support that lay down the pavement for secure investments, serve the path for an impressive development of the sector. With the years, this situation has been followed up to place Denmark as the country with the largest share of wind energy in the world.

### 1.3 Introduction to Electric Vehicles

The first EV was seen on the road shortly after the invention of rechargeable lead-acid batteries and electric motors in the late 1800s [10]. In the early years of 1900s, there was a golden period of EVs. At that time, the number of EVs was almost double that of gasoline power cars.

Limitations of heavy weight, short trip range, long charging time and poor durability of batteries at that time almost make EVs to disappear. Decline started



with improved road infrastructure requiring a greater range than that offered by electric cars, and the discovery of large reserves of petroleum in Texas, Oklahoma, and California led to the wide availability of affordable gasoline, making gas-powered cars cheaper to operate over long distance. Finally, the initiation of mass production of gasoline-powered vehicles by Henry Ford reduced significantly the cost of gasoline cars compared to electric ones.

In the last decade this situation is experimenting a change. Environmental impact of the petroleum-based transportation infrastructure and the peak on oil prices has made authorities aware of the necessity to change the model. In addition to that, utilities have seen the beneficial effect that such infrastructure will have in the operation of the Electric Power System and they are pushing the market of electrification of road transportation along with car manufactures.

Many projects financed by different independent institutions and public organizations are trying to assess those benefits from Electric Vehicles. This present work is encompassed in the Nikola project (A.5) which looks actively at synergies between the electric vehicles and the power system. Close collaboration is made with WP1 seeking the integration fo more wind energy and with WP3 to define baselines for using and charging patterns.

# Chapter 2

## Background

This chapter analyses the current and future electricity generation scenario in Denmark and how it has changed due to wind energy development, taking Western part as its main focus mainly because it has a bigger share in this resource than Eastern part. Special attention is made in analyzing the impacts of wind produced energy over energy prices, exports and CO<sub>2</sub> exports. The strategies from the local TSO towards present and future provision of regulating reserves is described in detail and for an end the technical capabilities from EVs are studied to arrive at a formulation of possible synergies between EVs and Wind Energy.

### 2.1 System Operation

System operation is a term that refers to all the activities for operating electric power systems, including security, control and quality of supply. A well functioning electric power system relies on the fact that at every instant energy production and consumption are matched. The modern electric power systems extend over large geographical areas and normally involve more than one country as in the case of Europe (figure 2.1.1). All Europe's electric systems works on the same frequency (50 Hz) but on different synchronism.

There are five different synchronous areas in Europe and Denmark is the only country with the particularity to belong to two of them. Western Denmark belongs to the UCTE Continental Europe system and is synchronously connected to it through AC connections with Germany and Eastern Denmark is connected to the Nordic system via AC connectors to Norway and Sweden. Between these two regions, energy flow is allowed with a HVDC connection.

The European Authority Entso-e (European Network of transmission system operators for electricity) coordinates the legal framework to allow interoperability but it is each countries TSO that must grant the correct operation. Traditionally Power systems have relied on large central power plants, fired mostly by fossil fuels,

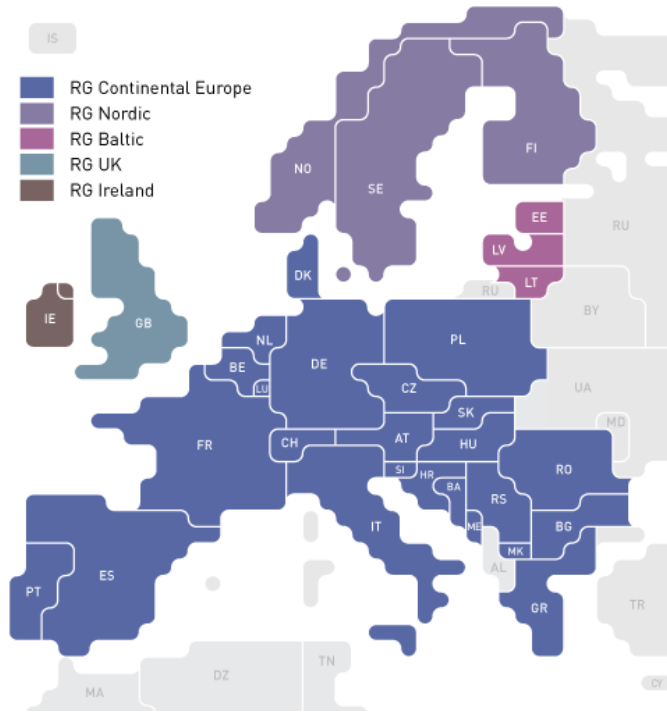

Figure 2.1.1: Different synchronous areas in Europe

that can maintain a constant power output and that have a huge inertia in the event of sudden power deviations. The even larger share of renewable and generally non-dispatchable generation units is threatening the normal operation.

The unpredictability of wind power makes it necessary to have the capability to regulate both up and down so as to accommodate deviations in wind power forecasts. In addition, there must be both appropriate access to reserves for voltage and frequency regulation and automatic and manual reserves. Also, a very well developed interconnection to neighbouring countries guarantee the trading of excess of production and buying at a more competitive price in the region.

### 2.1.1 Stakeholders

Below is an overall presentation of the relevant stakeholders in the Danish case on integration of wind power into the grid.

- **Transmission System Operator:** In Denmark, Energinet.dk is responsible for the Power System. Some of its responsibilities are to ensure that the physical balance in the power system is maintained and to develop the rules that articulate the well-functioning of the power market.

- Balance Responsible Parties: They are responsible of any Production, consumption or trade activity. They must enter an agreement with the TSO to assume responsibility for the specific activities. Upon entering the agreement they are financially responsible for the imbalances they may incur.
- Power Suppliers: Concludes contracts for the supply of power with the end users. They buy power at a power exchange, a power producer or another supplier.
- Grid companies: Responsible for operating the distribution network.
- The Producer: Produces power and sells it to a power supplier or to Nord Pool. They can participate to the regulating power market.
- Consumers: They consume power bought from the power supplier. They can also participate to the regulating power market.
- Nord Pool: It is the power exchange owned by Energinet.dk and other Nordic TSOs. It is divided in two markets for electricity trading: Elspot and Elbas.

This work takes into account the figure of the balance responsible party, the Transmission System Operator, the producer and the consumer.

### 2.1.2 The Aggregator

Provision of frequency regulation reserves is in the order of hundreds of kW to MW blocks and to purchase electricity in the day-ahead market, a simple consumer cannot purchase his own electricity. The aggregator in this work appears to Nord Pool as a power supplier and to the TSO as a BRP with a large battery storage with regulation capabilities [33] [26]. Figure 2.1.2 position the aggregator in the control flow scheme in between the EV user and the TSO.

In this work, the role of modeling the charging scheme of the electric vehicles to grant the best price of electricity and revenues from participating to frequency regulation is carried by the aggregator. He will manage information about the SOC of the battery, penetration forecast from the TSO and EVs availability to provide the best solution. It is assumed that the necessary system architecture between users, grid operators, utilities and governmental organizations exists [26]. In the event when V2G technology allows it and energy flows out of the battery to the grid the same principle as of a Virtual Power Plant [8] applies.

### 2.1.3 Regulation capability

When an extra load is connected to the power system or a sudden change in the level of production occurs an imbalance takes place. This imbalance translates in a frequency drop (or rise), the rate of which depends on the total angular momentum (rolling inertia) in the system which is mostly dependent in conventional production

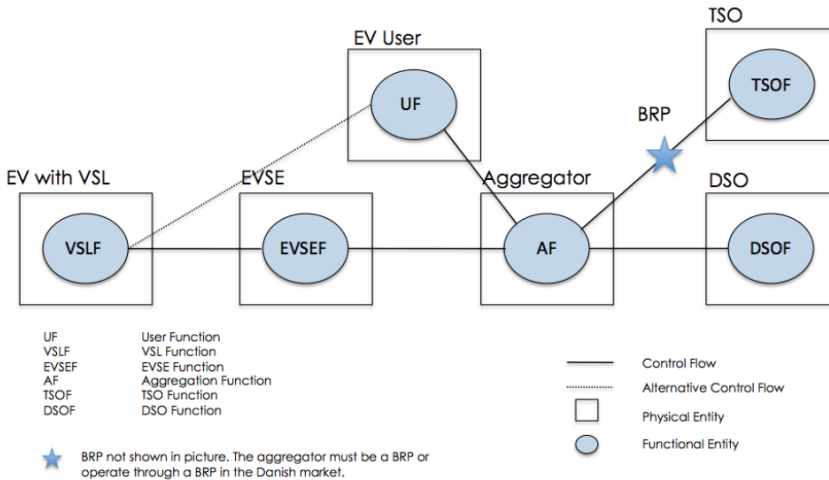

Figure 2.1.2: Functional Control Flow [9].

units. Regulation capability is the control mechanism that reacts to frequency changes (load changes) to stabilize the grid back (A.2).

Energinet.dk as the Transmission System Operator, must guarantee the stability of the electric power system at all times and that the imbalances do not affect the normal operation of the power system. For doing so, a series of rules defined under the umbrella "Ancillary Services" are designed so at all times production and consumption are matched in real-time, even when unexpected events may happen. This series of Services are described in [13] for the case of Denmark and following there is a description of their main characteristics:

- **Balancing reserves:** Intended to keep the balance between production and consumption in the event of a frequency deviation, stabilizing the frequency at close to but deviating from 50 Hz. It can be upward or downward so both consumption or production units can deliver this service in an automatic manner and which response is proportional to the deviation value. It is considered to be a zero-energy service.
- **Regulating reserves:** These reserves are used for regulating the frequency following substantial frequency drops resulting from the outage of major generation plants or lines.
- **Manual Reserves - DK1 & DK2:** Manual reserve is a manual upward and downward regulation reserve which is activated by Energinet.dk's Control Centre. It is activated by manually ordering upward and downward regulation by the relevant suppliers and relieves the LFC and the frequency-controlled normal operation reserve in the event of minor imbalances and ensures balance in the event of outages or restrictions affecting production plants and international connections.

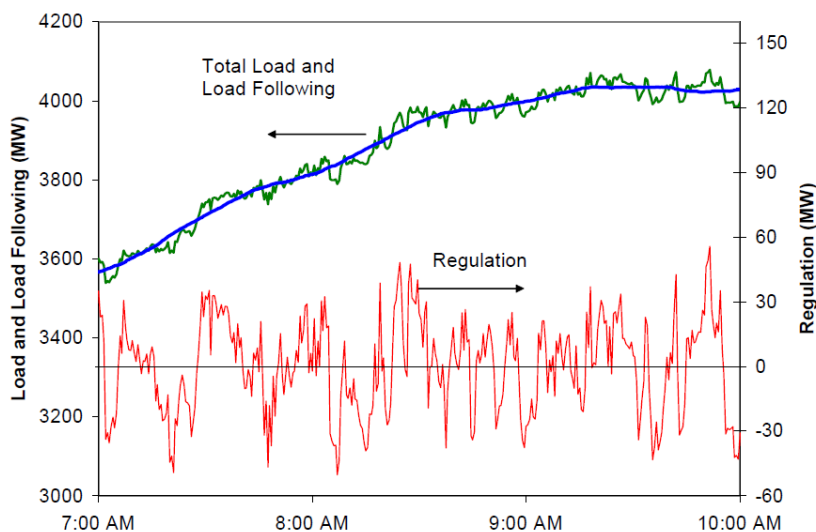

Figure 2.1.3: Representation of regulating reserves (red) response to imbalances between load (green) and production(blue)

As explained before, Denmark has the particularity of being divided into two separate synchronous areas connected by the Great Belt HVDC cable. This cable provides stability and market coupling. The West part (Jylland and Fyn) is connected to continental Europe and the East part (Sjælland) is connected to the Nordic regions. Table 2.1.1 summarizes the main characteristics of the different Ancillary Services to be provided in Denmark. For a more detail explanation see Appendix A.4

#### 2.1.3.1 How reserves are currently allocated in DK1

This section includes actual information referring to Ancillary Services in DK1 [31].

- Primary reserve: Primary reserves is a mixture of coal and gas fired units for up regulation and electrical boilers, covering 100%, for the down regulation. This is so because the boilers can offer the service at almost no cost. They are able to deliver the response at 0,3% of full load and thereby minimize the standby cost involved.
- Secondary reserve: Delivered from coal fired stations only.
- Regulating power: There are no exact figures but there is no doubt that CHP units on natural gas are the main providers. Nevertheless, when spot prices are very low, there is a significant contribution from electrical boilers and wind power.

### 2.1.3.2 Energinet.dk's strategy for individual ancillary services

All the information is extracted from [14] which is close to obsolescence and is intended to be reviewed in the present year. Nevertheless, until the date no further document has been release. An amendment of the initial document [15] was released in 2013 and is taken into consideration in this work.

At present, efforts are continuously being made to involve alternative suppliers of ancillary services, eg wind turbines and consumption units. Energinet.dk is supporting a number of research, development and demonstration projects through the ForskEL programme, like the Nikola project.

The overall objectives from Energinet.dk are as follow:

1. Achieving common market for frequency controlled reserves in synchronous areas.
2. Establishing larger markets for activating secondary reserves through cooperation with the German and Nordic TSOs. Share market with Svenska is already obtained but there are still negotiations going on with the German Market.
3. Ensuring broader product definitions in the regulating power market allowing larger available resources to participate. Energinet.dk strategy is for daily asymmetrical purchases and higher time resolution.
4. Developpe a regulating power market based on the same principle as the spot and intra-day markets.
5. Sharing manual reserves over larger geographical areas thus reducing the total amount of reserves in the system.

#### Frequency-controlled reserves

Currently, frequency controlled-reserves are blamed to be of low volumes and players point out that this is a barrier for an efficient market development. That is why Energinet.dk's objective is to have common markets across the synchronous areas.

In the future, requirement will continue to be dictated by international requirements in ENTSO-E, and is expected that demand will decline in the future:

- Primary reserve is been reduced since 1st January 2015 in  $\pm 10$  MW in connection with an agreement signed with Statnett with the establishment of the Skagerrak 4 interconnector to Norway.
- FDR demand in Eastern Denmark will decline if the reserve can be placed on the Great Belt Power Link. This might benefit players in West Denmark as it would bring new demand.

Secondary reserves

Energinet.dk has signed an agreement with Statnett for the delivery of +/- 100 MW of LFC with a matching 100 MW reservation which covers Western Denmark's LFC capacity requirements for a five-year period. Energinet.dk expects that it will also be possible for the 100 MW reservation on Skagerrak 4 to be used by Danish suppliers to deliver LFC capacity to Norway if a Nordic LFC is established, thus creating demand for such a product. Regarding the German market, the main barriers for Energinet.dk's are that Germany has different activation requirements and Energinet.dk does not want to change its activation time because it will exclude current players.

Manual Reserves and regulation power

In the future, and due to large amounts of wind power, larger imbalances are expected but Energinet.dk will not hold separate reserves for balancing wind power and he will not purchase more manual reserves as a result of the wind power expansion. The strategy is more flexible product definitions and specially how units with activation time of more than 15 minutes can participate.

## 2.2 Wind Energy in Denmark

Wind energy in Denmark has seen a stable growth for the last 30 years and in the last years it has been claiming the position of main energy producer to coal [12]. Next graph shows how the installed capacity has grown over the last years:

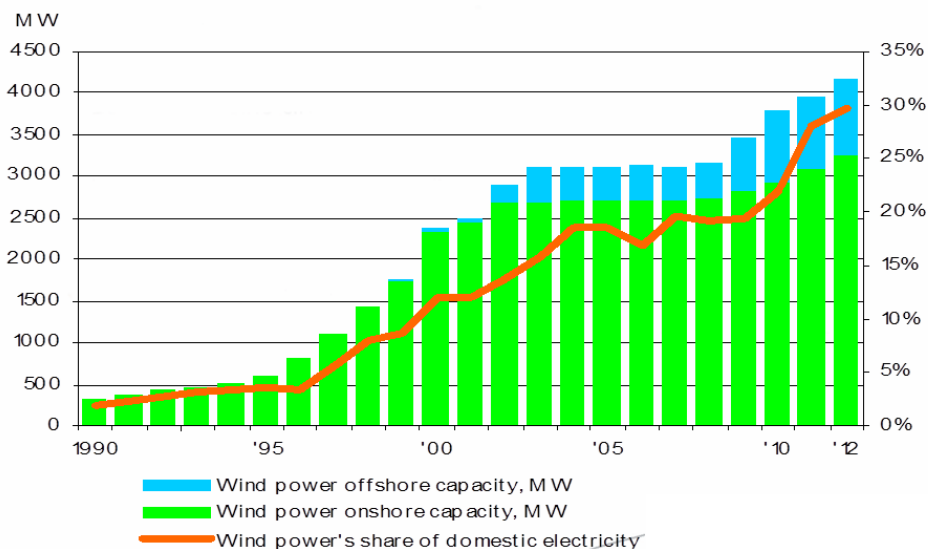

Figure 2.2.1: Wind Energy capacity and wind power's share of domestic electricity supply[3]



In table 2.2.1 the most recent numbers of installed capacity [2] are represented and the expected power for 2020.

	Capacity Installed (MW)			Power Production(GWh)		
	DK1	DK2	Total	DK1	DK2	Total
2014	3855	1032	4887	10346	2732	13 078
2020	4980	1857	6837	13773	5974	19757

Table 2.2.1: Comparison of capacity level in DK1 and DK2. Values at the end of the year.

With a load factor of 0.45 in off-shore installations, for 0,22 of on-shore ones [7], the 1,45 GW power that is planned to be installed will represent a 43% increase in energy output being able to get above the 50% wind penetration landmark for the danish territory by 2020. Efforts are being made towards more evenly distributed share of the wind capacity in the future offshore projects. Still, Western Denmark as of today has already reached 50% wind penetration on its territory and by 2020 the actual share will be approximately of 68% of local consumption. That is why this project will focus from now on in this area.

Wind Farm	Operational year	Capacity (MW)	Place	Area
Horns Rev III	2017	400	North Sea	DK1
Kriegers Flak	Before 2020	600	Baltic Sea	DK2
6 wind farms	Before 2020	450	Near Shore	DK1 and DK2 (50/50)
Experimental	Before 2020	50		
Repowering	Before 2020	500 <sup>(1)</sup>	onshore	DK1

Table 2.2.2: List of future wind farms to be built in Denmark. [23]

<sup>(1)</sup> *Scrapping 1300 MW and building 1800 MW of modern turbines. New wind turbines are technologically advanced and expected to have higher capacity factors.*

Some of the effects that wind energy has in the electric power system have been studied for DK1 are presented below:

### 2.2.1 Wind Energy and prices

The day-ahead market for electricity is by nature a very volatile market, special in cases of high wind penetration as in Denmark [25]. A significant level of wind penetration will drag prices down as it is explained in (figures 2.2.2 and 2.2.3).

Prices in the low demand hours (off-peak) that are selected when wind penetration is higher than 50% have a mean value of 187 DKK/MWh instead of 235 DKK/MWh.

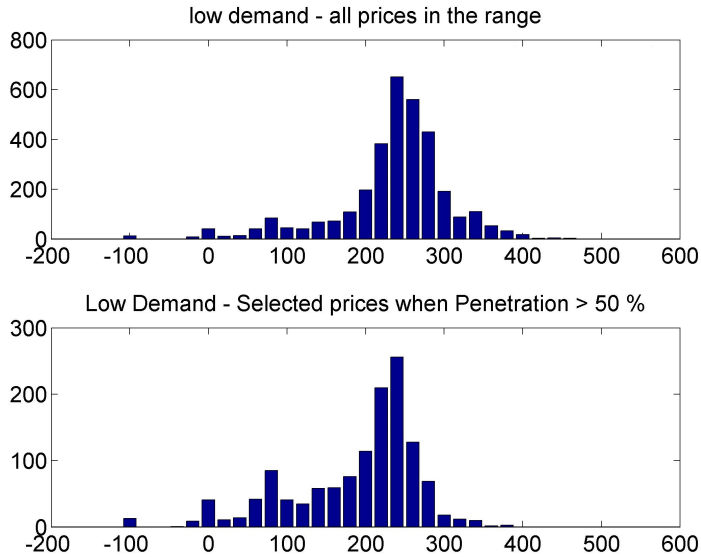

Figure 2.2.2: Distribution of prices for Low Demand hours.

For the hours of high demand, the same selection of prices when penetration is higher than 50% leads to a mean value reduction to 252 DKK/MWh instead of 328 DKK/MWh for the non-selected range and the dispersion of the values to 66. Aiming at purchasing electricity in this ranges will typically mean lower cost of electricity. This simple study is only an empirical study of what has been claimed in many other studies [24] [25]. It is out of the scope of this work trying to foresee future evolution of prices.

### 2.2.2 Wind Energy and Exports

Western Denmark is in a privilege position due to its geographical location and the large interconnection capacity it has developed with neighboring countries (see appendix A.3). The great power belt with Eastern Denmark is a grant for regulation reserve, the interconnection with Norway means provision of  $CO_2$  free hydro-power and an almost perfect sink for getting rid of surplus of energy, while the interconnection with Germany provides great stability with continental Europe frequency. A future connection to Holland will also facilitate a new market for the increase production of offshore wind from the Nordic sea.

This characteristics shape a flexible electric power system that can match production and consumption by means of trading energy. Figures 2.2.4 and 2.2.5 show local production and consumption in DK1 for two different weeks and the fact that local production rarely matches local consumption.

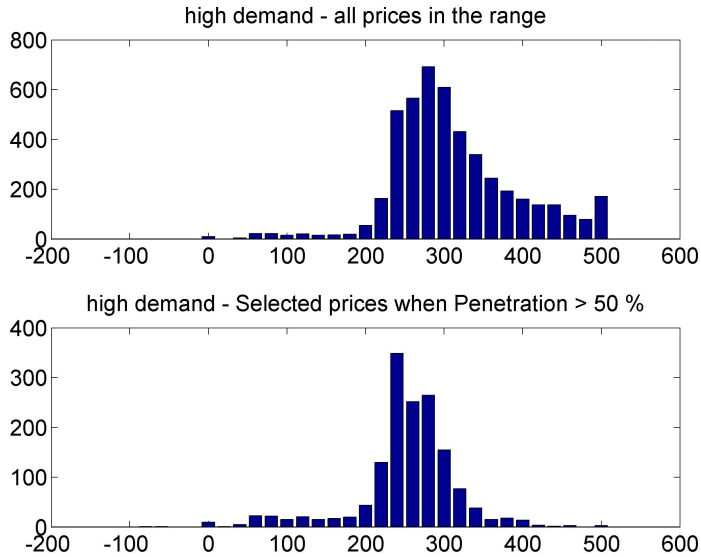

Figure 2.2.3: Distribution of prices for High Demand hours.

Exports are market driven mechanisms and since market is affected by wind energy hence are inter-area energy flows. What results is a big discussion trying to agree how much wind energy is actually consumed in Denmark. When scholars look into the topic there is big discrepancy analysing the driving factor. By analysing figures like 2.2.6, that compares wind production with Net exports (difference between all energy flow inside and outside DK1), that shows high correlation between wind energy production and exports, [4] claimed that Denmark had integrated wind by exporting most of the power generated.

In response, studies carried by the Coherent Energy and Environmental System Analysis published a detailed rebuttal [28] claiming that by the year 2008 Denmark exported less than 1% of its wind power generated if the merit order effect is included. In a separate study, [42] has found correlation between wind production and exports and wind production and central plant generation of the order of 0.6, but these correlations will also include the fact that variations in wind production has to be balanced by the means of interconnectors.

In the opinion of the author, there are evident signs that wind motivate exports but that does not mean that wind energy is not used in Denmark. These exports work almost in the same way as a storage system. If an infinite battery system was installed North of Jutland (Skagerrak) energy flow will be the same as we see today.

What seems clear is that having a set of flexible consumption units will reduce this virtual storage function of Norway and Sweden. Nevertheless, this will not be

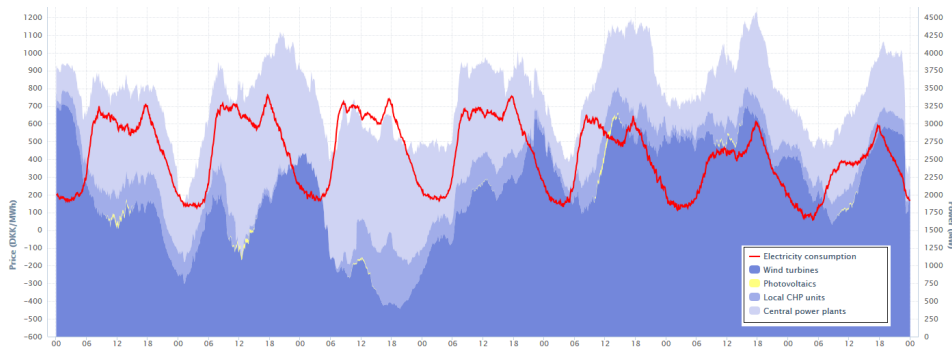

Figure 2.2.4: Production mix and consumption in DK1 in the week from December the 15th to the 21st

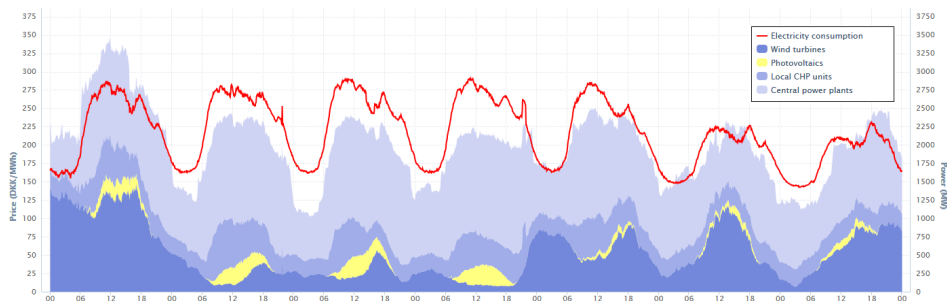

Figure 2.2.5: Production mix and consumption in DK1 in the week from August the 25th to the 31st

objective of this report, as it will be discussed in following sections, mainly because the situation considered is that of 2020 where the amount of EVs does not allow for a significant impact in energy.

### 2.2.3 Wind Energy and CO<sub>2</sub>

Higher wind install capacity does not necessarily mean lower  $CO_2$  emissions because wind is generally produced together with conventional sources and again depends on market mechanisms and EPS operation. 2013 saw an 8% increase in Net Power generation but since energy from coal fired units also increased by 35%, the resulting emissions of  $CO_2$  were 12% higher [12]. Energinet.dk offers an estimate of how much g/kWh are assigned to each type of production unit.

Central power stations are predominantly coal or natural gas powered, though increasingly more biomass is being used as a supplementary fuel. Decentralize power stations refers to CHP plants that are fired by natural gas but also some fired by waste and biomass fuels. For the countries, the emissions are calculated based on the most common type of generation. As it is specified in the document, the  $CO_2$

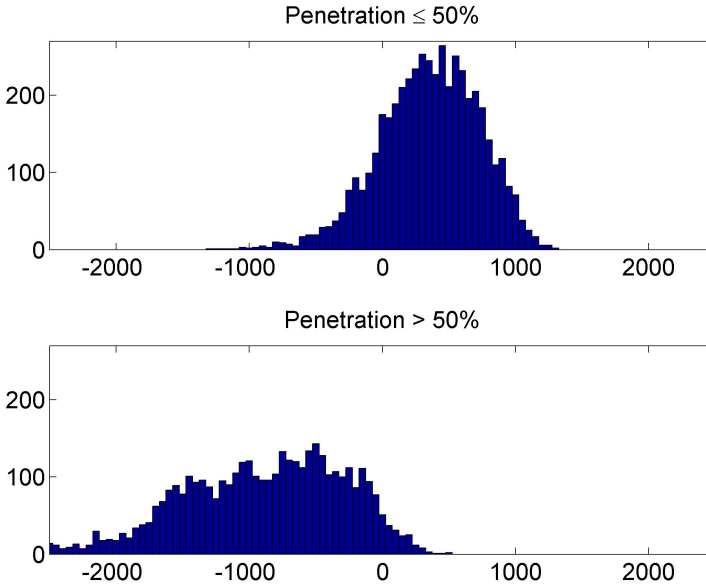

Figure 2.2.6: Net exports in West Denmark in 2014

emissions are calculated from the generation from each individual power plant as well as the average emissions from power generation type. The value represented for central power production is an annual average and generally is adjusted with the output of each power station.

## 2.3 Evolution of Denmark's consumption: Flexible loads

Energinet.dk has developed a set of assumptions that will be presented here. Electricity consumption has been divided into the classical consumption consider as non-elastic and flexible consumption whose largest contributors are heat pumps and electric vehicles.

Data about the projection of Danish electricity consumption is extracted from [16]. The general trend is an annual efficiency improvement in the sectors of 1,57% that will counteract the increase due to new loads in the system mainly EVs and Heat Pumps. The expected increase in consumption until 2020 is of 1,8%.

### 2.3.1 Electric Vehicles

Electric Vehicle is a term that generally refers to all vehicles for which an electric motor is the primary source of propulsion, including Plug-in hybrid electric vehicles,

Specifik CO <sub>2</sub> -emission	
Produktionstype	g/kWh
Centrale kraftværker	700
Decentrale kraftværker	300
Vindmøller	0
Sverige	40
Norge	0
Tyskland	500

Figure 2.2.7: Co2 emissions from different type of productions [1]

range-extended electric vehicles, battery electric vehicles or fuel cell electric vehicles. In this work the term EV will refer only to battery electric vehicles that have a private use and will have the same usage pattern as a conventional car but are powered by electricity and have a Lithium ion battery as storage system.

Due to their storage capacity and the fact that they are plug to the grid more time than they actually need to get fully charged, selecting the best time for doing such charge is becoming of major interest to users. Adaptive charging is the common term adopted to describe any method that controls when the car charges to pursue a defined purpose. In the last years and due to the remarkable increase of wind produced energy in Denmark, try to integrate as much as possible has been one of the preferred achievements together with finding times when electricity is cheaper. In [22] a simplistic option of delayed charging to start consuming at off-peak hours is evaluated and also a strategy that is market price based charging that requires a real time price signal to be send to the user. The work presented in [21] also uses optimization algorithms and works on the basis of a real-time price signal, while [44] assumes that the price is predicted. The present study is more aligned with the former as the price is kind of predicted by knowing the forecast penetration value.

Energy consumption by EVs in 2013 was of around 5 GWh for some 1400 units. For a expected consumption of 89 GWh by 2020 in DK1, around 23000 EVs are expected to be driven. This yearly consumption represents less than 1% of the estimated wind produced energy by 2020 which will not really impact the level of net wind penetration. Adaptive charging in this work will not pursue higher net wind penetration at a country level but instead net wind penetration as a share of the energy content in the battery of the EV.

The term "net" wind penetration, which represents the share of wind production within the whole generation mix against consumption, is introduced to be more specific than just simple penetration that is commonly used as a share of wind production versus local consumption.

## Converter topology

Most of the currently manufactured vehicles have a uni-directional power flow capability that only allows power to flow into the vehicle. The current architecture of an EV is rather simple. It has a converter that charges the interior battery of the EV from the external grid and an additional converter to provide the electrical motor with the convenient rate of current and voltage. The former only allows power flow into the vehicle, the latter, because the EVs want to use braking energy to regenerate the battery, allows reversible flow (figure 2.3.1).

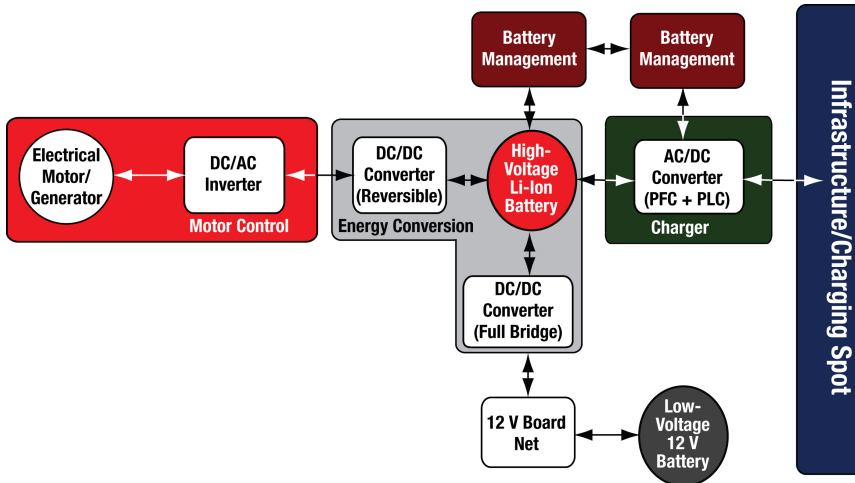

Figure 2.3.1: System architecture of an Electric Vehicle

In academia the term V2G is increasingly used to define a vehicle with Bi-directional power flow. Its advantages as a means of resolving imbalances between supply and demand are discussed in [26] [41]. Its topology allows it to act as a distributed energy resource capable of providing energy when required. It can be realized by installing a bi-directional power converter and allowing additional communication specifically for V2G operations (figure 2.3.2).

Digital communication devices are installed both on the vehicle and on the electric vehicle supply equipment (EVSE) so that the EVSE can receive commands from PJM Interconnection, the commands can be transferred from the EVSE to the vehicle, and the relevant signals can be sent from the vehicle to the EVSE. In [26] Kempton W. et al claims a bi-directional converter has the ability to contribute to stabilizing the power grid much more than a uni-directional converter for the following reasons:

- A bi-directional converter has twice the ability to adjust power flow between a vehicle and the power grid, that is, for a given power,  $p$ , uni-directional can be from 0 to  $+p$ , whereas bi-directional can be from  $-p$  to  $+p$ .

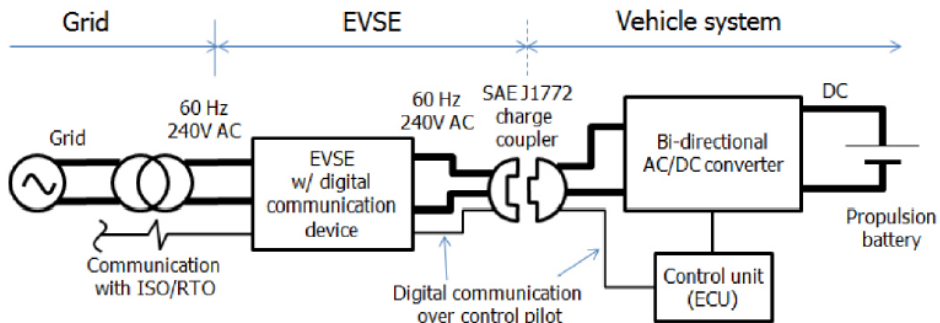

Figure 2.3.2: System architecture to allow V2G in an electric vehicle

- A bi-directional converter allows V2G operation for practically unlimited durations by repeating charging and discharging cycles, while a vehicle with a uni-directional converter stops charging once its battery is full.

Currently there are no incentives for the users or the industry to have a vehicle with bi-directional technology and most of the projects have been realized for experimental purposes.

### 2.3.2 Heat Pumps

They are, in the opinion of Energinet.dk's, the technology that may grow and contribute the most to wind energy integration. The assumption is that 32,000 heat pumps have an output of approx. 200 MW. In 2013 consumption from heat pumps were 126 GWh and is expected to get to 240 GWh by 2020. So a double up in the installed power of heat pumps can be expected. Therefore, 160.000 of heat pumps by 2020 with power output of 1000 MW (around 6,5 kW per unit). Large heat pumps installed for CHP could be of 125 MWh by 2020, which is not relevant as to compare with individual numbers.

#### Energinet.dk's Demonstration project: From Wind Power to Heat Pumps

Energinet.dk is looking for 300 house holds willing to replace old oil-fired boilers by new environmental friendly and intelligent heat pumps capable of storing electricity as heat. According to the text, 32.000 heat pumps have an output of approx 200 MW which means 6,25 kW of power consumption per heat pump. Currently there are around 80.000 heat pumps in Denmark.

## 2.4 EVs for provision of regulating reserves: Conclusions

Several projects have looked into the feasibility of Electric Vehicles to provide ancillary services. [32] shows the superior performance of V2G systems over con-



ventional regulation providers when acting on an islanded distribution network. In a more precise study for the case of Western Denmark and secondary regulation, [33] simulates the capability of a certain number of EVs to act as a single battery providing secondary regulation in DK1. The battery is designed using optimistic values of EV battery size motivated by top class vehicles. [34] also considers a fleet of 10% of vehicles in Denmark being electric driven which is an assumption far from what is considered here.

Into the revenues analysis from providing ancillary services, [27] introduces the economic benefits from participating to primary regulation based on prices paid to power made available and [45] look also into the secondary and tertiary regulation markets.

In a practical scenario, [39] S. Martineas et al. shows how the EV can provide fast frequency regulation for longer periods of time using a V2G enabled vehicle. [30] looked at the application of RF batteries in combination with wind power in two experiments, a first one supporting a 275 kW turbine to achieve constant output at a PCC and a second one backing up a 30.6 MW wind farm to smooth wind power fluctuations from seconds to minutes.

These mentioned experiments put together both the technical feasibility of EVs to participate to ancillary services and provide good support to large penetration of Wind Energy and the economic benefits that it will bring. Nevertheless, they all assume a penetration of EVs that is not realistic for 2020 according to the sources reviewed in this work. Considering also the previous background analysis and studies from the TSO, it is pretty certain that wind affects to a more extend long lasting manual reserves rather than automatic ones because of its nature of non-dispatchable producer and power variations over long periods of time. Nevertheless, this work will focus on the provision of primary reserves for two main reasons:

- It is the ancillary service product that currently fits the best the specifications of EVs as it has a low energy content but requires large amounts of power to be provided with fast response and during a short period.
- Data about frequency regulation is more easily reachable and frequency response can be simulated using a historic frequency signal. Secondary regulation reacts to LFC signals that are provided by the TSO and the prices and volumes are traded bilaterally between the players and the TSO. Tertiary reserve has an energy volume requirement that is far fetched from the amount of EVs expected by 2020.

From the literature review this present work becomes useful by using a dynamic approach that integrates in real time day-ahead and regulating market, using more realistic numbers of EVs and defining response from a small fleet of some hundreds of cars rather than macro response to a national level. Also, the usage of the penetration signal rather than requiring a real time market price has not been found in related works.

## 2.5 Problem statement

It is commonly stated that “In a system with well matched loads and strong inter-connections with neighbour grids there can be a range of 30–40% wind penetration, without compromising the reliability of the power system”[11]. Nevertheless, Denmark is aiming at a 50% wind penetration by 2020. Current consequences of the actual level of 32% wind integration are that moving down to a single day, the 21th of December 2014, wind covered an impressive 102 % of the energy demand (surplus energy had to be exported to neighboring countries). A different day the same year, March 11th, only an average of 9 MW wind power was generated out of the installed capacity of 4900 MW. Some figures showed that wind can vary as fast as to reduce output on 200 MW in 5 minutes. All this phenomena will turn down any power system in the world if not accurately predicted and controlled.

## 2.6 Project Objective, Research Questions and Approach

Aiming to simulate how the amount of electric vehicles expected for 2020 can contribute to a higher integration of wind energy and how they can participate to frequency regulation services and electricity market.

The objective of this project is to simulate how a fleet of electric vehicles managed by an aggregator organism could interact with the electricity market for provision of energy and participate to the regulating market to help stabilizing the grid while granting full time availability of the vehicle for the user without compromising its performance. There is a series of research questions that need to be answered:

- What is a suitable model to represent EVs in the future energy scenario and their contribution to frequency regulation?
- What is the economic impact that different adaptive charging schemes will have in the final cost of an EV compare with a non-controlled scheme?
- What is the best suiting adaptive scheme in order to reduce  $CO_2$  emissions?

The steps to approach these questions will be:

1. Design a model of flexible consumption from EVs and simulate the generation and consumption conditions in 2020.
2. Study EVs capability to act as flexible loads and availability to also provide frequency regulation.
3. Simulate response of EVs to different levels of wind penetration (over a week) and long-run performance (over a year).
4. Estimate economic impact to the EV user and the impact to  $CO_2$  emissions.

## 2.7 Thesis Outline

Chapter 2 presented the background for this work. It consists on introduction to the operation of the electric power system, presentation of the current regulation services in Denmark and the future strategy from the TSO, a literature review and data analysis of the impact of wind energy in the electric power system and finalize with a description of EVs capabilities towards Ancillary Services and a literature review of related projects related to frequency regulation. Chapter 3 defines the simulation setup and the methodological approach, introduces the model for the fleet of Electric Vehicles, describes the operation and interaction of the electricity market and the regulation market, the data used in the elaboration of the scenarios and the theory behind the optimization algorithms. Chapter 4 presents the simulation results and evaluate them first from an economic point of view in terms of savings and revenues for EV users and second on a socioeconomic point of view analyzing levels of wind penetration and reduction of CO<sub>2</sub> emissions. Chapter 5 lay down the conclusions of the work before suggesting some future work that has emerged relevant along the development of this project.

	DK1		DK1 & DK2	DK2	
	Primary	Secondary	Manual	FNR	FDR
Time of the auction	Daily	Monthly.	Daily	Daily.	Daily.
Up/Down	Both. Non Symmetrical. Delivery from several consumption or production units.	Both. Symmetrical. Delivery cannot mix production and consumption units.	Both. Delivery cannot mix production and consumption units.	Both. Symmetrical.	Only upward. Deliveries from several consumption or production units.
Response time	+/- 20 mH deadband. Half within 15 sec Full in 30 sec. Last up to 15 min.	Within 15 minutes. Mainly supplied by units in operation.	Within 15 minutes	No dead band. Supplied linearly within 150 sec.	Half in 5 sec. Full within 25 sec.
Size	Bids of min 0.3 MW.		Min 10 MW, Max 50 MW.	Bids of min 0.3 MW.	Bids of min 0.3 MW.
Volume to be supplied.	$\approx 15MW$	$\approx 90MW$ . Related to consumption.	900 - 1000 MW. 675 MW in Eastern and 250 in Western.	25 to 55 MW	
Activation	Automatic	Manual. LFC signal sent from Energinet.dk.	Manually ordered by Energinet.	Automatic	Automatic. Remains until balance is restored or manual takes over.
Price to bidder	Same to all bidders. Price of the highest.	Agreed individually by the bidder and TSO. Up price is settled related to spot price plus premium	Pay-as-Bid	Availability payment corresponding the price offered. Pay-as-bid.	Availability payment corresponding the price offered. Pay-as-bid.

Table 2.1.1: Table summarizing Ancillary Services to be provided in Denmark

Year	Classical Consumption		Individual Heat Pumps		Electric Vehicles		Total	
	DK1	DK2	DK1	DK2	DK1	DK2	DK1	DK2
2013	20.501	13.876	185	126	3	2	20.689	14.003
2014	20.575	13.955	207	140	6	4	20.788	14.099
2015	20.596	13.998	228	155	12	8	20.836	14.161
2016	20.608	14.025	250	170	20	14	20.878	14.209
2017	20.621	14.049	269	184	32	22	20.922	14.255
2018	20.648	14.073	298	203	47	32	20.993	14.309
2019	20.676	14.101	325	222	66	45	21.067	14.367
2020	20.712	14.124	352	240	89	60	21.153	14.425
2021	20.760	14.153	376	256	113	77	21.250	14.487
2022	20.808	14.183	398	271	140	95	21.346	14.549
2023	20.858	14.203	420	286	168	114	21.446	14.603
2024	20.896	14.230	441	301	198	135	21.535	14.666
2025	20.930	14.258	465	317	230	157	21.625	14.731
2026	20.966	14.282	491	335	264	180	21.721	14.796
2027	21.001	14.306	520	354	300	204	21.821	14.864
2028	21.034	14.328	551	375	337	230	21.923	14.933
2029	21.068	14.351	592	403	377	257	22.036	15.011
2030	21.102	14.375	638	434	418	285	22.158	15.094
2031	21.137	14.399	697	475	472	321	22.306	15.195
2032	21.174	14.423	768	523	531	362	22.473	15.309
2033	21.209	14.447	869	592	599	408	22.677	15.447
2034	21.247	14.473	1.000	681	675	460	22.922	15.614
2035	21.286	14.500	1.190	811	761	518	23.237	15.829

Table 2.3.1: Distribution of electricity consumption in GWh. Source [16]

# Chapter 3

## Simulation Setup

In this chapter the model used to represent a fleet of 400 EV will be presented. Also it will be explained the reference consumption scheme for a non-controlled situation and the different adaptive algorithms used.

The data used is that of 2014 for calculation of wind penetration, frequency response and spot market price. For the revenue of provision of frequency regulation data for 2015 is used due to the big differences compared with 2014.

### 3.1 Electric Vehicles Modeling

The following parameters are observed in an Electric Vehicle:

- The size and State of Charge of the battery which is set to 30 kWh. This value represent the current average size of the danish fleet of EVs considering the different vehicle makers [19].
- The plug size used to connect the EV to the grid. It will be assumed that most of danish house-holds will have a 3 phase and 16 A connection by 2020 [22]. This represent 11 kW of power capability which half of it (5 kW) will be dedicated to charging the EV. When the SOC of the battery is kept below 90%, the power curve can be assumed constant [44]:

#### 3.1.1 Variables definition

The different variables considered for the fleet of electric vehicles are:

- $P_{max}$ : Maximum power the car can be charged from the plug (5 kW).
- $P_{min}$ : Minimum power the car can be charged (maximum when is discharging). It will be zero in cases of unidirectional power capabilities and equal to the plug size when V2G is considered.

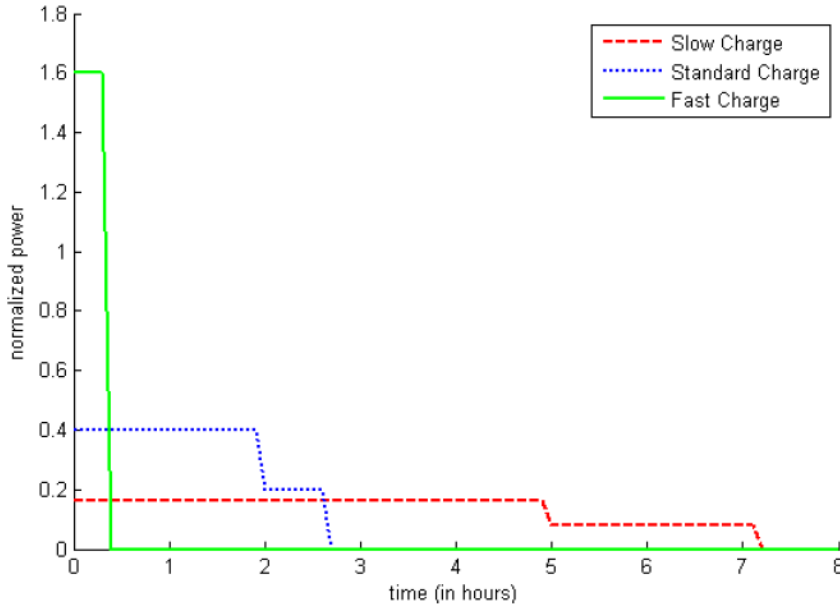

Figure 3.1.1: Load for the different types of charges [38]

- $E_{SOC}$ : Actual state of Charge of the combined fleet of vehicles.
- $E_{SOC,90}$ : It is considered the feasible maximum State of Charge of fleet of vehicles (90%).
- $P_{charging}$  Power at which the EV is being charged at a certain time.
- $n_{EV}$ : Number of Electric Vehicles considered in a certain fleet. For this problem the size is fixed to 400.
- $Bid$ : Energy bid for one hour in the day-ahead market. As the amount of time considered is one hour, power and energy result in the same value.

### 3.1.2 Fleet of Electric Vehicles profile

After studying different patterns of EV users behaviour several profile models have been used to simulate how a fleet of EVs would behave. These profiles introduce a difference between weekdays and weekends.

#### EV driving pattern

Defines when the cars are being used and when they are consuming energy. The driving distribution factor ( $\delta_d$ ) has been defined. According to [36], the average energy consumed by an EV is 150 Wh/km and the driving distance is 43.4 km on weekdays and 31.9 km on weekends. This study is also used as an indication

of the shape of the usage. A different study [5] that focuses in the danish case is used to assess the peak hour for users arriving home and plug in their cars. Following [20] it has been considered that more than 2 trips are made on average every day. The shape of the driving pattern has been emulated from [18]. An average consumption of 3,2 kWh is considered to calculate how much energy will be consumed approximately everyday from the EVs.

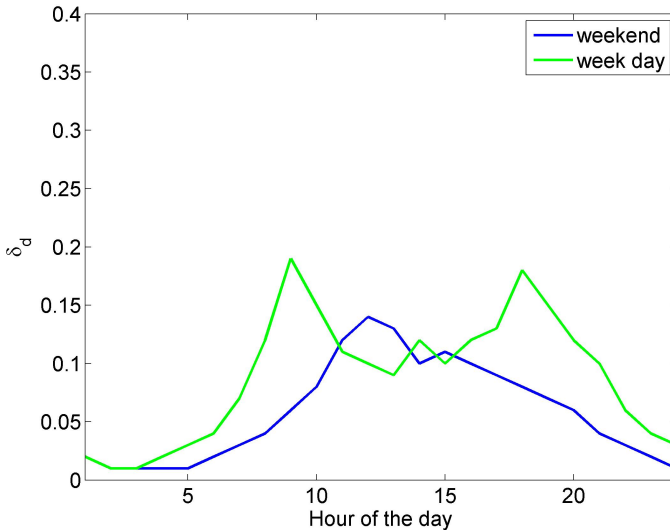

Figure 3.1.2: Statistical EV's user profile.

The cumulative value for the driving pattern is 2,01 in weekdays meaning that the cars will make approximately 2 trips a day. For weekends it is around 1,4.

#### Availability

Defines how many cars are expected to be plugged to the grid every hour. The availability distribution factor ( $\delta_a$ ) is defined in this case. No precise data has been found for the case of Denmark and some studies based in other European countries has been used [19]. The basic assumption is that a small portion of vehicles will be connected to a charging point at work.

#### Charging profile in a non-controlled scheme

It is used to define the charging profile in the case of non-controlled scheme applied. The variable defined is ( $\delta_c$ ) and it considers that from all the EVs plugged to the grid, at certain times only a small percentage of those connected are not fully charged. For example, at 9 am in the morning 25% of EVs are considered to be connected to the grid. Nevertheless, only a certain percentage are connected after having driven to working place. Another percentage is connected but has not been



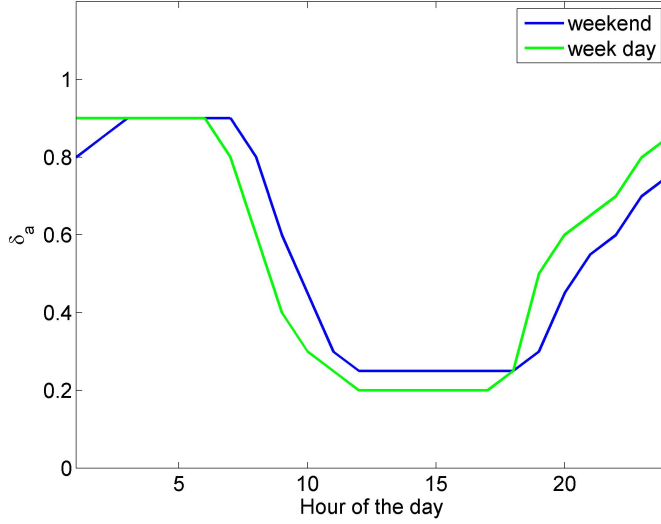

Figure 3.1.3: Statistical representation of EVs being connected to the grid.

driven so it is fully charged and with no capability of having the battery replenished.

### Dynamic Set-Point

This concept relates to how much regulation can be offered by a car taking into account its current charging status and the technology used in the control (sub-section 2.3.1). If a car has a plug size of 5 kW with unidirectional power flow capability only and considering the SOC does not restrict the allocation of reserves, the car may be at this point charging at 2kW. This result in 3kW (5-2) being available for downward regulation (additional consumption) and 2kW (Power charging) available for upward regulation (figure 3.1.4). In case that bi-directional capability is possible, the power available for upward regulation increases considerably. If car is charging at 2 kw, a total of 7 kw offer can be placed: 5 kW that can be offered using V2G technology and 2 kW that can be curtailed from consumption.

These principle is applied in the following equations:

$$P_{downward,EV} = P_{max} - P_{charging} \quad (3.1.1)$$

$$P_{upward,EV} = P_{min} + P_{charging} \quad (3.1.2)$$

The plug size is considered to allow same power capacity for charging and discharging. When the principle of the fleet of EVs is considered the new definition of power available for upward and downward regulation for a fleet of EVs will result:

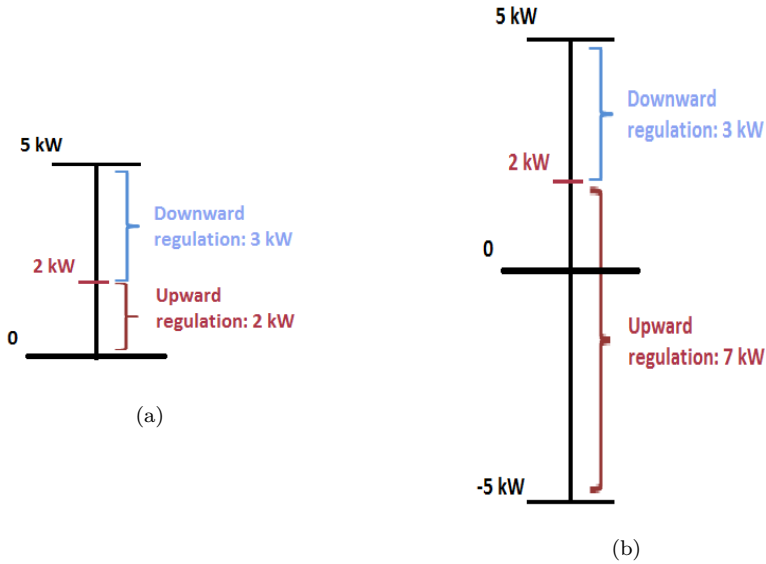

Figure 3.1.4: Comparison of DSP configuration for a) unidirectional and b) bidirectional capability

$$P_{downward,fleet} = P_{max}n_{EV}\delta_a - Bid \quad (3.1.3)$$

$$P_{upward,fleet} = P_{min}n_{EV}\delta_a + Bid \quad (3.1.4)$$

### 3.1.3 The aggregator (Cluster of EVs)

In this work, the aggregator is defined as the figure that interact in the day-ahead market to place the Energy Bids and deals with the TSO and guarantees provisioning of regulating reserves. It is the legal figure to answer in case there is any issue with the service. An introduction to the aggregator and its responsibilities were already presented in section 2.1.2.

The minimum amount of availability is 20% of the vehicles connected to the grid. With a 5kW connection this will mean that 300 vehicles is the minimum that would be necessary to make 300 kW available for downward regulation if no bid is made in the four hour block of upward regulation if full bid is made for the whole block. In order to provide a considerable safety margin, the number of EVs has been set up to 400.

### 3.2 Market Operation: Real Time constraints

The real time operation of the energy market is taken into account. Day ahead market closes at 12:00 and bids have to be placed before this time. The regulating market closes at 15:00 and also Bids have to be placed before this time. The challenge to the aggregator planning how much power to bid is that when bids are placed for the day ahead market for "day + 1" the aggregator does not really now the SOC by the end of the day (see figure 3.2.1), as there is still participation on the regulating market and this can have a significant impact on the SOC.

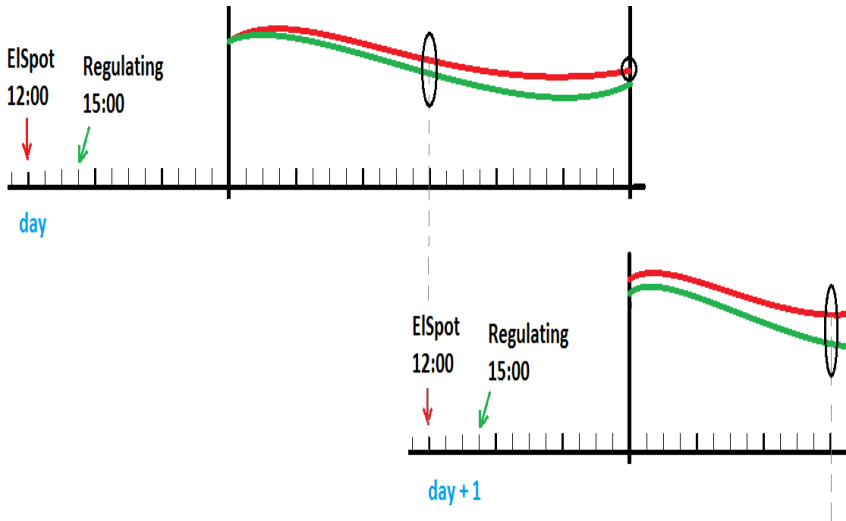

Figure 3.2.1: Representation of real time market and bidding system for following day.

For a more detail explanation on the working principle of the regulation market see appendix A.1.

### 3.3 Provision of Ancillary Services

As it was argued in 2.4, this study will focus solely in provision of frequency response regulation. Two different responds can be motivated in the EV depending on the sign of the frequency deviation:

- Upward regulation: When frequency is bellow 49'98 Hz but not lower than 49'8 Hz a power reserve is activated with the purpose of keeping the frequency within safety limits.
- Downward regulation: Same working principle as before but with a boundary of 50'02 Hz to 50'2 Hz.

The frequency data used for the study was supplied by Energinet.dk under request and it is 1 minute resolution. An intensive search was made trying to obtain better quality data but with no success. By definition, power response is linearly proportional to the frequency deviation and must be provided in half within 15 seconds and full within 30 seconds, but due to the poor definition of the data used the response was full from first frequency deviation detected. If the frequency deviation last more than 15 minutes, secondary regulation takes place and primary will not be required until another 15 minutes have passed by. Frequency data is rearranged based on this conditions as can be seen in the following figure.

Definitions for the provision of ancillary services defined by Energinet.dk 2.1.1 state that, in Western Denmark, power bids have to be arranged in blocks of 4 hours, stating the same amount for the whole period. For this reason, the minimum available power that can be offered for regulation is calculated for the whole block. Depending on the scenario the power that can be made available will vary:

	Regulating power	
	Upward	Downward
Unidirectional	Bid curtailment = $[0, P_{max}]$ (kW)	What is not allocated in Bid = $P_{max} - \text{Bid}$ (kW)
Bidirectional	V2G + Bid curtailment = $P_{min} + [0, P_{max}]$ (kW)	What is not allocated in Bid = $P_{max} - \text{Bid}$ (kW)

Table 3.3.1: Regulating power to be made available per EV depending on battery capability (Bid refers to each individual EV)

If a BRP fails to provide regulation in practical terms it will incur on a fault that implies a fine and eventually suspension from participating to ancillary services. This situation is not contemplated in this problem because it will imply the inclusion of penalty functions in all the schemes defined. Instead, large enough safety margins for the SOC are contemplated.

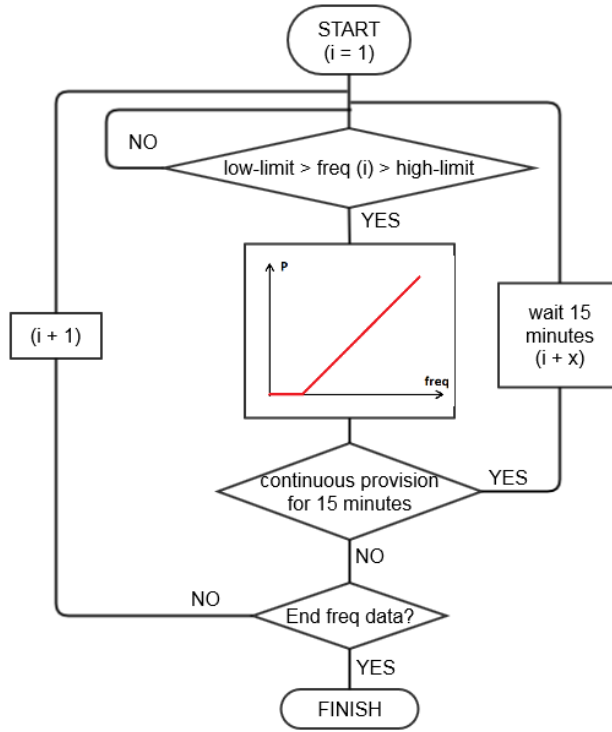

Figure 3.3.1: Flow chart for selecting frequency for calculating Ancillary Services energy content

## Energy content

When providing frequency regulation, the EV will provide power proportional to the frequency deviation. If the frequency deviation remains for enough time it will have an energy impact in the SOC.

The Nordic frequency system is well known for having large frequency deviations and being less stable than in continental Europe. At the beginning of the project, frequency data representative of East Denmark that was analyzed represented a quite significant impact on the SOC.

As it can be seen, the frequency data diverges very often from the dead-band range. In the case of Western Denmark, as it is tightly connected to continental Europe, the frequency that has been used for the calculation shows a much more stable situation.

Due to the nature of this project and the interaction between the day-ahead market and the regulation market, the impact that providing frequency regulation

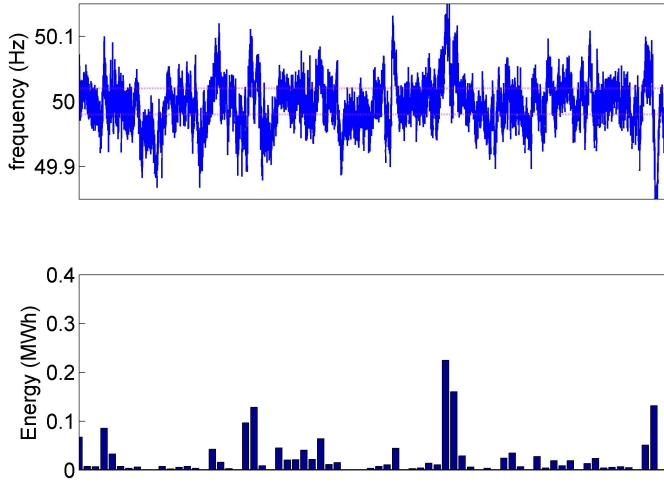

Figure 3.3.2: Energy impact due to frequency regulation in West Denmark. Representation over two days

has on the SOC of the battery needs to be assessed. A cumulative distribution of data from the whole 2014 year can be seen in the appendix A. The following are the values used in the problem:

Regulation \ Block	1	2	3	4	5	6
Upward (20th percentile)	0,004	0,006	0,007	0,008	0,021	0,040
Downward (80th percentile)	0,049	0,041	0,040	0,035	0,059	0,112

Table 3.3.2: Percentile 20th for Upward Regulation and 80th for Downward

Percentile 20th for upward regulation and Percentile 80th for downward are quite conservative values in order to prevent the SOC from going over the 90% limit.

Regulation \ Block	1	2	3	4	5	6
Upward (20th Percentile)	0,02	0,03	0,02	0,03	0,05	0,07
Downward (80th Percentile)	0,03	0,03	0,02	0,02	0,04	0,112

Table 3.3.3: Percentile 50th for Upward Regulation and Downward Regulation

Percentiles 50th are more representative and they are used in the main script of the function.

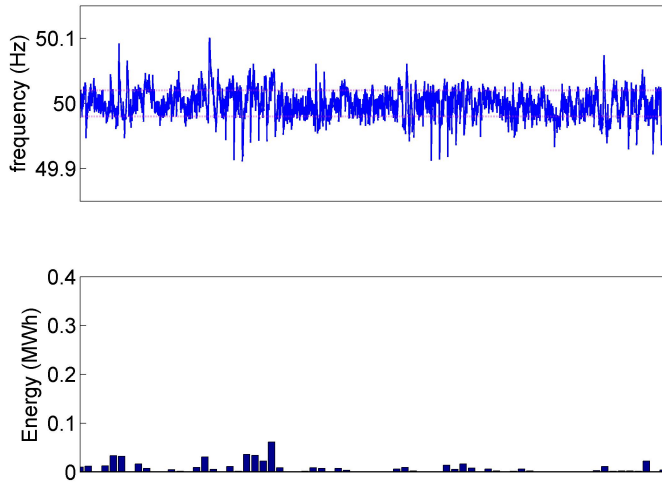

Figure 3.3.3: Energy impact due to frequency regulation in West Denmark. Representation over two days

Due to the nature of upward and downward regulation, the decision has been to define them in separate sets of variables and optimize them in sequence. First, provision of upward regulation will be implemented as it depends on some external factors as level of penetration. Once completed, provision of downward regulation will be calculated as to participate to the maximum amount of blocks and fit the maximum amount of volume.

### 3.4 Charging Schemes

In this section the different charging patterns will be presented. First, it is introduced the reference model for a non-controlled scheme where a plug-and-charge principle is considered. Initially, it was compared against an adaptive scheme where charging time was controlled to aim higher wind penetration and assess how much it can be participated to frequency regulation market. A last stage implied the development of optimization algorithms where the target was to maximize participation to regulation market and wind penetration at the same time.

All problems have a continuous nature, where the SOC of the battery in the following hour depends on how much it has been consumed and how much it got charged (3.4.1).

The vector that represents the SOC in the Matlab script has a length of 25 values representing hours [0,24]. The last value SOC(25) is used as the initial value

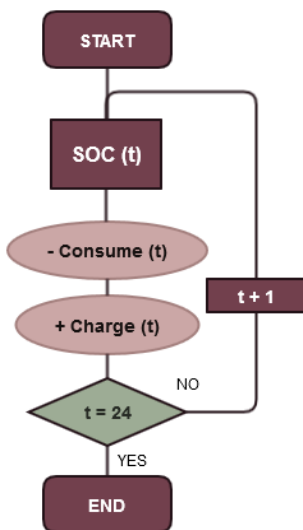

Figure 3.4.1: Flowchart about the continuous condition of the EV model

for the following day. For the cases when Ancillary Services are participated to, the impact on the SOC is included in the loop.

### 3.4.1 Non-controlled charging

The EVs are left to be charged on a non-controlled fashion. The EV will be charged when it is plug to the grid and the battery needs to be replenish. This model is mostly influenced by the fact that when EVs are at the working place only a small number are plugged to the grid and those being at home are fully charged. As a consequence, not much energy can be replenish during the period from 7:00 in the morning to 5:00 in the afternoon because even though there is a certain percentage of connected cars, most of them are fully charged and the majority are at the working place and not connected to the grid. Later in the afternoon, most of the vehicles will arrive home and be plugged at a very determined range of hours. This non-controlled charging profile was previously introduced in 3.1.2.

#### Implementation

The following flow chart describes how the different elements interact. EV Model represents the battery performance and guarantee the right performance of the SOC. Historic data is real data downloaded from Nordpoolspot.com showing the prices registered in the day ahead market in West Denmark for 2014.

The way the architecture is implemented in a Matlab script is pictured in figure 3.4.3 and a script has been added to appendix B:



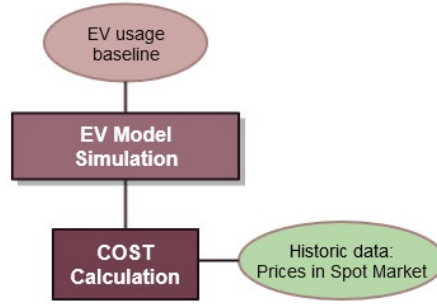

Figure 3.4.2: Flowchart showing the architecture of the reference model for non-adaptive charging

### 3.4.2 Basic Adaptive Charging

Adaptive charging means that the Electric Vehicle charging pattern is controlled as to follow a determined objective. The objective pursued in this work is to probe that using forecast penetration signal will yield simultaneously lower prices of electricity and higher wind penetration. The signal is a comparison of forecast of wind production and forecast of consumption:

$$Penetration = \frac{Wind_{production}}{Consumption} \quad (3.4.1)$$

The reasons for using this parameter as an indicator are as follow:

1. Forecast for wind production and consumption can be used as a real indicator as they are published before the day-ahead market closes.
2. Statistically it has been demonstrated that when there is a forecast of high penetration the prices in the spot market will be lower.
3. High Penetration will, of course, mean more wind energy content in the battery of the car which most likely will also reduce the level of  $CO_2$  footprint in the charge of the car.

Data of the forecast of wind penetration and prices in the spot market have been downloaded from Energinet.dk and Nordpoolspot.com web-pages. In order to simulate the penetration for 2020, the level of wind production in 2014 has been escalated by a factor 1,38 and the consumption to a factor 1,018 also with respect to 2014.

#### Implementation

This algorithm has been implemented using basic weight functions ( $f_P, f_{SOC}, \delta_a$ ) that motivate charging according to SOC and penetration level, having a differentiation by the time range where the Bid was placed. This differentiation is motivated

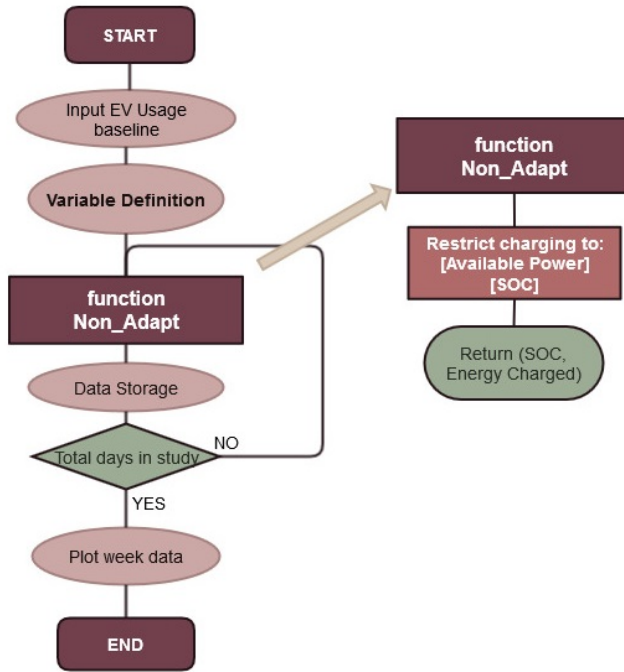

Figure 3.4.3: Flowchart of the script executed to calculate the final SOC of the car, Energy required and cost of providing service

by the findings mentioned in ???. Following flow chart (figure 3.4.4) shows an architecture similar to what was described in figure 3.4.2 but including some weight parameters and real historic data.

The equation to calculate the Bid size offered in the day-ahead market is:

$$SOC < 30\% \rightarrow Bid = \delta_a(SOC_{90} - SOC) \quad (3.4.2a)$$

$$SOC > 30\% \rightarrow Bid = f_P f_{SOC} \delta_a(SOC_{90} - SOC) \quad (3.4.2b)$$

The weight factors are defined as follow:

- Availability factor ( $\delta_a$ ), previously defined in figure 3.1.3.
- Penetration factor ( $f_P$ ), defined based on the level of wind Penetration defined in equation [3.4.1] and in the time range.
- SOC factor ( $f_{SOC}$ ), relative to the SOC of the EV.

### 3.4.3 Optimal Adaptive Charging

The objective of this work towards optimization tools is merely about getting a simple comparison without trying to explode all their potential. Based on the com-

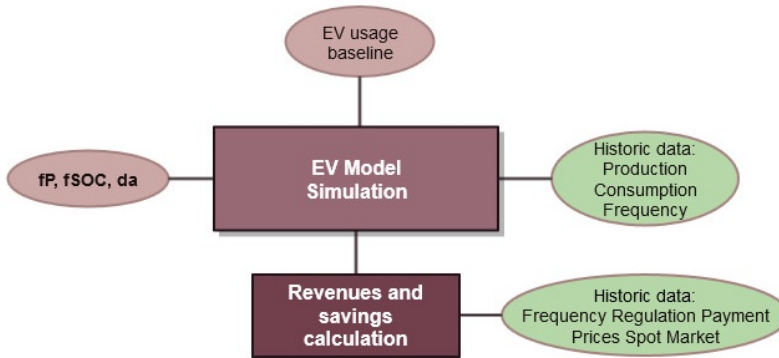

Figure 3.4.4: Flowchart showing the architecture of an adaptive charging scheme

mon known criteria that the cost of evaluating the gradient is proportional to the number of design variables [46] the set of variables used for addressing power bids to the regulating market has been divided in two. As can be seen in the Matlab script included in appendix B for the function *Adapt\_optimal\_DE*, first upward regulation optimization is achieved and consecutively downward regulation. The final set of variables is 6, representing each of the four hours blocks of the day. There is a difference between each of the regulating cases in the definition of the objective function.

The problem is of a continuous nature, with dynamical constraints and of deterministic condition as the demand is supposed well defined by the availability curves and driving patterns. The only stochastic variable is the energy impact that provision of ancillary services will have on the battery. This energy impact is estimated using the value of the 20<sup>th</sup> percentile for upward regulation and 80<sup>th</sup> percentile for downward regulation (table 3.3.2). Once a day the SOC is corrected with the actual impact of providing regulation, calculated from real frequency measurements. To avoid any possible situation of SOC trespassing the real limits of the battery, wide safety operational margins from 30% to 90% are set up. A condition of no availability of the car would be reached if SOC goes out of the range [20%,95%] but this condition has never occurred during simulations.

The architecture follows the principle of basic adaptive charging and introduces an objective function to minimize so it can guarantee the highest possible provision of frequency regulation. Figure 3.4.7 shows a flow chart where the previously used EV model is still the base model and the different optimizations are performed inside it, rather than using weight factors. Once the optimal is found, revenues and saving are calculated based on historic data.

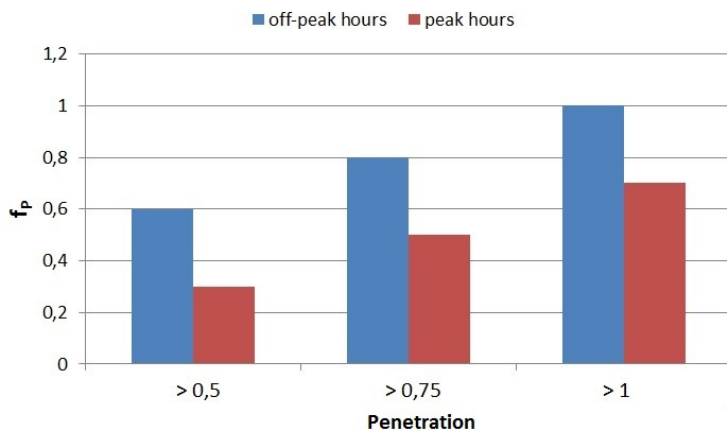

Figure 3.4.5: Representation of Penetration factor ( $f_P$ ) conditional to the degree of wind penetration

#### 3.4.3.1 Optimization algorithms

Three algorithms are implemented: gradient search, genetic and differential evolution.

##### Gradient Search Algorithm

It is a popular iterative method for solving systems of linear equations. From an initial estimation, it takes steps proportional to the negative of the gradient of the function at the current point, analyses the gradient at each of the steps and evaluate for the best solution (steepest gradient in the orthogonal direction) [40] [37].

The function "fmincon" is used in Matlab for the resolution of this problem. "Interior Point" is the algorithm applied and steps are defined from 0.1 to 0.01 to reduce the execution time after verifying that the range of solutions was as valid as with larger ranges but execution time much shorter. The maximum number of iterations is of 100 and all the other parameters are leaved as default.

##### Genetic algorithm

It is a search heuristic that is based on evolution theory where the best performing individuals (variables) will remain and reproduce. From a definition of a first population, following generations will be composed of the best fitting individuals from the previous generation and new individuals generated from cross-over and mutation of them. The new resultant population is analyzed to assess its performance towards an objective function and compared with the previous generation. Once not a significant improvement is achieved the best fitting set of variables is chosen among

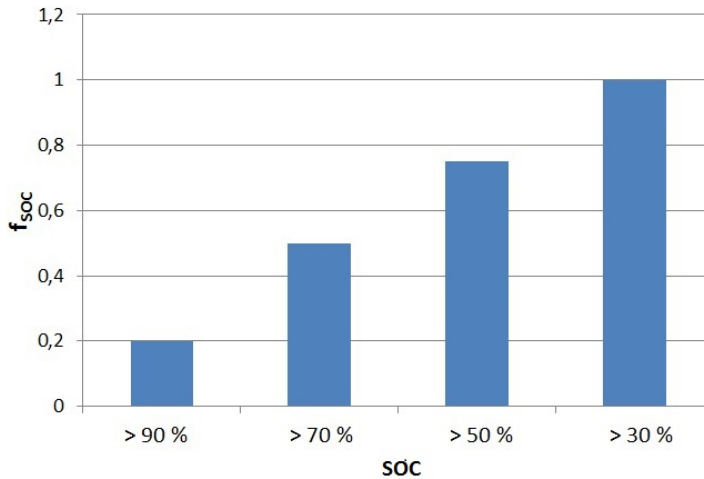

Figure 3.4.6: Representation of the SOC factor ( $f_{SOC}$ ) value depending on the SOC of the EV fleet

the population.

The function used in Matlab to set up this problem is "ga" and the parameters defined are a Population size of 18 individuals along 180 generations. As a simplification, variables are chosen to be Integers representing decimal values (i.e. if a variable can take from 0.3 MW to 1.8 MW solution an integer was bounded with minimum value of 3 and maximum of 18) which reduces greatly the set of possible solutions.

### Differential Evolution

It follows the same principle as Genetic Algorithm as it is a stochastic function minimizer with a defined population. The basic difference with the previous scheme is that DE adds the weighted difference between two population vectors to a third vector [43] that will be included in the next set of mutations. For practical reasons in this work, it differs from GA because it is defined as penalty based problem rather than constraint based as the previous two.

Differential evolution function's code for Matlab comes from [35]. The defined population size is 60, with a mutation factor of 0.6 and cross-over factor of 0.9. The total number of iterations is 18000 though a termination condition was established for an improvement condition of  $1e-12$  after 20 iterations. Other condition less restrictive would make the optimization function to terminate with a non-satisfactory solution.

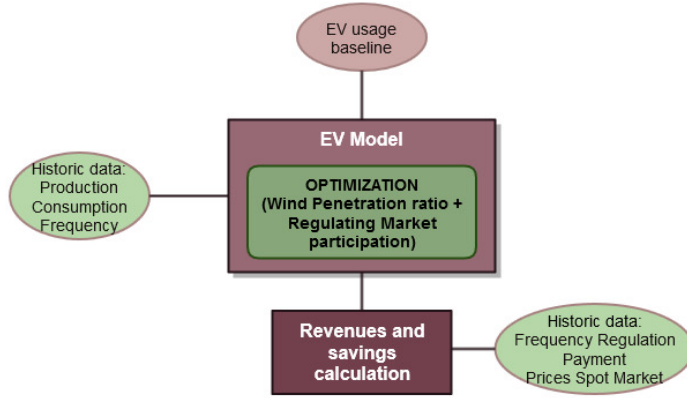

Figure 3.4.7: Flow chart showing the architecture of the optimization process.

### 3.4.3.2 Constraints vs Penalties

Regarding the practical setup, the previously mentioned optimization algorithms can be arranged in two groups whether constraints and boundaries are defined to limit the value of the variables or whether a penalty function is implemented inside the objective function to obtain the same effect. GSA and GA will fit in the former and DE respond to the latter set up.

#### Constraints based schemes:

The algorithm is implemented by defining some constraints, boundaries and an objective function that needs to be minimized.

As seen in figure 3.4.8, some adjustments are made before calling the optimization function. One of the particularities of the project is that to participate to frequency response regulation, the power stated in each of the 4 hours in a block has to be of 0.3MW minimum. This imply the definition of constraint 3.4.1j. The solution proposed is to perform a loop in which all variables were initialize at the minimum value of 0.3. If the final SOC, considering the correspondent share of energy from providing regulation and the consume of the battery, was still higher than the maximum the variable having the smaller share of wind penetration would be withdrawn. The process is represented in figure 3.4.9. The remaining variables will be called to the function with the certainty that the SOC constraint will not be violated.

Upward and Downward provision are calculated separately as it was introduced in section 3.3.

- Upward Regulation

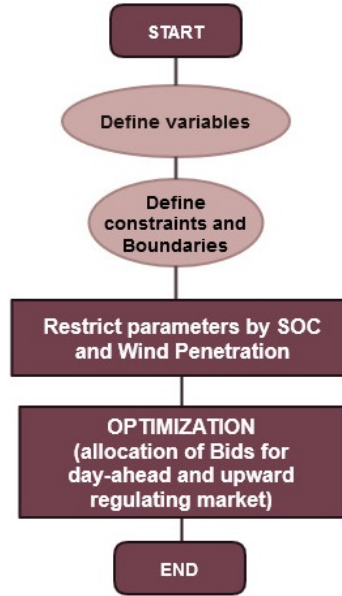

Figure 3.4.8: Flow chart showing the script for the optimization process with boundaries and constraints definition.

Objective Function:

$$\max \sum_{b=1}^6 x(t)(Penetration(t) - 0.5) \quad (3.4.1a)$$

Constraints:

$$SOC(t) = SOC(t - 1) + x(t) - EV_{usage}(t) - x(t) * factor_{AS,up}(t) \quad (3.4.1b)$$

$$SOC(2) \leq 90\%SOC \quad (3.4.1c)$$

$$SOC(3) \leq 89\%SOC \quad (3.4.1d)$$

$$SOC(4) \leq 88\%SOC \quad (3.4.1e)$$

$$SOC(5) \leq 87\%SOC \quad (3.4.1f)$$

$$SOC(6) \leq 86\%SOC \quad (3.4.1g)$$

$$SOC(7) \leq 85\%SOC \quad (3.4.1h)$$

$$SOC(3) \geq 55\%SOC \quad (3.4.1i)$$

$$x \geq 0.3MW | x = 0 \quad (3.4.1j)$$

Boundaries

$$0 \geq x \leq UB \quad (3.4.1k)$$

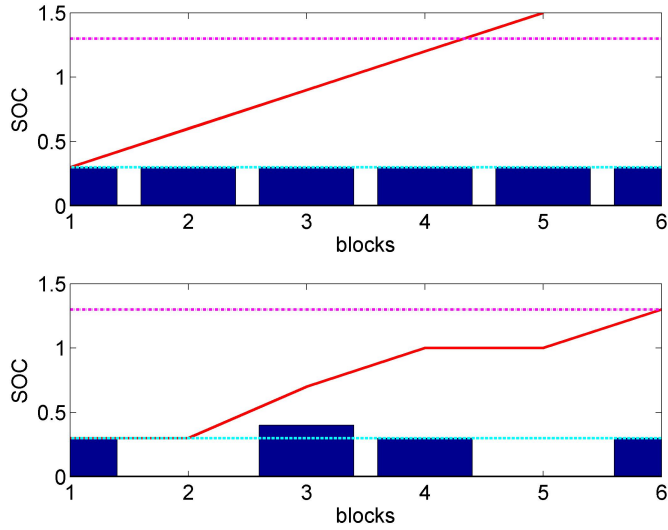

Figure 3.4.9: Representation of SOC overflow due to too many variables constraint.

In equation 3.4.1a the objective function refers to each of the six blocks. Value of penetration has previously been averaged for each block. For equations from 3.4.1c to 3.4.1h the SOC refers to the value at the last hour of the block. The SOC constraint is reduced every hour to favour downward regulation bids. As the problem is continuous the variables have a cumulative effect and this limits greatly allocation of downward reserves. Equation 3.4.1i constraint so the minimum amount of SOC is not reached. As the rate at which the battery discharges is known, it is not necessary to reproduce this constraint for every block. Equation 3.4.1j refers to the condition that either a variable is at least 0.3 MW or zero otherwise. The upper boundary referred to in equation 3.4.1k is variable for block to block and refers to the power of the hour with minimum available power in that particular block.

- Downward Regulation  
Objective Function:

$$\max \sum_{b=1}^6 x(t) \quad (3.4.2a)$$



Constraints:

$$SOC(t) = SOC(t - 1) + x(t) * factor_{AS,down}(t) \quad (3.4.2b)$$

$$SOC(2) \leq 90\%SOC \quad (3.4.2c)$$

$$SOC(3) \leq 90\%SOC \quad (3.4.2d)$$

$$SOC(4) \leq 90\%SOC \quad (3.4.2e)$$

$$SOC(5) \leq 90\%SOC \quad (3.4.2f)$$

$$SOC(6) \leq 90\%SOC \quad (3.4.2g)$$

$$SOC(7) \leq 90\%SOC \quad (3.4.2h)$$

$$x \geq 0.3MW | x = 0 \quad (3.4.2i)$$

Boundaries

$$0 \geq x \leq UB \quad (3.4.2j)$$

In the case of downward regulation, the objective function (equation 3.4.2a) is just to get as much allocation of power as possible, without prioritizing any block. For equation 3.4.2b, the SOC refers to the previously calculated in downward regulation provision so only needs to be adjusted by the energy impact that ancillary service provision will have on the battery. The SOC upper constraint (equation 3.4.2c to 3.4.2h) is fixed to 90% for all blocks. The Upper Boundary in equation 3.4.2j is the remaining from the available power to the block and the amount used previously in upward regulation as was defined in equation 3.1.1.

**Bi-directional condition** When bi-directional capability is studied, the only difference in the definition of the model is that constraints defined in equations 3.4.1j and 3.4.2i are substituted by just  $x \geq 0MW$  so the linear inequality constraints are removed from the script.

Penalties based scheme

It results in a much more clean and neat algorithm. It is based on weight penalties that try to allocate the variables in the desired region. Flow chart in figure 3.4.10 shows the architecture of this algorithm. Main differences with the previous algorithm is:

- It does to restrict the number of variables at the beginning of the simulation ( $0 \geq x \leq P_{max}$ ) as the cost function will provide that result.
- Constraints and boundaries are removed before calling the optimization function.

If compared to 3.4.8, it looks more simplified and no limits are set to the optimization. The decision making inside the objective function is defined by penalties as shown in 3.4.11 so the range of valid values is defined  $0, [0.3, MaxAvailablePower]$ .

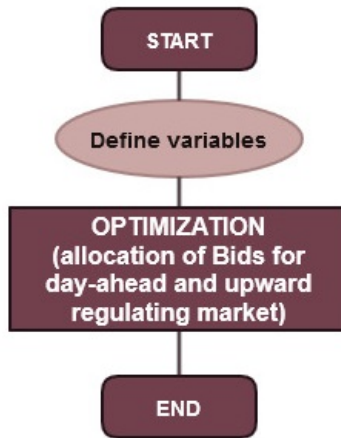

*Figure 3.4.10: Flow chart showing the script for the optimization process when all constraints and boundaries are verified inside the objective function.*

Objective functions are the same as defined in equations 3.4.1a and 3.4.2a. For the case of upward regulation, in the event of a variable being lower than zero the value was fixed to zero. Any other applied strategy always end up with some small negative values that when evaluated annually represented an unacceptable impact on the final energy calculation.

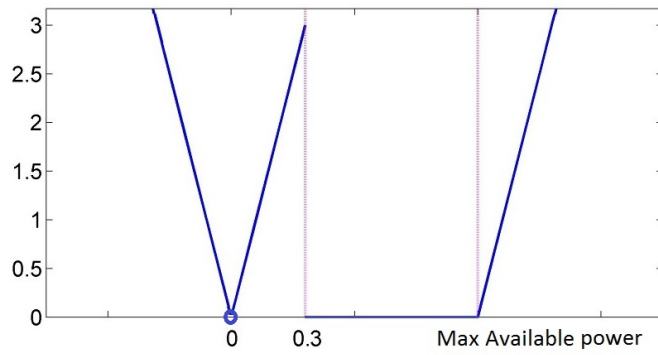

Figure 3.4.11: Representation of the weight coefficient applied in the objective function for DE algorithm.

## Chapter 4

# Simulation Results

In this chapter results from simulation of a fleet of 400 EVs will be presented and compared. The non-controlled scheme will be used as the reference model. Coming after, the adaptive charging scheme is presented and finally the optimized results are displayed. All results shown in the plots and the tables refer to values of the fleet of EVs. Only the economic values are referred to individual users. Each of the configurations are presented here:

1. Non controlled model: This scheme follows the principle plug-and-charge.
2. Basic Adaptive Charging: Decision making scheme based weight factors relating to SOC level and wind penetration forecast.
3. Optimal models applying Gradient Search, Genetic and Differential Evolution algorithms: Objective function is defined as to attain higher wind share in the battery of the car.

These configurations are initially verified in a week time frame and later on, a whole year is simulated to assess the performance in the long run. The level of penetration is escalated to accommodate to the expected values of 2020. The original data to simulate the different week levels are:

1. Week of high penetration: The week in 2014 that, considering from Monday to Sunday, had the largest average wind energy penetration. It happened from December the 15th to December the 21st.
2. Week of low penetration: The week in 2014 that, considering from Monday to Sunday, had the shortest average wind energy penetration. It happened on August the 25th til August the 31st.

As it was previously introduced, two technologies will be compared:

1. Uni-directional, that allows power flow only into the battery.
2. Bi-directional, that allows power flow in both directions, from the grid to the battery and vice-versa.

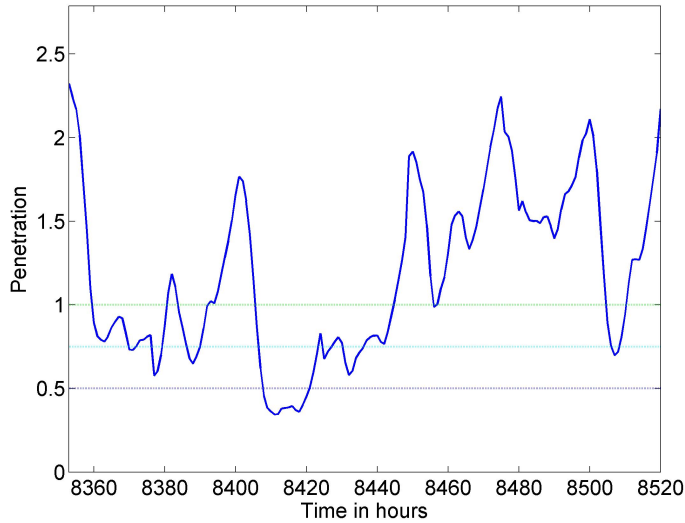

Figure 4.0.1: Level of wind penetration for a week representative of high values

The Matlab scripts used and the graph plots included in this chapter are supplemented with this report as additional material and an explanation is included in appendix B.

## 4.1 Non controlled Scheme

There is no differentiation in any high or low penetration week as this scheme does not respond to any external signal. It charges when plug to the grid and when a battery consumption has been produced. As it was argued in the background chapter (2.3.1) the amount of EVs expected in 2020 will not have a significant impact in the load profile for Western Denmark therefore a fleet of 400 EVs is only considered here.

This consumption curve follows the same pattern of other curves like the one developed by [38], that can be seen in figure 4.1.2, though with a smaller energy impact.

The charging profile in this case is very repetitive and hardly varies from one day to the other (figure 4.1.3). The magenta horizontal lines represent the maximum and minimum limits for the SOC and the continuous blue line is the SOC. The bar chart represents the power that is charged every hour with the dashes and dots horizontal line representing the low limit of 0.3 MW.

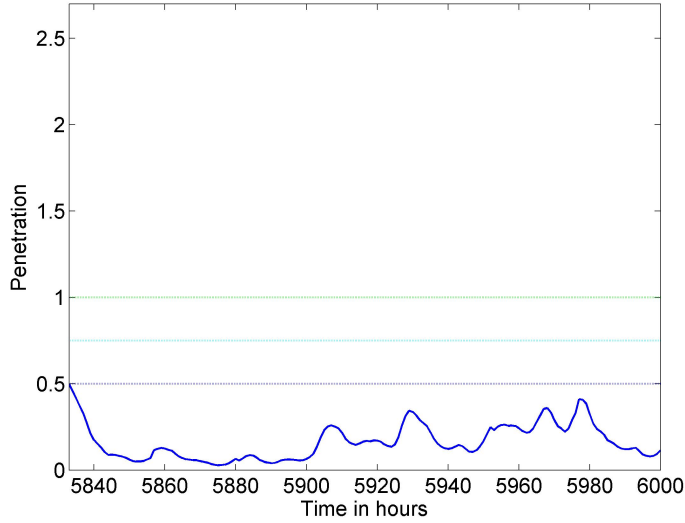

Figure 4.0.2: Level of wind penetration for a week representative of low values

## 4.2 Adaptive schemes

### 4.2.1 Basic adaptive charging

This model introduces some new features compared to the non-controlled one. As it was introduced in section 3.2, the real time constraints between the day-ahead market and the regulating market makes it necessary to estimate at noon the SOC at the end of the day. The result is a double curve plot (figure 4.2.2 above) which variables are:

- SOC real measure: results when calculating Energy content from ancillary service using real frequency data.
- SOC estimated: uses real frequency data until 12:00 p.m. and completes for the rest of the day with an estimate using values from 3.3.3.

When comparing the figures above, it is clear than with V2G capability the impact on the SOC of the battery is higher and the estimate differs greatly from the real measurement.

The reason why bidirectional capability yields higher energy content relays on its ability to send power back to the grid for frequency regulation purposes. Below there is a figure of the power bids that can be placed when using bi-directional capability compared to unidirectional. As explained in 3.1.2 with the idea of the dynamic set point, bi-directional allows more power to be offered, adapting to the legislation that says that frequency response can be providing from both consuming

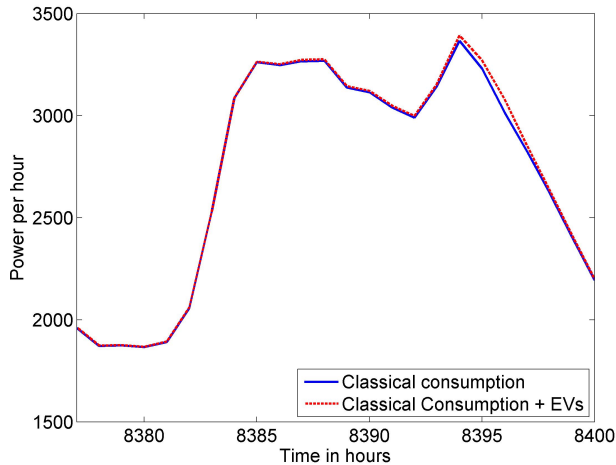

Figure 4.1.1: Comparison of classical consumption curve with consumption curve when EVs with non-controlled schemes are added. For simulation purposes, the number of EVs have been increased to 40000 to appreciate the shape of the curve.

and producing units (table 2.1.1). In figure 4.2.3, each bar represents a four hour block.

In figure 4.2.3, magenta lines represents the 0.3 MW limit to comply with the regulation asking for downward regulation. It can be appreciated that, even when some blocks have power offered in all their hours, very seldom the power is enough to be offered.

Finally, a special feature is shown considering the ability of the EV to stand some hours without being charged if the level of wind penetration is not satisfactory. Figure 4.2.4 is obtained in response to a week of low wind penetration represented in figure 4.0.2 while figure 4.2.5 is the response to a week of high wind penetration 4.0.1. Bars with positive value represent downward regulation while the negative ones represent upward regulation (power flowing out from the battery).

The power bids for the day-ahead market seen in the last figure generated the bids to the day-ahead market seen in figure 4.2.3.a.

## 4.2.2 Optimized results

Three algorithms have been used to compare for an optimization scheme. To reduce the amount of graphs only the most significant results will be shown. As it was introduced in the previous paragraph, the optimization problems designed in this work have a main focus to group power bids in hours belonging to the same block and make these bids of sufficient power as to offer them in the regulating market.

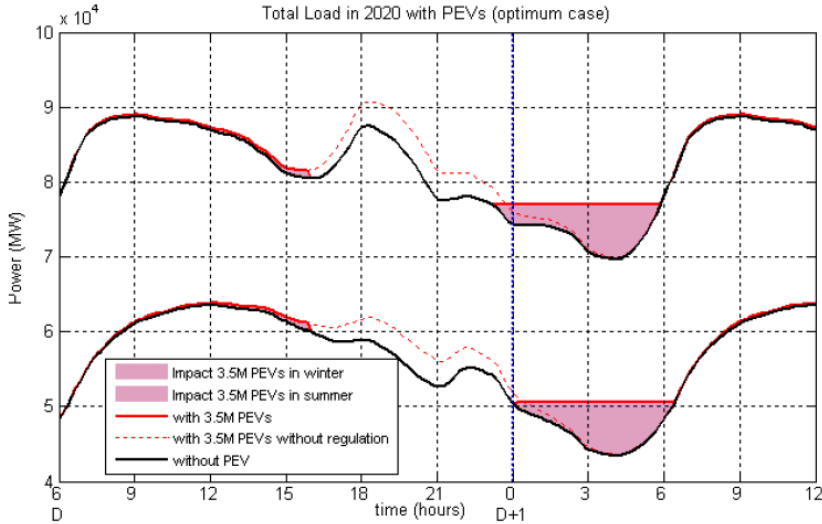

Figure 4.1.2: Impact of different consumption profiles in the load profile [38]

On the other hand, if not enough power can be purchased to offer it later in the frequency regulation market it will rather stay at zero. As can be seen in figure 4.2.6 the response of the simulation was as desired:

The blocks in which downward regulation is not provided (positive bars) are due to having not sufficient power at the central hours of the day for providing upward and downward regulation all together. If the EVs availability curve is studied (figure 3.1.3), at this central hours only some 20% of the cars are connected which represents some 400 kW of power available. Bi-directional capability shown in next figure does have enough power available to offer both upward and downward regulation at the central hours of the day, if the power is not used for charging as it happens in figure 4.2.7 at the first and last days represented. This will result though in more power available for upward regulation at that particular blocks.

For the case of low wind penetration, bids are accurately placed to comply with the minimum of 0.3 MW Bids and keep the SOC within satisfactory margins.

Among the architecture of the optimization algorithms, GSA and GA where grouped as constraint based where the variables were pre-evaluated before calling the optimization function to decide whether the Penetration level was high enough to bet. This result in the shape of figure 4.2.8 that is also common for GSA. For the case of DE, the architecture is penalty based so no pre-evaluation is made of SOC or level of wind penetration and all decisions are left to the objective function. The result is satisfactory as the shape of the SOC in the case of a week of low wind penetration is similar to the case of constraints algorithms:

The performance on the long run will be put together in the following section.



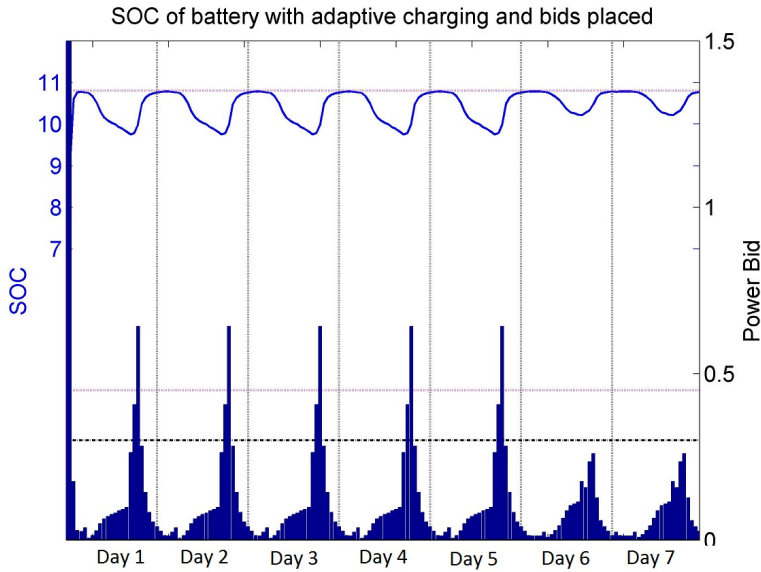

Figure 4.1.3: Evolution of SOC of fleet of EVs and Amount of energy being charged with no controlled strategy

## 4.3 Comparison of results

This section shows results from simulations comparing the different charging schemes studied. Data from the non-controlled scheme is not included in the week long results because it cannot participate to ancillary services. It will be used in the year long results.

### 4.3.1 Week long results

In table 4.3.1 results from applying the adaptive algorithm in a week of high wind penetration using uni-directional capabilities are shown. Under regulating market heading are the results of upward and downward regulation: Bid states how many blocks an offer could be made, Power refers to the total power offered to that type of regulation over the week period, Ratio is the coefficient between total power offered and the number of blocks where an offer is made (by definition it must be higher than 0.3 MW) and fval is the sum of results from the objective function (find minimum solution).

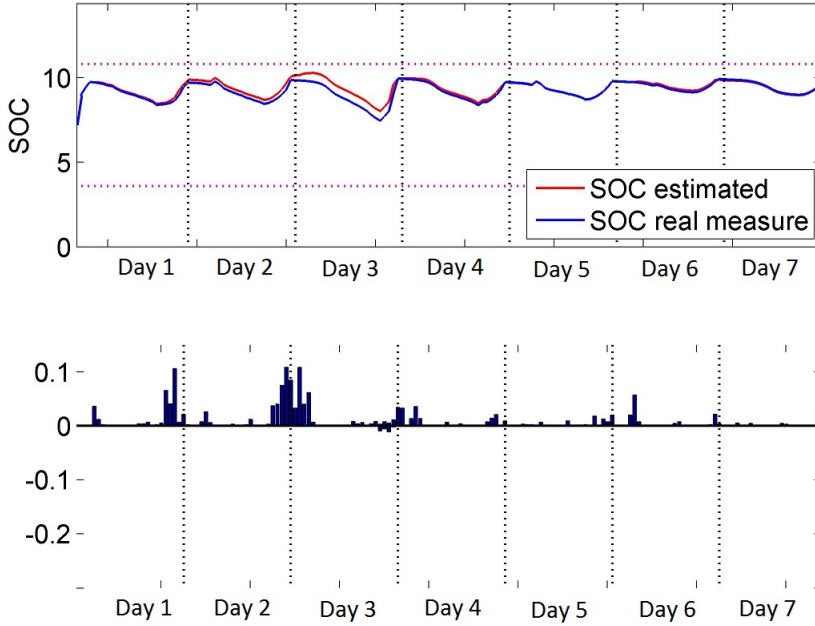

Figure 4.2.1: In top figure, comparative of the SOC estimated and real measurement with unidirectional capability. Lower figure shows the energy content of provision of Ancillary Services.

	SOC		Regulating market							
	Initial	Final	Upward				Downward			
			%	Power	Ratio	fval	%	Power	Ratio	fval
Basic	7,2	9,7	2	0,4	0,36	NA	98	33,5	0,82	NA
GSA	7,2	10,3	33	5,0	0,36	-3,96	57	8,8	0,37	-8,78
GA	7,2	10,3	31	4,8	0,37	-3,84	91	25,5	0,67	-25,50
DE	7,2	10,8	21	4,8	0,54	-4,46	95	20,6	0,52	-20,55

Table 4.3.1: Adaptive charging schemes using unidirectional capability for a week with high wind penetration

As expected, upward regulation provided with any of the optimization functions yield to higher offers for upward regulation and therefore the number of bids for downward is slightly smaller. The number of offers is a percentage of the maximum (42 bids). It is remarkable that GSA scores so poorly in downward regulation. Somehow it must have placed most of its bids in the central hours of the day when either upward or downward regulation can only be applied (figure 4.2.6).

To give a better impression, a graph is included with data from the different configurations. Results from previous table correspond to 4.3.1.b.

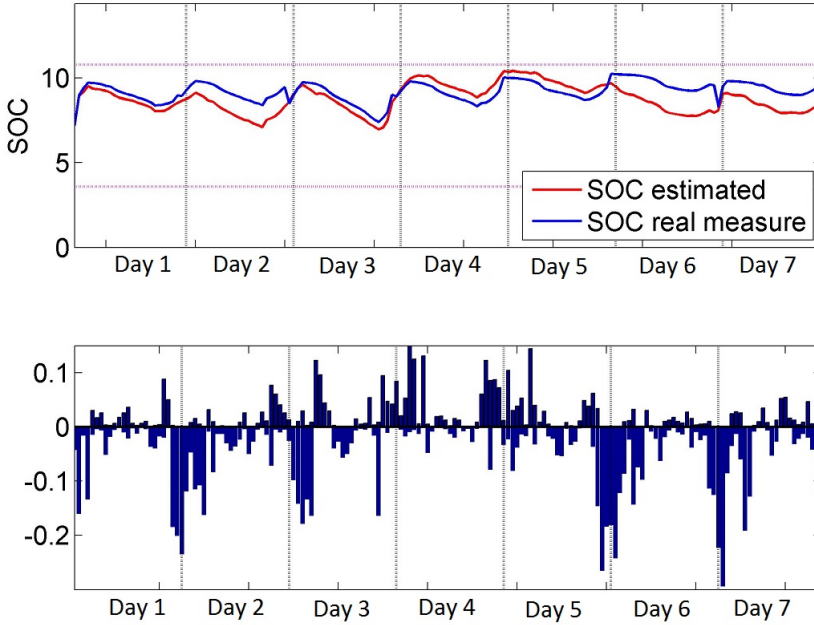

Figure 4.2.2: In top figure, comparative of the SOC estimated and real measurement with V2G capability. Lower figure shows the energy content of provision of Ancillary Services.

In the figure above the poor score for downward regulation using GSA can be seen as the number of bids significantly dropped and the ratio of power offered is also significantly lower. For a case of low wind penetration (figure 4.3.1.a) three optimized algorithms score similarly. DE offers better results in downward regulation as a consequence of being worse in upward.

In the overall result, GA seems to offer the best results.

### 4.3.2 Year long results

Evaluation over a whole year gives more consistent results about which algorithm adapts better. The unitary cost is calculated using the formula:

$$UnitaryCost = \frac{\sum_{h=1}^{8760} Bid(h)Cost(h)}{Bid} \quad (4.3.1)$$

Where the  $Bid(h)$  refers to the power bid each hour of the year and Bid stands for the sum of the whole power bid along the year. Unitary cost can be understood as the average cost of electricity in the spot market using each of the different algorithms.

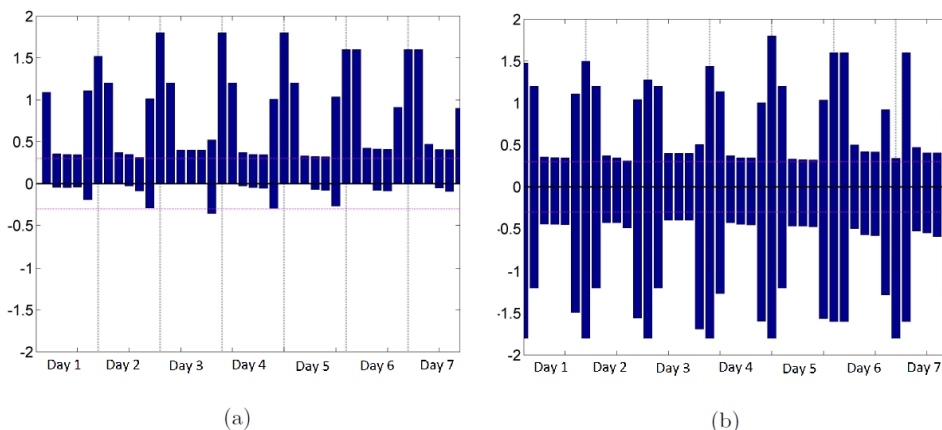

Figure 4.2.3: 4 hours block representation of the bids placed in the regulation market a week of high wind penetration with a) unidirectional and b) bidirectional capability

	Day-ahead Market		Regulating Market					
	Bid (MWh)	Unitary cost (DKK/kWh)	Upward			Downward		
			%	Power (MW)	Energy (MWh)	%	Power (MW)	Energy (MWh)
Non-controlled	891,7	0,251	0	0,0	0,00	0	0,0	0,0
Basic	822,9	0,212	2	14,0	0,8	94	1718,4	68,6
GSA	845,8	0,223	21	165,5	7,5	85	1375,1	52,8
GA	835,6	0,222	28	208,9	8,5	87	1608,3	63,9
DE	843,1	0,231	24	210,4	10,2	89	1490,1	57,6

Table 4.3.2: Whole year performance for an adaptive scheme using different optimization algorithms and unidirectional capability

	Day-ahead Market		Regulating Market					
	Bid (MWh)	Unitary cost (DKK/kWh)	Upward			Downward		
			%	Power (MW)	Energy (MWh)	%	Power (MW)	Energy (MWh)
Non-controlled	891,69	0,251	0	0,0	0,0	0	0,0	0,0
Adaptive	896,26	0,209	100	2132,4	73,5	93	1670,2	67,7
GSA	917,74	0,202	100	2268,7	79,1	85	1318,1	52,4
GA	912,40	0,209	100	2267,4	79,3	92	1497,3	58,0
DE	920,85	0,205	100	2269,5	79,6	84	1278,9	50,1

Table 4.3.3: Whole year performance for an adaptive scheme using different optimization algorithms and bidirectional capability

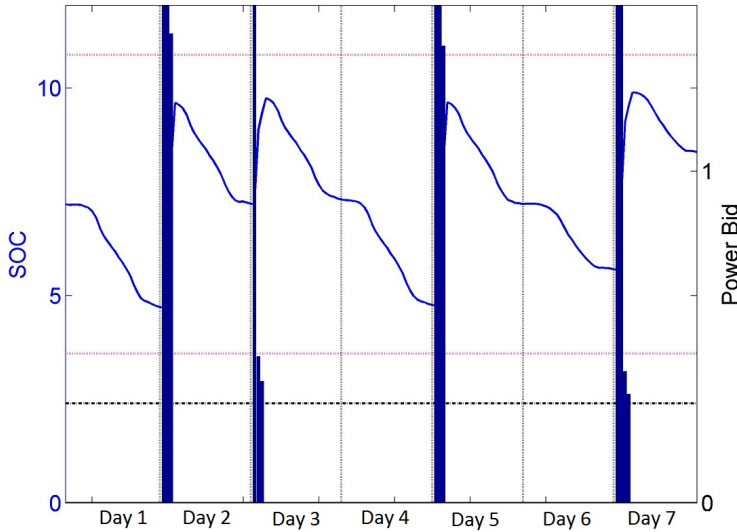

Figure 4.2.4: Hourly representation of bids placed in the day-ahead market and SOC with unidirectional capability in a week of low wind penetration

Previous table shows a significant feature common to all the optimized algorithms: more energy is purchase (Bid) because some of it will be provided back to the grid when participating to upward frequency regulation. As it is obvious, bi-directional capability allows upward regulation to be offered in all blocks (100 % times of the 2190 available bid blocks in one year) which will translate in higher revenues as will be put down later. One remarkable condition is that in both battery configurations, the amount of energy gained by the car by providing downward regulation is 6 to 8% of the total energy Bid, which will also be reflected as savings.

## 4.4 Economic Impact

EV user's, by participating of any of these schemes, can get economic benefits in two different ways:

- Savings: By purchasing electricity in an adaptive fashion owners will see their electricity bill reduced due to cheaper electricity.
- Earnings: Participating to the frequency regulation market has an economic reward for taking part as a BRP. This earnings can be estimated an averaged along all participants in the same cluster.

### 4.4.1 Savings: Purchase of Electricity

To simulate the purchase of electricity in the day-ahead market, the figure of the aggregator, described in 3.1.3, is essential. Traditionally, distribution companies,

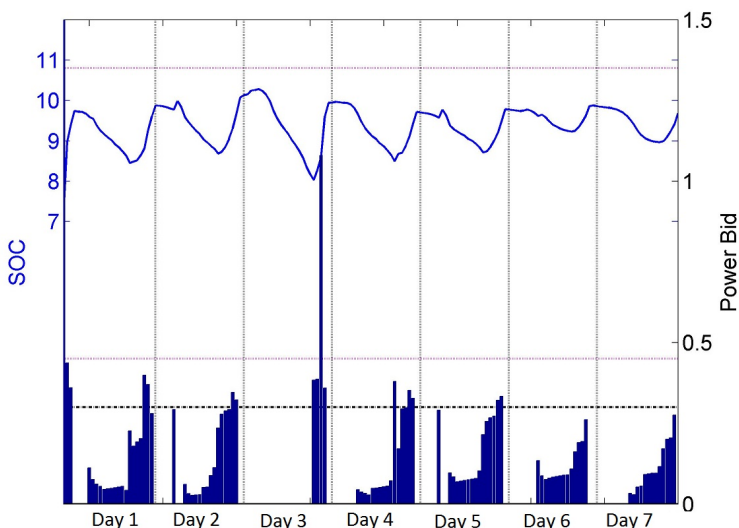

Figure 4.2.5: Hourly representation of bids placed in the day-ahead market and SOC with unidirectional capability with high wind penetration

if a variable tariff has not been signed up, will charge a fix price for the month independently to what is the time the electricity was consumed. The aggregator in this problem will charge taking into account when electricity is consumed. The other key assumption is Bids placed are considered small enough so no impact is made in the prices used for calculation. No sensitivity analysis was therefore necessary.

To better understand how much can be saved, a real electricity bill for a household is decomposed below. This bill corresponds to Eastern Denmark but it will be assumed that no significant differences apply with respect to Western Denmark.

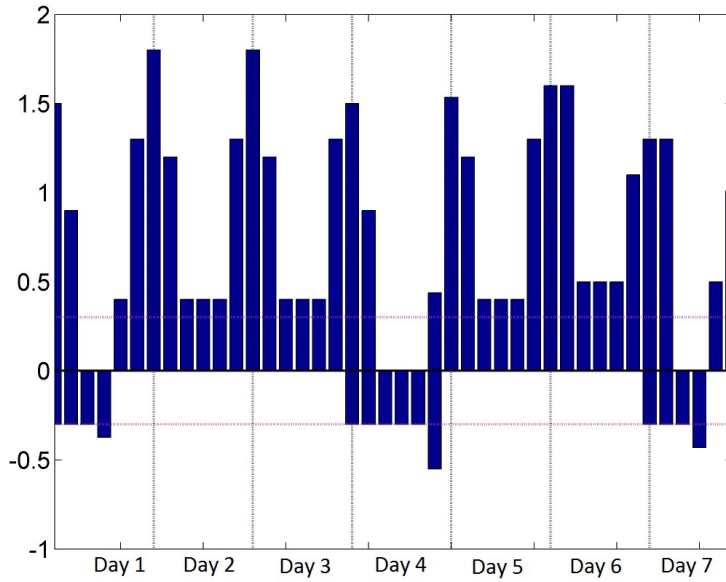

Figure 4.2.6: 4 hours block representation of Bids in the regulating market with unidirectional capability and a GSA

Electricity consumed (kWh) 336

**Payment for electricity (DKK)**

Basic price	68,0736
Electricity Subscription	69,6
VAT	34,4184
SubTotal	172,092

**Payment for distribution and taxes (DKK)**

Transport	127,008
public commitments	71,904
network subscription	99,01
electricity tax	295,008
VAT	148,2325
SubTotal	741,1625
Total	913,2545

Table 4.4.1: electricity bill

A electricity bill is not only composed composed of the actual cost of purchasing electricity but also subscription fees, cost of transport, public service obligation, VAT and electricity charges. If these elements are arranged the following chart pie

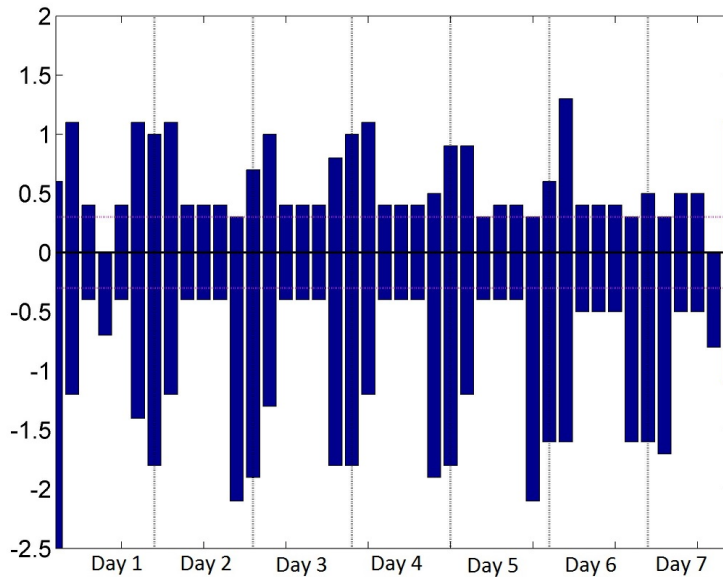

Figure 4.2.7: 4 hours block representation of Bids in the regulating market with V2G capability and a GA

is created:

As it was already introduced by [6], only a small part goes to electricity, which encompasses basic electricity and electricity subscription. From the other expenses, transport, public commitments and electricity tax is proportional to the amount of energy consumed so a reduction could be obtained also in those elements. Electricity subscription is considered constant for all cases but it is dependent on how much power is subscribed to the network operator. If a Electric Vehicle is purchased, some higher rates than the one showed here might apply as some more power might be contracted. For the aggregator, the share that previously was allocated for "network subscription" in table 4.4.1 will remain the same value and represent revenue for the aggregator.

Therefore, savings will come from a cheaper electricity and from purchasing in the day-ahead market less electricity when applied.

#### 4.4.1.1 Price of electricity

Price of electricity is composed from a basic price from purchasing at the day-ahead market ("Unitary cost" in the table below) and then a fixed value accounting for the cost of providing regulation and some other services to guarantee operability of the electric power system ("Fixed costs") [17]. The fixed costs are same for all schemes. Values refer to the total consumption and energy cost for the whole fleet of EVs.



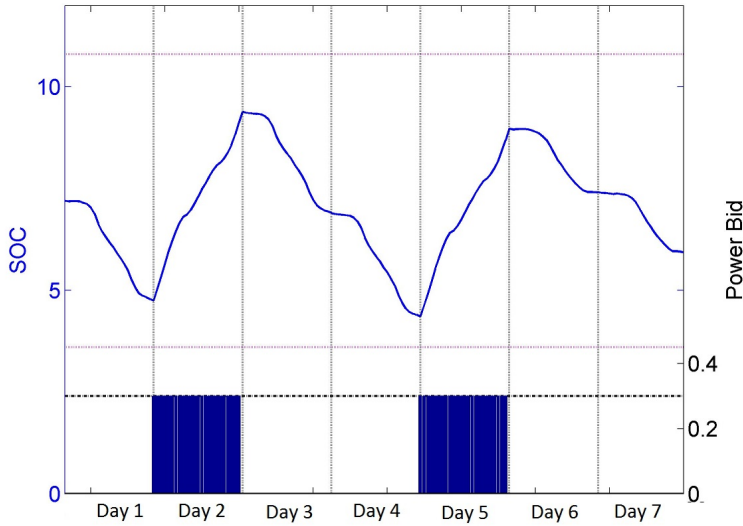

Figure 4.2.8: Hourly representation of the SOC and Power Bids in a day of low wind penetration and unidirectional capability with GA optimization algorithm

	Energy (MWh)	Cost (mDKK)	Unitary cost (DKk/kWh)	Fixed Cost (DKK)	Price of Electricity (DKK)
Non-controlled	891,69	223,9	0,251	0,04	0,291
Adaptive	822,91	174,6	0,212	0,04	0,252
GSA	845,80	188,9	0,223	0,04	0,263
GA	835,60	185,3	0,222	0,04	0,266
DE	843,09	195,1	0,231	0,04	0,271

Table 4.4.2: Average price of electricity for a whole year for the fleet of EVs if unidirectional capability

#### 4.4.1.2 Costs relative to consumption of electricity

As described when the bill expenses were introduced (figure 4.4.1), other expenses costs apart from the basic price are subjected to how much it is consumed. Real values applied to such bill are:

	DKK/kWh
Transport	0,378
Public Commitments	0,214
Electricity charge	0,878

Table 4.4.3: Costs applied to the energy consumed

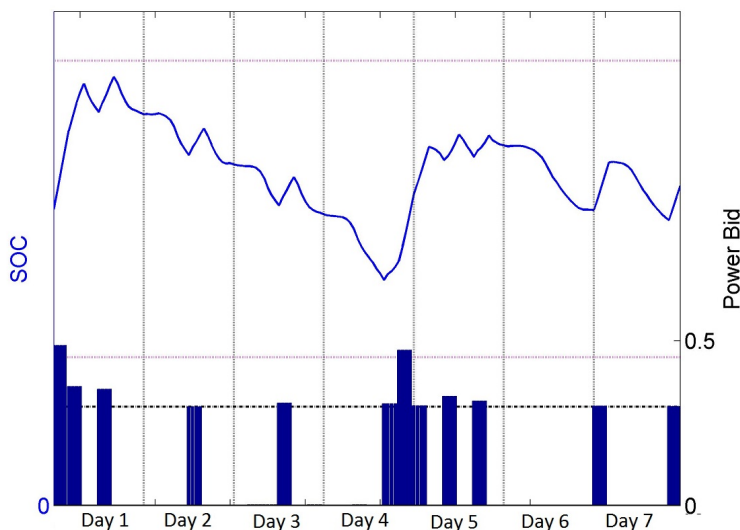

Figure 4.2.9: Hourly representation of the SOC and Power Bids in a day of low wind penetration and unidirectional capability with DE optimization algorithm

Using the assumed values for cost of electricity and extra energy costs and the energy purchase calculated, it yields figure 4.4.2 presenting all the results:

The lowest cost of electricity is 0.242 DKK/kWh when using a EV with bi-directional capability and a GSA is applied. The total cost of purchasing electricity with V2G is around the same as with the non-controlled schemes mainly because more electricity is purchased. For unidirectional capability, Basic adaptive scheme attains both the lowest unitary cost (0.252 DKK/kWh) and the lowest overall cost (4640 DKK).

In the next section the revenues from providing frequency regulation will be calculated to better compare which scheme is more beneficial for the user.

#### 4.4.2 Earnings: Participating to Regulating Market

Earning by participating to ancillary services have decreased almost to half from 2014 to 2015 due to the fact that demand was also reduced to half since the opening of Skagerrak 4 that introduces an agreement with Statnett.no to provide 10 MW of provisions (subsection 2.1.3.2). This reduction is best appreciated in the graph for the empirical cumulative distribution of prices for 2014 and 2015 (figure 4.4.3).

Until June the 24<sup>th</sup> 2015, the distribution of upward regulation reserves was fairly constant, with a probability of 80% for a payment of 54,6 DKK/MW and 32,4 DKK payment on 20% of the times and a maximum payment of 425 DKK/MW up to the date. Downward regulation was also studied until the above mentioned date and comparison can be seen in figure 4.4.4

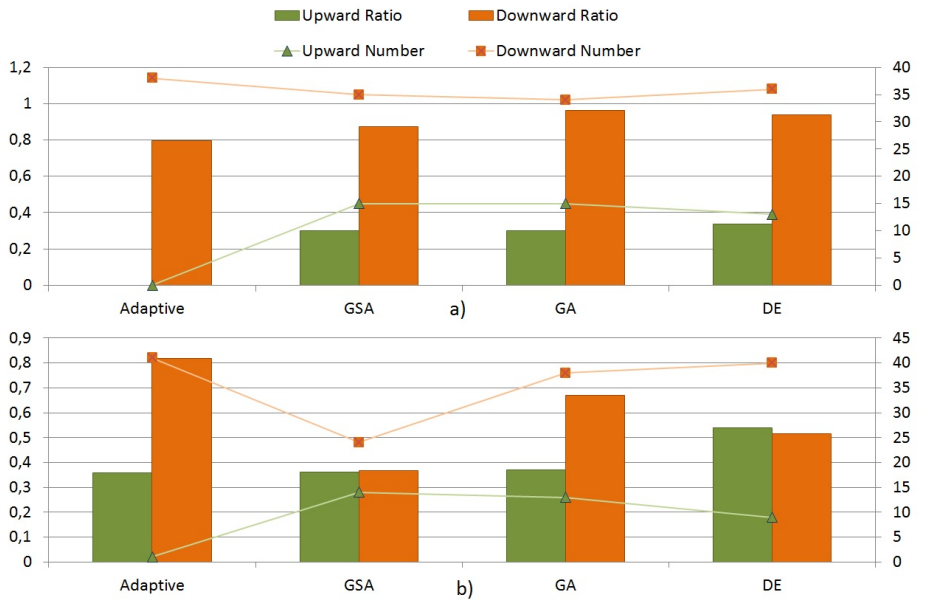

Figure 4.3.1: Comparison of Power available to be offered for frequency regulation with unidirectional capability for a week with a) low wind penetration and b) high wind penetration

In the case of downward regulation, probability is already more concentrated. 20% of the cases the revenue will be 4,25 DKK/MW per hour or below and in 80% probability the revenue was around 7 DKK/MW. Peak value was 310 DKK/MW.

This new agreement with Statnett.no means that the revenues are lower but less uncertain as can be appreciated by the fact that the lines are quite straight up until around 80% of the times. On the bad end, revenues are sensibly lower. Still, and following the initial strategy in the optimization functions, number of times that power can be offered prevails over total volume offered most specially for upward regulation because it shows higher dispersion of the values (standard deviation is 52). In the case of downward regulation a much smaller dispersion arises (standard deviation 20) so number of bids is not of such high significance.

This trend shows that lower demand yields lower revenues. If the offer even increases because of Electric Vehicles and other flexible loads get to participate, the revenues will go even lower. Nevertheless, Energinet.dk strategy is to have common markets for frequency-controlled reserves across the synchronous areas which might allow increase of demand to danish players.

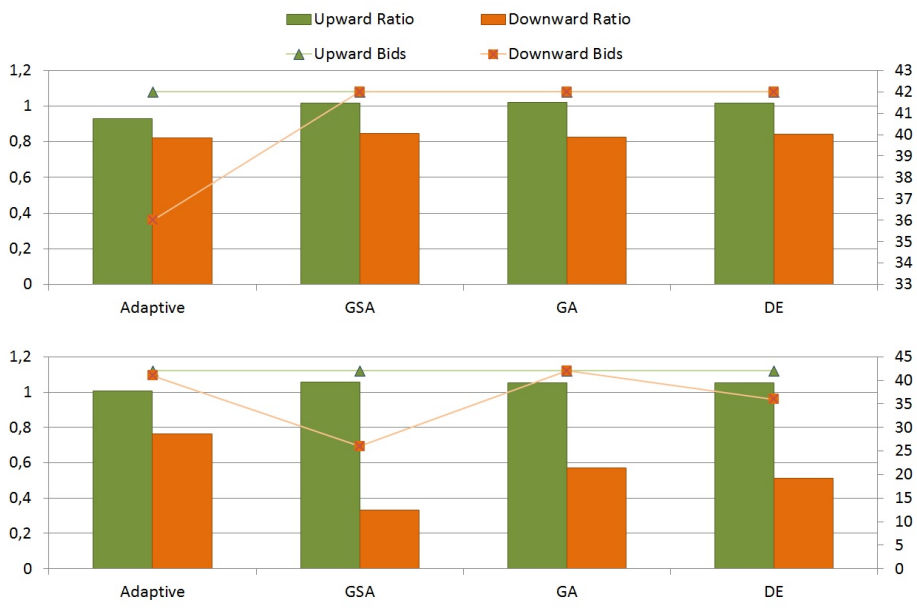

Figure 4.3.2: Comparison of Power available to be offered for frequency regulation with bidirectional capability for a week with a) low wind penetration and b) high wind penetration

### Earning estimation

Because of the significant change in revenue from 2014 to 2015, data from the latter seems much more realistic for a future 2020 scenario. As it is the current year, data is incomplete and it has been completed by duplicating the first half of the year as no significant differences are expected from first semester to second. This characteristic of prices behaving similar in the first and second semester was studied for 2014 and mean values and standard deviation were very approximate.

Earnings are calculated in the following way:

1. From tables 4.3.2 and 4.3.3 the percentage of times that a scheme can be participated to ancillary services is calculated.
2. Using this percentage of participation, a series of 100 simulations are run with the real payment from each of the services and mean value and standard deviation are calculated.
3. The revenue is calculated by multiplying the payment for each hour of service provided by the ratio of power in frequency regulation (total power offered divided by number of times a bid is made).

Total earnings using unidirectional capability are presented in figure 4.4.5 and with bidirectional capability in figure 4.4.6 GA yields the highest revenues with unidirectional capability, 247 DKK per user in one year, and has a standard deviation

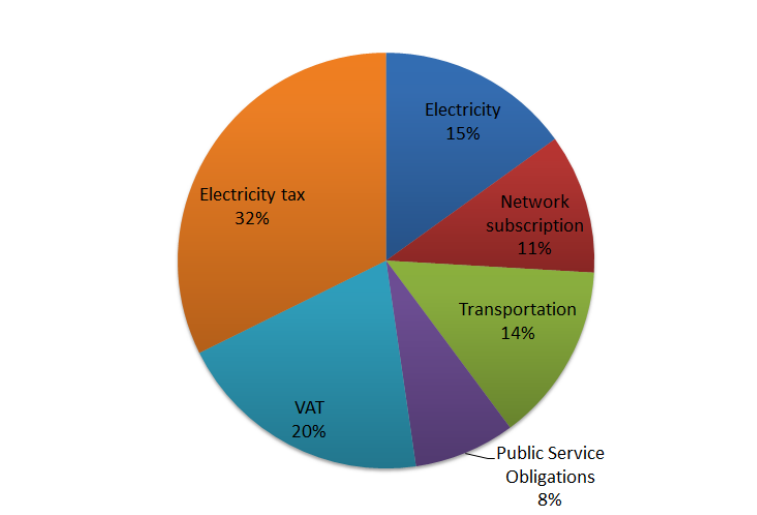

Figure 4.4.1: Pie chart with the contribution of the different elements in the bill to the final price

of 5.4 for upward regulation and 2.9 for downward.

Bi-directional capability yields around 5 times more revenues than uni-directional. Most of this revenue comes from upward regulation which offers higher payment for power capacity. GA offers again the highest revenue, 1385 DKK per user a year, with standard deviation of zero for upward regulation (it is offered in all available cases) and standard deviation of 2,2 for downward regulation.

#### Taxes applicable to capital income

Results would be misleading if taxes are applied to electricity cost but not to earnings. Following some basic guidelines, a tax rate of 30% could be applied to capital income that comes on a side from employment income. This deductions will be applied in the following section.

#### 4.4.3 Final Cost

The final cost is calculated as the difference between the total cost of purchasing electricity in the day-ahead market and the revenues by participating to ancillary services after deducting taxes (figure 4.4.7).

If the total cost of purchasing electricity and the revenues are included, a EV user with V2G capability and a basic adaptive scheme would get the lowest cost which is of 4100 DKK a year and represent a 20% reduction with respect to a non-controlled algorithm. The revenues are something smaller than with the optimized algorithms but it compensates by purchasing lower amount of energy. Also, if a different

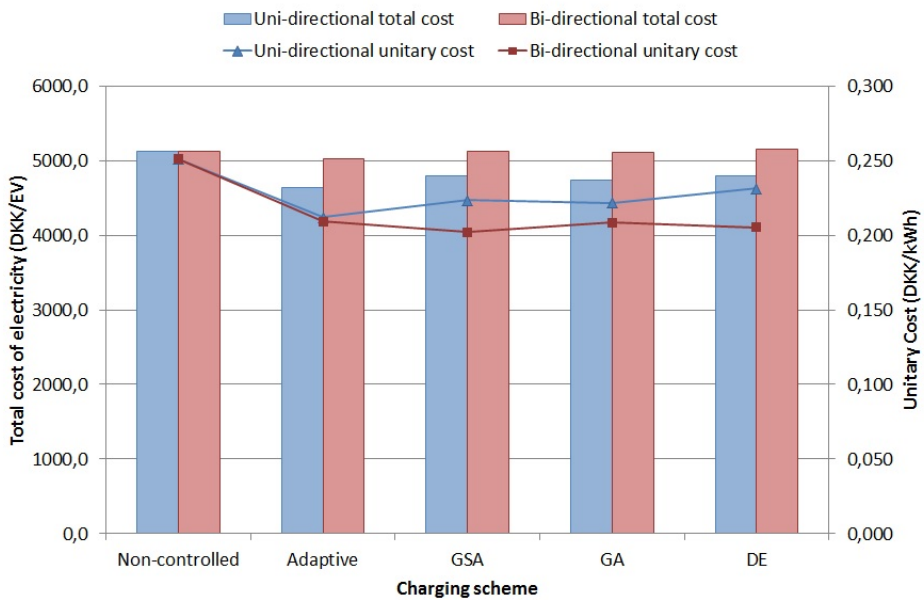

Figure 4.4.2: Comparison of cost with unidirectional and bidirectional capability for different charging schemes (DKK per EV owner)

tax rate would apply to the revenues results could be something different. If only uni-directional capability is available, again a basic adaptive scheme based in weight factors yield lower cost, 4535 DKK a year and reduction of 11% with respect to reference scheme, in this case mainly to a lower purchase of energy.

## 4.5 Socioeconomic Impact

This section analyzes benefits to society rather than just simple economics and revenues for the users.

### 4.5.1 Net wind energy penetration

To assess the net wind energy content the share of the different production facilities is compared. Production facilities are divided into Centralize, Decentralize and Wind. The presence of other production sources as solar is not taken into account. The data comes from Energinet.dk's ftp server for the year 2014. It is a 5 minutes resolution data and a mean value for each hour is used. Simplification is made that energy available is solely from any of these production facilities. Imports and exports which are assumed to be net balanced along the year.

Figure 4.5.1 shows wind energy as the major contributor when any of the adap-

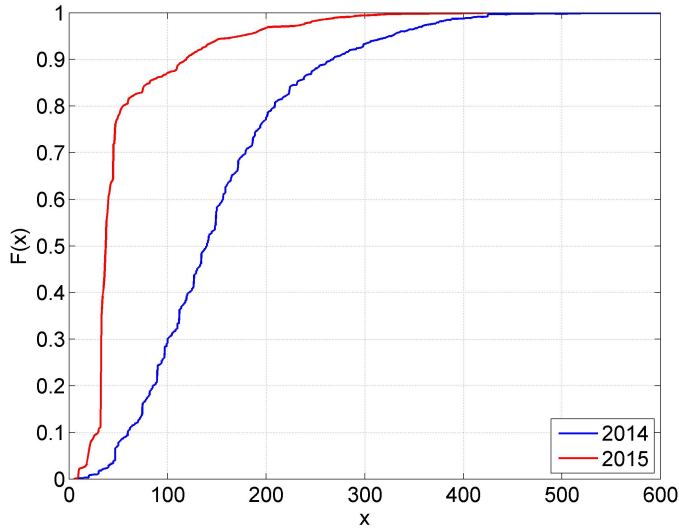

Figure 4.4.3: Empirical cumulative distribution function for the payment to primary upward regulation provision (DKK/MW per hour)

tive schemes is used. A difference is made when bi-directional capability is used as it allow a 36% more share of wind with Genetic and Differential Evolution Algorithms compared to the 22% that GSA provides with uni-directional capability.

When the whole picture is contemplated, a content of 55% of wind in the battery of each of the 23000 EVs in DK1 by 2020 will mean some 50 GWh of wind produced energy consumption. If compared to the expected production of 13773 GWh (table 2.2.1), it does not represent even the 0.5% of the whole wind energy produced.

#### 4.5.2 $CO^2$ Reduction

$CO^2$  reductions can be assessed by two actions: In one hand, by charging at times when energy has a bigger share from wind and also by the act of providing frequency regulation with EVs rather than with the conventional sources units fired fully by coal or gas.

When considering the energy content in the battery, the portion that was obtained by providing downward regulation will be assumed to have the base content of a non-controlled scheme.

Figure 4.5.2 clarifies that GSA algorithm with bi-directional capability offers the best results for  $CO^2$  reduction with a 16% cut down, same as DE. About frequency regulation, using information introduced in 2.1.3.1, in case it is

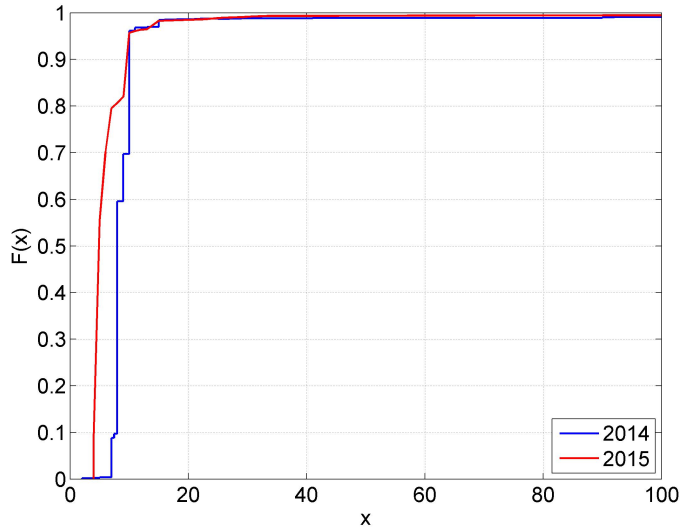

Figure 4.4.4: Empirical cumulative distribution function for the payment to primary downward regulation provision (DKK/MW per hour)

provided by EVs the reduction is compared to units fired by coal and gas which are the most polluting type. One EV participating to upward regulation with bi-directional capability and GSA algorithm will have an energy content with a  $CO_2$  presence of around 270 gr/kWh, while coal and gas fired power plants have a  $CO_2$  content of 700 gr/kWh. That will represent a reduction of 60% of  $CO_2$  emission on the provision of upward regulation.



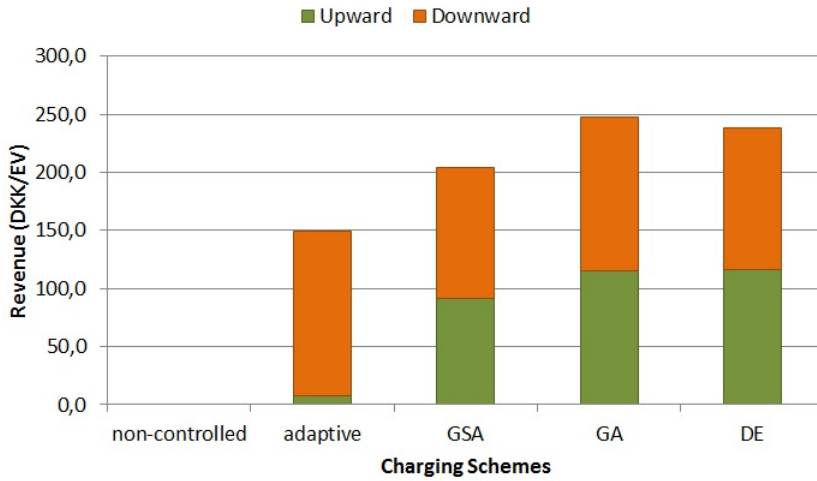

Figure 4.4.5: Total earnings per year by provision of ancillary services (DKK) with unidirectional capability

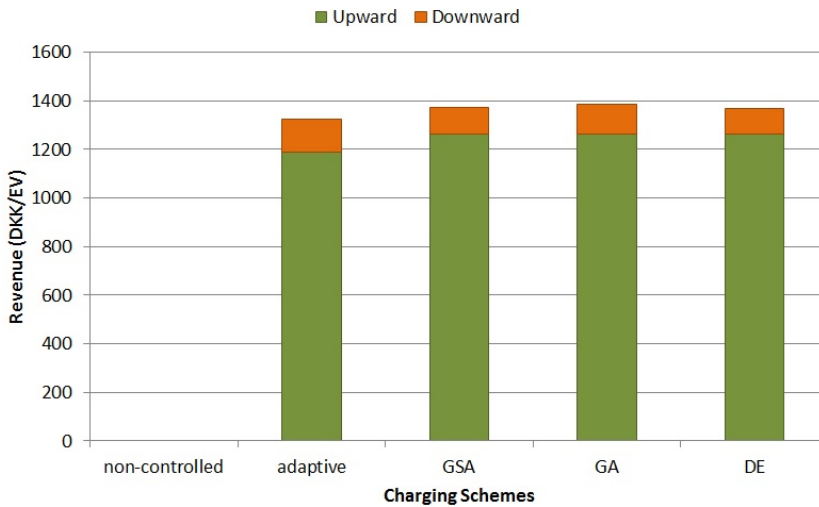

Figure 4.4.6: Total earnings per year by provision of ancillary services (DKK) with bidirectional capability

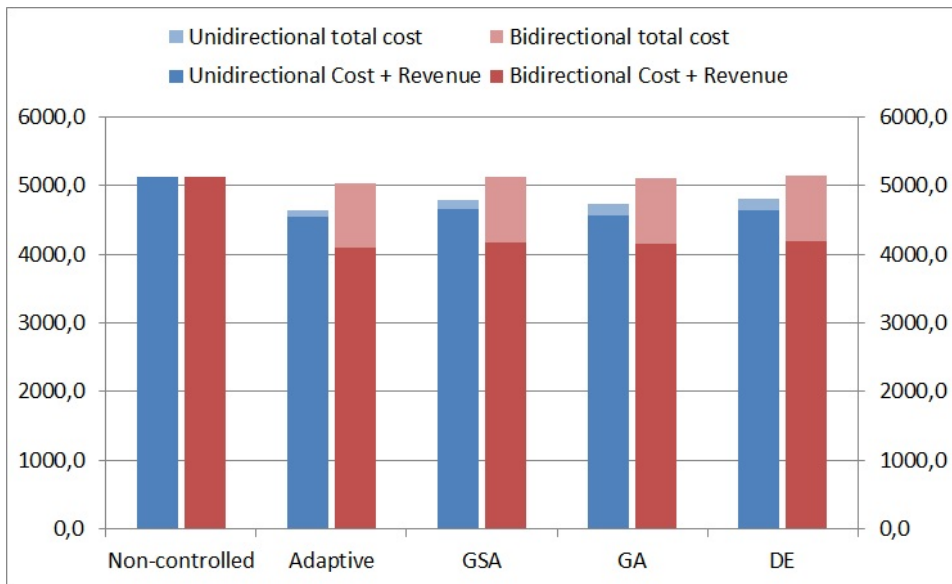

Figure 4.4.7: Final cost per year per EV user in DKK

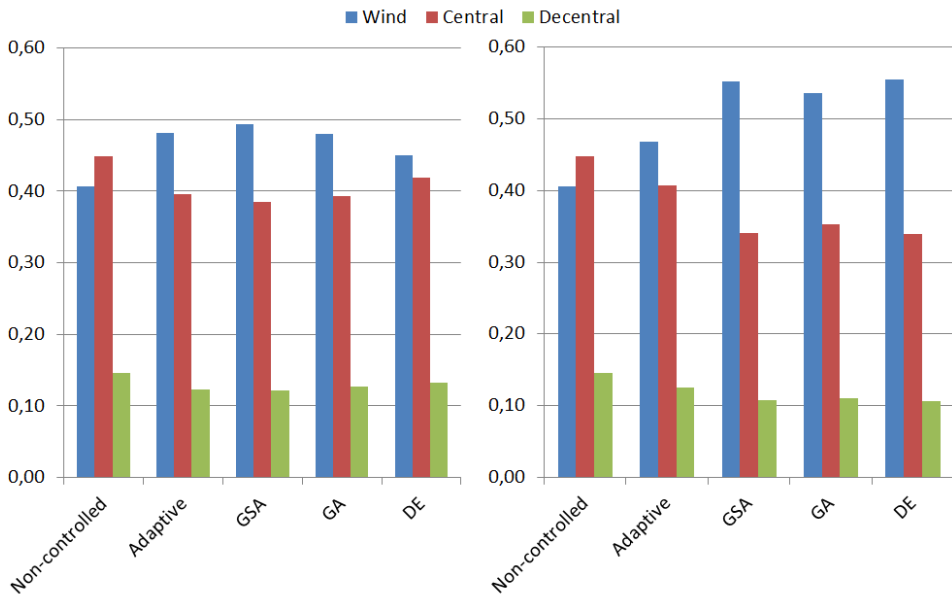

Figure 4.5.1: Share of each production type in the charge of the battery with a) Unidirectional capability and b) Bi-directional capability

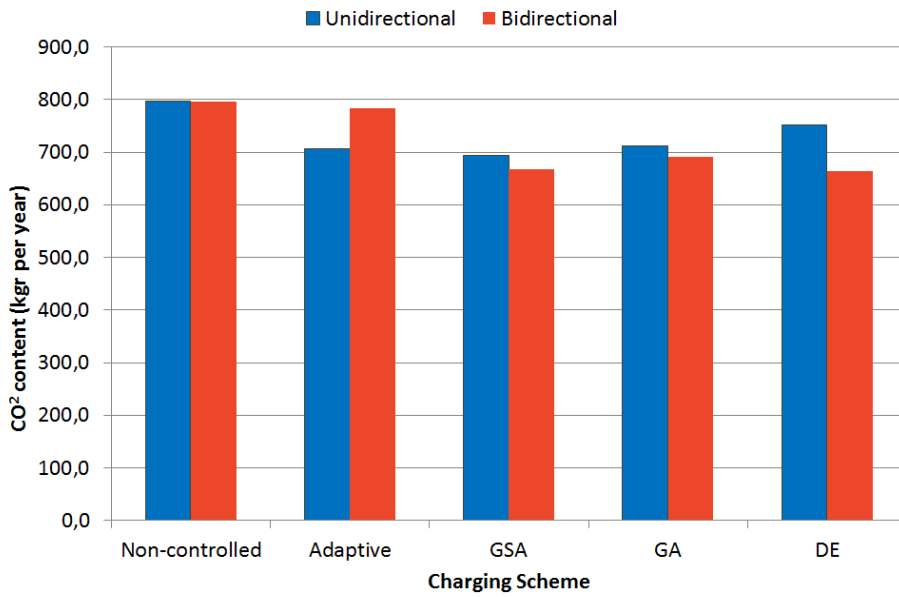

Figure 4.5.2: CO<sub>2</sub> content in the energy charged per year and per EV

## Chapter 5

# Conclusions and future work

An adaptive charging method based on forecast wind production has been probed here as a simple and reliable way to grant lower prices and higher wind penetration. A combined participation to both markets is also possible while not interfering with the normal usage of the Electric Vehicle. Any of the strategies following adaptive charging was able to cut the total expenses one year by almost 20% if a bidirectional capability was used. In case of using unidirectional capable batteries, reductions are limited to around 10%.

Among the optimization algorithms, in terms of total cost of electricity and revenue, the Genetic Algorithm seems to provide the best results but again there is no significant difference with the other two. The basic adaptive charging scheme based on weight factors achieves slightly lower revenues but due to the fact that also purchases lower amount of energy it yields the lowest overall cost. When the socioeconomic benefits are considered, optimization results due to its ability to assess a whole week data before making a decision bring some 15% more wind penetration when bi-directional technology is used.

400 EVs have been simulated here for provision of frequency regulation. Considering the case of lower availability, central hours of the day, 15000 EVs following the strategy proposed here will cope the whole market of upward frequency response regulation. The reduction seen in 2015 of cutting the demand of frequency regulation to half has also cut revenues almost to the same extent. With more EVs incorporating to the frequency regulation market the offer for provisions is increased and the price will drop further and see less dispersion. Nevertheless, if the recommendations of Energinet.dk are followed and the market is expanded to continental Europe it may bring new demand and rise prices again. In this context unidirectional capability has the advantage over bidirectional because it does not depend on uncertain prices for frequency regulation. Its price reduction is based on purchasing less energy because some is obtained collaterally "for free" by participating to ancillary services.

About the specific synergies between wind energy and EVs, in one direction EVs will benefit from Wind Energy because it yields to periods of low prices but in the other direction, Wind Energy will see less than 0.5% of its annual production consumed by EVs by 2020 using the best adaptive algorithm. Also the increase requirement of tertiary reserves from Wind Energy sees low probability of being covered by EVs due to the intense energy demand.

One extra advantage of the solution proposes in this work is the fact that it grants economic benefits while the charging scheme for the EVs is planned and known from the day-ahead. A popular solution to achieve better price for electricity in defining adaptive charging schemes proposes a real-time price signal [22] [27] [29]. This option would insert sudden and unpredicted load changes in the system that could create new imbalances.

## Future work

Along the development of this work some ideas for future studies have come out that would complement and reinforce the principles proposed here. On the topic of optimization algorithms, design an optimization problem that includes twelve variables as to represent both upward and downward frequency regulation bids in the same objective function and that takes into account weight function of the revenues will probably yield better results. More into mathematic studies, try to include the stochastic nature of EV driving pattern and connection hours to make the problem more realistic.

Further more, a sensitivity analysis of the impact over prices of loads reacting to the wind penetration signal will also be of the greatest interest as well as another sensitivity analysis about offer volumes of upward and downward regulation and revenues.

The next step about electric vehicles participating to the regulating market, and out of the scope of the 2020 scenario, is to perform a similar study of the number of EVs that could provide secondary regulation based on the same dynamic study that is presented here.

# Appendix A

## Energy Content in Ancillary Services

The energy requirement from the provision of Ancillary Services has been calculated in this section to assess how much impact the frequency regulation system will have on the battery. In the course of this project, the first data available was for East Denmark and later on data from West Denmark was obtained. Both are compared here.

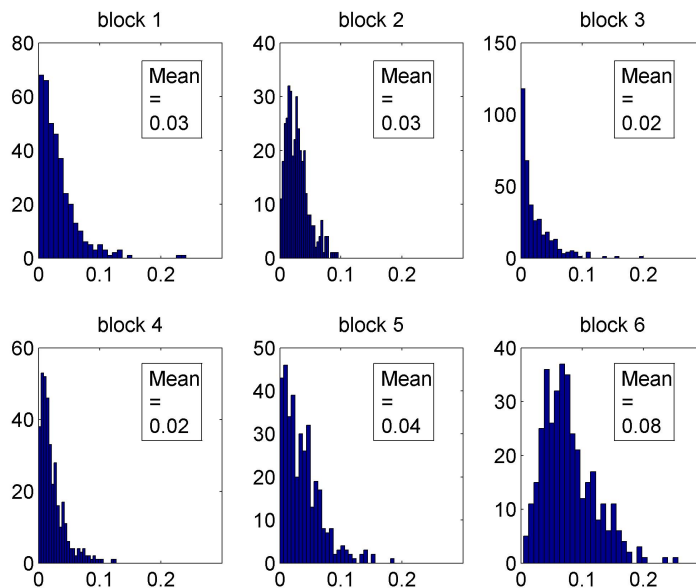

Figure A.0.1: Histogram of the ratio of  $E_{impact}/P_{bid}$  in Downward frequency regulation for West Denmark

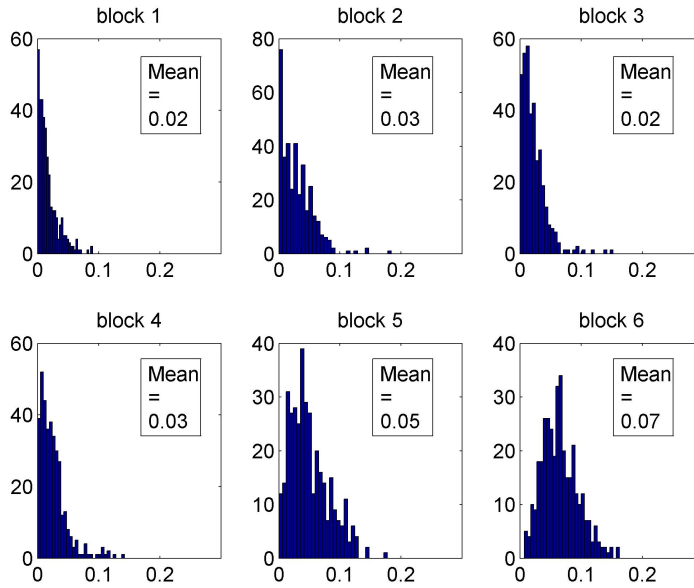

Figure A.0.2: Histogram of the ratio of  $E_{impact}/P_{bid}$  in Upward frequency regulation for West Denmark

## A.1 The Energy Market

The Danish electricity market is a part of the Nordic market model. In the wholesale market most of the electricity trading takes place on the common Nordic power exchange, Nord Pool, which is owned by the transmission system operators in the Nordic countries.

Nord Pool has divided the Nordic market area into bidding areas, with Denmark being divided into two areas separated by the Great Belt. One of the consequences of this is that all physical trading between areas must take place via Nord Pool.

In the spot market, Nord Pool uses implicit auction, which means that transfer capacity is allocated while electricity is traded. When there is a lack of transfer capacity (congestion), the Nordic area is divided into various price areas (market splitting), which may consist of one or several bidding areas.

### A.1.1 Day-Ahead Market

Elsport is based on the auction principle, which means that once a day Nord Pool will find a market price for the various price areas by matching purchase and sales bids. There is a fixed time schedule that operates as follow:

Before 10:00, the Nordic TSOs announces how much capacity is available for the spot market for the next day.

Before 12:00, the electricity suppliers and producers send purchase and sales bids for the next day to Nord Pool.

Before 13:00, Nord Pool matches all purchase and sales bids, giving due consideration to the restrictions in the power system, and sends BRP notifications to the individual electricity suppliers and producers together with information about traded amounts and prices for the next 24 hours.

### A.1.2 Intra-Day

It is the trade that takes place during the day of operation when the power exchanges (day-ahead market) are closed. In this market players can trade themselves into balance. Elbas is available on the interconnection to Norway (Skagerrak), Sweden (Konti-Skan and Øresund), Germany (Kontek) and on the Geat Belt Power Link.

### A.1.3 Regulation market

Suppliers must enter into a main agreement with Energinet.dk concerning the supply of ancillary services. The main agreement sets out the framework within which transactions take place on an ongoing basis. Main agreements are made only with balance responsible parties (BRPs) for production or consumption in Eastern or Western Denmark. Also, the plants which are to supply the ancillary services must be approved by Energinet.dk.

To participate in the frequency regulation market bids are made before 15:00 to Energinet.dk and by 15:30 an email is sent with the participants accepted and the price to be paid. This price is set up by the last bid to be accepted. Bids are arranged in blocks of 4 hours and have a minimum size of 300kW. The response has to be proportional to the frequency deviation. The frequency response will respect a dead-band of 20 mHz. After that and until a frequency deviation of maximum 0,2 Hz the power response must be linear. Downward regulation has to be provided from 50,02 to 50,2 Hz and upward regulation from 49,98 to 49,8 Hz. The power has to be delivered in half within 15 sec and full output in 30 sec, being able to last up to 15 minutes when secondary regulation takes over. In the case of more than 15 minutes of continuous provision there is a period afterwards of 15 minutes before providing regulation again.

## A.2 Regulation Capability Response

When an extra load is connected to the power system and imbalance is produced. The rate at which the frequency drops depends on the total angular momentum (rolling inertia) in the system. That rotating inertia is also understood as the short circuit power. Synchronous condensers are currently being reintroduced in the



power system to provide that lack of rotating inertia.

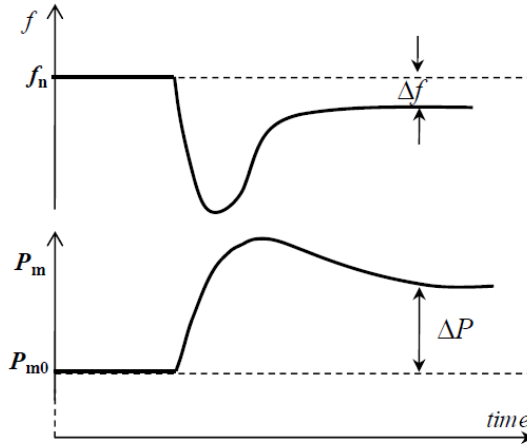

Figure A.2.1: Time response of a unit when the system frequency drops

It is worth noticing that frequency deviation  $\Delta f$  refers to the new steady state the system frequency has reached after a transient change in produced power  $\Delta P$ . During the first seconds of the transient change  $\Delta P$ , the frequency deviation typically gets higher values depending on the rotating inertia.

The process of stabilizing the frequency to a steady state value is performed through the primary control function, while the process of restoring is known as secondary control.

**Primary control:** Provided automatically by fast generating units through a frequency droop control loop. The frequency is stabilized to a lower level than the initial one. The power set-point ( $P_{ref}$  in figure A.2.1), which is the power delivered at nominal frequency, is fixed.

**Secondary control:** also called Load-Frequency control. It re-distributes load among various generation units to restore the frequency back to its nominal value. As a matter of saying, it modifies  $P_{ref}$  to match nominal frequency for the new found power demand (figure A.2.2). As a result a unit can produce more at the same frequency.

Each generating unit is driven by a prime mover and controlled by a governor that senses the speed changes of the turbine and controls it to a predefined set point value. The most used time nowadays is the Speed-Droop governor. It controls the frequency taking the generator loading into account. It provides the primary control function preventing counter-activation of reserves over large areas that will lead to frequency oscillation and instability. Secondary control will imply the modification

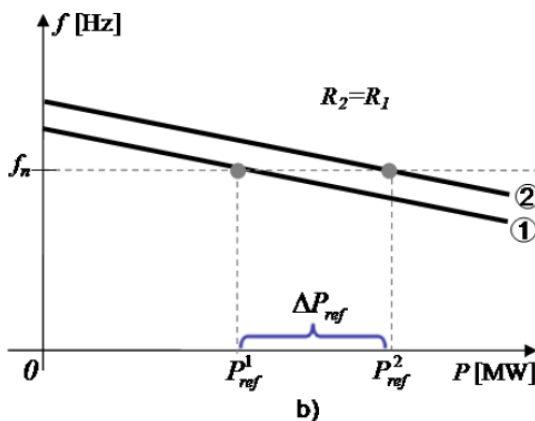

Figure A.2.2: Implication of changing the droop and the power set point of a unit

of the load associated to each unit in case the governed unit participate to secondary control.

### Droop Characteristic

Is a steady-state power-speed characteristic. It reflects an idealized relation between the system frequency and the power, which can be delivered by a generating unit into the system during its operation. According to the curve, the power of the unit slides back and forth to match the power consumption, regardless of the frequency. As its own, it is not a control system.

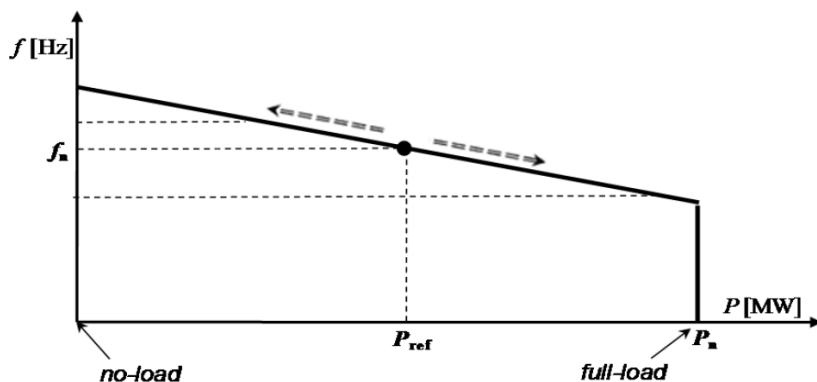

Figure A.2.3: Steady State droop characteristic

The droop of an unit is the percentage of the frequency change required for a governor to move a unit from no-load to full-load.

$$R = -\frac{\Delta f/f_n}{\Delta P/P_n} \quad (\text{A.2.1})$$

### Frequency Bias

It reflects the ability of an unit to compensate for a frequency deviation of 1 Hz. The larger the bias, the more power that needs to be varied to have a deviation of 1 Hz.

$$B = -\frac{\Delta P}{\Delta f} \quad (\text{A.2.2})$$

The steady state deviation in frequency from the initial steady state produced by a changing in power can be calculated as:

$$\Delta f = -\frac{\Delta P}{B_{PS}} \quad (\text{A.2.3})$$

It represents the ability (reserve) of an unit to compensate for 1 Hz deviation. This parameter could be used to compare technologies such as heat pumps and EVs.

## A.3 Interconnections to neighboring countries

The following is a description of the current interconnections existing between Denmark and the neighboring countries.

Table A.3.1 shows the future evolution of the interconnections for 2020.

Interconnectors (GW)	2015		2020	
	Export	Import	Export	Import
DK2 to SE	1,7	1,3	1,7	1,3
DK2 to DE (Kontek)	0,6	0,6	0,6	0,6
DK2 to DE (Kriegers Flak)	0	0	0,4	0,4
DK1 to NO (Skagerrak)	1,7	1,7	1,7	1,7
DK1 to SE (Konti-Skan)	0,74	0,68	0,74	0,68
DK1 to DE	1,78	1,5	2,5	2,5
DK1 to NE (COBRAcable)	0	0	0,7	0,7
DK1 to DK2	0,6	0,6	0,6	0,6
Total	7,12	6,38	8,94	8,48

Table A.3.1: Transmission capacity between Denmark and neighboring countries

Apparently, only VSC is capable of black start.

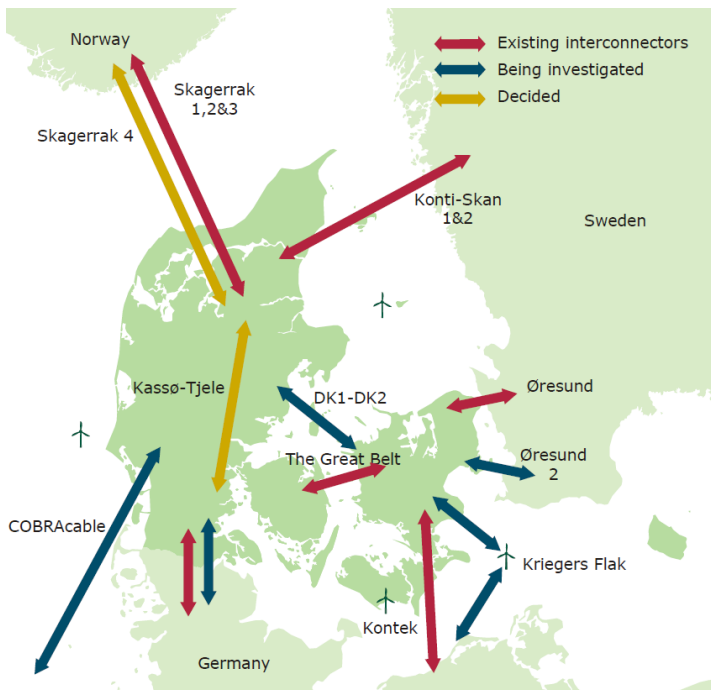

Figure A.3.1: Existing and planned interconnectors

### West Denmark to Norway

West Denmark is connected to Norway via the Skagerrak HVDC connection between Kristiansand (Norway) and Tjele (Denmark). It comprises 4 different cables.

Skagerrak 4 is capable of black-start due to its VSC technology. Currently, the system is 4 poles with 2 of them being bipolar. Nevertheless, 1, 2 and 4 are coupled together with 3 working as return.

Export capacity of

	Mode	Technology	Maximum power (MW)	Voltage (kV)	
				DC	AC
Skagerrak 1 & 2	Bipolar	Thyristor valves	2 x 250	250	300
Skagerrak 3	Monopolar	Thyristor valves	500	350	300
Skagerrak 4 <sup>(1)</sup>		VSC (thyristor)	700	500	400

<sup>(1)</sup> Became operation at the end of 2014.

### West Denmark to Sweden

The interconnection to Sweden, Konti-Skan, consists of two 285 kV DC connections with a total transmission capacity of 740 MW. The export capacity from Jutland is 740 MW, and the import capacity is 680 MW. The two connections were established in 1965 and 1988. In 2006, substation equipment relating to the oldest interconnection was replaced, which increased the total transmission capacity to 740 MW from the earlier 630 MW.

### West Denmark to Germany

The interconnection to Germany consists of four AC connections. Two 400 kV connections which start from Kassø and two 220 kV connections which start from Kassø and Ensted Power Station respectively. In addition to the four AC connections, there is a further 150 kV connection starting from Ensted Power Station to the city of Flensburg. The total transmission capacity is determined by congestions in the surrounding grids and is normally 1,780 MW in southbound direction (export) and 1,500 MW in northbound direction (import).

### West Denmark to East Denmark (The Great Belt)

The Storebælt HVDC is a 600 MW Line Commutated Converter (LCC) HVDC at a voltage of 400 kV. It consists of the Fraugde converter station on Funen connected to an existing 400 kV substation and the new Herslev converter station on Zealand connected to an existing 400 kV overhead line. The converter stations are supplied by Siemens Power Transmission and Distribution.[10] The interconnector includes 32-kilometre (20 mi) long sea cable, 16-kilometre (9.9 mi) long land cable on Funen and 10-kilometre (6.2 mi) long land cable on Zealand.

### East Denmark to Sweden

Four AC connections: two 400 kV cable connections and two 132 kV cable connections. Zealand has an export capacity of up to 1,700 MW to Sweden and an import capacity of up to 1,300 MW. The interconnection to Sweden is also a link to the Nordic grid.

### East Denmark to Germany

The interconnection to Germany, Kontek, is a 400 kV DC connection with a transmission capacity of 600 MW. The interconnection was established in 1995 in collaboration with the German company 50Hertz Transmission. Energinet.dk owns the Danish AC/DC converter station near Køge and the DC cable up to the German coastline.

## A.4 Reserves: Regulating and balancing

It is not easy to agree in a common term for the different types of Ancillary Services as different organisms will call them differently. This document will describe them as balancing reserves and regulating reserves.

Denmark operates separately the west part (Jylland and Fyn) to the East part (Sjælland). Both parts were recently interconnected via the Great Belt HVDC cable for stability and market coupling purposes A.3.

Another differentiation can be made regarding manual and automatic reserves. Automatic reserves are divided into frequency-controlled normal operation reserves (FNR), frequency-controlled disturbance reserves (FDR) and voltage-controlled disturbance reserves (which does not apply to Denmark). Manual reserves are divided into slow and fast reserves. No slow reserves are purchased in Western Denmark.

### A.4.1 Balancing reserves

Intended to keep the balance between production and consumption in the event of a frequency deviation, stabilizing the frequency at close to but deviating from 50 Hz. It can be upward or downward so both consumption or production units can deliver this service in an automatic manner and which response is proportional to the deviation value within a range of  $\pm 0,1$  Hz.

This type of reserve is defined as energy neutral as there is no net flow positive or negative balance of energy.

#### Balancing in DK1

Energinet.dk buys primary reserves at Daily auctions. Bids are placed until 15:00 the day ahead the day of operation. Bids must state an hour-by-hour volume and a price and are stated the same for upward and downward regulation. At 15:30, Energinet.dk informs the player of the bids accepted and the payment allocated on an hour-by-hour basis. It is in non-symmetrical of minimum size of 0,3 MW in blocks of 4 hours that can come from different sources as long as they can act as a single unit. Deadband of  $\pm 20$  mHz exist. The power has to be delivered at half within 15 sec and full output in 30 sec, being able to last up to 15 min, when the other reserves will take over. Following the end of the regulation, the reserve must be re-established after 15 minutes.

Import/Exports of primary reserves are allowed from neighboring countries as long as interconnection capacity is sufficient. The volume that DK1 can export for such purposes is up to  $\pm 90$  MW.

## Balancing in DK2

Very similar to the regulation in DK1 but Some differences apply. The provision has to be symmetrical, where both reserves are purchased together and the supplier must provide upward and downward regulation together, being activated within 150 sec. The allocation of reserves is defined commonly for all Nordic region and according to Entso-e it is of 600 MW. Energinet.dk is responsible for guaranteeing a proportional share which in 2012 was of  $\pm 23$  MW.

### A.4.2 Regulating reserves

This reserves are used for regulating the frequency following substantial frequency drops resulting from the outage of major generation plants or lines.

#### DK1 - Secondary reserve

In West Denmark the units providing secondary reserve follow the "Load Frequency Controlled" (LFC) control to indirectly restore frequency to 50 Hz following the stabilization of the frequency by means of primary regulation. It consist of a symmetrical upward and downward regulation reserve though in this occasion consumption and production units cannot participate in the same type of reserve. Response time is of 15 min and is mainly supplied by units in operation.

It is bought on a monthly basis by Energinet.dk following the recommendations of Entso-e for  $\pm 90$  MW for DK1, nevertheless Energinet.dk can decide to increase such reserves. The LFC reserve is activated on a pro rata basis and settled at a price fixed by Energinet.dk:

- Upward regulation reserves: Settled per MWh at the DK1 Elspot price + DKK 100/MWh, but not less than the balance price for upward regulation.
- Downward regulation reserves: Settled per MWh at the DK1 Elspot price -DKK 100/MWh, but not more than the balance price for downward regulation.

Only players having sold LFC capacity can be activated.

#### DK2 - Frequency controlled disturbance reserve

It is only upward regulation activated automatically of drops below 49,9 Hz and remains active until the frequency has been restored or manual reserve takes over. The volume is related to the dimensioning fault and is bought in collaboration with Svenska Kraftnat. Energinet.dk's share in 2012 was approximately 150-180 MW. Energinet.dk's actual required purchases often range between 25 and 55 MW as some of the disturbance reserve is supplied to the ENTSO-E RG Nordic area from the HVDC interconnections between Germany and Zealand, Jutland and Sweden and Jutland and Zealand.

Supply of 50% of the response within 5 seconds and the remaining 50% within 25 seconds. Delivery can be made up of supplies from several production units and also from consumption units with different properties but that collectively can provide the required response.

#### Manual Reserves - DK1 & DK2

Manual reserve is a manual upward and downward regulation reserve which is activated by Energinet.dk's Control Centre. It is activated by manually ordering upward and downward regulation by the relevant suppliers and relieves the LFC and the frequency-controlled normal operation reserve in the event of minor imbalances and ensures balance in the event of outages or restrictions affecting production plants and international connections.

It must be supplied in full within 15 minutes. The reserves in Western Denmark are purchased at daily auctions, while in Eastern Denmark they are purchased under five-year contracts.

This means that Energinet.dk's total purchases of manual reserves are now 900-1,000 MW, with 675 MW being purchased in Eastern and approximately 250 MW in Western Denmark. The reserves are sorted in Western Denmark because the dimensioning fault principle is applied but the amount of LFC reserves, reserves at emergency start-up plant entered in the regulating power market and the 300 MW on the Great Belt Power Link is subtracted.

## A.5 The Nikola Project

The Nikola project is actively looking at synergies between the electric vehicles and the power system. With sufficient control and communication it is possible to influence the timing, rate and direction of the power and energy exchanged between the EV battery and the grid. This ability can be used in a set of "services" that bring value to the power system, the EV owner and society in general.

Nikola is divided into four working packages:

- WP1: System-wide Services - will both investigate services that can be provided through current A/S products as well as services not yet enveloped by a market product. Some of the examples of these services are off-peak charging, Primary reserves and Secondary reserves.
- WP2: Distribution grid services - investigates the integration of the electric vehicle in the distribution grid. Some of the services to be demonstrated are overvoltage management, transformer and line capacity management and islanded microgrid and black start.
- WP3: User added services - where the involvement of EV owners in EV services is studied. Example of services are: automatic charging flexibility assessment and reduce complexity for end-users to participate in such services.



- WP4: Enabling technologies and standards. Example of services are: fast charging, intelligent vehicle pre-conditioning, vehicle data logging and controller development and programming.

# Appendix B

## Matlab Script

This section offers information about the additional code Matlab code provided with this report. All data refers to 2014 except the revenues for participating to frequency regulation that are 2015. The Matlab files are structured in the following way:

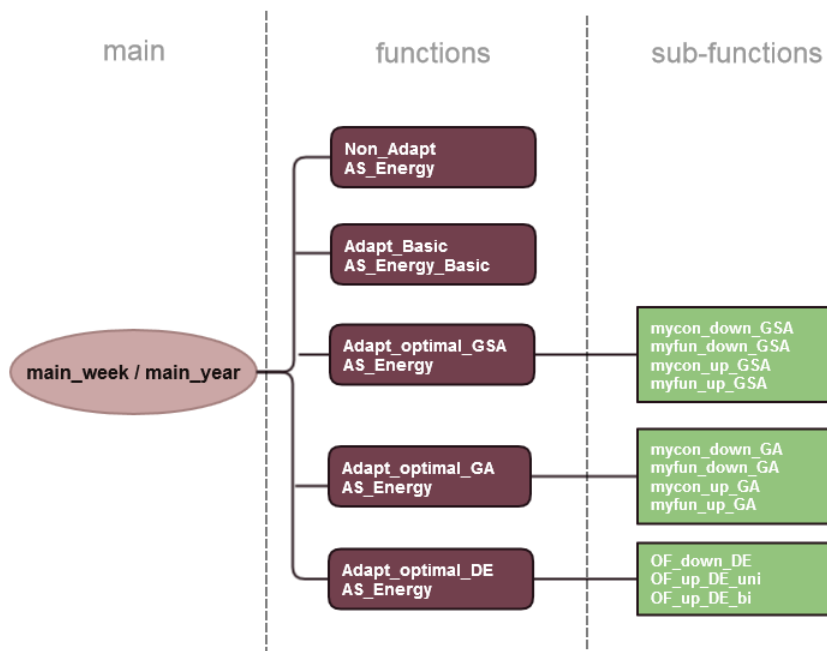

Figure B.0.1: Architecture of the Matlab function.

The control level can be divided in three steps: main scripts, functions and sub-functions. Only the optimization algorithms use sub-functions. The "main\_week" script will allow calculations of either a week of high or a week of low wind penetration and will show a series of plots with the most relevant results. The "main\_year"

script executes the selected function for a whole year and does not generate any plot. Both scripts will generate a .mat file that can be later called from an additional function that integrates all values in an excel file from which all the tables and graphs in the "Simulation Results" chapter have been obtained.

### .mat files

- content.mat Matrix with the different share in production each hour of the year.
- Day.mat It is a structure prepared to accommodate the values generated in the week representation.
- DK1.mat It is a structure Has data for years 2013 and 2014 of prices in the spot market, wind data, consumption and exports.
- EV\_usage.mat It contains all the EV profiles.
- freq\_DK1\_60.mat Real frequency data for DK1 for 2014. 1 minute resolution.
- variables\_down It stores the variables used between the functions and the sub-functions for the case of Downward regulation.
- variables\_up It stores the variables used between the functions and the sub-functions for the case of Upward regulation.

### "Tables" folder

It is the folder that already contains all the previously generated data from representations. If any data is generated again it will automatically be saved in this folder. It is divided into one week data and one year data.

### "Excel" folder

Contains the two autogenerated excel files with the results shown in the "Simulation Results" chapter. If the file "table\_creator\_year" is executed it will automatically update the values in the "table\_year.xlsx" file and if "table\_creator\_week" is executed it will be saved in "table\_week.xlsx".

### Matlab code Examples

The following is the function "Adapt\_optimal\_DE" to apply optimization process with Differential Evolution.

```

1 function [SOC_adapt, Bid, P_upward, P_downward, ConsumE, fval_up, ...
2         fval_down] = Adapt_optimal_DE (EV_n, EV_P, EV_E, EV_batt, subrange
3         , ...
4         range_1, range_2, Penet_local, usage_local, available_local, charging
5         , ...

```

```

4     SOC_ini,day, conv_topo, scheme)
5
6     % Define variables
7     Max_SOC = (EV_batt * EV_n)/1000; % MWh
8     Avai_P_EV = available_local*EV_n*EV_P/1000; % MW    available power
           fleet
9     ConsumE = (usage_local * EV_n* EV_E)/1000; % MWh    Energy consumed
           fleet
10    for i = 1:6 % Block variables
11        Media(i) = mean(Penet_local(i*4 3:i*4));
12        ConsumE_blk(i) = sum(ConsumE(i*4 3:i*4)); % Energy consumed
13        min_Avai_P (i) = min(Avai_P_EV(i*4 3:i*4)); % minimum power
           available
14    end
15    f_AS_up = [0.004 0.006 0.007 0.008 0.021 0.04]; % Percentile 20th
16    f_AS_down = [0.049 0.041 0.040 0.035 0.059 0.112]; % Percentile 80th
17    SOC_max = [0.9 0.89 0.88 0.87 0.86 0.85] * Max_SOC;
18
19    % Initialize variables
20    D = 6;
21    XVmin = 0;
22    XVmax = 1;
23    NP = 10*D;
24    fevalmax = 18000;
25    F = 0.6;
26    CR = 0.9;
27    strategy = 3;
28    refresh = 0;
29
30    save variables_up.mat SOC_ini ConsumE_blk Media min_Avai_P SOC_max
           f_AS_up Max_SOC
31    fprintf('Day %0f, calculating upward regulation \n',day)
32    %% Optimization function for upward provision of frequency regulation
33    if conv_topo == 1 % uni directional
34        fname = 'OF_up_DE_uni'; % objective function for upward regulation
35        [bestmem, fval_up, nfeval, OFbest, bestvec] = ...
36            DE_func_two(fname,D,XVmin,XVmax,NP,fevalmax,F,CR,strategy,
           refresh);
37    else % bi directional
38        fname = 'OF_up_DE_bi';
39        [bestmem, fval_up, nfeval, OFbest, bestvec] = ...
40            DE_func(fname,D,XVmin,XVmax,NP,fevalmax,F,CR,strategy,refresh)
           ;
41    end
42
43    % Outputs
44    P_upward = bestmem; % Bid Upward regulation and Bid day ahead market
45    P_pre_down = min_Avai_P    P_upward;
46    for i = 1:6
47        Bid(i*4 3:i*4) = repmat(P_upward(i),1,4);
48    end
49
50    SOC_up = [SOC_ini zeros(1,24)];
51    for i=1:24
52        SOC_up(i+1) = SOC_up(i) + Bid(i)*(1-f_AS_up(ceil(i/4)))    ConsumE(
           i);
53    end

```

```

54
55 %% Optimization function for downward provision of frequency
    regulation
56 save variables_down.mat SOC_up P_pre_down Max_SOC f_AS_down
57 fprintf('Day %.0f, calculating Downward regulation \n',day)
58 if conv_topo == 1 % uni directional
59     fname = 'OF_down_DE'; % objective function for upward regulation
60     [bestmem, fval_down, nfeval, OFbest, bestvec] = ...
61         DE_func_two(fname, D, XVmin, XVmax, NP, fevalmax, F, CR, strategy,
                refresh);
62 else % bi directional
63     fname = 'OF_down_DE';
64     [bestmem, fval_down, nfeval, OFbest, bestvec] = ...
65         DE_func_two(fname, D, XVmin, XVmax, NP, fevalmax, F, CR, strategy,
                refresh);
66 end
67
68 % Outputs
69 P_downward = bestmem; % Bring variable back to real value
70
71 SOC_adapt(1) = SOC_up(1);
72 for i=1:24
73     SOC_adapt(i+1) = SOC_adapt(i) + Bid(i)*(1 f_AS_up(ceil(i/4)))...
74         ConsumE(i) + P_downward(ceil(i/4))*f_AS_down(ceil(i/4));
75 end

```

The following is the script of the function "Non\_Adapt" that represent the reference consumption profile.

```

1  % calculates reference model for EV non adaptive consumption
2
3  function[SOC, Energy_Charged, P_up, P_down, ConsumE, fval_up, ...
4      fval_down] = Non_Adapt(EV_n, EV_P, EV_E, EV_batt, subrange, ...
5      range_1, range_2, Penet_local, usage, available_local, charging
6      , ...
7      SOC_0, i, conv, sch)
8
9  %% Initialize variables
10 SOC = zeros(1, length(subrange)+1); % vector length of subrange
11 SOC(1) = SOC_0;
12 Energy_Charged = zeros(1, length(subrange));
13 P_up = zeros(1,6);
14 P_down = zeros(1,6);
15 fval_up = 0;
16 fval_down = 0;
17
18 %% Calculated variables
19 driven_EV = usage * EV_n; % number of EVs being driven
20 Avai_P_EV = charging*EV_n*EV_P/1000; % MW available power to be
    absorbed by EV at every hour of the day
21 Max_SOC = (EV_batt * EV_n)/1000; % MWh
22 ConsumE = (driven_EV * EV_E)/1000; % MWh Energy consumed by EV when
    being driven

```

```
22
23 %% loop
24 for i=1:length(subrange)
25     if SOC (i) < 0.9 * Max_SOC
26         Energy_Charged(i) = charging (i)*(0.9*Max_SOC - SOC(i));
27         if Energy_Charged(i) > Avai_P_EV (i)
28             Energy_Charged (i) = Avai_P_EV (i);
29         end
30         SOC(i+1) = SOC (i) + Energy_Charged (i) - ConsumE (i);
31     else
32         Energy_Charged(i) = 0;
33         SOC(i+1) = SOC (i) - ConsumE (i);
34     end
35 end
```



# Bibliography

- [1] Technical report.
- [2] Master data register for wind turbines at end of march 2015. <http://www.ens.dk/sites/ens.dk/files/info/tal-kort/statistik-noegletal/oversigt-energisektoren/stamdataregister-vindmoeller/AnlaegProdTilNettet.xls>. Accessed: 2015-03-15.
- [3] Danish Energy Agency. Energy statistics 2013. Technical report, Danish Energy Agency, 2014.
- [4] B.L. Andersen. Danish wind power - how much is exported? a note on the dispute between ceps and ceesa.
- [5] Peter Bach Andersen, Jacob Østergaard, Bjarne Poulsen, and Dieter Gantenbein. *Intelligent electric vehicle integration-domain interfaces and supporting informatics*. PhD thesis, unknown, 2013.
- [6] Danish Energy Association. Follow the current: Your electricity guide.
- [7] Paul-Frederik Bach. Statistical survey 2012.
- [8] Carl Binding, Dieter Gantenbein, Bernhard Jansen, Olle Sundström, Peter Bach Andersen, Francesco Marra, Bjarne Poulsen, and Chresten Træholt. Electric vehicle fleet integration in the danish edison project-a virtual power plant on the island of bornholm. In *Power and Energy Society General Meeting, 2010 IEEE*, pages 1–8. IEEE, 2010.
- [9] Bjoern Christensen and Olesen Ole Jan. Nikola work package 1: Services overview document. version 1.1. Technical report, Nikola project, 2015.
- [10] D Corrigan and A Masias. Batteries for electric and hybrid vehicles. *Linden's handbook of batteries, 4th edn. McGraw Hill, New York*, 2011.
- [11] Iñigo Martínez de Alegría, Jon Andreu, José Luis Martín, Pedro Ibañez, José Luis Villate, and Haritza Camblong. Connection requirements for wind farms: A survey on technical requirements and regulation. *Renewable and Sustainable Energy Reviews*, 11(8):1858–1872, 2007.



- [12] Energinet.dk. Environmental report for danish electricity and chp. Technical report.
- [13] Energinet.dk. Ancillary services to be delivered in denmark. Technical report, Energinet.dk, 2011.
- [14] Energinet.dk. Energinet.dk’s ancillary services strategy. Technical report, Energinet.dk, 2011.
- [15] Energinet.dk. Amendment to energinet.dk’s ancillary services strategy. Technical report, Energinet.dk, 2013.
- [16] Energinet.dk. Energinet.dk’s analysis assumptions 2013-2035. Technical report, Energinet.dk, 2013.
- [17] Red Electrica Española. Boletín mensual mayo 2015.
- [18] Department for transport. National travel survey 2012. Technical report, Department for Transport, July 2013.
- [19] Amsterdam Roundtable Foundation and McKinsey Company The Netherlands. Evolution - electric vehicles in europe: gearing up for a new phase? Technical report, Amsterdam Roundtables, 2014.
- [20] A. Martino G. Scarcella A. Alemanno A. Zubaryeva C. Thiel G. Pasaoglu, D. Fiorello. Driving and parking patterns of european car drivers - a mobility survey. Technical report, European Commission - Institute for Institute for Energy and Transport, 2012.
- [21] Christophe Guille and George Gross. Design of a conceptual framework for the v2g implementation. In *Energy 2030 Conference, 2008. ENERGY 2008. IEEE*, pages 1–3. IEEE, 2008.
- [22] Camilla Hay, Mikael Tøgeby, Niels Christian Bang, Charlotte Søndergren, Lars Henrik Hansen, D Feng, and S Singh. Introducing electric vehicles into the current electricity markets. *Electric Vehicles in a Distributed and Integrated Market Using Sustainable Energy and Open Networks (EDISON), Tech. Rep.*, 2010.
- [23] T. Jensen. Offshore investments in denmark. Technical report, Danish Energy Agency, 2014.
- [24] Tryggvi Jonsson, Pierre Pinson, and Henrik Madsen. On the market impact of wind energy forecasts. *Energy Economics*, 32(2):313–320, 2010.
- [25] Henrik Madsen Pierre Pinson Marco Zugno Juan M. Morales, Antonio J. Conejo. Clearing the day-ahead market with a high penetration of stochastic production. In *Integrating Renewables in Electricity Markets*, pages 57–100. Springer, 2014.

- [26] Willett Kempton and Jasna Tomić. Vehicle-to-grid power implementation: From stabilizing the grid to supporting large-scale renewable energy. *Journal of Power Sources*, 144(1):280–294, 2005.
- [27] Esben Larsen, Divya K Chandrashekhara, and Jacob Østergård. Electric vehicles for improved operation of power systems with high wind power penetration. In *Energy 2030 Conference, 2008. ENERGY 2008. IEEE*, pages 1–6. IEEE, 2008.
- [28] Henrik Lund, Frede Hvelplund, Poul Alberg Østergaard, Bernd Möller, Brian Vad Mathiesen, Anders N. Andersen, Poul Erik Morthorst, Kenneth Karlsson, Peter Meibom, Marie Münster, et al. *Danish wind power export and cost*. Department of Development and Planning, Aalborg University, 2010.
- [29] Rosa Mora, Jose Oyarzabal, Miguel Cruz-Zambrano, Ana Gonzalez, and Jose Corera. E-car and economic impact: enhancing the smart grids. In *CIREN 2012 Workshop: Integration of Renewables into the Distribution Grid*, 2012.
- [30] NEDo-NP-0004. Investigation for introducing battery energy storage system to a wind power generation.
- [31] Henning Parbo. Private conversations with energinet.dk’s contact person.
- [32] Jayakrishnan R Pillai and Birgitte Bak-Jensen. Vehicle-to-grid systems for frequency regulation in an islanded danish distribution network. In *Vehicle Power and Propulsion Conference (VPPC), 2010 IEEE*, pages 1–6. IEEE, 2010.
- [33] Jayakrishnan Radhakrishna Pillai and Birgitte Bak-Jensen. Integration of vehicle-to-grid in the western danish power system. *Sustainable Energy, IEEE Transactions on*, 2(1):12–19, 2011.
- [34] Jayakrishnan Radhakrishna Pillai, Brigitte Bak-Jensen, and Paul Thogersen. Electric vehicles to support large wind power penetration in future danish power systems. In *Vehicle Power and Propulsion Conference (VPPC), 2012 IEEE*, pages 1475–1479. IEEE, 2012.
- [35] Kenneth Price, Rainer M Storn, and Jouni A Lampinen. *Differential evolution: a practical approach to global optimization*. Springer Science & Business Media, 2006.
- [36] Jacob Østergaard Qiuwei Wu, Arne H. Nielsen. Potential analysis for electric vehicles grid integration. *Electric Vehicles in a Distributed and Integrated Market Using Sustainable Energy and Open Networks (EDISON), Tech. Rep*, 2011.
- [37] RT Rockafellar. Fundamentals of optimization. Technical report, Technical report, University of Washington, Seattle, WA, 2006.
- [38] Méline Rouselle. Impact of ev on the electric system. Master’s thesis, unknown, 2009.

- [39] P. B. Andersen S. Martinenas, M. Marinelli and C. Træholt. Practical application of electric vehicle with v2g service automation for grid frequency support. In *Universities Power Engineering Conference (UPEC)*, 2014.
- [40] Jonathan Richard Shewchuk. An introduction to the conjugate gradient method without the agonizing pain, 1994.
- [41] Satoru Shinzaki, Hakaru Sadano, Yutaka Maruyama, and Willett Kempton. Deployment of vehicle-to-grid technology and related issues. Technical report, SAE Technical Paper, 2015.
- [42] Andrew Smith and London Analytics Director. Quantifying exports and minimising curtailment: From 20% to 50% wind penetration in denmark. In *BIEE Conference*, 2010.
- [43] Rainer Storn and Kenneth Price. Differential evolution—a simple and efficient heuristic for global optimization over continuous spaces. *Journal of global optimization*, 11(4):341–359, 1997.
- [44] Olle Sundström and Carl Binding. Optimization methods to plan the charging of electric vehicle fleets. In *Proceedings of the International Conference on Control, Communication and Power Engineering*, pages 28–29, 2010.
- [45] Qiuwei Wu, Arne Hejde Nielsen, Jacob Østergaard, Seung-Tae Cha, Preben Nyeng, Francesco Marra, Peter Bech Andersen, and Arshad Saleem. Potential analysis of regulating power from electric vehicle (ev) integration in denmark. In *IEEE PES General Meeting 2011*, 2011.
- [46] David W Zingg, Marian Nemeč, and Thomas H Pulliam. A comparative evaluation of genetic and gradient-based algorithms applied to aerodynamic optimization. *European Journal of Computational Mechanics/Revue Européenne de Mécanique Numérique*, 17(1-2):103–126, 2008.