

THE SILOS

THE DESIGN PROPOSAL

Julie Hilmersen and Nora Paulsen

INTRODUCTION.....	03
SURROUNDINGS.....	04
The site plan	04
Views from the site	05
Façades showing the surroundings	08
THE PROJECT.....	09
Conceptual drawings and program	10
Plans	13
Sections and façades	23
Temporary program	27
The workshop	31
DETAILS.....	32
Construction	32
Materials	37
Fire and ventilation plans	39
The old and the new	40
Reference projects	41

INTRODUCTION

Through our work we have designed a proposal transforming cement silos from 1962. The silos are located at Nyhavna, an industrial area that will change drastically the following decades.

In our project we want to convert the complex and the surroundings from being an inaccessible and largely unused space, to become an attraction. We want to create an interesting stopping point between the city and Ladestien, reflecting on the past of Nyhavna and allowing for a variety of creative uses.

We want to investigate these unique forms and their possible program. Based on the information from the previous booklet, we have created a design proposal presented here.

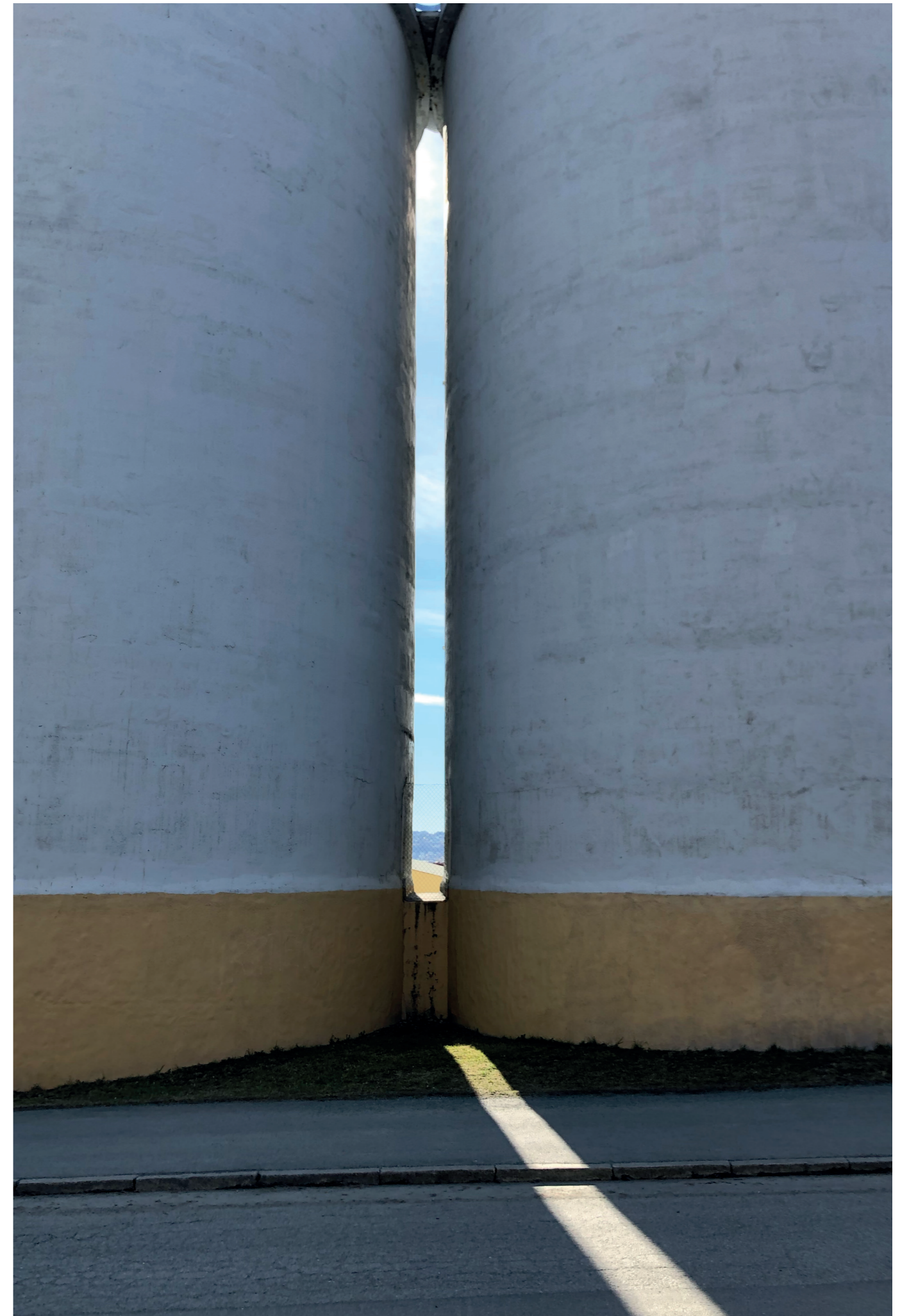

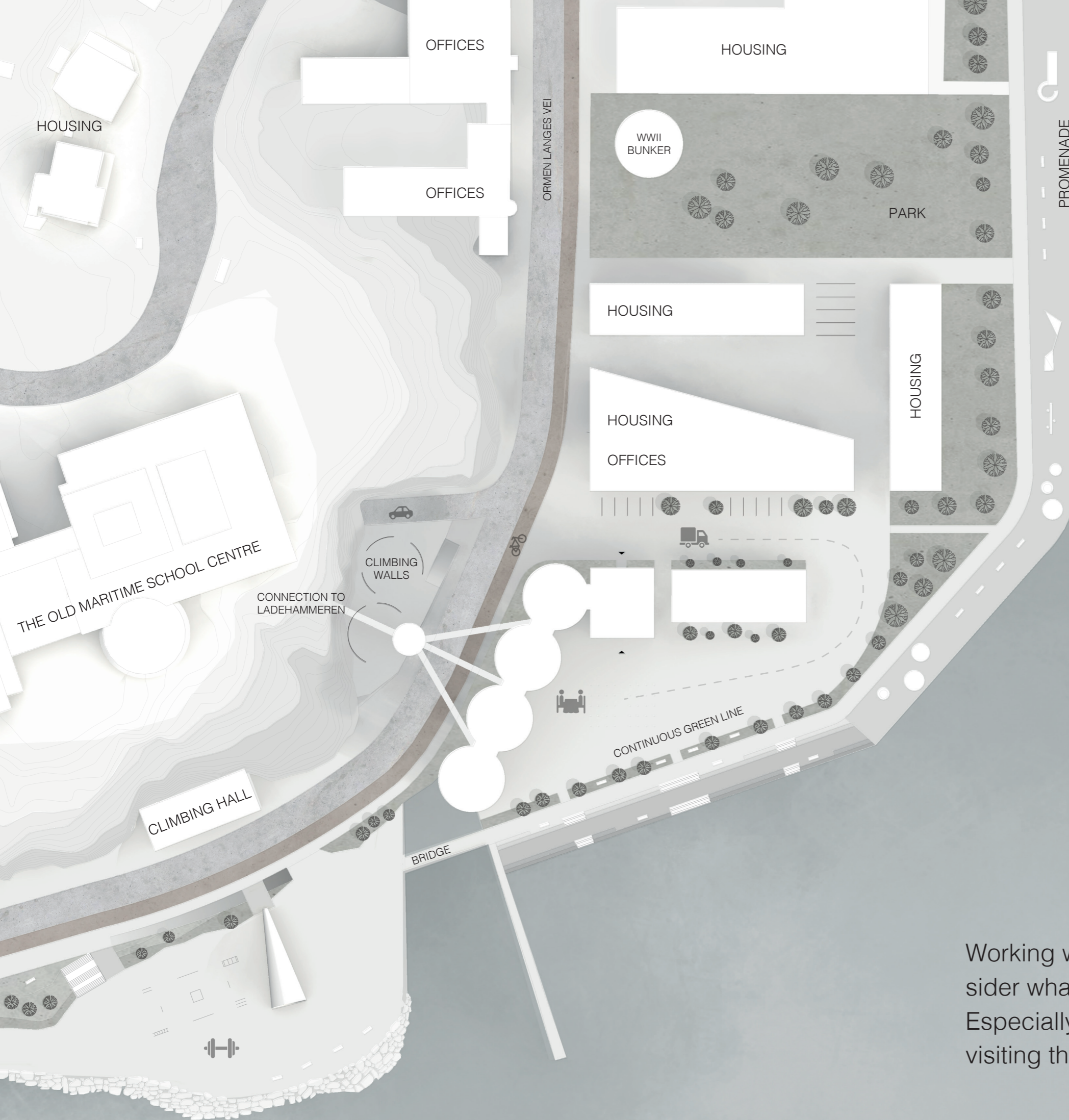

Working with the site, it has been important to consider what places lie in the immediate surroundings. Especially where you arrive from, where you go after visiting the site and what activities happen there.



THE PROMENADE

Most people will arrive from the city centre and Nyhavna. We want to create a public waterfront and have designed a promenade along the harbour basins. A line of trees follow the waterfront, and the promenade will have places to sit, to touch the water, to fish, to swim and other public activities. It should be an active and eventful stroll before arriving at the silos.

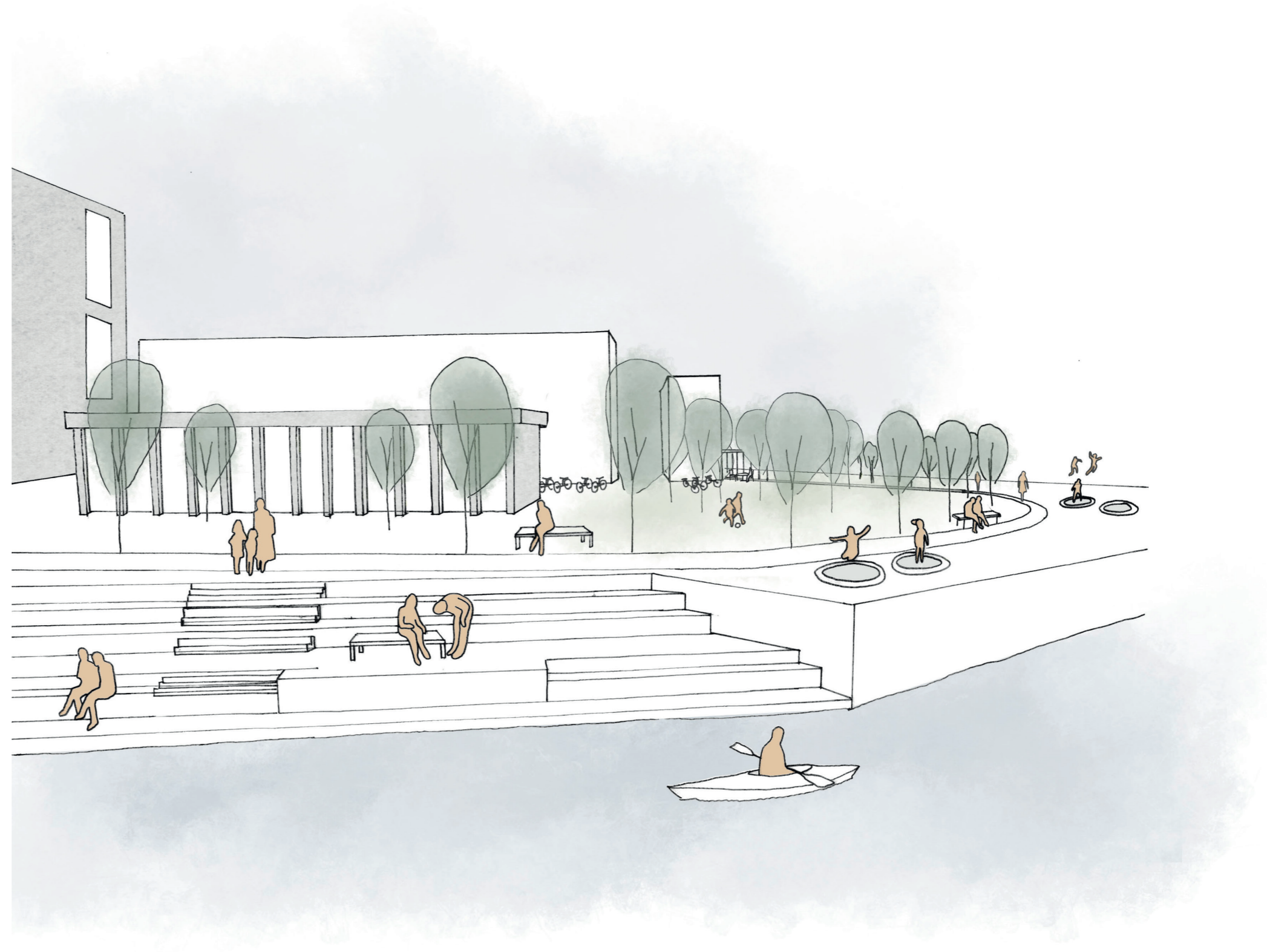
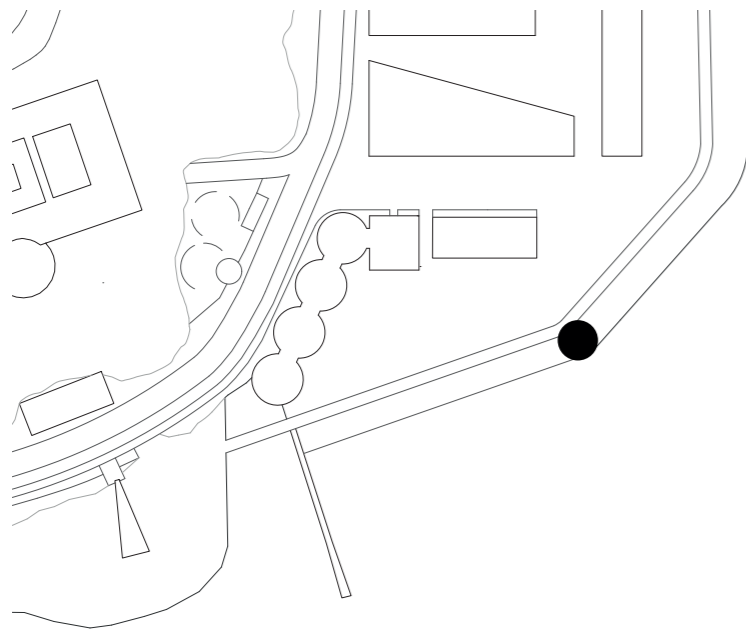

THE FIRE ESCAPE

Arriving from Ormen Langes vei, today's most used route, you will pass in between the buildings and the fire escape. Some old steel silos have been converted into an extension of the climbing hall next door, with outside climbing. To the right there is a cave in the mountain, reused as a parking to get the cars of the streets. The fire escape takes you up to Ladehammeren as well as into the buildings through bridges.

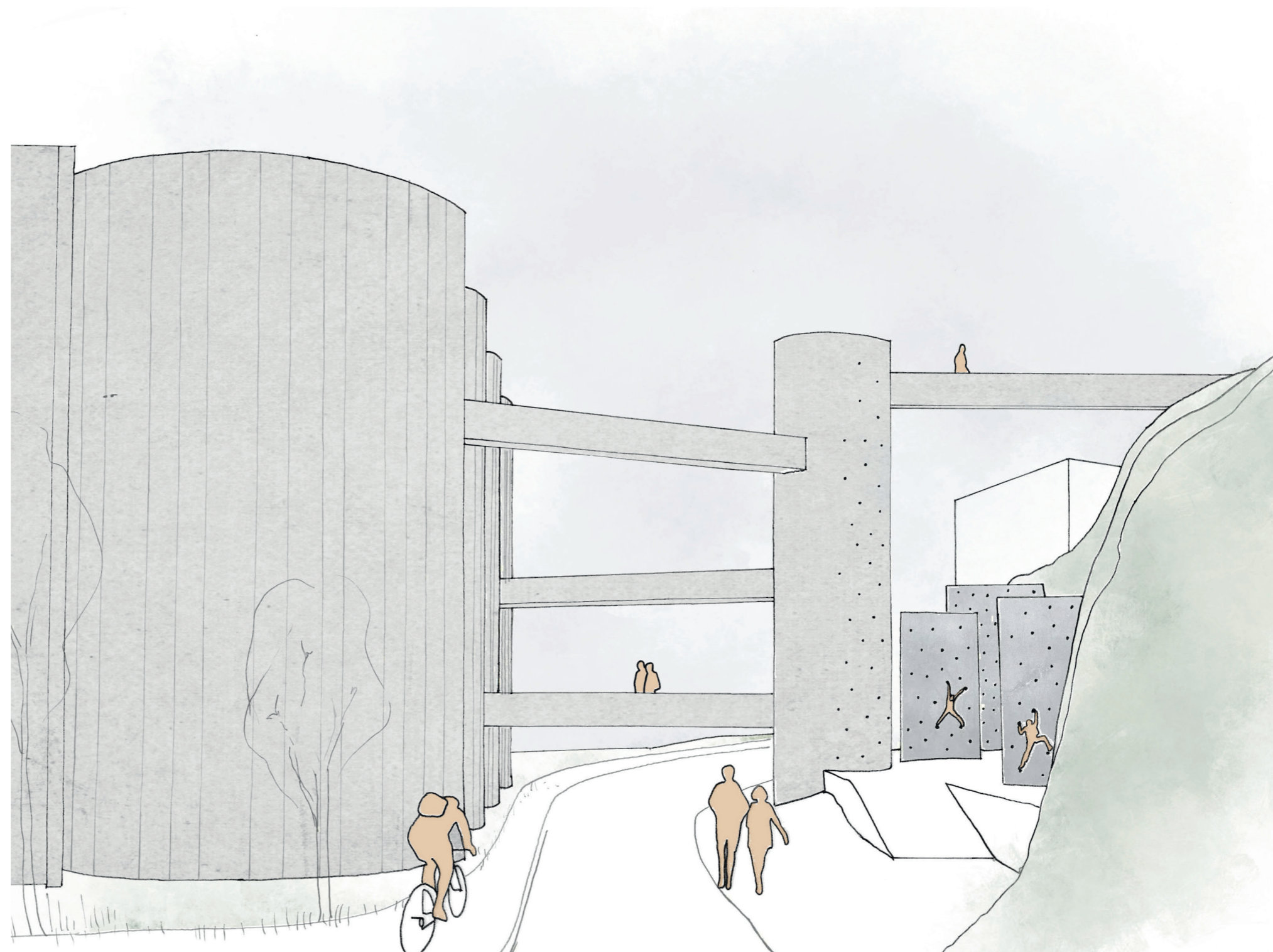
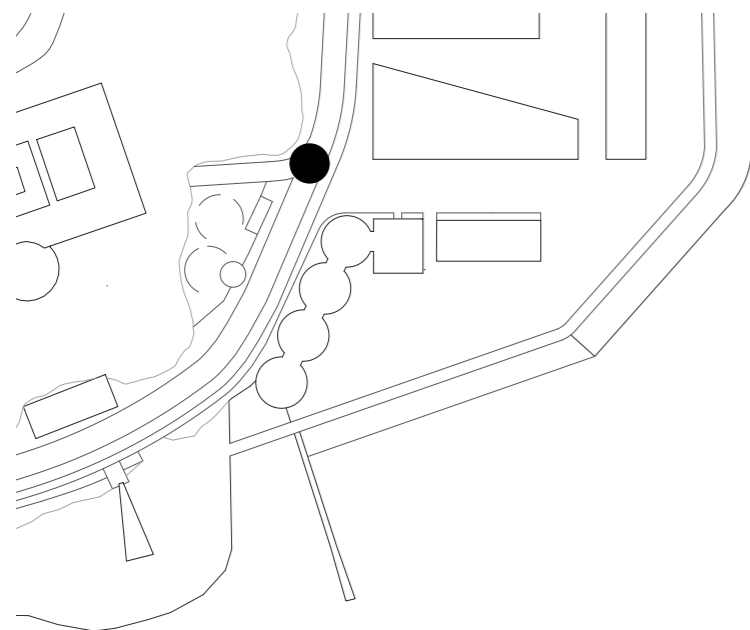

TALERØRSPLASSEN

Just before the beginning of Ladestien, you arrive at Talerørsplassen. Its most significant element is the Talerør, a huge megaphone where you can take in the beautiful view of Trondheimsfjorden. We have strengthened the relationship to Ladestien by creating a bridge from the promenade. We have also improved the connection from Ormen Langes vei through stairs and ramps. All the unused space at Talerørsplassen is turned into an outdoor training facility. Ladestien is a popular jogging spot, and it is natural to add more training facilities in connection to this.

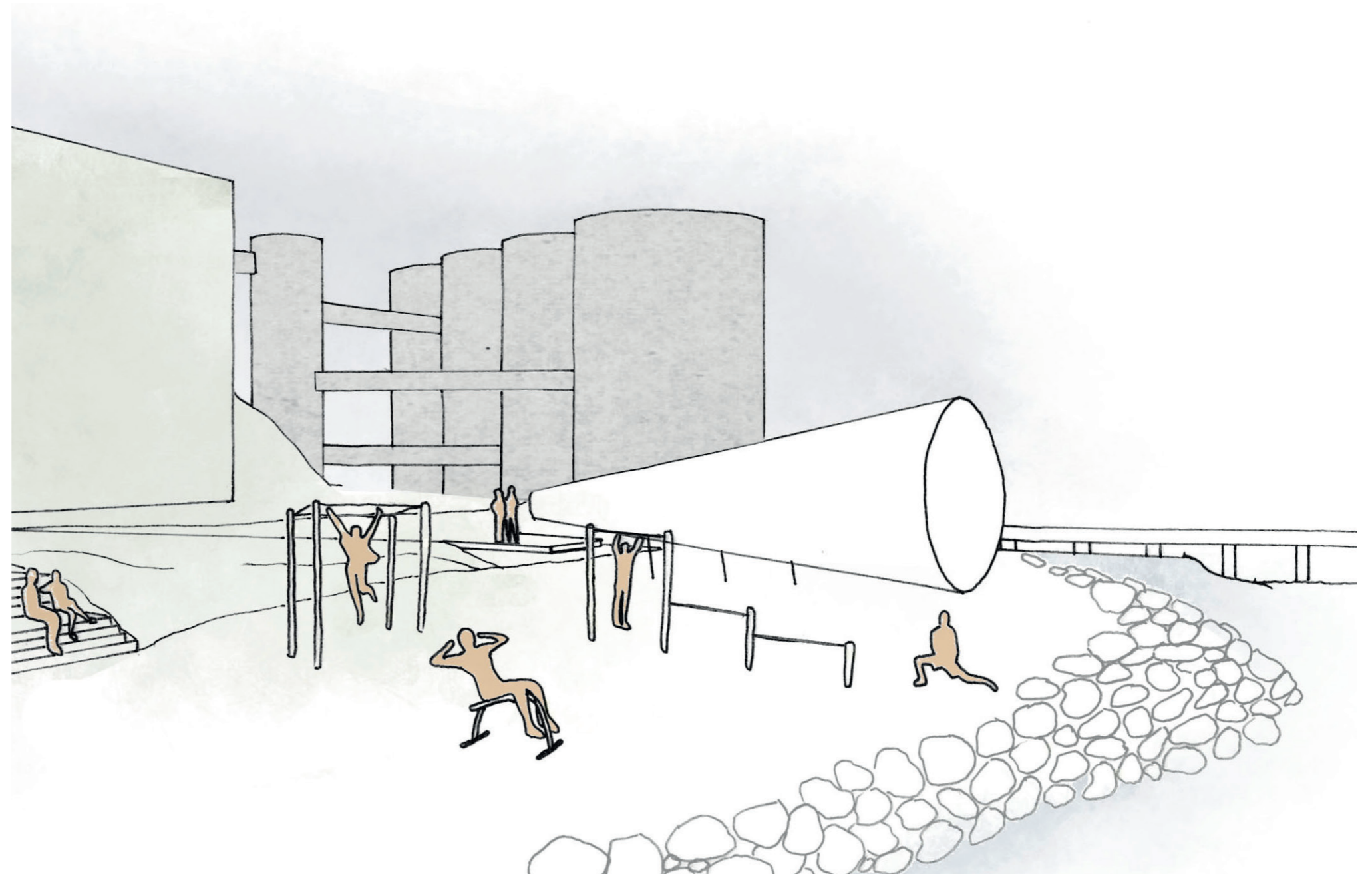
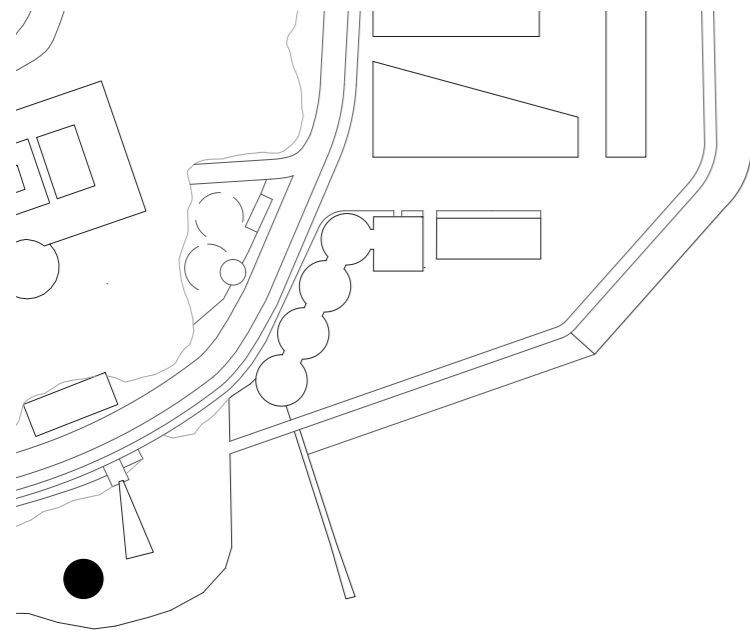

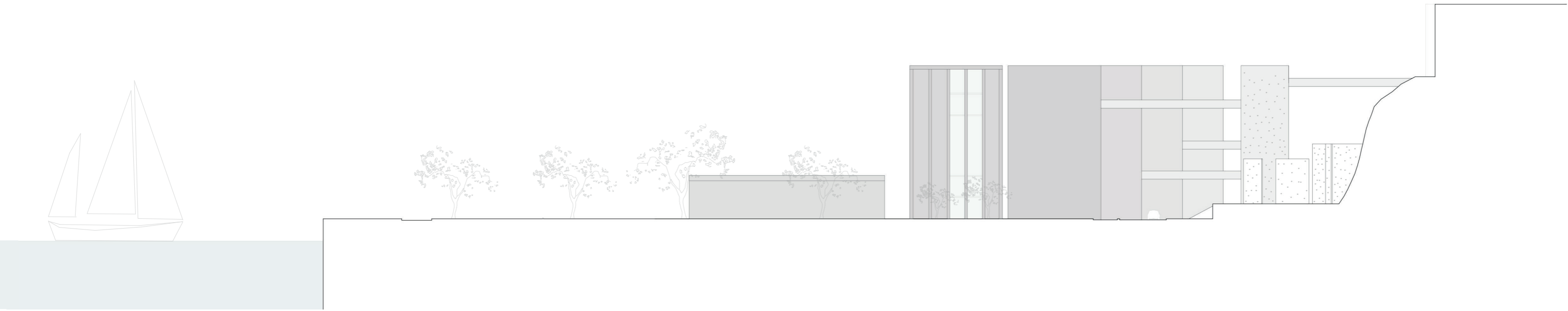

EAST FACADE 1:500

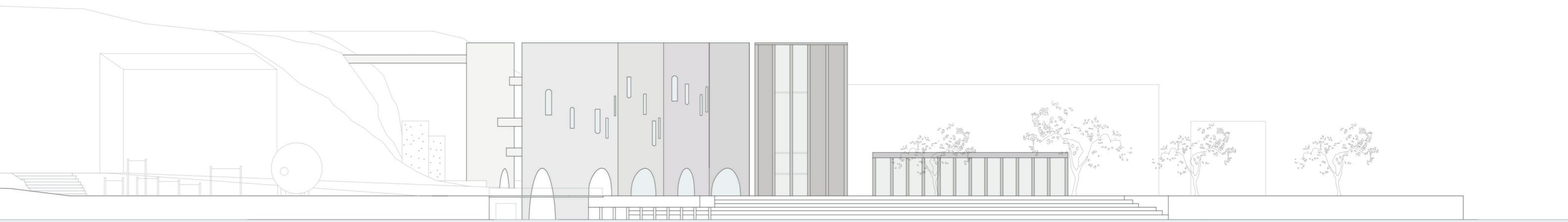

WEST FACADE 1:500



THE TRONDHEIM MET GALA

ARCHITECTURAL IDEAS

KEEPING THE GAP BETWEEN THE SILOS

Today the silos are perceived as five separate buildings, and we want to keep it that way. Through the design process we have always kept this in mind, to avoid that they become one big continuous building. This keeps the verticality of the space.

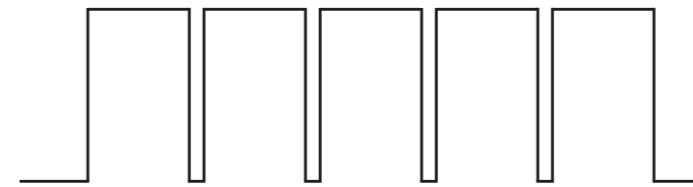

THE WAVE

Starting with four empty silos, we had infinite opportunities to investigate. During our process we discovered that designing a wave of curved floors and ceilings created interesting spaces. The wave is seen in the section and later reflected in the façade.

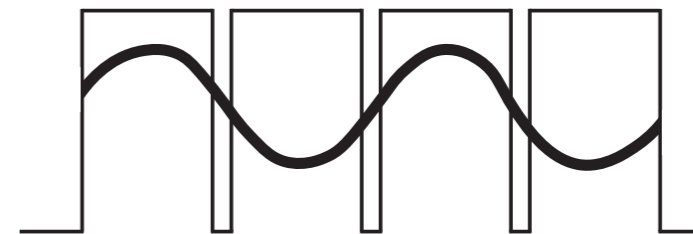

OPEN AND CLOSED

We open up the silos towards the public space, and keep them closed towards the street in the north. Walking along Ormen Langes vei today you experience the tall, vertical silos on one side and the steep terrain on the other, making the silos feel even more monumental.



COMMUNICATION

ENTRANCE

The squared silo stands out from the others, with its shape and position. We have therefore decided to place the entrance here.

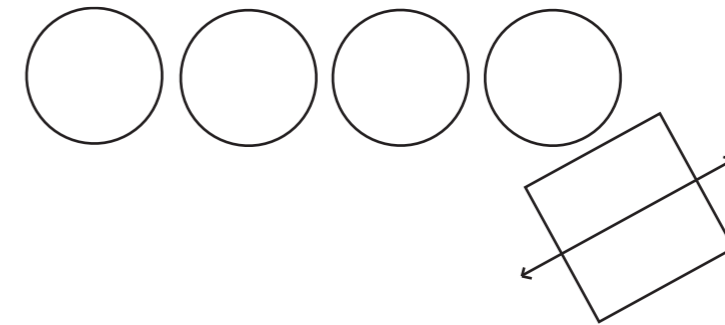

COMMUNICATION

We have one vertical staircase and lift in the squared silo, and one grand staircase with a lift in the round silos. From the entrance hall you will be able to see both stairs. In addition to this we have a fire escape across the road.

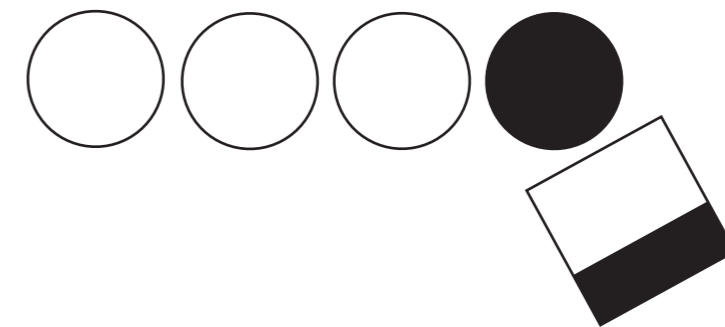

MOVEMENT

The system for moving around the silos is shaped as a helix. Starting from the spiral staircase you move along the walls, keeping the centre space more open and flexible. In the double-height rooms you move along balconies.

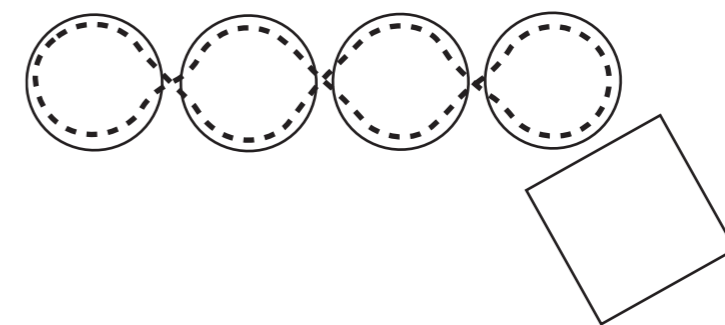

THE PROGRAM

The concept of the program is to create a cultural cathedral. Previously we have defined that the complex should be public and accessible for all ages and groups. It should reflect the cultural roots of Nyhavn. The spaces should be versatile and flexible. To achieve this, we have designed parts that are flexible and other parts that make the flexibility possible. We have divided the spaces into three categories. The cultural production aims to create and perform arts. The cultural experiences are spaces which allow you to read, observe and reflect on art. The serving functions are there to help the two previously mentioned functions.

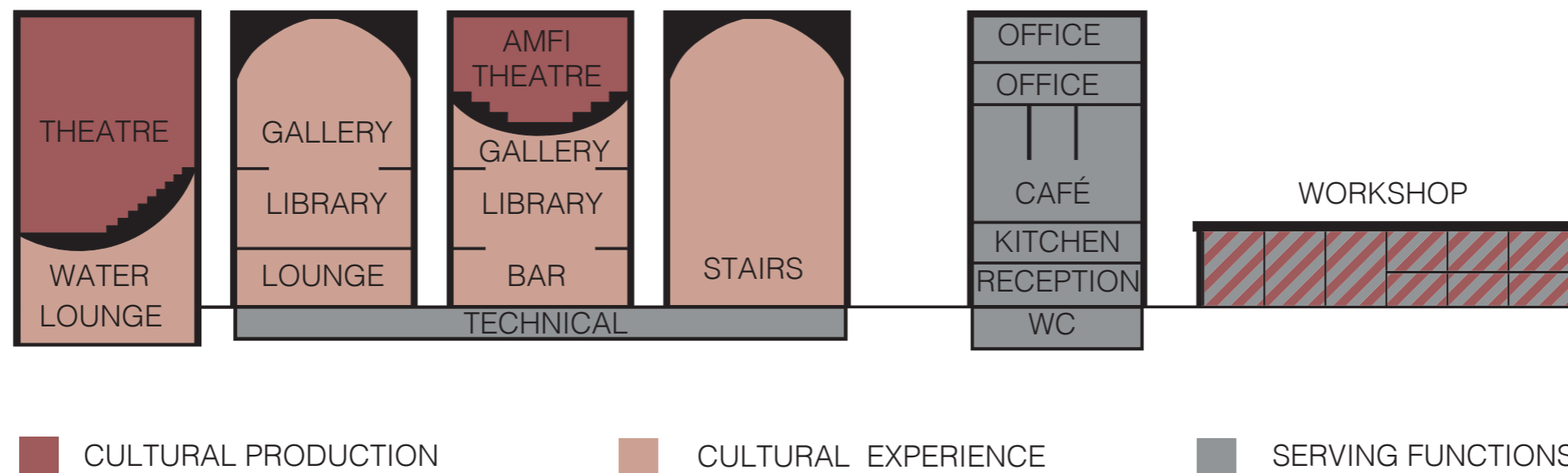



FIRE ESCAPE

BIKE LANE



GRAND STAIRCASE

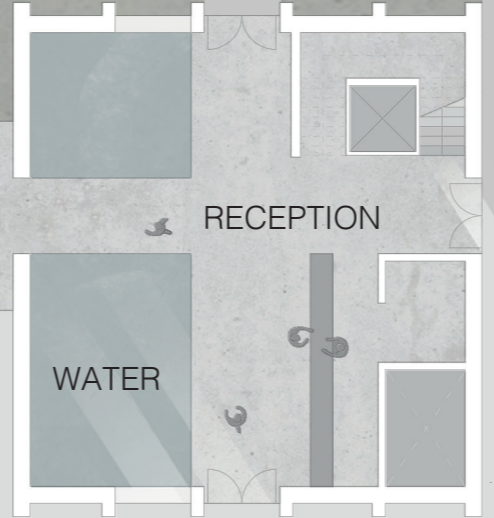

RECEPTION

WATER



BAR

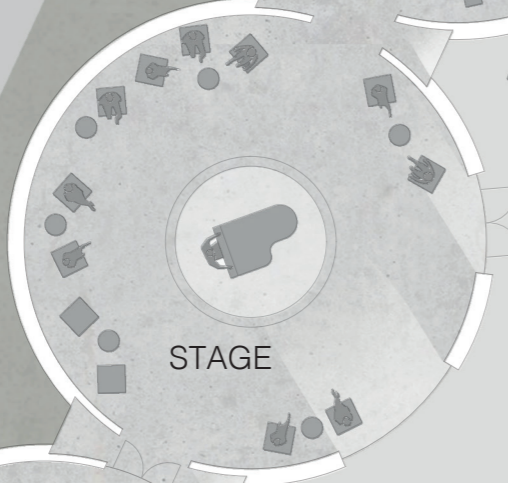

STAGE

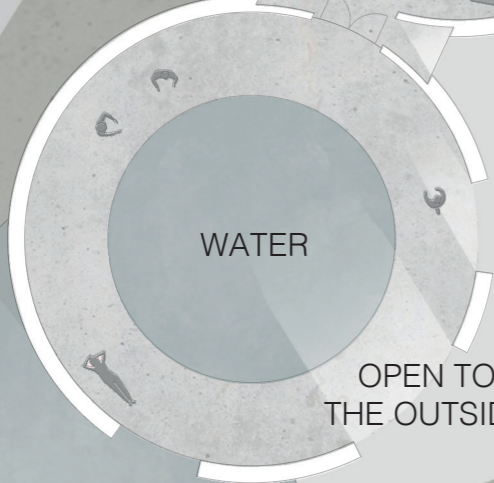

WATER

OPEN TO THE OUTSIDE



WATER FOUNTAINS

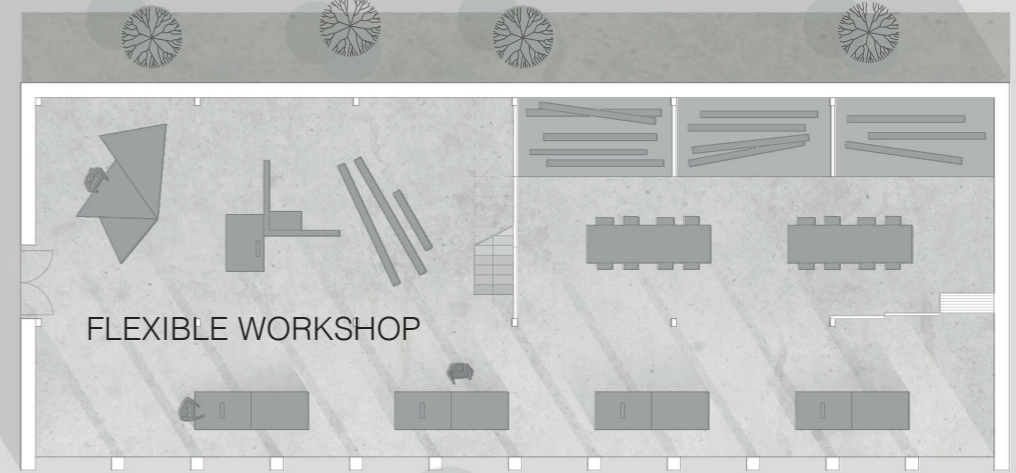

FLEXIBLE WORKSHOP

PEDESTRIAN ROAD

STEPS

ALL PLANS ARE ACCORDING TO THE STOREYS IN THE SQAURED SILO



GROUND FLOOR PLAN 1:200

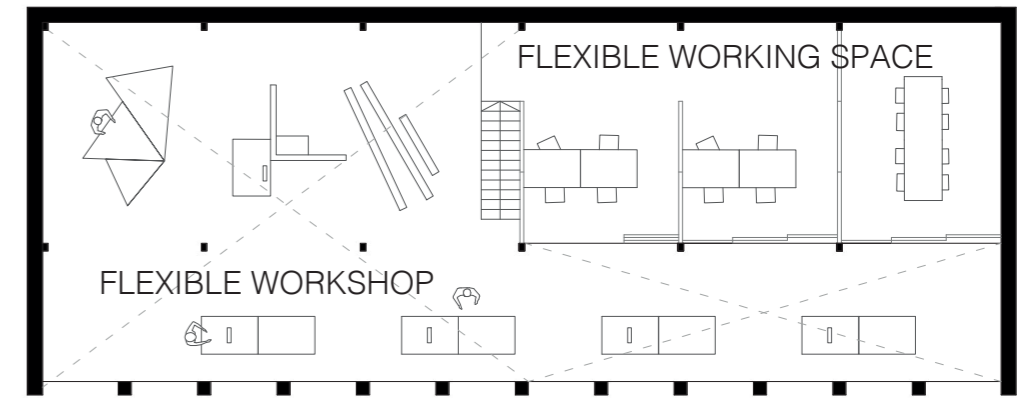
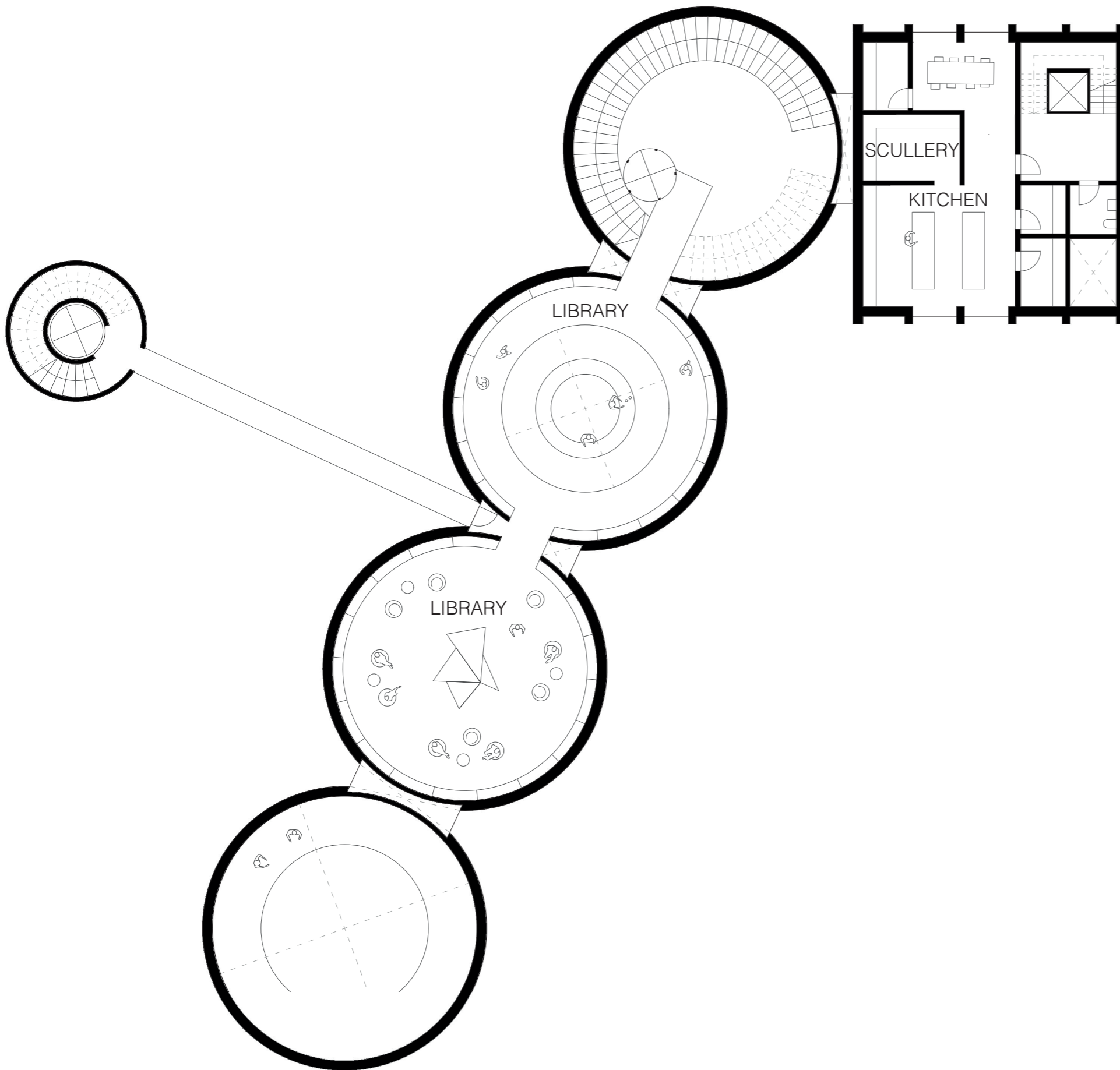

1ST FLOOR PLAN 1:200



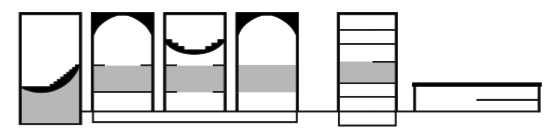
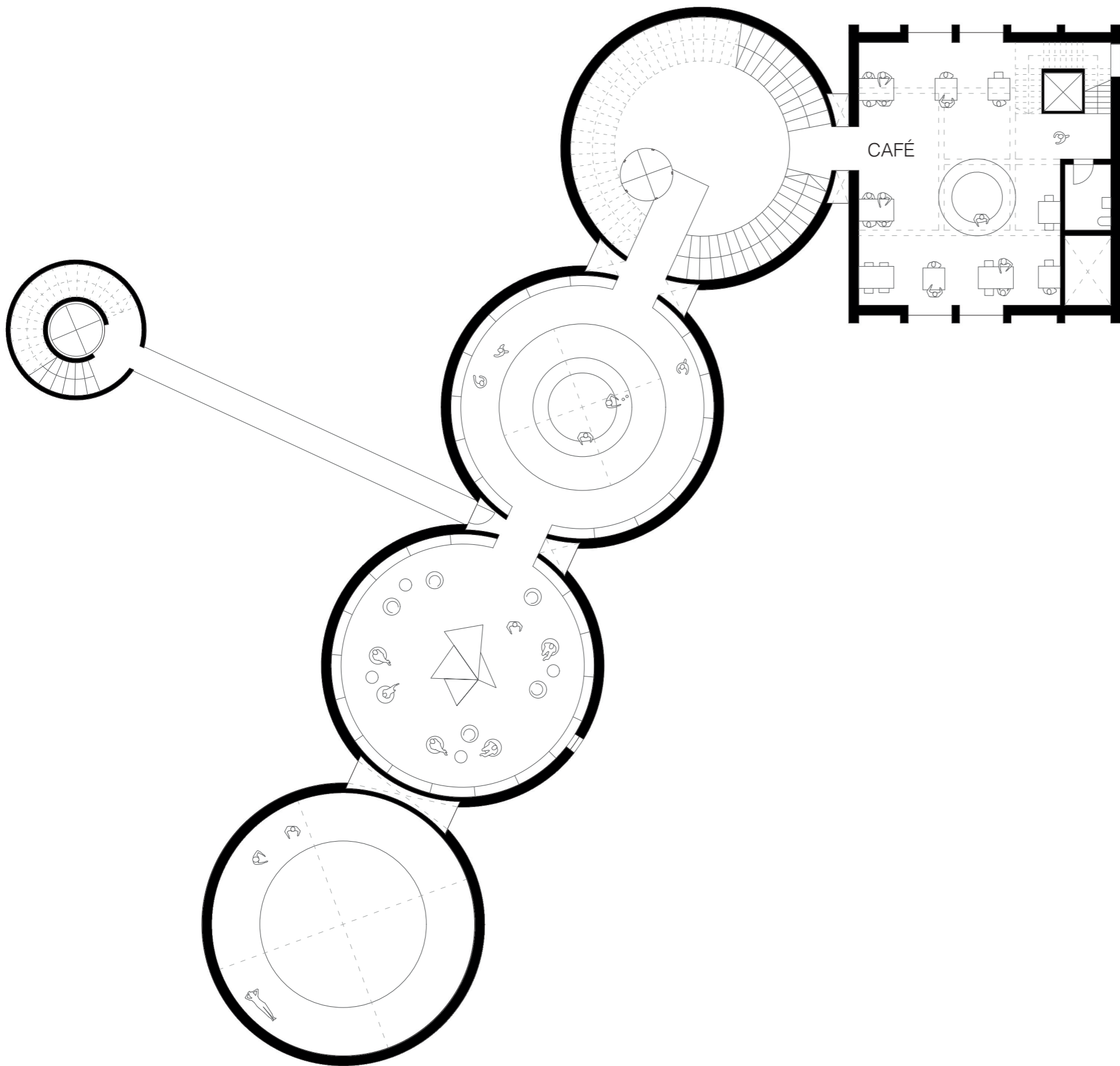

2ND FLOOR PLAN 1:200



THE EDWARDIANS

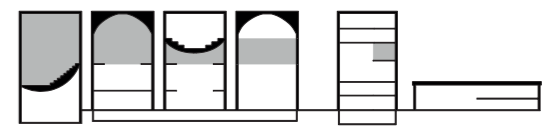
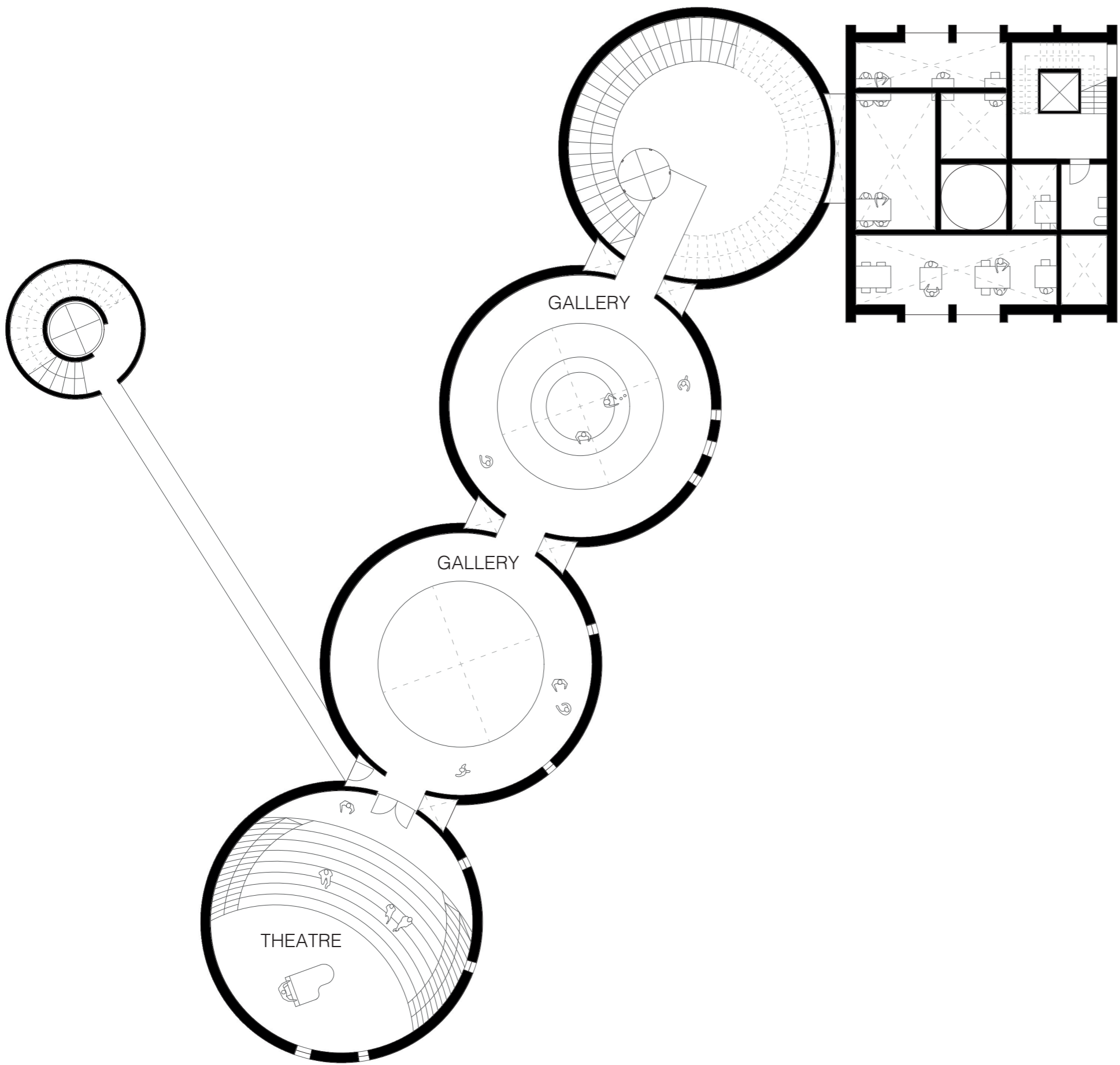

3RD FLOOR PLAN 1:200



THE WEDDING

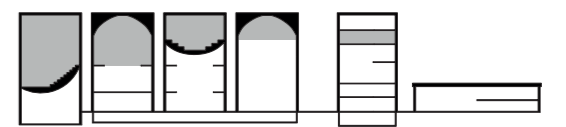
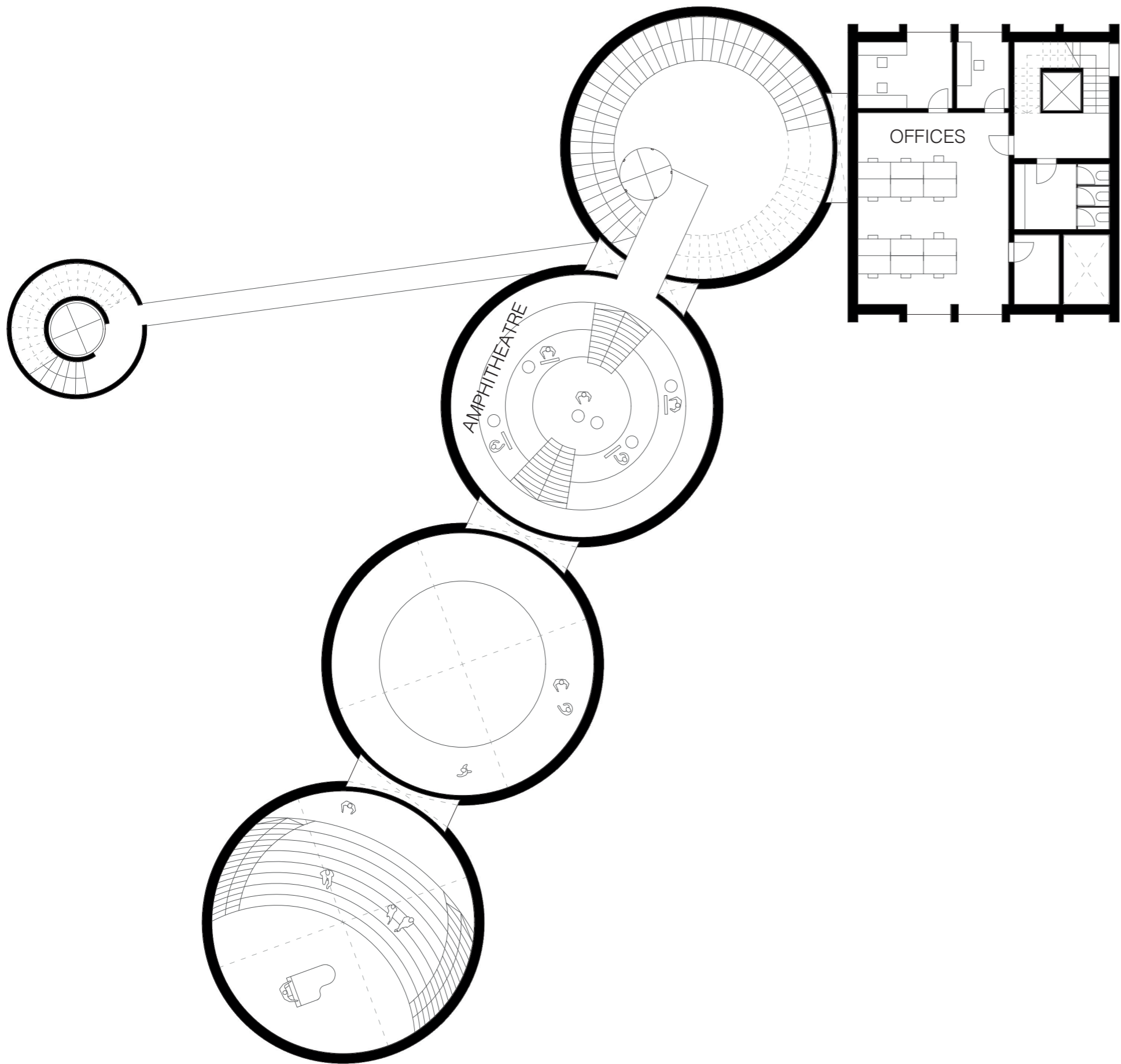

4TH FLOOR PLAN 1:200

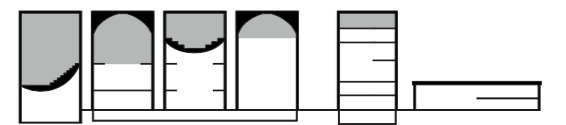
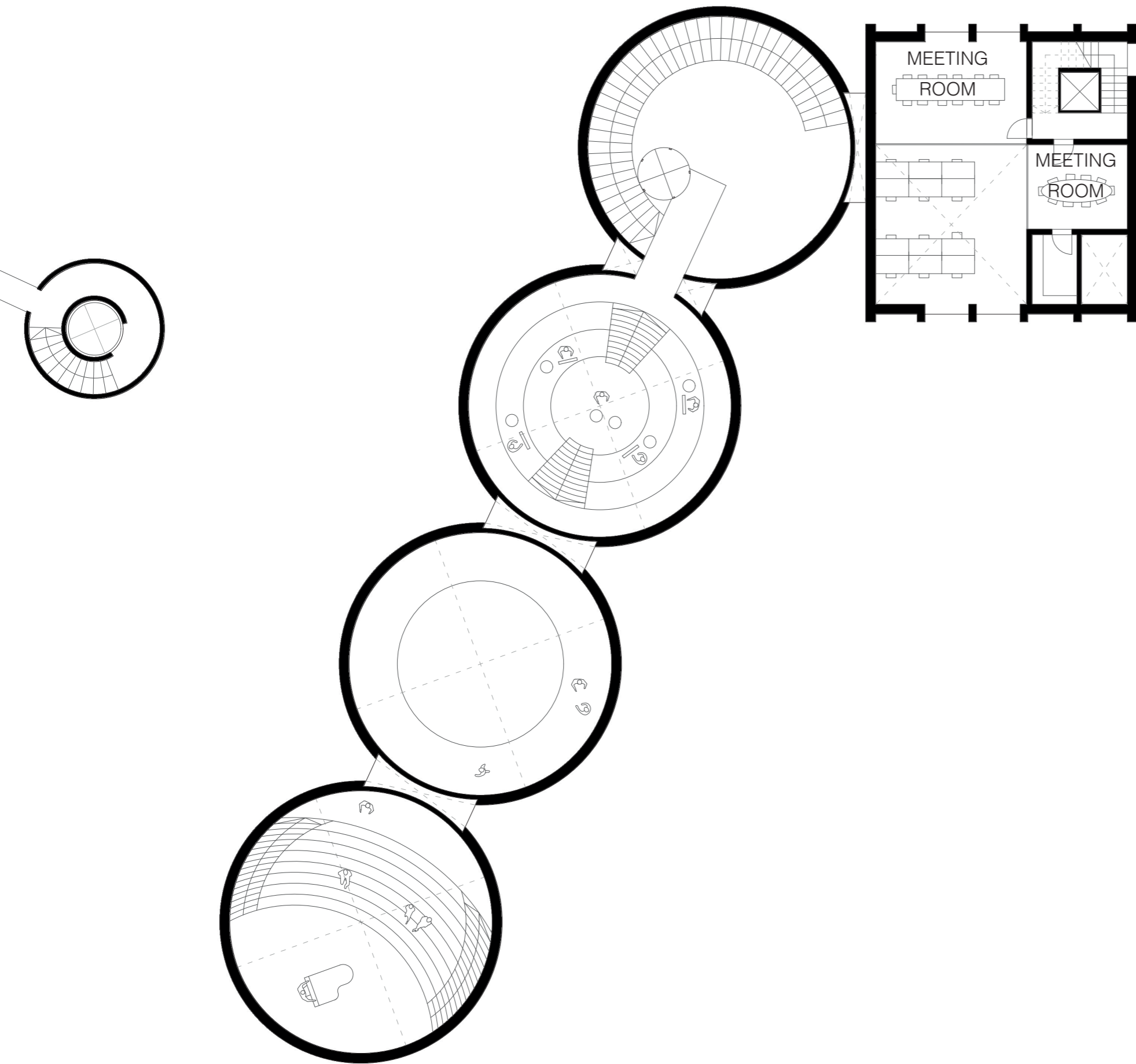

5TH FLOOR PLAN 1:200

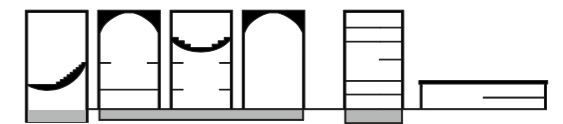
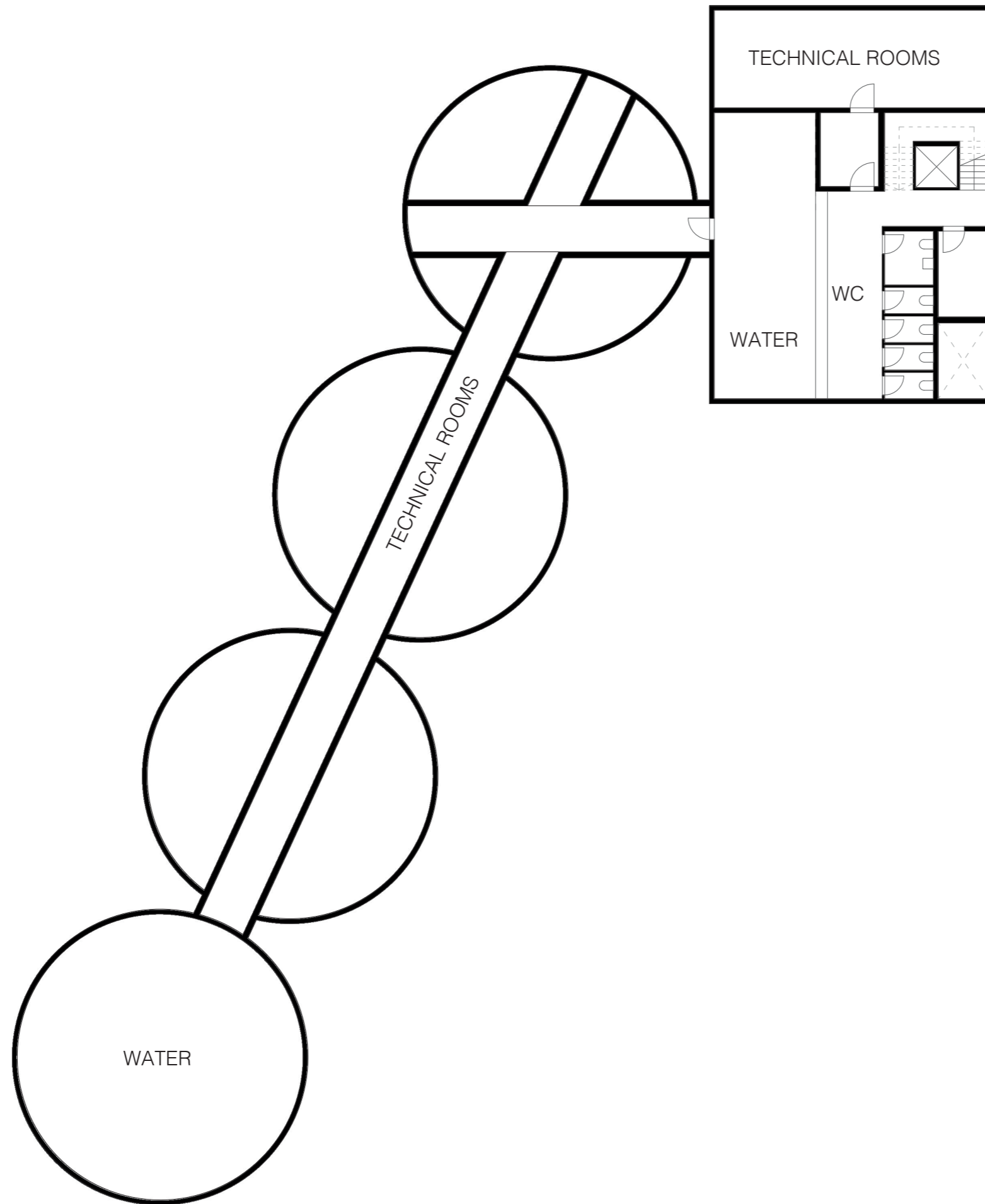

BASEMENT FLOOR PLAN 1:200

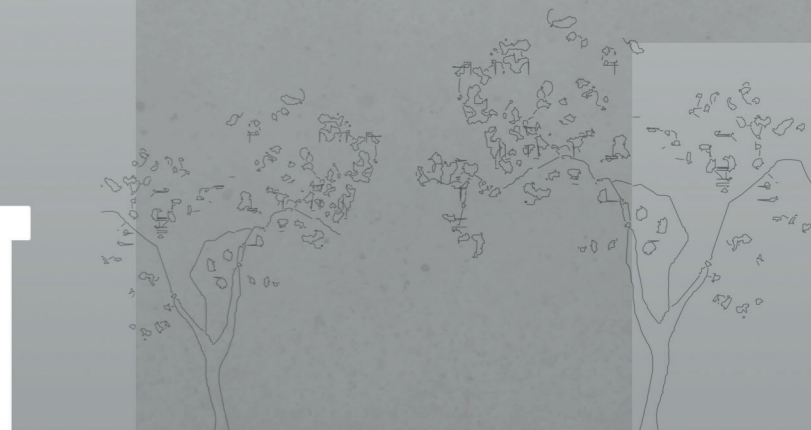
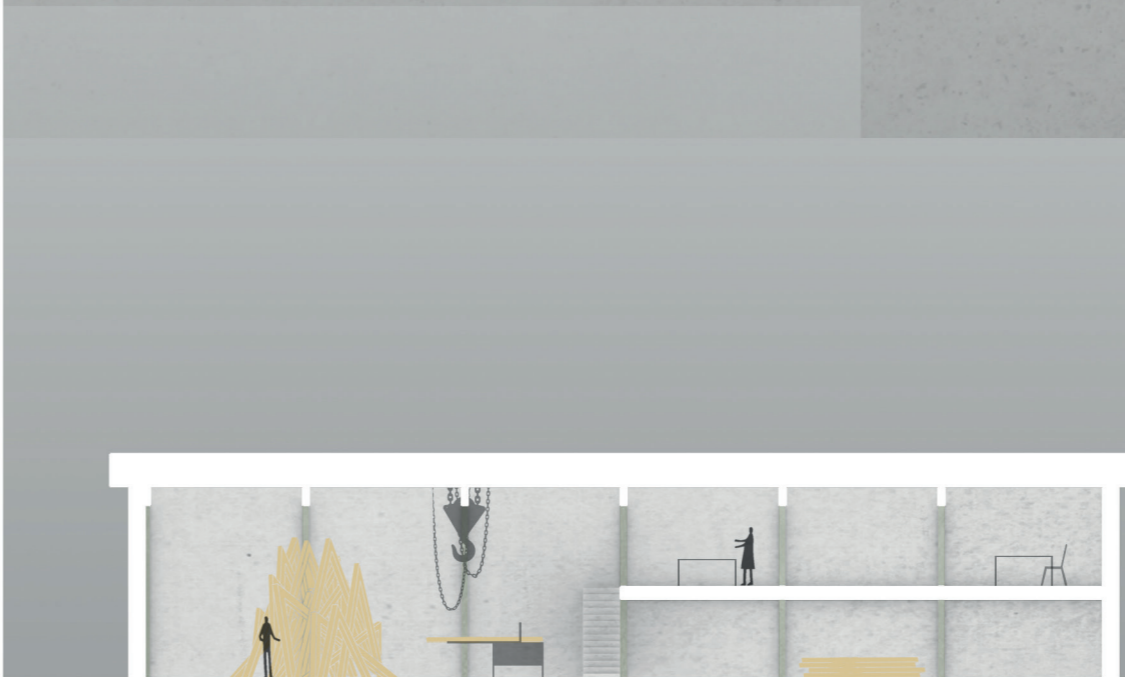
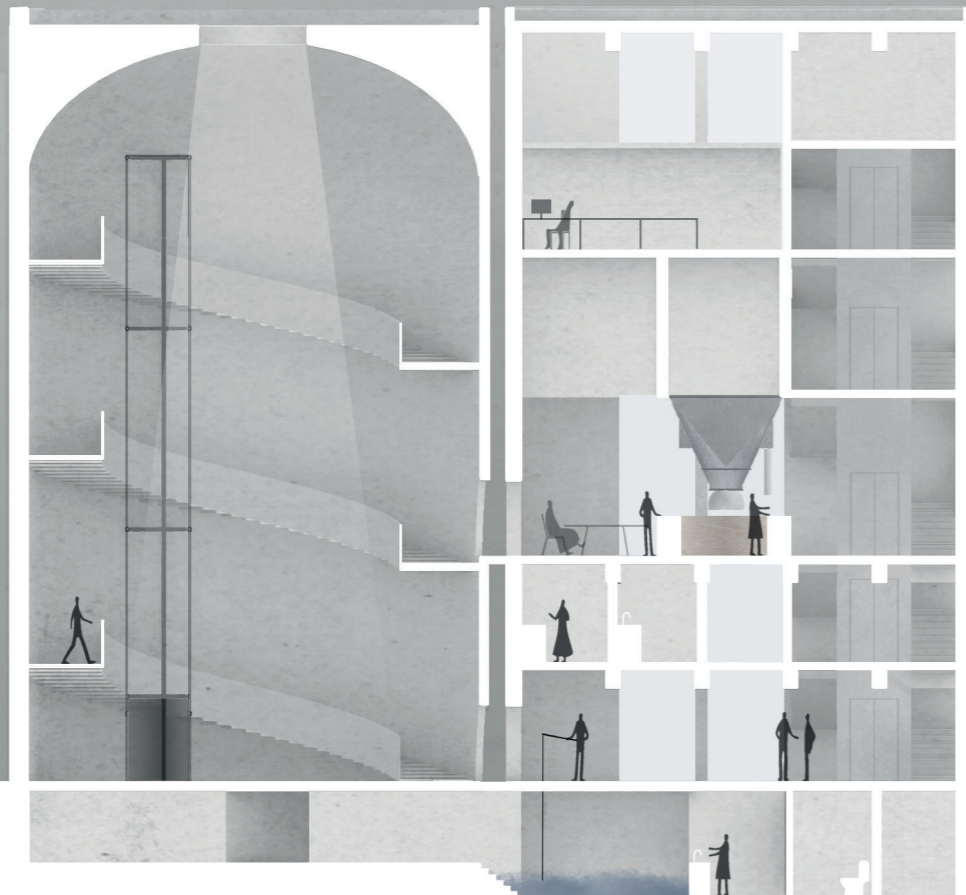

SECTION 1:200

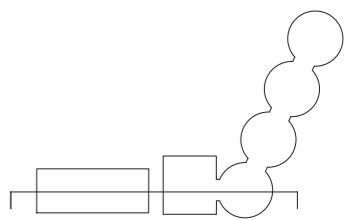

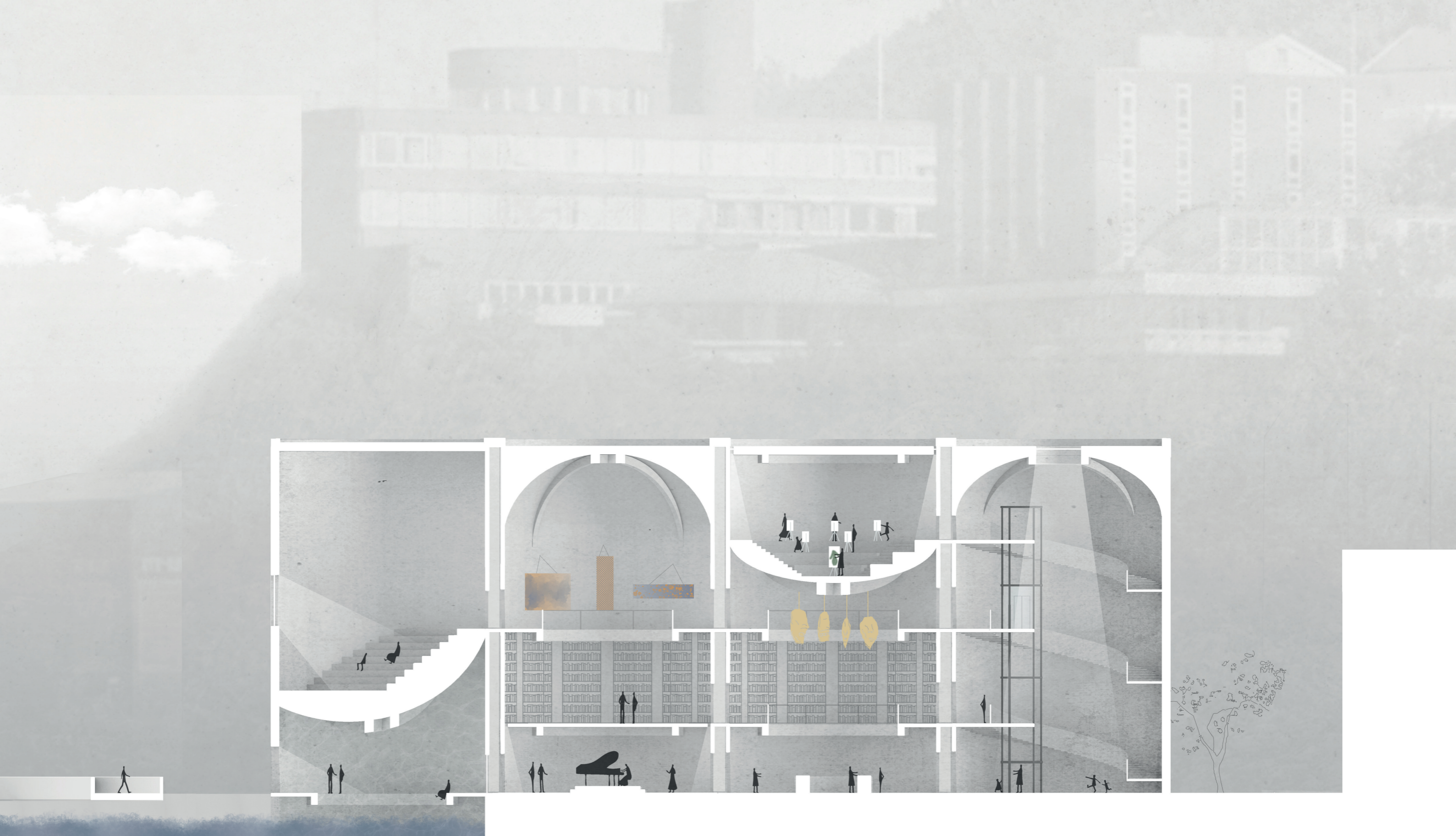

SECTION 1:200

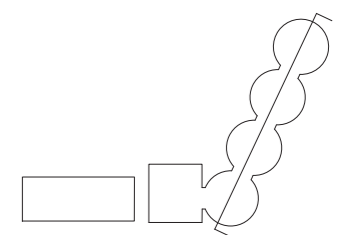



FACADE 1:200

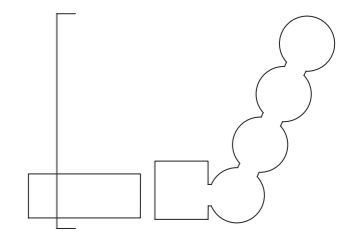

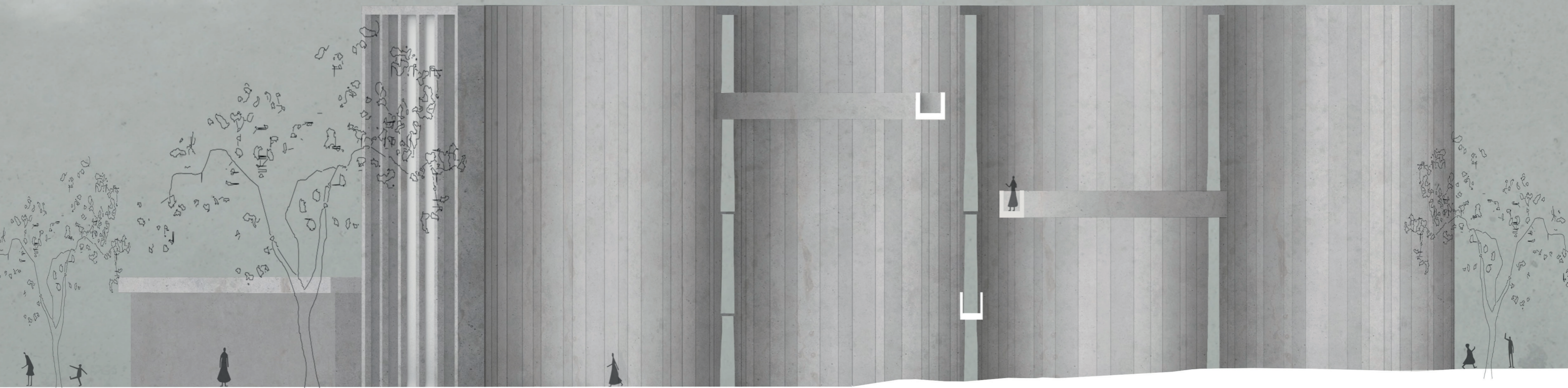

FACADE 1:200

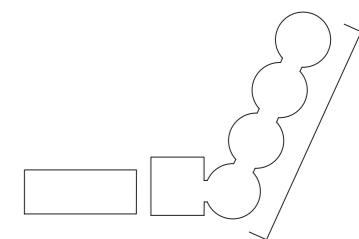

THE FLEXIBLE PROGRAM

THE PERMANENT PROGRAM

The buildings have an everyday program that is in use when there is no events.

In the silos the ground floor serves as a lounge with sitting areas, a bar and a small stage for low key performances. The first floor is the library, consisting of donated books which you can take home or donate your own. The second floor is the whispering gallery, with continuous exhibitions. The two theatres are used as auditoriums or for masterclasses.

The squared silo contains the entrance, bathrooms, a kitchen, a café, offices and meeting rooms. The new building alternates as a cultural production area and serving space. It can be used as a workshop or storage space, depending on what is needed at the moment.

THE TEMPORARY PROGRAM

In addition to the permanent program we want the building to be used for different cultural events during the year. The round silos will then be turned into an exhibition, an event or a festival. The people renting the silos will be given access to the round silos and the new building for their event. The new building can be used as temporary offices, workshops or storage space. The squared silo is not changing with the events.

These events can be music festivals, art or museum exhibitions, cosplay con, etc.

The following pages show some temporary uses.

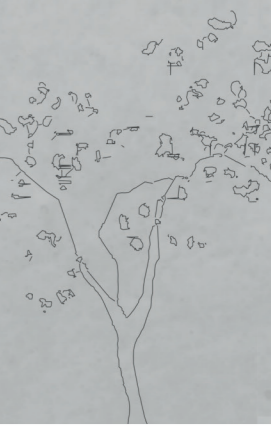
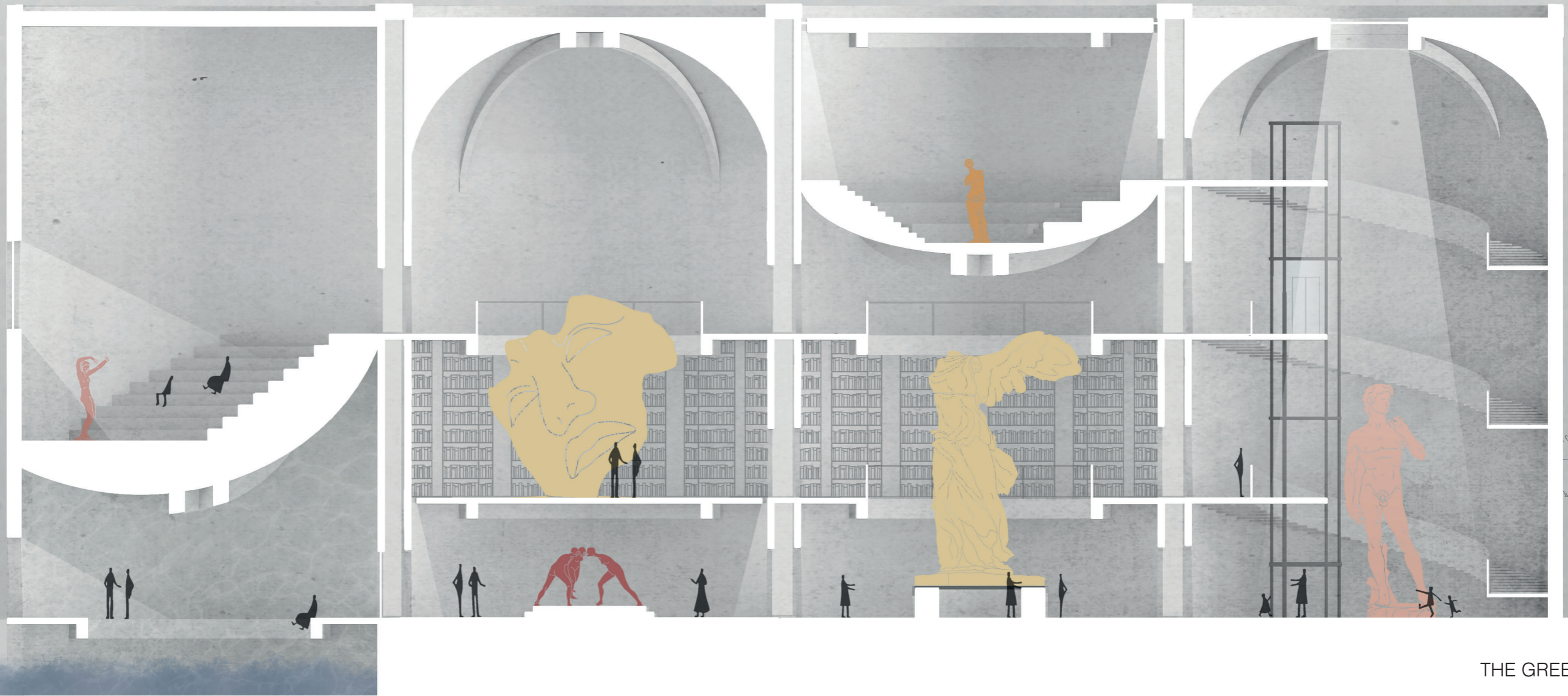

THE GREEK MUSEUM

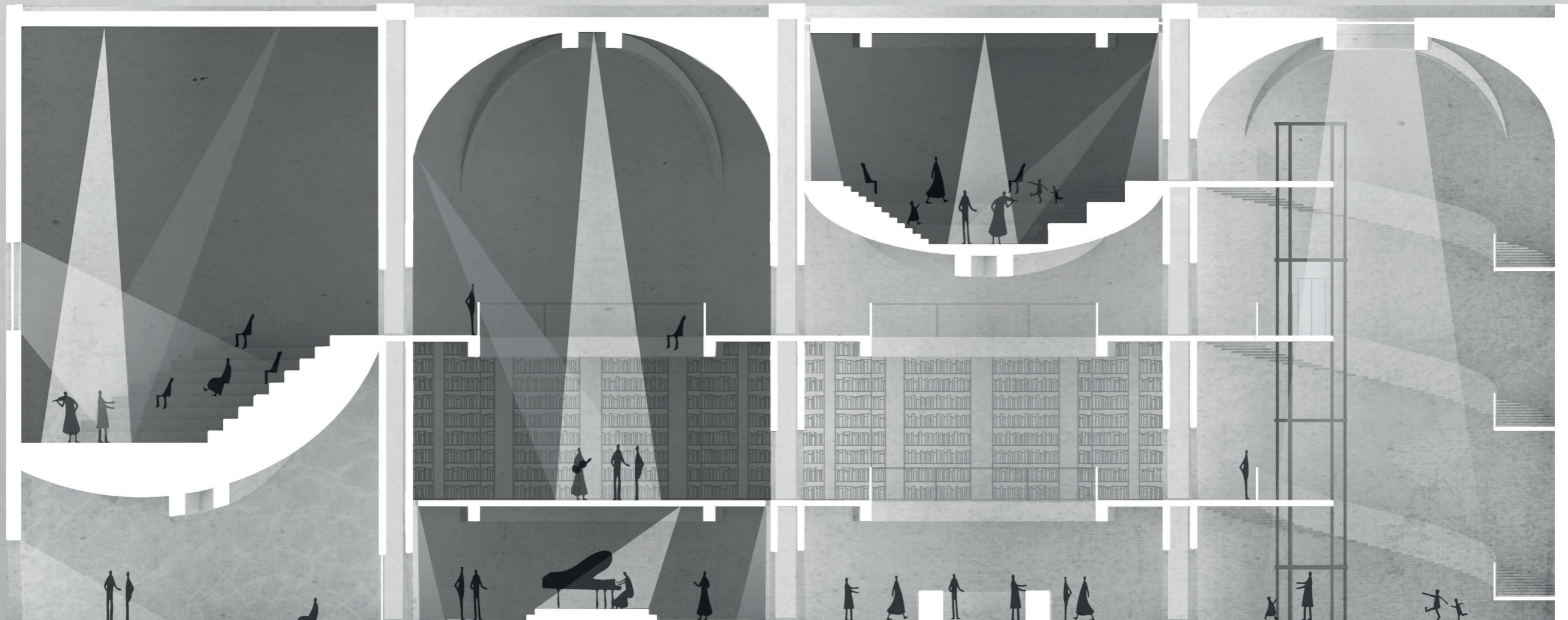

THE MUSIC FESTIVAL

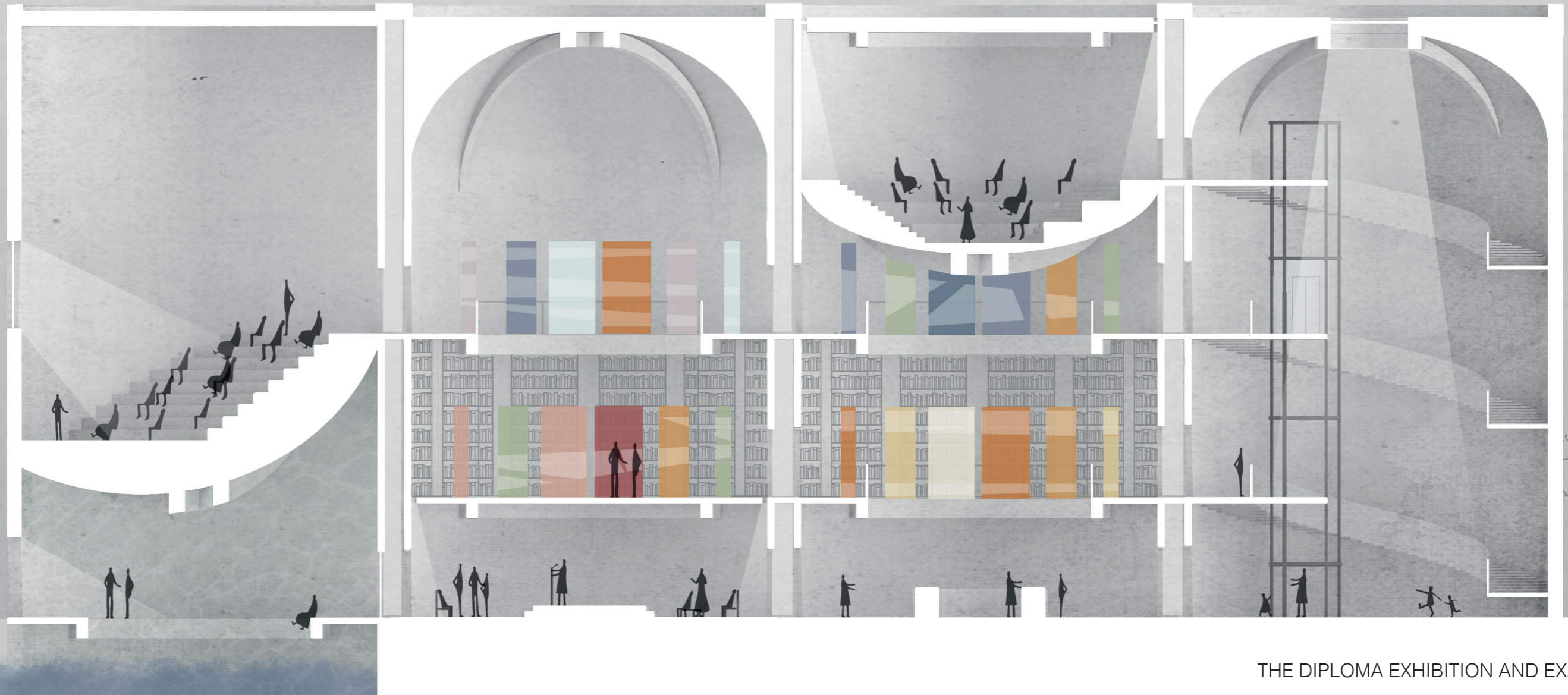

THE DIPLOMA EXHIBITION AND EXAMINATION



THE WORKSHOP

As previously mentioned, the new building is added to create more space and serve the round silos. The foundation is an existing concrete slab and a steel construction which previously belonged to the storage hall. We have added new exterior walls in concrete and glass. Part of the space have been divided into two floors. All interior walls are flexible sliding elements, inspired by Japanese architecture. The elements can be moved to create different spatial opportunities, as shown below. The building will contain machines and equipment, but they can also be stored away.

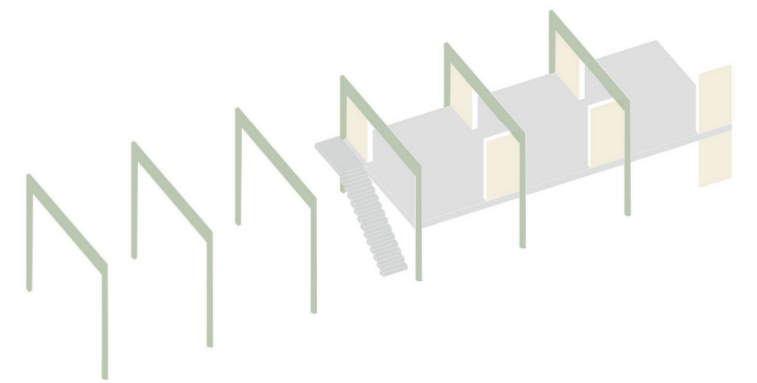
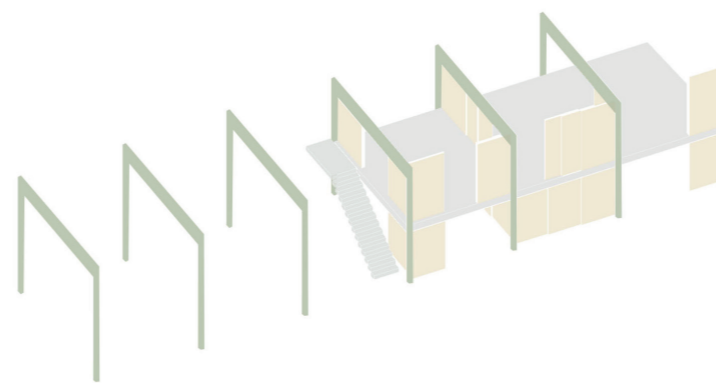
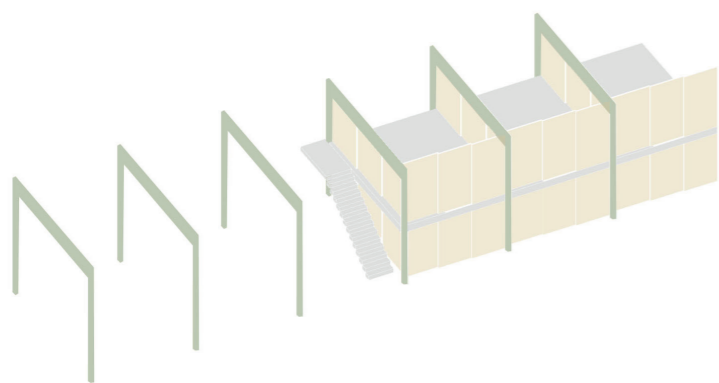

THE NEW FACADE

The buildings are completely uninsulated today. Because of the new program the buildings need better thermal conditions. We have decided to insulate the building on the outside for technical reasons and because the raw concrete is only exposed on the inside. In this way we also avoid thermal bridges. We have added a 200 mm layer of soft insulation between a system of wood studs. 5mm thick prefabricated, fibre-reinforced concrete elements create the new façade. They are hung on the wall by a steel structure fastened to the wood studs.

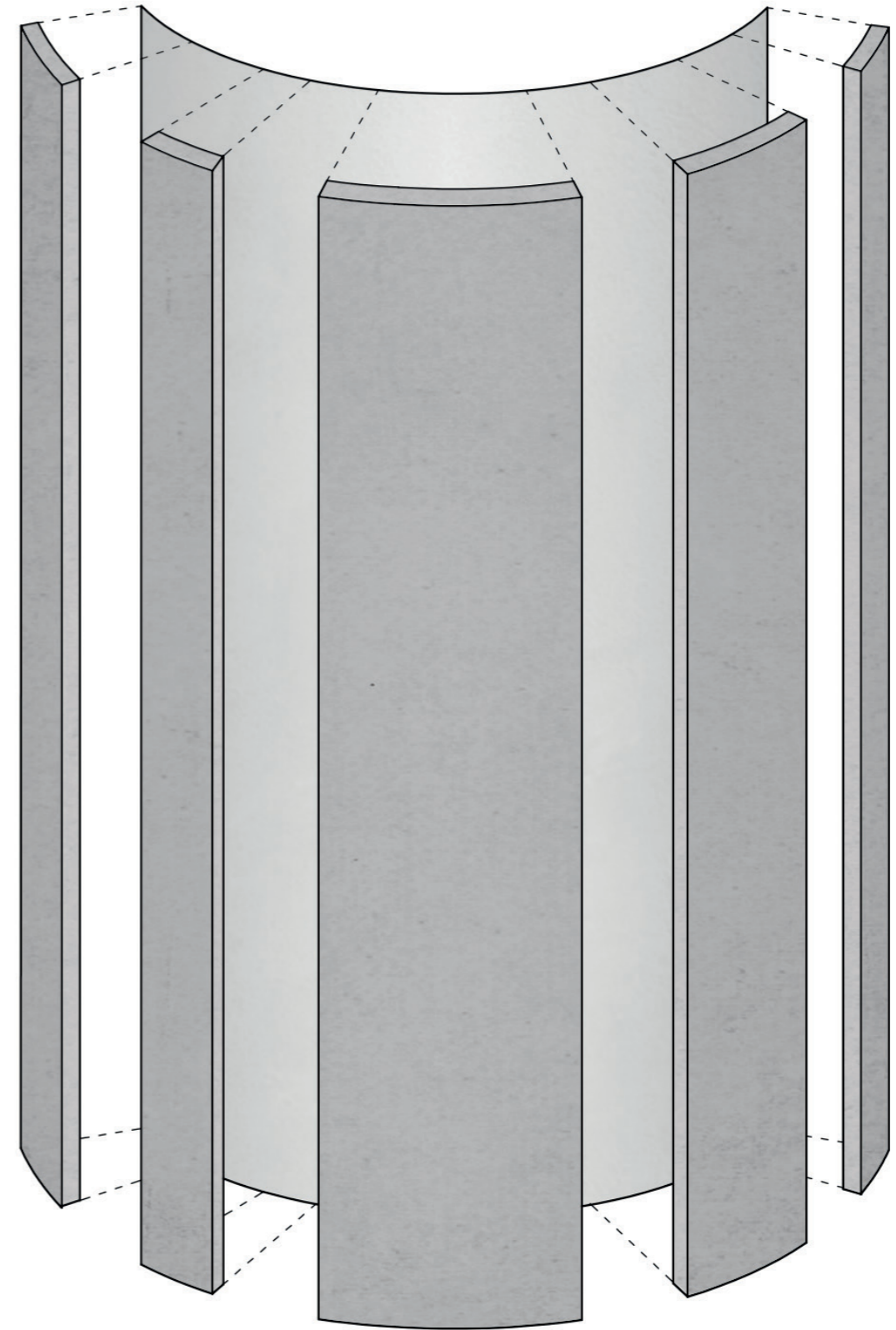
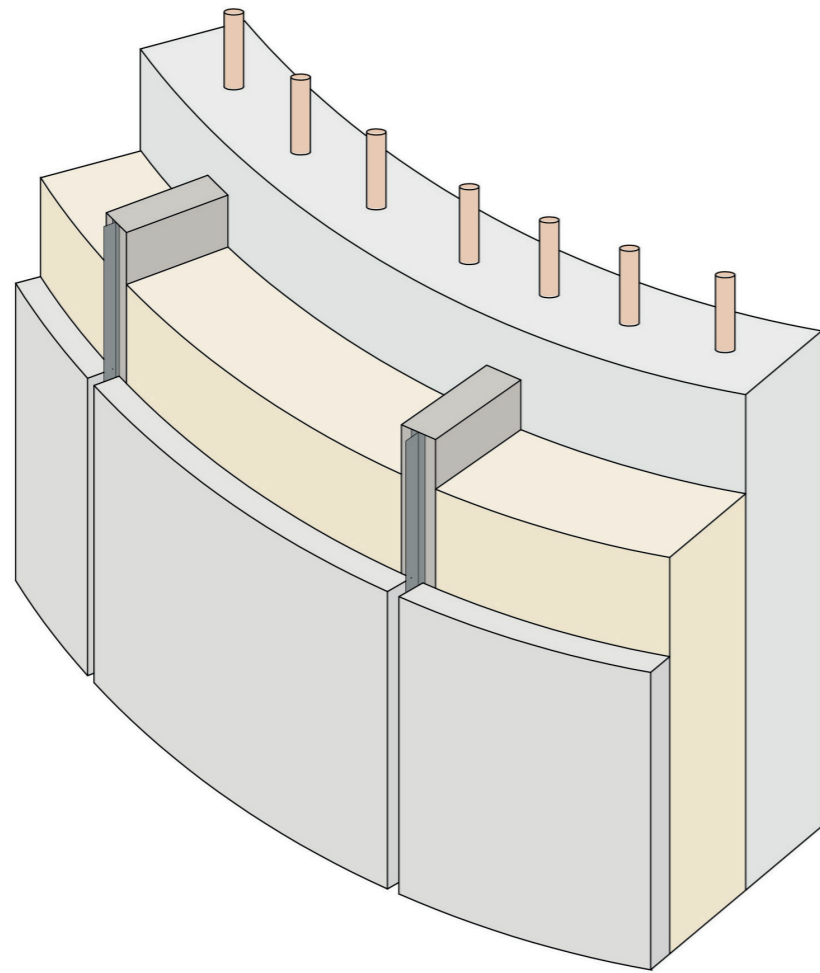

THE WINDOWS BETWEEN THE SILOS

Keeping the openings between the silos have been important to give it that vertical and monumental vibe. When adding enough insulation and a new façade, the walls would be so thick that they would close the gap. To avoid this, insulating glass has been fitted between the new exterior walls. The window frame is fastened behind the new concrete elements. From the outside you will perceive the concrete flowing directly into the glass. On the inside you will see the glass framed by wood.

You walk over a bridge to get from one silo to another. The bridge is drawn back from the windows, so that the windows will be a continuous, vertical element, not divided by any slabs. The handrails are made of glass with a banister made of the same wood as the window frames.

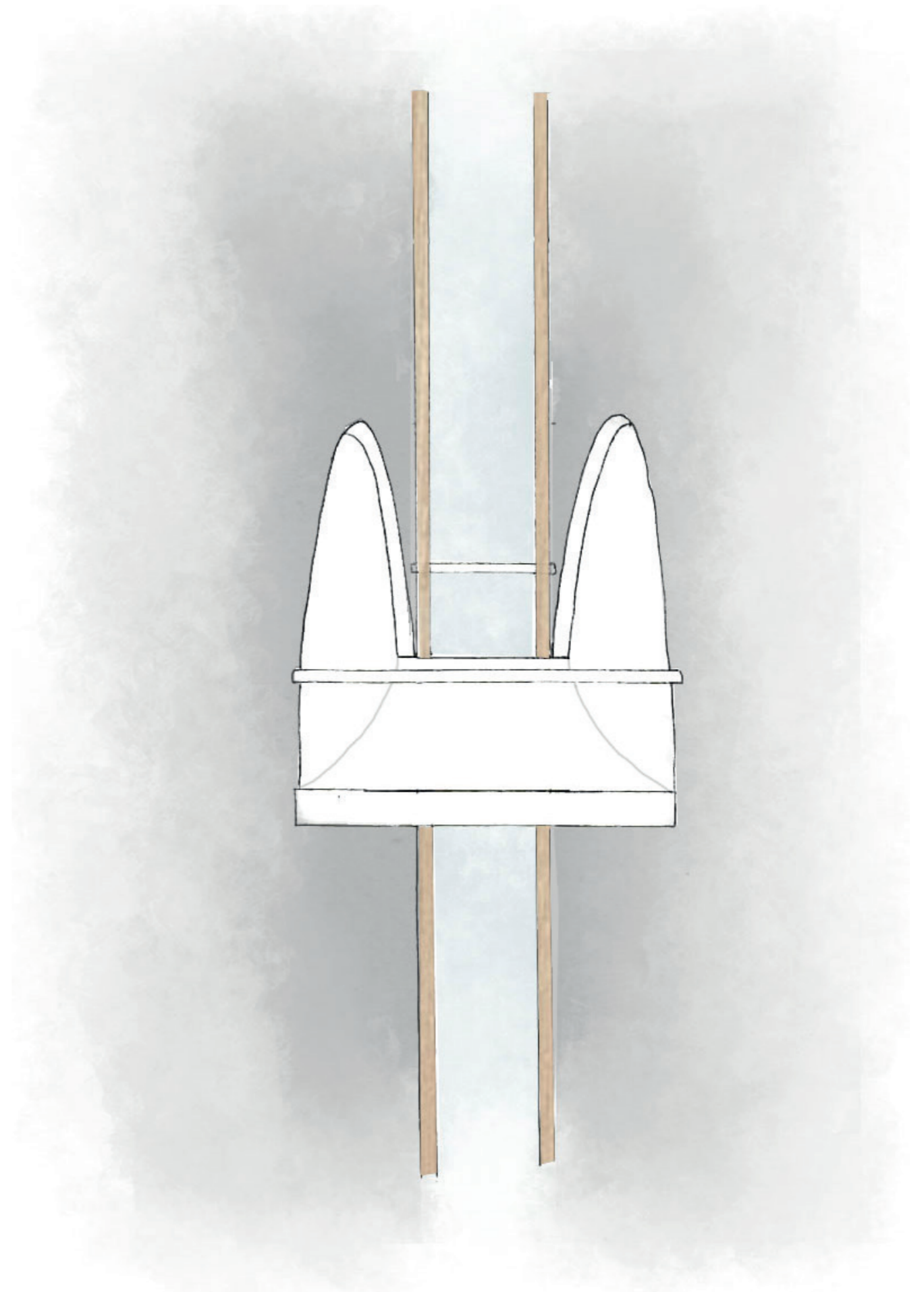
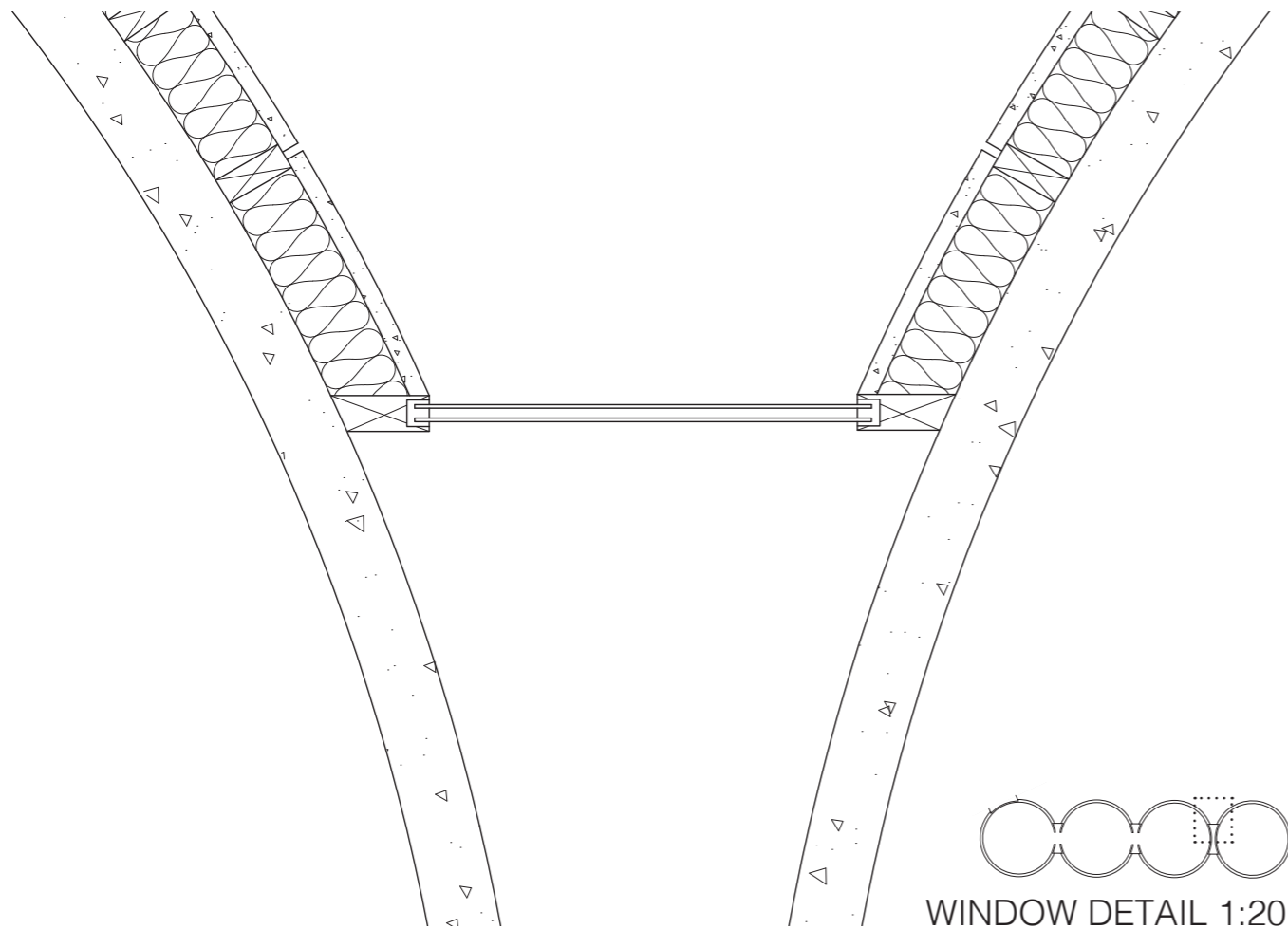

NEW BEAMS AND SLABS

To create new floors, we also had to add new beams carrying the loads of the slabs. We have tested different materials during the process, but decided that we wanted to keep concrete as the main material. All the new floors and beams are therefore in concrete. To get a smooth connection between the existing interior walls and the new elements, we take out part of the existing wall until arriving at the reinforced steel. The reinforced steel in the new beams are drawn around the existing steel, making the existing and the new work as one, as shown in the detail. This allows for a completely smooth connection.

We have three different connections between beams and the existing walls, shown on the next page.

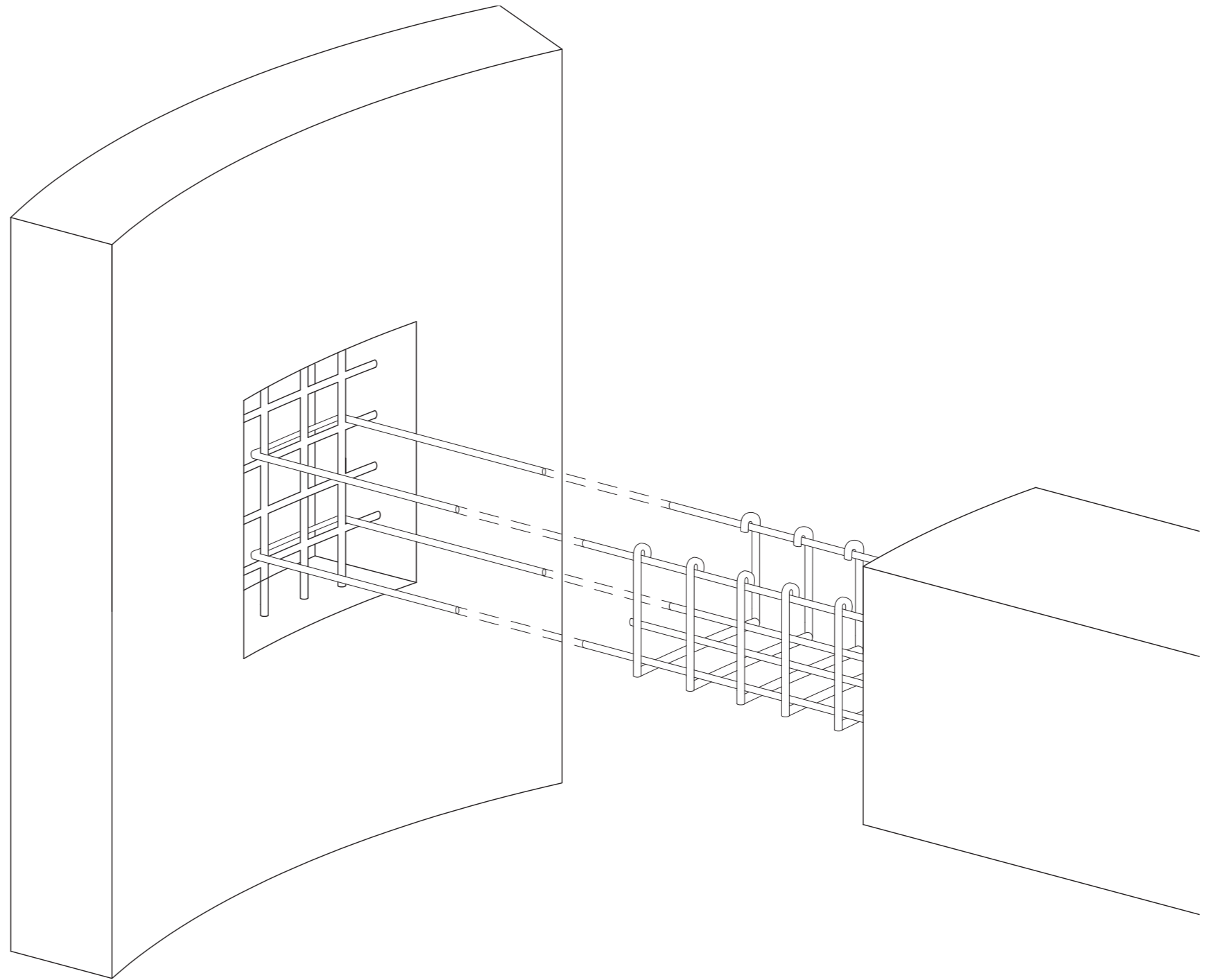

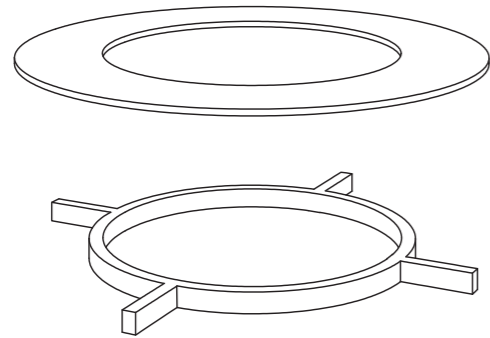

THE SLABS

We have created a system of exposed beams to carry the load of the slabs. It consists of four straight beams that are perpendicular to the circle and a circular beam. It is designed this way to allow open spaces between the floors. Another possibility it creates is to draw the slab back from the walls and have a gap of light flow into the room below. The beams have the same dimensions as the ones in the squared silo, 500mm x 350mm.

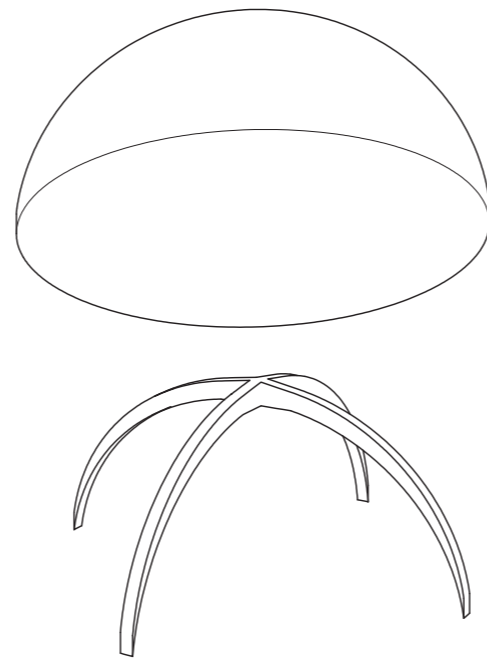

THE DOME

The dome works as a proper dome construction, but we have added some thinner beams under for aesthetical purposes.

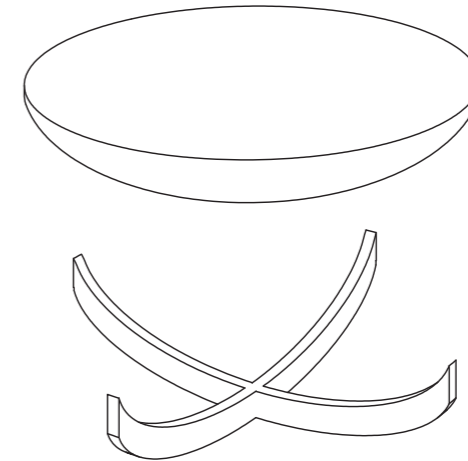

THE INVERTED DOME

The inverted dome carries the heaviest load and has therefore the thickest beams, 800 mm, being 1/18 of the total length. Above the beams there is a concrete slab containing the amphitheatre and theatre.

THE ROOF

THE EXISTING ROOF

As previously mentioned, the existing roof is leaking and is in a bad condition. It has to be completely refurbished.

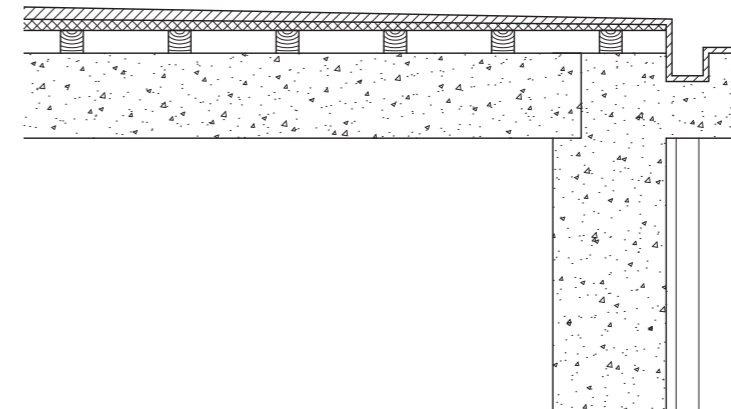

THE NEW ROOF

To get an acceptable U-value inside the building, we have added 300 mm of hard insulation and a vapor barrier on top of the existing concrete roof. The roof has a slight inclination and is covered with a membrane. Previously, the water was transported on the outside of the building, but we have now moved it in between the insulation. The parapet is covered with a metal cap and carried by wood studs.

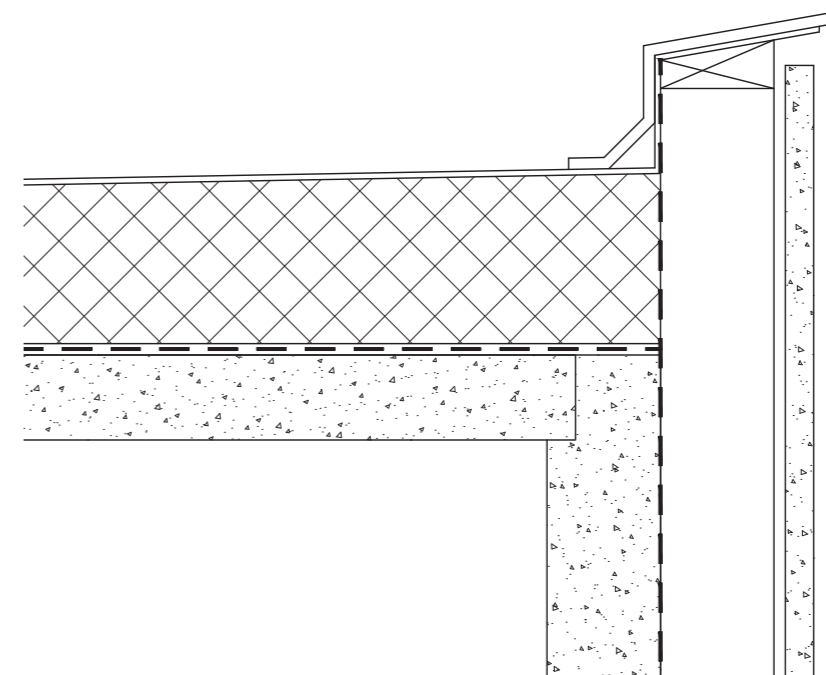

CONCRETE

After testing with various materials, we decided to maintain the concrete as our main aesthetical element and building material. We want to have a rough surface, so we have decided to use wood as formwork for the prefabricated exterior elements. Below is a test we made using wood as formwork

PERCIEVED COLOUR

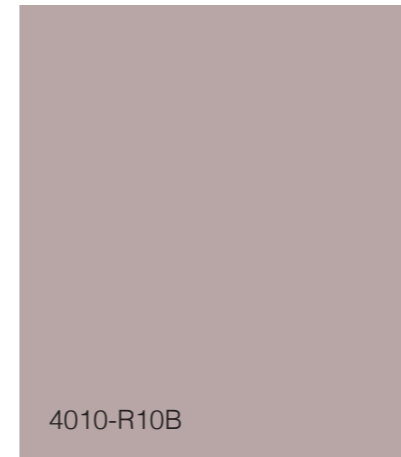

PHOTO



OUTSIDE FACADES

The new façade elements will have a slight red tint to the concrete.



THE CONCRETE INSIDE

The old interior concrete has a rough and unique feel to it that we want to maintain.



THE NEW INTERIOR CONCRETE

The new concrete in the interior beams and slabs will have a lighter tone than the existing, making the old and the new distinguishable.



INTERIOR MATERIALS

Our main material is concrete, but we want to add small details in other materials. Like the window frames in oak and the green steel frames in the workshop, which we will give a new coating of the original colour.

We wanted to use steel in other parts of the building, like in the round elevator. We also use a lot of glass, for example as railing with a wooden frame.

To create better acoustic performance, we want to add thin, wooden boards on parts of the walls. This is something we would like to further develop if we were to continue working on the project.

GLASS

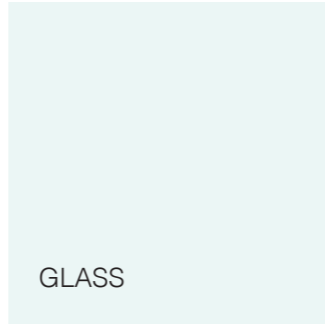

OAK



STEEL



STEEL



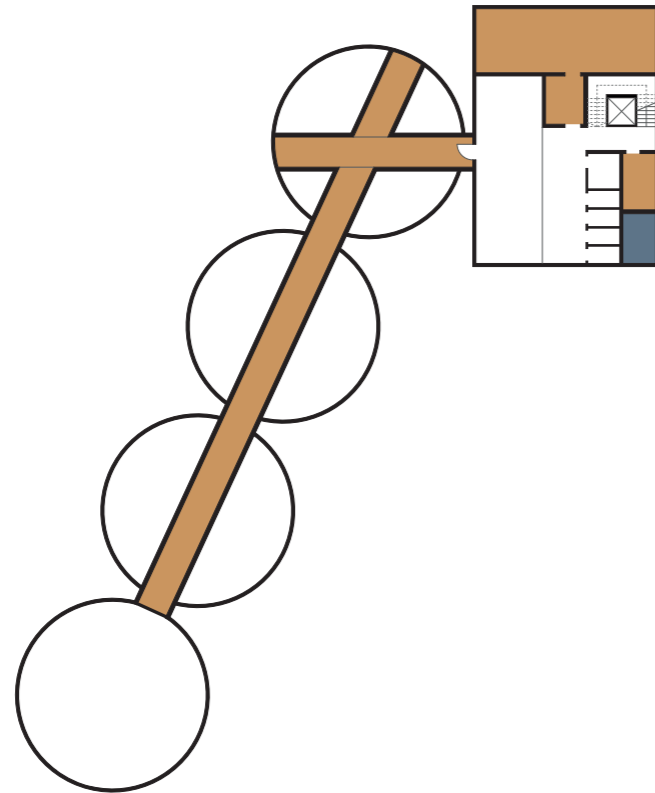

VENTILATION AND TECHNICAL ROOMS

We have one vertical, technical shaft in the squared silo (marked in blue). It leads down to the basement where the technical rooms are (marked on orange). The slabs will contain the rest of the necessary technical shafts.

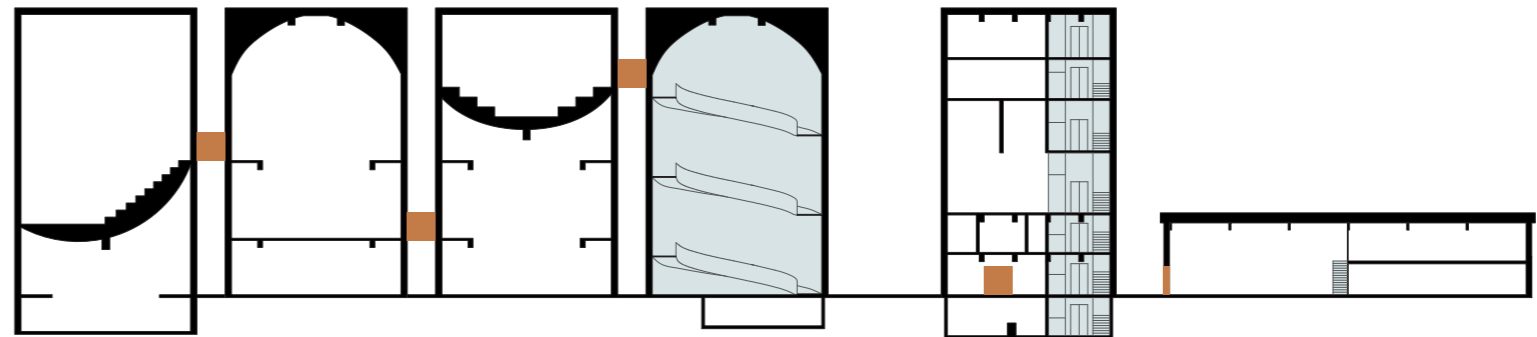

STAIRS AND FIRE ESCAPES

The complex has two main staircases. We have added a fire escape to the north of the complex in connection to the round silos. It is connected with bridges leading to a staircase across the road. The drawing above shows where the bridges are located on each floor and other emergency exits.

THE OLD AND THE NEW

The black lines represent the pre-existing elements and the orange areas show what we have added. As you can see new façades have been built around the existing buildings. Most of the vertical walls are kept, and almost all horizontal elements have been added. The staircases and lifts are also new. The squared silo is closest to its original state, having kept most of the slabs, beams and walls. We have also kept one of the machines inside the main room. The concrete floors have all been kept, apart from in the outer silo where the sea flows in. We have removed part of the floor in the round silos to make it level with the rest of the ground floor.

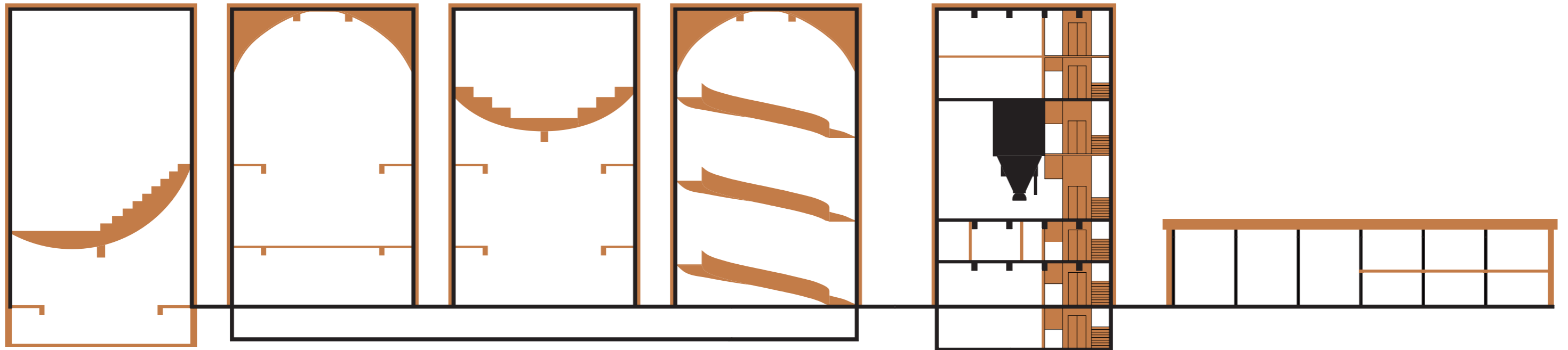

INSPIRATION AND REFERENCE PROJECTS

1. Pantheon by Giovanni Paolo Panini (1734)
2. UNESCO Meditation Space by Tadao Ando, unknown photographer
3. La Plage du Pacifique Hotel by Kristin Green, photo by Peter Bennets (2013)

THE CATHEDRAL

We were inspired by monumental buildings with creative shapes and interesting lights, for instance Pantheons dome and skylight, the Nidarosdomen's colours and St. Hallvards church's inverted dome.

THE CONCRETE

We have studied a lot of different projects that treat and use concrete in inspiring ways. Some examples are La Plage du Pacifique Hotel by Kristin Green and La Fábrica by Ricardo Bofill.

For the façade we were inspired by Strandingsmuseum St. George, where they have used 45mm thick concrete elements that measure 17 meters.

THE INTERIORS

For the interior features, in addition to the ones already mentioned, we studied UNESCO Meditation Space by Tadao Ando and Substrate Factory by Ayase Aki Hameda Architects.

We were also inspired by Solomon R. Guggenheim Museum by Frank Lloyd Wright, after visiting it in November 2019.



1



2



3

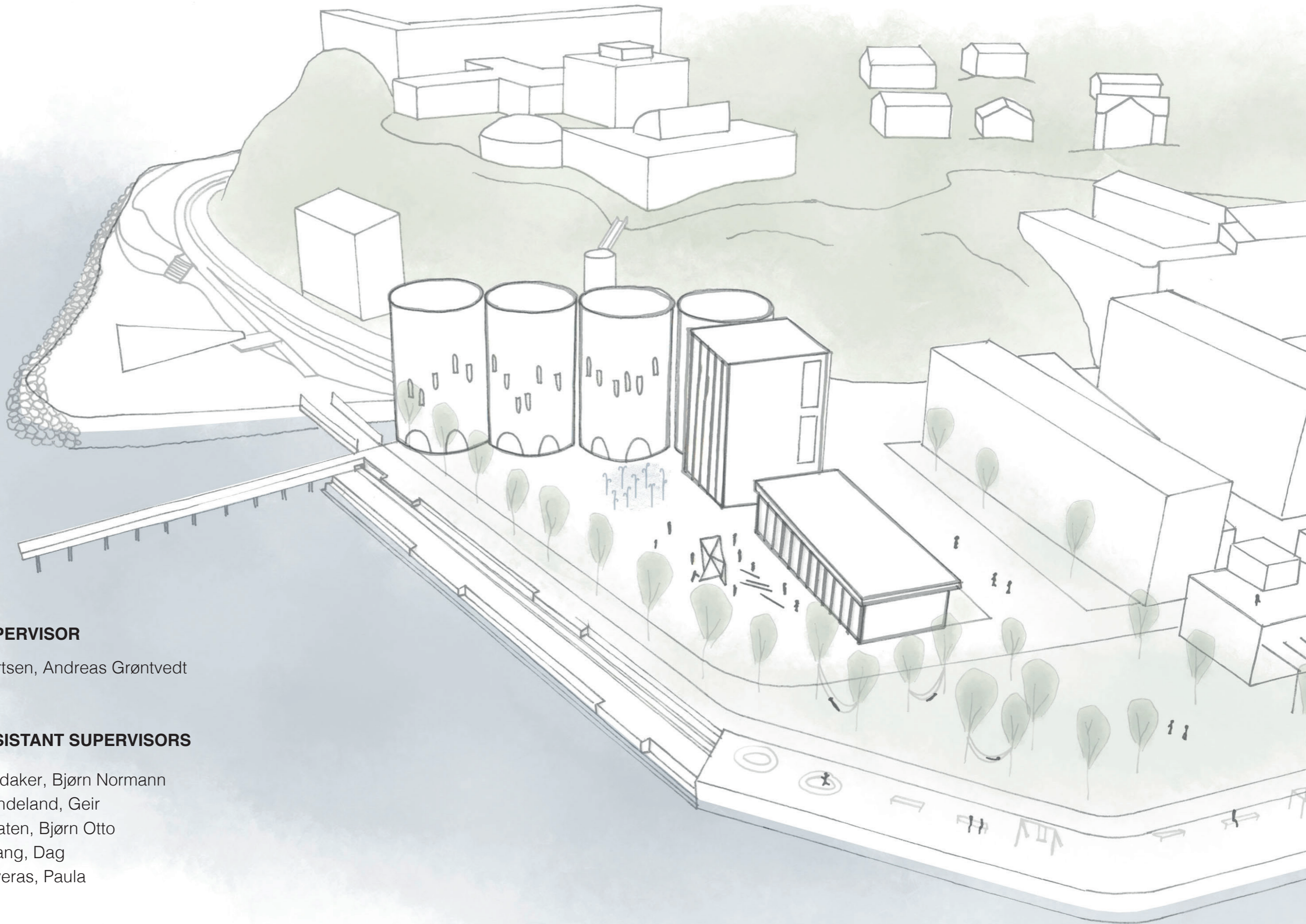

SUPERVISOR

Gjertsen, Andreas Grøntvedt

ASSISTANT SUPERVISORS

Sandaker, Bjørn Normann

Brendeland, Geir

Braaten, Bjørn Otto

Kittang, Dag

Lloveras, Paula