

Clayton Paul Skousen

NTNU
Norwegian University of
Science and Technology
Faculty of Architecture and Design
Department of Design

Clayton Paul Skousen

Keyboard Design to Help Digital Creators Optimize Their Workflow

May 2023





Norwegian University of
Science and Technology

Keyboard Design to Help Digital Creators Optimize Their Workflow

Clayton Paul Skousen

Industrial Design

Submission date: May 2023

Supervisor: Andre Liem

Co-supervisor: NA

Norwegian University of Science and Technology
Department of Design

Abstrakt

Mange digitale skapere sliter med å effektivt bruke snarveiene i sine respektive dataprogrammer. Dette problemet er en kombinasjon av volumet av snarveier og programmer og individuell bruk samt hindringene som ligger i veien for å oppdage svarveier. Å designe et tastatur som hjelper digitale skapere med snarveisoptimalisering og programnavigering er en gjennomførbar løsning på dette problemet. Forskning i snarveisoptimalisering ble utført i tidligere publikasjoner og er mye referert gjennom dette arbeidet. I dette prosjektet ble keycap-design utforsket for å sikre at alle tastaturløsninger er komfortable og innbydende for sluttbrukere. Gjennom undersøkelser, workshops og tilbakemeldinger fra brukere ble mulige tastaturoppsett utforsket. Etter at et tastaturoppsett var ferdigstilt, ble et tastaturdeksel designet for å passe til ønsket estetikk. Som en siste komponent ble kartlegging av funksjonene til en tilkoblings-UX utforsket. Funnene gjennom dette prosjektet dekker en rekke tastaturutvikling og design som kan være nyttig i videreutviklingen av andre tastaturer og design-UI-er. Et tastatur ble designet basert på funn fra observasjoner, workshops, en spørreundersøkelse, flere runder med tilbakemeldinger fra brukere og prototyping.

Abstract

Many digital creators struggle to effectively use the shortcuts in their respective computer programs. This problem is a combination of the volume of shortcuts and programs that individuals use, and the roadblocks in shortcut discovery. Designing a keyboard that assists digital creators with shortcut optimization and program navigation is a viable solution to this problem. Research in shortcut optimization was conducted in prior publications and is heavily referenced throughout this work. In this project, keycap design was explored to ensure any keyboard solutions are comfortable and inviting to end users. Possible keyboard layouts were explored through surveys, workshops, and user feedback. After a keyboard layout was finalized, a keyboard case was designed to fit the desired aesthetic. As a final component, mapping out the functions of an accompanying UX was explored. Findings throughout this project cover a range of keyboard development and design which could be useful in further developing other keyboards and design UIs. A keyboard was designed based on findings from observations, workshops, a survey, multiple rounds of user feedback, and prototyping.

Table of Content

1.0 Introduction	1	4.0 Layout Design	53
1.1 Who I am	2	4.1 QWERTY	54
1.2 Project Brief	2	4.2 Layout survey	55
1.3 Project Planning	3	4.2.1 Key Usage	56
1.4 Design Process	7	4.3 UI Analysis	57
1.5 Special Thanks	9	4.3.1 Space-Based Design	57
1.6 Masters Agreement	10	4.3.2 Visual-Based Design	59
1.7 Problem Statement	11	4.3.3 Time-based Design	60
1.8 Target Users - Digital Creators	11	4.3.4 Code Based Design	61
1.9 Product Work Environment	12	4.3.5 Analysis of is found in Digital Creator	62
1.10 Work Impact	14	4.3.6 Exploring Additional Keyboard Functions	67
1.11 Project Scope	14	4.4 Layout Exploration Workshops	69
1.12 Moodboard	15	4.4.1 EGGS Trondhiem	70
1.13. Keyboard History, Terms and Standards	17	4.4.2 K8 industridesign	72
1.13.1 Brief History of Mechanical Keyboards	17	4.4.3 EGGS Oslo	74
1.13.2 Modifiers	18	4.4.4 BERRE Kommunikasjon	76
1.13.3 Keyboard Sizes	19	4.5 Requirements List - Functional Analysis	78
1.13.4 Mechanical Switches	21	4.6 Layout Sketches	79
1.13.5 KeyCaps Profiles and Sizes	21	4.7 Layout Prototyping	80
2.0 Previous Supporting Research	23	4.8 User Analysis and Feedback	81
2.1 Competitors Analysis	24	4.9 Final Layout	83
2.2 Observation	29	5.0 Case Design	85
2.2.1 YouTuber 1 - Uncle Jessy	29	5.1 Disposable/Repairable/Recyclable	86
2.2.2 YouTuber 2 - Noggi	30	5.2 Analysis of Keyboard Assembly Methods	86
2.2.3 YouTuber 3 - Thomas Sanlanderer	31	5.3 Sketching	87
2.3 Methods of Shortcut Optimization	33	5.4 Prototypes	88
2.4 Shortcuts and the Paradox of the Active User	38	5.4.1 Prototyping Components	88
2.5 Reflections on Previous Research	38	5.4.2 Full Scale Prototypes	91
3.0 Keycap Design and Switch Selection	39	6.0 UX	93
3.1 Analysis of Keycap Types	40	6.1 Functions Exploration	94
3.2 Analysis of Key Mechanisms	41	6.2 UX Mapping	95
3.3 Keycap Design and Switch Selection	43	7.0 Final Detailing	97
3.3.1 Test 1 - Keycap Cap Angle	43	7.1. Material Selection	98
3.3.2 Test 2 - Keycap Profile	46	7.2 Branding and identity	99
3.3.3 Test 3 - Preferred Mechanical Switch	49	7.2.1 Logo	100
3.4 Form Exploration	50	7.3 Final Keyboard	101
3.5 Font Exploration	51	8.0 Discussion	109
3.6 Final Design	52		

8.1 Problem Statement	110
8.2 Qualitative vs. Quantitative Data	110
8.3 Reflection on the Process	110
8.4 Possible Source of Error	111
8.4.1 Survey	111
8.4.2 Observation	111
8.4.3 Competitors Analysis	111
8.4.4 User Feedback and Workshops	112
8.5 The Future	112
8.5.1 Future Work	112
8.5.2 The Future for Digital Creators	113
9.0 Conclusion	114

References

Appendix

Appendix 1.0 - Email to Youtubers

Appendix 2.0 - Keycap

 Appendix 2.1 - Keycap Sketches

 Appendix 2.2 - Rendered Form Exploration

 Appendix 2.3 - Fount Exploration

Appendix 3.0 - Layout

 Appendix 3.1 - Survey

 Appendix 3.2 - Layout Exploration

Appendix 4.0 - Case Design

 Appendix 4.1 - Case Mounting Options

 Appendix 4.2 Case Sketches

Appendix 5.0 - Logo Exploration

1.0 Introduction

The purpose and scope of this project were analyzed prior to any significant developments in designing a keyboard. Additionally, aesthetic inspiration for the final product was set forth through the use of a moodboard. As there are many terms and concepts of keyboard design with which readers may not be familiar, a brief history of keyboard design, as well as keyboard terms and standards, has been included to conclude this section.

1.1 Who I am



Clayton P. Skousen

M.S. Industrial Design

*B.S. Outdoor Product Design
and Development*

I started my education with completing 2 years in Mechanical Engineering before making the switch to complete a full bachelor's degree in product design with an emphasis on the outdoor recreational industry. Professionally, I have prototyping and design consulting experience working with various engineering research labs at Utah State University and managing St. Luke's Hospital Innovation Lab in Cedar Rapids Iowa, where I consulted medical staff on designing in-house medical devices. Additionally, I have experience as a welder, figurine designer, and YouTube educator.

This project was appealing to me as I love creating on my computer. Whether it is an educational video or a 3D animation, I love exploring my creative potential. I especially love helping other people do the same, which is why I chose to design a keyboard to help digital creators reach new heights in their individual professions.

1.2 Project Brief

The purpose of this project is to design a computer keyboard that helps digital creators optimize their creativity and efficiency when working on their respective computer programs. The keyboard will need to function seamlessly as an everyday typing keyboard while being able to perform effectively on a large range of design programs. Optimization of creativity and efficiency will ideally be achieved through improved keyboard layout and form, customizability, and self-learning technology. Additionally, the keyboard should be easily repairable, and fit in a range of work environments.

1.3 Project Planning

Planning out this project started with writing out all of the major components of the project which would need to be designed. These components were written on yellow sticky notes. On pink sticky notes, key questions relative to their respective

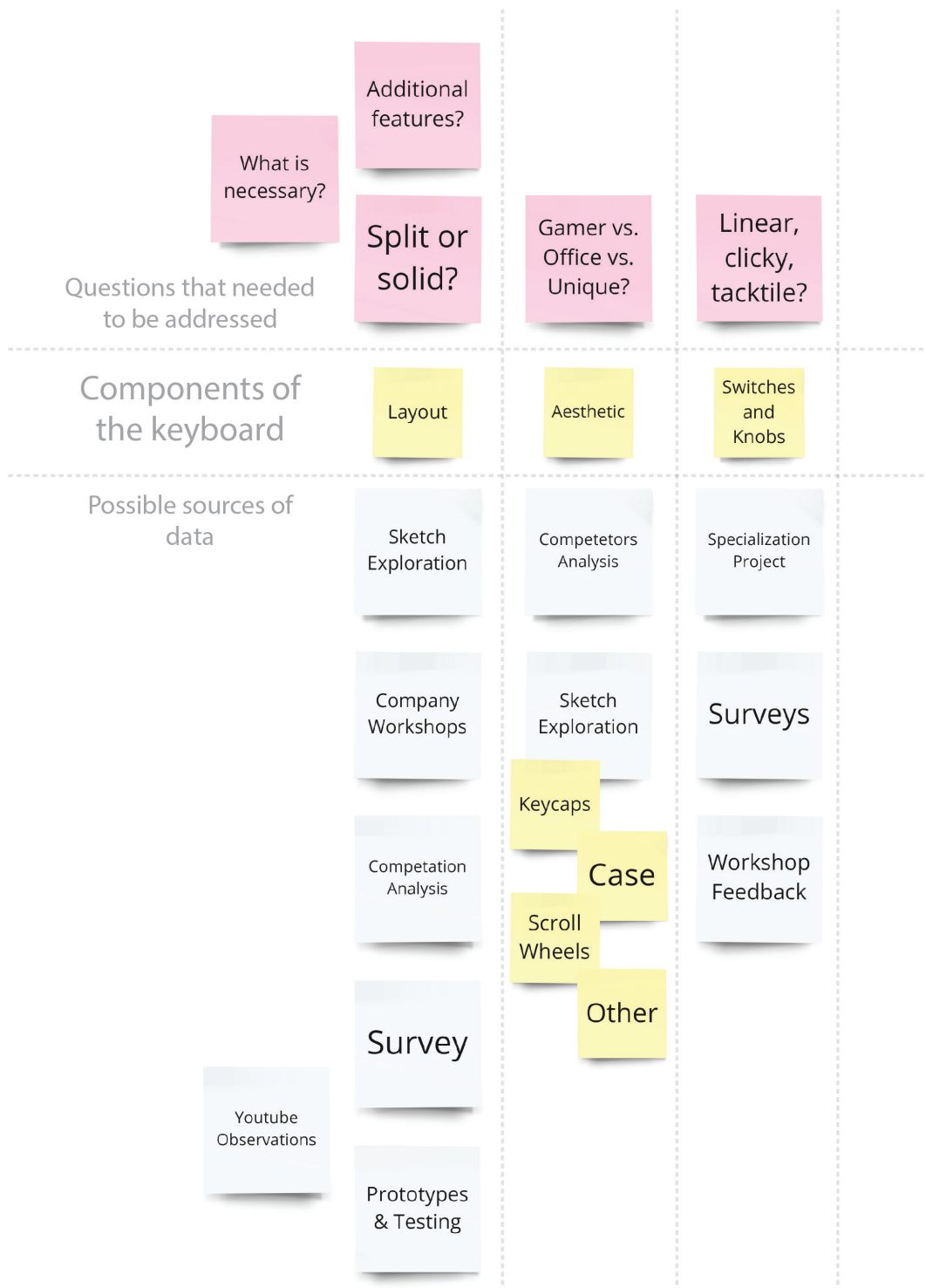

component were listed above the yellow. Below the yellow notes, white notes were used to indicate different methods and resources that could be used to test and design each individual component.

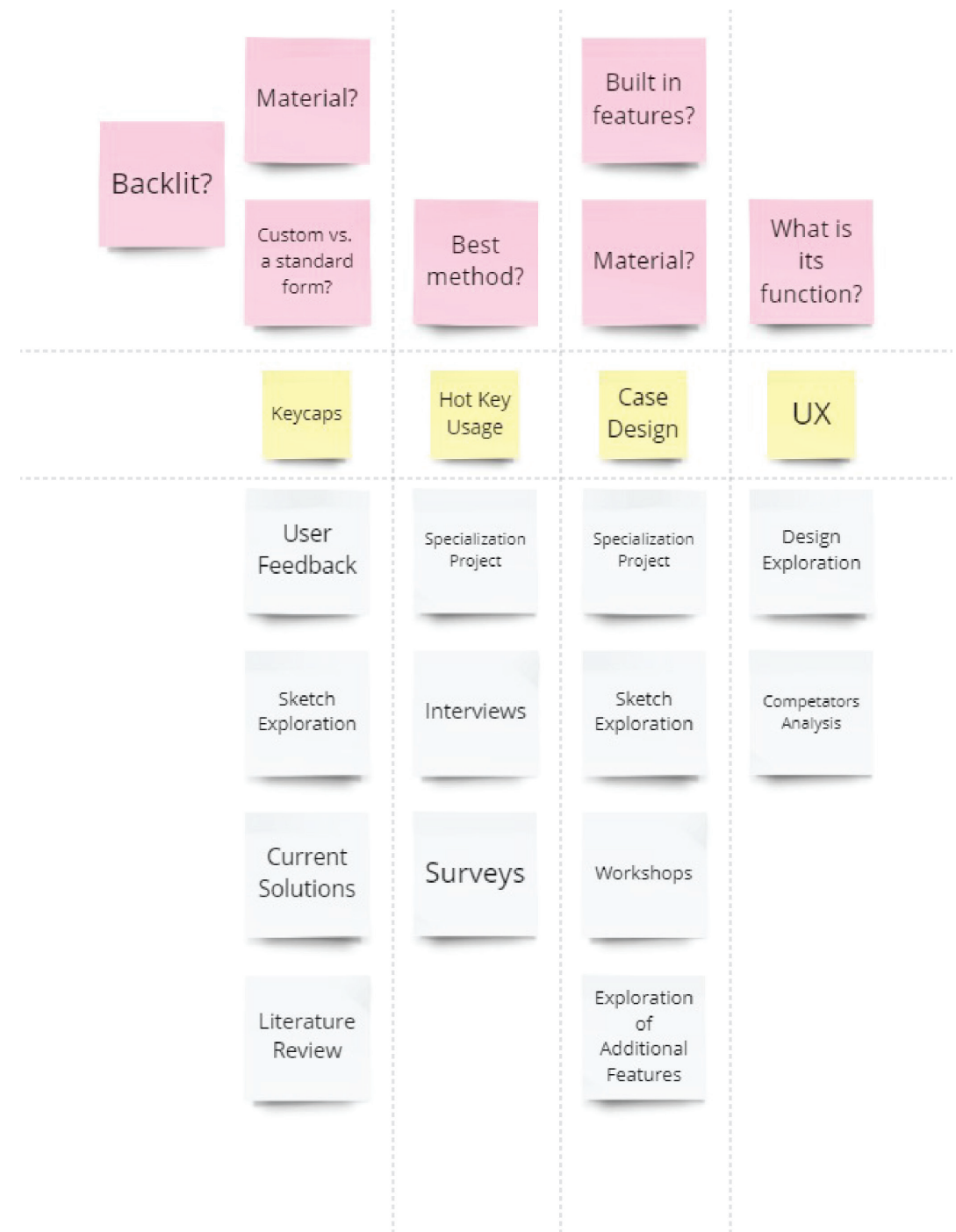

Figure 1. Project planning helped breakdown the various components of designing a keyboard.

This overview of the various components of the keyboard project was later digested into individual tasks and placed onto a Gantt chart. The 5 main tasks in the Gantt chart were as follows: Shortcut Optimization, Keyboard Layout, Keycap Design, Case and Assembly Design, and UX Design. As shortcut usage is one of the fundamental characteristics of digital creators, it seemed logical to start the project with research into methods of optimizing keyboard shortcuts. This research was completed as a “Specialization Project” prior to this project and will be sourced as previous research throughout this report. Following shortcut optimization, exploring keyboard layouts and keycap design were initiated. The functionality of a keyboard is most greatly affected by the overall layout and the quality of the keys with which users interact. For these reasons, the keyboard layout and the design of the individual keys were explored even before any substantial aesthetic decisions were considered. Only after the keyboard layout and keycap designs were finalized, were the designs of the case and UX initiated. This decision was made to ensure that the function of the keyboard drove the overall design of the keyboard.

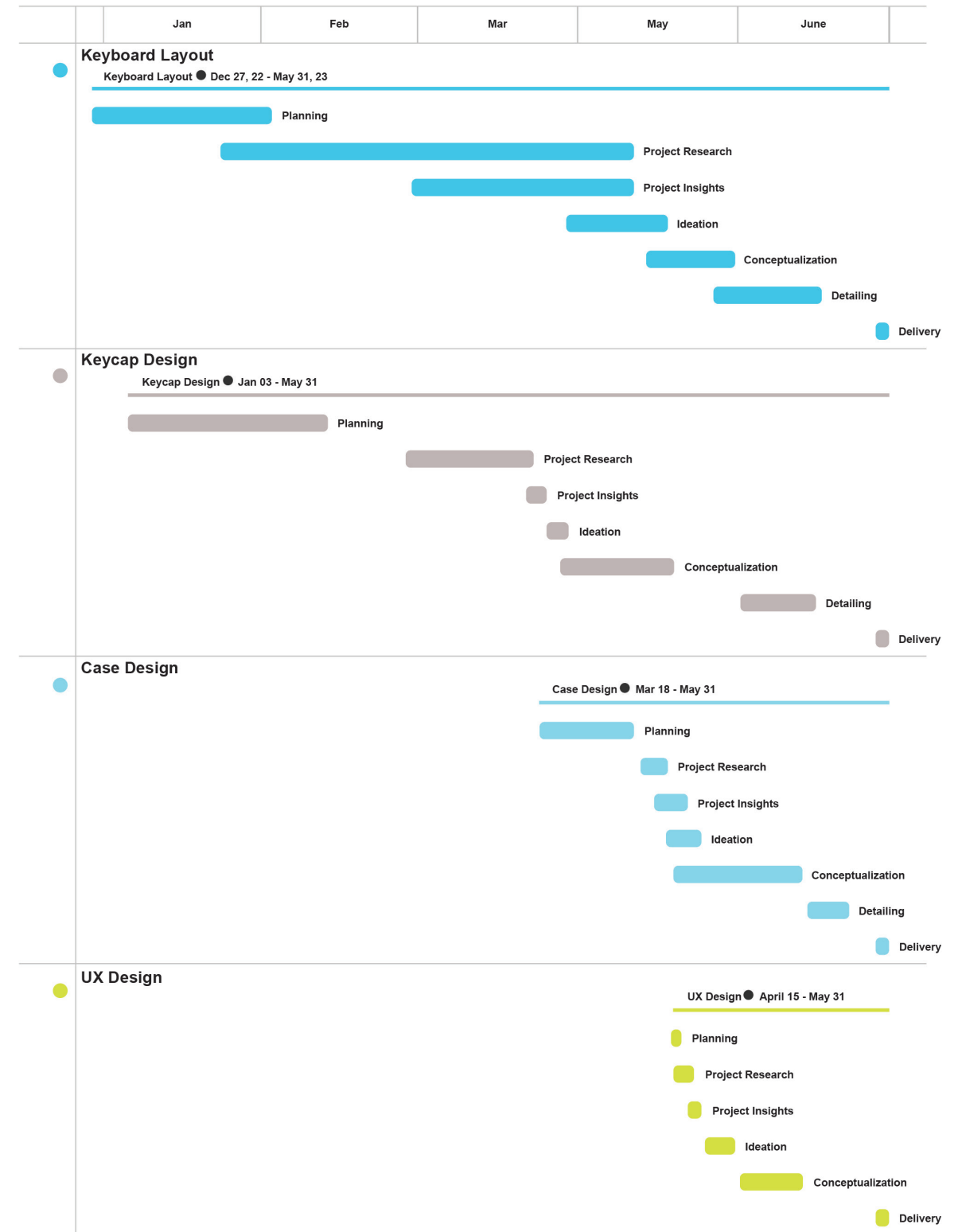

Figure 2. Keyboard design Gantt chart.

1.4 Design Process

Keycap Design

The task of designing the keycaps was seen to be of the highest importance as keycaps are the components with which users interact the most. If the keycaps were designed poorly, no one would use the keyboard no matter how efficient the keyboard may be. Additionally, the final design of the keycaps, and the font found on them, greatly affected the visual and interactive appeal to the layout of a keyboard, which was the next smaller project that was pursued.

Layout Design

Designing the layout of a keyboard drastically affects the design of the keyboard case, as any changes to layout can affect its final dimensions. As such, it was imperative that the keyboard layout be thoroughly tested and completely finalized before the keyboard case could move beyond early conceptualization.

Case Design

Eventhough the case, as a single piece, takes up the most space for a keyboard, it functions simply a box. Because of this, the design of the final case was one of the least important aspects in designing the keyboard. By the time the case was being designed, the overall aesthetic of the keyboard had been well defined, and a simple case that matched that aesthetic seemed to naturally develop.

UX Design

The UX really is what binds all of the research together into a cohesive presentation of functionalities of the final keyboard. As only a rough framework was ever intended to be created for this project, it was the last part of the project explored.

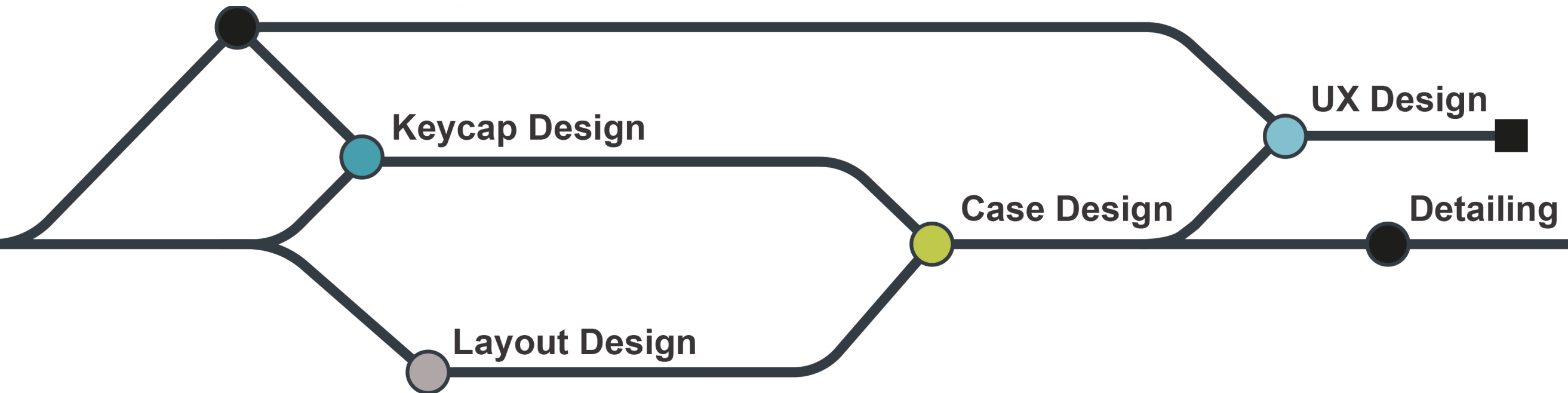

Figure 3. Design Process

1.5 Special Thanks

Although this was not a group project, there were various individuals and companies that contributed time, knowledge, information, and even equipment. Special thanks to Andre Liem for his incredible academic guidance throughout this project. Additionally, there were a number of companies that participated in workshops often in their own office spaces, namely EGGS Design in Trondheim, Studio Gauntlet, K8 industridesign, EGGS Design in Oslo, and BERRE Kommunikasjon.



Additional thanks should be mentioned to PFI, as they permitted their SLA printer, cleaning equipment, and facilities to be used for the creation of the final keycaps among other final components.



1.6 Masters Agreement



Masteroppgave for student Clayton Skousen

Title: Keyboard design to help digital creators optimize their workflow

- The project aims to explore and create a keyboard that will help digital creators better utilize built-in features in their respective design programs.

Background and purpose of the assignment

- Keyboards for years have been designed for the sole purpose to help individuals communicate and navigate through computers. As the functionality of computers has diversified, more industries have developed around the limitations of the QWERTY keyboard. Though in many situations this is not an issue, there are industries that do not function efficiently when restricted to standard QWERTY keyboards. Changes to materials, mechanics, and even layout have been utilized to adapt to the needs of these unique users. Digital creators are a community of unique keyboard users that need better functionality from their keyboards to optimize the complex design programs on which they work. Digital creators can be defined as professionals that use computers to create products or digitally edited content: engineers, industrial designers, video game developers, video editors, and graphic artists. Unfortunately, the numerous industries in which digital creators work are poorly equipped when it comes to the capabilities of their keyboards.

Expected approach

1. Sketching exploration for functionality and aesthetics
2. Workshops with stakeholders focusing on exploration and refinement of design
3. Analysis of competitors' products and aesthetic trends in keyboard design
4. Surveys from end users
5. Several iterative rounds of ideation
6. Several iterative rounds of conceptualized detailing
7. Iteration and refine prototype from feedback and iteration rounds

Expected results and format

1. A mechanically functioning keyboard with an emphasis on ergonomics and manufacturability
2. Project report

The assignment is carried out according to the "Guidelines for master's theses in Industrial Design".

Principal Supervisor: Andre Liem

Delivery Date: 9. January 2023

Submission Deadline: 29. May 2023

Andre Liem
Supervisor

NTNU, Trondheim, 09 January 2023

Sara Brinch
Institute Leader

1.7 Problem Statement

Current computer keyboards discourage digital creators from effectively using built-in shortcuts for their respective design programs.

1.8 User Group - Digital Creators

In this project, digital creators are defined as white-collar workers who use some form of design/art computer programs to generate digital or physical products or assets. This definition of digital creators can include but is not limited to:

- Graphic designers
- Videographers
- Architects
- Photographers
- Programmers
- Industrial designers
- Video game developers

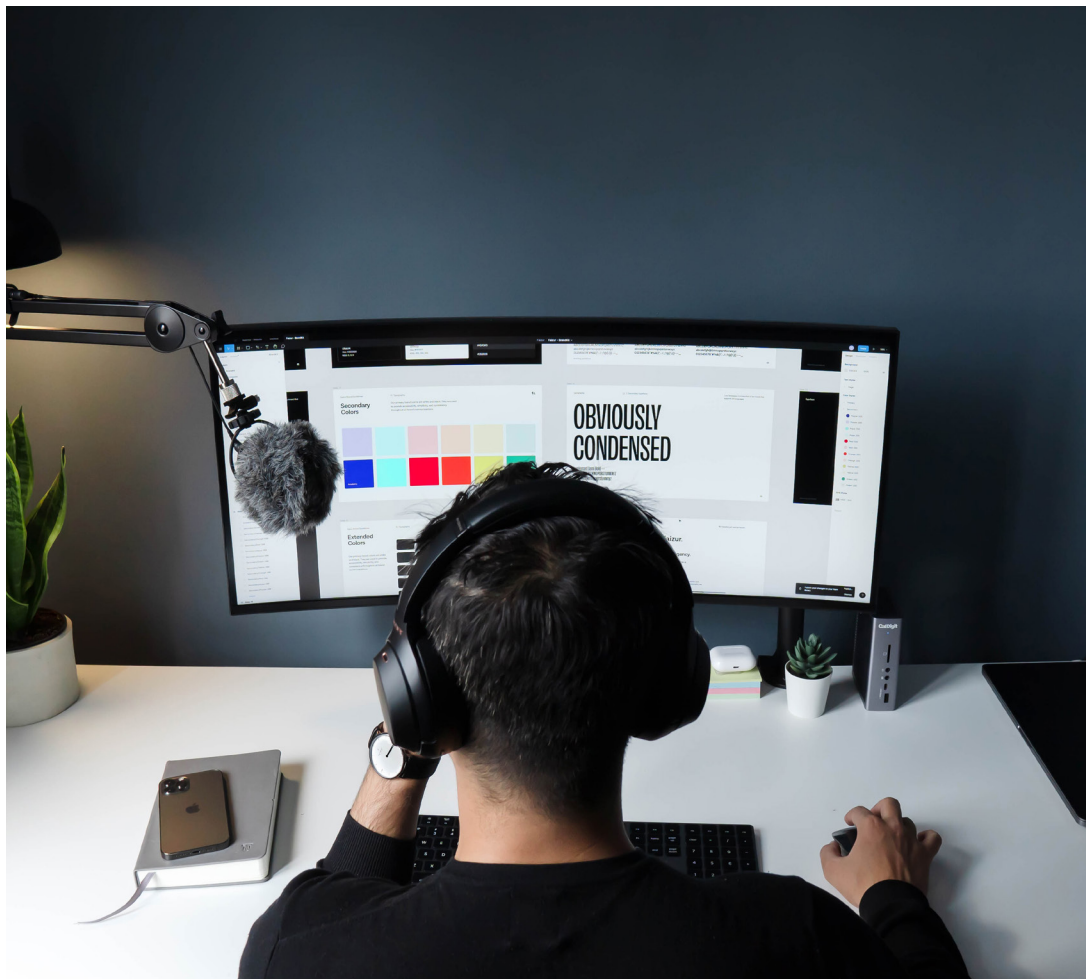

Figure 4. Example of a digital creators.

Why are these professions being grouped?

Digital creators have a number of commonalities. They all create digital products or assets using technical design programs. These programs often share a number of similar UIs and heavily rely on the use of shortcuts or “hotkeys”. Due to the high usage of shortcuts, digital creators typically have a “home position” of the left hand on the keyboard and the right hand on the mouse.

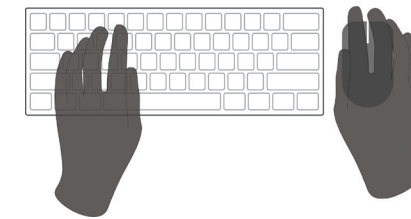

Figure 5. Type-touchist home position (top) compared to digital creators home position (bottom)

Additionally, digital creators often use peripheral tools such as sketch tablets, 3D mice, and specialized mice to easily navigate through their computer programs.

1.9 Product Work Environment

This product is intended to be used in business office spaces, home office spaces, and/or educational facilities. As such, there are a number of characteristics these spaces have that were taken into consideration as this project progressed.

Desk space: In all of these spaces, notes, projects, and many other objects often clutter the desk on which a digital creator is working. Because of this, keyboards may be moved around the desk temporarily or for long periods of time to make space for other tools (ie. sketch tablets) or tasks (working on physical prototypes or equipment)

Noise: Noise can be a huge distraction for some people when working. Distractions may come in the form of other people talking, phones ringing, or even someone using a keyboard in the same room. There are many factors that make the sound of a keyboard annoying for others, from cheap construction to high-end

“clicky” switches. Whatever the case, keyboards for office use need to be on the quieter side to help avoid being a distraction for others in the same room.

Debris: Whether you are a working professional or a student cramming for exams, it is not uncommon for computer users to eat and work at the same time. Unfortunately, this can lead to food and debris getting caught in keys and making components stick or malfunction. In extreme cases, spilling food on a keyboard may ruin it permanently. To combat this, keyboards need to be designed to withstand light misuse and be easily cleanable and repairable for catastrophic food-related incidents.

Peripheral Devices: Peripheral device would be considered any computer device that is internally or externally connected to a computer. Most computers require a minimum of a mouse, keyboard, and monitor in which to effectively navigate the computer’s processor. In some cases, such as digital creators, additional peripherals are used. Though the branding of these peripherals may differ, they all share aesthetic features and functions that help users identify their intended purpose. In some cases, these devices are designed to stand out, like gaming keyboards with RGB LED lights. While others tend to blend into the environment like some USB extensions or speakers.



Figure 6. Examples of peripheral devices can be see highlighted in blue.

1.10 Work Impact

To restate, the aim of this project is to design a computer keyboard that helps digital creators optimize their creativity and efficiency while working on their respective computer programs. By making a more useful keyboard for digital creators, it is believed that a substantial amount of time can be saved for each individual user. There are a number of potential ways that this could be achieved, one of which would be for the keyboard to help digital creators use keyboard shortcuts. In a study in 2005, it was found that if a computer user replaced one mouse command with a keyboard shortcut every minute, the user would save around 15 minutes a day. (Lane, Napier, Peres, and Sandor, 2005) Only saving 15 minutes may seem like a very small amount of time to gain back for an individual, but those 15 minutes add up quickly as seen in the equation below.

$$\begin{aligned} 15 \text{ minutes} \times 240 \text{ work days} &= 3600 \text{ minutes} \\ 3600 \text{ minutes} / 60 \text{ minutes} &= 60 \text{ hours} \\ 60 \text{ hours} / 8 \text{ hour work day} &= 7.5 \text{ work days} \end{aligned}$$

To further compound this time saved, it should be noted that a company could have multiple digital creators working for them. If there are 4 such workers saving 7.5 days a year, that company is gaining a monthsworth of work each year.

It should be noted that the above calculations are strictly speculative, but are also just one example of how a more effective keyboard for digital creators could affect individual users and the companies for which they work. With a keyboard that helps digital creators optimize the use of their programs beyond just keyboard shortcuts, there is potential for even more time to be saved.

1.11 Project Scope

As the research required to design a keyboard could span many topics involving keyboards, this project has focused chiefly on designing keycaps, exploring more efficient keyboard layouts, and creating a comfortable “designer” keyboard. It is believed that with a better-designed keyboard, digital creators will use keyboard shortcuts more efficiently in their respective programs. It should also be noted, the shortcuts in various programs differ significantly, therefore, designing a UX to help optimize shortcuts would be an ideal addition to any keyboard. This project was never intended to be a UX project, but as many additional functionalities can come from having a UX, time was spent exploring possible capabilities the keyboards UX should have.

1.12 Moodboard

As the design process of this project was intended to cycle each major component through designing, prototyping, testing, and evaluating, it was imperative that standard aesthetics should be generated to govern the design of each component generated throughout the project.

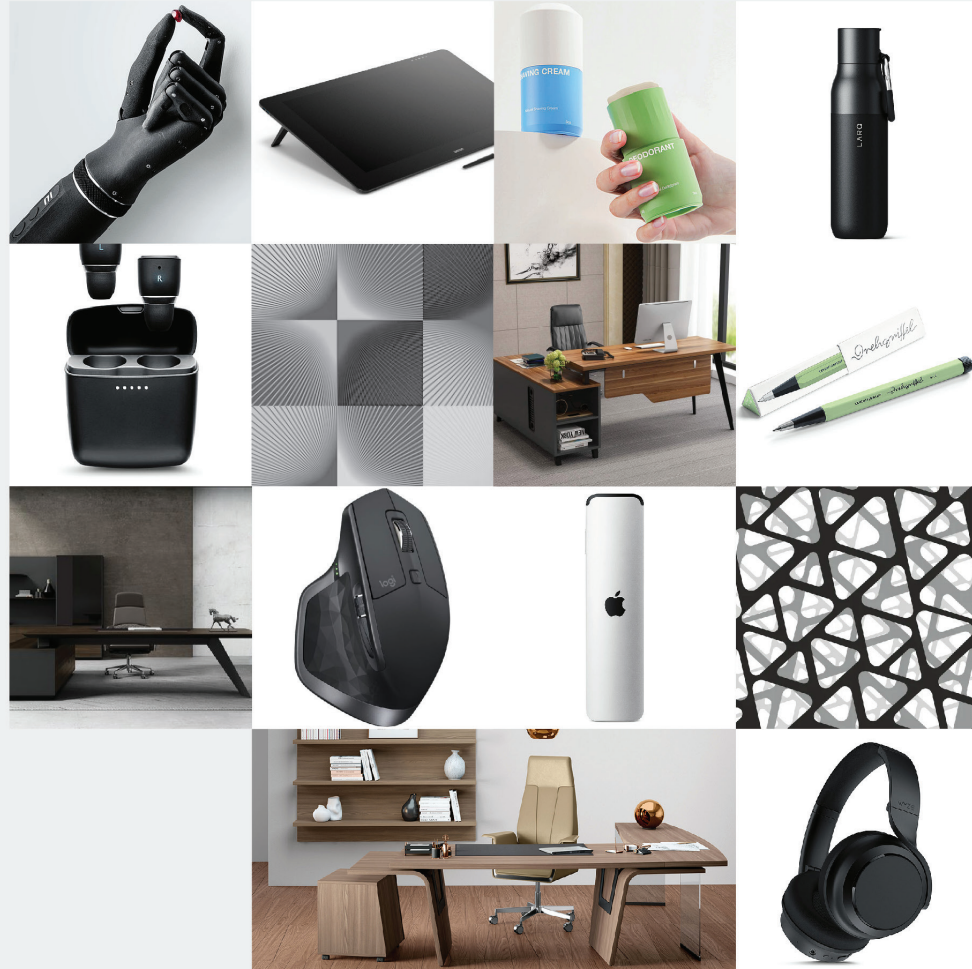

An hour was taken to collect images for the moodboard for this project. The moodboard explored images of materials, textures, and forms that embody a sense of design while keeping one foot in an office setting.

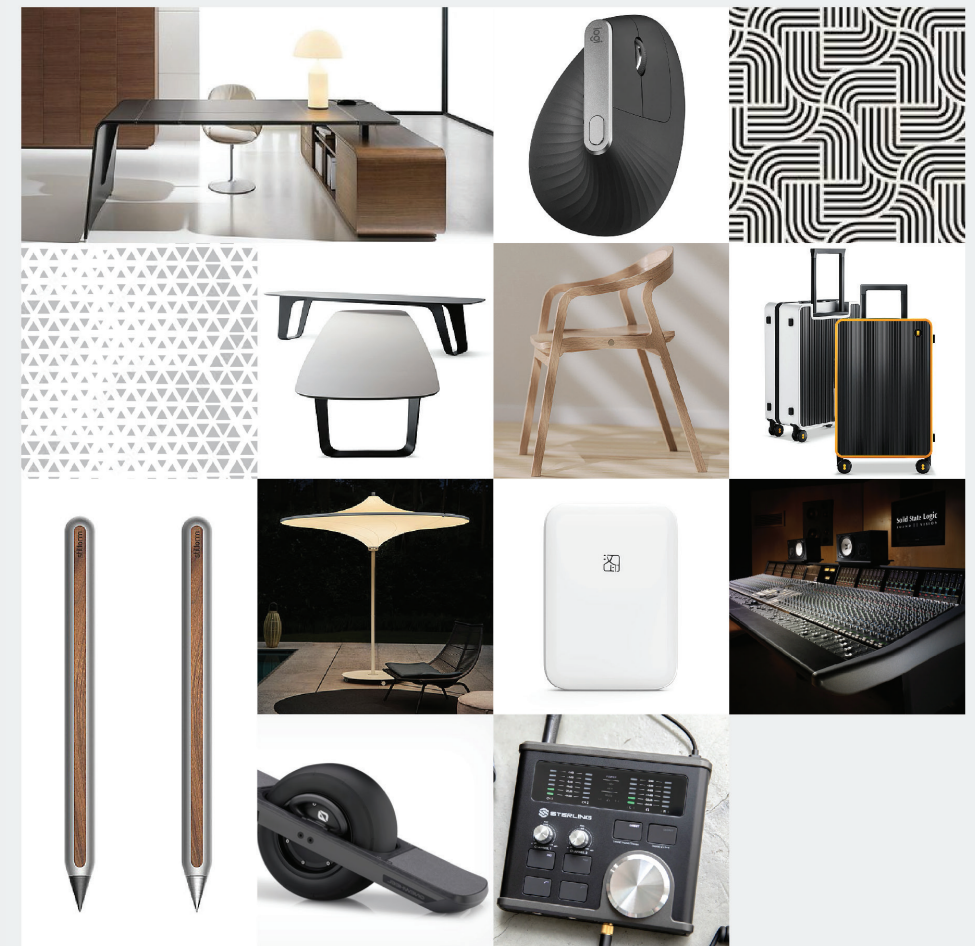

Figure 7.

1.13 Mechanical Keyboards History, Terms and Standards

When talking about designing a Mechanical Keyboard there are a number of standards and terms that are important to understand. As such, various key terms and principles have been defined below. Additionally a brief history of keyboard design has been provided.

1.13.1 Brief History of Mechanical Keyboards

For decades following the creation of the computer, keyboards have been designed for the sole purpose of helping individuals communicate on and navigate through computers. As technology and the need for computers have progressed, various changes have been proposed and in some cases adopted by various keyboard users. These changes go all the way back to when the first design for a split keyboard was patented in the 1910s. However, the first recorded research on a split keyboard did not take place till the 1920s. Substantial research wasn't performed on split keyboards until the 1970's when Dr. Karl Kroemer studied the preference and medical effects stenographers experienced while using a split keyboard (see Figure 8). In the 1990s computers started to become more commonly found in the average workplace and home. As such, typing-related injuries began to be more common. (Rempel, 2008) Carpal Tunnel Syndrome (CTS) and many other nerve-related injuries soon became a concern for type-touchist and the companies for which they worked. Such nerve damage is the effect of repetitive shock experienced by the hands and fingers of computer users, causing inflammation and in serious cases permanent damage to hands and wrists. (Miller, Barr, Riemer, and Harris, 2018; Rempel, 2008; Nagurka and Marklin, 1999)



Figure 8. Split keyboard experiment performed in the 1970's by Dr. Karl Kroemer (Rempel, 2008)

These issues led to research into alternative keyboard layouts and structures that would help support the wrist and hands of keyboard users better. The most well-known solution that came from these innovations was ergonomic keyboards. By adding the wrist support and splitting the QWERTY key layout. Typists could perform better and longer with less strain on their wrists and hands. This success led to ergonomic keyboards being some of the best-selling after-market keyboards in the 1990s and into the early 2000s (Rempel, 2008).

As the functionality of the computer has continued to increase in the 21st century, more industries have developed unique keyboards around the limitations of the common QWERTY keyboard. A great example of innovation has been seen in the computer gaming industry. Changes to materials, mechanics, and even layout (See Figure 9) have been utilized to adapt to the needs of this unique market, all while keeping to the traditional QWERTY arrangement. (Hong, Peck, and Lee, 2021; Miller, Barr, Riemer, and Harris, 2018) Unfortunately, the numerous industries in which digital creators are found have received little attention regarding more effective keyboards for their various design programs. (Skousen, 2022)



Figure 9. An example of one of Redragons "One-Handed" gaming keyboards (Redragon, n.d.)

1.13.2 Modifier Keys

Modifiers are keys that have the ability to modify the functions of another key. Some examples of modifiers on a keyboard would be Control (CTRL), Alternate (Alt), Command, Shift, and Function (Fn).

1.13.3 Keyboard Sizes

With a standard QWERTY keyboard layout, there are a number of differing sizes and layouts that are considered common in mechanical keyboards. Each of these sizes have their pros and cons, while users' opinions of each often depend on users' needs and personal preferences. Although there are a number of "standard" keyboard sizes, different markets gravitate to different sizes.

Sizes between 100% full size and the 80% Tenkeyless (TKL) keyboards tend to be favored in office settings. This is most likely due to the retention of the number pad or holds to layouts that are most familiar to the general public. In contrast, the smaller, and sometimes less common, layouts are typically favored more by keyboard enthusiasts and gamers.

Full Keyboard 104-108 keys

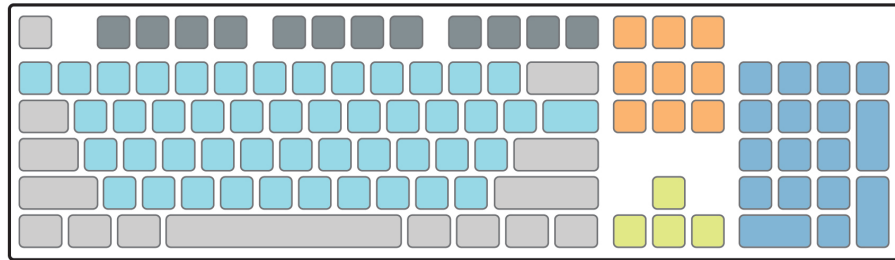

1800 99-104 keys, some home keys removed

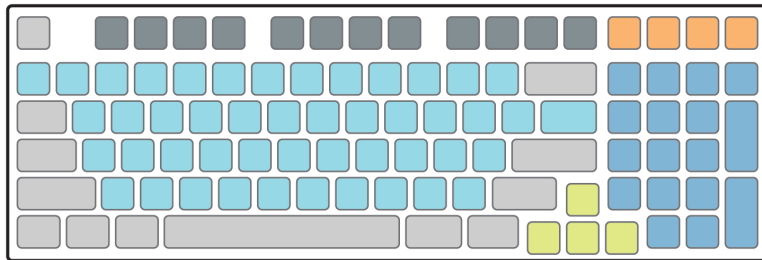

90% 99 keys, some home keys removed

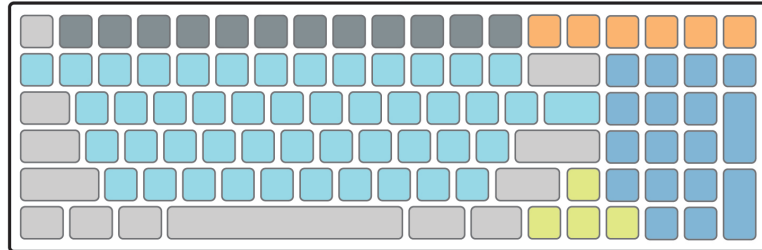

80% Tenkeyless (TKL) 88 keys, no numpad

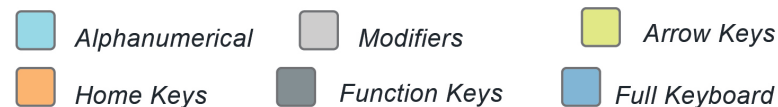
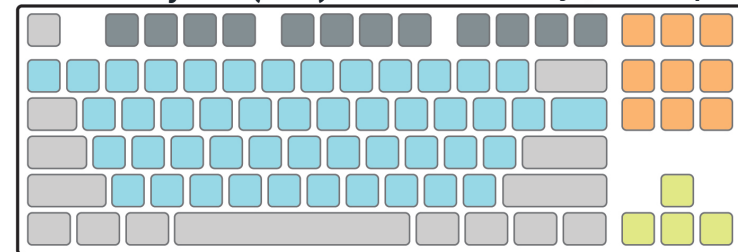

84 keys, no numpad, 7 home keys 75%

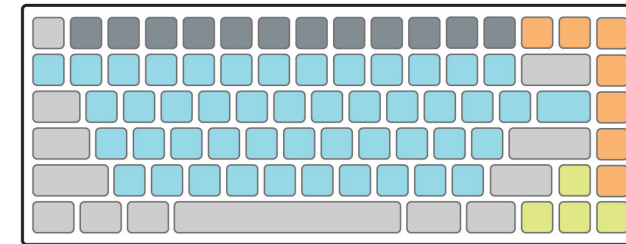

68 keys, no numpad or F-keys, 4 home keys 65%

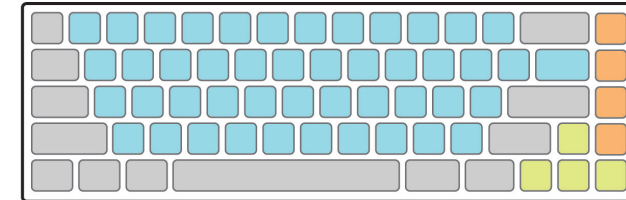

61 keys, only modifiers and Alpha keys 60%

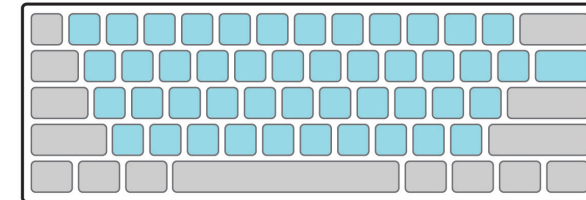

49-51 keys, letters, modifiers and 4 F-keys 50%

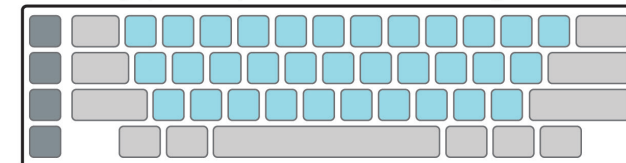

45-50 keys, letters and modifiers 40%

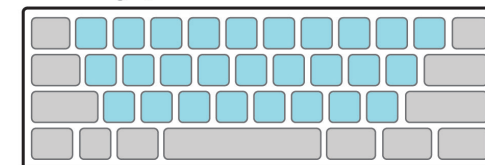

Figure 10. Keyboards can easily be found in full keyboards (100%) all the way down to 60% keyboards. Models smaller than 60% are more common among enthusiasts.

1.13.4 Mechanical Switches

Mechanical Switches can be categorized by 2 sizes (standard and low-profile), and 3 different tactile profiles (tactile, linear, and clicky), and can either be soldered onto the PCB or hot-swappable.

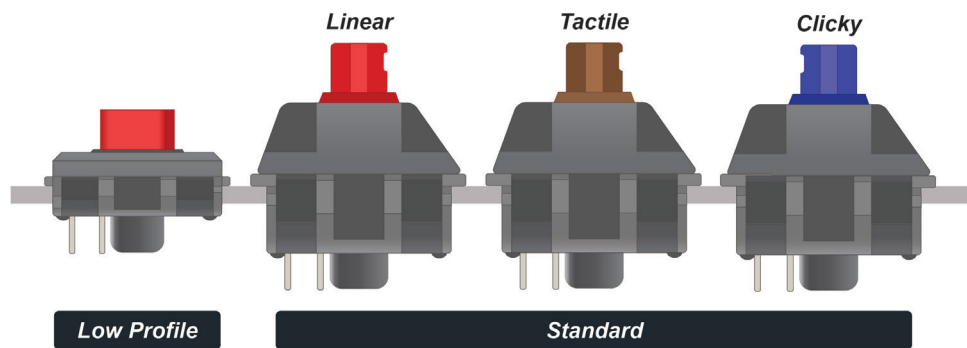

Figure 11.

1.13.5 Keycap Profiles and Sizes

Keycaps can be found in a number of different profiles which are divided into 2 different categories: sculpted and uniform. Sculpted caps are typically better for long durations of typing, though are more difficult to rearrange as each row differs from the others. (Keyboard University, n.d) In contrast, uniforms are all the same shape, which provides a more universal sound to typing as well as makes rearranging keycaps much easier.

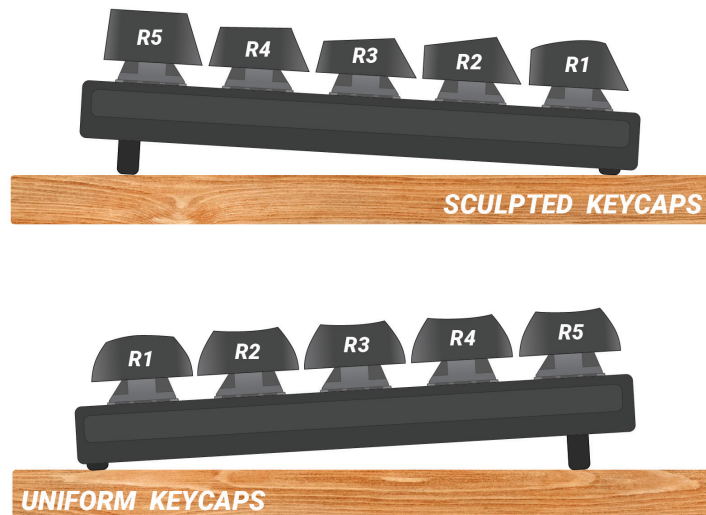
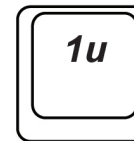

Figure 12.

Additionally, the shape of each profile may differ significantly from company to company. Different keycap designs can showcase various qualities such as graphics, sound, ergonomics, or a combination of the three.

The sizes of keycaps are standardized by basing all keycaps on the size of a “1u” keycap. All alphabet and number keycaps (the Alpha keys) typically are “1u”. It should also be noted that these measurements are not mathematically binding. For example, a “2u” keycap may not equal double the width of a “1u” as the distance of spacing between caps has to also be considered. As such, a “u” does not equal an exact measurement, but rather helps represent an approximate relation between keycap sizes.



+1u keys are typically used for modifiers

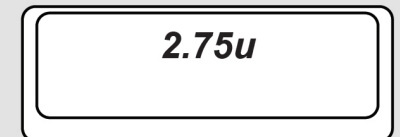
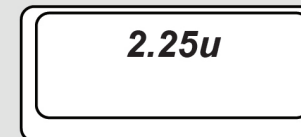
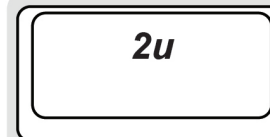
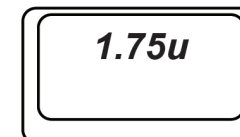
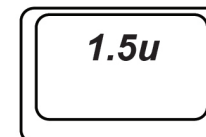
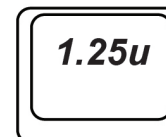

Typical Spacebar sizes

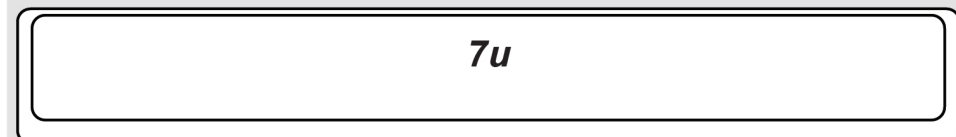
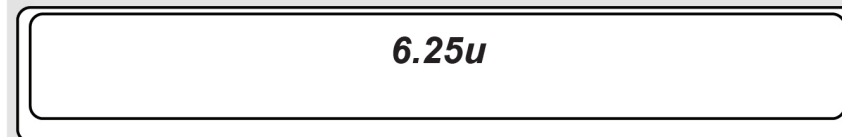
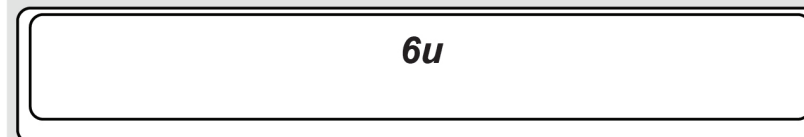

***any key 2u or larger requires stabilizers**

Figure 13. To scale keycap sizes

2.0 Previous Research

Prior to this project, research was performed in the form of a “Specialization Project”. The “Specialization Project” mostly focused on shortcut optimization, but also gathered general information about digital creators and how they interact with their keyboards. Large portions of data from that project have been used throughout this report, but the breadth of relevant data has been placed in this section. (Skousen, 2022)

2.1 Competitors Analysis

There are a number of solutions in the market that would be considered direct or indirect competitors. A product was considered a direct competitor if the product is specifically marketed to any users that can be defined as a digital creator. Products were considered an indirect competitor if the product is not marketed specifically to digital creators, but is still used by digital creators. As the keyboard market is fairly saturated the secondary competitors stand as representations for other similar products. An analysis of these products portrays the strengths and weaknesses of keyboards in the market that digital creators may use.

Primary Competitors



Figure 14. (Apple, n.d.)

Magic Keyboard with Finger Scanner

Company: Apple

Amazon Customer Ratings: 4.6/5

Cost: \$199

Size: 1.09 X 41.87 X 11.49 cm

Weight: 0.369 kg

Key features:

- Touch ID
- Wireless
- Rechargeable (battery life lasts for multiple weeks)
- Auto Pairs with Apple computers
- Lightning port
- Multimedia keys

Pros:

- Wireless
- Touch ID for unlocking the computer
- Pairs with other Apple products
- Compatible with Apple and Windows

Cons:

- Keys are not back lit
- Expensive
- Little additional functions for designers
- Finger scanner only works with newer Apple products



Figure 15. (Logitech, n.d.)

Craft Advanced

Company: Logitech

Amazon Customer Ratings: 4.3/5

Cost: \$139.00

Size: 14.9 x 43.03 x .99 cm

Weight: 0.96 kg

Key features:

- Spherical dishing keycaps
- The backlit activates when hands approach and adjust to lighting conditions.
- Independent Logitech UX program for keyboard
- Wireless
- Connects to up to 3 devices
- The Crown (dial knob): use the Crown to change design values in Photoshop, Illustrator, Premiere Pro, InDesign, PowerPoint, Excel and Word.

Pros:

- Wireless
- Backlite
- Connects to multiple devices
- Apple and Windows Compatible
- Decent price for what you get
- F-keys are programmable
- Knob is programmed for most Adobe products

Cons:

- Plastic case minus the aluminum bar at the top
- No angle adjustment
- Knob is the main feature for designers which can be very useful, but also might be a bit overloaded with features for being a knob



Figure 16. (Elkjop, n.d)

K95 RGB

Company: Corsair

Amazon Customer Ratings: 4.7/5

Cost: \$139.99

Size: 46.48 x 17.02 x 3.56 cm

Weight: 1.3 kg

Key features:

- Six fully programmable macro keys for complex macros and key remaps
- Cherry MX Speed RGB Silver mechanical key switches
- A detachable leatherette palm rest
- Multimedia keys and dial
- USB port on the back of the keyboard
- Independent Corsair UX program for keyboard
- "Near-limitless customization" for RGB backlighting and the light bar at the top of the keyboard

Pros:

- Removable wrist rest
- Brushed aluminum top plate
- 6 customizable rubber cap macro keys
- Customizable RGB
- Cable managing slots under keyboard
- USB Port

Cons:

- Wired
- Brushed aluminum is hard to keep clean
- Expensive
- Made for gaming, not designing
- Cherry Red switches: great for gaming, but not always the best for working as they are linears.
- The switches are solder on making it much more difficult to switch to something different.

Secondary Competitors



Figure 17. (Scandinavian Photos, n.d)

Loupedeck+

Company: Loupedeck
Cost: \$279
Size: 2.3 X 44.6 X 17.6 cm
Weight: 0.67 kg

Key features:

- Compatible with Adobe Lightroom Classic, Lightroom, Capture One Pro 21 for MacOS, Photoshop CC with Camera Raw, Premiere Pro, After Effects, Audition, Final Cut Pro and Skylum Aurora HDR
- Faster editing
- Customization options

Pros:

- Clean Design
- Speeds up video and photo editing
- Customizable inputs
- Decreases mouse/keyboard usage
- Moves away from "number driven" design, helping designers focus on what looks right

Cons:

- Plastic case
- Wired
- Expensive
- Easily collects dust in nooks
- Decent learning curve
- Still need a keyboard if you ever need to type



Figure 18. (dvt, n.d.)

Logickeyboards Products

Company: Logickeyboards
Cost: abt \$129-149
Size: abt 2.3 X 44.6 X 17.6 cm
Weight: abt 0.95 kg

Key features:

- keyboards with printed shortcuts for a large range of computer programs
- Two USB 2.0 ports
- Compatible for Apple and Windows
- Scissor switch key mechanism

Pros:

- Metal case
- Shows shortcuts on keys
- Low Profile
- Works for Apple and Window

Cons:

- Keys are not backlit
- Only shows shortcuts for one program
- A lot of visual clutter
- Paying for the print on the keycaps

2.2 Observations

Almost 200 YouTubers were contacted and asked to take a 20-30 minute video of their keyboards while working on their preferred design program. The background of these YouTubers varied greatly, though all fell under some form of educator for digital creators.

The email these YouTubers received explained the purpose of the project and directed them to a short instructional video that explained in greater detail how to submit the needed video information. Participants were asked to avoid showing their screens and anything on their desks that may be considered confidential (ie. family photos, or work for clients). These YouTubers were also given the alternative of simply taking a top-down picture of their at-home workstation including any design tools that they typically use. No top-down photos were submitted.

2.2.1 YouTuber 1 - Uncle Jessy

Channel: Uncle Jessy

Background: Youtuber 1 creates videos reviewing 3D printers and making cosplay outfits. He has been making videos on these topics since 2015

Subscribers: 456,000

Primary Program: Adobe Premier

Observations: During the video sample (about 1 minute long) that Youtuber 1 sent, he can be seen working on video editing while sitting on his couch with his legs propped up. He has set up a few custom shortcuts on his Mac laptop to speed up his editing process.



Figure 19. Youtuber 1 at his typical "workstation"

Comments from YouTuber 1: Upon further inquires, YouTuber 1 explained that old habits die hard, which is why he uses a track pad rather than a mouse. Additionally, he said he rarely used his desktop computer for work, but prefers to use his lab top to keep his desktop available for his children.

2.2.2 YouTuber 2 - Noggi

Channel: Noggi

Background: Makes YouTube tutorials for Blender users. Specifically the sculpting tools. He has been making videos since 2020

Subscribers: 54,700

Primary Program: Blender



Figure 20. Youtuber 2 at his workstation with a full size keyboard and a sketch tablet.

Observations: Throughout the duration of the video sample (about 30 minutes long), his left hand remained on the left side of the keyboard. His right hand alternated between sketching on the tablet and using the mouse (favoring the tablet). There were only 9 instances seen in which Youtuber 2 used his right hand to input keyboard commands. After slowing the recording down, it was found that many of his inputs were in sets and that there were a total of 14 keyboard inputs in which he used his right hand. His right-handed inputs were as follows:

Rt. Shift - 2
Enter - 4
Backspace - 6
"H" - 1
Unclear - 1 *(looked like either Backspace or Enter)

It was noted that his left hand almost never passed the "N", "H", or "Y" keys on his QWERTY keyboard. Youtube 2 did take a brief 30-second break 20 minutes into the recording, in which he left the workstation briefly.

2.2.3 YouTuber 3 - Thomas Sanlanderer

Channel: Thomas Sanlanderer

Background: Makes Youtube where he experiments with 3D printers trying to discover the limits of materials and equipment. He has been making Youtube videos since 2014

Subscribers: 446,000

Primary Program: Adobe Premier

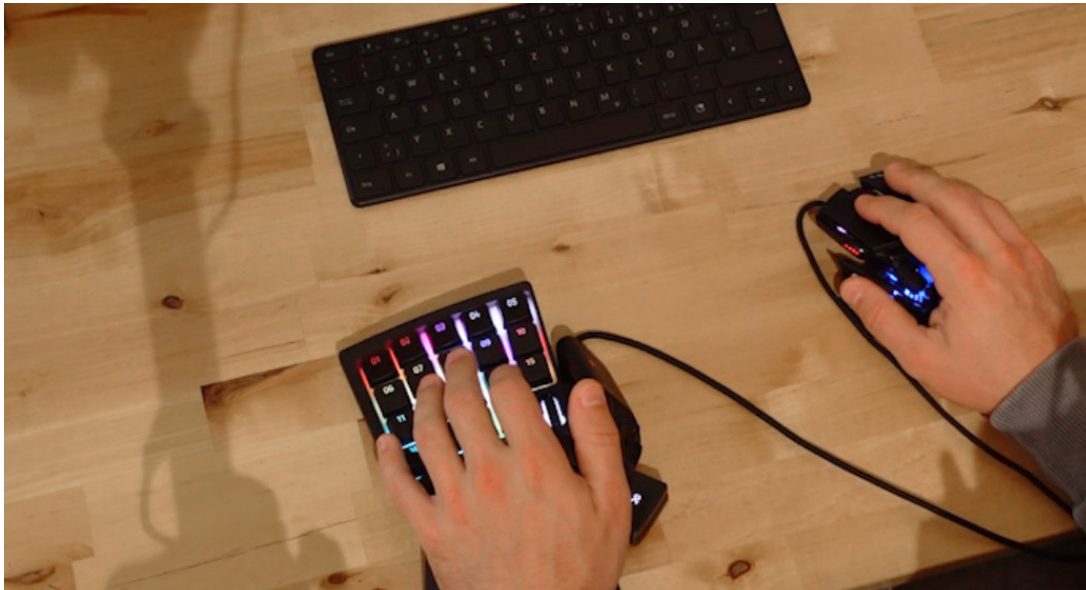

Figure 21. Youtuber 3 at his typical workstation with a gaming mouse, macro keyboard, and small wireless keyboard

Observations: During the video sample (about 30 minutes long) that Youtuber 3 sent, his left hand never left his macro keyboard, and his right hand never left his gaming mouse. At the beginning of the video sample, Youtuber 3 can be seen putting on a headset (presumably to listen to music). Something very noteworthy about his setup was he had, and actively used, 3 scroll wheels. One of the wheels was on his macro board, while the other two were on his mouse. Additionally, the macro keyboard had 2 buttons at his left thumb. At no point did he reach for his small keyboard located above both of his hands. It seemed that the middle keys, where typical “WASD” would be found, were preset as his main shortcuts. This was assumed to be due to gaming habits.

Comments from YouTuber 3: In addition to the 30-minute sample video, Youtuber 3 also sent a 2:30 video explaining his setup and why he liked it. In the secondary video Youtuber 3 explained that by having 3 different scroll wheels, he was able to better navigate through the videos on which he was working.



Figure 22. Youtuber 3's gaming mouse with 2 scroll wheels.

He briefly explained the various shortcuts he has set on his macro keyboard, then moved on to explain the compact keyboard found above his macro and mouse. The compact keyboard was only for instances in which text needed to be added. He mentioned that this was avoided when possible as having all 3 devices in a row was very uncomfortable as he has difficulties moving his right arm due to a past shoulder injury. And prefers to work with his hands a little closer to each other.



Figure 23. When Youtuber 3 needs to type he moves his macro pad to the side and takes his keyboard out.

2.3 Methods of Shortcut Optimization

Shortcut optimization is something that has been studied by a number of researchers, and has resulted in a number of suggested shortcut methods. A brief explanation of each method has been explored, as well as commentary as to the pros and cons of each. Some of these techniques can be found in various design programs with varying levels of success. Additionally, all design programs use a variety of methods to access shortcuts. This redundancy is used since no one method is perfect for the preferences of each user.

Method 1

While wearing a smartwatch, users can access various shortcuts by rotating their wrist while pressing a keycap down. With this method, individual keycaps may be able to be used to perform more commands than current hotkey setups, while avoiding the use of any additional command keys like "ctrl". (D. Buschek, B. Roppelt and F. Alt, 2018)

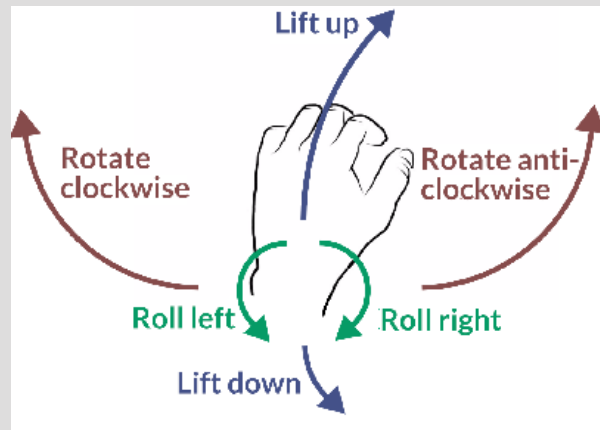

Figure 24. (D. Buschek, B. Roppelt and F. Alt, 2018)

Pros

- At least 6 different commands per key without the use of modifiers
- More shortcuts can be assigned phonetically (ex. "C" for Copy, Cut, CAPS, etc)

Cons

- The user has to have a smartwatch
- Shortcuts would have to be reassigned
- Might have a much higher learning curve than more conventional methods
- Some movements might feel unnatural
- Adding more motion to the shortcut process could produce wrist strain

Method 2

With FingerArcing, a camera with tracking abilities would use the position of the user's thumb to determine what shortcut the user desires to use. (Zheng, Lewis, Avery, and Vogel, 2018)



Figure 25. (Zheng, Lewis, Avery, and Vogel, 2018)

Pros

- At least 4 different commands per key without the use of modifiers
- More shortcuts can be assigned phonetically (ex. "C" for Copy, Cut, CAPS)

Con

- User has to use a tracking camera
- Shortcuts would have to be reassigned
- Might have a much higher learning curve than more conventional methods
- Adding more motion to the shortcut process could produce wrist strain
- Some movements might feel unnatural

Method 3

A camera with tracking abilities would be used to determine which finger and hand shape was used to select a shortcut the user desires to use. (Zheng and Vogel, 2016)



Figure 26. (Zheng and Vogel, 2016)

Pros

- Many different commands per key without the use of modifiers
- More shortcuts can be assigned phonetically (ex. "C" Copy, Cut, CAPS)

Cons

- User has to have a tracking camera set up
- Shortcuts would have to be reassigned
- Much higher learning curve than more conventional methods
- Adding more motion to the shortcut process could produce m wrist strain
- Some movements might feel unnatural

Method 4

By holding the right-click a gesture guide appears to show a number of commands. After hovering over the desired command and releasing the click the desired command is selected.

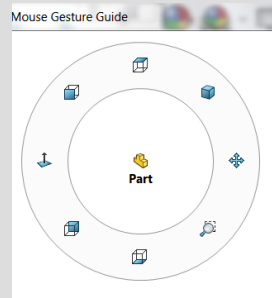

Figure 27. Gesture guide

Pros

- Often built into design programs
- Highly customizable
- Easy to build muscle memory

Cons

- Does not give opportunities to learn new shortcuts
- Solely relies on the use of a mouse
- Not available on all programs

Method 5

Place the shortcut next to the command in the dropdown menu or on a pop-up when a user hovers over the command

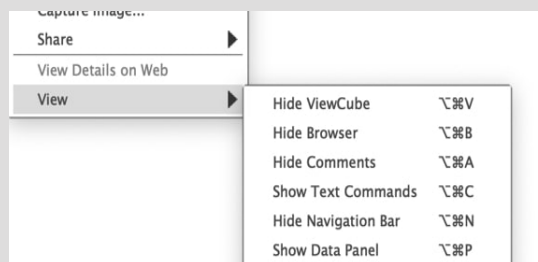

Figure 28. Dropdown menu.

Pros

- Makes shortcuts visible in locations where the user typically can see them
- Shortcuts do not have to be remapped

Cons

- Though the shortcut is more visible, it is a little buried
- Makes learning shortcuts a passive endeavor, encouraging mouse usage.

Method 6

A key is assigned to a pop-up window that displays all the shortcuts relevant to the current program opened.

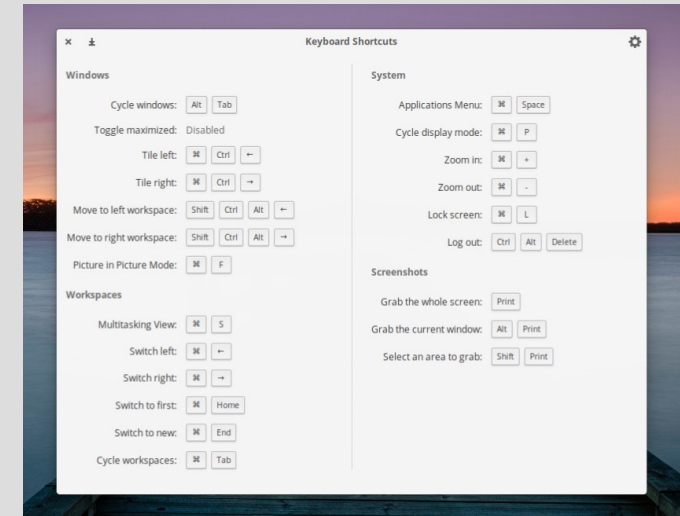

Figure 29. Shortcut popup built into Mac computers

Pros

- Quickly visualize available shortcuts
- Encourages shortcut discovery
- Shortcuts do not need to be remapped
- Encouraged using keys strokes before mouse usage

Cons

- Disrupts workflow
- Not as viable of an option for programs that heavily use shortcuts

Method 7

Method: Dictating design commands into a microphone



Pros

- Does not require shortcut discovery, just a knowledge of command names
- Hands free
- Does not disrupt design flow

Cons

- Requires a microphone
- Voice command needs conversation context to determine desired words (Begel, 2005; Kim, Dontecheva, Adar, Hulman, 2019)
- Will the microphone pick up on conversations with coworkers?

Method 8

Design program freezes when a command with a shortcut is selected with the mouse. To unfreeze the program, the user needs to input the the command using the shortcut



Pros

- Encourages shortcut discovery
- Default shortcuts can be used
- Encourages muscle memory (Grossman, Dragicevic, Balakrishnan, 2007)

Cons

- Disturbs workflow
- Method may be seen as more annoying than helpful

2.4 Shortcuts and the Paradox of the Active User

The paradox of the active user refers to when a user acquires the necessary skills to perform a task successfully, and even when presented with a more efficient method, repeatedly chooses the first even with the knowledge of a more efficient alternative. (Krisler and Alterman, 2008; Scarr, Cockburn, Gutwin, and Quinn, 2011) This paradox can apply to any activity, especially to the use of computer programs. As an example, the universal shortcuts for “Copy” and “Paste”, though used by most computer users, are still not used by all. This paradox can also be defined as satisficing, which is when an individual accepts an action or option as satisfactory, even if there are better options available. (Tak, Westendrop, and Rooij, 2013; Cockburn, Gutwin, Scarr, and Malacia, 2014; Lane, Napier, Peres, and Sandor, 2005) This phenomenon must be kept in mind when planning out solutions for how to improve the usage of keyboard shortcuts.

2.5 Reflections on Previous Research

Competitors Analysis:

After completing the competitor analysis, it was surprising that there were very few primary competitors that directly targeted digital creators. More design targeted solutions were found in secondary competitors, though all of these solutions only targeted one maybe two industries at a time.

Observations:

All of the YouTubers had drastically different setups from each other, which is a great example of the range of user preferences and needs. Something to be noted is all of the digital creators heavily used the home position unique to digital creators and gamers. Additionally, two of the YouTubers mentioned that they had custom-mapped keys, for the shortcuts that they used the most.

Methods of Shortcut Optimization:

Most of the more exploratory shortcut methods seem to be too far-fetched to ever be effectively marketable. The methods that are currently used don't work perfectly, which might be why many programs will utilize a number of these methods. Being able to dictate shortcuts does seem like it has some potential, though the technology is not there yet according to studies (Begel, 2005; Kim, Dontecheva, Adar, Hulman, 2019). Method 8 seems to have a lot of promise, though would definitely need to be implemented only occasionally or it would become more of a hindrance to one's workflow.

3.0 Keycap and Switches Design

This section specifically focused on the development of a keycap design that would provide digital creators with a comfortable and intuitive feel to the keyboard they are working on. Additionally, various types of key switches were analyzed, tested, and analyzed again to determine which switch would best suit the final design of this project's keyboard.

3.1 Analysis of Keycap Types

There are 2 different shape classifications that keycap designs can fall under, namely "sculpted" and "uniform".



Figure 12. The differences between sculpted keycaps (top) and uniform keycaps (bottom) can be seen when compared side by side.

Sculpted keycaps are designed to have keycap shapes that differ from row to row (Figure 12). Sculpted keycaps typically have better ergonomics for those using keyboards for a longer duration. Due to the keys being different shapes, keycaps can not be rearranged outside of the rows for which they were intended. Additionally, sculpted keycaps have a non-uniform sound profile, which can be seen as a downside for many keyboard enthusiasts.

Uniform keycaps are all the same shape (Figure 12). This makes them ideal for keyboard users who would like to rearrange their keys to an alternative layout such as "DVORAK". With their uniform shape, they also sport a very consistent sound profile and are often designed to have more acoustic sound. The downside to uniform keycaps is that they are less ergonomic, making them less ideal for long durations of use. Again both classifications are subject to personal preference, making it impossible to state which is superior.

3.2 Analysis of Key Mechanisms

There are a number of different types of mechanisms that are used for keyboard switches such as silicon bubbles, scissor switches, and mechanical switches to name a few. Each of these mechanisms has its pros and cons, but for this project, mechanical switches were selected early on due to their diversity in tactile feel and more importantly their ability to be hot-swappable.

Mounting Methods

As mentioned before, Mechanical switches have 2 different mounting methods, solder-on and hot-swappable. For this project, hot-swappable were chosen as they allow end users to change out switches for a tactile feel that better suits their liking. Additionally, one of the hopes of this project was to design a more repairable keyboard. This is achieved by using hot-swappable switches. If a switch breaks or gets dirty, it is easy to remove the individual switch and either repair or replace it.

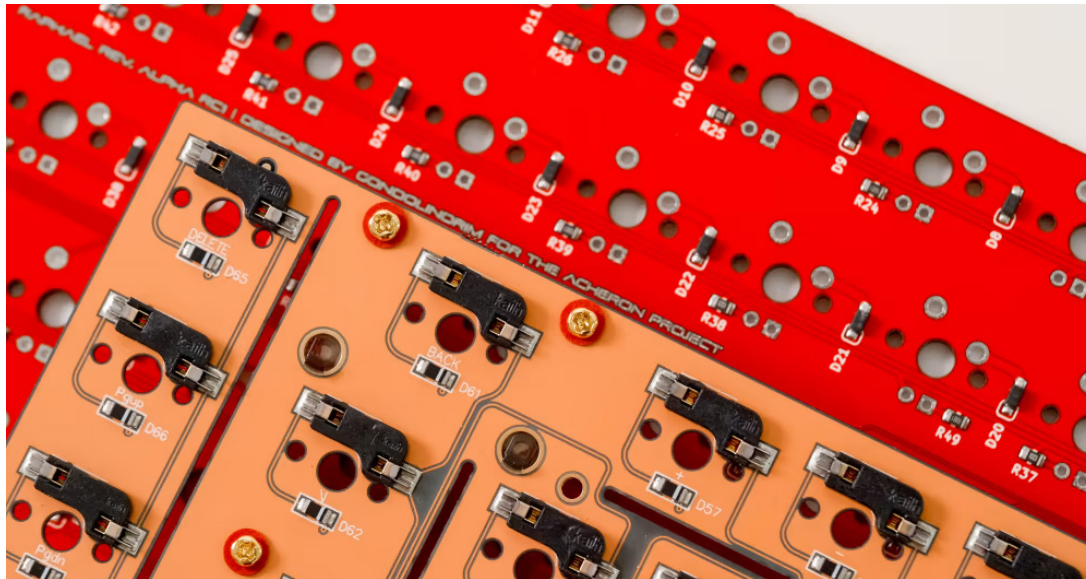

Figure 30. Solder-on PCB (top) and a hot-swappable PCB (bottom) are compared side by side. (S.P. 2023)

Hot-Swappable Switch Size:

Although there were a number of benefits to using low-profile switches, namely their lower profile, there were too many issues during this project that prevented pursuing them as the final switch. The first issue was accessibility. Although they are not extremely uncommon, they were difficult to acquire where this project took place. So due to cost and time limitations, they were never pursued, even though they may have been a better choice of switch for this project. As such the standard switch size was used for the entire duration of this project.

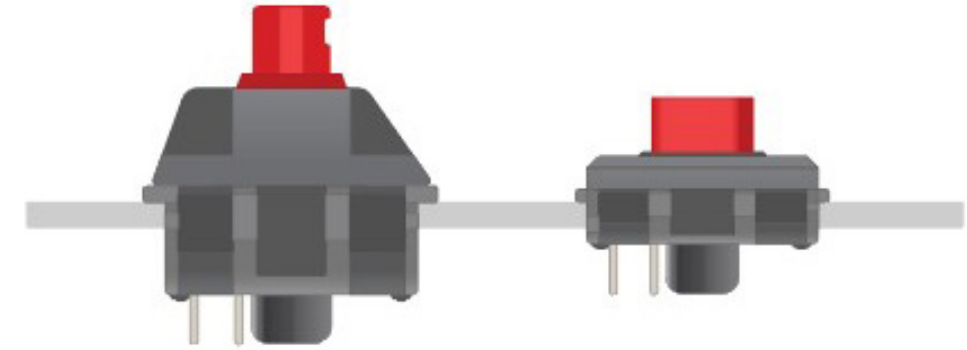

Figure 31. Solder-on PCB (top) and a hot-swappable PCB (bottom) are compared side by side.

Switch force (tactile) profile:

The diversity in force profile is one of the greatest benefits of mechanical switches as even within each category there is a large range of factors that can be chosen or modified (such as spring weight and travel distance). In this project, no deeper characteristics were tested within the 3 main force profiles. This is largely due to the complexity of individual preferences and the vast number of different combinations that could be tested.

Each of the 3 profiles is named based on the tactile feel that users experience when pressing down and up on a switch. As stated before the “best” switch for a situation is very much up to personal preference, though each profile is more commonly used by certain populations as stated below.

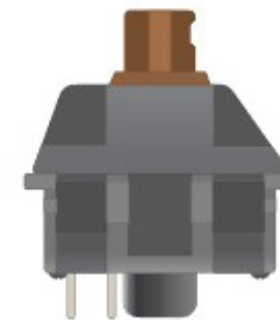

Figure 32.

Tactile force profile is commonly used for office and personal use. This is due to the quietness of the switch (although not as quiet as linear switches) and the slight bump that users feel before bottoming out the switch. The bump helps the user know that a key has been properly engaged, and the low sound profile tends to be better for work environments

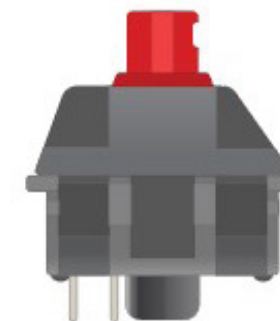

Figure 33.

Linear force profile is commonly used for gaming and by keyboard enthusiasts. These switches are popular in the gaming industry due to their quick response. Although the time saved is in the fractions of a second, it is believed beneficial for gamers. These switches are also loved by keyboard enthusiasts due to their sound and smooth feeling. The sound profile tends to be the quietest of the 3 profiles and allows for lower acoustic sounds to be heard generated from the keycaps and the keyboard case.

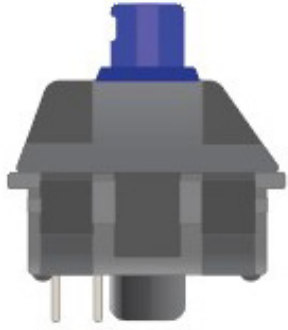

Figure 34.

Clicky force profile is commonly used for personal use. Many individuals really enjoy the sound profile of a clicky switch. Often described as very satisfying, it has a loud “click” prior to bottoming out. Of the three switch types, it has the most noticeable “bumps” as well. Users tend to avoid these switches in work environments, as coworkers may find the sound annoying.

Again, these force profiles are heavily subject to personal preference. As such the 3 force profile were tested to see which would best suit the keyboard designed in this project.

3.3 Keycaps Design and Switch Selection

There were 3 rounds of tests in which prospective end users tested out various keycap designs and switches and voted on which were their favorites

3.3.1 Test 1- Keycaps Cap Angle

As shown in research, the angle of attack on a keyboard is very important to the comfort, effectiveness, and health of any keyboard user. (Rempel, 2008) As many keycaps in the market have been studied for their health benefits, various side profiles that mimiced or were opposite to existing keycaps were tested. (See Figure 35)

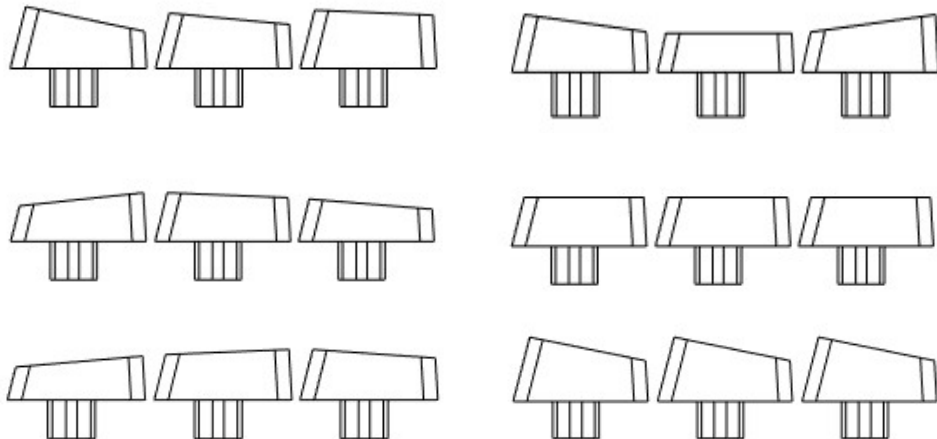

Figure 35. Angle types: Cherry (Top Left), Concave (Top Right), Convex Low (Left Middle), Flat (Right Middle), Convex High (Bottom Left), Stepped (Bottom Right)

After 3D printing, all the keycaps were attached to Gateron Tactile switches and mounted to small “half” keyboards. Users were asked to try the switches 2 at a time and through the process of elimination, vote on which of the six angle profiles they most preferred. The result can be seen below paired with statements made by those testing the caps.



Figure 36. Test “half keyboards” were made to allow users to test different keycap angles side by side. Each half had a different keycap



Figure 37. Users testing different keycap angles

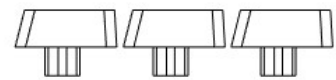

Flat
 Number of votes: 8
 Comments: "I use a laptop, so I like this as is very similar to what I am used to."

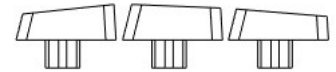

Convex Low
 Number of votes: 2
 Comments: "Felt like my fingers were sliding down toward the spacebar, not a fan."



Step
 Number of votes: 5
 Comments "Feels like an old typewriter. Not bad, but requires a little bit more work to type on."

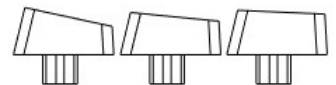

Cherry
 Number of votes: 11
 Comment: "Like how it feels like each key is perpendicular to the force I apply when I type."



Concave
 Number of votes: 11
 Comments: "I like how the keys almost cup my fingers into a home position."

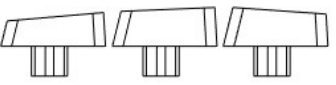

Convex High
 Number of votes: 4
 Comments: "Feels like my fingers slide down on to the space bar or off the top of the keyboard."

Figure 35

Total number of Participants: 36

As the Cherry and Concave angle profiles tied for the most liked, a new profile was created that was a hybrid of the 2 profiles in the hopes to combine the features that the users liked from each profile.

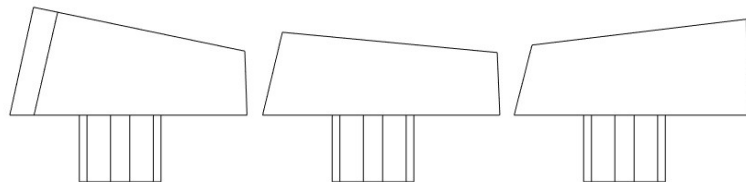

Figure 38. Final angle profile is a combination of Cherry and Concave

3.3.2 Test 2- Keycaps Cap Profile

Once the angle profile was determined, the keycaps cap profile was tested to see what users preferred. For Test 2 and Test 3, a new "half alpha" keyboard design with a steel plate base was used to better simulate the feel of a real keyboard, as well as to ensure more consistent experimentation. (See Figure 39)



Figure 39. New keycap test rig allowed users to switch keycaps on the left side with the keycaps right side

With the keycaps angle profile determined, seven different keycap cap profiles were tested. Like Test 1, these profiles were inspired by keycaps that are commonly found in the market. Some are replications, while others are the opposite profile of these common keycaps (ex. A concave surface vs. a convex surface)



Figure 40. Users testing out diferent cap profiles

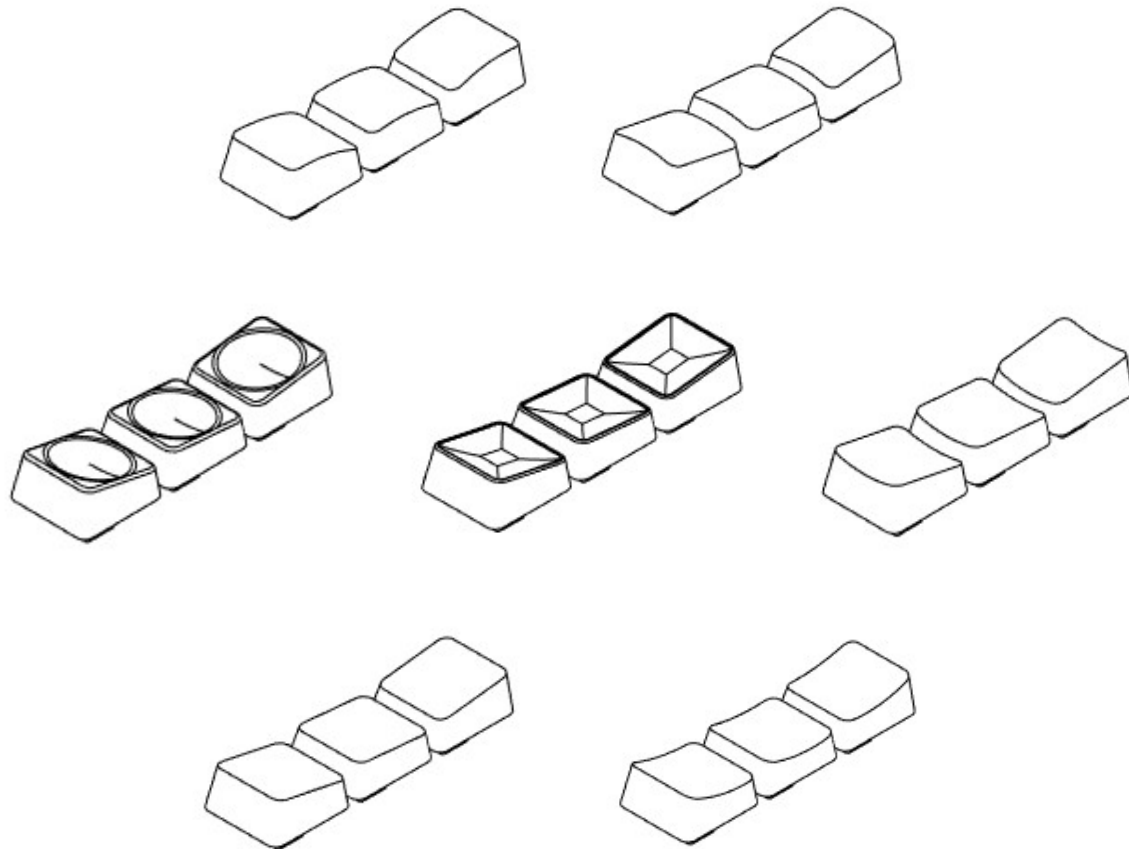
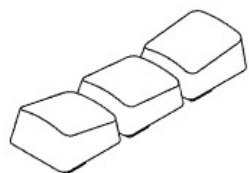

Figure 41. Angle types: Convex Horizontal (Top Left), Convex Vertical (Top Right), Dimpled (Left Middle), Square Dimpled (Middle), Concave Vertical (Right Middle), Flat (Bottom Left), Concave Horizontal (Bottom Right)

Participants for Test 2 were asked to rank their top three preferences. 1st place vote received 3 tallies, the second received 2 tallies, and the third received 1 tally. This change was added as multiple participants in test 1 mentioned liking more than one keycap angle. By including individuals second and third choices it is believed that the votes will more accurately reveal which keycap profile users prefer.

Before testing the keycaps, participants were instructed to only test 2 cap profiles at a time. They were encouraged to swap profiles from right to left and vis versa to better test which profile they preferred. once a preferred cap profile was selected, the profile that "lost" was removed and replaced by a new one. This method allowed each profile to be compared in a consistent systematic way.



Convex Vertical
 Number of votes: 9
 Comments: "My fingers are always falling off the keys."

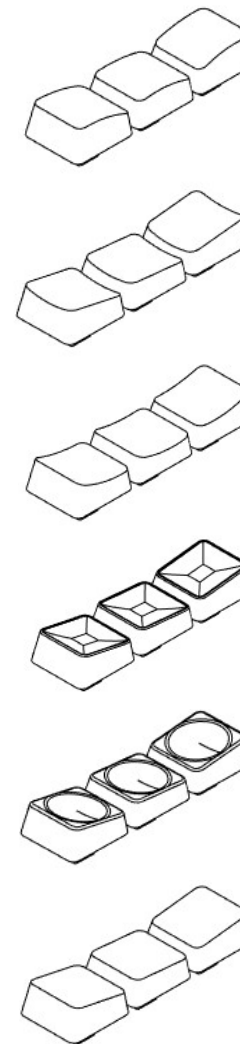

Figure 41.

Convex Horizontal
 Number of votes: 11
 Comments: "Very comfortable as I have long nails" "My fingers are always falling off the keys."

Concave Vertical
 Number of votes: 32
 Comments "Very comfortable, easy to find each key and move from key to key."

Concave Horizontal
 Number of votes: 15
 Comments: "Easy to travel side to side from key to key, but a little difficult changing rows."

Square Dimple
 Number of votes: 18
 Comment: "These keys feel okay, but have a bit of a ridge that is a little uncomfortable."

Dimple
 Number of votes: 32
 Comments: "Comfortable, and I am still able to move to other keys easily."

Flat
 Number of votes: 20
 Comments: "Fingers feel like they slide off of the top and bottom row of keys."

Number of Participants: 29

Even though Concave Vertical and Dimple had the same number of votes, Dimple was chosen to be used as the final keycap profile as it was more unique in its shape when compared to more common keycap designs used on mechanical keyboards.

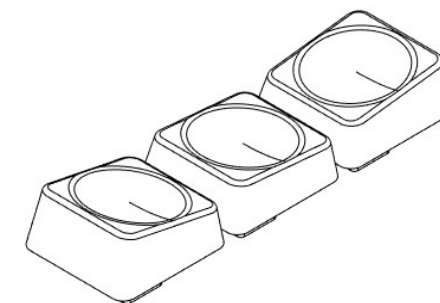

Figure 42.

3.3.3 Test 3 - Preferred Mechanical Switch

Test 3 followed the exact same procedure as Test 2 except all of the keycaps were the same and the mechanical switches on each mini-keyboard were different (tactile, linear, and clicky). Participants were asked to test each switch and rank them based on which they would mostly likely use in an office setting.

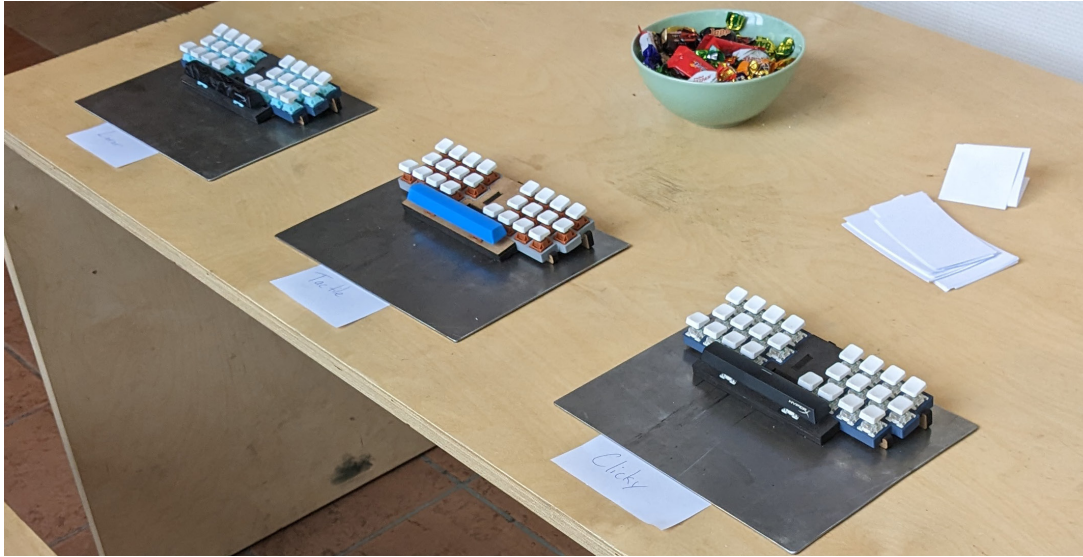
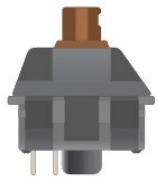

Figure 43. Mechanical Switch test



Tactile Switch

Number of votes: 23

Comments: "These are nice, in an office setting I would definitely choose these."

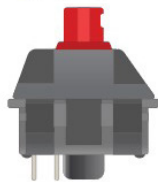

Linear Switch

Number of votes: 16

Comments: "Feel kind of mushy, they have a soft feel, but feel really weird."

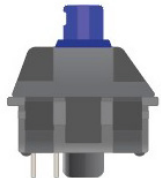

Clicky Switch

Number of votes: 16

Comments "Oooo, these are really fun. I would love to have these but not if I am working around other people."

Figures 32-34.

Number of Participants: 10

As expected, tactile switches were voted as the most preferred by users in a work environment. It should be noted that many participants said they would have chosen Clicky switches if they knew that they were not working around others

3.4 Form Exploration

When exploring the final form of keycaps, various forms were created through sketching and 3D modeling. The end goal was to find a form that would fit in an office work environment while also communicating a design language that would be family to digital creators. Office equipment throughout the decades has been traditionally driven by function making the equipment very geometric in shape. In contrast, creative professions (like digital creators) thrive by pushing the bounds of form past an object's base function. As such, design industries can be characterized more typically with more curvy, organic forms. With the desired characteristics of these 2 contrasting inspirations, the form of the keycaps was gradually refined and finalized.

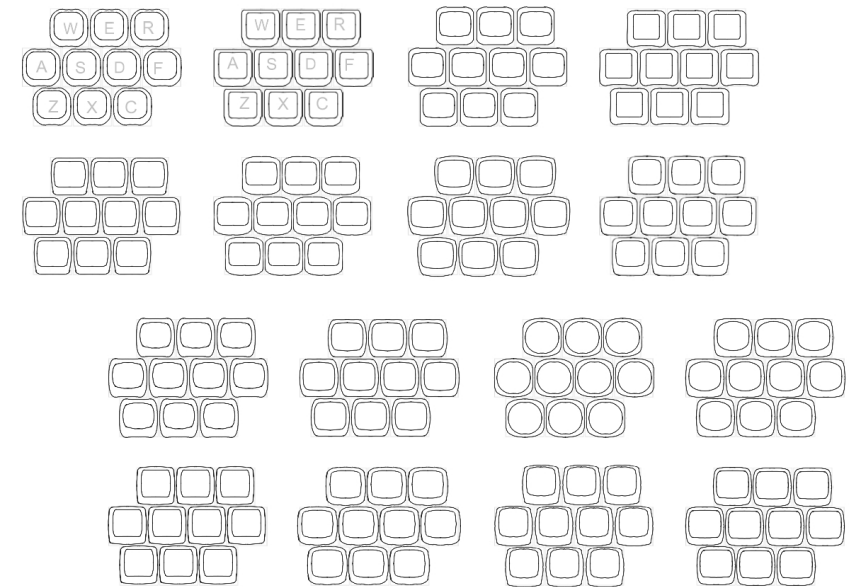

Figure 44. Keycap concept sketches (excerpt from Appendix 2.1)



Figure 45. Sketches that fit the overall target aesthetic were 3D modeled and rendered to be compared with each other (excerpt from Appendix 2.2)

Final Form

The final form nicely fits in an office environment by keeping to a fairly traditional square shape common in most traditional mechanical keyboards. Modifying the square to a “squiracle” shape helps soften the overall shape of the keycaps, avoiding the overly rigid look of a square. These soft edges, coupled with the circular dimples on the top of the keys, help to give the keycaps a more “designery” feel making them an ideal form for digital creators.

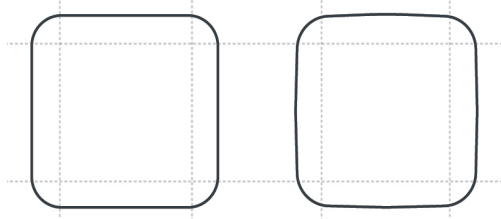

Figure 46. Square with rounded corners compared to a squiracle

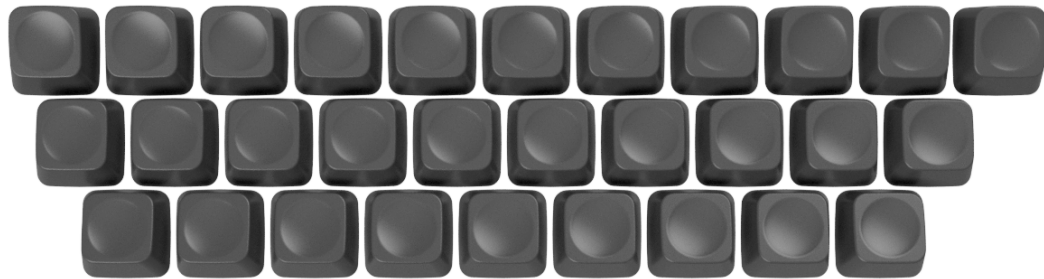

Figure 47. Final keycap design

3.5 Font Exploration

As the lettering of a keyboard determines much of a keyboard’s visual appearance, it is critical that the font chosen not only matched the overall aesthetic of the keyboard but also matched the work environment in which the product is intended to be used. With this in mind, it was determined that the font needed to be very conservative in appearance, to help keep the timelessness of the product. As such, san-serif fonts were chosen as they are characterized by their basic letter forms that are easy to read and don’t draw too much attention.

With the design of the keycaps finalized, a small 60% keyboard was generated with blank keycaps to act as a canvas for testing out different san-serif fonts. (Appendix 2.3) Fonts that had letters that were too wide were removed from the lineup, as they caused visual outliers on a full keyboard. In contrast, fonts with letters with a consistent width were meticulously compared and were eliminated solely based on individual letters that seemed to be visual outliers (like letters having tails that extended too high or low).

The lettering needed to be in the top half of each key as the LED that shined through each cap, shined through the top of the switch. Lettering was offset to the left corner of the caps as this provided a more dynamic feel to each key, when compared by having the letters centered.



Figure 48. Font Placement

3.6 Final Design

Roboto Black Italic was chosen to be the final font as it presented a universally clean appearance whether the key was an individual letter or a full word on one of the modifier keys. The choice to have the font italic was made as non italic Roboto made the visual appearance of the keyboard feel a little too static. Additionally, as the lettering is found in the left corner of each keycap, the italic letters helped balance the weight of each keycap by drawing the eye slightly more to the middle of each key.



Figure 49. Final keycap design with final font

4.0 Layout Design

Keyboard layout is probably one of the most important aspects of this project as creating a new keyboard layout has the potential to drastically improve the effectiveness of a keyboard. Conversely, a poorly designed layout can cause users to completely reject the end product. To avoid the later, an extensive amount of research was focused on exploring keyboard layouts. Analysis of QWERTY, and a survey for learning what keys digital creators commonly use helped find what keys to leave in familiar locations, while workshops testing new layouts explored the bounds to which keys could be relocated.

4.1 QWERTY

To the surprise and dismay of many, the QWERTY keyboard layout has withstood the test of time for over a century (David, 1985) There have been a variety of alternative keyboard layouts suggested such as well-known layouts such as DVORAK (Asikhia and Ehondor, 2010; David, 1985) to lesser-known layouts like ABCDE (Nicolson and Gardner, 1985), and :QJZY (Asikhia and Ehondor, 2010). Each of these differing keyboard layouts has been claimed to be faster to learn or more efficient to use than the QWERTY standard. Even with these findings, QWERTY keeps an iron grip on the title as the standard for the computer keyboard layout. This is believed to be due to luck and clever marketing during its birth, which gained it large popularity early on. This popularity has made any large-scale adoption of a new layout difficult, even if the new layout may be more efficient than QWERTY. (David, 1985; Asikhia and Ehondor, 2010; Skousen, 2022)

Making changes to QWERTY was not considered for this project as the intent of the project was to create a keyboard that digital creators could quickly adopt. As such, keeping to QWERTY seemed to be the best way to anchor the final keyboard design to other products with which users are familiar. This decision was made to encourage consumer adoption, as creating the keyboard too foreign, could affect how it performs in the market. (Reinhardt, Gurtner, 2015)



Figure 50. QWERTY keyboard layout

4.2 Layout Survey

The survey in Appendix 3.1, aimed to assess which design programs, design tools, and keyboards digital creators use. The information was then used to draw similarities and differences between the various industries in which the digital creators worked. Additionally, responses from the survey help map out keyboard keys that are rarely or never used.

The survey was given to digital creators from:

- 5th-year Architect students at NTNU
- 5th-year Industrial Design students at NTNU
- Digital creators from
 - EGGS (Oslo)
 - EGGS (Trondheim)
 - K8 industridesign
 - Studio Gauntlet
 - BERRE
 - Skibnes Arkitekter AS
 - Riddlebit Software

4.2.1 Key Usage

The survey provided a very thorough representation of what keys users heavily used and which were rarely or never used. From this data, a heat map was generated which made it very easier to see what keys need to be kept, and which could be eliminated or moved. This data coupled with the comments that were included with some of the surveys, helped generate a foundation for exploring alternative keyboard layouts.

Most frequent comments from the surveys:

- “F9-F12 were typically used by Apple users who mainly used those keys to control the Audio of their music and not for the F-key functions.”
- “Other than the Delete and to some degree the Insert button, almost none of the home keys were ever used.”
- “The number pad was typically heavily used by those who had one, though many users simply didn’t have a number pad and typically said they didn’t miss having one.”

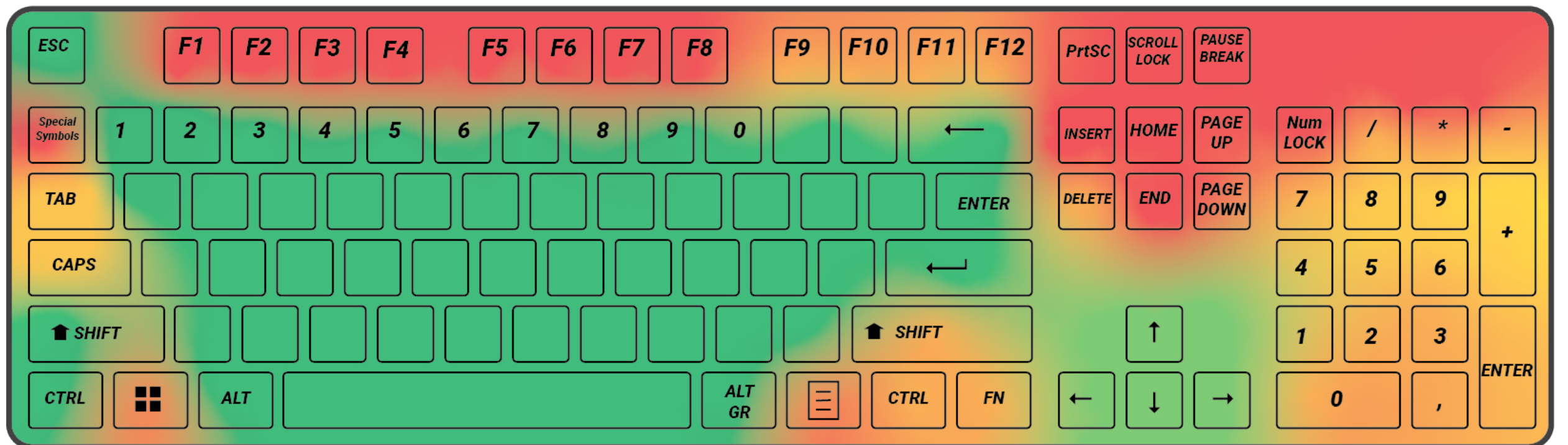

Percentage of usage by individual users



Figure 51. Heat map showing how frequent digital creators use each key

It should again be noted that digital creators have a different home position than most keyboard users, and would be better served by a keyboard with a heat map more like the one seen in Figure 52.



Figure 52. Hypothetical heat map for digital creators

4.3 UI Analysis

All design programs share one or more UIs that help digital creators achieve their design briefs. These UIs create work environments that, for this project, have been subdivided into 4 different types of design environments: space-based, visually-based, time-based, and code-based. Each of these design environments created different types of products or assets, and do so by using UIs that are unique to each of their environments. Data from the surveys were used to create a diagram that plotted out which design programs fell under each of these environments. It should be noted that many design programs are composed of a variety of design environments, and rarely consist of only one of the four design environments mentioned above.

4.3.1 Space-Based Design Environments

Space-based environments are so named as digital creators here are working in 3D space to create a 3D product or asset. These environments can differ in color and will sometimes sport a “floor” or “bed” and an XYZ origin icon to help keep track of the user’s location in the 3D space. Digital creators typically navigate these spaces with the help of mouse movement, the scroll wheel, and in some cases a 3D mouse or equivalent peripheral. Getting used to navigating in 3D space is often one of the hardest skills to acquire for digital creators first getting started in Space-based environments, but soon becomes second nature over time.

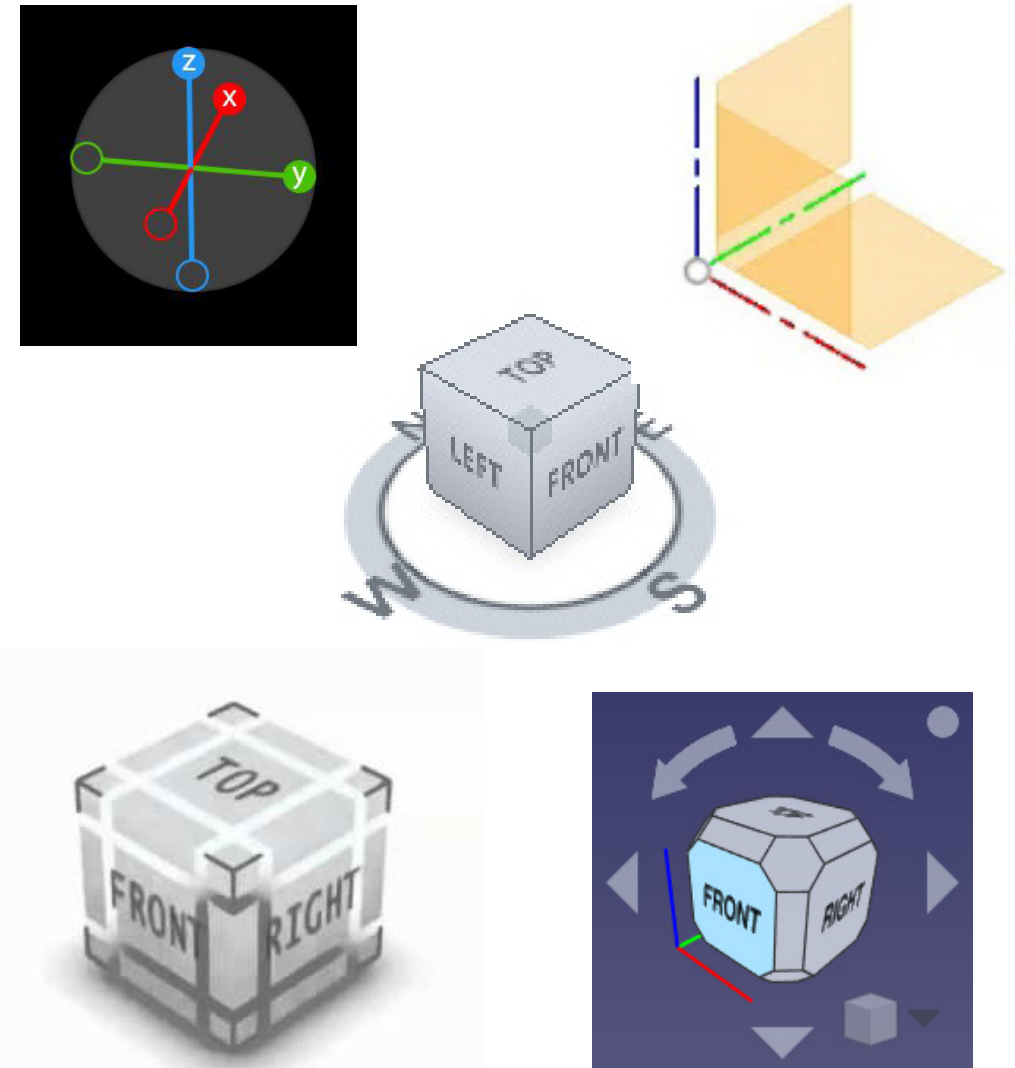

Figure 53. View cubes, origin planes, and origin axis are common UIs in Space-Based Design Environments

Current solutions to working in Space-Based Design Environments

There are a few peripheral devices that have been designed to help navigate through these 3D spaces. The most common being the 3D mouse. A 3D mouse can be found in a number of forms but typically consists of a mounted ball or cylinder that is capable of being rotated or transformed on all three axes as seen in Figure 53. This allows users to easily navigate through their 3d space by rotating, zooming, and panning their viewport.

4.3.2 Visual-Based Design Environment

Visual-based environments solely focus on creating 2-dimensional assets such as graphics, printed materials, textures, and photos. Visual-based design programs share a number of UI's, the most important being the "Canvas" where most of the work is performed. Additionally, color palettes, slide bars, and measurement inputs are frequent UI's shared by all visual-based design programs.

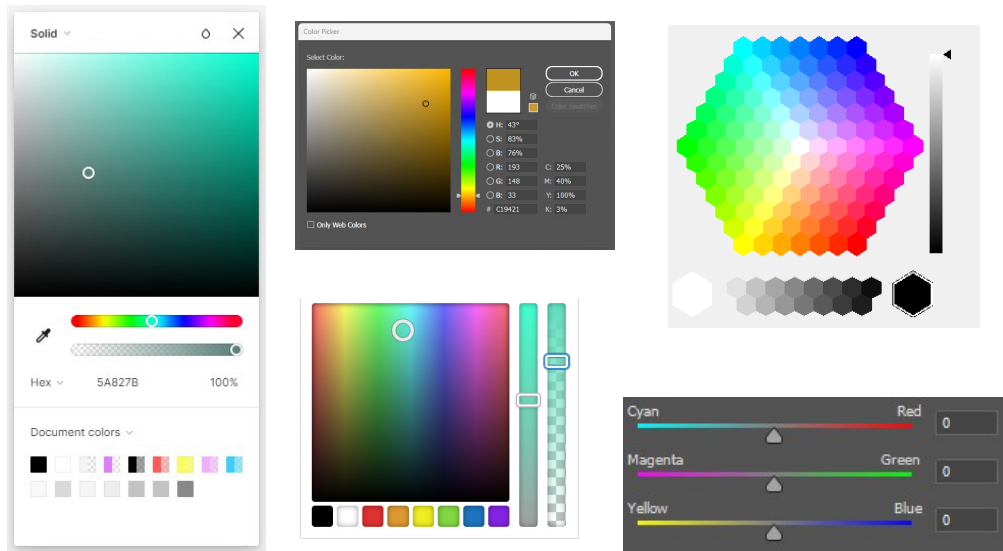

Figure 54. Color pickers and value slide bars are common in Visual-Based Design Environments

Current solutions to working in Visual-Based Design Environments

Navigating the canvas space

- The scroll wheel on a mouse often scrolls up and down on a canvas. Coupling the scrolling with modifiers will allow for zooming, and panning left and right.
- The mouse pad of a laptop is a very effective way to navigate these canvases as one can zoom, scroll, pan, and sometimes even rotate the canvas. The methods to achieve these movements vary from laptop to laptop but often involve different strokes with 1, 2, or 3 fingers.
- Depending on the type of device a digital creator has, a sketch tablet can also work similarly to the 2 above options. Lower-end sketch tablets will allow users to use a stylus to replace the function of a mouse. For higher-end/ sketch tablets which act as interactive monitor screens, fingers can be used to navigate the canvas similarly to using a mouse pad.

Changing Values:

- Typing the value in the text box
- Drag the value slider with the mouse
- Use the mouse scroll while hovering over a value slider.

4.3.3 Time-Based Design Environment

Time-based environments can be exclusively worked in or paired with 2D or 3D environments, and is used for creating animations, simulations, videos, and audio assets. This design environment mainly uses an area where time based assets can be edited, stacked, and transformed in endless combinations. These design assets can be audio files, animated text, paths for animations, or a number of other assets. Dials and slides to control various values in assets are also characteristic of time-based environments.

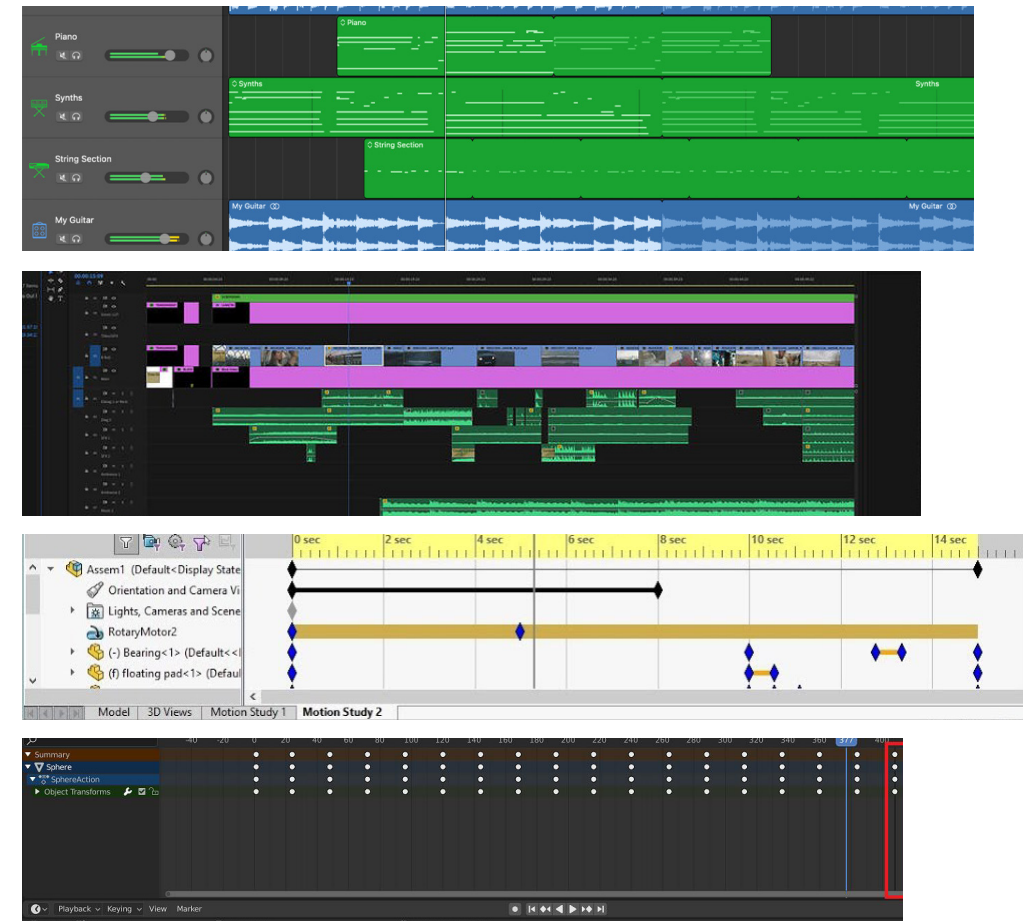

Figure 55. Timeline panels are common in Visual-Based Design Environments

Current solutions to working in Time-Based Design Environments

The scroll wheel on a mouse often scrolls left and right in time-base design environments . Coupling the scrolling with modifiers will allow for zooming, and scrolling up and down.

4.3.4 Code-Based Design Environment

Code-based environments are the simplest of design environments. The basic building blocks of these design environments are the window in which one writes code and the individual lines of code themselves. In many ways those who use code-based environments are very similar to type-touchists, however, the end results are always more than just words on a document.

Figure 56. Script windows are standard in all Code-Based Design Environments

Current solutions to working in Code-Based Design Environments

As code-based design environments function more like a text document, navigating these spaces typically consists of only scrolling up and down with a mouse pad or scroller on a mouse. As these digital creators also use more special characters (""(){};><), it is not uncommon for them to remap their keyboards to make these characters easier to access while writing code.

4.3.5 Analysis of the UIs found in Digital Creator Programs

All of the design programs digital creators recorded using on their surveys were plotted on a venn diagram to show which design environments were most typically used in each program. These findings were further broken down into the programs that individuals of certain industries use. The number of programs used by each study pool are represented by the gray circles.

*Adjustments were made to industries that had smaller test pools to artificially give their input the same value as industries better represented.

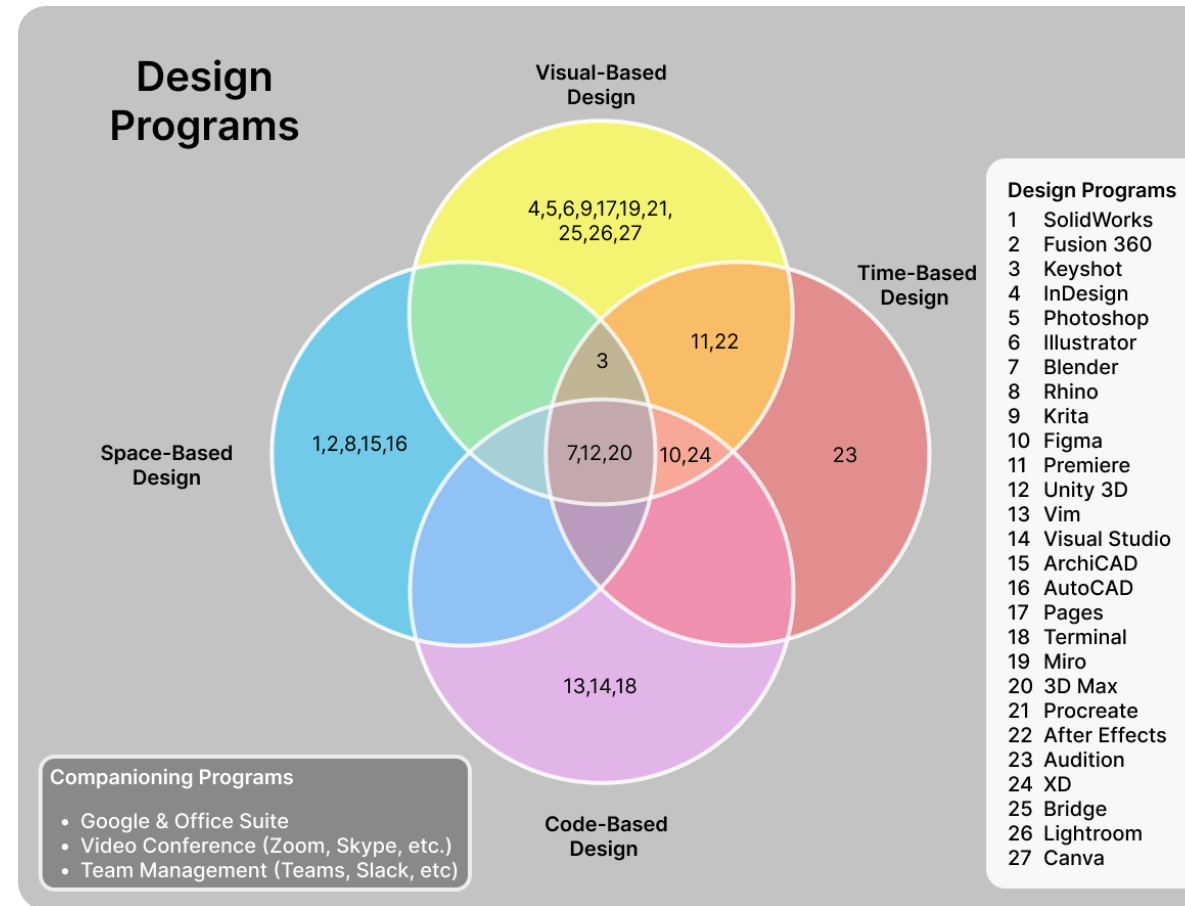

Figure 57. All of the design programs that survey takers use in thier respective field

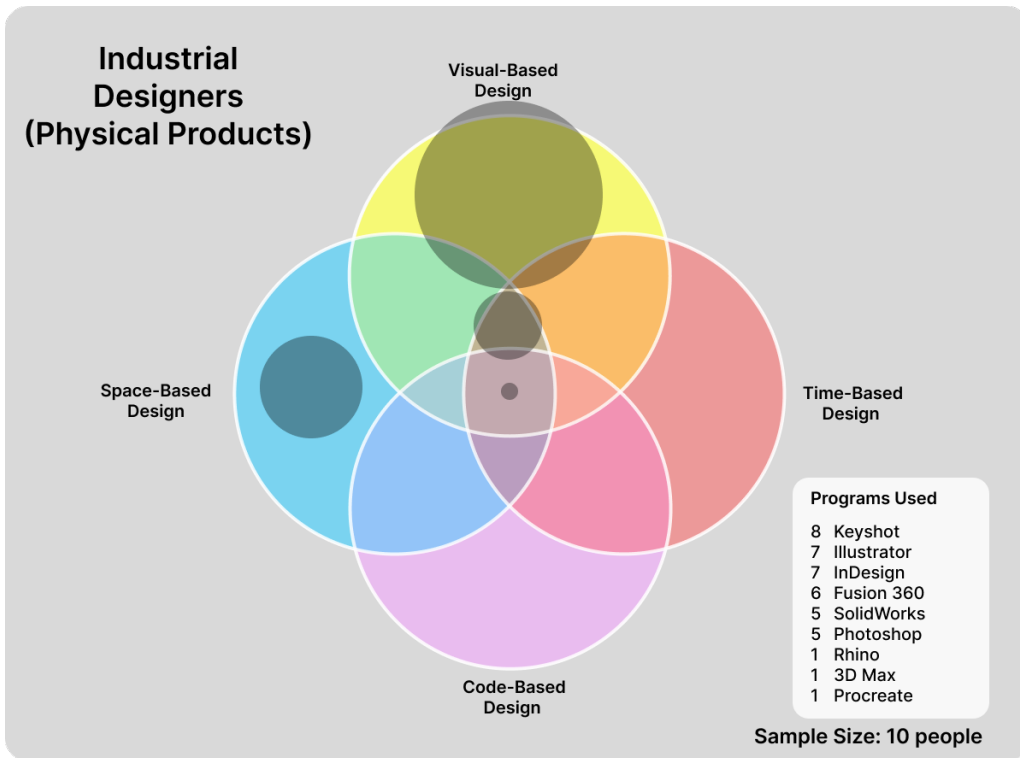

Figure 58. Survey results from Industrial Designers (physical products)

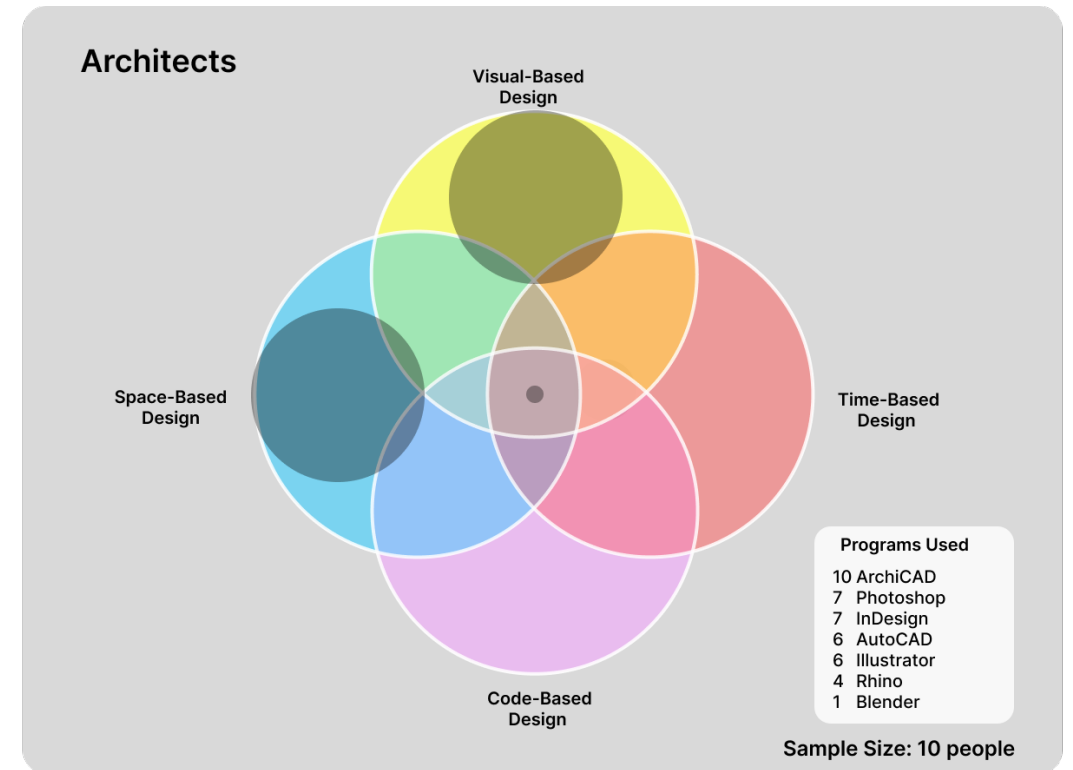

Figure 60. Survey results from Architects

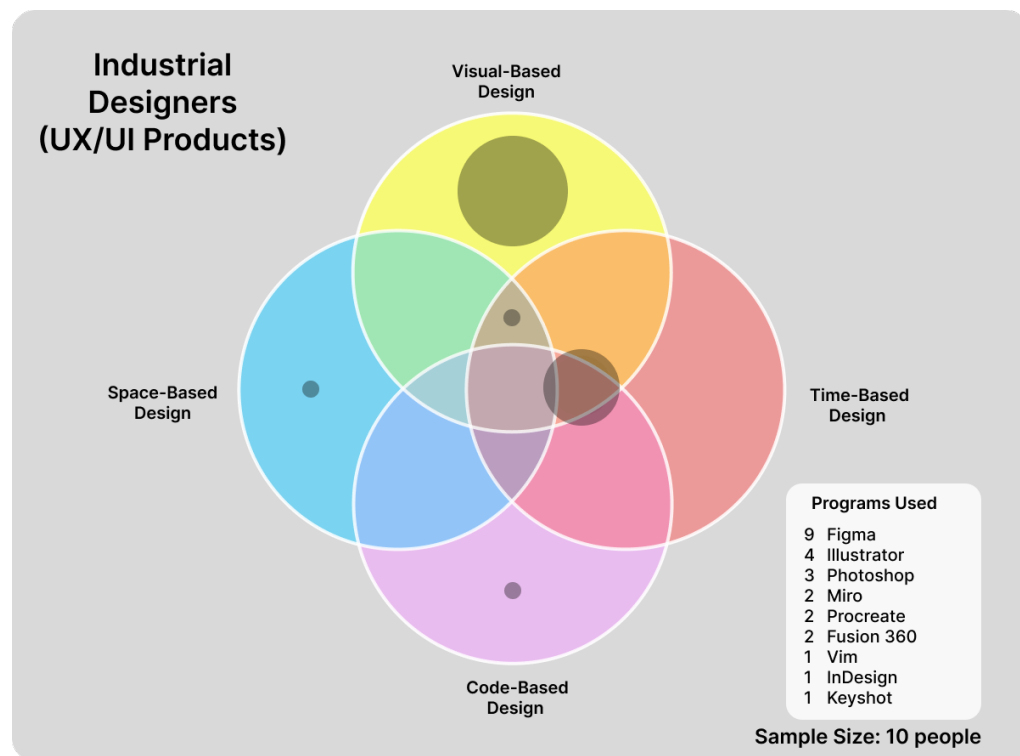

Figure 59. Survey results from Industrial Designers (digital products)

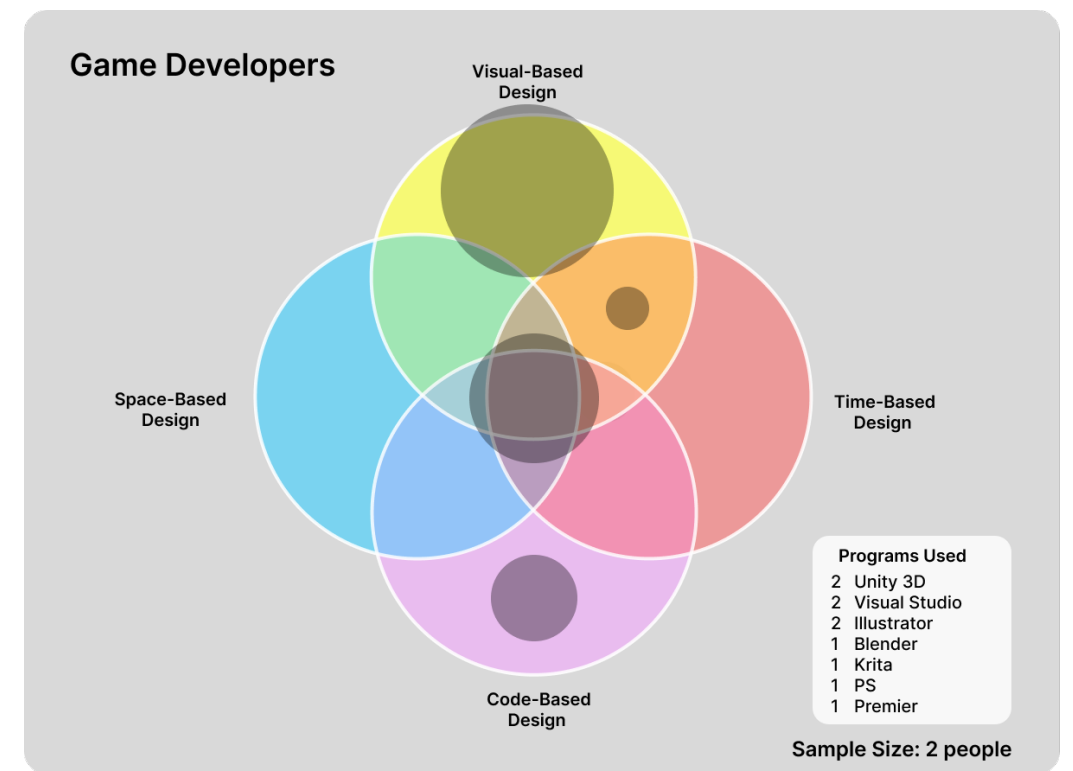

Figure 61. Survey results from Game Developers

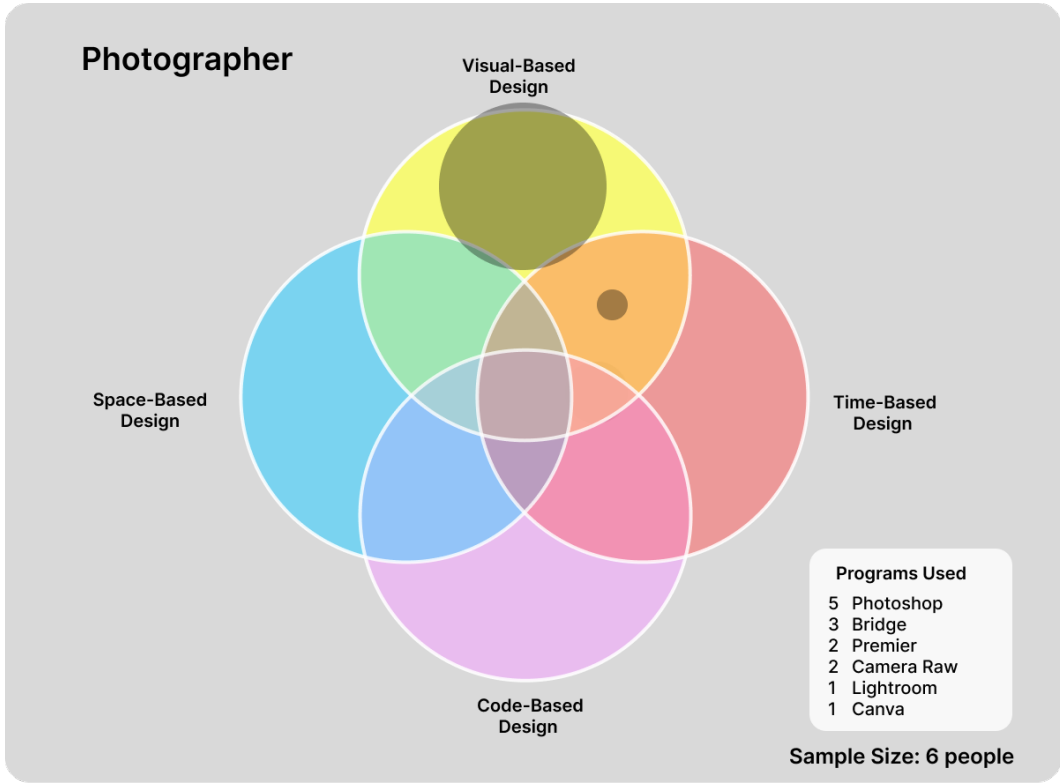

Figure 62. Survey results from Photographers

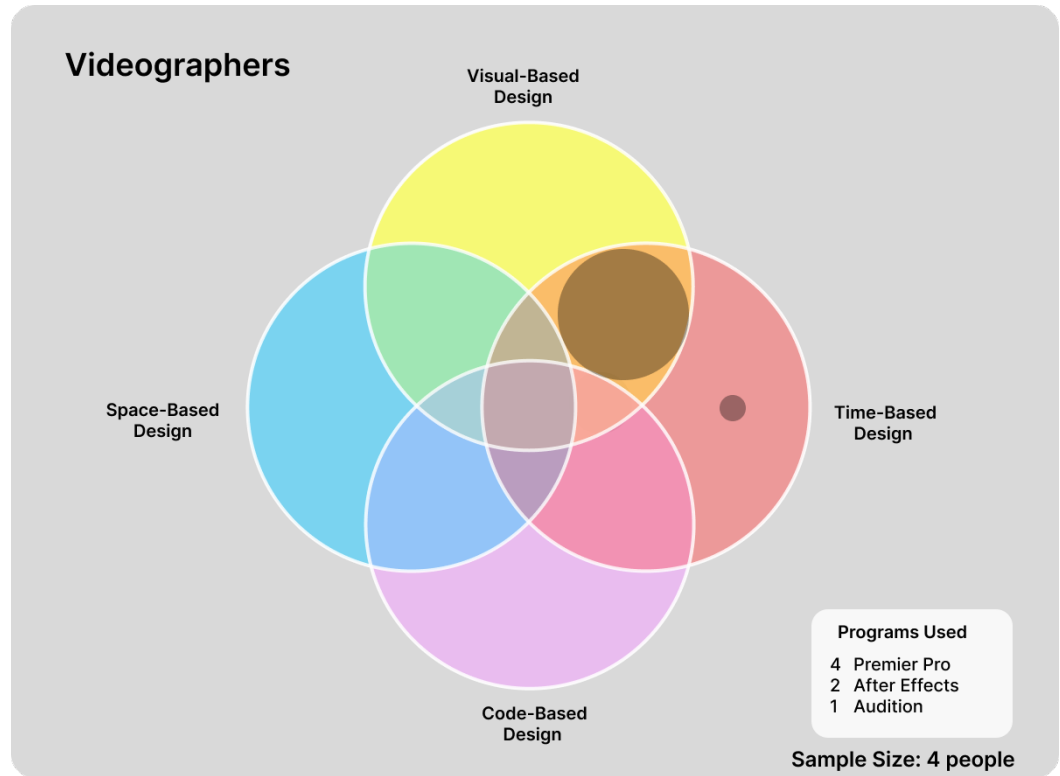

Figure 63. Survey results from Videographers

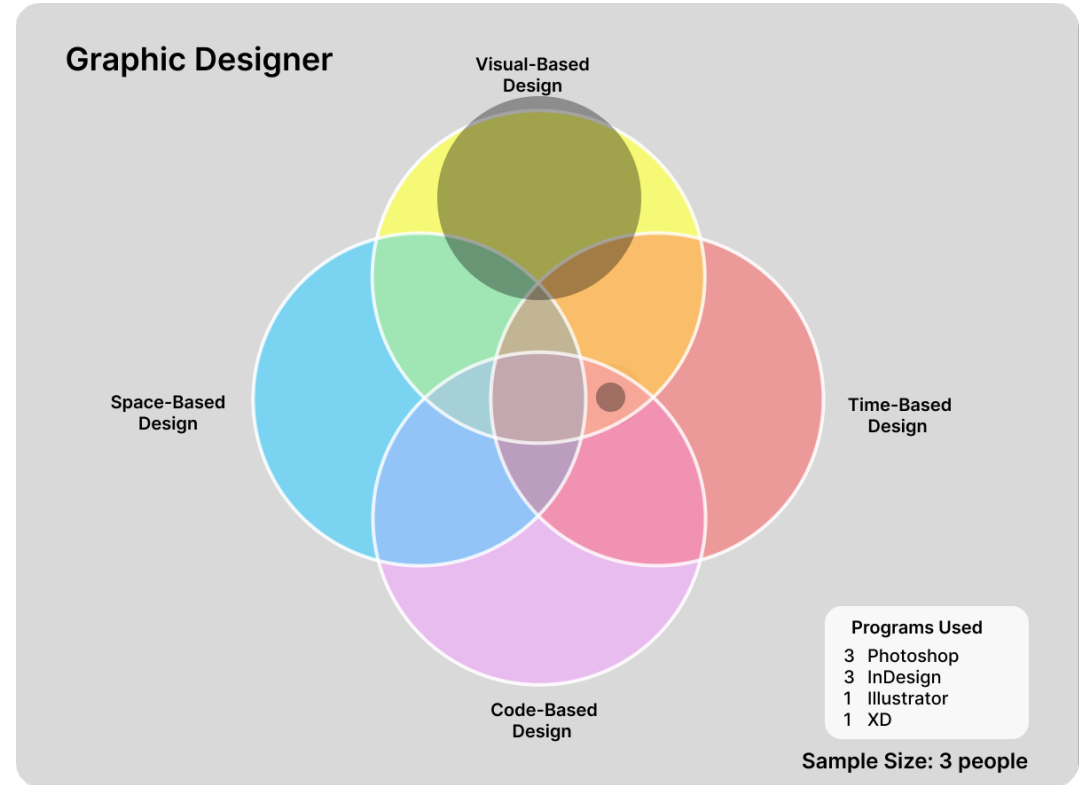

Figure 64. Survey results from Graphic Designers

A silhouette of each industry was placed on a blank van diagram to show that the UIs from visuals-based design environments were the most common UIs used by digital creators. This was followed by space and time-based design environments with code-based design environments being the least common.

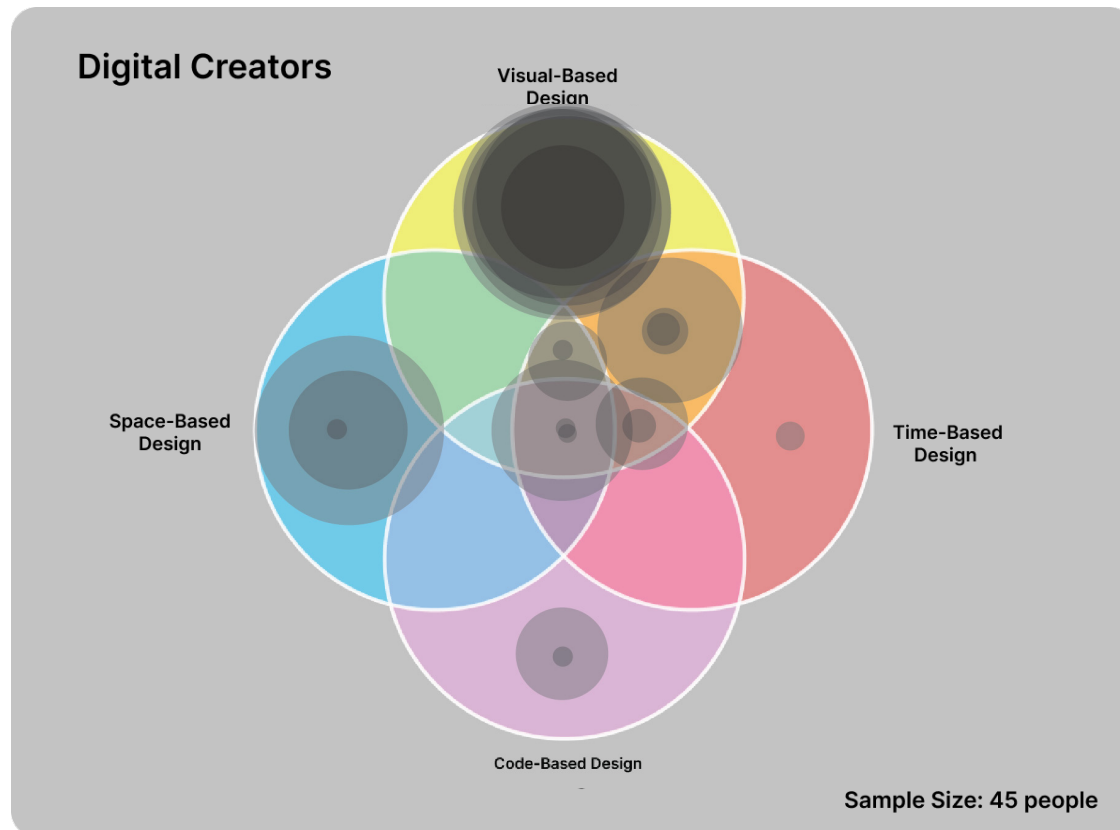

Figure 65. By combining all of the results onto one diagram the most commonly used UXs can be seen

4.3.6 Exploring Additional Keyboard Functions

With the data found in 4.3.5, it was determined that having a method to simplify the multiple functions of a mouse scroll would be the most beneficial feature to add to a keyboard. By doing so, digital creators would be able to more easily navigate visual, time, and code-based design environments. As such, adding a trackpad, scroll wheels, and scroll belts was explored.

Track Pad

Feedback from digital creators throughout this project revealed that the use of trackpads is a greatly contested topic. Those who are mostly in visual-based design environments love the versatility that trackpads (especially trackpads from Apple) provide. In contrast, those who mainly work in space-based design environments strongly dislike how cumbersome it is to navigate in 3D space with a trackpad.

Those who work in time and code-based design environments seemed somewhat split or indifferent as to having a preference. It was eventually decided a trackpad would not be used due to the mixed feeling about them. The addition of a trackpad to a mechanical keyboard also seemed to communicate conflicting design languages as mechanical switches are a mechanical solution, while track pads are purely an electrical solution.

Scroll wheels

Scroll wheels were then explored as they are a mechanical solution that is also very familiar to all computer users. As there are 3 functions that are trying to be achieved, the idea of having 3 different scroll wheels seemed logical. One for scrolling up and down, one for scrolling right and left, and one to scroll in and out. For much of the testing of various keyboard layouts later in this project, scroll wheels were used but seemed to be physically and visually cumbersome when surrounded by mechanical keys or when placed on the perimeter of the keyboards. Issues of ergonomics also were brought forward as heavy use of scroll wheels can cause unwanted stress from long durations of repetitive micro-movements in the fingers. (Jensen, Finsen, Søggaard, Christensen, 2002) For these reasons, the use of scroll wheels was abandoned.

Scroll belts

Functionally, scroll belts offered the same benefits as scroll wheels, however, if implemented properly, could avoid the ergonomic issues characteristic to scroll wheels. Although micro finger movement can still be used with using scroll belts, their longer profile, allows for macro arm movements to be used to operate. These macro arm movements cause far less stress on joints when compared to the stress of repetitive micro-movements used to operate scroll wheels. Additionally, due to their unique esthetic and mechanical properties, scroll belts were settled on as the best option for helping digital creators navigate their respective programs.

4.4 Layout Exploration Workshops

Workshops took place at EGGs in Trondheim and Oslo, K8 Designs in Oslo, and BERRE in Trondheim. The first workshop, held at EGGs Trondheim, acted as a test run for all future workshops.

The workshop at EGGs Trondheim consisted of the following itinerary:

- Meet and Great/Introduction presentation
- Quick survey (Split into groups based on survey responses)
- Activity 1: Groups are given a design brief based on their profession, and as a group make an order of operations to execute said brief in their preferred design programs. Groups will need to identify what phases will take the most time and why.
- Activity 2: In the same groups, use a “keyboard test rig” (See attached photos) to come up with keyboard layouts that would help them optimize the order of operations they created in Group Activity 1
- Group Presentations of solutions
- Closing remarks



Figure 66. Layout test rig used for EGGs Trondheim workshop

The keyboard test rig consisted of magnetic segments of a full-size keyboard as well as a number of dials and knobs. These components could be placed and rearranged on the metal plates to explore a variety of keyboard layouts.

Based on the results and feedback received from the EGGs Trondheim workshop, changes were made for the following 3 workshops, in which the keyboard test rigs were no longer used. The itinerary for the workshops at K8 Designs, EGGs Oslo, and BERRE was the following:

- Introduction presentation
- A quick survey
- Activity 1: Split into groups of 2+. Without a keyboard, complete simple tasks on your preferred design program. Use blank keycaps and “QWERTY” to build a keyboard layout that would best help you navigate your design programs
- Group presentations of solutions
- Activity 2: The groups will leave their keyboard layouts at their table, and all the groups will rotate to different tables. While at their new location, each group will analyze and record what they like and dislike about the other group’s layout. The process repeats until every group has tried every other group’s keyboard layout.
- Closing remarks

4.4.1 EGGs Trondheim

In this first workshop, there were 5 participants that fell under 3 different professions as digital creators. These 3 professions were split into 3 groups for the two activities.

- 2- Game Developers
- 2- UX designers
- 1- Industrial Engineer/Designer



Figure 67. EGGs Trondheim workshop

Results from Activity 1&2

For presentation purposes, the results from each group have been added to a keyboard with the basic functions of a 60% keyboard as this size keyboard has the basic function needed to operate any program a digital creator would work on. Features and keys shaded in blue represent the solutions that each group presented to the other groups.

Group 1: Gamer Developers

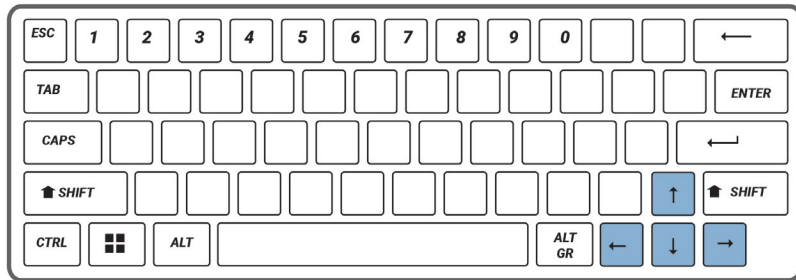

Figure 68.

Features:

- Small in size making more room on a desk
- Arrow keys are still included

Comments from other groups

- "This would be too small for me to use"
- "I probably could get away with working with something this small, pretty much just a normal 60% keyboard"

Group 2: UX Designers

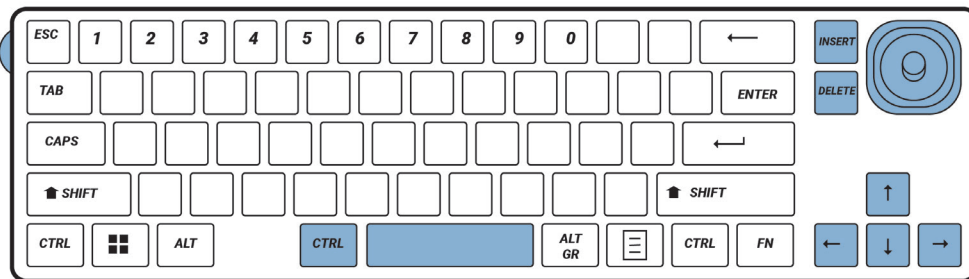

Figure 69.

Features:

- Half-space bar
- Arrow keys, Insert, and Delete are still included
- Additional Ctrl in the middle of the keyboard
- Joystick for moving objects around a program
- Volume wheel on left side

Comments from other groups:

- "Extra ctrl key close to space bar is an interesting idea, I would need to test it in real-life scenarios to see if I would like that or not"
- "I feel like the volume wheel is a bit unnecessary"

Group3: Industrial Engineer/Designers

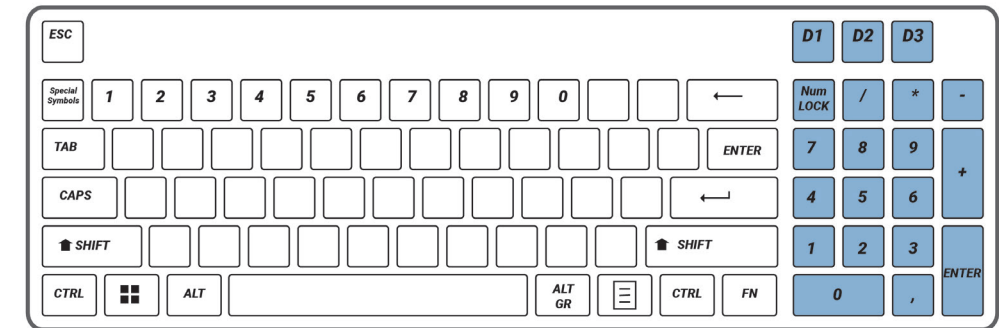

Figure 70.

Features:

- Keep the number pad
- 3 device buttons to allow the user to switch between devices

Comments from other groups

- "It's nice with the ability to switch between devices"
- "It's basically just a standard keyboard"

4.4.2 K8 industridesign

In K8's workshop, there were 2 participants.

- 1- Product designer
- 1- Graphic designer

Results from Activity 1&2

For presentation purposes, the results from each group have been added to a keyboard with the basic functions of a 60% keyboard as this size keyboard has the basic function needed to operate any program a digital creator would work on. Features and keys shaded in blue represent the solutions that each group presented to the other groups.



Figure 71. K8 industridesign workshop

Designer 1: UX Designer

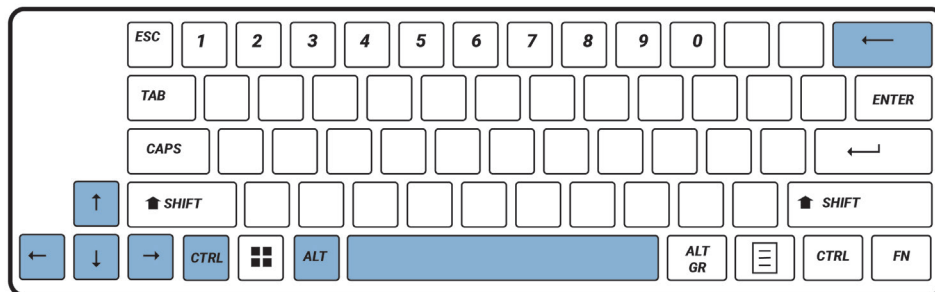

Figure 72.

Features:

- Arrow keys moved to the left side

Comments from other designer:

- "Pretty simple, though working in 2D, you might not need as many additional functions as when you are working in 3D."

Designer 2: Product Designer

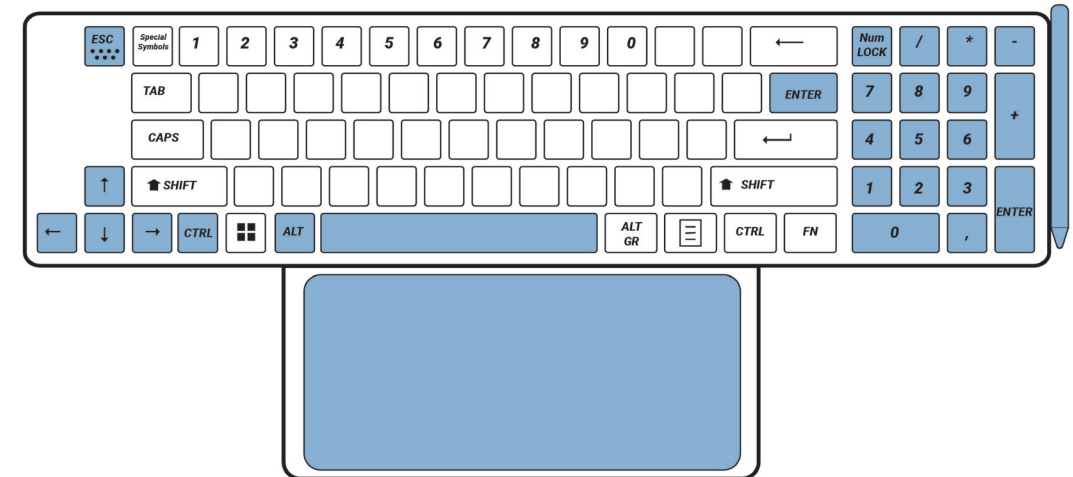

Figure 73.

Features:

- Arrow keys moved to the left side
- Added texture to Escape
- Keep number pad
- Attached sketch pad/track pad and stylus

Comments from other designer:

- "I really like the idea of having textured modifiers, that would be really nice. Having a track pad for a desktop computer is also a pretty interesting idea."

4.4.3 EGGS Oslo

Five digital creators participated in the layout workshop at EGGS Oslo. These digital creators were split into two groups for the two activities.

2- Product Designers

3- UX designers

Results from Activity 1&2

As was done for the workshop at EGGS Trondheim and K8, the results from each group have been added to a keyboard with the basic functions of a 60% keyboard as this size keyboard has the basic function needed to operate any program a digital creator would work on. Features and keys shaded in blue represent the solutions that each group presented to the other groups.

Group 1: Product Designers

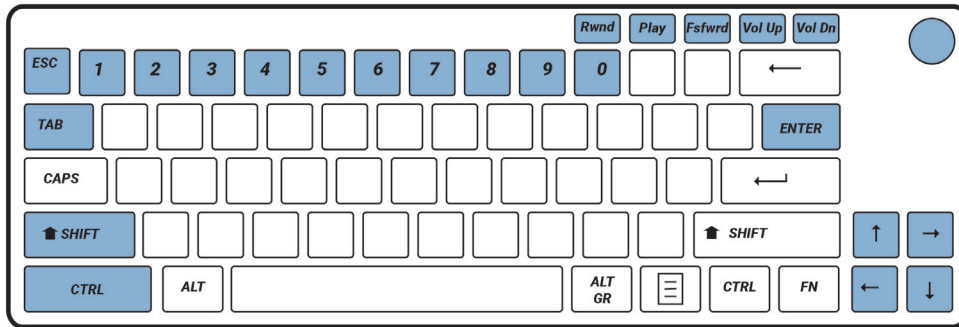

Figure 74.

Features:

- Condensed arrow keys
- Media keys are found in the top right
- Finger scanner in the top right corner
- Larger command/ctrl key in the left corner

Comments from other designers:

- "Finger makes sense most of us use Apple products here"
- "Interesting that you guys wanted arrows, we never use them"
- "Oooo... media controls, we definitely forgot that."

Group 2: UX Designers

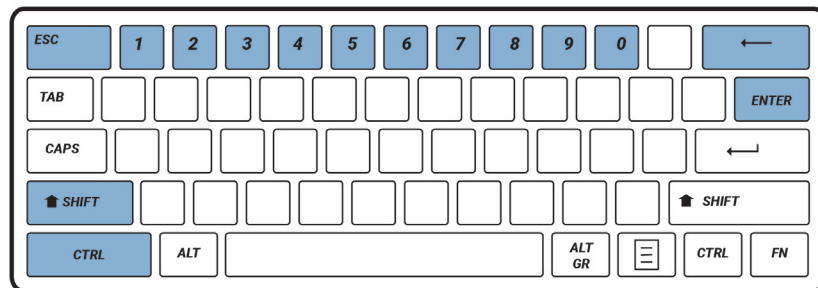

Figure 75.

Features:

- Larger command/ctrl key in the left corner

Comments from other designers:

- "Pretty much just a small keyboard. I guess it makes sense that UX designers would need as much on a keyboard"



Figure 76. K8 industridesign workshop

4.4.4 BERRE Kommunikasjon

Four digital creators participated in the layout workshop at BERRE Kommunikasjon. These digital creators were split into two groups for the two activities.

- 2- Photographers
- 2- Videographers



Figure 77. Results from a group at the BERRE workshop

Results from Activity 1&2

As was done for the previous workshops, the results from each group have been added to a keyboard with the basic functions of a 60% keyboard. Features and keys shaded in blue represent the solutions each group presented.

Group 1: Photographers

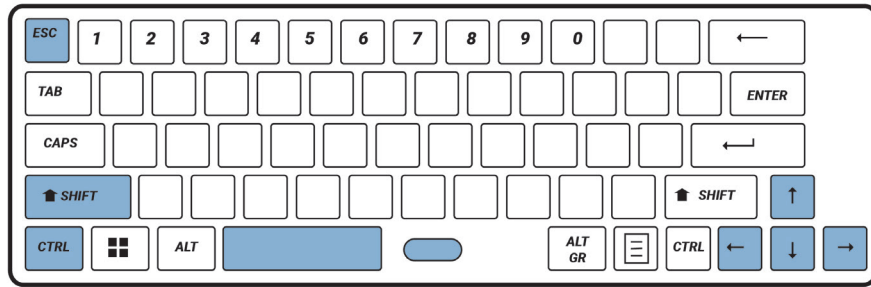

Figure 78.

Features:

- Half spacebar
- Horizontal scroller to the right of the spacebar
- Arrow keys are on the right side

Comments from other designers:

- “Really like the placement of your scroll wheel”
- “Where is your TAB key?”

Group 2: Videographers

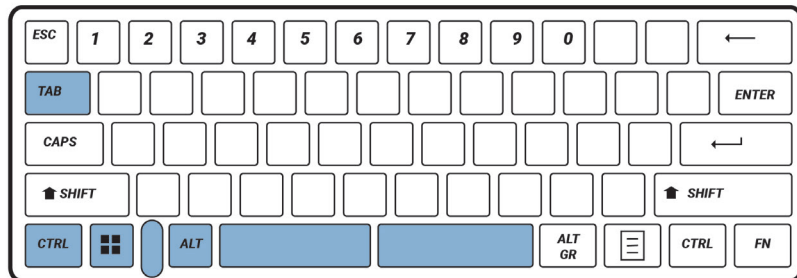

Figure 79.

Features:

- Right and left spacebars “maybe make them programmable”
- Vertical scroller to the left of the spacebar

Comments from other designers:

- “Not a fan of the placement of your scroll wheel”
- “I feel 2 spacebars with different functions would be confusing”

4.5 Requirements List - Functional Analysis

As this project developed, the need for a requirements list became clear. Items were added to the list based on information from the layout workshops, observations of the user videos submitted by the participating YouTubers, the keyboard survey, and informal feedback throughout the project.

Requirements	Must Have	Should Have	Could Have	Not Needed
Full Alphabet	X			
Keyboard must be fully functional with all programs	X			
Recognizable Layout	X			
12 Function keys				X
Number pad		X		
Home Keys				X
Typical left side modifiers		X		
Typical right side modifiers			X	
Macro keys			X	
Adaptive	X			
Shortcut optimization	X			
Splittable keyboard		X		
Accompanying UX		X		
Modulare			X	
Additional scroll wheels			X	
Wireless		X		
Extra USB ports			X	
Connects to multiple devices			X	
Finger scanners		X		
Arrow keys		X		
Delete key	X			
Windows button				X

Figure 80. Requirements list

4.6 Layout Sketches

Based on the results from the surveys, UI analysis, layout workshops, and requirements list, 30 different keyboard layouts were generated (Appendix 3.2). Each option attempted to capitalize on as many desired qualities as possible. Final layouts that moved forward to testing were among the most effective layouts. Additionally, the overall feeling of familiarity with the layouts was considered to ensure the designs tested did not feel too foreign to end users. This was achieved by grouping keys in familiar batches (such as arrow keys) and placing them in locations that seemed natural based on digital creators' needs and on typical keyboard layouts.

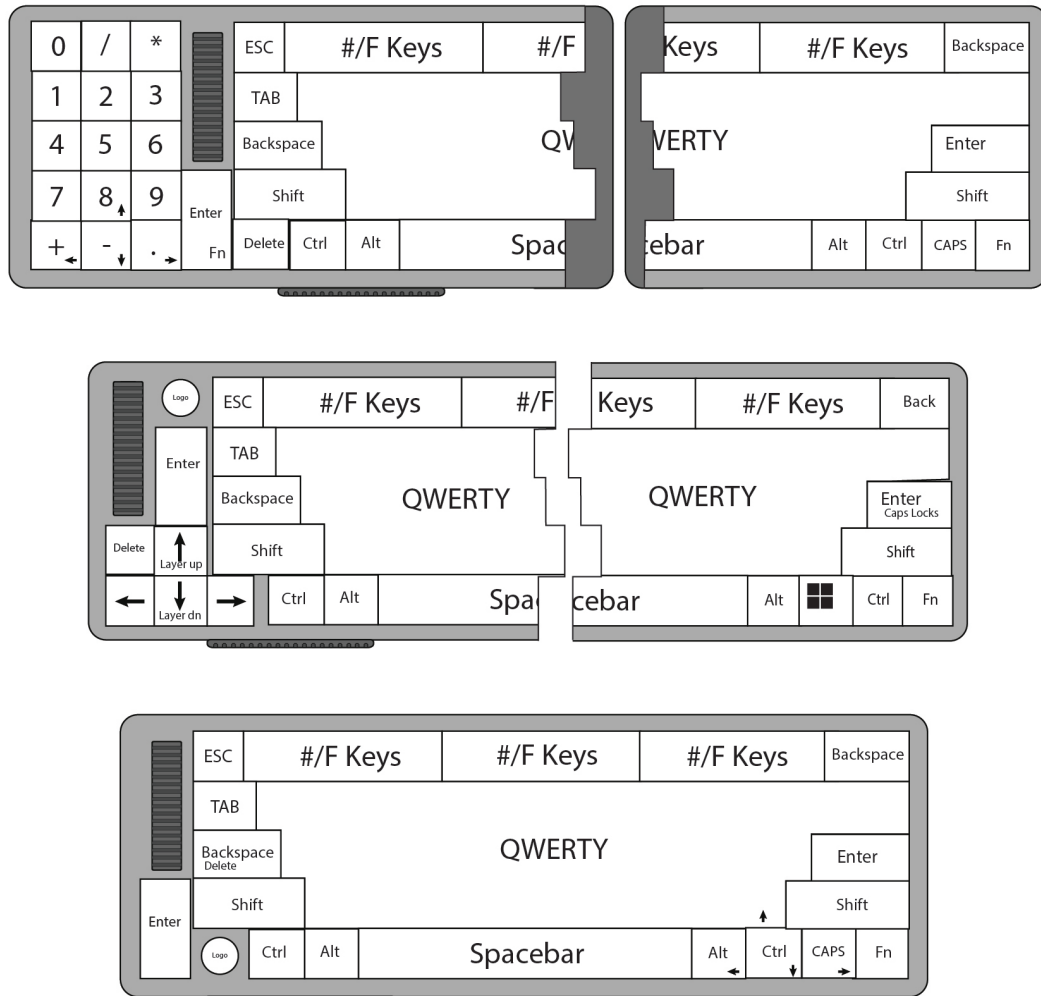

Figure 81. The 3 layouts that were moved on to being tested

4.7 Layout Prototyping

The three layouts that were tested were made from the test rigs that were used in the first layout workshop, however, all of the test rigs were modified to the final size of each layout. Due to a lack of tactile switches, each prototype layout used a different switch type. Additionally, the keycaps used for these prototypes were Cherry profile keycaps, not the final keycaps designed for this project as only a handful of final keycaps had been made at the time of making these prototypes.

Those who participated in testing out these layouts were informed the final switches would be the tactile switches to avoid bias in choosing a preferred layout. It would have been ideal to make these prototypes functional, but due to a lack of knowledge in PCB design and programming, they were only made to replicate the feel of the final layout.

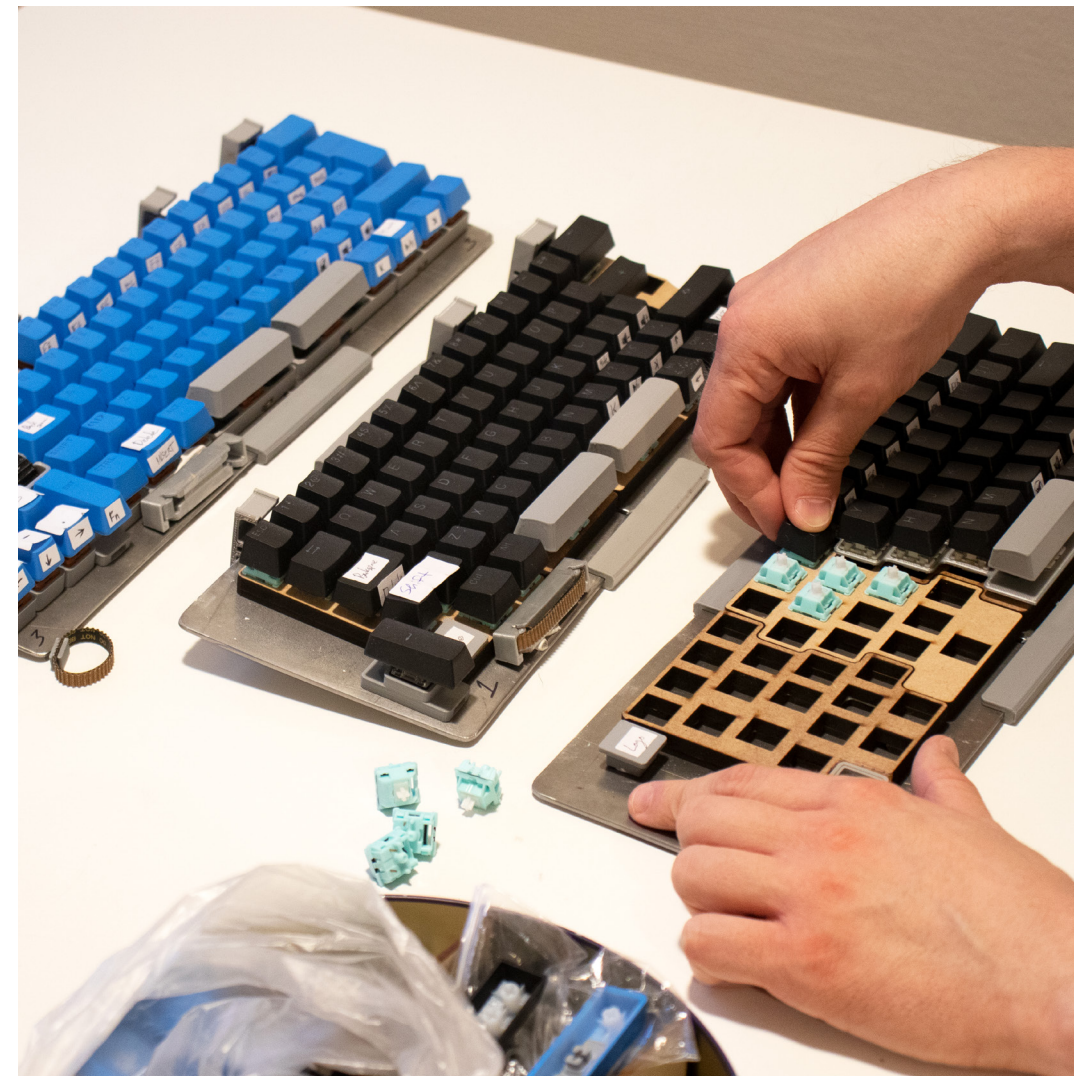

Figure 82. Building the 3 layout prototypes

4.8 User analysis and feedback

Multiple companies were contacted to test out the 3 final possible layouts, but due to problems with availability, only BERRE kommunikasjon was able to assist in testing the prototypes. Of the participants from BERRE there were 2 videographers, 2 photographers, and a musician who tested out the layouts. A number of UX and product design students also gave feedback on the 3 final options which were also taken into consideration. Comments and observations were recorded to determine the pros, cons, and feedback of each layout. The results were then taken and used to create the final keyboard layout.



Figure 83. Students testing out the 3 prototype layouts

Layout 1

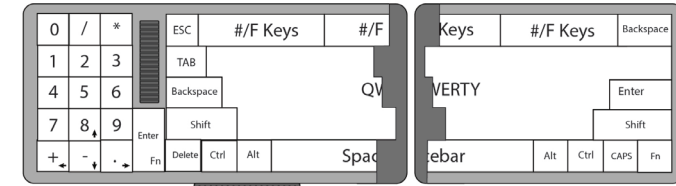

Modified Figure 81.

Pros

- Splittable
- Has an enter and delete on the left side
- Has 2 additional scroll wheels
- Has all the keys a digital creator needs

Cons

- A bit long, especially if you don't use the number pad
- Arrow keys are buried under the "Fn" key

Feedback

- "Not a huge fan of how the numbers on the number pad have been rearranged"
- "It would be nice to have a finger scanner"
- "Would be nice if the number pad was removable"

Layout 2

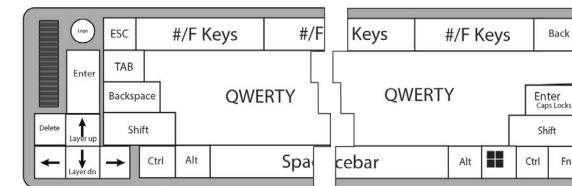

Modified Figure 81.

Pros

- Splittable
- Has an enter and delete on the left side
- Has 2 additional scroll wheels
- Good Size
- Has a nice overall look to the layout
- Arrows are easily accessible

Cons

- Enters placement is a little odd

Feedback

- "In design programs delete and backspace are pretty redundant. Is it necessary to have both on the left side?"
- "A couple Copy/Paste keys would be really nice"

Layout 3

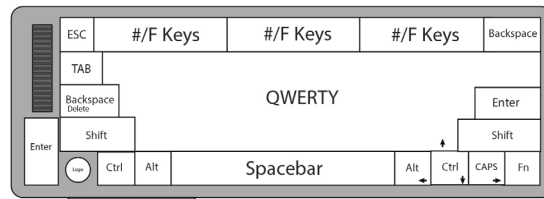

Modified Figure 81

Pros

- Compact
- Covers basic functions while prioritizing the left side
- Has an enter and delete on the left side
- Has 2 additional scroll wheels

Cons

- Keyboard is a little small for some users
- Not splittable
- Arrows are buried under the “Fn” key
- Arrows are found on the left side of the keyboard
- Doesn’t have as much functionality as the other 2 options

Feedback

“Not a huge fan of this layout. It’s not bad, just not really interesting”

4.9 Final Layout

After reviewing the feedback on the 3 prototype layouts, Layout 2 was modified to include a number of the suggestions that were given by the product testers. These changes consist of:

- Replacing the “Backspace” with the “Enter” key
- Placed 2 “Copy/Paste” keys above the arrow keys
- Adding a removable number pad
- Taking away the windows key and replacing it with a finger scanner

With these changes, the final layout (seen in Figure 84) was chosen to be moved forward to the final prototyping

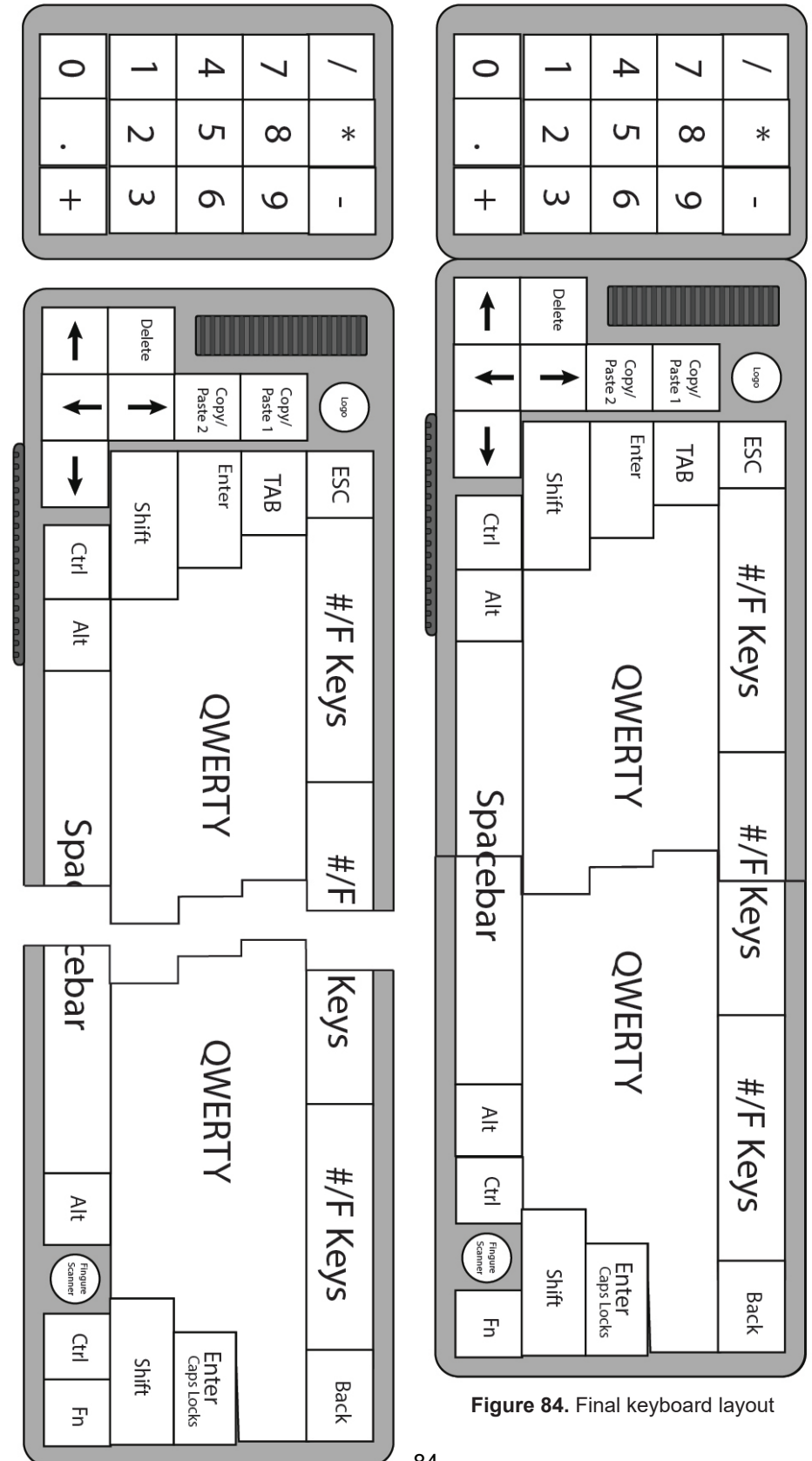

Figure 84. Final keyboard layout

5.0 Case Design

With the layout finalized and the keycaps final form determined, a case needed to be designed. The case not only needed to match the aesthetic of the moodboard and the above components, but also needed to be designed with manufacturability in mind. Assembly methods were studied and determined before moving onto sketching and prototyping a final case design.

5.1 Disposable/Repairable/Recyclable

Many electronic products often are not designed with reparability or recyclability in mind. Because of these design considerations, many electronics are also designed to be cheap to manufacture to accommodate replacing broken or old devices. These qualities lead to the disposal of many electronic devices as they are designed for the linear economic model (take-make-dispose). (Niinimäki, Durrani, 2020) One way this project hopes to combat this “throw-away mentality” is to create a product that encourages reparability and eventual recyclability (where possible). This was achieved by creating a keyboard in which a personal relationship can be made between the user and the keyboard. This project achieves this relationship by creating a keyboard that is a design companion to the user, to help the user enhance their personal touch in every project.

Customizability of the function of the keyboard is also at the center of the design of the keyboard helping users build a more dynamic relationship with the keyboard. Additionally, the materials and components chosen for this project were selected based on favorable characteristics such as being recyclable, durable, and/or repairable.

5.2 Analysis of Keyboard Assembly Methods

There are multiple ways that keyboards are assembled, and there is no better place to learn about methods of keyboard assembly than from the keyboard enthusiast community. Because the keyboard enthusiast community enjoys building and testing keyboards, there are many mainstream and outlandish assembly methods that individuals have built and tested. By building these keyboards, enthusiasts have generated standards and an understanding of the benefits and pitfalls of each method. Thomas Baart from the r/MechanicalKeyboards Discord server created a very clean display of the most common assembly methods and their pros and cons which can be found in Appendix 4.1. (Keyboard University, n.d)

After studying the information from his diagram, it was determined that building the keyboard with an integrated plate would be the best option for this project. This allowed for more freedom in designing the form of the keyboard case, though this was done at the expense of some sound qualities. Fortunately, these sound qualities are more valued by enthusiasts and should not affect digital creators who are less conditioned to analyze the sound of a keyboard. The rigidity that is characteristic of an Integrated plate also is not a problem for digital creators as rigidity causes more problems for type-touchist who are typing for long durations.

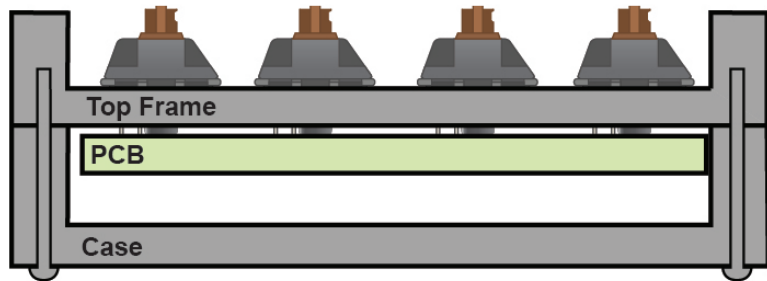

Figure 85. Integrated Plate mounting method

5.3 Sketching

As the keycaps and overall layout of the keyboard had been finalized prior to designing the actual case of the keyboard, much of the overall aesthetic was already determined prior to the design of the case. With these components already designed, sketches of the case were created around the final renders of the keycaps in their final layout. This helped ensure that there was visual consistency between components while holding true to the desired aesthetics expressed in the mood boards.



Figure 86. Sketch excerpt from Appendix 4.2

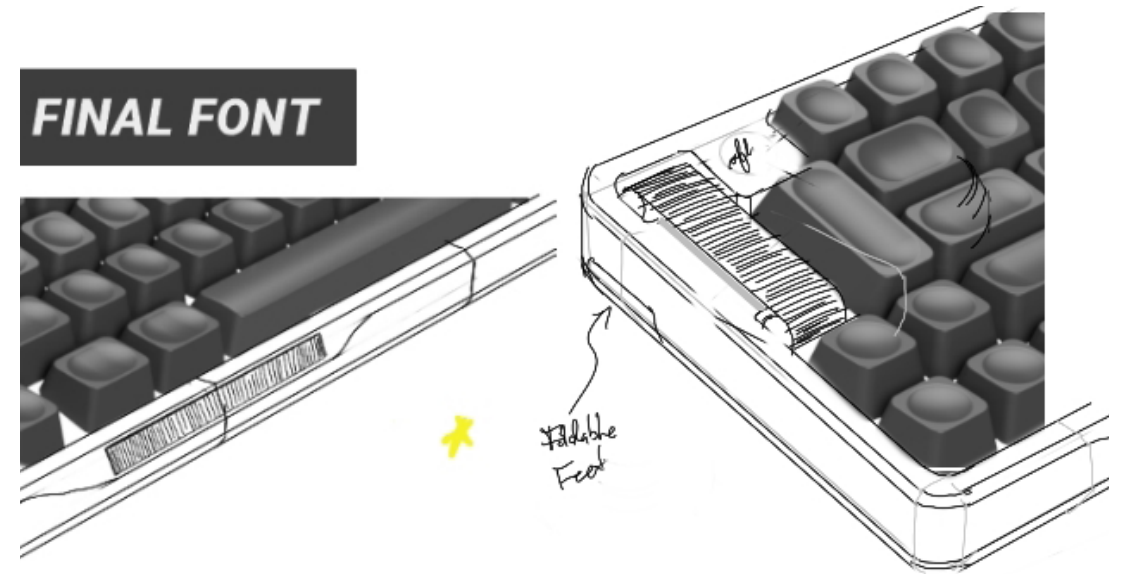

Figure 87. Sketch excerpt from Appendix 4.2

5.4 Prototypes

As the overall design of a keyboard case is that of a box, more emphasis was given to prototyping and testing the fit of various components rather than the cases form.

5.4.1 Prototyping components

The fit of mechanical switches was the first component prototyped. This was done with a tolerance mounting plate (see figure 88) which was milled out of aluminum and anodized to ensure all tolerances were accurate to the final manufactured dimensions. To prototype the fit of all the layers of the full keyboard a key with all the layers was made which simulated all of the internal components. This helped determine the overall thickness of the keyboard. The last component that was prototyped was the connecting joint in the middle of the keyboard. Before moving onto the full keyboard, the number pad was finalized to dial in all the tolerances for the full keyboard

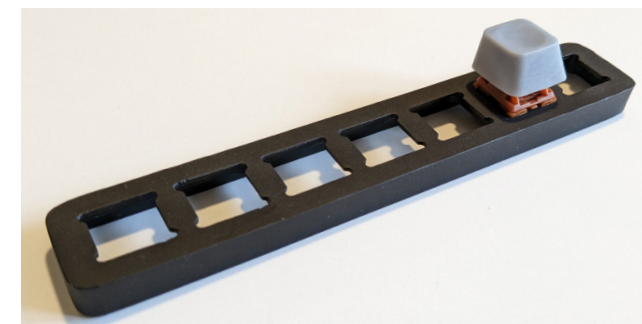

Figure 88. Tolerance mounting plate.



Figure 89. Prototyping keyboard internal layers.



Figure 91. The final number pad prototype.



Figure 90. Prototyping all of the internal layers for the number pad.



Figure 92. Prototyping the fit of the middle joint on the keyboard

5.4.2 Full scale prototype

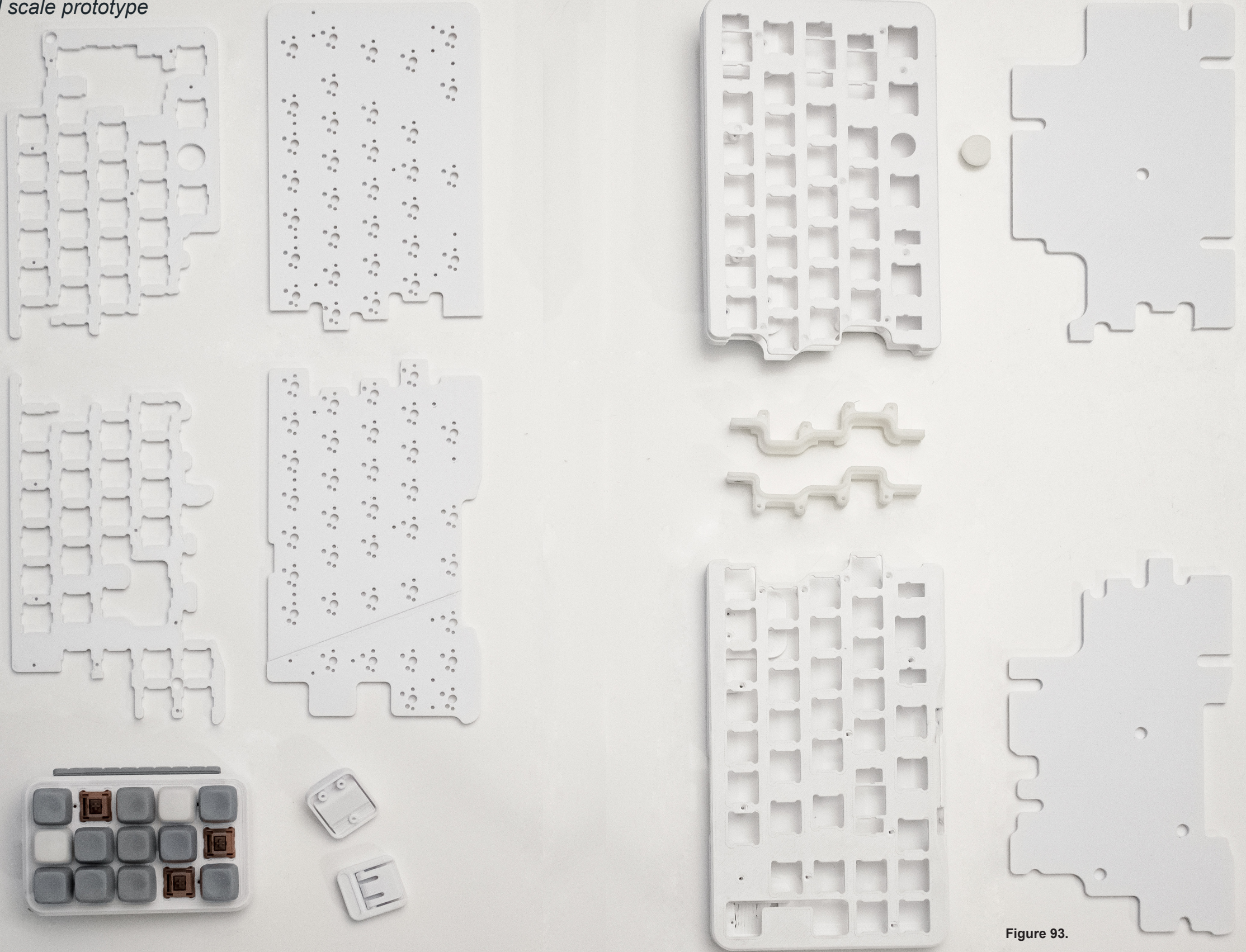

Figure 93.

6.0 UX Design

As every computer program maps out its shortcuts differently from each other, it would be very difficult to make changes to QWERTY that would have any universal benefit to digital creators. As such additional functions need to be built into the keyboard, these functions would tackle issues with shortcut learning and usage. Customization will also need to be possible, as many digital creators have strongly expressed the need for a range of unique keyboard functions. Designing was not intended to be part of this project, however, as the project progressed the need for a UX was realized. This section of this project was not intended to result in a refined solution, but more to provide readers with an understanding of the need for a UX.

6.1 Functions Exploration

Throughout this project, digital creators have given suggestions for additional functions built into the keyboard. While most of these suggestions involved the physical design of the keyboard, some specifically affected functions that were more rooted in the hardware of the keyboard. These suggestions, along with others added from short brainstorming session, were added to a Miro board which was used to help map out the basic functions of the keyboards UX.

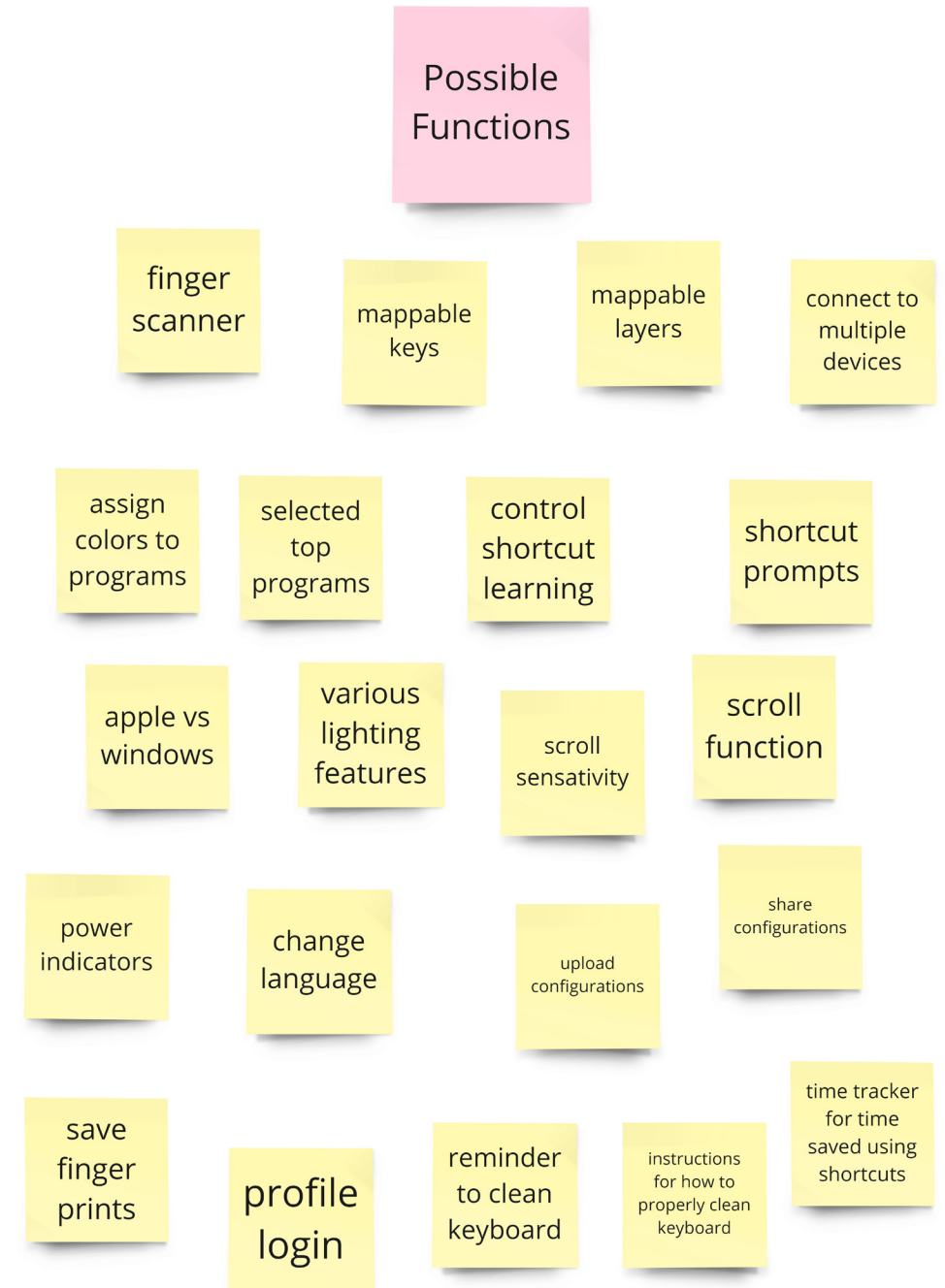

Figure 94.

6.2 UX Mapping

A hypothetical UX was mapped out using findings collected throughout the project. Essential functions were kept on the “home screen” of the UX, and are described below (see a-c). Additional functions have been placed in various tabs.

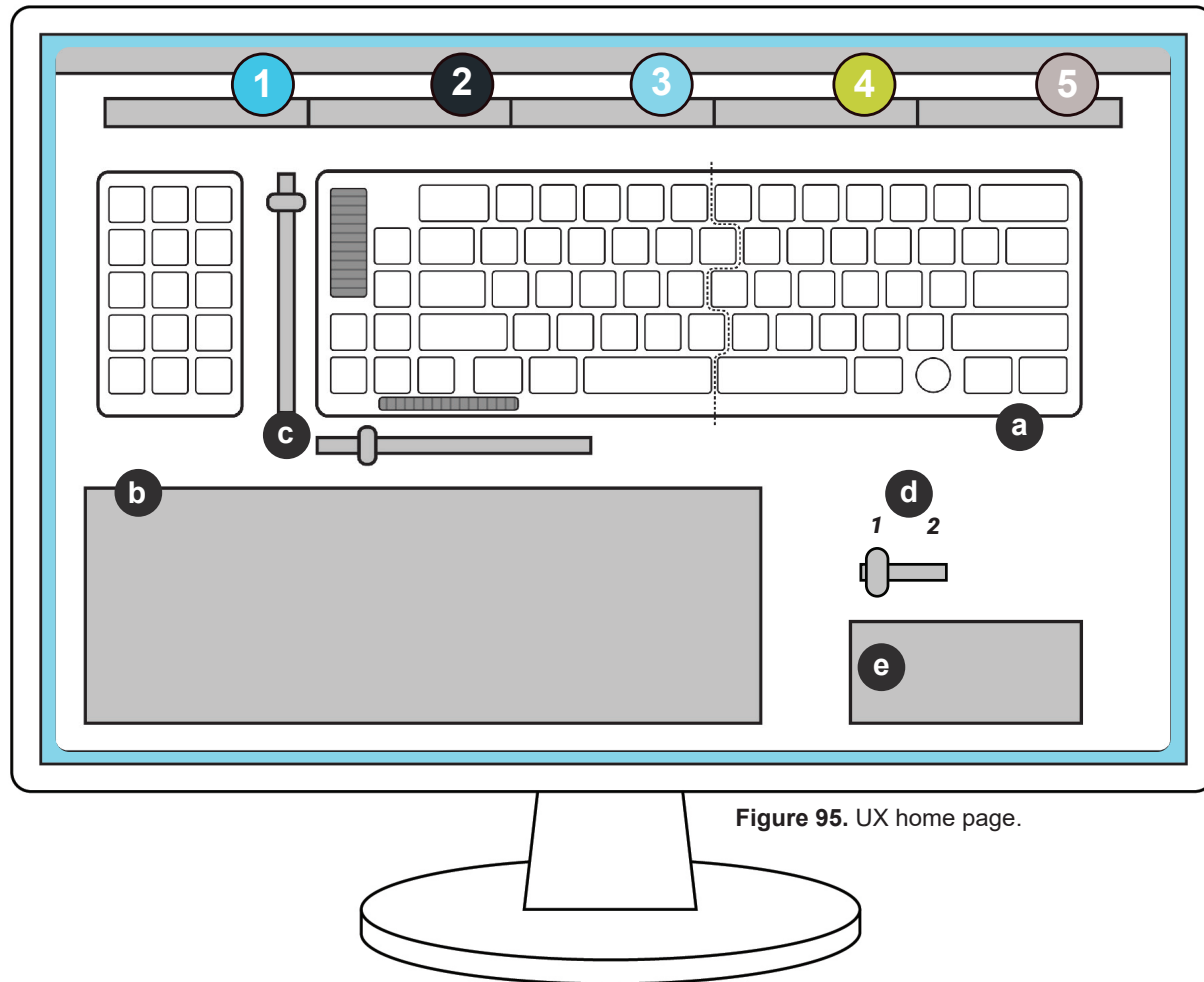

Figure 95. UX home page.

Home Page

When a user first plugs in the keyboard, the home page will pop up displaying the default key mapping and briefly explaining the various UX features. The main functions would be Key mapping, Design Programs (1), Shortcut Optimization (2), Color Settings (3), General Settings (4), and Keyboard Statistics (5), each found in their respective tab.

- a. Key Mapping Display - All assigned commands will be displayed for each key.
- b. List of available commands is displayed here.
- c. Sensitivity controls for the scroll wheels
- d. Users can make 2 different profiles of mapped keycaps. This slide would toggle users from one layout to the other.
- e. List of linked devices

1 Design Programs

In the “Design Programs” tab, users will again be presented with a Key Mapping Display similar to that on the Home Page. Users will then select what programs they use on their keyboard, and map keys to be bound only while in the selected program. Example: the “up arrow” may be set to the “up arrow” in normal computer functions, but in InDesign, it may get remapped to “Increase Font Size”.

2 Shortcut Optimization

The Delta Keyboard is a learning keyboard. It collects data on the commands in your design programs that have a keyboard shortcut that the consumer doesn’t use. With this data, the Delta Keyboard determines which keyboard shortcuts would best benefit the user. In the “Shortcut Optimization” tab, users are able to manage the settings for how often, how many, and in what form a shortcut notification is sent from the keyboard.

3 Color Settings

Even though the Delta Keyboard uses its backlit keycaps as a way to communicate with the user, the lights can also be set up for personal preference as well. In the “Color Settings” tab users will be able to control all color settings found on the Delta Keyboard

4 General Settings

There are a number of general settings found in this tab, some would be:

- Add fingerprints to the scanner
- Export a keyboard's mapping profile
- Upload mapping settings from others
- Change the language of UX and keyboard

5 Keyboard Statistics

As the Delta Keyboard is a learning keyboard, some users may find the data it collects interesting to look over. In “Keyboard Statistics”, users can find, export, and share statistics ranging from what shortcuts they use the most to how much time they have saved by using shortcuts. An additional tracker in keyboard statistics is a maintenance reminder, which shows users when they last cleaned their keyboard. This feature would also include information on how to best clean and maintain the Delta Keyboard.

7.0 Final Detailing

Reflections on branding elements created throughout the project were analyzed and used to refine the final branding of the keyboard and the hypothetical company that would have produced the keyboard.

7.1 Material Selection

There are a number of components that would need to be manufactured to create the final keyboard in this project. Since manufacturability was not one of the main focuses of this project, not every component was assigned a final material. That being said, all major components (the keycaps, keyboard case, scroll wheels, and the sound dampeners inside the keyboard) were assigned at the very least the general type of material that would be used for the final product.

KeyCaps - ABS

Keycaps are typically made out of ABS or PBT, both of which are recyclable. For this project, ABS seemed to be the best option as the final keycaps would be double shot to allow for shine-through for the LED lights on the PCB. Additionally molding in ABS typically creates cleaner lettering and more consistent shapes when compared to PBT. (Keyboard University, n.d.)

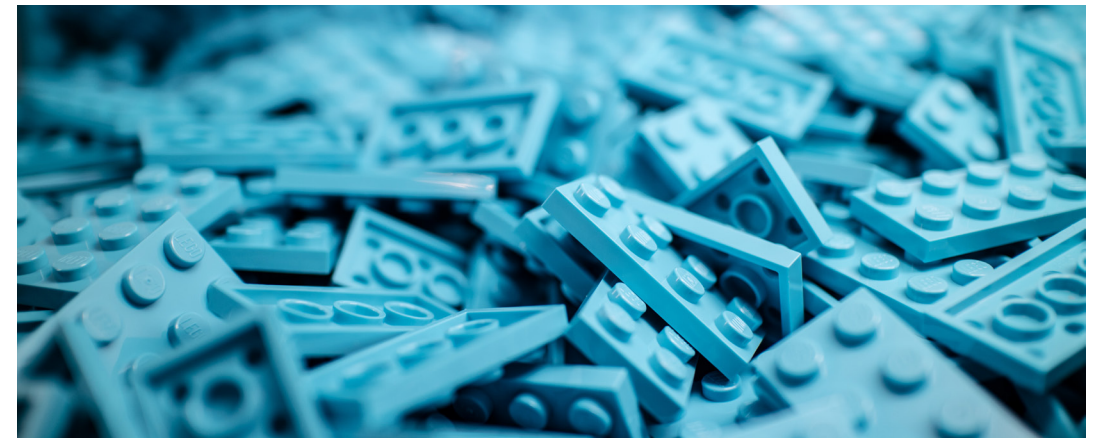

Figure 96. ABS is known for its durability and moldability

Case- 6061 Aluminum

To avoid unnecessary complexity in manufacturing the case was never designed to be made out of more than one material. Keyboard cases are typically made

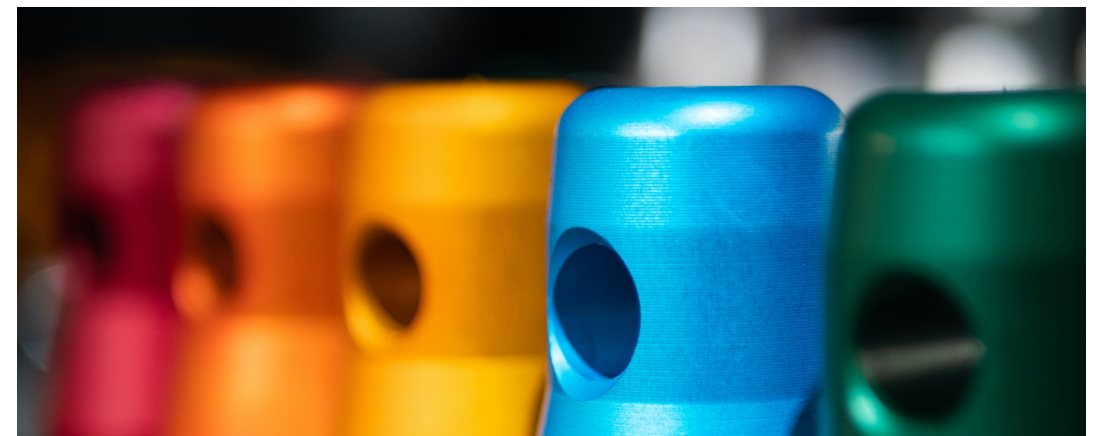

Figure 97. Anodized aluminum

out of plastic, steel, or aluminum, and for this project aluminum was selected as the final material for the case. Plastic was never considered as the final material as plastic tends to be lighter and has a cheaper feel when compared to metal options. Inversely steel was not considered as it would create a case much too heavy. Additionally, there were limitations with the equipment available for this project that made working with steel difficult. As such aluminum was selected as the final material. Aluminum 6061 was specifically chosen as the final material as it is easy to mill, holds anodized colors well, and is recyclable.

Sound dampener - Cork

Many custom and high-end keyboards will have some form of sound-dampening material inside of the keyboard. This helps prevent metallic undertones from the case from affecting the overall sound quality of a keyboard when typed on. There are a number of materials that individuals and companies use, though they typically are a type of foam. For this project cork was settled on as it is a natural sound diffuser and can be easily molded or cut in a die.



Figure 98. Cork disks

Scroll wheels - Rubber

Due to limitations in time and resources, the type of rubber for the scroll wheels was not determined.

7.2 Branding and Identity

The use of squircles when designing the alpha keys greatly affected the overall look and feel of the final design for the keyboard and held true to the mood board's aesthetic. The playful shape and anodized aluminum also helped anchor the keyboard into having a more "designery" feel while holding true to its purpose as an office desktop peripheral.

The use of the sans serif Roboto Bold has also helped provide a clean and consistent feeling throughout the keyboard. The font has helped round out the design language of the overall design of the keyboard, and has helped to communicate the intended market for which the keyboard was designed.

Alfa was decided to be the name of the hypothetical company which would produce this keyboard. The name was inspired by how the design of the Alpha keys (1u) laid the foundational form and function for the rest of the keyboard. As the keyboard has been designed in Norway, it also seemed fitting to use the norwegian spelling "alfa" as a nod to the origins of the design. As for the keyboard, it has been called the Delta Model after the Greek letter "δ" which in mathamatics means "change". This keyboard company ideally would make multiple models of keyboards, all of which would be named after letter in the Greek alphabet.

7.2.1 Logo

Logo ideas were explored, but not finalized. A number of concepts were sketched out for a logo, and making the logo out of a script version of "alfa" really seemed to elevate the "company's" overall branding. After a rough sketch was created, it was used as a point of reference in an AI calligraphy generator which created many script "alfa"s to be used for inspiration in the future. In the end the "final" concept settled on was a simple lowercase alpha letter in a squircle.



Figure 99. Excerpt for Appendix 5.0

7.3 Final Keyboard Design



Figure 100 & 101. Delta Model (Above) Delta Model with number pad (Below).



Figure 102. Fingure scanner to unlock the computer. Double-tapping the scanner will toggle between different mapped-out layouts as mentioned in Figure 6.2d.



Figure 103. New modifiers layout including 2 "Copy/Paste" command keys.



Figure 104. The power indicator for each keyboard section is displayed next to the charging port.



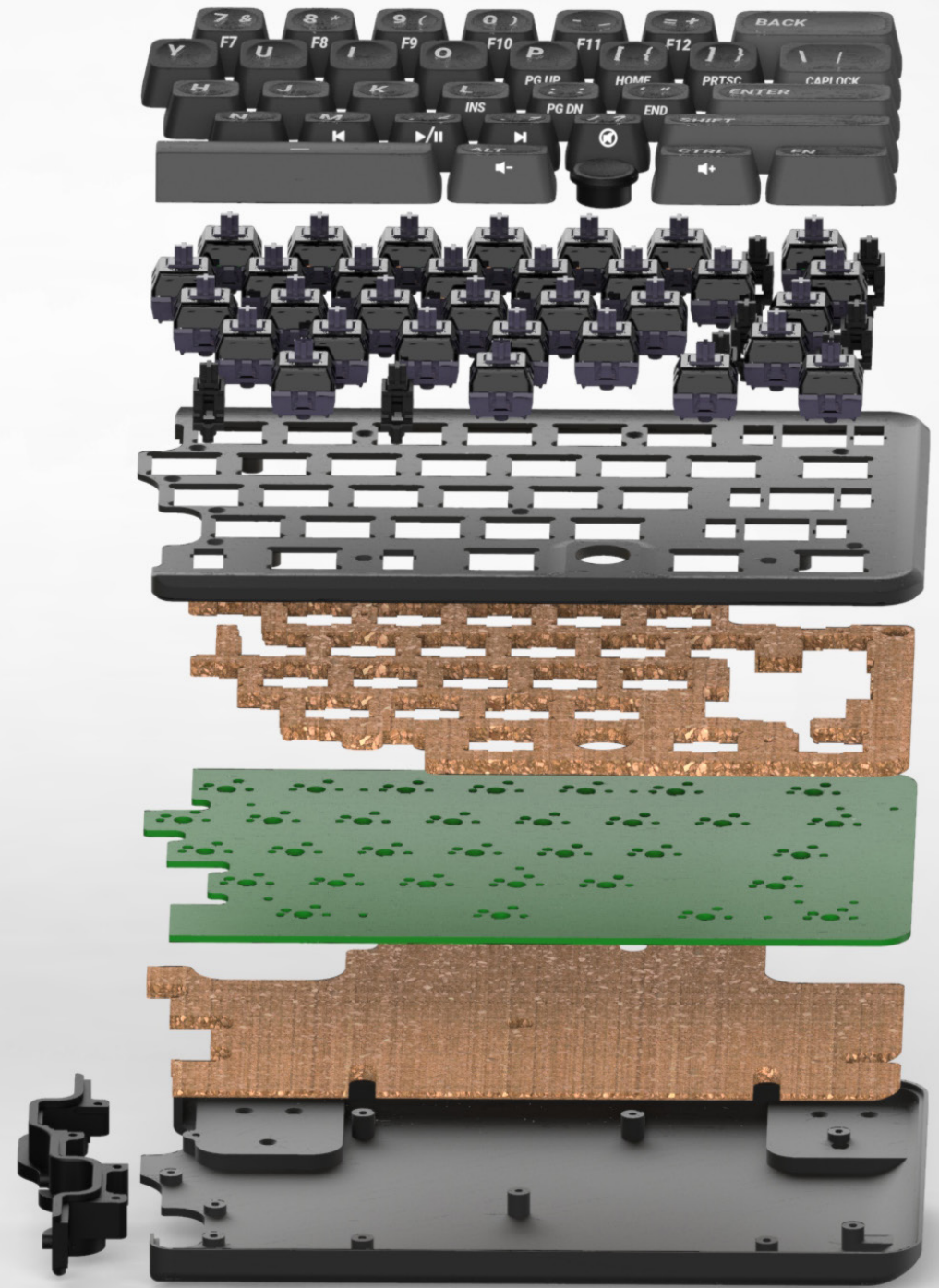
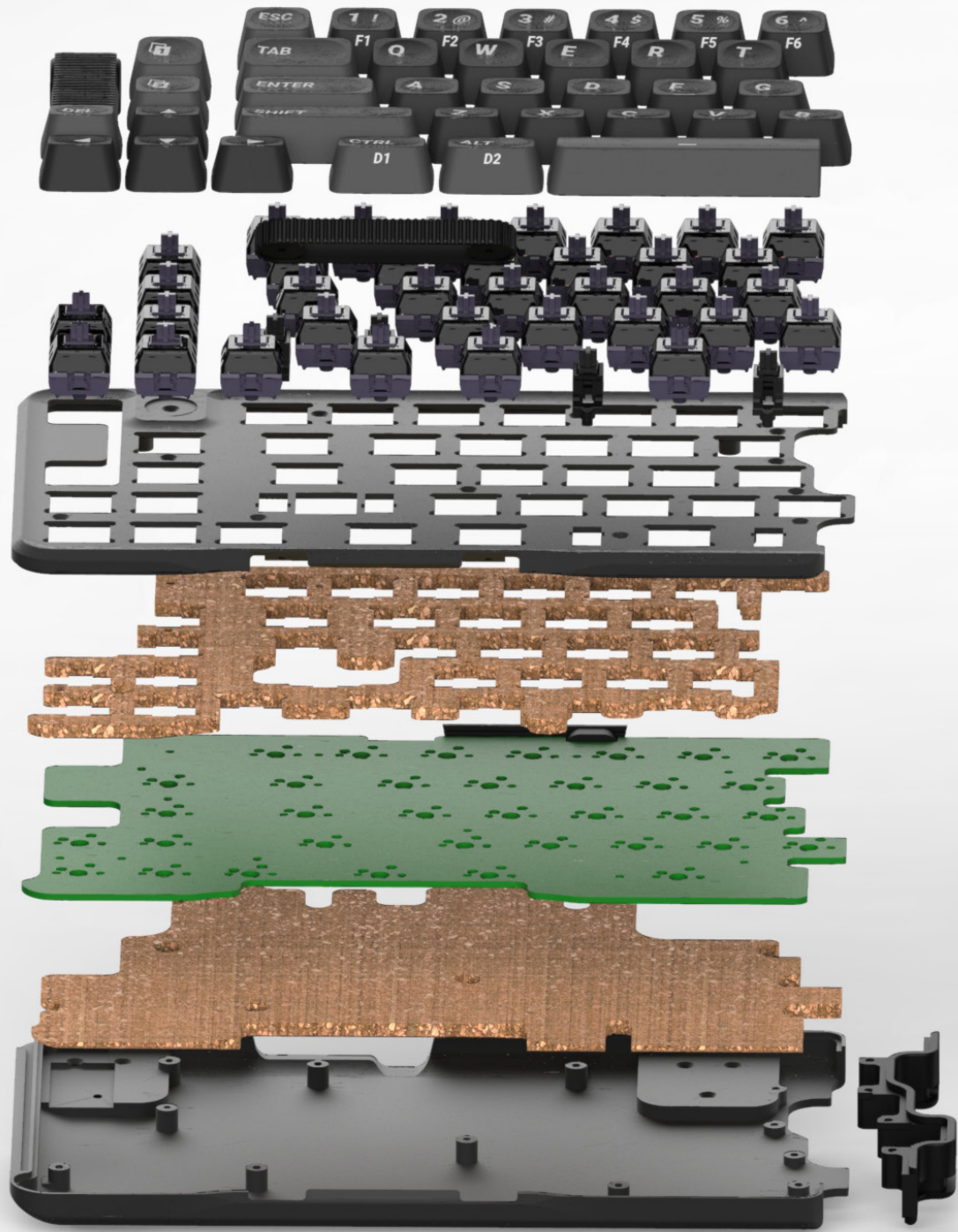

Figure 107. Keyboard components from the top down. Keycaps and scroll belts, switches and stabilizers, top plate, cork sound dampening, PCB, cork sound dampening, magnetic joint (middle), case base.

Delta Model
by alfa keyboards



8.0 Discussions

As designing a keyboard turned out to be a very complicated process, there are a number of reflection points that should be discussed. Reviewing the project's problem statement sets the stage for further discussions of decisions made throughout the project. Sources of error are explored, which leads to discussions on possible future developments for the keyboard and its manufacturability. This section is concluded with reflections on the future of digital creators and their respective industries.

8.1 Problem Statement

"Current computer keyboards discourage digital creators from effectively using built-in shortcuts for their respective design programs."

This problem statement may have been a bit vague for this project. Clarification was attempted in giving a thorough definition for digital creators, though was still left a little vague as there may be industries unmentioned that could also fall under the same definition. (ex. musicians, colorists, and some engineers)

8.2 Qualitative vs. Quantitative Data

As both qualitative and quantitative data have many benefits as well as drawbacks, both forms of data were collected to create a more well rounded set of data. Qualitative data on keyboards has helped create humanistic buildings blocked in the design process by collecting data on user opinions and preferences when working with keyboards. Quantitative data has been equally useful in generating concrete data that has created snapshots of the current state of keyboard usage among digital creators. The removal of either of these types of data from this project would result in a keyboard design that would be ill equipped for digital creators.

8.3 Reflections on the Process

The process that was chosen for this project seemed to be a little unorthodox as it felt as though the project was designed backwards. That being said, the process was very intentionally structured as it helped compartmentalize various parts of designing a keyboard into 4 "smaller design projects". By breaking up the whole project as such, it became easy to create a hierarchy of these "smaller design projects". Additionally, with the completion of each "project", it became easier to define the final design of the keyboard. This is believed to be a clear representation of the theory that form following function (Townsend, Montoya, Calantone, 2011)

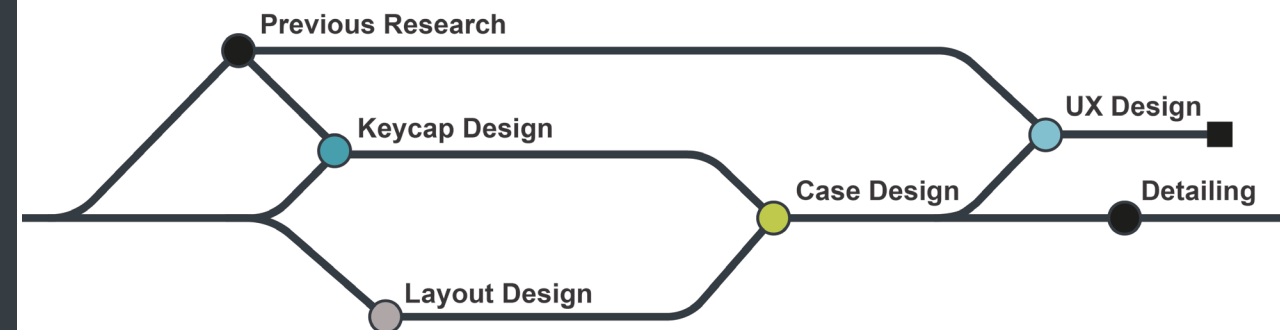

Figure 3. Design process

8.4 Possible Sources of Error

Although there were many considerations taken to avoid errors throughout this project, there were still many possible sources of error. The main areas of concern have been addressed below.

8.4.1 Survey

The survey in this project was used heavily to collect data about the state of the area in various industries and to map out general keyboard usage. It would have been ideal to have received an equal amount of surveys from digital creators from each industry targeted, however, this was not achieved. These holes in data may have created results that favor the industries that were well-represented and neglect those that were not. Additionally, some surveys left some information such as professions blank, and assumptions had to be made based on the design programs the individuals most used. A final flaw in the survey was that survey was designed based on keyboards designed for Windows and not Apple. Although most survey takers who used Apple products made notes on the surveys to clarify their inputs, there is the possibility of information that was not so clearly defined.

8.4.2 Observations

The majority of data that was collected from observations came from the YouTube educators who sent in videos of them using their keyboards. As the sample pool was so small, the data collected, though valuable, does not accurately represent how digital creators in each industry typically use their keyboards. Instead, the observations merely presented information about individuals' preferences and solutions.

8.4.3 Competitors Analysis

More keyboards could have been analyzed to give a more holistic representation of the state of the market, but as mentioned in the competitor's analysis, keyboards are in a saturated market. As such there are numerous keyboards that are used by digital creators across all industries. To combat the volume of competitors, keyboards that specifically targeted digital creators were analyzed as Primary competitors. An exception was made with the Corsair K95 RGB, which stood as a representation of all gaming keyboards that are sometimes used by digital creators who like gaming keyboards with additional functions. All secondary competitors were chosen as representations of all products that offer alternatives that benefit digital creators in minor ways but are not specifically designed for all digital creators.

8.4.4 User Feedback and Workshops

The method in which data was collected with the first run of feedback for the design of the keycaps differed slightly from later user testing. In the first round of testing, participants were only asked to vote for their favorite. It was soon realized that some individuals closely liked one or 2 other designs, so for future user testing, participants voted for their top 3.

A similar change occurred in the layout workshops. The testing methods used at the first layout workshop at EGGs Trondheim caused a few issues with collecting data as many participants became distracted by the testing rigs. Changes were made and applied to all future layout workshops.

The changes in both of these instances greatly improved the quality of data collected in later product tests and workshops. However, due to the errors in early data collection, these first rounds may have provided inconsistent data.

8.5 The Future

There is still a lot of work that would need to be done to make the Delta Keyboards a reality. Additionally, the future for digital creators seems to be very turbulent at the time of this project.

8.5.1 Future Work

With the complexities of designing the Delta keyboard, there are 3 tasks that would need to be completed to make this product fully viable.

Task 1:

The final design will need to be refined and tested further to make it fully manufacturable. Although many manufacturing considerations were taken in the initial design of the Delta Keyboard (the keycaps are capable of being moldable, and most of the aluminum case is designed for production-level milling), there are components that would need to be fine-tuned and tested further. Namely the haptics and construction of the scroll belts and the fit of the PCB.

Task 2:

Design the Final PCB. As the design of a PCB fell outside of the design brief, a PCB was not designed in this project. Any images portraying a PCB in this project, are merely visual representations of a PCB being present inside the keyboard.

Task 3

A more thorough design of the keyboards' UX. A complete concept for the UI was not explored in this project, instead only the possible functions were mapped out. This was done to clearly present some of the functionality of the Alfa-DC keyboard. Designing a UX for the keyboard was never intended to be a part of this project, but as the keyboard design developed, the need for a UX became apparent.

8.5.2 The Future for Digital Creators

At the time of this project, AI has been increasingly used in all industries in which digital creators work. This has increased the potential of each digital creator, but in many ways AI is increasingly moving in a direction that may eventually replace most, if not all, humans working as digital creators. Currently, AI is able to generate music, logos, graphics, animations, design concepts, and even video advertisements. These changes in AI design capabilities make it difficult to plan for the future of these industries. However, it is assumed these AI tools will continue to be used in the near future but may surpass being used solely as tools in the not-so-distant future.

9.0 Conclusion

To revisit the problem statement, current computer keyboards discourage digital creators from effectively using the built-in shortcuts for their respective design programs. The Delta Keyboard thoroughly addresses the statement above and provides a plausible solution to digital creators. This has been achieved by designing a keyboard with keycaps designed to feel comfortable and inviting. Additionally, a keyboard layout was created which is more intuitive for shortcut usage and helps digital creators navigate their respective programs. Furthermore, built-in UI features in the keyboard should increase shortcut learning and provide users with numerous options for keyboard customizability.



References

- Asikhia, O., & Ehondor, S. (2010). Ergonomics design of computer keyboard layout. *J. Sci. Multidisc. Res*, 2.
- Apple (n.d.). Magic Keyboard with Touch ID and Numeric Keypad for Mac models with Apple silicon - US English - Black Keys. <https://www.apple.com/shop/product/MK2C3LL/A/magic-keyboard-with-touch-id-and-numeric-keypad-for-mac-models-with-apple-silicon-us-english-white-keys>
- Begel, A. (2005). Programming by voice: A domain-specific application of speech recognition. AVIOS speech technology symposium–SpeechTek West,
- Buschek, D., Roppelt, B., & Alt, F. (2018). Extending Keyboard Shortcuts with Arm and Wrist Rotation Gestures Proceedings of the 2018 CHI Conference on Human Factors in Computing Systems, Montreal QC, Canada. <https://doi.org/10.1145/3173574.3173595>
- Cockburn, A., Gutwin, C., Scarr, J., & Malacria, S. (2014). Supporting Novice to Expert Transitions in User Interfaces. *ACM Comput. Surv.*, 47(2), Article 31. <https://doi.org/10.1145/2659796>
- Calligrapher.ai (n.d.). <https://www.calligrapher.ai/>
- David, P. A. (1985). Clio and the Economics of QWERTY. *The American economic review*, 75(2), 332-337.
- Dvt (n.d.). LogicKeyboard ALBA Mac Logic Pro X Keyboard (American English). <https://dvt.co.nz/logickeyboard-alba-mac-logic-pro-x-keyboard-amerivcan-english/>
- Elkjop (n.d.). Corsair K95 RGB Platinum Speed gamingtastatur. <https://www.elkjop.no/product/pc-datautstyr-og-kontor/pc-tilbehor/mus-tastatur/tastatur/corsair-k95-rgb-platinum-speed-gamingtastatur/CORK95RGBMXSP>
- Grossman, T., Dragicevic, P., & Balakrishnan, R. (2007). Strategies for accelerating on-line learning of hotkeys Proceedings of the SIGCHI Conference on Human Factors in Computing Systems, San Jose, California, USA. <https://doi.org/10.1145/1240624.1240865>
- Hong, Y. A., Peck, S. O., & Lee, I. M. (2021). A Comparison of Input Devices for Gaming: Are Gamepads Still Useful in PC Environment? *International Conference on Intelligent Human Computer Interaction*,
- Jensen, C., Finsen, L., Sogaard, K., Christensen, H. (2002). Musculoskeletal symptoms and duration of computer and mouse use. *International Journal of Industrial Ergonomics*. 30. 265-275. 10.1016/S0169-8141(02)00130-0.
- Keyboard University (n.d.). Welcome to Keyboard University. <https://www.keyboard.university/>
- Kim, Y.-S., Dontcheva, M., Adar, E., & Hullman, J. (2019). Vocal Shortcuts for Creative Experts Proceedings of the 2019 CHI Conference on Human Factors in Computing Systems, Glasgow, Scotland Uk. <https://doi.org/10.1145/3290605.3300562>
- Krisler, B., & Alterman, R. (2008). Training towards mastery: overcoming the active user paradox Proceedings of the 5th Nordic conference on Human-computer interaction: building bridges, Lund, Sweden. <https://doi.org/10.1145/1463160.1463186>
- Lane, D. M., Napier, H. A., Peres, S. C., & Sandor, A. (2005). Hidden Costs of Graphical User Interfaces: Failure to Make the Transition from Menus and Icon Toolbars to Keyboard Shortcuts. *International Journal of Human-Computer Interaction*, 18(2), 133-144. https://doi.org/10.1207/s15327590ijhc1802_1
- Logitech (n.d.). Logitech Craft. <https://www.logitech.com/en-us/products/keyboards/craft.920-008484.html>
- Miller, C., Barr, A., Riemer, R., & Harris, C. (2018). The Effect of 5 Mechanical Gaming Keyboard Key Switch Profiles on Typing and Gaming Muscle Activity, Performance and Preferences. Proceedings of the Human Factors and Ergonomics Society Annual Meeting,
- Nagurka, M., & Marklin, R. (1999). Measurement of impedance characteristics of computer keyboard keys. Proceedings of the 7th Mediterranean Conference on Control and Automation (MED99),
- Nicolson, R. I. and P. H. Gardner (1985). “The QWERTY keyboard hampers schoolchildren.” *British Journal of Psychology* 76(4): 525-531.
- Niinimäki, K., & Durrani, M. (2020). Repairing fashion cultures: from disposable to repairable. *RESPONSIBLE CONSUMPTION AND PRODUCTION*, 153.

- Redragon Shop (n.d.). DITI K585 Wireless One-Handed Gaming Keyboard. <https://redragonshop.com/products/diti-k585-wireless-onehanded-keyboard>
- Reinhardt, R., & Gurtner, S. (2015). Differences between early adopters of disruptive and sustaining innovations. *Journal of Business Research*, 68(1), 137-145.
- Rempel, D. (2008). The Split Keyboard: An Ergonomics Success Story. *Human Factors*, 50(3), 385-392. <https://doi.org/10.1518/001872008x312215>
- Scarr, J., Cockburn, A., Gutwin, C., & Quinn, P. (2011). Dips and ceilings: understanding and supporting transitions to expertise in user interfaces. *Proceedings of the SIGCHI Conference on Human Factors in Computing Systems*, Vancouver, BC, Canada. <https://doi.org/10.1145/1978942.1979348>
- Scandinavian Photo (n.d.). Loupedeck Loupedeck+ Photo Editing Console. <https://www.scandinavianphoto.no/loupedeck/loupedeck-photo-editing-console-1040366>
- Skousen, C. (2022). Exploration of Optimizing Computer Keyboard Usage for Digital Creators. Unpublished manuscript
- S.P. (2023.02.02). Hot-Swap Keyboard vs Soldered PCB: Does it Matter? kinetic labs. <https://kineticlabs.com/blog/hot-swap-vs-solderable-keyboard-pcbs>
- Tak, S., Westendorp, P., & Rooij, I. v. (2013). Satisficing and the Use of Keyboard Shortcuts: Being Good Enough Is Enough? *Interacting with Computers*, 25(5), 404-416. <https://doi.org/10.1093/iwc/iwt016>
- Townsend, J. D., Montoya, M. M., & Calantone, R. J. (2011). Form and function: A matter of perspective. *Journal of Product Innovation Management*, 28(3), 374-377.
- Zheng, J., Lewis, B., Avery, J., & Vogel, D. (2018). FingerArc and FingerChord: Supporting Novice to Expert Transitions with Guided Finger-Aware Shortcuts. *Proceedings of the 31st Annual ACM Symposium on User Interface Software and Technology*, Berlin, Germany. <https://doi.org/10.1145/3242587.3242589>
- Zheng, J., & Vogel, D. (2016). Finger-Aware Shortcuts. *Proceedings of the 2016 CHI Conference on Human Factors in Computing Systems*, San Jose, California, USA. <https://doi.org/10.1145/2858036.2858355>

Appendix 1.0 - Email to YouTubers

Hello,

My name is Clayton Skousen and I am a product designer, YT educator, and student who is currently working on designing a keyboard for my masters thesis. I hope to create a keyboard to help Digital Creators (individuals that work with 3D modeling, graphic, photography, VFX, videogames, music, etc) optimize their performance on their respective computer programs. I am reaching out to ask for a simple 20-30 minute video of you using your typical keyboard set up on your preferred design program.

Below is an unlisted YouTube video (abt 1:30) explaining what I specifically would need from you (pretty much just a low quality top-down recording). There you will also find the google drive link to upload your video. If you are willing to help with this project, please make sure that there is nothing in your video that is confidential in frame (ie. family photos, contract work, or passwords on a sticky note 😊). Additionally please do not delete anyone elses uploaded videos in the drive, though I will constantly be emptying it to avoid possible loss of video data.

Feel free to reach out to me if you have any questions or need clarification, and I hope you (or someone on your team if you have one) will be willing to help with this project.

Thanks for your time.

<https://youtu.be/pCMUX2aCXvc>

--

Clayton Skousen

<https://www.skousendesigns.com/>

skousendesigns@gmail.com

YouTube: The 3D Guy

Appendix 2.0 - Keycaps

Appendix 2.1 - Keycap Sketches

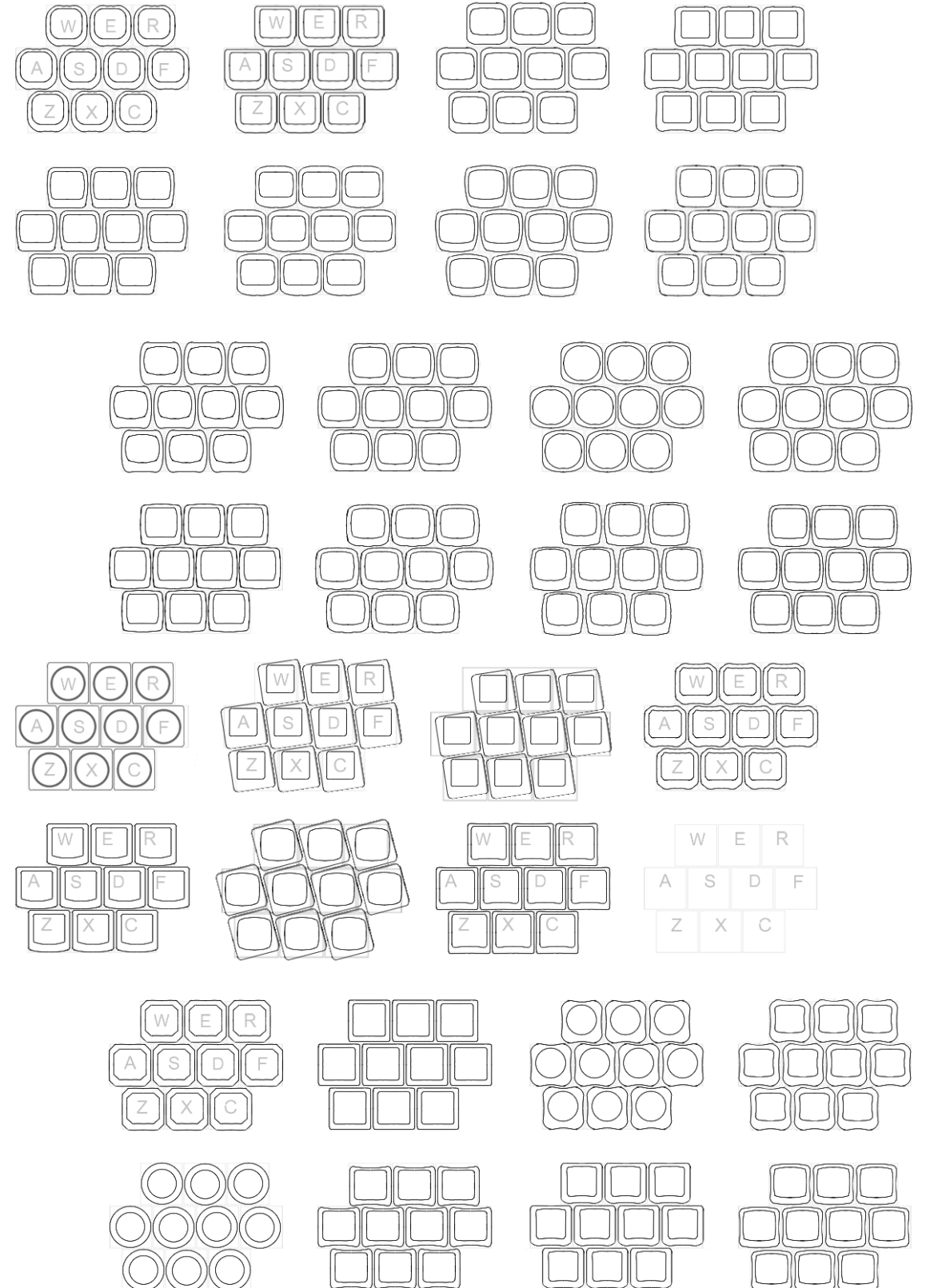



Appendix 2.2 - Rendered Form Exploration

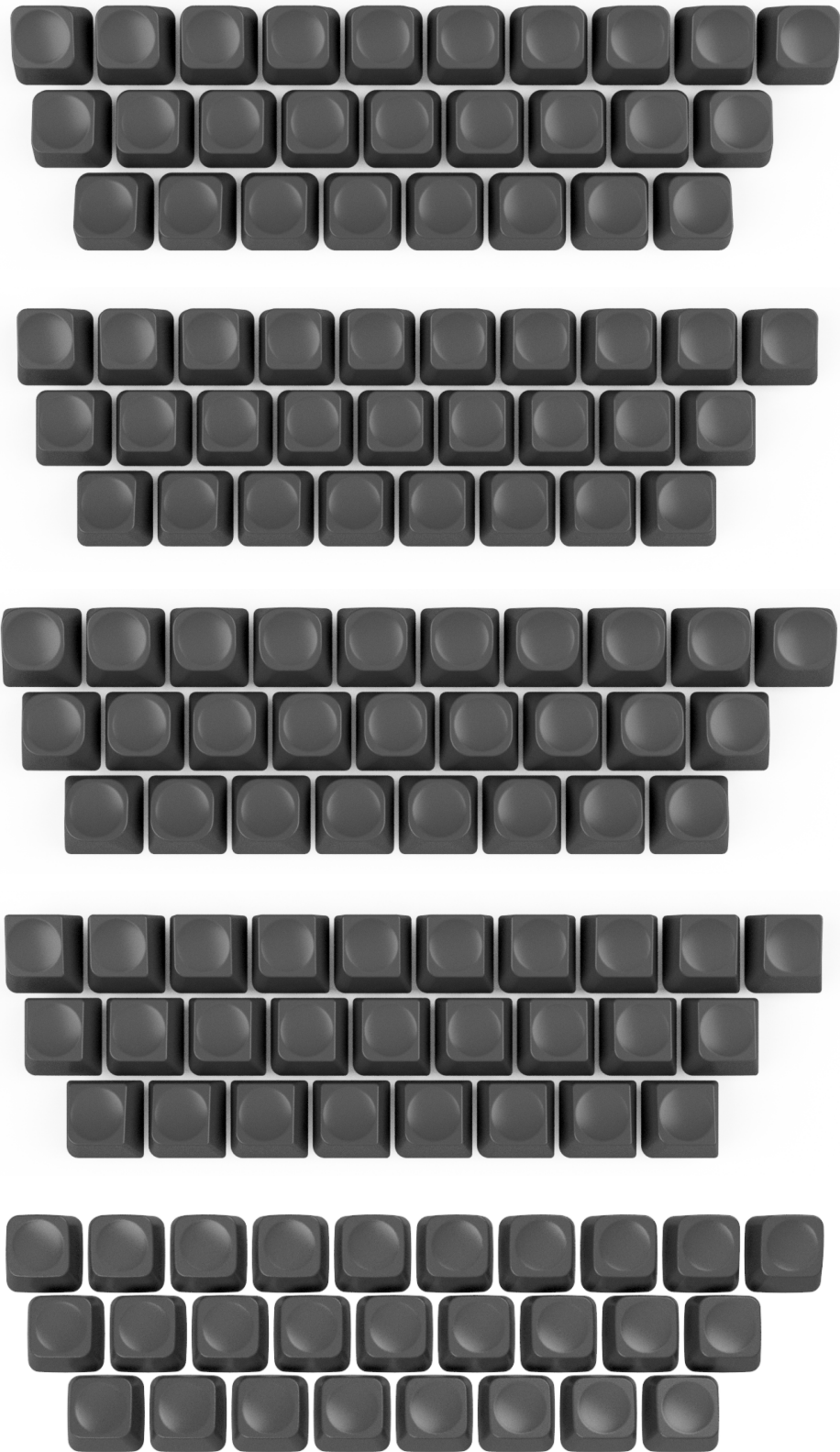

Appendix 2.3 - Font Exploration



Font: Bahnschriftn Bold
Alpha Keys: 5 mm
Peripherals: 4.5 mm



Font: Acumin Variable Concept SemiBold Italic
Alpha Keys: 5 mm
Peripherals: 4 mm



Font: Gill Sans MT Bold Italic
Alpha Keys: 5 mm
Peripherals: 4 mm



Font: Corporate Rounded Oblique
Alpha Keys: 5 mm
Peripherals: 4 mm



Font: Octarine Bold Oblique
Alpha Keys: 4.5 mm
Peripherals: 3.75 mm



Font: Tw Cen MT Bold Italic
Alpha Keys: 6 mm
Peripherals: 4.5 mm



Font: Microsoft Tai Le Bold
Alpha Keys: 5 mm
Peripherals: 4 mm



Font: Corporate Rounded Bold Oblique
Alpha Keys: 5 mm
Peripherals: 5 mm



Font: Swis721 BT
Alpha Keys: 5 mm
Peripherals: 4 mm

Appendix 3.0 - Layout

Appendix 3.1 - Survey



Font: *Trebuchet MS Bold Italic*
 Alpha Keys: 5 mm
 Peripherals: 4 mm



Font: *Tahoma*
 Alpha Keys: 5 mm
 Peripherals: 3.75 mm



Font: *Roboto Black Italic*
 Alpha Keys: 5 mm
 Peripherals: 4 mm

Profession: _____
 Other than mouse and keyboard, do you use any additional design tools at your work station (ie. 3D mouse, sketch tablet, design deck)?
 Yes / No If yes what: _____

Most commonly used programs:



Instructions: Circle the keyboard layout that most closely represents yours. Then keeping in mind your most commonly used programs, cross out keys that you rarely or never use.

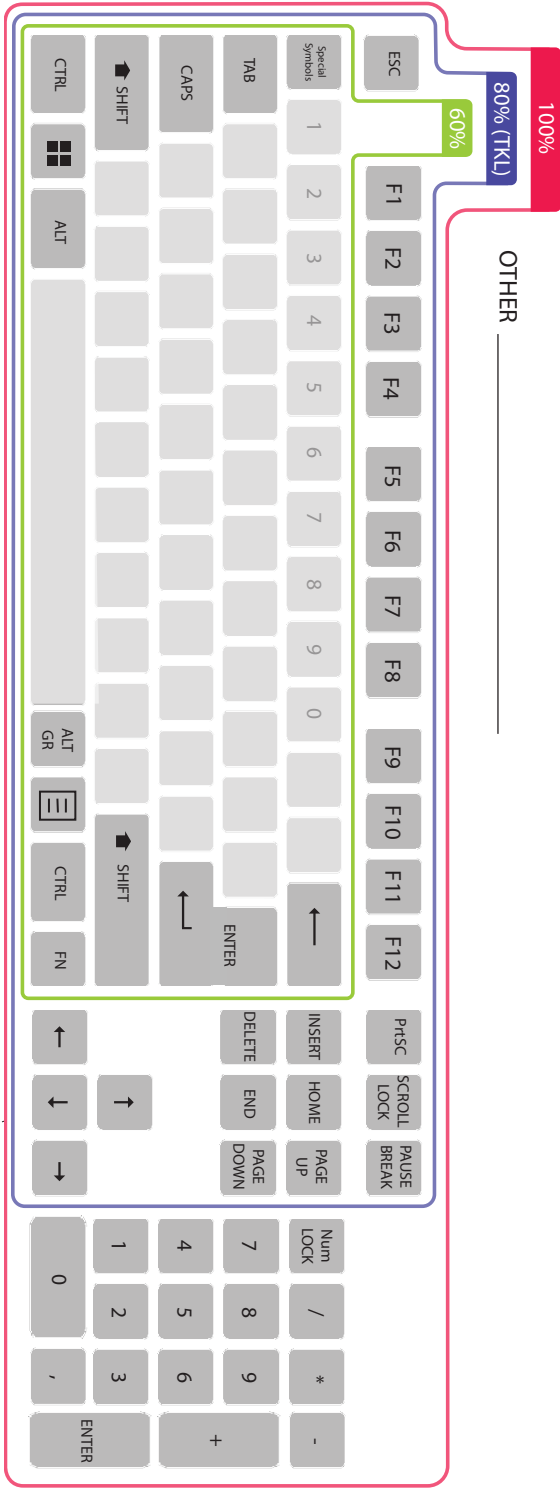

Personal notes (Optional):

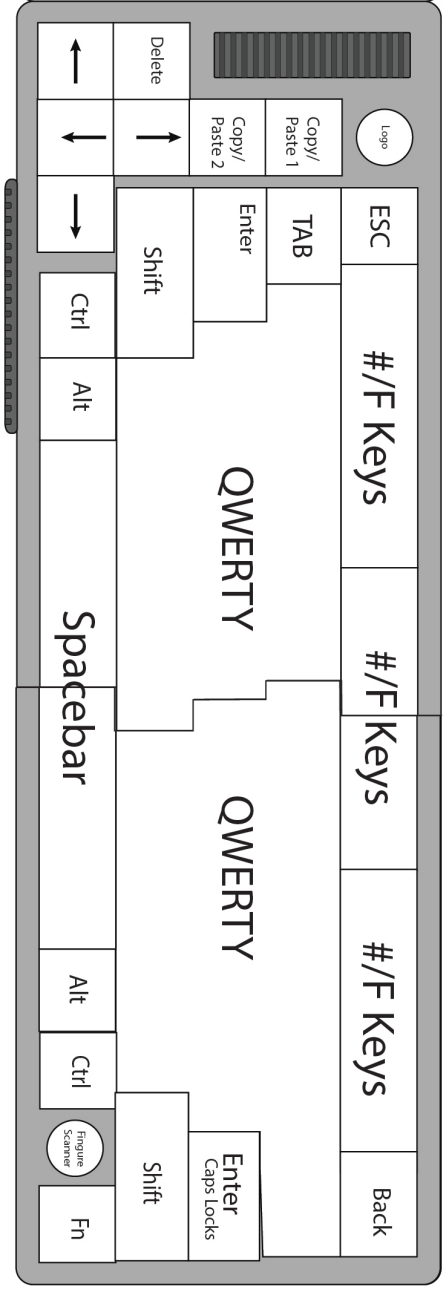
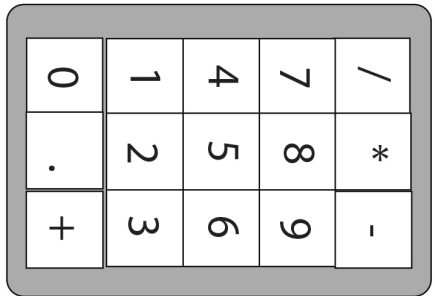
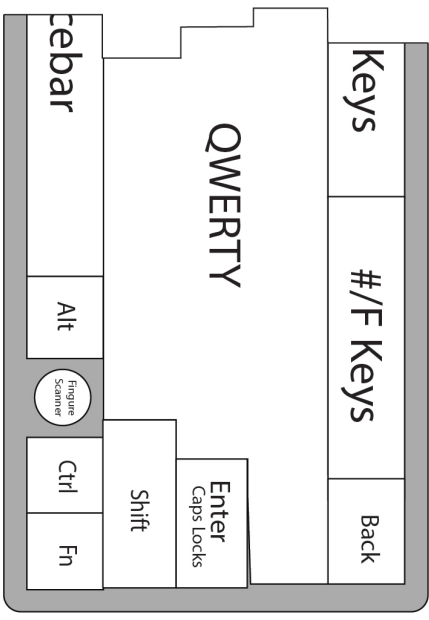
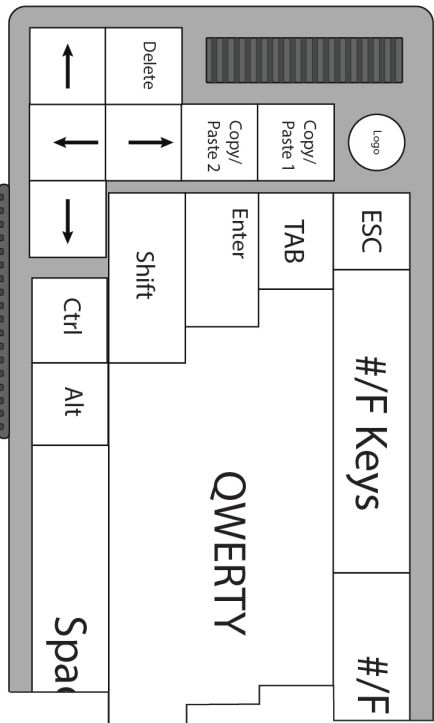
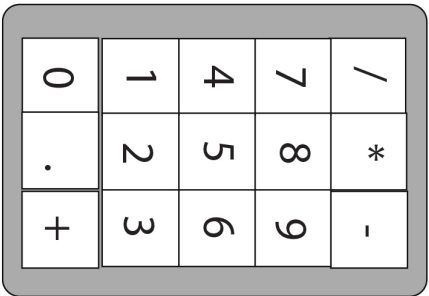
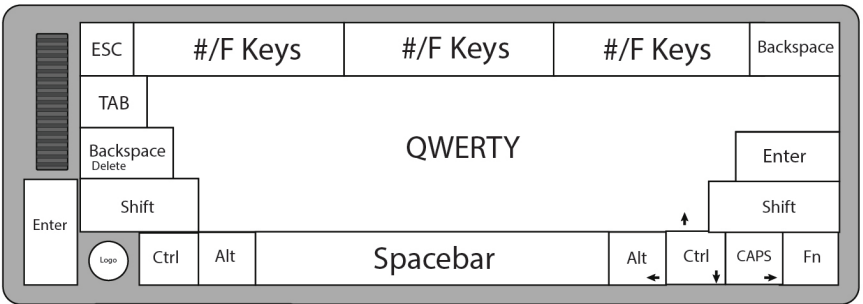
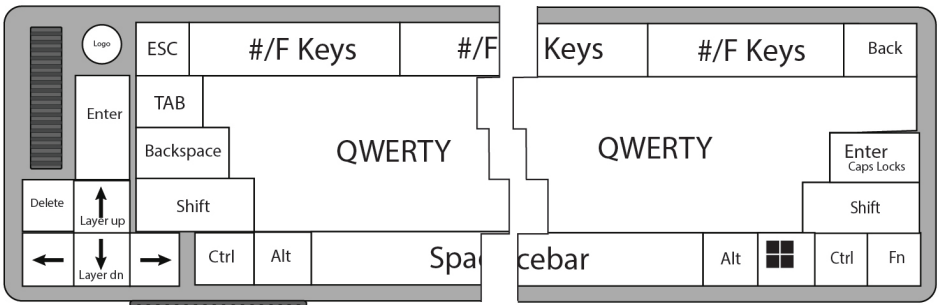
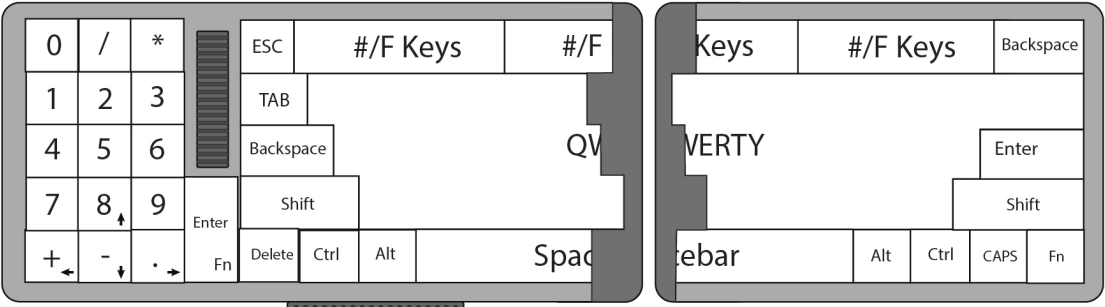

Appendix 4.0 - Case Design

Appendix 4.1 - Case Mounting Options

Top mount

· The plate is attached to a top frame, which is attached to the bottom of the case.

- + Can provide a more singular sound and more consistent feel
- + Many design variations possible
- + Compatible with both harder and softer plate materials
- Requires a custom plate

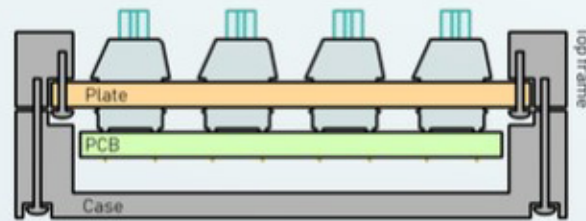

Plateless mount

· Like with a top- or bottom mount case, the PCB can be affixed to either a top frame or the bottom case. Plateless top mount is shown. Also known as PCB mount.

- + Provides much more flex than alternatives
- + Tends to be more affordable than more complex mounting styles
- Can be more fragile than cases that do use a plate

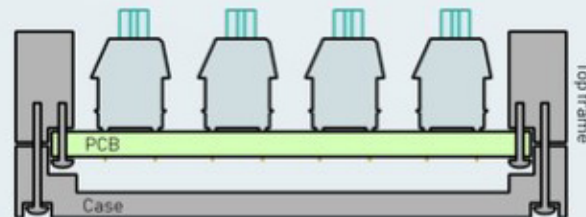

Bottom mount

· The plate is attached to the bottom frame.
· The top frame is optional, making it much like a sandwich mount.

- + Can provide a more singular sound and more consistent feel when compared to the top mounting style
- Requires a custom plate

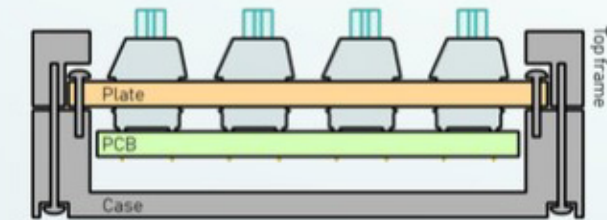

Integrated plate

· The top frame and plate are milled from one block of material.

- + Relatively easy to machine
- + Provides a unique look
- Tends to be loud when attached to just the top frame
- Tends to be stiffer than alternatives

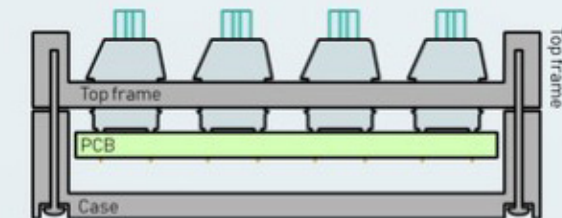

Gasket mount

· A form of dampener, often elastic material, is inserted between the top frame and case.
· Many variations available, using various materials and form factors.
· Most mounting styles can be made into a gasket mount.

- + Is able to provide a dampened sound and feel, tends to be quieter
- + More tolerant to factory tolerances than alternatives
- Tends to be more expensive than alternatives

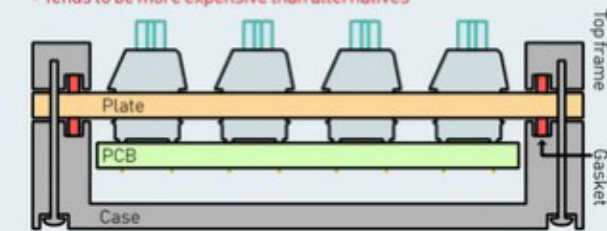

Cheat sheet: Custom keyboard mounting styles

Custom mechanical keyboard cases come in many different shapes and sizes. While each case has unique qualities, the way in which keyboard components are mounted often boil down to a number of different styles. Some designers might combine concepts from various styles to incorporate the various benefits of the different mounting styles. I hope that with these diagrams, you'll gain a better understanding of some popular mounting styles.



This cheat sheet was composed using the generous input from the community on the r/MechanicalKeyboards Discord server, and by using the following sources:
· <https://briankearreviews.wordpress.com/2018/11/23/guide-keyboard-construction-explained/>
· https://deskthority.net/wiki/Custom_Keyboard_Construction

Tray mount

- The PCB is affixed to the case by means of screws, mounting into threaded mounting posts.
- Holes in the plate allow for the screws to be installed.

- + Standardized mounting post positions for 60% boards
- + Affordable and relatively easy to machine
- Standardized positions can provide an uneven stiffness
- May cause inconsistent sound

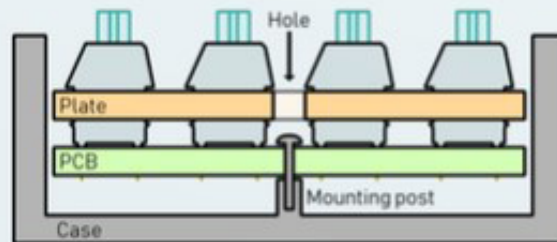

Sandwich mount

- The bottom case, plate and top frame are layered on top of each other, then affixed with a screw from the bottom.
- The top frame is optional, making for a low profile case.

- + Can provide a more singular sound and more consistent feel
- + Cost effective and relatively easy to design
- Tends to be stiffer than alternatives

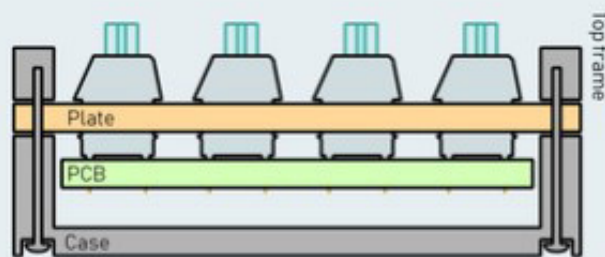



FINAL FONT

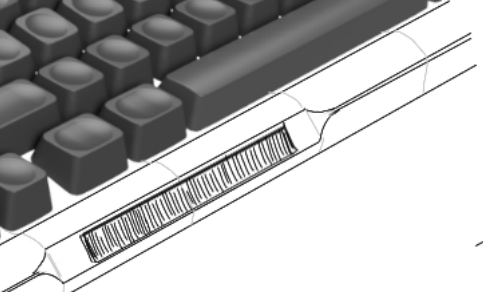
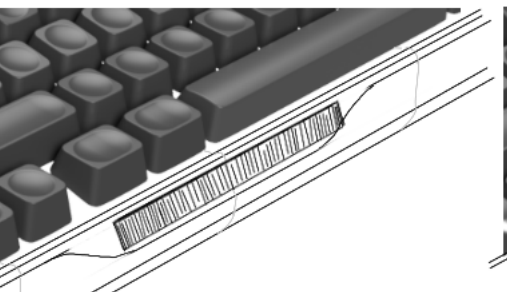
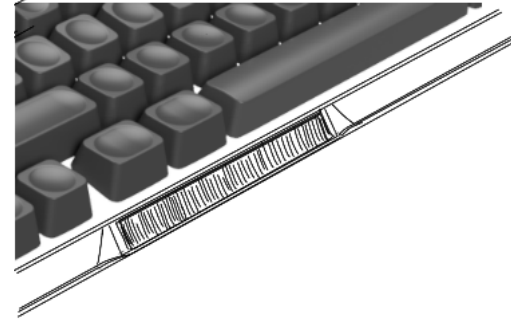
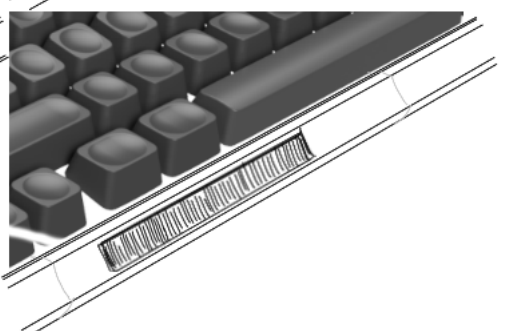
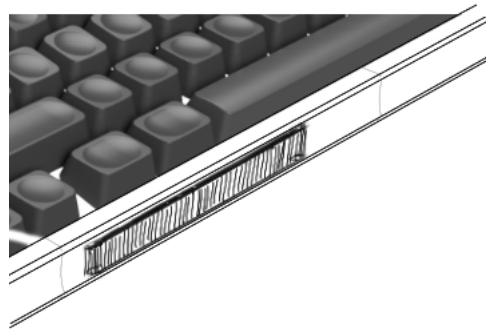
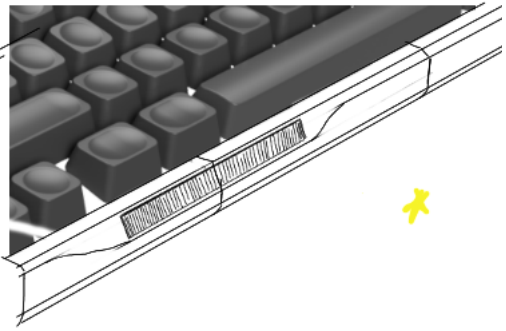
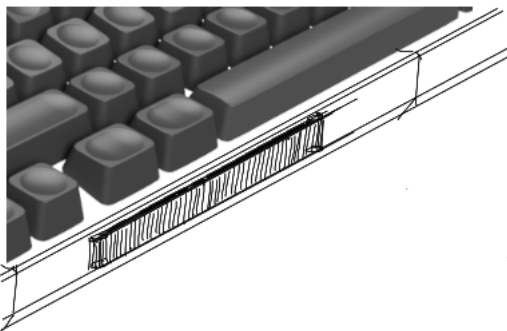
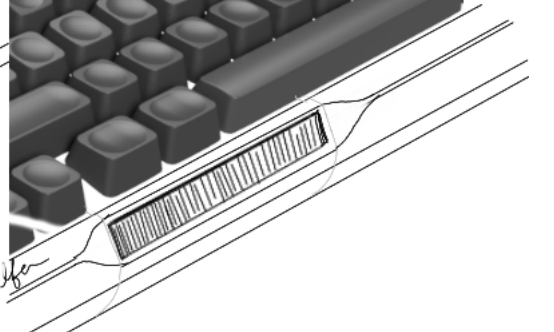
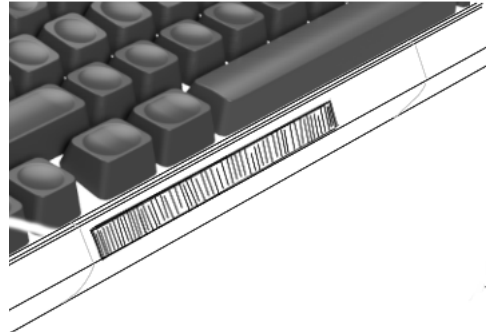
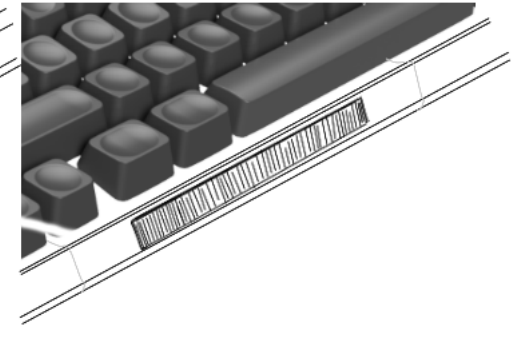

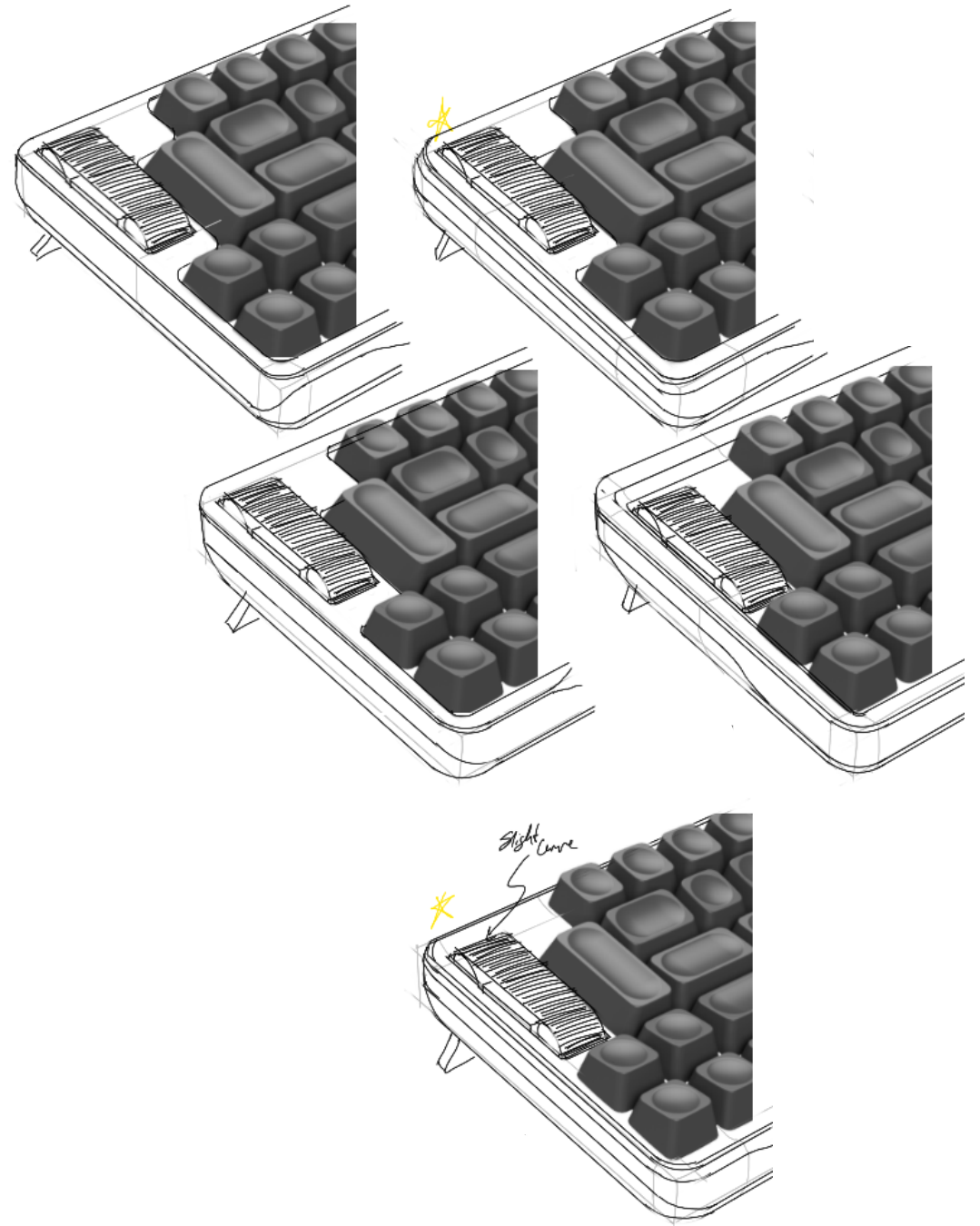
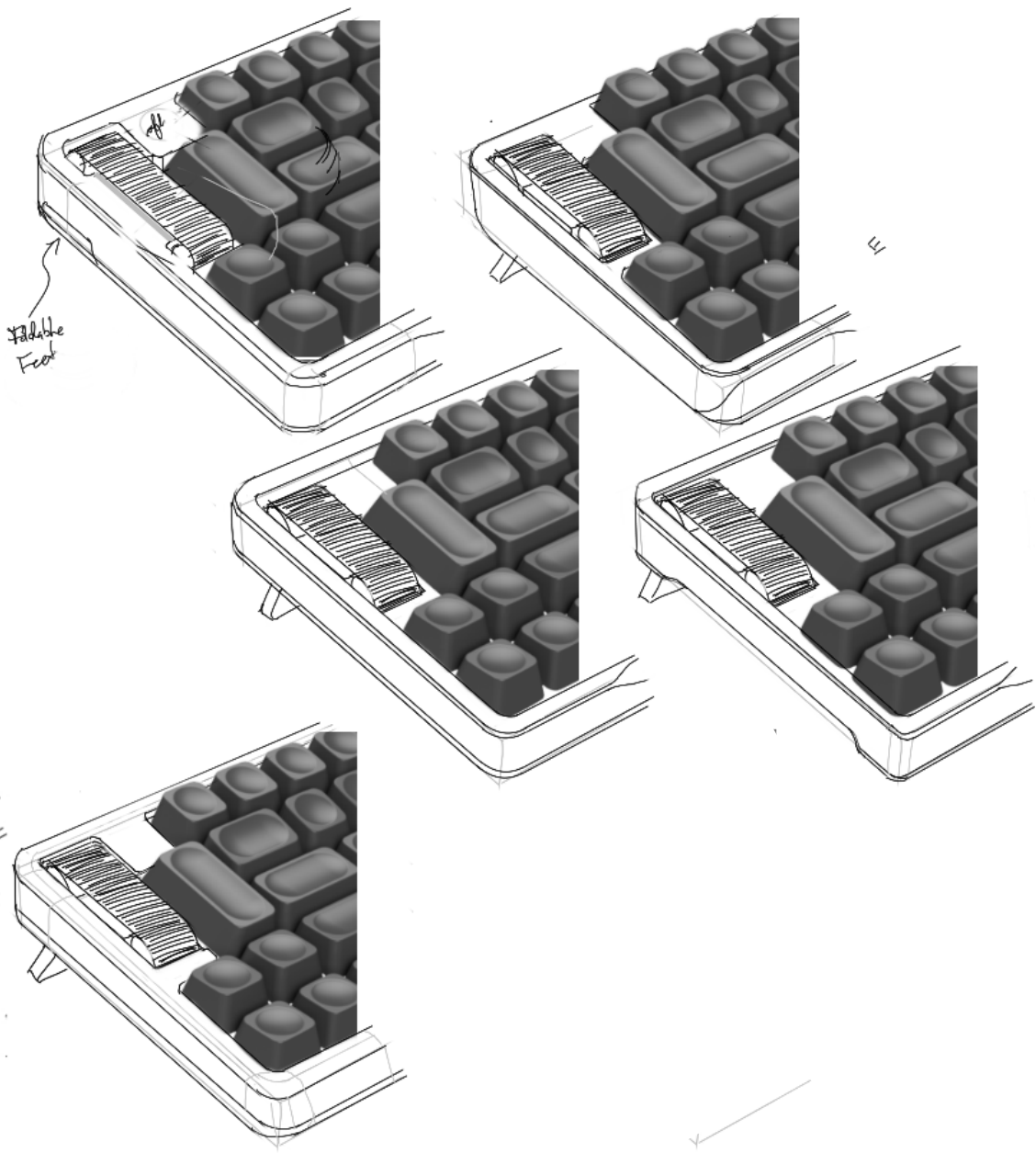

alfa alfa
alfa alfa
alfa alfa
alfa alfa
alfa alfa
alfa alfa
alfa alfa
alfa alfa
alfa alfa
alfa alfa
alfa alfa

alfa alter
alfa alfa
alfa alfa
alfa alfa

