

Ane Bakken Hodt
June Bakken Hodt

Real Options Approach to Analyse the Attractiveness of Different Grid Solutions for Offshore Wind Projects

A Case Study from Norway

Master's thesis in Industrial Economics and Technology
Management

Supervisor: Verena Hagspiel

Co-supervisor: Sjur Westgaard

June 2022

Ane Bakken Hodt
June Bakken Hodt

Real Options Approach to Analyse the Attractiveness of Different Grid Solutions for Offshore Wind Projects

A Case Study from Norway

Master's thesis in Industrial Economics and Technology Management
Supervisor: Verena Hagspiel
Co-supervisor: Sjur Westgaard
June 2022

Norwegian University of Science and Technology
Faculty of Economics and Management
Dept. of Industrial Economics and Technology Management

Abstract

As a step towards climate neutrality and the establishment of a new green industry in Norway, the Norwegian government has recently revealed plans to make large-scale offshore wind development on the Norwegian continental shelf a reality. From the perspective of an offshore wind developer, this paper aims to analyse the economic attractiveness of three offshore grid solutions for offshore wind projects: a radial connection and hybrid grids between two and three power markets, under different market conditions. We apply a real options approach implemented through a least squares Monte Carlo algorithm to account for uncertainty in electricity prices and managerial flexibility. Two support schemes for hybrid projects are examined: reallocation of a share of congestion income and a Transmission Access Guarantee (TAG). In addition, the impact of regulatory uncertainty in terms of unpredictable future grid solutions on developers' investment incentives is studied. We present a case study of an offshore wind project at Sørliche Nordsjø II in the North Sea considering a radial connection to Norway, a bilateral hybrid grid between Norway and the UK, and a trilateral hybrid grid between Norway, the UK and Denmark. Our findings suggest that for generally low home market prices, connecting three markets is most attractive to developers. We find that increased price fluctuations increase the developer's exposure to downside risk specifically under a bilateral hybrid setup, and that investing in a trilateral hybrid grid can give better protection under such market conditions. Reallocating congestion income can reverse the adverse impact of high price volatility and create larger investment incentives for hybrid projects. Under capacity limitations, the TAG can be more attractive than congestion income for high price volatility, however, the TAG alone is not sufficient to offset price risk in an offshore bidding zone. Further, we show that allowing for a trilateral hybrid solution from the beginning on is more economically beneficial than delaying this alternative on account of a first establishment of a radial project. Our results indicate that regulatory uncertainty has a significant impact on developers' investment incentives. We show that if developers do not have sufficient trust in that radial connections will be extended to a trilateral grid in time, investment incentives decrease. Our findings therefore support that the government should aim to create clarity on grid solutions in order to ensure an efficient build-out of offshore wind projects.

Sammen drag

På veien mot klimanøytralitet og etablering av ny grønn industri i Norge, har den norske regjeringen nylig avslørt planer for hvordan en storskala utbygging av havvind på norsk kontinentalsokkel skal realiseres. Formålet med denne artikkelen er å analysere den økonomiske attraktiviteten for tre nettløsninger til havs for havvindprosjekter: en radial forbindelse og et hybridnett mellom to og tre kraftmarkeder. Disse studeres under ulike markedsforhold fra et havvindutbyggers perspektiv. Vi foretar en realopsjonsanalyse gjennom å benytte en least squares Monte Carlo-algoritme for å ta hensyn til usikkerhet i elektrisitetspriser og beslutningstakerens fleksibilitet. To støtteordninger for hybridprosjekter er undersøkt: reallokering av en andel flaskehalsinntekter samt økonomisk kompensasjon på grunn av utilgjengelig transmisjonskapasitet til fastlandet (TAG). I tillegg studerer vi hvordan regulatorisk usikkerhet med tanke på uforutsigbarhet i fremtidige nettløsninger påvirker utbyggenes investeringsincentiver. Vi presenterer en casestudie av et havvindprosjekt i Sørlege Nordsjø II i Nordsjøen der vi ser på en radial tilknytning til Norge, et bilateralt hybridprosjekt mellom Norge og Storbritannia, og et trilateralt hybridprosjekt mellom Norge, Storbritannia og Danmark. Våre funn viser at en kobling mellom tre markeder er mest attraktivt for utbyggere dersom hjemmemarkedet generelt har de laveste prisene. Vi finner at økt prisvolatilitet gjør utbyggere i spesielt et bilateralt hybridprosjekt utsatt for tapsrisiko. Investering i et trilateralt hybridprosjekt kan gi bedre beskyttelse under slike markedsforhold. Reallokering av flaskehalsinntekter kan reversere den uheldige effekten av store prisvariasjoner og skape større investeringsincentiver for hybridprosjekter. Ved store prisvariasjoner under kapasitetsbegrensninger kan TAG være mer attraktivt enn flaskehalsinntekter. Dog er ikke TAG alene tilstrekkelig for å utlikne prisisiko i en offshore budsone. Videre viser vi at å tillate trilaterale hybridprosjekter fra begynnelsen av er mer økonomisk gunstig enn å forsinke dette alternativet ved å først etablere radiale prosjekter. Våre resultater indikerer at usikkerhet fra myndighetenes side har en betydelig påvirkning på utbyggenes investeringsincentiver. Vi viser at dersom utbyggerne ikke har tilstrekkelig tillit til regjeringen om at radiale forbindelser vil bli utvidet til et trilateralt nett til rett tid, vil investeringsincentiver reduseres. Våre funn støtter derfor at regjeringen bør strebe etter å skape klarhet rundt nettløsningene for å forsikre en effektiv utbygging av havvindprosjekter.

Preface

This thesis is carried out to conclude our Master of Science degrees in Industrial Economics and Technology Management, with a specialisation in Financial Engineering, at the Norwegian University of Science and Technology, NTNU. We are targeted to write an academic paper suited for a set of journals and aim for publication in one of the following journals: *Energy Economics*, *Energy Policy* or *Energy Strategy Review*.

We would like to express our deepest gratitude towards our supervisor Professor Verena Hagspiel for providing excellent guidance and insightful feedback throughout this semester. Thank you for inspiring, encouraging and challenging us to reach our goals along the way. We also gratefully acknowledge co-supervisor Professor Sjur Westgaard for sharing his knowledge and expertise. Lastly, we would like to express a special gratitude to Katarina Kloster and Arne Lie-Rasmussen at Hafslund Eco, for their valuable assistance, inspiring discussions and for providing us with relevant material. We appreciate their willingness to share their knowledge to develop our scientific work.

Norwegian University of Science and Technology
Trondheim, June 11, 2022



Ane Bakken Hodt



June Bakken Hodt

Table of Contents

List of Figures	I
List of Tables	I
List of Acronyms	II
1 Introduction	1
2 Literature Review	3
3 Background	6
3.1 Development of Offshore Wind Projects at Sørlige Nordsjø II	6
3.2 Electricity Market Arrangements for Hybrid Grids	6
3.3 Potential Investment Incentive Schemes for Hybrid Grids	7
4 Methodology	9
4.1 Problem Formulation	9
4.2 Assumptions	10
4.3 Modelling the Investment Timing Option	10
4.4 Modelling Regulatory Uncertainty	11
4.5 Revenue Functions for Radial, Hybrid and Meshed Grid Solutions	12
4.5.1 Stochastic Price Processes	15
4.5.2 Offshore Wind Production	16
4.5.3 Costs	17
4.5.4 Contract Structures	17
4.6 Solution Approach	18
5 Case Study	21
5.1 Parameterisation	21
5.2 Estimation of Price Process Parameters	22
5.3 Estimation of Capacity Factors	23
5.4 Estimation of Costs	23
6 Results and Discussion	24
6.1 Base Case	24
6.2 Sensitivity Analysis	25
6.2.1 Impact of Costs	25
6.2.2 Impact of Price Volatility	26
6.2.3 Impact of Long-Term Average Price Level	28
6.2.4 Impact of Congestion Income	29
6.2.5 Impact of Congestion Income and TAG under Capacity Limitations	30
6.3 Impact of Regulatory Uncertainty	32
7 Conclusion	34
Bibliography	36
A Appendix	42
A.1 Sensitivity Analysis of Price Volatility	42
A.2 Sensitivity Analysis of Price Volatility (UK and DK1) when Including Congestion Income	43
A.3 Sensitivity Analysis of Long-Term Average Prices (UK and DK1) when Including Congestion Income	44
A.4 Sensitivity Analysis of Price Volatility (UK and DK1) when Including Congestion Income and TAG	45
A.5 Sensitivity Analysis of Long-Term Average Prices (UK and DK1) when Including Congestion Income and TAG	46
A.6 Sensitivity Analysis of the Starting Date of Regulatory Uncertainty	47

List of Figures

1	Decision-making timeline for investment timing options	9
2	Decision-making timeline under regulatory uncertainty	10
3	Radial connection	12
4	Hybrid grid	13
5	Meshed grid	14
6	Mean-reversion price forecast	23
7	Predicted annual structure of hourly capacity factors for wind generation at SNII	23
8	NPV and ROA project value distribution	24
9	Optimal time to invest in the base case scenario	25
10	Sensitivity analysis of total investment costs	26
11	Optimal time to invest when increasing total investment costs	26
12	Sensitivity analysis of the NO ₂ , UK and DK1 price volatility	27
13	Sensitivity analysis of the long-term NO ₂ , UK and DK1 price	28
14	Sensitivity analysis of the NO ₂ price volatility when including congestion income	29
15	Sensitivity analysis of the long-term NO ₂ price when including congestion income	30
16	Sensitivity analysis of the NO ₂ price volatility when including congestion income and TAG	31
17	Sensitivity analysis of the long-term NO ₂ price when including congestion income and TAG	32
18	Sensitivity analysis of the switching rate when including congestion income	33
19	Sensitivity analysis of the NO ₂ , UK and DK1 price volatility	42
20	Sensitivity analysis of the UK and DK1 price volatility when including congestion income	43
21	Sensitivity analysis of the long-term UK and DK1 price when including congestion income	44
22	Sensitivity analysis of the UK and DK1 price volatility when including congestion income and TAG	45
23	Sensitivity analysis of the long-term UK and DK1 price when including congestion income and TAG	46
24	Sensitivity analysis of the time at which regulatory uncertainty is introduced	47

List of Tables

1	Base case parameters used in the case study	22
2	Input parameters for capacity factor modelling	23
3	NPV and ROA project values in the base case	24
4	Comparison of project values from immediate investment and when including switching option	33

List of Acronyms

EU European Union

KF CGS Kriegers Flak Combined Grid Solution

LSM least squares Monte Carlo

NPV net present value

NVE Norwegian Water Resources and Energy Directorate

ROA real options approach

SNII Sørilige Nordsjø II

TAG Transmission Access Guarantee

TSO transmission system operator

1 Introduction

Ambitious energy and climate targets raise climate change awareness globally, enhancing joint actions to tackle climate change impacts and risks. In order to combat climate change and limit global warming to 1.5°C above pre-industrial levels, offshore wind is set to play a key role in providing clean and competitive energy in the green transition, expected to produce 50% of Europe’s electricity by 2050. Leading the global combat against climate change, the European Union (EU) is calling for 300 GW of installed offshore wind capacity in 2050, up from a current level of 16 GW (European Commission 2020*d*, GWEC 2022). In Norway, offshore wind energy is touted to become the new industrial adventure, enabling future economic growth and new job opportunities. Thanks to extensive wind resources outside a long coastline, a strong supply chain and expertise from the maritime and petroleum industry, Norway is in a privileged position to take a substantial share of the offshore wind market (Ministry of Petroleum and Energy 2021*a*). To initiate the development, up from a current level of 5.9 MW of solely demonstration projects,¹ the Norwegian government has recently adopted an ambitious target of 30 GW of installed offshore wind capacity by 2040 being on a par with aggregate amount of electricity generated in Norway today (Norwegian Government 2022*a*). The Norwegian government officially opened on 1 January 2021 the first two areas for large-scale offshore wind projects on the Norwegian continental shelf, Sørlige Nordsjø II (SNII) and Utsira Nord. In close proximity to the European power market, SNII is particularly relevant for power supply to the international power market (Ministry of Petroleum and Energy 2020). This has raised discussions about whether offshore wind generation should be brought ashore with a direct connection from the wind farm to the onshore grid of Norway, i.e. a radial connection, or to develop so-called hybrid projects having dual functionality, combining offshore generation with transmission capacity connecting multiple onshore bidding zones. Whilst the majority of offshore wind farms are connected radially to shore, hybrid grids target a more efficient use of maritime space, cost savings and lower environmental impacts by reducing demand for aggregate infrastructure with fewer converter stations on land and reduced length of subsea electricity cables (European Commission 2020*b*, THEMA Consulting Group 2020). Whilst several hybrid projects are in planning,² only one hybrid grid solution has so far been realised.³ The industry argues that establishment of hybrid grids is crucial to make offshore wind development in Norway financially feasible. The Norwegian government has announced that hybrid grid solutions will be examined for future offshore wind projects (Norwegian Government 2022*a*), however, it is not clarified yet at what time such solutions will be introduced by the government (NRK 2022).

The aim of the present study is to investigate the economic attractiveness of three grid solutions for offshore wind energy projects, including a radial project connected to the home market and hybrid projects under the offshore bidding zone design involving two and three power markets. We aim to contribute to the current discussion in Norway by analysing investment incentives for the different configurations under various market conditions with the objective to support a timely and an efficient roll-out of offshore wind projects to meet the ambitious goals. We present a case study of an offshore wind project at SNII in Norway, considering the NO2, UK and DK1 market. We take the perspective of an offshore wind developer to analyse the effects of different cost, electricity price volatility and electricity price levels, as well as support schemes, notably reallocation of congestion income and a Transmission Access Guarantee (TAG), on the project value of the grid alternatives. We assume that the developer is exposed to uncertainty in electricity prices and holds an investment timing option having managerial flexibility with respect to postponing investment based on how electricity prices evolve. To take uncertainty into account, we apply a real options approach (ROA). We solve the investment problem using a least squares Monte Carlo (LSM) simulation algorithm. Focusing on qualitative differences between the grid structures, we conduct sensitivity analysis to gain insight into

¹ *Unitech Zephyros* (2.3 MW), the world’s first floating offshore wind turbine (METCentre n.d.), and *TetraSpar* (3.6 MW), the world’s first full-scale demonstration of an industrialised offshore foundation (Stiesdal 2021). Besides, the floating wind farm, *Hywind Tampen* (95 MW), is expected to be commissioned in 2022 and will be the world’s first offshore wind farm to electrify oil and gas platforms (Equinor n.d.).

² E.g. ELWIND, WindConnector, Bornholm Energy Island, North Sea Energy Island, North Sea Wind Power Hub, Nautilus interconnector (see WindEurope (2021), National Grid (2020), Energinet (2021*a*), Energinet (2021*b*), North Sea Wind Power Hub (2021), National Grid (n.d.)). Also, Denmark, Germany, the Netherlands and Belgium have recently combined forces to establish a meshed grid with four energy islands connected to the countries (E24 2022*b*).

³ Set in operation in 2020, the Kriegers Flak Combined Grid Solution (KF CGS) connects the transmission grid of Denmark and Germany through Kriegers Flak wind farm (600 MW) in Danish waters of the Baltic Sea with Baltic 1 (48 MW) and Baltic 2 (288 MW) wind farms in German waters of the Baltic Sea (Energinet n.d., European Commission 2020*a*).

the attractiveness of the alternatives. As an additional element in our analysis, motivated by the current policy discussions in Norway, we investigate the impact of regulatory uncertainty on investment incentives.

The contribution of this paper to the current literature is three-fold. First, we study investment incentives for three different grid solutions for an offshore wind energy project, considering two contract structures. Our findings suggest that exclusive of support schemes, a developer in a bilateral hybrid grid is specifically vulnerable to downside risk in case of large price fluctuations in any of the connected markets. A trilateral hybrid grid is the most profitable solution given that the home country is generally the low-priced market. We find that reallocation of a share of congestion income can hedge against the downside risk and a lower share can be reallocated if the wind farm is connected to three markets than two markets. Under capacity limitations, TAG can be more attractive than reallocation of congestion income for high price volatility levels, but is not sufficient alone to hedge against price risk. Second, we apply real options valuation to analyse investment incentives for the different grid solutions using LSM simulation. Overall, we find a small value of timing flexibility for the investment projects, however, the optimal investment time largely depends on investment costs for the respective project. Third, we study the impact of regulatory uncertainty on the developer's incentives to invest in a bilateral and trilateral hybrid grid, given that an investment in a radial project is undertaken today. Our results indicate that investing immediately in a trilateral hybrid grid is more attractive to developers than if regulators delay a possible investment in such a grid solution. If developers do not have sufficient trust in that radial connections will be extended to a trilateral grid in the future, we show that investment incentives decrease.

The remainder of this paper is structured as follows. A literature review is provided in Section 2. In Section 3, we present background information regarding offshore wind development at Sørlige Nordsjø II, market designs applicable to hybrid grids and discussed support measures to enhance investment incentives for hybrid grids. Thereafter, in Section 4, we describe the model setting and solution approach. Next, in Section 5, the proposed methodology is applied to a case study of an offshore wind project at Sørlige Nordsjø II in Norway considering two support schemes. The findings are discussed in Section 6. Section 7 summarises and concludes, including further research ideas.

2 Literature Review

With this paper, we aim to contribute to three strands of literature. The first strand pertains to offshore grids for wind energy which is rapidly growing to facilitate the realisation of hybrid grids providing infrastructure for the large scale-up of offshore wind generation needed to meet climate targets. An early contribution in this field is Schröder et al. (2010), examining during the planning phase of the later commissioned KF CGS between Denmark and Germany, four offshore grid configurations in the Kriegers Flak location in the Baltic Sea and their impact on the day-ahead power markets in Denmark, Germany and Sweden. They find that connecting the three countries via a common offshore node can be beneficial. Schröder (2013) finds that taking part in balancing markets under different market designs has a crucial impact on the economic attractiveness of offshore wind farms, however the focus is on operational aspects, considering up to two markets only. As in Schröder et al. (2010) and one of the design options considered in Schröder (2013), we study grid solutions involving several power markets with the assumption of an individual offshore price zone, which from a market integration perspective is conducive to the increased penetration of offshore wind energy, according to European Commission (2020*c*). In contrast to their works, our paper concentrates on offshore wind developers' investment incentives for grid solutions including up to three markets analysing qualitative differences, rather than studying congestion patterns, quantifying congestion income and identifying socio-economic benefits between different grid solutions, or focusing on the operational perspective.

Several investigations related to the field of offshore grids are conducted on technical level, including Trötscher & Korpås (2011) and Sedighi et al. (2016) who identify optimal offshore grid configurations for the high penetration of offshore wind power, Apostolaki-Iosifidou et al. (2019) who address various transmission infrastructures to bring offshore wind energy ashore and Elahidoost & Tedeschi (2017) who focus on strategy and planning requirements of offshore grids. Economic benefits of establishing meshed offshore transmission grids relative to exclusively radial transmission cables are also extensively investigated in the current literature (Spro et al. 2015, Dedecca & Hakvoort 2016, Houghton et al. 2016). In addition, whilst a major hindrance to the expansion towards a meshed offshore grid is the allocation of costs and benefits across involved countries and actors (Dedecca et al. 2018), studies on this topic have ensued. The contributions in this field include those of, inter alia, Konstantelos et al. (2017) who study costs, benefits and distributional effects on integrated North Sea grids concentrating on three case studies (German Bight, UK-Benelux and UK-Norway) and find asymmetric net benefit sharing between countries, which they suggest may impede investments in integrated offshore grid solutions. In a similar vein, Kitzing & González (2020) examine market arrangements applicable to future offshore hubs or energy islands connecting three countries focusing on Denmark, Germany and the Netherlands and find an economic imbalance between the involved countries. As most of extant literature have focused on countries in the North Sea region, a recent paper also contributing to this field is Tosatto et al. (2022), carrying out a large-scale impact analysis of energy islands in the North Sea on the European power system and all European countries. They focus on market consequences of such projects, the effect of different hub configurations and potential challenges regarding system and market operation. Their findings reveal that the North Sea energy hubs lead to higher European social welfare, although when studying the effect on individual countries, benefits are distributed unevenly. Authors also incorporate regulatory aspects, inter alia, Roggenkamp et al. (2010), examining different grid configurations for offshore wind farms connected to coastal countries in Western Europe with a major focus on the integration into power markets and regulatory regimes, and legal aspects, identified in a later contribution of Nieuwenhout (2022) discussing legal issues of hybrid grids based on the current EU legal framework.

Despite their contributions, the majority of the aforementioned papers disregard how particularly offshore wind developers are impacted under different offshore grid configurations, constituting a significant element of the regulatory toolkit to encourage greater investment in offshore wind power. Closest to our paper is the work of Kitzing & Schröder (2012) who consider the effect of an offshore grid involving up to four power markets under different market designs and support schemes on investors in offshore wind farms and transmission assets. The support schemes they examine are feed-in tariffs and feed-in premiums. They develop a stochastic model, including uncertainty in electricity prices and line failures, to determine the added value of having operational flexibility in terms of being connected to additional markets. Their findings suggest that the choice of market design with respect

to market access and price formation has a crucial effect on the attractiveness of generation and transmission assets. In contrast to their work, our focus is on the developer’s side and the offshore bidding zone design for grid solutions involving two and three markets, as well as on different support measures. Mentioned in Kitzing & Schröder (2012), congestion income earned by the transmission system operator (TSO) could be used to support developers active in an offshore bidding zone. Motivated by the current discussion of whether congestion income should be reallocated to developers (European Commission 2020c, THEMA Consulting Group 2020, ENTSO-E 2021, ENGIE Impact 2022), we study the attractiveness of different grid solutions under varying market conditions when including a share of congestion income in the developer’s income stream associated with offshore wind production. Also motivated by a recently suggested support mechanism (ENGIE Impact 2022), a second support scheme that we consider is a Transmission Access Guarantee, valid under capacity limitations. To the best of our knowledge, this paper contributes to the literature on offshore grids by considering how the mentioned support measures affect the developer’s investment incentives for various grid solutions under different market conditions.

The second strand of literature that we add to concerns the use of real options approach (ROA) to analyse offshore wind investments. Uncertainty regarding future electricity prices can create an added value by having an option, i.e. a right, but not an obligation, to invest in a certain offshore wind project. If current market conditions do not justify immediate investment, offshore wind developers can choose to defer investment. A number of papers contribute to this field in order to account for uncertainty and managerial flexibility. Kitzing et al. (2017) consider optimal investment timing and capacity sizing in their ROA model for wind energy investments, including a capacity constraint and one stochastic process combining multiple correlated sources of uncertainty, which allows for closed-form solutions. Considering a case study of an offshore wind project in the Baltic Sea, they quantify differences in investment incentives under different support schemes. Li et al. (2020) combines binary tree scenario generation with a least squares Monte Carlo (LSM) approach to quantify optimal dynamic feed-in tariffs using a case study for an offshore wind energy investment in China. Kim et al. (2018) develop a decision-making model relying on expansion options to assess the economic feasibility of offshore wind projects accounting for climate uncertainty. Using ROA, their findings suggest that managerial flexibility decreases risk and increases long-term profitability of an offshore wind farm in South Korea. According to Schwartz (2013), three major solution procedures are used to solve real options valuation problems: dynamic programming (e.g. binomial method), partial differential equations (e.g. Black-Scholes equation) and simulation techniques, with the simulation approach being the most flexible one when there are multiple factors impacting the option value. Pioneered by Longstaff & Schwartz (2001), we apply the simulation-based LSM approach to study the investment problem faced by the developer, due to its flexibility and efficiency. Whilst the extant literature commonly applies the LSM method to analyse wind energy investments (Boomsma et al. 2012, Díaz, Moreno, Coto & Gómez-Aleixandre 2015, Díaz, Gómez-Aleixandre & Coto 2015, Finjord et al. 2018, Zhao et al. 2019), we see a lack in the literature regarding the application of LSM to hybrid grid investment problems. Opposed to Kitzing & Schröder (2012) who use Monte Carlo simulations to account for uncertainty and to determine the option value, we close the research gap by approaching the investment problem using the LSM method. We apply the algorithm to account for managerial flexibility in that the developer can choose the investment timing of the specific grid solution for offshore wind energy based on how electricity prices evolve during the option period.

Lastly, this paper adds to the strand of literature concerning the impact of regulatory uncertainty on investors’ investment behaviours by using a Poisson distribution to model regulatory risk. A common approach in the extant literature to model sudden arrival of signals is to let signals follow a Poisson process. Boomsma & Linnerud (2015) examine market and policy risk under different support schemes, incorporating a Poisson jump process in their ROA model to account for random occurrences of scheme termination assuming that investors expect the decision to be retroactively applied or not. Adkins & Paxson (2016) use a Poisson jump process to model sudden occurrences of introduction or retraction of a subsidy. Finjord et al. (2018) model sudden collapses in green certificate prices and arrival of signals from the government and other institutions to learn about the probability of a price collapse with the use of a Poisson process. Kitzing & Schröder (2012) model the likelihood of occurrence of a line failure with a Poisson distribution. Unlike the mentioned studies, the approach taken here is that only the first Poisson jump is considered to model the arrival of signal from the government. Within the framework using a Poisson distribution to account for a governmental decision, the regulatory

uncertainty is assumed to be an exogenous risk which cannot be controlled by the developer. To the best of our knowledge, we aim to contribute to the literature by examining the impact on the developer's investment behaviour of unpredictability in terms of which grid solution for offshore wind energy that will be enforced by the regulator at a future point in time.

3 Background

In this section, we present background information regarding the development of offshore wind projects at Sørilige Nordsjø II, different market designs applicable to hybrid grids and potential investment incentive schemes for hybrid grids.

3.1 Development of Offshore Wind Projects at Sørilige Nordsjø II

Located 140 km off the coast close to the Danish border, in strong wind conditions with a capacity factor⁴ of around 50%, and average water depths of 60 m, Sørilige Nordsjø II (SNII) is suitable for both floating and bottom-fixed offshore wind technology (Ministry of Petroleum and Energy 2020). Given the long distance from the wind farm at SNII to the onshore grid of Norway and neighbouring countries, High Voltage Direct Current (HVDC) technology will be used for power transmission. High Voltage Alternating Current (HVAC) technology will be relevant for shorter connections. To be able to integrate radial lines into a hybrid grid in the future, anticipatory investment in additional technical solutions is required (Statnett 2022). The Norwegian government announced on 9 February 2022 that offshore wind projects at SNII will be developed in a two-stage process. The first phase allows for a radial connection including a generation capacity of 1,500 MW (around 7 TWh per year) – enough to power 460,000 households. The second phase includes an additional generation capacity of 1,500 MW with a potential development of a hybrid grid solution. Claimed by the Norwegian government, the initial radial build-out is implemented as a means to increase power supply to southern Norway to meet increasing demand arising from electrification of the Norwegian society and to secure Norwegian consumers with future access to abundant and affordable renewable power (Norwegian Government 2022*b*). According to Statnett (2021), southern Norway is expected to fall into power deficit as early as 2026. On 11 May 2022, the Norwegian government announced that its goal is to open up areas for offshore wind generation to reach 30 GW of offshore wind power production in Norway by 2040. The Norwegian government states that since the Norwegian electricity grid is not able to handle 30 GW of offshore wind power in its current form, offshore wind power needs to be transmitted to other countries. Three different grid structures will be examined for future offshore wind installations: a radial connection to Norway and Europe, and cables with two-way power flow. The Norwegian Water Resources and Energy Directorate (NVE) and the Ministry of Petroleum and Energy will study the consequences of the grid alternatives (Norwegian Government 2022*a*). According to the Ministry of Petroleum and Energy (2022), the competition of securing licences at SNII is planned to be held in the form of a price auction, in which qualified consortia may participate. The auction prices will reflect the project’s expected profitability. Participants offering the most profitable project are allocated the seabed (Ministry of Petroleum and Energy 2021*a*).

3.2 Electricity Market Arrangements for Hybrid Grids

Four market arrangements are applicable to hybrid projects: (1) dynamic flows to a high-priced market, (2) dynamic flows to a low-priced market, (3) home market design and (4) offshore bidding zone design (Roland Berger 2019). The dynamic bidding zone designs, options (1) and (2), are conceptually equal, in which the developer markets the electricity at respectively the highest and lowest price of the adjacent bidding zones. However, the designs impose two main challenges: discriminatory treatment of market participants by awarding developers with either the highest or lowest price,⁵ and instability of bidding zones, in which the high- and low-priced markets are shifting in time owing to price fluctuations in the bidding zones.⁶ Option (3), the home market design, defines the existing market solution for radially connected offshore wind farms, which are included in the country’s Exclusive Economic Zone and incorporated in the onshore bidding zone. Extending the home market zone to include offshore wind generation projects connected to more than one electricity market, developers bid into the home market and offshore injections have guaranteed access to the onshore grid of the home market. With regard to existing EU legislation⁷, the need for curtailment of offshore wind

⁴Capacity factor refers to the average annual wind power generation divided by the rated capacity (IEA 2019).

⁵Article 3(e) of Commission Regulation (EU) 2015/1222 (2015) aims at ensuring fair and non-discriminatory treatment of market participants.

⁶Article 33(1c) of Commission Regulation (EU) 2015/1222 (2015) shall ensure stable and robust bidding zones across market time frames.

⁷Article 16(8) of Regulation (EU) 2019/943 (2019) states that minimum 70% of transmission capacity shall be made available to market participants by the transmission system operator. This means that excess offshore wind generation beyond 30% of the transmission capacity that cannot be accommodated by the remaining transmission capacity must be

production would increase under the home market design in order to meet capacity rules, leading to economically inefficient dispatch.⁸ The first three options cause inefficiencies in the market clearing solution. To solve this issue, dedicated offshore bidding zones, option (4), are suggested to improve price signals in wholesale markets, reflecting the scarcity and abundance of generation and transmission capacity. The offshore bidding zone design signifies an individual bidding zone for offshore generation with an own wholesale price, enabling offshore injections into the grid to be fully integrated into the market. This mitigates transmission capacity limitations for accommodation of offshore wind power generation to shore, ensuring available transmission capacity to all market participants (THEMA Consulting Group 2020). Non-discriminatory access for all market players is a fundamental principle of EU law.⁹ The offshore bidding zone design can be implemented without modifications to the main Directives and Regulations of EU law, since bidding zones that do not attach to country borders are already allowed under current EU law (Nieuwenhout 2022).¹⁰ Several countries already operate with multiple bidding zones within country borders with the purpose to reflect structural congestion in the transmission grid, inter alia, Norway and Denmark, divided into five and two distinct bidding zones, respectively (Laur & Küpper 2021).

3.3 Potential Investment Incentive Schemes for Hybrid Grids

A report published by THEMA Consulting Group (2020) highlights that the choice of electricity market arrangement for future hybrid projects in the North Sea region, has a significant impact on wind farm revenues. Offshore bidding zones tend to decrease investment incentives for hybrid projects from an offshore wind developer’s point of view, due to disproportionate allocation of revenues between the offshore wind developer and TSO.¹¹ The reason is rooted in the market structure. The developer is exposed to lower electricity prices under the offshore bidding zone design than the home market design when transmission capacity towards a high-priced home market becomes structurally congested. In this case, the price offshore converges to a lower price than the high-priced market, whilst power producers bidding into onshore bidding zones would secure the home market price for the sale of electricity. This is based on the fact that zonal pricing reflects the scarcity or abundance of generation and transmission capacity, lowering the resulting price in the offshore bidding zone. The TSO gains the income lost by the developer as congestion income¹². Due to this, offshore wind developers argue for support payments to be compensated for the increased risk faced under the offshore bidding zone design. To this end, there are ongoing discussions between authorities and industrial actors about what is needed to realise hybrid projects. These have led to suggestions of different contract schemes. A direct solution to offset the higher risk is to reallocate the complete share or parts of the congestion income associated with wind power generation. A direct reallocation is not allowed under current EU law, requiring congestion income to be earmarked for use for particular purposes and not to be reallocated in favour of other groups of grid users.¹³ Other bespoke options suggested to enhance the viability of hybrid projects are, inter alia, Contracts for Differences (CfDs), Financial Transmission Rights (FTRs), Auction Revenue Rights (ARRs), Joint Ownership Approach, and awarding the developer with the highest price of onshore bidding zones on all wind power production (European Commission 2020c, Ørsted 2020, THEMA Consulting Group 2020, ENTSO-E 2021, Nieuwenhout 2022). These support measures are, however, not targeted at the risk of preventive congestion management, i.e. risk of discretionary actions taken by the TSO to solve congestion issues elsewhere in the transmission grid. ENGIE Impact (2022) argues that this is the sole risk faced by the developer caused by the offshore bidding zone design. Hence, it suggests a Transmission Access Guarantee (TAG) to offset the specific risk. The TAG is a

curtailed in order to ensure that the 70% rule on the interconnector holds.

⁸Transmission capacity towards the home market could be oversized to overcome the issue of curtailment of offshore wind generation, resulting from competition with cross-zonal flow. However, excessive capacity will impede the efficiency of a hybrid grid, compared to the use of a radial connection (THEMA Consulting Group 2020).

⁹Article 12(1) of Regulation (EU) 2019/943 (2019) states that power dispatch and demand responses shall be non-discriminatory, transparent and market-based.

¹⁰Article 14(1) of Regulation (EU) 2019/943 (2019) states that bidding zone borders shall be grounded on long-term, structural congestion in the transmission grid and that no such congestion occurs within a bidding zone.

¹¹THEMA Consulting Group (2020) finds that total income accrued by wind producers under the offshore bidding zone design is on average 1%-5% (11% in limited cases) lower, compared to the home market design.

¹²Congestion income is computed as the price spread between bidding zones multiplied by the traded volume across the interconnector in a given time period (Ministry of Petroleum and Energy 2021a).

¹³Article 19 of Regulation (EU) 2019/943 (2019) states that guaranteeing the actual availability of allocated capacity and optimising cross-zonal trade shall have priority as regards to the allocation of congestion income. When these objectives are achieved, congestion income is considered by regulatory authorities to calculate future grid tariffs, and remaining income shall be set on an individual internal account line.

monetary compensation paid by the TSO to offshore wind developers if the total net installed generation capacity of the offshore bidding zone is larger than the total export transmission capacity of the offshore bidding zone towards onshore bidding zones provided to the market clearing.

In this paper, reallocation of congestion income and TAG are studied as support measures for developers active in an offshore bidding zone. This is motivated by the following reasons. First, the Commission suggests that transfer of congestion income helps integrate offshore wind energy and thus will consider amending the rules on the allowed use of congestion income to align incentives for developers and TSOs (European Commission 2020c). Second, ENTSO-E (2021), representing the European TSO community, argues that reallocating congestion income is inconsistent with the principles underlying the Internal Energy Market and that higher congestion income caused by the offshore bidding zone design only reflects an efficient market structure (ENTSO-E 2021). Third, the recently proposed TAG, suggested by ENGIE Impact (2022) to only be targeted at the root cause and not overcompensating developers, is currently under discussion and, to the best of our knowledge, not analysed in past studies. Hence, we aim to contribute to the ongoing discussion by investigating the impact of these schemes on developer's investment incentives for a hybrid grid between two and three markets.

4 Methodology

This section formulates the investment situation faced by offshore wind developers and presents our modelling approach. Section 4.1 introduces the decision problem. Section 4.2 explains the main assumptions made. Section 4.3 presents the model setup for the developer’s investment timing option and Section 4.4 the model applied to incorporate regulatory uncertainty. Thereafter, Section 4.5 presents the revenues generated under three different grid setups. Lastly, Section 4.6 describes the solution approach.

4.1 Problem Formulation

In this paper, we consider an investment opportunity comparing three grid solutions for an offshore wind project: (1) offshore wind generation connected directly to the home country (radial connection), (2) offshore wind generation connected to the home country and a foreign power market (hereafter referred to as "hybrid" grid) and (3) offshore wind generation connected to the home country and two foreign power markets (hereafter referred to as "meshed" grid). We aim to evaluate the optimal time to invest under the presence of uncertainty in future electricity prices and investigate the difference of the grid solutions in terms of attractiveness from the perspective of an offshore wind developer. Figure 1 shows the decision-making timeline for the investment timing options. The developer can choose the timing τ_{radial} , τ_{hybrid} and τ_{meshed} of the investment in a radial, hybrid and meshed project, respectively, and holds the option to invest between today, t_0 , and T years into the future. If undertaking the decision, which is considered to be irreversible, the developer operates the wind farm over the lifetime, T_L .

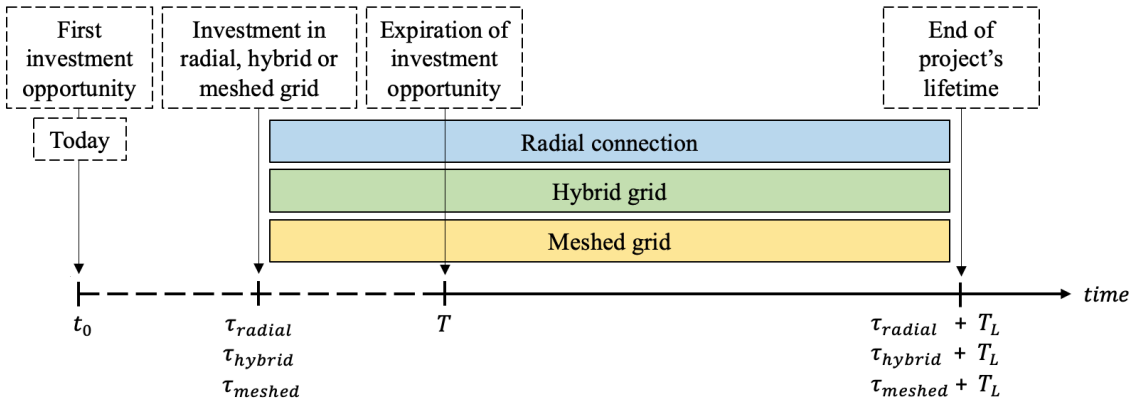

Figure 1: Decision-making timeline for investment timing options

In addition, a second decision setting is examined to incorporate regulatory uncertainty. For this setting we assume that the developer undertakes an immediate investment in a radial connection and faces regulatory uncertainty in terms of whether the radial solution can be integrated into a hybrid or meshed grid, or not, in the future. Figure 2 shows the decision setting, in which the developer invests immediately in a radial connection at time t_0 . The developer is opposed to regulatory uncertainty of when the switch to the hybrid or meshed grid will be enforced.¹⁴ The regulatory uncertainty poses an exogenous risk factor to the developer and is modelled as a jump process that is Poisson distributed. At time τ_{hm} , the developer can choose to connect to two power markets or to relinquish, and to three power markets or to relinquish. We consider the two cases individually. If extending the radial link, the developer operates the wind farm in the hybrid or meshed grid configuration dependent on the case for the remaining lifetime, $T_L - \tau_{hm}$, of the wind farm.

¹⁴The time from which the regulatory uncertainty is introduced would not impact our qualitative results. Therefore, in order to not add an unnecessary layer of complexity to the model, we introduce the uncertainty from time t_0 on. See Appendix A.6 for sensitivity analysis results.

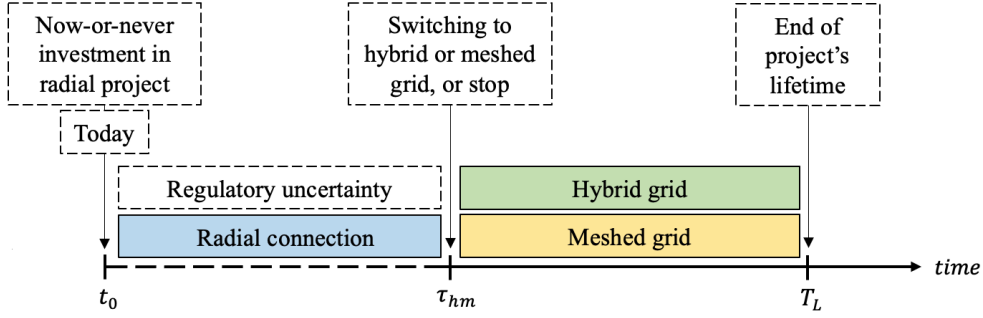

Figure 2: Decision-making timeline under regulatory uncertainty

4.2 Assumptions

In the following, we introduce the assumptions that we make in our model regarding market design, direction of power flow, lead time and allocation of seabed for offshore wind development.

Market arrangement. The radial project is incorporated in the home market zone, equivalent to existing offshore wind projects. The hybrid and meshed grid solutions are examined under the offshore bidding zone design, supported by existing EU legislation. The offshore bidding zone design ensures that renewable power is dispatched in the most efficient manner, i.e. power is transmitted to markets in most need of power (THEMA Consulting Group 2020).

Power dispatch. Wind power generation flows first to the highest price zone, satisfying the market with the highest power demand. Wind power is then dispatched to markets with lower demands in descending order in order to maximise wind power dispatch, mitigating curtailment of offshore generation and increasing security of power supply. This is based on several studies (PROMOTioN 2020, THEMA Consulting Group 2020, North Sea Wind Power Hub 2020). Following THEMA Consulting Group (2020), available transmission capacity is used for power exchange between onshore bidding zones with the direction of power flow from lower to higher price zones. If the grid is fully utilised, we assume that the lowest price of the markets is formed in the offshore bidding zone. If the price of two or three of the onshore bidding zones equalise, we assume that power is transmitted to one of the markets. Transmission loss is not accounted for in our model. Offshore wind power production is assumed to not affect electricity prices of onshore bidding zones.

Lead time. Given the objective of this study to observe key qualitative insights between grid solutions, we do not account for the lead time of the offshore wind farm and grid infrastructure, and assume that revenues from the respective project are generated from the time of investment and switching point on.

Price auction. The seabed in the area of the wind farm is assumed to be allocated via a price auction, which is common practice in the UK and expected to be pursued in Norway (Department for Business, Energy & Industrial Strategy 2022, Ministry of Petroleum and Energy 2022). According to Ministry of Petroleum and Energy (2021b), the granting of a licence for offshore wind development is time-limited to ensure progress of the licensee's development of the project. Based on this, we assume that after being granted the licence, the developer can wait with investment for a fixed number of years, i.e. T years. In addition, we assume that developers have optimised their technical solutions from the beginning on to be able to integrate a radial project into a hybrid or meshed grid in the future.

4.3 Modelling the Investment Timing Option

The offshore wind developer holds an investment timing option in an offshore wind project with a finite maturity of T years given the assumption of the time-restricted licence. We consider the three different cases of a radial connection, a bilateral hybrid grid and a meshed grid, respectively. The developer has the opportunity to invest in the respective project immediately, defer the investment decision to a later point in time, or not invest at all in the project. By having the exclusive right to invest, uncertainty about future electricity prices can create a value related to deferring investment. The value of timing flexibility cannot be reflected by a static net present value (NPV) evaluation. If uncertainty is high, the

timing flexibility can have significant value, which would impact the developer's investment decision. To correctly account for the possibility of postponing investment in the project, we apply a real options approach (ROA). On the grounds of then-current state of electricity price levels, the investor has managerial flexibility as regards to determining the investment timing. The developer is assumed to be able to reassess the decision to invest at predefined moments up to maturity, i.e. at the start of each year during the option's lifetime, considering investment is not previously undertaken. Upon exercise of the option, the developer makes an irreversible investment expenditure in exchange for uncertain cash flows. This implies that we evaluate the investment opportunity as a Bermudan-style call option.

From the year of investment $t_y \in [t_0, T]$, hourly revenues $R_{OW,t}^c$ for each project c , where $c = \{\text{radial, hybrid, meshed}\}$ denoting a radial, hybrid and meshed grid, respectively, are accrued over the lifetime of the project T_L . The hourly revenues depend on electricity price $P_{m,t}$ in the involved power markets m in hour t , and wind power generation $Q_{w,t}$ in hour t . The intrinsic value of project c at time t_y is given by the expected discounted revenues of the project,

$$V_c(P_{m,t}, t_y) = \sum_{t=1}^{8760 \cdot T_L} R_{OW,t}^c(P_{m,t}, Q_{w,t}) \cdot e^{-\frac{r}{8760} \cdot t}, \quad (1)$$

where r is the annual discount rate. Section 4.5 presents the hourly revenue functions applicable to the radial, hybrid and meshed grid solutions.

Given each investment option, the developer seeks to choose the optimal timing $\tau_c = t_y$ to invest in project c during the life of the option that maximises the value of the investment opportunity. Let I denote total investment costs related to the project paid upon investment. Thus, $V_c(P_{m,t}, t_y) - I$ is the payoff from investing at time t_y . Further, let $F_c(P_{m,t}, t_y)$ denote the value of the option to invest in project c . The developer solves the following optimal stopping problem.

$$F_c(P_{m,t}, \tau_c) = \max_{\tau_c} \mathbf{E} [e^{-r \cdot \tau_c} \cdot \{V_c(P_{m,t}, \tau_c) - I\}], \quad (2)$$

where \mathbf{E} denotes the expectation and r the annual discount rate. The value of the investment opportunity is solved using a simulation-based approach presented in Section 4.6.

If we do not account for the option to optimise the timing decision with respect to price uncertainty, we can apply a traditional NPV approach. Its underlying principle involves calculating the present value of expected future cash flows and determining whether the NPV yields a positive value, in which investment is undertaken today. The NPV for each investment project is given by the instantaneous payoff at $t_y = t_0$, i.e. $V_c(P_{m,t}, t_0) - I$. We calculate the NPV as a reference case.

Equal discount rate is used for the projects with and without flexibility accounting for time value of money and risks. Exercise of options may change the project's risk profile, and risks related to the project may change over time. In this regard, it may be argued whether a risk-neutral approach should be considered discounting all cash flows at the risk-free discount rate. In this paper, we consider the assumed discount rate to be appropriate for both the NPV and ROA valuation.

4.4 Modelling Regulatory Uncertainty

Our model in Section 4.3 allows us to get general insight into investment incentives for offshore wind developers. Motivated by the current situation in Norway, where the Norwegian government has decided on radial connections for the first build-out of offshore wind projects, but is unclear about when connections to foreign markets will be introduced, we consider a second decision setting that incorporates uncertainty in the future grid structure. The unpredictability of the governmental actions that developers cope with in terms of which grid solution for offshore wind energy that will be enforced, is seen as a regulatory uncertainty. This exogenous risk may impact developers' investment incentives and it is therefore desirable to investigate the impact of this source of risk on investment incentives. To this end, we assume an immediate investment in a radial connection and incorporate the possibility that the regulator suddenly permits the developer to integrate the radial link into a hybrid or meshed grid at a later stage. The regulatory uncertainty is modelled by a Poisson distribution. We assume that every year there is a likelihood that the regulator allows for the switch to an extended system. When permitted, the offshore wind developer chooses the grid solution that maximises the

profit stream for the remaining lifetime of the wind farm. Upon switching, the developer immediately starts to generate hourly revenues, $R_{OW,t}^c$, using the new grid solution. The hourly revenues depend on electricity price $P_{m,t}$ in the involved power markets m in hour t , and wind power generation $Q_{w,t}$ in hour t . The developer's project value including the switching possibility is given by

$$NPV_c^{switching}(P_{m,t}, \tau_{hm}) = -I + \sum_{t=1}^{8760 \cdot (\tau_{hm} - 1)} R_{OW,t}^{radial}(P_{m,t}, Q_{w,t}) \cdot e^{-\frac{r}{8760} \cdot t} + \kappa(t, \nu_t) \cdot \max \left\{ \sum_{t=8760 \cdot \tau_{hm} - 8759}^{8760 \cdot T_L} R_{OW,t}^c(P_{m,t}, Q_{w,t}) \cdot e^{-\frac{r}{8760} \cdot t}, 0 \right\}, \quad (3)$$

where

$$\kappa(t, \nu_t) = \begin{cases} 1 & \text{if } \nu_t > 0 \\ 0 & \text{if } \nu_t = 0. \end{cases}$$

In this setting, $c = \{\text{hybrid, meshed}\}$ denotes whether the developer switches to a hybrid or meshed grid, respectively, dependent on the case under study. $\kappa(t, \nu_t)$ is the variable that initiates the switch, $\nu_t \sim \text{Pois}(\lambda)$ a Poisson distributed random variable with mean arrival rate λ , and τ_{hm} the year from which the regulator enforces the switch from a radial to hybrid or meshed grid. Given the immediate investment at time t_0 and the lifetime of the wind farm of T_L years, we let $t_0 \leq \tau_{hm} \leq T_L$ to study the impact of a possible switch during the operating phase. I denotes aggregate investment costs incurred immediately and r the annual discount rate. Section 4.5 presents the hourly revenue functions applicable to the radial, hybrid and meshed grid solutions.

4.5 Revenue Functions for Radial, Hybrid and Meshed Grid Solutions

In the following, we elaborate on how revenues accrued by the offshore wind developer in each time period for each investment project are obtained. As the grid solutions under study involve different power markets, we let the involved power markets m denote market i under a radial setup, market i and j under a hybrid setup and market i, j and k under a meshed setup.

Radial Connection

Figure 3 illustrates the direction of power flow for a radial project in case wind power production at time t , $Q_{w,t}$, is less or equal to transmission capacity to home market i , Q_i . This permits that all power produced offshore can be transmitted to shore. In case the production exceeds the transmission capacity, i.e. $Q_{w,t} > Q_i$, excess generation is curtailed. Curtailment of wind power is illustrated by the red arrow pointing out from the wind farm. Connecting the offshore wind farm radially to an existing onshore bidding zone within the same Exclusive Economic Zone, ensures the operator that it can sell the electricity for the home market price (Roland Berger 2019). Under this market structure, the developer is exposed to uncertainty related to the home market price, $P_{i,t}$.

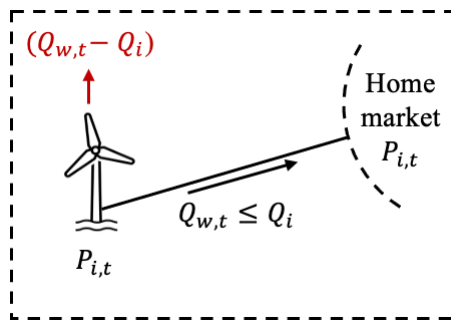

Figure 3: Radial connection to the home market

In a radial setup, the developer accrues hourly revenues, $R_{OW,t}^{radial}$, according to Equation (4).

$$R_{OW,t}^{radial}(P_{i,t}, Q_{w,t}) = P_{i,t} \cdot Q_{sell,1,t}, \quad (4)$$

where $P_{i,t}$ denotes the home market price in a given hour t , and $Q_{sell,1,t}$ denotes the amount of hourly wind power generation sold to the market at time t given by

$$Q_{sell,1,t} = \begin{cases} Q_{w,t} & \text{if } Q_{w,t} \leq Q_i \\ Q_i & \text{if } Q_{w,t} > Q_i. \end{cases}$$

Hybrid Grid

For a hybrid grid solution under the offshore bidding zone design, power markets i and j are considered, i.e. a low- and high-priced zone reflecting the underlying market supply and demand given grid constraints. Under this setup, the developer is exposed to price uncertainty related to the lowest and highest price of the markets, $P_{low,t}$ and $P_{high,t}$, respectively. Figure 4 illustrates the hybrid grid setup between the two distinct bidding zones. Electricity is sold at the price formed in the offshore bidding zone at time t , denoted by $P_{OBZ,2,t}$, which equals the price of the market to which there is no grid congestion (THEMA Consulting Group 2020). This means that wind power production is sold at $P_{low,t}$ or $P_{high,t}$ at time t . The resulting price effectively depends on the volumes of wind power production, $Q_{w,t}$, and transmission capacity, $Q_{low,t}$ and $Q_{high,t}$, to the corresponding low- and high-priced area, respectively. If transmission capacity to the high-priced zone is exceeding the sum of transmission capacity to the low-priced zone and offshore wind power generation, the transmission line to the low-priced zone becomes congested, forming a high price in the offshore bidding zone. Contrarily, congested flow towards the high-priced market forms a low price in the offshore bidding zone. Symmetric transmission capacity leads to a low price in the offshore bidding zone, due to supplies to the high-priced zone sourced from the low-priced zone, congesting the flow towards the high-priced market (THEMA Consulting Group 2020). Curtailment of wind power is illustrated by the red arrow pointing out from the wind farm, which happens when the wind production exceeds the transmission capacity in both directions, i.e. $Q_{w,t} > Q_{low,t} + Q_{high,t}$.

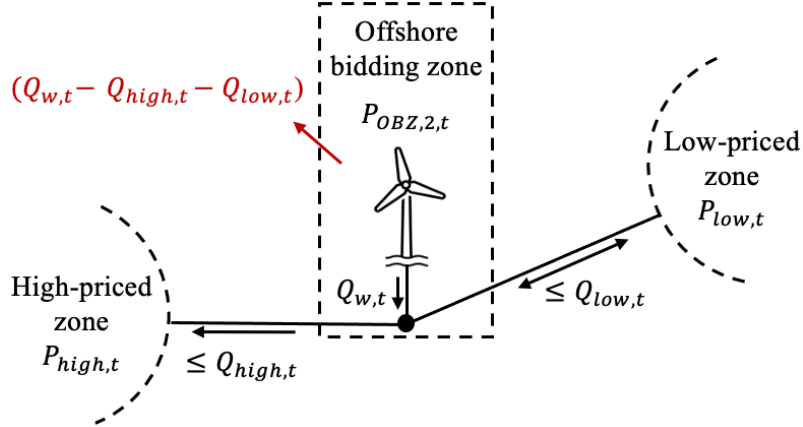

Figure 4: Hybrid grid solution

In a hybrid setup, the developer accrues hourly revenues, $R_{OW,t}^{hybrid}$, according to Equation (5).

$$R_{OW,t}^{hybrid}(P_{i,t}, P_{j,t}, Q_{w,t}) = P_{OBZ,2,t} \cdot Q_{sell,2,t}, \quad (5)$$

where $Q_{sell,2,t}$ denotes the amount of wind power generation sold to the market at time t at electricity price $P_{OBZ,2,t}$, depending on grid constraints. The developer sells electricity as long as there is sufficient transmission capacity in both directions. $P_{OBZ,2,t}$ and $Q_{sell,2,t}$ are given by

$$P_{OBZ,2,t} = \begin{cases} P_{low,t} & \text{if } Q_{w,t} \geq Q_{high,t} - Q_{low,t} \\ P_{high,t} & \text{if } Q_{w,t} < Q_{high,t} - Q_{low,t} \end{cases}$$

$$Q_{sell,2,t} = \begin{cases} Q_{w,t} & \text{if } Q_{w,t} \leq Q_{low,t} + Q_{high,t} \\ Q_{low,t} + Q_{high,t} & \text{if } Q_{w,t} > Q_{low,t} + Q_{high,t}. \end{cases}$$

Meshed Grid

For a meshed grid solution between three power markets i , j and k under the offshore bidding zone design, the developer is exposed to a third source of price uncertainty. The third market introduces a median price, $P_{med,t}$, besides, as before, the lowest and highest price of the markets, $P_{low,t}$ and $P_{high,t}$, respectively. Figure 5 illustrates the setup for the meshed grid between the three distinct price zones. The corresponding transmission capacity to the low-, medium- and high-priced market, is denoted by $Q_{low,t}$, $Q_{med,t}$ and $Q_{high,t}$, respectively. The price formed in the offshore bidding zone, $P_{OBZ,3,t}$, can be $P_{low,t}$, $P_{med,t}$ or $P_{high,t}$, depending on generation and transmission capacity. Offshore wind generation is matched with onshore demand through market coupling. The price of the offshore bidding zone is a result of market coupling and converges to the price of the market to which there is no grid congestion (North Sea Wind Power Hub 2020). Curtailment of wind power is illustrated by the red arrow pointing out from the wind farm, which occurs when the wind production exceeds the transmission capacity in all directions, i.e. $Q_{w,t} > Q_{low,t} + Q_{med,t} + Q_{high,t}$.

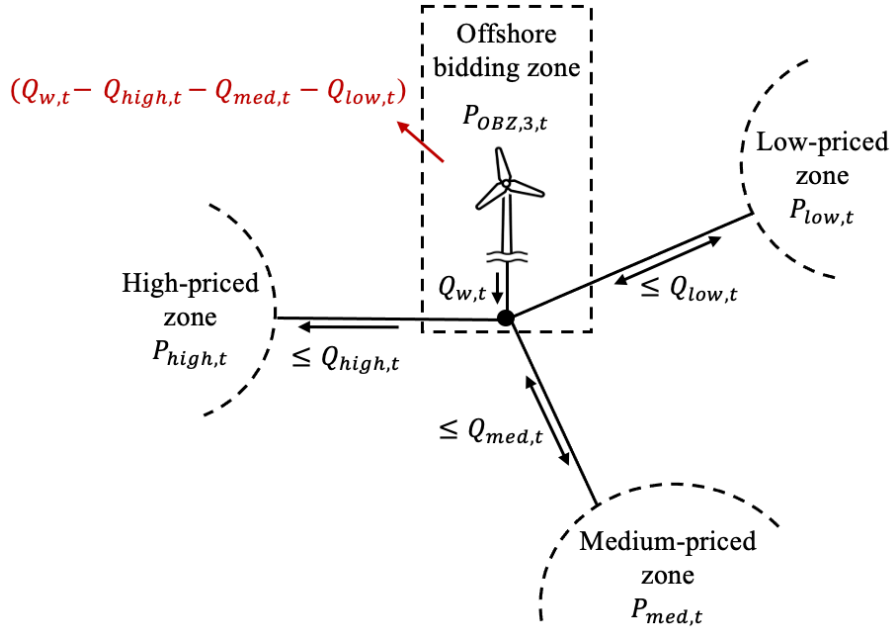

Figure 5: Meshed grid solution

In a meshed setup, the developer accrues hourly revenues, $R_{OW,t}^{meshed}$, according to Equation (6).

$$R_{OW,t}^{meshed}(P_{i,t}, P_{j,t}, P_{k,t}, Q_{w,t}) = P_{OBZ,3,t} \cdot Q_{sell,3,t}, \quad (6)$$

where $Q_{sell,3,t}$ denotes the amount of wind power generation sold to the market at time t at electricity price $P_{OBZ,3,t}$, depending on grid constraints. The developer sells power as long as there is sufficient transmission capacity in all directions. The price of the offshore bidding zone equals to the lowest price of the three markets if there is congested flow towards the high- and medium-priced markets. It equals to the median of the three prices if the transmission capacity towards the low- and high-priced market is fully utilised. The highest price is formed in the offshore bidding zone if there is available transmission capacity towards the high-priced market at the clearing solution (North Sea Wind Power Hub 2020, THEMA Consulting Group 2020). $P_{OBZ,3,t}$ and $Q_{sell,3,t}$ are thus given by

$$P_{OBZ,3,t} = \begin{cases} P_{low,t} & \text{if } Q_{w,t} \leq Q_{high,t}, Q_{low,t} \geq Q_{high,t} - Q_{w,t}, \\ & Q_{med,t} \leq Q_{low,t} - (Q_{high,t} - Q_{w,t}) \\ & \text{OR } Q_{w,t} \in (Q_{high,t}, Q_{med,t} + Q_{high,t}), Q_{low,t} \geq Q_{med,t} - (Q_{w,t} - Q_{high,t}) \\ & \text{OR } Q_{w,t} \geq Q_{med,t} + Q_{high,t} \\ P_{med,t} & \text{if } Q_{w,t} \leq Q_{high,t}, Q_{low,t} \geq Q_{high,t} - Q_{w,t}, \\ & Q_{med,t} > Q_{low,t} - (Q_{high,t} - Q_{w,t}) \\ & \text{OR } Q_{w,t} \leq Q_{high,t}, Q_{low,t} < Q_{high,t} - Q_{w,t}, \\ & Q_{med,t} \geq Q_{high,t} - Q_{w,t} - Q_{low,t} \\ & \text{OR } Q_{w,t} \in (Q_{high,t}, Q_{med,t} + Q_{high,t}), Q_{low,t} < Q_{med,t} - (Q_{w,t} - Q_{high,t}) \\ P_{high,t} & \text{if } Q_{w,t} \leq Q_{high,t}, Q_{low,t} < Q_{high,t} - Q_{w,t}, \\ & Q_{med,t} < Q_{high,t} - Q_{w,t} - Q_{low,t} \end{cases}$$

$$Q_{sell,3,t} = \begin{cases} Q_{w,t} & \text{if } Q_{w,t} \leq Q_{low,t} + Q_{med,t} + Q_{high,t} \\ Q_{low,t} + Q_{med,t} + Q_{high,t} & \text{if } Q_{w,t} > Q_{low,t} + Q_{med,t} + Q_{high,t}. \end{cases}$$

In the following subsections, we elaborate on the modelling of future electricity prices, offshore wind production and costs, as well as two support schemes for offshore wind developers.

4.5.1 Stochastic Price Processes

Hourly fluctuations in electricity prices create uncertainty in offshore wind investments. For a radial project, the offshore wind developer is exposed to price volatility in the home country to which the offshore wind farm is connected, whilst for a hybrid and meshed grid, the developer is subject to uncertainty in two or three electricity prices. To account for these sources of risk, we use stochastic processes to resemble actual market conditions. Looking specifically at a strand of literature considering wind energy investments, as well as the Nordic and the UK power market, an assumption of mean-reverting characteristics of electricity prices is suggested as one way of handling the stochastic behaviour. Lucia & Schwartz (2002) assume Nordic electricity prices to be of a mean-reverting nature as well as being exposed to seasonal variations. Likewise, Escribano et al. (2011) find evidence of seasonality and mean-reversion, in addition to jumps and volatility clustering of prices in the Nord Pool market. Using sample data from the UK, Abadie & Chamorro (2014) consider a mean-reverting model with a deterministic seasonal component in their real options valuation of wind energy projects. However, Kitzing & Schröder (2012) ignore the seasonal patterns and use plain mean-reverting processes when valuating a wind farm connecting up to four power markets. They argue that seasonal behaviours are expected to affect the countries under study similarly and thus are irrelevant when comparing the attractiveness of different cases. Other proposals in the literature are diverse. Fleten et al. (2007), Boomsma et al. (2012) and Fleten et al. (2016) assume a geometric Brownian motion for electricity prices, whilst Schwartz & Smith (2000) develop a two-factor model, enabling short-term prices to be mean-reverting and the long-term equilibrium price to follow a geometric Brownian motion.

With the objective of this study to observe key qualitative differences between various grid solutions, capturing special characteristics of electricity prices such as seasonality and spikes is considered less important. To gain general insights, we therefore assume mean-reverting processes to model future electricity prices in power market i , j and k . The stochastic change in the respective price over a small time interval dP_m is expressed with the Ornstein-Uhlenbeck process,

$$dP_m = \eta_m(\bar{P}_m - P_m)dt + \sigma_m dz_m, \quad (7)$$

where $m = \{i, j, k\}$ refers to market i , j and k , respectively, \bar{P}_m is the level to which P_m tends to revert, η_m is the speed of reversion, σ_m is the volatility, and dz_m is the increment of a Wiener process. The process stated in Equation (7) can be considered as the continuous-time analog of the first-order autoregressive process in discrete time,

$$P_{m,t} = P_{m,t-1}e^{-\eta_m \Delta t} + \bar{P}_m(1 - e^{-\eta_m \Delta t}) + \sigma_m \epsilon_{m,t} \sqrt{\frac{1 - e^{-2\eta_m \Delta t}}{2\eta_m}}, \quad (8)$$

where $\epsilon_{m,t}$ is a standard normal random variable (Dixit & Pindyck 1994). In each time period t , $\epsilon_{m,t}$ for each market m is correlated with correlation coefficients ρ_{ij} , ρ_{ik} and ρ_{jk} . It can be derived that uncorrelated Gaussian random variables can be transformed into correlated normal variables by using the Cholesky decomposition (McDonald 2014). The correlation structure for the three stochastic processes in Equation (8) is obtained by performing a trivariate Cholesky decomposition (Harville 1997, p. 235) of the correlation matrix computed from historical data. The symmetric positive-definite correlation matrix is decomposed, providing a lower triangular matrix, which combined with a vector of three uncorrelated Gaussian random variables, generates the desired correlation structure for the price processes. The correlation structure can be obtained following Equation (9)-(11).

$$\epsilon_{i,t} = \varepsilon_1 \quad (9)$$

$$\epsilon_{j,t} = \varepsilon_1 \cdot \rho_{ij} + \varepsilon_2 \cdot \sqrt{1 - \rho_{ij}^2} \quad (10)$$

$$\epsilon_{k,t} = \varepsilon_1 \cdot \rho_{ik} + \varepsilon_2 \cdot \frac{\rho_{jk} - \rho_{ij} \cdot \rho_{ik}}{\sqrt{1 - \rho_{ij}^2}} + \varepsilon_3 \cdot \sqrt{1 - \left(\rho_{ik}^2 + \frac{(\rho_{jk} - \rho_{ij} \cdot \rho_{ik})^2}{1 - \rho_{ij}^2} \right)}, \quad (11)$$

where ε_1 , ε_2 and ε_3 are uncorrelated Gaussian random variables.

Estimation of parameter values are described in Section 5.2.

4.5.2 Offshore Wind Production

The intermittent characteristics of wind conditions make wind to a variable energy source, causing wind energy production to vary from hour to hour. To handle its complex nature, Yu et al. (2006) consider wind speeds to follow fixed yearly patterns and model wind generation based on historical data in their valuation of a switchable tariff applied to wind generators in Spain. Likewise, Fleten et al. (2007) assume the major source of uncertainty in their investment analysis of a small-scale wind power generation unit to be the future electricity price, and estimate wind power generation by converting hourly historical wind speeds into expected electricity generation. Abadie & Chamorro (2014) model capacity factors via a deterministic component capturing seasonal behaviours and a stochastic term accounting for possible interruptions, in their real options valuation of wind energy investments. Reuter et al. (2012) compare the effect of a constant and variable capacity factor of wind power plants on profits, where the variable capacity factor is considered normally distributed with a certain mean and volatility. Their results suggest that using a constant capacity factor would lead to a considerable overestimation of the profitability of the wind technology.

In this paper, we consider hourly fluctuations in wind speed through each year over the lifetime of the project and assume an annual deterministic structure for capacity factors. This allows us to consider production variability within a year, enabling a realistic picture of future power generation output from offshore wind turbines. To model hourly wind generation, we choose to follow the model of Hayes et al. (2021). They developed a model for estimating long-term offshore wind production by using ERA5¹⁵ hourly wind speed data. Based on an offshore wind farm's geographic coordinate, hub height and turbine model, historical wind speeds are converted to capacity factors. On their accompanying website, predicted hourly capacity factors for offshore wind farms located within 200 km of the coast are available (ANU 100% Renewable Energy n.d.). Following this approach, hourly capacity factors in the area of the offshore wind farm can be predicted. Parameter values used in the model are described in Section 5.3. Accordingly, hourly wind power generation at time t is given by

$$Q_{w,t} = \gamma_t Q_{w,max}, \quad (12)$$

where $Q_{w,max}$ denotes the total installed generation capacity of the offshore wind farm and γ_t represents the capacity factor at time t .

¹⁵The ERA5 data is produced by the European Centre for Medium-Range Weather Forecasts (ECMWF) and provides estimates of atmospheric, land and oceanic climate variables on an hourly basis (ECMWF n.d.).

4.5.3 Costs

Project costs largely impact the profitability of the project. According to the Ministry of Petroleum and Energy (2021a), the developer is in charge of both the offshore wind farm and radial grid development. Following the integrated approach as mandated in the UK, the developer is responsible for developing either assets, and sells the grid for operation to a third party after commissioning via a competitive tender process (Girard et al. 2021). In this context, we assume that once the radial or extendable radial is built, the developer sells the cable to the grid owner, receives cash flows back and is charged grid tariffs for using the grid. Following Osmundsen et al. (2021), such a sale-leaseback solution would not impact the NPV if the interest rate applied in the leaseback is identical to the developer's loan rate. Argued by the authors, the developer would presumably require an additional return on the grid investment, however they neglect this value in their NPV analysis of Equinor's Dogger Bank project. Equally, we disregard any added value required by the developer. In addition, as connection charges and grid tariffs are uncertain, we ignore these by assuming that they balance out with potential profits from the sale of the grid. As it is not clear where the responsibility lies in terms of the development of the extended transmission asset to foreign countries, we discard this cost from the developer's side. In terms of integrating an extendable radial into a hybrid or meshed solution, we disregard any connection charges and assume that grid tariffs remain unchanged. Thus, related switching costs are neglected. Our cost parameter, I , is thus assumed to reflect expenditures exclusively related to the offshore wind farm. Given the objective of this study to observe qualitative differences between grid solutions, we limit I to capital expenditures, and assume this to be a fixed amount incurred upon investment.

4.5.4 Contract Structures

Reallocation of congestion income and a Transmission Access Guarantee (TAG) are amongst proposed options to support offshore wind developers active in an offshore bidding zone under a hybrid and meshed setup. Either one provides an additional component to the developer's revenue stream in Equation (5) and (6), depending on the chosen measure. Conceptually, each contract structure is similar for a hybrid and meshed solution, however two versus three connected markets affect the power flow in the system, thus impacting the resulting price offshore and price spread on interconnectors. The contract structures are defined as follows.

Reallocation of congestion income. This support scheme involves reallocating a share $\xi \in [0, 1]$ of congestion income on wind power production from the TSO to the offshore wind developer. Using congestion income for the redistribution to developers operative in an offshore bidding zone is emphasised by the European Commission (2020b) as one way to align incentives for developers and transmission owners. The reason for this is that offshore bidding zones tend to reduce the price offshore and thus the developer's income, whilst the TSO gains the income lost by the developer as congestion income.

For a hybrid setup, provided a price spread between bidding zones, congestion income is earned on wind power generation transmitted to a high-priced zone. Congestion income associated with wind production gained at time t is denoted by $PQ_{cong,2,t}$, and depends on available generation and transmission capacity, and the present state of electricity prices in the markets. The share of congestion income that is reallocated at time t in a hybrid setup is given by

$$\xi \cdot PQ_{cong,2,t}, \quad (13)$$

where

$$PQ_{cong,2,t} = \begin{cases} |P_{high,t} - P_{low,t}| \cdot Q_{w,t} & \text{if } Q_{w,t} \in [Q_{high,t} - Q_{low,t}, Q_{high,t}] \\ |P_{high,t} - P_{low,t}| \cdot Q_{high,t} & \text{if } Q_{w,t} > Q_{high,t} \\ 0 & \text{if } Q_{w,t} < Q_{high,t} - Q_{low,t}. \end{cases}$$

For a meshed setup, due to the inclusion of a third market, congestion income, $PQ_{cong,3,t}$, can be gained on more than one interconnector, depending on available generation and transmission capacity, and the present state of the electricity price in each of the markets. The share of congestion income that is reallocated at time t in a meshed setup is given by

$$\xi \cdot PQ_{cong,3,t}, \quad (14)$$

where

$$PQ_{cong,3,t} = \begin{cases} |P_{high,t} - P_{low,t}| \cdot Q_{w,t} & \text{if } Q_{w,t} \leq Q_{high,t}, Q_{low,t} \geq Q_{high,t} - Q_{w,t}, \\ & Q_{med,t} \leq Q_{low,t} - (Q_{high,t} - Q_{w,t}) \\ |P_{high,t} - P_{med,t}| \cdot Q_{w,t} & \text{if } Q_{w,t} \leq Q_{high,t}, Q_{low,t} \geq Q_{high,t} - Q_{w,t}, \\ & Q_{med,t} > Q_{low,t} - (Q_{high,t} - Q_{w,t}) \\ \text{or } Q_{w,t} \leq Q_{high,t}, Q_{low,t} < Q_{high,t} - Q_{w,t}, \\ & Q_{med,t} \geq Q_{high,t} - Q_{w,t} - Q_{low,t} \\ |P_{high,t} - P_{low,t}| \cdot Q_{high,t} + |P_{med,t} - P_{low,t}| \cdot (Q_{w,t} - Q_{high,t}) & \text{if } Q_{w,t} \in (Q_{high,t}, Q_{med,t} + Q_{high,t}), \\ & Q_{low,t} \geq Q_{med,t} - (Q_{w,t} - Q_{high,t}) \\ |P_{high,t} - P_{med,t}| \cdot Q_{high,t} & \text{if } Q_{w,t} \in (Q_{high,t}, Q_{med,t} + Q_{high,t}), \\ & Q_{low,t} < Q_{med,t} - (Q_{w,t} - Q_{high,t}) \\ |P_{high,t} - P_{low,t}| \cdot Q_{high,t} + |P_{med,t} - P_{low,t}| \cdot Q_{med,t} & \text{if } Q_{w,t} \geq Q_{med,t} + Q_{high,t} \\ 0 & \text{if } Q_{w,t} \leq Q_{high,t}, Q_{low,t} < Q_{high,t} - Q_{w,t}, \\ & Q_{med,t} < Q_{high,t} - Q_{w,t} - Q_{low,t}. \end{cases}$$

TAG. This support scheme involves a monetary compensation paid by the TSO to the offshore wind developer for the risk faced in the offshore bidding zone if the TSO should reduce transmission capacity to shore in order to relieve internal grid congestion elsewhere and the developer must curtail wind energy (ENGIE Impact 2022). Argued by ENGIE Impact (2022), the scheme is directly targeted at the identified problem and is valid if and only if the total transmission capacity to onshore bidding zones provided to the market clearing is below the sum of net installed generation capacity in the offshore bidding zone. The compensation is determined based on the maximum of the price differential between a reference bidding zone and the offshore bidding zone, and zero, on total generation available, $Q_{w,t}$, at time t . We set the reference prices $P_{ref,2,t}$ and $P_{ref,3,t}$ for a hybrid and meshed setup, respectively, to the price of the onshore bidding zone located in the same Exclusive Economic Zone as the offshore wind farm, i.e. $P_{i,t}$.¹⁶ As before, the price of the offshore bidding zone is denoted by $P_{OBZ,2,t}$ and $P_{OBZ,3,t}$ for a hybrid and meshed grid, respectively. $Q_{w,max}$ denotes the total installed generation capacity of the offshore wind farm.

For a hybrid setup, the TAG scheme is given by

$$y_{TAG,2} \cdot \max\{P_{ref,2,t} - P_{OBZ,2,t}, 0\} \cdot Q_{w,t}, \quad (15)$$

where $y_{TAG,2} = 1$ if $Q_{low,t} + Q_{high,t} < Q_{w,max}$, and $y_{TAG,2} = 0$ otherwise.

For a meshed setup, the TAG scheme is given by

$$y_{TAG,3} \cdot \max\{P_{ref,3,t} - P_{OBZ,3,t}, 0\} \cdot Q_{w,t}, \quad (16)$$

where $y_{TAG,3} = 1$ if $Q_{low,t} + Q_{med,t} + Q_{high,t} < Q_{w,max}$, and $y_{TAG,3} = 0$ otherwise.

4.6 Solution Approach

We apply the least squares Monte Carlo (LSM) approach, introduced by Longstaff & Schwartz (2001), to optimise the developer's decision of whether and when to invest in a radial, hybrid and meshed grid solution, respectively, accounting for price uncertainty and decision flexibility. The LSM method has

¹⁶ENGIE Impact (2022) proposes the onshore bidding zone associated with the hybrid asset's terminal in the country of the Exclusive Economic Zone to be the reference bidding zone for Long-Term Transmission Rights (LTTR). We take the same assumption for the TAG scheme.

the advantage that it enables a transparent and flexible algorithm without imposing limitations on the computational efficiency of the method when adding several sources of risk. It overcomes the curse of dimensionality in dynamic programming by approximating the conditional expectation function at each decision point based on least squares regression. This simulation-based approach has been proved to provide near-optimal results for financial options as well as applications of real options. Applying the LSM approach allows us to value the investment timing option subject to multiple uncertainty factors and with Bermudan-style exercise features.¹⁷

Applying the LSM method, we first generate three sets of s price paths of the mean-reverting price processes with hourly time steps. Combined with corresponding wind power output in the given time step, the present value of the developer's income stream can be calculated. This includes total discounted hourly revenues over the project's lifetime viewed from the time of investment. The optimal exercise strategy in each decision node for a radial, hybrid and meshed grid solution is then determined in a backward recursive manner. Based on a finite time horizon $[t_0, T]$, the investment decision is evaluated at specific yearly time steps t_y . The value of the investment opportunity is maximised pathwise. We solve in each time period $t_y \in [t_0, T]$ and for all simulation paths s the maximisation problem given by Equation (17), for each investment timing option. The value of the investment opportunity $\Theta_s^c(d_{s,t_y}^c)$ for every s , based on decision d_{s,t_y}^c of whether to invest in the project ($d_{s,t_y}^c = 1$) or defer investment ($d_{s,t_y}^c = 0$) at time t_y in simulation path s , for all t_y and s , serves as the objective value. $c = \{\text{radial, hybrid, meshed}\}$ denotes whether the investment problem applies to the radial, hybrid or meshed setup, which is considered independent of each other.

$$\begin{aligned} & \underset{d^c}{\text{maximise}} && \Theta_s^c(d_{s,t_y}^c) \\ & \text{subject to} && d_{s,t_y}^c \in \{0, 1\} \end{aligned} \tag{17}$$

where

$$\Theta_s^c(d_{s,t_y}^c) = \begin{cases} \Omega_s^c(d_{t_y}^c = d_{s,t_y}^c) & \text{if } d_{s,t_y}^c = 1 \\ \mathbb{E}[Y_{s,t_y}^c \mid P_{s,t_y}^c] & \text{if } d_{s,t_y}^c = 0. \end{cases}$$

$\Omega_s^c(d_{t_y}^c = 1)$ refers to the payoff in every s from immediate investment in grid solution c at time step t_y . $\mathbb{E}[Y_{s,t_y}^c \mid P_{s,t_y}^c]$ denotes the approximate conditional expected value of continuation for every s and t_y , and hence estimates the payoff from continuing the life of the option to the following decision point to reassess the investment decision. At the final decision point T , the optimal strategy is to invest in the project if the option is in the money, otherwise it is optimal to let the option expire. It is not possible to postpone investment at the last decision point. Thus, $\mathbb{E}[Y_{s,T}^c \mid P_{s,T}^c] = 0$ at expiration. At precedent exercise times $t_y \in [t_0, T - 1]$ for all s , the optimal decision is determined by comparing the conditional expected value to the developer from continuation given then-current state of price uncertainties, P_{s,t_y}^c , with the payoff from investing immediately in the project. The decision that maximises the value of the investment opportunity defines the optimal investment strategy to the developer at the given time step. For every s and t_y , $P_{s,t_y}^{\text{radial}} = P_{i,t_y}^s$ for a radial connection, $P_{s,t_y}^{\text{hybrid}} \ni \{P_{i,t_y}^s, P_{j,t_y}^s\}$ for a hybrid solution and $P_{s,t_y}^{\text{meshed}} \ni \{P_{i,t_y}^s, P_{j,t_y}^s, P_{k,t_y}^s\}$ for a meshed solution.

As suggested by Longstaff & Schwartz (2001), we approximate the conditional expected value of continuation at times $t_y \in [t_0, T - 1]$ by performing linear regression. We express the conditional expectation function as a linear combination of basis functions including terms in P_{s,t_y}^c for grid solution c , in addition to cross-product terms for the hybrid and meshed solutions to allow for interactions between explanatory variables. Longstaff & Schwartz (2001) and Moreno & Navas (2003) conclude that the LSM approach is generally robust in relation to the selection of basis functions. Our selection of basis functions may be relatively complex for this investment problem, however, it should still provide a sufficient degree of accuracy and not impose limitations on the computational efficiency of the algorithm. To capture the major effects in the regression model, we consider a second-order polynomial equation in the regression. As recommended by Longstaff & Schwartz (2001), we evaluate the in-the-money paths exclusively for the estimation of the regression parameters for an improved estimation of the conditional expectation function. Equation (18), (19) and (20) present the regression functions as estimators of the conditional expected value to the developer from continuation for the radial, hybrid and meshed grid, respectively.

¹⁷Implementation of the simulation algorithm is executed in MATLAB R2021a.

$$\mathbb{E}[Y_{s,t_y}^{radial} | P_{s,t_y}^{radial}] = \alpha_0 + \alpha_1 P_{i,t_y}^s + \alpha_2 (P_{i,t_y}^s)^2 \quad (18)$$

$$\mathbb{E}[Y_{s,t_y}^{hybrid} | P_{s,t_y}^{hybrid}] = \beta_0 + \beta_1 P_{i,t_y}^s + \beta_2 (P_{i,t_y}^s)^2 + \beta_3 P_{j,t_y}^s + \beta_4 (P_{j,t_y}^s)^2 + \beta_5 P_{i,t_y}^s P_{j,t_y}^s \quad (19)$$

$$\begin{aligned} \mathbb{E}[Y_{s,t_y}^{meshed} | P_{s,t_y}^{meshed}] &= \zeta_0 + \zeta_1 P_{i,t_y}^s + \zeta_2 (P_{i,t_y}^s)^2 + \zeta_3 P_{j,t_y}^s + \zeta_4 (P_{j,t_y}^s)^2 + \zeta_5 P_{k,t_y}^s + \zeta_6 (P_{k,t_y}^s)^2 \\ &+ \zeta_7 P_{i,t_y}^s P_{j,t_y}^s + \zeta_8 P_{i,t_y}^s P_{k,t_y}^s + \zeta_9 P_{j,t_y}^s P_{k,t_y}^s + \zeta_{10} P_{i,t_y}^s P_{j,t_y}^s P_{k,t_y}^s, \end{aligned} \quad (20)$$

where α_0 , α_1 and α_2 denote the regression coefficients related to the radial investment problem, $\beta_0, \beta_1, \dots, \beta_5$ the regression coefficients for the hybrid grid investment problem and $\zeta_0, \zeta_1, \dots, \zeta_{10}$ the regression coefficients for the meshed grid investment problem.

Discounted ex post cash flows from continuation are regressed on a constant and functions of then-current electricity price levels. Using the algorithm, for all simulation paths, we seek the earliest time at which investment is made to find the optimal stopping rule for the investment opportunity. The algorithm returns the percentage of total simulation paths for each time step $t_y = \{t_0, t_0 + 1, \dots, T\}$ in which investing in the project for each simulation path is the optimal strategy. Hence, the optimal time to invest in each of the projects is determined. Besides the optimal timing of investment, the aggregate value of each investment opportunity is obtained, identified from the stopping rule that maximises the option value. This total project value obtained from the ROA is given by the sum of two components: the value of immediate investment, given by the NPV, and an additional value due to the fact that the developer can optimise the decision timing. Based on the same price simulations used in the ROA, we calculate the NPV of investing today using Monte Carlo simulations. By comparing the ROA project value with NPV, we can identify the value of having the flexibility to delay the option.

5 Case Study

In the following, we present our case study and quantify the parameters used in the base case scenario. Section 5.1 provides an overview of the base case parameter values. In more detail, Section 5.2 describes the estimation of price process parameters, Section 5.3 the estimation of capacity factors and Section 5.4 total costs assumed in our model.

An offshore wind project at Sørilige Nordsjø II (SNII) within the Exclusive Economic Zone of Norway is used as a case study to investigate investment incentives from an offshore wind developer’s perspective for radial, hybrid and meshed grid arrangements. SNII is earmarked for large-scale offshore wind development by the Norwegian government with ongoing discussions on how to realise these projects. As the first offshore wind project at SNII is recently decided to be radially connected to the Norwegian mainland, we choose the NO2 price area in southern Norway as the home market zone, following Statnett (2022). In view of the recent unveiled plans by the Norwegian government, in which cables with two-way power flow can be considered for certain offshore wind projects in the future, the hybrid setup is chosen to involve the NO2 and UK market. This is based on the assumption that the UK has the highest power prices on average in Europe (Ministry of Petroleum and Energy 2021a), enabling us to study the effect of large price spreads earned on congested lines. According to ENTSO-E (2021), meshed solutions will be key for meeting global ambitious targets in a cost efficient and sustainable manner. With SNII located in the proximity of a future Danish artificial energy island in the North Sea serving as a hub to connect offshore wind farms with nearby power markets (Danish Energy Agency n.d.), the energy island is considered as a relevant target for connection from SNII for a meshed setup. With no offshore bidding zone yet established, DK1 is assumed to be representative for the Danish market. Accordingly, power market i , j and k , represented by the NO2, UK and DK1 bidding zone, respectively, are used in the case study. Based on historical price levels and expectation of future prices according to NVE (2021), the NO2, DK1 and UK market, respectively, is generally a low-, medium- and high-priced area, when compared. With this case study, we show that the proposed methodology is flexible such that it can easily be applied to other cases involving up to three power markets.

5.1 Parameterisation

An overview of the base case parameters used in the case study is reported in Table 1. With the first phase of the development at SNII allowing for a generation capacity of 1,500 MW (Ministry of Petroleum and Energy 2022), we set the installed capacity of the wind farm to $Q_{w,max}=1,500$ MW. To enable all wind production to be transmitted to the home market, we choose the maximum transmission capacity to the NO2 market, Q_N , to be 1,500 MW in all hours. For a fair comparison of different grid configurations, we use identical wind farm capacity in all setups. We also set the grid capacity the same in all directions, such that $Q_N=Q_{UK}=Q_D$. Following NVE (2022), we set the expected lifespan of the wind farm to $T_L=25$ years. Further, an option lifetime of $T=10$ years is considered, equivalent to Schwartz (1997). The first investment opportunity is set to year 1, i.e. $t_0=1$. This will also be the investment year considered in the NPV evaluation. In line with NVE (2022), using a discount rate of 6% for a common Norwegian project, we set the annual discount rate to $r=6\%$. This is in several contexts a relatively conservative rate (NVE 2017). In reality, the discount rate would vary between technologies and specific projects, with risk characteristics depending on, inter alia, the maturity of the technology, production profile and external conditions (NVE 2015). As we aim to study qualitative differences between the grid solutions, we assume the estimate to be appropriate for the goal of this study. Further, in the base case analysis we choose to exclude subsidy schemes. Thus, we set $\xi=0$ (no reallocation of congestion income) and $y_{TAG,2}=y_{TAG,3}=0$ (no TAG). The remaining parameter estimates are discussed in Section 5.2, 5.3 and 5.4.

Table 1: Base case parameters used in the case study.

Parameter	Description	Value
$Q_{w,max}$	Generation capacity of the wind farm	1,500 MW
Q_N	Transmission capacity towards NO2	1,500 MW
Q_{UK}	Transmission capacity towards UK	1,500 MW
Q_D	Transmission capacity towards DK1	1,500 MW
T_L	Lifetime of the wind farm	25 years
T	Lifetime of the option	10 years
r	Annual discount rate	6%
ξ	Share of reallocated congestion income	0
$y_{TAG,2}$	Variable to activate TAG in hybrid setup	0
$y_{TAG,3}$	Variable to activate TAG in meshed setup	0
P_{0N}	Initial price used in the simulation of $P_{N,t}$	29 EUR/MWh
P_{0UK}	Initial price used in the simulation of $P_{UK,t}$	50 EUR/MWh
P_{0D}	Initial price used in the simulation of $P_{D,t}$	32 EUR/MWh
\bar{P}_N	Price level to which $P_{N,t}$ tends to revert	50 EUR/MWh
\bar{P}_{UK}	Price level to which $P_{UK,t}$ tends to revert	65 EUR/MWh
\bar{P}_D	Price level to which $P_{D,t}$ tends to revert	55 EUR/MWh
$\hat{\sigma}_N$	Volatility of $P_{N,t}$	1.87 EUR/MWh
$\hat{\sigma}_{UK}$	Volatility of $P_{UK,t}$	17.94 EUR/MWh
$\hat{\sigma}_D$	Volatility of $P_{D,t}$	4.76 EUR/MWh
$\hat{\eta}_N$	Speed of reversion of $P_{N,t}$	0.009
$\hat{\eta}_{UK}$	Speed of reversion of $P_{UK,t}$	0.306
$\hat{\eta}_D$	Speed of reversion of $P_{D,t}$	0.048
$\rho_{N,UK}$	Correlation between $P_{N,t}$ and $P_{UK,t}$	0.42
$\rho_{N,D}$	Correlation between $P_{N,t}$ and $P_{D,t}$	0.62
$\rho_{UK,D}$	Correlation between $P_{UK,t}$ and $P_{D,t}$	0.43
I	Total investment costs for each project	EUR 4.4 bn

5.2 Estimation of Price Process Parameters

The market data used to calibrate the mean-reversion factor $\hat{\eta}_m$, the volatility $\hat{\sigma}_m$ and the correlation coefficients ρ_{ij} , ρ_{ik} and ρ_{jk} of the price processes, are hourly historical spot prices of electricity in the day-ahead market from 2016 to 2020 in NO2 and the UK, obtained from Nord Pool¹⁸, and DK1, from Montel¹⁹. Based on the regression in Equation (21), parameter estimates are found.

$$P_{m,t} - P_{m,t-1} = a_m + b_m P_{m,t-1} + \epsilon_{m,t}, \quad (21)$$

where $\hat{\eta}_m = -\ln(1 + \hat{b}_m)$ and $\hat{\sigma}_m = \hat{\sigma}_{\epsilon_m} \sqrt{\frac{2\ln(1+\hat{b}_m)}{(1+\hat{b}_m)^2-1}}$, where $\hat{\sigma}_{\epsilon_m}$ is the standard error of the regression (Dixit & Pindyck 1994).

For the long-term price level \bar{P}_m , we take another approach. Based on the regression in Equation (21) and the fact that $\bar{P}_m = \frac{-\hat{a}_m}{\hat{b}_m}$, historical price levels in the NO2, UK and DK1 areas reveal 29.16, 50.84 and 32.87 EUR/MWh, respectively. According to a long-term market analysis performed by NVE (2021), power prices in Europe the next 20 years are expected to stay at a higher level than seen historically. This is due to, inter alia, higher CO₂ prices, increased power consumption and increased transmission capacity between the Nordic and European power markets. Future predictions from NVE show NO2 and DK1 prices to stay around 50 EUR/MWh, with DK1 prices marginally higher than NO2 prices on average – which also agrees with historical data – and UK prices to be just above 60 EUR/MWh in 2040. Motivated by this, we set the long-term average price levels equal to these forecasts in the base case, i.e. $\bar{P}_N=50$, $\bar{P}_{UK}=65$ and $\bar{P}_D=55$ EUR/MWh, rather than the average price levels resulting from the historical market data. We conduct sensitivity analysis to investigate the impact of the price level assumption on obtained results in Section 6.

Figure 6 shows one sample price path for each of the markets resulting from the Monte Carlo simulations, along with confidence intervals and mean price levels for the first month in the estimated period. 3,000 simulations are carried out for each time step and serve as a basis for our following results. The variance of the three price processes increases initially but stabilises around a certain level shortly after, due to the mean-reverting nature of the prices. UK prices have the widest confidence band, followed by DK1 and NO2 prices, reflecting the highest volatility level.

¹⁸Nord Pool is Europe's leading power market (see Nord Pool (n.d.)).

¹⁹Montel is a leading information provider for the European energy markets (see Montel (n.d.)).

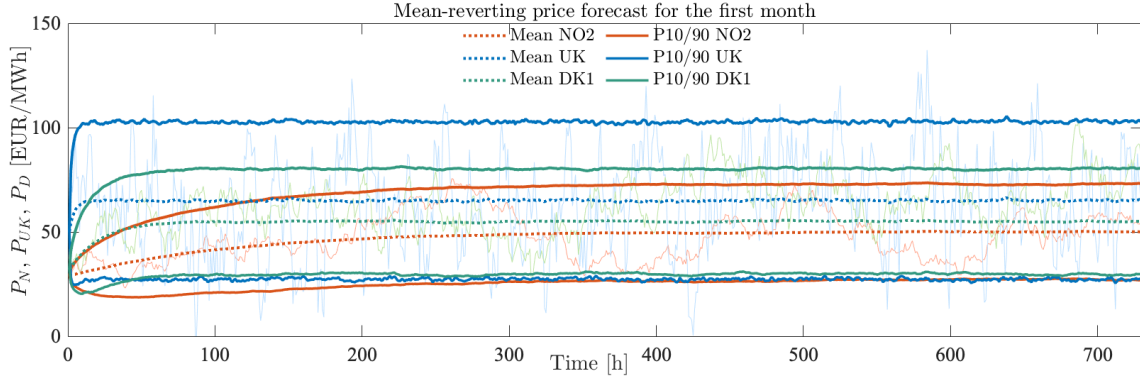

Figure 6: Mean-reversion forecast of NO2, UK and DK1 prices for the first month. One sample path for each market is included along with 90% confidence bands and the mean of price simulations in each hour.

5.3 Estimation of Capacity Factors

We follow the approach of Hayes et al. (2021), outlined in Section 4.5.2, to predict the annual structure of hourly capacity factors for offshore wind generation at SNII. We assume that hourly capacity factors for a given historical year are representative for future years, and consider wind speed data from 2019 in our analysis. In terms of turbine sizes, these are increasing owing to technology development. Amongst offshore wind farms under construction in 2021, turbine capacities ranged from 3.2 to 10 MW (WFO 2021), and for 2030, even larger turbines of 15 to 20 MW are expected (IEA 2019). Thus, we select amongst the highest rated turbines available from ANU 100% Renewable Energy (n.d.), and select a specific hub height. The chosen geographic coordinate is available from the Ministry of Petroleum and Energy (2020) and is considered representative for the entire SNII area. The assumed input parameters are reported in Table 2.

Table 2: Assumed input parameters for prediction of capacity factors in the model of Hayes et al. (2021).

Parameter	Value	Unit	Note
Wind turbine capacity	8	[MW]	MHI Vestas Offshore V164-8000
Hub height	150	[m]	Turbine's rotor height above ground
Latitude	56.44	[°]	Coordinate of Sørilige Nordsjø II
Longitude	5.29	[°]	

Figure 7 shows the estimated annual structure of hourly capacity factors at SNII assumed over the lifetime of the projects under study. According to wind speed data from 2019, the predictions exhibit hourly fluctuations and result in a mean of 56% and volatility of 38%.

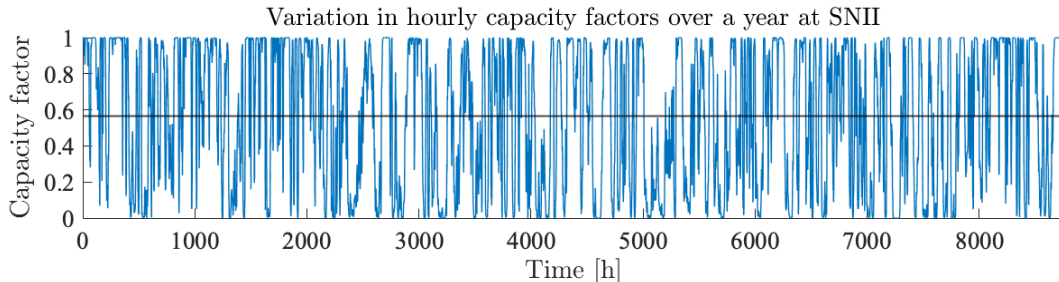

Figure 7: Predicted annual structure of hourly capacity factors for wind generation at SNII based on wind conditions in 2019 following the approach of Hayes et al. (2021). The black line represents the mean of 0.56.

5.4 Estimation of Costs

Osmundsen et al. (2021) report a detailed expected cost structure for the Dogger Bank project, including capital and operational expenditures over a baseline production period of 25 years. For each of three 1.2 GW wind projects, the assumed capital expenditures are set to GBP 3 bn. Based on analogous cost estimation, our cost parameter I , reflecting a fixed, sunk outlay incurred upon investment for each investment project, is set to EUR 4.4 bn. We perform sensitivity analysis to examine the impact on results.

6 Results and Discussion

This section presents the results based on the modelling approach described in Section 4. Firstly, in Section 6.1, we analyse the investment timing option for a radial, hybrid and meshed grid configuration, respectively, in our base case scenario. Secondly, in Section 6.2, we perform sensitivity analysis to examine how changes in selected parameter values impact the results. Lastly, in Section 6.3, we study the impact of regulatory uncertainty.

6.1 Base Case

The offshore wind developer is faced with the decision to invest immediately, delay the investment opportunity for a certain amount of time or to never invest at all in a radial, hybrid and meshed offshore wind project, respectively. As it is usually the regulator that is the decisive party regarding permitting a certain grid solution, we do not consider the optimal choice between the different grid solutions but study the investment opportunities as separate cases. We then compare the investment incentives across the different grid configurations. We aim to determine qualitative differences between the grid solutions and understand the difference in the attractiveness of the solutions from the developer’s perspective.

Applying the solution approach to our base case parameter set leads to the results presented below. Figure 8 illustrates the distribution of the NPV and ROA project values for each of the projects using 3,000 simulations, with average project values provided in Table 3.

Table 3: NPV and ROA project values in base case for a radial, hybrid and meshed project.

(in EUR m)	Radial	Hybrid	Meshed
NPV	418.3	9.0	857.1
ROA	418.3	21.8	857.1

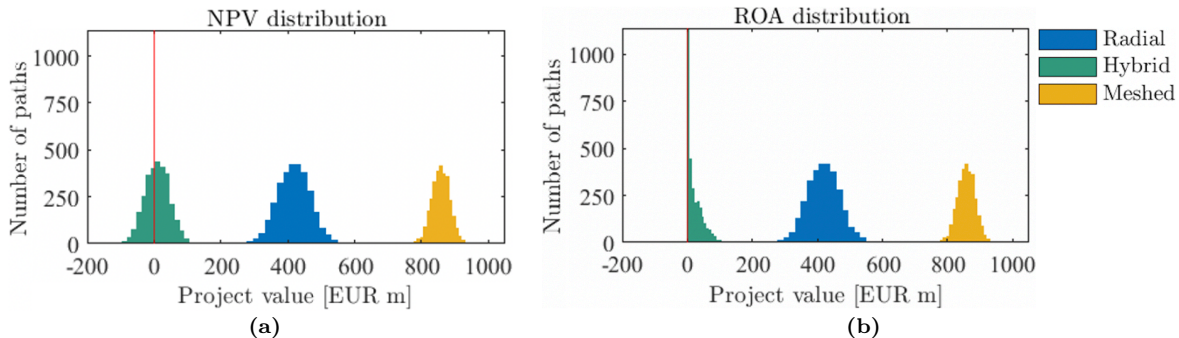

Figure 8: Distribution of (a) NPV and (b) ROA project values for a radial, hybrid and meshed project.

Our results indicate that the meshed grid is the most attractive solution to developers, according to both evaluation methods. The developer would be willing to pay 105% more for access to a meshed grid compared to a radial connection. This shows the upside of selling at higher foreign prices compared to lower home market prices. For the radial and meshed project, respectively, both the NPV and ROA project value are identical. The reason for this is that all paths are considered in the money in Year 1 and the conditional expected value of continuation does not exceed the now-or-never investment value. Hence, there is no value of waiting. The hybrid solution is the least profitable and findings reveal a significant number of negative NPVs for this configuration. This stems from electricity being sold at overall lower prices in a hybrid setup than in a radial and meshed setup. As there are no negative project values when applying the ROA, the average NPV is considerably lower than the ROA project value. The developer can limit the downside by choosing not to invest in case of low prices. However, there is room for wrong investment decisions still in theory.

Figure 9 illustrates the results related to the optimal investment time of a radial, hybrid and meshed project in terms of uncertainty in future electricity prices. By applying the LSM algorithm working in

a backward recursive manner, starting from Year 10 and moving stepwise to Year 1, the optimal timing for each simulation path is found. Whilst it is optimal to invest immediately for all simulation paths for the radial and meshed setups, the percentage distribution of the paths for the hybrid grid solution is more spread out. In 60% of the paths it is optimal to invest immediately, i.e. Year 1, and in 25.9% of the paths the optimal strategy is to delay the decision to observe how prices develop and invest between Year 2 and Year 10. In 14.1% of the cases it is never optimal to invest in the hybrid project due to unfavourable market conditions.

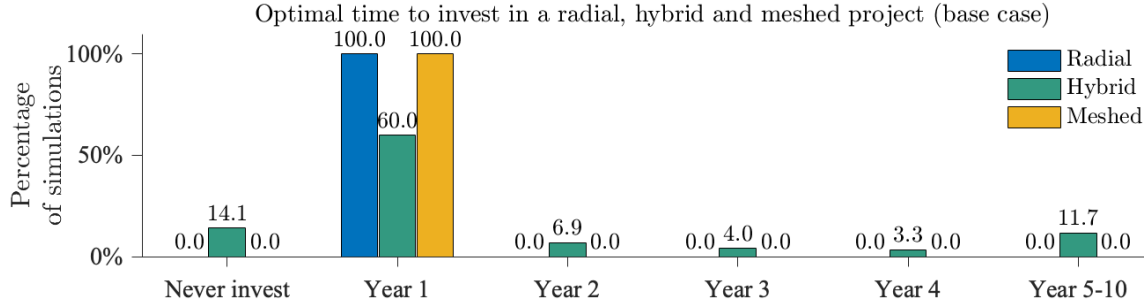

Figure 9: Optimal time to invest in a radial, hybrid and meshed project as a percentage of total simulation paths.

Given identical costs incurred in all grid solutions, results indicate that having the option to defer investment to observe if electricity prices have evolved such that it is interesting enough to invest, creates a value of waiting for developers in a hybrid grid as they bear the risk of selling at lower prices than developers in a radial or meshed setup. Overall higher prices to be captured in a radial and meshed project makes the investment incentive today so large that it is optimal to invest immediately in these grid solutions.

6.2 Sensitivity Analysis

In this section, we perform sensitivity analysis to examine the impact on the optimal timing, NPV and ROA project value to changes in selected parameter values. We concentrate on the effect of investment costs, price volatility and long-term average price levels in the connected markets, as well as the effect of two different contract structures for the following reasons. First, actual costs related to each investment project are difficult to estimate, which can impact the investment decision. Second, in the next decades, according to NVE (2021), larger build-outs of intermittent wind and solar power in Europe, combined with higher CO₂ prices, will lead to increased power price fluctuations in Norway. Likewise, with the expected growing offshore wind market in the UK and Denmark to meet ambitious offshore wind targets, UK and Danish prices are also expected to be more volatile. In this regard, the volatility parameters calibrated from historical data may not be representative for the future. Third, according to NVE (2021), power prices in Europe are expected to be higher in the future. This is due to, inter alia, higher CO₂ prices, increased power demand and increased power exchange between Nordic and European energy markets. Therefore, we next study how different price levels in one of the three markets relative to the other connected markets affect developers' investment incentives for the grid solutions. Lastly, as pointed out by the European Commission, financial support may be needed to create adequate investment incentives for developers (European Commission 2020c). To this end, we consider the effect of two different contract structures that have been discussed by European Commission (2020c) and ENGIE Impact (2022).

6.2.1 Impact of Costs

Investment costs largely impact the investment strategy and profitability of the projects. Figure 10 shows the effect on the NPV and ROA project value to changes in the total investment costs I . For our base case scenario, we assume a total cost of EUR 4.4 bn, making the meshed project the most interesting grid solution for the developer. Increasing I up from this level, we find that for both the NPV and ROA valuation, the hybrid project is the first to become unprofitable, followed by the radial and meshed solution. In terms of the relative difference in costs of when the project values turn negative, we find that developers would be willing to pay around 9.3% (9.4%) more for a radial than a

hybrid project according to the NPV (ROA) valuation, and 19.3% (18.3%) more for a meshed than a hybrid project according to the NPV (ROA) valuation. Similar for all projects, though at different cost levels, we find a small value of flexibility as the costs grow. This is due to an increasing percentage of simulation paths in which the optimal decision is to never invest. Having the option to not invest at a later point if market conditions should remain unfavourable provides insurance to the developer.

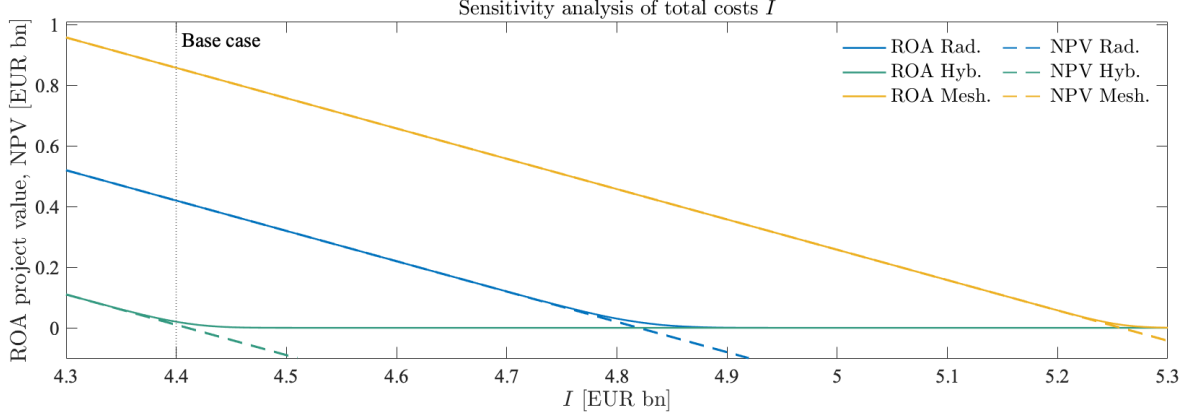

Figure 10: Sensitivity of the NPV and ROA project value to changes in total investment costs.

Figure 11 shows the effect on the optimal timing when total investment costs are increased to EUR 5.28 bn. Compared to results for the base case in Figure 9, findings indicate that rising costs increase the probability that the optimal decision is to never invest. As expected from Figure 10, the radial and hybrid projects are not profitable anymore with all paths out of the money and resulting negative NPVs (EUR -461.7 m and EUR -870.6 m, respectively). For the meshed project, the developer invests immediately in 19.8% of the cases, between Year 2 and Year 10 in 24.8% of the cases, and never invests in 55.4% of the cases. As a result of the majority of the paths never being exercised, the NPV turns negative (EUR -22.9 m). The ROA project value decreases less than the NPV and remains positive (EUR 4.1 m), reflecting the additional value due to timing flexibility, ignored by the NPV.

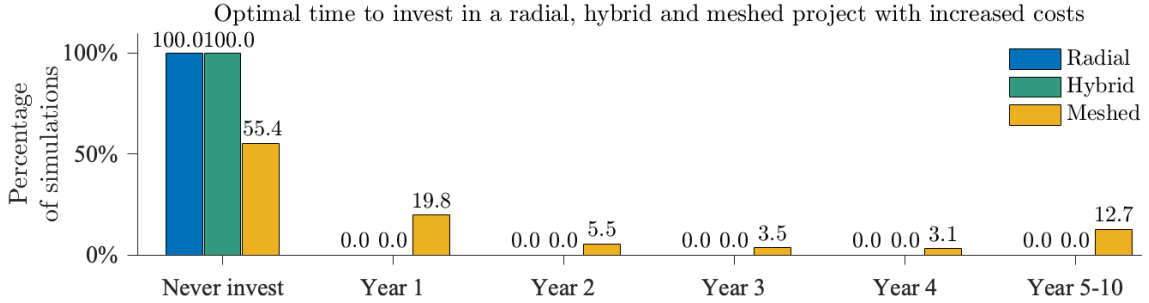

Figure 11: Optimal time to invest in a radial, hybrid and meshed project as a percentage of total simulation paths when total investment costs are increased by 20% (from EUR 4.4 bn to EUR 5.28 bn).

Although there are paths exercised later than Year 1, similar for the projects is that the value from waiting another year to invest is relatively small. Depending on total costs, the majority of the paths are either exercised in Year 1 or not at all, closely analogous to an NPV decision.

6.2.2 Impact of Price Volatility

Figure 12 depicts the change in the NPV and ROA project value for a radial, hybrid and meshed grid with changes in the price volatility in (a) NO₂, $\hat{\sigma}_N$, (b) the UK, $\hat{\sigma}_{UK}$, and (c) DK1, $\hat{\sigma}_D$.²⁰

²⁰The interplay between volatility parameters in connected markets have been checked for the hybrid and meshed project. Naturally, findings reveal changes in quantitative results, but similar curvatures are observed with changes in the respective volatility parameter such that general qualitative insights remain the same (see Appendix A.1).

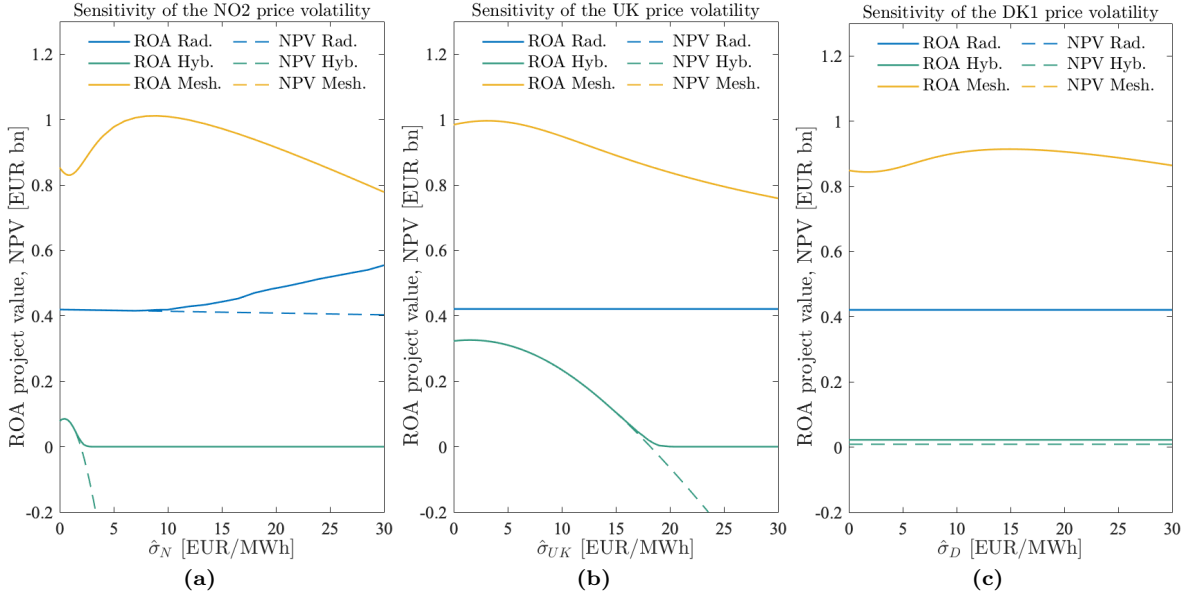

Figure 12: Sensitivity of the NPV and ROA project value to changes in the price volatility in (a) NO2; (b) the UK; and (c) DK1, i.e. generally the low-, high- and medium-priced market, respectively.

In Figure 12a, results for the radial project show that as the price volatility in the home market ($\hat{\sigma}_N$) increases, the ROA project value increases relative to the NPV. This indicates that it is more profitable to defer investment if we expect large price fluctuations in the home market. The intuition behind this result is that it provides the developer with a value of flexibility. For a moderate increase in volatility up from a generally low historical level as in the NO2 market, the opportunity cost of investing immediately in a radial project rather than waiting is negligible. These results support real options theory in observing increasing option value for increasing volatility (Dixit & Pindyck 1994).

Contrarily, Figure 12a and 12b show that for a hybrid project, higher price volatility in at least one of the markets involved only harms the developer's project value. The shape of the curves indicates that the relation between the two prices is decisive for the resulting price formed in the offshore bidding zone. With higher volatility, there is a larger possibility of both low and high future electricity prices. Since the developer always sells power at the lowest price in the hybrid setup (i.e. lowest of $P_{N,t}$ and $P_{UK,t}$), the exposure to the downside in terms of low prices has a significantly larger impact on the project value than the possibility of having an upside from high power prices. This downside risk reduces investment incentives for hybrid projects from the developer's point of view. We can also conclude from Figure 12a and 12b that if we expect significantly high volatility levels, the optimal decision would be to never invest in the hybrid grid.

For a meshed project, Figure 12 shows a different effect on the project value to changes in the volatility compared to radial and hybrid solutions. The initial downward and upward trend in project value for increasing volatility in a generally low- and medium-priced market (Figure 12a and 12c) can be explained by the interchangeable relationship between the lowest and median of the prices affecting the resulting price offshore. For low volatility levels in a generally high-priced market (Figure 12b), the project value exhibits less oscillation, due to prevention of selling at the highest price. With larger expected price fluctuations, findings reveal that investing in a meshed project would provide better protection for the developer against the downside of high volatility levels compared to a hybrid solution. The reason for less exposure to revenue loss is that the developer under some circumstances sells power at the medium price due to congested flow towards the low- and high-priced markets, which mitigates the downside in terms of low prices in one of the connected markets. This is in line with Kitzing & Schröder (2012), suggesting that connecting three markets can mitigate some of the risk faced in a two country setup. In addition, due to the meshed project's higher profitability, the NPV and ROA project value coincide, indicating that the additional value due to timing flexibility is unaffected by volatility. As such, the developer's optimal strategy is to invest immediately.

6.2.3 Impact of Long-Term Average Price Level

In our base case, we assume higher future price levels than obtained from historical data, due to the expectation of a further rise in electricity prices. Given average historical price levels (i.e. $\bar{P}_N=29.16$, $\bar{P}_{UK}=50.84$ and $\bar{P}_D=32.87$ EUR/MWh), we find the NPV of the radial, hybrid and meshed project to be EUR -1.6 bn, EUR -1.8 bn and EUR -1.1 bn, respectively, and the ROA project value zero in all cases. Whilst our base case results with higher prices indicate that the developer has certain incentives to invest in each of the grid solutions, none of the projects would be interesting enough to invest in with the low historical prices.

Using our base case price levels, Figure 13 shows the effect on the NPV and ROA project value for a radial, hybrid and meshed project to changes in the long-term price in (a) NO2, \bar{P}_N , (b) the UK, \bar{P}_{UK} , and (c) DK1, \bar{P}_D . In Figure 13a, as the home market price (\bar{P}_N) reverts to a higher level, the project value of a radial connection increases. As expected, this is due to sale of electricity at higher prices leading to higher expected revenues for the developer. If the home market price becomes significantly higher than the price in the other countries, investing in a radial project would be the most profitable alternative. With higher foreign prices, the meshed grid is preferable.

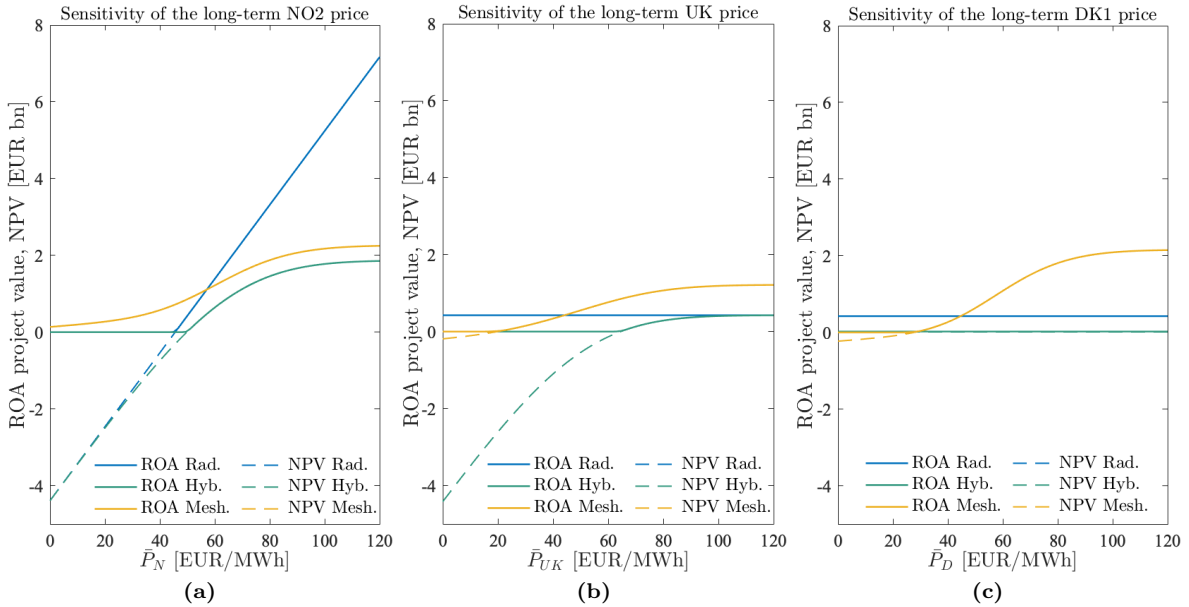

Figure 13: Sensitivity of the NPV and ROA project value to changes in the long-term price level in (a) NO2; (b) the UK; and (c) DK1.

In contrast to a radial, the project value of a hybrid and meshed grid is dependent on two (\bar{P}_N and \bar{P}_{UK}) and three (\bar{P}_N , \bar{P}_{UK} and \bar{P}_D) prices, respectively. Depicted in Figure 13a and 13b for the hybrid and also Figure 13c for the meshed project, the developer would not be able to gain from the upside of high prices in one of the markets should this price become significantly higher than the others. For the hybrid case, the project value of the radial connected to the home market also serves as an upper limit should the foreign market have considerably higher prices than the home market. The intuition behind these findings is that in the hybrid setting, the developer sells electricity at the lowest price. In the meshed case, the low and medium prices are the limiting factors where the flow always is congested towards the high-priced market. However, with the possibility of selling at higher prices in a meshed compared to a hybrid project, the developer is less exposed to the risk of foregoing upside potential of receiving a higher price than the lowest price. As suggested by Ørsted (2020), the market value of offshore wind power would be more transparent if the price formed in the offshore bidding zone is equal to the price of the market to which power flows. Thus, since only gaining from low or medium prices, the developer's income stream does not mirror nearby power demand. This may hinder development of especially hybrid projects.

6.2.4 Impact of Congestion Income

Transmitting power between distinct price zones creates potential wholesale price spreads, generating congestion income for the TSO. A part of this income is associated with offshore wind generation, leaving the developer with reduced income and causing disproportionate allocation of revenues across involved stakeholders, according to THEMA Consulting Group (2020). European Commission (2020e) highlights that reallocation of congestion income associated with offshore wind generation from the TSO to the developer can align investment incentives for developers and TSOs. Given the expectations of higher price volatility and price levels in the future, it is desirable to study whether introducing congestion income as part of the developer's income stream can mitigate offshore risk for hybrid and meshed projects under such market conditions.

From a developer's perspective, Figure 14 shows the effect on the ROA project value to changes in volatility levels in NO2 prices, $\hat{\sigma}_N$, for a (a) hybrid and (b) meshed project given five levels of congestion income gained on offshore wind production.²¹ $\xi = 0$ denotes no congestion income as in the base case and $\xi = 1$ denotes congestion income on all wind production. Our findings suggest that the negative effect of increased price volatility in especially a hybrid setup can be reversed if including a certain amount of congestion income. For increasing shares, the project value of a hybrid setup can also exceed that of a radial connection for a larger range of price volatilities. We also find that a lower share of congestion income is required from the developer's side in a meshed setup compared to a hybrid setup to offset the risk of income loss in case of increased price volatility. Whilst allowing for investment in meshed solutions would be beneficial for developers, the need of less reallocation would also benefit the TSO.

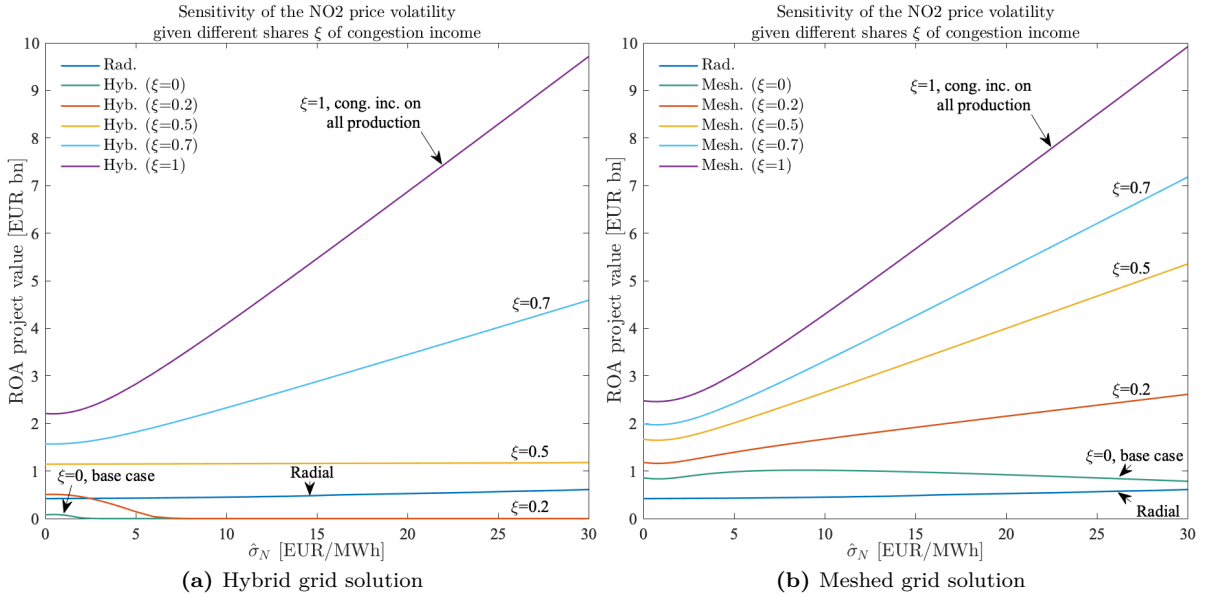

Figure 14: Sensitivity of the ROA project value to changes in the NO2 price volatility for the (a) hybrid; and (b) meshed project, given different shares of congestion income. The radial serves as a reference case.

In case of an increased long-term price level in one of the markets, Figure 15 shows this effect on results for a (a) hybrid and (b) meshed project when including shares of congestion income.²² Results indicate that the foregone upside potential of high power prices in one of the countries can be mitigated under both grid setups if reallocating congestion income. It is particularly visible for the hybrid project that the developer is vulnerable to low prices, and would need more congestion income to reach the project value of a radial than required in a meshed project. In the absence of congestion income, the developer would always have higher incentives to invest in a radial than a hybrid project, whilst a meshed grid would be more attractive for low home market prices. Enabling reallocation, the project values could

²¹General qualitative insights are the same when changing the price volatility in all markets under study. Sensitivity analysis results of changing $\hat{\sigma}_{UK}$ and $\hat{\sigma}_D$ are provided in Appendix A.2.

²²Variation in the level to which the home market price reverts (\bar{P}_N) is provided as an example. Similar major insights are found when changing \bar{P}_{UK} and \bar{P}_D . See Appendix A.3 for sensitivity analysis results.

reflect to a larger extent power demand in the market to which offshore wind power flows. However, congestion income for the developer would result in less income for the TSO. On this ground, ENTSO-E (2021) argues that reallocation of congestion income is not a transparent solution to support developers, with likely distortions of grid tariffs affecting onshore customers, i.e. grid tariffs paid by onshore grid users would need to increase by the corresponding share of reallocated congestion income used to cover costs of offshore generation. ENTSO-E (2021) also claims that expansion towards a meshed grid would enable the developer to capture a higher price in the offshore bidding zone than in a hybrid grid. Considering that, as our findings reveal, the resulting share of congestion income to be agreed upon by the parties should take into account the number of connected markets. Moreover, if projects are not profitable enough without subsidies, then it is better not to install them, but this could pose serious challenge towards achieving climate targets.

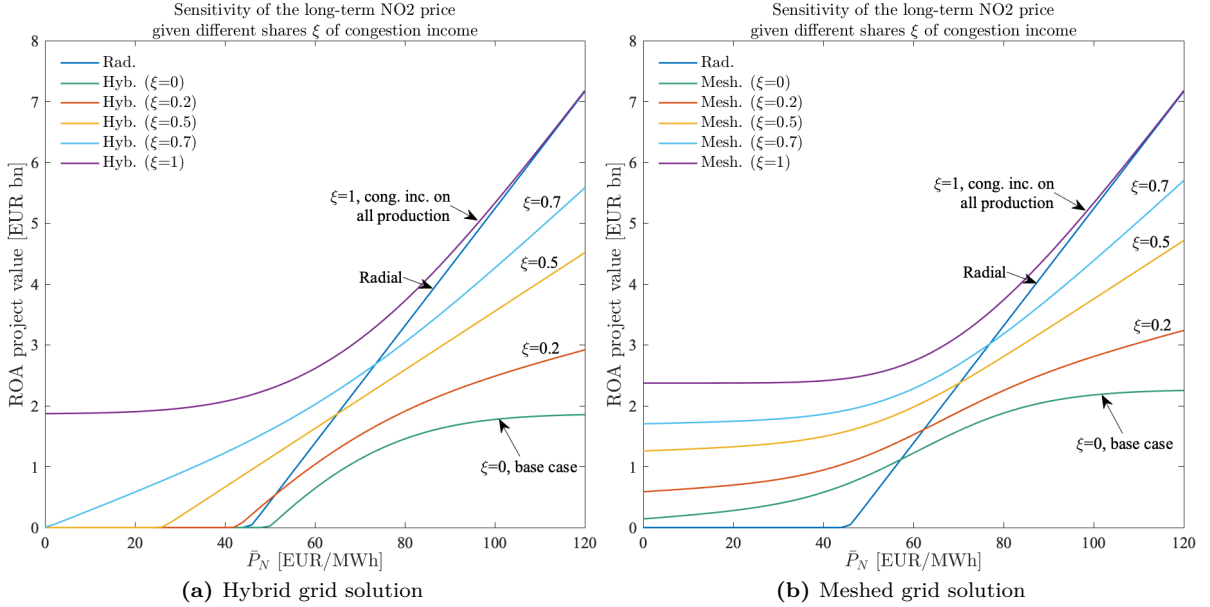

Figure 15: Sensitivity of the ROA project value to changes in the long-term NO2 price for the (a) hybrid; and (b) meshed project, given different shares of congestion income. The radial serves as a reference case.

6.2.5 Impact of Congestion Income and TAG under Capacity Limitations

Argued by ENGIE Impact (2022), reallocation of congestion income may overcompensate offshore wind developers, thus discriminating towards other power producers. To this end, it proposes a TAG scheme, i.e. a monetary compensation only targeted at the risk of potential reductions in interconnection capacity limiting developers to export available generation. Situations with reduced transmission capacity happen in practice, for example in Germany, the TSO TenneT frequently reduces cross-border electricity trade on the NordLink interconnector between Norway and Germany in order to relieve congestion inside the domestic grid. Similarly on the Norwegian side, Statnett occasionally reduces the capacity due to grid limitations in the NO2 area (Statnett 2020, Europower 2021). Another example is reduced grid capacity within Germany hindering import of Danish wind power, causing Germany to pay Danish wind farm owners for the power that was not delivered as agreed (DR 2022). Under capacity limitations, it is thus desirable to compare congestion income and TAG as support schemes. Due to expectations of larger price fluctuations and higher average price levels than seen historically, we focus on these market conditions. As a basis, we set 400 MW in all directions, and reduce each line to 100 MW to study the impact of limited capacity to each of the markets relative to the others.

Figure 16 shows the effect on the developer's project value for various NO2 price volatility levels, $\hat{\sigma}_N$, for a (a) hybrid and (b) meshed project, given no or full reallocation of congestion income and TAG.²³ Findings reveal that exclusive of support schemes, the developer is adversely impacted by increased price fluctuations under capacity limitations in both grid setups. Owing to more frequently congested

²³See Appendix A.4 for sensitivity analysis results when varying $\hat{\sigma}_{UK}$ and $\hat{\sigma}_D$.

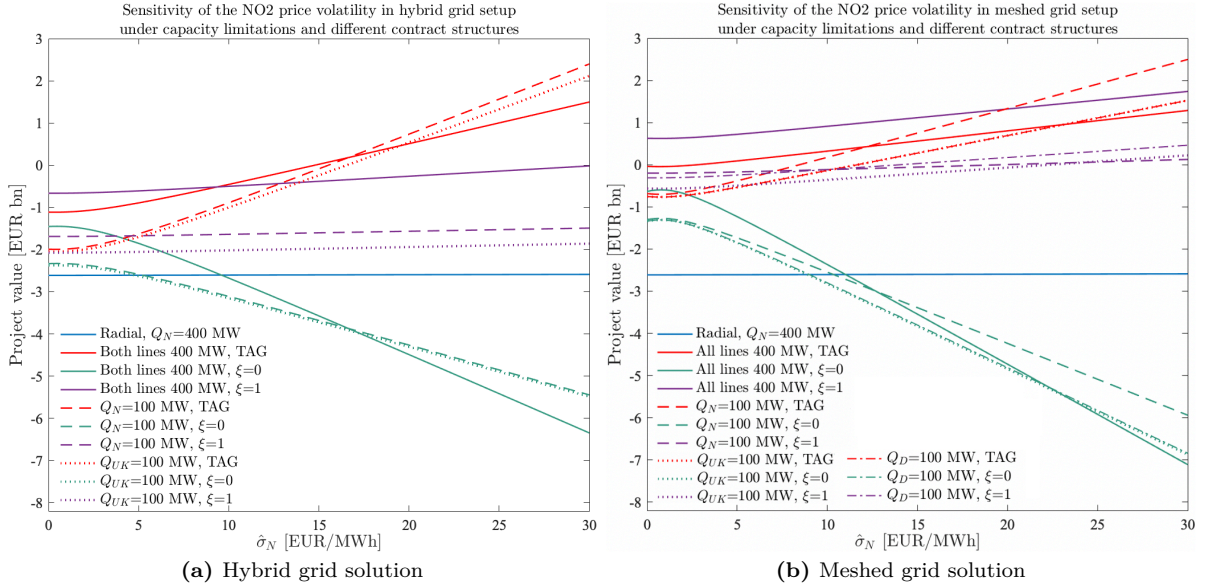

Figure 16: Sensitivity of the NPV to changes in the NO2 price volatility under capacity limitations and two support schemes for the (a) hybrid; and (b) meshed project. Green curves represent no compensation ($\xi=0$ and no TAG), purple curves reallocation of all congestion income on wind production ($\xi=1$), and red curves the TAG scheme. Different shares of congestion income fall between green and purple curves.

flow towards high- and medium-priced markets, the developer often sells power at zero or low prices, which can turn considerably low for high volatilities, explaining the declining effect. Entering into a contract of full reallocation of congestion income or a TAG scheme under capacity limitations can, however, create insurance for the developer against this revenue loss. We find that the TAG can be more attractive to developers than congestion income for high price volatilities, especially under a hybrid setup, although this depends on the specific volatility increase. For a meshed project, higher volatility levels are generally needed to prefer TAG over congestion income. These findings are related to the available export capacity, being specifically limited in a hybrid grid, reducing the amount of congestion income that can be reallocated. The TAG, on the other hand, providing compensation on total available generation, increases with higher reference prices relative to the offshore price. Another finding is that with reduced capacity towards a high-priced market, the TAG compensates more than congestion income over a larger volatility range compared to reduced capacity towards a low-priced market. This is related to reduced congestion income on the line towards the high-priced market. From the TSO's perspective being responsible for the compensation, introducing TAG with the prospect of larger price fluctuations could serve as a preventive measure to avoid grid limitations.

The difference between the two contract structures also comes to light looking at the results presented in Figure 17, showing the impact on project value for various long-term NO2 prices, \bar{P}_N , for a (a) hybrid and (b) meshed project.²⁴ We find that the TAG would only be more attractive than full congestion income if the reference price set under the TAG scheme becomes significantly higher than the price in the other markets. Thus, when the generally low-priced market is set as the reference zone, high prices in foreign markets can only be exploited with congestion income.

However, although TAG could compensate more than full reallocation of congestion income under certain scenarios, the TAG scheme only applies within a capacity range, and the developer would still be exposed to downside risk beyond this point. As such, the TAG might not be sufficient to warrant investment opportunities as profitable enough.

²⁴See Appendix A.5 for sensitivity analysis results when varying \bar{P}_{UK} and \bar{P}_D .

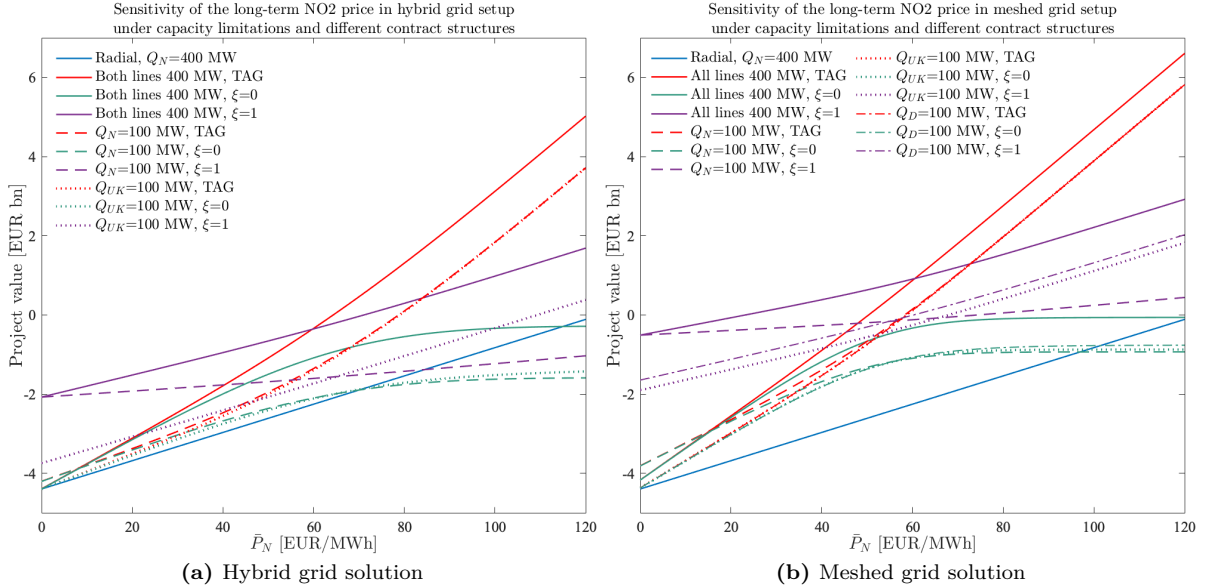

Figure 17: Sensitivity of the NPV to changes in the long-term NO₂ price under capacity limitations and two support schemes for the (a) hybrid; and (b) meshed project. Green curves represent no compensation ($\xi=0$ and no TAG), purple curves reallocation of all congestion income on wind production ($\xi=1$), and red curves the TAG scheme. Different shares of congestion income fall between green and purple curves.

6.3 Impact of Regulatory Uncertainty

As an additional element in our analysis, we examine the impact of regulatory uncertainty in terms of enforcing an extended grid solution at a future point in time. Motivated by the situation in Norway where the regulator decided to first establish radial connections and assess cables with two-way power flow later on, the following questions arise: How would developers of already operating radial projects be affected if having a chance to be integrated into hybrid or meshed solutions at a later point in time (given sufficient pre-investments in technical solutions)? How would this unpredictability of not knowing when and whether the integration occurs affect developers' investment incentives overall? To analyse this, we assume an investment in a radial project is undertaken. The developer then gets the opportunity to switch to a hybrid or meshed grid configuration if announced by the government at a later, unknown point in time.

Figure 18 shows the effect on the developer's project value to changes in the arrival rate of the switching announcement, λ . The project value exclusive of the switching option, i.e. the value of operating a radial project in a generally low-priced market over the lifetime, is included, along with the impact of different shares of congestion income. We find that when the likelihood of switching is higher, it only benefits the developer in case of a meshed solution. In the absence of a certain share of congestion income (less than approximately $\xi=0.2$ in our case), a higher likelihood of switching to a hybrid grid solution decreases the project value from the developer's point of view. Without additional support, staying with the radial would be more profitable than switching to the hybrid project. Thus, the developer would only benefit from higher likelihood to switch if bringing up the alternative of a meshed solution or including high enough congestion income for the hybrid solution. We can also confirm our findings from Section 6.2.4 that a meshed setup is always more profitable than a hybrid solution for a given share of congestion income.

From a regulator's perspective that aims at incentivising investments in offshore wind production, our results show that choosing for a meshed grid from the beginning on is always more attractive from a developer's perspective. For example, comparing the immediate investment value of a radial, hybrid and meshed solution with the project value including the switching option for a low ($\lambda=0.1$) and high ($\lambda=0.6$) likelihood of switching, as stated in Table 4, we find that an immediate investment in a meshed project yields a 5% higher project value than if there is a relatively high likelihood of switching from a radial to a meshed project. If reallocating congestion income on all production, an immediate investment in a hybrid grid yields a 8% higher project value than that obtained when there is a high likelihood of extending the radial link to a hybrid grid later on.

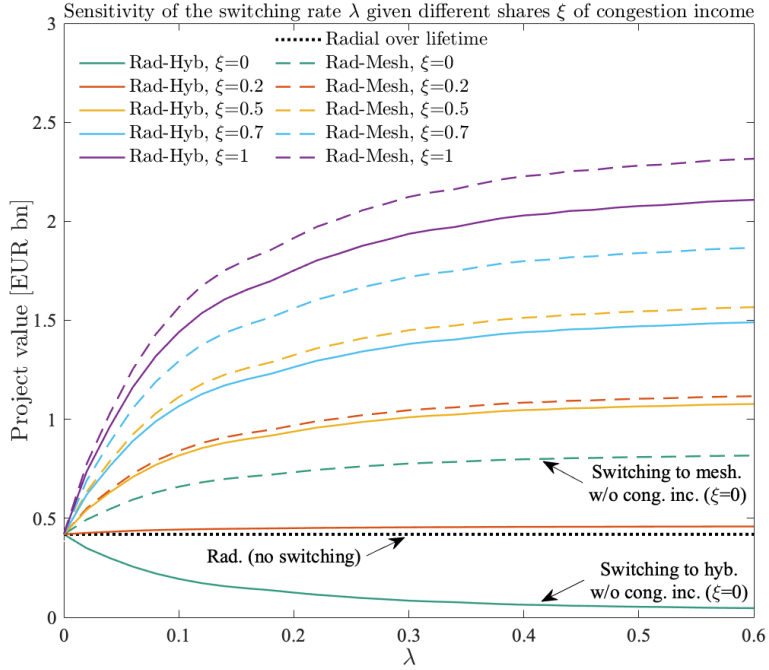

Figure 18: Sensitivity of project value to changes in the arrival rate of the regulatory announcement regarding a possible expansion from a radial to hybrid or meshed grid solution. Five different shares of congestion income earned on wind power production are examined.

Table 4: Comparison of project values from immediate investment for a radial, hybrid and meshed grid and project values including the switch from a radial to a hybrid or meshed solution for a low, i.e. $\lambda=0.1$, and high, i.e. $\lambda=0.6$, likelihood that the switch occurs, given $\xi=0$. Values in parenthesis refer to $\xi=1$.

(in EUR m)	Radial	Hybrid	Meshed
Immediate investment	418.3	9.0 (2,278)	857.1 (2,507)
		First radial, then hybrid	First radial, then meshed
Switching, $\lambda=0.6$		46.4 (2,108)	816.9 (2,316)
Switching, $\lambda=0.1$		194.0 (1,440)	659.6 (1,566)

According to the latest news release (E24 2022a, NRK 2022), the Norwegian government confirms that connections to foreign markets will be possible in the future. However, the timeline of when hybrid or meshed grid solutions will be introduced is still uncertain. Several opposition parties in Norway agree that lack of preciseness in development plans for offshore wind projects create false signals to industry actors. The unpredictability raises concern because relevant actors instead may look to foreign countries or invest in oil and gas projects. Confirmed by our results, the unpredictability about whether and when the radial connection will be integrated into a hybrid or meshed solution has a significant impact on developers' investment incentives. Based on governmental actions, developers form expectations about possible outcomes, which is related to λ . If developers do not have sufficient trust in that the grid will soon or eventually be integrated into a meshed solution, the overall project does not seem very attractive to them. In order to enhance the attractiveness and help to increase trust, our results show that more clarification of future plans and signalling from the government is advised. It could also be argued whether an added value should be priced into the radial transmission asset when it is sold and starts to generate revenues in a hybrid grid, as an alternative to receiving congestion income. From Figure 18, a monetary compensation equivalent to a certain share of congestion income could promote hybrid grid investments.

7 Conclusion

This paper analyses the economic attractiveness of three grid solutions for offshore wind projects from an offshore wind developer's perspective: (1) a radial connection, (2) a hybrid grid between two power markets, and (3) a meshed grid between three power markets. To study the developer's investment incentives, we apply real options theory accounting for uncertainty in future electricity prices and managerial flexibility, modelling the prices as mean-reverting processes. Expanding on existing literature, a least squares Monte Carlo (LSM) method is applied to identify the value of flexibility to postpone each investment decision along with the optimal investment time. Impacts on project values are studied under different market conditions, focusing particularly on price volatility and long-term average price levels. With this analysis, we discuss the importance of introducing support schemes for developers in hybrid and meshed setups and examine reallocation of congestion income and a Transmission Access Guarantee (TAG) as potential support measures. Further, this paper fills the gap in the literature on offshore grids on how developers are influenced by the risk of regulatory changes. To this end, we assume that investment in a radial project has been undertaken and examine the impact of a sudden enforcement of an extended grid solution by the regulator, modelled by a Poisson distribution. The proposed methodology is flexible and applicable to other related offshore wind investment problems involving up to three power markets. Our analysis provides valuable insight into the offshore risk faced by developers in an offshore bidding zone, being helpful for developers to make informed choices, and for regulators to create adequate investment incentives for developers to achieve offshore wind energy targets.

A case study of an offshore wind project at Sørilige Nordsjø II in Norway is presented, considering the NO2, UK and DK1 price areas. Results show that total investment costs largely impact the profitability of the projects and the optimal investment time, with overall a small value of waiting to invest with respect to price uncertainty. Findings also reveal important effects of volatility changes on project values. Whilst the project value including timing flexibility increases for the radial project with increasing volatility, contrary effects are seen for the other projects after a certain threshold level. Particularly for the hybrid case, the downside in terms of low prices has a significantly larger impact on the project value than the possibility of having an upside from high power prices. Investing in a meshed project with possibility to sell at the median of three prices, could provide better protection for the developer against high volatility levels compared to a hybrid solution. Given that the radial is connected to a generally low-priced market, we find that low home market prices make a meshed project more attractive to developers as they are able to exploit higher foreign prices.

We find that reallocating congestion income to developers can reverse the adverse impact of high price volatility in a hybrid and meshed grid, with a resulting lower share to be needed in a meshed case than a hybrid case to balance out the offshore risk. Under capacity limitations, full reallocation of congestion income and TAG can create insurance against high price volatility. The TAG is more attractive than congestion income for large price fluctuations, especially for hybrid grids, as well as over a larger volatility range with reduced capacity towards a high-priced market than a low-priced market. In addition, when the generally low-priced market is set as the reference zone, high foreign prices can only be exploited with congestion income. Yet, TAG alone is not sufficient to insure developers against offshore risk.

Lastly, our findings suggest that regulatory uncertainty has an important impact on developers' investment incentives. We find that developers are more likely to invest in a meshed grid solution when the arrival rate of a switching possibility increases. To incentivise investments, introducing such a project from the beginning on rather than delaying the meshed grid alternative, is more attractive to developers. We show that if developers do not have adequate trust in that the radial connection will be integrated into a meshed grid in the future, investment incentives decrease. Clear plans and signalling from the government can help to increase trust.

In what follows we touch on several future research ideas. In light of our findings, a pertinent extension of this analysis would be to also incorporate the TSO's perspective when comparing the different support measures under the specific market conditions, in order to ensure adequate investment incentives for either stakeholders. Further, a coordination issue between the corporate and regulatory side may arise if the developer is not responsible for extending the radial link into a bilateral or multilateral solution

and thus depends on the TSO's transmission planning. Therefore, another interesting direction would be to extend our model to incorporate the risk of a potential delayed grid connection. Looking forward, given increasing offshore wind capacity in the North Sea in the future, another interesting direction is to extend our model to include Power-to-X facilities in the grid system that can absorb excess generation that would otherwise be curtailed.

Bibliography

- Abadie, L. M. & Chamorro, J. M. (2014), ‘Valuation of Wind Energy Projects: A Real Options Approach’, *Energies* **7**(5), 3218–3255. URL: <https://doi.org/10.3390/en7053218>.
- Adkins, R. & Paxson, D. (2016), ‘Subsidies for Renewable Energy Facilities under Uncertainty’, *The Manchester School* **84**(2), 222–250. URL: <https://doi.org/10.1111/manc.12093>.
- ANU 100% Renewable Energy (n.d.), ‘windatlas’. URL: <http://windatlas.xyz/> [Accessed: 01.02.22].
- Apostolaki-Iosifidou, E., McCormack, R., Kempton, W., McCoy, P. & Ozkan, D. (2019), ‘Transmission Design and Analysis for Large-Scale Offshore Wind Energy Development’, *IEEE Power and Energy Technology Systems Journal* **6**(1), 22–31. DOI: 10.1109/JPETS.2019.2898688.
- Boomsma, T. K. & Linnerud, K. (2015), ‘Market and policy risk under different renewable electricity support schemes’, *Energy* **89**, 435–448. URL: <https://doi.org/10.1016/j.energy.2015.05.114>.
- Boomsma, T. K., Meade, N. & Fleten, S.-E. (2012), ‘Renewable energy investments under different support schemes: A real options approach’, *European Journal of Operational Research* **220**(1), 225–237. URL: <https://doi.org/10.1016/j.ejor.2012.01.017>.
- Commission Regulation (EU) 2015/1222 of 24 July 2015 establishing a guideline on capacity allocation and congestion management (Text with EEA relevance) (2015), *Official Journal of the European Union*, L 197, pp. 24–72 . URL: <http://data.europa.eu/eli/reg/2015/1222/oj> [Accessed: 29.04.22].
- Danish Energy Agency (n.d.), ‘Denmark’s Energy Islands’. URL: <https://ens.dk/en/our-responsibilities/wind-power/energy-islands/denmarks-energy-islands> [Accessed: 19.04.22].
- Dedecca, J. G. & Hakvoort, R. A. (2016), ‘A review of the North Seas offshore grid modeling: Current and future research’, *Renewable and Sustainable Energy Reviews* **60**, 129–143. URL: <https://doi.org/10.1016/j.rser.2016.01.112>.
- Dedecca, J. G., Lumbreras, S., Ramos, A., Hakvoort, R. A. & Herder, P. M. (2018), ‘Expansion planning of the North Sea offshore grid: Simulation of integrated governance constraints’, *Energy Economics* **72**, 376–392. URL: <https://doi.org/10.1016/j.eneco.2018.04.037>.
- Department for Business, Energy & Industrial Strategy (2022), ‘Government hits accelerator on low-cost renewable power’. [Press release]. 9 February. URL: <https://www.gov.uk/government/news/government-hits-accelerator-on-low-cost-renewable-power> [Accessed: 16.05.22].
- Dixit, A. K. & Pindyck, R. S. (1994), *Investment Under Uncertainty*, Princeton University Press.
- DR (2022), ‘Landmand løfter sløret for mystisk fænomen: Derfor står vores vindmøller bomstille, når det blæser’. URL: <https://www.dr.dk/nyheder/landmand-loefter-sloeret-mystisk-faenomen-derfor-s-taar-vores-vindmoeller-bomstille-naar-det> [Accessed: 08.05.22].
- Díaz, G., Gómez-Aleixandre, J. & Coto, J. (2015), ‘Dynamic evaluation of the levelized cost of wind power generation’, *Energy Conversion and Management* **101**, 721–729. URL: <https://doi.org/10.1016/j.enconman.2015.06.023>.
- Díaz, G., Moreno, B., Coto, J. & Gómez-Aleixandre, J. (2015), ‘Valuation of wind power distributed generation by using Longstaff-Schwartz option pricing method’, *Applied Energy* **145**, 223–233. URL: <https://doi.org/10.1016/j.apenergy.2015.02.046>.
- E24 (2022a), ‘Fremskynder havvindplaner uten å nevne hybridkabler: – Forventer avklaring snarest’. URL: <https://e24.no/det-groenne-skiftet/i/nWoBln/fremskynder-havvindplaner-uten-aa-nevne-hybridkabler-forventer-avklaring-snarest> [Accessed: 06.06.22].
- E24 (2022b), ‘Norge blir ikke med på historisk havvindsatsing i Nordsjøen’. URL: <https://e24.no/det-groenne-skiftet/i/G3Ej86/norge-blir-ikke-med-paa-historisk-havvindsatsing-i-nordsjoen> [Accessed: 05.06.22].
- ECMWF (n.d.), ‘ERA5’. URL: <https://www.ecmwf.int/en/forecasts/datasets/reanalysis-datasets/era5> [Accessed: 01.02.22].

- Elahidoost, A. & Tedeschi, E. (2017), Expansion of offshore HVDC grids: An overview of contributions, status, challenges and perspectives, in ‘2017 IEEE 58th International Scientific Conference on Power and Electrical Engineering of Riga Technical University (RTUCON)’, pp. 1–7. DOI: 10.1109/RTUCON.2017.8124767.
- Energinet (2021a), ‘*A Danish-German breakthrough for Bornholm as a future energy island*’. URL: <https://en.energinet.dk/About-our-news/News/2021/01/20/LoI-energy-island-baltic-sea> [Accessed: 18.04.22].
- Energinet (2021b), ‘*North Sea energy island can make Denmark and Belgium electricity neighbours*’. URL: <https://en.energinet.dk/About-our-news/News/2021/02/12/Elia-PR?listId=3187dd0d-12d9-4de8-9f78-ea5c9d11227c> [Accessed: 18.04.22].
- Energinet (n.d.), ‘*Kriegers Flak - Combined Grid Solution*’. URL: <https://en.energinet.dk/Infrastruktur-re-Projects/Projektliste/KriegersFlakCGS> [Accessed: 15.04.22].
- ENGIE Impact (2022), Support on the use of congestion revenues for offshore renewable energy projects connected to more than one market. ENER/C3/2021-373. 2nd Workshop.
- ENTSO-E (2021), ‘*ENTSO-E Position on Offshore Development: Assessing Selected Financial Support Options for Renewable Generation*’. URL: <https://www.entsoe.eu/outlooks/offshore-development/> [Accessed: 16.04.22].
- Equinor (n.d.), ‘*Hywind Tampen: the world’s first renewable power for offshore oil and gas*’. URL: <https://www.equinor.com/en/what-we-do/hywind-tampen.html> [Accessed: 07.06.22].
- Escribano, A., Peña, J. I. & Villaplana, P. (2011), ‘Modelling Electricity Prices: International Evidence’, *Oxford Bulletin of Economics and Statistics* **73**(5), 622–650. URL: <https://doi.org/10.1111/j.1468-0084.2011.00632.x>.
- European Commission (2020a), ‘*Commission Decision (EU) 2020/2123 of 11 November 2020 granting the Federal Republic of Germany and the Kingdom of Denmark a derogation of the Kriegers Flak combined grid solution pursuant to Article 64 of Regulation (EU) 2019/943 of the European Parliament and of the Council*’, *Official Journal of the European Union* . L 426/35. URL: <https://eur-lex.europa.eu/legal-content/EN/TXT/HTML/?uri=CELEX:32020D2123&from=EN> [Accessed: 15.04.22].
- European Commission (2020b), ‘*An EU Strategy to harness the potential of offshore renewable energy for a climate neutral future*’. SWD(2020) 273 final. URL: https://ec.europa.eu/energy/sites/ener/files/offshore_renewable_energy_strategy.pdf [Accessed: 18.04.22].
- European Commission (2020c), ‘*An EU strategy to harness the potential of offshore renewable energy for a climate neutral future*’. COM(2020) 741 final. URL: https://ec.europa.eu/energy/sites/ener/files/staff_working_document_on_the_offshore_renewable_energy_strategy.pdf [Accessed: 21.04.22].
- European Commission (2020d), ‘*COM/2020/562 final. Stepping up Europe’s 2030 climate ambition. Investing in a climate-neutral future for the benefit of our people.*’. URL: <https://eur-lex.europa.eu/legal-content/EN/ALL/?uri=CELEX:52020DC0562> [Accessed: 09.04.22].
- Europower (2021), ‘*Så ofte strupes utenlandskablene*’. URL: <https://www.europower-energi.no/nett/sa-ofte-strupes-utenlandskablene/2-1-1071860> [Accessed: 15.04.22].
- Finjord, F., Hagspiel, V., Lavrutich, M. & Tangen, M. (2018), ‘The impact of Norwegian-Swedish green certificate scheme on investment behavior: A wind energy case study’, *Energy Policy* **123**, 373–389. URL: <https://doi.org/10.1016/j.enpol.2018.09.004>.
- Fleten, S.-E., Linnerud, K., Molnár, P. & Nygaard, M. T. (2016), ‘Green electricity investment timing in practice: Real options or net present value?’, *Energy* **116**(1), 498–506. URL: <https://doi.org/10.1016/j.energy.2016.09.114>.
- Fleten, S.-E., Maribu, K. M. & Wangensteen, I. (2007), ‘Optimal investment strategies in decentralized renewable power generation under uncertainty’, *Energy* **32**(5), 803–815. URL: <https://doi.org/10.1016/j.energy.2006.04.015>.

- Girard, Y., Kemfert, C. & Stoll, J. (2021), ‘Comparing Regulatory Designs for the Transmission of Offshore Wind Energy’, *Economics of Energy & Environmental Policy* **10**(1), 229–249. URL: <https://doi.org/10.5547/2160-5890.10.1.ygir> [Accessed: 27.04.22].
- GWEC (2022), ‘Global wind report 2022’. URL: <https://gwec.net/wp-content/uploads/2022/03/GWEC-GLOBAL-WIND-REPORT-2022.pdf> [Accessed: 01.05.22].
- Harville, D. A. (1997), *Matrix Algebra From a Statistician’s Perspective*, 1 edn, Springer, New York, NY. URL: <https://doi.org/10.1007/b98818>.
- Hayes, L., Stocks, M. & Blakers, A. (2021), ‘Accurate long-term power generation model for offshore wind farms in Europe using ERA5 reanalysis’, *Energy* **229**(120603). URL: <https://doi.org/10.1016/j.energy.2021.120603>.
- Houghton, T., Bell, K. R. W. & Doquet, M. (2016), ‘Offshore transmission for wind: Comparing the economic benefits of different offshore network configurations’, *Renewable Energy* **94**, 268–279. URL: <https://doi.org/10.1016/j.renene.2016.03.038>.
- IEA (2019), ‘Offshore Wind Outlook 2019’. URL: https://iea.blob.core.windows.net/assets/495ab264-4ddf-4b68-b9c0-514295ff40a7/Offshore_Wind_Outlook_2019.pdf [Accessed: 27.03.22].
- Kim, K., Kim, B. & Kim, H. (2018), ‘A decision-making model for the analysis of offshore wind farm projects under climate uncertainties: A case study of South Korea’, *Renewable and Sustainable Energy Reviews* **94**, 853–860. URL: <https://doi.org/10.1016/j.rser.2018.06.061>.
- Kitzing, L. & González, M. G. (2020), ‘Market arrangements for offshore wind energy networks’. URL: https://backend.orbit.dtu.dk/ws/portalfiles/portal/222047192/NSON_DK_WP5_offshore_market_arrangements_final.pdf [Accessed: 22.05.22].
- Kitzing, L., Juul, N., Drud, M. & Boomsma, T. K. (2017), ‘A real options approach to analyse wind energy investments under different support schemes’, *Applied Energy* **188**, 83–96. URL: <https://doi.org/10.1016/j.apenergy.2016.11.104>.
- Kitzing, L. & Schröder, S. T. (2012), ‘Regulating Future Offshore Grids: Economic Impact Analysis on Wind Parks and Transmission System Operators’, *European University Institute* (65). URL: https://cadmus.eui.eu/bitstream/handle/1814/24679/RSCAS_2012_65.pdf.
- Konstantelos, I., Pudjianto, D., Strbac, G., De Decker, J., Joseph, P., Flament, A., Kreutzkamp, P., Genoese, F., Rehfeldt, L., Wallasch, A.-K., Gerdes, G., Jafar, M., Yang, Y., Tidemand, N., Jansen, J., Nieuwenhout, F., van der Welle, A. & Veum, K. (2017), ‘Integrated North Sea grids: The costs, the benefits and their distribution between countries’, *Energy Policy* **101**, 28–41. URL: <https://doi.org/10.1016/j.enpol.2016.11.024>.
- Laur, A. & Küpper, G. (2021), ‘ASSET study on smaller bidding zones in European power markets: liquidity considerations’, *Publications Office*. URL: <https://data.europa.eu/doi/10.2833/708220> [Accessed: 16.04.22].
- Li, L., Liu, J., Zhu, L. & Zhang, X.-B. (2020), ‘How to design a dynamic feed-in tariffs mechanism for renewables – a real options approach’, *International Journal of Production Research* **58**(14), 4352–4366. URL: <https://doi.org/10.1080/00207543.2019.1652776>.
- Longstaff, F. A. & Schwartz, E. S. (2001), ‘Valuing American Options by Simulation: A Simple Least-Squares Approach’, *The Review of Financial Studies* **14**(1), 113–147. URL: <https://doi.org/10.1093/rfs/14.1.113>.
- Lucia, J. J. & Schwartz, E. S. (2002), ‘Electricity Prices and Power Derivatives: Evidence from the Nordic Power Exchange’, *Review of Derivatives Research* **5**(1), 5–50. URL: <https://doi.org/10.1023/A:1013846631785>.
- McDonald, R. L. (2014), *Derivatives Markets*, 3 edn, Pearson.
- METCentre (n.d.), ‘Unitech Zephyros (Hywind Demo)’. URL: <https://metcentre.no/project/unitech-zephyros-hywind-demo/> [Accessed: 03.05.22].

- Ministry of Petroleum and Energy (2020), ‘*Opning av områda Utsira Nord og Sørlege Nordsjø II for konsesjonshandsaming av søknader om fornybar energiproduksjon etter havenergilova*’. URL: <https://www.regjeringen.no/contentassets/aaac5c76aec242f09112ffdceabd6c64/kg1.res-12.-juni-2020-opning-av-omrade-for-fornybar-energi-produksjon-til-havs.pdf> [Accessed: 15.04.22].
- Ministry of Petroleum and Energy (2021a), ‘*Meld. St. 36 (2020–2021). Energi til arbeid - langsiktig verdiskaping fra norske energiressurser*’. URL: <https://www.regjeringen.no/no/dokumenter/meld.-st.-36-20202021/id2860081/> [Accessed: 14.04.22].
- Ministry of Petroleum and Energy (2021b), ‘*Veileder for arealtildeling, konsesjonsprosess og søknader for vindkraft til havs*’. URL: <https://www.regjeringen.no/contentassets/5a7268e3397b4f4ea6eb4fa84897808e/veileder-for-arealtildeling-konsesjonsprosess-og-soknader-for-vindkraft-til-havs-11244319.pdf> [Accessed: 05.06.22].
- Ministry of Petroleum and Energy (2022), ‘*Meld. St. 11 (2021–2022): Tilleggsmelding til Meld. St. 36 (2020–2021) Energi til arbeid – langsiktig verdiskaping fra norske energiressurser - Foreløpig utgave*’. URL: <https://www.regjeringen.no/no/dokumenter/meld.-st.-11-20212022/id2908056/> [Accessed: 15.04.22].
- Montel (n.d.), ‘*Market data*’. URL: <https://www.montelnews.com/marketdata> [Accessed: 06.06.22].
- Moreno, M. & Navas, J. F. (2003), ‘On the Robustness of Least-Squares Monte Carlo (LSM) for Pricing American Derivatives’, *Review of Derivatives Research* **6**, 107–128. URL: <https://doi.org/10.1023/A:1027340210935>.
- National Grid (2020), ‘*National Grid and TenneT to jointly develop vision to link offshore wind farms to Britain and the Netherlands*’. [Press release]. 22 September. URL: <https://www.nationalgrid.com/national-grid-and-tennet-jointly-develop-vision-link-offshore-wind-farms-britain-and-netherlands> [Accessed: 18.04.22].
- National Grid (n.d.), ‘*Nautilus Interconnector*’. URL: <https://www.nationalgrid.com/national-grid-ventures/interconnectors-connecting-cleaner-future/nautilus-interconnector> [Accessed: 18.04.22].
- Nieuwenhout, C. T. (2022), ‘Dividing the sea into small bidding zones? The legal challenges of connecting offshore wind farms to multiple countries’, *Journal of Energy & Natural Resources Law* pp. 1–21. URL: <https://doi.org/10.1080/02646811.2021.2011034>.
- Nord Pool (n.d.), ‘*Market data*’. URL: <https://www.nordpoolgroup.com/en/Market-data1/#/nordic/table> [Accessed: 06.06.22].
- North Sea Wind Power Hub (2020), ‘*Market setup options to integrate hybrid projects into the European electricity market: Discussion Paper*’. URL: https://northseawindpowerhub.eu/sites/northseawindpowerhub.eu/files/media/document/NSWPH-Discussion_Paper_Market-Setups-for-Hybrid-projects1.pdf [Accessed: 22.04.22].
- North Sea Wind Power Hub (2021), ‘*Towards the first hub-and-spoke project*’. URL: https://northseawindpowerhub.eu/sites/northseawindpowerhub.eu/files/media/document/NSWPH_Concept%20Paper_05_2021_v2.pdf [Accessed: 18.04.22].
- Norwegian Government (2022a), ‘*Kraftfull satsing på havvind*’. [Press release]. 11 May. URL: <https://www.regjeringen.no/no/aktuelt/kraftfull-satsing-pa-havvind/id2912297/> [Accessed: 11.05.22].
- Norwegian Government (2022b), ‘*Storstilt satsing på havvind*’. [Press release]. 9 February. URL: <https://www.regjeringen.no/no/aktuelt/storstilt-satsing-pa-havvind/id2900436/> [Accessed: 27.03.22].
- NRK (2022), ‘*Lanserer store planar for havvind: Slik skal Noreg bli verdsleiande*’. URL: https://www.nrk.no/vestland/lanserer-store-planar-for-havvind__slik-skal-noreg-bli-verdsleiande-1.15993003 [Accessed: 07.06.22].
- NVE (2015), ‘*Kostnader i energisektoren: Kraft, varme og effektivisering*’. URL: http://publikasjoner.nve.no/rapport/2015/rapport2015_02a.pdf [Accessed: 14.04.22].
- NVE (2017), ‘*Revidert kostnadsrapport*’. URL: https://www.nve.no/Media/5869/tekstforklaring_kostnadsrapport2017_publicert09102017.pdf [Accessed: 14.04.22].

- NVE (2021), ‘*Langsiktig kraftmarkedsanalyse 2021-2040: Forsterket klimapolitikk påvirker kraftprisene*’. URL: https://publikasjoner.nve.no/rapport/2021/rapport2021_29.pdf [Accessed: 10.04.22].
- NVE (2022), ‘*Kostnader for kraftproduksjon*’. URL: <https://www.nve.no/energi/analyser-og-statistikk/kostnader-for-kraftproduksjon/> [Accessed: 01.05.22].
- Osmundsen, P., Emhjellen-Stendal, M. & Lorentzen, S. (2021), ‘Project economics of offshore windfarms. A business case’. URL: <https://norceresearch.brage.unit.no/norceresearch-xmlui/bitstream/handle/11250/2830740/Rapport%20NORCE%20samfunn%2032%202021.pdf?sequence=1&isAllowed=y> [Accessed: 04.05.22].
- PROMOTioN (2020), ‘*D12.4 - Final Deployment Plan*’. URL: https://www.promotion-offshore.net/fileadmin/PDFs/D12.4_-_Final_Deployment_Plan.pdf [Accessed: 25.04.22].
- Regulation (EU) 2019/943 of the European Parliament and of the Council of 5 June 2019 on the internal market for electricity (Text with EEA relevance.)* (2019), *Official Journal of the European Union* . L 158/54, pp. 54–124. URL: <http://data.europa.eu/eli/reg/2019/943/oj> [Accessed: 13.04.22].
- Reuter, W. H., Szolgayová, J., Fuss, S. & Obersteiner, M. (2012), ‘Renewable energy investment: Policy and market impacts’, *Applied Energy* **97**, 249–254. URL: <https://doi.org/10.1016/j.apenergy.2012.01.021>.
- Roggenkamp, M. M., Hendriks, R. L., Ummels, B. C. & Kling, W. L. (2010), ‘Market and regulatory aspects of trans-national offshore electricity networks for wind power interconnection’, *Wind Energy* **13**(5), 483–491. URL: <https://doi.org/10.1002/we.378>.
- Roland Berger (2019), ‘*Hybrid projects: How to reduce costs and space of offshore developments. North Seas Offshore Energy Clusters study*’. URL: <https://op.europa.eu/en/publication-detail/-/publication/59165f6d-802e-11e9-9f05-01aa75ed71a1/language-en/format-PDF/source-234398412> [Accessed: 07.04.22].
- Schröder, S. T. (2013), ‘Interconnector capacity allocation in offshore grids with variable wind generation’, *Wind Energy* **16**(2), 309–319. URL: <https://doi.org/10.1002/we.537>.
- Schröder, S. T., Meibom, P., Spiecker, S. & Weber, C. (2010), Market impact of an offshore grid — A case study, in ‘IEEE PES General Meeting’, pp. 1–5. URL: <https://doi.org/10.1109/pes.2010.5590044>.
- Schwartz, E. S. (1997), ‘*The Stochastic Behavior of Commodity Prices: Implications for Valuation and Hedging*’, *The Journal of Finance* **52**(3), 923–973. URL: <https://doi.org/10.2307/2329512>.
- Schwartz, E. S. (2013), ‘The Real Options Approach to Valuation: Challenges and Opportunities’, *Latin American Journal of Economics* **50**(2), 163–177. DOI: 10.7764/LAJE.50.2.163.
- Schwartz, E. & Smith, J. E. (2000), ‘Short-Term Variations and Long-Term Dynamics in Commodity Prices’, *Management Science* **46**(7), 893–911. URL: <http://www.jstor.org/stable/2661607>.
- Sedighi, M., Moradzadeh, M., Kukrer, O., Fahrioglu, M. & Vandeveld, L. (2016), ‘Optimal Electrical Interconnection Configuration of Off-Shore Wind Farms’, *Journal of Clean Energy Technologies* **4**, 66–71. DOI: 10.7763/JOCET.2016.V4.255.
- Spro, O. C., Torres-Olguin, R. E. & Korpås, M. (2015), ‘North Sea offshore network and energy storage for large scale integration of renewables’, *Sustainable Energy Technologies and Assessments* **11**, 142–147. URL: <https://doi.org/10.1016/j.seta.2014.12.001>.
- Statnett (2020), ‘*Gradvis økning av minimumskapasitet på NordLink*’. URL: <https://www.statnett.no/om-statnett/nyheter-og-pressemeldinger/nyhetsarkiv-2020/gradvis-okning-av-minimumskapasitet-pa-nordlink/> [Accessed: 15.04.22].
- Statnett (2021), ‘*Kraftig forbruksvekst og industrialiseringsplaner gir behov for mer kraftproduksjon*’. URL: <https://www.statnett.no/om-statnett/nyheter-og-pressemeldinger/nyhetsarkiv-2021/kraftig-forbruksvekst-og-industrialiseringsplaner-gir-behov-for-mer-kraftproduksjon/> [Accessed: 01.05.22].
- Statnett (2022), ‘*Fagrapport om havvind i Sørlige Nordsjø II*’. URL: <https://www.statnett.no/globalassets/for-aktorer-i-kraftsystemet/planer-og-analyser/havvind/fagrapport-om-havvind-i-sorlige-nordsjo-ii.pdf> [Accessed: 03.05.22].

- Stiesdal (2021), ‘*The TetraSpar full-scale demonstration project*’. URL: <https://www.stiesdal.com/offshore-technologies/the-tetraspar-full-scale-demonstration-project/> [Accessed: 20.04.22].
- THEMA Consulting Group (2020), ‘*Market arrangements for offshore hybrid projects in the North Sea*’. URL: <https://op.europa.eu/en/publication-detail/-/publication/28ff740c-25aa-11eb-9d7e-01aa75ed71a1/language-en> [Accessed: 08.04.22].
- Tosatto, A., Beseler, X. M., Østergaard, J., Pinson, P. & Chatzivasileiadis, S. (2022), ‘North Sea Energy Islands: Impact on National Markets and Grids’. DOI: 10.48550/ARXIV.2103.17056.
- Trötscher, T. & Korpås, M. (2011), ‘A framework to determine optimal offshore grid structures for wind power integration and power exchange’, *Wind Energy* **14**(8), 977–992. URL: <https://doi.org/10.1002/we.461>.
- WFO (2021), ‘*Global Offshore Wind Report: 1st half 2021*’. URL: https://wfo-global.org/wp-content/uploads/2021/08/WFO_Global-Offshore-Wind-Report-HY1_2021-1.pdf [Accessed: 15.04.22].
- WindEurope (2021), ‘*Ensuring the best possible conditions for the Estonia/Latvia hybrid offshore wind farm*’. URL: <https://windeurope.org/newsroom/news/ensuring-the-best-possible-conditions-for-the-estonia-latvia-hybrid-offshore-wind-farm/> [Accessed: 18.04.22].
- Yu, W., Sheblé, G. B., Lopes, J. A. P. & Matos, M. A. (2006), ‘Valuation of switchable tariff for wind energy’, *Electric Power Systems Research* **76**(5), 382–388. URL: <https://doi.org/10.1016/j.epsr.2005.09.004>.
- Zhao, X., Yao, J., Sun, C. & Pan, W. (2019), ‘Impacts of carbon tax and tradable permits on wind power investment in China’, *Renewable Energy* **135**, 1386–1399. URL: <https://doi.org/10.1016/j.renene.2018.09.068>.
- Ørsted (2020), ‘*Regulatory set-up for hybrid offshore wind projects*’. URL: <https://orstedcdn.azureedge.net/-/media/www/docs/corp/com/about-us/whitepaper/orsted-note-on-eu-framework-for-offshore-grids.ashx?la=en&rev=8ba187dc7ab3432f8dede75e7695141e&hash=A3056A194DC5FB25AF4030BB06842C2F> [Accessed: 16.04.22].

A Appendix

A.1 Sensitivity Analysis of Price Volatility

Figure 19 shows the effect on the NPV and ROA project value for a radial, hybrid and meshed project when varying the price volatility in the (a) NO2, (b) UK and (c) DK1 power market. Unlike Figure 12 in Section 6.2.2, different levels of volatility in the other respective markets are included for the hybrid (dark and light green) and meshed (yellow, orange and red) project, in order to understand the interplay between the parameters. For each of these projects, similar shape of the curves is observed for changes in the respective volatility parameter. As discussed in Section 6.2.2, major findings reveal that the value of timing flexibility for a radial project increases with increased price volatility. For the hybrid project, larger price fluctuations in any of the markets will only hurt the developer with reduced project value. Only for a significantly low volatility in both markets, the developer is able to reach the same project value for a hybrid as with a radial setup given that the wind farm is radially connected to the generally low-priced market. In contrast, the meshed project is much less negatively affected overall compared to the hybrid grid, and investing in a meshed project could provide an insurance to the developer against high volatility levels.

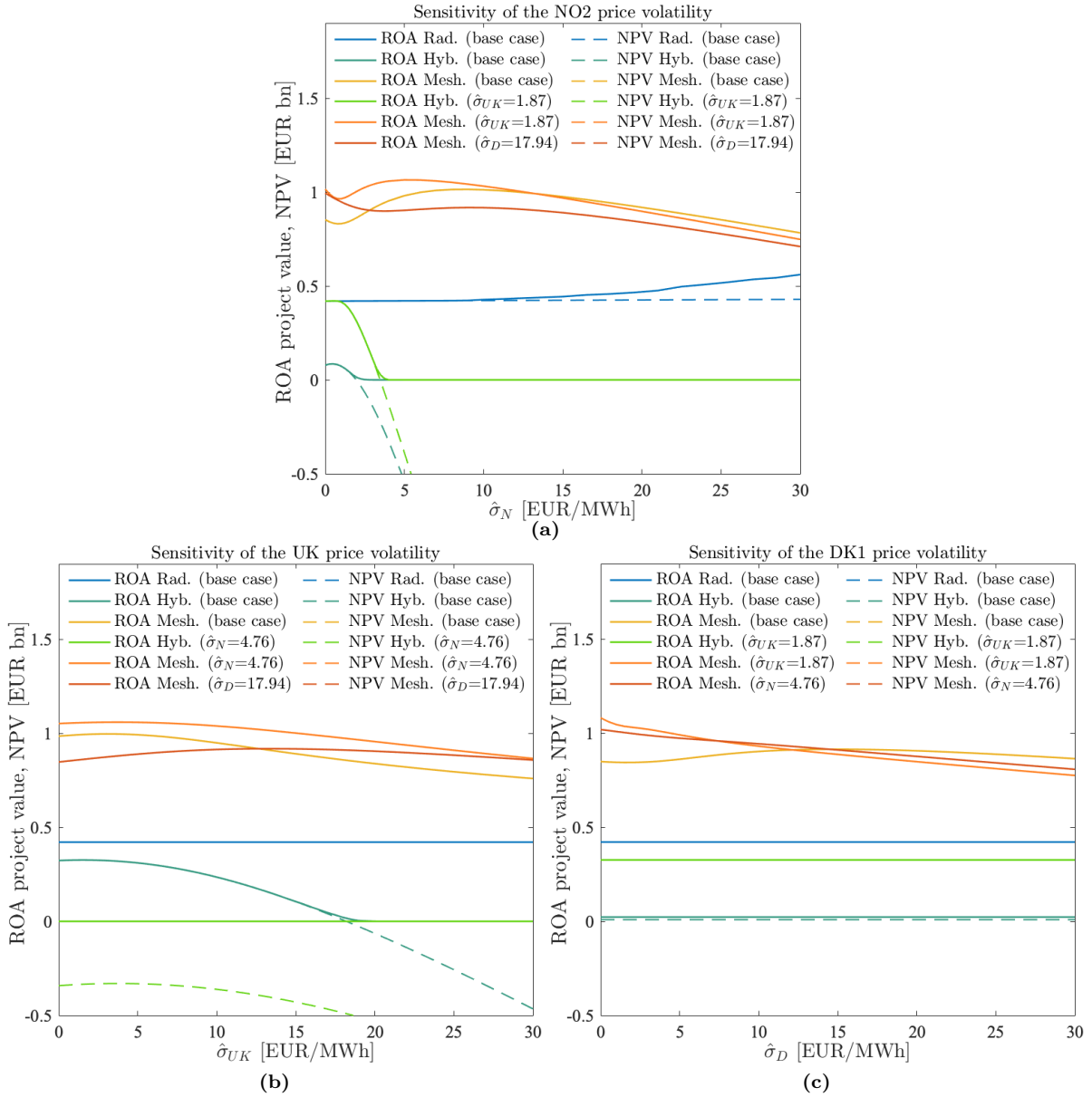

Figure 19: Sensitivity of the NPV and ROA project value to changes in the price volatility in (a) NO2; (b) UK; and (c) DK1, given different levels of volatility in the other countries. The base case is represented by blue (radial), dark green (hybrid) and yellow (meshed) curves in all plots.

A.2 Sensitivity Analysis of Price Volatility (UK and DK1) when Including Congestion Income

Figure 20 shows the effect on the ROA project value for a hybrid (a) and meshed (b and c) project inclusive of certain shares of congestion income when varying the price volatility in the generally high- and medium-priced market, i.e. $\hat{\sigma}_{UK}$ and $\hat{\sigma}_D$, respectively. Similar to increases in the price volatility in the generally low-priced market, $\hat{\sigma}_N$ (see Section 6.2.4), the downside risk faced in particularly a hybrid grid can be mitigated by including a certain share of congestion income. Developers in meshed projects would require a significantly lower share than in hybrid projects to not fear income loss for excessively large price fluctuations.

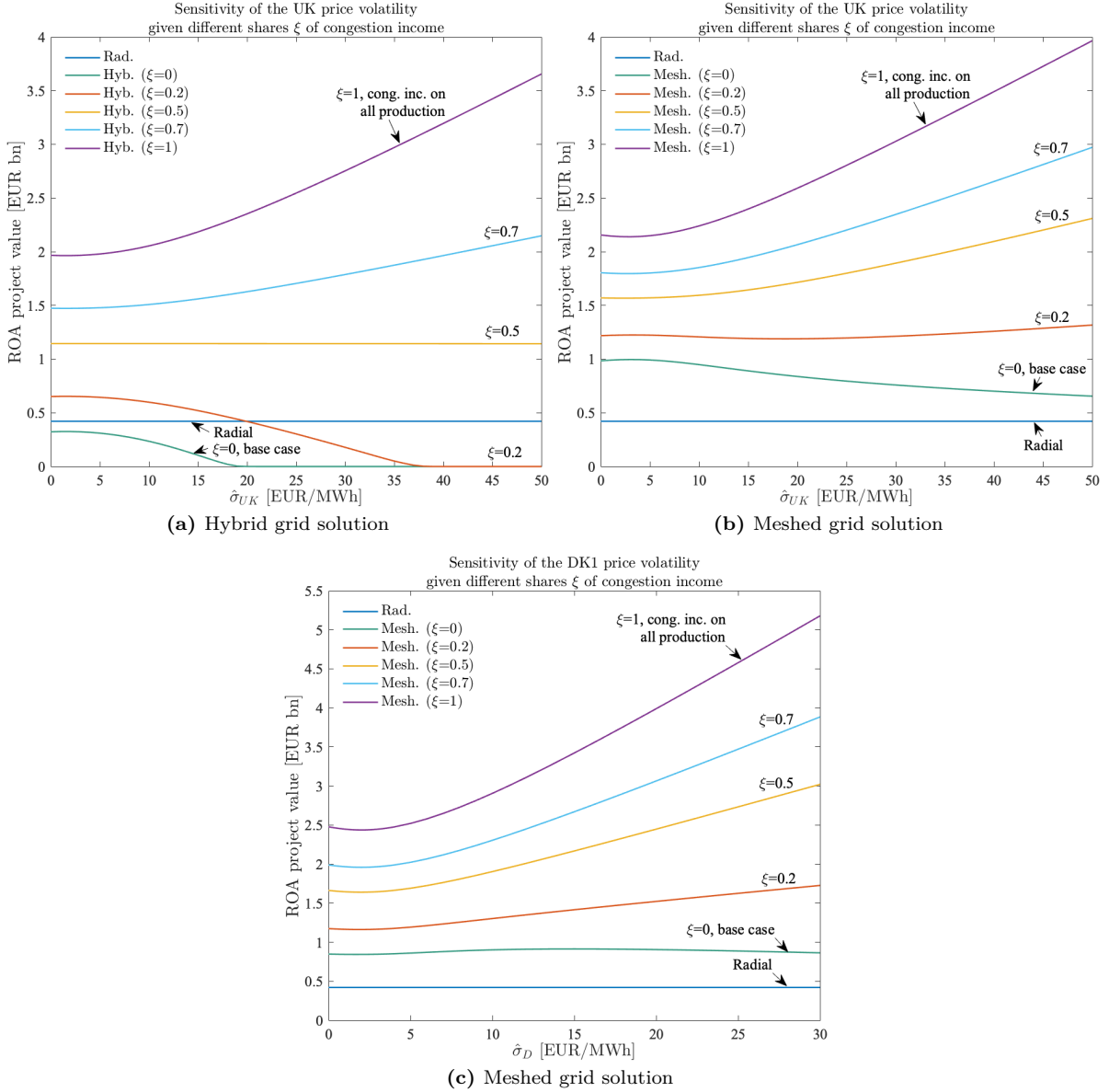

Figure 20: Sensitivity of the ROA project value to changes in the UK price volatility for the (a) hybrid; and (b) meshed project, and the DK1 price volatility for the (c) meshed project, given different shares of congestion income. The radial connection serves as a reference case.

A.3 Sensitivity Analysis of Long-Term Average Prices (UK and DK1) when Including Congestion Income

Figure 21 shows the effect on the ROA project value for a hybrid (a) and meshed (b and c) project inclusive of certain shares of congestion income when varying the long-term average prices \bar{P}_{UK} and \bar{P}_D . Similar to findings in Section 6.2.4 for varying \bar{P}_N , results indicate that reallocation of congestion income could offset some of the risk of limited revenues due to sale of electricity at low prices in an offshore bidding zone. The mechanism could hence contribute to secure incentives, especially for hybrid grid investments.

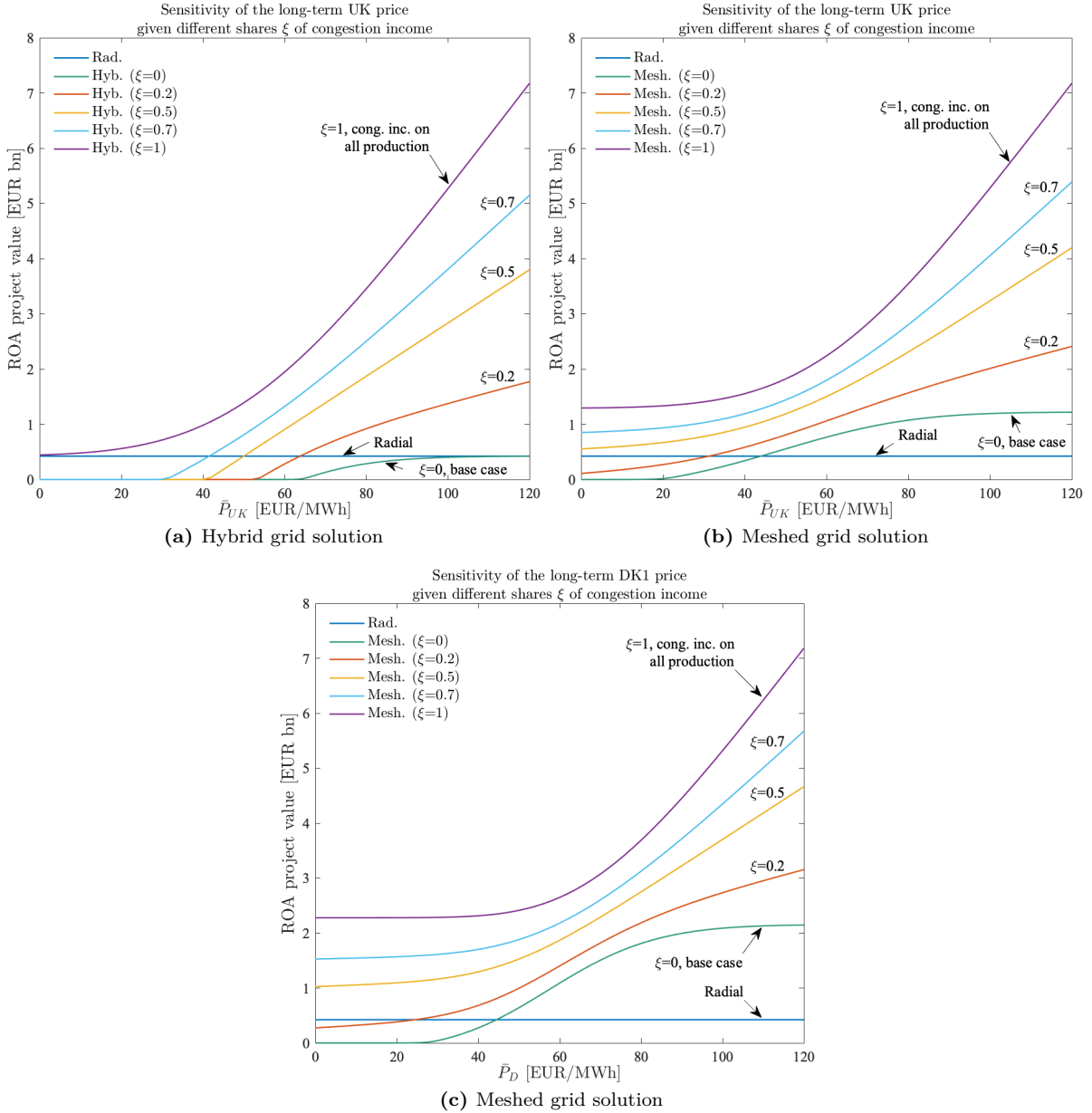

Figure 21: Sensitivity of the ROA project value to changes in the long-term UK price for the (a) hybrid; and (b) meshed project, and the long-term DK1 price for the (c) meshed project, given different shares of congestion income. The radial connection serves as a reference case.

A.4 Sensitivity Analysis of Price Volatility (UK and DK1) when Including Congestion Income and TAG

Figure 22 compares no and full reallocation of congestion income with TAG as support measures for hybrid (a) and meshed (b and c) projects under various price volatility levels in the UK and DK1. Similar as in Section 6.2.5, the TAG scheme could be more beneficial for developers than congestion income under capacity limitations for increased price fluctuations, although this would depend on the expected increase. However, in a meshed project, the developer would prefer congestion income over TAG up to a significantly higher price volatility threshold in a high- or medium-priced market than in a hybrid solution.

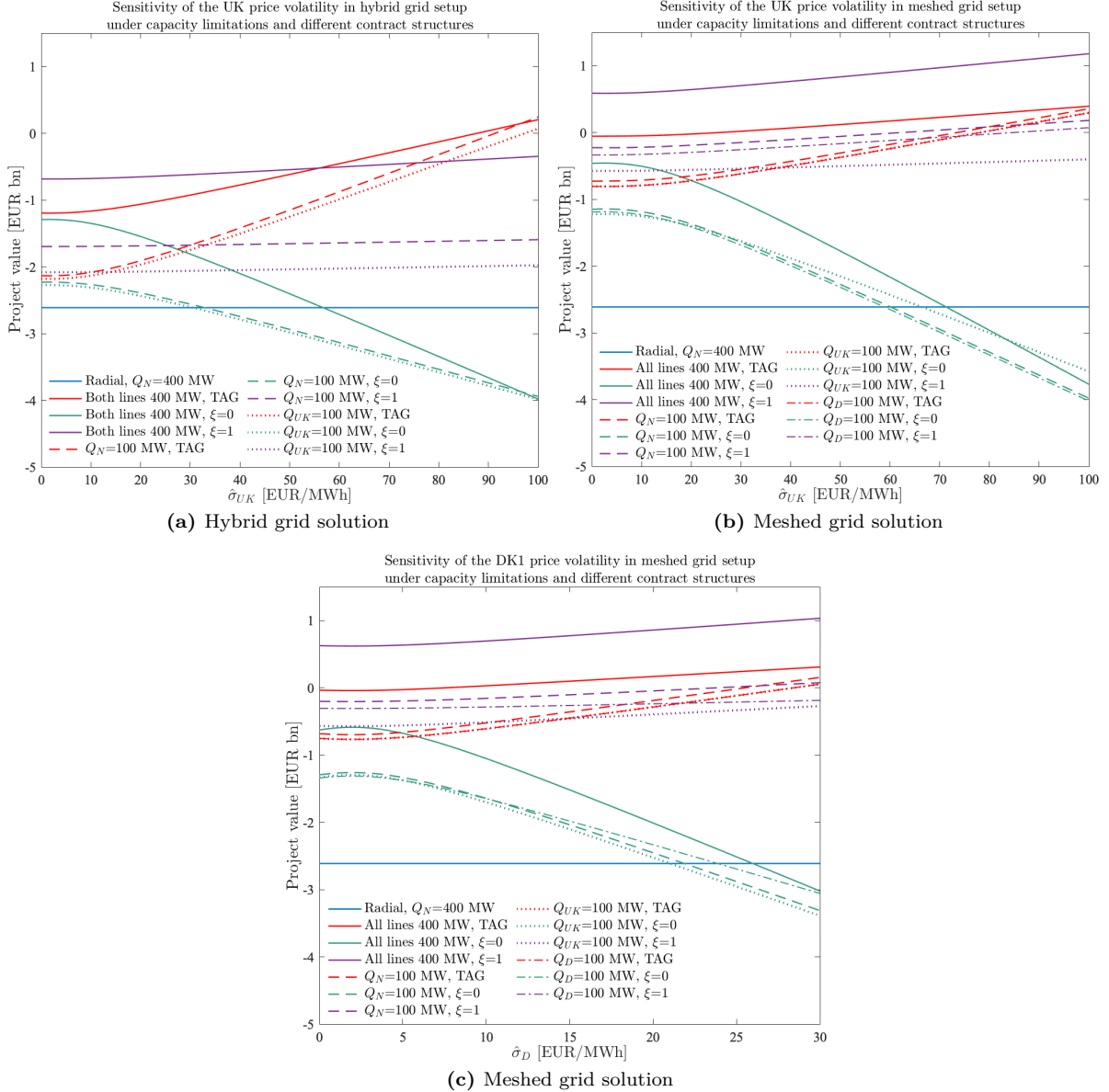

Figure 22: Sensitivity of the NPV to changes in the UK and DK1 price volatility under capacity limitations and two support schemes for the hybrid (a); and meshed (b and c) project. Green curves represent no compensation ($\xi=0$ and no TAG), purple curves reallocation of all congestion income on wind production ($\xi=1$), and red curves the TAG scheme. Different shares of congestion income fall between green and purple curves.

A.5 Sensitivity Analysis of Long-Term Average Prices (UK and DK1) when Including Congestion Income and TAG

Figure 23 compares no and full reallocation of congestion income with TAG as support measures for hybrid (a) and meshed projects (b and c) under various long-term average price levels in the UK and DK1. Similar as in Section 6.2.5, the TAG scheme is found to be preferred over full reallocation of congestion income only if the reference price under the TAG scheme (\bar{P}_N in our case) is significantly higher than the price in the other markets (\bar{P}_{UK} and \bar{P}_D). As \bar{P}_{UK} and \bar{P}_D are not the reference prices, the red and purple curves are reversed compared to Figure 17.

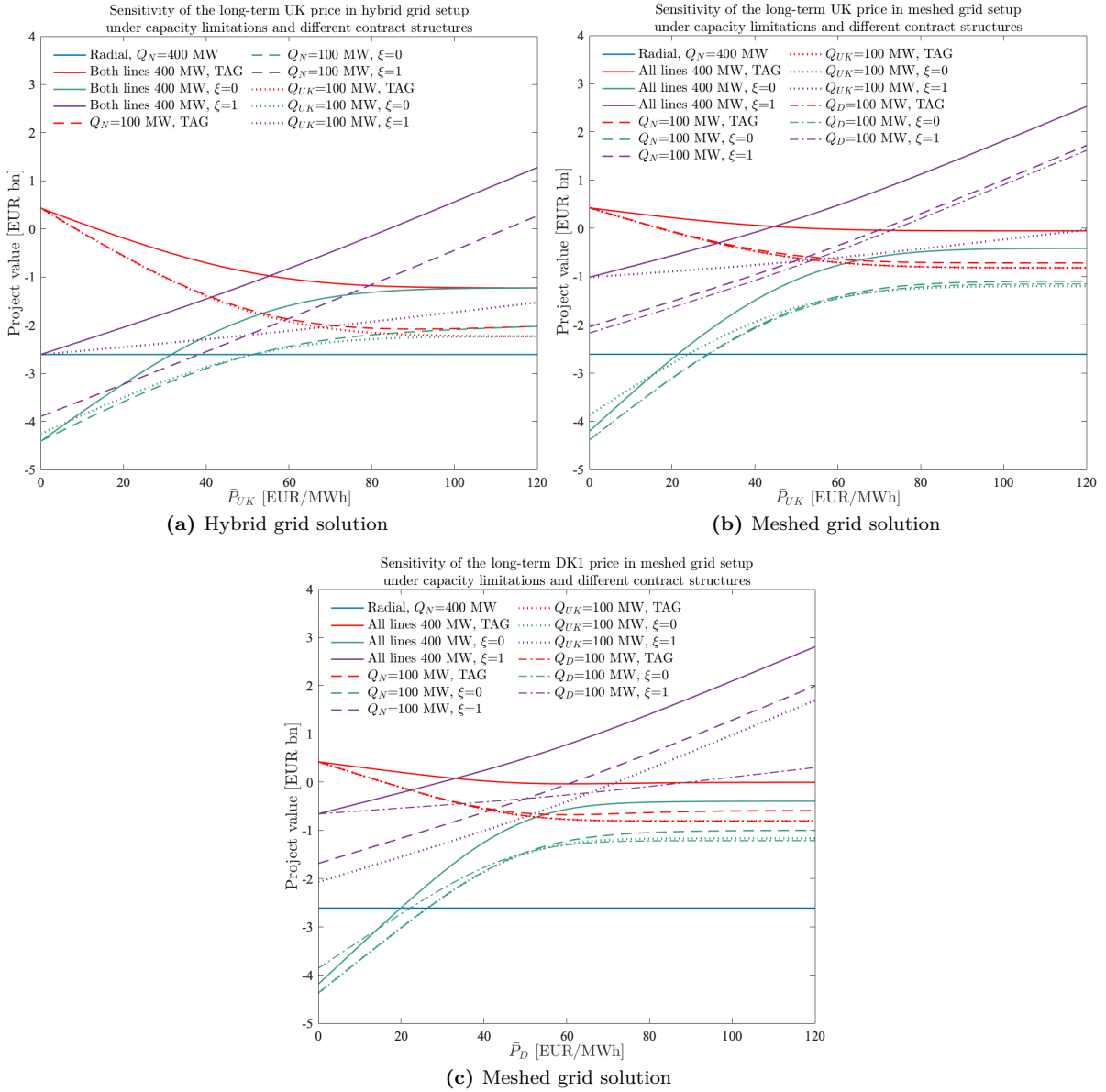

Figure 23: Sensitivity of the NPV to changes in the long-term UK and DK1 price under capacity limitations and two support schemes for the hybrid (a); and meshed (b and c) project. Green curves represent no compensation ($\xi=0$ and no TAG), purple curves reallocation of all congestion income on wind production ($\xi=1$), and red curves the TAG scheme. Different shares of congestion income fall between green and purple curves.

A.6 Sensitivity Analysis of the Starting Date of Regulatory Uncertainty

In our model, the regulatory uncertainty in terms of whether the regulator allows for an extension from a radial to a hybrid or meshed grid solution, is introduced from time t_0 on. The reason for introducing it from the beginning on is grounded in sensitivity analysis. Figure 24 displays the effects on the project value to changes in the arrival rate of the announcement, λ , when varying the starting year in which the regulatory uncertainty is introduced in our model, i.e. (a) from time t_0 , (b) after 5 years and (c) after 15 years. Our findings suggest that introducing the uncertainty at later points in time only affects numerical results as the developer operates a radial project for certain over a longer period of time, but does not change qualitative insights.

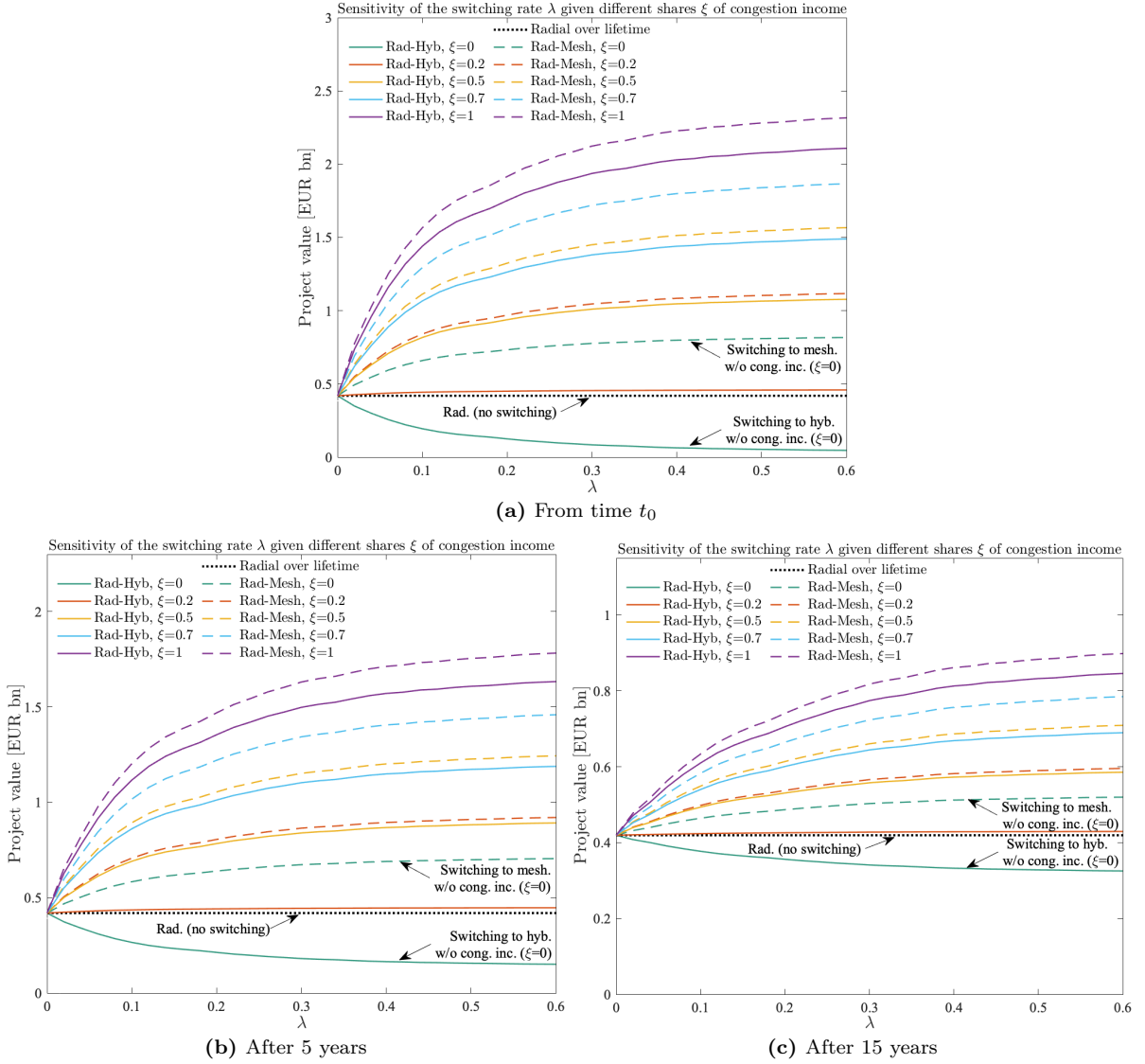

Figure 24: Sensitivity analysis of the time at which regulatory uncertainty is introduced. The starting year is set to (a) today, t_0 ; (b) after 5 years; and (c) after 15 years, out of an expected wind farm lifetime of 25 years.

