

Andreas Klever

Development and Design of Portable Flood Protection in Aluminum with Variable Length

Master's thesis in Produktutvikling og produksjon (MIPROD)

Supervisor: Christer Westum Elverum

June 2020

Andreas Klever

Development and Design of Portable Flood Protection in Aluminum with Variable Length

Master's thesis in Produktutvikling og produksjon (MIPROD)
Supervisor: Christer Westum Elverum
June 2020

Norwegian University of Science and Technology
Faculty of Engineering
Department of Mechanical and Industrial Engineering



Preface

This thesis was submitted to the Norwegian University of Science and Technology (NTNU) for the degree of Master of Science. The work was executed at the Department of Mechanical and Industrial Engineering (MTP) under the superintendence of Professor Christer Westum Elverum.

It should be noted that due to restrictions put into practice due to COVID- 19, the University was locked down during the majority of the time this thesis was written. This put some restrictions of what work that could be done, and it was not possible to perform any physical testing on the campus.

Acknowledgements

I would like to thank my supervisor Professor Christer W. Elverum for all the help and guidance I have received throughout this master thesis.

I also want to thank AquaFence AS for this exciting project. A special thanks goes to Thomas H. Briedis who has offered support during this entire project.

Abstract

The purpose of this master thesis is to investigate the prospect of creating a flexible flood wall that could be used in the installation of a flood protection system from AquaFence AS, a Norwegian company who specializes in portable floodwalls. When AquaFence deploys one of its systems they plan for the circumference to match an even number of elements. Experience have shown that installing two elements with zero angle to each other is very difficult. If two elements are installed with an angle at an early stage in a stretch of the floodwall, it will lead to a big misplacement of the system further down. A flexible floodwall element would make the system much less vulnerable to variations and gaps that do not match the standard length.

Standard elements from AquaFence are usually made in plywood but creating a flexible element in plywood has resulted in a heavy and not very user-friendly element. In an effort to work around this, a set of concepts in aluminum were created and compared. The focus was put on their V1800-model in this thesis, and on how aluminum can be utilized to replace plywood. FEA was used to check the structural integrity of the concepts, and a grading matrix to rank the following concepts. A structural design that is able to withstand the forces from a flood was developed by the help of analytical prototypes.

The use of computer aided design made it possible to close knowledge gaps swiftly. The analytical result from FEA showed a high performance of the elements. The concepts that were created had the ability to improve many of the problems that today's solution has. The use of principles in set-based design allowed several sub-solutions to be designed and tested. Various suggested designs were narrowed down to a single proposed design accordingly. This resulted in a suggested design that is lighter, easier to install and has a greater flexibility.

All the concepts presented in this thesis has been developed further from sketches created in the fall of 2019s project thesis.

Sammendrag

Hensikten med denne masteroppgaven er å undersøke mulighetene til å lage et fleksibelt flomvern som kan brukes i installasjonen av et flomvern fra AquaFence AS, et norsk selskap som spesialiserer seg på mobilt flomvern. Når AquaFence skal installere et av sine systemer planlegger de at omkretsen skal matche et helt tall av antall elementer. Erfaring tilsier at det er vanskelig å installere AquaFence-panelene helt rett i forhold til hverandre. På lange strekninger vil en liten vinkling mellom to elementer tidlig på strekningen kunne forskyve hele systemet ganske langt i enden av strekningen, som kan føre til at hele strekningen må installeres på nytt. Et fleksibelt flomverns-element vil gjøre systemet mye mindre sårbart for hull som ikke samsvarer med standardlengden.

Standard elementer fra AquaFence har alltid vært laget av kryssfiner, men å lage et fleksibelt element i kryssfiner har resultert i et tungt og lite brukervennlig element. I et forsøk på å løse dette ble en serie konsepter i aluminium laget og sammenlignet. Fokuset ble satt på deres V1800-modell i denne oppgaven, og på hvordan aluminium kan brukes til å erstatte kryssfiner.

FEA ble brukt til å sjekke konseptets strukturelle integritet, og en gradering-matrise ble brukt til å sammenligne konseptene. Et strukturelt design som er i stand til å motstå kreftene som oppstår i en flom ble utviklet ved hjelp av analytiske prototyper. Bruken av CAD gjorde det mulig å dekke kunnskapshull raskt. Det analytiske resultatet fra FEA viste en høy ytelse av elementene. Konseptene som ble opprettet var i stand til å forbedre mange av problemene som dagens løsning har. Bruken av prinsipper i "set-based design" gjorde det mulig å teste flere «sub-solutions» slik at det beste konseptet ble designet. De ulike designene ble så innsnevret til ett enkelt foreslått design til slutt. Dette resulterte i et design som er både lettere, enklere å installere og har større fleksibilitet.

Alle konseptene presentert i denne masteroppgaven har blitt videre utviklet fra resultatene fra prosjektoppgaven fra høsten 2019.

Table of Content

Preface	2
Acknowledgements	3
Abstract	4
Sammendrag	5
List of tables	8
List of figures	9
1 Introduction	13
1.1 <i>Background and current product</i>	13
Current product.....	13
Specialized modules	14
1.2 <i>Problem description</i>	15
1.3 <i>Objectives</i>	17
1.4 <i>Problems with plywood</i>	17
Why aluminum?	17
1.5 <i>Thesis structure</i>	17
1.6 <i>Areas of improvement</i>	18
1.7 <i>Requirement specification</i>	19
1.8 <i>Mathematical symbols</i>	20
2.0 Theory	21
2.1 <i>Development methodology</i>	21
2.1.1 Set-based design	21
2.1.2 Modularity.....	23
2.1.3 Linking modularity and set-based design	24
2.2 <i>Aluminum processing</i>	24
2.2.1 Aluminum extrusion	24
2.2.2 Joining aluminum	25
2.2.3 General design guidelines for aluminum.....	26
2.4 <i>FEA</i>	29
2.4.1 Load cases	29
3 Methods	31
3.1 <i>CAD modelling in SolidWorks</i>	31

3.2 CAE with SolidWorks simulation	32
Drawbacks to simulations	33
3.3 Finding the best beam dimensions	33
4 Results.....	41
4.1 Choosing the aluminum alloy.....	41
4.2 Fixed frame solutions.....	42
4.2.1 Production	42
4.3 Fixed frame concept 1 (FFC 1).....	44
4.3.1 Extendable area.....	46
4.3.2 Stability.....	46
4.3.3 Extension	47
4.3.4 Weight	47
4.3.5 Uncertainties	47
4.3.6 User friendliness.....	47
4.3.7 Modularity.....	47
4.3.8 FEA Model	47
Constraints and loads.....	48
Results	49
4.4 Fixed frame concept 2 (FFC 2).....	51
4.4.1 Extendable part	51
4.4.2 Stability.....	53
4.4.3 Extension	54
4.4.4 Weight	55
4.4.5 Uncertainties	55
4.4.6 User friendliness.....	56
4.4.7 Modularity.....	56
4.4.8 FEA Model	56
Constraints and loads.....	56
Results	57
4.5 Adjustable frame concept (AFC)	58
4.5.1 Production	60
4.5.2 Stability.....	62
4.5.3 Extension	63
4.5.4 Weight	64
4.5.5 Uncertainties	64
4.5.6 User friendliness.....	64
4.5.6 Modularity.....	64
4.5.8 FEA Model	65
Constraints and loads.....	65
Results	67
4.6 Grading Matrix.....	68
4.6.1 Comparing key factors.....	68
Stability.....	68
Extension	68
Weight	69
Uncertainties	69
User friendliness.....	69
4.6.2 Summary of key factors.....	70
4.6.3 Grading matrix.....	71

4.7 Fastening of canvas	71
4.8 Corner hinge.....	72
4.8.1 Hinge concept 1 (HC1)	73
4.8.2 Hinge concept 2 (HC2)	73
4.8.2 Hinge concept 3 (HC3)	74
4.9 Sealing in front.....	74
4.9.1 Sealing using water load.....	75
Dynamic sealing concept 1 (DSC1)	75
Dynamic sealing concept 2 (DSC2)	77
Dynamic sealing concept 3 (DSC3)	78
4.9.2 Fixed sealing concept	79
5 Detailed design.....	81
5.1 Extendable element	81
5.2 Sealing in front.....	81
5.3 Corner hinge.....	81
5.4 Proposed design.....	82
6 Discussion	85
6.1 Discussion of development method	85
6.2 Discussing the solutions	86
Canvas fastening.....	87
Corner hinge.....	87
Front sealing.....	87
7 Conclusion and future work	89
BIBLIOGRAPHY	90

List of tables

Table 1.1: Symbols for calculations.....	20:
Table 2.1: Material properties from Solidworks 2019.....	29:
Table 4.1: Strength of the alloys	40:
Table 4.2: Summary of key factors	70:

List of figures

Figure 1.1: V1200	14
Figure 1.2: V1800	14
Figure 1.3: V2400	14
Figure 1.4: Connected elements	14
Figure 1.5: Corner element	15
Figure 1.6: Element with integrated door	15
Figure 1.7: Element with flexible width	15
Figure 1.8: Illustration of the problem with installing element	16
Figure 1.9: Illustration of flood wall blocking a road.....	16
Figure 1.10: The area that lies on the ground cannot be included	18
Figure 1.11: Transverse beam that seals of the canvas	18
Figure 1.12: How the gasket is installed in todays model.....	19
Figure 2.1: Difference between set-based and Point based	21
Figure 2.2: Example of a Set-based approach	23
Figure 2.3: Extrusion process	25
Figure 2.4: Hollow profile extrusion.....	25
Figure 2.5: solid profile extrusion	25
Figure 2.6: Casted T-joint	26
Figure 2.7: Corner bracket joint that take advantage of self-tapping screws and stamping.....	26
Figure 2.8: Channel Width to height	27
Figure 2.9: corners should be rounded	27
Figure 2.10: Transformation from hollow profile to solid profile	27
Figure 2.11: Profiles should have even thickness	28
Figure 2.12: Shows the recommended wall thickness.....	28
Figure 2.13: horizontal pressure	30
Figure 2.14: vertical pressure.....	30
Figure 2.15: Dynamic pressure.....	30
Figure 2.16: Resulting pressures	31
Figure 3.1: Initial designs.....	31
Figure 3.2: CAD model, FE-model and Results	33
Figure 3.3: Illustration of how the load was altered	34
Figure 3.4: shear force in the profiles	35

Figure 3.5: Bending moment in the profiles.....	35
Figure 3.6: Bending moment in the profiles.....	36
Figure 3.7: Shear force in the profiles	36
Figure 4.1: Results from the script	41
Figure 4.2: Anchor point for the wire.....	42
Figure 4.3: Illustration of a single frame	43
Figure 4.4: Exploded view of a single frame.....	43
Figure 4.5: Four frames put together to form a flood wall.	43
Figure 4.6: FFC1 collapsed.....	44
Figure 4.7: FFC1 extended.....	44
Figure 4.8: FFC1 complete with canvas.....	44
Figure 4.9: calculation model	46
Figure 4.10: Simulation model	48
Figure 4.11: This illustrates how the forces act on the model	49
Figure 4.11: Analysis results, stresses (MPa).....	50
Figure 4.12: Analysis results, deflection (mm)	50
Figure 4.13: FFC2 collapsed.....	51
Figure 4.14: FFC2 expanded	51
Figure 4.15: FFC2 completed.....	52
Figure 4.16: Gap that needs sealing in the front.....	53
Figure 4.17: Gap sealed with a pre-cut profile	53
Figure 4.18: Gap sealed with a gliding profile	53
Figure 4.19: calculation model for FFC2.....	54
Figure 4.20: Extension of the hinges	54
Figure 4.21: Gap that needs sealing in the front.....	55
Figure 4.22: Gap sealed with a pre-cut profile.....	55
Figure 4.23: Illustrates the problem when the hinges can rotate freely.....	55
Figure 4.24: Hinge - Front view	56
Figure 4.25: Hinge- Sideview	57
Figure 4.26: loads (purple arrows) and constrains (green arrows)	57
Figure 4.27: Analysis results, stresses (MPa).....	58
Figure 4.28: Analysis results, displacement (mm).....	59
Figure 4.29: AFC collapsed	59
Figure 4.30: AFC expanded.....	59
Figure 4.31: AFC completed with canvas	60

Figure 4.32: Illustrates how the transverse beam can be made.....	60
Figure 4.33: Designs on how the front beam can be made.....	60
Figure 4.34: Demonstrates where the holes (green) can be put.....	62
Figure 4.35: Calculation model for AFC.....	63
Figure 4.36: Illustrates how the horizontal grid.....	63
Figure 4.37 illustrates how the vertical grid is connected.....	64
Figure 4.38: The simulation model.....	65
Figure 4.39: Loads (red arrows) and constrains (green arrows).....	66
Figure 4.40: Analysis results, stresses (MPa).....	67
Figure 4.41: Analysis results, displacement (mm).....	67
Figure 4.42: Grading matrix example.....	68
Figure 4.43: Grading matrix.....	71
Figure 4.44: Fastening mechanism of canvas.....	72
Figure 4.45: The corner in attention circled in red.....	72
Figure 4.46: Assembly with no hinge.....	73
Figure 4.47: Extruded profiles connected with a flexible material.....	74
Figure 4.48: Three hinges cut from the same extruded profile.....	74
Figure 4.49: The gap that appears between the canvas and frame.....	75
Figure 4.50: The vertical wall rests on the gasket.....	75
Figure 4.51: Demonstrates how the force on the gasket.....	76
Figure 4.52: Shows the rest of the graph from figure 4.51.....	76
Figure 4.53: The mechanism will be open when there is no water on the wall.....	77
Figure 4.54: This graph shows the force acting on the gasket the first 100 mm.....	77
Figure 4.55: The mechanism is closed as when there is no water.....	78
Figure 4.56: The graph shows the force acting on the gasket the first 100 mm.....	78
Figure 4.57: Illustrate how the FSC can look like.....	79
Figure 5.1: Adjustable frame concept.....	81
Figure 5.2: DSC2.....	81
Figure 5.3: Hinge concept 1.....	82
Figure 5.4: Proposed design.....	83

1 Introduction

1.1 Background and current product

The definition of a flood is a large water mass that overflow a normally dry land, and in some cases this might be a good thing, as flood water will help refuel ground water and help give nutrition to the soil, but in many cases a flood will cause both structural and economical damage and even loss of human life. Because floods destroy so much it is of great interest of people around the world to protect them self from these natural disasters. (Oxford Dictionaries, n.d)

According to EAVC, floods occur four times more frequent today than in the 1980s, and double since 2004 (EASAC, 2018). This trend crates an increasing demand for flood protection and innovation. The most used flood protection today consists of sandbags. Sandbags is an affordable and easy way of protecting our surroundings from flood, and it has the advantage of being mobile and demands no permanent alterations to the surroundings. Even though sandbags are a good alternative in flood protection, it has some drawbacks. One of the most significant drawbacks of the sandbags is the huge workload that lies behind every sandbag. It will for example take two people one hour to fill 12 sandbags, and a 60 cm x 100 cm wall require approximately 80 sandbags (Environment Agency, 2009). Another major drawback is that the sandbags are not waterproof by themselves and may absorb sewage or toxic waste that the floods are carrying, which means many of the sandbags will need to be replaced after the flood have ended.

A company that has specialized in a more innovative solution is AquaFence. AquaFence was founded in 1999 in Norway. Today, AquaFence sell their patented technology all around the world. Their goal is, and has always been, to offer people and companies high quality and reliable flood barriers that can be deployed quickly in case of emergency, with the possibility to keep it out of sight when the need is not present.

Current product

The standard floodwalls provided by AquaFence today consists of four different heights. The different heights are 120 cm, 180 cm, 210 cm and 240 cm tall. Even though the heights and width of the modules differ, the functionality of the walls are basically the same. The flood wall is constructed by linking a series of modules together which results in keeping the water from causing damage. The modules mainly consist of two plates of plywood, which may vary in thickness. These plates are connected by a PVC canvas, which makes the angle waterproof. Rods and wires are then used to keep the plates standing and to transfer forces from the floor plates to the walls. The connection between modules consist of PVC canvas and an aluminum rail which is used to clamp down the canvas to the next module.

The biggest advantage, and most important feature of this kind of flood protection, is that it uses the force of the water to stabilize itself. This means that the floodwall will become more and more stable as the water level rises, and in addition to this, the seal will become more and more secure. This is because the pressure on the floor will always be greater than that on the walls. The same goes for the seal, whereas the water pressure increases against the gasket on the ground - the seals performance will increase and do a better job at keeping the water out. Since the modules are stable by themselves and require no extra support, the footprint of a module is relatively small and makes it better suited for installing in tight spaces.

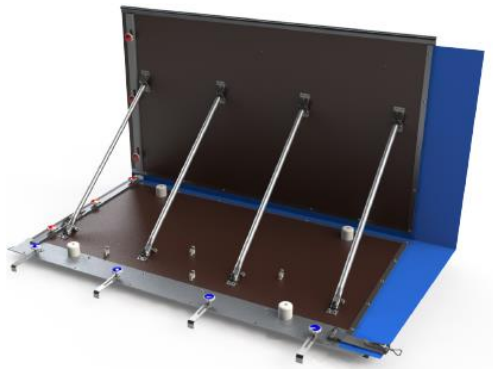

Figure 1.1: V1200 (Sapa Group AB.2007)

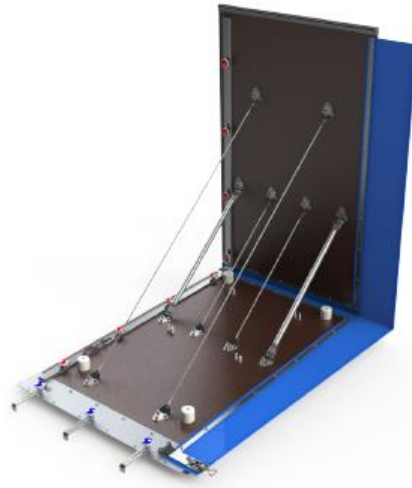

Figure 1.2: V1800 (Sapa Group AB. (2007)

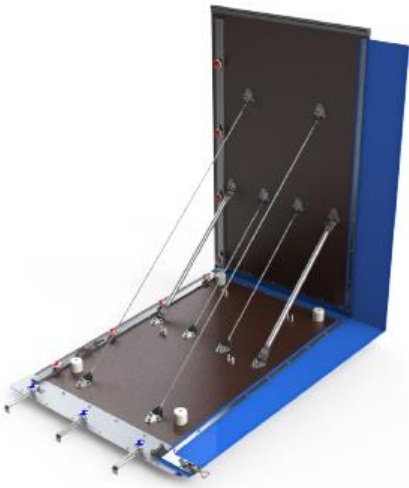

Figure 1.3: V2400 (Sapa Group AB.2007)

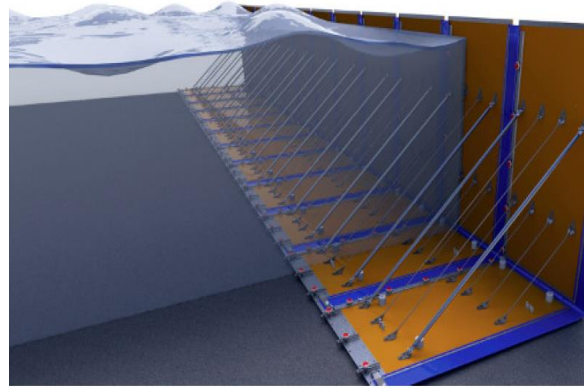

Figure 1.4: Connected elements subjected to water. (Sapa Group AB.2007)

Specialized modules

In addition to standard modules, AquaFence provides a series of specialized modules. The plated structure of the modules makes it easy to customize them if the need arises. Some of the specialized modules includes integrated doors, outward angles, inwards angles, wall mountings and modules which allow for extension.



Figure 1.5: Corner element. (Sapa Group AB.2007)

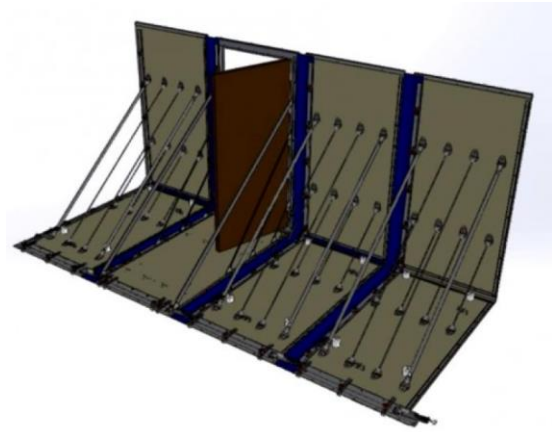

Figure 1.6: Element with integrated door. (Sapa Group AB.2007)



Figure 1.7: Element with flexible width. (Sapa Group AB.2007)

1.2 Problem description

When AquaFence deploys their flood protection system, they start by deploying one element and then attach it to the next element. They repeat this process until they have a complete circle around the object they are supposed to protect.

When AquaFence deploys one of its systems, they will usually plan for the circumference match an even number of elements, but experience has showed that installing the elements perfectly accordingly to the plan is difficult in real life. This means that if some variations occur during installation, it may create trouble when it comes to connecting the two ends, and often resulting in having to redeploy the system.

The same problem can occur when AquaFence are to seal off a given length, for example a road or a doorway. It is not given that the length adds up to their standard length of 1200mm or 2400 mm. Today, this problem is solved by creating custom elements with the exact length they are missing by to connect to standard elements.

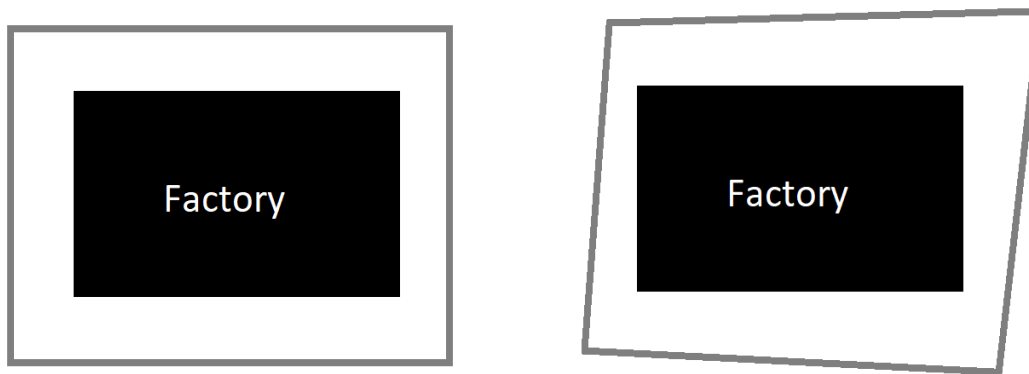

Figure 1.8: Illustration of the problem with installing element with an angle

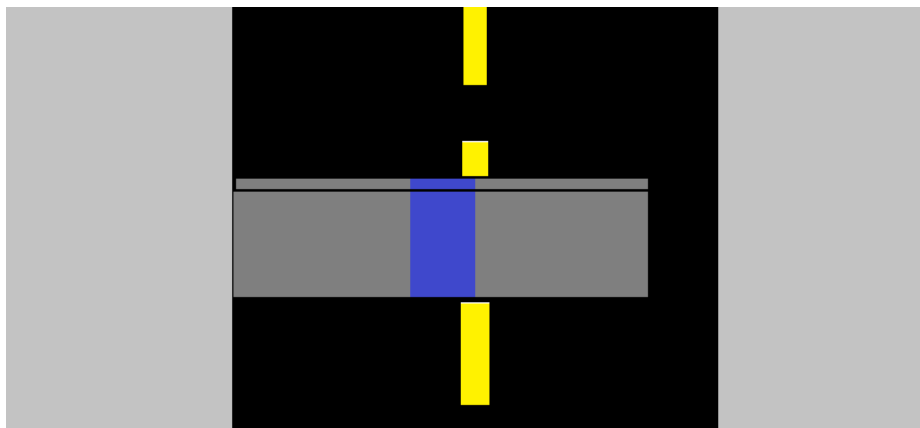

Figure 1.9: Illustration of flood wall blocking a road, but standard sizes elements does not cover the entire road

The solution to this is that AquaFence has created an element that is able to extend in order to match the gap exactly. After consulting with AquaFence, there were some aspects of the existing extendable element that needed improvement. The most troublesome features were the weight, limited possibility of extension, and difficulties with sealing the front of an element.

This thesis will focus on the design of a flood wall with a shift of material, from plywood to aluminum. This is to see if it's possible to obtain an increase in extension, as well as a reduction in weight. The physical design will pay special attention to weight, strength and sealing in the front of an element.

As the final product will be constructed on AquaFence's factory, it is preferable that the same parts can be used in all the different modules, and that it is possible to extend and replace parts with ease.

1.3 Objectives

The aim of this project is to create an element that has flexible length using aluminum and developing concepts that provides reduction in weight and gives an increased performance. Utilization of modularity and scalability will be emphasized, and 3D modelling tools will be used to give an early estimate on the weight and practicality of the concept.

The following tasks have been performed during this thesis:

- Research the functionality of today's products
- Establish requirements that focus on weight reduction, flexibility and rigidity
- Create a series of concepts
- Evaluate the practicability of the concepts
- Select the most applicable concept for further development

1.4 Problems with plywood

Wood absorbs water, which can cause the elements to rot. This is especially problematic in humid areas. Plywood leaves the elements subjectable to vermin while in storage, resulting in the element being damaged. Wood has relatively low stiffness, and this leads to a problem with very thick walls. As the walls become taller, AquaFence needs to compensate with thicker plates, which in turn leads to the elements quickly becoming heavier as the height increases.

AquaFence have had problems with organic material and would therefore like to switch material to aluminum.

Why aluminum?

The properties of aluminum such as low weight, high strength and excellent corrosion resistance makes this metal ideal for a mobile flood protection. Aluminum is easy to form and machine, which makes the possibilities of the material nearly endless (Sapa Group AB., 2007).

Aluminum is extracted from bauxite which usually is very energy demanding, and therefore can be an unattractive process from an environmental perspective. In Norway, on the other hand, the extraction happens using waterpower which is a renewable and environmentally friendly solution. Aluminum is also as close as possible to absolute recyclable, as there is only a short percentage loss in the re-melting process, and the recycling only requires 5% of the energy used in the extraction process (Sapa Group AB., 2007).

1.5 Thesis structure

This thesis is divided into 5 chapters. Chapter 1 includes an introduction to the topic and the background for this project. Chapter 2 consists of theory that the thesis rests on. Chapter 3 will give some insight in why the different methods are being used and how they have been applied to this specific project. Chapter 4 includes the results and present detailed models. Chapter 5 contains a suggested design for the flexible element. Discussion and future work, as well as conclusion will be presented in chapter 6.

1.6 Areas of improvement

Today's model requires the installer to measure the gap, then cut the gasket to length. This creates an opportunity for mistakes to be made, and therefore, it is desirable to create a solution that has an integrated gasket which does not require an external gasket to be installed.



Figure 1.10: The area that lies on the ground cannot be included in calculating the safety factor

The solution to seal the gap between the external gasket and the canvas utilizes a beam that is tightened against the external gasket by the means of bolts. This solution is unpractical, since it takes a lot of time to tighten two bolts. The biggest drawback is that it is vulnerable to human error, in such way that if someone forgets to tighten the beam upon installing it, it will compromise the module and it will not hold any water at all.

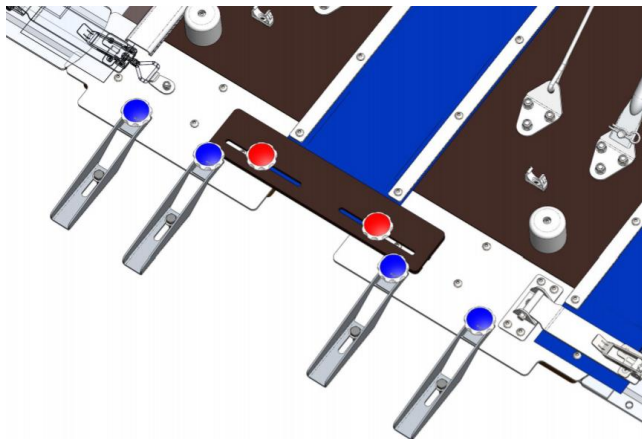

Figure 1.11: Transverse beam that seals of the canvas in front.
Bolts used to tighten the beam is red.

It's preferable to reduce the weight of the element to ease the installation process. Today's model weighs 65 kg. It can be acceptable that the element weighs more if this can provide further extension of the element, but the total weight of the element should not exceed 82 kg, which is the weight of a standard element.

The biggest flaws of today's model roots in the complexity of its installation. During flooding AquaFence will not always be available to assist with the installation of the system, which

increases the risk of installing modules faulty. Therefore, installation steps with the potential for human error will appear less appealing to the customer.



Figure 1.12: How the gasket is installed in today's model. (AquaFence, n.d)

1.7 Requirement specification

The development of this element was not given absolute requirements, but rather what we call "soft requirements". AquaFence asserted aspects that were important for a product such as this. These acted as the framework for the solution. These aspects were mentioned as vital:

- The element should be able to have variable length
- Weight
- Stability
- Foldable, easy to pack
- Stiffness

Today's specifications acted as reference points throughout the development of the concepts.

1.8 Mathematical symbols

In table 1 is an overview of the mathematical symbols that are used during this thesis, and their meaning in addition to their units.

Data	Symbol	Unit
Force	F	Newton(N)
Hight	H	Millimetre(mm)
Width	W	Millimetre(mm)
Area	A	Square millimetres (mm ²)
Pressure	P	Megapascal (MPa)
Length	m	Meter(m)
Saltwater density	ρ	Kilograms/cubic meter(kg/m ³)
Coefficient of water drag	a	unitless
Velocity of flood water	v	Meter/second (m/s)
gravitational acceleration	g	Meter/second squared (m/s ²)
Buoyancy	B	Newton (N)

Table 1.1: Symbols for calculations

2.0 Theory

2.1 Development methodology

2.1.1 Set-based design

The main thoughts behind set-based design is to reduce the rework and increase the flexibility in a design process. The main asset of set-based design is to maintain as many design variations as possible for as long as possible, and only committing to a solution after testing and providing validation of assumptions. Set-base seek to eliminate weaker alternatives as the process moves on, this is in opposition to the more traditional method of point-based design, (Sobek, 1996) where different options are made and ultimately one is chosen to be developed further (Singer, 2009). How the two differ from each other can be seen on figure 2.1.

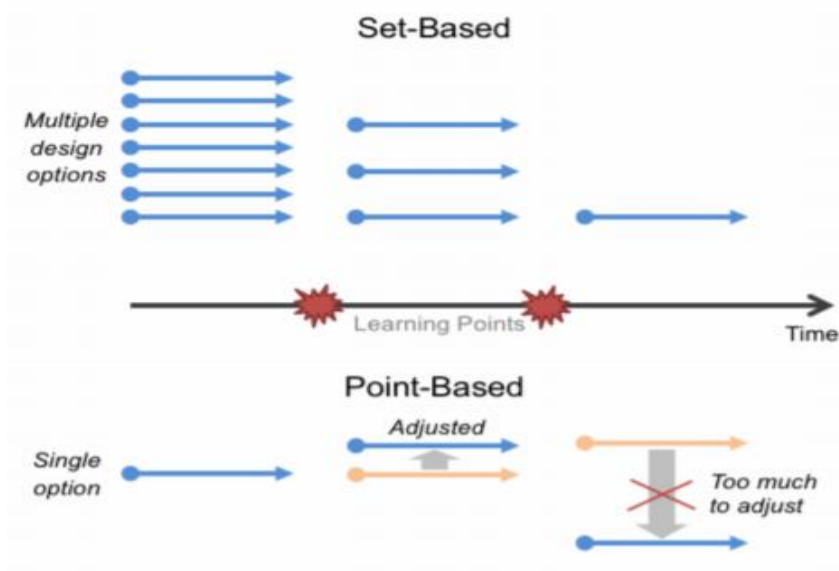

Figure 2.1: Difference between set-based and Point based. (Lynn, n.d.).

The first principle in set-based design is to define a design space in order to map every feasible design possibility. This phase is believed to be the most crucial in set-based design, meaning a set-based approach will use more time and resources in this phase than point-based design. The most consequential design decisions should always be made based on knowledge in order to avoid changes later in the process (Ward, Liker & Sobek, 1999).

A large portion of this phase is also dedicated to exploring tradeoffs within the different solutions. In a point-based design, the most promising solution would be chosen for further developing, but this method can prove to be very limiting. Also, in many occasions the design is not based on knowledge. Set-based design differs from this by exploring different sub-sets by testing multiple versions of the same part. This research will create a foundation for where a knowledge-based decision can be made. Testing and validations can be a great way to deal with knowledge gaps (Kennedy, 2014).

The Wright brothers can be a great example of this when they were about to build the first airplane. Where the Wright brothers differ from their predecessors is that instead of building an aircraft, they first constructed a wind tunnel. This allowed them to test the components of the aircraft one by one, and later on, put the best combinations together bit by bit. While others were using the "design and test"- approach, the Wright brothers would test many variations and then choose the best. They would rather spend hours testing their components before building a prototype. Other engineers would spend hours building a prototype first, and then only got to test it for a few seconds before it would crash - leaving them not knowing which parts worked and which did not. By using the design- build- test approach it would end up resulting in a binary answer. It would either work or not, and they would not know which parts worked and which did not (Kennedy, 2014).

The next principle is to look for intersections in the options that proves to be feasible. In point-based design, the approach would be to try merging the best versions of each subcomponent into a single system. Set-based design, however, will take aim to optimize the overall performance of the system rather than look at single components. This can mean that some components may have better performing concepts by themselves. However, choosing a lower performing subsystem may cause the overall performance of the system to increase as a whole (Bernstein, 1998). Another important aspect would be to postpone key decisions as long as possible. This is to make it possible to generate the necessary knowledge before making these decisions. With this, set-based design tries to break the circular dependency on needing the knowledge to make good decisions in the early phases, which is often only available after testing. This can lead to expensive rework later in the process (Ward, Liker & Sobek, 1999).

Traditionally, key dimensions would be made early on to avoid confusion. Although it is shown that freezing these points early on can create problems further down the line, resulting in either costly changes or an underperforming design. By delaying decisions, it will increase the flexibility of the design process. An example can be found at Toyota, where they keep a 10 mm flexibility to the car's key dimensions. The dies are then manufactured as close to the nominal dimensions as possible. After testing, they conducted the most effective changes to create the best performing car. In the end, engineers believe that the customers do not care about whether the car is 4410 mm or 4400 mm. They only care about the performance of the car (Ward, Liker, Cristiano & Sobek, 1995).

Set-based design seeks to obtain as much robustness as possible. This means optimally, that each subsystem should be unaffected by changes in the other. Robust design means that the interface between two components are well defined, but changes within the set does not affect other parts. This results in less sensitivity to inaccuracy in productions and unpredictable mechanisms such as wear (Bernstein, 1998). One of the main elements of set-based design is that it will try to eliminate the lowest performing alternative, rather than trying to choose which is the best to begin with. This process can be illustrated as a funnel. The funnel has many concepts at the beginning, and the concepts are very little detailed and may appear rough. After testing and knowledge gaps has been closed, the funnel will become more and more narrow as the weakest options are eliminated along the way. In the end it should result in producing better and cheaper products than point-based design (Ward, Liker & Sobek, 1999).

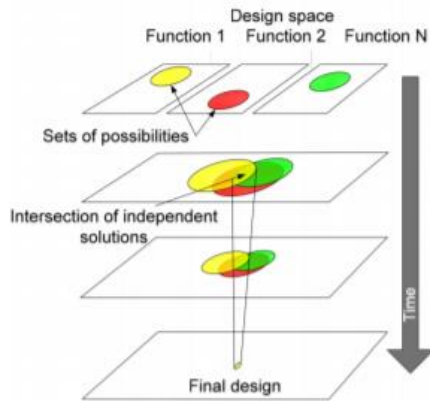

Figure 2.2: Example of a Set-based approach. (Raudberget, 2010)

The set-based approach is described by Tronvoll, Elverum and Welo as to creating a series of designs what could possibly function at a certain level and anticipate that at least one of the designs are applicable. Convergence is based on estimation of performance and incremental elimination of the weaker alternatives (Tronvoll, Elverum, Welo, 2016 B). A strategy from set-based design is to have a so-called "fallback" design. A fallback design is usually a design that is not very innovative and is often known to work. There are often many radical and new concepts that can work within a set, but to create more robust sets it is often beneficial to include a fall back design. This is to ensure that the project is not stuck without any solutions within a cut-off date. So, if everything else fails, there still is a viable option - even if all the more innovative concepts fails (Ward, Liker & Sobek, 1999).

2.1.2 Modularity

The modular design theory aims to create designs that each component will perform completely independent of each other, while all the functional requirements are fulfilled (Suh, 1997). Important things to consider is attribute independence, attribute similarity, process independence and process independence. The benefits from modular design is the increase in end-customer value. Modular design will provide the customer with an easy upgrade, increase in adaptability and flexibility. This will help to decrease the cost of a product's lifecycle. Some examples of products that has used the modular design is power drills, vehicle roof racks, and computers. The flexibility these products offer the customer is astonishing. Take the computer, for example. Older computer models can be upgraded with new hardware and software, with ease.

No one knows exactly which customer needs will appear in the future, but with modular design any upgrades or new attachments can easily be implemented with the use of the same interface that we see in today's products. It is worth mentioning that the design and functionality of this modularity will usually lead to more expensive products. Implementing modular design theory into manufacturing may also prove beneficial. Modular manufacturing will require a smaller space because production cells can be switched between different tasks with ease. The most important benefit is that it is easy to convert or change a manufacturing line fast so the company can stay on top of an ever changing market (Gershenson & Prasad, 1997).

One of the strengths that modular design possesses is that the product architecture makes it easier to assemble, reuse parts and recycle parts with a longer lifetime (Gu, Hashemian, Sosale & Rivin, 1997). On the downside, modular designs have proven to be much more difficult to design than designs that are interconnected. The problem with creating the boundaries of a module at an early stage and then proceeding to create a stand-alone working product, is that a product can work fine by itself, but when all modules are put together the system can end up underperforming as a unit (Baldwin & Clark, 2003).

2.1.3 Linking modularity and set-based design

As mentioned above, one of the core elements of set-based design is that it seeks robust design and also wants to impose as little constraints in order to avoid locking onto a solution too early. An example of this is how Toyota imposes little to no constraints on their manufactures, but instead provide performance requirements and a fixed interface (Clark & Fujimoto, 1991). This is aligned with the modular design ideas, where modular designs rely on the independence of each subsystem within a product (Baldwin & Clark, 2000). This independence comes by defining a fixed interface between each subsystem inside a product (Sosa et al., 2004).

Using modular design will also be beneficial within set-based design because this will allow different departments to innovate and develop their sub system independently and only stay within their design space and the interface that will be used to integrate their part (Thomke, 1997).

2.2 Aluminum processing

2.2.1 Aluminum extrusion

The process of extrusion begins with logs of aluminum being cut into billets, which are put into a furnace and then heated to approximately 450-500 degrees celsius. During the next step, the billets are exposed to tremendous pressure and each billet is forced through a die, and the finished profile emerges from the opposite side. The dies are normally made from tool steel.

The profile emerges from the die at a speed of 5-50 meters per second, and then the profile is cooled down immediately after in either water or air. After cooling, the profile may be warped, so this is countered by stretching the profile to achieve the desired straightness. (*Sapa Group AB., 2007*).

Profiles can be divided into two main categories; hollow and solid. Solid profiles are made from a disc-shaped die, and the hollow profiles are made from a die which consists of two parts. Hollow parts are generally more time consuming and costly because it has a more complex geometry and it require dies, unlike the solid extrusion which require only one die. (*Sapa Group AB., 2007*)

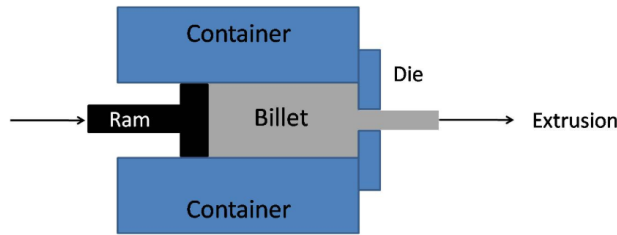

Figure 2.3: Extrusion process. (Aluminum-production. 2009)

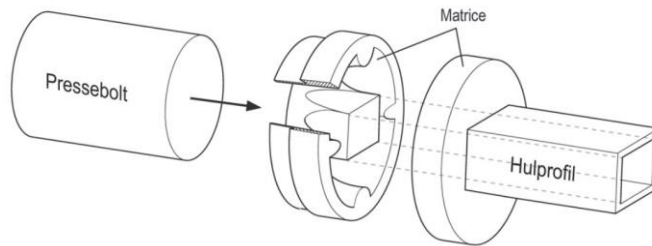

Figure 2.4: Hollow profile extrusion. (Alumeco, n.d)

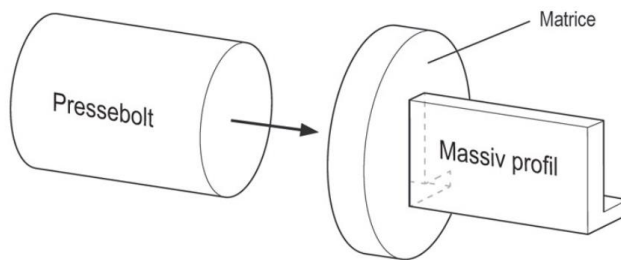

Figure 2.5: solid profile extrusion. (Alumeco, n.d)

2.2.2 Joining aluminum

The high elasticity of aluminum makes it a well-suited material for snap-fit joints. Snap-fit means that one profile may be snapped together with another profile with the help of notches and hooks. Snap-fit joints is far more superior to other joining methods like welding or bolting. These connections can be made to be opened again or permanently connected (Sapa Group AB., 2007).

The use of brackets is very effective to obtain a stiff and lasting connection in corners. Corner brackets can be fitted with screw ports for self-tapping screws, stamping channels or even both (Sapa Group AB., 2007). There are other methods of joining aluminum, such as welding and gluing. These methods were considered less relevant to this thesis, but gluing can be used to attach the canvas to the frame.

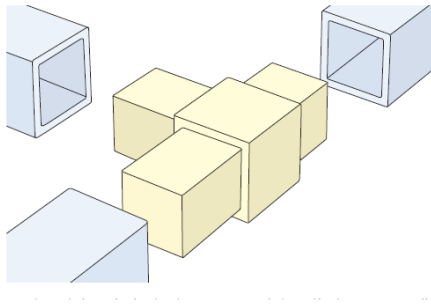

Figure 2.6: Casted T-joint (Sapa Group AB., 2007).

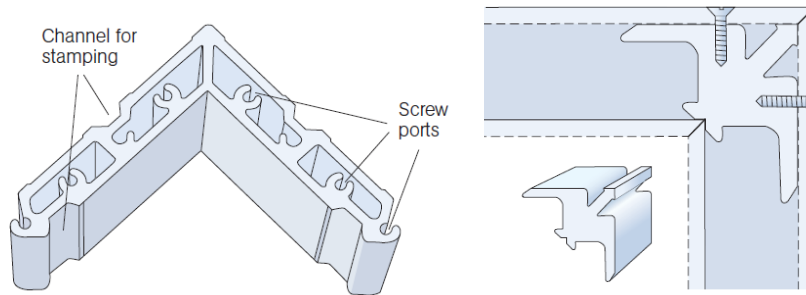

Figure 2.7: Corner bracket joint that take advantage of self-tapping screws and stamping channels (Sapa Group AB., 2007).

2.2.3 General design guidelines for aluminum

SAPA do give some advice on how to succeed in creating extruded profiles. They recommend creating profiles that are solid instead of hollow, as solid profiles are cheaper and easier to extrude. The profile should have uniform wall thickness as far as possible. It is possible to have uneven thicknesses if the structure demands it. Extruding also has a problem with sharp corners, therefore all corners should be rounded off with a radius to avoid this problem, a radius of 1-2 mm is enough. Extruded parts should not have deep narrow channels either, the width of a channel should not be smaller than $\frac{1}{3}$ of the depth. This is to not risk damaging the die.

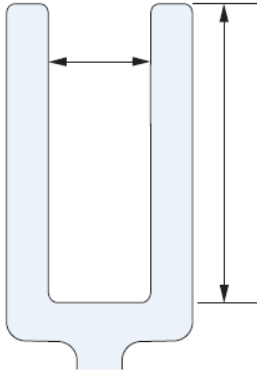

Figure 2.8: Channel Width to height ratio should not be lower than 1/3. (Sapa Group AB., 2007).

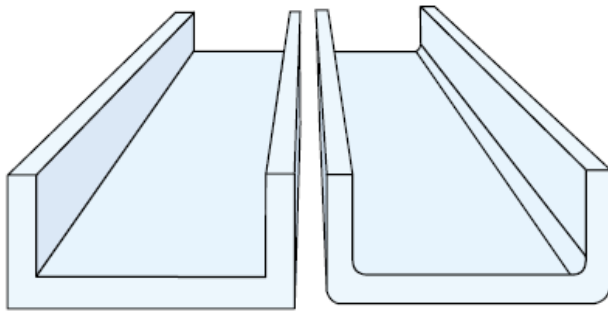

Figure 2.9: corners should be rounded of(Sapa Group AB., 2007).

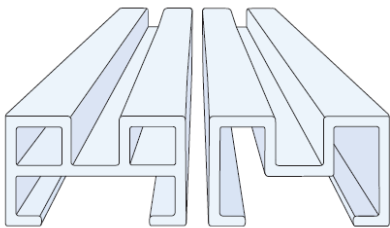

Figure 2.10: Transformation from hollow profile to solid profile (Sapa Group AB., 2007).

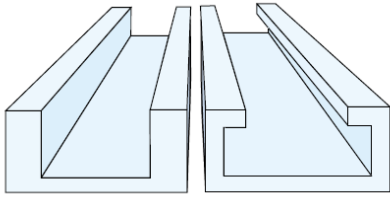

Figure 2.11: Profiles should have even thickness. (Sapa Group AB., 2007).

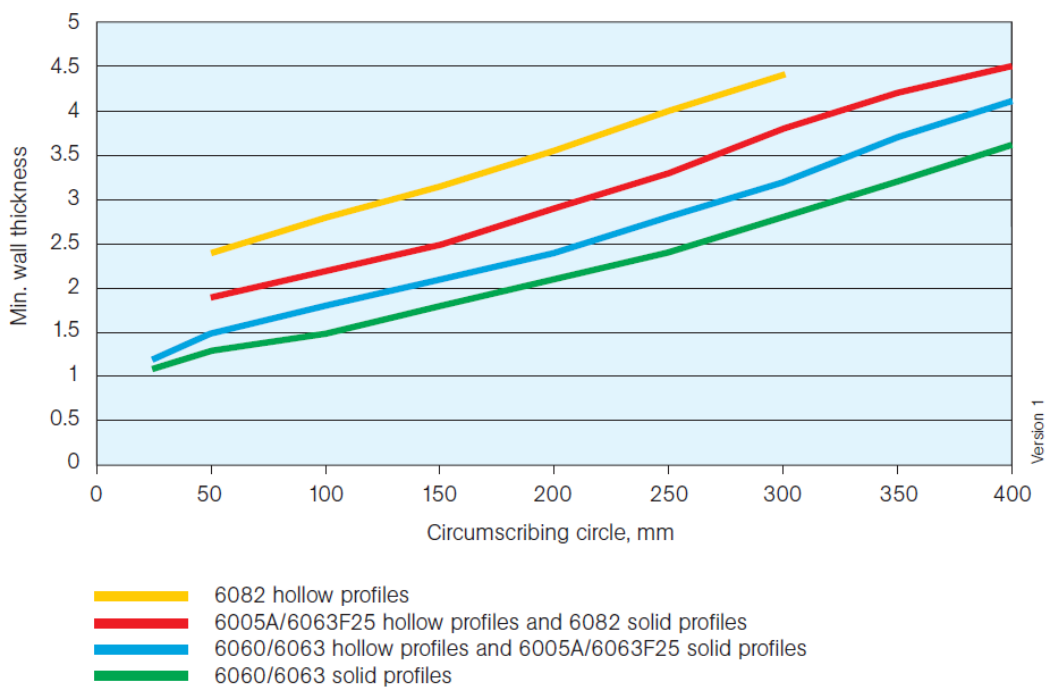

Figure 2.12: Shows the recommended wall thickness as a function of circumscribing circle on the different SAPA alloys. (Sapa Group AB., 2007).

2.4 FEA

SolidWorks 2019 version was used to perform finite element analysis on the structure to verify that the structure could withstand the loading cases the flood wall would be subjected to. SolidWorks 2019 possess features which includes a material library. The material properties concerning aluminum alloy 6061-T6 is seen in table X. This was also used to calculate the weight and examine the integrity of the product. This is not the same alloy that is used in the design process in this thesis, but the properties except the yield stress and tensile strength are the same.

Data	Unit	Value
Yield stress	MPa	215
Tensile stress	MPa	240
Young's modulus	MPa	69000
Density	kg/m ³	2700
Poisson's ratio	----- -	0.33

Table 2.1: Material properties from Solidworks 2019

2.4.1 Load cases

The models will be subjected to loads during the analysis, and these loads should be as close to a real-life scenario as possible. The element will be submerged in water, which will result in an increase in pressure from the water as the water level rises. This will result in an unevenly distributed force. Because the elements will be deployed in flood scenarios, it can be assumed that the water will have some dynamic forces too. For this early stage analysis, the dynamic load will be added to the static load from the water. The horizontal plate will be subjected to static pressure only.

It is to be expected that the flood wall will be vulnerable for overturning if it is subjected to large winds before the water level has risen enough to apply significantly pressure to keep it stable. This problem is acknowledged but will not be further addressed in this thesis.

Load 1 - static

$$\rho = 1000 \frac{kg}{m^3} \quad g = 9,81 \frac{m}{s^2} \quad h = 1.8 m$$

$$P_{static} = \rho gh$$

$$P_{static} = 1000 * \frac{kg}{m^3} * 9,81 \frac{m}{s^2} * 1.8 m * 10^{-6} \rightarrow P_{static} = 0.018 MPa$$

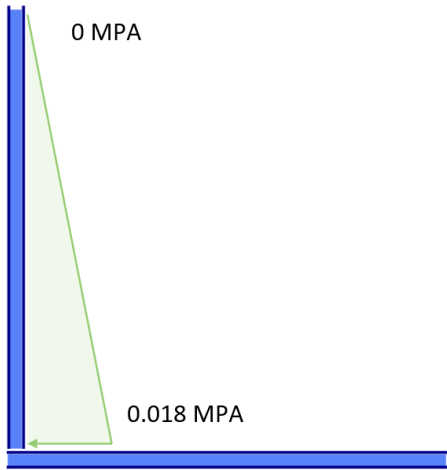

Figure 2.13: horizontal pressure

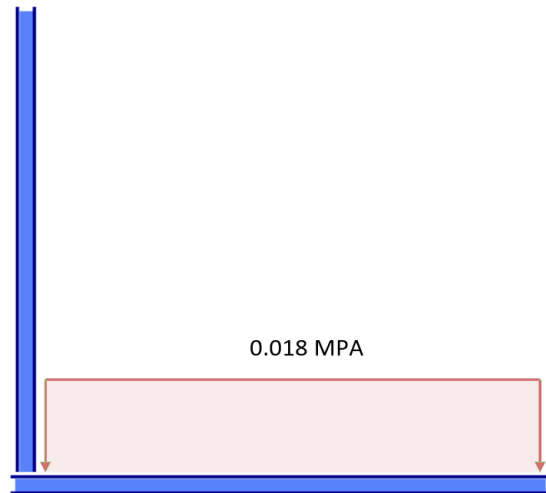

Figure 2.14: vertical pressure

Load 2 – dynamic

$$\rho = 1000 \frac{kg}{m^3} \quad a = 1.28 \quad v = 2,1 \frac{m}{s}$$

$$P_{dynamic} = \frac{1}{2} \rho a v^2$$

$$P_{dynamic} = \frac{1}{2} * 1000 * \frac{kg}{m^3} * 1.28 * \left(2,1 \frac{m}{s}\right)^2 * 10^{-6} \rightarrow P_{static} = 0.018 MPa$$



Figure 2.15: Dynamic pressure

Resulting loads

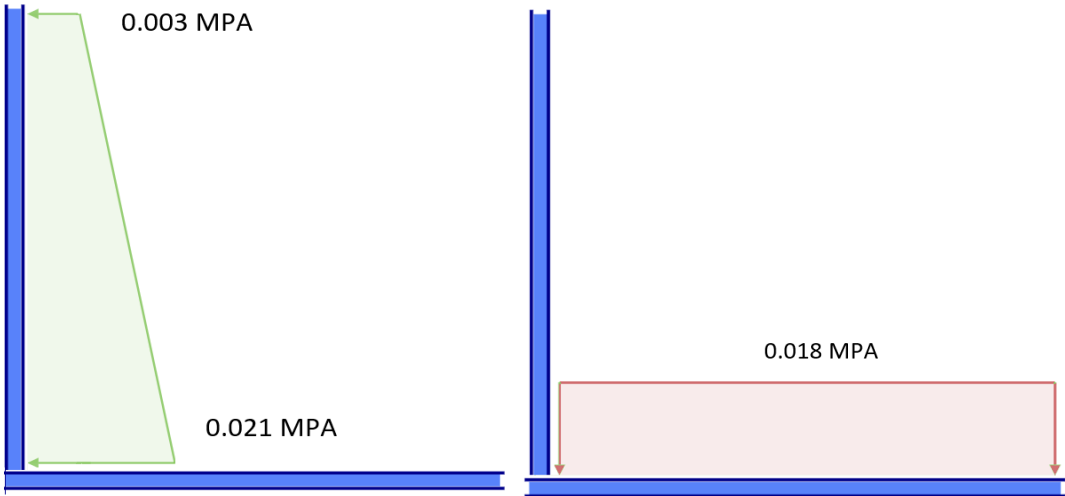

Figure 2.16: Resulting pressures

3 Methods

3.1 CAD modelling in SolidWorks

As the original design was made up of two plywood panels and AquaFence wanted the new design to be made up from aluminum and was in need for a new model. This task was made easy with computer aided design. All models were created as hand sketches and later modelled using SolidWorks.



Figure 3.1: Initial designs

The different designs that were made will be named Fixed frame concept 1, Fixed frame concept 2 and Adjustable frame concept. Today's model will be used as a benchmark, and the other designs will be compared to this concept. One of the main advantages with CAD is that it is possible to create visual prototypes at low cost in a short amount of time (Elverum, Welo & Tronvoll, 2016).

By creating CAD models of the concepts, it opened the doors for Computer aided engineering, which means it was possible to perform structural analysis on the different designs. Computer aided engineering will be elaborated further in chapter 3.2

3.2 CAE with SolidWorks simulation

Ulrich and Eppinger states in their book "Product Design and Development" that when it comes to prototyping, an analytical prototype is much more flexible than a physical prototype. This is because making changes in a digital tool is generally cheaper and faster than making changes in a physical product. Further in this book, Ulrich and Eppinger claims that digital prototypes are a good tool to limit parameters when developing prototypes. Physical prototypes should then be created in order to verify the design afterwards (Ulrich & Eppinger, 2012).

With this in mind, multiple concepts were created in SolidWorks and tested in SolidWorks simulator using FEA. By creating FE-models of the concepts, it was possible to see how the different concepts would react when subjected to the loads that were provided by AquaFence. The simulations gave important feedback that laid the foundation for further development of the concept, and which changes that was needed to be made. New simulations were then initiated to see if the changes had improved the performance.

The vertical panel was the one of interest, as the horizontal panel would be supported by the ground. This means that the stresses in the horizontal plate would be smaller than in the vertical wall, also the deflections would be neglectable. As for the simulation models, they would only include the aluminum frame.

As the simulation model is so simplified, they would not be representative of how a physical model would react in the real world. Although, these simulations give an indication of where the highest stresses would appear, and because the same boundary conditions are applied to all designs, it will create an opportunity to compare them among themselves.

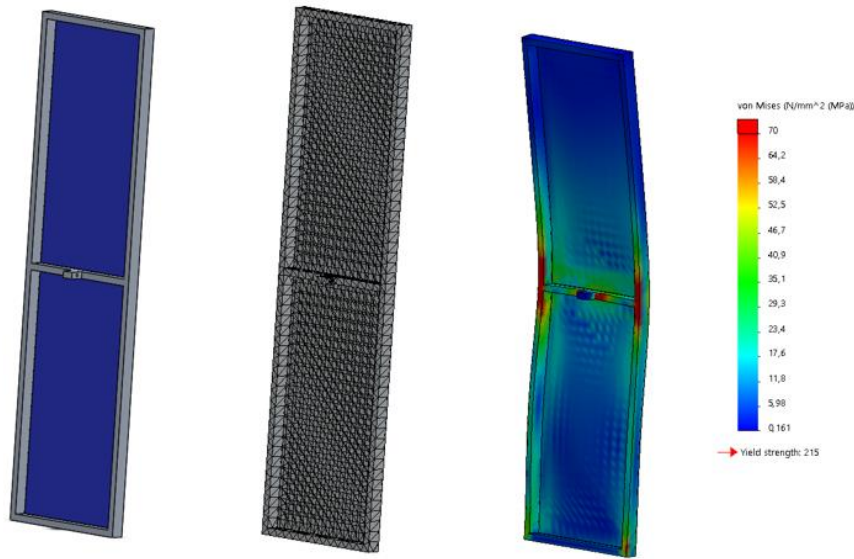

Figure 3.2: CAD model, FE-model and Results

Advantages to simulations

One of the most notable advantages of CAE and CAD is that after an acceptable model has been created and a FEA model has been made, it is possible to run simulations at practically zero cost compared to physical testing. Furthermore, the time it takes to perform a simulation can range from hours or minutes, which in turn makes it easy to perform incremental improvements very fast. On the other hand, simulations can often be too simplified and will not give a complete picture of exactly how a model will perform overall, unlike a physical prototype would.

Physical testing is often initiated with scaled down versions, as this will often save time and money, but this will in some cases create problems on its own if the environment or design is sensitive to scaling. For example, in this project, smaller prototypes could be affected by scaling as the mechanics of fluids is very sensitive to this (Iansiti, 2016). When we use simulation models, the models can be tested in full scale because the scale of the models does not add to the cost of creating a digital model. This will in turn eliminate any decrease in accuracy from scaling.

Drawbacks to simulations

While digital prototyping offers many possibilities, it is crucial to be aware of this tool's limitations. As stated in Elverum and Welo (2015), digital tools should not replace physical prototyping, but rather be used as a complimentary tool. They suggest that the digital tools are based on already existing knowledge and inhibits the ability to discover unforeseen problems with the design because of this. In addition to this, digital tools perform much better when confirming already existing knowledge.

3.3 Finding the best beam dimensions

Because the element is thought to be constructed from aluminum beams, and weight and strength are of importance, it will be beneficial to have the strongest and lightest beams possible.

In order to find the best beam dimensions for this construction it was first necessary to find the load that each beam was set to carry. To find out what load they needed to carry a simplified model was used, where the total force of the water was distributed in an uneven distributed load among the vertical beams.

$$W_h = 1300 \text{ mm} \quad H = 1800 \text{ mm} \quad P_h = 0.021 \text{ MPa}$$

$$F_h = 1300 \text{ mm} * 1800 \text{ mm} * 0.021 \text{ MPa} * 0.5 \rightarrow F_h = 24570 \text{ N}$$

$$\frac{F_h}{4 \text{ vertical beams}} = F \rightarrow F = \frac{24570 \text{ N}}{4} \rightarrow F = 6143 \text{ N}$$

In order to shift the pressure from the entire face of the element to just the beams, the total force was divided with the length of the beams.

$$\frac{F}{l} = \text{Distributed load} \rightarrow \text{Distributed load} = \frac{6143 \text{ N}}{1800 \text{ mm}} \rightarrow \text{Distributed load} = 3,4 \text{ N/mm}$$

Because the water load will act on the wall in a triangle shape, it is necessary to double the distributed load at the bottom and make it zero at the top.

The forces were calculated by using SkyCiv Beam calculator (Skyciv, n.d). This is a cloud software that allows calculations of simply supported beams. The software is part of the Hong Kong Building Department's pre-accepted Structural Software list (Carigliano, 2017). The results from this software is therefore considered accurate enough for this project.

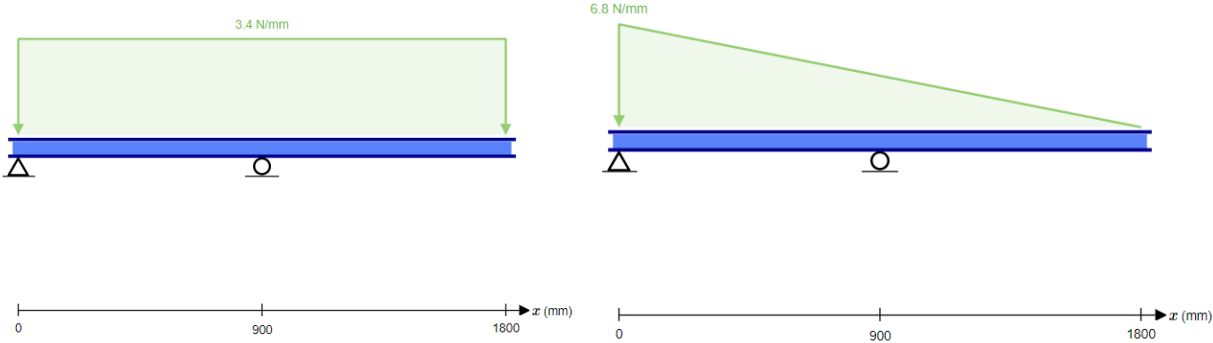

Figure 3.3: Illustration of how the load was altered from an even to an uneven distributed load

This calculation model gives the forces of shear force equal to 4090 N and bending moment of 459000 Nmm

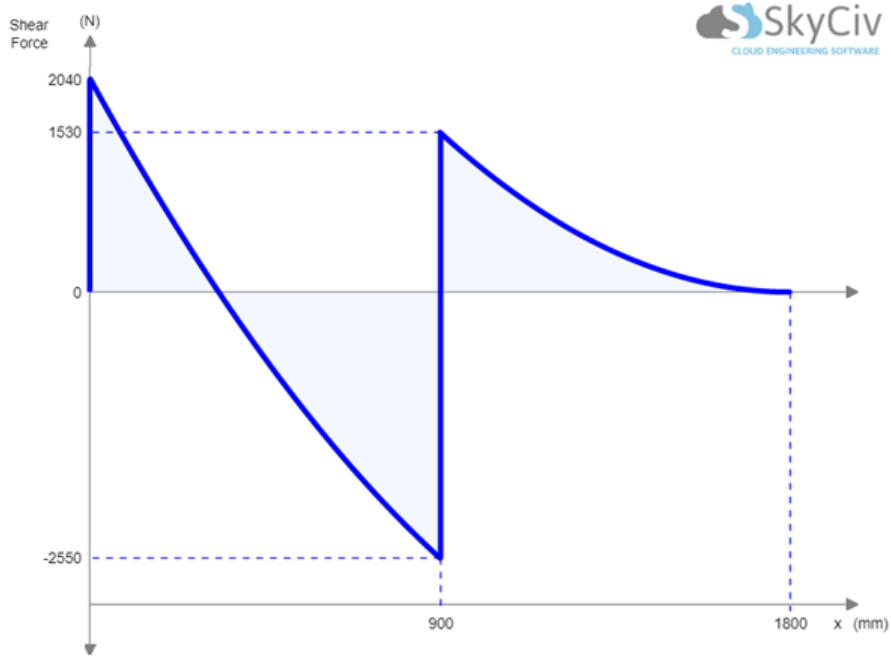

Figure 3.4: shear force in the profiles from the Fixed frame concepts.

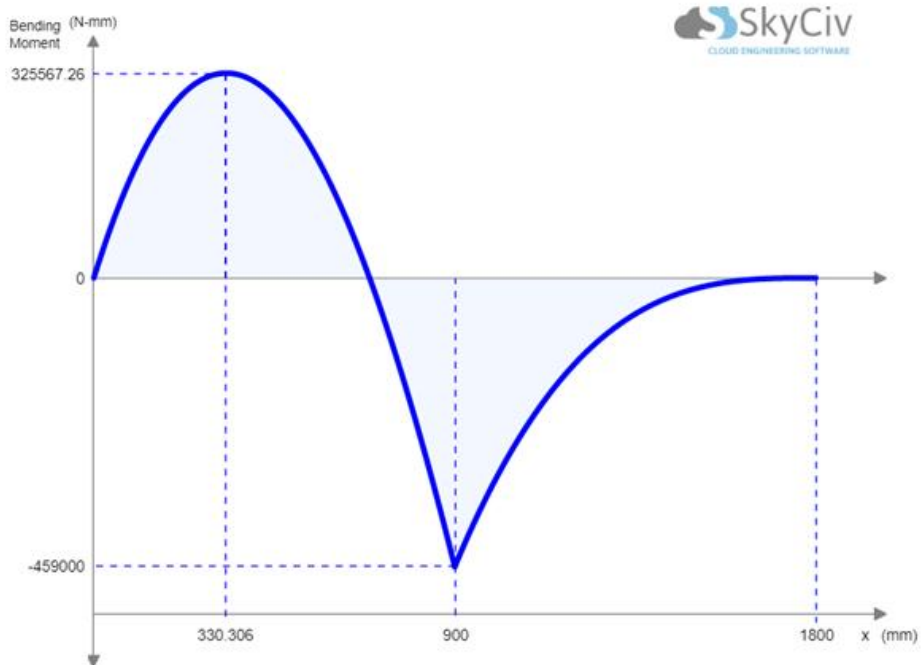

Figure 3.5: Bending moment in the profiles from the Fixed frame concepts.

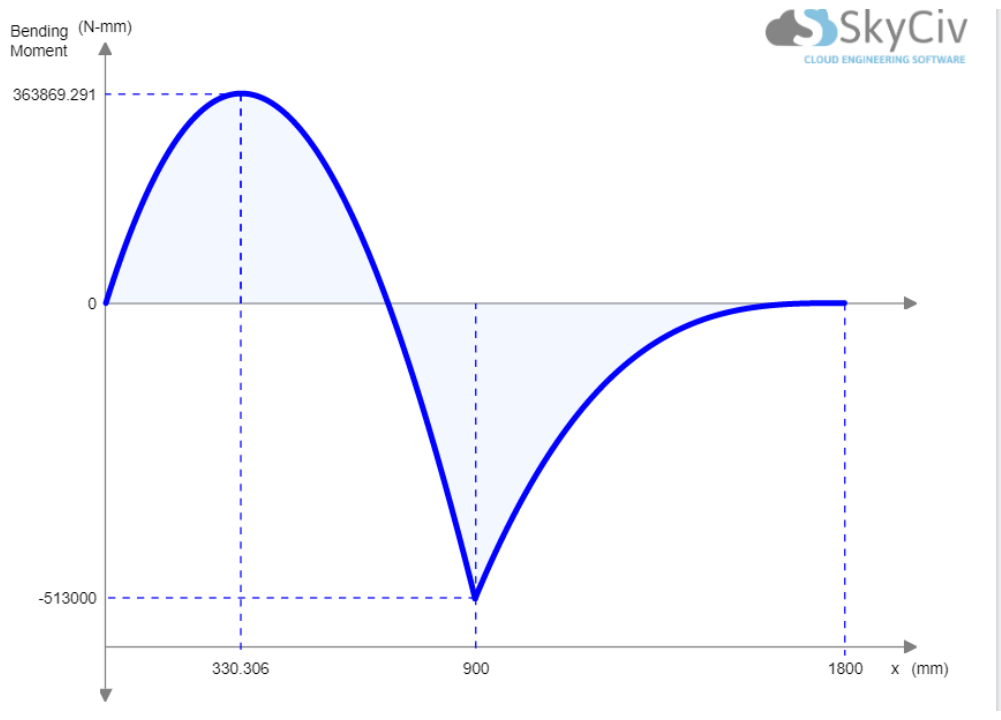

Figure 3.6: Bending moment in the profiles from the adjustable frame concepts.

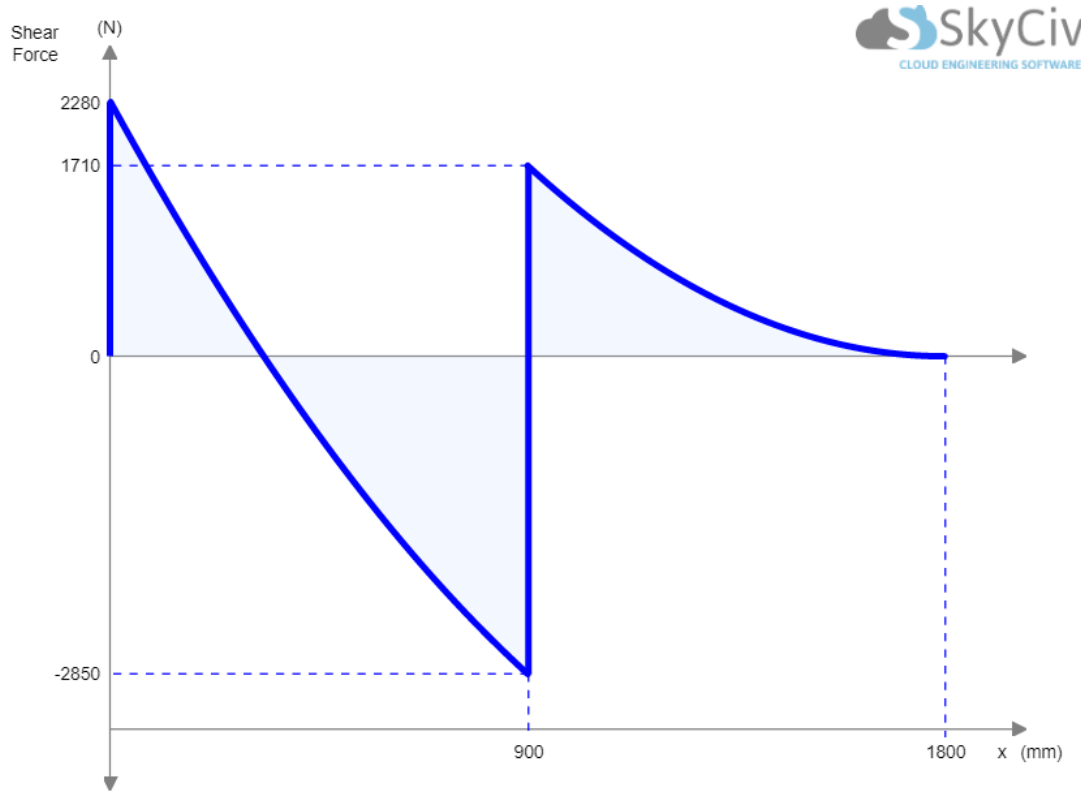

Figure 3.7: Shear force in the profiles from the Fixed frame concepts.

In set-based design it is important to not only design and test different concepts, but also subsystems. It will be insufficient to just identify possible options and then go for a best

guess and iterate from this. The best way will be to test all viable options and explore the different tradeoffs in all options and then make a well-informed decision based upon the gathered data (Ward, Liker & Sobek, 1999).

Because the strength of a beam relies on the width, height and thickness, there will be many different combinations of these three variables that will provide the needed strength. Therefore, it was added a fourth variable that will be the weight. This means that out of all the possible solutions, the lightest would be the best in this case.

To ensure that the best option was chosen, it would be necessary to test all viable options. A way to test many options in a short time would be to create a computer script that would test all the different combinations of height, width and thickness - then compare them to each other based on weight.

```
1  beam_dimensions=[]
2  lowest_weight=10000
3  for height in range(10,100):
4      for widht in range(10,100):
5          for x in range(25,31):
6              wall_thickness=x/10
7              shear_stress=4090/(((widht*height)-(widht-(2*wall_thickness))*
8                  (height-(2*wall_thickness))))
9              i=(((widht*height**3)/12)-(((widht-(2*wall_thickness))*(height-
10                  (2*wall_thickness))**3)/12))/(height/2)
11             weight=int((((widht*height)-((widht-(2*wall_thickness))*(height-
12                 (2*wall_thickness))))*1800)*2700/1000000)
13             bending_stress=460000/i
14             von_mises=(bending_stress**2+3*shear_stress**2)**(1/2)
15             if von_mises < 125:
16                 if weight < lowest_weight:
17                     lowest_weight=weight
18                     summary=[int(weight),height,widht,int(i),wall_thickness]
19                     beam_dimensions.append(summary)
20             beam_dimensions.sort()
21     for x in beam_dimensions:
22         print(x)
```

Description of each line:

1. Introduces an empty list that will be filled with plausible combinations av height, width and wall thickness
2. Variable called 'lowest weight', which is set to 10000. This is to save the weight of a profile, and in this context, this will mean 10 kg. 10 kg is unreasonably high because it will be replaced later with the weight of the element if it is smaller. 10000 is therefore unreasonably high to ensure that it will change as soon one profile is found to be strong enough

3. A For-loop that represents all beams heights between 10 mm and 100 mm
4. A For-loop that represents all beams widths between 10 mm and 100 mm
5. A variable that represents all wall thicknesses between 1 mm and 3mm, with a step size of 1/10
6. A calculation that calculates the right thickness to be used in the upcoming calculations
7. Introduces a variable called 'shear stress'. Shear stress calculates shear stresses with the help of height, width and wall thickness, in addition to the shear force calculated with the beam calculator

$$\tau = \frac{F}{A}$$

8. Introduces a variable called I. I calculate the moment of inertia

$$W = \left(\frac{B * H^3}{12} - \frac{b * h^3}{12} \right) * \frac{y}{2}$$

9. Introduces a variable called weight. This line calculates the weight of the beam

$$mass = (H * W - h * w) * 1800 \text{ mm} * \frac{2700 \frac{kg}{M^3}}{1000000}$$

10. Introduces a variable called bending stress. This calculates the bending stress, using variable I and the bending moment found from the beam calculator
11. Introduces a variable called von mises, this line calculates the simplified von mises stresses using shear stress and bending stress

$$\sigma = \sqrt{\sigma^2 + 3 * \tau^2}$$

12. Introduces an if-condition, this means that if the variable von mises is lower than 125 Mpa, it can precede, otherwise it will continue with the for-loop
13. Introduces an if-condition. If the weight of the beam in question is lower than the weight saved in variable weight, with von mises stress lower than 125, it will proceed. The lowest weigh will be replaced with the current weight of the beam. This is the reason the lowest weight needed to be so high in the beginning, so it would not miss any solutions. This prevents the script to add all the solutions to the list - just the one that is lighter than the ones before
14. Replaces lowest weight with the current weight, this is to save the weight of the beam
15. This line creates a summary that can be added to list of beam dimensions. It consists of width, height and thickness, as well as weight. This is to see what the

best combinations would be. The summary will appear like this: weight, height, width, wall thickness

16. It adds the summary to the lists "beam dimensions"

17. It sorts the list "beam dimensions", the beams added will appear with decreasing weight

18. For-loop that goes through all items in list "beam dimensions"

19. Print each item in list "beam dimensions"

4 Results

4.1 Choosing the aluminum alloy

The two alloys that was of interest that SAPA offered was the SAPA 6060 T6 and the SAPA 6082 T6. The 6060 T6 alloy is the most common alloy, and the 6082 is the strongest alloy. The two alloys will only be compared from their performance, not their price or difficulties in production. From the recommended wall thickness in figure 2.12, it can be found that the minimum wall thickness for 6060 is 1,7 mm because of the circumscribed circle, and the minimum for 6082 is 2,5 mm.

Alloy	Yield strength	Maximum stress
SAPA 6082 T6	250 MPa	125 MPa
SAPA 6060 T6	150 MPa	75 MPa

Table 4.1: Strength of the alloys

This script has calculated that the best dimensions for the beams would have the dimension 47x24x2,5 mm for the 6082 and 72x33x1,7 mm. Because 6060 is about 100 g heavier for each 1800 mm than 6082, SAPA 6082 T6 will be the alloy used in this thesis.

[1579, 47, 24, 3738, 2.5]	[1678, 72, 33, 6392, 1.7]
[1603, 43, 28, 3736, 2.5]	[1695, 67, 39, 6396, 1.7]
[1628, 41, 31, 3754, 2.5]	[1711, 63, 44, 6366, 1.7]
[1652, 39, 34, 3747, 2.5]	[1728, 61, 47, 6382, 1.7]
[1676, 38, 36, 3777, 2.5]	[1744, 59, 50, 6382, 1.7]
[1701, 36, 39, 3734, 2.5]	[1761, 57, 53, 6366, 1.7]
[1725, 35, 41, 3742, 2.5]	[1777, 56, 55, 6397, 1.7]
[1749, 34, 43, 3741, 2.5]	[1794, 54, 58, 6355, 1.7]
[1773, 33, 45, 3732, 2.5]	[1811, 53, 60, 6371, 1.7]
[1814, 33, 44, 3775, 2.6]	[1827, 52, 62, 6381, 1.7]
[1822, 32, 48, 3783, 2.5]	[1844, 51, 64, 6385, 1.7]
[1839, 32, 46, 3760, 2.6]	[1860, 50, 66, 6384, 1.7]
[1846, 31, 50, 3756, 2.5]	[1877, 49, 68, 6376, 1.7]
[1865, 31, 48, 3736, 2.6]	[1893, 48, 70, 6364, 1.7]
[1895, 30, 53, 3783, 2.5]	[1910, 47, 72, 6345, 1.7]
[1915, 30, 51, 3768, 2.6]	[1926, 46, 74, 6321, 1.7]
[1919, 29, 55, 3736, 2.5]	[1959, 45, 77, 6363, 1.7]
[1940, 29, 53, 3725, 2.6]	[1976, 44, 79, 6326, 1.7]
[1968, 28, 58, 3740, 2.5]	[2009, 43, 82, 6351, 1.7]
[1991, 28, 56, 3733, 2.6]	[2025, 42, 84, 6301, 1.7]
[2010, 28, 54, 3716, 2.7]	[2058, 41, 87, 6309, 1.7]
[2016, 27, 61, 3730, 2.5]	[2089, 41, 82, 6301, 1.8]
[2041, 27, 59, 3727, 2.6]	[2091, 40, 90, 6309, 1.7]
[2062, 27, 57, 3715, 2.7]	[2124, 39, 93, 6299, 1.7]
[2089, 26, 65, 3761, 2.5]	[2158, 38, 96, 6280, 1.7]
[2117, 26, 63, 3763, 2.6]	[2193, 38, 91, 6296, 1.8]
[2138, 25, 68, 3723, 2.5]	[2219, 38, 86, 6275, 1.9]
[2168, 25, 66, 3728, 2.6]	[2228, 37, 94, 6275, 1.8]
[2193, 25, 64, 3725, 2.7]	[2275, 37, 90, 6325, 1.9]
[2211, 24, 72, 3720, 2.5]	[2281, 36, 98, 6303, 1.8]
[2244, 24, 70, 3729, 2.6]	[2312, 36, 93, 6300, 1.9]
[2272, 24, 68, 3730, 2.7]	[2332, 36, 88, 6264, 2.0]
[2297, 24, 66, 3723, 2.8]	[2349, 35, 96, 6265, 1.9]
[2308, 23, 77, 3746, 2.5]	[2391, 35, 92, 6299, 2.0]
[2319, 23, 74, 3712, 2.6]	
[2351, 23, 72, 3716, 2.7]	
[2378, 23, 70, 3713, 2.8]	
[2381, 22, 81, 3705, 2.5]	
[2421, 22, 79, 3721, 2.6]	

Figure 4.1: Results from the script. SAPA 6082 T6 on the left, SAPA 6060 T6 on the right

4.2 Fixed frame solutions

4.2.1 Production

An element of a fixed frame solutions consists of three parts. Two of them are made up of aluminum frames that are created from extruded hollow profiles. The easiest way to create the fixed part for this group of elements is by creating a frame of aluminum beams. The beams will be connected with T-joints and corner joints. The beams will be fastened to the joint with self-tapping screws. The anchor point for the wires will be located on the middle transverse beam. This beam is fastened with T- joints, but the other two support beams are fastened with L-brackets. There is much lower force in these two beams, and therefore it can have a lighter and weaker connection.

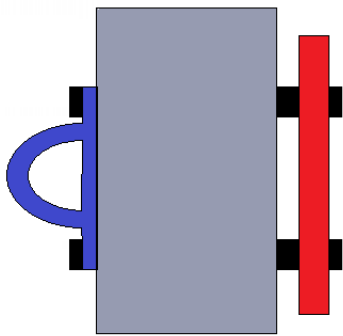

Figure 4.2: Anchor point for the wire. Notice that the bolts go thru the beam and are fasten on the back side.

To create this element, it would require creating four identical frames in the dimensions 1800x500x24 mm. The four frames will create a platform that can be used to create an element that is extendable.

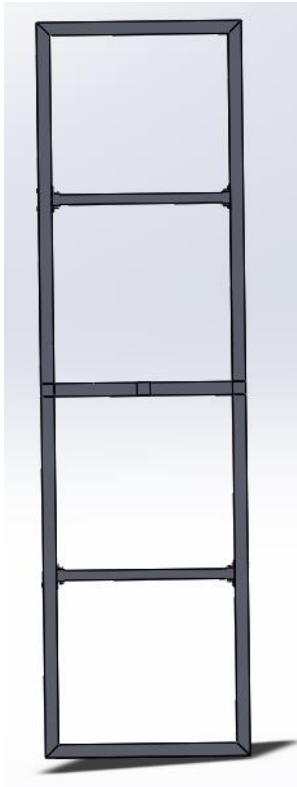

Figure 4.3: Illustration of a single frame

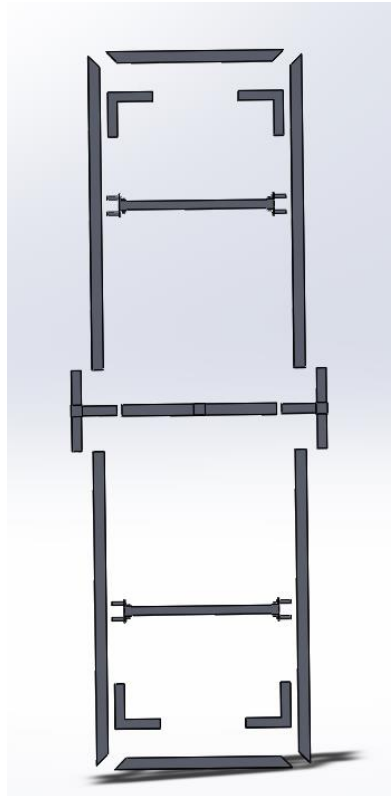

Figure 4.4: Exploded view of a single frame



Figure 4.5: Four frames put together to form a flood wall. The middle is empty, but can be replaced with a solution that can make this flood wall flexible.

The optimal dimension for the structural beams has been calculated to 47x24x2,5 mm. These beams are strong enough to carry the entire load, including the water load that will be subjected to the middle area, which is empty. By using a frame that can withstand the force by itself, it opens the possibility to use different materials to waterproof the frame. This thesis will focus on covering the entire frame in PVC canvas that is already used between elements today, to reduce the weight. For example, it will be possible to replace the canvas in the fixed parts with aluminum sheets to decrease the puncturing risk, or other materials as the user or AquaFence pleases.

4.3 Fixed frame concept 1 (FFC 1)

The concept of the hollow core consists of two fixed elements connected by a canvas. The fixed elements are made from a frame of extruded aluminum beams. The beams that reaches across the frame will provide extra stiffness to the frame as well as anchoring points to the wires, fastening mechanisms and any other features that the element need.

The biggest disadvantage of this concept is that it does not provide any support for the canvas in between the elements. This will result in a reduction of the supporting area of the horizontal plate, hence causing the normal force of the horizontal plate to be smaller. This will then lead to a decrease in the safety factor the element will have of overturning.

The aluminum frame will support the water load, and wires will be anchored to the horizontal plate as well as the vertical plane, in the same way as todays solution. This will ensure that the forces from the water are being transferred between the plates, and consequently, the element will support itself.

On the other hand, the main advantages this concept offer lie in its simplicity. This concept has no mechanism or moving parts that allow for the extension. Because of this there is no need for extra parts and will therefore make production and installing both faster and relatively easy. Another advantage is the flexibility in producing elements. The connectors in the frame will be the same, and there is only need for cutting the aluminum tubes and plate in different lengths to create an expandable element to fit the V1200 or V2400, for example.

A gasket is glued in the front of the fixed elements in order to keep the front sealed against the ground, in the same way as it is today. To keep the front sealed while the element is expanding, and a gap starts to appear. This is illustrated in figure 1.12.

This concept can be regarded as a "fall back"-design for this set.



Figure 4.6: FFC1 collapsed

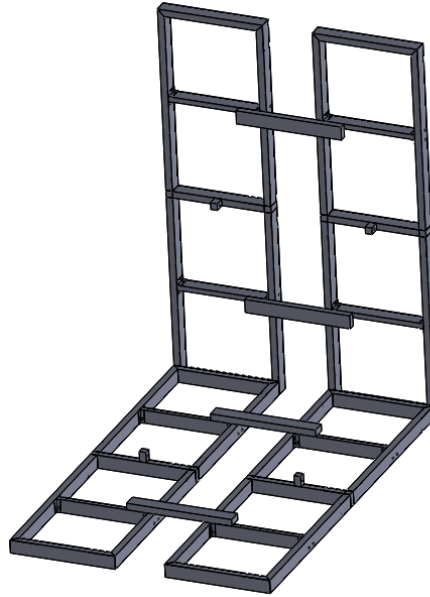

Figure 4.7: FFC1 extended

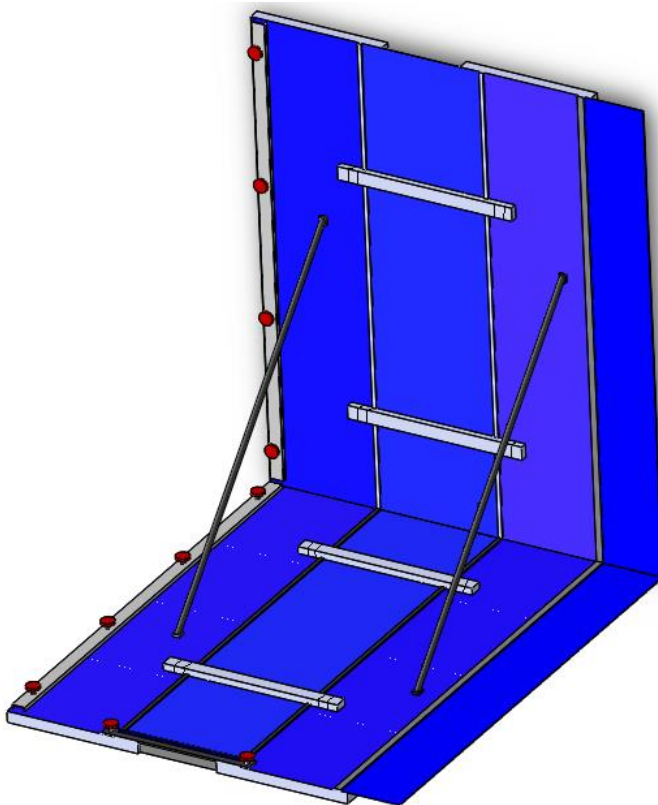

Figure 4.8: FFC1 complete with canvas

4.3.1 Extendable area

This concept will have a hollow core, and the way this element is extendable is by having a flexible PVC-canvas covering the middle area. This makes this concept much lighter than the others because the middle is empty. This will however impact the safety factor of overturning.

4.3.2 Stability

This concept will have a lower factor against overturning since the vertical area will be larger than the horizontal area, because of the gap that appear in the middle when the element extends.

$$W_h = 1000 \text{ mm} \quad W_v = 700 \text{ mm} \quad H = 1800 \text{ mm} \quad P_h = 0.021 \text{ MPa} \quad P_v = 0.018 \text{ MPa}$$

$$F = A * P$$

$$F_h = 1000 \text{ mm} * 1800 \text{ mm} * 0.021 \text{ MPa} * 0.5 \rightarrow F_h = 18900 \text{ N}$$

$$F_v = 700 \text{ mm} * 1800 \text{ mm} * 0.018 \text{ MPa} \rightarrow F_v = 22680 \text{ N}$$

$$M = F * m$$

$$M_1 = 18900 \text{ N} * 0.6 \text{ m} \rightarrow M_1 = 11240 \text{ Nm}$$

$$M_2 = 22680 \text{ N} * 0.9 \text{ m} \rightarrow M_2 = 20412 \text{ Nm}$$

$$\frac{M_2}{M_1} = \frac{20412 \text{ Nm}}{11240 \text{ Nm}} \rightarrow \frac{M_2}{M_1} = 2$$

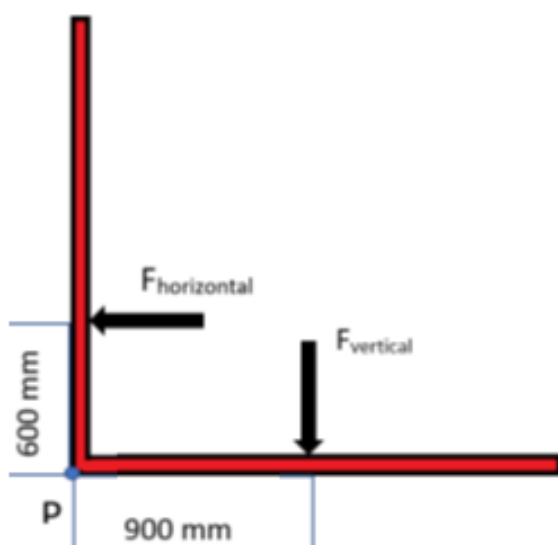

Figure 4.9: calculation model

4.3.3 Extension

Because there is no support of the canvas in the middle, the ground pressure will decrease as the elements are moved apart. Therefore, the largest extension this concept can achieve, while maintaining a safety factor of 2, is approximately 300 mm.

4.3.4 Weight

The weight of the model is found by using SolidWorks. The only parts that are included in this weight estimate are the aluminum profiles. The rest of the components are assumed to be approximately the same for all the concepts and the existing solution, therefore this weight difference is neglectable.

$$\text{Weight} = 34 \text{ Kg}$$

4.3.5 Uncertainties

To get the system waterproof is the main concern. To be completely certain about how waterproof the element is, there is need for a prototype in full scale. There are many locations that will have the potential of being problematic when it comes to waterproofing. The locations with the biggest risk of leakage will be in the corners and places where extra features such as wires have been fastened, and places where holes have been made. This can be countered with the use of thread sealant.

Places where the beams are connected may also prove themselves to be problematic, maybe not in the case of the entire system leaking water, but it may have a leakage inside the beams.

The danger of puncturing the canvas should be considered since flood water is very contaminated and may carry sharp objects.

4.3.6 User friendliness

Because the model will leave a gap between the plates when it is expanded, it will require the installation of an external gasket to make it waterproof. This concept will also need to seal off the gap between the canvas and the gasket. If this gap is not sealed, the system cannot be considered waterproof. This may add an extra step to the installation and will further complicate the installation process. The sealing of the gap will be looked further into later in the thesis.

4.3.7 Modularity

The design of the element is relatively good in terms of modularity. The frame is constructed in such a way that many different features can be integrated. The transverse support beams offer great anchoring points for wires and support rods. Beams around the main frame can easily be switched out in favor of beams with special features, such as beams integrated with hinges, for example. When it comes to connecting the element to other elements, it is initially equipped the same solution that is used today.

In the realm of production, the element consists of four frames that are covered with a canvas, and all the plates are made exactly the same. The assembly processes of the frame will be independent. Other parts, such as wires, canvas brackets and such, are also independent and can be mounted at any time.

4.3.8 FEA Model

A simple model of the concept was made to verify the structural integrity of the element. The only part of the element that is tested is the frame, which is to ensure that the frame will stand the entire load by itself. There are two reasons behind this, the first is to give

the design considerably more flexibility. When the frame supports the load, the canvas will only waterproof the element. The ground will provide support for the horizontal plate, so it is only the vertical wall that is tested. Because the vertical plate consists of two identical frames, the simulation is performed on only one. The canvas is included in this analysis only to provide accurate load distribution, this made it possible to use the water pressure of 0,021 MPa as an uneven distributed load instead of a resulting force. The thickness of the canvas is set to 0,1 mm, this is to not add stiffness to the frame.

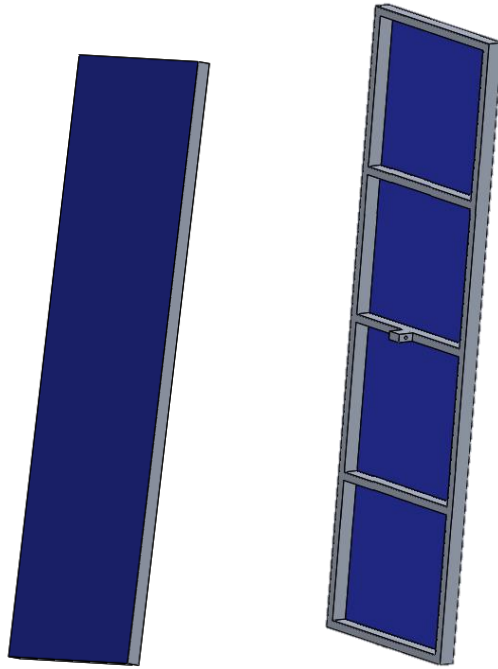

Figure 4.10: Simulation model

Constraints and loads

The model is constrained (green arrows) at the bottom and in the places where the wire is fastened. The constraints that are used are “fixed” at the bottom and pinned at the wire attachment. The load (red arrows) that act on the frame is found by taking the entire area of the plate and multiply it with the water pressure. This force is then spread across the entire front surface of the frame. The force is also increased from 0.003 MPa on the top, to 0.021 MPa at the bottom. These numbers come from the dynamic and static water pressure, which is provided by AquaFence.

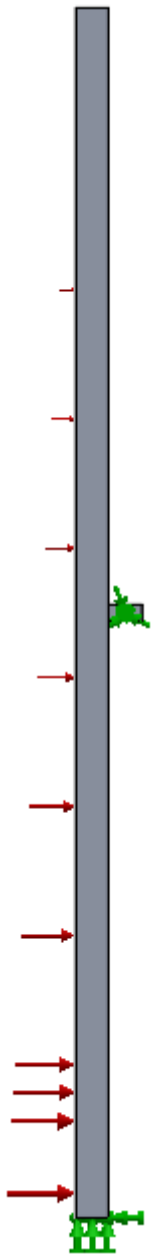

Figure 4.11: This illustrates how the forces act on the model. Red arrows = distributed load, green arrows = fixed/pinned constraints

Results

The stresses in the frame according to the analysis is considerably lower than the yield strength (250 MPa) of the material, with a safety factor of 2. This makes it reasonable to assume that further weight reduction can be made.

The displacement can be considered relatively low as maximal deflection shows to be 10,6 mm

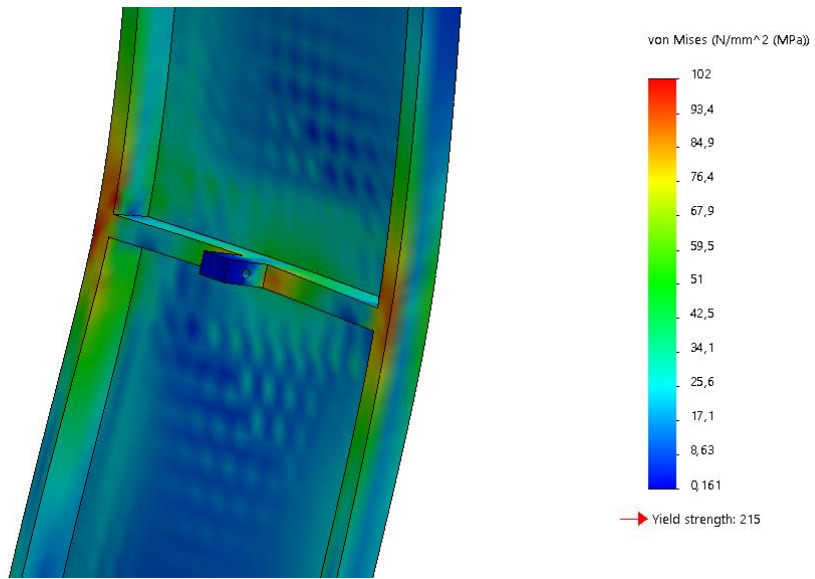

Figure 4.11: Analysis results, stresses (MPa)

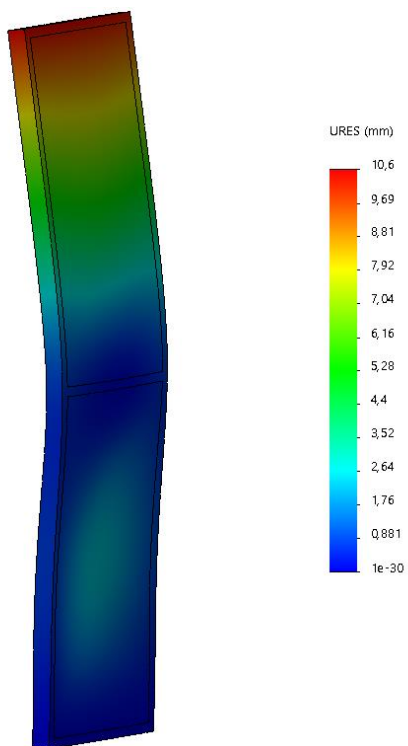

Figure 4.12: Analysis results, deflection (mm)

4.4 Fixed frame concept 2 (FFC 2)

4.4.1 Extendable part

This solution uses the same fixed elements as described in 4.2.1, but instead of a hollow core, this concept used a hinge mechanism in the middle to create an extendable element.

The hinge mechanism consists of extruded aluminum profiles which has integrated hinges. These profiles will need some machining and work to create usable hinges. Then a canvas will be glued to the hinges to make them waterproof. Gluing will need some preparation first. This concept will also be easy to scale in the way that the same parts can be used in all the different sizes. The extruded beams can be cut in different sizes and the same goes for the hinges in the middle as well.

Fastening mechanisms and other features that need to be installed will be anchored to the frame. Since the canvas is glued to the hinges, there will be no need for sealing the canvas against the hinges. There will be a gap that needs to be sealed in front of the elements, especially when the hinges are not fully extended. It can be expected that other materials can be used as hinges instead of extruded profiles, but this is not covered in this thesis.



Figure 4.13: FFC2 collapsed



Figure 4.14: FFC2 expanded, notice that the hinges are not connected in the corner

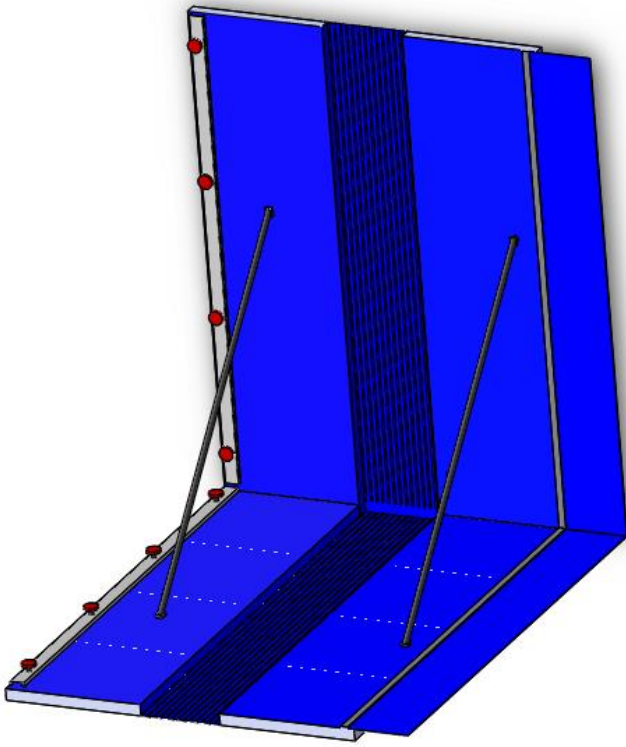

Figure 4.15: FFC2 completed with canvas

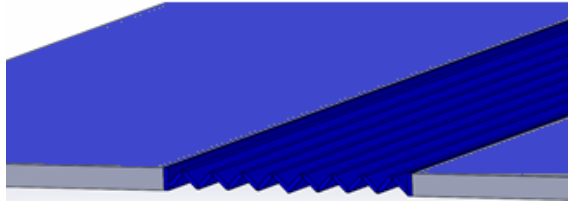

Figure 4.16: Gap that needs sealing in the front

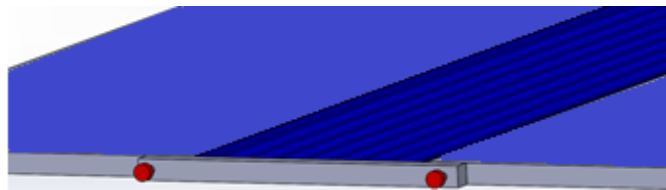

Figure 4.17: Gap sealed with a pre-cut profile

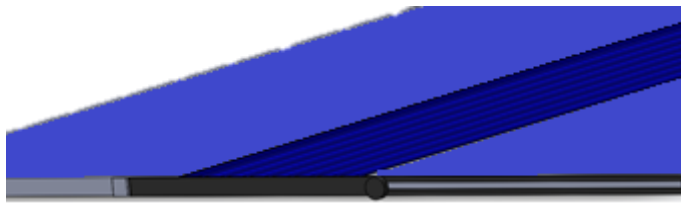

Figure 4.18: Gap sealed with a gliding profile

4.4.2 Stability

Because the vertical hinges have no support in the horizontal direction the vertical plate can be expected to bulge if the plate is not fully extended and the hinges are free to move in a horizontal direction. This bulge will change the load picture and the element will get a force that will counter the force of the horizontal plate. This will in turn lead to a decrease in safety factor against overturning. In the example below it is assumed that the element is only extended halfway, which will allow a bulge of 250 mm.

$$W = 1250 \text{ mm} \quad H = 1800 \text{ mm} \quad P_h = 0.021 \text{ MPa} \quad P_v = 0.018 \text{ MPa} \quad r = 250 \text{ mm}$$

$$F = A * P$$

$$F_h = 1250 \text{ mm} * 1800 \text{ mm} * 0.021 \text{ MPa} * 0.5 \rightarrow F_h = 18900 \text{ N}$$

$$F_v = 1250 \text{ mm} * 1800 \text{ mm} * 0.018 \text{ MPa} \rightarrow F_v = 40500 \text{ N}$$

$$F_2 = 250 \text{ mm} * 1800 \text{ mm} * 0.021 \text{ MPa} * 0.5 * \cos 45 \rightarrow$$

$$\rightarrow F_{2\text{horizontal}}, F_{2\text{vertical}} = 3341 \text{ N}$$

$$M = F * m$$

$$M_1 = (18900 \text{ N} + 3341) * 0.6 \text{ m} \rightarrow M_1 = 13344 \text{ Nm}$$

$$M_2 = 40500 \text{ N} * 0.9 \text{ m} - 3341 \text{ N} * 0.250 \text{ m} \rightarrow M_1 = 35614 \text{ Nm}$$

$$\frac{M_2}{M_1} = \frac{35614 \text{ Nm}}{13344 \text{ Nm}} \rightarrow \frac{M_2}{M_1} = 2,6$$

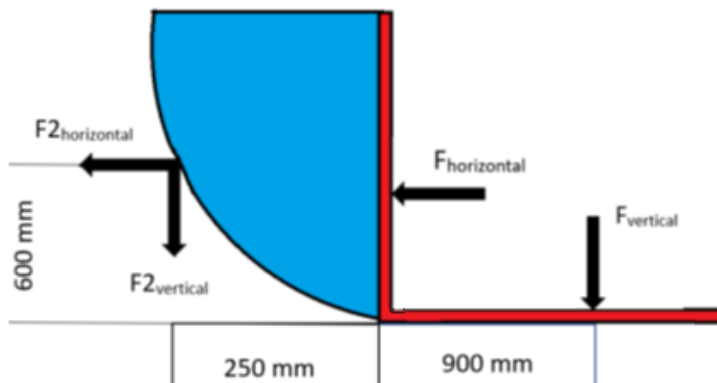

Figure 4.19: calculation model for FFC2. The bulge (blue) is oversized to show the problem.

4.4.3 Extension

The hinge mechanism will be limited by the thickness of the extruded beams that are in the frame, as the hinges cannot be wider than the frame because this will complicate the sealing in the front. The thickness of the profile in this example is 47 mm, and this means that each hinge can maximum be 48 mm wide. With a thickness of 2,5 mm of the extruded hinge, and a minimum diameter of 5 mm of the hinge mechanism (Sapa Group AB., 2007).

Thus, each hinge will build 15 mm compressed and build 32 mm fully extended. This means that the module will need 16 hinges to be able to extend 500 mm. The model can operate with a gliding profile which will limit the possible extension to the size of the fixed frames on the sides. Alternatively, the profile can be made separately and pre-cut in the desired length. This cutting and installing of an external gasket will complicate the installing process further.

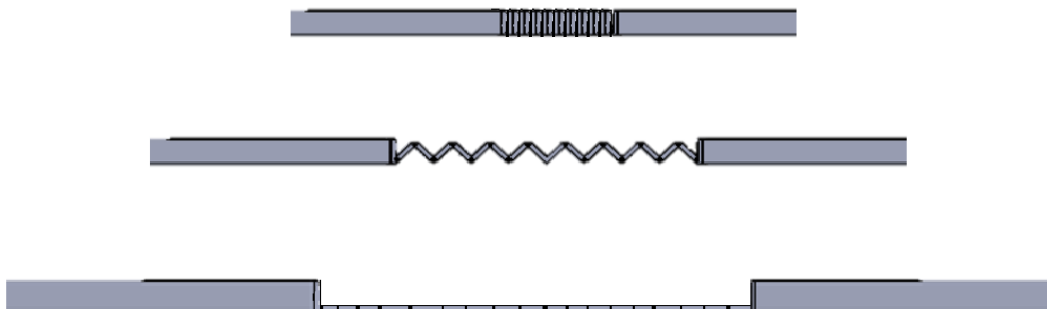

Figure 4.20: Extension of the hinges

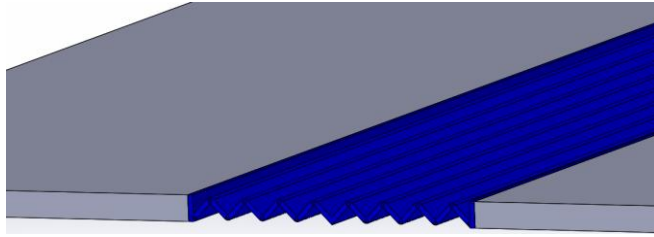

Figure 4.21: Gap that needs sealing in the front

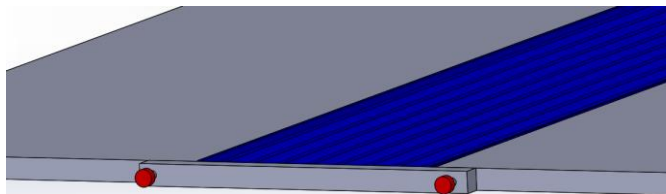

Figure 4.22: Gap sealed with a pre-cut profile

4.4.4 Weight

The weight of the model is found by using SolidWorks. The only parts that are included in this weight estimate are the aluminum profiles.

$$\text{Weight of the frame} = 34 \text{ kg} \quad \text{weight of the hinge} = 0,6 \text{ kg} * 16 \quad \text{Total Weight} = 44 \text{ Kg}$$

4.4.5 Uncertainties

To get the system waterproof is the main concern. To be completely certain about how waterproof the element is, there is need for a prototype in full scale. There are many places that will have the potential of being problematic when it comes to waterproofing. The places with the biggest risk of leakage will be in the corners and places where extra features such as wires have been fastened, and places where holes have been made. This can be countered with the use of thread sealant. It is unclear how the hinges will act in the model, both when they are not subjected to any load and when they are under pressure. It can be expected that the hinges on the vertical plate will bulge out on the back side when the water starts to rise, and how this will affect the system is unknown.



Figure 4.23: Illustrates the problem when the hinges can rotate freely. They can not be expected to stack nicely by them self

4.4.6 User friendliness

This solution will require some extra work in form of installing the external gasket in the front. This will add an extra step in the process and create an opportunity to make mistakes. It is also to be expected that it will be problematic with many loose hinges. Especially when installing and uninstalling the element the hinges may be hard to manage as they are free to rotate.

4.4.7 Modularity

This solution offers great modularity as the fixed plates can be produced and assembled by themselves. This also applies for the hinge mechanism in the middle as well, so it can be assembled later. This means that damaged parts can be replaced with ease and alterations can be made without replacing the entire element. The same components can also be cut into different length as well, hence create the different sizes of the product.

4.4.8 FEA Model

The fixed frames are the same for this concept as it was in the hollow core concept, the only difference will be the hinges from this concept. Therefore, there will be no need to run this simulation again. This analysis focusses only on the integrity of the hinge.

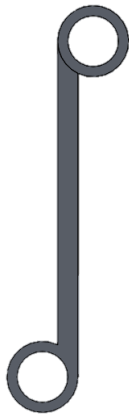

Figure 4.24: Hinge - Front view

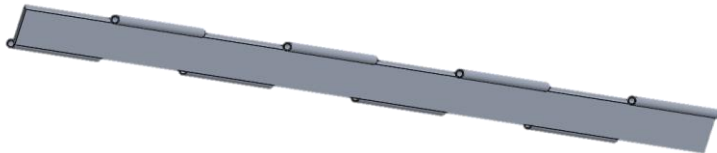

Figure 4.25: Hinge- Sideview

Constraints and loads

The model is constrained (green arrows) in the bottom and in the places where the wire is fastened. The constraints that are used are "fixed". The load (purple arrows) that act on the hinge is found by taking the entire area of the hinged part and multiply it with the water pressure - then divide it by two, half the load carried on each side. This force is then spread across holes where the pins should be.

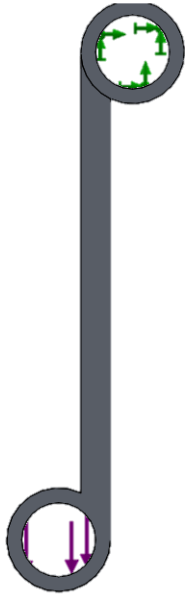

Figure 4.26: loads (purple arrows) and constraints (green arrows)

Results

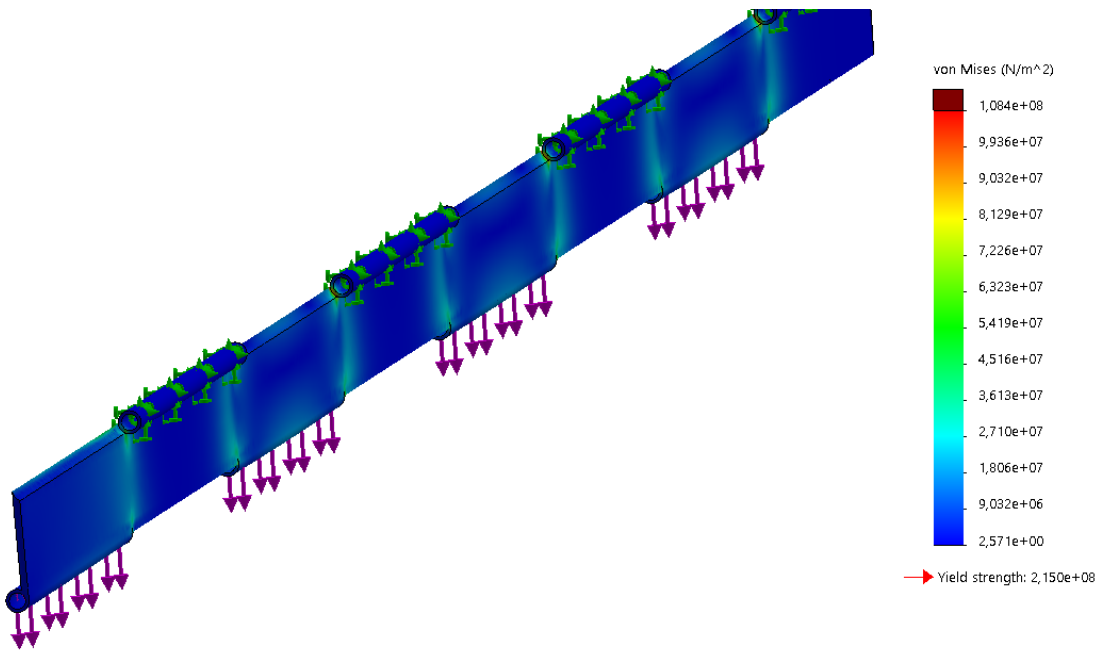

Figure 4.27: Analysis results, stresses (MPa)

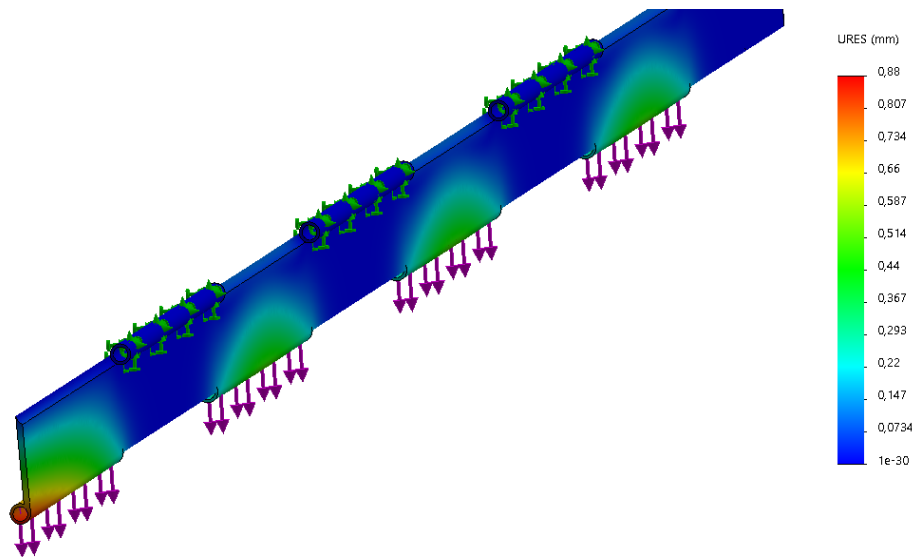

Figure 4.28: Analysis results, displacement (mm)

4.5 Adjustable frame concept (AFC)

This concept consists of two fixed plates, and an aluminum grid in the middle. The fixed plates and the grid are made up of extruded aluminum beam. Wires are fastened in the middle of the frame with bolts the same as figure 4.2

One of the most notable disadvantages with this solution is that it will leave a gap in the front between the grid and the fixed frame. This is because the grid will need a little space between to allow the sliding between the frames. This can be countered with an extra gasket that seals this gap while allowing the gliding between the frames.

A benefit of this solution is that there is no need for an extra gasket to seal the gap against the ground. Both the grid and the fixed frame will have gaskets that overlap so that the seal will not be broken as the element expands. This concept also allows the element to be extended to almost double width. This is because the grid in the middle will support the canvas, so this concept is not limited by the loss of safety factor.



Figure 4.29: AFC collapsed

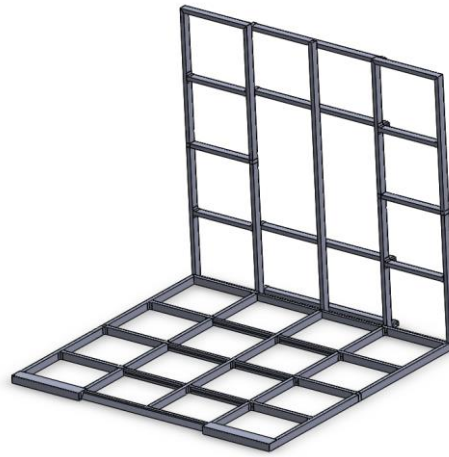

Figure 4.30: AFC expanded

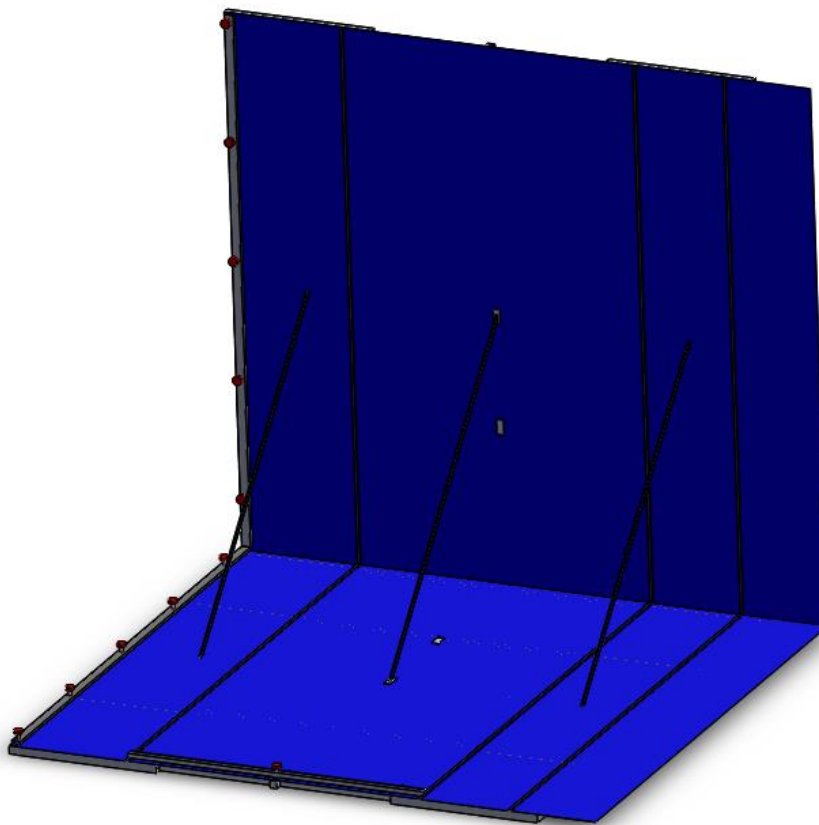

Figure 4.31: AFC completed with canvas

4.5.1 Production

In the aluminum frame and the aluminum grid, it makes sense to use extruded beams. This design offer great flexibility in the production line as the connectors and the beams can be the same in all models, so by cutting the beams in different length it is possible to produce all the different models such as V1200, V2400 and so on with the same parts.

It is favorable to seal off all the ends of the hollow profiles to keep the water out, so it does not get trapped inside the profiles. This is possible to achieve by using endcaps that are glued in place.

Because the support beams at 450 mm and 1350 mm are connected with L-brackets and fastened with bolts, the bolts will end up blocking the passage for the sliding beam. This can easily be countered in the horizontal element because this element will have serious support in form of the ground, therefore it is assumed that cutting a groove in the support beams will not compromise the structural integrity in the grid of the horizontal element.

Because the gliding profiles will need some clearance in order to move, there will be a vertical gap in the front of the element. This can be countered by using a transverse beam in the front. This beam will need to be triangle shaped and be able to move up and down. This will make the frame adjustable when installing but will also seal the gap as the water level rises and the water pushes the gasket flat.

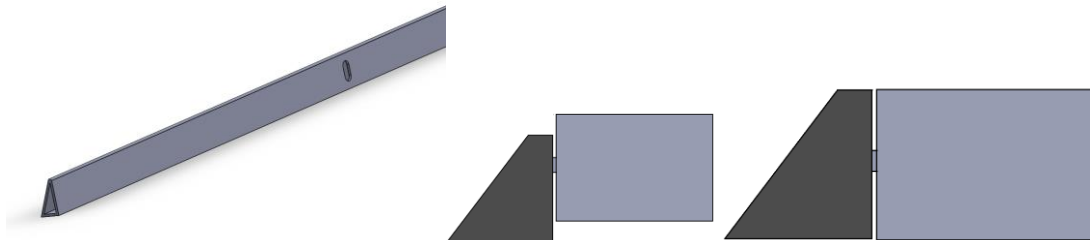

Figure 4.32: Illustrates how the transverse beam can be made. Notice the oval hole in the back, this will allow the profile to seal of the gap as the water rises

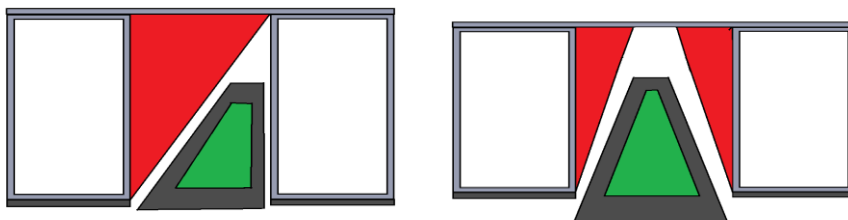

Figure 4.33: Designs on how the front beam can be made. The gasket (black) will be pushed against the walls (red) by the transverse beam (green) from 4.32

It is assumed that each bracket will carry equally, and the load it has to carry will be the weight of the water that is subjected to the vertical grid. Because the profiles in the frame will have the width of 24 mm, it is assumed that having the same width on the sliding profiles will ease the assembly of an element. And, according to SAPAs construction manual, the minimum wall thickness of an extruded part should be 2,5 mm. With these dimensions and a calculated water load of 15120 N, the stresses in these profiles will be 19 MPa. This is much lower than the yield strength of 250 MPa, but because this profile will weigh 26 grams, it will not impact the total weight of the entire element too much. Additionally, it can be beneficial to have a high safety factor in this part as this will transfer the load from the middle grid to the side elements, and there is considerable uncertainty linked to how the forcers will act in this part of the element. This part is important to the structure, and a failure in this area will compromise the entire element. All this taken into consideration, it will be favorable to have a large safety factor in this area, at least until physical testing have been performed.

$$p = 0,021 \text{ MPa} \quad W = 800 \text{ mm} \quad H = 1800 \text{ mm} \quad w = 26 \text{ mm} \quad h = 2,5 \text{ mm}$$

$$F = A * P \rightarrow F = 800 \text{ mm} * 1800 \text{ mm} * 0,021 \text{ MPa} * 0,5$$

$$F = 15120 \text{ N}$$

$$\sigma = \frac{F}{A} \rightarrow \sigma = \frac{15120 \text{ N}}{26 \text{ mm} * 2,5 \text{ mm} * 16}$$

$$\sigma = 16 \text{ MPa}$$

As it is important to seal off the beams so they do not get filled with water, it cannot be expected that the beams will be completely waterproof. Therefore, it can be beneficial to include some holes in the frame behind the sealed front that can help drain water that have seeped into the beams. Because the beams are divided by a T-joint in the middle it is recommended that there is drainage before this joint and in the end of the beam to drain any water that are able to pass the T-joint. It is also important that any water that seep through the gasket against the ground are also drained in order to avoid any pressure building up under the element. If pressure builds up under the element it can compromise the floodwall. However, this is not seen as a problem in with any of the solutions presented in this thesis, as none of them have a gasket at the backside against the ground. This will allow any water that seeped through to escape quickly.

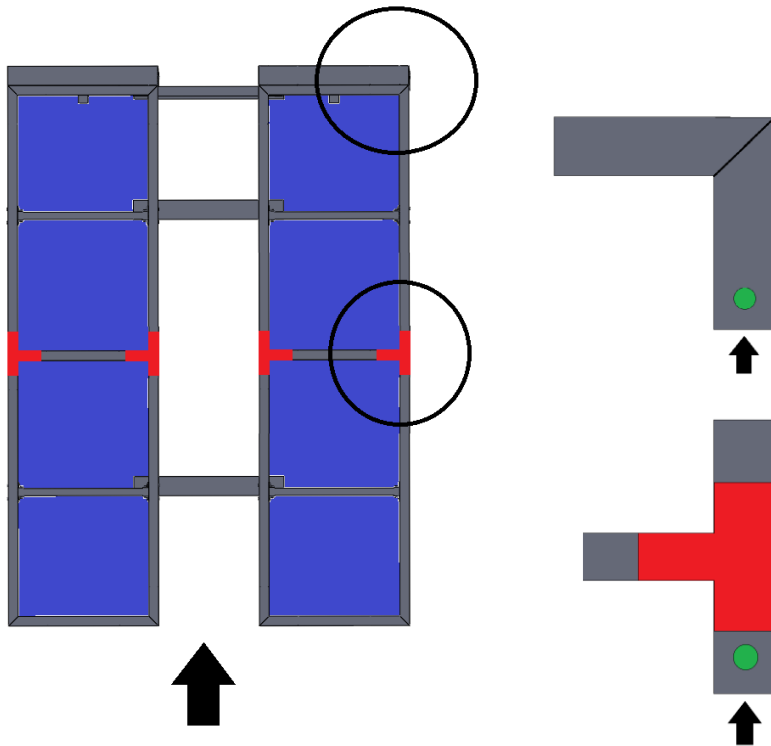

Figure 4.34: Demonstrates where the holes (green) can be put in order to drain any water that may seep into the profiles

4.5.2 Stability

The grid will always support the canvas so it does not touch the ground, this means that the force ratio between the vertical wall and the horizontal plate will stay the same as the element expands. Because of this, the safety factor against overturning will stay the same as a standard element.

$$W = 1800 \text{ mm} \quad H = 1800 \text{ mm} \quad P_h = 0.021 \text{ MPa} \quad P_v = 0.018 \text{ MPa}$$

$$F = A * P$$

$$F_h = 1800 \text{ mm} * 1800 \text{ mm} * 0.021 \text{ MPa} * 0.5 \rightarrow F_h = 34020 \text{ N}$$

$$F_v = 1800 \text{ mm} * 1800 \text{ mm} * 0.018 \text{ MPa} \rightarrow F_v = 58320 \text{ N}$$

$$M = F * m$$

$$M_1 = 34020 \text{ N} * 0.6 \text{ m} \rightarrow M_1 = 20415 \text{ Nm}$$

$$M_2 = 58320 \text{ N} * 0.9 \text{ m} \rightarrow M_2 = 52488 \text{ Nm}$$

$$\frac{M_2}{M_1} = \frac{52488 \text{ Nm}}{20415 \text{ Nm}} \rightarrow \frac{M_2}{M_1} = 2,6$$

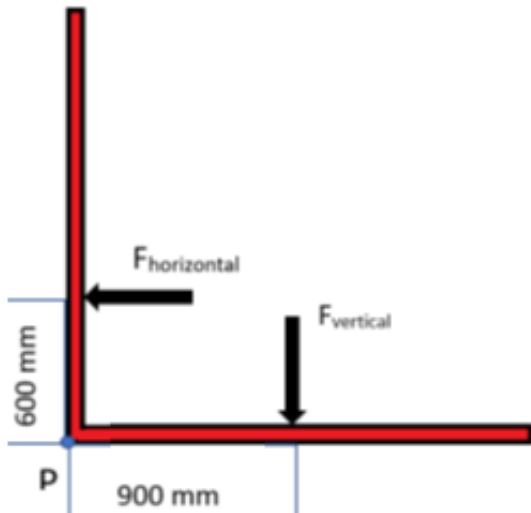

Figure 4.35: Calculation model for AFC

4.5.3 Extension

Because both sides possess the telescope functionality, this concept offer a great percentage of expansion. The model presented in this project is 1000 mm compressed while it will become 1800 mm fully expanded. If not for the bracket that is used to hold and lock the telescope mechanism, it would have been possible to expand the element to twice its original length. The transverse beams that enter frame needs to be of different dimensions as in order to have the clearance it will need to avoid jamming. Because the horizontal plate has support from the ground this will not affect the structural integrity.

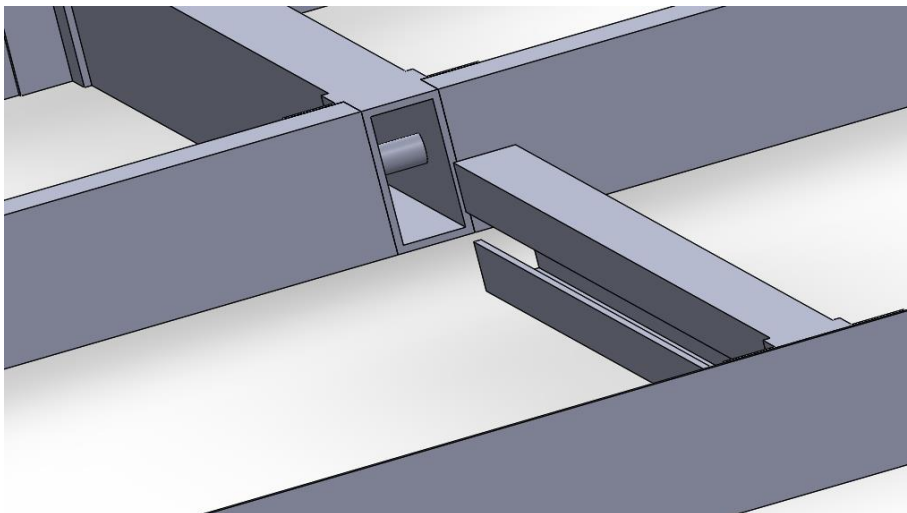

Figure 4.36: Illustrates how the horizontal grid as connected to the horizontal frame

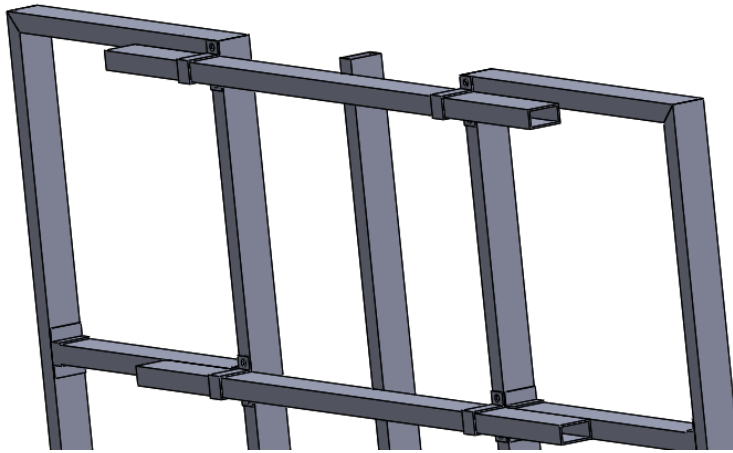

Figure 4.37: illustrates how the vertical grid is connected to the vertical frame

4.5.4 Weight

The weight of the model is found by using SolidWorks. The only parts that are included in this weight estimate is the aluminum profiles. The rest of the components are assumed to be about the same for all the concepts and the existing solution, and therefore this weight difference is neglectable.

$$\text{Weight} = 47 \text{ Kg}$$

4.5.5 Uncertainties

Waterproofness is an uncertainty with this concept as well. Unique to this model is that it does not have a transverse beam in the front to cover the gap, and the telescope mechanism will have a need of a tolerance to allow gliding. Furthermore, the rails can jam if the tolerances are too tight and sand or other foreign objects enters the sliding rails. The vertical grid can become skewed against the horizontal grid, and this can disrupt the force picture in the middle wire and leave it less effective in translating the forces.

4.5.6 User friendliness

Like the other concepts this will also use a transverse beam to lock down the canvas in the front. As far as installations steps goes, this concept will use bolts to fasten the telescope mechanism in desired length and will not need a transverse beam in the front to cover the gap as the profiles and gaskets are made with an overlap. This will reduce the steps of installation, hence help minimize the risk of installations errors.

4.5.6 Modularity

In this concept the aluminum frame will be possible to construct and assemble alone. The fixed plates, however, will be dependent on both the aluminum sheet and extruded profiles.

Some of the profiles will be fastened only in the sheet, which means that a damaged sheet will demand extra work to replace the profiles too. This concept will not be as modular as the others, because some of the beams will need to be fastened only in the aluminum sheet and cannot be assembled separately. The middle grid and the fixed plates can be assembled separately and be put together later.

4.5.8 FEA Model

A simple model of the concept was made to verify the structural integrity of the element. The only part of the element that is tested is the frame, which is to ensure that the frame will withstand the entire load by itself. The reason behind this is to give the design considerably more flexibility. When the frame supports the load, the canvas can be replaced if a different material is found to outperform the PVC canvas. The ground will provide support for the horizontal force, so only the vertical plate is tested.

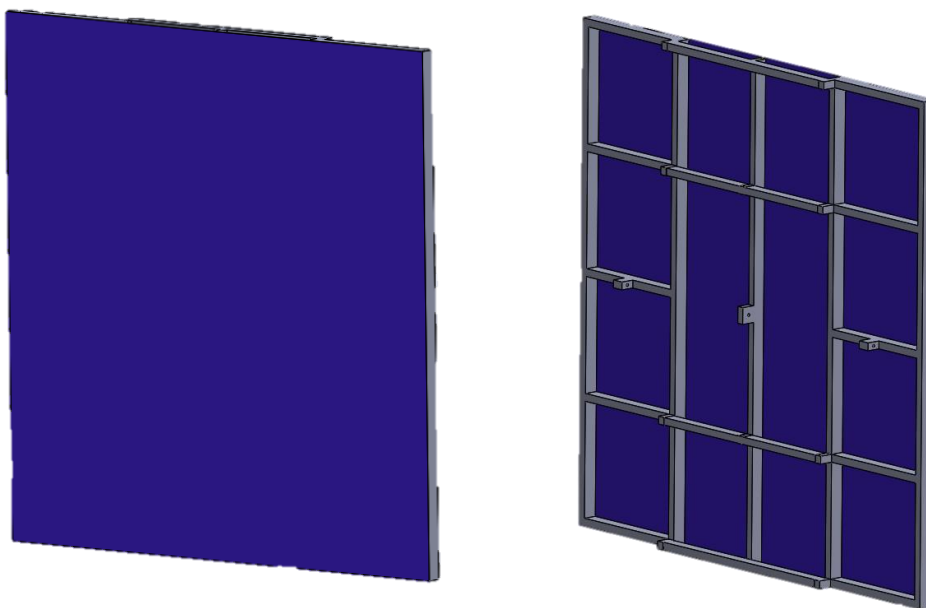

Figure 4.38: The simulation model

Constraints and loads

The model is constrained (green arrows) in the bottom and in the places where the wire is fastened. The constraints that are used are "fixed". The load (red arrows) that act on the frame is found by taking the entire area of the plate and multiplying it with the water pressure. This force is then spread across the entire front surface of the frame. The force is also increased from 0.003 MPa on the top, to 0.021 MPa at the bottom. These numbers come from the dynamic and static water pressure, which is provided by AquaFence. This concept consists of three frames that are connected with rails, but for the sake of this analysis, all the frames are joined together in one part. This may cause the result to be less realistic as they will not move against each other.

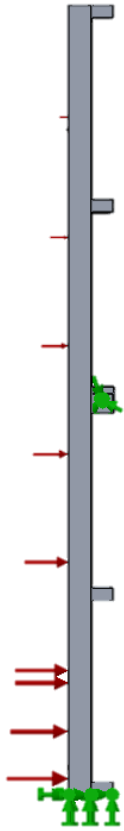

Figure 4.39: Loads (*red arrows*) and constraints (*green arrows*)

Results

The stress in the frame according to the analysis is considerably lower than the yield strength (215 MPa) of the material, with a safety factor of 2. This makes it reasonable to assume that further weight reduction can be made. The displacement can be considered relatively low as maximal deflection shows to be 4,6mm.

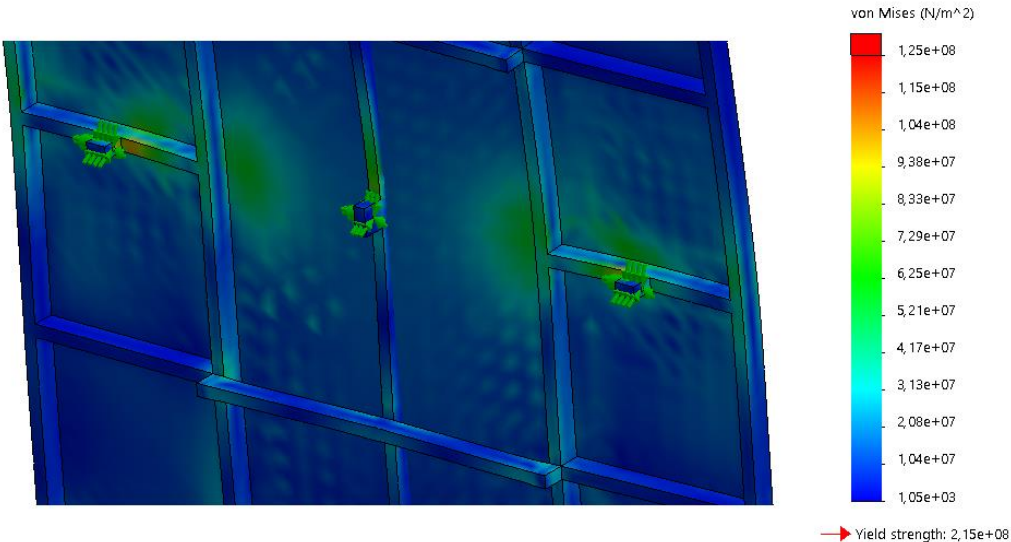

Figure 4.40: Analysis results, stresses (MPa)

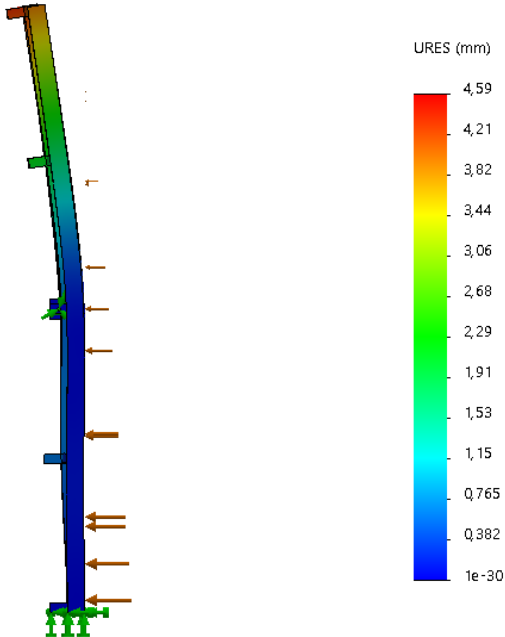

Figure 4.41: Analysis results, displacement (mm)

4.6 Grading Matrix

When it comes to picking the right concept, it is beneficial to put a structural method to use. In this project it has been chosen to use a *Weighted criteria matrix*. The matrix consists of the criteria, and their importance to the customer. Each concept is rated from one to five. After each concept is rated, the rating is multiplied by each criteria importance, which in its turn, gives the concept a weighted score. After all concepts are given its score, the weighted scores are added together and the sum equals the total score of the concept, and then the concepts are ranked against each other (Eppinger & Ulrich, 2012).

		Concept 1		Concept 2		Concept 3	
	weighted	Rating	weighed rating	Rating	weighed rating	Rating	weighed rating
Stability							
Extension							
Weight							
Uncertainties							
User friendliness							
Total score							
Rank							

Figure 4.42: Grading matrix example

4.6.1 Comparing key factors

Stability

The stability of an element is its ability to stand by itself without additional support. An important factor to the AquaFence product is that a single element will stand by itself without falling over. The way this is rated is the elements factor against overturning. A standard element from AquaFence will have a safety factor from overturning that is 2,6. This means that an AquaFence element can handle a lot of unexpected loads without overturning. It is preferable for a flexible element to have the same factor against overturning, but a lower safety factor can be tolerated. A safety factor below 2 is not acceptable by Aqua Fence's own standards. Today's product has a safety factor against overturning at 2.

Extension

Extension is how long the flexible element can extend its length. Today's design of the flexible element can extend 300mm. Any new design should be able to extend to the same length or preferably longer. The concepts will be judged by its ability to extend, which will be measured in percentages in order to eliminate individual differences. Today's product is able to expand with 300 mm.

Weight

The weight may vary from concept to concept, so in order to compare the concept more equally, the weight will be ranked based on the ratio between the extension and the weight. The weight will be determined by the structural components and unique components for each concept. Components such as canvas, wire fasteners, and support rods are excluded because they will be approximately the same for all and the differences are assumed to be neglectable. Today's concept weights 65 Kg excluding the different attachments.

Uncertainties

Uncertainties are aspects and details in each concept that are impossible to find without physical testing. The concepts will be rated on how many uncertainties each have.

User friendliness

User friendliness is how easy it is for users to install the element. It is expected that it is easier to make mistakes based on the number of installation steps an element has, and that the element could be installed wrong which likely result in leaks. The concept will be rated on how many extra steps the installation has beyond that of a standard element. The flexible element that is provided by AquaFence today has seven extra steps.

4.6.2 Summary of key factors

Stability	Safety factor	Rating
FFC 1	2	3
FFC 2	2,6	5
AFC	2,6	5
Extension	Extension in percent	Rating
FFC 1	30%	1
FFC 2	50%	3
AFC	80%	5
Weight	Weight to extension ratio	Rating
FFC 1	12,5	3
FFC 2	7,6	1
AFC	38,7	5
Uncertainties	Number of uncertainties	Rating
FFC 1	1	4
FFC 2	5	1
AFC	3	3
User friendliness	Number of installation steps	Rating
FFC 1	1	4
FFC 2	2	2
AFC	1	4

Table 4.2: Summary of key factors

4.6.3 Grading matrix

		FFC 1		FFC 2		AFC	
	Weighted	Rating	Weighted rating	Rating	Weighted rating	Rating	Weighted rating
Stability	40 %	3	1,2	5	2	5	2
Extension	20 %	1	0,2	3	0,6	5	1
Weight	20 %	3	0,6	1	0,2	5	1
Uncertainties	10 %	4	0,4	1	0,1	3	0,3
User friendliness	10 %	4	0,4	2	0,2	4	0,4
Total score		3,1		3,0		4,7	
Rank		2		3		1	

Figure 4.43: Grading matrix

4.7 Fastening of canvas

This thesis will not aim to improve the fastening mechanism of the canvas, but rather take use of the same system that is being used today in both the standard elements and the flexible one. All concepts are designed in such a way that today's systems can be integrated with ease. On one side, the canvas is fastened permanently with aluminum rail and bolts, and on the other side, the canvas is clamped down with the use of an aluminum U-profile. On the side with the clamping, the canvas has a solid rubber tube that prevent the canvas from slipping after the clamping is in place. The U-profile is tightened and loosened with the use of bolts.

AquaFence has developed a new system to fasten the canvas, but this system was under evaluation of the patent board and was classified when this thesis was written. Because of this, the new fastening mechanism were not considered when the concepts were made.

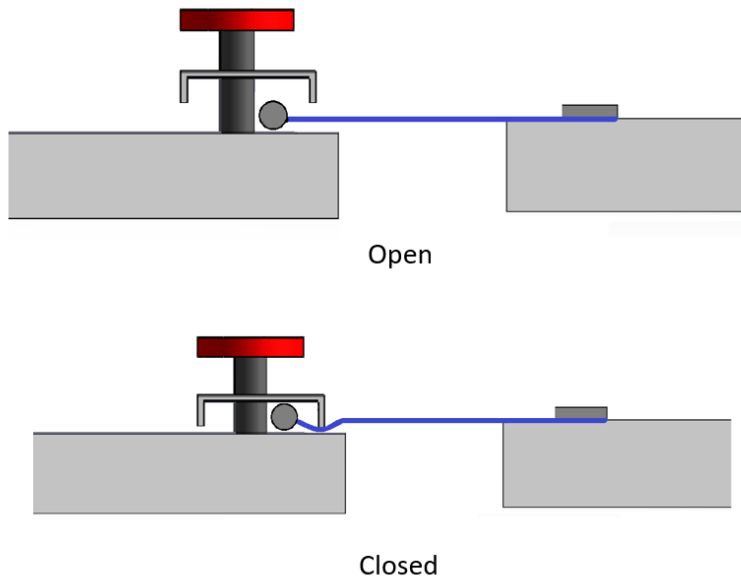

Figure 4.44: Fastening mechanism of canvas

4.8 Corner hinge

Because the element is to be foldable, it will need a mechanism in the corner between the vertical and horizontal plate. The alternatives presented in chapter 4.8 are to be viewed as suggestions of how the elements can be made foldable. It is assumed that all concepts presented in chapter 4.8.1, 4.8.2 and 4.8.3 can be equipped with any of the corner hinges.

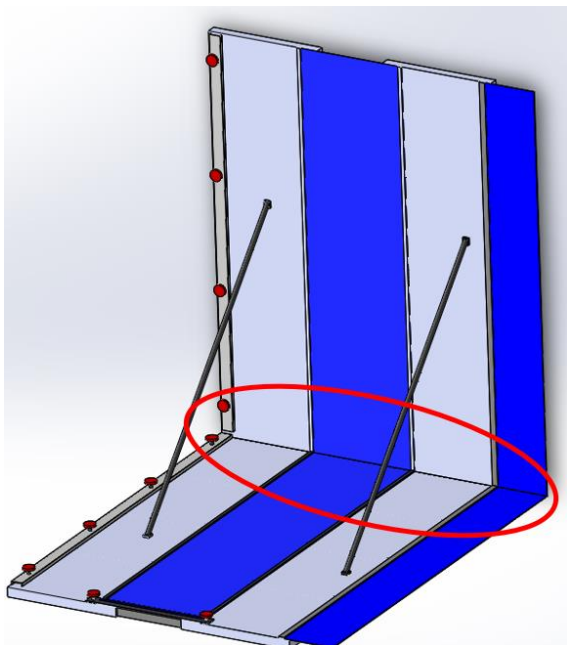

Figure 4.45: The corner in attention circled in red

4.8.1 Hinge concept 1 (HC1)

Today's solution does not have any form of hinge between the vertical and horizontal plate, but rather an L-shaped profile attached at the back of the horizontal plate, which is possible to slip the vertical plate into. The benefits of this solution are that it does not need any extra parts or time in production, and it is easy to use out in the field. On the downside, this solution does not offer any stiffness or rigidity in the joint. The plates will only be held together by the canvas.

This solution can be regarded as the "fallback" concept of this set, as it is the same solution used by AquaFence today, meaning it is tested and known to work.

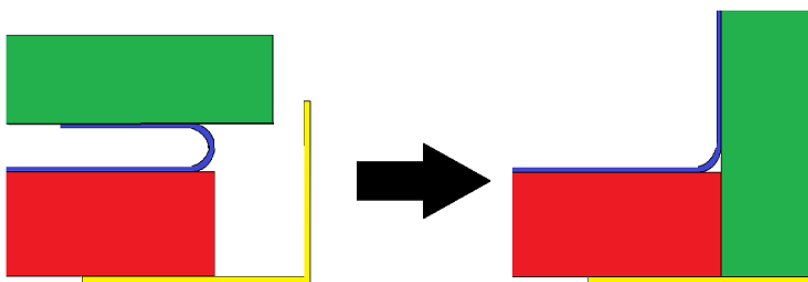

Figure 4.46: Assembly with no hinge, Vertical plate = green Horizontal plate= red Canvas =blue L-profile= yellow

4.8.2 Hinge concept 2 (HC2)

It is possible to replace the profile in the back of both plates with one that has an integrated groove, which allows for a connector that consists of a flexible material. This will offer great flexibility and a better joint with no hinges. It will be necessary to find a different material that is both flexible and strong enough to withstand the force. It is also important that this material waterproof and durable. This will not need a canvas to be waterproof.

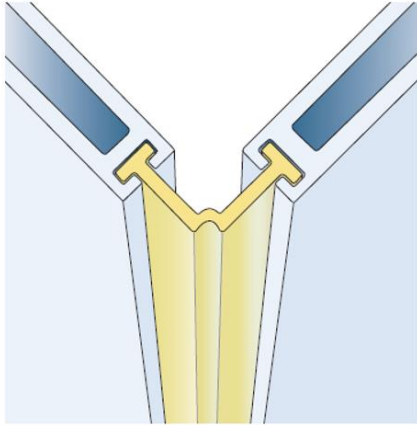

Figure 4.47: Extruded profiles connected with a flexible material. (Sapa Group AB.,

4.8.2 Hinge concept 3 (HC3)

With the use of aluminum extrusion, it is possible to extrude a profile that can be cut into two hinges. This will look like a standard butterfly hinge, and this can easily be bolted or riveted in place in the back of the elements. This solution will still rely on a canvas between the plates to ensure that the joint is waterproof.

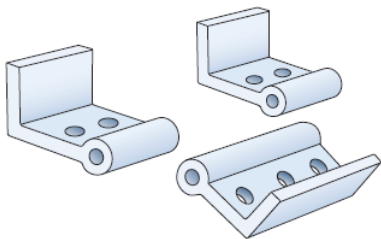

Figure 4.48: Three hinges cut from the same extruded profile. (Sapa Group AB., 2007).

4.9 Sealing in front

One challenge that occurs in all concepts presented in this thesis and is a known problem with the elements today, which is that it's very difficult to get the front waterproof. The problem arises when the element extends, and a gap appears between the canvas and the ground beam in the front.

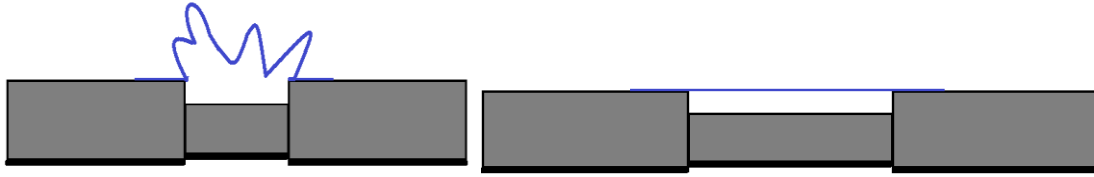

Figure 4.49: The gap that appears between the canvas and frame

4.9.1 Sealing using water load .

Dynamic sealing concept 1 (DSC1)

Sealing this gap by utilizing the water load would mean that the more water is added, the more secure the seal would become. A disadvantage of this is that when there's no water, there's no sealing. This will can be problematic when the water level reaches the same height as the gap. The water will then be allowed to seep through in between the horizontal frame and the canvas. The main advantage with this solution is that it is simple to use, and the installer doesn't need to worry about sealing the front, as the element will do this by itself. This helps reduce the number of steps when installing the element.

This solution can take use of the weight of the vertical element by implementing a rod that is connected to the top of the vertical wall and fastened at the tip of the mechanism. This version uses the weight of the vertical element to compress the gasket and seal of the gap in the front. A downside to this solution is that as the water level rises, there will be a period of time where the water pressure works against the weight of the vertical wall. This will lead to a decrease in sealing during the time the water pressure matches the weight of the vertical wall, which will result in zero pressure to the gasket. As the water level rises further it will resume the pressure on the gasket, and the mechanism will seal the gap. Below is an example with calculations.

The pressure will be around 30 N, until the water level reaches the same height as the beams. After this, water will be present, but there will be no forces acting on the gasket. It can therefore be assumed that the gap will leak at this point.

How much leakage that will occur at this point is dependent on how swiftly the flood rises. As the graph shows, the pressure on the gasket will rise quickly as the water level rises. How big the leakage will be depending on how long the water level will stay at this level. If the water rises quickly, the mechanism will stay at this at a short period of time. This will result in a smaller amount of water seeping through, than if the water level rises slowly - which will result in the element being stuck at this area of the graph for a longer time.

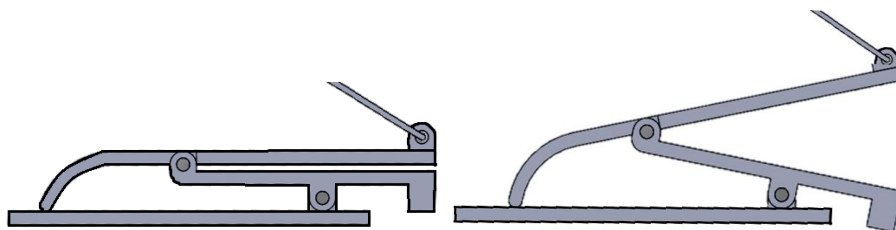

Figure 4.50: The vertical wall rests on the gasket (left). The water pressure has pushed the vertical wall back and the force have been transferred to the gasket (right)

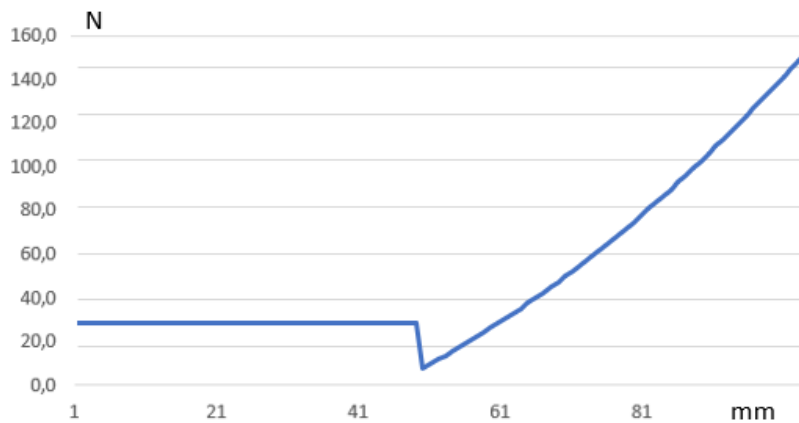

Figure 4.51: Demonstrates how the force on the gasket for the first 100 mm. The calculations can be found in appendix 2

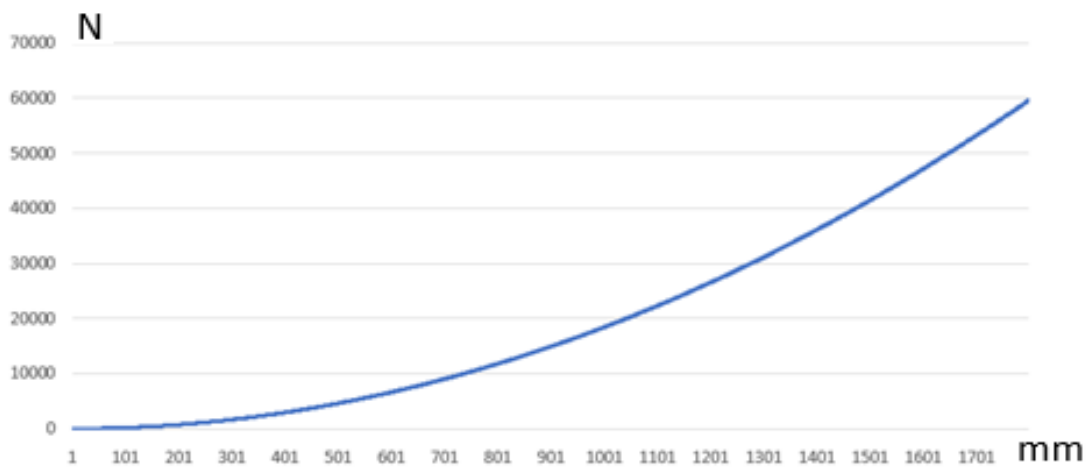

Figure 4.52: Shows the rest of the graph from figure 4.51. Calculations can be found in appendix 2

Just by this example, it is clear that transferring the forces from the vertical wall onto the gasket will generate a lot of pressure on the gasket. If the water level is at its maximum capacity, the pressure on the gasket is about 60000 N. This force is very large compared to the other forces discussed in this thesis. It can be assumed that this force is more than enough to seal the gap and compress ant folds in the canvas that has occurred when the element is not fully extended. It can therefore be useful to install a safeguard on the wire that transfer forces to ensure that the force in the gasket does not exceed what is necessary. What force is required will need to be tested by investigating how much force needs to be applied to seal the gap. A load relief spring is then installed to ensure that the force does not exceed the load.

Dynamic sealing concept 2 (DSC2)

A different way of sealing using water load would be to use a wire instead of a rod. This wire would be connected to the back of the mechanism and at the top of the vertical wall. This will result in no pressure against the gasket when no water is present. However, when the water level reaches the vertical wall it will start sealing the gap right away, unlike DSC1 who will experience a dip in force after the first millimeters after the water level reaches the vertical wall. Since this concept only requires one additional beam, it can be considered to be the least complex concept.

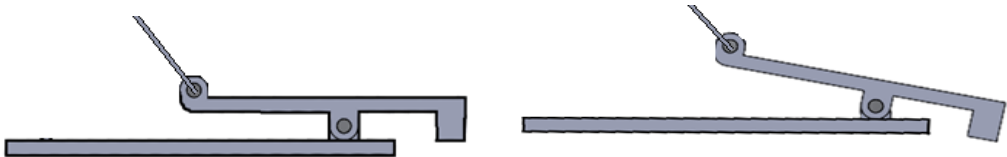

Figure 4.53: The mechanism will be open when there is no water on the wall (left), but when the water level reaches the vertical wall, it starts to close. (right)

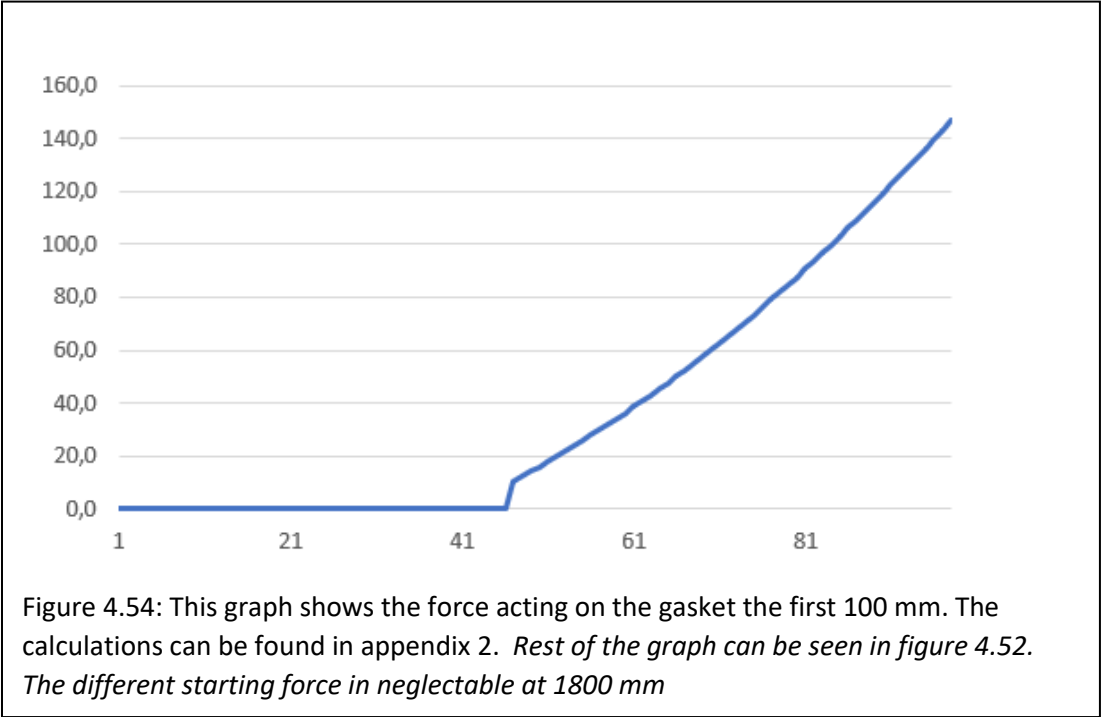

Figure 4.54: This graph shows the force acting on the gasket the first 100 mm. The calculations can be found in appendix 2. Rest of the graph can be seen in figure 4.52. The different starting force is neglectable at 1800 mm

Dynamic sealing concept 3 (DSC3)

Another version of this mechanism does not utilize the weight of the vertical wall to compress the gasket while the water is absent. Instead, it uses a floating beam to use buoyancy and leverage to seal the gap. The main advantage of this is there will be pressure on the gasket as soon as the water level rises. In addition, this removes the decrease in force, unlike in DSC1. This solution can be regarded as the most complex, since it contains both the beams that are mentioned in the other dynamic concepts. Additionally, it also has a floating beam. Although, this beam can also get damaged or filled with water, which can cause the mechanism to malfunction.

Because of the floating beam in this solution, the beam will lower the force the element has against the ground. However, this buoyancy is so small compared to the force acting on the horizontal plate and can therefore be considered neglectable. This solution will also need a load relief present on the wire, to keep the force from exceeding what is necessary to seal off the gap.

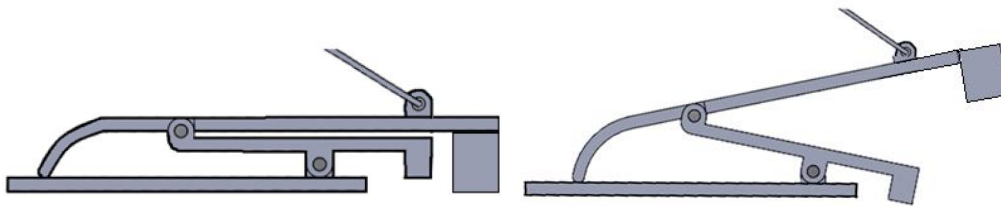

Figure 4.55: The mechanism is closed as when there is no water (left), but closes as soon the water starts to rise (right)

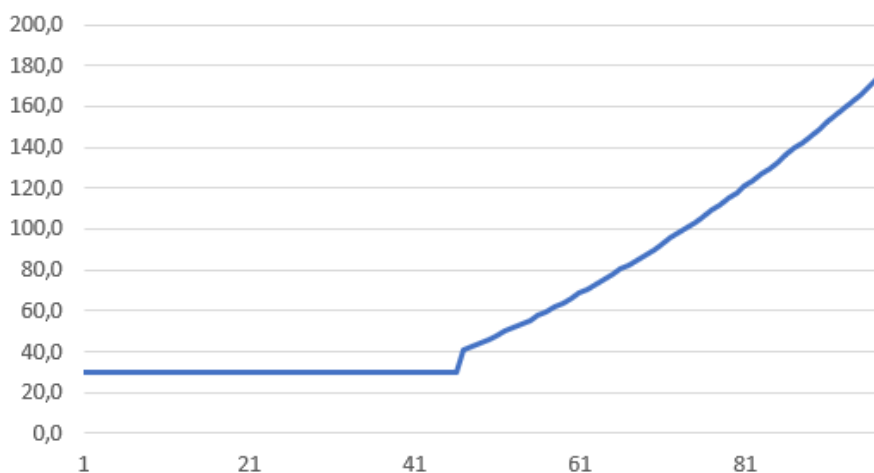

Figure 4.56: The graph shows the force acting on the gasket the first 100 mm. Rest of the graph can be seen in figure 4.52. Calculations can be found in appendix 3. The different starting force is neglectable at 1800 mm

4.9.2 Fixed sealing concept

This concept consists of sealing the gap in the front with an external force like bolts. Sealing the gap by using a transverse profile mounted to the horizontal frame. This beam can be used to apply pressure on the gasket, which will help seal the gap - this can be achieved by using bolts or clamps to press down the transverse beam.

Advantages of this concept will be that it does not depend on the water level, and the forces acting upon the gasket will remain the same.

Disadvantages can be that errors may occur during the installation if the transverse beam is not tightened correctly; it can result in the gap not being waterproof. This complicates the installation process further, as it creates an extra step for installing the element.

This solution can be regarded as the "fallback" concept of this set, since it is the same solution used by AquaFence today. This solution has been tested and confirmed to work.



Figure 4.57: Illustrate how the FSC can look like. The transverse beam can be tightened with the red bolts

5 Detailed design

5.1 Extendable element

The most promising concept of the ones presented. This concept allows the greatest expansion of the element without compromising the safety factor.



Figure 5.1: Adjustable frame concept

5.2 Sealing in front

The main challenge with the expandable element was how to seal the gap that occurs in the front as the element expanded, without adding extra steps to the installation process. Using the version which utilized the forces already present to seal off the gap in the front, will remove some of the steps needed to install the elements.

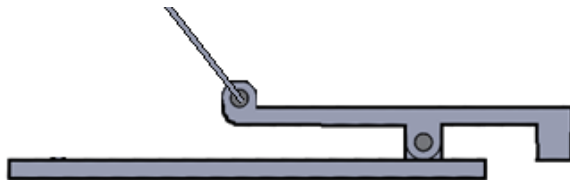

Figure 5.2: DSC2

5.3 Corner hinge

The main function of this part is that it will allow the element to be folded when it is not in use. This is to ease transportation and storing.

Using the option of just placing the vertical wall in a slot fastened at the horizontal wall presents seems to be the best. This solution does not have any fine mechanics of loose parts that can break or get jammed.

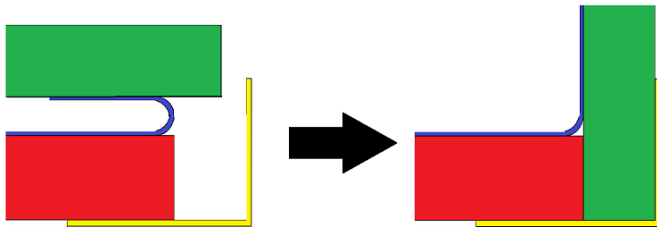

Figure 5.3: Hinge concept 1

5.4 Proposed design

The proposed design is presented in figure 5.4. The model has been designed to have flexible width, be capable of withstanding the water pressure from flooding up to 1800 mm. This element is designed to be modular, both regarding its components within the elements itself and to be integrated to an entire floodwall. The element is also designed to be as easy as possible to install, with as few steps as possible in the installation process and little room for misinterpretation. All this is to ensure that the element is correctly installed every time, even when AquaFence is not present.

The system has been created by eliminating the weakest alternative along the way. This method has allowed analyzing many different alternatives to gain knowledge before a decision was made.

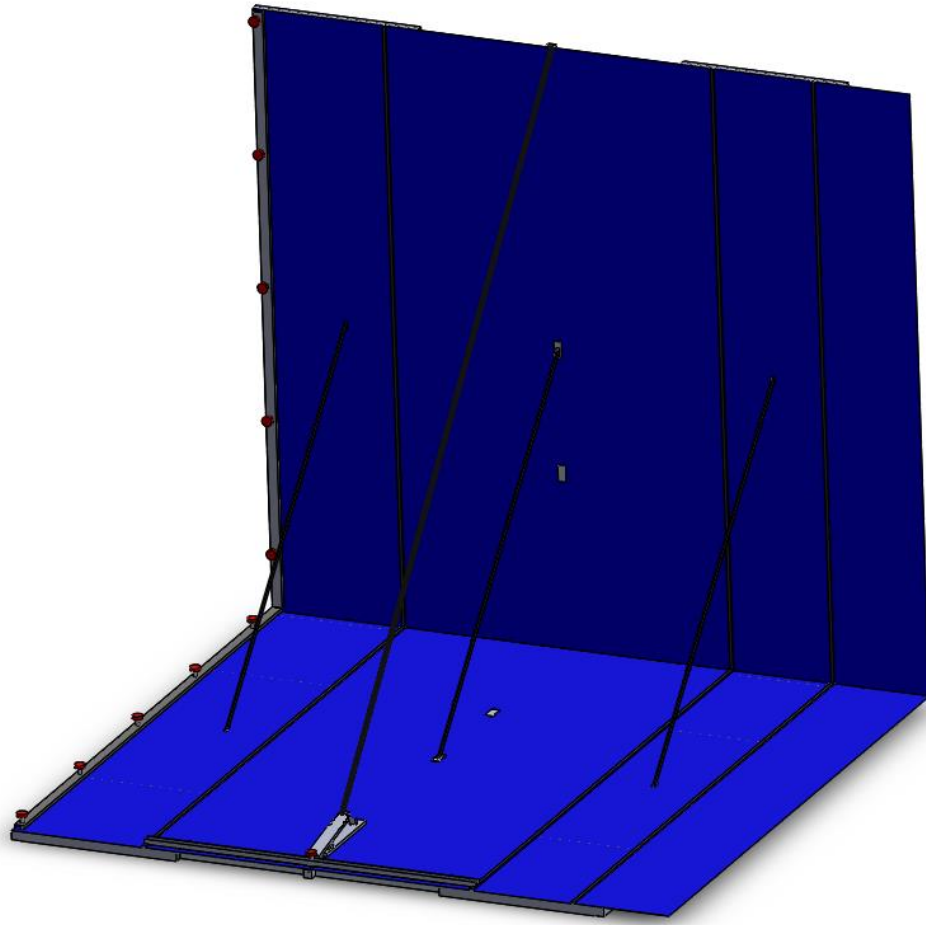

Figure 5.4: Proposed design

6 Discussion

6.1 Discussion of development method

The load used to test the structural integrity of the concepts was obtained from manual calculations done by AquaFence. The loads that were used can be considered simplified as they only consider the static water pressure and the dynamic load that is caused by waves. In a real-life scenario both wind and impact by debris should be considered. These structural integrity analyses should only be used for guidance and to identify problematic areas in the structure.

As previously stated in this thesis, absolute requirements for the design and functionality was not provided by AquaFence. Rather, some aspects were given to be used as the framework for developing the new solution. All the "soft requirements" helped set the parameter during the design phase and became the basis of what the concepts were built around. AquaFence stated that they wanted to remove the transverse beam in the front that seals the canvas, as this was a solution that created the opportunity to make mistakes in the installation process. This beam has not been removed, but a different solution has been suggested that does not require human interaction, hence decreased the chance of error when installing the element.

Another aspect that AquaFence wanted to improve, if possible, was the weight of the element. Two of the concepts were able to lower the weight, but for the hinge concept, the weight was increased. AquaFence wanted more flexibility, and an increase in weight was acceptable if this made the element more flexible. Two of the concepts had an increase in flexibility, but the FFC1 model's flexibility remained the same.

The chosen development methodology used in this thesis was set-based design combined with modular design. These combined allows for great flexibility in the development process and in the finished product. This was chosen because of the practicality of allowing designs to be upgraded, repaired, customized and for the parts to be reused. This is beneficial to customers because of the option to reuse parts as well as to make incremental upgrades, as opposed to replacing an entire unit, as well as being a sustainable option. This allows you to compare the different solutions and make an assessment on which one will work best for your project. This is because you lack the knowledge needed in order to make a calculated decision, until you have tried which solutions work and which does not. This allowed this project to try exploring innovating alternatives in the area of flexible elements, and because of limited testing leaves a lot of uncertainties. However, modularity will allow the chosen options to be replaced with ease if better options are proven available.

A python script was used to calculate the best beam dimensions. The dimensions used in this thesis can be regarded as odd, but because the price of using custom-made dies is not considered. The dimensions that has the highest performance in the load case are considered in this project. If standard dimensions are not to be used, new dies need to be created, nonetheless.

This thesis only focuses on water pressure that is submitted normal to the walls. This is only *one* of the load cases that the element will be exposed to. One of the more significant load cases will be when the element is hit by large debris carried by the flood. It will therefore be of interest to research further with more load cases, to ensure that the element does not collapse if it is struck by a horizontal force at an angle. Because the elements in this thesis is only subjected to a normal force, they can be expected to have too little width to withstand a large horizontal force.

6.2 Discussing the solutions

There are several reasons as to why different solutions were eliminated in the process. FFC1 was hardly innovative, and its main weakness was the limited flexibility of only 300mm. The FFC2 solutions biggest weakness was the complexity which can only be assumed to render the element difficult to use. This is because it cannot be expected that the hinges will stack properly, especially after use. However, this can be solved by replacing the hinges with something else as discussed earlier in the thesis, which could make FFC2 a more viable option. It is also difficult to predict how the forces will transfer between the hinges, so this would be beneficial to prototyped in order to get an evident understanding, if one is to move further with this concept.

AFC is proposed as the best solution in this thesis because it possesses the greatest flexibility, and this was deemed the most important asset of the designs. However, there are still great uncertainties tied to this concept. For example, the most notable uncertainty exists in the transfer of forces between the grid and the frames. The U-bracket that connects the grid to the frames has a safety factor of 8, with a minimal addition to the overall weight. Because it is considerably over-dimensioned it will decrease the probability of failure in this area. In addition to this, there are considerable uncertainties associated to the tolerances in the telescope mechanisms. Floodwater is typically very contaminated, which can lead us to assume that the risk of introducing foreign material in the telescope mechanism is high, which in turn can jam the mechanism. This problem should be tested, since it is unsure whether it would be more suited to have a larger or a tighter clearance. FFC1 can be a viable option if the AFC1 is proven not to work. As FFC1 is a "fallback"-concept, it is expected to work if testing shows that the other concepts are not viable. The structure of FFC1 is based on the same structure as the one that AquaFence uses today, so the concept is expected to work. However, the waterproofing is still questionable in the joints and in the front.

SAPA 6082 T6 and SAPA 6060 T6 are both considered in this thesis. There is not much that separates them in terms of weight, but 6060 is much easier and cheaper to produce. This thesis has chosen the best alternative, regardless of production or price. SAPA 6082 T6 alloy is therefore used in this thesis, as it was found to produce the lightest elements.

The weight can possibly be reduced as this thesis have focused on modularity, and in this case have standardized the profiles in order to ease productions and storage. If all parts are analyzed and dimensioned with a safety factor of 2, it can be assumed that the weight can be reduced. For example, the horizontal beams are the same dimensions as the vertical beams. And, in the FEA these beams are submitted to very little stress compared to the vertical beams.

Canvas fastening

The aim of this thesis was not to improve the fastening mechanism of the canvas but rather take use of the same system that being used today in both the standard elements and the flexible one. All concepts are designed in such a way that today's systems can be integrated with ease.

Corner hinge

The HC1 solution was chosen as the proposed design for the corner hinge because of its simplicity. However, it is only held together by the canvas, which might make the corner connection unstable when the vertical wall is not placed in the slot at the horizontal plate. The HC2 solution would provide a more stable and stronger connection than the two others presented in this thesis. On the other hand, the implementation of extruded hinges will increase the complexion of the element as well as the weight of the element. Nevertheless, there is no need to replace the connection used by AquaFence today, because this solution has been tested and can be expected to work. Having said that, this thesis has not focused on the HC3 solution, involving other materials than aluminum. Other materials have been mentioned in this thesis just to show that there can be options other than aluminum. In addition to this, the frame is created to be modular which means that the corner connection can easily be replaced in order to create alternative solutions with different material.

Front sealing

DC1 will just move the problem of sealing the front, as shown in figure 4.51 and 4.52. By using DSC2, the gap will be sealed with a force of 30 N when there is no water pressure. The force will start to decrease as the water level starts to climb onto the vertical wall. Upon this occurrence, the sealing force will decline down to 0 N. This dip in force will occur when the force from the water equals the force from the vertical wall before the force will start to increase. The DSC2 solution, will not have this dip in force applied to the gasket, as the force will start to act on the gasket as soon as the water level reaches the vertical wall. Instead, the DSC2 concept will start at 0 N and rise with the water level. In contrast to both these solutions, the DSC3, utilizes buoyancy. Thus, it will start to apply force on the gasket as soon as the water level starts to rise. A decrease in force will not happen as the force will only increase further as the water level reaches the vertical wall.

It is worth mentioning that even though it was not covered in this thesis, the wind will also work against the DSC1. For the same reason, the dip occurs from the water pressure, the wind can help lift the vertical wall, resulting in a decrease in sealing force. This will only increase the force in DSC2 and DSC3.

Both DSC1 and DSC2 will have leakage as they do not seal the gap from the start. How much leakage that will occur depends on the speed of the rising water. If the water rises slowly, the leakage will be more severe than if the water rises quickly. The reason being that the longer the element stand with insufficient force on the gasket with water present, the more water will leak. The DSC3 is always expected to seal the gap, as the floating bar will begin to rise at the same time as the water. Because DSC3 will have a buoyancy effect, it will impact in the elements ground force, but this buoyancy is so little compared to the weight if the water that it can be viewed as neglectable.

As far as complexity goes, the DSC1 will be the least complex solution, as it will only consist of one profile that will transfer force from the vertical wall. The DSC2 and DSC3 consists of two and three elements, which provides us with more moving parts that creates more room for something to malfunction. The FSC solution would be the most consistent among those presented, as this concept will apply a fixed load onto the gasket. This load will be independent from other forces that may act on the element. This solution will, however, complicate the installation process.

All this taken into consideration, the DSC2 is left as the best suited option in this thesis to seal of the gap in front. It should be mentioned that there are still a lot of uncertainties with all the concepts when it comes to how they will work, and if the force generated from the vertical wall will be great enough to seal the gap at all. If this is proven to be the case, the "fallback"-concept FSC, can be used instead.

7 Conclusion and future work

The concepts presented in this project thesis are aimed to gain a further understanding of how aluminum can be utilized to produce an element with a variable length and are to be regarded as suggestions on how the requirements can be met. The report also includes a grading system that has identified the most promising concept which can be used as a foundation in further development. While developing this flood protection system with flexible length, analytical prototypes were created using a CAD software. These were created at an early stage in order to close knowledge gaps. Through iterative improvements the elements are optimized for strength and weight. Simplified models were also created in order to accelerate the FEA process. The results of the FEA process highlighted key areas that are of importance to the strength of the module when the frame was exposed to water pressure.

The results from this project suggests that it is possible to use aluminum to create a higher performing element with flexible width. The three concepts show different results; one has decreased weight, and two has decreased weight as well as increased flexibility. The lack of physical testing during this project resulted in a lot of knowledge gaps left open. The analytical testing showed that the elements would be strong enough to handle the water load, but there is no way to know exactly how waterproof they would be. The structural design is created to be waterproof, but it is impossible to predict how the interaction between the gaskets and the aluminum would be without testing. The same can be said for the sealing in the front. It is impossible to know how waterproof this area will be when there is a lot of folded canvas under the transverse beam in the front, without testing.

It's recommended that future work will revolve around creating more detailed versions of the concept that hold the most potential. Additionally, using manual calculations as well as structural analysis to refine the structure to both decrease weight and increase performance. An area of focus in the future may be creating physical models to test strength, rigidity and maybe most importantly, securing the element being waterproof. The forces considered in this thesis are based on hydrostatic pressure only. Future work should include more load cases in order to secure that the element can withstand all possible scenarios it can encounter in a real-life flood.

BIBLIOGRAPHY

Aluminum Extrusion. (2009) *Aluminum Extrusion Process Basics*. Retrieved from: http://www.aluminum-production.com/aluminium_extrusion_process_basics.html (Last accessed: 18.03.2020)

Alumeco, *Different tools – different aluminium profiles*. Retrieved from: <https://www.alumeco.com/knowledge-technique/profile-and-design/tool> (Last accessed: 15.10.19)

AquaFence (n.d), *AquaFence flood wall*. Retrieved from: <https://www.aquafence.com/floodwall> (Last accessed: 27.11.19)

Baldwin, C. Y., Clark, K. B. (2000) *Design rules: The power of modularity*, Vol. 1. MIT press.

Bernstein, J. I. (1998). *Design Methods in the Aerospace Industry: Looking for Evidence of Set-based Practices*. (Unpublished doctoral dissertation). Massachusetts Institute of Technology.

Carigliano, S. (2017) *How Do We Ensure the Accuracy of Our Structural Software?* SkyCiv, Cloud Engineering Software. Retrieved from: <https://skyciv.com/product/quality-assurance-at-skyciv/>

Clark, K. B., Fujimoto, T. (1991) *Product development performance: Strategy, organization, and management in the world auto industry*.

EASAC (2018). *Extreme weather events in Europe*. Retrieved from: <https://easac.eu/press-releases/details/new-data-confirm-increased-frequency-of-extreme-weather-events-european-national-science-academies/> (Last accessed: 15.10.2019).

Environment Agency. (2009) *Sandbags and How to Use Them Properly for Flood Protection*. Retrieved from: https://assets.publishing.service.gov.uk/government/uploads/system/uploads/attachment_data/file/467902/LIT_3833.pdf?fbclid=IwAR2_ky57N9RfFNgKuiNuU3V_NWASUJvF_6rw_IbnAhdjLC9WVJcBJZAelsHk (Last accessed 04.04.2020)

Eppinger, S.D., Ulrich, K.T. (2012). *Product Design and Development*. McGraw-Hill. 5th Edition. Pages: 150-158.

Gershenson, J.K., Prasad, G.J., (1997). *Modularity in product design for manufacturability*. International Journal of Agile Manufacturing, Pages: 99-110.

Iansiti, M. (2016). *Team New Zealand (A)*. Pages 1-14.

Kennedy, B. M., Sobek, D. K., & Kennedy, M. N. (2014). *Reducing Rework by Applying set-based Practices Early in the Systems Engineering Process*. *Systems Engineering*. 17(3), Pages: 278–296.

Lynn, R. (n.d.). *Set-Based Design vs. Point-Based Design*. Retrieved from <https://www.planview.com/resources/articles/lkdc-set-based-design/>. (Last accessed 06.06.2020).

National Aeronautics and Space Administration (n.d). *Shape Effects on Drag*. Retrieved from: <https://www.grc.nasa.gov/www/k-12/airplane/shaped.html> (Last accessed: 09.12.2019).

Nuseibeh, B., Easterbrook, S. (2000). *Requirements Engineering: A Roadmap*. Proceedings of the Conference on The Future of Software Engineering. Pages: 35-46.

Oxford Dictionaries. (n.d). *Flood*. Definition of flood in English. Retrieved from: <https://www.lexico.com/definition/flood> (Last accessed: 29.03.2020).

Raudberget, D. (2010). *Practical applications of set-based concurrent engineering in industry*. *Journal of Mechanical Engineering*. 56(11). Pages: 685–695.

Redd, N. T. (2017). *Flood facts, Types of Flooding, Floods in History*. Live Science. Retrieved from: <https://www.livescience.com/23913-flood-facts.html> (Last accessed: 12.10.2019).

Sapa Group AB. (2007). *Design Manual*. First UK Edition. Pages: 6-56.

Singer, D. J., Doerry, N., Buckley, M. E. (2009). *What Is Set-based Design?* *Naval Engineers Journal*, 121(4), Pages 31-43.

SkyCiv. Cloud Engineering Software. (n.d). Retrieved from: <https://skyciv.com/>

Sobek II, D. K. (1996). *A Set-based Model of Design*. *Mechanical Engineering*, 118(7), 78

Sosa, M. E., Eppinger, S. D., Rowles, C. M. (2004) *The misalignment of product architecture and organizational structure in complex product development*. *Management Science* 50.12. Pages: 1674-1689.

Suh, N.P. (1997). *Design of Systems*. *CIRP annals - Manufacturing Technology*. Volume 46. Issue 1. Pages: 75-80.

Taguchi, G., Chowdhury, S., Wu, Y., et al. (2005). *Taguchi's quality engineering handbook*. (Vol. 1736). Wiley Online Library.

Thomke. S.H. (1997) *The Role of Flexibility in the Development of New Products: An Empirical Study*. *Research Policy*. Volume 26. Pages: 105–119.

Tronvoll, S. A., Elverum, C. W., Welo T. (2017). *Prototype Experiments: Strategies and Tradeoffs*. *Procedia CIRP* 2017;60. Pages: 554-559.

Tronvoll, S. A., Elverum, C. W., Welo T. (2016a) *Prototyping in New Product Development: Strategy Considerations*. Procedia CIRP. Pages: 117-122.

Tronvoll, S. A., Elverum, C. W., Welo T. (2016b) *Test Environments in Engineering Design: A conceptual study*. DS 85-1: Proceedings of NordDesign 2016, Volume 1, Trondheim, Norway, 10th - 12th August 2016. 2016;(August).

Ward, A., Liker, J. K., Cristiano, J. J., Sobek, D. K. (1995) *The Second Toyota Paradox: How Delaying Decisions Can Make Better Cars Faster*.

Ward, A. C., Liker, J. K., Durward, K., Sobek, D. K. (1999) *Toyota's Principles of Set-Based Concurrent Engineering*.

Appendix

1 Calculate bolt dimensions

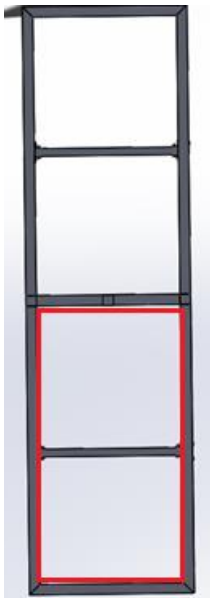

The bolts that are used to hold the transverse beams needed to be calculated. The area that bolts needed to support are marked in red. The pressure is higher on the beam at 450 mm than the one at 1350 mm, this is the reason that only this beam are considered.

$$p = 0,016 \text{ MPa} \quad W = 500 \text{ mm} \quad h = 900 \text{ mm}$$

$$F = A * P \rightarrow F = 500 \text{ mm} * 900 \text{ mm} * 0,016 \text{ MPa}$$

$$\sigma = \frac{F}{A} \rightarrow A = \frac{F}{\sigma} \rightarrow A = \frac{F}{\frac{\pi * d^2}{4}} \quad d = \sqrt{\frac{F * 4}{\sigma * \pi * 4}}$$

$$d = \sqrt{\frac{7200 \text{ N} * 4}{640 \text{ MPa} * \pi * 4}} \rightarrow d = 7 \text{ mm}$$

2 Calculations of force on the gasket

The forces that was acting on the gasket was calculated using Excel. The formula that was used were the formula of $F=P*A$, Where the force equals the pressure times the area. As the water level rises, so does the pressure and the area. The design of the mechanism made in into to lever that would further increase the force in the gasket. The acting force was calculated for all 1800 mm. The resulting force on the gasket was similar for all the Dynamic Sealing Concepts, but the force was different the first 48 mm. How the calculations looked in excel can be seen in a screen shoot from the excel sheet. The AFC are used in this example.

The resulting force for DSC1 needed to be subtracted 30 N for the weight of the wall that was resting on the gasket. The resulting force on the DSC3 needed to be added 41 N to the resulting force. DSC2 was directly connected to the vertical wall. When the water level became higher, the difference became neglectable.

Water level(mm)	Water pressure (Mpa)	Force on the Vertical wall(N)	Force against the gasket
1	0,000010	0,0	0,0
2	0,000020	0,0	0,1
3	0,000029	0,1	0,2
4	0,000039	0,1	0,3
5	0,000049	0,2	0,5
6	0,000059	0,3	0,7
7	0,000069	0,4	0,9
8	0,000078	0,5	1,2
9	0,000088	0,6	1,5
10	0,000098	0,7	1,8
11	0,000108	0,9	2,2
12	0,000118	1,1	2,6
13	0,000128	1,2	3,1
14	0,000137	1,4	3,6
15	0,000147	1,7	4,1
16	0,000157	1,9	4,7
17	0,000167	2,1	5,3
18	0,000177	2,4	6,0
19	0,000186	2,7	6,6
20	0,000196	2,9	7,4
21	0,000206	3,2	8,1
22	0,000216	3,6	8,9
23	0,000226	3,9	9,7
24	0,000235	4,2	10,6
25	0,000245	4,6	11,5
26	0,000255	5,0	12,4
27	0,000265	5,4	13,4
28	0,000275	5,8	14,4
29	0,000284	6,2	15,5
30	0,000294	6,6	16,6
31	0,000304	7,1	17,7
32	0,000314	7,5	18,8
33	0,000324	8,0	20,0
34	0,000334	8,5	21,3

A screen shot of how the calculations used to create the graphs looked, this is around the 48 mm mark.

DSC1	DSC2	DSC3
30	0	41
30	0	41
30	0	41
30	0	41
10	40	81
12	42	83
14	44	85
16	46	87
18	47	89
19	49	91
21	51	93

