

Live Jacobsen  
Siri Gulliksrud

# Expandable Ground Control System for Satellite

Designing for Space Operations

Master's thesis in Industrial Design Engineering  
Supervisor: Thomas Porathe

June 2020



Live Jacobsen  
Siri Gulliksrud

# **Expandable Ground Control System for Satellite**

Designing for Space Operations

Master's thesis in Industrial Design Engineering  
Supervisor: Thomas Porathe  
June 2020

Norwegian University of Science and Technology  
Faculty of Architecture and Design  
Department of Design







Image on previous pages: Graham Holtshausen (2018)

Expandable ground control system for satellite

First edition

Master thesis, Industrial Design, NTNU

By Live Jacobsen and Siri Gulliksrud

All photos and illustrations are and made by the authors,  
unless stated otherwise

Included in this print are Appendix A1 - A8

Printed in Norway by NTNU Grafisk senter

2020

## Preface

This master's thesis has been written at the Department of Design at the Norwegian University of Science and Technology, during the spring of 2020.

The thesis describes and documents our exploration of the subject of control room design for small satellites. It describes the research results from getting to know control room design, high-performance human machine interaction, and the HYPSON project. Further, it describes a proposed solution developed during the project.

## Aknowledgements

Thanks to:

Thomas Porathe, for guiding us throughout the project, and helping us narrow it down

The HYPSON team, for trying to answer all of our questions, no matter how stupid

Ivar Spydevold and the rest of Statsat, for existing and share their knowledge and work processes on satellite operations

Avinor and Jens Petter Duestad, for giving us valuable information about remote operations now and in the future

All of the different digital media we've used for social communication during the COVID-19 lockdown



## Abstract

We have designed and tested a prototype of a graphical user interface for the HYPSONO project at NTNU SmallSat Lab. In addition we have researched and conceptualized a control room with workstations, which is represented in a 3D model render.

To be able to do this we have researched the fields of human factors in control rooms, high performance human-machine interaction and information visualization, as well as the HYPSONO project itself.

For HYPSONO the most important information we leave them with are the GUI Design Guide and the Control Room Design Guide. These documents can be found in appendix A1 and A2. Assignment and final results can be found in chapters 1 and 6.

Key findings and other significant information has been marked with colored circles throughout the document.

Figure 1: Illustration of HYPSONO-1 (NanoAvionics, n.d)



## Sammendrag

Vi har designet og testet en prototype av et brukergrensesnitt for HYPSONO prosjektet ved NTNU SmallSat Lab. I tillegg har vi utforsket og satt sammen et konsept for et kontrollrom med tilhørende arbeidsstasjoner, representert i en render av en 3D-modell.

For å gjennomføre dette har vi utforsket fagområdene human factors i kontrollrom, effektiv menneske-maskin interaksjon og informasjonsvisualisering, samt HYPSONO-prosjektet i seg selv.

Det mest verdiskapende vi legger igjen til HYPSONO, er designguider for grafiske brukergrensesnitt og kontrollrom. Disse dokumentene kan finnes i appendix A1 og A2. Oppgave og sluttresultater kan finnes i kapittel 1 og 6.

## List of Abbreviations

<b>ADCS</b>	Attitude Determination and Control System
<b>CDR</b>	Critical Design Review
<b>DCS</b>	Distributed Control System
<b>EPS</b>	Electrical Power System
<b>ESA</b>	European Space Agency
<b>FC</b>	Flight computer
<b>HF</b>	Human Factors
<b>HMI</b>	Human-Machine Interface
<b>HSI</b>	High Spectral Imaging
<b>HYPISO</b>	Hyperspectral Imager for Oceanographic Applications
<b>HW</b>	Hardware
<b>LSD</b>	Large Screen Display
<b>LEOP</b>	Launch and Early Orbit Phase
<b>OPU</b>	On-board Processing Unit
<b>PDR</b>	Preliminary Design Review
<b>PL</b>	Payload
<b>P-POD</b>	Poly Picosatellite Orbital Deployer
<b>SC</b>	Spacecraft
<b>SmallSat</b>	Small satellite
<b>SW</b>	Software
<b>TLE</b>	Two Line Element set
<b>TM</b>	Telemetry
<b>UHF/S-band</b>	Ultra High Frequency/Super High Frequency band
<b>WCAG</b>	Web Content Accessibility Guidelines

## Definitions

Throughout this document we'll use the following definitions.

<b>Control centre</b>	All HYPSON related locations on NTNU campus. This includes the control room, ground station, work spaces and leisure spaces
<b>Ground station</b>	Antenna and servers used for sending and receiving and data from the satellite. Located on NTNU campus
<b>Control room</b>	The room containing the work stations of the operators and mission planner
<b>SmallSat Lab</b>	Workspaces for the HYPSON team members not working in the control room
<b>HYPSON mission</b>	The entire HYPSON project
<b>Command</b>	A script to perform an action
<b>Task</b>	A set of commands
<b>Mission</b>	A set of satellite tasks
<b>Nominal operations</b>	Operations in normal conditions with all systems working

## CHAPTER 1 - INTRODUCTION

- 15 ASSIGNMENT**  
*Scope, masters agreement  
and team presentation*
- 18 HYPISO MISSION**  
*Introduction to the HYPISO  
project at NTNU*

## CHAPTER 2 - RESEARCH

- 22 HYPISO TIMELINE**  
*Timeline of the HYPISO  
project*
- 28 USERS &  
STAKEHOLDERS**  
*The users and stakeholders  
considered in this thesis*
- 34 DESIGN IN SPACE**  
*The position of UX/UI in  
space operations*
- 36 DESIGN BRIEF**  
*What should our thesis  
contain?*

## CHAPTER 3 - DESIGN THEORY

- 39 HUMAN FACTORS**  
*Accommodating the limits  
of the user*

- 40 SITUATION  
AWARENESS**  
*Perception in context*

- 42 HIGH  
PERFORMANCE HMI**  
*Introduction to the High  
Performance HMI Handbook*

- 43 INFOVIZ.**  
*How to present information  
in an understandable way*

- 45 LARGE SCREEN  
DISPLAYS**  
*An introduction to large  
screen displays*

- 46 THE SRK MODEL**  
*Skill, rule, and knowledge  
based performance*

- 47 ECOLOGICAL  
INTERFACE DISPLAY**  
*An introduction to  
ecological interface displays*

- 48 CONTROL ROOM  
DESIGN**  
*ISO standards considered in  
this thesis*

- 50 CRIOP**  
*Crisis Intervention and Oper-  
ability analysis*

- 51 COCOM**  
*Contextual Control Model*

## CHAPTER 4 - METHODS

- 55 HCD PROCESS**  
*Taking the design approach*
- 56 DOUBLE DIAMOND**  
*Discover, define, develop, deliver*
- 57 PROTOTYPING**  
*Low and high-fidelity prototyping*
- 58 USABILITY TESTING**  
*Why user involvement is critical*
- 59 CO-CREATING**  
*Utilizing expert resources*
- 60 REMOTE COLLABORATION**  
*Staying connected in lockdown*

## CHAPTER 5 - PROCESS

- 63 OUR PROCESS**  
*Process structure and teamwork*
- 64 PROJECT TIMELINE**  
*Timeline of our project*
- 66 CRITICAL DESIGN REVIEW**  
*Evaluating a space mission*
- 67 INTERVIEWS**  
*Introduction to resources and key findings*
- 70 AVINOR VISIT**  
*Key takeaways from Avinor visit*
- 72 STATSAT VISIT**  
*Key takeaways from Statsat visit*
- 74 USER SCENARIOS**  
*Scenarios developed by the software team*
- 75 INTERFACE TASKS**  
*What should the interface do in each phase?*
- 78 PROTOTYPING & USABILITY TESTING**  
*78 1st Iteration*  
*82 2nd Iteration*  
*92 3rd Iteration*

## CHAPTER 6 - FINAL CONCEPT

- 105 GUI**  
*Key features of final  
concept GUI*
- 109 HIERARCHY**  
*Hierarchy of the GUI  
elements*
- 110 COLOURS**  
*Colour criterias*
- 112 TEXT**  
*Ensuring readability*
- 113 CHARTS**  
*Depiction of lines*
- 114 RESPONSIVE GUI**  
*Suggestions for the future*
- 118 CONTROL ROOM**  
*Final concept*
- 119 DESIGN GUIDES**  
*Documentation for the  
HYPSO mission*
- 120 PDR**  
*Preliminary Design Review*
- 121 REFLECTIONS**  
*Final thoughts and  
reflections*

## REFERENCES

### APPENDIX

- A1 CONTROL ROOM  
DESIGN GUIDE**
- A2 GUI  
DESIGN GUIDE**
- A3 OPERATIONAL  
SCENARIOS**
- A4 HYPSO ORGANIZA-  
TION MAP**
- A5 SCRIPT, USABILITY  
TEST 2**
- A6 PROTOTYPE,  
USABILITY TEST 2**
- A7 SCRIPT, USABILITY  
TEST 3**
- A8 PROTOTYPE,  
USABILITY TEST 3**
- A9 FINAL CONCEPT**





# 01

## Introduction

*Algal blooms near Gotland ("Baltic blooms", modified Copernicus Sentinel data (2019), processed by ESA, CC BY-SA 3.0-IGO)*



## Team

The project was performed by master students Live Jacobsen and Siri Gulliksrud. This design work is part of a bigger project done in collaboration with the HYPSON team at NTNU Smallsat Lab, consisting of several engineers and developers.

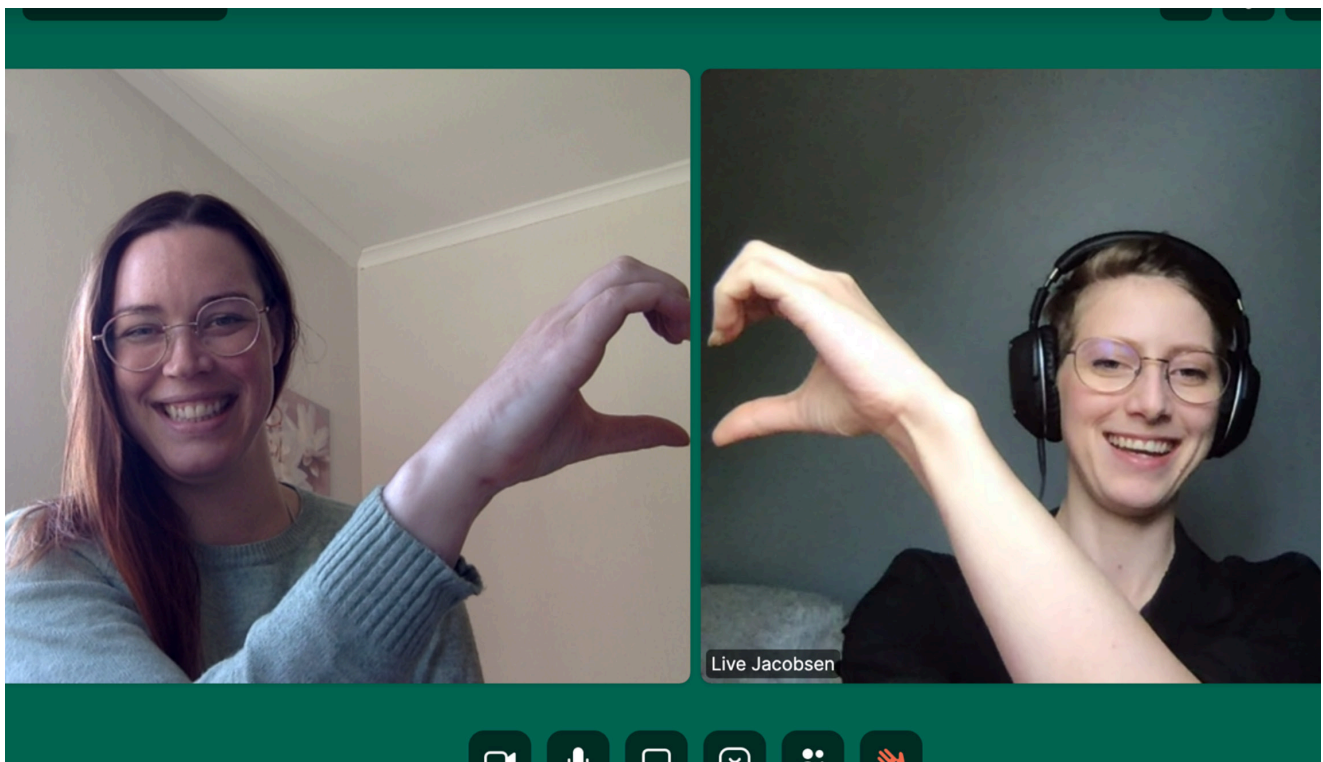

# Scope

In the beginning, the scope was quite vague, as shown in the master's agreement. After gaining deeper knowledge about the HYPSON project, we narrowed it down to tasks and roles in the control room, the control room layout, and GUI for nominal operations.

As we assumed that the HYPSON project would not be ready to build neither the control room nor develop the GUI before our departure, our main focus was to leave behind good documentation of our findings, as well as guidelines for further work.

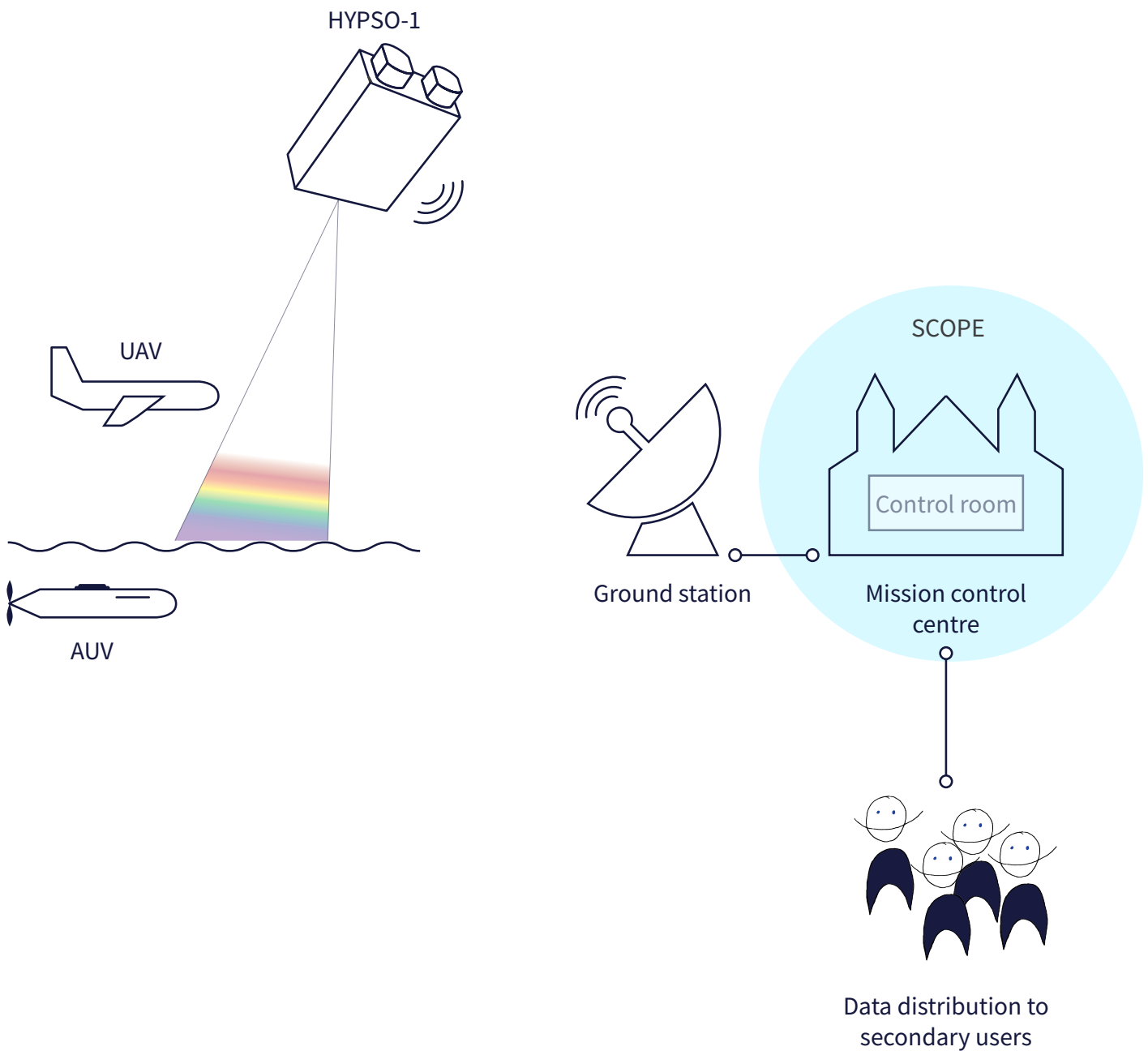

Figure 2: Our scope within the HYPSON project

---

## Masteroppgave for Live Jacobsen og Siri Gulliksrud

### Utvidbart kontrollrom for satellitt Expandable ground control system for satellite

NTNU SmallSat Lab ønsker å etablere et forskningsdrevet operasjonssenter for å støtte drift av to småsatellitter. Ambisjonen er å utvikle et nasjonalt kompetansesenter for småsatellitt-teknologi. Langsiktig mål er at operasjonssenteret skal integreres som en del av laboratoriekjeden ved NTNU og SINTEF kjent som «Ocean Space Laboratories», den samlede laboratorie-infrastrukturen i Ocean Space Centre.

Operasjonssenter defineres av SmallSat som “kombinasjonen av kontrollrom, kontrollsuiter og arbeidsstasjoner som er funksjonelt beslektede”. Mye av innholdet og oppsettet er usikkert, men det er et ønske om å utvikle et gjenbrukbart kontrollcenter til fremtidige satellitter og autonome fartøy. I tillegg er det ønskelig å kunne bruke oppsettet til å trene personell, og gi tilgang til studenter for å øke kompetanse innen satellittoperasjon. Oppgavens hovedmål er å definere innholdet i et slikt operasjonssenter.

Opgaven inkluderer:

- Identifisering av brukere, interessenter og deres behov
- Utforskning av beslektede systemer
- Prototyping og brukertesting
- Retningslinjer for innhold og arbeidslast for operatør(er)

Opgaven utføres etter «Retningslinjer for masteroppgaver i Industriell design».

Ansvarelig faglærer (hovedveileder IPD): Jóhannes Blöndal Sigurjónsson

Faglig veileder: Thomas Porathe

Eventuelt biveileder:

Bedriftskontakt: Evelyn Honoré-Livermore / Mariusz Eivind Grøtte (SmallSat Lab)

Utleveringsdato: 09.01.2020

Innleveringsfrist: 04.06.2020

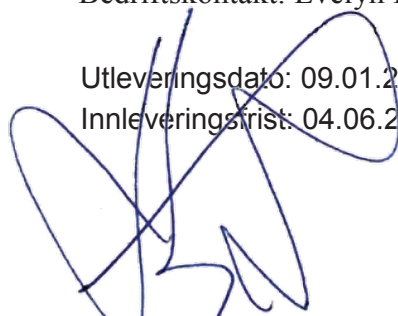

Thomas Porathe  
Faglig veileder

Trondheim, NTNU, dato

2020-06-05



Ole Andreas Alsos  
Instituttleder

# The HYPSON Mission

The HYPSON mission is a satellite project under development at NTNU. Around 50 students, Ph.D. candidates, engineers and professors from different fields are currently working on the project. The project is divided into several departments, by field of expertise.

These departments are System integration and electronics, On-board processing algorithms, HSI payload, Attitude Determination and Control System (ADCS), Mission and operations. This thesis is a part of the Mission and operations department. See organisational chart of the HYPSON project in appendix A3.

The HYPSON mission will launch a small satellite in december 2020. The content of the satellite is being developed at NTNU. Parts are modelled and machined, hardware is designed and software developed.

The body of the satellite itself is being built by a third party vendor. The launch will also be performed by a third party.

In addition to the satellite itself, a ground station and control room are being built at the NTNU Campus.

*Figure 3: HSI image of algal bloom in the ocean (USGS, 2019)*



The HYPSON mission is meant to be a “science-oriented technology demonstrator”, meaning that the project is meant to be a beacon in norwegian space technology, and inspire and invite students to join the space community, thus increasing space competence in norwegian universities. This will be the first small satellite developed at NTNU.

HYPSON-1 will perform low-cost and high-performance hyperspectral imaging (HSI) of the oceans (figure 3). This technology can be used to observe algae bloom, oil spills, or other factors that affect the oceans colour.

The current satellite HYPSON-1 will be followed by HYPSON-2, carrying more technology and features than its predecessor. In the long term, there is a vision of connecting the satellites to a constellation of autonomous vessels like UAVs, USVs, AUVs and buoys, to further explore the oceans.

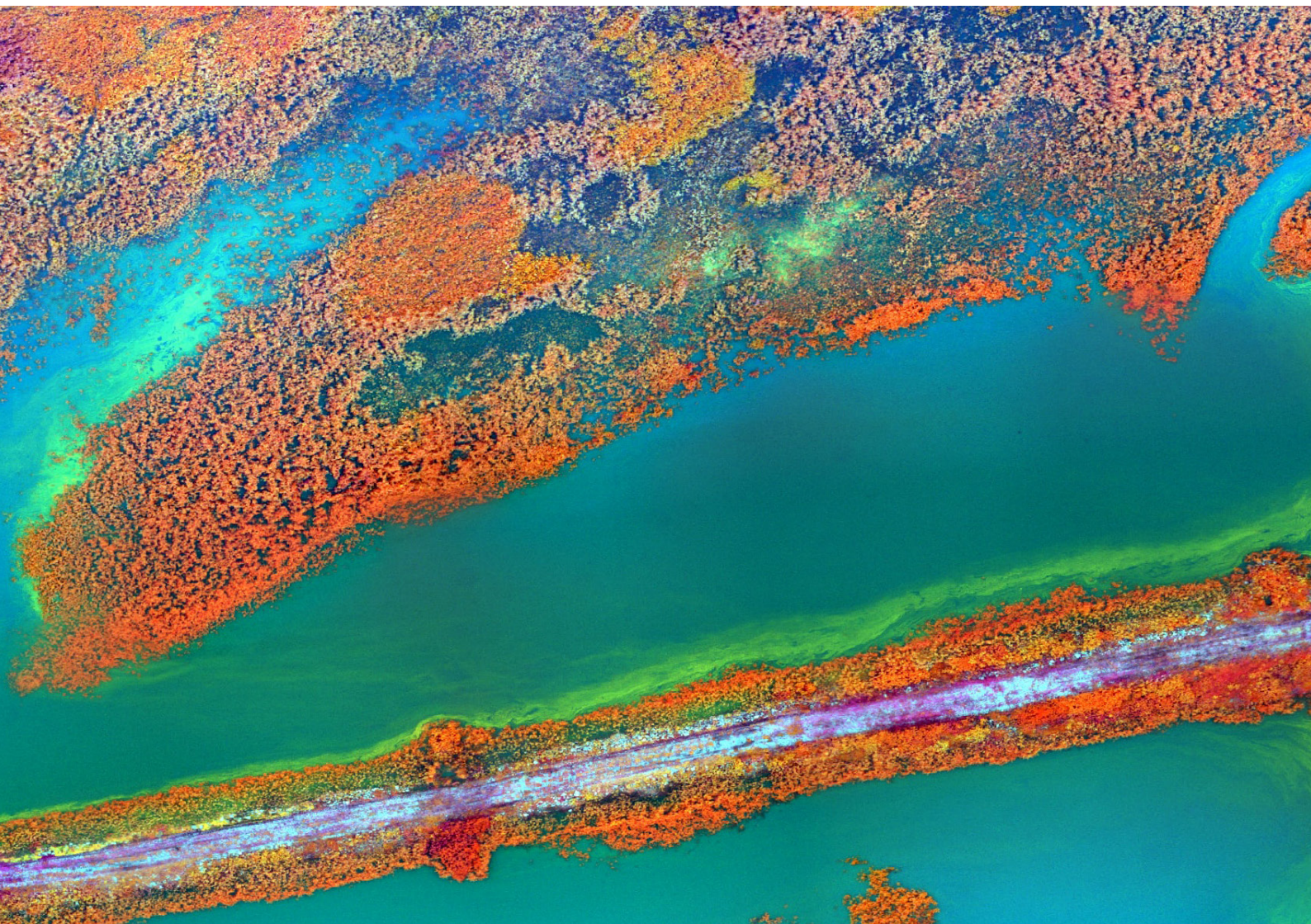



# 02

## Research

*Algal bloom in the Barents Sea ("Barents bloom", modified Copernicus Sentinel data (2016), processed by ESA, CC BY-SA 3.0 IGO)*

## Introduction

To be able to start the design work, we needed to familiarize ourselves with the field and the project. There is a substantial amount of documentation produced in the HYPSON project, and we needed some time to get an overview of the project. Without really knowing where to start, we had several meetings with other members of the team.

The leader of our department, Mariusz Grøtte, took us through the mission timeline as best he could at the time. Things changed quickly and there were a lot of unknowns and to-be-added, but we had to find our starting point.

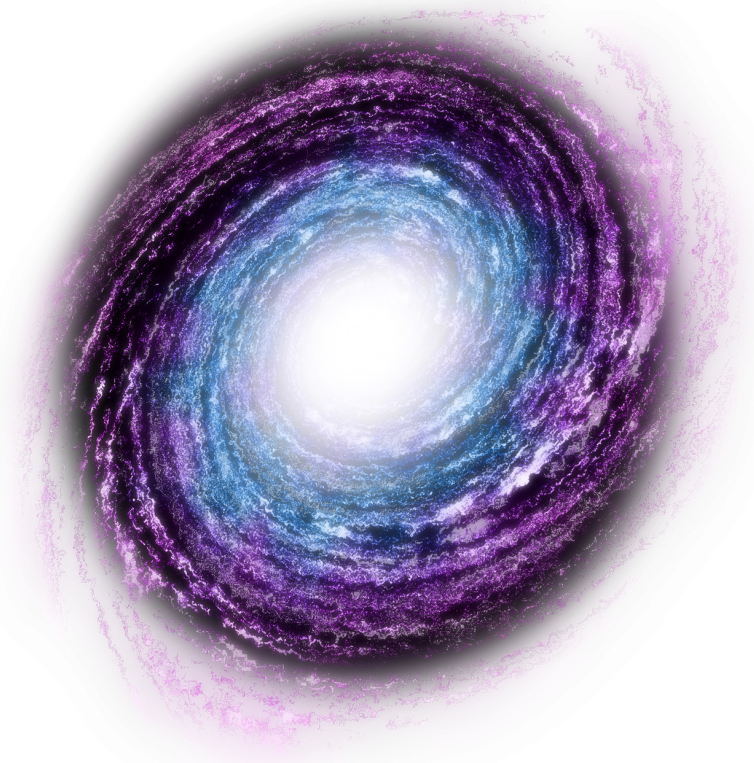
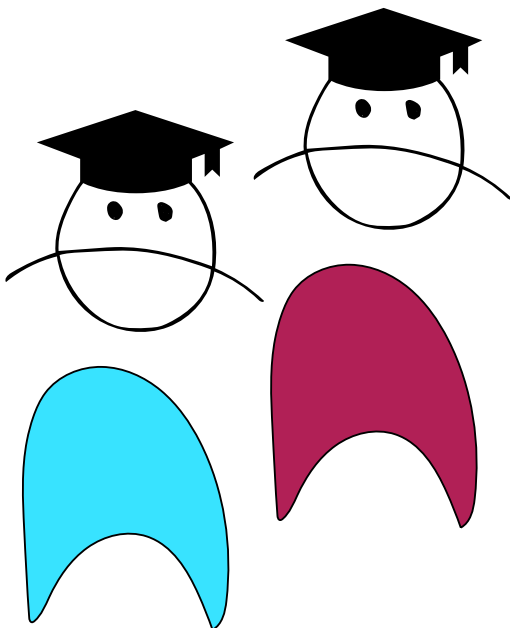

# HYPISO Timeline

Q3 2018

Development started

First PDR

Q4 2018

## Development

The current phase is the development phase. The development of HYPISO-1 began in August 2018. Since then, planning and development of hardware (HW) and software (SW) has been done at NTNU.

The project is heavily influenced by a large turnover of people, as the team members finish their theses and project work. This calls for a strict system for documentation. All team members spend a significant amount of time documenting their work.

## PDR and CDR

Preliminary and Critical Design Review (PDR, CDR) are tools for evaluating the current state of the project, and set deadlines and plans for future work.

PDR is performed to set goals and go/no-go criteria for the CDR. Should these criteria not be met during CDR, the process is judged “not finished” and launch is moved to a later date.



Q1 2020

CDR:  
Launch decided

Q4 2020

Launch

Pre-  
deployment

Q2 2020

Our process

## Pre-deployment

Pre-deployment refers to the time period after the HYPSON team has finished with their in-house HW development and testing, and shipped the HW to NanoAvionics in Lithuania.

At NanoAvionics, functional testing is performed. Remote performance testing from the HYPSON team is possible. SW development and testing continues at NTNU.

## Launch

The launch is handled by supplier SpaceX in California, USA. Several satellites get launched in the same rocket.

At launch time, the supplier is responsible for calculating a two-line element set (TLE) and delivering it to the HYPSON team. TLEs are used for estimating location and trajectory of the satellite. When the rocket reaches orbital altitude, a new, more accurate TLE is generated.

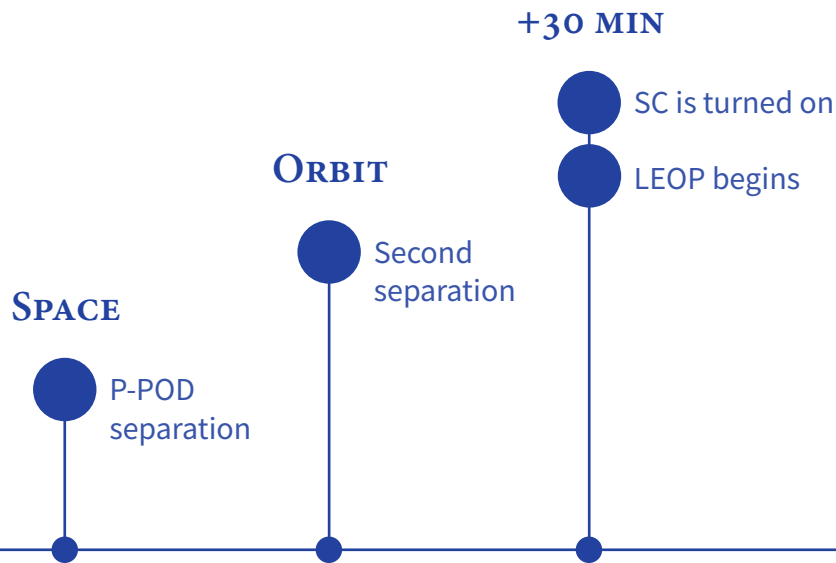

## Deployment

After entering the correct altitude, each satellite is separated from the rocket in a Poly Picosatellite Orbital Deployer (P-POD).

The satellite is then separated from the P-POD into the correct orbit. About 30 minutes after the second separation, the spacecraft (SC) is turned on.

## Launch and Early Orbit Phase (LEOP)

After deployment, the spacecraft is spinning rapidly. When the spacecraft is turned on, the Attitude Determination and Control System (ADCS) automatically kicks in, initiating detumbling to stop the spacecraft from spinning. Slowing down to a spin suitable for nominal operation can take weeks to a year.

During detumbling the spacecraft transmits ID, velocity, spin, power levels, temperature and solar panel status by the onboard UHF antenna. At this point, the location of the satellite is still unknown. There is the TLE-estimated trajectory, but this is not enough to pinpoint position.

The transmitted signal needs to be picked up by one of the searching ground stations. These are located at NTNU in Norway, Vilnius in Lithuania and Aalborg in Denmark, and the search is performed by NanoAvionics. When the satellite is located, a precise trajectory can be calculated.

2 - 52 WEEKS

HANDOVER

Spacecraft  
commissioning

Payload  
commissioning

## SC Commissioning

During this phase, NanoAvionics is responsible for ensuring that all SC sub-systems turn on and function properly (subsystem checkout).

It might be necessary to reconfigure and reboot the system, thus going back to LEOP, several times during this phase. NanoAvionics is responsible for keeping the team informed on commissioning status. SC commissioning does not include the PL, as this is the responsibility of the HYPSON team.

## PL Commissioning

From this phase onwards, the HYPSON team has full responsibility for the satellite. Each subsystem of the PL is tested to ensure proper functionality.

Test images are taken to see if the HSI and RGB cameras function as desired. It might be necessary to reconfigure and reboot the system several times during this phase.

2021/2022

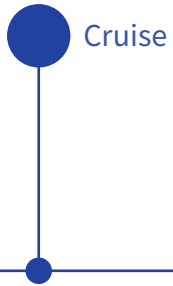

## Cruise

This is the primary phase of the satellite's lifetime. The satellite is operational, and is used for imaging along the norwegian coast.

Reconfiguring is done regularly, as the team learns from each mission.

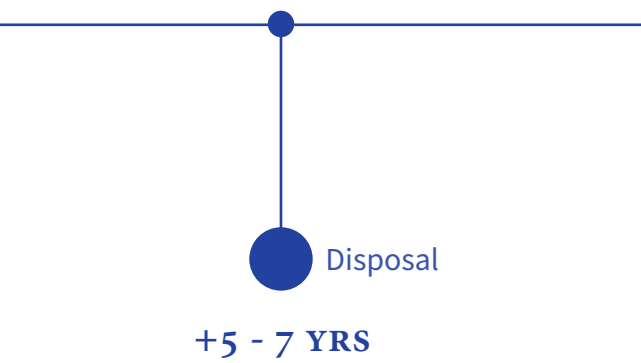

## Disposal

The satellite is turned off and removed from the register of active satellites.

Eventually, the velocity and altitude will decrease sufficiently for the satellite to fall down and burn up in the atmosphere.

## Users & Stakeholders

We started out by defining users and stakeholders. The documentation suggested that a lot of different stakeholders were involved. These have been modified throughout the project, as we've learned more about the project and the field itself.

The users have been defined through information from the HYPSON management team, workflows in similar control centres and literature.

### Main users

Following is a description of those considered main users of the control room systems. Throughout our project, our focus has been on the operator and mission planner in the control room. Further development should include more research work into secondary users and stakeholders.

As the satellite's life has several phases, as do the tasks to be managed from the control centre. In the beginning there will be a lot of manual debugging and configuration. As more data is gathered, more of these tasks can be automatic, lightening the strain on the people working in the control room. In the long term, we envision a control room that sits empty most of the day, and can be used as a co-working space during planning of larger missions.

The operator and mission planner might become the same person over time, as the workload lightens. During the phases containing a lot of manual work, these are best separated.

## Operator

The operator is vital in everyday operations. The operators tasks include communicating with the satellite by uplinking tasks and downlinking results and telemetry (TM) and monitoring the satellites health.

The operator is responsible for fixing simple errors, and alerting the mission planner when unusual or critical errors occur. The operator logs events during their shift, and prep the next shift during changeover.

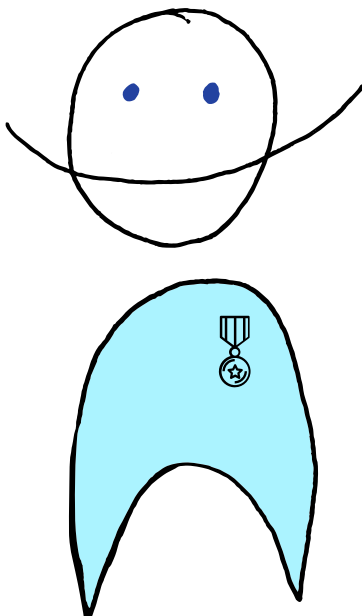
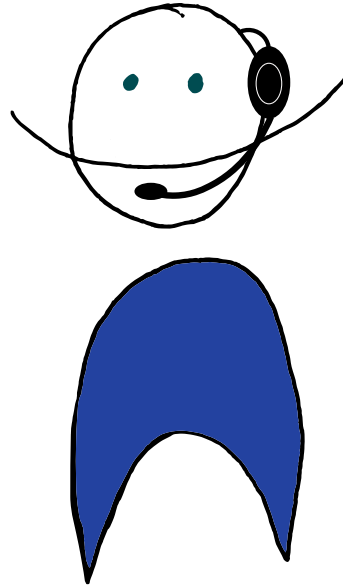

## Mission Planner

The mission planner is responsible for keeping an overview of the whole operation, and to support the operator when needed. The mission planner plans each mission as a set of tasks, validates it separately and together with the mission queue, and adds it to the mission queue. The mission planner decides at what time the image is to be taken, the area to be imaged, imaging mode and other settings.

Forwarding mission data to secondary users or other third parties is the responsibility of the mission planner. Should the operator identify a fault with the satellite, the mission planner is responsible for summoning the correct expert to handle the situation.

## Secondary Users

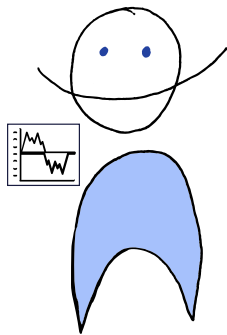

### Experts/Analysts

These are the members of the HYPSON team working outside the control room. The analysts and experts check the data to see if it's correct and usable. Should there be something off with the data, they alert the mission planner and operator.

The experts are then responsible for figuring out what the fault is, and reconfigure the payload in collaboration with the mission planner and operator.

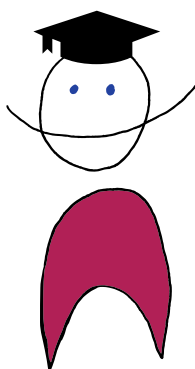

### Students

Students working with the HYPSON team should be able to get training in the operating system, plan and execute simple missions in collaboration with the mission planner and operator.

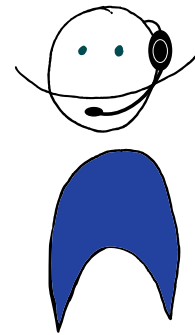

### Radio Operators

The radio operator is responsible for maintaining the ground station antenna and the related servers.

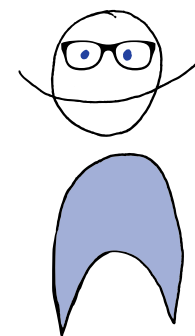

### NanoAvionics

NanoAvionics is responsible for the satellite and payload from pre-deployment until SC commissioning is finished.



# Stakeholders

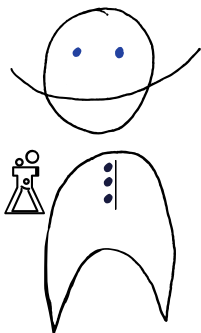

## Project

These are the stakeholders with interests in the scientific side of the project. They have in common that they wish to learn from the project, and increase knowledge about the ocean, space and space operations in Norway.

- NTNU
- Ocean Space Lab
- Norsk Romsenter
- Scientific Community

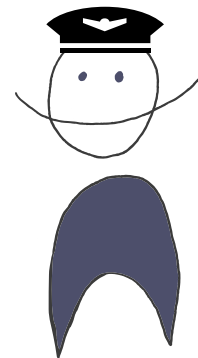

## API

These are stakeholders that want to use the distributed data as a means to enrich their projects or businesses. This could be for safety or optimized operations.

- Kystverket
- Ocean Research
- Oil Industry
- Fish Industry
- Scientific Community

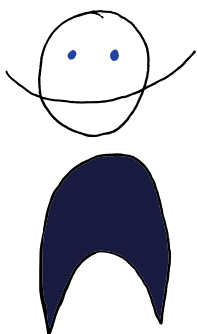

## Suppliers

The suppliers are connected to the project financially.

- Space X
- NanoAvionics
- Others

# User & Stakeholder Timeline

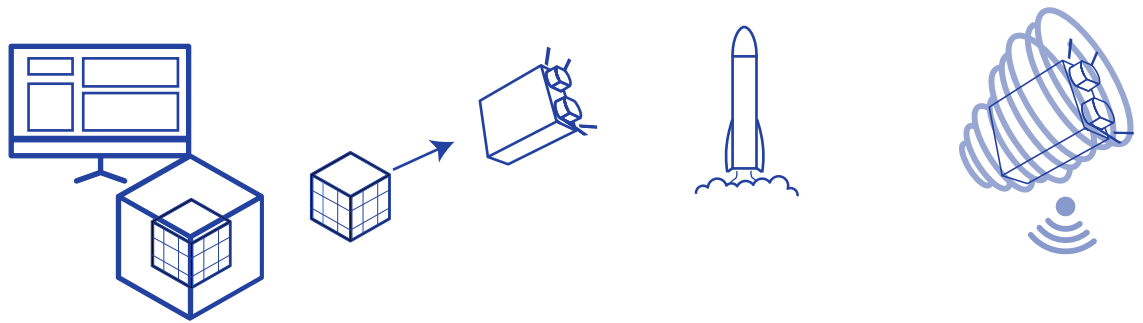

**Development      Pre-deployment      Launch & Deployment      LEOP**

	Development	Pre-deployment	Launch & Deployment	LEOP
<b>Responsible</b>	HYPSO	NA	SpaceX	NA
<b>Tasks</b>	Developing HW Developing SW	Building Performance testing	Launching Deploying Distributing TLE	Distributing TLE Searching
<b>Stakeholders</b>	NTNU			

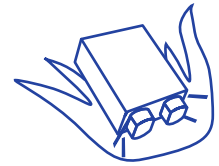
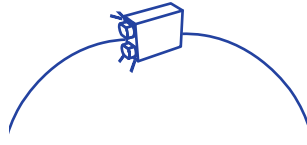
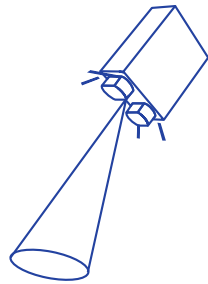
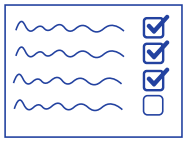

**SC  
commissioning**

**PL  
commissioning**

**Cruise**

**Disposal**

	NA	HYP SO	HYP SO	HYP SO	
	Test subsystems Reconfiguring Rebooting	Test subsystems Reconfiguring	Perform missions Collect data Distribute data Development Student training	Decommissioning	
		NTNU	NTNU Ocean Space Lab Norsk Romsenter Scientific community		



## Accidents

In some cases, bad information visualization and design can be the cause of major accidents. In these examples, visual information was presented in such a way that the risk of the missions was not perceived in the right way.



*AP Photo (1968)*

It has been argued that badly designed charts contributed to the decision to launch the 1968 Challenger space shuttle in sub-prime conditions. 73 seconds after launch, the shuttle exploded, killing all 7 members of the shuttle crew (Tufte, 1997).



*AP Photo/ Tyler Morning Telegraph (2003)*

Bad layout in PowerPoint was involved in the Columbia accident in 2003. Important information were put in a bulletpoint in a list and not given any special attention. During reentry, atmospheric gases penetrated the heat shields, causing the shuttle to burn up and kill all 7 crew members (Columbia Accident Investigation Board, 2003 and Tufte, n.d).

# Design Brief

## Purpose

The purpose of the thesis is to provide the HYPSON project with research-backed knowledge about how to develop a GUI for operating a small satellite, as well as how to design and build a control room for the same purpose.

The solution needs to be expandable as the project plans to expand later on.

## Scope

GUI for nominal operations, including prioritizing missions and responding to alarms.

Layout of control room and workstations.

### GUI

Contents of GUI  
Tasks to perform  
Number of displays  
Display hierarchy  
Design guide

### Control Room Design

Purpose of the room  
Roles of people working in the room  
Number of workstations  
Ergonomic recommendations  
Design Guide

## Background and context

### Vision

NTNU SmallSat Lab wants to establish a research-driven operations center to support the operation of two small satellites. The ambition is to develop a national center of excellence for small satellite technology.

The long-term goal is for the operation center to be integrated as part of the laboratory chain at NTNU and SINTEF known as “Ocean Space Laboratories”. Having physical facilities which can accommodate visitors and can be used to train students and teach about space missions and technology is their vision. Our thesis leaves them with knowledge on how to build this.

### **Users**

Participants in the HYPSON project will be the main users, both employees and students at NTNU. This includes the roles of operator and mission planner. Expert/analyst/maintenance are secondary users.

### **Constraints**

HYPSON do not yet know exactly what they need, as work on the design of the ground segment has yet to begin.

The GUI and the needs of the users has not been in focus so far in the HYPSON project, as there is so much advanced development needing attention. Finding out the exact needs are challenging as this is the first time a small satellite is built at NTNU.

None of the team members have any experience with building satellites. The high turnover rate, combined with the participants focus on their own projects, and a low presence of cross-department teamwork makes it difficult to get a complete overview.

### **Timespan and dependencies**

The timespan of this thesis is one semester. The HYPSON project will go on for several years. Thus, it is necessary for us to leave behind something that is easy to develop further.

We are dependent on correct and updated information from the HYPSON team, as well as resources outside of NTNU. As we are not trained in the space field, there is a need for information about practical experience.

### **Stakeholders**

**Project Stakeholders**  
These are the stakeholders with interests in the scientific side of the project.

**API stakeholders**  
These are stakeholders that want to use the distributed data as a means to enrich their projects or businesses.

**Suppliers**  
The suppliers are connected to the project financially.

### **Success factors**

In order for the HYPSON project to be a success, it is necessary to have a proper system for handover. The turnover in the project is rather large, since the participants are mainly master students and Ph.D. candidates.

A success factor is how HYPSON manages to convey an alumni's results to the next student. Google Drive is used for filing, combined with a system of documentation where everything shall be recorded. Our documentation is one way of how such a handover can be done.

### **Deliverables**

Our main deliverables will be guidelines and "how to's" for the coming designers and developers. This includes our GUI Design Guide and Control Room Design Guide documents, as well as the GUI prototype and control room render.

This will, in our opinion, cover the current need for knowledge for working with the GUI and control room design.

An aerial photograph of a glacier system. A large, flat, blue ice shelf is visible on the left side, partially covered by a layer of pinkish clouds. The surrounding ice is a mix of light blue and white, with numerous cracks and crevasses. The overall scene is a vast, textured landscape of ice and snow.

# 03

## Design Theory

*“Larsen Ice shelf” (blue) covered in clouds (pink) (modified Copernicus Sentinel data (2017), processed by ESA, CC BY-SA 3.0 IGO)*



# Human Factors

The field of human factors revolves around designing products or systems that accommodate the limits of the user.

Meister and Enderwick (2002) define human factors as “the study of how humans accomplish work-related tasks in the context of human machine system operation, and how behavioural and non behavioural variables affect that accomplishment”(figure 5). Human factors engineering strives to reduce error, increase productivity and enhance safety and comfort when humans interact with a system (Wickens & Hollands, 2000).

In this project, our main focus has been on the presentation of information, but not all human factors are related to information processing. Ergonomics should also be considered, as this is what makes people able to physically perform tasks without unnecessary strain.

Considering human factors in this project is important, as we want to know which factors affect the operators performance when using the GUI. The literature often describes guidelines, “do’s and don’ts” regarding control room operations.

This information can be used to design a system that can balance the strengths and limitations of humans, and minimize human errors. In some cases, a more accurate term for human errors could be design-induced errors as they are outside of the operator’s control.

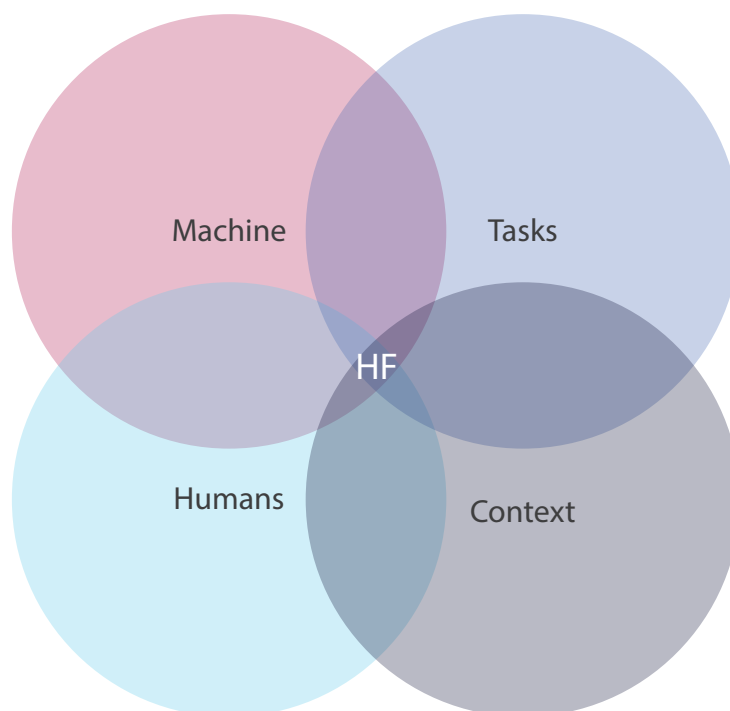

Figure 5: The components affecting human factors, according to Meister and Enderwick(2012)

# Situation Awareness

Situation awareness is defined in three different levels: how we perceive the objects around us in a context of time and space, understanding their meaning, and foreseeing their status in the near future (Endsley, 2012).

Hollifield et al. (2008) suggest splitting an interface into three levels of detailing to accommodate these three different levels of situation awareness:

**Level 1 - Process overview**

**Level 2 - Process unit operation graphics**

**Level 3 - Process detail**

An individual can hold and manipulate 7 plus minus 2 chunks of unrelated information simultaneously (Miller, 1952). When dealing with large amounts of complex information, simplifying and designing it to address different parts of the brain can be advantageous.

This lightens the load on working memory, making it easier for the operator to get an overview of the situation. The overall workload is reduced, lowering the risk of stress and fatigue. Simplifying information can increase comprehension, and has been shown to improve performance and decision making (Endsley, 2012).

Attention tunneling

Complexity creep

Workload

Anxiety

Fatigue

Data overload

Misplaced salience

Errant mental models

Out-of-the-loop-syndrome

Obstacles preventing good situation awareness (SA) can be referred to as SA Demons (Endsley, 2012). In this project it has been important to work towards enhancing situational awareness through avoiding the SA Demons.

For example, data overload can be avoided through keeping the interface clean and uncluttered, as well as not having too many screens in the control room and at the workstation.

Misplaced salience is avoided through designing the GUI in a way that places the salience on what matters, e.g. only using colors on the chart lines and alarms.

Keeping the operator in the loop is another way of making sure the situation awareness is good. This can be done by designing the system to always provide feedback for the operator and update the operator on ongoing processes, even if they are automated.

# High Performance HMI

Central to the literature we have used in this project is the High Performance HMI Handbook. (Hollifield, Oliver, Nimmo & Habibi, 2008). It is “a guide to designing, implementing and maintaining effective HMI’s for industrial plant operations”.

Even though we are not working with a plant, the theory can be utilized for other operator rooms and GUIs. The book describes, in detail, HMI best practices, from which shades of gray to use in the interface to how the operator should be positioned in the control room. An example of such an HMI can be seen in figure 5.

The hierarchy of the HMI, the trends in the charts and the use of alarm prioritizing and color usage are among the most important information we have used in this project.

See appendix A1 and A2, as well as chapter 5, Final Concept for more information.

Figure 5: A level 1 overview display, Hollifield et al. (2008)

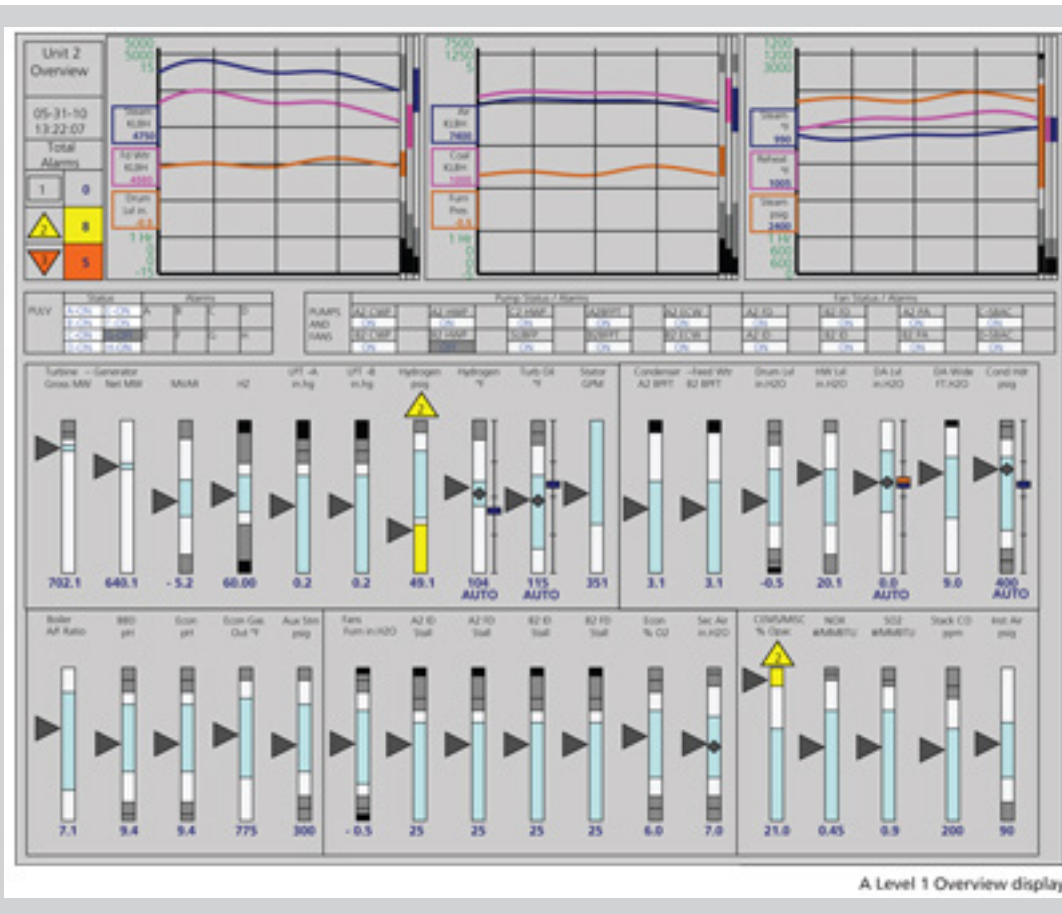

# Information Visualization

How information is presented affects our ability to perceive it. Following are a few key factors according to Johnson (2010) to consider when presenting information visually.

## Structure

We seek and use visual structure (figure 6). Structure enhances the ability to understand long numbers.

81549300  
815 493 00  
81 54 93 00

Figure 6: Example of visual structure

## Hierarchy

Like Hollifield et al. (2008), Johnson stresses that visual hierarchy helps people focus on the relevant information. The frequency of use of a piece of information should affect its position in the hierarchy. See figure 7.

Temp: **42.3** °C

Figure 7: Where is the important information?

## Text readability

Poor design of text can disrupt reading. Things to avoid are uncommon and unfamiliar vocabulary, difficult scripts and typefaces, tiny fonts, noisy backgrounds. See figure 8.

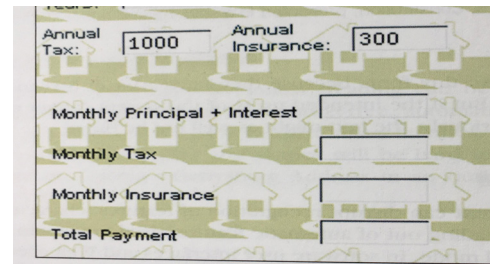

Figure 8: Low readability due to patterned background (Johnson, 2010)

## Color and brightness

Our ability to differentiate colours depends on how they are presented. Background colours and other colours in the interface affects how the colour is perceived (see figure 9). There are also external factors to be considered, such as the colour and brightness of the surroundings.

Colours should be distinguished by saturation and brightness as well as hue, and should not be too close in the colour space. The human has a higher sensitivity to brightness than hue. Pairings like red-green are to be avoided, as these can be difficult to distinguish for color-blind people.

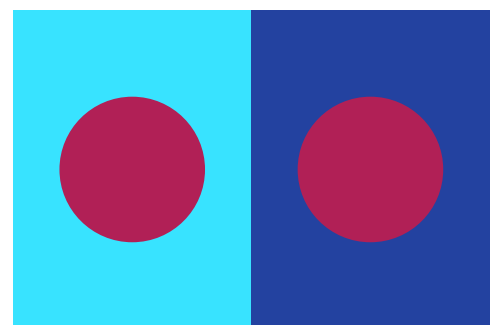

Figure 9: The pink color looks darker with a darker background.

## Getting attention

When aiming for the user's attention, like with an alert, there are some things to consider.

Our peripheral vision is poor. Stationary items in muted colors in the periphery of our visual field will not be noticed. Motion can be used as a tool to grab the users attention, as we have a higher sensitivity to movement in our visual field.

To gain attention, pop-ups, sound or flashing can be used. Figure 10 shows how a circular animation around the alarm icon can be used to draw attention. These should be used with caution, as the user might start to ignore them should they happen too frequent.

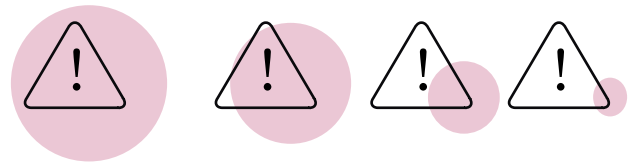

Figure 10: An attempt to show animation. Inspired by Alf Ove Braseth (2013)

## Recognition

Recognition is easy, recalling is hard.

Seeing and choosing a function is easier than recalling and typing it. Use visual cues to let the user recognize where they are. Where possible, icons or images should be used to convey function. Figure 11 shows the use of an icon to convey a function.



Figure 11: An icon displaying the "upload to cloud" function

# Large Screen Displays (LSD)

Large screen displays refers to displays larger than regular desktop displays. These can be custom screens for larger workstations or wall-mounted displays. During this project, the following guidelines have been used when considering the wall-mounted display (Braseth & Øritsland, 2013).

Display graphics should be information rich. Positioning and size should match importance. Visual complexity can be reduced by limiting the amount of display objects.

Extensive use of grayscale should be used with caution when using front-projection in a well lit room.

Trended information is preferable to un-trended. Display relevant target values and rate-of-change cues to keep the operator informed. An example of a LSD is shown in figure 12.

Alarms should be positioned within a natural context of the graphical objects. New, unacknowledged alarms should be highlighted. To avoid annoyance, gentle animations can be used instead of abrupt flashing.

Figure 12: An example of an information rich LSD (Braseth & Øritsland, 2013)

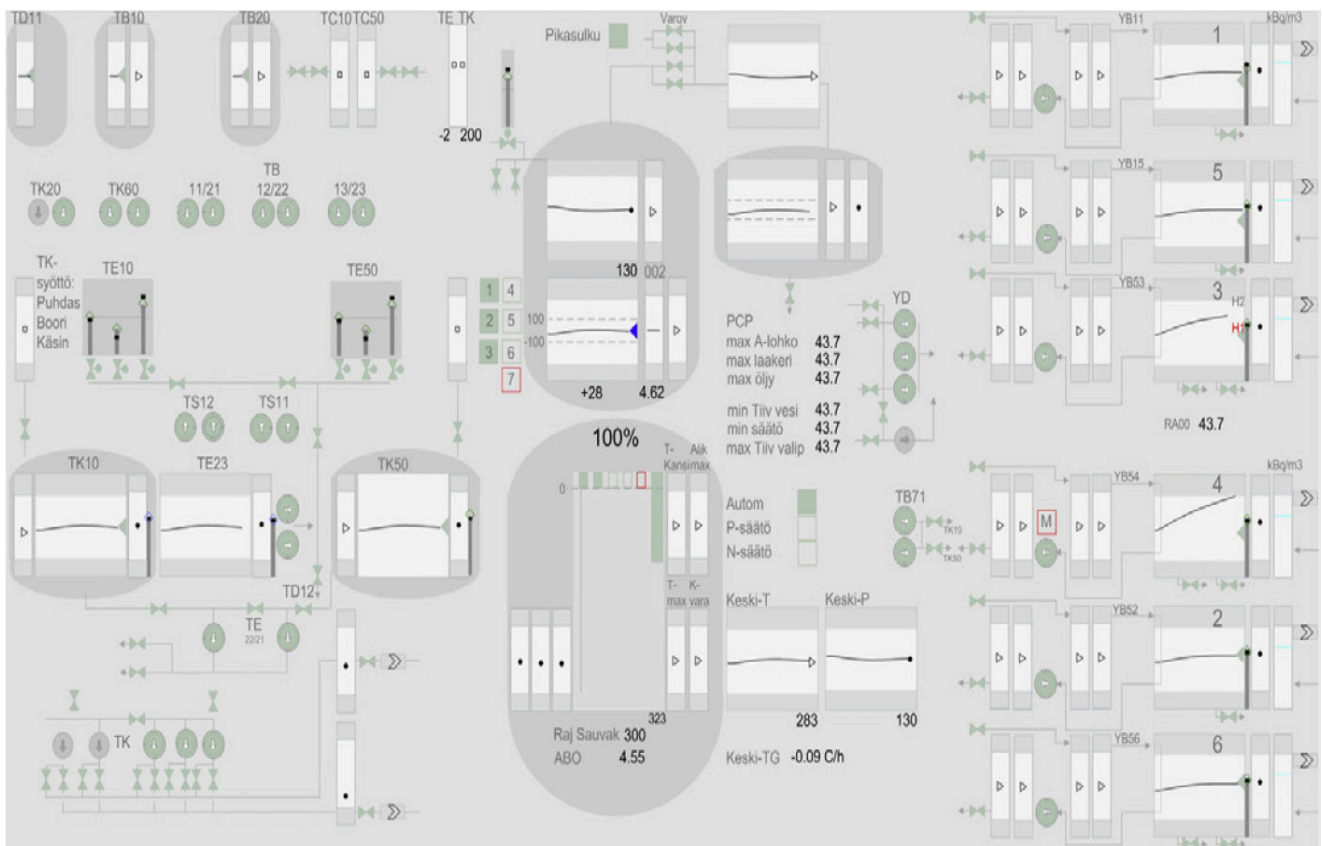

# The SRK Model

The SRK model developed by Rasmussen (1983) represents human performance. The model splits cognition into three levels: skill, rule and knowledge based behaviour.

## **Skill based performance**

At this level, the user performs actions they have learned before (e.g. through training), barely conscious of their actions. Most of the actions are automatic,

## **Rule based performance**

This level is, as the name suggests, based on rules or sequences of subroutines. At this level, the user performs operations according to a set of rules in a familiar work situation. The rules are not necessarily absolute. The user may require to use experience in familiar situations. This gives a higher cognitive demand, and the need for decision making.

## **Knowledge based performance**

Should an unfamiliar situation arise in an environment with no rules, the lower conceptual levels does not give the needed performance to resolve the situation. At this point, the user must rely on their own knowledge towards a determined goal.



# Ecological Interface Design

The Ecological Interface (Vicente & Rasmussen, 1992) is an interface designed to support the three levels of cognition, making an efficient interface for complex systems. Figure 13 shows an example of such an interface.

To facilitate skill based behaviour, a physical means of navigation (like a mouse) is preferred to a command line interface (CLI), as it doesn't interfere with the continuity of situation perception. To facilitate high performance, the operator must have access to several information levels at the same time, making it easy to access lower levels of the interface (Schneidermann, 1983).

To facilitate rule based behaviour, Vicente and Rasmussen suggest displaying cues for the operators to notice. E.g. in addition to displaying temperature as a cue, additional information

such as under which conditions the temperature is valid, is necessary. This attempts to negate operator errors by giving the operator cues instead of relying on knowledge. Knowing the temperature boundaries for each state is not necessary if it's displayed on the interface.

Facilitating knowledge based behavior is vital, as this is the most straining on the operator. Knowing all the possible consequences of an action might be difficult, so the interface should strive to lift the burden of keeping track of all details of the system. By displaying mental models to reduce the mental workload, the operator gains more attention to be used in solving the problem at hand. For example, visualising the battery level instead of just writing it with number helps with quick understanding of the situation.

Figure 13: An example of ecological interface design (Hugo, 2009)

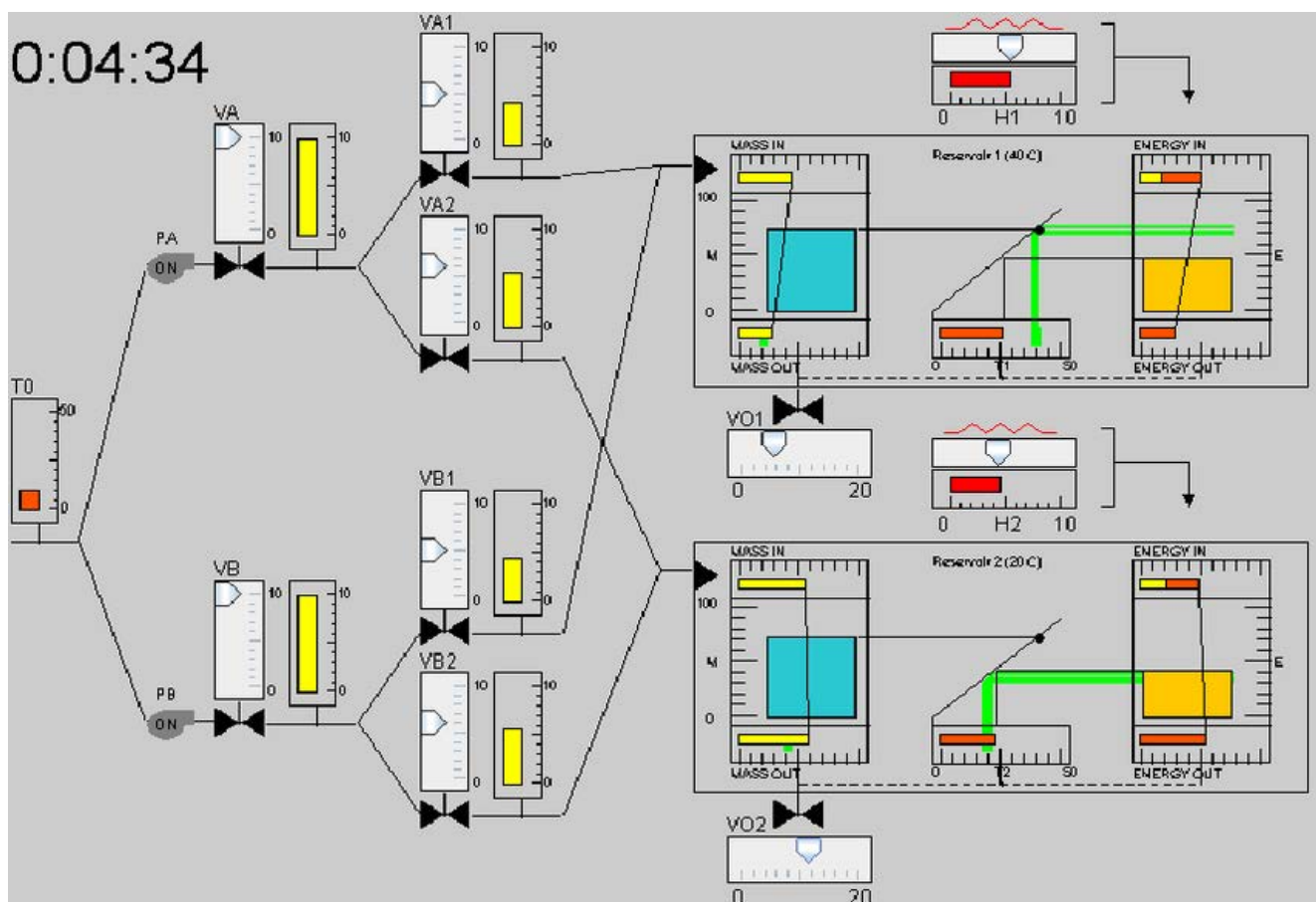

# Control Room Design

Many control centres rely on ISO 11064, “Ergonomic design of control centres” (ISO 1999, ISO 2000) as a standard for development. This project is no different. Following are some key points from the standard considered in our thesis. Combined with other standards and guidelines, this has been the basis of our guidelines for control room design, that can be found in appendix A1.

## Control room layout

The layout shall facilitate efficient co-working. The operators and supervisor workstation shall be close enough for verbal communication without shouting, this applies to work topics and social interactions.

The workstations shall be wide enough for operators to sit next to each other during co-working sessions or when training a new operator. A control room should contain allowance for an expansion of 25%

Wall mounted displays shall be visible and readable to all workstations. All operator workstations shall be visible to the supervisor.

Main entrances and exits should not be in the working visual fields of the operators, nor directly behind them. The same applies for windows. Windows situated behind the operators might result in reflections on the display screens.



Figure 14: Render of control room concept for HYPSON-1



## Ergonomics

### Seating

Posture variations should be possible during the workday. This can be achieved by different seating possibilities, and adjust the workflow so that the operator is able to move from their workstation for shorter periods of time.

### Wall mounted display

The lowest operational information presented on the wall mounted display must be at least 400 mm above floor level to ensure readability from all workstations. This should be tested when the control room is set up.

### Lighting

Ensure sufficient lighting. Avoid dimly lit rooms.

### Sound

The control room should be properly sound-proofed, to ensure no outside distractions during stressful situations.

### Navigation space

There shall be sufficient room between stations (900 mm) for it to be wheelchair accessible.

### Supporting Areas

To ensure a functional workspace, some supporting areas are needed. This includes toilets, showers and wardrobes within close range of the control room, personal storage space for the operators, as well as welfare areas such as a small kitchen and/or relaxation space.

# CRIOP

Crisis Intervention and Operability analysis (CRIOP) is a methodology developed to verify and validate a control centre's ability to operate safely and efficiently in all operational modes.

It recommends a viewing distance to desktop displays between 450 and 800 mm. All important information should be located within 35 degrees of the visual field (figure 15)(Johnsen et al., 2011).

Workstation desks and chairs should be easily adjustable, making it possible to change seating positions throughout the day. Thicker desk plates are advised against, as they may cause unwanted working postures.

Figure 15: Viewing distance recommendations (Johnsen et al., 2011)

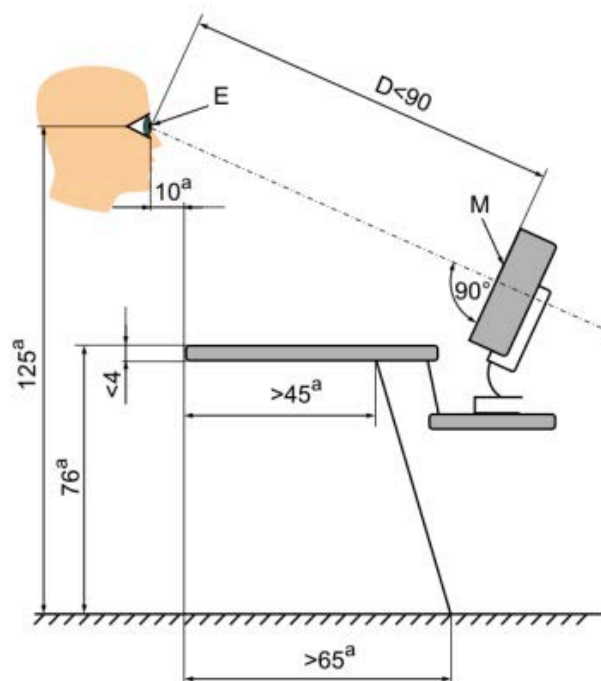

### Legend

- <sup>a</sup> Examples, the values of the anticipated user population shall be applied
- D Viewing distance
- M Monitor (20" LCD)
- E Design eye point

# Contextual Control Model (COCOM)

COCOM is a model proposed by Hollnagel (1993, 2016), describing control modes that appear in different contexts. The modes range from scrambled, with a low level of planning and overview, to strategic, with long term planning and higher level of control.

## Strategic control mode

In the strategic control mode, several operations have been made automatic, and the main objects on the interface have less influence on the choice of action. The operator has more time to look ahead at long term goals. Actions are planned in detail well in advance, sometimes addressing several goals.

## Tactical control mode

In the tactical control mode, the operator follows a set of rules or procedures. This gives them a slight notion of the next actions to be performed. There is still only a low level of planning, and some action might still be improvised.

## Opportunistic control mode

In this mode, the current status of the system determines the next action. There is little to no presence of planning, and the operator does not have a proper overview of the situation. This

could be due to a lack of competence, an unfamiliar setting, the amount of tasks to be performed, a limited amount of time, or a combination. Because of this, the choices made are often inefficient, not producing the desired result.

## Scrambled control mode

In this mode, the operator's choice of actions are mostly random. There is a trial-and-error approach, and little to no reflection involved. This mode usually happens when situation assessment is faulty or down, and there is little or no correspondence between the situation and the actions. Worst case, the operator has no control at all.

In our project, the operators are in tactical and strategic control modes, until an unknown situation happens and they might go into opportunistic control mode or even scrambled control mode. As the operators are not working with live values, that means the information they have is mostly stored data. They are rarely in a position where they have to act fast.

## Conclusion

This literature has been used as a basis for the design work in this project. As mentioned, literature on designing interfaces for space operation is scarce. The literature review shows that there are several related fields that have been studied in detail, such as human factors, cognition, information visualization, display and control room design. These can be combined to create the field of space operations design, if they are applied in space operation projects and documented properly.





# 04

## Methods

*Satellite image ("Sharm El Sheikh", modified Copernicus Sentinel data (2017), processed by ESA, CC BY-SA 3.0 IGO)*



## HCD Process

The control room layout, workflow and work stations graphical user interface (GUI) has been developed through a human centered design (HCD) process. A HCD process revolves around the user's needs.

After identifying the users and their needs, a solution is found through iterations and usability testing, to address those needs. This ensures that the solution creates value for the user, the user's needs are met and the solution is user friendly, as traditional approaches might not achieve (ISO 9241-210, 2011 & Norman, 2013).

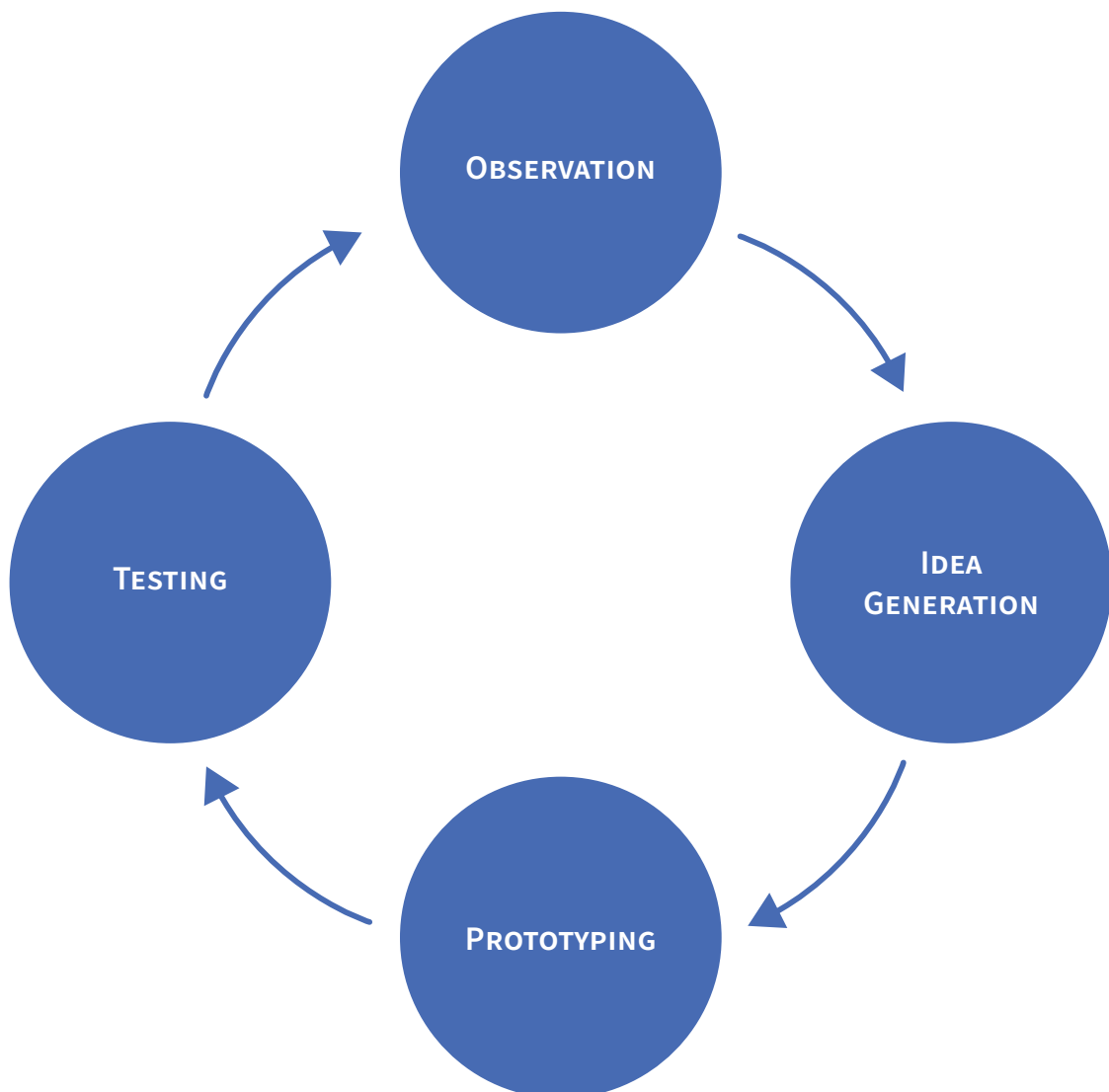

Figure 16: Normans design process

# Double Diamond

The double diamond (The Design Council, 2015) is a model for a design process that describes the diverging and converging nature of moving towards a solution (figure 17). This is what happens in most design processes, with the exploration of ideas, defining an issue to be solved, exploring solutions and finalizing the product or service. Our project has followed a similar pattern.

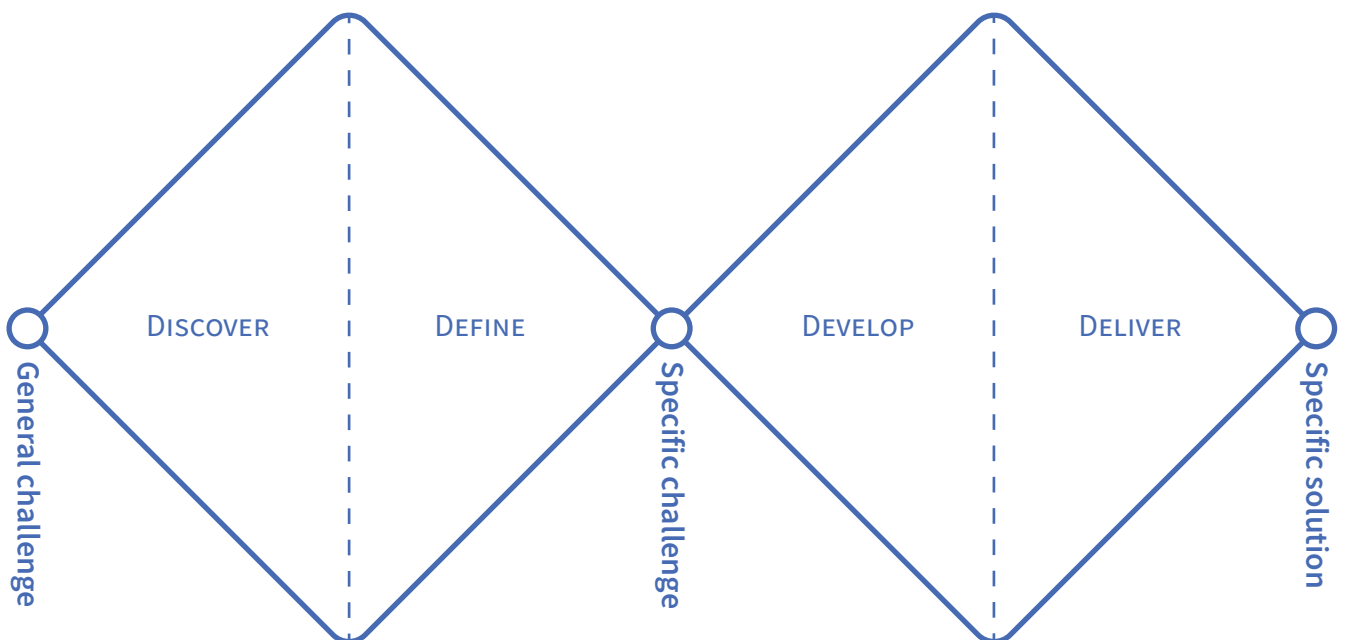

Figure 17: The double diamond

# Prototyping

Prototyping is the making of physical or digital artifacts of different levels of resolution, for testing out ideas and developing them with users. It is a critical step in the design process and represents the designers research and ideas in physical form (Martin & Hanington, 2012).

## Low-fidelity Prototyping

Low-fidelity prototyping facilitates criticism on the concept level, like hierarchy and logical flow. They are good for testing out early ideas and involving a client early in the ideation process. The users are introduced to paper prototypes, i.e. hand drawn (figure 18) and are asked to provide feedback while working toward a goal or executing a task. Wherever the user has an issue or a request, the designer takes note of it and considers it for the next iteration (Martin et al, 2012).

## High-fidelity prototyping

High-fidelity prototypes are more detailed, and might appear as the finished product. These can be digital drawings, or coded prototypes. High-fidelity prototyping facilitates criticism on more detailed problems, like the positions of buttons or word usage (Martin et al, 2012).

Figure 18: Low-fidelity prototyping

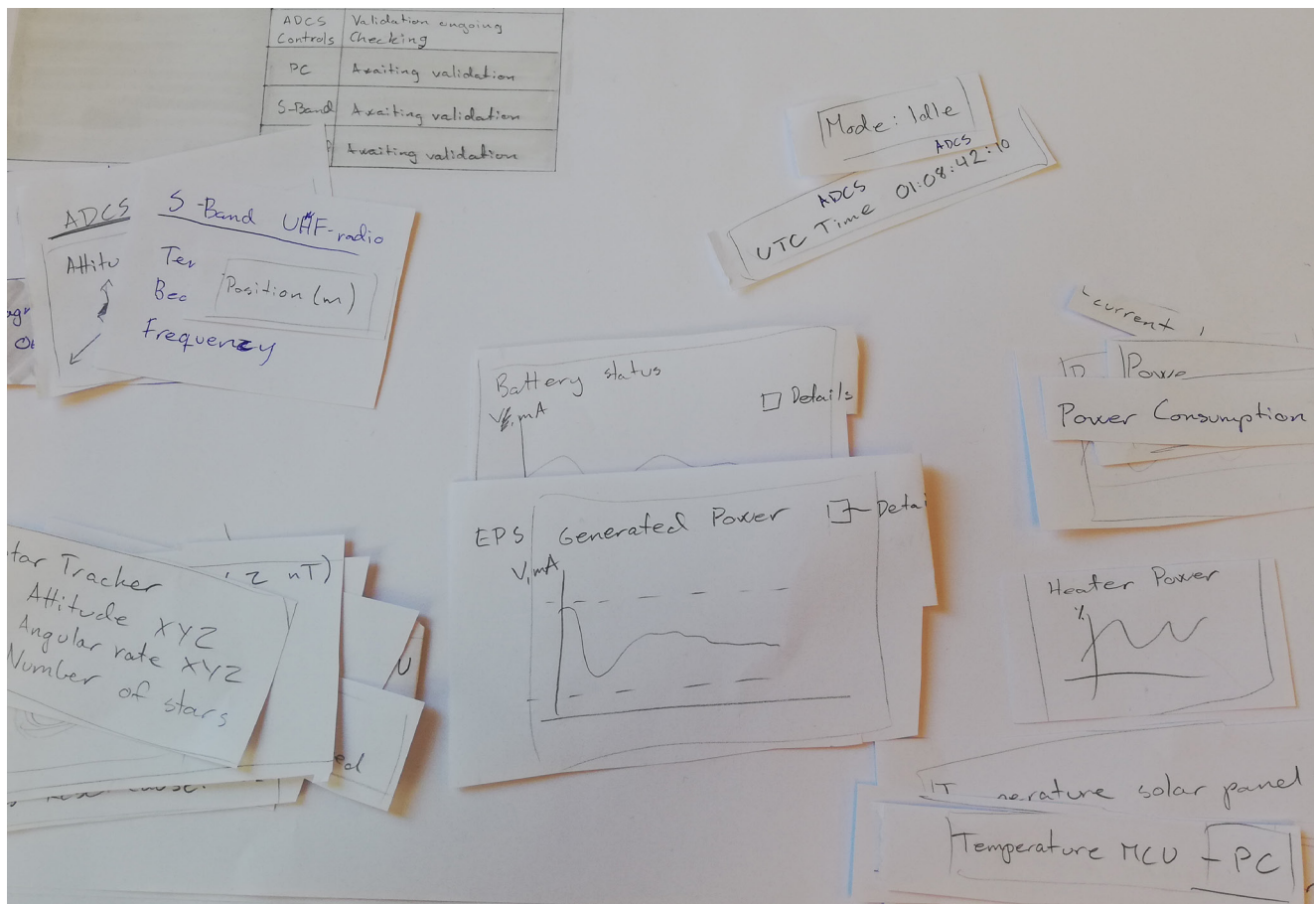

# Usability Testing

Usability testing is an evaluation method which can be used to observe a user's experience with a website or application as they perform a set of tasks given by the designers. (Martin et al, 2012)

Badly designed user interfaces makes it hard for the user to understand it, and difficult to perform tasks (Setthawong et. al, 2019). Testing the design allows the designers to find the areas where users struggle to perform tasks, or are misguided into making the wrong decisions, so the problem areas can be redesigned and retested before launch. (Martin et al, 2012).

Before testing, setting up a couple of scenarios and tasks which represent the typical end-users goals in the application, is necessary. It is a good idea to do this together with other team members, such as the developers or the project manager. This is because different team members have different perspectives on what possible scenarios and tasks can be (Martin et al, 2012).

In this project, the scenarios were constructed together with a frontend developer, as well as the head of the operations department. This gave us insight into which tasks are available, as well as what can go wrong with the satellite in the different scenarios.

One of the design team members acts as the moderator and guides the user through the test, as the other observes, taking notes and watching carefully to see what the user does, in addition to what they say. The user is asked to think out loud, to let the moderator and the observer know what they are thinking without having to ask questions. Additionally, if the user asks the moderator any questions related to the tasks they are trying to perform, the moderator will wait before answering to make the user try to figure it out on their own. This is because the user will be on their own when using the system in real life.

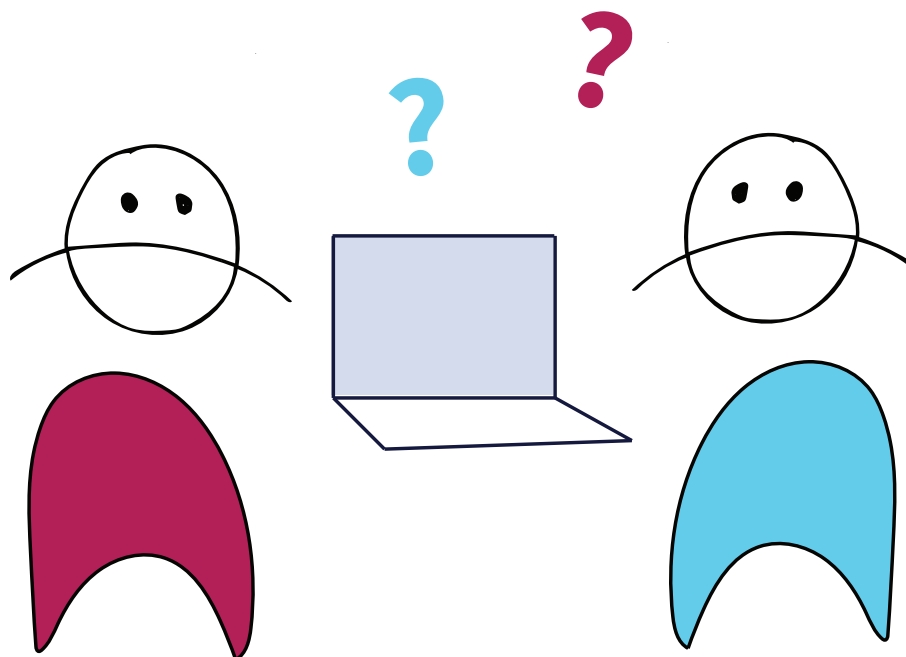

## Co-creations sessions

According to Norman (2013), 5 users are enough for one version of a prototype. This is because when five different users try to perform the same tasks with the same goal in mind, they will encounter the most important errors or shortcomings the prototype has. Any additional test users will encounter most of the same errors, and it is more cost effective to create a new iteration of the prototype before testing again.

However, according to Virzi (1992), the number of test users directly affects the number of issues that are found. His experiments show that 80% of issues can be found with five test users, and even though testing on more users will reveal more issues, five is enough to uncover the major usability problems in one iteration of the prototype. In this project we chose to go with five test users for the 2nd and 3rd iteration.

Co-creation with experts was used as an evaluation tool over usability testing in the first iteration (IDEO, 2015). This was due to the sheer complexity of the domain. This prototype displayed our limited knowledge of the domain. Discussing and redrawing it with more experienced members of the team helped create a believable 2nd prototype. Whereas the 1st prototype would have been too far from reality to seem believable to the users we wanted to test.

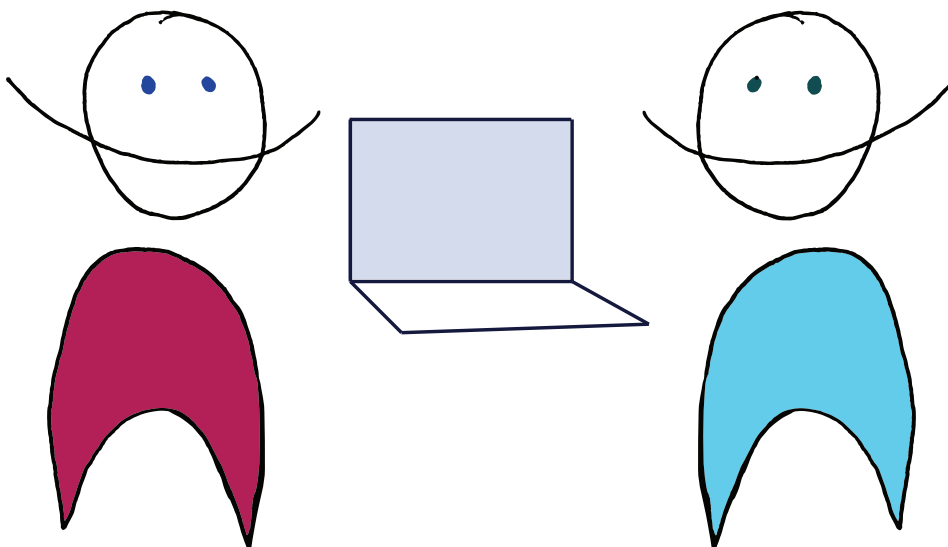

## Remote Collaboration

As this project progressed, there was an increasing need for tools for remote usability testing, as we were unable to meet our users in real life due to COVID-19. Luckily, there are several tools for remote usability testing.

Schall and Horst divided remote usability testing into two categories; synchronous and asynchronous. When a usability test is done synchronously, the facilitator and participant interact in real time. In an asynchronous test, the participant works independently in a largely automated system (Schall & Horst, 2006).

Experiences from synchronous usability tests suggest that expert users evaluating expert interfaces will have similar success in identifying usability issues with either remote or local usability testing (Brush, Ames & Davis, 2004).

Although it takes time and effort to set up a remote usability test, remote collaboration unlocks a bigger number of possible participants, regardless of location. It also saves the facilitator the time and cost of travelling to meet the participant.

With the correct tools, the facilitator can record and watch the participants eye movement, facial expressions and cursor movement, giving a higher level of insight than self reporting. The test subject might also be more relaxed testing in the comfort of their regular workspace or home (Schall & Horst, 2006).

In our project, usability testing for the 2nd and 3rd iteration was done remotely through a tool called Lookback. Lookback allows a facilitator to video chat with a test subject, as well as watch the test subjects screen. Secondary members of the design team can be present as observers and take time stamped notes in the tool.

Everything is recorded and can be looked at later. As the usability tests were split in half with easter break, these recordings were a good refresher before the remaining tests. The tool worked smoothly for usability testing, with little to no technical problems, allowing us to perform the test similarly as we would have done if we had tested locally in real life.

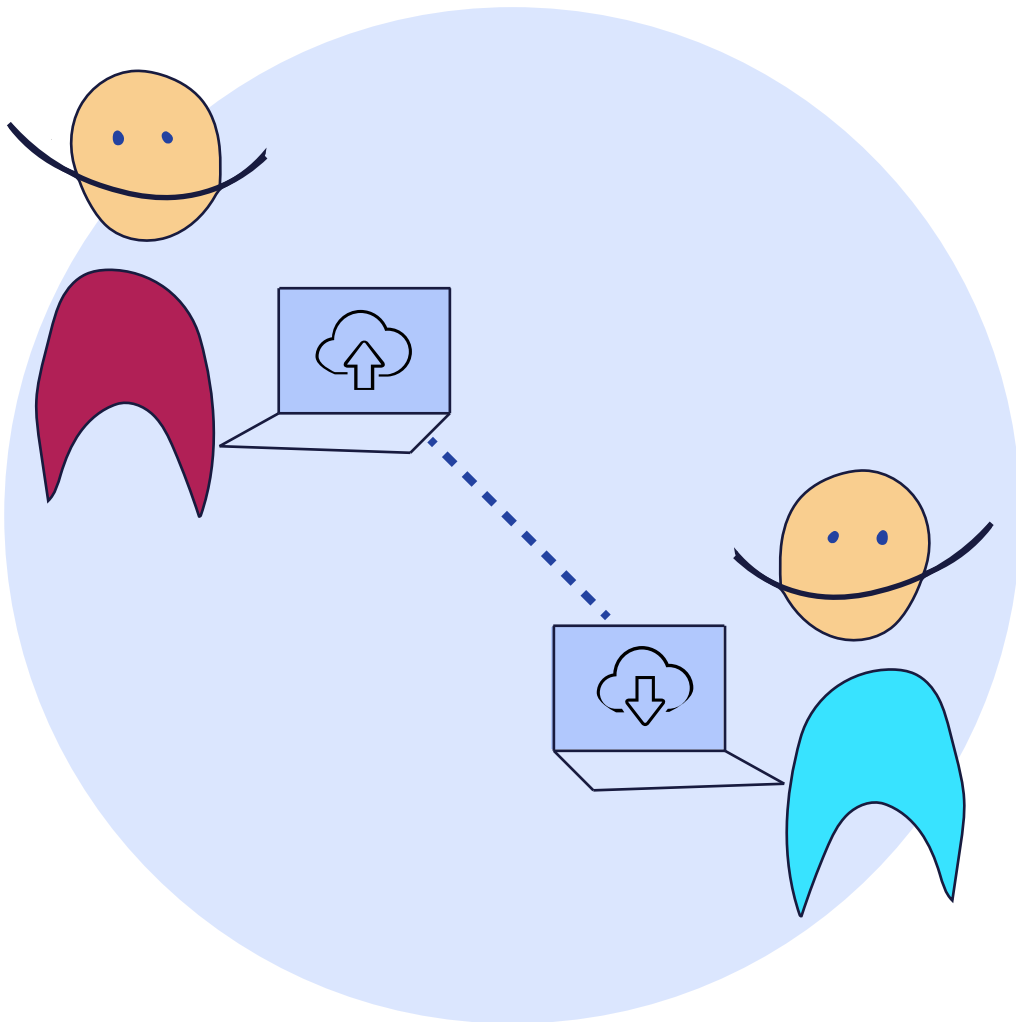

A satellite image of South Georgia Island, showing its rugged terrain and extensive snow cover. The island is surrounded by dark blue ocean water. A prominent cyan-colored overlay is visible, tracing a path along the coast and inland, likely representing a specific process or data set. The cyan color is most intense near the coast and in certain inland areas, fading or becoming more transparent in others.

# 05

Process

*Satellite image ("South Georgia Island", modified Copernicus Sentinel data (2018), processed by ESA, CC BY-SA 3.0 IGO)*



# Our process

The focus through this process is to enhance situational awareness, meaning that the staff in the control room easily gets an overview of the current status, and notice a situation the moment it arises. Human factors are critical in a control room situation (Wickens & Hollands, 2000). Accidents happen when people make the wrong decisions based on poorly designed information (Tufte, 1997). Well designed systems increase safety and reduce training time (Endsley, 2012).

## Teamwork

During the project, we've used different tools for collaboration. From the beginning, we used Trello as a way of setting tasks and deadlines. Proper planning in the first weeks ensured that we were able to meet all deadlines in comfort.

As COVID-19 sent us home, we started meeting on video chat platforms once every morning and afternoon. After a couple of weeks, we agreed that this was an inefficient way of communication. The last two months of the project, we communicated with voice chat by Discord. With this setup, it felt closer to working next to each other, talking or not talking, but always available

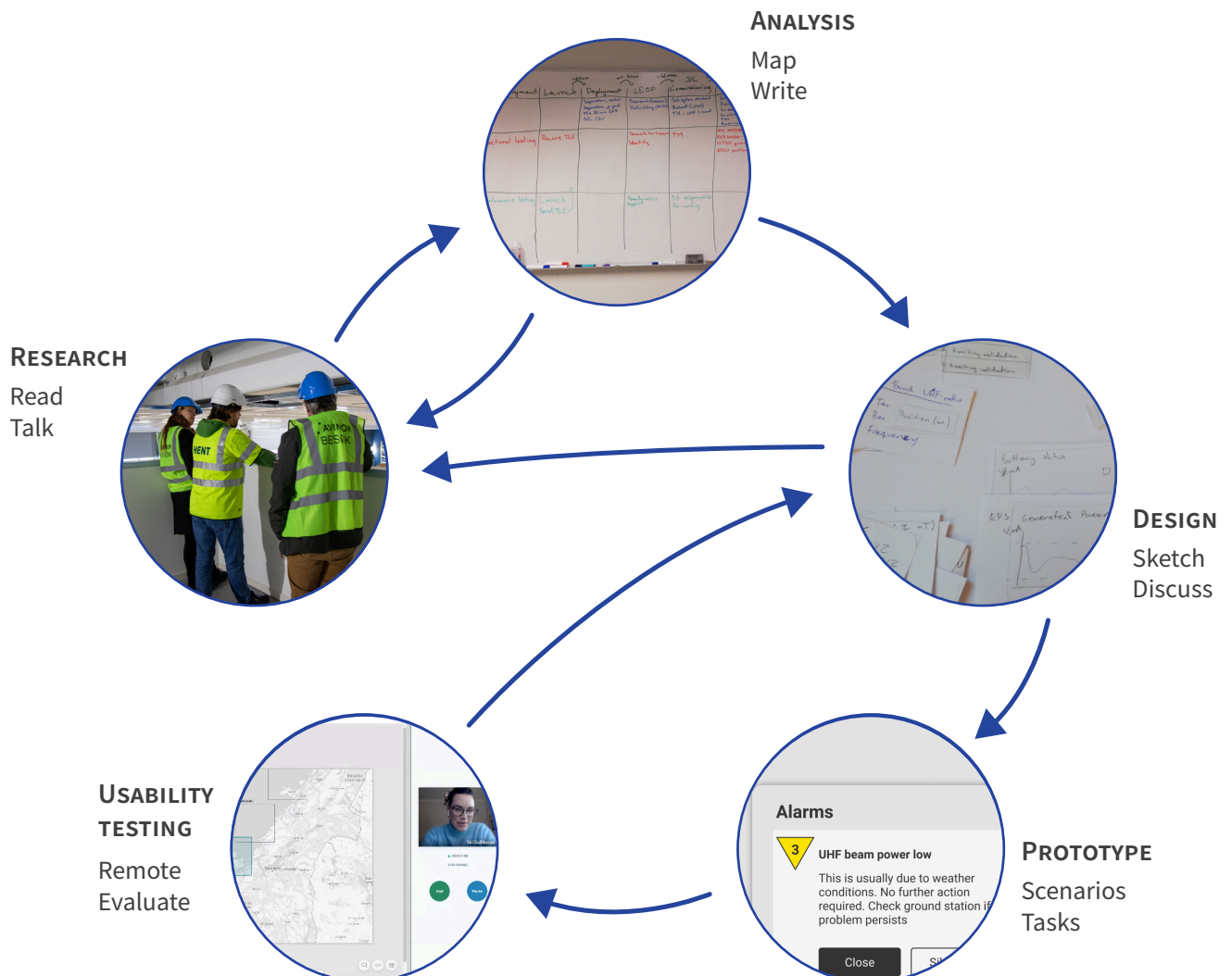

Figure 19: Our process

## JANUARY

Desktop research  
Interviews with  
Sintef, Avinor &  
Kystverket  
HYPSO meetings

## FEBRUARY

Desktop research  
Interviews with  
Statsat & Equinor  
Defining scope  
Paper sketches  
Avinor visit

## MARCH

Desktop research  
Interview with Statsat  
Sketching and testing  
prototype 1  
Scope update  
Sketching prototype 2  
CDR

*COVID- 19 = Home office & remote collaborat*

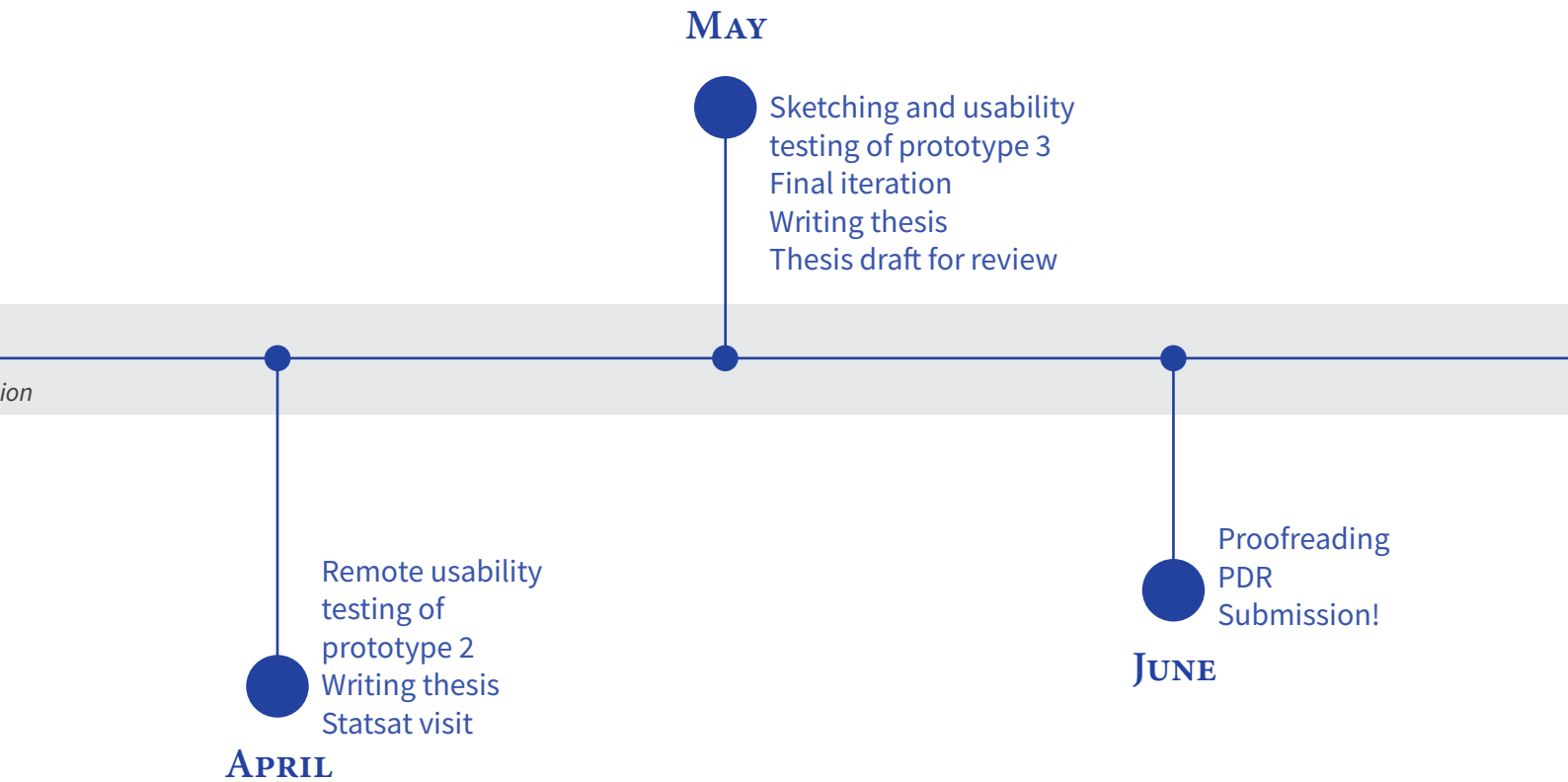

## Research

Our research phase began with reviewing internal documents. As the HYPSON mission is highly affected by a high turnover rate, all previous work should be meticulously documented. In practice, this varies a lot from person to person, resulting in confusion and extra work in some areas. This has also affected our research, as some conclusions are stated without documentation. This has required extra time and detective work on our part.

## Literature Study

In addition to reviewing internal documents, we've searched for relevant publications. There is little to no research published on user interfaces and human performance in relation to space operations. Because of this, we've used a lot of literature regarding control centres and control rooms in other industries, as well as more general publications on human performance and user experience.

# Critical Design Review (CDR)

The 31st of march and the 1st of april was spent doing a CDR together with the entire HYPSON team. Each division was to deliver a set of documents explaining the current status and further plans a week in advance.

These documents were reviewed and commented by other team members and external partners. These comments were discussed in smaller groups of 6-10 over video chat (figure 20). The purpose of this exercise was to ensure that the process was on track, and that all groups would be ready for the deadlines to reach launch in time.

Many of the groups were delayed due to COVID-19. As third parties providing testing facilities and equipment were shut down or otherwise unavailable. At this point, it was uncertain if booked times in laboratories and machining facilities would remain unchanged, as all other time slots would also be postponed.

The second day of CDR, three critical tasks remained to decide go/no go. All delayed due to COVID-19.

Shock and vibration testing of hardware  
 Testing camera settings as FPS and exposure times  
 Changing software on-board including different types on on-board processing

The result of the CDR was to postpone launch by 6 months. However, this was not acceptable to the launch supplier, and the original launch date had to be maintained.

CDR was a good way for us to learn about other parts of the project. Although some of the content discussed was highly complex, it gave us some idea of what people were working on.

Figure 20: CDR

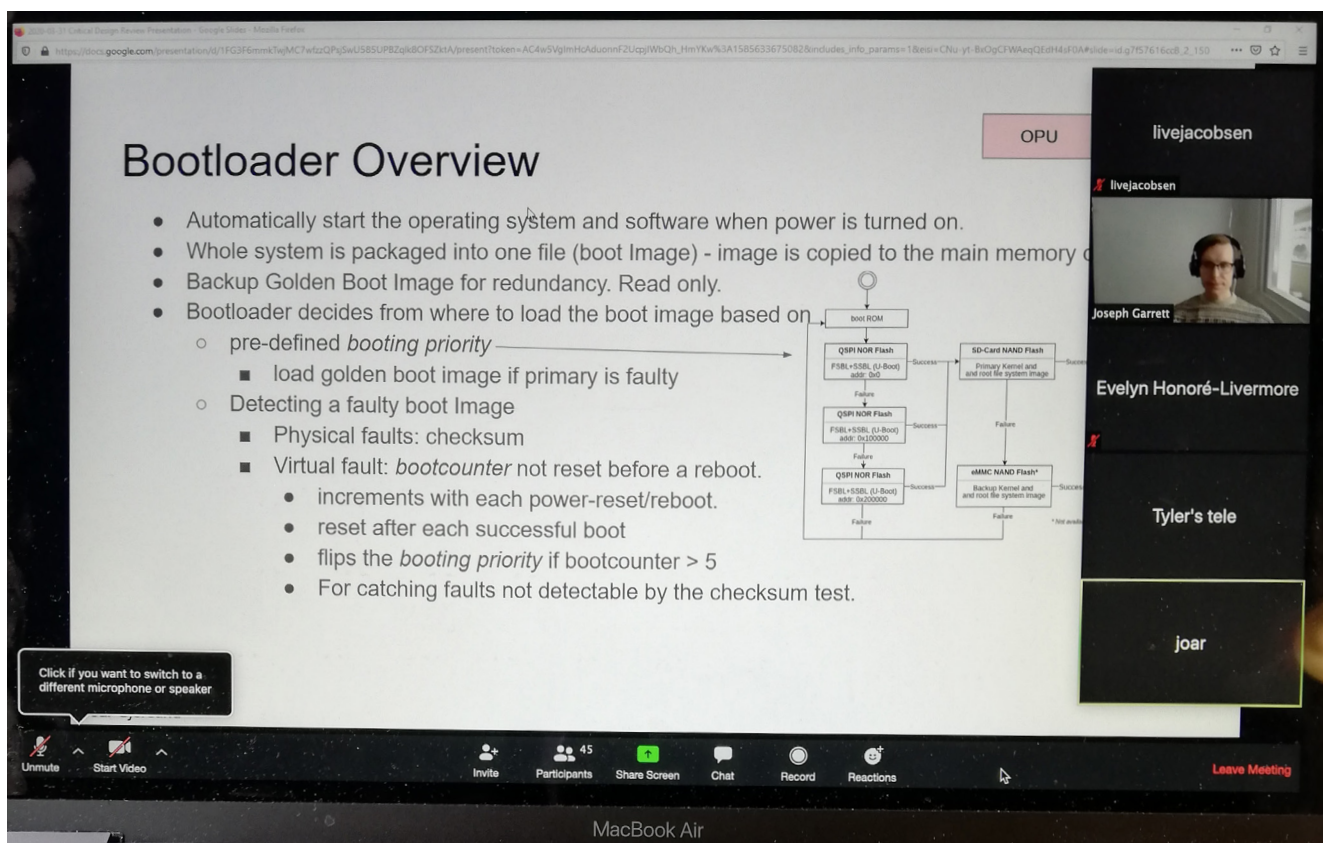

## Interviews

As most of the interviews were performed early in the process, they were usually unstructured (Martin & Hanington, 2012), to allow the other part to talk freely about their experiences and share as much as possible of their knowledge. This form of interviews might give some irrelevant information, but is helpful to form an image of the domain you're about to enter. The questions were fairly open, and the subject was encouraged to elaborate their digressions.



SINTEF is a broad, multidisciplinary research institute with internationally leading expertise in technology, natural and social sciences. They carry out research as an R&D partner for business and management and are among the largest research institutes in Europe. They have 2000 employees with 75 nationalities, and 3700 customers (SINTEF, 2020).

At SINTEF we talked to Stig Ole Johansen, who is knowledgeable about situation awareness, security, accidents and human factors. SINTEF are a part of the Forum for Human Factors in Control which is a professional network for people working with human factors (Forum for Human Factors in Control, 2014). They organize conferences and work on developing standards for human factors.

Our main takeaway from this interview were the contacts that he gave us. Aker BP, Equinor and Avinor. Unfortunately, Aker BP never responded to emails, but both Equinor and Avinor agreed to meet with us. Additionally, we used the Human Factors in Control checklist (Johnsen et al., 2011) for designing control rooms in our Control Room Design Guide that we delivered to HYPSSO. Equinor is an energy company with 21000

As there are only two norwegian actors in the satellite business, Statsat and Telenor, we've also contacted resources with competence in human factors, operations and control rooms. We were briefly in touch with Telenor, but they did not get back to us.



employees. They are involved in developing oil, gas, wind and solar energy in more than 30 countries worldwide. They are one of the world's largest offshore operators (Equinor, 2020). Here we talked to Vidar Hepsø, who is currently working with Equinor's digitalisation challenges in established and emerging business areas like wind operations, with focus on human factors and multi-asset command and control.

At Equinor, Hepsø told us about the process and methodology they use when developing a control room. He did not think that visiting the control rooms would be appropriate for us, as they are too big and complex in relation to the small control room we were designing. He put us in contact with someone at ESA, but there was no further communication.

The key takeaways from this interview was that visualising the state of the system, which mode the system is in, is a difficult design task that we should pay extra attention to.

# Interviews

Statsat was founded to investigate the possibilities of exploiting space infrastructure for public purposes. It consists of about 7 full time employees. Together, they've managed the satellites AISSat-1, -2 and -3 for Kystverket since 2015, as well as NorSat-1 and NorSat-2 for the government. They've also built and are managing a ground station for downlinking in Vardø (Statsat, 2020).

We've talked to Statsat represented by Ivar Spydevold on several occasions. Statsat is the only satellite owner and operator in Norway, except from Telenor. Some of Statsat's satellites have somewhat similar imaging functions as HYPSON-1, making our systems more comparable, and making the employees at Statsat valuable as test subjects.

Talking to Ivar Spydevold at Statsat was extremely useful, as he shared with us the years of experience Statsat has with operating satellites and developing corresponding GUI. We had an initial interview, followed by an interview regarding how they treat telemetry, before visiting their offices in April.



*“There’s never enough time to fix something during a pass”*

## Key Takeaways

There are two main “modes” of working. Most of the work happens when there is no communication with the satellite. Some things are done “live” while communicating with the satellite.

For recurring tasks, scripts are created so that the task is executed in the same way every time. Most tasks have been automated, so the control room usually sits empty. If there is a problem, the control room is used as a co-working space for problem solving.

Daily operations are performed on high-level displays. There’s a minimal number of clicks to find the information you’re searching for. The user interface enhances errors as opposed to processes doing fine, to avoid information overload.

Statsat recommends visualising the satellites orbit and position in the GUI because just seeing coordinates is not intuitive enough. It is easier to see and it increases understanding, and it simplifies handover when switching between operators.

Initially, we were planning to visit Statsat in the end of March, but this became difficult due to COVID-19. Instead, Live was able to visit on the 22th of April, when she was in Oslo on private business.

Avinor is responsible for 44 state-owned airports and the civil aviation security service in Norway. The company has a leading role in the work on the development of electric aircraft, and the supply of biofuels to aircraft. They contribute to about 50 million flights every year. About half of these are to and from Oslo Airport. Around 3,000 employees are responsible for planning, developing and operating a comprehensive airport and aviation security system. Avinor's operations are financed through aviation fees and sales at airports (Avinor, 2020).

Avinor is currently developing a center for remote towers, where they eventually will remote control air towers in 15 different airports in Norway. They are building the center and also developing and testing the solution for the operators desk and screens, which they get from Kongsberg. We got to visit these places on our trip to Bodø, accompanied by Erik Veitch, who is writing his Ph.D. on controls for autonomous vessels.

Our contact at Avinor was Jens Petter Duestad, whom we first interviewed over Skype twice, and then at our visit to Avinor in Bodø. We also interviewed two flight operators during the visit, both with several years as flight operators.



### Key Takeaways

Each desk should have space for two people to sit next to each other.

The operator should have instant overview over what is wrong, not what is right

Prioritizing alarms is very important.

In the case of a supervisor:

Separating the operators tasks into several layers is useful, what is done daily is the top layer, and tasks done less often in a layer below etc. Creating a hierarchy

The operators should not have to call on the supervisor multiple times, the supervisor should have such an overview over what's going on that they will know whether an operator needs assistance.

Operators are given a digital card with instructions on what to do when the individual alarms go off. This is on a separate screen.

Operators have been involved in prioritizing which alarms are important.

The system sends messages to other parts of the system so that you do not have to do this manually.

They have a limit of 5 things that they can do at the same time, to not exceed their workload.

The gray background is boring, but the alarms is very visible

One operator wanted a touch screen and the alarm instruction on the same screen as the alarm itself.

## Avinor Visit

On the 25th of February we traveled by train to Bodø to visit Avinor. We wanted to observe their operators at work, interview them, and see the new remote control centre that they are building. This control centre is to be finished in 2021, and in the meantime Avinor are testing out the work stations (figure 21) at their offices in Bodø airport. At the time of our visit, they had one fully functional workstation where their air traffic controllers had their workplace. We got the chance to interview two air traffic controllers, and see one of them work.

### The building of the new control centre

The control centre is in the process of being built and will have 15 workstations, where the layout is such that the supervisor can see all the work stations.

### The plans for the operators

Avinor is planning to maximize the efficiency of the work stations by having the operators control 3 air control towers at a time.

### The desk setup

The desks Avinor had were designed by Einar Hareide, and have room for one person. As shown in the picture, the operator had another table because the desk was too small. Duestad recommends being able to fit two people at the desk for a comfortable co-working situation.

The software they are using is Ninox from Kongsberg (link til nettside?), and they are doing their own adjustments to it to best suit their own needs. In the process of building the control centre, the workstations and the GUI/SW they have had help from experts on human factors.

Figure 21: Operative work station





## Key Takeaways

The operators sit at their station the entire shift. Portable communication devices are crucial, so that the operators might leave their station for shorter periods of time. There are long periods of time where nothing happens, and there is a need to have either a space to relax nearby or some space by the desk to have personal things.

Their display setup is to ensure the operator has an overview of the situation. The system provides information, not instructions.

Figure 22:  
Guided tour of the new control centre during building



Figure 23:  
First floor of the Avinor control centre taking shape

# Statsat Visit

On the 22nd of april, Live got to visit Statsats offices in Oslo. Statsat had recently built a new control room, and the goal of the visit was to see how the new control room was functioning, and what considerations had been done by Statsat to ensure a good working space. As with the previous version, the control room sits empty most of the time.

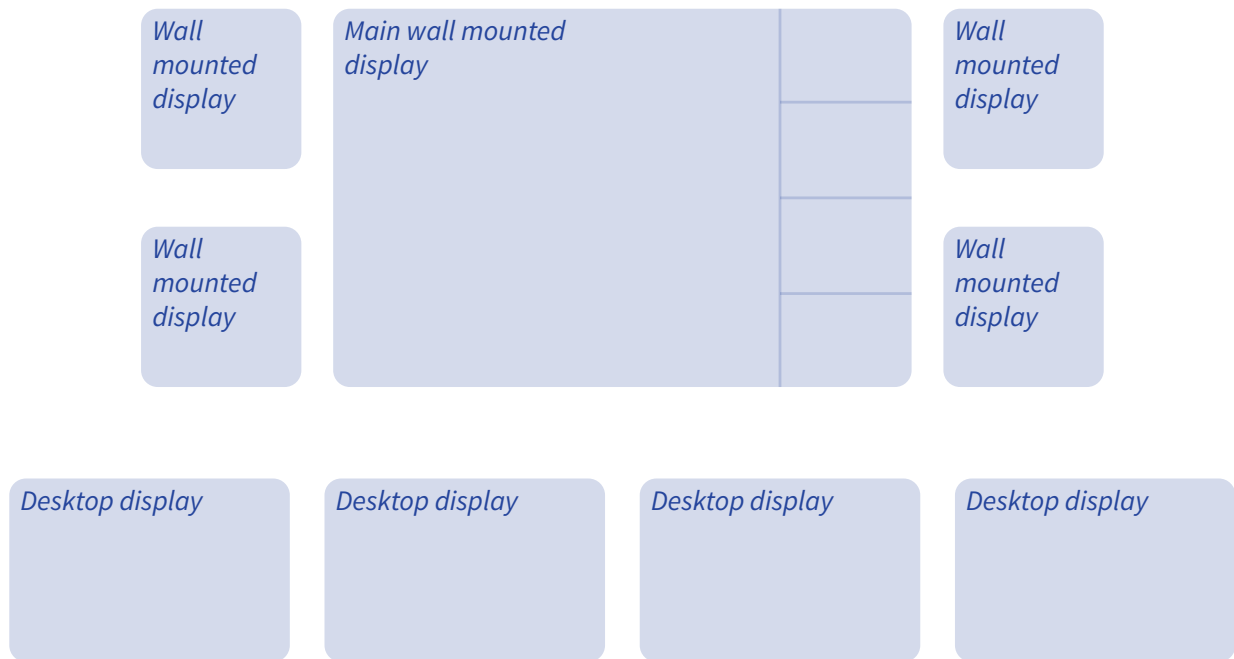

Figure 24: Physical setup at Statsat

The operator stations are situated close to the wall-mounted screens. There is room for 4-5 people at the station at a time.

The new display layout (figure 24) had been changed somewhat, but was heavily inspired by the previous layout. In addition to the screens in figure X, there are two large, wall-mounted screens on the wall of the operator's right hand side. These are not connected to anything at the time, as Statsat have yet to figure out what to use them for.

### Wall-mounted displays

The main display shows a world map with the trajectory and location of each satellite. The four smaller panels on the right hand side show the footprint of each satellite.

The four smaller wall-mounted screens show details for each of the four satellites. Each display contains time until the next ground station pass, how long the pass will be, expected results from the pass and ongoing tasks. On-board lead time is also displayed. The lead time shows how much time is left until the satellite runs out of commands. During a ground station pass, signal strength and data transfer speed is displayed.

The content of the small wall-mounted screens are made for desktop, and are somewhat difficult to read from the operators seat.

### Desktop displays

There are four desktop displays, connected to the same computer, and controlled with two keyboards and two mouses. Several programs are used for satellite operations, scattered across the screens. There is no default setup of these windows, and some searching is required.

## Key Takeaways

Statsat has developed a fully automated system that makes the physical presence of the operator unnecessary. There is always someone on call, but operations can be done from anywhere in the world as long as you have a phone or laptop, and an internet connection. The operator on call gets a text when the system sounds an alarm.

Statsat encourages the HYPSON project to teach the system to recognize errors so that it can handle the basics that happen regularly by itself. There is never enough time for an operator to fix an error during the time of a ground station pass. By automating recurring operations, the operator might have time to start fixing an error during the pass.

Statsat also uses a tool for visualizing the satellites orbit and maneuvering in 3D, with the possibility to see simulations of previous and future maneuvers. This has been very useful for calibration when launching new satellites, to make sense of the movement data received. Statsat encourages the HYPSON project to have something similar for three reasons:

1. It moves and looks impressive
2. It can be difficult to make sense of coordinates. Visual presentation makes it easier to understand
3. Makes handover easier between shifts

To simplify handover, Statsat has implemented error logging with Slack, posting error messages to a designated channel. A separate channel is used for publishing images used for calibration, to show how the satellite is doing..

### Feedback on our GUI (version 2)

When there are default options, the checkboxes in the GUI should be pre-checked, so the user has to actively un-check it to change the settings. This saves time, and also lowers the chance of human error.

Charts should contain projections of values based on the current task queue. There should be a detailed log somewhere. How are alarms logged? How do you let the next shift know? We (Statsat) automatically add cards to Jira, that notifies the Slack channel.

*“A new satellite from the same producer will not take the same commands in the same way as the last one. Make sure your system is flexible enough for this.”*

# User Scenarios

The scenarios for the HYPSON mission are constructed by a master student in system development, Sergio G. Ferragut, and revolves around the backend that will support our GUI. The scenarios, or use cases, are heavily linked to what the software should be able to do. In other words; which commands are necessary to perform each task.

Looking at the HYPSON mission long term, the expectation is that nominal operations is the main scenario. We have translated the scenarios into interface tasks for each phase. The following scenarios and interface tasks are what we consider to be the most important, and thus the ones we have considered and/or designed for in our process.

See appendix A3 for full scenario details, focused at SW development.

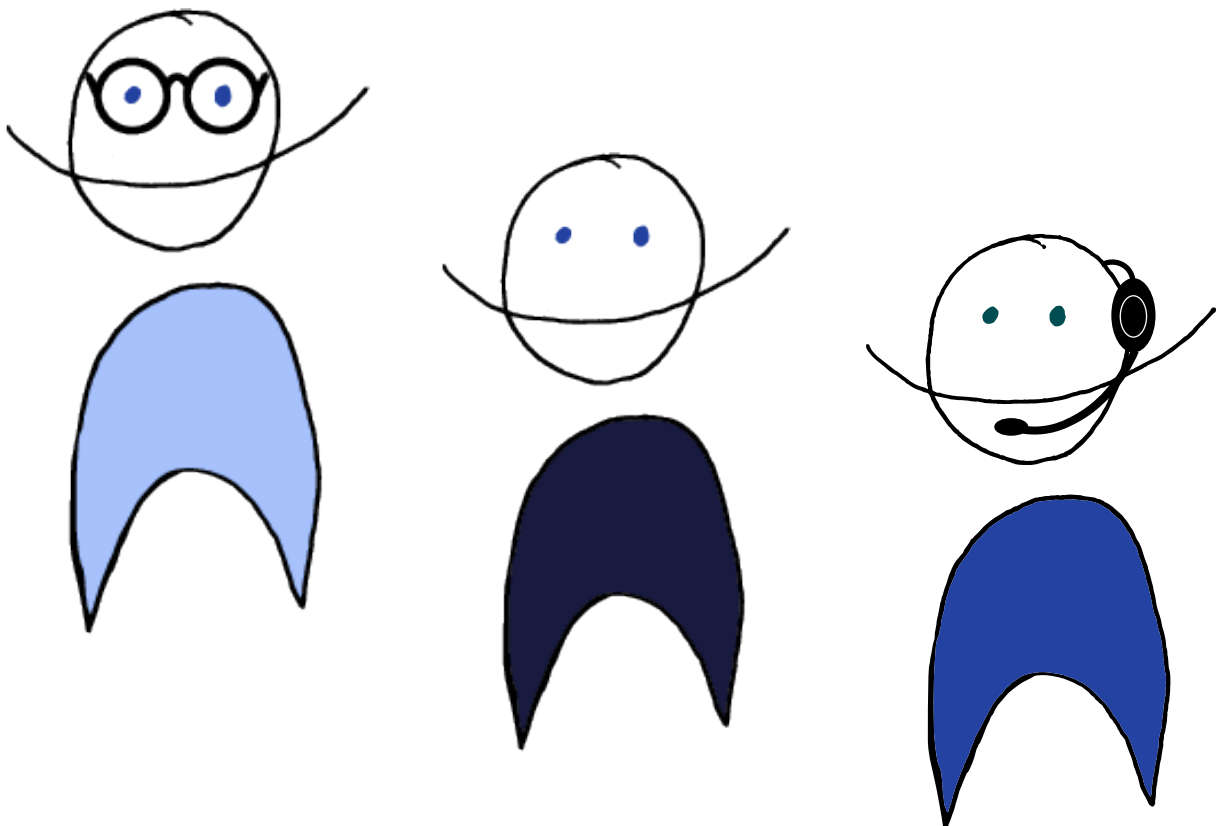

# Interface tasks in each phase

An attempt to explain the needs of the system



## Launch

- Receive position estimate (TLE) from NA
- Enter TLE into system
- Send time of watchdog to ground station
- Show operator the estimated trajectory in comparison to earth

Figure 25:  
Falcon 9 (Official SpaceX Photos, 2015)

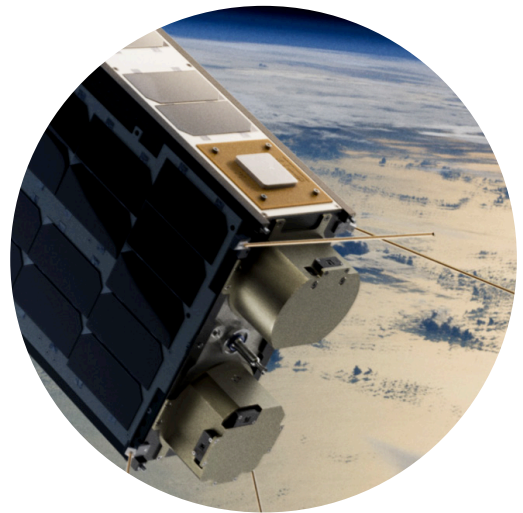

## LEOP

- Show operator the estimated trajectory, as well as areas being searched
- Show operator exact location and correct trajectory
- Detumbling: show the operator a simulated estimate of when this will finish
- Send received Telemetry to experts for review - commissioning?
- Receive feedback from experts

Figure 26:  
Spacecraft (NanoAvionics, n.d)

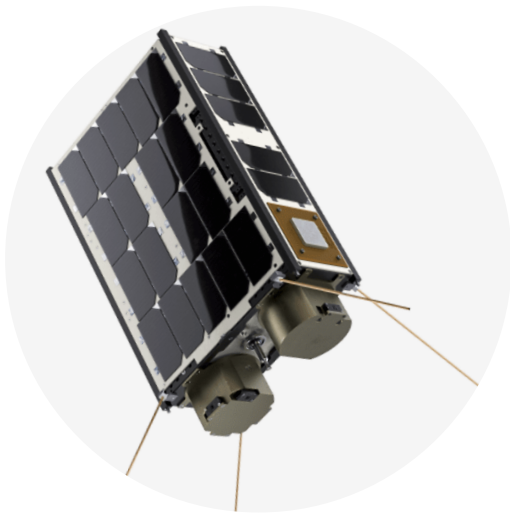

### SC commissioning

Display SC TM received by NanoAvionics  
 Overview of subsystem checkout, what had been validated and not.

Progress - see status whether it is rebooting, reconfiguring or moving forward.

Figure 27:  
 Spacecraft (NanoAvionics, n.d)

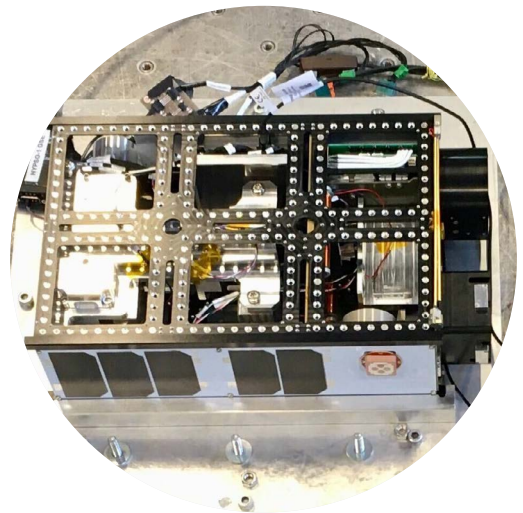

### PL commissioning - many of the same functions as during cruise

Overview of subsystem checkout, what had been validated and not.

Progress - see status whether it is rebooting, reconfiguring or moving forward.

Actually perform the subsystem checkout, experts needed for this.

See the ADCS positioning/perform this

See progress of in-orbit calibration/perform this

Take test-pictures, see files, sizes and timeline of this

Figure 28:  
 Payload during testing on ground

Figure 29:  
HYPSO-1 during imaging

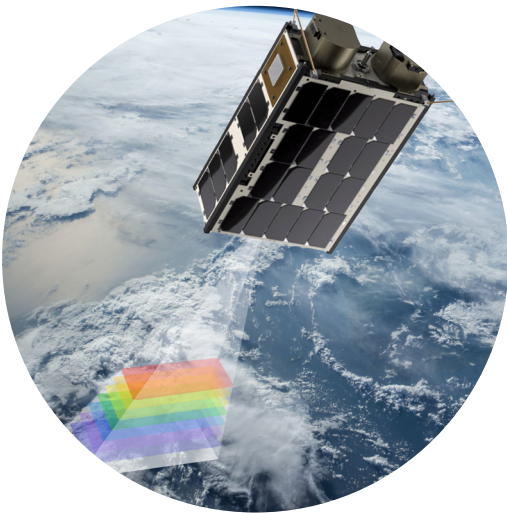

**Cruise/mission utilization and training** - *this is what we have designed for*

1. See PL health TM
2. See alarms and possible actions
3. See timeline of missions
4. See planned maintenance/reconfiguration
5. Add a new mission with different parameters, choosing a target on a map
6. See the log of passes and alarms, and which operator has responded
7. See commands - both previous current and planned
8. Observe storage, signal strength, time left and progress of up- and downlink during pass
9. See the ADCS positioning
10. See the mode of the spacecraft
11. Display subsystem status
12. See SC health TM
13. Show operator location and trajectory of satellite
14. Display passes, how long until next pass, and how long until pass ends during pass.

The requirements are marked in the prototype descriptions with e.g R10.

# Prototyping & Usability Testing

## 1st Iteration

Our first prototype was a simple wireframe hand drawn on paper. The prototype contained all the screens for the phases of deployment, LEOP, S/C commissioning and PL commissioning.

As the domain is so extensive, co-creation (IDEO, 2015) with experts was used as an evaluation tool over user testing in this iteration, to ensure our understanding of the domain was correct. The sketches were first discussed and redrawn with the Head of Operations, and then discussed with the entire operations team.

## Scenario

The discussion followed the timeline of the satellite. Needed information for deployment, LEOP, S/C commissioning, PL commissioning and the transition between the phases was discussed.

Figure 30: Co-creation with experts







The wall mounted screen #1 shows the simulated trajectory of the satellite's orbit before any contact is made. The circles near Norway on the map are where the ground station radio signals are searching for the satellite.

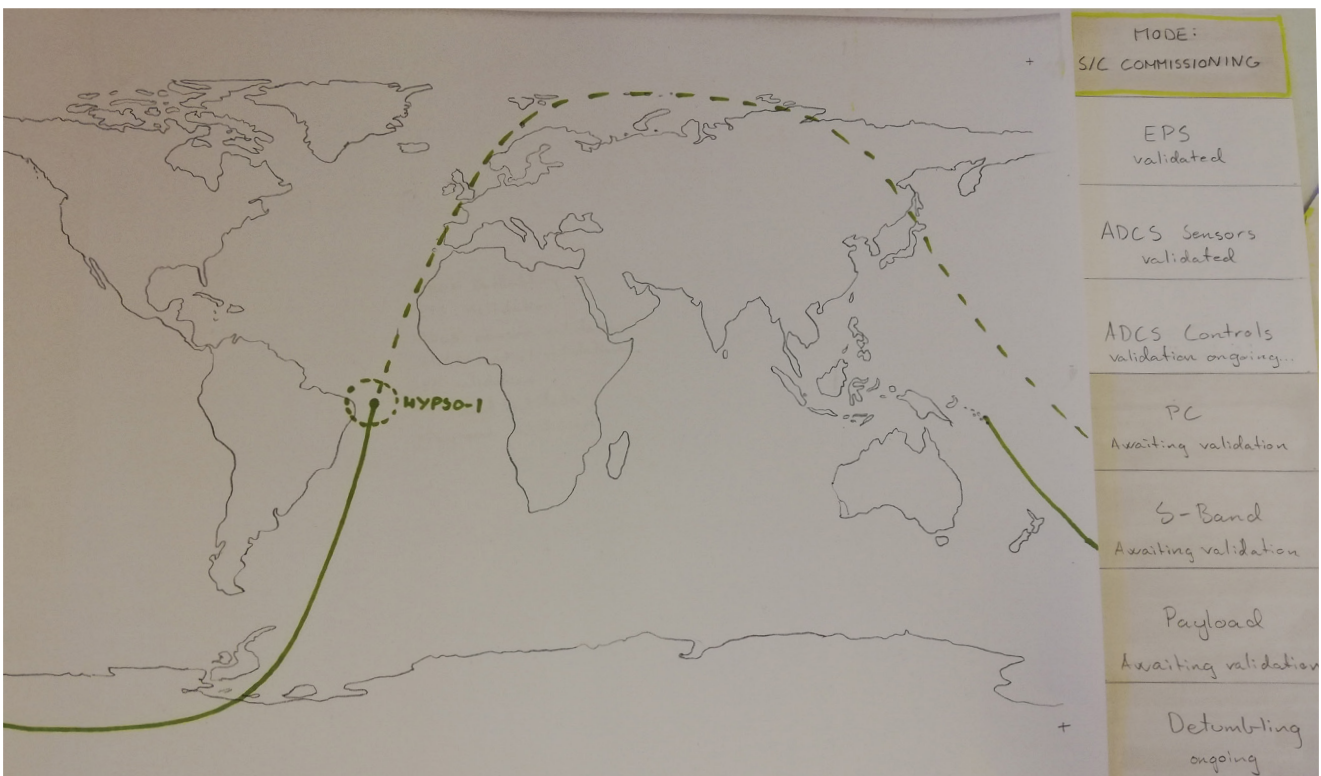

The wall mounted screen #2 contains the correct trajectory of the satellite after initial radio contact is made and the very first TM is downloaded. Here, the progress in the SC commissioning done by NA is displayed for the HYPSO team at NTNU to follow.

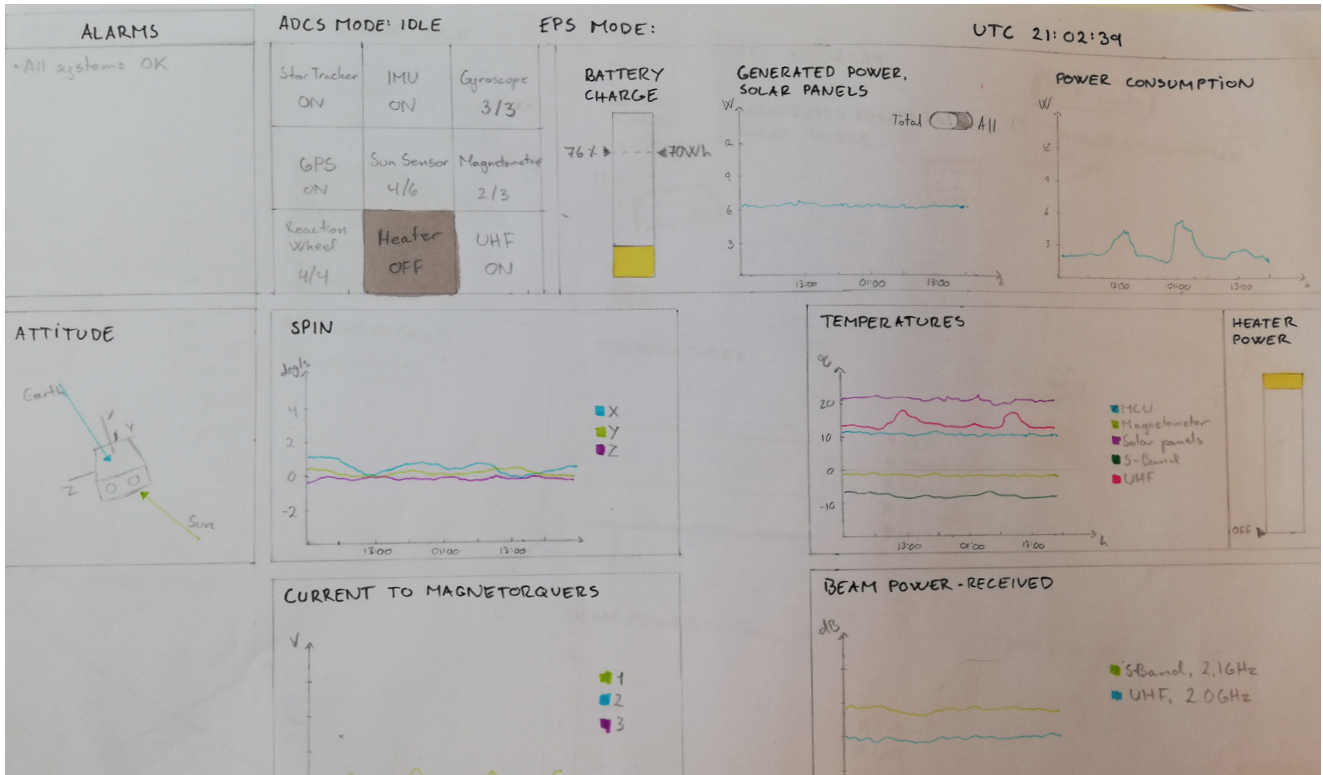

Screen #3 shows the SC health, subsystems on/off and the available ADCS data.

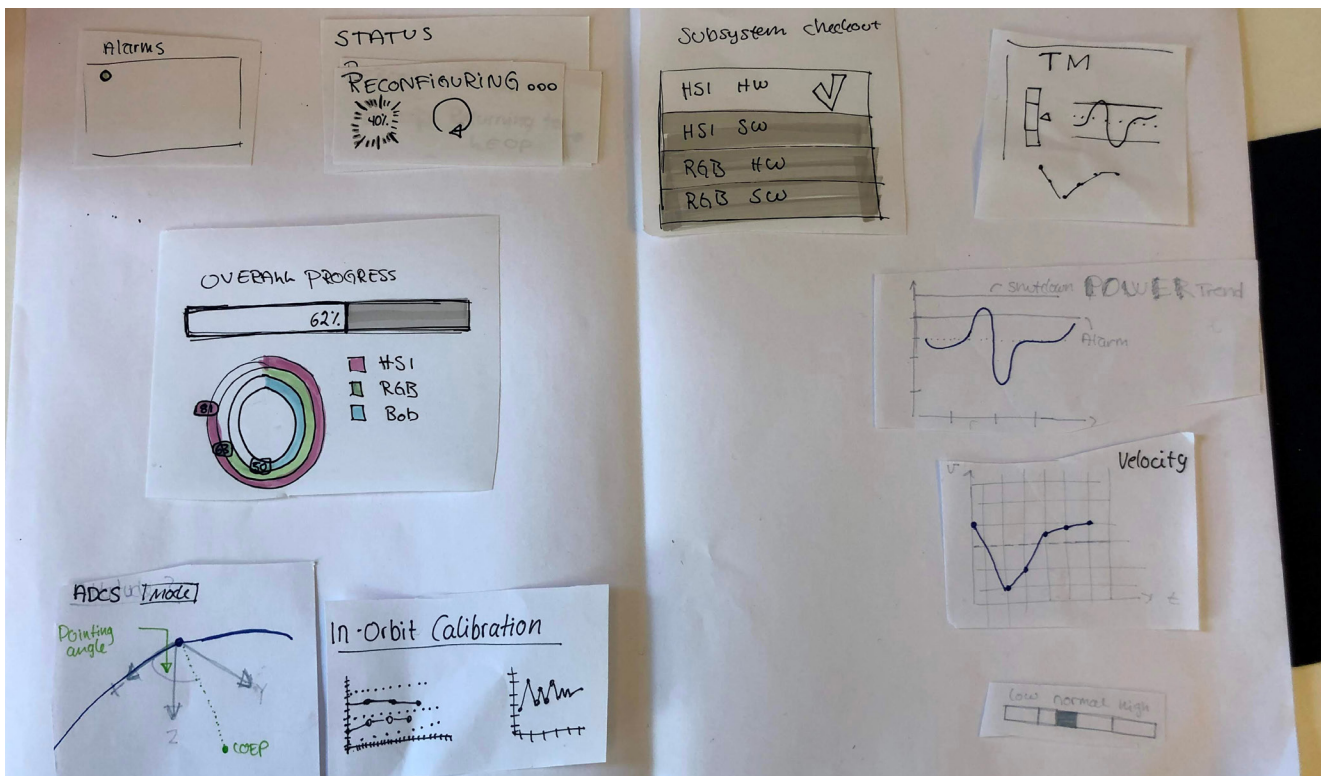

Screen #4 shows the PL health, the status of the system, and the progress of the PL commissioning.

## Key Takeaways

### Wall mounted screen

In addition to the NTNU ground station and the NanoAvionics ground stations in Denmark and Lithuania, we have access to ground stations in Spain and Svalbard. These are paid services and might not be used.

Would like to see the position in orbital elements functions on the screen.

### Operator screens

Would like to be able to see the performance of each solar panel separately. Seeing the magnetic field is not necessary, but magnetorquers are important, as well as the spin of the spacecraft.

Would like to see on/off status on the star tracker, IMU, gyroscope, UHF, sun sensor, magnetometer, reaction wheels, heater and GPS.

Should be able to see the different modes of the payload as well as the ADCS. Subsystems to be seen from the PL are OPU, HSI and RGB.

See what missions are currently ongoing. Have a timeline for missions, planned, history and current status. See where in a script operations are ongoing.

Overview of available memory, file sizes and buffering time.

During these sessions it became apparent that a lot of the data exchange and handovers had not yet been discussed with NanoAvionics. There was agreement in the operations team that further action was required in this area as soon as possible.

## 2nd Iteration

### The scope changes

Based on the workshops, conversations and interviews, we decided to design for the cruise phase. The functions required during cruise include most of the functions required during commissioning, and there were so many unknowns and things that were not yet in place regarding these early phases.

Additionally, the commissioning is more likely to rely on CLI, as there is a high demand for custom operations that will only happen once. We believe that designing for the cruise phase will provide more value for the HYPSON project.

We designed using the takeaways from the first iteration of testing. However, since we decided to design for the cruise phase, some takeaways were no longer relevant. We chose to focus on how alarms would appear and be addressed by the operator, as this is an important part of the system.

Adding new missions to the mission queue by the operator and mission planner was also an important feature. These functions are critical in the cruise phase, and will also be relevant in the commissioning phases.

### Payload Health and Mission Overview

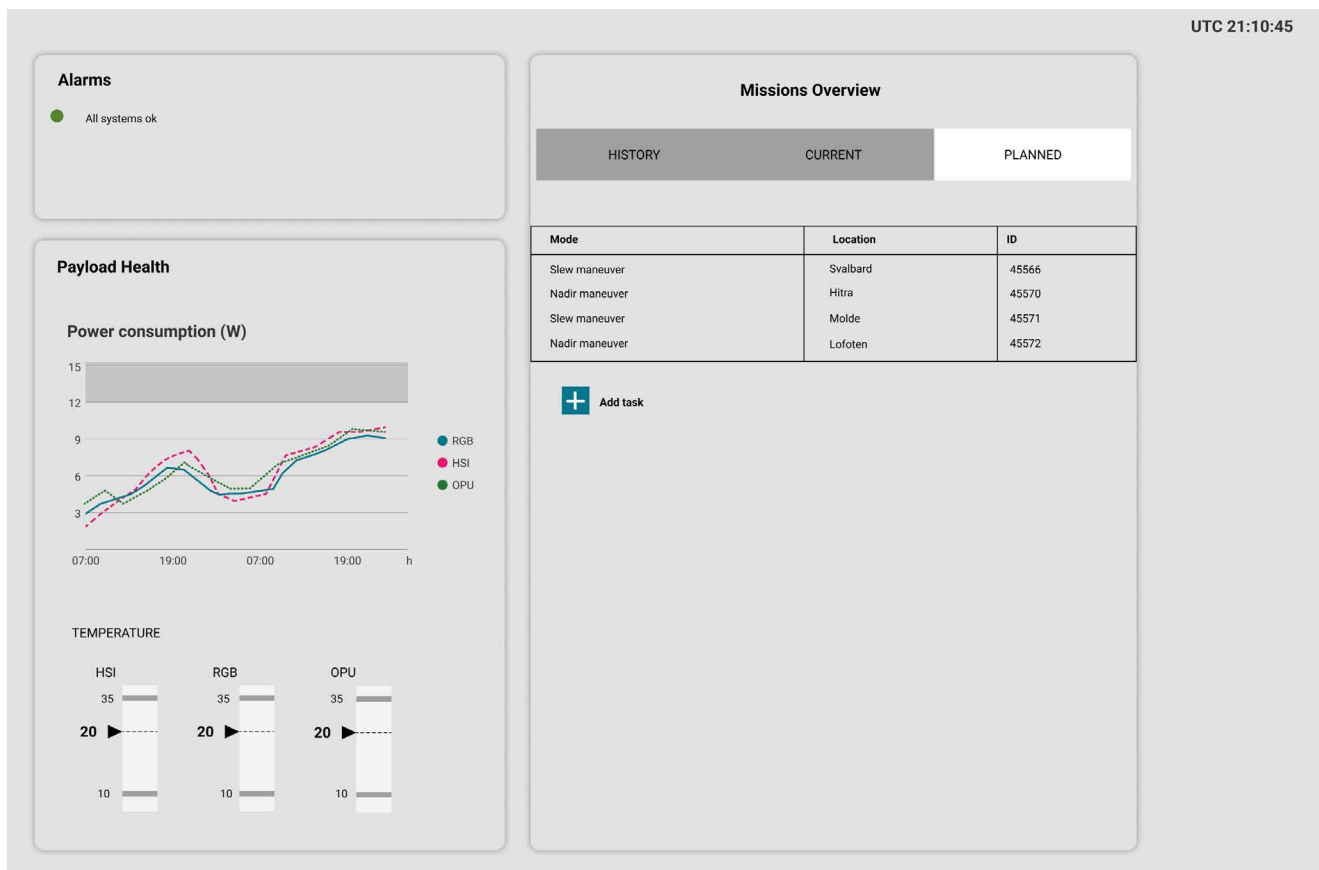

Top left is the alarm module.(R2) All alarms will be displayed in this module, in prioritized order should there be several alarms at once. On the bottom left is the PL health module, which shows the temperature and power consumption of the two cameras and the OPU.(R1)

The mission overview module to the right contains the log of previous missions, the current commands being executed, and the mission queue.(R3 and 7) This is also where the user can add a new mission to the queue by clicking the “add task” button.

### New task

**TASK OUTLINE**

**Template** ⓘ

**Priority task** ⓘ  
 Yes  
 No

**Can be split in multiple passes?** ⓘ  
 Yes  
 No

**Start time** ⓘ  
 First available pass  
 Enter custom value

**INITIALIZATION**

Can be used to enter cli commands and definitions

1

**ADCS**

**Set ADCS state** ⓘ

**Choose maneuver** ⓘ  
 Nadir  
 Slew

**Select imaging area** ⓘ  
 Select area on map: ⓘ  
 or enter corner coordinates manually:

1:	<input type="text" value="63.389485"/>	N	<input type="text" value="7.874009"/>	E
2:	<input type="text" value="64.063605"/>	N	<input type="text" value="9.508225"/>	E

**HSI**

**Number of frames** ⓘ

**Camera parameters** ⓘ  
 Default  
 Enter custom values

**File naming** ⓘ  
 Default  
 Enter custom values

**RGB**

**Initialization** ⓘ  
 Default  
 Upload custom config file

**Camera parameters** ⓘ  
 Default  
 Enter custom values

**Hardware trigger** ⓘ  
 On  
 Off

**Demosaic options** ⓘ  
 rgb  
 raw

**Image format**

**File naming** ⓘ  
 Default  
 Enter custom values

### Mission planning form (R5)

Upon clicking the add task button, the user is taken to the mission planning form. A number of choices are presented to the user. The question mark icons to the right of each headline reveal an infobox with assistance upon hovering. When it is time to choose the target area for the pictures to be taken, the user can either choose to input coordinates manually, or click “select area on map”.

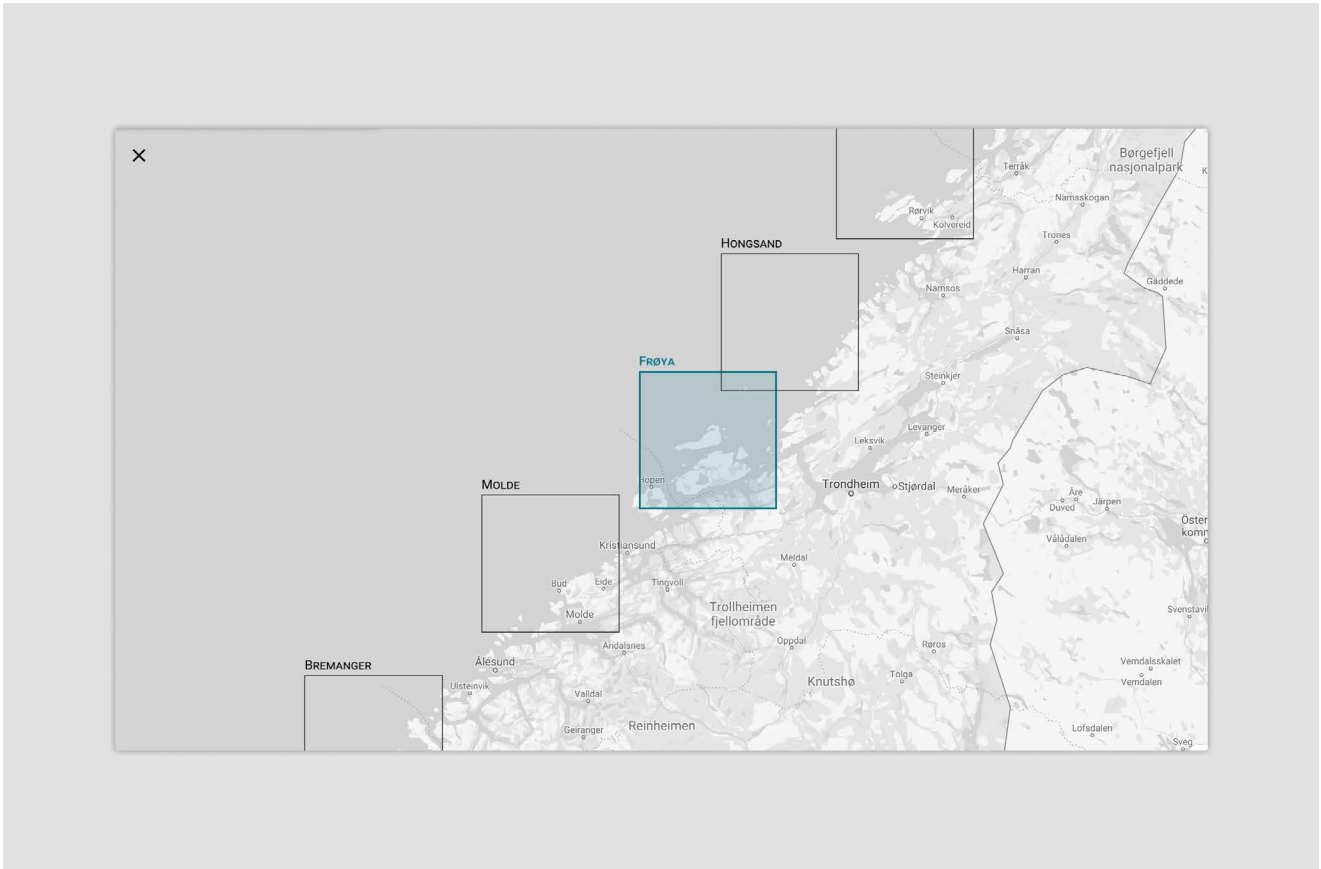

The map gives the user predetermined targets to choose from. When a target is chosen, it changes color. The user can then click the x mark in the top left corner to go back to the mission planning form.

When the user has finished the form, they can choose to save a draft and come back later, or validate the mission. Validating the mission means that the system checks the storage, power, time and weather to see if the mission can be executed.

HSI

**Number of frames** ?

! Value can not be larger than 2300

**Camera parameters** ?

Default

Enter custom values

Default

Enter custom values

! Task too large to be performed in one pass

If something is wrong, the user gets an error message to inform them what is wrong, and why. The related area in the form is also highlighted.

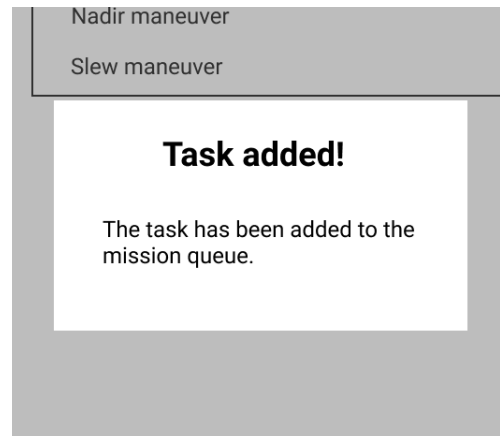
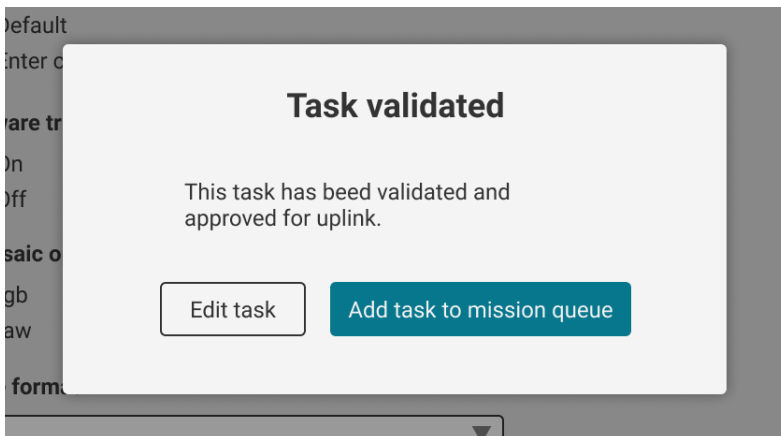

When the task has been validated, the user gets a prompt where they can choose to change the task, or add it to the mission queue.

Mode	Location	ID
Slew maneuver	Svalbard	45566
Nadir maneuver	Hitra	45570
Slew maneuver	Molde	45571
Nadir maneuver	Lofoten	45572
Slew maneuver	Frøya	45573

When adding a task to the mission queue, the user is shown another infobox to keep them informed on the process. The task is highlighted in the queue for a few seconds to ensure the user is aware of its position in the queue.



## Spacecraft Health, attitude and subsystems on/off

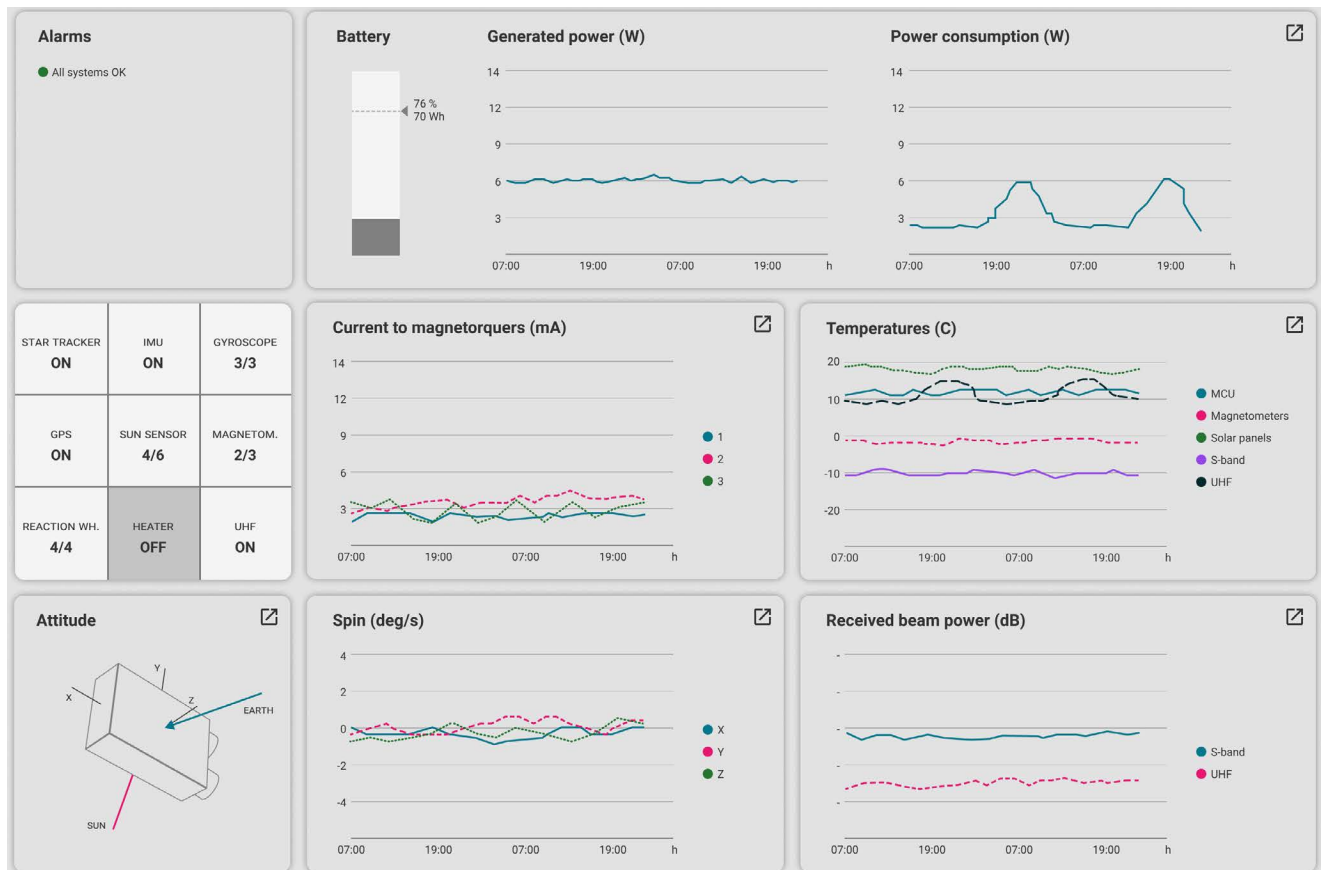

This screen shows the health of the spacecraft. (R12) For the sake of the format of the usability testing, there is an alarm module in this sketch as well.

The power module shows the battery status, as well as the generated and consumed power of the subsystems in the SC. Furthermore, the subsystems which can have on/off states are shown in a grid to the left (R11). Right below the subsystem grid is the attitude, which shows the satellite's

position in relation to the sun and the earth. (R9) The other graphs on this screen shows the spacecraft's health and state, through temperature, spin, current to magnetorquers and received beam power from the satellite to the ground station.

# Alarms

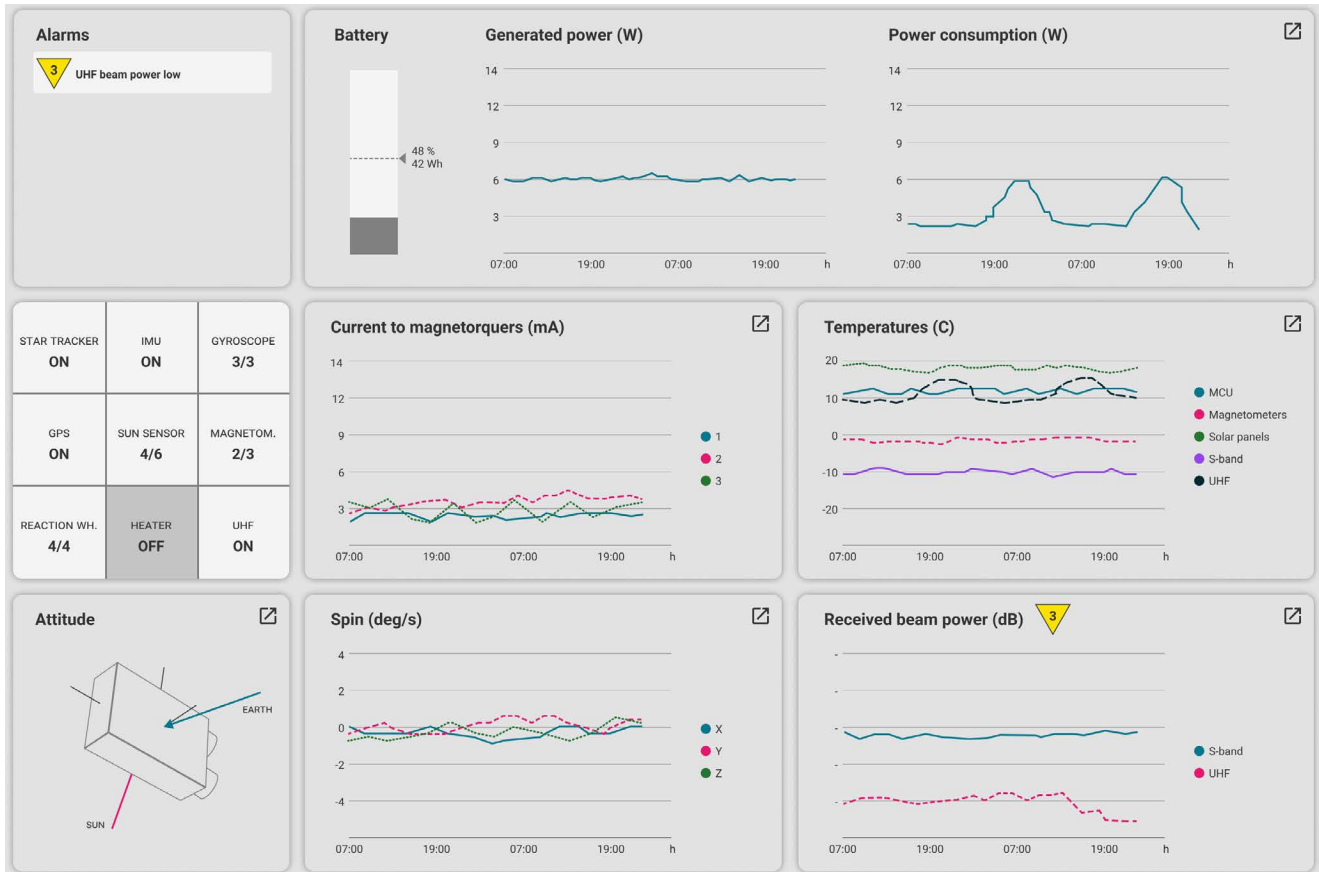

When an alarm goes off, an icon appears in both the alarm module and the related health module. The user can click both icons and get an infobox explaining what the alarm is for and what the recommended response is, as well as related action buttons.

For the priority three alarm, the user can either silence the alarm to acknowledge that they have seen it, or close the box and the alarm stays active. Silencing the alarm will make the alarm change appearance to make it clear that it has been acknowledged, but will not remove it completely, so that it is still accessible to the user.

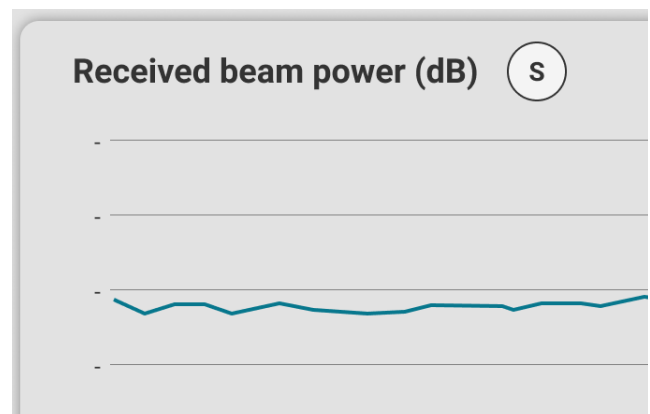
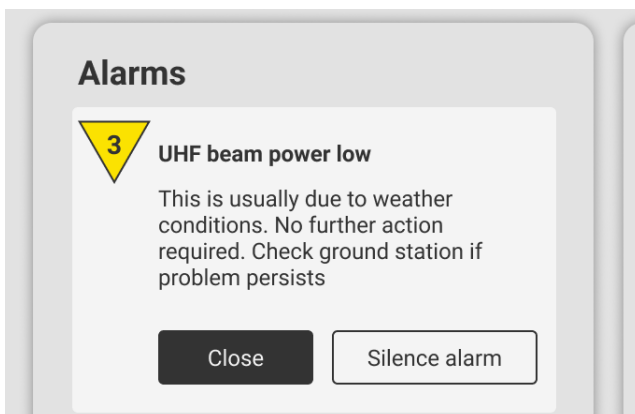

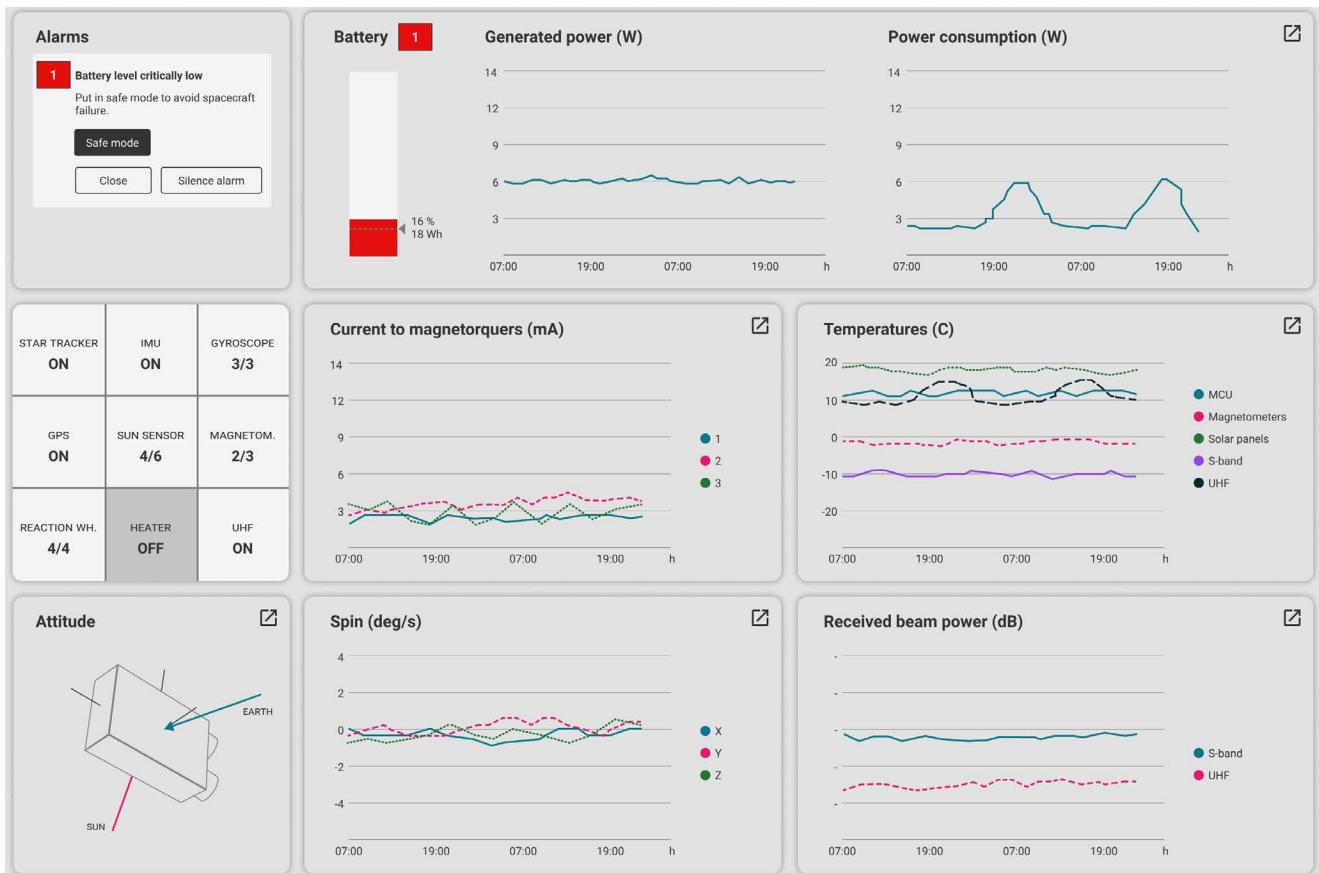

If a priority 1 alarm goes off, a critical situation has occurred and the SC might need to change its mode to avoid damage. In this sketch, the battery level is too low and the system recommends putting the SC in safe mode. The user may still silence or close the alarm.

When the user clicks the “Activate safe mode” button, they are asked to confirm the choice to make sure the action is intentional.

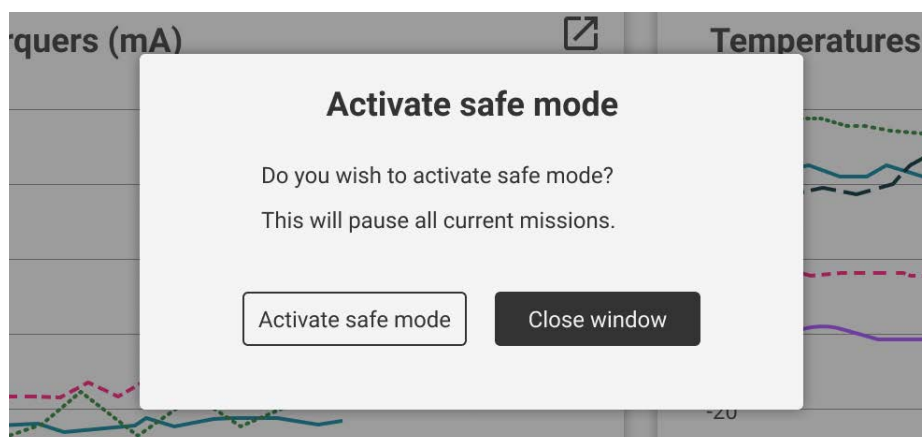

# Testing the second iteration

Six members from different parts of the HYPSON team were used as test subjects, all with different fields of expertise. Their fields ranged from software development, verification and testing, hardware design and testing, to project management. Testing people with different academic backgrounds and from different parts of the project allowed for a wider range of feedback, which was very useful. As mentioned, the testing was done remotely through lookback.io (figure 31).

## Scenario

As only one screen could be displayed at a time, the usability test was divided into two parts.

In the first part, the test subject is shown the PL health and mission overview screen, and told to explain what they see. After orienting, they get a request to take some images for fish farmers at Frøya. The test subject finds and fills out a task template to complete the task.

During the second part, the test subject is shown the SC health screen, and told to explain what they see. After a predetermined number of seconds, a low level alarm goes off. The test subjects are asked what they would do in such a situation. After handling the low level alarm, a high level alarm goes off. After handling the high level alarm, a debrief concludes the session.

Full test script and corresponding prototype is available in appendix A5 and A6.

Figure 31: Remote usability testing

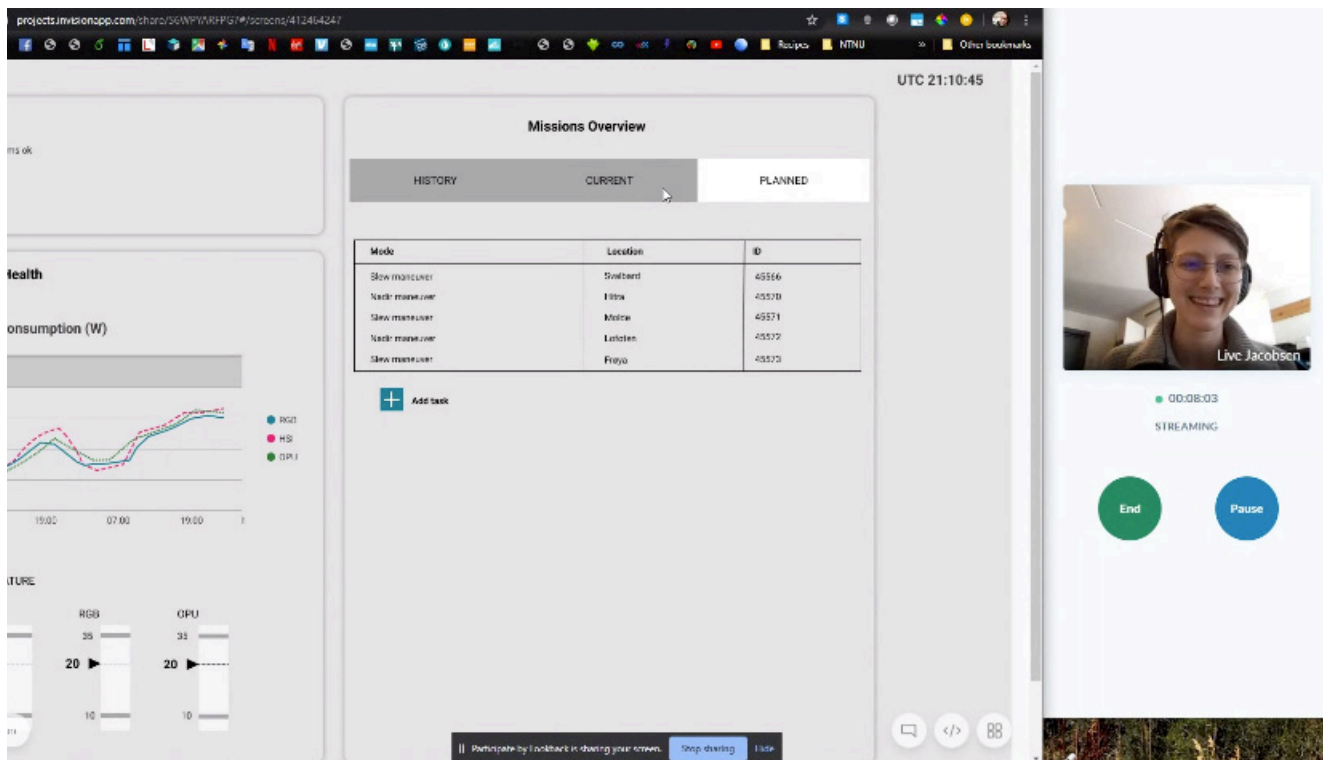

# Key Takeaways

## Payload health

The health data of the payload was mostly understandable. One user understood that the temperature gauges had limits, but was unsure what the limits signified, indicating that this could be specified further. Another user requested the possibility to see total power consumption for the payload, as well as for each subsystem.

## Mission overview

The tabs of the mission overview were a little difficult to distinguish, and should be clarified. Several users wanted more information in the list of tasks, or had trouble making sense of the displayed data. Suggestions were made to be able to add custom names to a task, to be able to distinguish highly similar tasks from each other.

The “add task” button did not stand out as much as desired, and must be highlighted further in the next iteration.

## Mission form

Some users commented that the CLI window was placed too early, or were unsure of what to use it for. This might be because they have no experience with CLI commands, or that they in the scenario we presented had no use for it. It might not be necessary to display this window in all templates.

Several users looked for some way to complete their task when choosing the target area in the map. One expected it to close by itself, and others wanted to click an OK button to be sure the target area had been registered.

One user pointed out the options in the form where “default” is the recommended choice can be opt-out, meaning the check boxes are already checked and the user has to actively opt-out to change it. This also makes filling out the form more efficient for standard cases.

Also, “number of frames” might not be the right parameter to enter, as the users seemed more concerned with how much ground could be covered, and what resolution the images could achieve.

The question marks were seldom used by the test subject to find information. Several of the test subjects were aware of them, but did not use them. A possible explanation for this is that it was easier to ask the facilitator if they had any questions. Some of the test subjects are experts in HYPSON related fields, and might also feel that they are “too qualified” to rely on the support functions while being watched.

## Spacecraft screen

Some users were confused as to what the “critical area” in the battery status bar was symbolising. One thought the area might be the total power left in the battery.

Several users missed to see what mode the spacecraft was currently in, as well as the state of the EPS and FC, to get a better understanding of the current situation. All modes should be displayed clearly on all the affected TM, to understand what makes the values vary.

The TM should also contain some sort of information on when TM was last received, and the next expected TM downlink. Downlink progression, size of data being sent and progress of transmission were some of the features mentioned would be worth having. The meaning of “beam power” seems unclear. Is it received or sent, on earth or in the satellite? Values should be in dBm/dBW. Is only received when the satellite passes the ground station.

The attitude display seemed interesting to most. “I think that makes sense” was exclaimed by several users. As this is quite advanced, visualizing simply is a challenge. One user suggested adding the mathematical values in euler angles, as this is more familiar to some. Another suggested adding the curvature of the earth to further enhance the position of the spacecraft.

The silenced alarm to be clickable, to remind the user what the alarm is.

## 3rd Iteration - prototype changes

As the sketches became more detailed, we needed to talk to other HYPISO team members more frequently, to fully understand the use and importance of each element. This type of small conversations with experts has its advantages and disadvantages. The advantages include quick answers and good explanations for deeper understanding. The disadvantage is that an expert might think that a certain visualization is simple to understand, as they have deep knowledge on the subject, whereas anybody else might find it hard to understand. This is why usability testing on people within different fields is so important, to ensure that all the components are easy enough to understand for someone without expert knowledge.

For the third and last iteration of the GUI, we had hopes of doing physical usability tests with all three screens at a time. However, the COVID-19 situation made this difficult. While working on this iteration, we located facilities off campus that could be used for usability testing. But after much debate, we agreed that summoning people for usability testing would be irresponsible. Thus, the usability testing was performed with lookback.

### Wall mounted screen before pass



This time, we wanted to test the wall mounted display with the desktop displays. This display is visible for everyone in the control room, and gives the user an overview of the situation of the satellite. This sketch shows when the satellite is out of range for communication.

The display contains the trajectory of the satellite, as well as the footprint of both satellite and ground station. To the right, a timer visualises how much time is left until the next pass and the exact time the next pass will happen.(R13-14)

## Payload health, alarms, mission timeline and mission overview

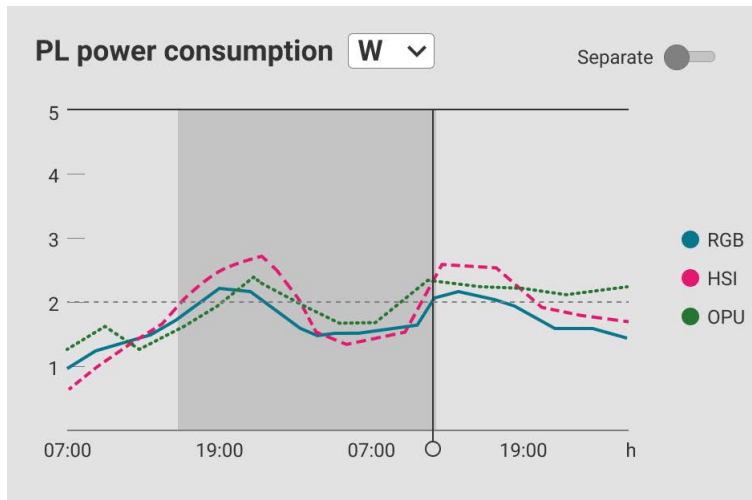

The PL health module was changed to include the possibility of toggling between the separate subsystems power consumption and the combined power consumption. The temperature of the RGB camera and the OPU are not available, and have been removed.

The dark grey field and the dark line in the graphs represents estimated values and current time. This is to separate what is known and what is estimated. When a pass has occurred and data is downloaded, the graphs will be updated and the grey area moves in front of the “current time” marker.

Mission queue		Commands	Log	Pass details
		START TIME	END TIME	
Template "Norwegian coast, morning/midday, high resolution"		2020-04-25 04:51:03	2020-04-25 19:00:00	
Pass		2020-04-25 11:10:12	2020-04-25 11:21:00	
Pass		2020-04-25 15:01:00	2020-04-25 15:12:42	
Idle mode		2020-04-25 19:00:00	2020-04-26 07:00:00	
Pass		2020-04-25 19:09:42	2020-04-25 19:20:59	
Pass		2020-04-25 23:20:33	2020-04-25 23:27:51	

[+ Create new mission](#)

The mission overview module was changed based on feedback. The tabs are more distinctive, and the “pass details” tab has been added.

Mission queue		Commands	Log	Pass details
			START TIME	END TIME
	lorem ipsum		2020-04-25 10:51:03	2020-04-25 10:52:20
	dolor sit amet		2020-04-25 10:52:20	2020-04-25 10:56:00
▷	consectetur		2020-04-25 11:06:00	2020-04-25 11:09:42
	initalize pass		2020-04-25 11:09:42	2020-04-25 11:09:59
	sed do eiusmod		2020-04-25 11:10:00	2020-04-25 11:20:32
	tempor incididunt ut labore		2020-04-25 11:20:33	2020-04-25 11:27:51
	et dolore magna aliqua		2020-04-25 11:27:51	2020-04-25 11:42:16
	ut enim ad		2020-04-25 11:42:16	2020-04-25 11:42:47

The commands tab contains all commands that have been sent to the satellite. The white highlights which command is being executed at the moment. Double clicking a mission in the queue sends the user to the corresponding commands. (R7)

Mission queue		Commands	Log	Pass details
			OPERATOR	TIMESTAMP
	Pass complete	120/120 MB downlinked, 8/8 MB uplinked		2020-04-25 07:00:06
	Alarm silenced	<i>HSI temperature approaching limit (2)</i>	Hansen, Andreas	2020-04-25 07:00:00
	Pass complete	17/17 MB downlinked		2020-04-25 03:12:42
	Pass incomplete	103/120 MB downlinked		2020-04-24 23:36:50
	Alarm silenced	<i>UHF beam power low (3)</i>	Sand, Gjertrud	2020-04-24 23:36:45
	Task completed	<i>HSI calibration test imaging</i>		2020-04-24 23:27:51
	Pass complete			2020-04-24 19:46:02
	Pass complete	12/12 MB uplinked		2020-04-24 14:10:31

The log tab contains all activity relevant for the next shift of operators or mission planner. It displays key events, like whether an alarm has been addressed, together with the responding operator and time. Logging makes handover easier. (R6)



### Mission timeline

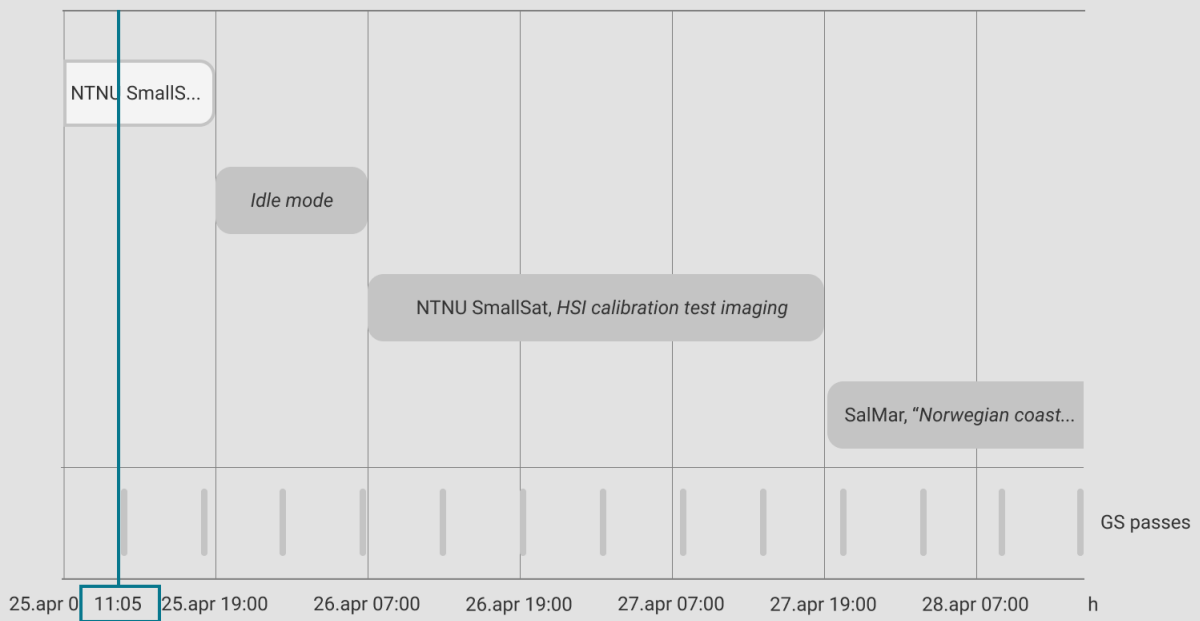

### Mission timeline

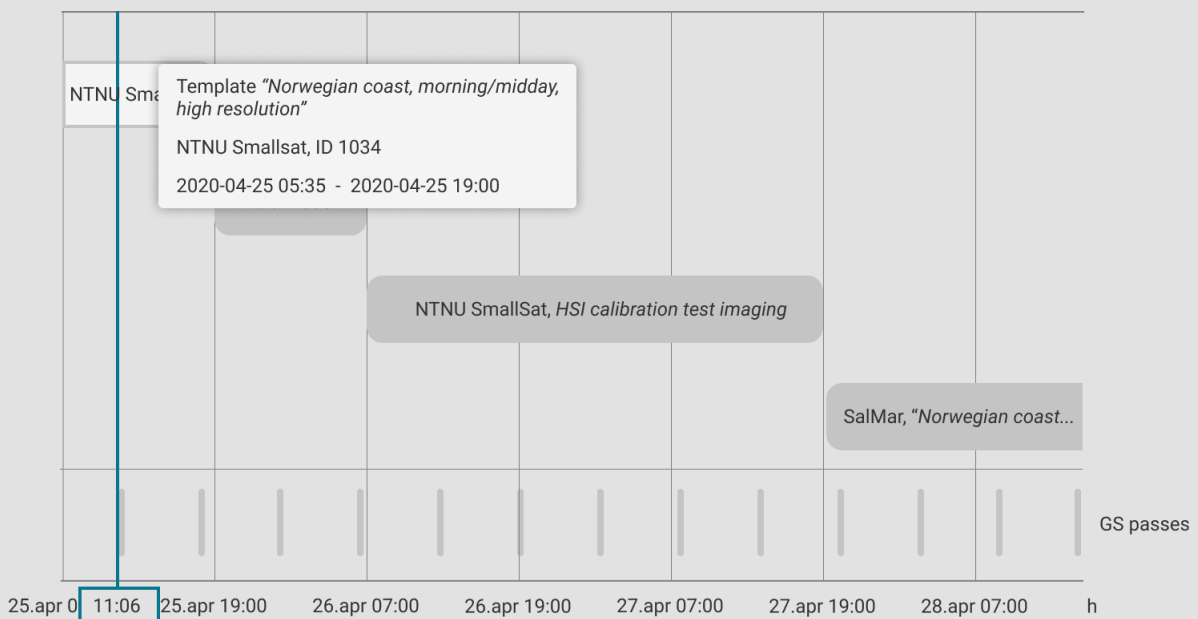

Below the mission overview module is the mission timeline module.(R3) This is a visualisation of the mission queue and ground station passes, with the current time marked in blue. The current mission is at the top. When the user hover on a mission, they get an infobox with details of the mission. Clicking the mission takes the user to a level 3 display for more detail.

## Mission planning form

**TASK OUTLINE**

Template ?  
Norwegian coast, evening

Priority task ?  
 No  
 Yes

Start time ?  
2020-04-25 19:00:01  
 First available pass matching template

**ADCS**

Select imaging area ?  
Select area on map, or enter coordinates manually:

1: 63.389485 N 7.874009 E  
2: 64.063605 N 9.508225 E

Maneuver type ?  
 Nadir  
 Slew

**HSI**

Desired resolution ?  
480 \* 760 px

Camera parameters ?  
 Template default  
 Enter custom values

File naming ?  
 Default  
 Enter custom values

**RGB**

RGB settings ?  
 Template default  
 Use custom settings

Save draft Generate script and validate task

The main change in mission planning was that the form and the map were merged into one. (R5) Additionally, the scenario of nominal operations and a standard pass gives little need for customizing the parameters, and this version of the form has pre-checked all available recommended values. Templates are made to

standardize recurring missions, to ensure that the same type of mission is performed the same way each time. This results in more comparable data. At the bottom, the validate task button has been expanded to generating a script as well. This is because the CLI command window was taken out of the form.

**Task validated**

This task has been validated and approved for uplink.  
Script can be edited manually in the window below.

This window contains auto-generated commands generated by the template.

1

Edit task Add task to mission queue

When the task is validated, the user sees this infobox with a list of the commands that have been generated to send to the satellite. Here they have the option to make changes to the script in a CLI command window, but it should be considered whether only qualified users have access to this function.

## Wall mounted screen during pass



During a ground station pass the footprint of the satellite and the ground station overlaps, which instantly gives the impression of connection. The timer changes color and is counting down the remaining time of the pass. The signal strength (sensitivity), is shown in a bar-graph.

The polar plot indicates the shape of the pass, and the progress bars indicate what has been downlinked or uplinked to the satellite. (R8 and 13-14)

## Pass details in the mission overview module

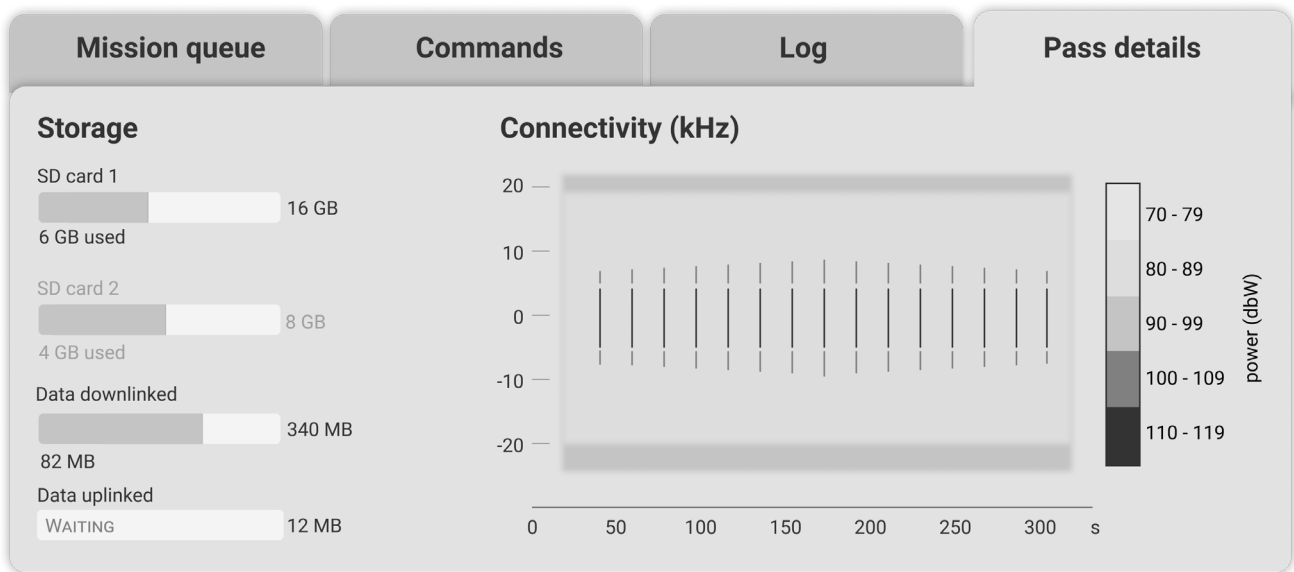

The “pass details” tab contains detailed information that is relevant during a pass. This gives the operator the possibility to see the signal strength in more detail. This graph was previously located on the SC health screen, but was moved after usability testing. This data is important to monitor to know if the antennas are functioning properly.

Storage information is necessary to have when planning a mission, and also to see during a pass to judge if the right amount of data is being stored. Only one SD card can be accessed at a time, and is displayed as active. The data down-, and uplink statuses are located here as well, and can be clicked on to reveal the corresponding level 3 display. (R8)

## Alarm priority 1 and automatic safe mode

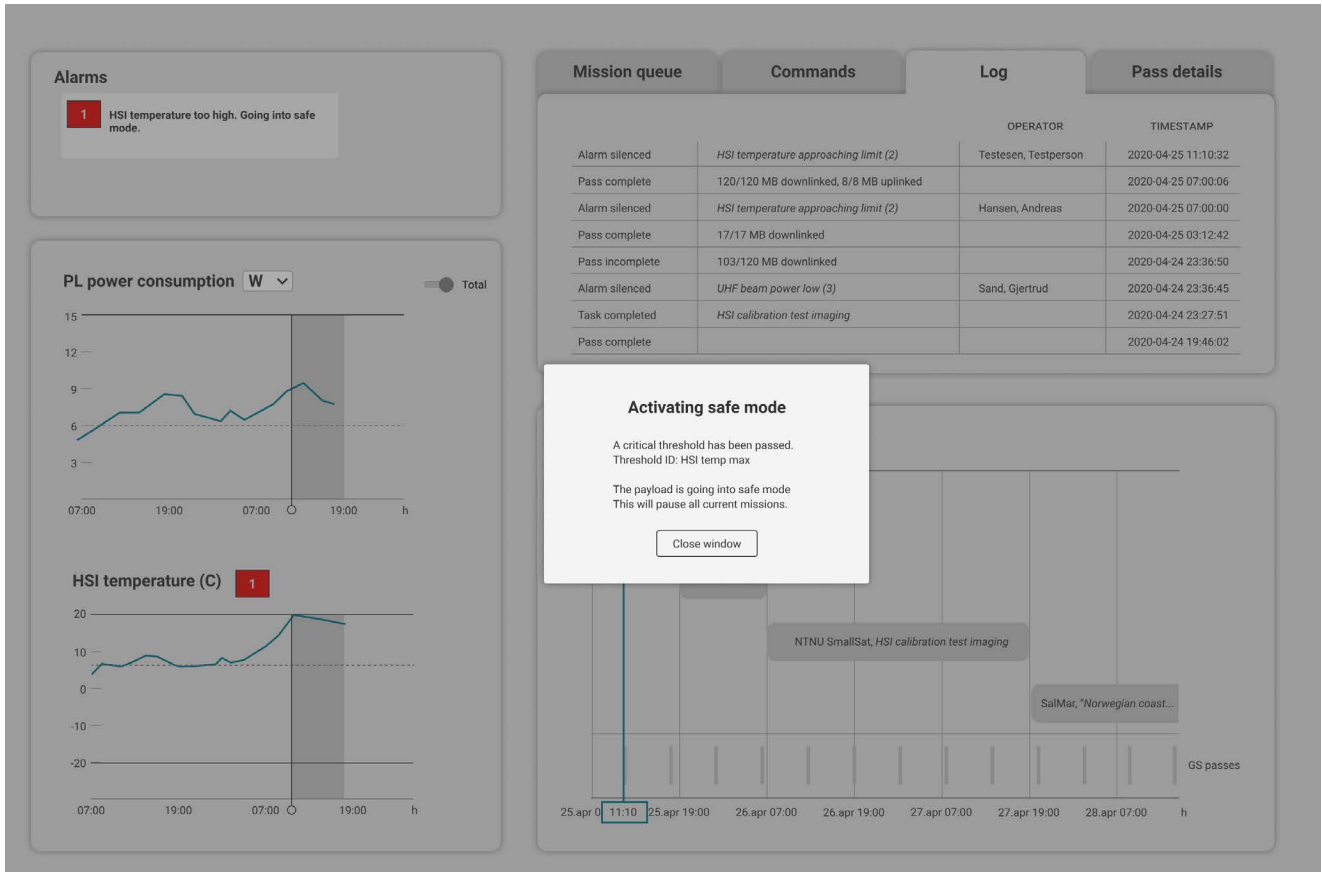

After feedback on the previous sketches, we realized that during a critical situation, the system should go to safe mode automatically, as to giving the choice to the operator. The 3rd iteration shows an example of a priority 1 alarm going off, and the system automatically sets the satellite in safe mode. The user is informed of this by a prompt.

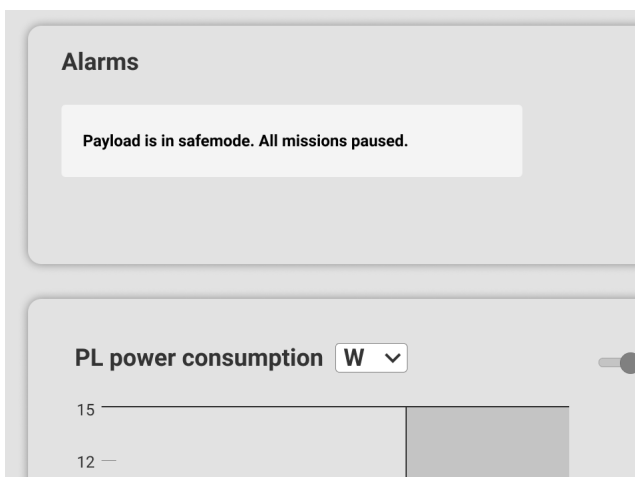

The alarm module during safe mode (R10)

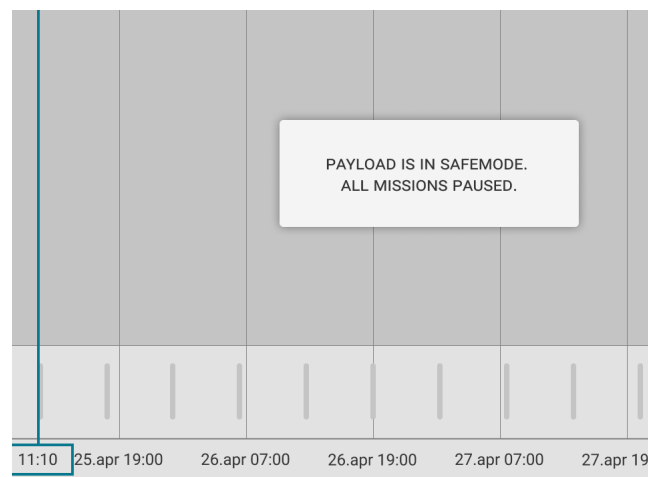

Mission timeline during safe mode. Missions are paused in safe mode because some subsystems are turned off. (R10)

# Spacecraft health, attitude and subsystems on/off

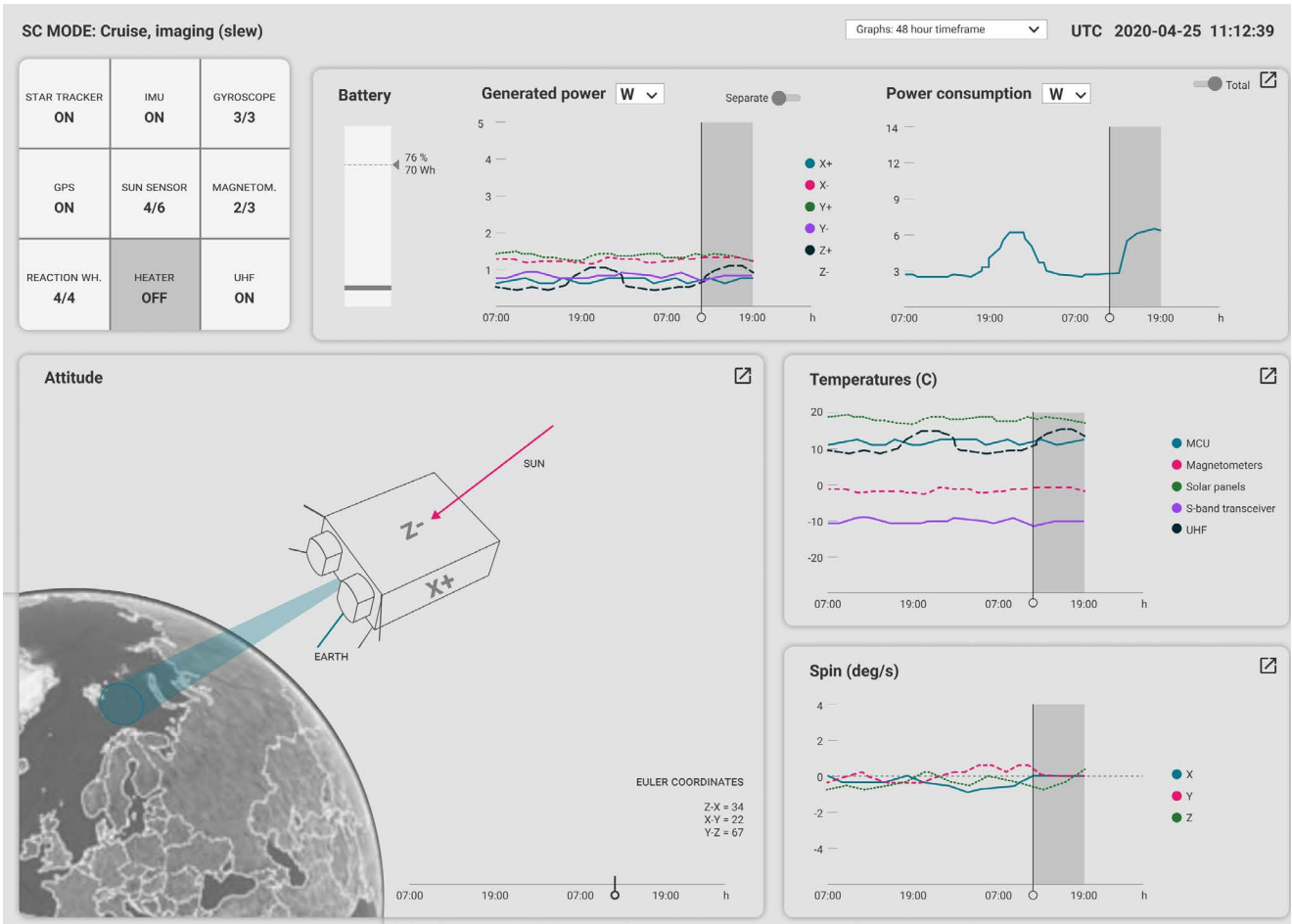

Changes made to the SC health screen after user testing were that the toggling function was added, the attitude got more room as this was seen as more important, and some of the less necessary graphs were removed or moved. (R9-12)

Additionally, the prediction of values and marking of current time in the graphs were added. The handle on the timeline can be dragged to see simulations of how the satellite has and will move.

The possibility of choosing the timeframe in the graphs was added in the form of a dropdown.

## Testing the third iteration

Five people from different parts of the HYPSON project were recruited for usability testing. The execution was similar to the previous test, except for different users and slightly different tasks, in addition to including the wall mounted display. The users were from the fields of software development and testing, radio communication and administration. The test script and full prototype can be found in appendix A7 and A8.

### Scenario

The users were asked to explain what they saw on the wall mounted display, as well as the left and right operator display. They were asked to add a new mission, and look for it in the queue. The users were then asked to explore the command and log tabs, after which they were directed to the wall mounted display to observe when a pass started. After this they were directed back to the left operator display to examine the pass details tab.

After handling a level 2 alarm experiencing the satellite entering safe mode, a new scenario was given for the right screen. This showed the SC screen during nominal operations. Here they were asked to explore and explain, and the users were given specific tasks if they did not explore the desired functions by themselves.

# Key Takeaways

## Wall mounted screen

Several of the users were not sure what the blue circles around the satellite and the ground station on the map were, even though most of them guessed it right. Marking the ground station circle in some way may be useful to enhance understanding of the circles.

The word sensitivity was not understood by any of the users, even though some of them almost guessed it, it needs to be changed. This is a word that mostly those who work with radio and signals will understand.

Some of the users pointed out that knowing whether the satellite is in the sun or the shadow might be useful, as the spacecraft changes its mode accordingly.

## PL Screen

### Health graphs

All of the users had trouble identifying the grey area where the simulated TM was. This must be a part of training as the future users will be “experts” and after a simple explanation all the test users understood the visualisation.

The users quickly understood the toggle buttons, but marking both sides would be preferable as you then always see what will happen when you toggle.

## Mission Overview

In the pass details tab, the word connectivity did not resonate with the users, and better wording is needed. The users also commented on the fact that we had changed the x and y axis from a normal waterfall plot to this, which is a better fit for our GUI. They could not provide a good reason to keep the time along the y-axis other than that it is how it normally is.

## Alarms/safe mode

The alarms were easily understood, and some users requested information about how long alarms will be silenced for.

Safe mode might be timed and some users requested information about this.

## Mission planning form

Some users requested more details about what the “default” setting was. This design is for a future scenario where the task template is for a standardized mission, and the use of the info-boxes will address this issue.

Several of the users would prefer a different way of choosing the resolution of the images. Instead of pixels, wavelength and width were suggested by the users with knowledge within the field.

Not all users understood clearly where the satellite could and could not take pictures. Marking the area where the satellite can take pictures can be a solution to this.

One of the users suggested showing how large the image file will be and estimating the time it will take to downlink it, can be good information to have when creating a new mission.

## SC screen

Most of the users pointed out that the battery level limit must be at 75%. It should not go any lower than this.







06

Final Concept

*Algal blooms in the South Atlantic Ocean ("A southern summer bloom", ESA, CC BY-SA 3.0 IGO)*



## Wall mounted screen

An icon to clarify the nature of the ground stations footprint has been added. The dark areas on the map show where the satellite will be in the shadow of the earth.

When this happens, the satellite enters the power saving eclipse mode, as there is no power generated by the solar panels.



## During pass

Minor fixes; changing “Sensitivity” to “Signal strength” for a more inclusive wording, and small corrections to the polar plot.

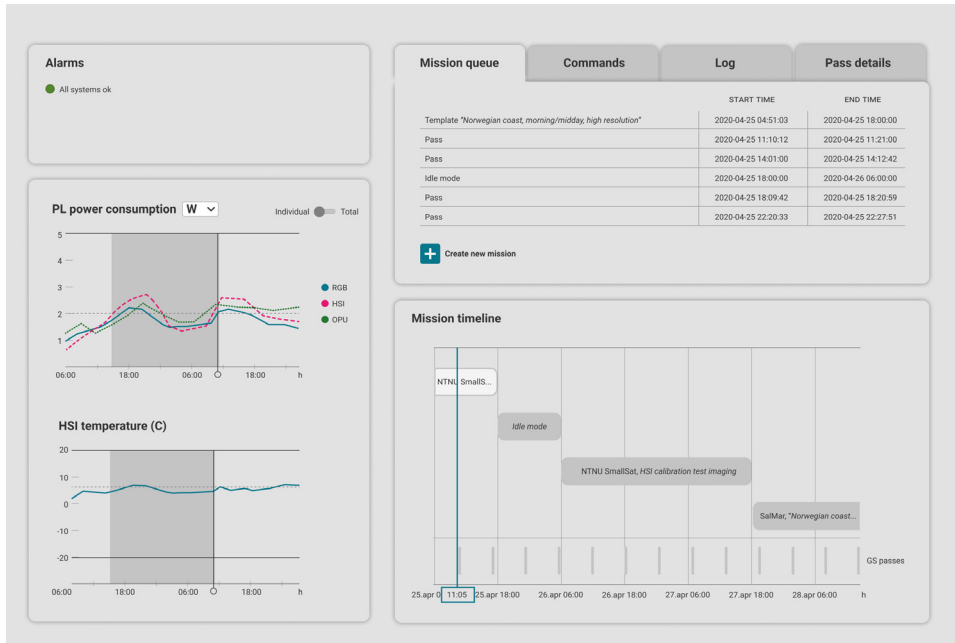

## Payload health

The toggle function labels were changed from “separate” to individual after feedback. The timeline in the graphs were also changed from to 06 and 18, removing the legacy time notations from the first prototype.

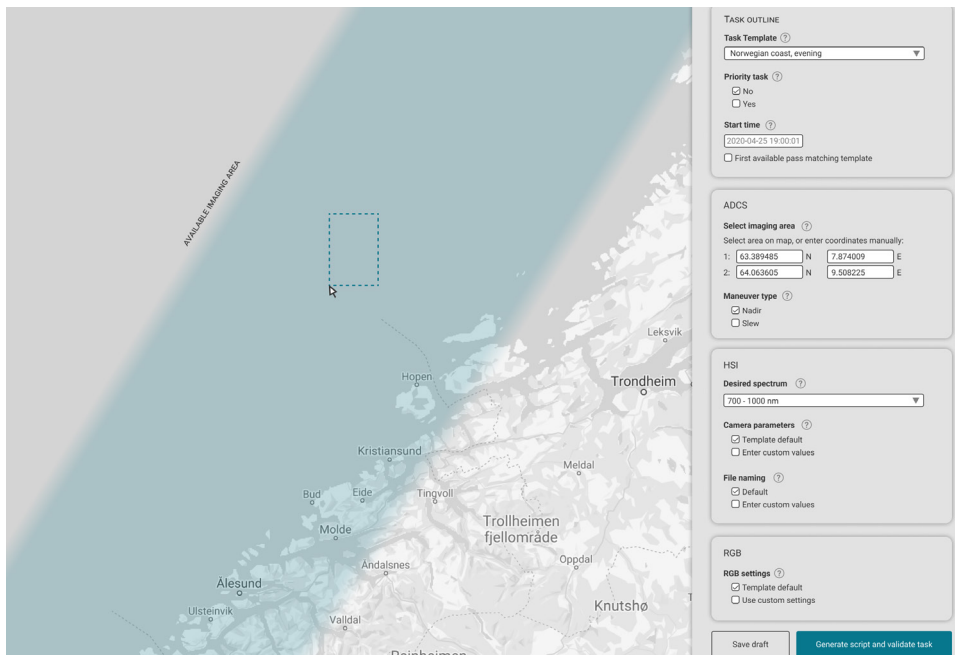

## Mission planning form

Smaller changes were made to the mission planning form and the map. The available imaging area has been marked and the form title changed.

Changing the parameters for the HSI camera will help the users with their mental model, as pixels are not easily transferred to an area on earth.

The task validation infobox has been updated to include estimates for file size and downlink time.

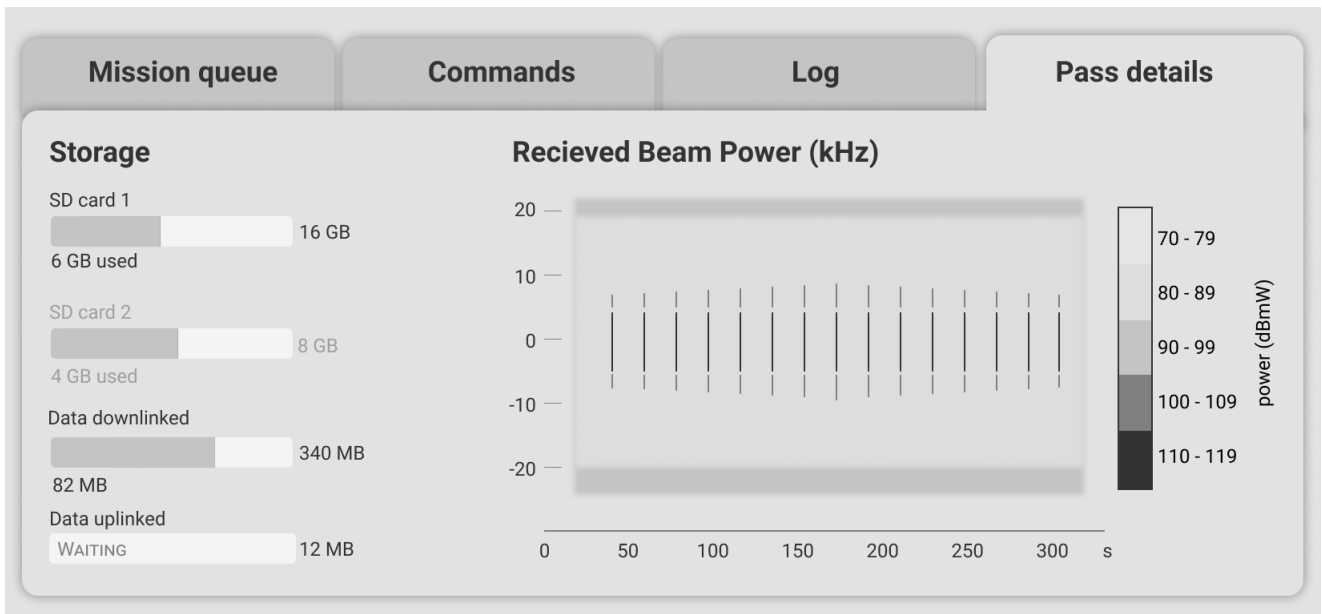

## Pass details

Changing from “Connectivity” to “received Beam Power” makes it easier to understand. Feedback on the shape of this “waterfall plot”(top image), is that the axes are usually the other way round.

The sketch features the time on the x-axis, as all the other graphs in this GUI, to create cohesiveness. We have yet to receive an answer as to why time should be on the y-axis as suggested by the users.

Mission queue	Commands	Log	Pass details
		OPERATOR	TIMESTAMP
Pass complete	120/120 MB downlinked, 8/8 MB uplinked		2020-04-25 06:00:06
Alarm silenced	<i>HSI temperature approaching limit (2)</i>	Hansen, Andreas	2020-04-25 06:00:00
Pass complete	17/17 MB downlinked		2020-04-25 02:12:42
Pass incomplete	103/120 MB downlinked		2020-04-24 22:36:50
Alarm silenced	<i>UHF beam power low (3)</i>	Sand, Gjertrud	2020-04-24 22:36:45
Task completed	<i>HSI calibration test imaging</i>		2020-04-24 22:27:51
Pass complete			2020-04-24 18:46:02
Pass complete	12/12 MB uplinked		2020-04-24 13:10:31

## Logging alarms

When an alarm has been acknowledged, it will be displayed in the log (bottom image).

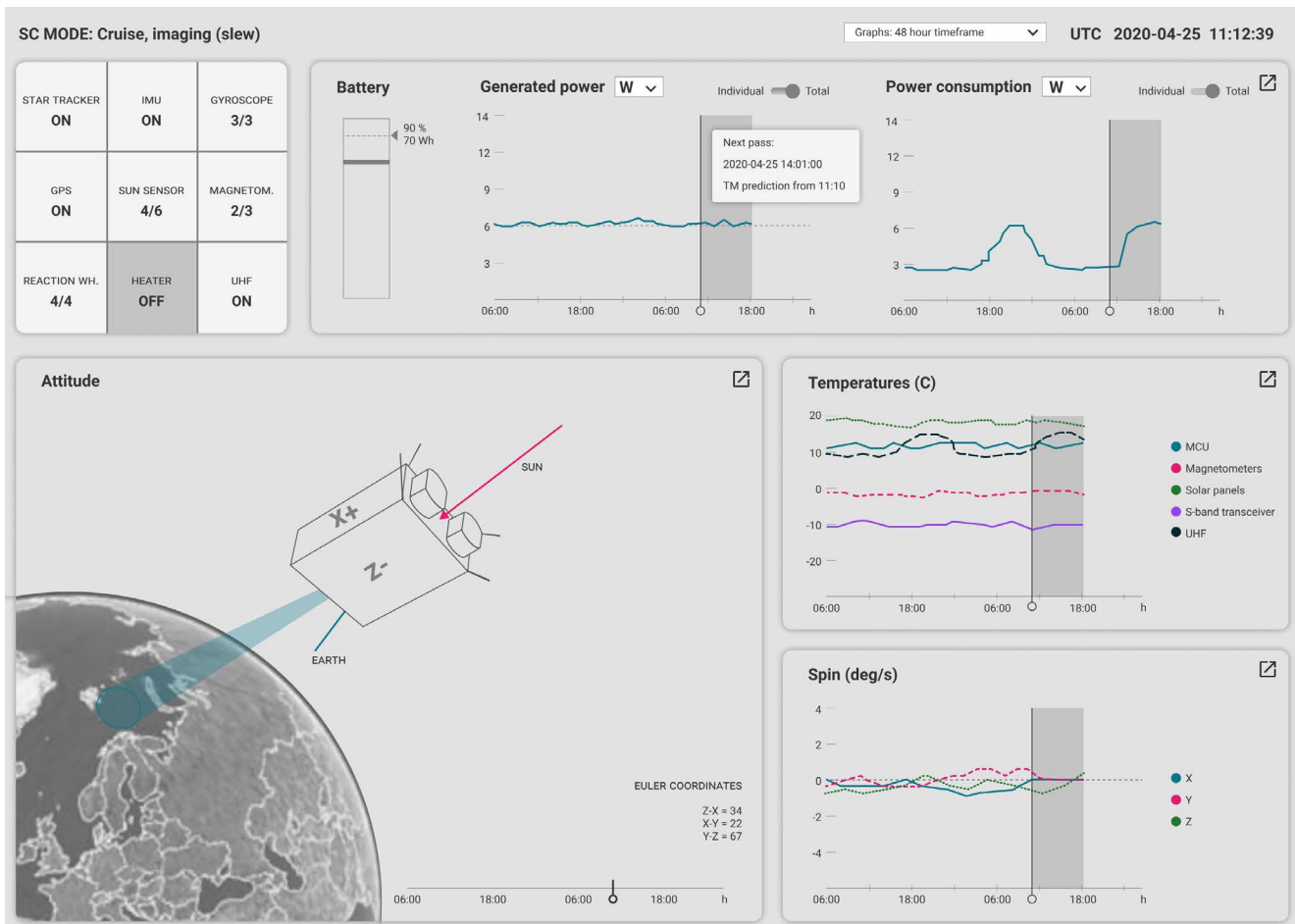

## SC health

The battery threshold has been moved up to 75% as this is the lowest it should be before an alarm should go off. Minor changes in the attitude to visualise the satellites position correctly.

## Design for colour deficiency

Even though the lines are redundantly coded with both colour and different patterns, the descriptions are not (circles with colour). This is something that has remained from earlier sketches and should be changed to accommodate people with colour deficiencies during further work.

In addition, we had a few users comment on the pink colour, that it was quite close to the red colour of the alarms. This is something that also should be considered changed during further work.

# Hierarchy

1

## **Process Overview**

The level 1 display is the wall mounted overview display, and will give an at-a-glance view of the situation of the satellite. It shall give a clear indication of the current status and where the satellite is in its process. It should contain high level Key Performance Indicators such as quality, efficiency, progress, safety and environment. It can also contain values, trends and deviations of the Key Performance Indicators, and alarms of the top 2 or 3 priorities.

2

## **Process Unit Operation Graphics**

For ongoing process manipulation. The level 2 graphic should contain information and control needed for the operator to perform most tasks. The operator should be able to do routine changes and some interventions when an unusual situation occurs. Values, such as telemetry, should be trended, and it should be possible to rescale the trends individually. Access to a level 3 view should be provided. Progress indicators are valuable, such as task lists that show where in the process a mission is or a timeline showing planned missions.

3

## **Process Detail Display**

For close, detailed examination. Shall contain a detailed view of subsystems, telemetry and other information available but not necessary to see all the time. Custom, pre-built trend displays are also valuable here, such as openMCT components. It should be possible for the user to do specific diagnostics and give access to troubleshooting features. All indicators, controllers and alarms of all priorities can be shown here, and there can be several level 3 displays for each level 2 display.

4

## **Process Support and Diagnostic Displays**

For troubleshooting. This is the most detailed display, and should mainly be accessible by maintenance personnel or experts. It should contain detailed information about equipment and instruments. Help displays, system diagnostics, alarm summary etc is also possible to display here. Procedure information and documentation could also be kept here.

# Colours

## Definitions & Settings

Colour is to be used consistently in all workstations, to prevent confusion. Following are the colours to be used in the GUI. High-contrast displays are to be avoided, as they are fatiguing to the eyes of the users.

Likewise, it's important to have high enough contrast to support readability. To ensure this, all colours are set by following the Web Content Accessibility Guidelines (WCAG 2.1).

## Colour Deficiencies

It is important to consider the effects of colour deficiencies such as colour blindness. Important information must never be conveyed by colour alone. Colour can be used in combination with text, shape or texture to ensure redundancy (Ware, 2013).

The colours of the GUI are placed throughout the CIE 1931 colour space. The further apart two colours are, the easier it is for the human eye to distinguish them from each other. Alarm colours should be placed outside the colour space of the process colours, to ensure standing out sufficiently (Ware, 2013).



Figure 32: Foreground colours with contrast numbers of text and background colour, displayed on background colour



## Background Colour

The background colour is a light gray, to avoid interference with other colour coding and prevent glare. The contrast ratio between the background and foreground colours is according to WCAG 2.1 AA recommendations.

See figures 32 and 33 for contrast ratios.

## Foreground Colours

Text should be a dark grey, not black, to prevent fatigue in the operators eyes.

Bright or highly saturated colours are only to be used to draw the operators attention to abnormal situations or alarms. Alarms must be accompanied by more than just colour. Redundant coding is necessary. It also lowers the risk of errors being made due to cultural differences in colour association (Cooper, Reimann, Cronin & Noessel, 2014).

The level 3 yellow alarm does not have enough contrast with the background to qualify for WCAG 2.1 AA. Thus, it shall always be used with a low luminance contrast boundary, to separate it from the background (Ware, 2013).

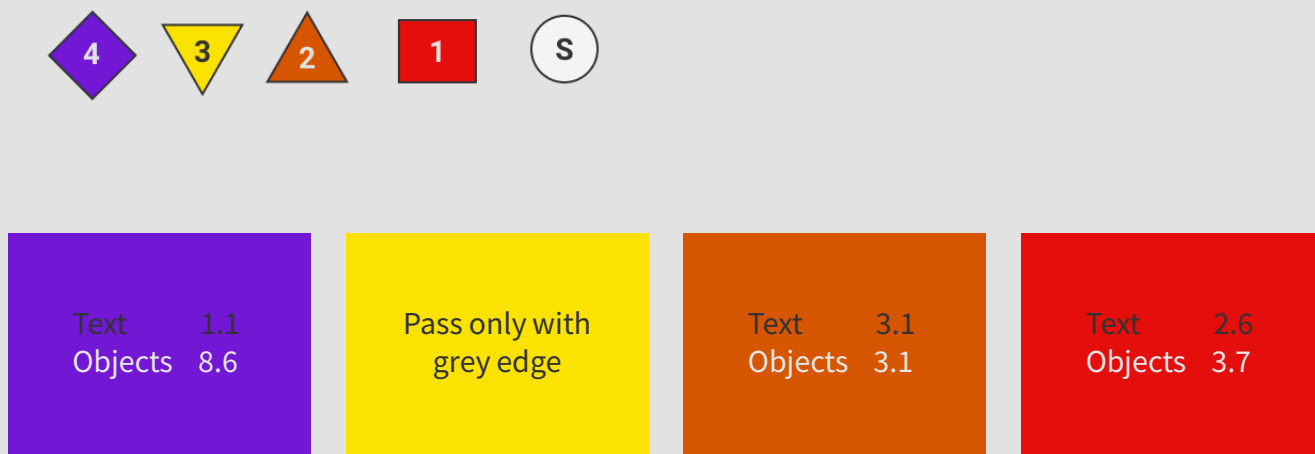

Figure 33: Alarm colours with contrast numbers of text and background colour, as well as alarm shapes, displayed on background colour

# Text

Text shall be a dark grey, not black, to prevent fatigue in the operators eyes. Sans-serif fonts are preferred. There should be as little text as possible, without losing important data.

When operating several spacecraft with the same system, use larger, highly visible text to identify the spacecraft. Emphasize which spacecraft is being shown.

Text sizes follow WCAG 2.1 AAA standard.

## Wall Mounted Screens

This should be considered upon determining the size of the screen. All text shall be readable from every operator workstation, as well as slightly readable to visitors in the far back of the control room.

## Desktop screens

Titles: Roboto Bold 18pt, dark gray - #333333

Subtitles: Roboto Regular 14pt, uppercase 16pt, dark gray - #333333

Text, labels and axis values: Roboto Regular 12pt, dark gray - #333333

Text depicting commands: Inconsolata Regular 12pt, dark gray - #333333

## Lists and Tables

Lists and tables shall have a line height of 15. Columns containing numbers shall be aligned on the decimal point. Avoid tables consisting solely of numbers (Hollifield, 2008).

**Headline Roboto Bold 18pt**

SUB HEADER  
ROBOTO REGULAR 14 PT

**VULUES ROBOTO BOLD 16PT**

Text and chart values  
Roboto Regular 12 pt

# Charts

Axes and grid lines shall be a dark gray. Significance is determined by line thickness, not colour. In a chart, there shall be no more than three line types (solid, dashed, dotted). Likewise, there shall be no more than three line thicknesses (Hollifield, 2008).

The average reading is to be displayed as a dashed line.

## Edges

Module edges are to be displayed as a solid, dark gray line, with a 40% black, 8px wide drop shadow, to separate from the background.

When an item is selected, that status should be indicated. This can be done by highlighting the items edges with a white line.

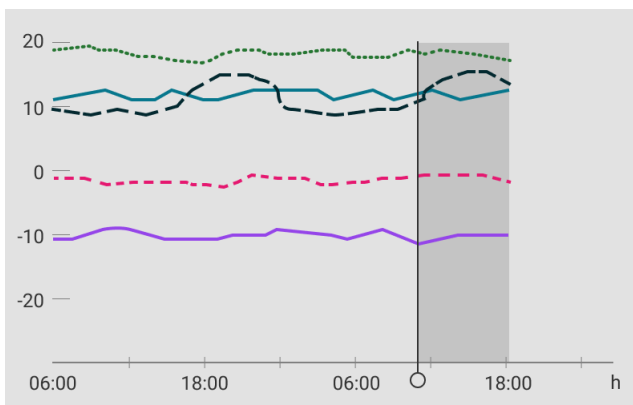

Figure 34: Depictions of lines in the final concept

# Responsive GUI

The system will be developed to be responsive, so the operator and mission planner can access it from outside the control room. To illustrate this we have created a few mockups, which are untested.

Figure 35: Mockup for iPad



### Alarms

● All systems ok

Mission queue
Commands
Log
Pass details

	START TIME	END TIME
Template "Norwegian coast, morning/midday, high resolution"	2020-04-25 04:51:03	2020-04-25 18:00:00
Pass	2020-04-25 11:10:12	2020-04-25 11:21:00
Pass	2020-04-25 14:01:00	2020-04-25 14:12:42
Idle mode	2020-04-25 18:00:00	2020-04-26 06:00:00
Pass	2020-04-25 18:09:42	2020-04-25 18:20:59
Pass	2020-04-25 22:20:33	2020-04-25 22:27:51

+ Create new mission

### PL power consumption W

Individual  Total

### HSI temperature (C)

### Mission timeline

## SC MODE: Cruise, imaging (slew)

Graphs: 48 hour timeframe
UTC 2020-04-25 11:12:39

STAR TRACKER	IMU	GYROSCOPE
ON	ON	3/3
GPS	SUN SENSOR	MAGNETOM.
ON	4/6	2/3
REACTION WH.	HEATER	UHF
4/4	OFF	-

### Battery

### Generated power W

Individual  Total

### Power consumption W

Individual  Total

### Attitude

EULER COORDINATES  
Z-X = 34  
X-Y = 22  
Y-Z = 67

### Temperatures (C)

### Spin (deg/s)

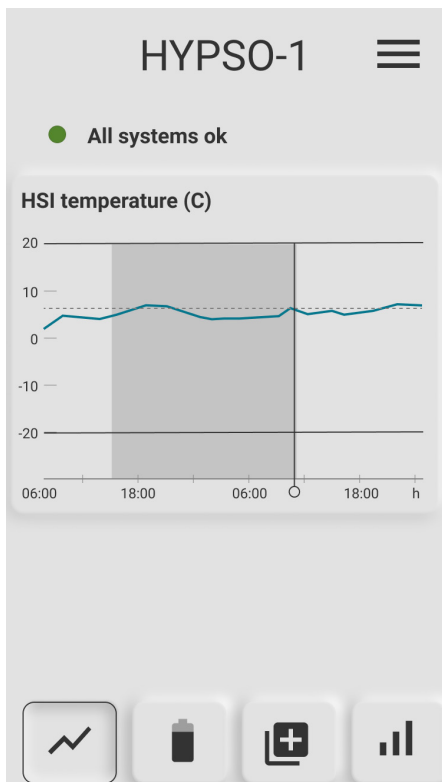
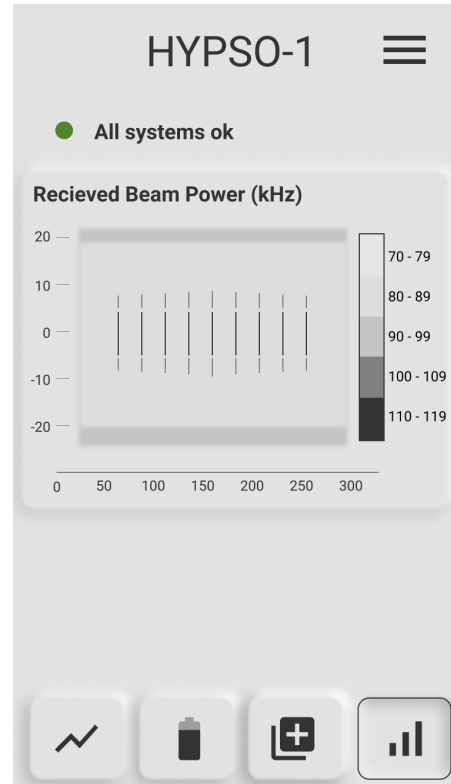
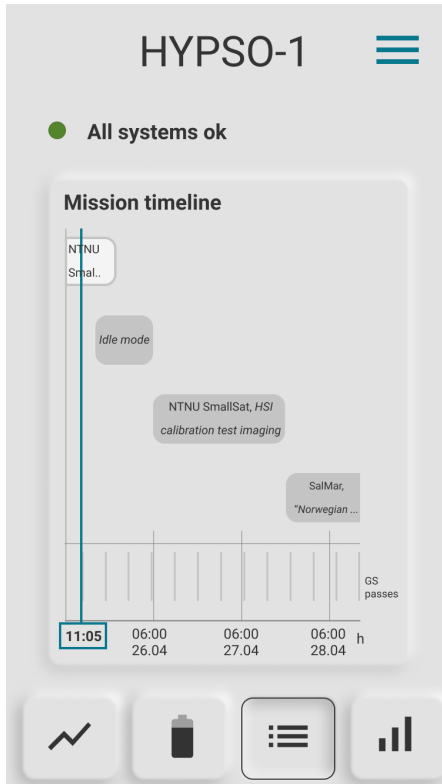

- 👤
✕
- MISSION TIMELINE
  - COMMANDS
  - ADD NEW MISSION
  - DETAILED TM
  - LOG
  - 🔍 HELP
  - 📞 CONTACT
  - SETTINGS
  - LOG OUT
- 📈
🔋
+
📊

Figure 36: Mockup for smartphone



# Control Room Design

The control room is designed with thoughts to future use, based on the literature findings. The room is split into two parts, the control stations part and an observation/lounge area for visitors. This to ensure that the operators are not disturbed during their shifts, while still being accessible for visits and observations.

The mission planner or administrator is placed at the back of the room to ensure full control of the processes currently ongoing. While there is only a single vessel to operate, this might not be necessary, but as the number of vessels increases, the need for an administrator increases.

The desks are wide enough for two operators to sit next to each other during co-working sessions, and close enough to communicate between stations. There is also sufficient room between stations for it to be wheelchair accessible.

In the long run, the project goal is to operate several satellites and autonomous vessels from the same control room. At that time the room layout can be modified as shown below. At this point, it's uncertain how automatic or manual the operations will be. This depends on the HYPISO team. The room must be able to be scaled up and down for future tasks.

This layout has not been tested due to COVID-19. We recommend testing before implementing the setup.

*Figure 37: Render of control room concept for HYPISO-1*





# GUI and Control Room Design Guide

The Control Room Design Guide and GUI Design Guide are inspired by documents recommended by Hollifield et al. (2008), that we leave behind for the HYPSON team.

The Control Room Design Guide document (appendix A1) contains guidelines for designing a control room, and can be applied to different types of DCSs.

The GUI Design Guide (appendix A2) contains rules and guidelines regarding GUI layout, hierarchy, background, lines, text, objects, colors, navigation and so on.

The documents mentioned are based on design literature (Hollifield et al., 2008, Cooper et al. 2014 and Ware, 2013), standards (ISO 11064, ISO 9241-210, ECSS-E-ST-70C and WCAG 2.1) and the contents of this thesis.

# PDR

The 4th of July, the HYPSON team had a PDR for the operations part of the HYPSON project. The PDR was conducted over zoom. Outside of NTNU, Statsat and Autonaut were a part of the review team.

The PDR was a very nice way to finish our collaboration with the HYPSON project. We got to present our work to some extent, and discuss it with several participants afterwards. See figure 38. We got great feedback from both external and internal participants during the PDR. We felt that we got the opportunity to really press on the importance of the ground work before putting the control room to use, and got the impression that the HYPSON project will carry on our work in the next phase.

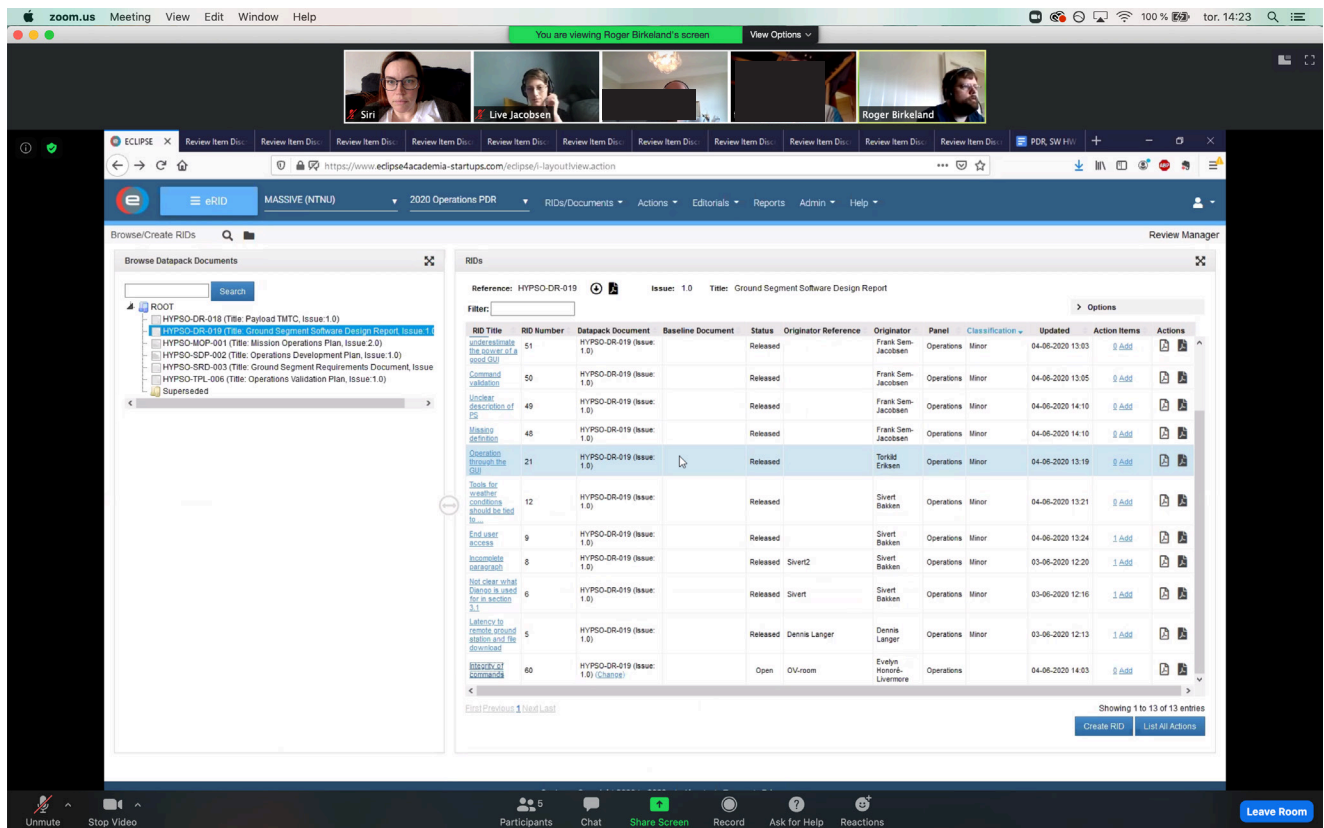

Figure 38: Screenshot from PDR - one of the group discussions

# Reflections

## **Working with design in space operations**

The collaboration with the HYPSON team has been both challenging and educational. The lack of focus on design has caused some frustration on our part, right until the end of our project. Still it is fully understandable that design is placed on the back burner when no one in the team had any experience or knowledge about design thinking, and the way it can enhance and help the work process.

Additionally, due to the high turnover and the advanced technology, there are still a lot of things that need work before it is possible to have an operational satellite.

The space operations field as a whole lacks literature on how human factors and design are connected to the performance of the technology. The common “that’s how we’ve always done it” is very much present and it is simply human nature to not challenge something that appears to be working. It has been a good learning experience for us and has challenged our communication skills.

## **User centered design during COVID-19**

The corona virus lockdown forced us to change the way we work. We had to stop meeting at school every day, and the weekly lab day was cancelled. We continued with the weekly operations meetings, and talked to each other over skype and discord.

The lockdown resulted in some delay, but not significantly. We managed to stick to our plan and stayed on track until delivery. The lack of physical usability testing might have had some consequences for the design, and we did our best to make it work. A full test with three screens should be conducted during further work with the GUI.

The control room design might be the part of the project that suffered the most because of COVID-19. If we had an actual room to test our design, we would have prioritized it more. Then again, that might have affected the quality of the GUI design.

## **Evaluation of the result**

The most difficult part of designing for HYPSON has been that they do not yet know what they will need from the design solution. The many unknown factors that will be figured out later on and even after launch has challenged us as designers, and has partly shaped our delivery. It has been exciting working on a project where things could change from one day to another, and evolve so quickly. The way we managed to solve the uncertainties was to create the design guides, and the sketches made for a future scenario when things are more in place.

# References

- Accessibility Guidelines Working Group (2018). Web Content Accessibility Guidelines (WCAG) 2.1. Retrieved from <https://www.w3.org/TR/WCAG21/>
- AGeekMom (2010). Image of mission control overview display. Retrieved from: <https://www.flickr.com/photos/wildtexas/5170431156>
- Antonissen, B. (2019). iPad mockup. Retrieved from <https://unsplash.com/photos/37UYj2pnRac>
- AP Photo (1986). Challenger disaster. Retrieved from <https://www.voanews.com/silicon-valley-technology/nasa-remembers-space-shuttle-challenger-disaster>
- AP Photo/Tyler Morning Telegraph (2003). Columbia disaster. Retrieved from <https://www.britannica.com/event/Columbia-disaster> 31.05.2020
- Avinor (n.d.). Fjernstyrte tårn. Retrieved from <https://avinor.no/flysikring/vare-tjenester/remote-towers/> 28.02.2020
- Braseth, A., & Øritsland, T. (2013). Visualizing complex processes on large screen displays: Design principles based on the Information Rich Design concept. *Displays*, 34(3), 215-222. Elsevier B.V.
- Brush, A., Ames, M., & Davis, J. (2004). A comparison of synchronous remote and local usability studies for an expert interface. *CHI '04 Extended Abstracts on Human Factors in Computing Systems*, 1179-1182.
- Columbia Accident Investigation Board (2003). Report of Columbia Accident Investigation Board, Volume I. NASA. Retrieved from [https://www.nasa.gov/columbia/home/CAIB\\_Vol1.html](https://www.nasa.gov/columbia/home/CAIB_Vol1.html), 23.05.2020.
- Cooper, A., Reimann, R., & Cronin, D., Noessel, C. (2014). *About Face: The essentials of interaction design*, Fourth Edition. Indianapolis, Ind: Wiley.
- Copernicus Sentinel (2016). Barents bloom (modified and processed by ESA) Retrieved from [https://www.esa.int/ESA\\_Multimedia/Images/2016/08/Barents\\_bloom](https://www.esa.int/ESA_Multimedia/Images/2016/08/Barents_bloom)
- Copernicus Sentinel (2017). Larsen Ice Shelf (modified and processed by ESA) Retrieved from [http://www.esa.int/ESA\\_Multimedia/Images/2017/10/Larsen\\_Ice\\_Shelf#.XteWmEyjhVs.link](http://www.esa.int/ESA_Multimedia/Images/2017/10/Larsen_Ice_Shelf#.XteWmEyjhVs.link)
- Copernicus Sentinel (2017). Sharm El Sheikh (modified and processed by ESA) Retrieved from [https://www.esa.int/ESA\\_Multimedia/Images/2018/07/Sharm\\_El\\_Sheikh](https://www.esa.int/ESA_Multimedia/Images/2018/07/Sharm_El_Sheikh)
- Copernicus Sentinel (2018). South Georgia Island (modified and processed by ESA) Retrieved from [https://www.esa.int/ESA\\_Multimedia/Images/2018/12/South\\_Georgia\\_Island](https://www.esa.int/ESA_Multimedia/Images/2018/12/South_Georgia_Island)
- Copernicus Sentinel (2019). Baltic blooms (modified and processed by ESA) Retrieved from [https://www.esa.int/ESA\\_Multimedia/Images/2019/12/Baltic\\_blooms](https://www.esa.int/ESA_Multimedia/Images/2019/12/Baltic_blooms)
- The Design Council (2015). Design methods for developing services. Retrieved from <https://www.designcouncil.org.uk/resources/guide/design-methods-developing-services> 22.04.2020
- Endsley, M. R. (1988). Design and evaluation for situation awareness enhancement. *Proceedings of the Human Factors and Ergonomics Society Annual Meeting*. SAGE Publications.
- Endsley, M.R. (2012). *Designing for situation awareness: An approach to user-centered design*. CRC Press.

- Envisat (2018). A southern summer bloom. Retrieved from [https://www.esa.int/ESA\\_Multimedia/Images/2012/01/A\\_southern\\_summer\\_bloom](https://www.esa.int/ESA_Multimedia/Images/2012/01/A_southern_summer_bloom)
- Equinor(n.d.). About us. Retrieved from <https://www.equinor.com/en/about-us.html> 21.05.2020
- ESA (2018) Mission Control Graphical User Interface. Retrieved from [http://www.esa.int/ESA\\_Multimedia/Images/2018/07/Mission\\_Control\\_System\\_graphical\\_user\\_interface](http://www.esa.int/ESA_Multimedia/Images/2018/07/Mission_Control_System_graphical_user_interface)
- Forum for Human Factors in Control (2014). Brochure. SINTEF
- Hollifield, B., Oliver, D., Nimmo, I., Habibi, E. (2008) The High Performance HMI Handbook.
- Hollifield, B. (2012). A level 1 overview display. Retrieved from: <https://www.isa.org/standards-publications/isa-publications/intech-magazine/2012/december/system-integration-the-high-performance-hmi/>
- Hollnagel, E. (1993). Requirements for dynamic modelling of man-machine interaction. Nuclear Engineering and Design(144), 375-384. North-Holland
- Hollnagel, E. (2016) Contextual Control Model (COCOM). Retrieved from <https://erikhollnagel.com/ideas/cocom.html>, 22.04.2020
- Holtshausen, G. (2018). Image of space. Retrieved from <https://unsplash.com/photos/fUnfEz3VLv4>
- Hugo, J. V. (2009). Ecological Interface Design for the DURESS simulator. Retrieved from: [https://www.researchgate.net/figure/Ecological-Interface-Design-for-the-DURESS-simulator\\_fig3\\_235643614](https://www.researchgate.net/figure/Ecological-Interface-Design-for-the-DURESS-simulator_fig3_235643614)
- IDEO (2015). The field guide to human-centered design : Design kit (1st. ed.). San Francisco, Calif: IDEO.
- ISO 9241-11, Ergonomics of human-system interaction - Part 11: Usability: Definitions and concepts (2018)
- ISO 11064-2, Ergonomic design of control centres - Part 2: Principles for the arrangement of control suites. Annex A(11-13). (2000)
- ISO 11064-3, Ergonomic design of control centres - Part 3: Control room layout (1999)
- Johnsen, S. O., Bjørkli, C., Steiro, T., Fartum, H., Haukenes, H., Ramberg, J., Skriver, J. (2011). CRIOP: A Scenario method for Crisis Intervention and Operability analysis. SINTEF Technology and Society
- Johnson, J. (2010). Designing with the mind in mind: Simple guide to understanding user interface design rules. Amsterdam ; London: Morgan Kaufmann.
- Kystverket (n.d.). Kva er Kystverket? Retrieved from <https://www.kystverket.no/Om-Kystverket/Kva-er-Kystverket/> at 29.05.2020
- Martin, B. & Hanington, B. M. (2012) Universal Methods of Design : 100 Ways to Research Complex Problems, Develop Innovative Ideas, and Design Effective Solutions. Rockport publishers.
- Marshak, W. P., Adam, T. J., Monk, D. L. (2000) Space Review Study: Human Factors Engineering's Role in Unmanned Space Operations. United States Air Force Research Laboratory
- Meister, D., & Enderwick, T. (2002). Human factors in system design, development, and testing. Mahwah, N.J. L. Erlbaum.

- Miller, G. A. (1956). "The magical number seven, plus or minus two: Some limits on our capacity for processing information". *Psychological Review*. 63 (2): 81–97.
- NanoAvionics (n.d). Images of spacecraft. Retrieved from <https://nanoavionics.com/nanosatellite-buses/6u-nanosatellite-bus-m6p/>
- Norman, D. (2013). *The design of everyday things* (Rev. and exp. ed.). New York: Basic Books.
- Official SpaceX Photos (2015). Falcon 9. Retrieved from <https://www.flickr.com/photos/spacex/16698990475/>
- Penetron (2019) RKA Mission Control Centre. Retrieved from: <https://www.penetron.com/projects/view/RKA-Mission-Control-Center/>
- Rasmussen, J. (1983). Skills, rules, and knowledge; signals, signs, and symbols, and other distinctions in human performance models. *IEEE Transactions on Systems, Man, and Cybernetics*, SMC-13(3), 257-266.
- Schall, A., & Horst, R. (2006). Demonstration of Remote Usability Testing Practices and Procedures. *Proceedings of the Human Factors and Ergonomics Society Annual Meeting*, 50(20), 2284-2287.
- Schneiderman, B. (1983) *Direct Manipulation: A step beyond programming languages*. *IEEE Comput.* vol. 16, o 8, pp 57-69, 1983
- SINTEF (n.d.). Om SINTEF. Retrieved from <https://www.sintef.no/om-sintef/> 26.02.2020
- Statsat (n.d.) Statsat – et ledende mikrosatellittmiljø. Retrieved from <http://statsat.no/> 01.04.2020
- Tufte, E. (1997). *Visual and statistical thinking : Displays of evidence for making decisions*. Cheshire, Conn: Graphics Press.
- Tufte, E. (n.d). *PowerPoint Does Rocket Science: Assessing the Quality and Credibility of Technical Reports*. Retrieved from [https://www.edwardtufte.com/bboard/q-and-a-fetch-msg?msg\\_id=0001yB](https://www.edwardtufte.com/bboard/q-and-a-fetch-msg?msg_id=0001yB) 20.04.2020
- USGS (2019). Algal bloom. Retrieved from <https://unsplash.com/photos/08hjz7VzB84>
- Vicente, K., & Rasmussen, J. (1992). Ecological interface design: Theoretical foundations. *IEEE Transactions on Systems, Man, and Cybernetics*, 22(4), 589-606.
- Ware, C. (2013). *Information visualization : Perception for design* (3rd ed.). Amsterdam: Elsevier/Morgan Kaufmann.
- Wickens, C., & Hollands, J. (2000). *Engineering psychology and human performance* (3rd ed.). Upper Saddle River, N.J: Prentice Hall.
- YTCount (2019). iPhone mockup. Retrieved from <https://unsplash.com/photos/0kjXasMy2o4>

# Control Room Design Guide

HYPSO-DR-021

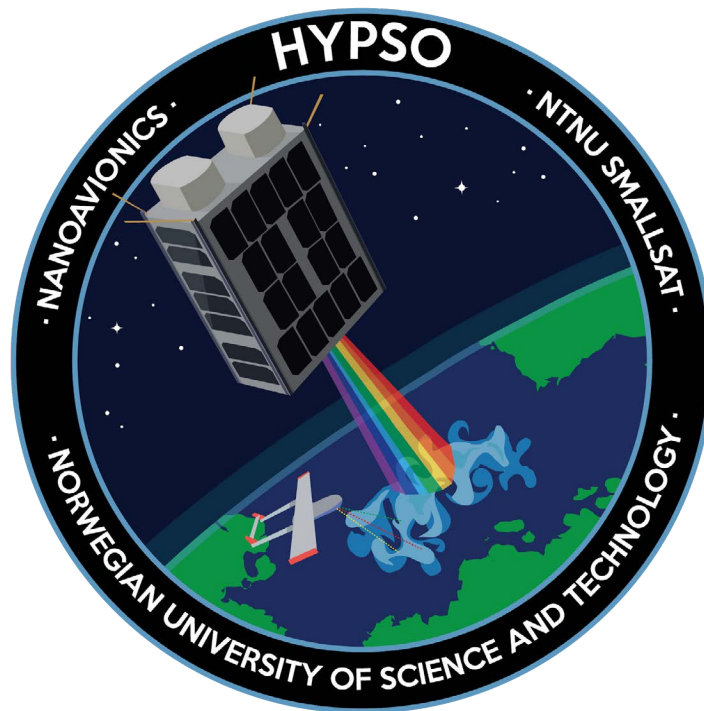

<b>Prepared by:</b>	HYPSO Project Team
<b>Reference:</b>	HYPSO-DR-021
<b>Revision:</b>	1
<b>Date of issue:</b>	15.05.2020
<b>Status:</b>	Preliminary
<b>Document Type:</b>	XXX

---

## Table Of Contents

---

<b>1 Overview</b>	<b>4</b>
1.1 Purpose	4
1.2 Scope	4
1.3 Summary	4
1.4 Applicable Documents	4
1.4 Referenced Documents	5
<b>2 Introduction</b>	<b>6</b>
2.1 Definitions	6
2.2 Development Process	6
2.3 The Control Room Purpose and Function	6
<b>3 Control Room Layout</b>	<b>7</b>
3.1 Facilitating co-working	8
3.2 Doors and windows	8
<b>4 Ergonomics</b>	<b>9</b>
4.1 Seating	9
4.2 Displays	9
4.2.1 Wall mounted display	9
4.3 Lighting	9
4.4 Glare and Reflection	9
<b>5 Operator Workstation Design</b>	<b>10</b>
5.1 Space between workstations	10
5.2 Equipment and spaces within workstations	10
5.3 Operator Workflow	12
<b>6 Supporting Areas</b>	<b>12</b>
6.1 Training and visits	12
<b>7 HYP SO Control Room</b>	<b>12</b>
7.1 Physical equipment	12
7.1.1 Wall mounted, large screen display	12
7.1.2 Operator workstations	12
<b>8 List of Abbreviations</b>	<b>13</b>





Table 1: Table of Changes

Rev.	Summary of Changes	Author(s)	Effective Date
1	<i>First issue</i>	<i>Siri Gulliksrud, Live Jacobsen</i>	<i>15.05.2020</i>



---

# 1 Overview

The HYPSO Mission will primarily be a science-oriented technology demonstrator. It will enable low-cost & high-performance hyperspectral imaging and autonomous onboard processing that fulfill science requirements in ocean color remote sensing and oceanography. NTNU SmallSat is prospected to be the first SmallSat developed at NTNU with launch planned for Q4 2020 followed by a second mission later. Furthermore, vision of a constellation of remote-sensing focused SmallSat will constitute a space-asset platform added to the multi-agent architecture of UAVs, USVs, AUVs and buoys that have similar ocean characterization objectives.

## 1.1 Purpose

The purpose of the Control Room Design Guide is to ensure a functional, safe and state-of-the-art control room.

## 1.2 Scope

This Design Guide applies to the HYPSO ground control room. The guidelines in this document are created specifically for operations in this environment.

## 1.3 Summary

The document consists of the following:

- Chapter 2: xxx

## 1.4 Applicable Documents

The following table lists the applicable documents for this document and work.

Table 2: Applicable Documents

ID	Author	Title



## 1.4 Referenced Documents

The documents listed in have been used as reference in creation of this document.

Table 3: Referenced Documents

ID	Author	Title
[RD01]	Hollifield, B., Oliver, D., Nimmo, I. & Habibi, E.	The High Performance HMI Handbook
[RD02]	ISO	Ergonomic Design of Control Centres - Part 2: Principles for the arrangement of control suites (ISO 11064-2:2000)
[RD03]	Gulliksrud, S., Jacobsen, L	Master Thesis: Expandable ground control system for satellite (2020)
[RD04]	SINTEF	The CRIOP Handbook (2011)
[RD05]	ISO	Ergonomic Design of Control Centres - Part 3: Control room layout (ISO 11064-3:1999)
[RD06]	ISO	Ergonomic Design of Control Centres - Part 4: Environmental requirements for control centres (ISO 11064-6:2005)



---

## 2 Introduction

### 2.1 Definitions

Throughout this document we'll use the following definitions

<b>Control centre</b>	All HYPSO related locations on NTNU campus. This includes the control room, ground station, work spaces and leisure spaces
<b>Ground station</b>	Antenna and servers used for sending and receiving and data from the satellite. Located on NTNU campus
<b>Control room</b>	The room containing the work stations of the operators and mission planner

### 2.2 Development Process

The control room should ideally be developed through a human-centered, ergonomic design process:

1. The jobs to be performed should be determined
2. The nature of the jobs determine the tasks to be accomplished
3. The tasks dictate the information requirements
4. The information requirements determine the [GUI design](#)
5. The GUI design directly influences the number of screens per workstation
6. The number of workstations depends on the work to be performed, the capabilities of the GUI and workload analysis.
7. The work stations and placement partially dictate the control room layout
8. Then the needs of the secondary users can be considered and the final design of the control room can be determined. [RD01]

SINTEF has published a [checklist](#) for the development of a control centre, which will be useful to look at when planning and building the control room. [RD04]

### 2.3 The Control Room Purpose and Function

The control room shall be designed with thoughts to future use, with possibilities of expansion. The room shall be split into two parts, the control stations part and an observation/lounge area for visitors. This to ensure that the operators are not disturbed during their shifts, while still being accessible for visits and observations.



The mission planner or administrator shall be placed at the back of the room to ensure full control of the processes currently ongoing. While there is only a single vessel to operate, this might not be necessary, but as the number of vessels increases, the need for an administrator increases. [RD03]

In the long run, the project goal is to operate several satellites and autonomous vessels from the same control room. At that time the room layout can be modified as shown below. At this point, it's uncertain how automatic or manual the operations will be. This depends on the HYP SO team. The room must be able to be scaled up and down for future tasks.

### 3 Control Room Layout

The control room layout reflects the responsibilities of the operators and the requirements for supervision by the mission planner.

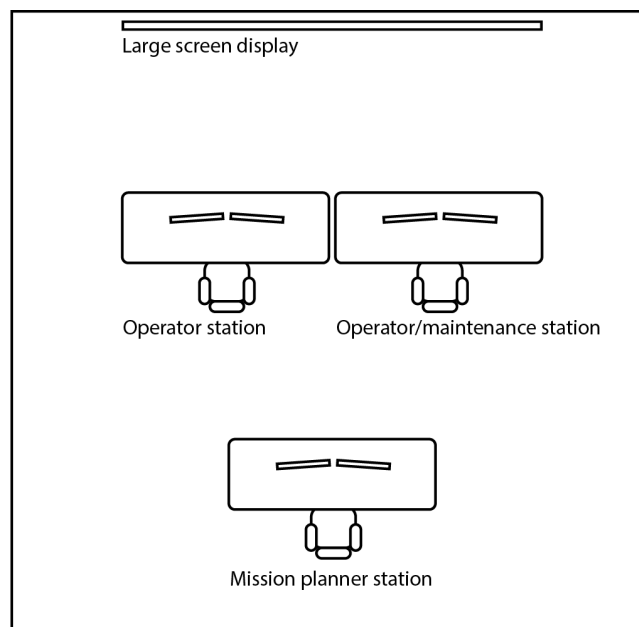

*Figure 3.1: Workstation layout*

One of the operator workstations (together with the wall mounted display) is sufficient to control the satellite. The other operator workstation is intended for maintenance work. A control room should contain allowance for an expansion of 25% [RD05]. The second operator workstation can be used for this purpose when another vessel is implemented in the system.

The mission planner is located at the back of the room. This makes it easier to support the operators when a situation occurs, without the need of verbal communication.



### 3.1 Facilitating co-working

The layout shall facilitate efficient co-working. The operators and mission planners workstation shall be close enough for verbal communication without shouting, this applies to work topics and social interactions. The workstations shall be wide enough for two operators to sit next to each other during co-working sessions or when training a new operator or a student. [RD03]

The wall mounted display shall be visible and readable to all workstations.

### 3.2 Doors and windows

Main entrances and exits should not be in the working visual fields of the operators, nor directly behind them. The same applies for windows. Windows situated behind the operators might result in reflections on the display screens [RD05].



*Figure 3.1.3: Render of control room layout*

## 4 Ergonomics

### 4.1 Seating

Posture variations should be possible during the workday. This can be achieved by different seating possibilities, and adjust the workflow so that the operator is able to move from their workstation for shorter periods of time [RD05].

### 4.2 Displays

High-contrast displays are to be avoided, as they put unnecessary strain on the operators eyes [RD01].

#### 4.2.1 Wall mounted display

The lowest operational information presented on the wall mounted display must be at least 400 mm above floor level to ensure readability from all workstations [RD05]. This should be tested when the control room is set up.

### 4.3 Lighting

500 Lux is the proper lighting level for a control room. Avoid dimly lit rooms (<250 Lux). [RD01]

### 4.4 Glare and Reflection

A brightly lit room can cause glare and reflection in the operators screens. Try modifying the walls and ceiling to avoid this.

As little as possible contrast of the ceiling and the ceiling lighting is desirable.

Ceiling lights should be spread out evenly, not centered in one place.

Avoid contrast between the wall and the wall hangings, e.g. dark walls with whiteboards.

In addition, the desk surfaces in front of the screen should have low contrast and reflectivity. [RD01]

Make room for supervisory tasks and associated task zone (ISO 11064-2)

---



---

The control room should be properly sound-proofed, to ensure no outside distractions during stressful situations.

Plants can be used to offer some variation to the room [RD06]

## 5 Operator Workstation Design

### 5.1 Space between workstations

There shall be sufficient room between stations for it to be wheelchair accessible. [RD03]

From the SINTEF checklist, to avoid accidental altering of controls:

“For main walkways:

Vertical - 2700 mm (2300 mm is recommended)

Horizontal – 1000 mm.

For access ways:

Vertical – 2100 mm (2050 mm in door openings and above each step in a fixed stepladder)

Horizontal – 600 mm.

Minimum width 900 mm for access to permanently and intermittently manned workplaces.

Distance between panels / cabinets / walls / equipment should be greater than 915 mm for desk to opposing surface, or 1250 mm between a single row panel where one person works at a time, 2500 mm for opposing rows where two or more persons work simultaneously.” [RD04]

### 5.2 Equipment and spaces within workstations

All workstations shall have two displays, and there shall be a keyboard and a computer mouse accessible to the operators. If the need for more than two displays arises, be aware that excessive amount of displays spread over a large space reduces their effectivity significantly [RD01]

When the operator is sitting or standing at the workstation, they should be able to see all displays without strain.

From the SINTEF checklist:

“Viewing distance to the visual display should be between 450 mm and 800 mm. It should not be necessary to turn the head more than 35 degrees left or right to see important displays (95 degrees for less important / not frequently used displays).”





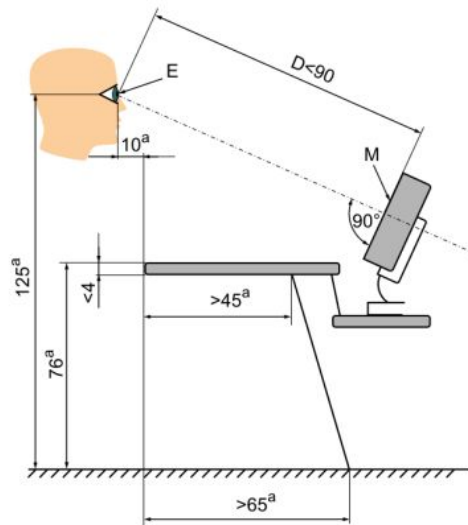

**Legend**

- <sup>a</sup> Examples, the values of the anticipated user population shall be applied
- D Viewing distance
- M Monitor (20" LCD)
- E Design eye point

Figure 3.3.2: Example of a seated and standing workstation. Measures in cm, seated. [RD04]

“The desk and chair at the operator's workplace shall be easily adjustable from seated and standing position. Note that a thick desk plate (e.g. with draws) may cause an unwanted working posture. Desk thickness shall be <40 mm. It is important that the desk is adjustable” [RD04]

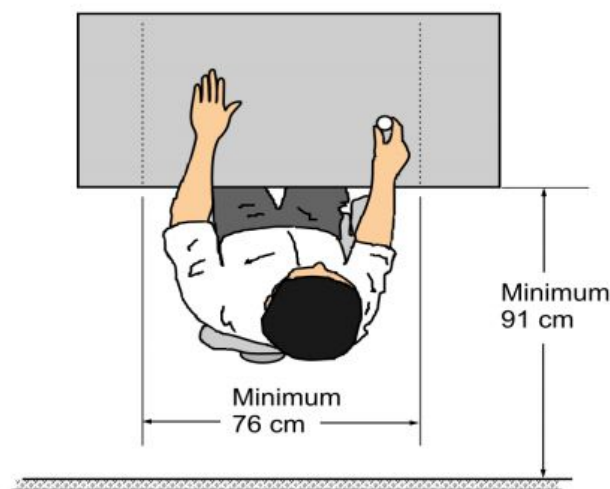

Figure 3.3.2: Spacing of equipment to accommodate seated users [RD04]



---

## 5.3 Operator Workflow

An operator should always meet their station in the default state, for easy navigation.

The manager (/mission controller) should be able to see all workstations from their seat, to easily catch when a situation arises. This gives a fallback to the operator, who might forget to notify the manager when engaged in a stressful situation.

## 6 Supporting Areas

To ensure a functional workspace, some supporting areas are needed. This includes toilets, showers and wardrobes within close range of the control room, personal storage space for the operators, as well as welfare areas such as a small kitchen and/or relaxation space [RD02].

### 6.1 Training and visits

Visitors area

The floor can be raised slightly to give the visitors easier access to the wall mounted display  
Security zones

## 7 HYP SO Control Room

### 7.1 Physical equipment

#### 7.1.1 Wall mounted, large screen display

Visible from all workstations

#### 7.1.2 Operator workstations

- Computer
- 2 displays
- Keyboard and mouse
- Room for co-working on the workstations. Should be room for at least two people seated at the table
- Mission planner/administrator workspace



---

## 8 List of Abbreviations

Table 3: List of Abbreviations

Abbrev.	Description
DCS	Distributed Control System
HF	Human Factors
HMI	Human Machine Interface



# GUI Design Guide

HYPSO-DR-020



<b>Prepared by:</b>	HYPSO Project Team
<b>Reference:</b>	HYPSO-DR-020
<b>Revision:</b>	1
<b>Date of issue:</b>	Date
<b>Status:</b>	Preliminary
<b>Document Type:</b>	Design Report

---

## Table Of Contents

---

<b>1 Overview</b>	<b>4</b>
1.1 Purpose	4
1.2 Scope	4
1.3 Summary	4
1.4 Applicable Documents	5
1.4 Referenced Documents	5
<b>2 Development Process</b>	<b>6</b>
2.1 Research	6
2.2 Prototyping	6
2.2.1 Low-fidelity prototyping	6
2.2.2 High-fidelity prototyping	6
2.3 Usability Testing	6
2.4 Analysis	7
<b>3 Object Library - Description and Use</b>	<b>7</b>
<b>4 Display Concepts, Objectives and Content</b>	<b>7</b>
4.1 Level 1 Display - Process Overview	7
4.2 Level 2 Display - Process Unit Operation Graphics	7
4.3 Level 3 Display - Process Detail Display	8
4.4 Level 4 Display - Process Support and Diagnostic Displays	8
<b>5 Display Layout and Density</b>	<b>8</b>
<b>6 Navigation Methods and Practices</b>	<b>8</b>
<b>7 Use, Implementation and Importance of Trends</b>	<b>9</b>
<b>8 Colour Usage</b>	<b>10</b>
8.1 Colour Definitions & Settings	10
8.1.1 Background colour	10
8.1.2 Foreground colours	10
8.2 Designing for Colour Deficiencies	12
<b>9 Detailed Display Element Specification and Functionality</b>	<b>13</b>
9.1 Depiction of Lines	13
9.1.1 Charts	13
9.1.2 Edges	13
9.2 Depiction of Static Text, Lists, Tables and Similar Structures	13

---



---

9.2.1 Static Text	13
9.2.1.1 Wall Mounted Screens	14
9.2.1.2 Desktop screens	14
9.2.2 Lists and Tables	14
9.3 Subsystems and Other Static Equipment	14
9.4 Dynamic States	15
9.5 Depicting Values	15
9.5.1 Live values	15
9.6 Data Input Mechanisms and Safeguards	16
9.7 Infoboxes	17
9.8 Shutdown Actuation Elements	17
<b>10 Alarm Functionality</b>	<b>18</b>
10.1 Proper Depiction of Alarms	18
10.2 Audible Alarm Tones	18
10.3 Alarm Management Functionality	18
10.4 Alarm and Graphic Association	18
10.5 Operator Alarm Responses	19
10.6 Spacecraft Modes	20
10.7 Multiple Alarms	20
<b>11 Special Purpose Graphics</b>	<b>20</b>
11.1 Startup Assistance	20
11.2 Shutdown Assistance	20
11.3 Expected Abnormal Situations	20
11.4 Product Change	20
<b>12 Display Call-up Speed and Performance Requirements</b>	<b>20</b>
<b>13 Management of Change</b>	<b>21</b>
<b>14 Master List - Abbreviations in the GUI</b>	<b>21</b>
<b>15 HYP SO GUI</b>	<b>21</b>
15.1 Displays	21
15.1.1 Level 1 - Overview Large Screen Display (LSD)	21
15.1.2 Level 2 - Spacecraft GUI	22
15.1.3 Level 3 - Payload GUI	23
15.1.4 Level 3 - Maintenance GUI	25
<b>16 List of Abbreviations</b>	<b>25</b>

---



Table 1: Table of Changes

Rev.	Summary of Changes	Author(s)	Effective Date
1	<i>First issue</i>	<i>Live Jacobsen, Siri Gulliksrud</i>	<i>15.05.2020</i>

# 1 Overview

The HYPSO Mission will primarily be a science-oriented technology demonstrator. It will enable low-cost & high-performance hyperspectral imaging and autonomous onboard processing that fulfill science requirements in ocean colour remote sensing and oceanography. NTNU SmallSat is prospected to be the first SmallSat developed at NTNU with launch planned for Q4 2020 followed by a second mission later. Furthermore, vision of a constellation of remote-sensing focused SmallSat will constitute a space-asset platform added to the multi-agent architecture of UAVs, USVs, AUVs and buoys that have similar ocean characterization objectives.

## 1.1 Purpose

The purpose of the GUI Design Guide is to ensure continuity across the distributed control systems (DCSs). Standardized HMIs reduce training time and simplify shift rotations. Operator stress, and situation-induced operator errors can be reduced, improving operator efficiency and job satisfaction.

## 1.2 Scope

This Design Guide applies to all DCSs used in the HYPSO ground control room. The guidelines in this document are created specifically for operations in this environment. Guidelines for other interfaces can be found in related documents.

## 1.3 Summary

A human centered design (HCD) process will be used for developing the graphical user interface (GUI). A description of the process is followed by chapters on display contents and layout. Display details are presented in chapters 7, 8 and 9. Alarm functionality is presented in chapter 10. Chapter 14 contains a list of all abbreviations used in the GUI.



## 1.4 Applicable Documents

The following table lists the applicable documents for this document and work.

Table 2: Applicable Documents

ID	Author	Title

## 1.4 Referenced Documents

The documents listed in have been used as reference in the creation of this document.

Table 3: Referenced Documents

ID	Author	Title
[RD01]	Hollifield, B., Oliver, D., Nimmo, I. & Habibi, E.	The High Performance HMI Handbook (2008)
[RD02]	Ware, Colin	Information Visualization (2013)
[RD03]	ISO	Ergonomic design of control centres - (ISO 11064-1 - 11064-7)
[RD04]	WAD	WCAG 2.1 (2018)
[RD05]	Martin, B. & Hanington, B. M.	Universal Methods of Design: 100 Ways to Research Complex Problems, Develop Innovative Ideas, and Design Effective Solutions. (2012)
[RD06]	Cooper, A., Reinmann, R., Cronin, D. & Noessel, C.	About Face: The essentials of interaction design (2014)
[RD07]	Gulliksrud, S. & Jacobsen, L.	Master Thesis: Expandable ground control system for satellite (2020)
[RD08]	IDEO	Human centered design : toolkit (2011)





## 2 Development Process

The GUI shall be developed through a human centered design (HCD) process. A HCD process puts the user first. The process identifies users and their needs, before locating the solution, through iterations and usability testing, to address those needs. This ensures that the solution creates value for the user, the user's needs are met, and that the solution is user friendly [RD08].

The HCD process used in the HYPSO mission is an iterative process, where each iteration contains four phases; research, prototyping, usability testing and analysis. Iterations can span from hours to weeks, depending on the desired outcome.

### 2.1 Research

During the research phase, information is gathered from both within and outside the project. This can be done by reading reports or papers, interviewing persons of interest or observing other solutions. Similar problems and solutions in other industries can be of interest when there is limited data in your own industry.

### 2.2 Prototyping

Prototyping can be done in high or low fidelity. Each with its own advantages.

#### 2.2.1 Low-fidelity prototyping

Low-fidelity prototypes can be as simple as a hand drawing on paper, or digital drawings. Low-fidelity prototyping facilitates criticism on the concept level, like hierarchy and logical flow [RD05].

#### 2.2.2 High-fidelity prototyping

High-fidelity prototypes are more detailed, and might appear as the finished product. These can be digital drawings, or coded prototypes. High-fidelity prototyping facilitates criticism on more detailed problems, like the positions of buttons or word usage [RD05].

### 2.3 Usability Testing

Usability testing is performed to locate the flaws in the prototype. This allows us to see how a user interacts with the prototype when given a set of tasks. This is highly efficient to locate pain points for the user. Usability testing is often performed as a simulation of a future scenario. This could be day-to-day operations, or specifically stressful situations [RD05].



## 2.4 Analysis

Results from the usability testing are evaluated and analysed up against a set of criteria. This analysis is the basis for the next iteration.

## 3 Object Library - Description and Use

The object library contains documentation on all objects used in the GUI. All components, symbols, colours and fonts can be found here.

Components from the object library can be altered, but only within the constraints of this design guide. New components should be developed through the use of this design guide.

The library can be found at link

## 4 Display Concepts, Objectives and Content

### 4.1 Level 1 Display - Process Overview

The level 1 display is the wall mounted overview display, and will give an at-a-glance view of the situation of the satellite. It shall give a clear indication of the current status and where the satellite is in its process. It should contain high level Key Performance Indicators such as quality, efficiency, progress, safety and environment. It can also contain values, trends and deviations of the Key Performance Indicators, and alarms of the top 2 or 3 priorities [RD01].

### 4.2 Level 2 Display - Process Unit Operation Graphics

For ongoing process manipulation. The level 2 graphic should contain information and control needed for the operator to perform most tasks. The operator should be able to do routine changes and some interventions when an unusual situation occurs. Values, such as telemetry, should be trended, and it should be possible to rescale the trends individually. Access to a level 3 view should be provided. Progress indicators are valuable, such as task lists that show where in the process a mission is or a timeline showing planned missions [RD01].



### 4.3 Level 3 Display - Process Detail Display

For close, detailed examination. Shall contain a detailed view of subsystems, telemetry and other information available but not necessary to see all the time. Custom, pre-built trend displays are also valuable here, such as openMCT components. It should be possible for the user to do specific diagnostics and give access to troubleshooting features. All indicators, controllers and alarms of all priorities can be shown here, and there can be several level 3 displays for each level 2 display. [RD01]

### 4.4 Level 4 Display - Process Support and Diagnostic Displays

For troubleshooting. This is the most detailed display, and should mainly be accessible by maintenance personnel or experts. It should contain detailed information about equipment and instruments. Help displays, system diagnostics, alarm summary etc is also possible to display here. Procedure information and documentation could also be kept here [RD01].

## 5 Display Layout and Density

Displays should be clean and uncluttered. The design must have a consistency, where the same “look and feel” should be present in all displays. This means that buttons with the same functions should be placed in the same location, and all graphs should have similar placements of units on axis etc. It is good practice to build and use standard display layout templates which contain common items for the different displays. This way the operators can recognize functionality without having to familiarize themselves with a new look for a different display [RD01].

## 6 Navigation Methods and Practices

There shall be navigation methods on desktop interfaces for both mouse and keyboard. All level 2 modules shall have a dedicated hotkey to open the corresponding level 3 detailed display.

There shall never be a need to type in names to locate a graph or module. Maintenance personnel should be able to find any graphic without knowing the hierarchy of the system. This can be solved by including a menu or providing direct access through the level 2 graphics/modules.



---

There shall never be a need to type in filenames to navigate in the GUI. Standard naming conventions must be created for all graphics and embedded displays, and the names shall be clear and descriptive. The names shall be shown clearly on the modules [RD01].

## 7 Use, Implementation and Importance of Trends

All key values shall be trended. Every level 2 graphic should have at least one trend of the important values. Trends facilitate situational awareness by giving the operator a context to the value, and an understanding of the process.

All charts of similar typings shall appear with the same, default timebase. The Y-axis on each chart shall scale automatically to a predetermined size relative to the average reading. The scale shall not be too large to show meaningful changes in value. Both axes should be bigger than 2 inches (on desktop), to have any effect. Normal values and bounds of operating range should be indicated where possible.

The operator shall not have to manipulate the axis' to make the trend usable. Manual operation of the axis' should be possible. If manually adjusted, a "return to default" option should be available.

Trends containing several traces should be consistently implemented. [RD01]



# 8 Colour Usage

## 8.1 Colour Definitions & Settings

Colour is to be used consistently in all workstations, to prevent confusion. Following are the colours to be used in the GUI. High-contrast displays are to be avoided, as they are fatiguing to the eyes of the users.

Likewise, it's important to have high enough contrast to support readability. To ensure this, all colours are set by following the Web Content Accessibility Guidelines (ver. 2.1).



Figure 8.1: Contrast ratio of main colors and text

### 8.1.1 Background colour

The background colour is a light gray, to avoid interference with other colour coding and prevent glare. The contrast ratio between the background and foreground colours is according to WCAG 2.1 AAA recommendations.

### 8.1.2 Foreground colours















Text should be a dark grey, not black, to prevent fatigue in the operators eyes.

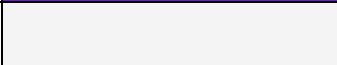

Bright or highly saturated colours are only to be used to draw the operators attention to abnormal situations or alarms. Alarms must be accompanied by more than just colour. Redundant coding is necessary. It also lowers the risk of errors being made due to cultural differences in colour association [RD06].

The level 3 yellow alarm does not have enough contrast with the background to qualify for WCAG 2.1 AA. Thus, it shall always be used with a low luminance contrast boundary, to separate it from the background [RD02].

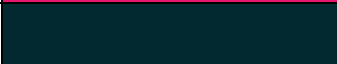
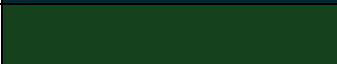
Table 4: GUI colours

Type	Hex code	Example
Background	#E2E2E2	
Text	#333333	
Alert, level 1	#E40F0D	
Alert, level 2	#D65600	
Alert, level 3	#FBE201	
Maintenance, level 4	#7217D4	
Prompt boxes and silenced alarms	#F4F4F4	
Dividers, axes	#808080	
Process, primary 1	#07778D	
Process, primary 2	#267632	
Process, primary 3	#9545E9	
Process, primary 4	#E51870	
Process, secondary 1	#032930	
Process, secondary 2	#15421C	
Process, secondary 3	#7217D4	
Process, secondary 4	#A81252	



## 8.2 Designing for Colour Deficiencies

It is important to consider the effects of colour deficiencies such as colour blindness. Important information must never be conveyed by colour alone. Colour can be used in combination with text, shape or texture to ensure redundancy [RD01, RD02].

The colours of the GUI are placed throughout the CIE 1931 colour space. The further apart two colours are, the easier it is for the human eye to distinguish them from each other. Alarm colours should be placed outside the colour space of the process colours, to ensure standing out sufficiently [RD02].

**Figure of CIE model**

Colour combinations that are easiest to perceive by most, are yellow-purple and green-purple. Colour combinations to avoid are red-green, green-yellow and white-cyan [RD02].



## 9 Detailed Display Element Specification and Functionality

### 9.1 Depiction of Lines

#### 9.1.1 Charts

Axes and grid lines shall be a dark gray. Significance is determined by line thickness, not colour. In a chart, there shall be no more than three line types (solid, dashed, dotted). Likewise, there shall be no more than three line thicknesses [RD01].

The average reading is to be displayed as a dashed line.

#### 9.1.2 Edges

Module edges are to be displayed as a solid, dark gray line, with a 40% black, 8px wide drop shadow, to separate from the background. [RD07]

When an item is selected, that status should be indicated. This can be done by highlighting the items edges with a white line. [RD01]

### 9.2 Depiction of Static Text, Lists, Tables and Similar Structures

#### 9.2.1 Static Text

Text shall be a dark grey, not black, to prevent fatigue in the operators eyes. Sans-serif fonts are preferred. There should be as little text as possible, without losing important data.

When operating several spacecraft with the same system, use larger, highly visible text to identify the spacecraft. Emphasize which spacecraft is being shown.

Ensure consistency with abbreviations. Maintain a master list (see chapter 13) [RD01].

Text sizes follow WCAG 2.1 AAA standard [RD04].





### 9.2.1.1 Wall Mounted Screens

*This should be considered upon determining the size of the screen. All text shall be readable from every operator workstation, as well as slightly readable to visitors in the far back of the control room. [RD07]*

### 9.2.1.2 Desktop screens

Titles: Roboto Bold 18pt, dark gray - #333333

Subtitles: Roboto Regular 14pt, uppercase 16pt, dark gray - #333333

Text, labels and axis values: Roboto Regular 12pt, dark gray - #333333

Text depicting commands: Inconsolata Regular 12pt, dark gray - #333333

### 9.2.2 Lists and Tables

Lists and tables shall have a line height of 15. Columns containing numbers shall be aligned on the decimal point. Avoid tables consisting solely of numbers [RD01].

## 9.3 Subsystems and Other Static Equipment

Subsystems should be depicted in 2D. The representation should show the subsystems shape, but not with too much detail. The interior of the subsystem should be uniformly shaded, and be the same as the background colour (see figure).

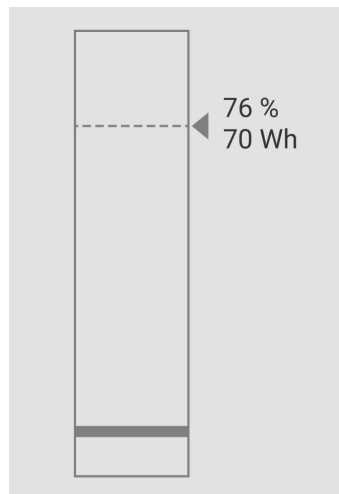

*Figure 9.3: Representation of battery status*

The subsystem should be outlined with a thin line of dark gray. There should be no animation associated with internal processes in the subsystem [RD01].



## 9.4 Dynamic States

It is important to show the current condition of subsystems that can have multiple operational states. State depiction should not depend on colour, but upon fill status, shape or simple text. The depiction must differentiate between equipment whose state is known, and equipment that gives no such signal [RD01].

STAR TRACKER <b>ON</b>	IMU <b>ON</b>	GYROSCOPE <b>3/3</b>
GPS <b>ON</b>	SUN SENSOR <b>4/6</b>	MAGNETOM. <b>2/3</b>
REACTION WH. <b>4/4</b>	HEATER <b>OFF</b>	UHF -

*Figure 9.4: Representation of subsystems in different states. Light gray is on, dark gray is off, while neutral gray is inactive or unknown*

## 9.5 Depicting Values

Values are shown only in the detail level required for the operator. More detailed values should be found elsewhere. Leading zeroes are not displayed, except on fractional values (e.g., 0.21). Where needed, the measurement unit can be displayed in lower contrast next to the value [RD01].

### 9.5.1 Live values

Live values should be shown in a different way than static text. [RD01]

Roboto bold 25pt, dark grey #333333 (for the timer on the wall mounted screen. Font size may be changed)



## 9.6 Data Input Mechanisms and Safeguards

Human error can occur whenever an operator inputs information. To avoid mistakes, the system shall give feedback to the user when something is wrong, why it is wrong, and how to fix it.

[RD01]

Example:

In the mission planning form, the input field where the wrong input was entered shall be highlighted with a red box, a small icon appears and a text explaining what was wrong and how to fix it. [RD02]



*Figure 9.6.1: Example of feedback given to user*

In addition, the mechanism used to try and validate the input must also give feedback to the user that something went wrong. [RD02]



*Figure 9.6.2: Example of mechanism feedback.*

When a task is validated, the user must be shown a prompt to ensure they are in the loop of what is happening and they should be given the opportunity to go back and change what they did. [RD07]



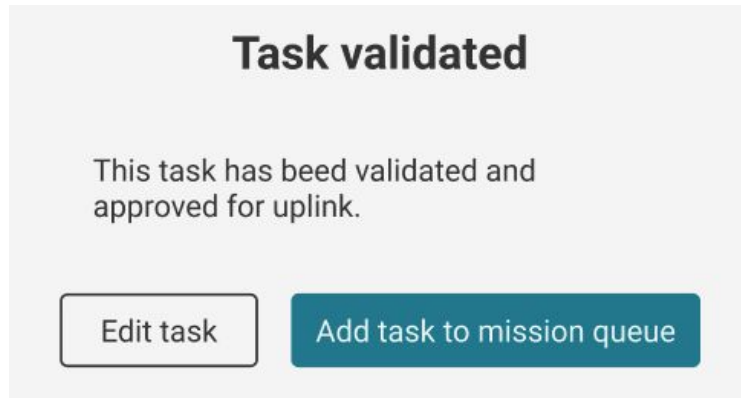

Figure 9.6.2: Example of feedback to the user with editing possibility

## 9.7 Infoboxes

Next to the input fields there shall be help for the user; e.g. a question mark icon can reveal upon hover an informational text about the input fields purpose. [RD07]

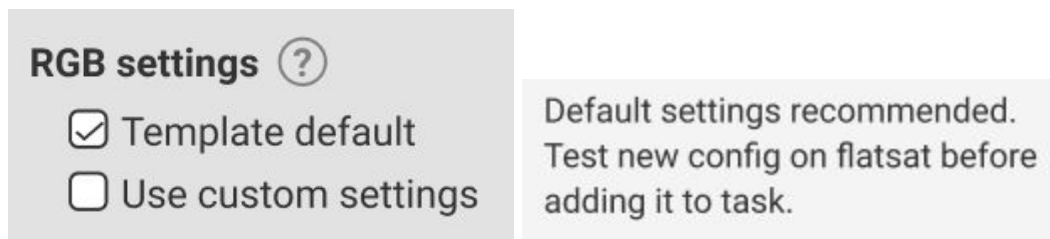

Figure 9.7: Example of input guidance for the user

## 9.8 Shutdown Actuation Elements

It should never be possible to perform a shutdown with a single selection. A “shutdown button” should call up at least one layer of confirmation before shutdown is possible. The default option on such a layer should always be the “safe” one, such as “Close window” or “Go back”. [RD01]



---

## 10 Alarm Functionality

### 10.1 Proper Depiction of Alarms

Any value related to an alarm must be shown clearly. If a value is connected to several alarms, the highest priority alarm should be indicated.

Every module with a configured alarm should have an associated Level 2 or Level 3 graphic display on the DCS, making it easily accessible to the operator. When an item comes into alarm, the display should be configured to show not only which value is in alarm, but to also highlight predetermined items associated with the alarm [RD01].

We follow a three-priority alarm system. Diagnostic or maintenance type alarms should be separated from these three.

### 10.2 Audible Alarm Tones

Every alarm priority should have a unique alarm sound. Sound levels should be about 15 dBA above background noise, but should not exceed 80 dBA [RD01].

Sound should be used sparingly. If alarms are highly frequent, alarms sounds can easily become an annoying disturbance. It should be possible to turn off the sound of the lower priority alarms during periods of high alarm load. If there are several workstations situated next to each other, but connected to different systems, different sounds should be used to avoid confusion.

### 10.3 Alarm Management Functionality

Unacknowledged alarms should be distinguished from acknowledged alarms. If an alarm has been suppressed, it should be clearly stated. The most common method is the flashing of the alarm indicator for the unacknowledged condition [RD01].

### 10.4 Alarm and Graphic Association

Colour is related to alarm priority. Every alarm priority has its own colour which is used for nothing else, on any graphic, than to depict alarm-related behavior.

Our peripheral vision is poor and colourblind. Stationary items in muted colors presented in the periphery of people's visual field will usually not be noticed. Motion in the periphery is usually noticed [RD02]. Thus, flashing alarms are a good tool for getting the operators attention.



A flashing alarm should never be displayed over/behind a process value, as it might obscure the value to the operator.

Priority 1: Red

Priority 2: Orange

Priority 3: Yellow

Diagnostic or maintenance: Purple

Alarms must always be coded redundantly, to ensure that colour blind users can operate the system safely. Colour can be used in combination with text, shape or texture to ensure redundancy [RD01, RD02].



Figure 10.4: Redundantly coded alarm symbols

## 10.5 Operator Alarm Responses

There shall be as few as possible number of clicks required to respond to an alarm.

After acknowledging an alarm, there shall be the possibility of one touch access to functionality or support for dealing with the issue at hand.

Alarms should only be acknowledged once, and be registered in the log for the next shift of operators to view.

When an alarm is acknowledged, e.g. silenced, it should not completely go away, but still be present both in the alarm module and the graphic where it is relevant, so that the operator can deal with it when they need. It should however change in appearance, to be distinguished from the unacknowledged alarm.

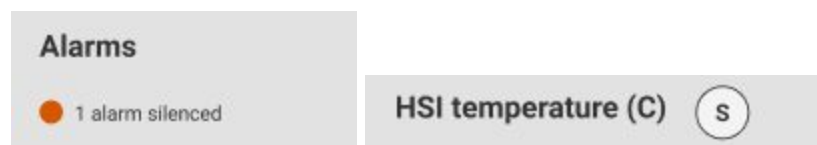

Figure 10.5: Examples of silenced alarms



## 10.6 Spacecraft Modes

If the spacecraft goes into a different mode, either automatically or manually, the operator shall be alerted about this and it shall clearly be stated on the level 1 and 2 displays. An autonomous change in mode shall be alerted through an alarm appropriate to the severity level. For example, if the system goes into safe mode, a priority 1 alarm goes off and the screen is locked while a pop up message informs the operator about what is going on. The screen shall then show what the new mode is and what functionality or data is no longer available, and for how long the mode will last if it has a time. [RD07]

*This needs further work to ensure that the different modes/situations have appropriate alarm priorities.*

## 10.7 Multiple Alarms

If multiple alarms should go off at once, the alarms with the highest priority shall be shown to the operator. Once the highest prioritized alarms have been dealt with, at least acknowledged, the lower prioritized ones should be presented. [RD01]

# 11 Special Purpose Graphics

## 11.1 Startup Assistance

## 11.2 Shutdown Assistance

## 11.3 Expected Abnormal Situations

## 11.4 Product Change

# 12 Display Call-up Speed and Performance Requirements

---



## 13 Management of Change

## 14 Master List - Abbreviations in the GUI

## 15 HYPSO GUI

### 15.1 Displays

#### 15.1.1 Level 1 - Overview Large Screen Display (LSD)

The wall mounted display contains a world map with the satellite's trajectory and current position. The satellite's radio footprint, as well as the ground stations radio range is also marked on the map. A timer displays when the next ground station pass will be, or how much time remains of an active pass.

During an active pass, a polar plot displaying the satellite's movement through the pass appears. Signal strength, as well as up- and downlink status, is also displayed during a ground station pass [RD07].







Figure 7.3.2.2.1: Wall-mounted display

### 15.1.2 Level 2 - Spacecraft GUI

The SC Health Display is situated to the right of the PL and Mission Planning Display. It contains a status panel (on/off/inactive) of all subsystems.

The battery module contains a battery charge level meter, and two charts depicting total generated and consumed power. When the charts are toggled, power generation and consumed power per subsystem is displayed. There is also a temperature and spin module with similar functionalities.

The attitude module depicts a simulation of the satellite's movement. Simulations from different points in time can be seen by dragging a handle on the time axis [RD07].



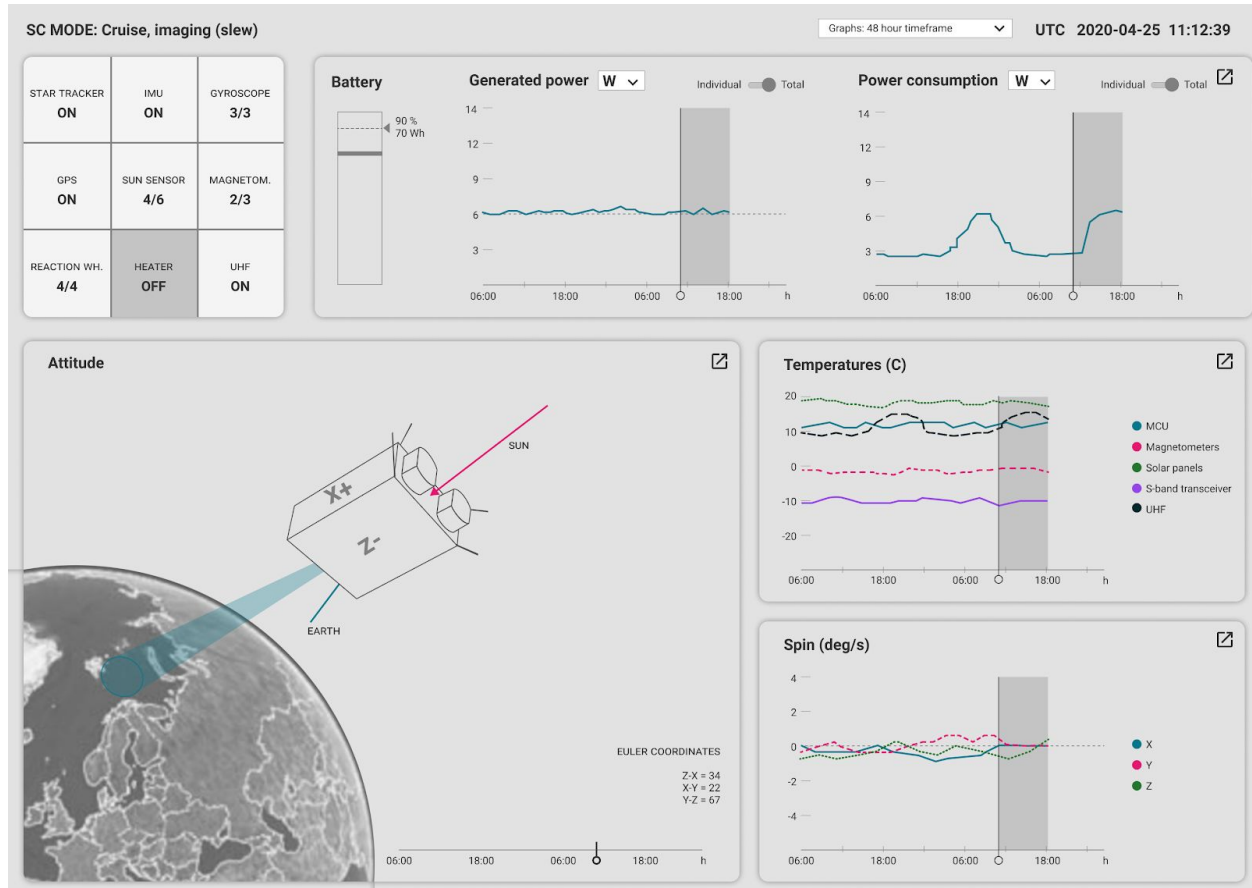

Figure 7.3.2.2.2: Right operator display

### 15.1.3 Level 3 - Payload GUI

The PL and Mission Planning Display is a level 2 display to the left on the desk of the operator. This display consists of four main modules.

The **alarm module** is an overview where all current alarms are shown.

The **payload health module** contains two graphs. The first shows the trend of the power consumption of the HSI, RGB and OPU, where it is possible to toggle between total power consumption and seeing the three subsystems separately. The second graph in this module displays the trend of the temperature of the HSI.

The **mission planning module** is a tabbed module containing the following tabs: Mission queue, commands, log and pass details.



- The mission queue tab shows the current mission and planned missions in a table with corresponding start time and end time. This tab also contains a “create new mission” - button which leads to the mission planning form.
- The commands tab contains a list of the commands that has been uplinked to the payload. It illustrates which commands have been executed and which command are currently being run.
- The log tab displays what has occurred and at what time, such as passes being initiated and completed (or not completed), and alarms that have gone off. It gives some information about the occurrences, and names of responsible operators if there are any.
- The pass details tab shows the SD card storage, data uplink and downlink progress, and contains a waterfall plot displaying the received power from the satellite during pass.

The **mission timeline module** illustrates the mission queue with an intuitive and interactive graphic.



Figure 7.3.2.2.3: Left operator display

Each module of the payload GUI expands to a level 3 interface when clicked, revealing all relevant data connected to the module[RD07].



## 15.1.4 Level 3 - Maintenance GUI

A Level 4 interface for maintenance personnel.

# 16 List of Abbreviations

Table 5: List of Abbreviations

Abbrev.	Description
DCS	Distributed Control System
HF	Human Factors
HMI	Human-Machine Interface
WCAG	Web Content Accessibility Guidelines
GUI	Graphical User Interface
CIE	Commision Internationale de l'Eclairage
UAV	Unmanned Aerial Vehicle
USV	Unmanned Surface Vehicle
AUV	Autonomous Underwater Vehicle



# Operational Scenarios

HYPSON-RP-040



<b>Prepared by:</b>	HYPSON Project Team
<b>Reference:</b>	HYPSON-RP-040
<b>Revision:</b>	1.0
<b>Date of issue:</b>	26.05.20
<b>Status:</b>	Preliminary
<b>Document Type:</b>	Report

---

## Table Of Contents

---

<b>1 Overview</b>	<b>4</b>
1.1 Purpose	4
1.2 Scope	4
1.3 Summary	4
1.4 Applicable Documents	4
1.5 Referenced Documents	5
<b>2 Operational Scenarios Overview</b>	<b>6</b>
2.1 Summary of groups of scenarios considered	6
2.2 Process of identifying scenarios	7
2.3 Operator Guidelines	8
<b>3 Nominal Scenarios</b>	<b>10</b>
3.1 Summary of scenarios considered	10
3.2 Slew imaging	10
3.2.1 Sequence of Activities	10
3.2.2 Sequence of Telecommands-type	10
3.2.3 Limitations/Requirements	11
3.3 Nadir imaging	12
3.5 Downlinking file in multiple passes	13
3.6 Telemetry data	14
<b>4 Problem Scenarios</b>	<b>15</b>
4.1 Safe scenario	15
4.2 Hardware Critical Scenario	15
4.3 Missed target for hw/sw reasons	16
4.4 Missed target for operational reasons	16
4.5 Memory management	17
4.6 Temperature-too-high	18
<b>5 List of Abbreviations</b>	<b>19</b>

Table 1: Table of Changes

Rev.	Summary of Changes	Author(s)	Effective Date
------	--------------------	-----------	----------------

---



---

1	<i>Initial issue</i>	<i>Sergio Carcelen Mariusz Grøtte</i>	<i>26.05.2020</i>



# 1 Overview

The HYPSO Mission will primarily be a science-oriented technology demonstrator. It will enable low-cost & high-performance hyperspectral imaging and autonomous onboard processing that fulfill science requirements in ocean color remote sensing and oceanography. NTNU SmallSat is prospected to be the first SmallSat developed at NTNU with launch planned for Q4 2020 followed by a second mission later. Furthermore, vision of a constellation of remote-sensing focused SmallSat will constitute a space-asset platform added to the multi-agent architecture of UAVs, USVs, AUVs and buoys that have similar ocean characterization objectives.

## 1.1 Purpose

The purpose of the Operational Scenarios report is to identify operational scenarios that the HYPSO satellite operational team will find itself in, identify the

Portion of requirements for ESA's Space Segment User Manual Standard.

**NOTE: THIS DOCUMENT IS UNDER DEVELOPMENT AND SHOULD BE CONSIDERED AS A DRAFT.**

## 1.2 Scope

This document covers some selected (more to be defined) operational scenarios that are expected during the mission operations of HYPSO-1. These are identified as "Normal" and "Problem" scenarios (for now).

## 1.3 Summary

The document consists of the following:

- Chapter 2: Operational Scenarios Overview
- Chapter 3: Nominal Scenarios
- Chapter 4: Problem Scenarios

## 1.4 Applicable Documents

The following table lists the applicable documents for this document and work.

Table 2: Applicable Documents

ID	Author	Title





---

## 1.5 Referenced Documents

The documents listed in have been used as reference in creation of this document.

Table 3: Referenced Documents

ID	Author	Title
[RD01]	Mariusz Grøtte	<a href="#">HYP SO-MOP-001 - Mission Operations Plan</a>
[RD02]	Sergio Carcelen	Commands for scenarios <a href="#">Scenarios commands</a>
[RD03]	Mariusz Grøtte	HYP SO Telemetry Format <a href="#">HYP SO Telemetry Format</a>



## 2 Operational Scenarios Overview

The operational scenarios represent the most important situations in which the satellite could be involved during its operational lifetime. The possible scenarios for the early phases of the launch are not studied in this document. The consequences and the regularity of the situations are the criteria that have been used to assess the importance of each one of the scenarios. That is to say, the aim is to have a response both for the most common situations and also for the most dangerous ones.

The scenarios can be used as the guidelines for developing the different commands and scripts that will be needed to successfully perform the mission. The first scenario will be a nominal mission with no unexpected events and the next ones are problems that could appear or situations in which certain planning is needed.

It is important to make clear that the scenarios are developed considering a base system consisting of NTNU and KSAT Svalbard ground stations and the HYP SO-1 satellite in addition to the operations center. Moreover, the strategies, associated commands, and scripts and implementation in the Graphical User Interface (GUI) to guide the satellite through these scenarios are currently being developed. Command-line (cli) tools are also used to communicate with the satellite.

Telemetry such as position, power consumption and temperature measurements need to be monitored by operators at all times (i.e. in every scenario).

### 2.1 Summary of groups of scenarios considered

The scenarios considered can be split into two groups: scenarios for nominal operations and for unexpected events. Below the most relevant ones are shown and will be described later in this document:

Nominal scenarios	Unexpected events
Slew imaging	Safe scenario
Nadir imaging	Hardware Critical Scenario
Software update, calibration and reboot	Missed target for hw/sw reasons
Downlinking file (multiple passes)	Missed target for operational reasons
Telemetry data	Memory management
Downlinking while imaging	Temperature-too-high



---

	S-band radio fails
--	--------------------

## 2.2 Process of identifying scenarios

The process of identifying the scenarios is:

1. **Determining the pertinent subsystems and their interfaces:**
  - a. **Defining the system.** The base system consists of the operations centre, NTNU and KSAT Svalbard ground stations and the HYP SO-1 satellite. Since these elements are the most critical, they are the ones considered. However, there will be other elements in the ground segment besides the ground stations as well as other ground stations that could be added to the base system in the near future.
  - b. **Learning from each of the elements of the system.** There has been a special focus on the satellite and its subsystems so the ground stations have been considered as one subsystem more when it comes to importance. Learning from the different elements in this step as well as deeper in the step 5 are the bigger tasks of the whole process of identification. The sources that have been used for this purpose are data sheets, previous documents developed by the team, papers, books, videos and direct talks with members of the team specialized in the field of interest for the question, either privately or through workshops. Some of the most important sources used for this purpose have been:
2. **Tasks to execute in each scenario:**
  - a. **Defining what each of the elements of the system should do sequentially** to perform a standard mission. Break down the mission into smaller actions.
  - b. **Assessing in which of the steps a problem could appear and its importance.** Along this step it was really important to know which processes are automatically done by the satellite and which ones are done manually.
  - c. **Learning what each subsystem should do internally to execute each task.** That is to say, extract the smallest possible actions to translate them into commands.
  - d. **Comparing the smallest tasks against the existing commands.** Some of the existing ones were provided by the NanoAvionics software and were being copied to the hypso-cli while the commands for the payload were being created by the hypso software team. Therefore working close to the software team was needed to understand and update the commands.
3. **Classification and sequencing of commands:**
  - a. **Creating a spreadsheet to classify the commands by functionality/subsystem, order them sequentially, define and explain their inputs if needed and indicate if they are already created in hypso-cli** all in the same page. This is done for the standard scenario but also later for the other most important scenarios. Although it is still in development since it is a work in parallel with the development of commands by the software team. The spreadsheet is quite relevant because it is the closest document to a script so it will be useful when developing them. Also, it should be clarified that these scripts



should be scheduled with a timestamp to execute them and the proper delay between commands (which is another command) should be tested.

- b. **Assessing in which steps of the internal process a problem could appear and its importance.** At this point, together with the already registered possible problems and the ones added at this step, many scenarios are identified, analysed and explained.
4. **Categorizing the scenarios:**
    - a. **Choosing the most important scenarios.** These scenarios are added to the spreadsheet for further analysis. As already mentioned, this is done by criteria of frequency and consequences.
    - b. **Assessing whether the solution to the problems could be automatic or should be manual.**

#### The process for identifying scenarios has limitations:

- N-squared matrixes for at least the most relevant interfaces to unveil possible problems and improvements have not been done. This could be a more precise and visual tool to analyse subsystems and its interfaces.
- A more sound way to justify the importance of each scenario would include further calculations and simulations, risk assessments and statistics.

## 2.3 Operator Guidelines

Tools provided to operators based on this document include a list of commands ordered and classified for each scenario to see more clearly in which step a problem may appear, and the interfaces and subsystems that are involved as well as the sequence can be consulted in [Scenarios commands](#) [RD02].

This document provides several tools for the operators:

- The scenarios could be used as a guideline to develop a document on how to analyse and unveil a possible error/how to deal with operational problems. That is to say, a concise guide with steps on how to solve the most common troubles that an operator has to face related to each of the scenarios will help operators to know what to do and what parameters to check. Each of the examined scenarios contain a list of potentially important aspects that the operators should monitor.
- This document should make it easier to check if a script is missing something and also to develop new scripts, as you would find the processes of each scenario sequentially described.
- The scenarios help also to reveal limitations and requirements of the different subsystems, so they can be used to check (as a checklist) if the requirements that are



being detected are met for each of the scenarios and also to reveal more plausible scenarios which the satellite might enter in.



### 3 Nominal Scenarios

#### 3.1 Summary of scenarios considered

The structure of the scenario presentation is:

- (1) sequential description
- (2) critical commands
- (3) relevant telemetry
- (4) limitations/requirements extracted from that scenario.

#### 3.2 Slew imaging

##### 3.2.1 Sequence of Activities

1. Uplinking process from KSAT with the scripts of what the satellite should do (including the target and the times). Pointing toward KSAT Svalbard shall be scheduled at desired specific times during the day.
2. Configuration of ADCS, set Slew Maneuver Mode (Flow Maneuver or Vector-Fixed strategies can be chosen).
3. Configuration of HSI and RGB camera (parameters and time).
4. Imaging with HSI for 56.9 seconds
5. Imaging with RGB for 1 second mid-scan of HSI (at 28.5 seconds).
6. Buffer the payload data from OPU (from memory RAM or SD cards) to PC.
7. (Buffer payload data to SD cards). Currently takes 1.8 hrs.
8. Downlinking at NTNU. Pointing toward ground stations shall be scheduled at desired specific times during the day. # of these passes is calculated according to the data budget. Currently 2 passes need to be scheduled for ADCS to point towards NTNU and KSAT Svalbard.

This is the baseline scenario from which the rest will be developed.

##### 3.2.2 Sequence of Telecommands-type

Sequence	Critical telecommands-type	Executor
1	Uplink files with configuration for each subsystem and timestamps for pointing and imaging	Ops.Center
2	ADCS configuration	FC
3	HSI configuration, RGB	FC



	configuration	
4	HSI capturing	FC
5	RGB capturing	OPU
6	Data buffering	OPU
7	Download telemetry from every subsystem	Ops.Center
8	Download RGB image	Ops.Center
9	Download cube with HSI images	Ops.Center

**Telemetry** desired:

- From FC (Startracker and IMU data is included in ADCS TM from FC)
- OPU
- EPS
- Memory in OPU and PC

See [RD03] for standard spacecraft telemetry and desired payload telemetry.

### 3.2.3 Limitations/Requirements

- The Ops. Center schedules the communication with the satellite and then the pointing of both will be automatic. That is to say, once the satellite gets on its line of sight, the Ops. Center needs to automatically point through the Ground Station and send the desired commands/scripts if they are scheduled. What's the UI to do that right now? What the GS sends to start the communication?

Then, this should be synchronized with the satellite pointing so the configuration of the ADCS state and initialization through the scheduler must be done in advance. The needed number of passes can be calculated from the data budget and that may mean more passes/scheduled pointing.

- Assessment of the resolution variance with each of the ADCS modes and make strategies on which one is better for each situation. HSI imaging time for 56.9 s is the maximum?
- Integration of commands/scripts and scheduling with the UI. A Command Line Interface is used as well as forms (it could be other type) strategies that makes it more user-friendly to take the most common decisions (file names, # of images...).
- More than one RGB frame at the beginning to have a backup. If the resolution is bad or something fails through the pipeline, it is easy to have just another image.
- Automatically suggest an scheduled downlinking when the payload data memory is getting full and also an upcoming imaging is scheduled. Since it would be done already in the standard script, this would be useful just as a backup in case the downlinking is not successful.
- Development of a document on how to analyse and unveil a possible error/



how to deal with operations problems would also be useful and these scenarios could be used as a guideline through some of the possible problems.

### 3.3 Nadir imaging

Uplinking process from KSAT with the scripts of what the satellite should do (including the target and the times). Pointing toward KSAT Svalbard shall be scheduled at desired specific times during the day.

1. Configuration of ADCS, set Nadir.
2. Configuration of HSI and RGB camera (parameters and time).
3. Imaging with HSI for 9.2 seconds
4. Imaging with RGB for 1 second mid-scan of HSI (at 4.1 seconds).
5. Buffer the payload data from OPU (from SD card) to PC.
6. (Buffer payload data to SD cards). Currently takes 33 min.
7. Downlinking at NTNU. Pointing toward ground stations shall be scheduled at desired specific times during the day. # of these passes is calculated according to the data budget. Currently 0.5 passes need to be scheduled for ADCS to point towards NTNU and KSAT Svalbard.

This is the baseline scenario from which the rest will be developed.

Sequence	Critical telecommands-type	Executor
1	Uplink files with configuration for each subsystem and timestamps for pointing and imaging	Ops.Center
2	ADCS configuration	FC
3	HSI configuration, RGB configuration	FC
4	HSI capturing	FC
5	RGB capturing (simultaneously with command 4)	OPU
6	Data buffering	OPU
7	Download telemetry from every subsystem	Ops.Center
8	Download RGB image	Ops.Center
9	Download cube with HSI images	Ops.Center





**Telemetry** desired:

- From FC (Startracker and IMU data is included in ADCS TM from FC)
- OPU
- EPS
- Memory in OPU and PC

See [RD03] for standard spacecraft telemetry and desired payload telemetry.

### 3.5 Downlinking file in multiple passes

More than one pass may be required to downlink all the images. It depends on the number of images, resolution and if the user wants the raw data or already processed data (operational data). To calculate the number of passes, one needs to know the size of the data, the rate of radio and the time available to downlink in each pass.

1. Firstly, the mission is performed as the standard scenario.
2. In each subsequent pass, the more data is downloaded, until the whole file is downloaded.

For the first part of the mission, the critical telecommands will be the same ones as for the standard scenario. For the second part:

Sequence	Critical telecommands-type	Executor
1	ADCS configuration	FC
2	Download telemetry from payload	Ops.Center
3	Download telemetry from every subsystem	Ops.Center
4	Download cube with HSI images	Ops.Center
5	Release the memory	Ops.Center

**Telemetry** desired:

- From FC (Startracker and IMU data is included in ADCS TM from FC)
- OPU
- EPS
- Memory in OPU and PC

#### Limitations/Requirements

- When the schedule, number of images and operational data type is selected, there



should be compute automatically how many passes would you need to perform the mission taking into account the scheduled missions.

- It could be useful to automatically schedule a slot for the KSAT ground station when filling out the mission planning form.

### 3.6 Telemetry data

- This scenario is active when the user does not want to take images, or if the satellite is in safe mode.
- Only telemetry data for housekeeping purposes will be downloaded.

Sequence	Critical telecommands-type	Executor
1	ADCS configuration	FC
2	Download telemetry from every subsystem	Ops.Center

**Telemetry desired:**

- From FC (Startracker and IMU data is included in ADCS TM from FC)
- OPU
- EPS
- Memory in OPU and PC

See [RD03] for standard spacecraft telemetry and desired payload telemetry.



## 4 Exceptional Scenarios

### 4.1 Safe scenario

- There can be an anomaly or something wrong in the functioning of the satellite, so it may be dangerous to stay active.
- The power goes below a threshold and the satellite (EPS) turns off the payload. Safe Mode is triggered automatically by the EPS. Telemetry needs to be monitored.

Sequence	Critical telecommands-type	Executor
1	ADCS configuration	FC
2	Downlink Telemetry	Ops.Center

- It could also happen that something is ON that should not be ON. This should be manually corrected.

**Telemetry desired:**

- EPS
- OPU
- Memory in OPU and PC
- From FC (Startracker and IMU data is included in ADCS TM from FC). General telemetry is more important in this case than ADCS related data.

See [RD03] for standard spacecraft telemetry and desired payload telemetry.

#### Limitations/Requirements

- In this scenario would be also included the case in which the environmental conditions are not suitable for imaging so it would be delayed. Therefore, it should be needed to define a threshold over which a recommendation to “not image for environmental difficulties” pop up. This would save memory and power.

### 4.2 Hardware Critical Scenario

- There can be a critical damage to a subsystem or component, that may cause further damage to the satellite. For instance, this can be a consequence of an overheated EPS. But it can also happen that there is a critical error in the EPS/FC or other systems.
- Turn off everything for mitigation, done automatically after exceeding the security thresholds.
- Critical subsystems are turned OFF



- EPS is automatically turned ON at 6.5 V.

**Limitations/Requirements**

- Strategy after this? What should be checked, how much should we wait if there is no Damage? In general we should try to download telemetry at every pass.

**4.3 Missed target for hw/sw reasons**

- In this scenario, the target is missed or is anticipated to be missed. For instance, there might be a problem with the on-board processing unit (OPU), e.g. the image file is not saved, or the satellite pointed at the wrong location.
- The downloading of images is rescheduled manually from the ground station, if the downlink has not already begun.
- The telemetry data is used to analyse the problem.

Sequence	Critical telecommands-type	Executor
1	ADCS configuration	
2	Rescheduled download of the images	Ops.Center
3	Release memory*	PC

\* In case that the script has not been rescheduled in time, the memory will be released by deleting the images.

**Limitations/Requirements**

- In future HYPSON updates, it should be useful to cancel a script even if it is already running to save memory, power and time.

**4.4 Missed target for operational reasons**

- The target is missed because the ground station made a mistake in the uplinked parameters or the uplinked script so the process of downlinking is cancelled. This scenario can also be a solution for the situation in which the resolution of the operational data is not good enough and it is necessary to image again (for example if the weather was not forecasted with enough accuracy).



- Similar to scenario 6, but in this one for sure it will be needed to upload the corrected scripts again, instead of just rescheduling the timestamp.

Sequence	Critical telecommands-type	Executor
1	ADCS configuration	
2	Send uplinking files with parameters	Ops.Center
3	Release memory*	PC

\* In case that the script has not been cancelled in time, the memory will be released by deleting the images.

**Limitations/Requirements**

- For avoiding this situation, a checker for the scripts could be developed. NA has its own checker so the HYP SO team would develop one mostly for the payload. Also, once you fill out the mission planning form, you could instead of submitting, have another page in which you see all you have selected and you confirm. That second page could be useful to look at the form with another perspective and realize any mistake.

**4.5 Memory management**

- It is not possible to downlink the images at NTNU and/or KSAT Svalbard in first pass(es). Perhaps due to power consumption issues or problems with the antennas on ground.
- In the next pass over KSAT Svalbard, the uplinking commands send the satellite to take more images (maybe because something important is happening in the target).
- (When possible to downlink in subsequent passes), even if it could be possible to downlink at the same time, decisions must be made on how to manage a limited memory resource.
- Don't take more images than 1 per pass, schedule downlink for subsequent passes.
- You can get memory issues in buffering, needing to schedule to be only one HSI cube at the time.

**Telemetry desired:**

- From FC (Startracker and IMU data is included in ADCS TM from FC)
- OPU
- EPS
- Memory in OPU and PC



See [RD03] for standard spacecraft telemetry and desired payload telemetry.

**Limitations/Requirements**

- This unveils a useful alert in the UI. In order to avoid a critical situation with the memory, when you insert a new mission in the UI, if the memory is too full to perform that new mission (taking into account the number of images selected...) it could recommend to schedule a mission that releases the memory before if possible. And depends on the situation, if you do not take into account the suggestion because is more relevant to image in that moment, a pop-up could appear saying something like “You should delete data from previous missions in order to perform the mission. Do you continue anyway?”.
- In general, make a profound evaluation of the possible memory problems, taking into account space and time (1.8 hrs. To buffer payload data to SD cards...)

**4.6 Temperature-too-high**

- The temperature is too high, so ADCS is set to “barbeque” (BBQ) mode. In the BBQ mode the spacecraft spins rotating about its z-axis aligned with the velocity vector - this avoids solar heating and dumps the accumulated heat.
- The operator needs to manually turn off the payload.

Sequence	Critical telecommands-type	Executor
1	Power off <OPU, HSI, RGB>	Ops.Center
2	ADCS set to BBQ Mode	Ops.Center

**Limitations/Requirements**

- Even if it is not automated in the satellite, It could be relevant to automate the ‘turn off’ from the GS because it could save time before something is damaged. The payload would not be in a big danger since is on just for a few minutes but it could be worse in the EPS.
- A calibration maybe could be needed after executing the BBQ mode when the satellite is already safe?



## 5 List of Abbreviations

Table 5.1: List of Abbreviations

Abbrv.	Description
ABD	Aided Blind Deconvolution
AC	Atmospheric Correction
AIT	Assembly, Integration and Test
ADC	Analog to Digital Converter
ADCS	Attitude Determination and Control System
AOCS	Attitude and Orbit Control System
Aoi	Area of Interest
API	Application Programming Interface
AxV	Autonomous Vehicles
BB	Breadboard
BER	Bit Error Rate
CAD	Computer Aided Design
CAN	Controlled Area Network
CCSDS	Consultative Committee for Space Data Systems
CDR	Critical Design Review
CoG/COG	Centre of Gravity
COM	Communication
CoM	Center of Mass
COTS	Commercial Off-The-Shelf
CPU	Central Processing Unit
CSP	Cubesat Space Protocol
CTE	Coefficient of Thermal Expansion
DAC	Digital to Analog Converter
DN	Digital Number
DSP	Digital Signal Processor



ECEF	Earth Centered Earth Fixed
ECI	Earth Centered Inertial
EEE	Electrical, Electronic and Electro-mechanical
EM	Engineering Model
EPS	Electric Power System
ESA	European Space Agency
FC	Flight Computer
FEM	Finite Element Method
FFT	Fast Fourier Transform
FM	Flight Model
FOV	Field of View
FPGA	Field Programmable Gate Array
FPS	Frames Per Second
FRR	Flight Readiness Review
FWHM	Full-Width Half-Maximum
GMSK	Gaussian Minimum Shift Keying
GNSS	Global Navigation Satellite System
GPS	Global Positioning System
GSE	Ground Support Equipment
HSI	HyperSpectral Imager
HW	Hardware
HYPSO	HYPer-spectral Smallsat for Ocean observation
ICD	Interface Control Document
IMU	Inertial Measurement Unit
IOCCG	International Ocean-Colour Coordinating Group
IOD	In Orbit Demonstration
IOP	Inherent Optical Properties
IR	InfraRed





---

I2C	Inter-Integrated Circuit
LEO	Low-Earth Orbit
LEOP	Launch and Early Orbit Phase
LNA	Low Noise Amplifier
LQR	Linear-Quadratic Regulator
Lw	Water Leaving Radiance
MM	Mass Model
Mol/MOI	Moment of Inertia
MPC	Model Predictive Control
MTF	Modular Transfer Function
NASA	National Aeronautics and Space Administration
NTNU	Norwegian University of Science and Technology
OBPG	Ocean Biology Processing Group
OTFP	On-The-Fly-Processing
PA	Power Amplifier
PCB	Printed Circuit Board
PDR	Preliminary Design Review
PID	Proportional-Derivative-Integral
PSD	Power Spectral Density
PSF	Point Spread Function
QAR	Qualification and Acceptance Review
RAM	Random Access Memory
RF	Radio Frequency
RGB	Red-Green-Blue
RMS	Root-Mean-Square
RW	Reaction Wheel
RX	Receive
SD	Secure Digital

---



---

SDR	Software Defined Radio
SNR	System to Noise Ratio
SOC	System-on-Chip
SOM	System-on-Module
SST	NX Space Systems Thermal
STM	Structural Thermal Models
SW	Software
SWIR	Short-Wave Infrared
TBC	To Be Confirmed
TBD	To Be Determined
TM/TC	Telemetry/Telecommand
TRL	Technology Readiness Level
TRB	Test Review Board
TRR	Test Readiness Review
TX	Transmit
UART	Universal Asynchronous Receiver-Transmitter
UHF	Ultra High Frequency
UxV	Unmanned Vehicles
WCS	World Coordinate System



# Organization chart for HYPSON, spring 2020

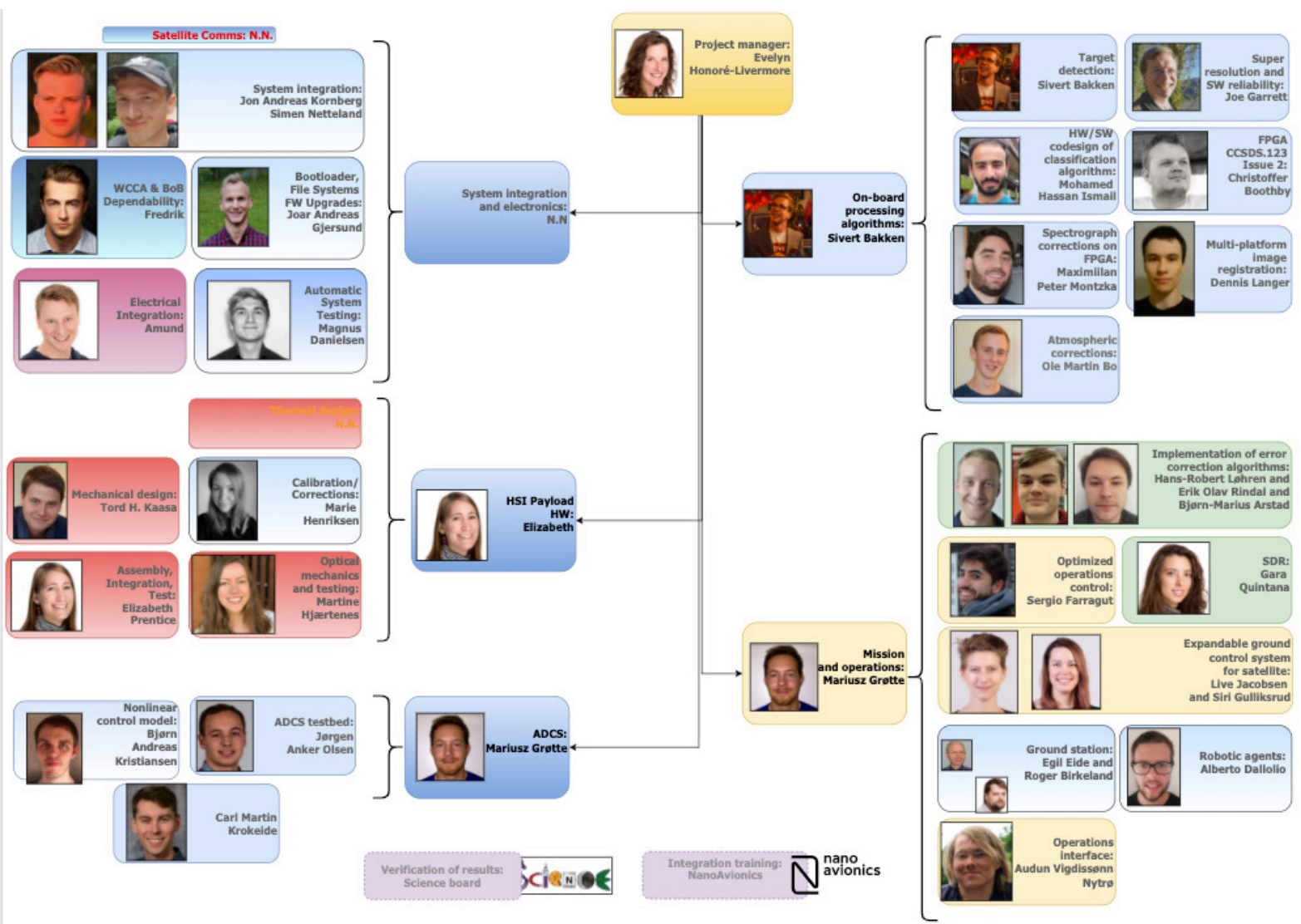

### **Consent form**

During this test we will be recording audio and video of you, as well as your screen. These recordings will be used solely in relation to our master thesis. Should we want to use this for other purposes, we need your permission.

You can withdraw from the test at any time, also after the test has ended. Contact us to erase your test data. Does this sound ok to you?

### **Initial questions**

Age?

Nationality?

What is your role on the HYPSON team?

What academic background do you have?

What is your future within the HYPSON team?

### **Initial information**

This test consists of two parts. The operator will have two screens in the future, but here we'll be testing them one by one. At first you'll see the overview screen of payload health and current task queue. Here you will receive an order from a customer to execute.

The second screen will be an overview of the health of the overall spacecraft. Here we'd like to see if you get enough information for decision making.

You are a new operator without any training in this system.

During the tests we'd like for you to think out loud, tell us why you decide to do each action, and what you expect will happen when you do so. We are not testing you, we are testing our sketches.

### **Mission planning**

This is the first out of two screens. Can you tell us what you see?

So we just received a call that some fish farmers want us to take a look outside Frøya, to check for algae.

What do you see?

A standard pass should be sufficient.

We can assume that the task is small enough to be performed in one pass  
As we're doing a standard pass, no extra cli commands are needed

We'll stick to the default image params for both rgb and hsi

2500 frames

The rgb images should be compressed and saved as png's

What do you think validate task means? What do you expect will happen?

What happened now? What do you have to do?

What do you think add task to mission queue means?

Can you see your task?

What do you think about this?

Is there any other information you need to add a task?

Was anything unnecessary?

Did they use infoboxes, why/why not

### **Spacecraft screen**

This is the second of the two screens. Tell us what you see here.

- What do you think silence alarm means, if they don't comment
- Explain whatever they don't understand?
- The alarms are supposed to be blinking?
- If they don't do anything about the alarms, suggest that they take action

Red alarm

- What do you think is the difference between yellow and red, if they don't comment
- What do you expect to happen when you choose to go into safe mode?
  
- What do you think the small arrows up in the right corners mean?

# Prototype 2, all screens

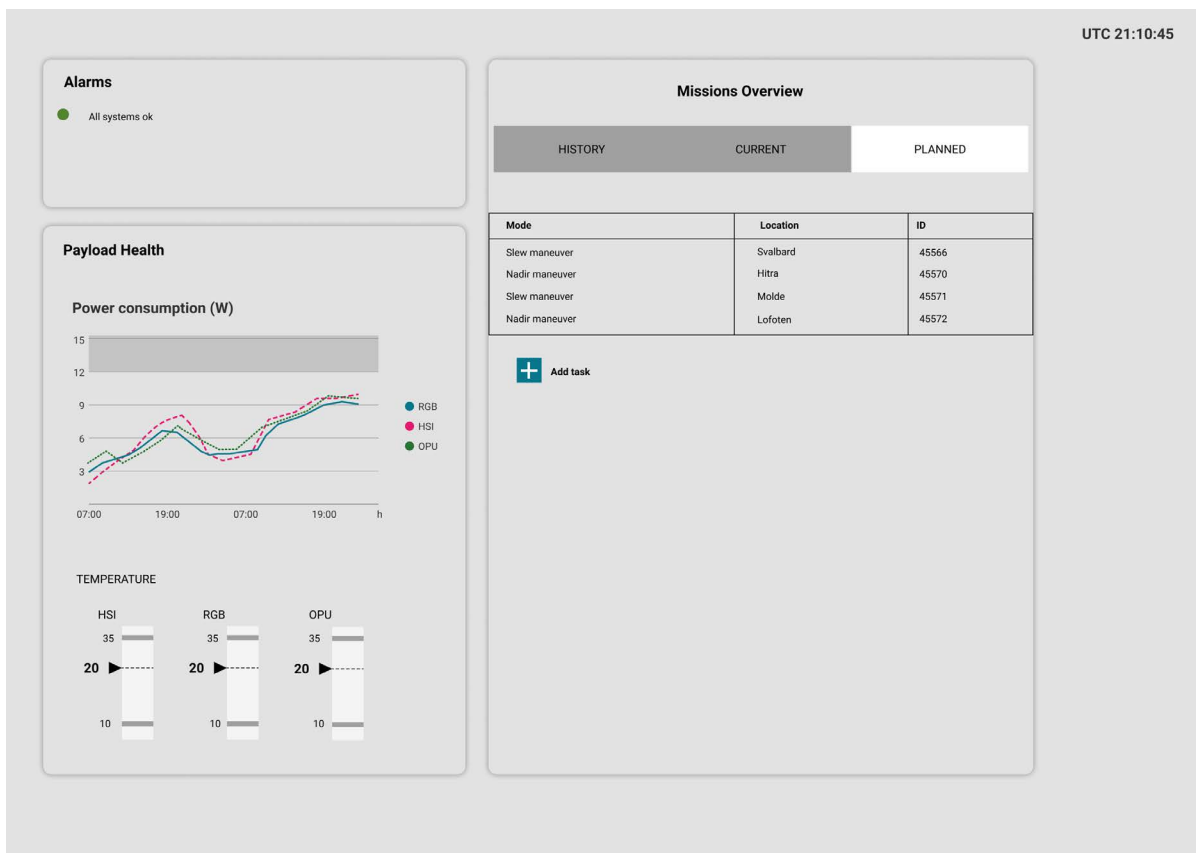

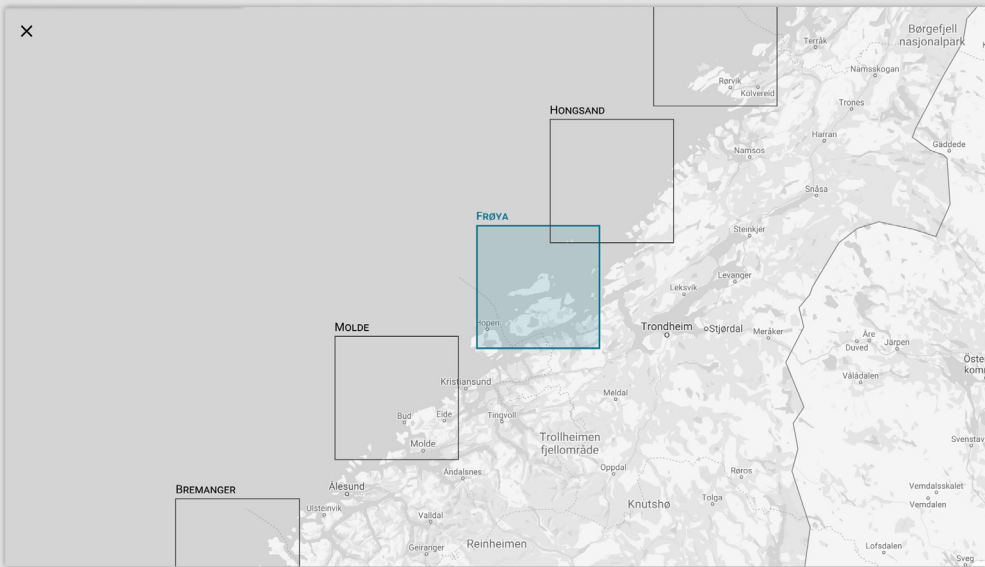
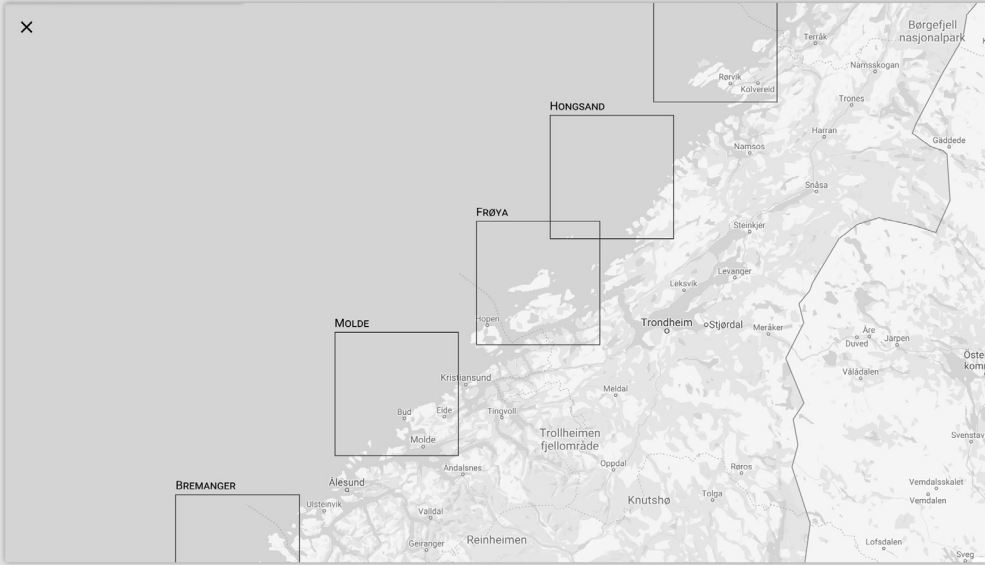

## New task

### TASK OUTLINE

#### Template ?

Standard Pass

#### Priority task ?

- Yes  
 No

#### Can be split in multiple passes? ?

- Yes  
 No

#### Start time ?

- First available pass  
 Enter custom value

### INITIALIZATION

Can be used to enter cli commands and definitions

1:

### ADCS

#### Set ADCS state ?

Pointing

#### Choose maneuver ?

- Nadir  
 Slew

#### Select imaging area ?

Select area on map: 

or enter corner coordinates manually:

1:  N  E  
2:  N  E

### HSI

#### Number of frames ?

2300

#### Camera parameters ?

- Default  
 Enter custom values

#### File naming ?

- Default  
 Enter custom values

### RGB

#### Initialization ?

- Default  
 Upload custom config file

#### Camera parameters ?

- Default  
 Enter custom values

#### Hardware trigger ?

- On  
 Off

#### Demosaic options ?

- rgb  
 raw

#### Image format

png

#### File naming ?

- Default  
 Enter custom values

Save draft

Validate task



## New task

**TASK OUTLINE**

**Template** ⓘ  
Standard Pass ▼

**Priority task** ⓘ  
 Yes  
 No

**Can be split in multiple passes?** ⓘ  
 Yes  
 No

**Start time** ⓘ  
 First available pass  
 Enter custom value

Task too large to be performed in one pass

**INITIALIZATION**

Can be used to enter cll commands and definitions

1

**ADCS**

**Set ADCS state** ⓘ  
Pointing ▼

**Choose maneuver** ⓘ  
 Nadir  
 Slew

**Select imaging area** ⓘ  
Select area on map ⓘ  
or enter corner coordinates manually:

1:	63.389485	N	7.874009	E
2:	64.063605	N	9.508225	E

**HSI**

**Number of frames** ⓘ  
2300

**Camera parameters** ⓘ  
 Default  
 Enter custom values

**File naming** ⓘ  
 Default  
 Enter custom values

**RGB**

**Initialization** ⓘ  
 Default  
 Upload custom config file

**Camera parameters** ⓘ  
 Default  
 Enter custom values

**Hardware trigger** ⓘ  
 On  
 Off

**Demosaic options** ⓘ  
 rgb  
 raw

**Image format**  
png ▼

**File naming** ⓘ  
 Default  
 Enter custom values

Task too large to be performed in one pass

Save draft

Validate task

or enter corner coordinates manually:

1:	63.389485	N	7.874009	E
2:	64.063605	N	9.508225	E

**HSI**

**Number of frames** ⓘ  
2300

**Camera parameters** ⓘ  
 Default  
 Enter custom values

**File naming** ⓘ  
 Default  
 Enter custom values

**RGB**

**Initialization** ⓘ  
 Default  
 Upload custom config file

**Camera parameters** ⓘ  
 Default  
 Enter custom values

**Hardware trigger** ⓘ  
 On  
 Off

**Demosaic options** ⓘ  
 rgb  
 raw

**Image format**  
png ▼

**File naming** ⓘ  
 Default  
 Enter custom values

### Task validated

This task has been validated and approved for upload.

Edit task

Add task to mission queue

Save draft

Validate task

### Alarms

● All systems ok

### Payload Health

#### Power consumption (W)

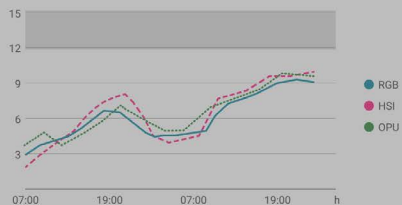

#### TEMPERATURE

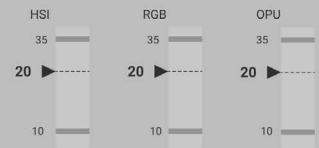

### Missions Overview

- HISTORY
- CURRENT
- PLANNED

Mode	Location	ID
Slew maneuver	Svalbard	45566
Nadir maneuver	Hitra	45570
Slew maneuver	Molde	45571
Nadir maneuver	Lofoten	45572
Slew maneuver	Frøya	45573

**Task added!**

The task has been added to the mission queue.

### Alarms

● All systems ok

### Payload Health

#### Power consumption (W)

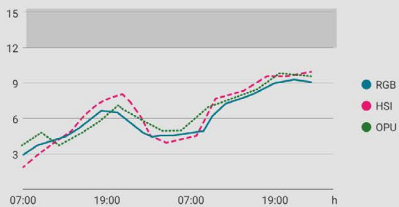

#### TEMPERATURE

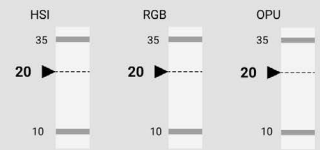

### Missions Overview

- HISTORY
- CURRENT
- PLANNED

Mode	Location	ID
Slew maneuver	Svalbard	45566
Nadir maneuver	Hitra	45570
Slew maneuver	Molde	45571
Nadir maneuver	Lofoten	45572
Slew maneuver	Frøya	45573

Add task

### Alarms

● All systems OK

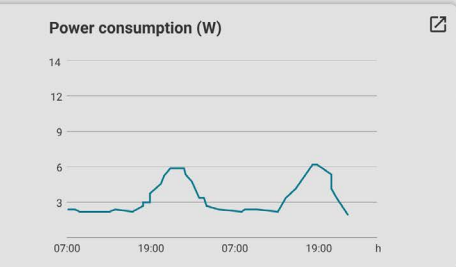
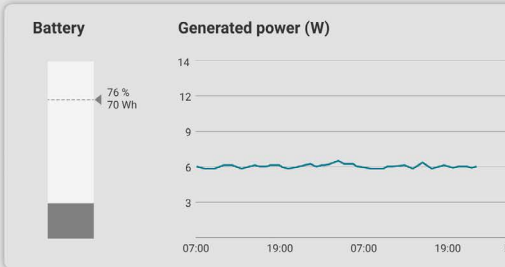

STAR TRACKER <b>ON</b>	IMU <b>ON</b>	GYROSCOPE <b>3/3</b>
GPS <b>ON</b>	SUN SENSOR <b>4/6</b>	MAGNETOM. <b>2/3</b>
REACTION WH. <b>4/4</b>	HEATER <b>OFF</b>	UHF <b>ON</b>

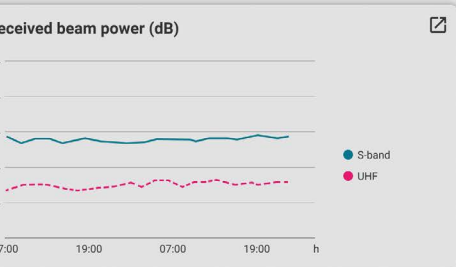
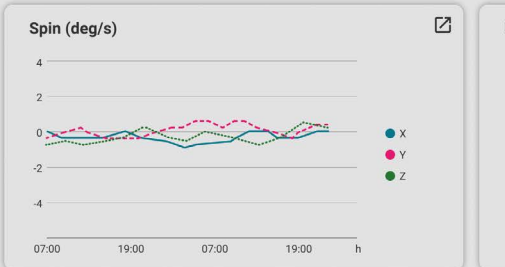
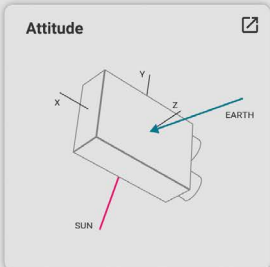
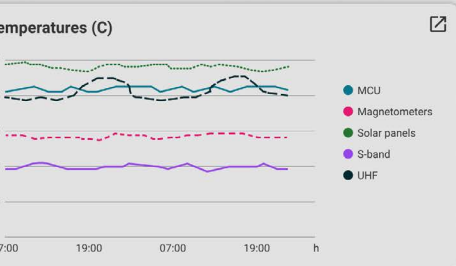
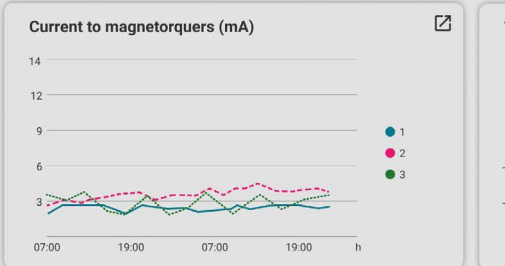

### Alarms

3 UHF beam power low

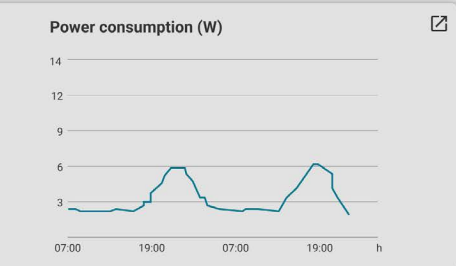
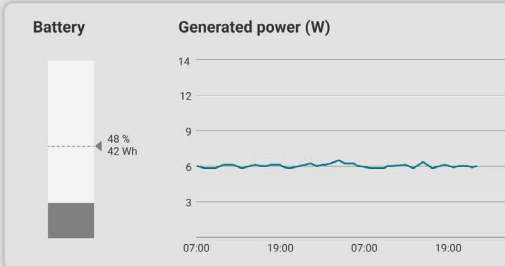

STAR TRACKER <b>ON</b>	IMU <b>ON</b>	GYROSCOPE <b>3/3</b>
GPS <b>ON</b>	SUN SENSOR <b>4/6</b>	MAGNETOM. <b>2/3</b>
REACTION WH. <b>4/4</b>	HEATER <b>OFF</b>	UHF <b>ON</b>

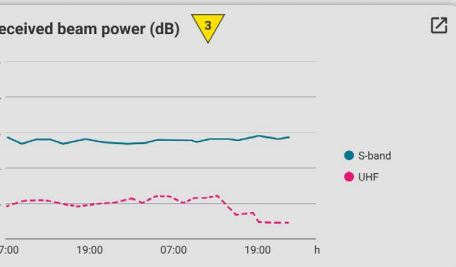
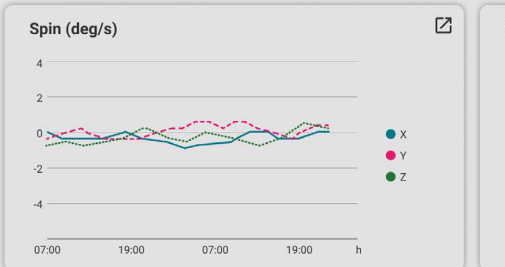
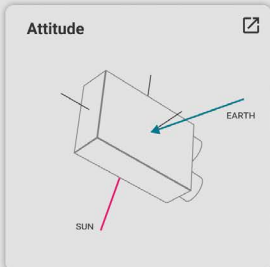
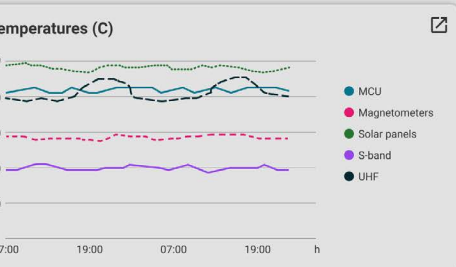
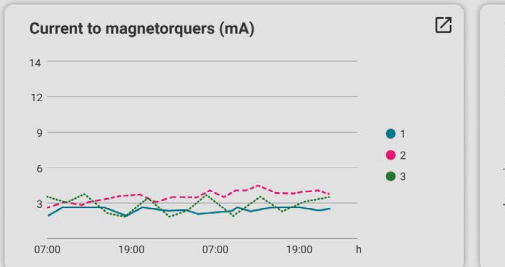

Alarms

**3** UHF beam power low  
This is usually due to weather conditions. No further action required. Check ground station if problem persists

Close Silence alarm

Battery



Generated power (W)

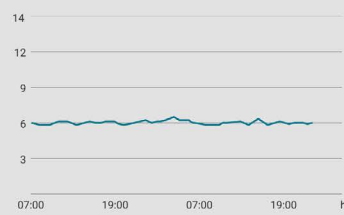

Power consumption (W)

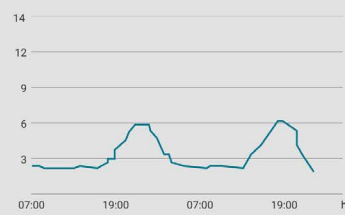

STAR TRACKER <b>ON</b>	IMU <b>ON</b>	GYROSCOPE <b>3/3</b>
GPS <b>ON</b>	SUN SENSOR <b>4/6</b>	MAGNETOM. <b>2/3</b>
REACTION WH. <b>4/4</b>	HEATER <b>OFF</b>	UHF <b>ON</b>

Current to magnetorquers (mA)

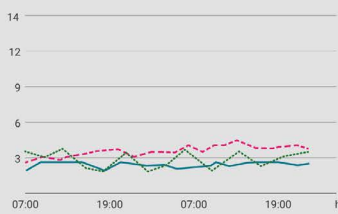

Temperatures (C)

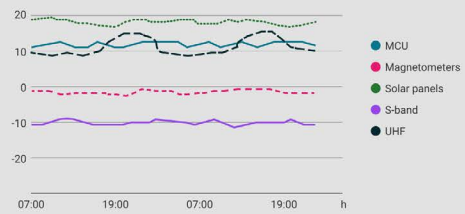

Attitude

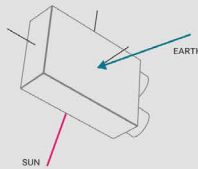

Spin (deg/s)

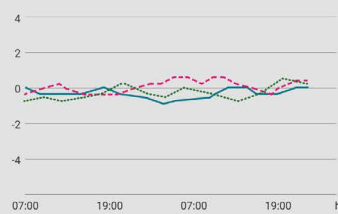

Received beam power (dB)

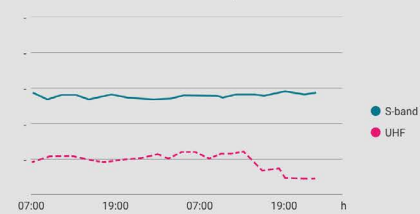

Alarms

1 alarm silenced

Battery



Generated power (W)

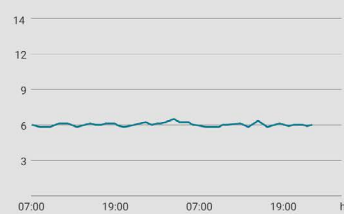

Power consumption (W)

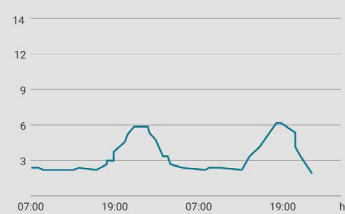

STAR TRACKER <b>ON</b>	IMU <b>ON</b>	GYROSCOPE <b>3/3</b>
GPS <b>ON</b>	SUN SENSOR <b>4/6</b>	MAGNETOM. <b>2/3</b>
REACTION WH. <b>4/4</b>	HEATER <b>OFF</b>	UHF <b>ON</b>

Current to magnetorquers (mA)

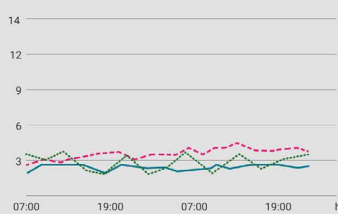

Temperatures (C)

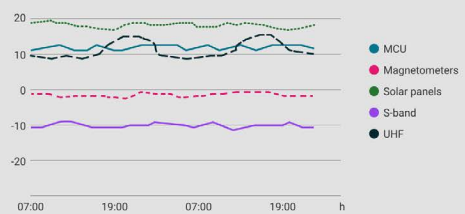

Attitude

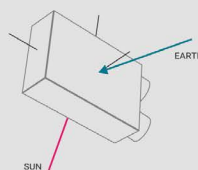

Spin (deg/s)

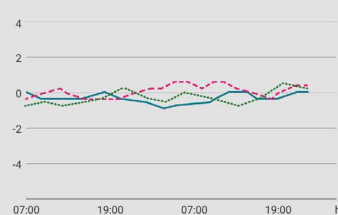

Received beam power (dB)

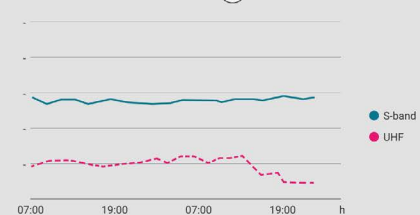

### Alarms

**1** Battery level critically low

### Battery **1**



### Generated power (W)

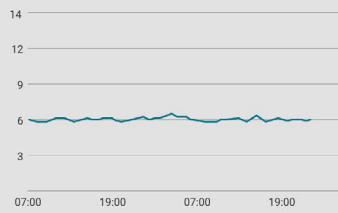

### Power consumption (W)

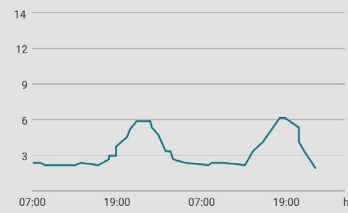

STAR TRACKER <b>ON</b>	IMU <b>ON</b>	GYROSCOPE <b>3/3</b>
GPS <b>ON</b>	SUN SENSOR <b>4/6</b>	MAGNETOM. <b>2/3</b>
REACTION WH. <b>4/4</b>	HEATER <b>OFF</b>	UHF <b>ON</b>

### Current to magnetorquers (mA)

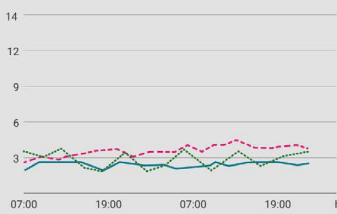

### Temperatures (C)

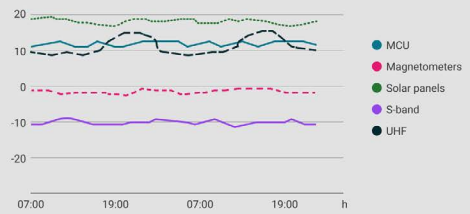

### Attitude

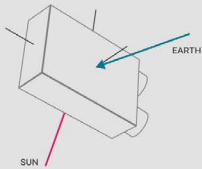

### Spin (deg/s)

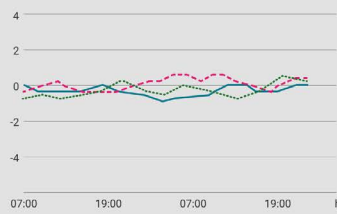

### Received beam power (dB)

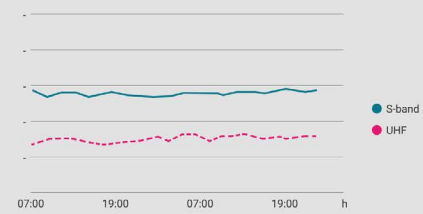

### Alarms

**1** Battery level critically low  
Put in safe mode to avoid spacecraft failure.

**Safe mode**

Close Silence alarm

### Battery **1**



### Generated power (W)

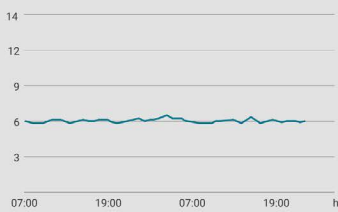

### Power consumption (W)

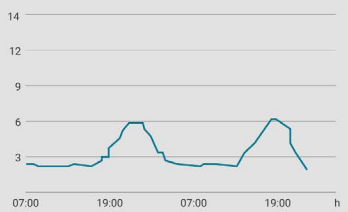

STAR TRACKER <b>ON</b>	IMU <b>ON</b>	GYROSCOPE <b>3/3</b>
GPS <b>ON</b>	SUN SENSOR <b>4/6</b>	MAGNETOM. <b>2/3</b>
REACTION WH. <b>4/4</b>	HEATER <b>OFF</b>	UHF <b>ON</b>

### Current to magnetorquers (mA)

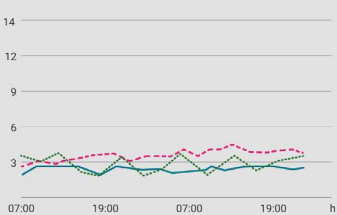

### Temperatures (C)

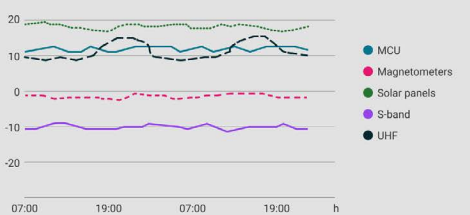

### Attitude

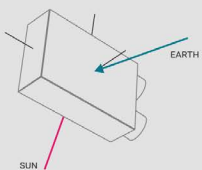

### Spin (deg/s)

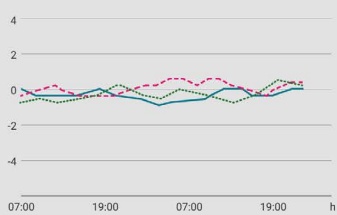

### Received beam power (dB)

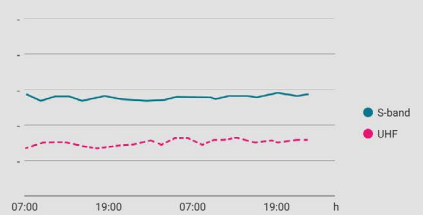

Alarms

1 Battery level critically low

Battery 1



Generated power (W)

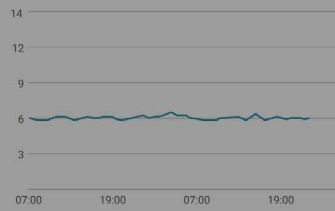

Power consumption (W)

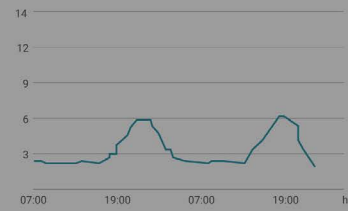

STAR TRACKER ON	IMU ON	GYROSCOPE 3/3
GPS ON	SUN SENSOR 4/6	MAGNETOM. 2/3
REACTION WH. 4/4	HEATER OFF	UHF ON

Current to magnetorquers (mA)

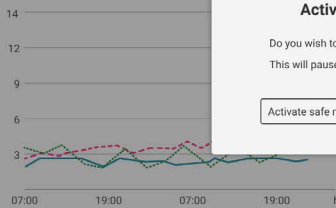

Temperatures (C)

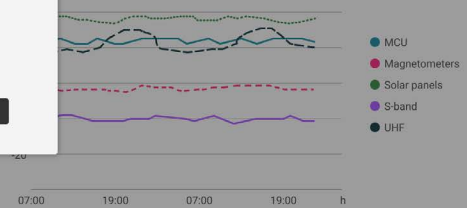

**Activate safe mode**

Do you wish to activate safe mode?  
This will pause all current missions.

Activate safe mode Close window

Attitude

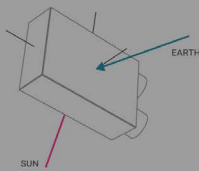

Spin (deg/s)

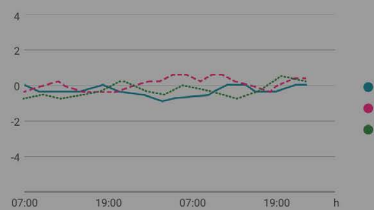

Received beam power (dB)

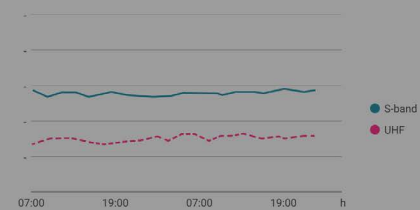

Alarms

1 Battery level critically low

Battery 1



Generated power (W)

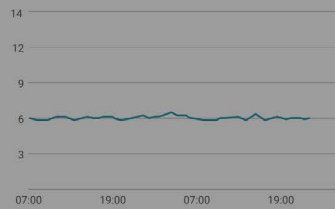

Power consumption (W)

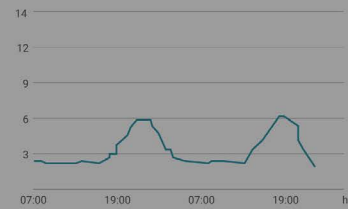

STAR TRACKER ON	IMU ON	GYROSCOPE 3/3
GPS ON	SUN SENSOR 4/6	MAGNETOM. 2/3
REACTION WH. 4/4	HEATER OFF	UHF ON

Current to magnetorquers (mA)

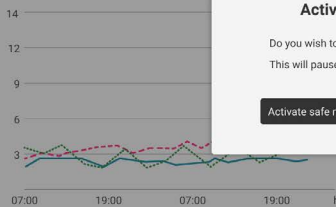

Temperatures (C)

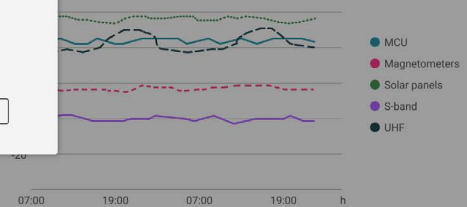

**Activate safe mode**

Do you wish to activate safe mode?  
This will pause all current missions.

Activate safe mode Close window

Attitude

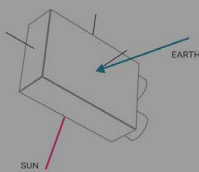

Spin (deg/s)

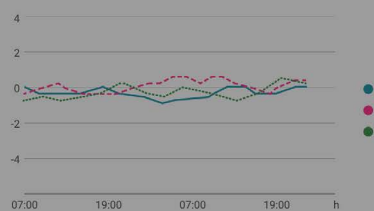

Received beam power (dB)

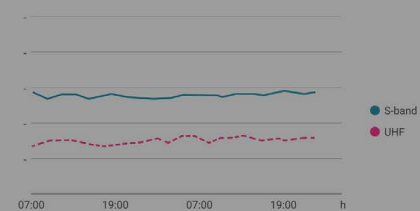

## **Samtykkeskjema**

I løpet av denne testen vil vi ta opp lyd og bilde av deg, i tillegg til skjermen din. Disse opptakene vil kun bli brukt i forbindelse med masteroppgaven vår. Om vi ønsker å bruke opptakene til andre ting, må vi be deg om tillatelse. All personinformasjon slettes når prosjektet er ferdig. Senest utgangen av juli 2020.

Du kan trekke deg når som helst, også etter testen er ferdig. Ta kontakt med oss for sletting av data. Høres dette greit ut?

## **Oppstarts-spørsmål**

Alder?

Nasjonalitet?

Hva slags rolle har du i Hypsoprosjektet?

Hva slags akademisk bakgrunn har du?

Hvor lenge skal du jobbe med prosjektet?

## **Oppstartsinfo**

Denne testen er delt i flere deler. Som nevnt vil det være tre skjermer å forholde seg til av gangen i det ferdige oppsettet, men her vil vi teste alle på én. Hovedsakelig vil vi se på desktop-skjermene, med innslag av den store veggskjermen av og til.

I den første delen vil vi vise deg oversiktskjermen for payloaden. Her vil du få en oppgave om å legge inn et standardisert mission, og se hva som skjer under et pass.

I den andre delen vil vi vise en oversikt over helsa til fartøyet, og ta en gjennomgang av de ulike modulene på skjermen.

Du spiller operatør uten opplæring. Underveis kommer vi til å fortelle litt om hver modul, eller spørre deg om hva du tror modulens funksjon er. Det er ingen gale svar.

Underveis vil vi at du tenker høyt. Fortell oss hva du gjør, og hva du forventer skal skje før hver handling. Det er skissene vi tester, ikke deg. Om noe går galt, eller er vanskelig å forstå, ligger det på skissene.

## **Stor skjerm - før pass**

Hva ser du her?

Trykk hvor som helst for å komme videre

## **PL og mission planning**

Dette er den ene av de to desktop-skjermene. Kan du fortelle oss litt om hva du ser?

Kan du se om du finner en oversikt over samlet strømforbruk?

Kan du se om du finner noe informasjon om det mission'et som er underveis?

Noen fra SmallSat-lab vil ta noen lavoppløselige bilder utenfor Trondheim.

Hva gjør du da?

Hva kan du se her?

Det er ikke mye som kan klikkes på, så bare fortell oss hvordan du tror dette fungerer

Hva tror du "validate task" betyr?

Hva forventer du at skal skje?

Hva tror du "add task to mission queue" betyr?

Så du hva som skjedde med mission'et ditt?

Hva synes du om det du nettopp gjorde? (tanker om create mission)

Var det noe informasjon som manglet for å lage et nytt mission?

Var noe overflødig, unødvendig?

Prøvde de å bruke infoboksene?

Hvis du vil se kommandoene i køen, hvor går du da?

Hvis du vil se hva som har blitt utført, hvor går du da?

Hva slags informasjon forventer du å finne i loggen?

## **Big Screen during pass**

Her har vi juksa litt. Om du trykker på tittelen i mission timeline, så får du opp den store skjermen igjen.

Hva skjer her?

Du kan trykke hvor som helst for å komme tilbake til desktop

Om du nå vil vite mer om passet enn det du så på den store skjermen, hvor går du da?

## **Pass begins**

Hva ser du her?

Hva er status på up- og downlink?



Hva tror du plottet viser?

### **Alarm**

Hva vil du gjøre da?

Hva tror du silence betyr?

Kan du se om noe har endret seg i loggen?

### **Ny alarm**

Hva skjedde nå?

### **Spacecraft**

Da beveger vi oss til et nytt scenario. Her er det nominell drift

Fortell hva du ser

Kan du endre hvor langt tilbake du ser på grafene?

Kan du sjekke hvor mye strøm reaction wheels trekker?

Hvilket solcelleplan har vært mest effektivt de siste 48 timene?

Attitude

Slider

# Prototype 3, all screens



### Alarms

All systems ok

### PL power consumption W

Separate

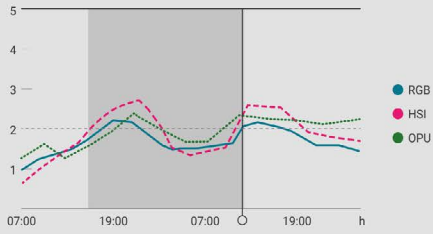

### HSI temperature (C)

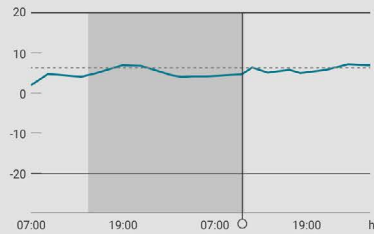

### Mission queue

### Commands

### Log

### Pass details

	START TIME	END TIME
Template "Norwegian coast, morning/midday, high resolution"	2020-04-25 04:51:03	2020-04-25 19:00:00
Pass	2020-04-25 11:10:12	2020-04-25 11:21:00
Pass	2020-04-25 15:01:00	2020-04-25 15:12:42
Idle mode	2020-04-25 19:00:00	2020-04-26 07:00:00
Pass	2020-04-25 19:09:42	2020-04-25 19:20:59
Pass	2020-04-25 23:20:33	2020-04-25 23:27:51

[+](#) Create new mission

### Mission timeline

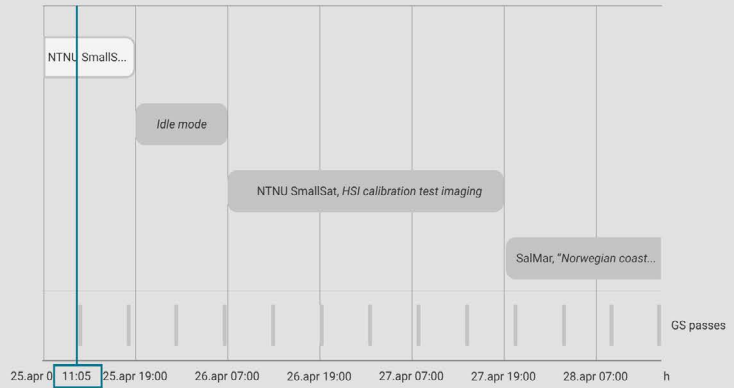

### Alarms

All systems ok

### PL power consumption W

Total

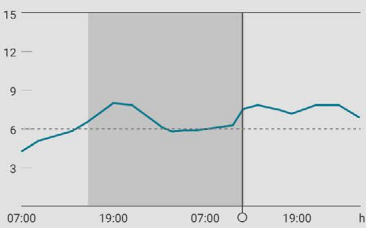

### HSI temperature (C)

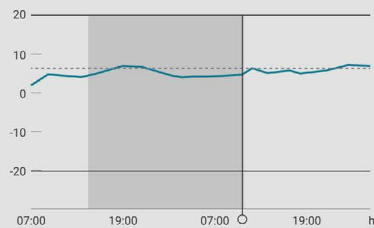

### Mission queue

### Commands

### Log

### Pass details

	START TIME	END TIME
Template "Norwegian coast, morning/midday, high resolution"	2020-04-25 04:51:03	2020-04-25 19:00:00
Pass	2020-04-25 11:10:12	2020-04-25 11:21:00
Pass	2020-04-25 15:01:00	2020-04-25 15:12:42
Idle mode	2020-04-25 19:00:00	2020-04-26 07:00:00
Pass	2020-04-25 19:09:42	2020-04-25 19:20:59
Pass	2020-04-25 23:20:33	2020-04-25 23:27:51

[+](#) Create new mission

### Mission timeline

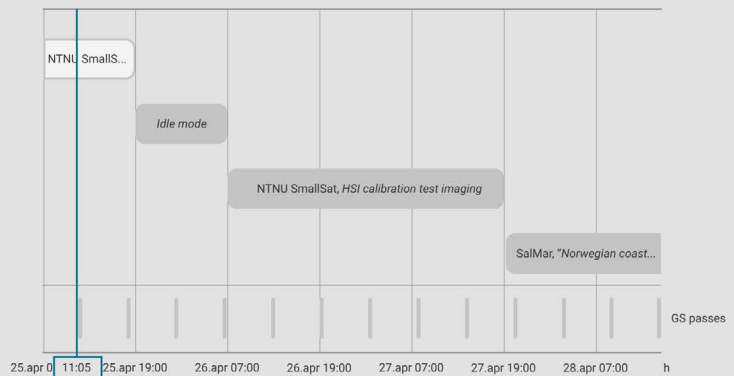

### Alarms

● All systems ok

### PL power consumption W

● Total

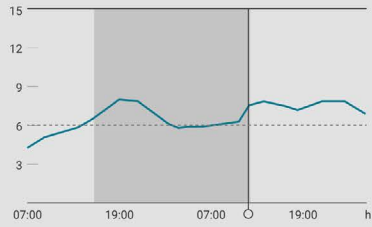

### HSI temperature (C)

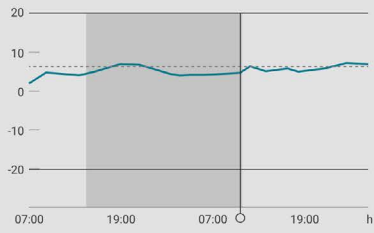

### Mission queue

### Commands

### Log

### Pass details

	START TIME	END TIME
Template "Norwegian coast, morning/midday, high resolution"	2020-04-25 04:51:03	2020-04-25 19:00:00
Pass	2020-04-25 11:10:12	2020-04-25 11:21:00
Pass	2020-04-25 15:01:00	2020-04-25 15:12:42
Idle mode	2020-04-25 19:00:00	2020-04-26 07:00:00
Pass	2020-04-25 19:09:42	2020-04-25 19:20:59
Pass	2020-04-25 23:20:33	2020-04-25 23:27:51

Create new mission

### Mission timeline

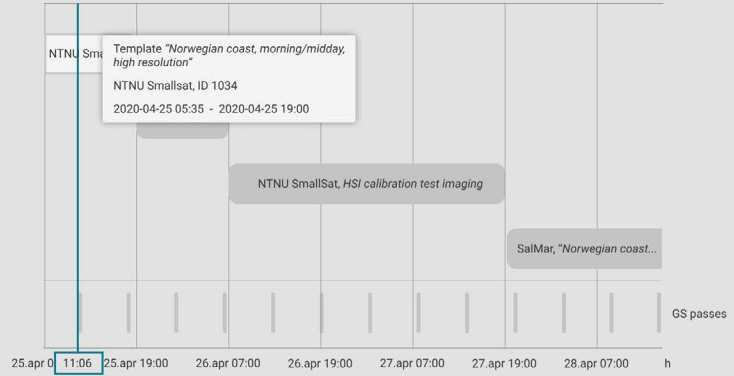

### TASK OUTLINE

#### Template

Norwegian coast, evening

#### Priority task

No  
 Yes

#### Start time

2020-04-25 19:00:01

First available pass matching template

### ADCS

#### Select imaging area

Select area on map, or enter coordinates manually:

1:  N  E

2:  N  E

#### Maneuver type

Nadir  
 Slew

### HSI

#### Desired resolution

480 \* 760 px

#### Camera parameters

Template default  
 Enter custom values

#### File naming

Default  
 Enter custom values

### RGB

#### RGB settings

Template default  
 Use custom settings

### Task validated

This task has been validated and approved for uplink.  
Script can be edited manually in the window below.

This window contains auto-generated commands generated by the template.

Edit task
Add task to mission queue

**TASK OUTLINE**

**Template** ?  
Norwegian coast, evening

**Priority task** ?  
 No  
 Yes

**Start time** ?  
2020-04-25 19:00:01  
 First available pass matching template

---

**ADCS**

**Select imaging area** ?  
Select area on map, or enter coordinates manually:

1:  N  E  
2:  N  E

**Maneuver type** ?  
 Nadir  
 Slew

---

**HSI**

**Desired resolution** ?  
480 \* 760 px

**Camera parameters** ?  
 Template default  
 Enter custom values

**File naming** ?  
 Default  
 Enter custom values

---

**RGB**

**RGB settings** ?  
 Template default  
 Use custom settings

Save draft
Generate script and validate task

**Alarms**

● All systems ok

**PL power consumption** W ▼ Total

**HSI temperature (C)**

Mission queue
Commands
Log
Pass details

	START TIME	END TIME
Template "Norwegian coast, morning/midday, high resolution"	2020-04-25 04:51:03	2020-04-25 19:00:00
Pass	2020-04-25 11:10:12	2020-04-25 11:21:00
Pass	2020-04-25 15:01:00	2020-04-25 15:12:42
Template "Norwegian coast, evening, low resolution"	2020-04-25 19:00:00	2020-04-26 07:00:00
Pass	2020-04-25 19:09:42	2020-04-25 19:20:59
Pass	2020-04-25 23:20:33	2020-04-25 23:27:51

+ Create new mission

**Mission timeline**

### Alarms

● All systems ok

### PL power consumption W

● Total

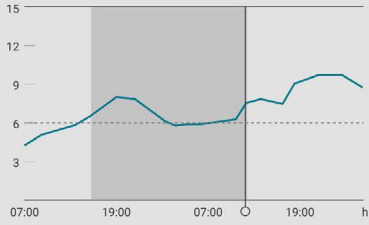

### HSI temperature (C)

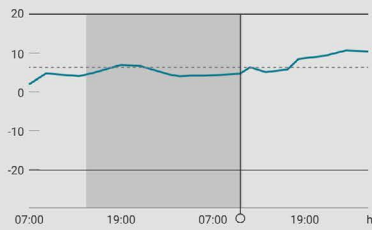

### Mission queue

### Commands

### Log

### Pass details

	START TIME	END TIME
lorem ipsum	2020-04-25 10:51:03	2020-04-25 10:52:20
dolor sit amet	2020-04-25 10:52:20	2020-04-25 10:56:00
consectetur	2020-04-25 11:06:00	2020-04-25 11:09:42
initialize pass	2020-04-25 11:09:42	2020-04-25 11:09:59
sed do eiusmod	2020-04-25 11:10:00	2020-04-25 11:20:32
tempor incididunt ut labore	2020-04-25 11:20:33	2020-04-25 11:27:51
et dolore magna aliqua	2020-04-25 11:27:51	2020-04-25 11:42:16
ut enim ad	2020-04-25 11:42:16	2020-04-25 11:42:47

### Mission timeline

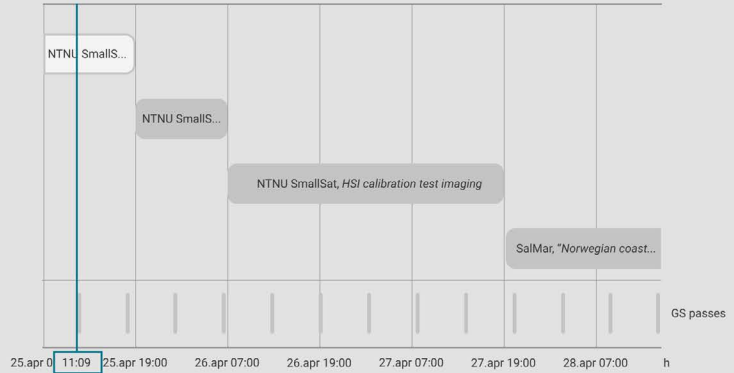

### Alarms

● All systems ok

### PL power consumption W

● Total

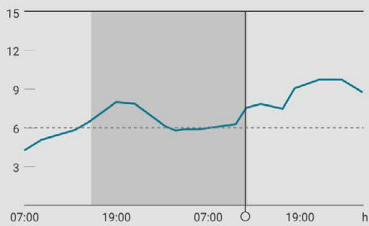

### HSI temperature (C)

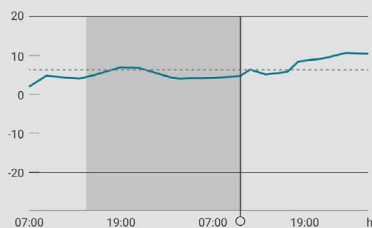

### Mission queue

### Commands

### Log

### Pass details

		OPERATOR	TIMESTAMP
Pass complete	120/120 MB downlinked, 8/8 MB uplinked		2020-04-25 07:00:06
Alarm silenced	HSI temperature approaching limit (2)	Hansen, Andreas	2020-04-25 07:00:00
Pass complete	17/17 MB downlinked		2020-04-25 03:12:42
Pass incomplete	103/120 MB downlinked		2020-04-24 23:36:50
Alarm silenced	UHF beam power low (3)	Sand, Gjertrud	2020-04-24 23:36:45
Task completed	HSI calibration test imaging		2020-04-24 23:27:51
Pass complete			2020-04-24 19:46:02
Pass complete	12/12 MB uplinked		2020-04-24 14:10:31

### Mission timeline

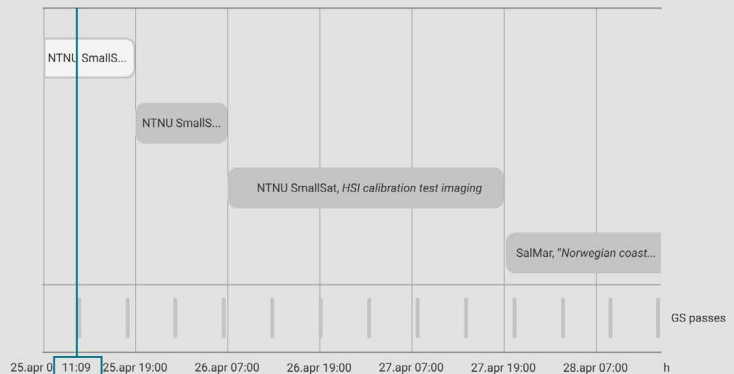

### Alarms

All systems ok

### PL power consumption W

Total

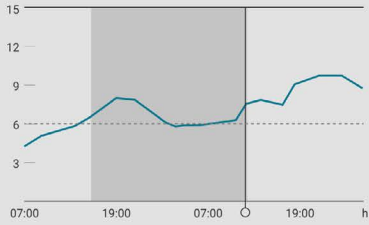

### HSI temperature (C)

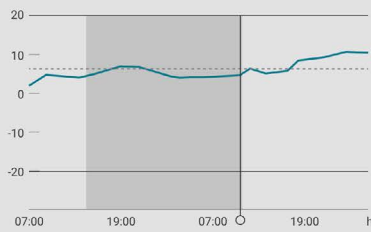

### Mission queue

### Commands

### Log

### Pass details

### Storage

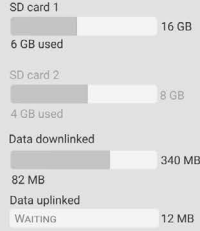

### Connectivity (kHz)

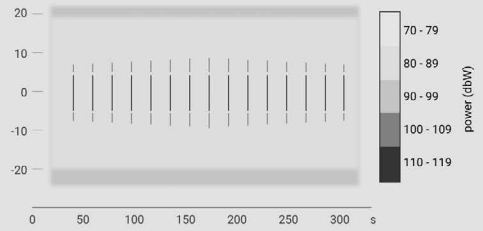

### Mission timeline

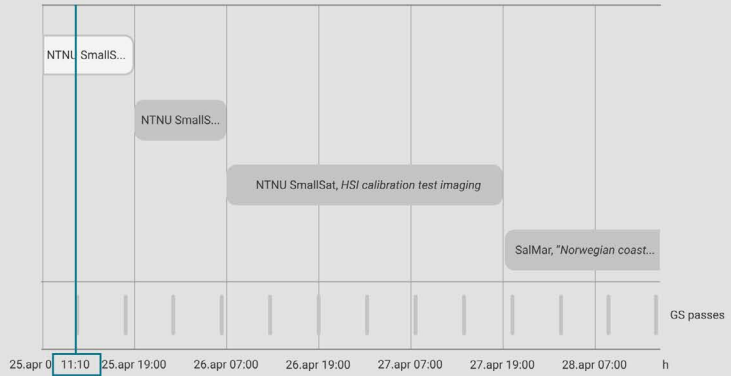

### Alarms

**2** HSI temperature approaching limit

### PL power consumption W

Total

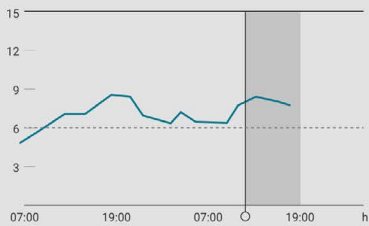

### HSI temperature (C)

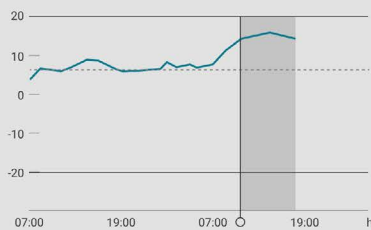

### Mission queue

### Commands

### Log

### Pass details

### Storage

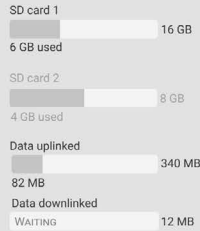

### Connectivity (kHz)

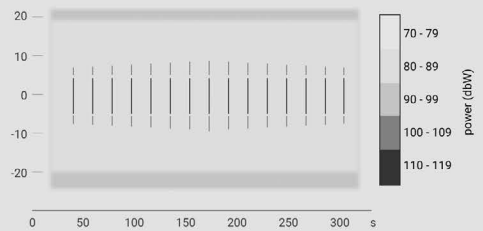

### Mission timeline

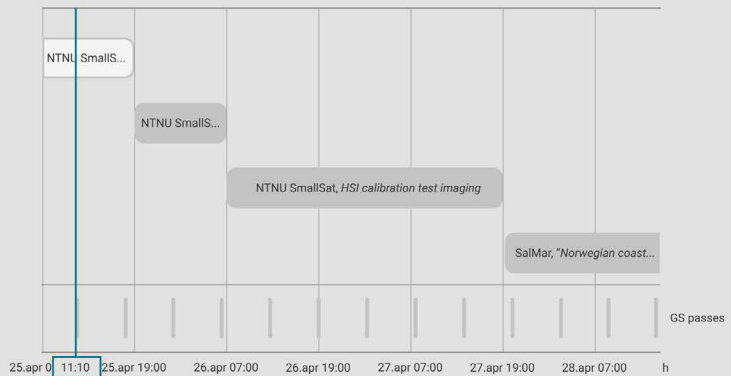

### Alarms

**2** HSI temperature approaching limit

### PL power consumption W

Total

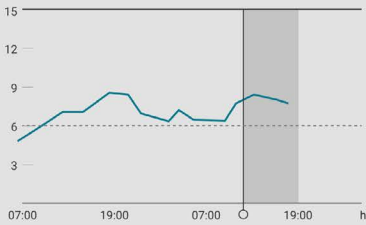

### HSI temperature (C)

**2** HSI temperature approaching limit

The temperature is getting too high. Monitor carefully. Check up on this during next pass.

Close

Silence alarm

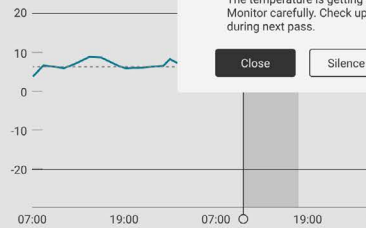

### Mission queue

### Commands

### Log

### Pass details

### Storage

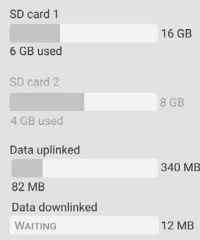

### Connectivity (kHz)

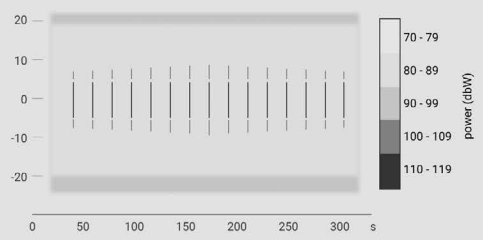

### Mission timeline

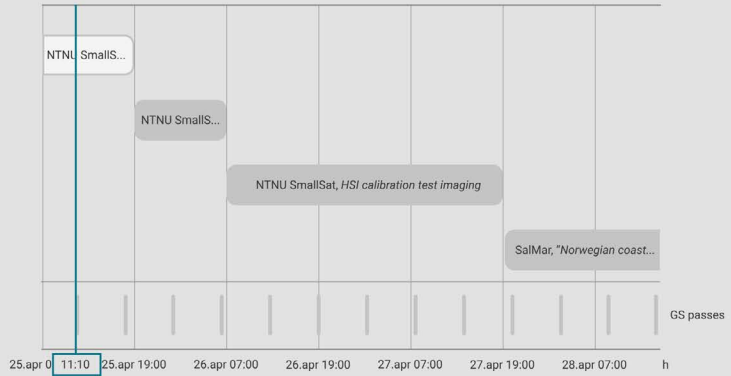

### Alarms

1 alarm silenced

### PL power consumption W

Total

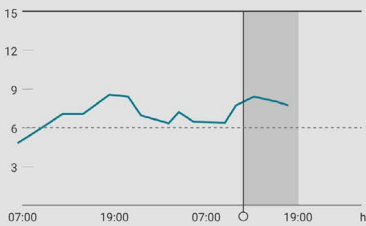

### HSI temperature (C)

s

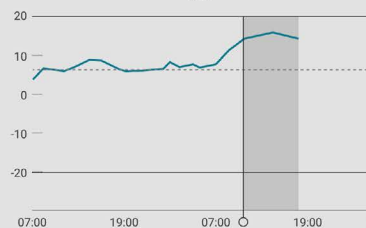

### Mission queue

### Commands

### Log

### Pass details

### Storage



### Connectivity (kHz)

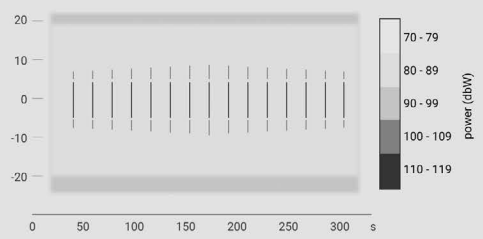

### Mission timeline

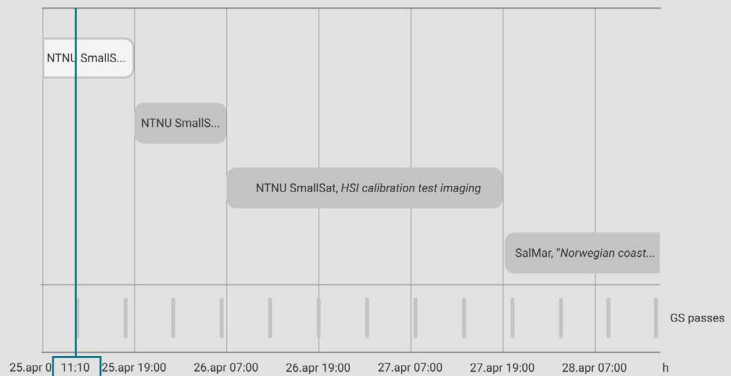



### Alarms

All systems ok

### PL power consumption W

Total

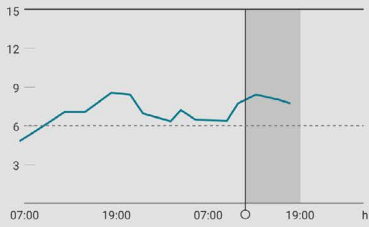

### HSI temperature (C) s

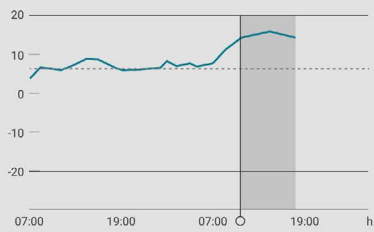

### Mission queue

### Commands

### Log

### Pass details

		OPERATOR	TIMESTAMP
Alarm silenced	HSI temperature approaching limit (2)	Testesen, Testperson	2020-04-25 11:10:32
Pass complete	120/120 MB downlinked, 8/8 MB uplinked		2020-04-25 07:00:06
Alarm silenced	HSI temperature approaching limit (2)	Hansen, Andreas	2020-04-25 07:00:00
Pass complete	17/17 MB downlinked		2020-04-25 03:12:42
Pass incomplete	103/120 MB downlinked		2020-04-24 23:36:50
Alarm silenced	UHF beam power low (3)	Sand, Gjertrud	2020-04-24 23:36:45
Task completed	HSI calibration test imaging		2020-04-24 23:27:51
Pass complete			2020-04-24 19:46:02

### Mission timeline

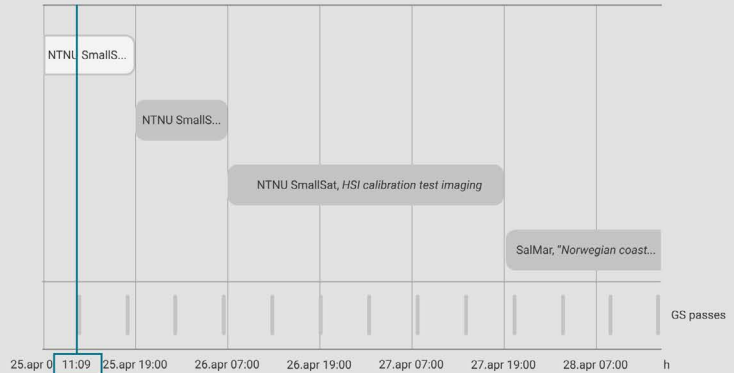

### Alarms

**1** HSI temperature too high. Going into safe mode.

### PL power consumption W

Total

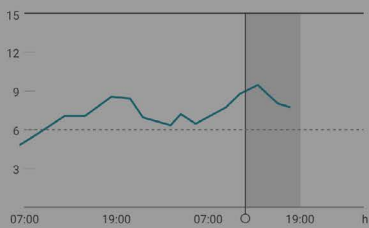

### HSI temperature (C) 1

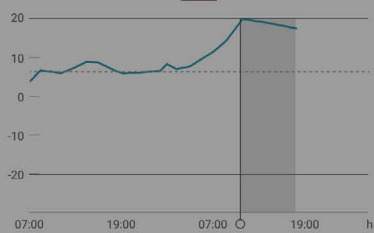

### Mission queue

### Commands

### Log

### Pass details

		OPERATOR	TIMESTAMP
Alarm silenced	HSI temperature approaching limit (2)	Testesen, Testperson	2020-04-25 11:10:32
Pass complete	120/120 MB downlinked, 8/8 MB uplinked		2020-04-25 07:00:06
Alarm silenced	HSI temperature approaching limit (2)	Hansen, Andreas	2020-04-25 07:00:00
Pass complete	17/17 MB downlinked		2020-04-25 03:12:42
Pass incomplete	103/120 MB downlinked		2020-04-24 23:36:50
Alarm silenced	UHF beam power low (3)	Sand, Gjertrud	2020-04-24 23:36:45
Task completed	HSI calibration test imaging		2020-04-24 23:27:51
Pass complete			2020-04-24 19:46:02

### Activating safe mode

A critical threshold has been passed.  
Threshold ID: HSI temp max

The payload is going into safe mode  
This will pause all current missions.

Close window

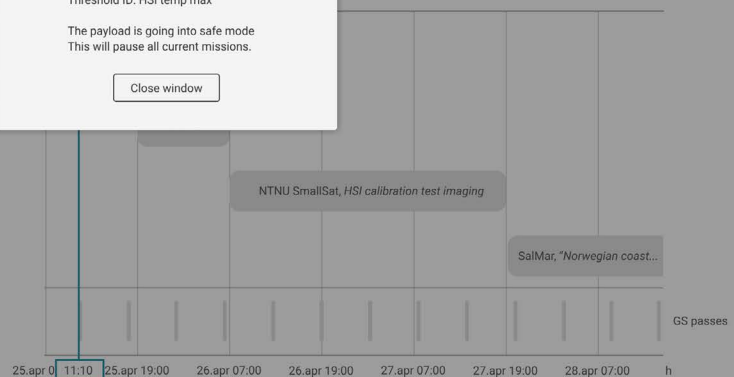

### Alarms

Payload is in safemode. All missions paused.

### PL power consumption W

Total

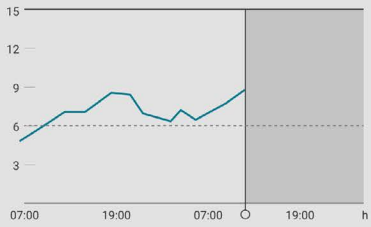

### HSI temperature (C)

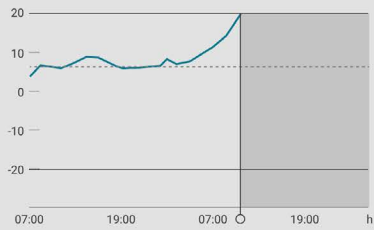

### Mission queue

### Commands

### Log

### Pass details

		OPERATOR	TIMESTAMP
Safe mode activated	HSI temperature above limit (1)		2020-04-25 11:11:09
Alarm silenced	HSI temperature approaching limit (2)	Testesen, Testperson	2020-04-25 11:10:32
Pass complete	120/120 MB downlinked, 8/8 MB uplinked		2020-04-25 07:00:06
Alarm silenced	HSI temperature approaching limit (2)	Hansen, Andreas	2020-04-25 07:00:00
Pass complete	17/17 MB downlinked		2020-04-25 03:12:42
Pass incomplete	103/120 MB downlinked		2020-04-24 23:36:50
Alarm silenced	UHF beam power low (3)	Sand, Gjertrud	2020-04-24 23:36:45
Task completed	HSI calibration test imaging		2020-04-24 23:27:51

### Mission timeline

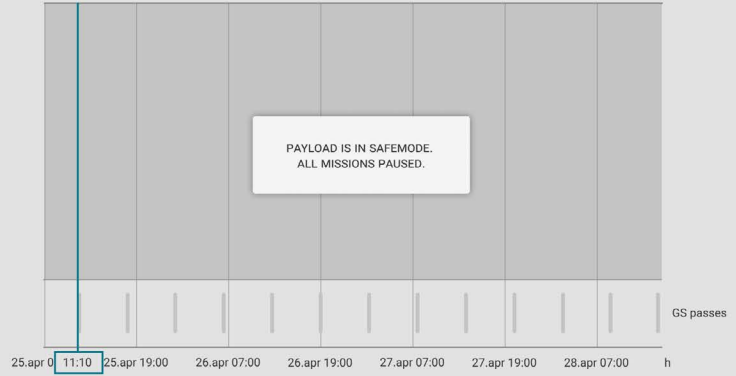

STAR TRACKER <b>ON</b>	IMU <b>ON</b>	GYROSCOPE <b>3/3</b>
GPS <b>ON</b>	SUN SENSOR <b>4/6</b>	MAGNETOM. <b>2/3</b>
REACTION WH. <b>4/4</b>	HEATER <b>OFF</b>	UHF <b>-</b>

Battery



Generated power **W**

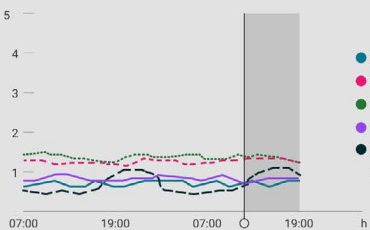

Power consumption **W**

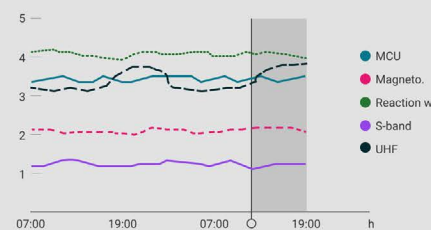

Attitude

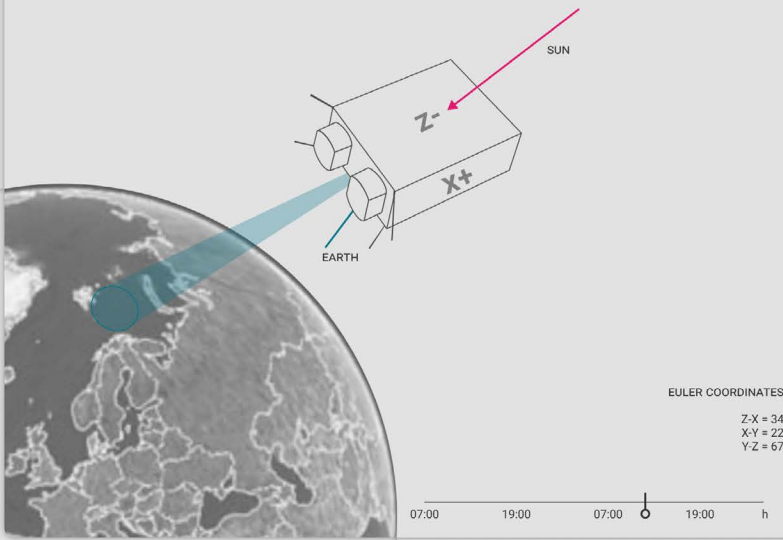

Temperatures (C)

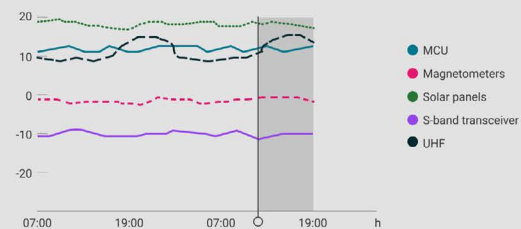

Spin (deg/s)

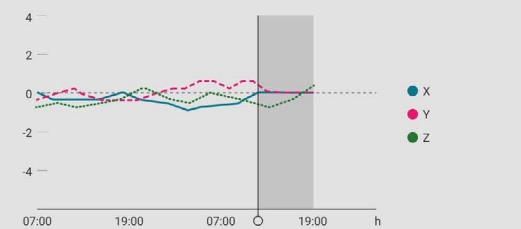

STAR TRACKER <b>ON</b>	IMU <b>ON</b>	GYROSCOPE <b>3/3</b>
GPS <b>ON</b>	SUN SENSOR <b>4/6</b>	MAGNETOM. <b>2/3</b>
REACTION WH. <b>4/4</b>	HEATER <b>OFF</b>	UHF <b>ON</b>

Battery



Generated power **W**

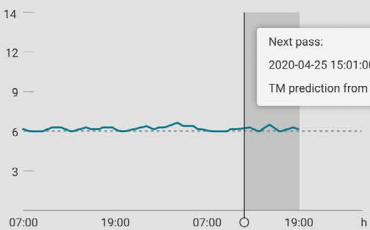

Power consumption **W**

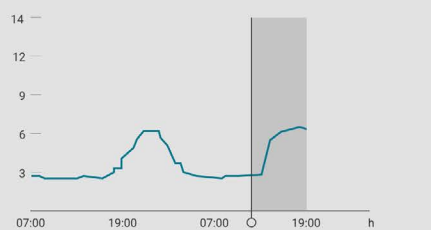

Attitude

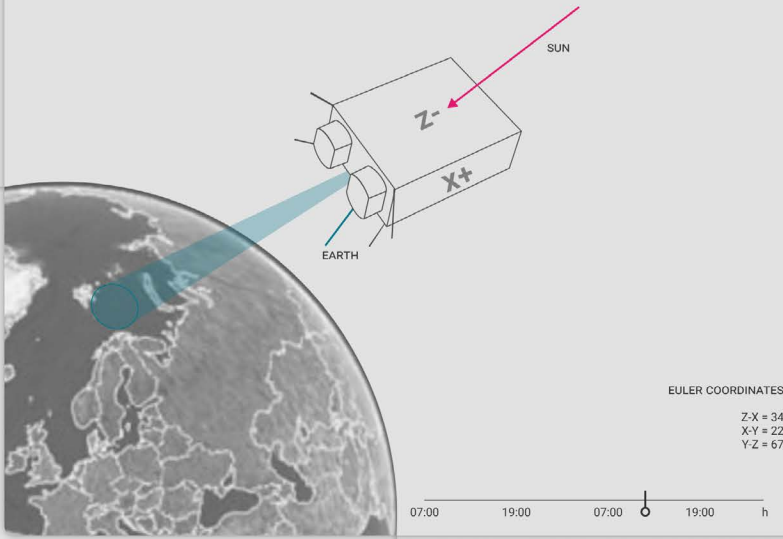

Temperatures (C)

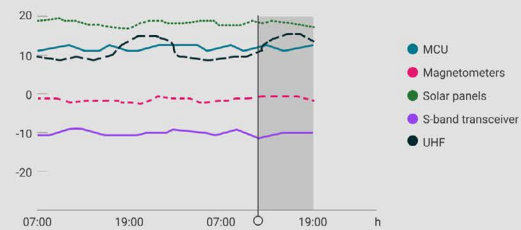

Spin (deg/s)

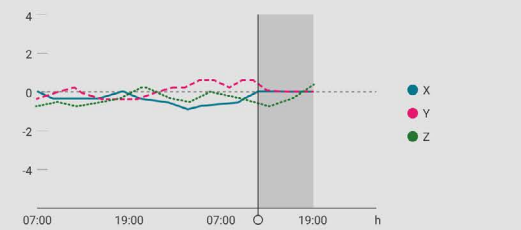

Final version of the prototype, all screens



### Alarms

All systems ok

### PL power consumption W

Individual Total

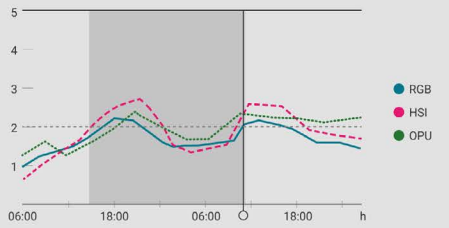

### HSI temperature (C)

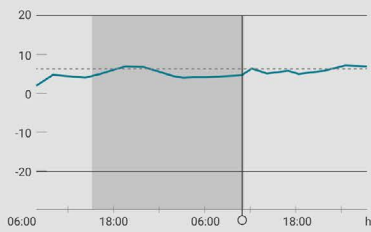

### Mission queue

### Commands

### Log

### Pass details

	START TIME	END TIME
Template "Norwegian coast, morning/midday, high resolution"	2020-04-25 04:51:03	2020-04-25 18:00:00
Pass	2020-04-25 11:10:12	2020-04-25 11:21:00
Pass	2020-04-25 14:01:00	2020-04-25 14:12:42
Idle mode	2020-04-25 18:00:00	2020-04-26 06:00:00
Pass	2020-04-25 18:09:42	2020-04-25 18:20:59
Pass	2020-04-25 22:20:33	2020-04-25 22:27:51

+ Create new mission

### Mission timeline

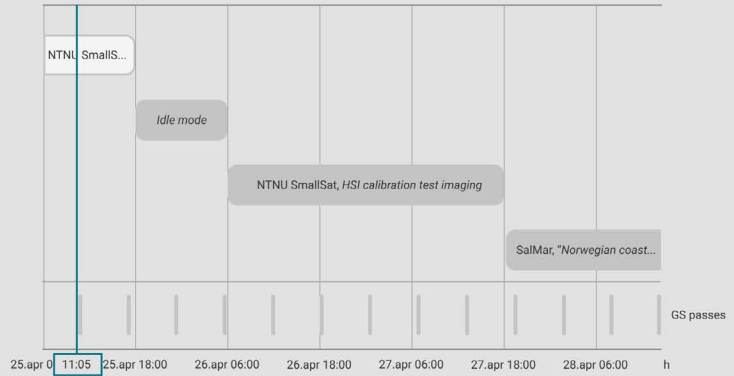

### Alarms

All systems ok

### PL power consumption W

Individual Total

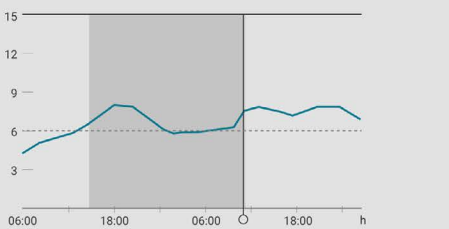

### HSI temperature (C)

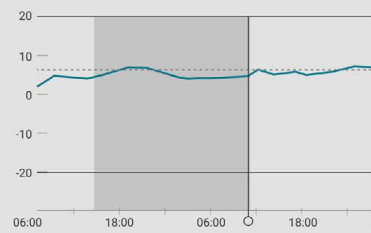

### Mission queue

### Commands

### Log

### Pass details

	START TIME	END TIME
Template "Norwegian coast, morning/midday, high resolution"	2020-04-25 04:51:03	2020-04-25 18:00:00
Pass	2020-04-25 11:10:12	2020-04-25 11:21:00
Pass	2020-04-25 14:01:00	2020-04-25 14:12:42
Idle mode	2020-04-25 18:00:00	2020-04-26 06:00:00
Pass	2020-04-25 18:09:42	2020-04-25 18:20:59
Pass	2020-04-25 22:20:33	2020-04-25 22:27:51

+ Create new mission

### Mission timeline

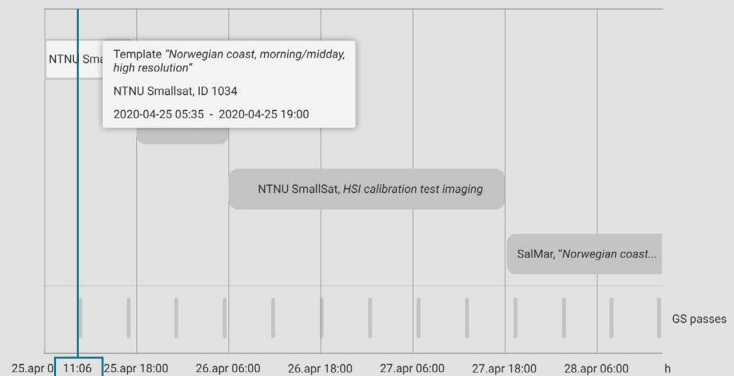

**TASK OUTLINE**

**Task Template** [?](#)  
 Norwegian coast, evening

**Priority task** [?](#)  
 No  
 Yes

**Start time** [?](#)  
 2020-04-25 19:00:01  
 First available pass matching template

**ADCS**

**Select imaging area** [?](#)  
 Select area on map, or enter coordinates manually:

1:  N  E  
 2:  N  E

**Maneuver type** [?](#)  
 Nadir  
 Slew

**HSI**

**Desired spectrum** [?](#)  
 700 - 1000 nm

**Camera parameters** [?](#)  
 Template default  
 Enter custom values

**File naming** [?](#)  
 Default  
 Enter custom values

**RGB**

**RGB settings** [?](#)  
 Template default  
 Use custom settings

**TASK OUTLINE**

**Task Template** [?](#)  
 Norwegian coast, evening

**Priority task** [?](#)  
 No  
 Yes

**Start time** [?](#)  
 2020-04-25 19  
 First availab

Note that first available pass might not have the desired light or weather conditions. Manually selected start time is recommended.

**ADCS**

**Select imaging area** [?](#)  
 Select area on map, or enter coordinates manually:

1:  N  E  
 2:  N  E

**Maneuver type** [?](#)  
 Nadir  
 Slew

**HSI**

**Desired spectrum** [?](#)  
 700 - 1000 nm

**Camera parameters** [?](#)  
 Template default  
 Enter custom values

**File naming** [?](#)  
 Default  
 Enter custom values

**RGB**

**RGB settings** [?](#)  
 Template default  
 Use custom settings

AVAILABLE IMAGING AREA

### Task validated

This task has been validated and approved for uplink.

Estimated file size is 340 MB.

Estimated time for downlink is 2 min 34 sec.

Script can be edited manually in the window below.

This window contains auto-generated commands generated by the template.

```
1 Lorem ipsum dolor sit amet consectetur.
  Quisque scelerisque luctus magna.
  Nulla tortor ante suscipit quis orci quis.
  Integer maximus eros vitae placerat mollis.
  Integer malesuada pellentesque sapien.
  Ut ex augue hendrerit in tristique.
```

Edit task
Add task to mission queue

#### TASK OUTLINE

**Template** ?  
Norwegian coast, evening

**Priority task** ?  
 No  
 Yes

**Start time** ?  
2020-04-25 19:00:01

First available pass matching template

#### ADCS

**Select imaging area** ?  
Select area on map, or enter coordinates manually.

1:  N  E  
 2:  N  E

**Maneuver type** ?  
 Nadir  
 Slew

#### HSI

**Desired spectrum** ?  
700 - 1000 nm

**Camera parameters** ?  
 Template default  
 Enter custom values

**File naming** ?  
 Default  
 Enter custom values

#### RGB

**RGB settings** ?  
 Template default  
 Use custom settings

Save draft
Generate script and validate task

#### Alarms

● All systems ok

Mission queue
Commands
Log
Pass details

	START TIME	END TIME
Template "Norwegian coast, morning/midday, high resolution"	2020-04-25 04:51:03	2020-04-25 18:00:00
Pass	2020-04-25 11:10:12	2020-04-25 11:21:00
Pass	2020-04-25 14:01:00	2020-04-25 14:12:42
Template "Norwegian coast, evening, low resolution"	2020-04-25 18:00:00	2020-04-26 06:00:00
Pass	2020-04-25 18:09:42	2020-04-25 18:20:59
Pass	2020-04-25 22:20:33	2020-04-25 22:27:51

+ Create new mission

#### PL power consumption W

Individual  Total

#### HSI temperature (C)

#### Mission timeline

### Alarms

All systems ok

### PL power consumption W

Individual  Total

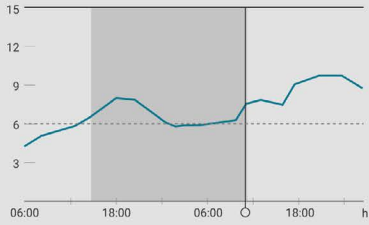

### HSI temperature (C)

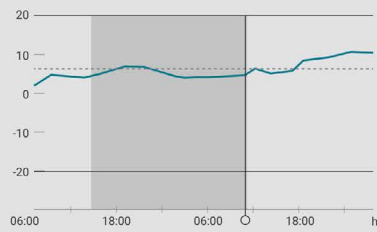

### Mission queue

### Commands

### Log

### Pass details

	START TIME	END TIME
lorem ipsum	2020-04-25 10:51:03	2020-04-25 10:52:20
dolor sit amet	2020-04-25 10:52:20	2020-04-25 10:56:00
consectetur	2020-04-25 11:06:00	2020-04-25 11:09:42
initialize pass	2020-04-25 11:09:42	2020-04-25 11:09:59
sed do eiusmod	2020-04-25 11:10:00	2020-04-25 11:20:32
tempor incididunt ut labore	2020-04-25 11:20:33	2020-04-25 11:27:51
et dolore magna aliqua	2020-04-25 11:27:51	2020-04-25 11:42:16
ut enim ad	2020-04-25 11:42:16	2020-04-25 11:42:47

### Mission timeline

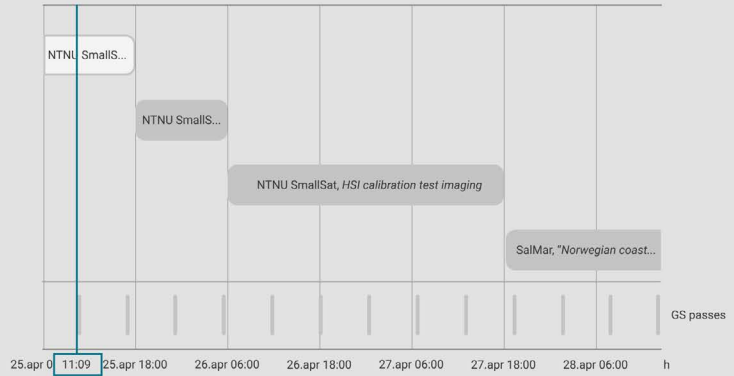

### Alarms

All systems ok

### PL power consumption W

Individual  Total

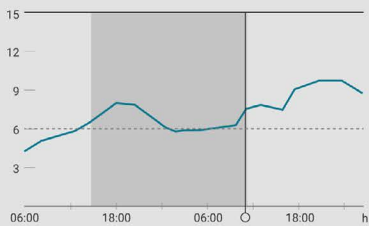

### HSI temperature (C)

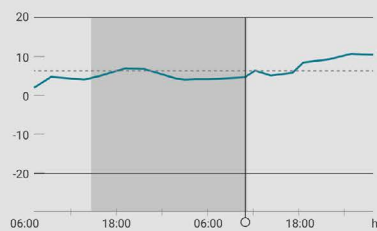

### Mission queue

### Commands

### Log

### Pass details

		OPERATOR	TIMESTAMP
Pass complete	120/120 MB downlinked, 8/8 MB uplinked		2020-04-25 06:00:06
Alarm silenced	HSI temperature approaching limit (2)	Hansen, Andreas	2020-04-25 06:00:00
Pass complete	17/17 MB downlinked		2020-04-25 02:12:42
Pass incomplete	103/120 MB downlinked		2020-04-24 22:36:50
Alarm silenced	UHF beam power low (3)	Sand, Gjertrud	2020-04-24 22:36:45
Task completed	HSI calibration test imaging		2020-04-24 22:27:51
Pass complete			2020-04-24 18:46:02
Pass complete	12/12 MB uplinked		2020-04-24 13:10:31

### Mission timeline

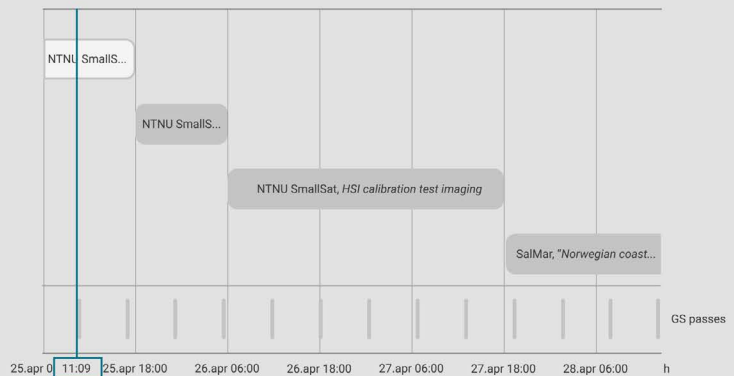



### Alarms

All systems ok

### PL power consumption W

Individual  Total

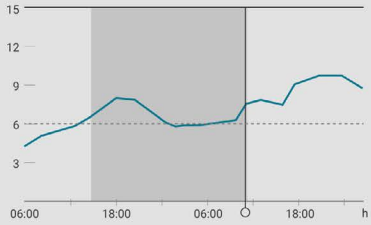

### HSI temperature (C)

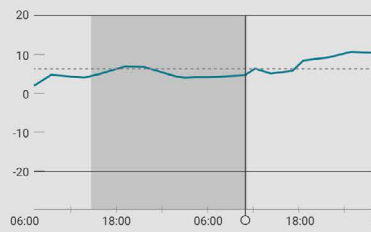

### Mission queue

### Commands

### Log

### Pass details

### Storage



### Received Beam Power (kHz)

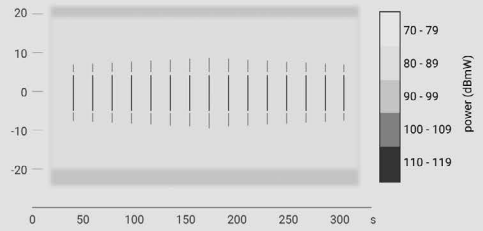

### Mission timeline

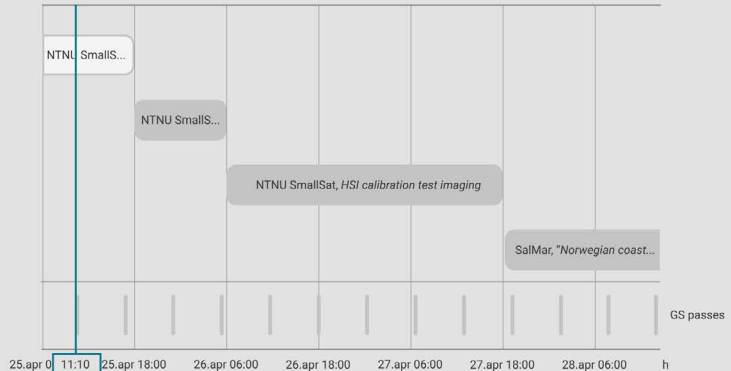

### Alarms

**2** HSI temperature approaching limit

### PL power consumption W

Individual  Total

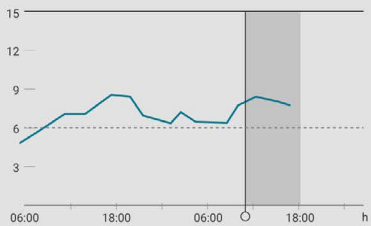

### HSI temperature (C) **2**

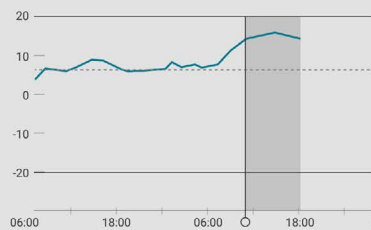

### Mission queue

### Commands

### Log

### Pass details

### Storage

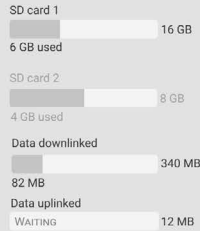

### Received Beam Power (kHz)

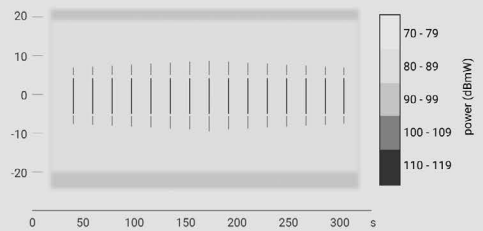

### Mission timeline

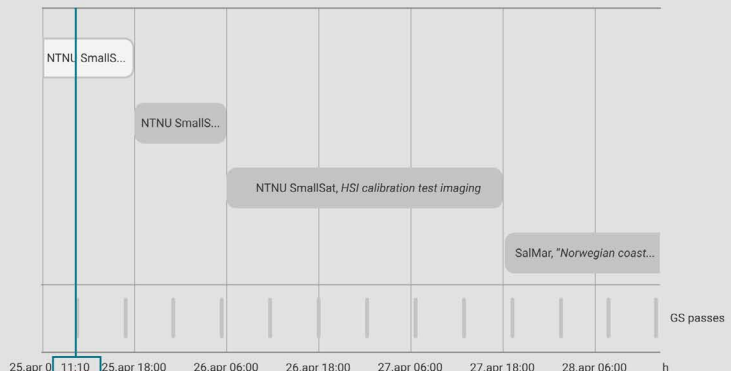

### Alarms

**2** HSI temperature approaching limit

### PL power consumption W

Individual  Total

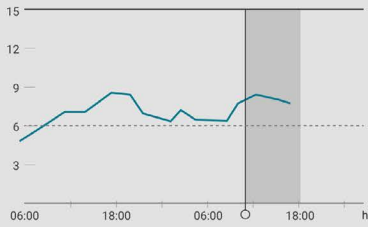

### HSI temperature (C)

**2** HSI temperature approaching limit

The temperature is getting too high. Monitor carefully. Check up on this during next pass.

Close

Silence alarm

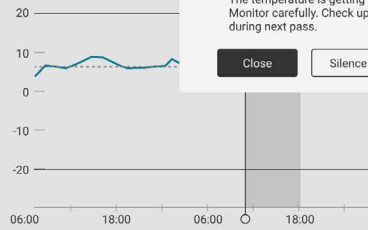

### Mission queue

### Commands

### Log

### Pass details

### Storage

SD card 1  
16 GB  
6 GB used

SD card 2  
8 GB  
4 GB used

Data downlinked  
340 MB  
82 MB

Data uplinked  
12 MB  
WAITING

### Received Beam Power (kHz)

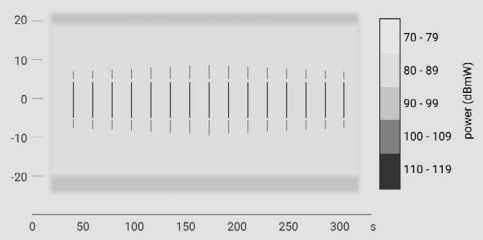

### Mission timeline

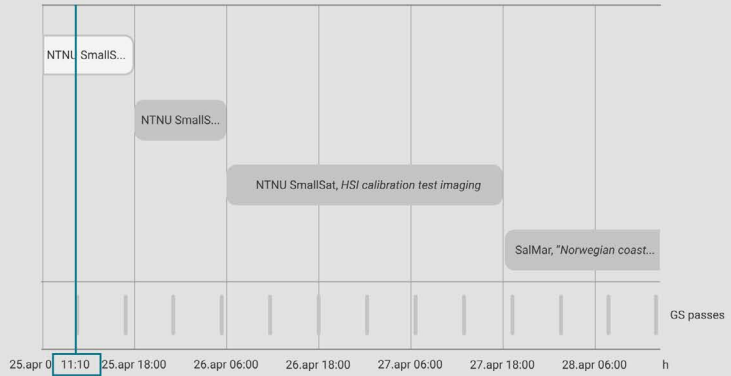

### Alarms

**2** HSI temperature approaching limit

The temperature is getting too high. Monitor carefully. Check up on this during next pass.

Close

Silence alarm

### PL power consumption W

Individual  Total

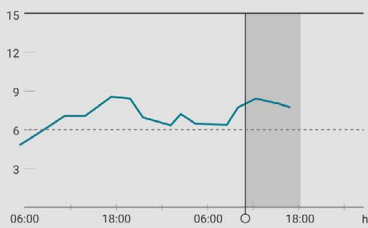

### HSI temperature (C)

**2**

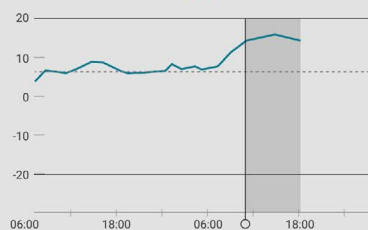

### Mission queue

### Commands

### Log

### Pass details

### Storage

SD card 1  
16 GB  
6 GB used

SD card 2  
8 GB  
4 GB used

Data downlinked  
340 MB  
82 MB

Data uplinked  
12 MB  
WAITING

### Received Beam Power (kHz)

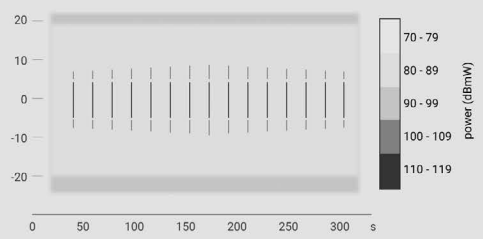

### Mission timeline

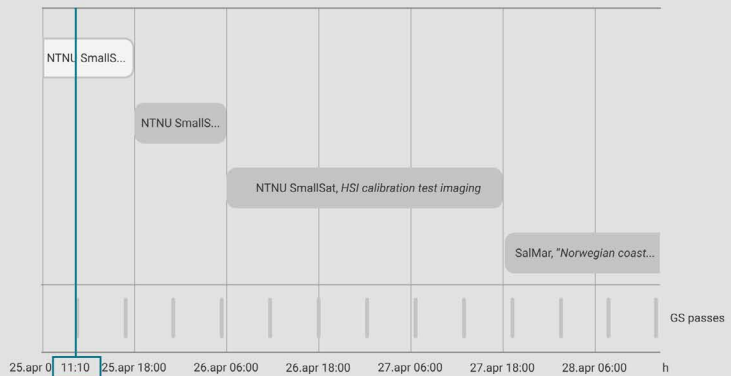

### Alarms

● 1 alarm silenced

### PL power consumption W

Individual  Total

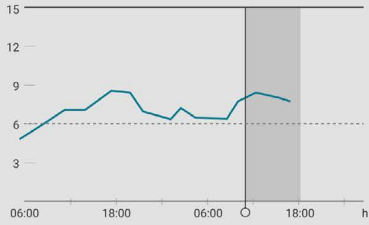

### HSI temperature (C) s

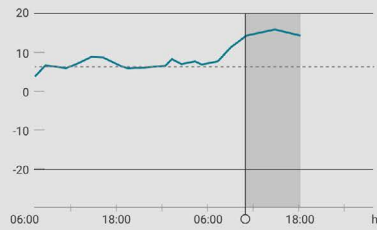

### Mission queue

### Commands

### Log

### Pass details

		OPERATOR	TIMESTAMP
Alarm silenced	HSI temperature approaching limit (2)	Testesen, Testperson	2020-04-25 11:10:32
Pass complete	120/120 MB downlinked, 8/8 MB uplinked		2020-04-25 06:00:06
Alarm silenced	HSI temperature approaching limit (2)	Hansen, Andreas	2020-04-25 06:00:00
Pass complete	17/17 MB downlinked		2020-04-25 02:12:42
Pass incomplete	103/120 MB downlinked		2020-04-24 22:36:50
Alarm silenced	UHF beam power low (3)	Sand, Gjertrud	2020-04-24 22:36:45
Task completed	HSI calibration test imaging		2020-04-24 22:27:51
Pass complete			2020-04-24 18:46:02

### Mission timeline

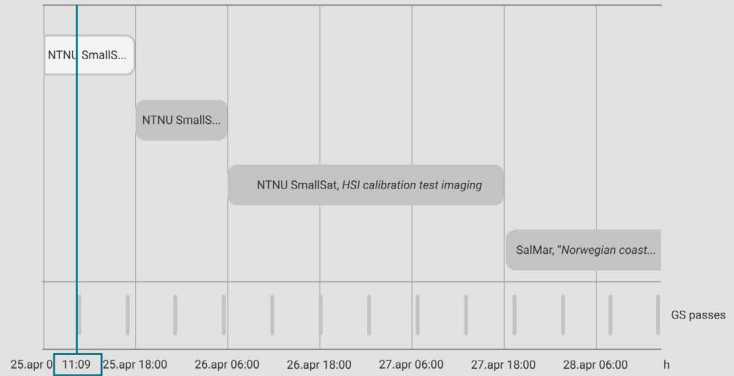

### Alarms

● 1 alarm silenced

### PL power consumption W

Individual  Total

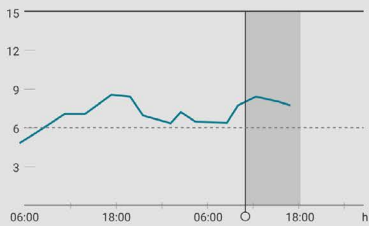

### HSI temperature (C) s

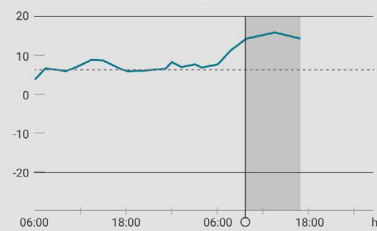

### Mission queue

### Commands

### Log

### Pass details

### Storage

SD card 1  
16 GB  
6 GB used

SD card 2  
8 GB  
4 GB used

Data uplinked  
340 MB  
82 MB

Data downlinked  
12 MB  
WAITING

### Received Beam Power (kHz)

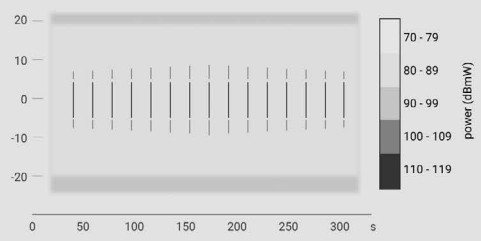

### Mission timeline

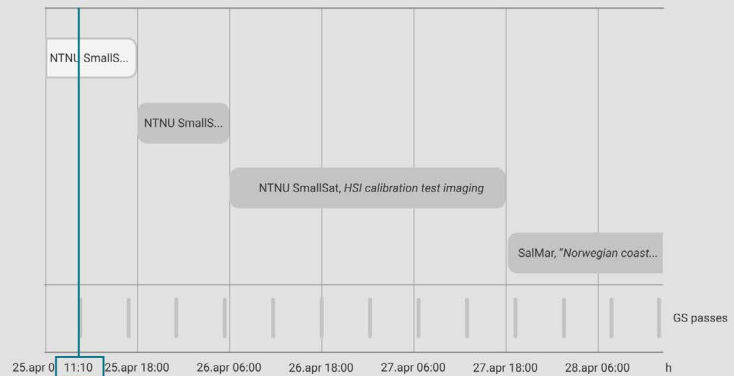

### Alarms

**1** HSI temperature too high. Going into safe mode.

### PL power consumption

W

Individual  Total

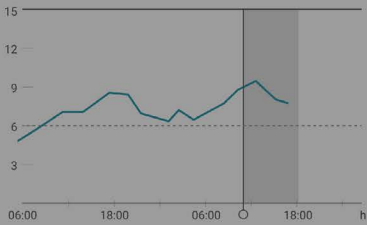

### HSI temperature (C)

**1**

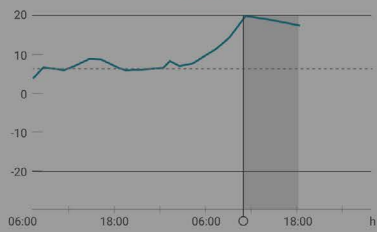

### Mission queue

### Commands

### Log

### Pass details

		OPERATOR	TIMESTAMP
Alarm silenced	HSI temperature approaching limit (2)	Testesen, Testperson	2020-04-25 11:10:32
Pass complete	120/120 MB downlinked, 8/8 MB uplinked		2020-04-25 06:00:06
Alarm silenced	HSI temperature approaching limit (2)	Hansen, Andreas	2020-04-25 06:00:00
Pass complete	17/17 MB downlinked		2020-04-25 02:12:42
Pass incomplete	103/120 MB downlinked		2020-04-24 22:36:50
Alarm silenced	UHF beam power low (3)	Sand, Gjertrud	2020-04-24 22:36:45
Task completed	HSI calibration test imaging		2020-04-24 22:27:51
Pass complete			2020-04-24 18:46:02

### Activating safe mode

A critical threshold has been passed.  
Threshold ID: HSI temp max

The payload is going into safe mode  
This will pause all current missions.

Close window

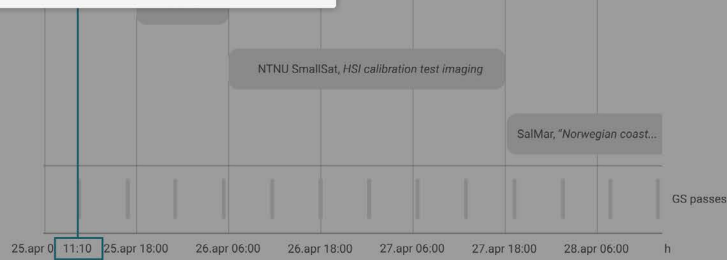

### Alarms

Payload is in safemode. All missions paused.

### PL power consumption

W

Individual  Total

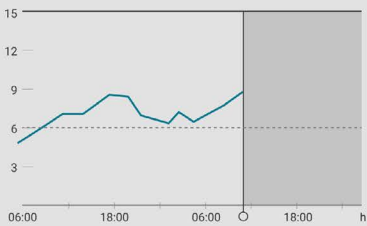

### HSI temperature (C)

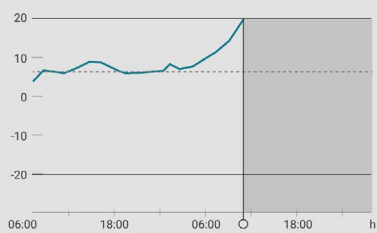

### Mission queue

### Commands

### Log

### Pass details

		OPERATOR	TIMESTAMP
Safe mode activated	HSI temperature above limit (1)		2020-04-25 11:11:09
Alarm silenced	HSI temperature approaching limit (2)	Testesen, Testperson	2020-04-25 11:10:32
Pass complete	120/120 MB downlinked, 8/8 MB uplinked		2020-04-25 06:00:06
Alarm silenced	HSI temperature approaching limit (2)	Hansen, Andreas	2020-04-25 06:00:00
Pass complete	17/17 MB downlinked		2020-04-25 02:12:42
Pass incomplete	103/120 MB downlinked		2020-04-24 22:36:50
Alarm silenced	UHF beam power low (3)	Sand, Gjertrud	2020-04-24 22:36:45
Task completed	HSI calibration test imaging		2020-04-24 22:27:51

### Mission timeline

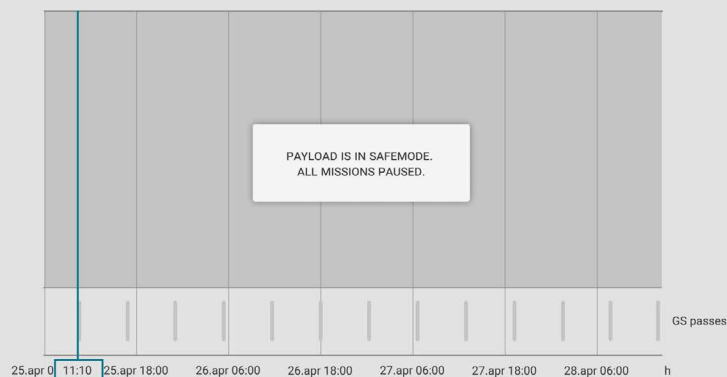

STAR TRACKER <b>ON</b>	IMU <b>ON</b>	GYROSCOPE <b>3/3</b>
GPS <b>ON</b>	SUN SENSOR <b>4/6</b>	MAGNETOM. <b>2/3</b>
REACTION WH. <b>4/4</b>	HEATER <b>OFF</b>	UHF

Battery



Generated power W

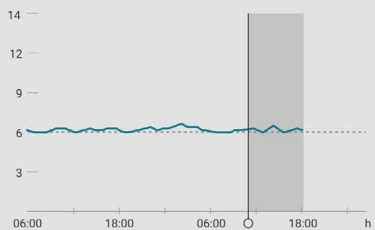

Power consumption W

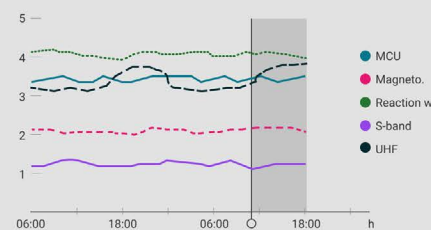

Attitude

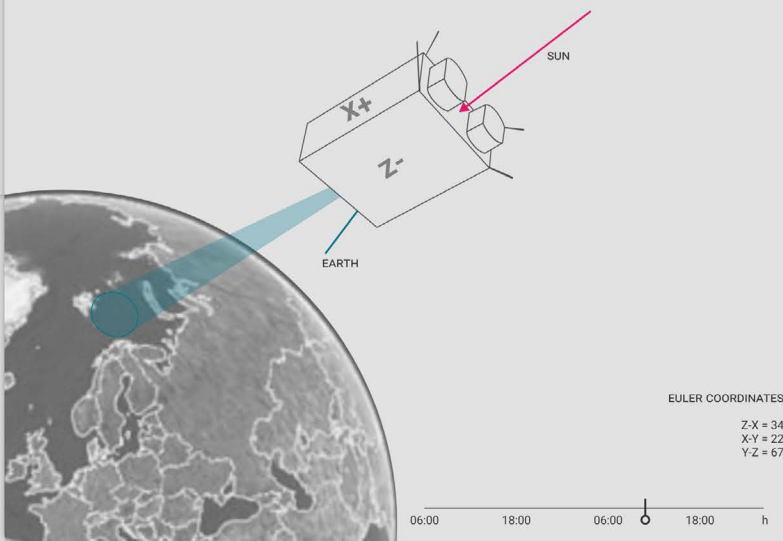

Temperatures (C)

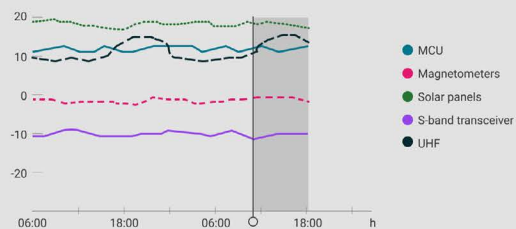

Spin (deg/s)

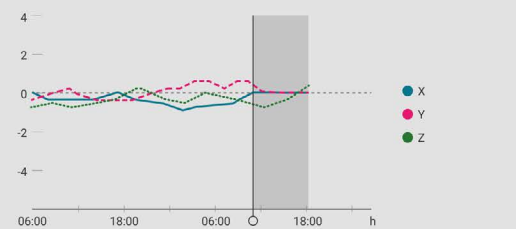

STAR TRACKER <b>ON</b>	IMU <b>ON</b>	GYROSCOPE <b>3/3</b>
GPS <b>ON</b>	SUN SENSOR <b>4/6</b>	MAGNETOM. <b>2/3</b>
REACTION WH. <b>4/4</b>	HEATER <b>OFF</b>	UHF <b>ON</b>

Battery



Generated power W

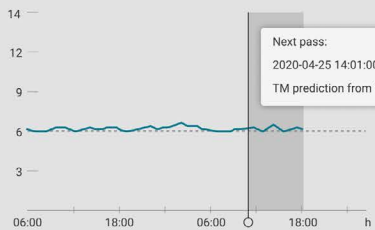

Power consumption W

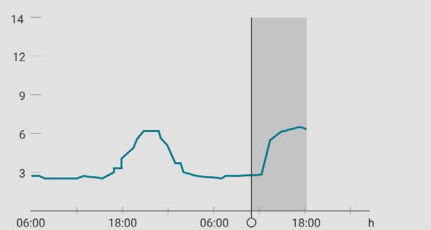

Attitude

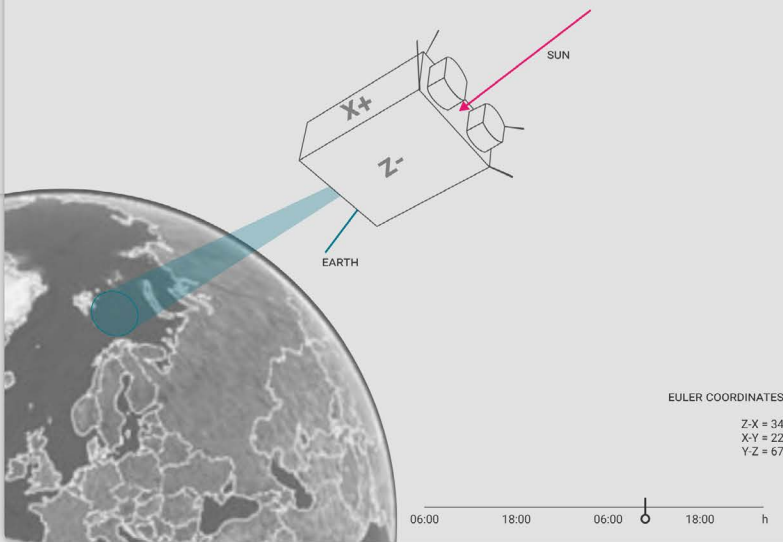

Temperatures (C)

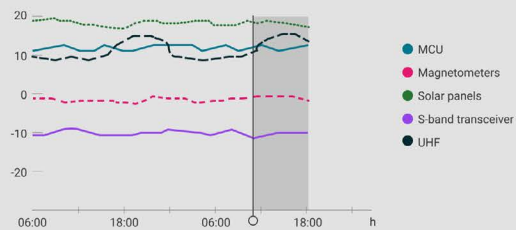

Spin (deg/s)

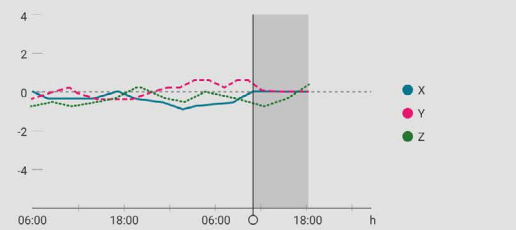

STAR TRACKER <b>ON</b>	IMU <b>ON</b>	GYROSCOPE 3/3
GPS <b>ON</b>	SUN SENSOR 4/6	MAGNETOM. 2/3
REACTION WH. 4/4	HEATER <b>OFF</b>	UHF -

Battery



Generated power W

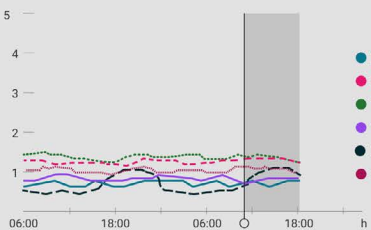

Power consumption W

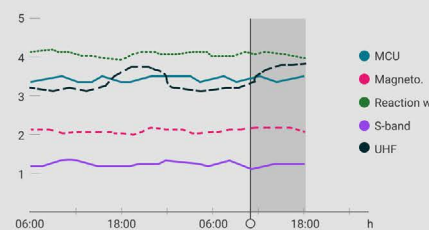

Attitude

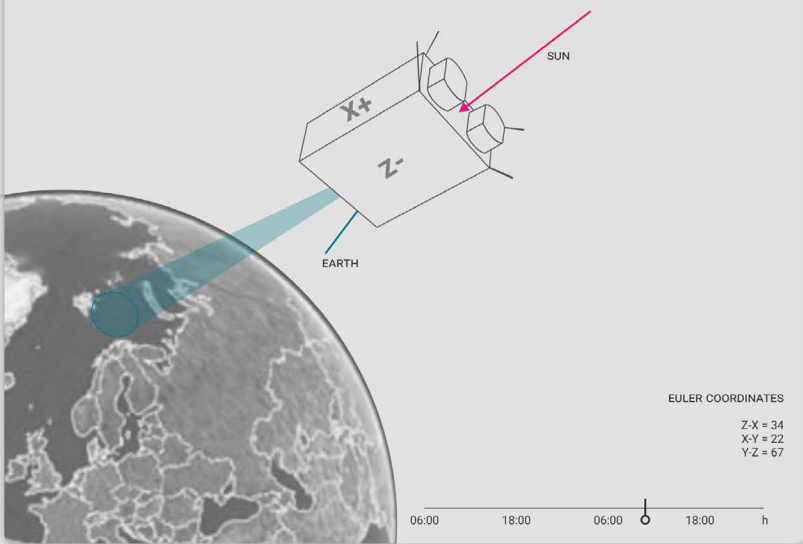

Temperatures (C)

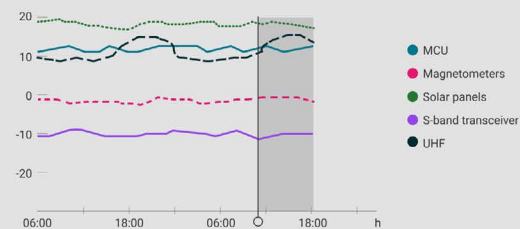

Spin (deg/s)

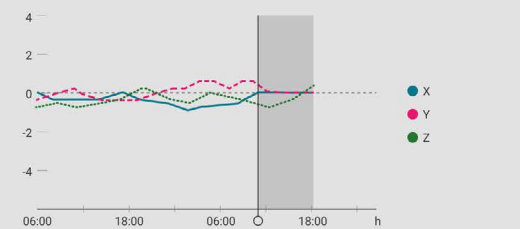

STAR TRACKER <b>ON</b>	IMU <b>ON</b>	GYROSCOPE 3/3
GPS <b>ON</b>	SUN SENSOR 4/6	MAGNETOM. 2/3
REACTION WH. 4/4	HEATER <b>OFF</b>	UHF <b>ON</b>

Battery



Generated power W

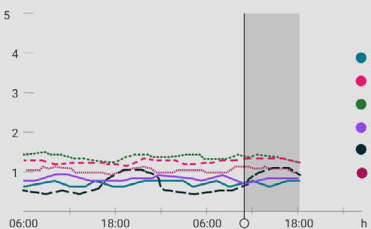

Power consumption W

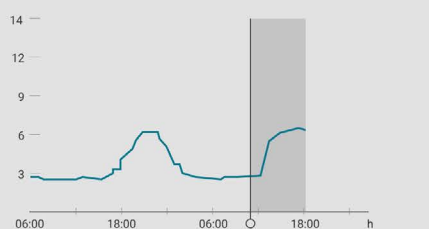

Attitude

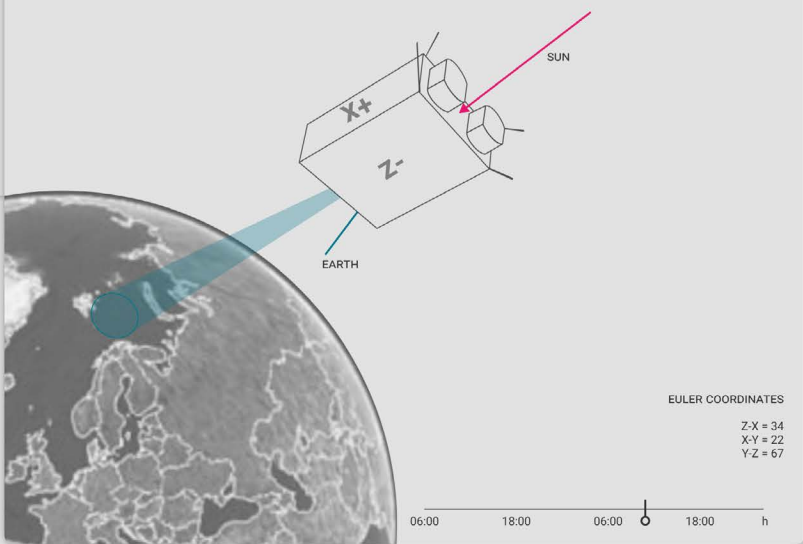

Temperatures (C)

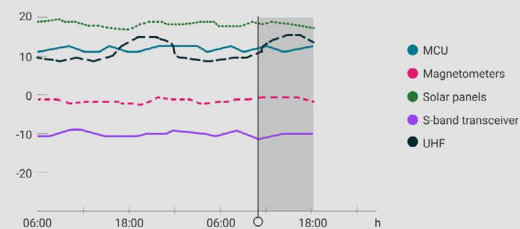

Spin (deg/s)

