

ISBN 978-82-326-5054-5 (printed ver.)
ISBN 978-82-326-5055-2 (electronic ver.)
ISSN 1503-8181

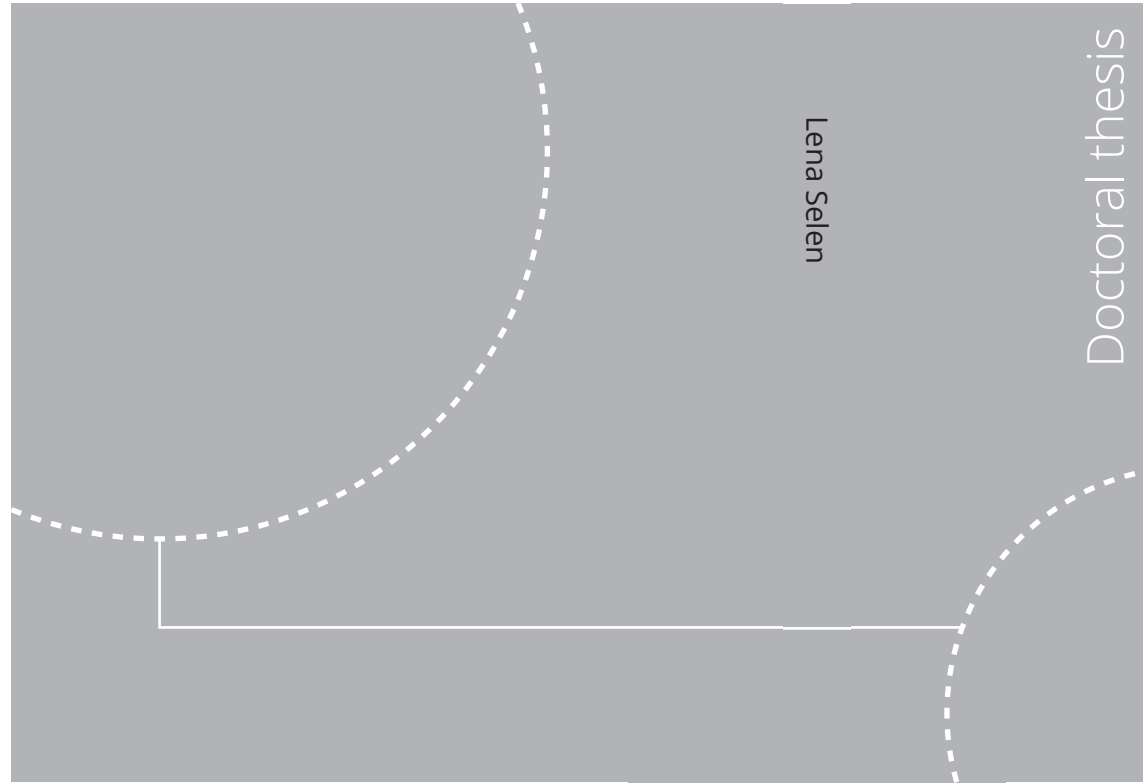

Doctoral theses at NTNU, 2020:354

Lena Selen

Assessment on the swelling and disintegration potential of weak and weathered rocks in water tunnels of hydropower projects - a contribution based on use of laboratory testing methods

Doctoral theses at NTNU, 2020:354

NTNU
Norwegian University of
Science and Technology
Thesis for the degree of
Philosophiae Doctor

 **NTNU**
Norwegian University of
Science and Technology

 NTNU

 **NTNU**
Norwegian University of
Science and Technology

Lena Selen

Assessment on the swelling and disintegration potential of weak and weathered rocks in water tunnels of hydropower projects - a contribution based on use of laboratory testing methods

Thesis for the degree of Philosophiae Doctor

Trondheim, November 2020

Norwegian University of Science and Technology



Norwegian University of
Science and Technology

NTNU

Norwegian University of Science and Technology

Thesis for the degree of Philosophiae Doctor

© Lena Selen

ISBN 978-82-326-5054-5 (printed ver.)

ISBN 978-82-326-5055-2 (electronic ver.)

ISSN 1503-8181

Doctoral theses at NTNU, 2020:354



Printed by Skipnes Kommunikasjon AS

Preface

This research project was accomplished in the period of August 2017 – August 2020 at the Department of Geoscience and Petroleum, Faculty of Engineering of the Norwegian University of Science and Technology (NTNU), Norway. The project is a part of a large research initiative in Norway in the field of renewable energy called FME HydroCen (the Norwegian Research Centre for Hydropower Technology) at NTNU. HydroCen is a centre for environment-friendly Energy Research (FME) established in 2017 by The Research Council of Norway. Its main objective is to enable the Norwegian hydropower sector to meet complex challenges and exploit new opportunities through innovative technological solutions whereby the research areas include hydropower structures, turbine and generator, market and services and environmental design. NTNU is the host institution and is the main research partner together with SINTEF Energy Research and the Norwegian Institute for Nature Research (NINA). HydroCen include almost 60 national and international partners from industry, R&D institutes and universities.

Statkraft is a sponsor of HydroCen and a leading company in hydropower internationally. The company have experienced challenging rock behavior during development of several hydropower projects in the southern parts of Europe, South America, East Asia and Africa. Many of these challenges were related to a variation of rock properties from the estimated behavior in the planning phase to the construction and operation phase. Such behavior included swelling, disintegration, loss of strength and deformability properties, which is less familiar in the Norwegian environment. Some of the projects are still in the feasibility stage or under construction, and two of their projects are used as case-studies during the work of this PhD. Statkraft has funded field work, sampling and laboratory testing for this research.

Acknowledgements

First, I would like to express my gratitude to my main supervisor Prof. Krishna Kanta Panthi for giving me the opportunity to fulfill this project and for his theoretical, technical and personal assistance throughout the obstacles of this work. Further, no words can express how much I appreciate the peerless encouragement and support from my co-supervisor, Adjunct Associate Professor Siri Stokseth (Statkraft). I also feel extremely privileged and thankful to Statkraft for providing necessary financial and technical support required for the field work and laboratory testing, and to Mr. Thomas Schönborn (Statkraft) for empowering this unique collaboration. I would also like to express my gratitude to FME HydroCen for providing the required resources to accomplish my research objectives, and to Ms. Hege Brende for her consistent support. A great thanks is also given Sylvi Vefsnmo (Head of Administration, NTNU) for her assistance during periods where facilitation was required to keep me on schedule.

I am thankful for the close cooperation Dr. Maximiliano Vergara (Züblin AG; Karlsruhe Institute of Technology) with the swelling tests, for him giving me inspiration to my ideas and for sharing of his confidence from start to end of my research work. He proved me the paramount value of sharing and collaborating abroad as a researcher. I will further express my gratitude to Senior Laboratory Engineer Gunnar Vistnes (NTNU) for his enthusiasm and support in turning my ideas into reality in the laboratory and for his company on laboratory visits abroad. The obstacles between theory and practice turned into joy, thanks to him. A great thanks is also sent to Mr. Lloyd Tunbridge (Norges Geotekniske Institutt) for proofreading this thesis and for sharing of his experience and enthusiasm during the instrumentation of the flatjacks in Albania.

Thanks to Prof. Bjørn Nilsen (NTNU), Mr. Laurentius Thijus (NTNU), Prof. Mai Britt Mørk (NTNU), Ass. Prof. Bjørn Eske Sørensen (NTNU), Dr. Kristian Drivenes (NTNU), Mr. Jon Runar Drotningshaug (NTNU), Ms. Marianne Metz (Karlsruhe Institute of Technology), Mr. Filip Dahl (SINTEF) and Mr. Joakim Eggen (SINTEF) for the continuous discussions and valuable inputs on my laboratory experiments throughout the research period. Thanks also to Ms. Julia Leuthold (Karlsruhe Institute of Technology) and Dr. Marco Barla (Politecnico di Torino) for their generosity in spending of their time to show me around at the laboratories and for fruitful discussions on testing methodologies.

To all my precious friends (you know who you are), family (bounded by blood or by heart) and my dear beloved; thank you for brightening my days, months and years throughout this period. And mom; thank you for always believing in me and for your unconditional love. I am blessed to be your daughter.

*There's a fine line between fishing and just
standing on the shore like an idiot.*

- Steven Wright

Abstract

Swelling of rocks is a time-dependent phenomenon and a result of multiple and interactive rock characteristics interplaying in a complex picture. Further, the swelling responses of the rock mass are conditioned on the project-specific phases of operation and the consequential changes in rock material characteristics over time. Assessments on the swelling character and state of degradation of rocks are therefore fundamental in avoiding difficulties in tunnels constructed for both infrastructure and hydropower. Since testing of in-situ rock masses on a realistic scale is difficult to conduct due to excessive costs and resources, the prediction of rock mass behavior to a large extent must rely on laboratory assessments on sampled rock specimen.

Despite the large number of testing procedures and classification systems of rocks, the different methods suggested for assessments on the weak and intermediate rock types are not univocal. Further, testing programs conventionally used in rock mechanics are found difficult to apply on weak rocks due to preparation issues, and procedures used in soil mechanics tend to neglect important material parameters of the intact rock. In addition, the project-specific aspects of rock behavior are usually discounted in standardized test procedures as this will reduce the applicability of the classification system across engineering disciplines. Major generalizations are therefore prevailing in many widely used investigation procedures.

An increasing number of cases reported from the hydropower industry witness about instabilities and collapses whereby swelling and disintegration of degraded rocks are among the causes. Several of the cases are assumed related to a mismatch between the estimated rock characteristics and the experienced behavior of the in-situ rock mass, which is a serious challenge as the adequacy of the support system is dependent on factual input data to modeling tools. However, the intense exposure to moisture fluctuations in hydropower water tunnels passing through weak rock masses are seldom addressed in the applied laboratory tests. Considering the current need of understanding the mechanisms causing swelling and slaking behavior of degraded rocks, this research aims to examine frequently used investigation strategies applied in weak rock engineering with emphasis on water tunnels for hydropower projects.

The research work includes literature reviews, field work, laboratory visits, sampling and testing of rock specimens. Based on close cooperation with different institutions, i.e.; Statkraft, SINTEF, NGI (Norges Geotekniske Institutt), KIT (Karlsruhe Institute of Technology) and Politecnico di Torino, inside information on investigation strategies in weak rock assessments is obtained. The testing procedures used at three European institutions for determination of rock material parameters as mineralogical composition, structural features, swelling potential and slake durability are assessed down to single detail. Rock

specimens from two hydropower projects are sampled, prepared and tested at KIT and NTNU. The processing of the obtained data is based on both quantitative analyzing methods and qualitative descriptions and comparisons. In addition to the industrial partners of this research, continuous discussions with research colleagues, both domestic and abroad, are performed during the entire research period.

The findings of this research imply that the frequently used ISRM (International Society for Rock Mechanics) suggested methods for assessments on swelling potential and slake durability of rocks needs adjustments when applied on weak and intermediate rock types. The oedometer swelling test for assessments on swelling gouge material in weakness zones are found inadequate in characterizations of intact rock swelling properties. Limitations are also revealed on the general consistency of the testing manuals, on the preparation techniques, on the apparatus configurations, on the temperature exerted on the samples during both preparation and testing, and on the interpretation systems for the results. Further improvements on the methodologies are found necessary when applied in determinations of the long-term degradation behavior of weathered and swelling rocks in hydropower projects. In addition, major weaknesses are found for the X-Ray Diffraction (XRD)-analysis used to quantify mineralogical constituents when applied on weathered rocks.

The extensive laboratory work in combination with the wide-ranged cooperation has resulted in suggestions on project-specific modifications on standardized laboratory tests which enable an interpretation of weak rock behavior closer to the in-situ situation of water tunnels. Improvements are made explicit on the oedometer swelling test procedure in operation at the NTNU laboratory, including preparation techniques and apparatus configuration, and investments on new equipment is in progress. Additionally, the research includes an experimental application of the in-situ flatjack test normally used to measure in-situ stresses around tunnels which now is installed in a hydropower tunnel to measure changes in stress during the initial phase of operation. The flatjacks will hopefully produce valuable data for comparison with and evaluation of the obtained laboratory results. The overall findings are highly relevant for the hydropower industry but may also be relevant for other geotechnical projects where weathered and swelling rock materials cause challenges related to construction and/or operation of geotechnical structures.

List of main publications and note on contribution

The present thesis is based on four scientific peer-reviewed papers and one conference paper. The authors' contribution on each paper is listed together with the publication details. The papers will be referred with their roman numbers as following:

Paper I

An analysis on the slaking and disintegration extent of weak rock mass of the water tunnels for hydropower project using modified slake durability test

Lena Selen, Krishna Kanta Panthi and Gunnar Vistnes

Published in Bulletin of Engineering Geology and the Environment, Volume 79, Issue 4, pp. 1919-1937, 2019.

The concept on the modified version of Slake Durability Test was proposed by the main supervisor Professor Krishna Kanta Panthi and the planning of the laboratory assessments was performed by Lena Selen in collaboration with main supervisor and senior laboratory engineer Gunnar Vistnes. The laboratory work and data analysis were carried out by Lena Selen and Gunnar Vistnes with assistance from Jon Runar Drotningshaug (NTNU) and Laurentius Thijus (NTNU). The paper was written by Lena Selen and reviewed and edited during the process by Krishna Kanta Panthi.

Paper II

An investigation on the compositional features and swelling potential of two weak rock types affecting their slake durability

Lena Selen, Krishna Kanta Panthi, Mai Britt Mørk and Bjørn Eske Sørensen

Submitted to Geotechnical and Geological Engineering, 04.08.2020.

The planning of the laboratory assessments was performed by Lena Selen and Krishna Kanta Panthi. The thin section analysis was performed by Mai Britt Mørk and Lena Selen. The SEM-analysis was performed by Bjørn Eske Sørensen, Mai Britt Mørk and Lena Selen. The analysis of the results was carried out in close cooperation between Lena Selen, Mai Britt Mørk and Bjørn Eske Sørensen with assistance from Laurentius Thijus (NTNU). The paper was written by Lena Selen and reviewed and edited during the process by Krishna Kanta Panthi and Mai Britt Mørk.

Paper III

Investigation on the effect of cyclic moisture change on rock swelling in hydropower water tunnels

Lena Selen, Krishna Kanta Panthi, Maximiliano Vergara and Mai Britt Mørk

Published in Rock Mechanics and Rock Engineering, online 10.10.2020.

The planning of the laboratory assessments was performed by Lena Selen and Krishna Kanta Panthi in cooperation with Maximiliano Vergara. The swelling tests were performed by Lena Selen and Maximiliano Vergara with assistance from Gunnar Vistnes (NTNU) and Marianne Metz (KIT). The mineralogical analyses (thin section analysis and XRD analysis) were performed by Mai Britt Mørk, Laurentius Thijus (NTNU) and Lena Selen. The paper was written by Lena Selen and Maximiliano Vergara and reviewed and edited during the process by Krishna Kanta Panthi and Mai Britt Mørk.

Paper IV

A discussion on the laboratory testing approaches for swelling rocks at three European institutions

Lena Selen and Krishna Kanta Panthi

Submitted to Geomechanics for Energy and the Environment, 05.08.2020.

The planning of the work and the concept of the paper were developed by Lena Selen and Krishna Kanta Panthi. The need for such assessment and comparison was discussed with Thomas Schönborn (Statkraft). The laboratory visits were carried out by Lena Selen, Gunnar Vistnes and Krishna Panthi. Inputs were received from Gunnar Vistnes, Maximiliano Vergara (KIT) and Marco Barla (Politecnico di Torino) while collecting information about different laboratory methods. Analysis and manuscript writing were carried out by Lena Selen and reviewed and edited by Krishna Kanta Panthi.

Paper V

**Field testing of weak rock deformation in water tunnels:
A practical review of the flatjack test**

Lena Selen, Krishna Panthi, Lloyd Tunbridge and Thomas Schönborn

Published in Rock Mechanics for Natural Resources and Infrastructure Development (2019) and presented at ISRM2019, Brazil.

The planning of the measurements was carried out by Lena Selen, Krishna Panthi, Thomas Schönborn (Statkraft) and Lloyd Tunbridge (NGI). Lloyd Tunbridge was the main responsible for the technical issues of the instrumentation with assistance from Thomas Schönborn and Krishna Panthi. The instrumentation was carried out in close cooperation between all four authors. The analysis of the data was performed by Lloyd Tunbridge in cooperation with Krishna Panthi. The paper was written by Lena Selen with assistance from the three other authors.

List of additional contribution during this PhD study

Selen, L. (2017). Svellmekanismer i bergarter som ikke inneholder svelleleire. In: *Fjellsprengningsdagen, Bergmekanikkdagen, Geoteknikkdagen*. Norsk Forening for Fjellsprengningsteknikk, Norsk Bergmekanikkgruppe og Norsk Geoteknisk Forening, Oslo, 23–25 Nov. 2017, Article No. 28, 15 p.

Selen, L., Panthi, K.K. and Vergara, M.R. (2018). Swelling pressures of some rocks using different test procedures. In: *Proceedings of the 2018 European Rock Mechanics Symposium (EUROCK 2018)*, Saint Petersburg, Russia, 22–26 May 2018: Volume 1, pp.401–410.

Selen, L. and Panthi, K.K. (2018). Influence of Slaking and Disintegration Effect on the Stability of Water Tunnels for Hydropower. In: *Proceedings of the ARMS 10th Asian Rock Mechanics Symposium*, The ISRM International Symposium for 2018, 29. Oct.–03. Nov. 2018, Singapore. 9 p.

Selen, L. (2019). *Det enkle er ofte det beste - men kanskje ikke alltid? Testmetoder for sleppemateriale og svellende berg i vannkraft*. Webinar, «God Forsker Morgen», HydroCen/Multiconsult, Oslo, Norway, 21. June 2019. Available at : https://www.youtube.com/watch?v=m5B9ejKkgmg&feature=emb_title. (Accessed at: 09.08.2020).

Selen, L. and Panthi, K.K. (2019). Slaking og disintegrering av svake bergarter i vanttunneler. In: *Fjellsprengningsdagen, Bergmekanikkdagen, Geoteknikkdagen*. Norsk Forening for Fjellsprengningsteknikk, Norsk Bergmekanikkgruppe og Norsk Geoteknisk Forening, Oslo.

Selen, L. (2020). *Svelling og disintegrering av svakt bergmateriale i vanttunneler*. Presentation at PTK2020 (Produksjonsteknisk konferanse), 2.–4. March 2020, Trondheim, Norway.

Selen, L. (2020): Tett hovedpulsåre? Svellende berg i vanttunneler. Popular Science article. In: *Energiteknikk nr. 4 – juni 2020*, pp.40–41.

Thesis structure

Part 1: Summary

Part 2: Main publications

Table of Contents

Preface	i
Acknowledgements	iii
Abstract.....	vii
List of main publications and note on contribution.....	ix
List of additional contribution during this PhD study	xii
Thesis structure.....	xiii

Part 1: Summary

1. Introduction	1
1.1 Geology and rock engineering	1
1.2 Constructions in degraded rock masses	2
1.2.1 Rock degradation	2
1.2.2 The project related features of hydropower water tunnels	3
1.3 Critical behavior parameters of degraded rocks	4
1.3.1 Swelling of rocks	4
1.3.2 Slaking of rocks	5
1.4 Laboratory assessments of swelling and slaking rocks	5
1.4.1 Compositional analyses	5
1.4.2 Swelling tests	6
1.4.3 The slake durability test.....	7
1.5 Uncertainties in estimating rock mass behavior	8
1.5.1 Sample uncertainties.....	8
1.5.2 Uncertainties related to test method	9
1.5.3 Classification uncertainties.....	9
1.6 Motivation.....	11

1.7	Scope and objectives.....	11
1.8	Ethical issues.....	12
2.	Study cases and rock material	13
2.1	Alimit HPP.....	13
2.2	Moglicë HPP.....	14
3.	Research approach.....	17
3.1	Theoretical framework.....	17
3.2	Field work and sampling.....	17
3.3	International collaboration.....	18
3.4	Laboratory work	19
3.4.1	Laboratory tests	19
3.4.2	The applied laboratory tests.....	19
3.4.3	Upgrading the NTNU oedometers.....	20
3.5	In-situ testing	21
4.	Paper-specific approach and main findings.....	23
4.1	Paper 1	23
4.2	Paper 2	24
4.3	Paper 3	26
4.4	Paper 4	28
4.5	Paper 5	28
4.6	Interrelations of individual papers	29
5.	Discussions	31
5.1	The intricate properties of the degraded rock	31
5.2	The classification problem(s) in weak rock engineering	32
5.2.1	When the standardized test is too general	32
5.2.2	When the standardized test is too flexible.....	34

5.2.3	When the standardized test is tailored to hard rocks or soil	34
5.3	Limitations of this study	35
5.3.1	Sample disturbances during extraction and storage	35
5.3.2	Sample disturbance during preparation and testing.....	36
5.3.3	Interpretation of laboratory results	36
6.	Conclusions	39
6.1	Characterization of weak and swelling rocks	39
6.2	Testing and classification of weak and swelling rocks.....	39
7.	Recommendations and future research.....	43
7.1	Recommendations on future test procedures	43
7.2	Suggestions on future research	44
	References.....	47

Part 2: Main Publications

Paper I	An analysis on the slaking and disintegration extent of weak rock mass of the water tunnels for hydropower project using modified slake durability test
Paper II	An investigation on the compositional features and swelling potential of two weak rock types affecting their slake durability
Paper III	Investigation on the effect of cyclic moisture change on rock swelling in hydropower water tunnels
Paper IV	A discussion on the laboratory testing approaches for swelling rocks at three European institutions
Paper V	Field testing of weak rock deformation in water tunnels: A practical review of the flatjack test

Part 1:

Summary

1. Introduction

This chapter gives an overview of the main topics in this thesis. Different aspects related to laboratory testing and classification of rock properties are introduced with emphasis on the construction of water tunnels in heterogeneous, weathered and swelling rock masses.

1.1 Geology and rock engineering

In geological nomenclature, rock names are defined and used according to the abundance and type of the present minerals in addition to the mode of formation and geological processes involved (Palmström, 1995). From the name given to a sample of rock, a geologist will therefore understand how the rock has been formed and the possible geological transformations it has been subjected to (Stille and Palmström, 2003), however, it does not include definitive information on its mechanical properties. From the engineer's point of view, pores, defects, strength and anisotropy are of greater mechanical significance (Franklin, 1970), but these properties are not reflected by the rock name. This can be frustrating for the engineer, as for each category of rocks the mechanical properties may vary considerably. Knowledge on the geological history and petrological data can, however, make an important contribution towards the prediction of mechanical performance (Palmström, 1995), and the rock names can give relative indications of the inherent properties of the rock constituting the rock mass (Piteau, 1970). Provided the engineering objectives of a project are understood, it is possible to assess the impact of the project on the ground as well as the impact of the ground on the project, both during construction and over the lifetime of the construction (Parry et al., 2014). The role of the engineering geologist, as a predictor, is to translate the observed or measured geological information to identify areas of significant constraint that will affect the design, construction and maintenance of any intended engineering project (Mathewson, 1981; Ulusay, 2013). The geological information includes rock characterizations which aid the rock engineer in relating the information to requirements on construction design.

In order to obtain a safe and economical geotechnical structure there must be taken decisions both prior to, during and after construction. It is, however, generally accepted that the cost and time are of main concern in any engineering project, and the accuracy of the predicted geological conditions during the planning phase plays an important role (Panthi and Nilsen, 2007). No simple universal rules for acceptability or standard factors of safety exist to guarantee that a rock construction will be safe and that it will perform adequately (Hoek, 1995). Each design is unique and the durability of the structures has to be considered in terms of the particular set of rock conditions, such as rock types, material properties, project type and expected support loads of the construction. The sources of

information may include geological explorations, field tests, laboratory tests, statistical computations, field measurements and experience (Hudson, 1993). However, with a rock mass as construction material, a common understanding is required between geologists and engineers on the challenges to overcome.

1.2 Constructions in degraded rock masses

The variability in rock material characteristics, both at a spatial and temporal scale, cause challenges which are of relatively little concern in most other construction branches (Palmström, 1995). In weaker rocks, the material itself can be predominant controlling factor of rock mass behavior, while in hard rocks the major discontinuities control the stability (Ulusay, 2013). Due to different nature and origin of the rock types, their inherent geological features are also different. Knowledge on the complexity of the ground and the way the rock mass surrounding an underground excavation behave are therefore essential for a good geotechnical design (Stille and Palmström, 2008).

1.2.1 Rock degradation

It is well known that rocks may undergo degradation when they are exposed to environmental agents (Ulusay, 2013), primarily during long-term geological transformation processes as metamorphism, weathering and alteration. In general, rocks are most stable under their formation conditions, and are in equilibrium with the temperature, pressure, water and air-conditions at the time of formation and lithification. As rocks and minerals are subjected to a variety of physical and chemical changes during their lifetimes, the actual properties of a rock are results of combinations of physio-chemical forces acting together over time (Wahlstrom, 1973).

Hydrothermal alteration is a process controlled by major or minor channel-ways of circulation localized by faults or joints, or by movement of solutions along grain boundaries of mineral aggregates (Wahlstrom, 1973). The alterations range from weak, where only some of the minerals or matrix in the host rock is altered, to high, where virtually all primary phases in the rock are altered to new hydrothermal minerals. Argillization is a common hydrothermal alteration process whereby rocks are converted to clay mineral aggregates, where chlorite and montmorillonite may replace silicate minerals and reduce a previously competent rock to an incoherent and swelling aggregate (Wahlstrom, 1973). Further, laumontite is a common zeolitic replacement of feldspar in porous volcanic rocks where hydrothermal alteration mechanisms find place (Deer et al., 2004).

Weathering is the process of breakdown of rock and soil materials by chemical and physical processes causing both mineralogical and lithological alterations (Vivoda Prodan and Arbanas, 2016). Chemical weathering leads to the decomposition of the constituent minerals to stable or metastable secondary mineral products (Utili, 2004), whereby different

types of clay minerals are common products. Differential weathering, which generally occurs in cases where the rock mass consist of interlayered hard and weak rock units, can cause extremely spatial variance in properties of the rock mass surrounding an underground opening or construction.

In addition to the geological history of the rock, degradation may also be consequential to short-term processes during construction works, especially for the weaker rocks. When unloaded during construction and exposed to atmospheric conditions during operation, weathered and/or altered rocks may further change their deformation characteristics. This temporal degradational behavior during construction and operation of a geotechnical project is an important rock mass parameter affecting the construction stability throughout its lifetime. The assessment of rock mass behavior should therefore be made by combining relevant rock mass characteristics with various project related features.

1.2.2 The project related features of hydropower water tunnels

The exposure of rocks to degrading agents is highly controlled by the type of engineering project with respect to moisture, temperature and air, and especially the periodical changes of these environmental parameters. The major difference in hydropower compared to other underground engineering projects is the intensity of moisture changes exposed to the rock mass surrounding the water tunnels throughout the lifetime of the project. During construction, the rock mass is first at the stage of drained condition due to contentious ventilation and heat released by the moving construction equipment. Once the construction is completed, the waterway system (tunnels) is filled with water for the generation of hydroelectricity, and during operation the rock mass near the tunnel periphery and below the hydrostatic line is fully saturated. Dewatering of the waterway system is carried out periodically to inspect the stability condition of the tunnels and thus, for the time of the operational life of the hydropower plant, several watering and dewatering cycles will take place (Selen et al., 2019).

Due to the varying interaction of the specific engineering works and the ground, different engineering projects will require different questions to be asked and different types of investigations to be carried out for exactly the same geological setting (Parry et al., 2014). Furthermore, certain rock material characteristics may be more critical than others depending on the project as some projects, by their very nature or setting, will be exposed to more geotechnical risk. As the project related conditions of a water tunnel located in a weak rock mass often result in a situation which departs from the baseline, certain material characteristics and behavior parameters needs special attention. In these cases, the role of the engineering geologist is to identify the rock parameters that are most significant to the hydropower project, assess their likely variations and estimate their potential impact on tunnel stability. By identifying potentially critical responses of the rock mass

to the project related features, these can be factored into the site investigation and design through additional targeted ground investigations.

1.3 Critical behavior parameters of degraded rocks

In hydropower, the potential of weak and degraded rocks to swell and slake are among the most critical behavior parameters for tunnel stability and support measures.

1.3.1 Swelling of rocks

According to ISRM (International Society for Rock Mechanics), swelling of rock materials is defined as a physio-chemical reaction involving water and stress relief. Swelling of minerals, such as smectites, mixed-layer clays, anhydrite and zeolites, results in a volume increase of the crystal lattice and expansion forces in the rock material (Vergara and Triantafyllidis, 2015; Selen et al., 2019). The term “free swelling” is used on the increase in volume of the material without any restrictions or application of external forces. When volume expansion is restricted, the swelling instead results in a swelling pressure acting on its surroundings (Vergara and Triantafyllidis, 2015), as a geotechnical structure. Swelling of clay materials is frequently reported in relation to clay-holding weakness zones and soil, however, the phenomenon is also highly relevant for intact rocks.

The two main swelling mechanisms of rock materials are osmotic swelling and intracrystalline swelling, both related to the presence of clay minerals (Einstein, 1996). However, rocks not containing swelling clays may also experience swelling due to structural and textural features as porosity, permeability and layering. In addition, swelling is experienced in rocks containing anhydrite and zeolites, whereby the latter are hydrated aluminosilicates with a high swell and shrink potential often associated with clay minerals (Bravo et al., 2017). Unlike most other tectosilicates, zeolites have large vacant spaces or cages in their structure which allow incorporation of large cations and molecules (Marosvölgy, 2009). Laumontite is a zeolite which, when present in weathered volcanic rocks, has been found to be responsible for rock swelling and subsequent damage of a hydropower tunnel (Bravo et al., 2017).

Changes in moisture content in swelling rocks can cause significant problems related to high swelling pressures (Piteau, 1970). In addition to expansion, swelling minerals occurring either as infilling or alteration products in seams or faults, have a low shear strength which may contribute to rock falls and slides in underground openings (Palmström, 1995). These rock types can be shales, altered or weathered basalts, igneous or metamorphic rocks, or sedimentary rocks containing mixed rock materials. Some of these rocks may also slake, disintegrate or otherwise weather in response to the change in humidity and temperature consequent on excavation.

1.3.2 Slaking of rocks

The process of weakening and disintegration upon wetting and drying is known as slaking (Panthi, 2006; Admassu et al., 2016) and can be defined as the structural breakdown of a mass to small size particles in response to cyclic changes in moisture content (Czerewko and Cripps, 2001). The process of wetting and drying stresses the mineral bindings of the rock and acts to enlarge and extend pores by a combination of air pressure increase, as water invades narrow capillaries, and tensile failure of weak inter-crystalline bonds due to drying induced pore water suctions. The structural features of the rock and the initial degree of micro-fracturing exerts an important control on the rate of water ingress into the material and are factors which separates durable from non-durable rocks otherwise similar (Russell, 1982; Olivier, 1991; Dick and Shakoor, 1992).

The weakening of the rock mass caused by cycles of drying, saturation and drainage may lead to instabilities in the tunnels, especially when constructed in weak and/or clay bearing rocks (Panthi, 2006). In fact, cyclic moisture change is considered as one of the main processes that can induce micro-fissures in the rock material which may lead to the failure to the construction work (Dick et al., 1994; Erguler and Shakoor, 2009). However, structural failure of the rock mass may not be immediate but induced after some time of operation (Hudec, 1982; Czerewko and Cripps, 2001). In order to characterize the disintegration potential of the rock mass surrounding a tunnel, laboratory tests on the rocks constituting the rock mass are required.

1.4 Laboratory assessments of swelling and slaking rocks

For evaluating stability and rock support in an underground opening, the intact rock properties are of main importance where the rock is weak or overstressed (Stille and Palmström, 2008). Since testing of in-situ rock masses on a realistic scale is not practical, the understanding of rock material properties and their effects on rock mass behavior to a large extent must rely on laboratory assessments on sampled rock material. The first step is to get an overview of the compositional features of the rock samples, including their swelling capacity and disintegration potential.

1.4.1 Compositional analyses

X-ray diffraction (XRD) analysis is a method used for identifying and determining the mineralogical composition of the rock samples. Every mineral or compound has a characteristic X-ray diffraction pattern, called “fingerprint”, which can be matched against a database of over thousands of recorded phases (Dutrow and Clark, 2012). Identification and quantification of minerals are carried out by comparing relative peak heights of the crystalline phases. The method is strictly standardized in terms of the involved techniques and procedure of mineral quantification.

The degree of weathering is usually estimated from visual observations combined with knowledge on the composition and geological history of the rock. A more detailed and precise characterization of alteration and weathering of the rock can be found from optical methods such as analysis of thin sections in a microscope (Stille and Palmström, 2008). Thin section analysis and Scanning Electron Microscopy (SEM) analysis are also used to gain information on porosity, micro-fracturing, grain-size distribution and clay content in rock materials. The methods can be combined with XRD-analysis to obtain a comprehensive overview of rock composition.

1.4.2 Swelling tests

Different laboratory testing methodologies have been developed aiming to characterize the swelling and slaking potential of rocks and are illustrated in the recommendations of the ISRM Commission on Swelling Rock (ISRM, 1979–1989; Barla, 1999; Madsen, 1999). Dependent on the test configuration, the tests measure maximum swelling deformation/strain, maximum swelling pressure when volumetric expansion is constrained, or a combination of both. Several variations of oedometer tests are being used around the world, whereas many of them are based on the work performed by Huder and Amberg (1970) and Grob (1972). In addition, different swelling tests aiming to describe the 3D swelling behavior of rocks are proposed, such as the ISRM (1977) suggested method for determination of the swelling strain. More recently, different authors have been studying the three-dimensional swelling behavior of rocks in triaxial cells (Barla, 2008). Among these research developments, a novel triaxial apparatus is recently proposed at Politecnico di Torino aiming to describe the swelling behavior of rocks around tunnels (Barla et al., 2010).

The free swelling test on rock powder is an index test normally used to examine the swelling potential of swelling gouge in weakness-zones but is also regarded as an indicator on the swelling potential of intact rocks. The test measures the volume increase of rock powder when immersed in water, and mainly determines the content of swelling clay minerals in the prepared sample. The NTNU free swelling test on sieved and dry clay powder has been extensively used in Norway for swelling gouge materials (Nilsen, 2010) and the technique is in accordance with the handbook of Statens Vegvesen (2005) for testing of swelling gouge materials.

Different trials are performed to find relations on the pressure induced by the rock material to the in-situ behavior of the ground. Terzaghi (1968) set forth that manifestations of the swelling pressure in the field can be explained based on the behavior of clay samples in oedometer tests (Kovari et al., 1988). Based on this, Huder and Amberg (1970) performed multiple oedometer tests on clay rocks and determined the stress-strain curve given in Fig. 1 whereby the relationship between swelling stress and swelling strain

(extension) is presented on a logarithmic scale. ϵ_0 is the axially unrestricted swelling strain and σ^* the stress resulting from a total constraint of the deformations. The validity of this uniaxial "swelling law", which is attributable to Grob (1972), has since been experimentally reconfirmed, at least for clay rocks (Kovari et al., 1988).

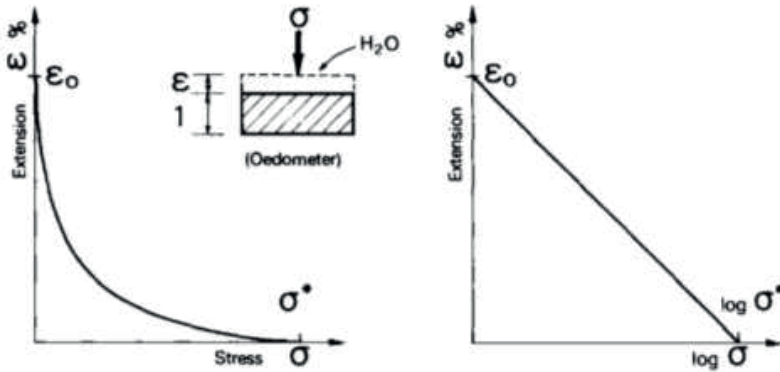

Fig. 1. The "swelling law" based on oedometer tests on clay rocks (after Kovari et al., 1988).

Based on the work of Huder and Amberg, the ISRM (1979–1999) has suggested different variations of oedometer swelling tests, including a maximum swelling pressure test which can be applied to pulverized rock material or intact rock disks. The test measures the maximum pressure induced by a dried and prepared rock sample after water immersion when volume expansion is hindered. The standardized methodology includes recommendations on preparation, apparatus configuration, procedures and reporting of the results, however, several modifications are used around the world.

1.4.3 The slake durability test

Various slaking tests are in use for determining the resistance of rocks to disintegration when exposed to water, as the slake index test (Deo, 1972), static slaking immersion test (Sadisun et al., 2002) and the slake durability test (Franklin and Chandra, 1972). The slake durability test was first presented by Franklin and Chandra (1972) and is also the ISRM (1979) suggested method for durability assessments. The calculation of slake durability index (SDI) is based upon the mass records of 10 rock lumps, prepared from a rock sample, when exposed to two cycles of wetting and drying in a specially designed drum consisting of a mesh with openings of 2*2 mm. The test procedure is designed in such a way that the samples are first completely dried and then kept in the drum for a wetting period of 10 minutes in a slow rotating mode. The samples are again dried in the oven, weighed, and the material loss is measured. The slake durability index is then calculated based on the weight of the sample after the test procedure relative to the initial weight. The slake durability index is considered as one of the most important indicators on weak rocks that change properties in contact with water (Ankara et al., 2013).

1.5 Uncertainties in estimating rock mass behavior

Since rocks have considerable variations in composition and complexity and since it is not possible to detect these variations by any pre-investigation of the rock mass conditions, there will always be uncertainties connected to construction in rock masses (Stille and Palmström, 2008). The geological uncertainties include rock stresses which vary in both magnitude and direction, ground water conditions, the presence rock mass discontinuities and the distribution of various rock types including their mechanical properties. However, the development of computer hardware and software tools over the past decades has enabled scientists and engineers to carry out analyses on rock mass behavior which were previously unavailable (Hoek, 1995). Prior to this technical revolution, the ability to collect geotechnical data surpassed the ability to use it for meaningful engineering analyses. Now the situation has been turned around and the most crucial uncertainties are related to the quality and reliability of the input data to the models, as laboratory test results.

1.5.1 Sample uncertainties

Due to the spatial and temporal heterogeneity of a rock mass, the representativeness of the sampled rock will always be connected to some degree of uncertainty. In the preliminary phase of a project the samples available are usually obtained from scattered boreholes close to the planned construction. Sample disturbances from both the excavation and extraction process will influence their present properties, including damage to the microstructure, changes in effective stress compared to geostatic conditions and decrease of the degree of saturation (Rocchi et al., 2013). These processes start during drilling and continue during extraction of the samples, transport to laboratory, storage, specimen preparation and assembly in the testing apparatus. In the field, samples for laboratory assessments are often collected from core-boxes which, dependent on the level of planning and communication between the different parties involved, are stored under variable conditions. The magnitude of the total of disturbances will depend on the rock material strength and moisture sensitivity, and on the extraction technique. After the field-sampling of rock specimens, the samples are transported to the laboratory for further investigations.

In every laboratory assessment of rocks, the ideal situation is to minimize further disturbances to the rock material which may have influence on the rock behavior measurements. However, the preparation technique related to the specific test procedure may include variable disturbances to the sample. This challenge applies especially for test methods originally developed for hard rock assessments, as weak rock types may require a lot of effort to prepare in accordance to the standard used for the test. Due to the sample uncertainties related to both limitations of the sampling procedure and the unknown extent of disturbance related to testing, the final design has to be decided in connection with the

rock excavations work and based on geological follow up of actual conditions (Stille and Palmström, 2008).

1.5.2 Uncertainties related to test method

Standardized tests are required to obtain reproducible rock parameter data and to obtain databases for statistical analyses and comparisons. The parameters are further used in different numerical models in order to simulate the rock mass behavior near the construction opening. Standards for tests performed in the laboratory are specified in ASTM Standards, Recommendations of the International Society of Rock Mechanics (ISRM) and in the Rock Testing Handbook (Williams, 1997). The methods aim to characterize rock mass properties from which empirical design tools are developed (Stille and Palmström, 2003).

Despite the numerous versions and variations of standardized test procedures, no general and consistent guideline on swelling tests for weak but intact rock samples are found in the literature. Instead, institutions tend to operate with their own internal modifications or have developed their own tests based on experience and traditions. This applies especially for testing of weak and weathered rocks, as difficulties are frequently met on achieving the requirements in existing procedures originally developed for hard rock assessments. At some laboratories, the issue of varying rock quality is solved by consequently and equally remolding test specimens prior to testing independent of intact rock features. This practice is observed in swelling tests where the sample quality is poor and fragile at arrival on the laboratory. Instead of keeping the material as close to its in-situ condition as possible, the rock material is remolded in order to obtain similar conditions among the tested samples and this way limit uncertainties related to different sample quality. This solution, among others, is based upon a preposition on the content of swelling clay minerals to hold the major control on the swelling behavior of the rock material (Wan et al., 2002; Høien et al., 2020). The rationale is that by crushing, milling and drying the rock material into dehydrated rock powder, the “worst case scenario” in terms of swelling potential will be revealed during wetting, as the water will have easy access to the swelling clay minerals. Even if the preparation produces a fundament for quantification of the test results, it may counteract the relevancy of the results to the estimation of in-situ behavior and support measures.

1.5.3 Classification uncertainties

The process of rock mass characterization consists of describing and quantifying the parameters that govern or influence the rock mass behavior. Further, the result of the characterization process is used to assess the rock mass quality according to a pre-defined system (Stille and Palmström, 2003). In projects involving rock construction, this process can be simplified by putting the measured rock properties into classes which are used to

assess the required design of the construction. A certain group of empirical design tools which often are based on adopting previous experience gained in conditions that can be characterized as similar, are known as classification systems (Stille and Palmström, 2003). Most of the classification systems developed in rock engineering have tried to meet the following requirements (Brekke and Howard, 1973):

- (1) Simple and meaningful in terminology.
- (2) Based on parameters that can be measured or assessed rapidly and inexpensively.
- (3) Exact enough to yield quantitative data that can be readily applied in engineering design.

However, for a classification system to be successful the classified parameters must be relevant to their application, especially if the findings are to be related to the determination of actual design parameters (Williams, 1997). Numerous cases have shown the need for an adaption on existing classification systems to the actual in-situ condition and calibrate the system against the experience gained from a specific project (Stille and Palmström, 2003). Even if simplified engineering-geological classifications in many instances have proven to be valuable tools in rock engineering, they have often been given a validity for “quantification” of rock mass behavior that is far more general than was intended by their authors, both in the literature as well as in engineering practice (Brekke and Howard, 1973).

Einstein et al. (1979) warn that the accuracy of the existing empirical design methods is not yet established, and that the existing classification procedures probably lead to an overestimation of the support requirements (Stille and Palmström, 2003). In many of these cases, the index of the rock mass quality derived from the existing classification system has been the only indicator to evaluate the support class. This has created contractual problems when unforeseen geological conditions have been encountered, and where the system has not been applicable. Swelling ground is among the conditions not covered by the existing systems (Stille and Palmström, 2003).

1.6 Motivation

An increased number of cases reported from the industry witness about instabilities and collapses of engineering constructions whereby swelling and slaking of intact rocks are among the causes, especially in international hydropower projects. Several of the cases are related to a mismatch between the estimated material properties and the experienced behavior of the in-situ rock mass during operation. Despite considerable testing and rock material investigations, the reasons of many construction difficulties and tunnel collapses are not fully understood. The need of increased knowledge on the degradational behavior of weak rocks during construction and operation of hydropower projects is univocal and has been the main motivation for this research.

1.7 Scope and objectives

This study aims to test the leading hypothesis on the swelling of clay minerals to be the preeminent parameter of rocks controlling swelling behavior in tunneling projects. Further, the study aims to analyze standardized laboratory test procedures frequently used in Europe in assessments of weak and swelling rocks and test their validity when applied in the rock engineering field of hydropower construction. The objectives are to uncover eventual limitations of the existing procedures and move towards a project-specific interpretation of rock properties. The goal is to enable future improvements on classification systems for rock support modeling in hydropower tunnels. In order to reach the goal, modifications on existing procedures are implemented in the existing procedures and tailored to the features of weathered rocks and the extraordinary exposure of the rock mass to moisture fluctuations in hydropower projects.

In order to achieve the objectives, the following sub-tasks are defined:

- Theoretical review on swelling, degradation and slaking potential of rocks, with focus on weak and weathered rock masses.
- Review existing test methodologies used in Europe in assessments on rock properties which influence on the response of the rock to stress release and water, as swelling tests, slake durability tests and mineralogical analyses.
- Thoroughly assess preparation procedures, test configurations and apparatus details which may affect the validity of the test results when applied in support modeling tools for water tunnels.
- Establish contact with researchers and technicians at different European institutions to enable sharing of information and collaboration on both the present and future work on the research topics.

- Sample rocks from hydropower projects, prepare test specimens for laboratory assessments and carry out both standardized tests and modified tests to characterize rock composition, swelling properties and slake durability.
- Compare test methodologies applied on both intact rock material and rock powder at laboratory facilities located at European institutions in order to critically assess the details in apparatus configuration and methodology.
- Analyze and compare the test results obtained at the different European institutions to detect linkages between eventual methodology differences and the corresponding results from similar samples.
- Contribute to a widening of the range of tests in operation at NTNU by suggesting improvements on existing facilities and present guidelines for alternative methods.

To achieve these goals, series of field work, laboratory experiments and laboratory visits, both domestic and abroad, are performed. In the next Chapter 2 the study cases and material used for the research are presented. The research approach is explained in Chapter 3, while the paper-specific methods and main findings are presented in Chapter 4. Chapter 5 discusses topics relevant for the research objectives and main findings. The conclusions and recommendations for future research are given in Chapter 6.

1.8 Ethical issues

All theories, accepted data, information and methodologies are referenced. The project title does not have any conflicting issues on society, and the research is carried out with a minimum of environmental impact. Approvals are received on the project specific sensitive data and information prior to the publications. In overall, the outcomes of the study have positive impacts on the hydropower industry as well as on society at large.

2. Study cases and rock material

The rocks tested within this research are of sedimentary and volcanic origin and are obtained from two different hydropower projects owned by Statkraft and its subsidiary SN Power in the Philippines (Alimit HPP) and Albania (Moglicë HPP).

2.1 Alimit HPP

The hydropower project is in feasibility stage and located at Ifugao, North Central Luzon in the Philippines (Fig. 2). The region is bounded by a mountain range to the north and west, with a highest elevation of 2523 meters above sea level.

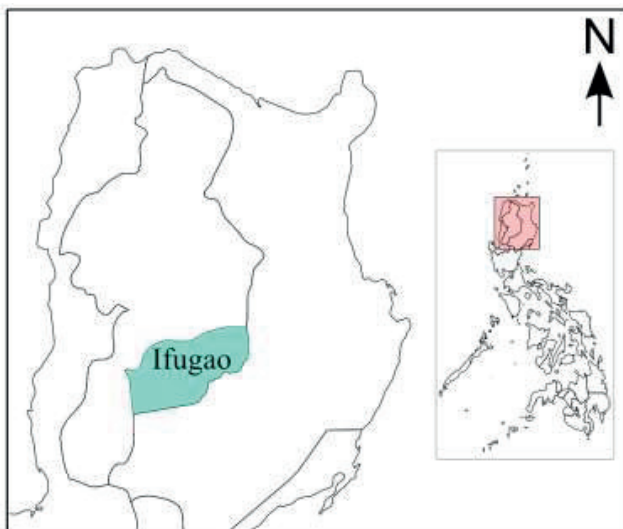

Fig. 2. Location of the project area within Luzon, Philippines

The rocks in the area are primarily volcanic rocks of basaltic and andesitic origin, which have undergone hydrothermal alteration or metamorphic transformation processes and can be found in different weathering stages (SN Aboitiz/Stache, 2015). The rock quality within the sampled rocks vary from intact and apparently strong cores to very heterogeneous rocks which easily break by hand force (Fig. 3).



Fig. 3. Examples of the volcanic rocks from Alimit HPP

2.2 Moglicë HPP

The hydropower project was under construction during the work of this research and is now under operation. The project is located within the eastern mountainous part of Albania along the Devoll River, in the southern part of the Alpine fold belt. The project utilizes a 300 m water head from a reservoir created by a 150 m high asphalt-core rockfill dam. The 10.7 km long medium to high-pressure headrace tunnel conveys water from intake to the underground powerhouse cavern close to the Devoll River, with two turbines generating a total of up to 172 MW installed capacity. (Fig. 4).



Fig. 4. Map of Moglicë HPP (modified after Flåten, 2015)

The vertical rock cover varies between approximately 200 m and 500 m, with a lateral cover of approximately 300 m. The rocks are dominated by flysch, a sequence of sedimentary rocks, and ophiolite, a crust intrusion. All the sampled rocks were cored during the construction of the headrace tunnel and collected from core-boxes. The flysch sequences contain claystone, siltstone, marls and sandstones with varying degrees of weathering and alterations (Selen et al., 2018). The rock material is best described as very heterogeneous in terms of color and fabric, with sections of intact rocks alternating with sections of partly or totally disintegrated rock material (Fig. 5).



Fig. 5. Example of flysch material from Moglicë HPP

The ophiolitic rock mass comprises highly weathered serpentinite which forms as a result of serpentinization of ultramafic rocks by hydration of ferromagnesian silicate minerals during low-temperature metamorphic processes (Moody, 1976). The common alteration assemblage produced by serpentinization is lizardite, chrysotile and kaolinite, occasionally together with brucite, antigorite and clay minerals. The sampled rocks were already disintegrated to lumps of varying sizes but otherwise apparently homogeneous in terms of color and fabric (Fig. 6).



Fig. 6. Example of serpentinite material from Moglicë HPP

The nature of both rock types is complex as a result of their depositional and tectonic history, which means that they cannot easily be described in terms of widely used rock mass characterization systems. However, both rock types are categorized as weak and contains clay minerals which results in a vulnerability to weathering and degradation.

3. Research approach

The research approach has an iterative and outgoing character including literature reviews, discussions with authors of relevant research papers, laboratory experiments including close communication with laboratory technicians on technical details, in-situ test experiments and continuous collaboration with partners in the hydropower industry. The goal of the research approach has been to unify scientific knowledge with applicability of the investigated methods for the industry.

3.1 Theoretical framework

Different scientific papers and books related to the subject matter were thoroughly reviewed to establish a theoretical framework for the research. Reports, maps and other background information related to relevant case histories on tunnel collapses were studied. The suggested rock testing standards by ISRM which are used at different European institutes were reviewed and used as basis for the laboratory work. Recent experience and updates on laboratory test methodologies by different researchers were reviewed and compared to the prevailing methodology at NTNU/SINTEF. Spoken and written discussions with professors and lab-technicians at NTNU, SINTEF, KIT (Karlsruhe Institute of Technology) and Politecnico di Torino related to the subject enriched the theoretical base-ment and have resulted in multiple loops of literature reviews, laboratory experiments and field work.

3.2 Field work and sampling

The field work was arranged and supported by Statkraft at both project locations. The field visit to Alimit HPP found place in May 2016 during the work of the author's master's thesis. As the project was in its feasibility stage, no tunnels or other construction elements existed. The survey was therefore based on surface inspection and sampling of stored borehole cores from the feasibility investigation of the project.

The field work at Moglicë HPP was performed in stages whereby the first visit found place in October 2017 during the construction phase of the project. The visit included tunnel inspections and sampling of rock specimens from already obtained borehole cores. The next visits were in December 2018 and January 2019 and included instrumentation of flatjacks in the headrace tunnel and direct sampling of rock specimens at the location of the instrumentation.

The sampling strategy was, as far as possible, to collect representative rock types from the case project areas with focus on the intact rock swelling potential. The samples were chosen based on their lithological origin, position related to planned construction

elements and/or constructed tunnels and visual appearance. Heavy disintegrated material was not prioritized, but some disintegrated rocks were collected and tested for comparison purposes with respect to mineralogical composition and swelling potential. Each sample was visually characterized, labeled and photographed to record the findings and the suitability of the material to the planned laboratory tests.

3.3 International collaboration

As a part of the author's master thesis in 2016, NTNU and Statkraft engaged a staff member at KIT, Dr. Maximiliano Vergara, as a supervisor for the laboratory testing at KIT of the volcanic samples from Alimit HPP. This cooperation was extended in this research, whereby rock samples from Moglicë HPP underwent the similar swelling test procedure as of the Alimit-samples in 2016. Dr. Vergara functioned as an external instructor for the KIT laboratory technicians to make sure that sample preparation, apparatus and methodology were consistent to the previous tests. Dr. Vergara is also a co-author on Paper 3 of this research and has contributed with information and input on the ongoing process of upgrading the oedometers at NTNU.

Prof. Krishna Panthi, Mr. Gunnar Vistnes (laboratory technician at NTNU), Mr. Joacim Eggen (laboratory technician at SINTEF) and the author visited KIT in March 2019 to get further information about their current research, laboratory equipment and testing methodologies. During the visit, fruitful connections to professors, lab-technicians and a PhD-student were established. This cooperation on laboratory work and sharing of information on central topics related to improved test methodologies of swelling rocks will hopefully proceed after this PhD research.

Mr. Gunnar Vistnes and the author visited Prof. Marco Barla at Politecnico di Torino in September 2019 in order to get insight in the prevailing swelling test methodologies in Italy. Productive discussions on theoretical aspects of swelling rocks, tunnel support modeling and laboratory methods were obtained, including laboratory visits. No tests were conducted due to time- and resource limitations.

3.4 Laboratory work

Most of the laboratory work was performed at the NTNU/SINTEF Engineering Geology and Rock Mechanics Laboratories where test equipment, laboratory conditions, preparation procedures and test methodologies were inspected and explored in detail. In addition, a similar examination was performed at the rock mechanical laboratory of KIT where swelling tests and mineralogical analyses were performed on similar rock material. Additional visits were made to different Norwegian and European laboratories, as the Schmertmann Research Laboratory (NGI, Oslo, Norway), the laboratory of the Norwegian Public Roads Administration (Statens Vegvesen, Oslo, Norway), the laboratory of geomechanics and geotechnology at Politecnico di Torino (Torino, Italy) and the geotechnical laboratory of TU Berlin (Berlin, Germany).

3.4.1 Laboratory tests

The laboratory tests were performed in stages whereby widely used standardized tests were performed in the first stage. Thereafter, the results of the tests were analyzed and discussed and modifications on the existing procedures were implemented in the next stage. The modifications were either based on novel modifications already suggested by research partners (swelling tests) or adjustments based on revealed limitations during the laboratory work (slake durability tests and mineralogical analyses) with emphasis on the applicability of the tests in hydropower projects.

It is noted that the strength parameters of the rock normally should be included in assessments of rock characteristics, however, the weak rock materials of this research were not up to standards of existing strength test methods. Instead, indirect estimations on strength properties based on visual characterization and durability test results were considered as qualitative substitutes for methods normally used on stronger rock types. In addition, spatial variations within the rock mass, states of stress around the tunnel periphery, pore water chemistry and other rock mass characteristics will influence the response to excavation and the swelling behavior, but these topics are outside of the scope of this thesis.

3.4.2 The applied laboratory tests

The laboratory methods which define the test-suite of the research were chosen based on the time and equipment available and the current knowledge on principal parameters affecting swelling behavior of weak rocks. The main emphasis was on swelling potential, slake durability and mineralogical composition of the sampled rock material. In addition, structural and textural features of the intact rock were examined.

The methods investigated are frequently used to describe the swelling behavior and durability of different rock materials, i.e.; mineralogical analysis (XRD), the free swelling test, the oedometer swelling pressure test and the slake durability test. Complementary

analyses on the structural and textural features were included in order to fulfill the requirements for a reasonable assessment of swelling rock behavior, as thin section analysis (TS), SEM-analysis and grain-size distribution analyses. The test suite (Table 1) included both standardized test procedures and project-specific modifications of the chosen tests, aiming to assess the extraordinary conditions in hydropower water tunnels.

Table 1. Overview of the laboratory tests

Material parameter	Rock composition including textural features			Swelling behavior		Structural strength and durability	
Analysis	XRD	SEM	TS	Free swelling	Oedometer swelling pressure		Slake durability
					Single	Cyclic	Grain-size distribution
Testing institute	NTNU, KIT	NTNU	NTNU	NTNU	NTNU, KIT	KIT	NTNU

A review on the methodologies (XRD, SEM, thin section analysis) for assessments of mineralogical and textural features affecting intact rock degrading behavior, including suggestions on modification of XRD in weak rock assessments, is given in Paper 2. Important findings related to the applicability of the compositional and textural analyses in swelling rock assessments are discussed in Paper 3, in addition to a modified oedometer test aiming to evaluate the effect of cyclic wetting and drying of intact rocks. A comparison of the prevailing mineralogical analysis procedure at three European institutions is discussed in Paper 4, in addition to a comparison and discussion on the preferred oedometer tests at these institutions. A detailed overview of the differences between NTNU and KIT in the prevailing methodologies, including the consequential deviations in the results, is previously presented in “Swelling pressures of some rocks using different test procedures” (Selen et al., 2018).

The slake durability test is generalized for quantification and comparison purposes whereby the boundary conditions of the test poorly correspond to the in-situ conditions of the rock mass surrounding a hydropower water tunnel. This research therefore suggests a modified test procedure which is presented and evaluated in Paper 1.

3.4.3 Upgrading the NTNU oedometers

Based on the experiences during the laboratory work of this research and the current need for improved testing facilities for assessments on swelling rocks, new oedometers and preparation equipment at NTNU will be developed. The configuration of the oedometers and the overall testing methodology will be based on the conclusions of this research and is funded by HydroCen.

3.5 In-situ testing

The flatjack test is normally used to measure the average normal stress at a rock surface and to evaluate the rock mass deformation modulus, however, an experimental modification of the procedure was developed in close cooperation with Statkraft and Mr. Lloyd Tunbridge from NGI. Modified flatjacks were instrumented in the headrace tunnel of Moglicë HPP in December 2018 and January 2019. Rocks from the test location were sampled for laboratory assessments. The aim was to use flatjacks for the monitoring in-situ swelling pressure and deformation in the headrace tunnel during full operation of the hydropower plant. This application is, to the author's knowledge, one of the first of its kind in hydropower construction. Since data acquisition will not be possible before 2021, no correlations between laboratory results and in-situ swelling are analyzed yet. However, descriptions of the modified test procedure and experience on practical challenges during the instrumentation process are described in Paper 5.

4. Paper-specific approach and main findings

4.1 Paper 1

Selen, L., Panthi, K.K. and Vistnes, G. (2020). An analysis on the slaking and disintegration extent of weak rock mass of the water tunnels for hydropower project using modified slake durability test. Bulletin of Engineering Geology and the Environment, Volume 79, Issue 4, pp.1919–1937.

This paper was written in collaboration with Prof. Krishna Panthi and Mr. Gunnar Vistnes and presents results of the laboratory analyses on the extent of slaking and disintegration of two weak rock types prevailing along the headrace tunnel of Moglicë HPP. The ISRM (1979) suggested method for the slake durability test was thoroughly reviewed from the preparation stage to the analysis procedure of the results. Each step of the method was assessed in the context of weak rock durability determinations in hydropower projects and the applicability of the results in rock support evaluations. Important weaknesses of the procedure were revealed and discussed. Based on this, a modified variant of the test was developed in order to suit the project-specific challenges in hydropower. In general, the modified test procedure has the same framework and follows the similar standardized steps as the ISRM suggested method, but the major difference is the moisture and temperature condition of the rock samples throughout the test.

Both the standardized ISRM (1979) slake durability test and the modified variant were performed on duplicate sets of samples. The results were then compared and analyzed in order to detect and evaluate differences in slaking behavior which may be attributed to the moisture sensitivity of the rock material. In addition, the paper presents mineralogical assessments by use of XRD analysis to investigate the linkage between the slake durability indices and the content of water sensitive clay mineral components. At last, particle size distribution analyses were performed and presented in order to assess the degree of disintegration after both slake durability test procedures. All tests were performed at NTNU.

The modified methodology presented in this paper provides insights on the linkage between the initial moisture content and the degradation potential of rocks exposed to heavy moisture changes. The general pattern is, for rock materials composited of moisture sensitive minerals, that the water-weakening effect of saturation is prominent both in a short term and long-term perspective. In order to obtain an index value on moisture sensitivity and slaking behavior, the modified test seems to uncover these features more efficiently than the ISRM (1979) suggested method. With the proposed modified steps in the slake durability test procedure, the boundary conditions are closer to the in-situ environment

around the periphery of a water tunnel, which in turn produce more reliable estimates on the behavior to be expected. The method can therefore be regarded as an informative alternative when evaluating the durability of weak rocks surrounding a water tunnel for hydropower or similar projects where the rock mass is continuously exposed to water.

The effect of initial moisture content on the obtained slake durability indices was varying between the samples tested, and the particle size distribution analysis uncovered noticeable differences between the degree of disintegration within similar slake durability categories. For the flysch rocks, this can somehow be explained by different contents of clay minerals. However, the content of clay is not alone a valid explanation when evaluating the entire sample assemblage of the study. Variations were found both between the different rock types and within groups of rock types with similar composition. Other material parameters as fabric, structure, strength and initial micro-fracturing of the material are assumed to interplay on the degradation behavior, but to verify this, further analyses on structural and textural features are required.

4.2 Paper 2

Selen, L., Panthi, K.K., Mørk, M.B. and Sørensen, B.E. An investigation on the compositional features and swelling potential of two weak rock types affecting their slake durability. Submitted to Geotechnical and Geological Engineering, 04.08.2020.

This paper is an extension of the work presented in Paper 1 and is written in collaboration with Prof. Krishna Panthi, Prof. Mai Britt Mørk and Ass. Prof. Bjørn Eske Sørensen. The study evaluated the overall material composition of the flysch and serpentinite rocks in order to further understand the differences in slaking and disintegration behavior of the samples which underwent the slake durability tests. The assumption was that textural features and swelling behavior cause the differential resistance to moisture changes when comparing the disintegration behavior of the samples. The material properties investigated therefore included mineral distribution, texture, cementation, porosity, the presence of micro-discontinuities and swelling potential. In addition, the mineralogical composition of the samples after the slake durability tests were further investigated in order to detect patterns in the content of moisture sensitive minerals. The methods used were XRD analysis, thin section analysis, SEM analysis, free swelling tests and oedometer tests, all tests were performed at NTNU. The material used for the tests was the residuals of the samples from Paper 1 including fresh duplicate samples. The preparation method of the performed swelling tests included milling the rock material to powder, as is the standard methodology at NTNU.

Based on the XRD results of the flysch material it can be implied that weathered and clay rich rock constituents are the first to be eroded from the samples when immersed in water,

both during static wetting phase of the modified test and during the slaking phase using both the test procedures (i.e.; the ISRM (1979) slake durability test and the modified procedure of the similar test). The link was especially evident when analyzing the content of amorphous constituents in the retained and slaked material after the tests. However, the swelling results of the flysch samples showed no clear pattern on the changes in swelling potential when comparing the fresh duplicate samples and the residuals after the slake durability tests. Further, no clear correlation was found between the measured swelling potential and the slake durability indices of the material. It is realized that the attempt to detect changes in swelling potential based on the performed swelling tests were not proper since the structural features of the material will control the swelling behavior. The amount and distribution of potential swelling mineral components in the intact rock structures were not recognizable after the process of powder preparation for swelling tests and therefore may not reflect the swelling potential of the intact rock.

The thin-section analyses revealed a microscale heterogeneity in the tested rocks which was not detectable by visual inspection of the samples. The different nature of the microfractures and textural properties of the rock samples, observed by use of thin-section microscopy and SEM-analysis, can be connected to the measured slaking behavior. Among the tested flysch rocks, samples showing the highest degree of weathering and uncemented or clay-filled microfractures also experienced extensive disintegration. The importance of identifying structural and textural features in assessments of durability was therefore verified, however, an extended database of results obtained from similar test procedures on different rock types is required before a conclusion can be drawn.

In addition to the findings related to identifying rock material parameters controlling the slake durability, the thin section analysis in combination with SEM-analysis uncovered a mismatch in the content of clay minerals and brucite compared to the XRD-analysis results. As the XRD-analysis is mainly a method for detecting and quantifying crystalline minerals it may not be a proper method to assess the mineralogical composition of weak and weathered rocks. Modifications on the XRD procedure is therefore discussed at the end of this paper.

4.3 Paper 3

Selen, L., Panthi, K.K., Vergara, M.R. and Mørk, M.B. Investigation on the effect of cyclic moisture change on rock swelling in hydropower water tunnels. Published in Rock Mechanics and Rock Engineering, published online 10.10.2020.

This paper was written in collaboration with Dr. Maximiliano Vergara, Prof. Krishna Panthi and Prof. Mai Britt Mørk and presents a study on swelling potential of intact rocks. The study includes the interaction between mineralogical composition, textural features and the exposure to cyclic wetting and drying on the long-term swelling behavior. The rocks tested are of volcanic and sedimentary origin and were sampled from Alimit HPP and Moglicë HPP, respectively. First, the tested samples were analyzed by XRD in order to determine the mineral components of the different rocks. Oedometer swelling tests were then performed on both pulverized samples and intact rock specimens. Further, thin section microscopy was performed to further assess the mineralogical composition and to describe the textural features of each sample. A comparison of the swelling test results is presented and correlated to the compositional and structural characteristics of each sample. The findings are discussed in the context of long-term stability and support assessment of hydropower tunnels with main emphasis on the applicability of the performed oedometer swelling tests.

For the XRD analyses, the volcanic samples from Alimit HPP were prepared and analyzed at NTNU while the flysch samples from Moglicë were analyzed at KIT. This solution was based on practical causes and on the assumption that XRD-analyses are performed similarly from institution to institution so that dividing the sample assemblage for testing at different laboratories would not have any implications on the results. It was later revealed that the analyses are performed differently between the two institutions. Further, the analyst at NTNU reports a quantification of the crystalline phases only while the analyst at KIT does a more comprehensive but more approximate analysis of crystalline phases, amorphous phases and content of swelling clays. It was therefore decided to re-investigate the diffractograms of the volcanic samples at NTNU and a re-calculation of the results was performed to enable comparison of the results between the two institutions.

The oedometer tests were performed at KIT based on knowledge on their recent research on testing intact rock specimens under conditions of cyclic wetting and drying. Two different configurations of the oedometer swelling test were performed; the maximum swelling pressure test (ISRM, 1999) and the cyclic swelling test with controlled deformation (Vergara and Triantafyllidis, 2015). The maximum swelling pressure test was performed on both powder samples and intact rock specimens whereas the cyclic oedometer test was performed on intact rock specimens only. The idea behind the cyclic tests is to simulate

the moisture changes and stress release experienced by the rock mass around the head-race tunnel periphery in hydropower. The applicability of rock powder tests in intact rock assessments were discussed based on the results.

Duplicate samples of all the tested specimens were prepared and analyzed by thin section microscopy at NTNU. The aim was to get an overview of the main structural and textural features which potentially control the swelling behavior of intact rocks. The findings were combined with the results from the XRD analyses and the swelling potential was qualitatively estimated based on the mineralogical and textural characteristics. A comparison was then made between the estimated swelling potential and the measured swelling pressures from the oedometer tests, and the discovered linkages were discussed.

Important differences with the XRD analyses were identified in this study, especially the standard methodology in operation at NTNU. The differences are related to the poorly recognition of amorphous phases lacking crystalline order which may result from natural weathering of the rock and/or from destructions of weak components during preparation. The procedure used at KIT, which includes steps for differentiating between different types of clay minerals and estimations on the content of amorphous phases, results in quantification uncertainties but the procedure seems more applicable to describe the composition of weathered rocks where the minerals lack crystalline order. The thin section analyses revealed highly weathered and intermediate states of the minerals in nearly all the tested samples which explained the difficulties of reading the diffractograms from the XRD.

The estimation of swelling potential based on the combination of thin section analyses and XRD results correlated well with the measured swelling behavior in the oedometer tests. In cases where the intact rock samples showed a deviating behavior compared to the powder samples, the explanation could be found in the textural characteristics of the rocks. This confirmed the assumption of textural and structural control in long-term swelling behavior of intact rocks. In addition, the results of the cyclic swelling tests showed that some intact rocks hold a potential to increase the swelling pressure on a tunnel lining over time, a feature not revealed by single swelling pressure tests on pulverized rock material. However, an extended dataset with cyclic swelling test results on different rock types, is required before a conclusion can be drawn.

4.4 Paper 4

Selen, L. and Panthi, K.K. A discussion on the laboratory testing approaches for swelling rocks at three European institutions. Submitted to Geomechanics for Energy and the Environment, 05.08.2020.

This paper presents a review of the different testing approaches in swelling rock assessment at three different European institutes. Oedometer tests and XRD analysis are frequently used laboratory methods at all the institutes, however, intern modifications on the methodology result in three unique approaches. Laboratory visits, continuous communication with different European researchers and data obtained from mineralogical analyses and swelling tests throughout the research period were used as basement for analyses and discussions.

4.5 Paper 5

Selen L, Panthi KK, Tunbridge L and Schönborn T. (2019). Field testing of weak rock deformation in water tunnels: A practical review of the flatjack test. Published in Rock Mechanics for Natural Resources and Infrastructure Development (2019) and presented at ISRM Congress (ISRM2019) held in Brazil in September 2019.

This conference paper presents a modified variant of the flatjack test for the long-term monitoring of pressure and deformation development in the headrace tunnel of Moglicë HPP. The flatjack method as described by ASTM (2008) was modified to monitor the stress changes for a longer period, whereby both the equipment and test procedure required corrections. As the instrumentation was performed in a constructed and heavy shotcrete supported tunnel, the initial deformations were assumingly already occurred. The aim was to monitor eventual time-dependent deformations which can be attributed to swelling pressure development in the rock mass after water filling and during one year of operation of the hydropower plant. Parallel laboratory test results on swelling behavior were obtained on samples extracted during the instrumentation process and will be compared to the acquired data from the flatjacks after one year of operation.

Due to project delays, the tunnel came in operation in April 2020 and the instrumentation results will be available in spring 2021. The paper therefore focuses on the experienced challenges during the instrumentation process, including the preparation of the rock surface and cutting of slots in a heavily supported tunnel, the installation process and unexpected challenges which were handled during the work. Important observations on the rock mass response and the required modifications which were revealed during installation are described in detail.

4.6 Interrelations of individual papers

The presented papers cover the intended scope and objectives of the PhD thesis. Paper 1 suggests a modification on the slake durability test which is a widely used laboratory test for disintegration assessments of weak rocks. The modification simulates the in-situ exposure to cyclic moisture changes in hydropower and enables an early detection of the moisture sensitivity and water-weakening effects on weak and swelling rocks. Paper 2 provides a wider understanding of the rock material parameters affecting the slake durability of the rocks assessed in Paper 1, including material composition and swelling potential. Paper 3 presents a study on intact rock swelling under conditions of cyclic moisture changes, including a project-specific modification of the oedometer swelling test. A comparison and discussion of the prevailing swelling test approaches at three European institutes are presented and discussed in Paper 4. Paper 5 presents a modified flatjack test which may enable a correlation between laboratory test results and the actual in-situ swelling behavior of the rock mass around a water tunnel.

In the next chapter 5, different topics related to the relevancy of the work to the objectives of the research are discussed.

5. Discussions

In contrast to the processed and manufactured construction materials, the rock engineer is faced with a complex rock mass with specific properties which cannot be prescribed (Bieniawski, 1993). However, there is also in rock construction a need for a material specification, i.e. the rock mass (Stille and Palmström, 2008). Since the material already exists, the task is to sensibly describe and estimate the properties it possesses.

5.1 The intricate properties of the degraded rock

The engineering properties of a weak and weathered rock depend on a wide range of material characteristics as the mineral composition, grain size distribution, microfractures and rock fabric. However, the potential swelling problems related to underground construction projects are often diagnosed by the content of swelling clay minerals, and XRD is frequently used as first-hand estimation on the swelling potential of the rock material. Further, at some laboratories, the “worst case scenario” of swelling pressure to be exerted on the engineering structures is determined based on a narrow focus on the presence of swelling clay minerals. Consequent on the assumption on swelling clay to be the preeminent cause of swelling, remolding of rock samples to powder is commonly assumed to reveal the maximum potential of the rock to swell as this produce easy access for the water to react with the swelling clay during the swelling test. The test results are then categorized and classified for support evaluations based on the potential “worst case” of swelling behavior. This exfiltration of one mechanism in assessments of a complex problem may lead to inadequate conclusions and mis-judgements on critical rock material properties.

Throughout this research, it became clear that the swelling properties of intact rocks cannot be attributed only to the swelling of clay minerals. Several of the tested samples showed remarkable swelling behavior even when minor or zero swelling clay was detected by XRD. Instead, the mineralogical composition was dominated by amorphous constituents, i.e., minerals which do not have a crystalline structure. By studying thin sections of these samples, signs of extensive weathering and alteration were observed. In many cases the texture of the rocks was chaotic where microfractures either were cemented or presented clay-like infillings. A thin section scan of one of these samples is, together with its corresponding pulverized form, shown in Fig. 7.

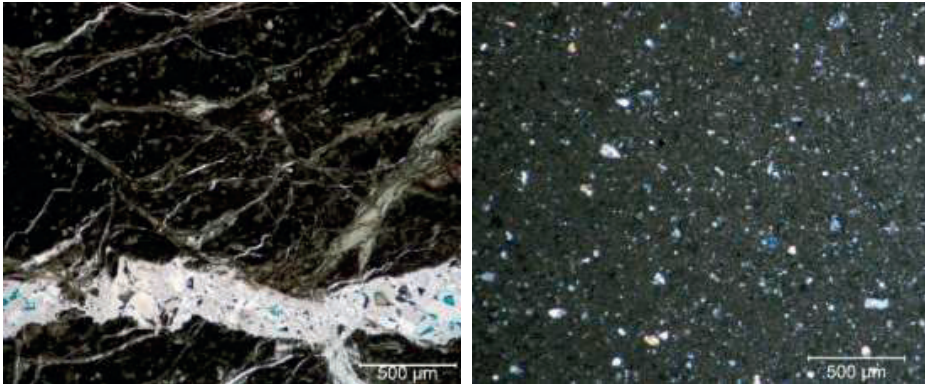

Fig. 7. Thin section scan of a weathered volcanic rock (left) and the corresponding pulverized rock sample (right)

In some measurements, the intact rock swelled even more than its corresponding pulverized form, and the swelling pressure increased with repeated cycles of wetting, drying and unloading; the opposite behavior of Grob's "swelling law". The suggested explanation to this phenomenon is the intricate properties of the degraded rock where the structural features in combination with swelling of intermediate non-crystalline constituents (amorphous mineral phases) result in a mix of physical and chemical swelling mechanisms. The swelling properties are not sufficiently indicated by XRD nor by swelling tests on pulverized samples. As can be seen in Fig. 7, the true composition of the rock is not recognizable after preparation to powder and the structural features are eliminated.

5.2 The classification problem(s) in weak rock engineering

Most of the classification systems developed in rock engineering have tried to meet requirements on measurability of parameters, simplicity and efficiency. In order to do so, complex problems are split into smaller groups of mechanisms whereby the assumed most influencing parameters are emphasized in testing programs, as in swelling assessments. For the input parameters to a classification system to be valid, they must be obtained from standardized tests where every detail of the entire procedure is similar from test to test. However, standards for laboratory tests may either aim to characterize a specific rock material property or relate test results to the determination of actual design parameters (Williams, 1997). Caution is required when these two classification objectives are coupled.

5.2.1 When the standardized test is too general

The behavior of the surrounding rock mass in underground construction depends on complex internal and external factors which interplay throughout the lifetime of the construction project. Laboratory methodologies are normally developed for characterizing the

internal factors, as material properties of the rocks constituting the rock mass, resulting in classification indexes on rock quality independent on project type. However, the exposure to project-specific external agents during operation, as water fluctuations, temperature variations and air, hold a potential for changing the rock material properties over time. In the case of hydropower projects, the intensity of water fluctuations is far more severe compared to most other geotechnical constructions. If the hydropower tunnels are constructed within a weak and/or swelling rock mass, the material properties are especially vulnerable for these external factors. The generalization of test procedures and their respective classification systems may therefore result in inadequate interpretations on the required rock support.

The lack of incorporation of project-specific parameters in test procedures is one of the main arguments on modifying standardized methods to improve their applicability in certain geotechnical projects. However, the development of a reliable rock classification system is time consuming and requires multiple iterative processes producing the necessary laboratory- and field data. Further, the implementation of new methods or modifications on frequently used methodologies is a sacrifice of comparability to the existing set of data obtained over decades by established testing procedures. A reasonable question in this regard is if the effort in improving laboratory methods, which either way around are to be considered as index tests and not direct measurements on rock behavior, is worth the resources required.

The results of this research show that the inclusion of project-specific features in standardized test procedures, as the implementation of the moisture condition of the rock surrounding a hydropower tunnel in the slake durability test, have major implications on the results (Paper 1). The effect of project-specific modifications is also seen in the swelling test results of intact rock types, where the swelling potential in some cases increases with repeated cycles of wetting, drying and unloading (Paper 3). The findings indicate a necessity of further investigations on the validity of the existing classification systems, both in terms of the test procedures they are based on and their application in support measures.

It is, however, emphasized here the value of existing datasets of material parameters obtained from the original test procedures. The suggested modified tests therefore retain the framework of the standardized tests and the suggested procedures can be considered as a compromise between keeping the advantages of the established tests and improving the boundary conditions with respect to the in-situ environment of hydropower tunnels. The results can be indirectly compared to existing databases of results and characterization systems of material parameters. The suggested modifications can therefore be expressed as a first step towards an improved strategy of project-specific testing and classification of weak rocks.

5.2.2 When the standardized test is too flexible

Some standardized tests include details which are inconsistent and thus open up for different translations of test elements. One example of this “classification problem” revealed in this study is the oedometer swelling pressure test. Swelling pressure tests on pulverized samples are performed at both NTNU and KIT and both institutes base their laboratory assessment of swelling rocks on the suggested methods of ISRM (1979–1999). However, major deviations in the procedures are prevailing. The preparation method including milling and drying of the material is not similar, and the two institutes have different traditions regarding the sample size, grain size, compaction procedure, testing apparatus and climate control. This means that even if both procedures are based on the ISRM suggested methods, the results can neither be directly compared nor can the similar characterization system be applied. This will consequently result in confusion and lack of consistency of the data produced when comparing the results from the two institutions.

The flexibility of some standardized tests may be intended in order to enable adjustments on test procedures based on the aim of investigation. However, during numerous discussions with researchers and lab-technicians throughout this research period, the problem of unspecific testing manuals has shown to produce major problems in classifying the results. The proposed modifications on test procedures, as the cyclic oedometer test in Paper 3, also needs further specifications in order to be consequent and unmistakable. This apply especially to the preparation method, apparatus configuration and sample size used for the tests. It is therefore highly recommended that institutions and companies collaborate on a common methodology, so that a database of comparable test results can be obtained efficiently in future laboratory work.

5.2.3 When the standardized test is tailored to hard rocks or soil

One main challenge of testing of weak rocks is their heterogeneous nature and sensitivity to mechanical forces and moisture. When methods originally developed for hard rocks are transferred to assessments of weaker rocks it can be difficult to achieve the specifications in practice. One of the main obstacles is to develop a preparation technique which is both applicable to produce specimens with comparable parameters and at the same time preserve important “weak rock features”. As discussed previously, the easiest way out may be to consequently disturb weaker rocks types by remolding them into powder samples in order to obtain “equal rock material quality” of the tested specimen, strictly speaking; treat the weak rock as a soil. The issues related to this solution is quite obvious given the intention of characterizing the intact rock properties, however, it also reflects the research gap in terms of weak rock preparation techniques.

The shortcomings in weak rock test methodologies are hardly solved by inconclusive substitutes derived from hard rock empiricism, nor will weak rocks fit into classification

systems tailored to soils. Appropriate testing procedures for intermediate rock types are deficient, which may lead to highly inadequate interpretations on rock mass behavior in terms of restrictive assumptions on the variability of rock masses. Misused in this way, the classification systems developed for hard rock or soil may be more misleading than helpful by giving a false feeling that adequate design procedures have been followed (Brekke and Howard, 1973). The solution to this problem is not further assessed in this research, however, the issue is hereby addressed for future research projects on weak rock classification systems.

5.3 Limitations of this study

In this section, some of the uncertainties and limitations experienced during the work of this research are discussed.

5.3.1 Sample disturbances during extraction and storage

Initially in the work of this research, rock specimens were sampled from borehole core assemblages obtained in the feasibility- and construction phases of the case projects. The author had no or minor influence on the location from which the samples were cored, nor on the extraction procedure or the storage conditions prior to sampling. The cores from Alimit HPP were not wrapped or otherwise sealed after extraction and were stored under questionable conditions in terms of temperature and humidity. Therefore, the sampled rocks from Alimit have assumingly undergone some degree of degradation after extraction, as mechanical damage and weathering. On the other hand, the sedimentary rocks from Moglice HPP were wrapped in plastic foil and stored in core boxes inside the constructed tunnel between extraction and sampling.

After sampling, the rocks from both locations were wrapped in plastic foil and packed in core boxes before transportation to NTNU (Trondheim, Norway) and KIT (Karlsruhe, Germany) by air. Before arriving the laboratory, the sealing may have reduced but not completely prevented changes of the initial water content of the rocks. In addition, mechanical damage during transportation cannot be excluded. During the period of laboratory work, the core boxes and plastic foil were reopened several times in the laboratories. The mentioned limitations on how the samples were handled may have caused changes in the degradation state of the rocks compared to their in-situ condition.

In retrospect, even if the mentioned limitations are familiar problems met in engineering projects where multiple actors are involved, several improvements could have been implemented. During the planning phase of the field work, a closer communication with the working crew could have resulted in a more gently handling of the rocks prior to sampling, especially the pervasive fissured rock materials which are very sensitive to sampling disturbance (Coli, 2013). This was, however, hardly implementable as the majority

of the samples were extracted and stored before the projects were included in this research. At site, the samples should have been waxed or otherwise more securely wrapped in order to reduce moisture fluctuations and mechanical damage during storing and transport.

5.3.2 Sample disturbance during preparation and testing

The issues of sample disturbance are questions on how to reduce rather than avoid. In the laboratory work of this research the aim was to limit sample disturbance connected to existing preparation methods frequently applied in rock property assessments. Several modifications were therefore introduced and implemented aiming to reduce the sample disturbances related to moisture effects, temperature effects and destruction of structural features of the intact rock. Further, modifications were implemented on the test procedures whereby the rocks were tested in a condition closer to their in-situ state in a hydro-power tunnel under operation. Even with the suggested modifications, the experience during this research was that it is difficult to fulfill the preparation requirements and testing techniques whereby the overall methodology is both applicable to produce specimens with comparable parameters and at the same time preserve important “weak rock features”. The suggested procedures still involve some disturbances to the samples, especially related to cutting and hammering of the intact rock to the required size for laboratory testing.

Despite the mentioned difficulties, some improvements on sample preparation are obtained which are applicable for future investigations. Firstly, it is experienced that intact rock specimens may be obtained from rocks with quite poor quality, which enables swelling tests on weaker rock types without destroying their intact features. However, this requires equipment tailored to preparation of weak and water-sensitive rock types, skills in how to use them and experience with the test procedures. Secondly, the temperature exerted on the samples during both preparation and testing is lower compared to the original test manual. It should be noted that several of the ISRM suggested methods, as the swelling tests and slake durability tests, include oven-drying of the rock samples at a temperature of 105°C. With lower temperatures it is avoided that minerals sensitive to high temperatures change their characteristics during preparation and testing, and that undesired temperature-induced slaking is exerted to the samples. On the other hand, with lower temperatures the time spent on preparation and testing test is extended compared to procedures which involve oven-drying at extremely high temperatures.

5.3.3 Interpretation of laboratory results

Testing of rock masses in-situ has brought out very clearly the enormous spatial variations that exist in the mechanical behavior of a rock mass (Palmström, 1995) and depend on complex factors including the overburden, horizontal stresses, discontinuities, tectonics

and elastic properties of the rock material. To portray the rock mass behavior at laboratory scale will always be connected to a great deal of uncertainty and correlations to the in-situ behavior of the rock are therefore necessary in order to verify the reliability of the presented laboratory results. In addition, the project-specific conditions of a water tunnel running through weak rock masses will often result in a situation which departs from the baseline and are hardly generalized. Due to the great number of physical and technical parameters involved, the results of this research do not allow for classifications or support design procedures of general validity.

6. Conclusions

This research has revealed important limitations in test procedures frequently used in the assessments on material properties of weak and weathered rocks, and consequently on their related classifications systems. The results and observations presented provide an enhanced understanding of swelling mechanisms of intact rocks and guidance in how to identify the possible problems that a weak and swelling rock mass may cause in hydro-power projects. The main conclusions are categorized into two separated but closely interrelated areas of focus; the characterization of weak and swelling rocks and the test methods in use to determine and classify their properties.

6.1 Characterization of weak and swelling rocks

1. Differential rock properties within rock units: The visual appearance of collected samples at a given location may be similar among rock types with equal origin but different history of weathering/alteration. This means that similar mechanical behavior cannot be taken for granted. The properties of samples obtained from the same borehole and at almost similar depth should therefore be determined by tailored testing procedures.

2. A wider understanding of the term “swelling minerals”: The assumption on specific clay minerals and anhydrite to be the main controlling parameters on swelling potential do not always apply, and a narrow focus on these minerals may lead to the neglect of other swelling rock components such as zeolites and amorphous rock components. Consequently, misinterpretations may occur when several mechanisms interplay on the swelling behavior of the intact rock.

3. Physical swelling of degraded rock materials: In order to characterize a potential swelling rock material, the identification of weathered rock structures is crucial as a previously competent rock material may change its mechanical properties due to weathering and alteration. Despite similar structural framework, the distribution of weathered and amorphous constituents in the rock texture, the presence of microstructures and the nature of eventual microfractures may lead to physical swelling even when minor or no swelling clay minerals are detected.

6.2 Testing and classification of weak and swelling rocks

In general, the complex interaction of different internal and external factors controlling the project-specific rock mass behavior is challenging to transform to laboratory scale, and several limitations must be encountered in every model developed from laboratory measurements. However, several improvements on test procedures are possible in order to reduce the risk for misinterpretations.

A. Intact rock features and material preparation: Remolding techniques aiming to produce a “worst case scenario” on swelling potential, as consequent pulverizing rock materials to powder aiming to investigate swelling of clays, are found somewhat misleading when applied to detect the swelling potential of intact rocks. The remolding technique used for swelling tests may accelerate the potential swelling of swelling clay minerals, however, other important factors controlling the swelling behavior of the intact rock might be ignored through by this procedure.

B. Detecting swelling minerals: The XRD analysis may, dependent on the methodology used, not sufficiently quantify the mineralogical content of weathered rock material. Weak and swelling constituents may either be camouflaged, destroyed during preparation or neglected in the analysis procedure.

- The XRD methodology should be adjusted by means of a separate manual when applied to weathered and swelling rocks and ensure a gently handling of the rock material.
- The amorphous constituents should be implemented in the calculation procedure even if this result in a reduced accuracy of the quantified minerals.
- In order to characterize the weathered, altered and amorphous constituents, thin section analysis and SEM analysis should complement the analysis.
- In order to check for swelling potential of clay-sized amorphous minerals, free swelling tests can assist the assessment.

C. The lack of common and consistent procedure for intact rock swelling tests: Different institutions operate with different laboratory test approaches which make a common database of comparable test results for classification purposes challenging to obtain.

- The standardized test procedures of the oedometer swelling tests suggested by ISRM (1979–1999) are translated differently between laboratories. Different versions of the ISRM suggested methods are used or combined. In addition, internal modifications on preparation technique, sample dimensions, apparatus configuration, boundary conditions of the test and the test procedure itself have direct implications on the comparability of the results.
- It is not clearly distinguished between the test procedures used to assess swelling gouge materials from weakness zones and the test procedures used to assess weak but intact rocks.
- The inclusion of project-related features in the test procedures vary between institutions. Generalized test procedures challenge the applicability of the consequential classification of the measured material properties.

D. Potential misinterpretation on the required rock support in tunnels: A narrow focus on swelling clay minerals in assessments of intact rock swelling in combination with extensive preparation techniques, as of the powder swelling tests, may lead to misinterpretations on potential swelling problems and the required rock support.

- Overestimations on support requirements may occur when the rock contains swelling clay minerals but their distribution in the rock structure do not favor water ingress to the material and swelling to occur.
- Underestimations on support requirements may occur when the rock contains minor or no swelling clay minerals and the structural features and/or the nature of weathering/alteration favor other swelling mechanisms to occur.

E. Limitations of the ISRM slake durability test when applied in hydropower projects: The ISRM slake durability test is useful as a general comparison of the slaking properties of stronger rock types but poorly recognize the differential disintegration behavior of weak and moisture sensitive rock materials.

- Improvements are generally required on the limited deviation between grain sizes in the calculation of the slake durability index.
- To reflect the project-related features of water-tunnels, modifications are required on the initial moisture state of the tested samples, the temperature exerted on the samples between the cycles and the number of cycles.

F. In-situ measurements in supported water tunnels: The installation of flatjacks in a supported water tunnel is a resource-demanding task which require several field-specific modifications in order to be successful, where the main challenges are related to interference with the applied support. The modifications apply to:

- the preparation technique of the rock surface between elements of the applied support
- case-specific adjustments on the equipment used
- the installation procedure
- the monitoring of the overall function of the instruments during installation and operation

7. Recommendations and future research

Based on the findings presented in this thesis, recommendations on future test procedures on weak and swelling rock materials are given herein. Further, as this research has a testing-out character which can work as a basis for future problem-solving studies on improved investigation strategies for tunnel design in hydropower projects located in weak and weathered rock masses, future research topics are suggested.

7.1 Recommendations on future test procedures

i. Preparation techniques and methods used in hard rock assessments should be modified when applied on weaker rock types.

- It should be clearly distinguished between intact rock assessments and swelling gouge assessments. When the rock can withstand the preparation of intact test specimens, powder tests tailored to assessments on swelling gouge material should not be a substitution for test methods tailored to intact rocks.
- In the preparation of intact rock specimen, preparation techniques which include destructive techniques as hammering and crushing should be replaced by more gentle methods as sawing and cutting. High temperatures and water should be avoided, especially if the material contain weak and sensitive constituents as clay minerals.
- The ISRM standard should, when applied at weak rocks, include a separate manual tailored to the use of powder tests in weak rock assessments. The method description should include details on the temperature exerted on the rock material during preparation, the remolding technique used, the desired grain size of the prepared specimen, sample dimensions, sample density and compaction procedure.

ii. Oedometer testing of intact rocks should be improved and standardized. Based on the experiences during the laboratory work of this research and the collaboration with KIT, the new NTNU-oedometers and the associated test procedures are suggested based on the ISRM standard (1989, 1999) with adjustments favoring intact rock testing.

- The configuration of the oedometer should emphasize small increments in swelling pressure to be detected. The latter requires sufficient stiffness of the apparatus elements and a minimum of distance between the sample and the pressure measuring gauge(s).
- Cyclic oedometer swelling tests which combines maximum swelling pressure testing with pressure measurements during controlled deformation of the specimen are recommended as basis for swelling tests for water tunnels.

- To ensure reproducibility, the procedure should specify sample dimensions, external forces applied to the specimen during the test, temperature- and moisture condition during the test, climate control of the laboratory and duration of the test. In the cyclic swelling test, the duration of swelling, the duration of draining, the number of cycles and the magnitude of de-loading increments, should be made explicit.
- A closer collaboration between institutions is strongly recommended for a collectively contribution on databases of test results. This require the agreement upon a detailed test strategy and sharing of information.

iii. The modified slake durability test is suggested for use in behavioral assessment of weak rocks in hydropower water tunnels. The test is time-efficient, semi-quantitative, reproducible, and comparable to the original ISRM slake durability test. The influence of water saturation on durability can be detected using this method, and the material response to cyclic moisture changes under conditions similar as the in-situ condition can be evaluated.

iv. In-situ measurements should be carefully planned prior to execution. For future in-situ measurements of time-dependent swelling pressure development in water tunnels, the equipment should be installed during excavation in order to minimize the interference by the applied support. When time and resources are available, it is highly recommended that parallel laboratory tests are performed to obtain correlations between laboratory test results and in-situ swelling behavior.

7.2 Suggestions on future research

This research has proposed several adjustments and modifications on the existing laboratory test procedures, however, in order to validate their contribution to an improved characterization system of swelling rocks, repeated tests must be conducted to obtain a representable database of results. Further, in order to develop a project-specific classification system for tunnel support in hydropower, correlations between laboratory experiments and in-situ observations must be conducted. Based on the overall findings of the present research, the following future research topics are relevant:

- **Standardization on preparation techniques for weak rocks:** The manual should include a detailed procedure description and equipment specifications in order to avoid flexibility in how the techniques are translated into operation.
- **Standardization of the oedometer swelling pressure test on pulverized samples when applied in assessments of intact rock swelling.** The details should include the temperature exerted on the rock material during preparation, the remolding technique

used, the desired grain size of the prepared specimen, sample dimensions, sample density and compaction procedure. The standard must include explicitly the aim of the test and to which rock material it is tailored to, in order to distinguish clearly between assessments on swelling gouge material in weakness zones and weak intact rock material.

- **The effect of rock materials containing the mineral brucite on concrete-based tunnel support.** Brucite holds a potential to dissolve into ions which may, when dissolved in water, degrade concrete elements of tunnel support. Further research on the interaction between brucite, water and concrete is therefore strongly recommended.
- **Extension of datasets obtained from the modified slake durability test for hydro-power projects.** The modified slake durability presented in this research should be applied on an extended number of rocks and rock types. The procedure should include a complementary element of grain size distribution analysis, either after the test procedure, as performed in this research, or as an implemented element in the test procedure itself. The latter may be solved by designing a drum which separate between different grain sizes during the test.
- **Correlation analysis on project-specific laboratory tests and in-situ behavior of the rock mass.** The modified laboratory test results must be correlated to field observations and in-situ measurements in case projects in order to find a correlation between the measured properties of the rock and the in-situ behavior of the rock mass. The field observations may include measurable deformation/stress of tunnel walls or visual degradation of the tunnel lining. Close collaboration with the industry is required and should be planned in detail in advance of the field work.
- **Analysis on the data obtained from the flatjacks instrumented in Moglicë HPP.** The proposed flatjack-test of this study may produce interesting data on the in-situ swelling of the instrumented tunnel in Albania. The data can be correlated to the corresponding laboratory results of this research and analyzes on whether or not the experiment is successful can thus be an interesting topic for future research work.

References

- Admassu, Y., Hamdan, H. and Gautam, T. (2016). Multivariate statistical approach to re-evaluate the slake durability index test (ASTM 4644–08). *Engineering Geology*, 209, pp.12–20. <https://doi.org/10.1016/j.enggeo.2016.05.004>.
- Ankara, H., Aksoy, M., Yerel, S. and Keser, Y. (2013). Determination of Slake Durability Index with Spherical Samples. *Key Engineering Materials*, 548, pp.247–252. <https://doi.org/10.4028/www.scientific.net/KEM.548.247>.
- ASTM (2008) Standard test method for in situ stress and modulus of deformation using flatjack method (ASTM D4729-08). ASTM International, West Conshohocken, PA, 1-7.
- Barla, M. (1999). *Tunnels in Swelling Ground – Simulation of 3D stress paths by triaxial laboratory testing*. PhD Thesis, Politecnico di Torino, Italy, 180 p.
- Barla, M. (2008). Numerical simulation of the swelling behaviour around tunnels based on special triaxial tests. *Tunnelling and Underground Space Technology*, 23(5), pp.508–521. <https://doi.org/10.1016/j.tust.2007.09.002>.
- Barla, G., Barla, M. and Debernardi, D. (2010). New Triaxial Apparatus for Rocks. *Rock Mechanics and Rock Engineering*, 43(2), pp.225–230. <https://doi.org/10.1007/s00603-009-0076-7>
- Bieniawski, Z.T. (1993). Principles and methodology of design for excavations in geologic media. *Research in Engineering Design*, 5(1), pp.49–58. <https://doi.org/10.1007/BF01608397>
- Bravo, A., Jerez, O., Kelm, U. and Poblete, M. (2017). Dehydration-hydration reactivity of laumontite: analyses and tests for easy detection. *Clay Minerals*, 52(3), pp.315–327. <https://doi.org/10.1180/claymin.2017.052.3.03>.
- Brekke, T.L. and Howard, T.R. (1973). Functional Classification of Gouge Material from Seams and Faults in Relation to Stability Problems in Underground Openings. Technical report, U.S. Bureau of Mines (ARPA), University of California, Berkeley.
- Coli, M. (2013) Characterization of the “Chaotic Complex” (Northern Apennines, Italy). In: Kwasniewski & Lydzba (eds.), *Rock Mechanics for Resources, Energy and Environment*. Taylor & Francis group, London.

- Czerewko, M.A. and Cripps, J.C. (2001). Assessing the durability of mudrocks using the modified jar slake index test. *Quarterly Journal of Engineering Geology and Hydrogeology*, 34(2), pp.153–163. <https://doi.org/10.1144/qjegh.34.2.153>
- Deer, W.A., Howie, R.A., Wise, W.S. and Zussmann, J. (2004). *Rock-forming minerals. Volume 4B: Framework silicates: silica minerals, feldspathoids and the zeolites*. Geological Society, Geological Society Publishing House, Bath, UK, 982 p.
- Deo, P. (1972). Shales as Embankment Materials : Final Report. Publication FHWA/IN/JHRP-72/45, Joint Highway Research Project, Indiana Department of Transportation and Purdue University, West Lafayette, Indiana. <https://doi.org/10.5703/1288284314547>.
- Dick, J.C. and Shakoor, A. (1992). Lithological controls of mudrock durability. *Quarterly Journal of Engineering Geology and Hydrogeology*, 25(1), pp.31–46. <https://doi.org/10.1144/GSL.QJEG.1992.025.01.03>
- Dick, J.C., Shakoor, A. and Wells, N. (1994). A geological approach toward developing a mudrock-durability classification system. *Canadian Geotechnical Journal*, 31(1), pp.17–27. <https://doi.org/10.1139/t94-003>
- Dutrow, B.L. and Clark, C.M. (2012). *X-ray powder diffraction (XRD)*. Geochemical Instrumentation and Analysis. Available at: https://serc.carleton.edu/research_education/geochemsheets/techniques/XRD.html (Accessed 08.04.2019).
- Einstein, H. (1996). Tunnelling in Difficult Ground - Swelling Behaviour and Identification of Swelling Rocks. *Rock Mechanics and Rock Engineering*, 29(3), pp.113–124.
- Einstein, H., Steiner, W. and Baecher, G.B. (1979). Assessment of empirical design methods for tunnels in rock. In: A.C. Maevis and W.A. Hustrulid, eds., *Conference on Rapid Excavation Tunneling*. United States: Society for Mining Metallurgy & Exploration, pp.683–706.
- Erguler, Z.A. and Shakoor, A. (2009). Quantification of Fragment Size Distribution of Clay-Bearing Rocks after Slake Durability Testing. *Environmental and Engineering Geoscience*, 15(2), pp.81–89. <https://doi.org/10.2113/gsegeosci.15.2.81>
- Flåten, M. (2015). *Stress Induced Stability Assessment of the Underground Caverns for Moglicë Hydropower Project, Albania*. PhD Thesis, NTNU, Trondheim, Norway.
- Franklin, J.A. (1970). Observations and Tests for Engineering Description and Mapping of Rocks, In: *Proceedings of the Second Congress of the International Society for Rock Mechanics*, 1(1–19), International Society for Rock Mechanics, Belgrade, pp.1–6.

- Franklin, J.A. and Chandra, R. (1972). The slake-durability test. In: *International Journal of Rock Mechanics and Mining Sciences & Geomechanics Abstracts*, 9(3), pp.325–328. [https://doi.org/10.1016/0148-9062\(72\)90001-0](https://doi.org/10.1016/0148-9062(72)90001-0)
- Grob, H. (1972). Schwelldruck im Belchentunnel. In: *Proceedings of the International Symposium on Underground openings*. Lucerne, Switzerland, pp.99–119.
- Hoek, E. (1995). When is a rock engineering design acceptable. In: *Practical Rock Engineering*, collected notes by E. Hoek. Rocscience. Available at: <https://www.rocscience.com/assets/resources/learning/hoek/Practical-Rock-Engineering-Full-Text.pdf> (Accessed 07.08.2010).
- Hudec, P.P. (1982). Statistical analysis of shale durability factors. *Transportation Research Record*, 873, pp.28–35.
- Huder, J. and Amberg, G. (1970). Quellung in Mergel, Opalinuston und anydrit. *Schweizerische Bauzeitung*, 88(43), pp.975–980.
- Hudson, J.A. (1993). Rock Properties, Testing Methods and Site Characterization. *Rock Testing and Site Characterization*, 3, pp.1–39. <https://doi.org/10.1016/B978-0-08-042066-0.50008-2>.
- Høien, A.H., Nilsen, B., Vistnes, G. and Olsson, R. (2019). Experimental triaxial testing of swelling gouge materials. *Bulletin of Engineering Geology and the Environment*, 79(1), pp.355–370.
- ISRM (1977). SM for Determining Water Content, Porosity, Density, Absorption and Related Properties and Swelling and Slake-Durability Index Properties. In: R. Ulusay and J.A. Hudson (eds.): *The Complete ISRM Suggested Methods for Rock Characterization, Testing and Monitoring:1974-2006*, 628 p. ISBN: 978-975-93675-4-1.
- ISRM (1979). Suggested methods for determining water content, porosity, density, absorption and related properties and swelling and slake-durability index properties. *International Journal of Rock Mechanics and Mining Sciences & Geomechanics Abstracts*, 16(2), pp.143–151. [https://doi.org/10.1016/0148-9062\(79\)91452-9](https://doi.org/10.1016/0148-9062(79)91452-9).
- ISRM (1989). International society for rock mechanics commission on swelling rock and working group on swelling rock of the commission on testing methods. *International Journal of Rock Mechanics and Mining Sciences & Geomechanics Abstracts*, 26(5), pp.415–426. [https://doi.org/10.1016/0148-9062\(89\)90937-6](https://doi.org/10.1016/0148-9062(89)90937-6).

- ISRM (1999). Suggested methods for laboratory testing of swelling rocks. In: *International Journal of Rock Mechanics and Mining Science & Geomechanics Abstracts*, 36(3), pp.291–306.
- Kovari, K., Amstad, C. and Anagnostou, G. (1988). Design/construction methods – Tunnelling in swelling rocks. In: Cundall et al. (eds), *Key Questions in Rock Mechanics*. Proceedings of the 29th U.S. Rock Mechanics Symposium, Balkema, Rotterdam, pp.17–32.
- Madsen, F.T. (1999). Suggested methods for laboratory testing of swelling rocks. *International Journal of Rock Mechanics Mining Sciences*, 36, pp.291–306.
- Marosvolgyi, K. (2009). *Retrograde Alteration of Basaltic Rocks in the Þeistareykir High-Temperature Geothermal Field*. Master`s thesis, RES/the School for Renewable Energy Science, North-Iceland.
- Mathewson, C.C. (1981). *Engineering Geology*. Charles E. Merrill Publishing, London.
- Moody, J.B. (1976). Serpentinization: a review. *Lithos*, 9(2), pp.125–138. [https://doi.org/10.1016/0024-4937\(76\)90030-X](https://doi.org/10.1016/0024-4937(76)90030-X).
- Nilsen, B. (2010). Cases of instability caused by weakness zones in Norwegian tunnels. *Bulletin of Engineering Geology and the Environment*, 70(1), pp.7–13. <https://doi.org/10.1007/s10064-010-0331-x>
- Olivier, H.J. (1991). Some aspects of the engineering-geological properties of swelling and slaking mudrocks, In: *Proceedings of 6th International IAEG Congress*. Rotterdam, pp.707–711.
- Palmström, A. (1995). *RMi – a rock mass characterization system for rock engineering purposes*. PhD thesis, Oslo University, Norway, 400 p.
- Panthi, K.K. (2006). *Analysis of engineering geological uncertainties related to tunnelling in Himalayan rock mass conditions*. PhD thesis, NTNU, Trondheim, Norway. ISBN 82-471-7826-5.
- Panthi, K.K. and Nilsen, B. (2007). Predicted versus actual rock mass conditions: A review of four tunnel projects in Nepal Himalaya. *Tunnelling and Underground Space Technology*, 22(2), pp.173–184. <https://doi.org/10.1016/j.tust.2006.04.005>.
- Parry, S., Baynes, F.J., Culshaw, M.G., Eggers, M., Keaton, J.F., Lentfer, K., Novotny, J. and Paul, D. (2014). Engineering geological models: an introduction: IAEG commission 25. *Bulletin of Engineering Geology and the Environment*, 73(3), pp.689–706. <https://doi.org/10.1007/s10064-014-0576-x>.

Piteau, D.R. (1970). Geological Factors Significant to the Stability of Slopes Cut in Rock. In: Van Rensburg, P.W.J. (ed.), *Planning Open Pit Mines Proceedings*, Open Pit Mining Symposium, Johannesburg, South African Institute of Mining and Metallurgy, pp.33–53.

Rocchi, G., Vaciago, G., Fontana, M. and Da Prat, M. (2013). Understanding sampling disturbance and behaviour of structured clays through constitutive modelling. *Soils and Foundations*, 53(2), pp.315–334. <https://doi.org/10.1016/j.sandf.2013.02.011>.

Russell, D.J. (1982). Controls on shale durability: the response of two Ordovician shales in the slake durability test. *Canadian Geotechnical Journal*, 19(1), pp.1–13. <https://doi.org/10.1139/t82-001>.

Sadisun, I.A., Shimada, H., Ichinose, M. and Matsui, K. (2002). Improved procedures for evaluating physical deterioration of argillaceous rocks. In: *Proceedings of the 2nd International Conference on New Development in Rock Mechanics and Rock Engineering*, Shenyang, China, pp.36–39. <https://doi.org/10.13140/2.1.3499.8400>.

Selen L., Panthi, K.K. and Vergara, M.R. (2018). Swelling pressures of some rocks using different test procedures. In: Geomechanics and Geodynamics of Rock Masses – Litvinenko (ed.), *Proceedings of the 2018 European Rock Mechanics Symposium (EUROCK 2018)*, Saint Peterburg, Russia, 22–26 May 2018, Volume 1, pp.401–410.

Selen, L., Panthi, K.K. and Vistnes, G. (2019). An analysis on the slaking and disintegration extent of weak rock mass of the water tunnels for hydropower project using modified slake durability test. *Bulletin of Engineering Geology and the Environment*, 79(4), pp.1919–1937. <https://doi.org/10.1007/s10064-019-01656-2>.

SN Aboitiz/Stache (2015). *Olilicon and Alimit HPP's and Alimit pump storage schemes*. Geological report. (Unpublished).

Statens Vegvesen (2005). *Laboratorieundersøkelser*. Håndbok R210, 14.418, 3 p. Available at: https://www.vegvesen.no/attachment/1183695/binary/1090660?fast_title=H%C3%A5ndbok+R210+Laboratorieunders%C3%B8kelser+%282005%29.pdf. (Accessed: 09.08.2020)

Stille, H. and Palmström, A. (2003). Classification as a tool in rock engineering. *Tunnelling and Underground Space Technology*, 18(4), pp.331–345. [https://doi.org/10.1016/S0886-7798\(02\)00106-2](https://doi.org/10.1016/S0886-7798(02)00106-2).

Stille, H. and Palmström, A. (2008). Ground behaviour and rock mass composition in underground excavations. *Tunnelling and Underground Space Technology*, 23(1), pp.46–64. <https://doi.org/10.1016/j.tust.2006.11.005>.

Terzaghi, K. (1968). Introduction to Tunnel Geology. In: Proctor, R. and White, T (eds.), *Rock Tunnelling with Steel Support*, Youngstown Printing Co., Youngstown, Ohio, USA.

Ulusay, R. (2013). Harmonizing engineering geology with rock engineering on stability of rock slopes. In: Feng, Hudson and Tan (eds.), *Rock Characterisation, Modelling and Engineering Design Methods*, pp.11–22. <https://doi.org/10.1201/b14917-4>.

Utili, S. (2004). *Evolution of natural slopes subject to weathering: an analytical and numerical study*. PhD thesis, Politecnico di Milano, Italy.

Vergara, M.R. and Triantafyllidis, T. (2015). Swelling behavior of volcanic rocks under cyclic wetting and drying. *International Journal of Rock Mechanics and Mining Sciences*, 80, pp.231–240. <https://doi.org/10.1016/j.ijrmms.2015.08.021>.

Vivoda Prodan, M. and Arbanas, Ž. (2016). Weathering Influence on Properties of Siltstones from Istria, Croatia. *Advances in Materials Science and Engineering*, 2016, pp.1–15. <http://dx.doi.org/10.1155/2016/3073202>.

Wahlstrom, E. (1973). *Tunneling in rock*. Developments in Geotechnical Engineering 3, Elsevier, The Netherlands, 263 p. ISBN 0-444-41064-3.

Wan, Y., Kwong, J., Brandes, H.G. and Jones, R.C. (2002). Influence of Amorphous Clay-Size Materials on Soil Plasticity and Shrink-Swell Behavior. *Journal of Geotechnical and Geoenvironmental Engineering*, 128(12), pp.1026–1031.

Williams, O. (1997). Engineering and design-tunnels and shafts in rock. *US Army Corps of Engineers*, Washington DC, pp.20314–21000.

Part 2:

Main publications

Paper I

Title:

An analysis on the slaking and disintegration extent of weak rock mass of the water tunnels for hydropower project using modified slake durability test

Authors:

Lena Selen

Krishna Kanta Panthi

Gunnar Vistnes

Published in:

Bulletin of Engineering Geology and the Environment, Volume 79, Issue 4, pp. 1919-1937, 2019

<https://doi.org/10.1007/s10064-019-01656-2>



An analysis on the slaking and disintegration extent of weak rock mass of the water tunnels for hydropower project using modified slake durability test

Lena Selen¹ · Krishna Kanta Panthi¹ · Gunnar Vistnes¹

Received: 8 July 2019 / Accepted: 25 October 2019 / Published online: 22 November 2019
© The Author(s) 2019

Abstract

Water tunnels built for hydropower passing through weak and heterogeneous rock mass pose challenges associated to slaking and disintegration, as they are first exposed to dry condition during excavation and are then filled with water to produce hydropower energy. Over the period of operational life, these tunnels are drained periodically for inspections and repair leading to drainage and filling cycles. The weakening of rock mass caused by cycles of drying, saturation and drainage may lead to the propagation of instabilities in the tunnels. Therefore, it is important to study the slaking and disintegration behavior of the weak rock mass consisting of clay and clay-like minerals. This paper assesses the mineralogical composition of flysch and serpentinite from the headrace tunnel of Moglicë Hydropower Project in Albania. Further, to determine the slaking and disintegration behavior of these rocks, extensive testing using both the ISRM, Int J Rock Mech Min Sci Geomech Abstr 16(2):143-151, (1979) suggested test method and a modified variant of this test are performed. Finally, comprehensive assessments, discussions and comparisons are made. It is found that the modified slake durability test better suits for the tunnels built as water conveying systems such as hydropower tunnels.

Keywords Weak rocks · Mineralogy · Slaking and disintegration · Water tunnels for hydropower project

Introduction

Weak and weathered rocks are well known for their sensitivity to changes in moisture content. These rocks can disintegrate and rapidly change from rock-like to soil-like materials upon exposure to water, leading to numerous stability problems to engineering constructions (Rincon et al. 2016). The structure and initial degree of micro-fracturing exerts an important control on the rate of water ingress into the material and are factors which separates durable from non-durable rocks otherwise similar (Russell 1982; Olivier 1991; Dick and Shakoor 1992). Santi et al. (1997) define weak rocks as “either intact, unweathered to slightly weathered materials that have low compressive strength or rocks that are highly fractured”, and

weathered rocks as “materials that show significant deterioration”. Nickmann et al. (2006) define weak rocks as an intermediate state between hard rocks and soil, whereby the borders between them are variable and linked to complex processes. Moreover, disturbances on the original rock material structure due to changes made by the excavation methods applied such as drill and blast method of excavation, may further degrade the rock material properties. The rate of degradation of an intact rock depends on both the properties of the rock material and the exposure to environmental agents such as water, and this interrelation is crucial in every stability assessment of a construction project, especially the water tunnels for hydropower. Throughout this paper the term “weak rock” is used for the rocks vulnerable to deterioration and disintegration.

Cyclic wetting and drying is considered as one of the main processes that can induce micro-fissures in the rock material which may lead to the failure to the construction work (Dick et al. 1994; Erguler and Shakoor 2009). The process of disintegration upon wetting and drying is known as climatic slaking (Franklin and Chandra 1972), a phenomenon which is a

✉ Lena Selen
lena.selen@ntnu.no

¹ Department of Geosciences and Petroleum, Norwegian University of Sciences and Technology (NTNU), Trondheim, Norway

result of shearing produced by volume change associated with hydration and dehydration (Panthi 2006). Okamoto (1993) defines slaking as the structural breakdown of a mass to small size particles in response to change in moisture content. The process of wetting and drying stresses the skeletal framework of the rock and acts to enlarge and extend pores. Taylor (1988) attributed slaking in less indurated mudrocks to a combination of air pressure increase, as water invades narrow capillaries, and tensile failure of weak inter-crystalline bonds due to drying induced pore water suctions. The failure may not be immediate but induced after repeated cycles of wetting and drying, especially if cementing material is removed during the cyclic process (Hudec 1982; Czerewko and Cripps 2001).

Water-weakening effects on rocks have been a major research topic in rock engineering field due to high practical values. Moisture sensitive rocks tends to degrade easily when in contact with water, and the strength loss is related to the saturation degree of the rock material (Bauer et al. 1981; Chugh and Missavage 1981; Goodman et al. 1982; Molinda et al. 2006; Erguler and Ulusay 2009; Karakul and Ulusay 2013; Wong et al. 2016; Vergara and Triantafyllidis 2016). In general, the strength and stiffness of a rock are reduced with increasing water content, spanning from nearly negligible in quartzite to over 90% reduction of uniaxial compressive strength (UCS) in shale and mudrocks (Vergara and Triantafyllidis 2016; Wong et al. 2016). On the other hand, dehydration caused by high temperature can also contribute to rock decay if the thermal stress exceeds the tensile strength of the rock (Hu et al. 2017). Due to higher temperatures, more water will evaporate from the rock pores and fissures, resulting in tension cracks which in turn provides channels for water. The extent of the degradation due to both temperature effects and moisture changes vary among rock types due to considerable variations of mineralogical composition, texture, and lithology (Erguler and Ulusay 2009; Wong et al. 2016; Cano et al. 2017).

Various slaking tests are in use to quantify or qualify the degree of degradation and disintegration due to altering moisture content of rocks. Among many others, the slake index test (Deo 1972), static slaking immersion test (Sadisun et al. 2002), and the slake durability test (Franklin and Chandra 1972) have been proposed, where the latter is most widely used and accepted method to assess durability of the rock material (Erguler and Ulusay 2009). Czerewko and Cripps (2001) investigated the durability of mudrocks and reviewed various tests that have been used for predicting the slaking potential. Their study shows that the standard slake durability test as proposed by Franklin and Chandra (1972) is too aggressive to assess the behavior of weak rocks and lacks sensitivity when it is used to distinguish between durable and non-durable mudrocks. Therefore, several authors have proposed modified variants of the test to address weaknesses in the proposed methods. Erguler and Shakoor (2009)

introduced the disintegration ratio (D_R) based on particle size distribution curves aiming to better reflect the actual disintegration of samples exposed to static wetting and drying cycles in the laboratory. As an extension of this work, Gautam and Shakoor (2013) proposed a method in which the disintegration ratio (D_R) is calculated from particle size distribution curves of samples exposed to natural climatic conditions for a year. Heidari et al. (2015) introduced a nested mesh drum apparatus with different mesh openings, enabling sieving of different grain sizes during the slake durability test. However, methods that embraces both the actual climatic conditions of the engineering project and the need for a relatively quick slake durability analysis are limited.

This paper presents results of the laboratory analyses on the extent of slaking and disintegration of weak rocks prevailing along the headrace tunnel of a hydropower project under construction. To do so, both the ISRM (1979) suggested method for slake durability test, and a modified version of the slake durability test have been used. The ISRM (1979) suggested slake durability index (SDI) is defined as the percentage ratio of the final to initial dry sample masses after two standard cycles of wetting and drying. Following this procedure, the samples are completely dehydrated both initially and between the wetting cycles. On the other hand, the modified slake durability test (MSDI) is an adjusted version of the slake durability test where samples are not completely dried but drained instead to reflect the condition prevailing in a water tunnel. Both methods were extended to four repeating cycles so that long-term slaking behavior of the rocks tested can be achieved. In addition, the paper presents mineralogical analysis to investigate the linkage with the content of water sensitive clay mineral components. Particle size distribution analyses are also presented in order to assess the degree of disintegration after both slake durability test procedures.

Modifications on the ISRM slake durability test for water tunnels

The ISRM (1979) suggested method does not distinguish project types and long-term exposure to environmental condition that a real project is subjected to, such as a water tunnel for hydropower projects. The environmental setting imposes an important control on the behavior of the rocks; therefore, some modifications on the original ISRM test procedure are considered herein.

The environmental setting of waterway tunnels for hydropower

In underground engineering, the environmental condition is highly controlled by the type of construction project with respect to the exposure of rocks to moisture, temperature and air,

and especially the periodical changes on these parameters. Heterogeneous rock mass undergone different degrees of metamorphism and weathering exhibit changed geotechnical properties related to disintegration and degradation when exposed to environmental agents (Cano et al. 2017; Vivoda Prodan and Arbanas 2016) such as air and water. Caution is required for the prediction of the response of the rock material to the disturbances brought up by the excavation, as this depend on the present weathering state and the rate at which the properties change in response to the environmental changes (Czerewko and Cripps 2001). Therefore, selection of appropriate test procedures will help to improve the assessment of long-term durability.

The major difference in water tunnels compared with other underground engineering projects is the intensity of exposure to water during the life-time of the project. The rock mass is first at the stage of drained condition during construction period due to contentious ventilation and heat released by the moving construction equipment. Once the construction is completed, the waterway system (tunnels) is filled with water for the generation of hydro-electricity. Dewatering of the waterway system is carried out periodically to inspect the stability condition of the tunnels which mainly are supported by thick layers of sprayed concrete (shotcrete). During operation, the rock mass near the tunnel periphery and below the hydrostatic line is fully saturated. For the time of the operational life of the hydropower plant, several watering and dewatering cycles will take place. The cycles of dewatering are relatively short, and the temperature is relatively stable, resulting in draining effects rather than a complete dry-out of the rocks near the tunnel periphery. This periodical exposure to wetting and draining is assumed to amplify the weakening and degradation of the rock material, especially the weak and/or clay bearing rocks. In addition, the water tunnels for hydropower are subjected to dynamic pressure fluctuations caused by cyclic change in the production magnitude of the power plant. The response of the rock mass to complete saturation, cyclic drainage under relatively stable temperature conditions, and dynamic pressure fluctuations are of main interest when assessing the degradation behavior of the rocks which influences the long-term stability of the water tunnels.

Review of the ISRM slake durability test

Franklin and Chandra (1972) developed a slake durability test methodology at laboratory scale where the boundary conditions are standardized for quantification and comparison purposes. The technique itself has been discussed in detail by Franklin and Chandra (1972), Koncagül and Santi (1999), Czerewko and Cripps (2001), Erguler and Ulusay (2009) and is also the ISRM suggested method for determination of the slake-durability index (ISRM 1979). The test procedure is designed in such a way that the samples are first completely

dried, which is achieved by leaving the prepared lumps in an oven at 105 °C until no more weight loss, whereby 2–6 h are regarded as sufficient time (ISRM 1979). After drying, the samples are kept in a specially designed drum for a wetting period of 10 min in a slow rotating mode. The samples are again dried in the oven and weighted, and the material loss is measured. The method aims to accelerate weathering to a maximum by combining the processes of slaking and sieving whereby the latter requires some motion in the test process.

In general, it is fair agreement between a low durability and high degree of disintegration. Although material has broken down during the test, a high slake durability index value may arise because it is not recorded as having done so if it does not pass through the 2-mm mesh test drum (Czerewko and Cripps 2006). In fact, the prepared lumps prior to the slake durability test have a diameter of approximately 30–50 mm, and extensive disintegration may occur within the span of particle sizes greater than 2 mm. In addition, the shape of the grains comprising the retained material may produce misleading results since splintered grains less likely pass the 2-mm square openings of the mesh. This means that the slake durability index is not necessarily reflecting the actual disintegration degree during the test, and rocks with similar slake durability index may show very different disintegration behavior.

Franklin and Chandra (1972) thoroughly explained the rationale of the suggested test with the description of different features of the testing procedure. They argued that other processes than climatic wetting and drying, such as mechanical abrasion, leaching, solution, and chemical alteration, can locally result in short-term damage where the environment is particularly severe or where the rock is already in an advance state of “geological” weathering. Further, they stated that the ideal way of assessing the slake durability is to compare complete particle-size distributions before and after slaking, but concluded that for most practical purposes, a single sieve gives a satisfactory index.

Introduction to the modified ISRM slake durability test

The suggested modifications of the ISRM slake durability test are based on the extraordinary conditions met in a water tunnel discussed in “The environmental setting of waterway tunnels for hydropower”-section. The modified test has the same framework and follows similar standardized steps as the ISRM test with two main deviating boundary conditions. First, the lump samples are immersed in water to achieve full saturation prior to the first cycle of rotation in the drum, and then the samples are drained at 30 °C between the cycles instead of drying at high temperatures as suggested in ISRM (1979). Draining is performed by leaving the samples in a drying cabinet for 24 h between the cycles. The samples will not be completely dried out neither will they be exerted to

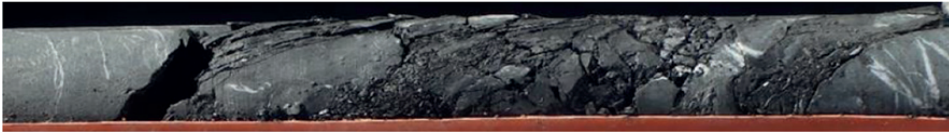

Fig. 1 Flysch rock extracted from the borehole drilled parallel to Headrace tunnel at Moglicë HPP

temperatures higher than what is expected maximum during the construction of the tunnels. In order to calculate the slake durability index, however, dehydration is accomplished by drying the samples at 50 °C as a part of the preparation and additionally after the completed test. This enables a comparison of the slake durability indices obtained from both test methods. In addition, a particle size distribution analysis on the material after a completed test procedure is introduced in order to assess the actual degree of disintegration, which may vary between different rock types.

Materials

The rock material in this research is sampled from two different core boreholes extracted from the headrace tunnel of the Moglicë hydropower project in Albania. The rocks are dominated by flysch, a sequence of sedimentary rock formation, and ophiolite belonging to magmatic rock formation.

The nature of the studied rock types

The flysch sequences contain claystone, siltstone, marls, and sandstones with varying degrees of weathering and alterations (Selen and Panthi 2018). The material is best described as very heterogeneous in terms of color and fabric, with sections of intact cores alternating with sections of partly or totally disintegrated rock material (Fig. 1). The heterogeneous nature of the flysch results in a great variation of material properties within meters down to centimeters of the material. In terms of evaluating the locational degradation potential of the rock mass surrounding a tunnel, it is not distinguished between claystone, siltstone, sandstone, marl, or other sub-types of rock material type in this connection.

The ophiolitic rock mass comprehends highly weathered serpentinite. Serpentinite forms as a result of serpentinization of ultramafic rocks by hydration of ferromagnesian silicate minerals during low-temperature metamorphic processes (Moody 1976). The common alteration assemblage produced

by serpentinization is lizardite, chrysotile, and kaolinite, occasionally together with brucite, antigorite, and clay minerals. The material is of moderately disintegrated to lumps of varying sizes, but otherwise apparently homogenous in terms of color and fabric (Fig. 2).

The nature of these two rock types are complex, resulting from their depositional and tectonic history, which means that they cannot easily be classified in terms of widely used rock mass classification systems. Both rock types are categorized as weak and contains clay minerals, which means they are vulnerable to exposure to environmental conditions and weathering.

The selection of samples

Despite of varying material composition, one core meter of rock material is regarded as a sample representing the expected behavior of this rock type at the particular section of the tunnel. Some segments of the sample material are strong and required further preparation to achieve lumps of appropriate shape and sizes. Other segments included splintered and weak material, and preparation of lumps had to be done carefully to not to shatter the whole sample to splinters. Fig. 3a–c illustrates the outcome of the preparation of sample Flysch 8.

The serpentinite material is already disintegrated to lump-sizes at arrival. At some locations, the lumps were too small compared with the preferred sizes for the slake durability test, i.e., less than 40 g. Therefore, lumps with sizes 40–60 g were chosen from one to two core meters at these locations. An overview of all the selected samples and visual characteristics, including heterogeneity, is given in Table 1.

Adopted testing approach

Each sample was divided in two duplicate sets of 10 lumps, whereby one set underwent the standardized ISRM slake durability index test (SDI) and the other set underwent a modified slake durability index test (MSDI). In both tests, 4 cycles



Fig. 2 Serpentinite rock extracted from the borehole drilled parallel to Headrace tunnel at Moglicë HPP

Fig. 3 a. Flysch 8 before preparation b. Prepared material ISRM test c. Prepared material modified test



of wetting and drying/draining were performed aiming to evaluate the long-term slaking behavior of the material tested. The mineralogical composition of all samples was investigated by XRD analysis with aim to link the results with the content of water sensitive material components. At last, particle size distribution analyses were carried out in order to assess the degree of disintegration after both test procedures.

Mineralogical assessment by XRD analysis

The first step in detecting the potential of a rock to degrade and slake is to evaluate the mineralogical composition of the rock itself. X-ray diffraction (XRD) analysis is a method used

in identifying and determining the mineralogical composition of the rock samples. It is common to perform a bulk analysis of the mineralogical content, and then treat the fine-fraction powder of the material with ethylene glycol to detect swelling minerals. Every mineral or compound has a characteristic X-ray diffraction pattern, call it “fingerprint”, which can be matched against a database of over thousands of recorded phases (Dutrow and Clark 2012). Identification and quantification of minerals is carried out by comparing relative peak heights of the crystalline phases. However, weathering may cause a destruction of the crystalline structures of the minerals, seen as amorphous reflections in the X-ray diffraction patterns. Although a semi-quantitative deviation between

Table 1 The tested sample

Sample name	Rock type	Visual characteristics	No. of lumps
Flysch 6	Flysch	Homogeneous, intact, strong.	20
Flysch 7	Flysch	Homogeneous, intact, strong	20
Flysch 8	Flysch	Heterogeneous, schistose, partly disintegrated, weak	20
Flysch 9	Flysch	Heterogeneous, schistose, partly disintegrated, weak	20
Flysch 10	Flysch	Heterogeneous, schistose, partly disintegrated, weak	20
Flysch 11	Flysch	Heterogeneous, schistose, partly disintegrated, weak	20
Serp 5	Serpentine	Homogeneous, disintegrated, moderate strength	20
Serp 6	Serpentine	Homogeneous, disintegrated, moderate strength	20
Serp 7	Serpentine	Homogeneous, disintegrated, moderate strength	20
Serp 8	Serpentine	Homogeneous, disintegrated, moderate strength	20

crystalline and amorphous phases is approximate and questionable (Tijhuis 2018), it reveals valuable information on the variable degree of weathering of the samples.

The XRD analysis was conducted at NTNU with a Bruker D8 ADVANCE. Only crystalline phases were quantified, while a semi-quantitative deviation between crystalline and amorphous phases is performed to indicate the amount of weathered minerals. Identification of crystalline phases is done with DIFFRAC.SUITE.EVA software combined with PDF-4+ database. Quantification of the minerals is done by Rietveld refinement in Topas with an accuracy of 1–2 percent (%). Further, glycolation is used on fraction sizes of < 6 µm to identify swelling clays, but quantification on the amount of swelling minerals based on this method is highly questionable and is not performed. The detected swelling minerals are therefore only indicated as “detected” or “not detected”.

It is assumed that the most moisture sensitive rock components are clay minerals as smectite and kaolinite. In addition, clay-like minerals such as chlorite and mica are susceptible to weathering agents and may transform into clay minerals or intermediate states of these mineral groups (Wilson 2004). To enable a distinction between the different moisture sensitive minerals and their properties, pervasive mineral and swelling analyses must be confirmed. In this study, in terms of defining moisture sensitive rock components in the context of the slake durability assessment, it is not distinguished between clays and clay-like minerals.

The procedure of the ISRM suggested slake durability test

The sample is placed in a clean drum with a standard mesh of 2 mm and dried to a constant weight at 105 °C (A). The drum plus the sample is then put in the slaking container with tap water at 20–25 °C, and the drum is rotated at 20 rpm for 10 min. The drum plus the retained portion of the sample is removed from the container and dried to a constant weight at 105 °C (C₁). The procedure is repeated, and the dry weight C₂ of the drum plus retained portion of the sample is recorded. The dry weight of the drum, D, is then used to calculate the slake-durability index (SDI) of the sample after two cycles of drying and wetting. The slake-durability index (SDI) is the percentage ratio of final to initial dry weights of rock in the drum:

$$SDI_2 = \frac{C_2 - D}{A - D} \times 100 \quad (1)$$

The slake durability test as suggested by ISRM (1979) uses the second cycle as slake durability index (SDI₂) in the assessment of the degradation potential of rocks, which describe the short-term effect of wetting and drying. For long-term evaluations, the cycles can be repeated *i* times to better reflect the

evolution of weathering over time. As suggested by Selen and Panthi (2018), the above formula can be extended to apply for *i* cycles of drying and wetting:

$$SDI_i = \frac{C_i - D}{A - D} \times 100 \quad (2)$$

The number of cycles used in this study is 4, where 2 h of drying between the cycles is chosen of practical reasons as explained previously. Minor amounts of water may be retained after 2 h; therefore, an extended phase of drying is included after the last cycle and before the final calculation of SDI₄.

The procedure of the modified ISRM slake durability test

As a part of the preparation, the sample is placed in a clean glass container and dried in a drying cabinet at 50 °C until no more weight loss, and the initial dry weight of the sample plus the dry drum is recorded (A). The static wetting phase is then performed by leaving the samples in a container filled with tap-water having temperature between 20 and 25 °C for 72 h. Visual signs of disintegration are described and photographed. The wetting phase is not regarded as a part of the slake durability test itself but rather a separate phase after preparation of the lumps and prior to the first cycle.

After the static wetting phase, the sample is gently moved from the glass container to a clean and wetted drum (D (wet)) with a standard mesh of 2 mm. This is performed by placing the drum in a glass container and carefully pouring the sample and water solution into the drum, whereby the portion of the sample > 2 mm is sieved by the drum mesh. Dependent on the rock type, some of the material dissolve and/or disintegrate to less than 2 mm and is therefore removed from the sample before the first slake cycle. This material is dried and recorded for control and further analyses. The wet sample (> 2 mm) and the wetted drum are weighted (A (wet)) for further testing.

The drum containing the sample is put in the slaking container with tap water at 20–25 °C, and the drum is rotated at 20 rpm for 10 min. The drum plus the retained portion of the sample is removed from the container and weighted (C_i (wet)) before a draining phase in a drying cabinet at 30 °C for 24 h. The procedure is repeated *i* times, meaning *i* cycles of wetting, weighting, and draining. After the last cycle, in this case after 4 cycles, the sample is dried in the oven at 50 °C to a constant weight. The dry weight of the drum plus the retained portion of the sample is recorded (C_i). Table 2 summarize the notations used for the weight records used in the calculations.

The calculation of the modified slake durability index (MSDI) is based on the dry weights of the sample prior to the first cycle and after a complete test cycle. The slaking trend during the cycles can be obtained by calculating the slake

trend index (STI) after each cycle; however, the weight records include water to an unknown amount. Three different parameters are possible for evaluations of the wetting effect:

Wetting index, $I_{wetting}$, which describes the material loss < 2 mm during static wetting for 72 h of the sample. The index is calculated based on the dry weight of the material passing through the drum after wetting subtracted from the initial dry weight of the sample ($C_{wetting}$).

$$I_{wetting} = \frac{C_{wetting}-D}{A-D} \times 100 \tag{3}$$

Slaking trend index, STI_i (wet), which describe the evolution of material loss < 2 mm during repetitive cycles of wetting and draining. The index is calculated based on the wet weight of the retained material of cycle i compared with the initial wet weight of the sample after wetting. Since the amount of water in the samples is unknown, the trendline numbers do not reflect the exact material loss.

$$STI_i(wet) = \frac{C_i(wet)-D(wet)}{A(wet)-D(wet)} \times 100 \tag{4}$$

Modified slake durability index, $MSDI_i$, which describe the material loss < 2 mm after i cycles of wetting and draining, whereby the initial state of the samples is saturated. The index is calculated based on the dry weight of the retained material after the last cycle (C_i) compared with the initial dry weight of the sample after wetting (A'). The index is only to be calculated after a complete test procedure of i cycles. The index can be compared with the ISRM slake durability index (SDI_i) when the number of slaking cycles is similar.

$$MSDI_i = \frac{C_i - D}{A' - D} \times 100 \tag{5}$$

By computing the slake trend index (STI_i) after each cycle, one can evaluate the evolution of slaking during the test. The slake trend index after first cycle will indicate the weakening effect of the static wetting phase prior to the mechanical exposure in the rotating drum. The complete trendline during i cycles can further be compared with the trendline of the ISRM test so that any behavior change related to the different initial moisture state of the samples is detected. It should be noted that the slake trend index is calculated by comparing wet weights of the sample prior to and after the cycles, while the modified slake durability index ($MSDI_i$) is calculated based on the dry weights. The slake trend index after the i -th cycle is therefore not directly comparable with the modified slake durability index due to the water content.

Particle size distribution analysis

To enable an assessment of eventual differences in the degree of disintegration in the performed slake durability

tests, a particle size distribution analysis is performed on the samples after the completion of the test procedures. The analysis is performed by sieving both the retained material in the drum (> 2 mm) and the material left in the slaking container (< 2 mm). Sieves with quadratic mesh openings spanning from 62 to 0.063 mm are used, and a cumulative weight % analysis is performed on all samples in both slake durability tests. The particle size analysis enables further assessments on the extent of disintegration of the rock material after the complete slake durability test cycles when this is desired. Similar approaches of disintegration analysis have also been carried out by authors such as Erguler and Shakoor (2009), Gautam and Shakoor (2013), Heidari et al. (2015), and others.

Laboratory test results

XRD results

The mineralogical composition of the all samples prior to slake durability tests is determined. In addition, the composition of the dissolved and disintegrated material < 2 mm during wetting in the modified test is also assessed for the samples where the material loss is higher than 0.5% (samples Flysch 7–11). Only minerals presenting > 2% in at least one sample is accounted for, and the values are rounded up to nearest %.

The main constituents of the flysch samples are quartz, chlorite, calcite, plagioclase, and mica, with smaller amounts of k-feldspar. The composition is varying between the different samples, where high amounts of quartz and plagioclase are related to lower amounts of mica, chlorite and amorphous phases, and vice versa. The deviation between crystalline and amorphous phases is semi-quantitative. The results are given in Table 3.

The mineral constituents of the serpentinite samples were difficult to assess by the XRD analysis, due to highly amorphous diffraction patterns. This means that the

Table 2 Notations used for the weight records in the calculations of the slake durability indices

Object	Notation
Dry drum	D
Wet drum	D (wet)
Dry sample + dry drum	A
Dry sample – material loss wetting + dry drum	A'
Wet sample (initial) + wet drum	A (wet)
Dry material > 2 mm after wetting	$C_{wetting}$
Dry sample + dry drum after cycle i	C_i
Wet sample + wet drum after cycle i	C_i (wet)

Table 3 XRD bulk analysis of flysch samples and serpentinite samples, given in %

	Flysch sample no.						Serp sample no.			
	6	7	8	9	10	11	5	6	7	8
	Semi-quantitative analysis*						Approx. deviation of phases*			
Crystalline phases	77	72	63	60	57	52	43	42	44	42
Amorphous phases	23	28	37	40	43	48	57	58	56	58
Swelling clay**	yes	yes	yes	no	yes	no	yes	no	no	no
	Quantitative analysis of crystalline phases						Approx. quantification of crystalline phases			
Brucite	-	-	-	-	-	-	2	2	1	2
Calcite	19	19	40	21	17	15	-	-	-	-
Chlorite	8	12	23	27	32	30	20	12	26	27
Chrysotile + Lizardite	-	-	-	-	-	-	30	23	42	46
Enstatite/Fosterite	-	-	-	-	-	-	-	7/25	-	-
K-feldspar	3	3	1	2	2	1	-	-	-	-
Kaolinite	-	-	-	-	-	-	29	19	22	18
Magnetite	-	-	-	-	-	-	1	1	4	2
Mica	5	6	7	14	14	20	-	-	-	-
Népouite	-	-	-	-	-	-	9	4	5	6
Plagioclase	17	17	6	11	11	12	-	-	-	-
Pyrope	-	-	-	-	-	-	5	5	-	-
Quartz	48	43	23	25	24	22	-	-	-	-

*Crystalline and amorphous phases are calculated percent-based on the sample as a total

**Corrensite is the only detected mineral with known swelling potential, not quantified

original crystal structures are broken which indicate extensive weathering of the rock material. As a very high percentage of the mineral structures are destroyed, the quantification of even the crystalline phases is approximate (Tijhuis 2018). Based on the experience of the analyst at NTNU, the main crystalline constituents are recognized as chrysotile, lizardite, kaolinite, and nepouite, with smaller amounts of pyrope, brucite, calcite, dolomite, and magnetite. In addition, sample Serp 6 contains enstatite and fosterite. The chrysotile and lizardite diffraction

patterns are overlapping and not distinguished. The only sample where swelling clay is detected is sample Serp 5, with an unknown amount of corrensite. Due to a high degree of weathering/crystal destructions of the samples, the quantification of both crystalline and amorphous phases is approximate. The results are given in Table 3.

The composition of the dissolved and disintegrated material (< 2 mm) sieved after the wetting phase of the modified slake durability test is assessed. Only the samples Flysch 7–11 have a material loss exceeding 0.5%. The

Table 4 XRD analysis of dissolved and disintegrated material < 2 mm during wetting of the flysch samples in the modified test

Sample	Material < 2 mm (%)	Semi-quantitative analysis*			Quantitative analysis of crystalline phases					
		Cryst. phases	Amorph. phases	Swelling clay**	Calcite	Chlorite	K-feldspar	Mica	Plagioclase	Quartz
Flysch 7	1,4	52	48	Yes	2	21	4	15	21	36
Flysch 8	0,8	36	64	Yes	11	32	4	16	6	29
Flysch 9	1,7	42	58	No	9	34	3	19	11	24
Flysch10	1,3	38	62	Yes	7	36	3	16	12	26
Flysch11	0,7	37	63	No	10	21	4	23	13	27

*Crystalline and amorphous phases are calculated percent-based on the sample as a total

**Corrensite is the only detected mineral with known swelling potential in the flysch samples, not quantified

Table 5 ISRM slake durability index results

Sample	Slake Trend Index (SDI _i)				Dry state calculation and classification	
	SDI ₁	SDI ₂	SDI ₃	SDI ₄	SDI ₄ (dried)	Classification*
Flysch 6	99,1	98,6	98,2	97,7	97,6	High
Flysch 7	97,2	95,6	94,8	93,6	93,4	Medium high
Flysch 8	89,1	80,7	75,5	70,9	70,8	Medium
Flysch 9	86,5	71,5	59,7	49,2	48,9	Low
Flysch 10	84,2	74,9	69,9	65,0	64,9	Medium
Flysch 11	87,0	64,6	52,0	43,4	43,3	Low
Serp 5	98,4	97,2	95,9	94,9	93,4	Medium high
Serp 6	97,4	95,4	93,4	92,1	91,8	Medium high
Serp 7	96,9	95,4	94,4	93,4	92,9	Medium high
Serp 8	96,9	93,8	92,3	90,0	89,2	Medium high

*ISRM (1979) defines slake durability (SDI) as follows: 98 – 100 as very high, 95 – 98 as high, 85 – 95 as medium high, 60 – 85 as medium, 30 – 60 as low and < 30 as very low.

main constituents of the material are chlorite, mica, and quartz, where the content of chlorite and mica is slightly higher compared with the sample composition prior to wetting. The results are given in Table 4.

ISRM slake durability index results

The slake trend index (SDI_i) of the ISRM suggested method is calculated after each cycle; whereby, the final calculation of

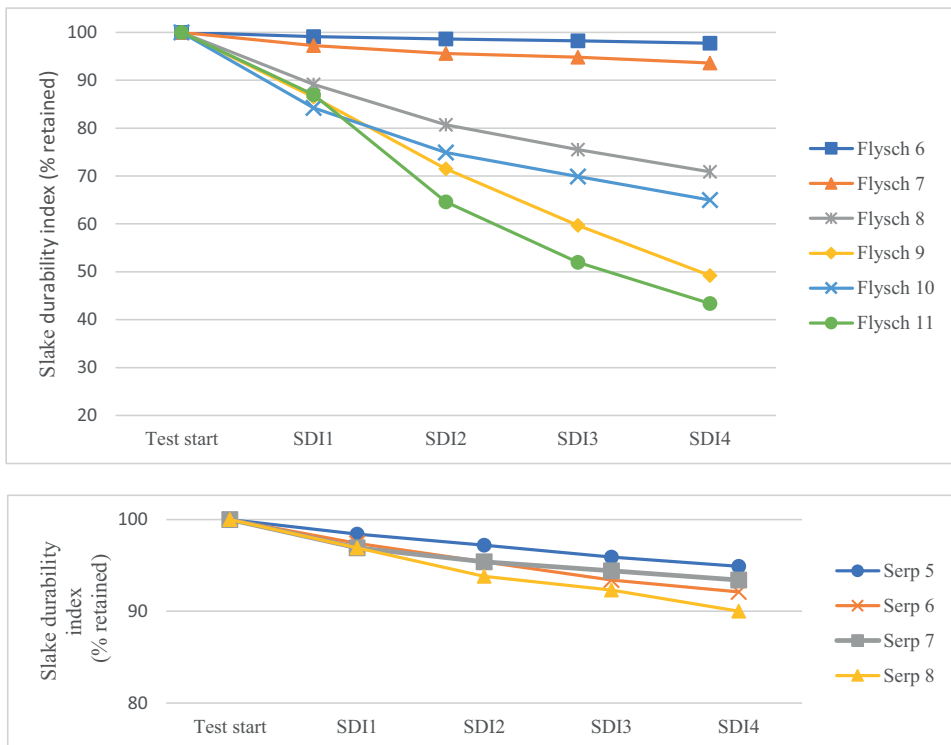

Fig. 4. a. Slaking evolution of the flysch samples in the ISRM test. b. Slaking evolution of the serpentinite samples in the ISRM test

Table 6 Results of the static wetting phase prior to the modified slake durability test

Sample	I_{wetting}	Visual assessment after wetting
Flysch 6	99,0	No disintegration, minor color-changes of water
Flysch 7	98,6	Some disintegration, minor color-changes of water
Flysch 8	99,2	Moderate disintegration, minor color-changes of water
Flysch 9	98,3	Moderate disintegration, minor color-changes of water
Flysch 10	98,7	Heavy disintegration, moderate color-changes of water
Flysch 11	99,3	Heavy disintegration, moderate color-changes of water
Serp 5	99,9	No disintegration, no color-changes of water
Serp 6	99,9	No disintegration, no color-changes of water
Serp 7	99,8	Minor disintegration, no color-changes of water
Serp 8	100,0	No disintegration, no color-changes of water

the slake durability index is performed after an additional phase of drying. The results are given in Table 5.

The slaking evolution during the test is plotted based on the slake durability indices after each cycle, shown in Fig. 4a (flysch samples) and b (serpentinite samples).

Modified ISRM slake durability results

The dissolved and disintegrated material < 2 mm left in the water after the static wetting phase was dried and weighted in

order to calculate the material loss. Based on the material loss, the dry weight of the samples after wetting is calculated, and the wetting index (I_{wetting}) is determined. Visual descriptions of the samples are also recorded. The results are given in Table 6.

The samples Flysch 7, Flysch 9, and Flysch 10 show the highest material loss (< 2 mm) during wetting, while Flysch 6 and the serpentinite samples show minor weight loss. However, the visual assessment reveals appreciable disintegration and changes in the samples Flysch 8–11, some

Fig. 5 Visual signs of disintegration during wetting of the samples Flysch 11 and Serp 7

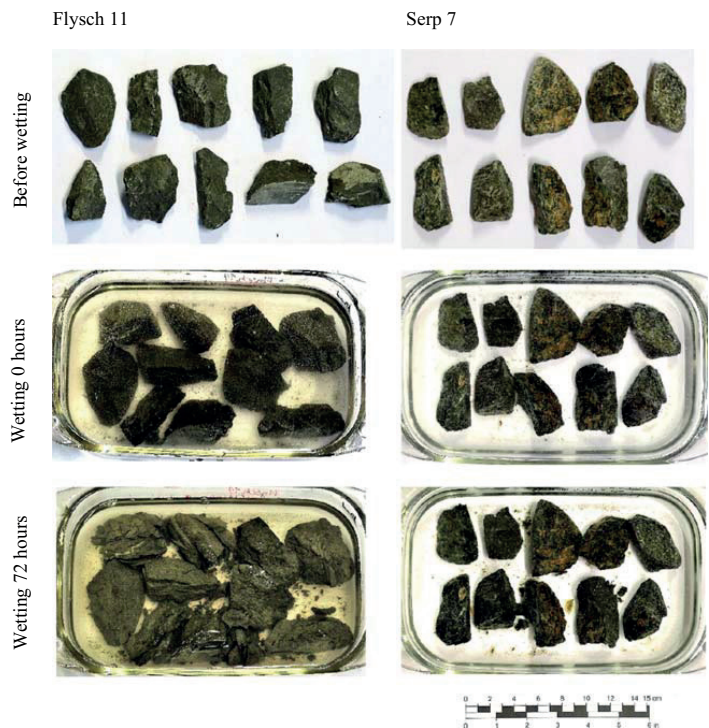

Table 7 Durability indices obtained from the modified slake durability test procedure of 4 cycles

Sample	Wetting $I_{wetting}$	Slake Trend Index (STI _i) (wet)				Dry state calculation and classification	
		STI ₁	STI ₂	STI ₃	STI ₄	MSDI ₄	Classification*
Flysch 6	99,0	98,9	98,3	97,8	97,3	97,8	High
Flysch 7	98,6	95,6	93,5	91,9	90,7	91,9	Medium high
Flysch 8	99,2	77,3	74,6	73,3	71,5	73,4	Medium
Flysch 9	98,3	66,5	54,0	46,9	42,7	43,9	Low
Flysch 10	98,7	66,5	57,0	51,9	49,3	51,2	Low
Flysch 11	99,3	72,7	51,7	39,0	32,1	31,8	Low
Serp 5	99,9	99,0	97,5	96,4	96,1	96,9	High
Serp 6	99,9	97,9	95,8	93,9	91,7	92,2	Medium high
Serp 7	99,8	94,8	91,8	89,8	88,9	90,1	Medium high
Serp 8	100,0	97,9	95,2	93,9	92,4	92,9	Medium high

*ISRM (1979) defines slake durability (SDI) as follows: 98 – 100 as very high, 95 – 98 as high, 85 – 95 as medium high, 60 – 85 as medium, 30 – 60 as low and < 30 as very low.

changes of Flysch 7 and Serp 7, and little or no changes in Flysch 6, Serp 5, Serp 6, and Serp 8. The visual changes during wetting are exemplified in Fig. 5, by the photos of Flysch 11 and Serp 7.

After the wetting phase, the samples underwent the modified slake durability test. The results include all the durability indices obtained from the testing procedure, whereby the modified slake durability index (MSDI) is the parameter describing the slaking potential based on the dry weight loss of the samples during cyclic wetting and draining (Table 7). It is reminded that the STI and MSDI are calculated based on two different moisture states of the samples, explaining why the MSDI₄ show slightly higher values compared with the STI₄ for some of the samples.

Based on the slake trend indices calculated after each cycle (wet state), the slaking evolution can be assessed (Figs. 6 and 7)

Particle size distribution curves

After the last cycle, each sample is sieved in aiming to analyze the actual disintegration. Particle size distribution curves are obtained by plotting the cumulative weight of each fraction of the sample passing the respective sieves, with mesh openings spanning from 62 to 0.063 mm. The results are illustrated in Fig. 8 a (flysch samples) and b (serpentine samples).

Overall analyses

The effect of initial wetting on the slake durability index

A detailed assessment on loss of durability due to initial wetting is performed by comparing the slake durability indices, where the initial state before the tests is dry (SDI of the ISRM

Fig. 6 Slaking evolution of the flysch samples in the modified test

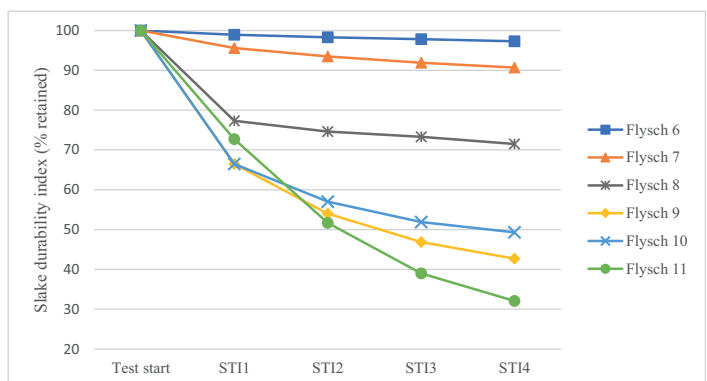
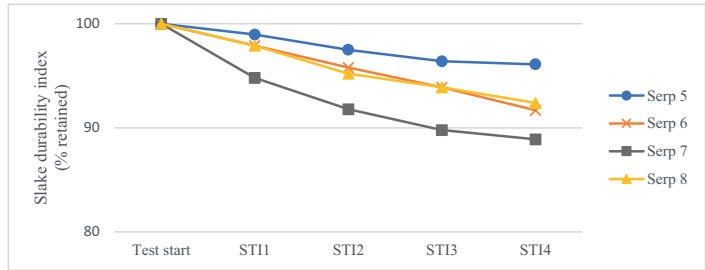

Fig. 7 Slaking evolution of the serpentinite samples in the modified test



test) and wet (MSDI of the modified test). Abundant differences in slaking behavior are observed during the first cycle of the two test procedures, illustrated in Fig. 9. It should be noted that the slake durability indices obtained after the first cycle may not be directly comparable due to different moisture content, still, the obtained values demonstrates a tendency of relative disintegration. The samples Flysch 8–11 show extremely reduced resistance to the mechanical impact imposed by the rotation of the drum, while the other samples show minor

deviating results when comparing the two test methodologies. This indicate that the samples have different material properties and vulnerability to changes in moisture content in terms of water-weakening effects due to saturation.

The slake durability indices after 4 cycles, calculated based on dry weights, can be compared directly (Fig. 10). The samples Flysch 8–11 show the lowest durability in both test procedures, while Flysch 6–7 and the serpentinite samples show relatively high durability. The

Fig. 8. a. Particle size distribution of flysch samples. b. Particle size distribution of serpentinite samples

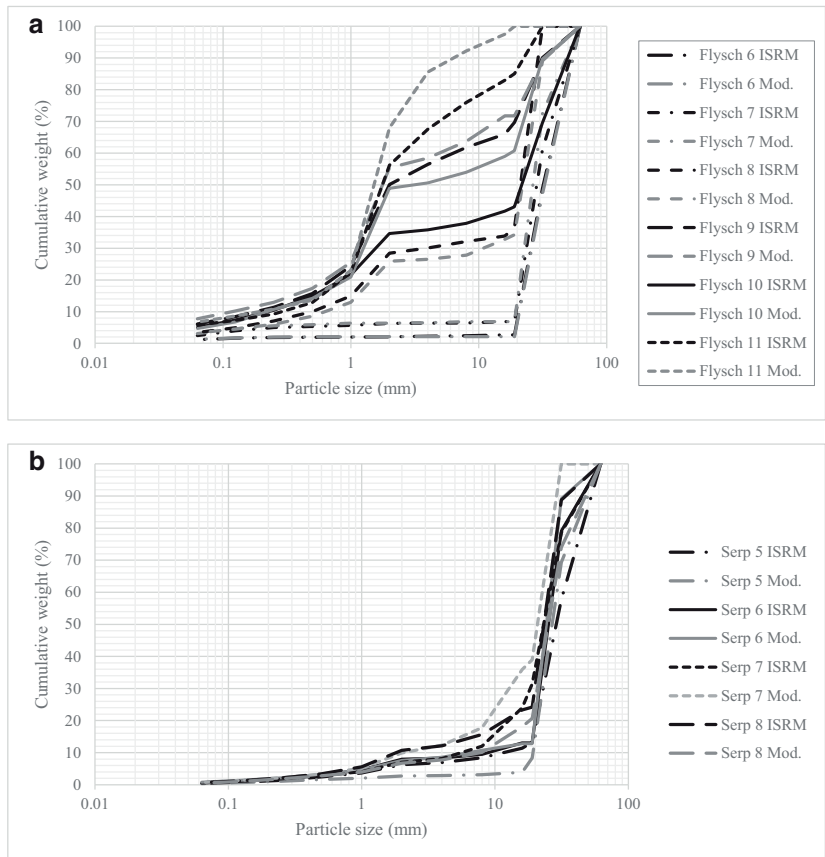
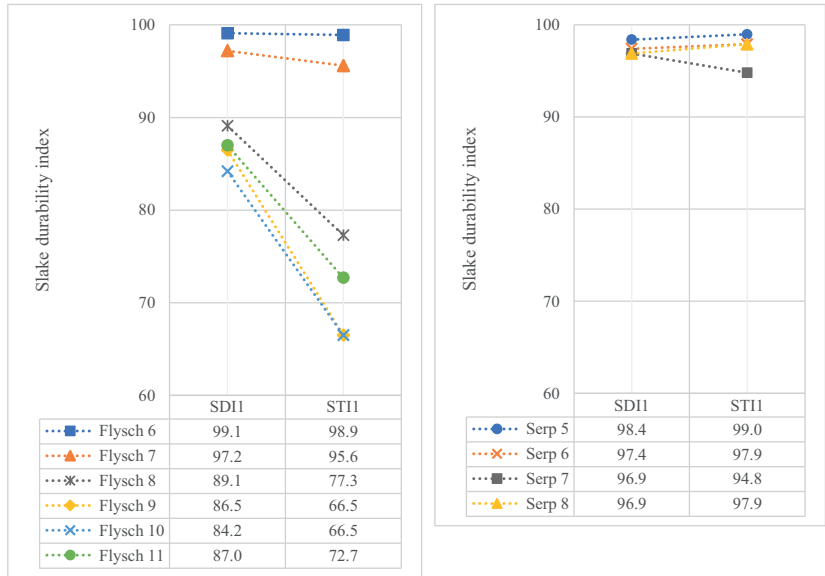

Fig. 9 Comparison of the slaking behavior after the first cycle of flysch samples (left) and serpentinite samples (right)



water-weakening effect of the initial wetting on repeated slaking cycles is prominent in Flysch 9–11 and virtually absent in Flysch 6–7 and the serpentinite samples. A comparison of the slake durability indices of the ISRM method and the modified method is shown in Fig. 10.

The slake durability index and actual disintegration

Although the slake durability index is an indicative material parameter on disintegration, it may fail to detect the disintegration behavior of rock materials where at least one diameter

Fig. 10 Slake durability indices after 4 cycles of flysch samples (left) and serpentinite samples (right)

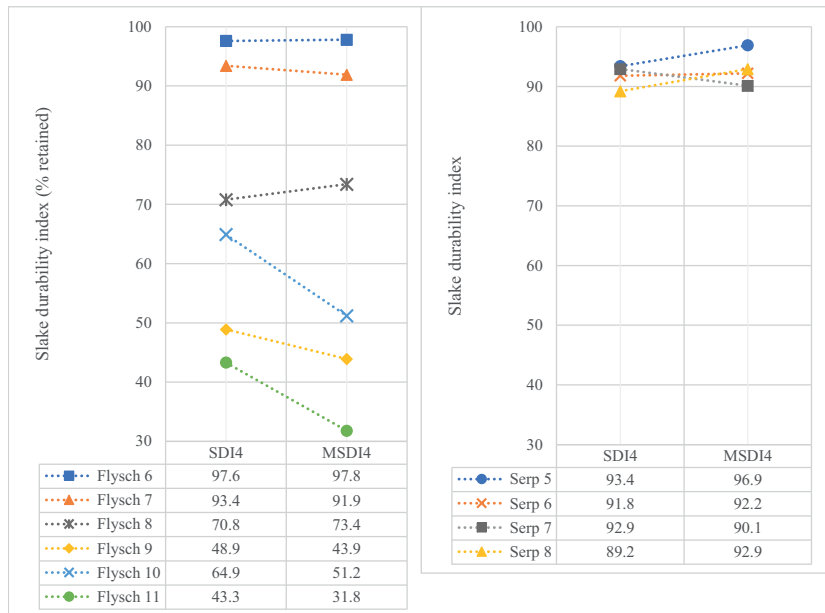

Table 8 Comparison of slake durability indices and weight % of particles disintegrated to <16 mm and < 4 mm

Sample	Slake durability indices		Weight % < 16 mm		Weight % < 4 mm	
	SDI ₄	MSDI ₄	ISRM	Mod.	ISRM	Mod.
Flysch 6	97,6	97,8	2,6	2,1	2,3	2,1
Flysch 7	93,4	91,9	6,8	6,9	6,3	6,5
Flysch 8	70,8	73,4	33,8	32,8	30,1	26,5
Flysch 9	48,9	43,9	66,0	71,8	56,4	58,4
Flysch10	64,9	51,2	41,7	59,0	35,8	50,6
Flysch11	43,3	31,8	83,0	97,5	67,5	85,6
Serp 5	93,4	96,9	11,4	3,9	6,9	2,9
Serp 6	91,8	92,2	13,1	12,8	8,3	8,6
Serp 7	92,9	90,1	24,0	35,9	8,2	12,3
Serp 8	89,2	92,9	23,3	18,1	12,2	7,7

of the disintegrated particles exceeds 2 mm. Even at high slake durability indices, major size and mass reductions of the lumps can be the case. A comparison of the slake durability index and the cumulative weights of particle sizes > 2 mm capture this feature. Table 8 show a comparison the slake durability indices and weight % of particles < 16 mm and < 4 mm after the tests.

A fair correspondence between slake durability indices and disintegration require a low weight % of fractions less than the initial diameter of the samples (~ 40 mm) for high slake durability index values. For the samples Flysch 6 and Flysch 7, both the slake durability indices correspond fairly to the weight % of material less than 16 mm and 4 mm, meaning that the low actual disintegration is the reflection on the high slake durability index.

In the case of sample Flysch 8, the slake durability indices are $SDI_4 = 70.8$ and $MSDI_4 = 73.4$, i.e., medium slaking. However, the disintegration is quite extensive compared with the slake durability index, with 32.8–33.8 % of the grains being less than 16 mm and 26.5–30.1 % of the grain less than 4 mm in the modified test and ISRM test, respectively.

For the samples Flysch 9–11, the slake durability indices indicate low durability (< 60). However, based on the weight % of the particles passing through the 16 mm and 4 mm sieves, the slake durability indices are relatively high compared with the actual disintegration of the rock material. Flysch 11 show the most extensive disintegration whereby most of the particles of the retained material pass the 16 mm sieve (83.0% in the ISRM-test-and 97.5% in the modified test) and the 4 mm sieve (67.5 % in the ISRM test and 85.6 % in the modified test). In addition, the grains are splintered, a factor contributing to misleading results even after the grain size analyses due to the quadratic openings of the sieves (Fig. 11).

The limited correspondence between the slake durability index and actual disintegration is obvious for some of the samples and may cause underestimated disintegration

potentials. For example, the serpentinite samples and Flysch 7 achieve similar slaking indices, but the disintegration behavior is considerably different when the material is assessed by visual inspection. The deviating disintegration behavior despite quite similar slake durability indices is illustrated in Fig. 12.

The effect of material composition on the slake durability indices

The sensitive components (i.e., the clay/clay-like minerals) and the slake durability indices of all samples were calculated and compared (Fig. 13) in order to detect eventual patterns in rock material composition and water-weakening effects. A general trend is that an increasing degree of weathering,

**Fig. 11** Splintered material of Flysch 11 after the ISRM slake test

Fig. 12 Samples showing similar slake durability indices but different disintegration behavior



indicated by high estimates of clay and clay-like mineral content (left axis), result in a lower slake durabilities (right axis). The lower slake durability indices in the modified test is pronounced in the flysch samples where the clay content exceeds 20% (samples Flysch 9–11).

A similar analysis was performed with respect to the actual disintegration, whereby the cumulative weight of particles passing through the 16-mm sieve is used to exemplify this trend (Fig. 14). An increasing content of clay and clay-like minerals correlates with increased disintegration and larger span between the ISRM test results and modified test results.

Discussions

The slake durability index as support design parameter

The ISRM slake durability test is useful as a general comparison of the slaking properties of different rock types. In terms of support design of a tunnel, however, it is crucial to obtain material parameters based on assessment obtained as close to the environmental conditions of the actual project as possible. As Franklin and Chandra already mentioned in 1972, other mechanisms than simple drying and wetting may have

Fig. 13 Correlation between the content of clay or clay-like minerals and slake durability indices

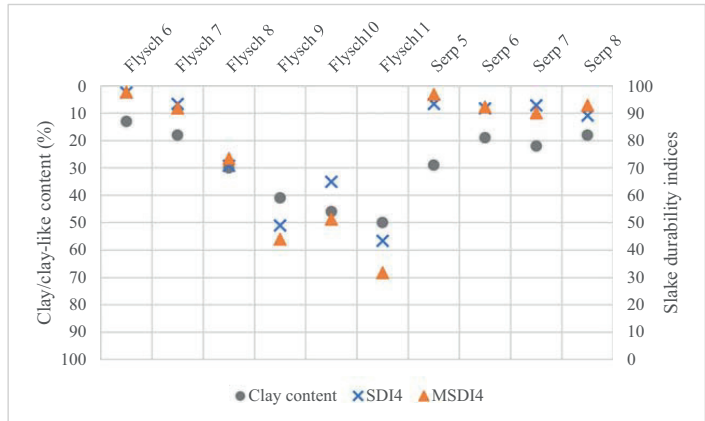

considerable effect on the deterioration of geologically weathered rocks if the environment is particularly severe.

In general, rock mass classification systems for engineering purposes combine findings from observation, experience and engineering judgment to provide a quantitative assessment of rock mass quality (Williams 1997). These can be used either to simply characterize rock properties and thereby facilitate the application of information into a design or relate findings to the determination of actual design parameters. For a classification system to be successful, the parameters must be relevant to their application, especially if the findings are to be related to the determination of actual design parameters.

The rock mass surrounding an underground opening will, dependent on the construction method, be disturbed and degraded already during the construction phase of the project. In terms of stability assessments of a tunnel traversing a heterogeneous and disturbed rock mass, the behavioral characterization of the material at a defined location is considered as more helpful than general parameters of a specific rock type.

Further, eventual changed behavior resulting from the exposure to degrading agents such as water in water tunnels during operation is crucial information for the support design analysis.

The duration of 10 min in the slake durability test exposes the rock samples to a limited wetting phase, where the saturation degree of the lumps is variable and uncertain. As a result, only an unknown % of the rock material is saturated and exposed to the slaking effect. The modified slake durability index (MSDI) test aims to bridge this gap and to specify the environmental effects on the slaking properties of rocks in water tunnels for hydropower projects, without significantly reducing the simplicity and comparability of the established ISRM procedure. Firstly, the slaking properties of the material constituting a defined location are assessed rather than the properties of a single rock type. This enable an evaluation of heterogeneous and disturbed rock mass where the material properties may change within very short distances. Secondly, by introducing the samples to an extensive wetting

Fig. 14 Correlation between the content of clay or clay-like minerals and disintegration

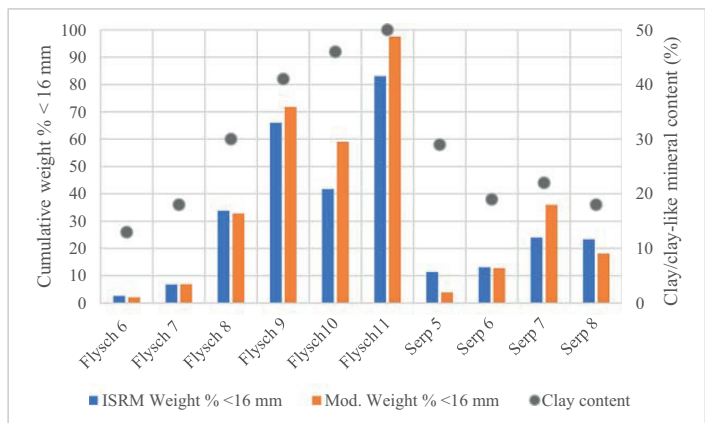

phase prior to the test, the slaking effect of moisture changes is assessed closer to the in-situ condition of water tunnels. Thirdly, the rock material is not exposed to artificially high temperatures or dehydration states during the test, which potentially can change the material behavior. In addition, the method allows a separation between the effect of static wetting and mechanical abrasion, which opens up a possibility for an early assessment of the moisture sensitivity of the tested material.

Discussion on the slake durability parameters in the modified test

Three slake durability parameters are obtained in the modified test; the wetting index (I_{wetting}), the slake trend index (STI_i), and the modified slake durability index ($MSDI_i$).

The wetting index in combination with visual characterization intend to indicate the resistance of the material to dissolution and disintegration due to static wetting and may function as a first-hand determination on the moisture sensitivity of the rock material. By visually comparing the lumps before and after the wetting phase, one can qualitatively assess the rock material (Fig. 5). By comparing the color of the water, eventual structural changes and disintegration of the lumps, a first prediction of the water sensitivity can be made already at this stage. By examining the dissolved and disintegrated material by XRD, one can also indicate which components of the material are more sensitive to the water exposure. Based on the calculation procedure of the slake durability index generalized in both the ISRM procedure and the modified procedure, the wetting index is computed from the weight of retained material after sieving the material passed through 2-mm mesh of the drum. As shown in Table 6, the wetting index is very high for all samples. However, some of the lumps disintegrates heavily during wetting into rock pieces > 2 mm, such as sample Flysch 11 (Fig. 11). Similar as for the slake durability index, the variation between the samples in regard of the actual disintegration behavior during wetting is not reflected in the weight records, since the calculations are based on the weight of particles less and larger than 2 mm only. This weakness is connected to the calculation procedure rather than the test procedure itself and can be solved by descriptions and/or photographs of the retained material. A first-hand determination on the water-weakening effect can therefore be made at this stage, but the wetting index should be evaluated together with visual observations of the material. If the samples show heavy disintegration due to the static wetting phase, an analysis procedure and classification system as suggested by authors describing static slaking tests can be chosen, and the test can be closed already at this stage.

The slake trend index intends to produce values to evaluate the evolution of slaking during repeated cycles of changed moisture conditions. This enables an evaluation of the water-

weakening effect on the samples when they are introduced to minor mechanical forces, and an assessment of the slaking progress due to repeated cycles. The slake trend indices in the modified test are calculated when the samples are partly saturated by water and cannot be compared with the slake trend indices of the ISRM procedure directly. However, the trends may be compared in order to uncover eventual changes in slaking behavior due to the initial moisture state. In cases where the STI is low after one or few cycles, the test can easily be closed by drying the retained material and calculate the slake durability index. This is recommended in cases where time saving is crucial and where the durability is obviously lower than a specified support design limit.

The modified slake durability index intends to quantify the slake durability of samples exposed to an extensive wetting phase prior to cycles of changed moisture content under stable temperatures. The index is calculated after drying the retained material at 50 °C until no more weight loss and is therefore also comparable with the ISRM slake durability index. The index and its precedent procedure are recommended in cases where abundant water exposure is natural in terms of project type, as in hydropower.

Comparison of the slake durability indices in the two procedures

In order to assess eventual differences in slaking behavior of saturated rocks compared with dry rocks, the modified test has the same framework and follows similar standardized steps as the ISRM suggested method, and both procedures are performed on similar samples. This enable a comparison of the slake durability indices, whereby the main deviating test conditions are the initial moisture state of the samples and the temperature exerted on the rock material during the test.

The wetting phase in the modified test revealed a significantly lowered slake durability of some samples compared with the ISRM test, which is very useful information for the water tunnels. The effect is varying between the samples tested, where the heterogeneous flysch samples are extensively affected compared with the homogeneous samples. The homogeneous samples did not show noteworthy different slaking behavior in the two test procedures. This deviation seems to be somehow connected to an increasing content of clay minerals, which may again be linked to the initial degree of weathering. Other factors may also contribute, as fabric, structure, strength, and initial micro-fracturing of the material. The samples in which the water sensitivity is revealed during passive wetting, are similar samples which show a lowered slake durability in the modified test. The lowered durability due to initial saturation is most prominent in the first cycle of the test, when minor mechanical forces are introduced due to collision of the lumps (Fig. 9). This water-weakening

effect is apparently connected to the structure and composition of the samples, and most likely also to the dry strength of the rock material. To verify this, analyses such as strength tests, microscopy, and SEM-analyses are recommended for further research.

As some rocks are more sensitive to moisture changes than others, the modified test is assumed to reflect the degradation potential more efficiently than a test carried out on dehydrated samples as suggested by ISRM (1979). With the proposed modified test, the boundary conditions are closer to the in situ environment of the rock close to the periphery of a water tunnel, which in turn produce more reliable estimates on the behavior to be expected. It is possible to close the test after fewer cycles than of this research, if the samples show an extensive slaking behavior exceeding the support design limit. In order to obtain an index value on moisture sensitivity and slaking behavior, the modified test seems to uncover these features more efficiently than the ISRM suggested method.

Disintegration analysis as a part of the slake durability assessment

The practical value of a database with slake durability results of different rock types is significantly reduced if no other disintegration parameters are obtained. The weight % of material fractions spanning from > 2 mm up to the initial lump diameters can be used to assess the linkage between the calculated slake durability indices and actual disintegration of the retained material. Such analyses enable further disintegration parameters to be evaluated if found necessary, based on the purpose of the durability assessment. For example, the retained fragments may be categorized by a disintegration ratio (D_R) analysis as suggested by Erguler and Shakoor (2009) or other similar categorization systems. For a complete overview of the disintegration behavior, the material passing the 2-mm mesh of the drum can be included in the disintegration analysis.

As performed in this research, a particle size distribution analysis uncovers noticeable differences between the disintegration behavior of the rock types tested compared with the slake durability indices obtained. The materials which disintegrates the most (Fig. 8a, b) are also the samples that show degradation at the wetting stage of the modified test (Table 6). These samples disintegrate more when exposed to the modified slake durability test procedure compared with the ISRM procedure, which may be connected to the content of clay (Fig. 14). The methodology of integrating the disintegration analysis into the slake durability assessment should be adjusted to the purpose of the analysis, as support design or similar motives.

Conclusion

A modified slake durability test has been developed for use in behavioral assessment of weak rocks in hydropower water tunnels. The test is time-efficient, semi-quantitative, reproducible, and seem quite promising. Weathering behavior and the influence of water saturation in slake durability tests can be detected using this method, and the material response to cyclic moisture changes under conditions similar as the in situ condition can be evaluated.

The general pattern is, for rock materials composited of moisture sensitive minerals, that the water-weakening effect of saturation is prominent both in a short-term and long-term perspective. The total degradation of weak rocks is higher in a saturated condition compared with an initial dehydrated state when exposed to repeated cycles of changed moisture conditions. These findings are important to keep in mind when evaluating the durability of rocks in an environment where the exposure to water is abundant for a longer period.

Predicting the durability of weak rock materials on the basis of a few index tests is a difficult task, and the modified slake durability test described herein is not intended to replace the ISRM standardized slake durability index test, rather it intends to improve the methodology so that test results reflect more to the environment that prevails in the water tunnel. This is the reason for keeping the framework and test principles of the modified test similar to the ISRM test. The method can be regarded as an informative alternative when evaluating the durability of weak rocks surrounding a water tunnel for hydropower or similar projects where rock mass is continuously exposed to water. The methodology presented in this paper provides insights to evaluate the effect of saturation on the degradation potential of rocks exposed to heavy moisture changes and flowing water, and helps to understand the extent of rock support required in water tunnels passing through weak rock mass conditions.

Acknowledgements This research is a part of large research initiative in Norway in the field of renewable energy called FME HydroCen (the Norwegian Research Centre for Hydropower Technology) at the Norwegian University of Science and Technology (NTNU). The authors are thankful to Statkraft (one of the industrial partners of FME HydroCen) for providing necessary financial and technical support needed in coring the rock samples and transportation from Moglice Hydropower Project in Albania to NTNU. The authors are also thankful to the Norwegian Research Council (NFR) who financially supports FME HydroCen. The authors would like to express their gratitude to Dr. Laurentius Tjihuis at NTNU mineralogy lab for his support in carrying out mineralogical tests, Mr. Thomas Schönborn and Dr. Siri Stokseth from Statkraft and Ms. Hege Brende from HydroCen for their encouragement and consistent support. It is acknowledged that the need for modification in ISRM suggested method for slake durability test was visualized and proposed by Professor Krishna Kanta Panthi who has over 26 years of research, design and construction experience of unlined/shotcrete lined water tunnels for hydropower projects.

Open Access This article is distributed under the terms of the Creative Commons Attribution 4.0 International License (<http://creativecommons.org/licenses/by/4.0/>), which permits unrestricted use, distribution, and reproduction in any medium, provided you give appropriate credit to the original author(s) and the source, provide a link to the Creative Commons license, and indicate if changes were made.

References

- Bauer SJ, Friedman M, Handin J (1981) Effects of water-saturation on strength and ductility of three igneous rocks at effective pressures to 50 MPa and temperatures to partial melting. Technical Report, Texas A and M Univ., College Station (USA), Center for Tectonophysics. <https://doi.org/10.2172/6381419>
- Cano M, Tomás R, Riquelme A (2017) Relationship between monitored natural slaking behaviour, field degradation behaviour and slake durability test of Marly Flysch rocks: preliminary results. *Procedia Eng* 191:609–617
- Chugh YP, Missavage RA (1981) Effects of moisture on strata control in coal mines. *Eng Geol* 17(4):241–255
- Czerewko MA, Cripps JC (2001) Assessing the durability of mudrocks using the modified jar slake index test. *Q J Eng Geol Hydrogeol* 34(2):153–163
- Czerewko MA, Cripps JC (2006) The implications of diagenetic history and weathering on the engineering behaviour of mudrocks. International Association for Engineering Geology and the Environment, 2006 Conference Proceedings 118: 1–12
- Deo P (1972) Shales as Embankment Materials. Publication FHWA/IN/JHRP-72/45, Joint Highway Research Project, Indiana Department of Transportation and Purdue University, West Lafayette, Indiana. doi <https://doi.org/10.5703/1288284314547>
- Dick JC, Shakoor A (1992) Lithological controls of mudrock durability. *Q J Eng Geol Hydrogeol* 25(1):31–46
- Dick JC, Shakoor A, Wells N (1994) A geological approach toward developing a mudrock-durability classification system. *Can Geotech J* 31(1):17–27
- Dutrow BL, Clark CM (2012) X-ray powder diffraction (XRD). Geochemical Instrumentation and Analysis. https://serc.carleton.edu/research_education/geochemsheets/techniques/XRD.html. Accessed 15 November 2019
- Erguler ZA, Shakoor A (2009) Quantification of fragment size distribution of clay-bearing rocks after slake durability testing. *Environ Eng Geosci* 15(2):81–89
- Erguler ZA, Ulusay R (2009) Assessment of physical disintegration characteristics of clay-bearing rocks: Disintegration index test and a new durability classification chart. *Eng Geol* 105(1–2):11–19
- Franklin JA, Chandra R (1972) The slake-durability test. In: International Journal of Rock Mechanics and Mining Sciences & Geomechanics Abstracts, 9(3)325–328
- Gautam TP, Shakoor A (2013) Slaking behavior of clay-bearing rocks during a one-year exposure to natural climatic conditions. *Eng Geol* 166:17–25
- Goodman RE, Shi G, Boyle W (1982) Calculation of support for hard, jointed rock using the keyblock principle. American Rock Mechanics Association, The 23rd U.S Symposium on Rock Mechanics (USRMS), 25–27
- Heidari M, Rafiei B, Mohebbi Y (2015) Torabi-Kaveh M (2015) Assessing the behavior of clay-bearing rocks using static and dynamic slaking indices. *Geotech Geol Eng* 33:1017–1030. <https://doi.org/10.1007/s10706-015-9884-6>
- Hu M, Liu Y, Ren J, Zhang Y, Wu R (2017) Temperature-induced deterioration mechanisms in mudstone during dry–wet cycles. *Geotech Geol Eng* 35(6):2965–2962
- Hudec PP (1982) Statistical analysis of shale durability factors. *Transp Res Rec* 873:28–35
- ISRM (1979) Suggested methods for determining water content, porosity, density, absorption and related properties and swelling and slake-durability index properties: Part 1: suggested methods for determining water content, porosity, density, absorption and related properties. *Int J Rock Mech Min Sci Geomech Abstr* 16(2):143–151
- Karakul H, Ulusay R (2013) Empirical correlations for predicting strength properties of rocks from P-wave velocity under different degrees of saturation. *Rock Mech Rock Eng* 46(5):981–999
- Koncagül EC, Santi PM (1999) Predicting the unconfined compressive strength of the Breathitt shale using slake durability, Shore hardness and rock structural properties. *Int J Rock Mech Min Sci* 36(2):139–153
- Molinda GM, Oyler DC, Gurgunli H (2006) Identifying moisture sensitive roof rocks in coal mines. Proceedings of the 25th international conference on ground control in mining, West Virginia University, p 57–64
- Moody JB (1976) Serpentinization: a review. *Lithos* 9(2):125–138
- Nickmann M, Spaun G, Thuro K (2006) Engineering geological classification of weak rocks. In: Proceedings of the 10th International IAEG Congress: 492, 1–9 p
- Okamoto T (1993) Testing methods of indurated soils and soft rocks—suggestions and recommendations. In: Technical committee on indurated soils and soft rocks, Intern. society for Soil Mechanics and Foundation Engineering
- Olivier HJ (1991) Some aspects of the engineering geological properties of swelling and slaking mudrocks. In: 6th International IAEG Congress: 285, pp 707–712, 6 p. [https://doi.org/10.1016/0148-9062\(91\)90244-G](https://doi.org/10.1016/0148-9062(91)90244-G)
- Panhi KK (2006) Analysis of engineering geological uncertainties related to tunnelling in Himalayan rock mass conditions. PhD thesis, NTNU, Trondheim, Norway
- Rincon O, Shakoor A, Ocampo M (2016) Investigating the reliability of H/V spectral ratio and image entropy for quantifying the degree of disintegration of weak rocks. *Eng Geol* 207:115–128
- Russell D (1982) Controls on shale durability: the response of two Ordovician shales in the slake durability test. *Can Geotech J* 19(1): 1–13
- Sadisun IA, Shimada H, Ichinose M, Matsui, K (2002) Improved procedures for evaluating physical deterioration of argillaceous rocks. In: Proc. 2nd Intl. Conf. on New Development in Rock Mech. and Rock Eng, p 36–39. <https://doi.org/10.13140/2.1.3499.8400>
- Santi PM, Doyle BC, Shakoor A (1997) The locations and engineering characteristics of weak rock in the US. Association of Engineering Geologist, Denver, Special Publication No 9: 1–22
- Selen L, Panhi KK (2018) Influence of slaking and disintegration effect on the stability of water tunnels for hydropower. In: ARMS10 10th Asian Rock Mechanics Symposium The ISRM International Symposium for 2018, 29 Oct–3 Nov, Singapore-proceedings, 1–9
- Taylor R (1988) Coal Measures mudrocks: composition, classification and weathering processes. *Q J Eng Geol Hydrogeol* 21(1):85–99
- Tijhuis L (2018) Personal communication during laboratory work. NTNU 2018
- Vergara MR, Triantafyllidis T (2016) Influence of water content on the mechanical properties of an argillaceous swelling rock. *Rock Mech Rock Eng* 49(7):2555–2568
- Vivoda Prodan M, Arbanas Ž (2016) Weathering influence on properties of siltstones from Istria, Croatia. *Proc. Adv Mater Sci Eng*:3073202 15 p
- Williams O (1997) Engineering and design-tunnels and shafts in rock. US Army Corps of Engineers, Washington, DC, pp 20314–21000
- Wilson M (2004) Weathering of the primary rock-forming minerals: processes, products and rates. *Clay Miner* 39(3):233–266
- Wong LNY, Maruvanchery V, Liu G (2016) Water effects on rock strength and stiffness degradation. *Acta Geotech* 11(4):713–737

Paper II

Title:

An investigation on the compositional features and swelling potential of two weak rock types affecting their slake durability

Authors:

Lena Selen

Krishna Kanta Panthi

Mai Britt Mørk

Bjørn Eske Sørensen

Submitted to:

Geotechnical and Geological Engineering (submitted 04.08.2020)

This paper is awaiting publication and is not included in NTNU Open

Paper III

Title:

Investigation on the effect of cyclic moisture change on rock swelling in hydropower water tunnels

Authors:

Lena Selen

Krishna Kanta Panthi

Maximiliano Vergara

Mai Britt Mørk

Published in:

Rock Mechanics and Rock Engineering (online 10.10.2020)



Investigation on the Effect of Cyclic Moisture Change on Rock Swelling in Hydropower Water Tunnels

Lena Selen¹ · Krishna Kanta Panthi¹ · Maximiliano R. Vergara^{2,3} · Mai Britt Mørk¹

Received: 15 May 2020 / Accepted: 29 September 2020
© The Author(s) 2020

Keywords Rock swelling · Cyclic moisture change · Oedometer test · Water tunnel · Rock texture

1 Introduction

Swelling of rocks is often forecasted by the content of swelling clay minerals or anhydrite; however, the intensity of the expansion and subsequent swelling pressure cannot be attributed only to these rock constituents (Ruedrich et al. 2010). Rocks show a wide range of grain sizes, porosities and fabrics which can act as controlling factors on the swelling behavior upon ingress of water (Russell 1982; Olivier 1991; Dick and Shakoor 1992). In addition, the interaction between the rock material properties and the construction-specific exposure to degrading agents controls important swelling characteristics of the weak and weathered rock mass. The surrounding rock mass on the periphery of hydropower water tunnels is unloaded and drained during tunnel construction and then the tunnel is exposed to cyclic wetting and drying processes during the operational lifetime of the project (Selen et al. 2019). This may lead to time-dependent changes in the rock mass properties aggravating risk on tunnel instability. Hence, the extensive moisture fluctuations are special features of hydropower water tunnels compared to other tunneling projects which seldom are addressed in laboratory testing procedures.

Several laboratory testing methodologies have been developed to determine the swelling behavior of rocks and the induced pressure from the rocks on their surroundings, as

tunnel linings. According to Grob (1972), the swelling strain can be expressed as a function of the swelling pressure and is expressed as a linear relationship in a semi-logarithmic diagram. The so-called “Grob’s law” can be assessed by use of oedometer tests and assumes that the material behaves linear elastically and increases in volume as the applied stresses decrease (Einstein 1994). ISRM (1989, 1999, 1979) has suggested different oedometer swelling tests, including a maximum swelling pressure test. The test measures the maximum pressure induced by a prepared rock disk after water immersion when volume expansion is hindered. However, the long-term swelling characteristics of a weathered rock mass surrounding a water tunnel may not be addressed using this method due to the intricate interaction between the rock properties and the cyclic moisture change during operation.

This manuscript investigates the interaction between cyclic wetting and drying, material composition/structure and swelling potential of weathered rocks. Laboratory tests were performed at the Norwegian University of Sciences and Technology (NTNU) and the Karlsruhe Institute of Technology (KIT). The rocks tested are of sedimentary and volcanic origin and were sampled from the headrace tunnels of two different hydropower projects located in Albania and the Philippines. Both headrace tunnels will experience a medium static water head of about 60 m at a base load of operation. However, hydropower plants of modern age are seldom operated to their base load due to power demand in the market, which causes fluctuation in the operation regime of the power plants. To determine the effect of moisture fluctuations on the swelling behavior of weathered rocks surrounding water tunnels, repeated wetting and drying cycles of swelling tests were performed on intact rock samples. The effect of unloading and thus allowing stagewise deformation to occur, as is the case in rock mass of shotcrete supported water tunnels, was comprehended in the

✉ Lena Selen
lena.selen@ntnu.no

¹ Department of Geosciences and Petroleum, Norwegian University of Science and Technology (NTNU), Trondheim, Norway

² Tunnel Engineering, Ed. Züblin AG-Zentrale Technik, Stuttgart, Germany

³ Institute of Soil Mechanics and Rock Mechanics, Karlsruhe Institute of Technology (KIT), Karlsruhe, Germany

testing procedure. Maximum swelling pressure tests on both pulverized and intact rock samples were included in the testing program. A comparison of the swelling test results is presented and correlated to the compositional and structural characteristics of each sample obtained by XRD and thin-section analyses. Finally, the effect of cyclic moisture change on the rock swelling is discussed in the context of long-term stability and support assessment of hydropower water tunnels.

2 Brief on the Tested Rocks and Test Methods

An overview of the testing and analyses carried out is given in Table 1. An assessment of the mineralogical composition and textural features was performed on all samples using XRD and thin-section analyses. Maximum swelling pressure tests on intact rock specimen and on samples made of compacted rock powder were obtained, whereby the intact specimen additionally underwent cyclic wetting–drying tests with controlled deformation.

2.1 Tested Rocks

A total of 14 samples were chosen for laboratory testing; 7 flysch rock samples from Albania and 7 volcanic rock samples from the Philippines (Table 2). Intact rock specimens for the oedometer swelling tests and thin-section analysis were prepared from the samples which did withstand the preparation, i.e., all volcanic and three flysch rock samples. Powder swelling tests were performed on all 14 rock samples (Fig. 1). All the prepared samples have a diameter of about 60 mm.

2.2 Mineralogical Investigation by XRD

X-ray diffraction (XRD) analysis is carried out to identify and determine the mineralogical composition of the tested rock samples by comparing relative peak heights of the crystalline phases. The XRD analysis may not fully recognize clay and clay-like amorphous components in weathered and altered rocks, since the original crystalline structure may be broken or altered into non-crystalline intermediates, including different sub-groups of swelling clays (Banfield and Eggleton 1990). Both natural

Table 1 Summary of performed tests

Methods	XRD analysis	Swelling tests		Thin-section analysis
		Powder	Intact	
Samples tested	7 flysch samples 7 volcanic samples	7 flysch samples 7 volcanic samples	3 flysch samples 7 volcanic samples	3 flysch samples 7 volcanic samples
Aim of test	Mineralogical composition	Maximum swelling pressure	Maximum swelling pressure and pressure evolution at cycles with controlled deformation	Structural and mineralogical characterization

Table 2 Overview of the rocks and the prepared samples

Rock type	Specimen name	Description	Preparation/testing condition
Flysch	Flysch A	Clay-/siltstone, highly disturbed, fractured	Powder
	Flysch B	Claystone-/siltstone, highly disturbed, crumbly	Powder
	Flysch C	Alternating claystone/siltstone	Powder and intact
	Flysch D	Intact claystone	Powder and intact
	Flysch E	Siltstone, intact	Powder and intact
	Flysch F	Claystone, disturbed	Powder
	Flysch G	Claystone-/siltstone, highly disturbed	Powder
Volcanic	Volcanic A	Altered volcanic rock, intact, strong	Powder and intact
	Volcanic B	Basaltic rock, intact, strong	Powder and intact
	Volcanic C	Altered volcanic rock, intact, weak	Powder and intact
	Volcanic D	Altered volcanic rock, intact, strong	Powder and intact
	Volcanic E	Volcanic breccia, intact, weak	Powder and intact
	Volcanic F	Volcanic breccia, intact, weak	Powder and intact
	Volcanic G	Altered volcanic rock, intact, weak	Powder and intact

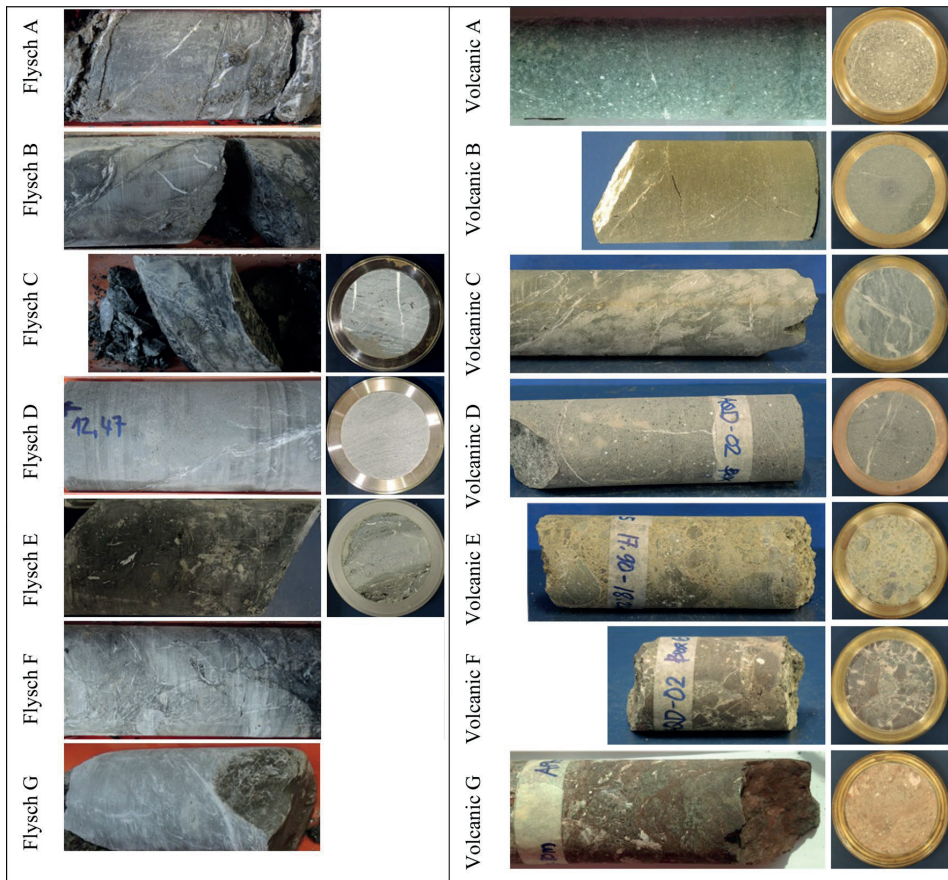

Fig. 1 Flysch rock samples from Albania (left) and Volcanic samples from the Philippines (right)

degradation of crystalline structures, as weathering and mineral transformations, and destructions of weak constituents during preparation may result in amorphous material. Different methods exist among analysts on how the results are calculated if the amorphous constituents are present.

For the volcanic rock samples from the Philippines, the samples were prepared and analyzed at NTNU. The preparation was performed by grinding the rock to a sieve size of < 0.020 mm and the samples were analyzed using a Bruker D8 ADVANCE. The identification of crystalline phases was carried out with the DIFFRAC.SUITE.EVA software combined with the PDF-4 + database. Quantification of the minerals was performed by Rietveld refinement in Topas, normally with an accuracy of 1–2%. Glycolation was used on fraction sizes of < 6 μm to identify

swelling clays. Quantification on the amount of swelling minerals or differentiation between clay minerals is not a standard procedure at NTNU, nor is the amorphous phases indicated.

The flysch samples from the Albania were prepared and examined at KIT. The quantification of the crystalline phases was made using the Rietveld calculation. Through this process, X-ray amorphous, nanocrystalline and organic components may elude the determination and affect the overall material content. Therefore, the standard procedure at KIT is to carry out a semi-quantitative determination of the different types of clay minerals by XRD on texture slides. The reported percentage of minerals include estimated amount of swelling minerals and amorphous phases, in addition to deviating between different types of clay minerals.

2.3 Structural and Textural Assessment by Thin-Section Analysis

The thin-section analyses were performed at NTNU. The rock specimens were impregnated with blue epoxy aiming to detect open discontinuities and pores. An initial inspection of the samples was carried out by transmitted light microscopy of polished thin sections using a Nikon Eclipse E600 microscope. Optical micrographs were studied using parallel and cross-polarized light. The textural features were described by studying thin sections in an Olympus BX51 microscope. Scans were obtained by stitching $5 \times$ microscope images together using the Olympus stream motion and the Märzhäuser Wetzlar automated stage. The porosity was qualitatively estimated by studying the thin-section scans of each sample. The findings were combined with the results from XRD analyses and the swelling potential was qualitatively estimated, aiming to compare the mineralogical/structural features in the evaluations of swelling test results. The content of clay minerals was also estimated based on this method.

2.4 Oedometer Swelling Tests

The oedometer swelling tests were performed at KIT. Two different configurations of the oedometer swelling test were applied; (1) maximum swelling pressure test (ISRM 1999) and (2) the cyclic swelling test with controlled deformation (Vergara and Triantafyllidis 2015). The maximum swelling pressure test was performed on both powder and intact rock specimens, whereas the cyclic oedometer test was applied on the intact rock specimen. The tests were performed with the apparatus configuration, as shown in Fig. 2. In the laboratory, the apparatus is kept in an acclimatized room with a constant temperature of 20 °C and with a relative humidity of 40%.

The rock specimens were prepared from core samples, whereby a disk was cut from the drill core and trimmed using a lathe to make faces flat and parallel to each other so that the sample fits into the oedometer ring. The apparatus (Fig. 2) allows control of the vertical deformation and load on the specimen using a manual spindle. Demineralized water was added to the watering cell to activate swelling. During this phase, the vertical deformation of the specimen was hindered and kept to zero, while the load was measured over time. In general, the swelling pressure reached a constant value after a few days.

The similar tests were also performed on compacted powder specimens. The powder was prepared by milling the rock material in an agate stone mill and sieving to a maximum grain size of 0.25 mm. The powder was pressed into the oedometer ring using a piston of an uniaxial testing machine. The load (approx. 200kN) was kept constant for about one

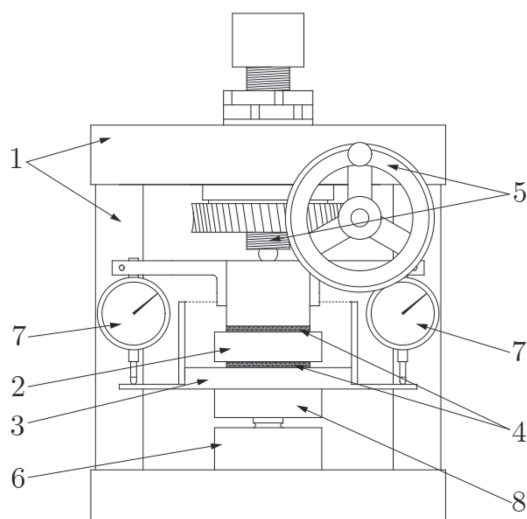

Fig. 2 Apparatus for performing oedometer swelling tests (1) Rigid frame, (2) ring and specimen, (3) watering cell, (4) porous metal sintered plates, (5) manual spindle, (6) load cell and (7) dial gauges (Vergara and Triantafyllidis 2015)

hour. The density of the prepared powder samples is in general lower than that of the intact rock, which is around 2.6 g/cm^3 . It is underlined here that the powder tests were mainly conducted for comparison purposes to investigate the influence of the rock structure in the swelling behavior and to check whether this “quick version” of swelling tests is appropriate in the investigation of rock swelling.

The cyclic swelling tests followed a procedure in which the samples were exposed to repeated cycles of wetting and drying, at stages with different levels of deformation. Each swelling-drying cycle followed the same procedure, where the pressure development under swelling and drying was measured over time, while the deformation level was kept constant. After the swelling pressure reached a constant value in a cycle, the water was removed and the specimen was left to dry at 20 °C and at a relative humidity of 40% until no further reduction of the pressure was measured. The same water used in the previous cycle was poured again into the vessel. Water loss by evaporation was refilled to maintain the same water level in the watering cell. The deformation of the specimen was adjusted before the peak pressure was reached during wetting so that prescribed deformation level was maintained. No deformation adjustment was made in the dry state.

The first stage of the test consisted of a maximum swelling pressure test at zero deformation. In the second stage, a non-zero deformation level was applied. It was observed that the peak swelling pressure at a given level

of deformation rised from cycle to cycle, until reaching a constant level. As soon as an asymptotic peak swelling pressure was estimated from the cycles, a new stage (new deformation level) followed. The procedure was repeated for several stages with increasing deformation levels.

3 Achieved Results

3.1 XRD- and Thin-Section Analysis Results

The mineralogical composition was assessed by XRD analysis. The textural features of the rock, including mineral characteristics, grain size, estimated porosity, microfracturing and clay distribution were determined by the thin-section analyses. The clay content is estimated based on the observed swelling minerals from the thin-section analysis. Furthermore, a qualitative estimation of the swelling potential was performed based on mineralogical and textural characteristics.

3.2 Flysch Rocks

The XRD results show that the flysch samples hold a moderate content of quartz, chlorite and calcite, a low feldspar content and relatively high contents of amorphous phases and swelling clays. An overview of the main results obtained from the thin-section analysis of the flysch rocks is given in Table 3. Some examples of the images of the thin sections are presented in Fig. 3.

3.3 Volcanic Rocks

Based on the XRD results, all the volcanic rocks show high contents of silica minerals as plagioclase, pyroxenes and quartz, which are typical forming minerals of igneous rocks. Some samples show alteration- and weathering products such as laumontite, clay minerals and chlorites. The content of amorphous phases is very high. The content of swelling minerals is uncertain as detected swelling minerals may be masked by other mineral peaks in the XRD diffractogram and may also be present as intermediate constituents of the amorphous phases. However, possible swelling clay minerals are observed in the thin sections. An overview of the main results obtained from the thin sections of the volcanic rocks is given in Table 4. Some examples of the images of thin sections are presented in Fig. 4.

3.4 Oedometer swelling test results

3.4.1 Maximum Swelling Pressure

The results of the maximum swelling pressure tests (maximum swelling pressure at zero deformation), the density of both powder and intact rock specimens (first cycle of the cyclic swelling tests) and indications on initial water content of the intact rocks are presented in Table 5.

3.4.2 Cyclic Tests with Controlled Deformation

Results of the equilibrated deformation and pressure reached at the wet phase of each cycle for flysch and volcanic rocks are shown in Figs. 5 and 6, respectively. The swelling pressure in the first cycle corresponds to the standard maximum

Table 3 Main textural and fracture characteristics of the flysch rocks including estimations of clay content, visible porosity and swelling potential of the intact rock specimen

Sample	Texture	Estimated clay content	Fracture characteristics*	Estimated porosity	Estimated swelling potential
Flysch C	Finely laminated micrite with dispersed calcite microspar	15–20%	Mainly calcite cemented Some very thin clay-filled microfractures Low permeability	<0.5%	Medium
Flysch D	Laminated mudstone with sandy layers. Concentrated, lenticular clay aggregates within the laminations	~40%	Open microfractures with parallel cleavage defined by clay aggregates, chlorite and mica. Some calcite as intergranular cement Low–medium permeability	~1%	High
Flysch E	Distinct turbidite lamination included fine lamina of micrite, clay aggregates and sand	~40%	Carbonate cemented fractures transecting matrix. Thin, open fractures and voids in cemented fractures Medium permeability	~2%	Medium–high

*Fractures may have been slightly dilated during sampling

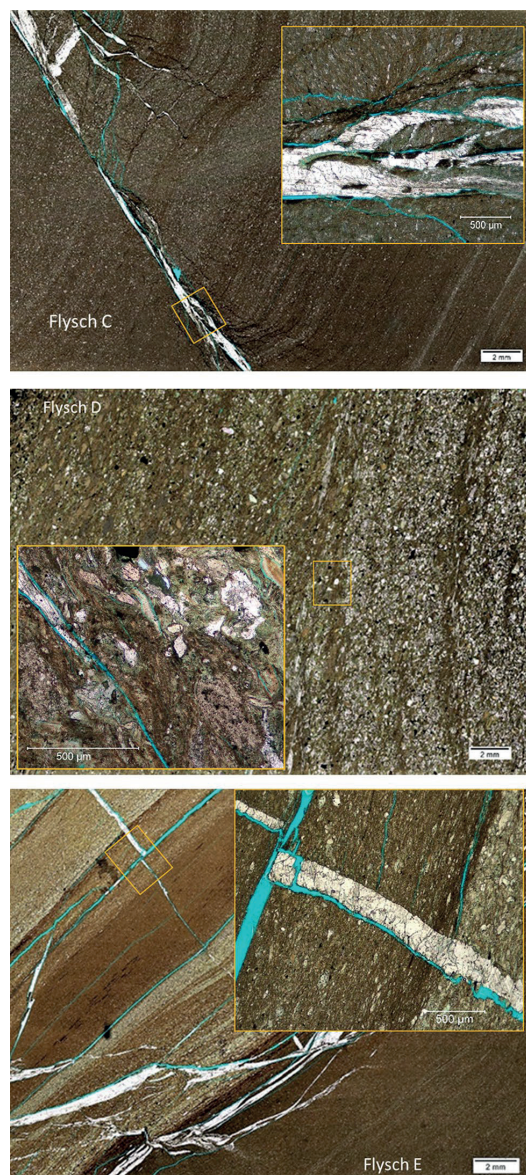

Fig. 3 Thin-section scans of Flysch C–E, including magnifications of fracture details (yellow boxes) (color figure online)

swelling pressure tests. The specimens Volcanic B and Volcanic D did not swell nor reacted to the cyclic wetting and were terminated after three test cycles.

4 Analysis of the Results

4.1 Relationship Between Swelling Pressure, Critical Minerals and Petrographic Data

4.1.1 The Flysch Rocks

While carrying out swelling pressure tests, only 3 out of 7 flysch samples (Flysch C, Flysch D and Flysch E) could be tested as intact and as pulverized rock sample. Since the remaining flysch samples were highly weathered and weak, no thin sections or intact rock specimen could be prepared. The summary of the potential swelling and respective content of critical minerals possibly leading to swelling, in addition to calcite which may prevent swelling to occur, are presented in Table 6.

As indicated in Table 6, the swelling extent of rocks not only depend on the content of detected swelling clay minerals but is also influenced by the content of amorphous material. Higher the content of swelling clay and amorphous material in the rock, higher is the swelling potential.

The swelling potential of samples Flysch D and E are high and medium–high, respectively. The test on intact rock sample Flysch E developed a higher pressure. Comparison made with the petrographic data shows that Flysch E contains mud-sized calcite within clay matrix, whereas sample Flysch D is coarse-grained and includes some of the calcite as intergranular cement (Table 3). This cementation may have inhibited the swelling. When crushing the rock to powder the cementation is destroyed and the actual swelling potential may have developed, resulting in a distinct increase in swelling pressure. It is interesting to note that the intact sample Flysch E shows much higher swelling pressure than the powder sample, suggesting that the structural features of this rock have a strong effect on the swelling behavior.

4.1.2 The Volcanic Rocks

The XRD analysis indicates high contents of amorphous minerals in all the samples, which is supported by microscopy observations of variably altered volcanic glass and matrix in the rocks. The most distinct swelling is seen in the heterogeneous volcanic breccias, (samples Volcanic E and Volcanic F) which are rich in glassy fragments as well as swelling clay in matrix. The estimated swelling potential, based on the textural and fracture characteristics, estimations of clay content and visible porosity of the intact rock specimen, correlates well with the laboratory measured swelling pressures for most of the volcanic rocks. The summary of the potential swelling and

Table 4 Main textural and fracture characteristics of the volcanic rocks including estimations of clay content, visible porosity and swelling potential of the intact rock specimen

Sample	Texture	Clay content* (%)	Fracture characteristics	Visible porosity (%)	Estimated swelling potential
Volcanic A	Random oriented laths and needles. Laumontite pseudomorphs after feldspar. Interstitial clay minerals (chlorite and corrensite)	5–10%	A few crosscutting veins consisting of silt-sized fibrous mica/clay aggregate Low permeability	< 1%	Medium
Volcanic B	Random oriented laths and needles. Network of wedge-like needles and opaque rods with interstitial quartz and chalcedony. Green clay mineral rims and patches	5–10%	0.1 mm thick open fracture ~ 1 mm thick quartz cemented vein Low permeability	< 0.5%	Low
Volcanic C	Curly texture with sparse microphenocrysts of feldspar, clinopyroxene, quartz, and spherulitic textures	10–15%	Quartz veins, and thin crosscutting green veins of chlorite corrensite Low permeability	~ 1%	Medium
Volcanic D	Volcanic texture, random oriented 0.5 mm albite and laumontite pseudomorphs, patches of fibrous aggregates 1–2 mm, pyroxene altered to calcite and prehnite	10–15%	Quartz and calcite cemented fractures, local thin porous central parts. Minor leaching of matrix along ~ 1 mm thick veins. Low permeability	< 0.5%	Low
Volcanic E	Volcanic breccia, fragments from sand size to several cm. Volcanic glass with very thin feldspar laths. Fragments rich in spherulites with clay	~ 20%	Open fractures around fragments (possibly from sampling) High permeability	1–2%	Very high
Volcanic F	Volcanic breccia. Green fibrous clay as coronas and in pseudomorphs	~ 10%	Thin fractures partly cemented by calcite Medium permeability	1–2%	High
Volcanic G	Volcanic breccia/weathered rock. Fibrous quartz aggregates, oxidised matrix. Irregular calcite patches and fracture fill	~ 10%	Dark irregular fractures. Some open fractures. Green clay minerals filling thin fractures in quartz and spheruloids Medium permeability	< 1%	Medium

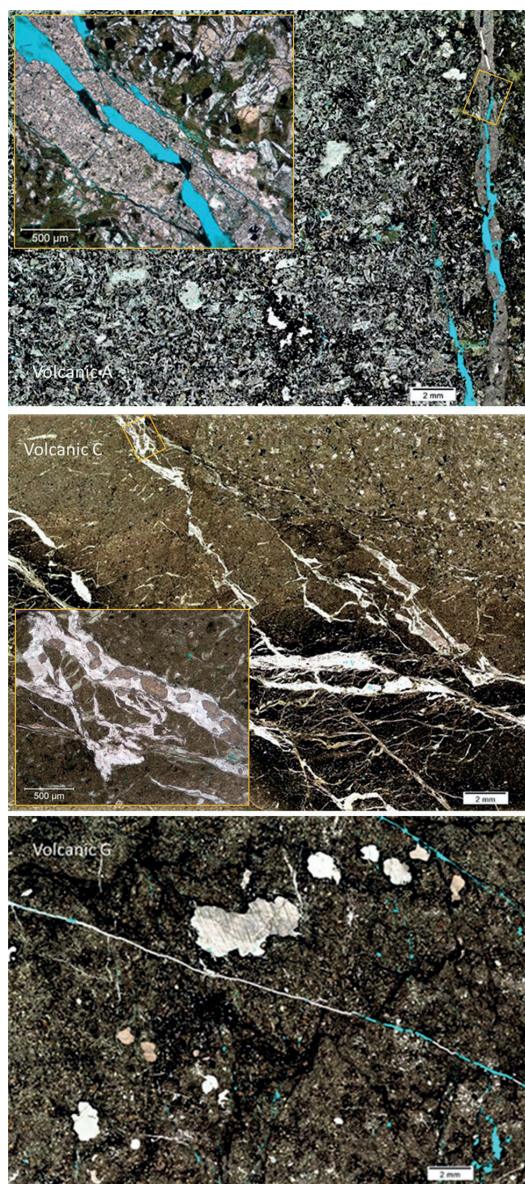

Fig. 4 Thin-section scans of Volcanic A, Volcanic C and Volcanic G, including magnifications of fracture details (yellow box) (color figure online)

respective content of critical minerals possibly leading to swelling is presented in Table 7, including the content of calcite which may prevent swelling to occur.

As one can see in Table 7, the result of the measured swelling pressure and mineralogical composition indicates

a distinct link between swelling behavior and amount of amorphous, as well as laumontite minerals. The measured swelling pressures of the pulverized samples are higher than the swelling pressures of the intact rock samples.

Sample Volcanic A is an apparently homogeneous volcanic rock with a very high content of laumontite (31%) and amorphous constituents (45%). The XRD analysis did not indicate any swelling clay minerals (Table 7); however, the thin-section analysis clearly identifies potential swelling clay minerals in the rock structure (Table 4). The specimen reached high swelling pressure in both pulverized and intact rock samples. Considerable amount of both laumontite and amorphous material is suspected to be among the main reasons for this high swelling potential. According to Bravo et al. (2017) the content of laumontite in sedimentary and crystalline rocks is usually not considered to produce considerable swelling but laumontite present in volcanic rocks has been found to be responsible for rock swelling and subsequent damage of a hydropower water tunnel. The test results of this study confirm this finding, where the presence of laumontite seems very influential in aggravating swelling.

The samples Volcanic C, E and F have high content of amorphous minerals. From the thin-section analysis, their swelling potential was estimated as medium, very high and high, respectively. When tested as intact rock, they show relatively low maximum swelling pressure. It is observed that after grinding the sample and destroying their fabric, the swelling potential could develop resulting in high swelling pressure confirming the initial estimation of the swelling potential. Samples C and F were very reactive to the cyclic wetting and drying, showing a significant increase in swelling pressure with the number of cycles. This may be explained by uneven distribution of swelling clay in the matrix, i.e., the concentration of swelling clay as aggregates in the matrix and/or as fracture infillings.

The sample Volcanic G, for which only medium swelling potential was estimated, showed a strong increase in swelling pressure in the cyclic test. The thin-section analysis shows green clay minerals filling with thin fractures in quartz and spheroids. The textural/structural properties of the rock may have interacted with the swelling minerals, resulting in a combination of chemical and physical swelling.

4.2 Analysis of Cyclic Swelling Tests

Grob (1972) suggested that there is a logarithmic link between swelling strain (axial deformation) and swelling pressure, which is expressed by Eq. 1 (swelling curve). In this equation, K is a material constant, σ_0 corresponds to the swelling pressure at zero deformation and σ corresponds to the pressure at increased deformation:

Table 5 Results of the oedometer swelling tests on both pulverized and intact rock specimen, including the measured initial water content of the intact rock and the measured densities of all samples

Rock type	Specimen	Initial moisture content, intact samples (%)	Density (g/cm ³)		Maximum Swelling Pressure (MPa)	
			Compacted powder	Intact rock	Compacted powder	Intact rock
Flysch	Flysch A	–	2.11	–	0.53	–
	Flysch B	–	2.15	–	0.29	–
	Flysch C	2.6	2.16	2.58	0.66	0.46
	Flysch D	7.2	2.32	2.50	4.13	0.91
	Flysch E	3.8	2.18	2.47	1.50	3.79
	Flysch F	–	2.15	–	0.61	–
	Flysch G	–	2.06	–	0.18	–
Volcanic	Volcanic A	1.2	1.87	2.60	4.9	2.08
	Volcanic B	1.9	1.98	2.76	0.4	0.05
	Volcanic C	1.4	1.99	2.66	2.4	0.13
	Volcanic D	0.6	1.94	2.82	0.4	0.04
	Volcanic E	5.0	1.95	2.32	3.0	0.38
	Volcanic F	5.5	1.69	2.26	2.9	0.17
	Volcanic G	1.9	1.92	2.50	0.8	0.49

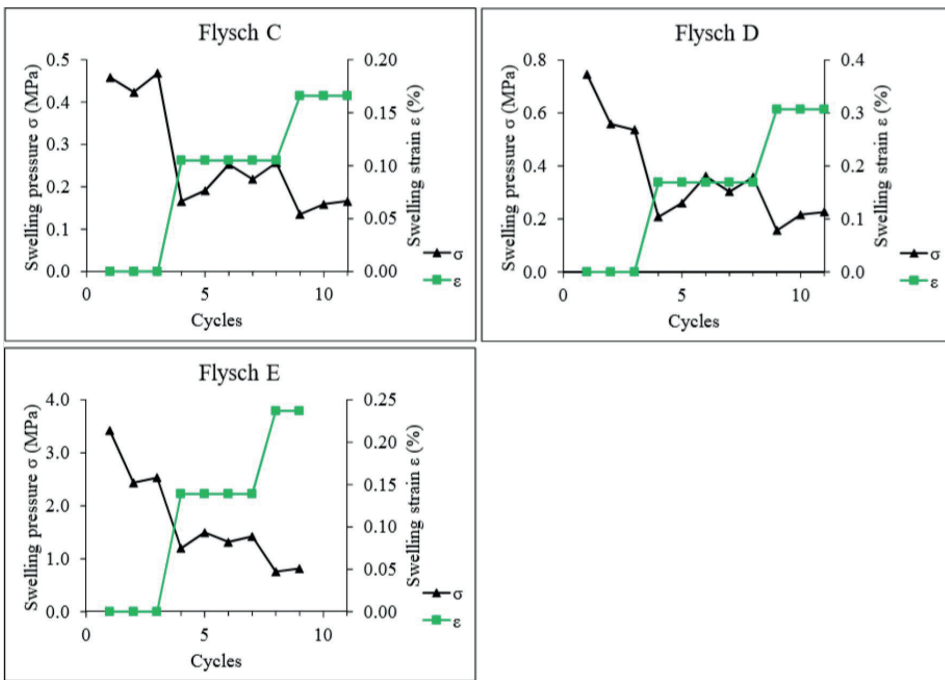

Fig. 5 Evolution of swelling pressure and strain with number of wetting cycles in oedometer test for flysch rock specimens

$$\epsilon = K \log\left(\frac{\sigma}{\sigma_0}\right).$$

(1)

Following Grob’s law, the swelling pressure should be reduced after allowing deformation to occur in the specimen. This reduction was observed in the tests in the first cycle of each stage (first cycle after new deformation). However,

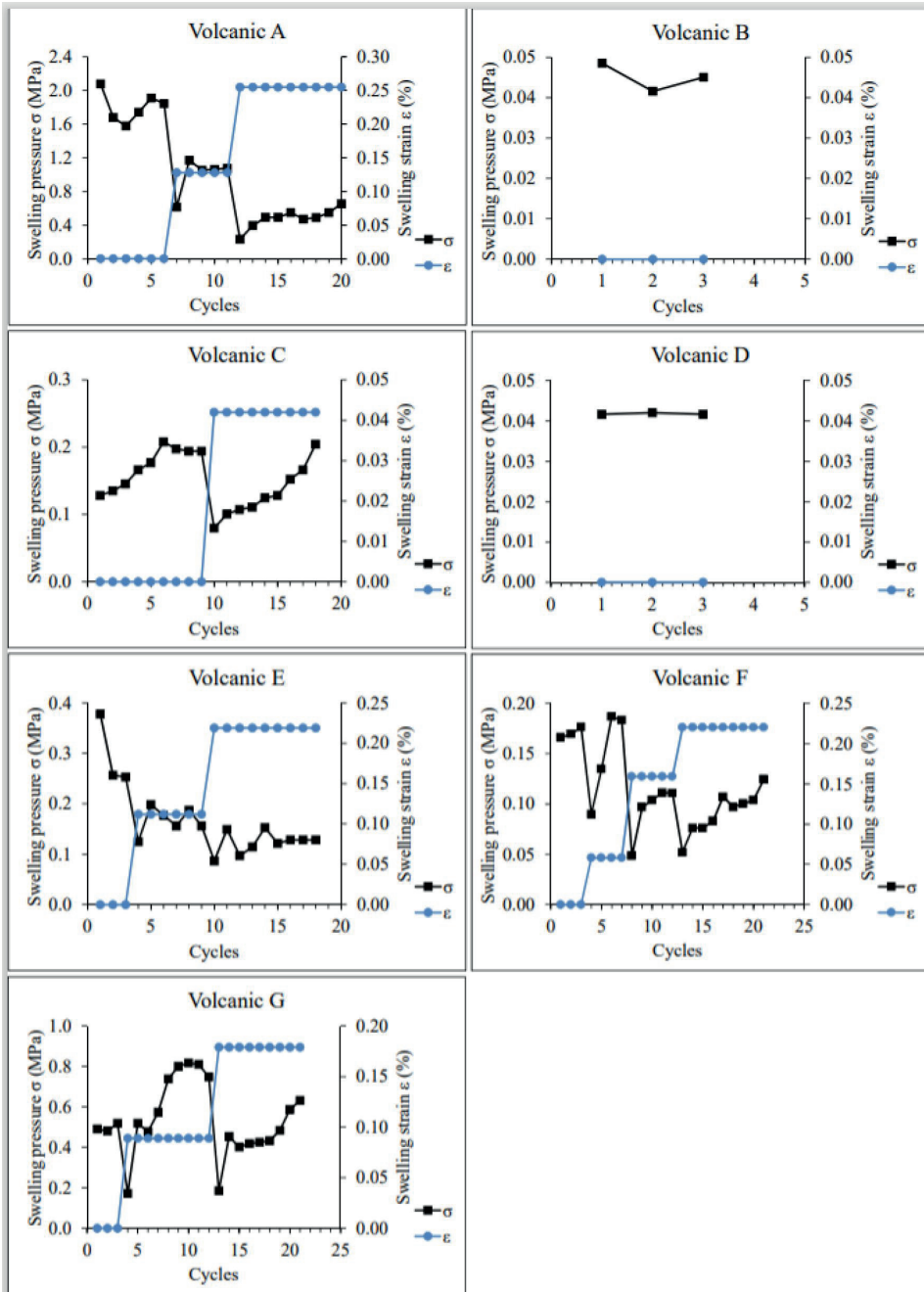

Fig. 6 Evolution of swelling pressure and strain with number of wetting cycles in oedometer test on volcanic rock specimens

Table 6 Summary of measured maximum swelling pressure (MPa) and critical minerals from XRD of the flysch rocks. The XRD analysis is performed at KIT

Sample	Swelling potential			Critical minerals from XRD (% mass)			
	Estimated from thin section	Lab tested pressure for intact rock (MPa)	Lab tested pressure, for rock powder (MPa)	Amorphous	Chlorite	Swelling clay	Calcite
Flysch A	–	–	0.53	19	22	24	9
Flysch B	–	–	0.29	14	22	9	19
Flysch C	Medium	0.46	0.66	9	11	5	41
Flysch D	High	0.91	4.13	22	3	32	19
Flysch E	Medium–high	3.79	1.50	22	18	26	13
Flysch F	–	–	0.61	18	19	20	19
Flysch G	–	–	0.18	10	8	8	53

Table 7 Summary of measured swelling pressure (MPa) and critical minerals from XRD of the volcanic rocks. The XRD analysis was performed at NTNU

Sample	Swelling potential			Critical minerals from XRD (%)				
	Estimated from thin section	Lab. tested pressure for intact rock (MPa)	Lab. tested pressure for powder (MPa)	Amorph	Chlorite	Swell. clay*	Calcite	Laumontite
Volcanic A	Medium	2.08	4.9	45	2	–	–	31
Volcanic B	Low	0.05	0.04	44	5	–	–	2
Volcanic C	Medium	0.13	2.4	46	12	u.a	–	8
Volcanic D	Low	0.04	0.4	29	9	–	4	1
Volcanic E	Very high	0.38	3.0	53	–	u.a	8	3
Volcanic F	High	0.17	2.9	58	–	u.a	1	–
Volcanic G	Medium	0.49	0.8	40	5	u.a	4	4

*The amount of swelling clay is unknown (u.a = “unknown amount”)

the swelling pressure increased during cycling, recovering the reduction produced by the unloading. This results in a steeper curve, which means higher pressure compared to that would be found in a conventional test.

In some cases, a drop of the pressure was observed between the first and subsequent cycles under zero deformation (first stage). This may have been caused by differences between the initial water content and the water content reached in the testing room during the drying phase. Differences in the initial water content of the same rock will produce different swelling pressure.

Even if the swelling curves of all samples were affected by the cyclic wetting and drying, becoming steeper, all three tested rock samples of flysch show the general trend of decreased pressure upon increased strain (Fig. 5). However, the samples Volcanic C, Volcanic F and Volcanic G showed almost an opposite behavior, whereby the swelling pressure increased beyond to the level of zero deformation once deformation was allowed and kept constant (Fig. 6). In other words; by repeating the cycles of wetting and drying, the measured pressure after allowing axial expansion was higher than that reached under zero deformation. This

is contrary to that expected according Grob’s swelling law, which relates lower swelling pressure to higher deformation. The swelling strain and pressure of the equilibrium points of each cycle are shown in Fig. 7, where standard swelling pressure tests at zero deformation correspond to the first equilibrium point of the cyclic tests.

5 Discussion

5.1 XRD- and Thin-Section Analyses in Swelling Rock Assessments

Estimation of the amorphous content is extremely important in quantifying mineral constituents so that degree of weathering of the rock material is well understood. The main drawback with XRD is the poor recognition of amorphous phases lacking crystalline order. In addition, different procedures in analyzing XRD results are found between institutions, which have major implications on the results when the weathering extent is high in the samples. On the other hand, thin-section analysis

Fig. 7 Swelling strain (%) vs. swelling pressure (MPa) for flysch (top) and volcanic rock (bottom) specimens

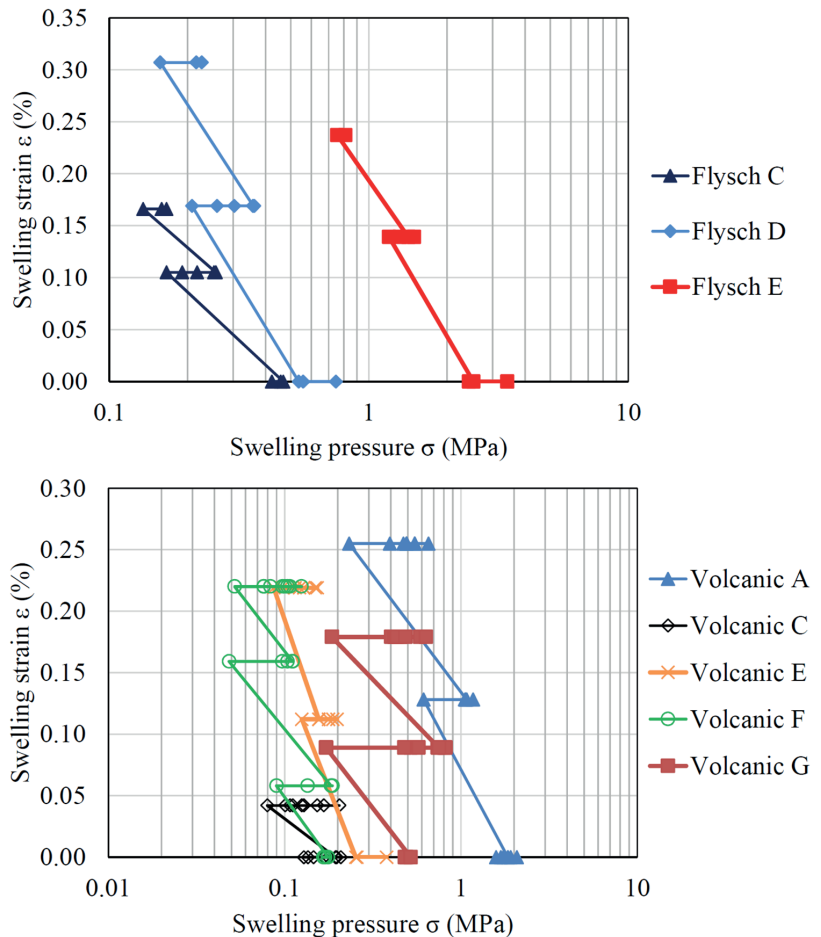

enables a qualitative assessment of the mineralogical and textural features of the rock, which can be compared to the quantitative estimations of mineral constituents from the XRD analysis. The distribution of minerals and fracture characteristics can be observed, which have important implications on the rock behavior when exposed to water. In addition, the amorphous content can be assessed and identified based on optical properties.

This study revealed major deviations between the XRD results and the thin-section descriptions of several samples. The deviations are mainly related to the estimation of clay in the tested samples. This may be due to the coexisting amorphous and clay-sized constituents, which is not easily separated. It is assumed that the amorphous content includes swelling mineral phases that are not

detected by traditional methods. Still, the estimation of swelling potential based on the combination of XRD and thin-section analyses correlates well with the measured swelling pressure in the oedometer tests.

5.2 Comments on the Oedometer Swelling Tests

The main advantage of oedometer swelling pressure tests on powder samples is that it is quick, straight-forward and not dependent on rock quality. The test results are given in the form of swelling pressure, and they indicate whether the rock has a swelling potential or not. On the other hand, the intact rock may behave very differently compared to the pulverized samples due to structural/textural properties, differential density and differential distribution

of swelling minerals. These drawbacks can have major implications on the applicability of the results and hence the swelling pressure test results obtained from powder samples, are conservative results and should be taken as index tests only.

The cyclic swelling test results of intact rock samples, where changes in deformation and moisture content are allowed (Figs. 5 and 6), have shown that the textural/structural features of the intact rock may interact with swelling minerals on the swelling behavior. In some cases, the observed porosity and low density of the rocks indicate a weak structure, which can easily degrade during repeated wetting and drying, leading to disintegration on a long-term perspective and consequently further activating swelling in the rock.

Caution is required for rock types holding a potential for high swelling pressure when exposed to changes in boundary conditions, i.e., allowed deformation and repeated cycles of wetting and drying, as this behavior may be connected to physical swelling mechanisms of the rock, which are not recognizable by XRD or powder swelling tests. Rock types which have a heterogeneous texture, uneven distribution of swelling clay minerals and open and/or clay-filled microfractures show a tendency to higher swelling potential with repeated moisture changes compared to rock types with a homogeneous texture. These findings are important knowledge on support evaluations of water conveying (headrace and tailrace) tunnels of hydropower projects that experience changes at different stages of their life cycle. For example, a headrace tunnel passing through weak rock mass having swelling minerals, first experiences unloading and complete drainage after excavation. After the completion of the excavation, the tunnel is filled with water causing complete saturation. Over the lifetime of the project, the headrace tunnel will experience changes in pressure, and it will be dewatered and filled again several times, which could result in changes of the rock mass properties.

The cyclic tests revealed that Grob's law is not valid for the case of cyclic swelling. This is presumably caused by degradation of weaker rock structures during the wetting and drying cycles (Fig. 7). This degradation makes the rock not comparable to that in a previous deformation stage. In some cases, the swelling potential instead increases after allowing expansion. With such a swelling behavior, the swelling curve of the rock is unknown, and it is not possible to calculate an equilibrium state of swelling pressure and deformation (strain). This has implications on the design of water tunnels, where the design of required support is based on the estimated swelling pressure and deformation of the tunnel lining.

6 Conclusions

- The XRD analysis is not a proper method for describing weathered and swelling rock compositions unless it is complemented with thin-section analysis, which considers other features of the minerals to describe their origin and their characteristics.
- Heterogeneous rocks with uneven distribution of swelling clay minerals and open and/or clay-filled microfractures may hold a higher swelling potential compared to rock types with a homogeneous texture.
- Structural breakdown and disaggregation of the intact rock may occur during cyclic swelling, allowing a greater volume of swelling minerals to adsorb water in the next wetting cycle. The location of the swelling minerals within the rock texture seem to play an important role and underlines the importance of performing swelling tests on intact rock and to analyze the structure of the rock to assess the swelling characteristics of rocks containing even low amounts of swelling minerals.
- Significant physical swelling can develop even for small concentrations of swelling clay. Induced and/or advancing microfractures in the rock due to allowed deformation during cyclic wetting may lead to alteration of the rock properties. The relation between swelling strain and stress proposed by Grob (1972) is therefore not valid in the case of swelling affected by cyclic wetting.
- None of the applied methods, when applied isolated, can assess the swelling potential of rocks, but the combination of the different methods gives a fair estimation on the swelling behavior.
- The cyclic swelling test carried out on intact rock represent a condition closer to the in-situ condition of a water tunnel when compared to the standard swelling test and is recommended to be adopted for swelling tests in future hydropower projects.

Funding Open Access funding provided by NTNU Norwegian University of Science and Technology (incl St. Olavs Hospital - Trondheim University Hospital)

Open Access This article is licensed under a Creative Commons Attribution 4.0 International License, which permits use, sharing, adaptation, distribution and reproduction in any medium or format, as long as you give appropriate credit to the original author(s) and the source, provide a link to the Creative Commons licence, and indicate if changes were made. The images or other third party material in this article are included in the article's Creative Commons licence, unless indicated otherwise in a credit line to the material. If material is not included in the article's Creative Commons licence and your intended use is not permitted by statutory regulation or exceeds the permitted use, you will

need to obtain permission directly from the copyright holder. To view a copy of this licence, visit <http://creativecommons.org/licenses/by/4.0/>.

References

- Banfield JF, Eggleton RA (1990) Analytical transmission electron microscope studies of plagioclase, muscovite, and K-feldspar weathering. *Clays Clay Miner* 38:77–89. <https://doi.org/10.1346/CCMN.1990.0380111>
- Bravo A, Jerez O, Kelm U, Poblete M (2017) Dehydration-hydration reactivity of laumontite: analyses and tests for easy detection. *Clay Miner* 52(3):315–327. <https://doi.org/10.1180/claymin.2017.052.3.03>
- Dick JC, Shakoor A (1992) Lithological controls of mudrock durability. *Q J Eng GeolHydrogeol* 25(1):31–46
- Einstien H (1994) Comments and recommendations on design and analysis procedures for structures in argillaceous swelling rock. In: *International Journal of Rock Mechanics and Mining Sciences and Geomechanics Abstracts*. Oxford; New York: Pergamon Press, 1974-c1996: 535–546.
- Grob H (1972) Schwelldruck im Belchentunnel. *Proc. Int. Symposium on Underground Opening*, Lucerne: 99–119
- ISRM (1979) Suggested methods for determining water content, porosity, density, absorption and related properties and swelling and slake-durability index properties. *Int J Rock Mech Min Sci Geomech Abstr* 16(2):143–151. [https://doi.org/10.1016/0148-9062\(79\)91452-9](https://doi.org/10.1016/0148-9062(79)91452-9)
- ISRM (1989) ISRM commission on swelling rocks. Suggested methods for laboratory testing of argillaceous swelling rock. *Int J Rock Mech Min Sci Geomech Abstr Res* 26(5):415–426
- ISRM (1999) ISRM commission on swelling rocks. 1999. Suggested methods for laboratory testing of swelling rocks. *Int J Rock Mech Min Sci Geomech Abstr Res* 36(3):291–306
- Olivier HJ (1991) Some aspects of the engineering-geological properties of swelling and slaking mudrocks, In: *Proceedings of 6th International IAEG Congress*. Rotterdam: 707–711
- Ruedrich J, Bartelsen T, Dohrmann R, Siegesmund S (2010) Moisture expansion as a deterioration factor for sandstone used in buildings. *Environ Earth Sci* 63:1545–1564. <https://doi.org/10.1007/s12665-010-0767-0>
- Russell DJ (1982) Controls on shale durability: the response of two Ordovician shales in the slake durability test. *Can Geotech J* 19(1):1–13. <https://doi.org/10.1139/t82-001>
- Selen L, Panthi KK, Vistnes G (2019) An analysis on the slaking and disintegration extent of weak rock mass of the water tunnels for hydropower project using modified slake durability test. *Bull Eng Geol Environ* 79(4):1919–1937. <https://doi.org/10.1007/s10064-019-01656-2>
- Vergara MR, Triantafyllidis T (2015) Swelling behavior of volcanic rocks under cyclic wetting and drying. *Int J Rock Mech Min Sci* 80:231–240. <https://doi.org/10.1016/j.ijrmmms.2015.08.021>

Publisher's Note Springer Nature remains neutral with regard to jurisdictional claims in published maps and institutional affiliations.

Paper IV

Title:

A discussion on the laboratory testing approaches for swelling rocks at three European institutions

Authors:

Lena Selen

Krishna Kanta Panthi

Submitted to:

Geomechanics for Energy and the Environment (submitted: 05.08.2020)

This paper is awaiting publication and is not included in NTNU Open

Paper V

Title:

Field testing of weak rock deformation in water tunnels: A practical review of the flatjack test

Authors:

Lena Selen

Krishna Panthi

Lloyd Tunbridge

Thomas Schönborn

Published in:

Rock Mechanics for Natural Resources and Infrastructure Development (2019)

Presented at:

ISRM Congress (ISRM2019) held in Brazil in September 2019

This paper is not included due to copyright
available at <https://doi.org/10.1201/9780367823177>

