

Håkon Hornburg Løken

Energy and economic balance analysis for a Net Zero Energy Building with solar heating, cooling and PV electricity generation.

Master's thesis in Mechanical Engineering

Supervisor: Professor Vojislav Novakovic

August 2019

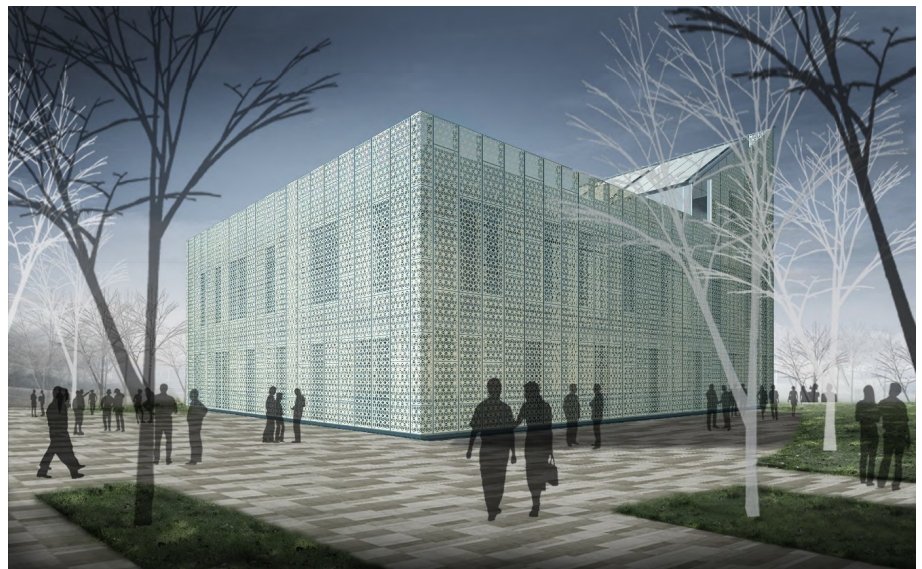

Håkon Hornburg Løken

**Energy and economic balance analysis
for a Net Zero Energy Building with solar
heating, cooling and PV electricity
generation.**

Master's thesis in Mechanical Engineering
Supervisor: Professor Vojislav Novakovic
August 2019

Norwegian University of Science and Technology
Faculty of Engineering
Department of Energy and Process Engineering

 **NTNU**
Norwegian University of
Science and Technology

Preface

This report is the written work for the master thesis in the course Energy and Indoor Environment, course code TEP 4910 at Norwegian University of Science and Technology (NTNU), and accounts for 30 credit points. The thesis is the final work for the 5 year master's degree program in mechanical engineering at NTNU, Trondheim. The assignment is realized as part of a collaboration between the Joint Research Centre in Sustainable Energy at NTNU and Shanghai Jiao Tong University (SJTU). The report is written for the Department of Energy and Process Engineering, NTNU, and is conducted at SJTU, spring 2019. Supervisor has been Professor Vojislav Novakovic (NTNU) and Co-Supervisor has been Professor Yanjun DAI (SJTU).

The main motivation for this project was the interest of contributing to a sustainable energy future by investigating the possibility of profitable net Zero Energy Buildings. This interest comes from courses given at NTNU, and information obtained from young age.

August 23, 2019, Oslo

Date, Place



Håkon H. Løken



NTNU

Norwegian University of
Science and Technology

Acknowledgments

I would like to thank the Department of Energy and Process Engineering at the faculty of engineering at NTNU. The courses taught by the department, by the professors connected to it, has given me the knowledge that made it possible to complete this work. I want to thank especially my supervisors, professor Vojislav Novakovic and Professor Yanjun DAI for guiding me in this project. I also want to thank Professor Hans Martin Mathisen, Professor Guangyu Cao, Associate Professor Laurent Georges, Associate Professor Natasa Nord and Associate Professor Mohamed Hamdy for lecturing in courses connected to this topic, and providing help when needed. The courses has developed my interest in the field of study and is the main reason for conducting this work.

I would like to thank the Department of Energy and Process Engineering for providing a great study environment with an open office study room at "Varmetekniske laboratorier". The room has been optimal as it is always space and storage possibilities and access to an additional monitor. It has also been great to study in a room with so many fellow students that has knowledge on the same topic. The close access to the professors and other people working for the department has also been very helpful. Finally I want to thank the department for the supply of coffee that was especially appreciated at early mornings and long nights working.

The main part of the thesis was written in Shanghai at Shanghai Jiao Tong University. I would like to thank professor Vojislav Novakovic and Professor Yanjun DAI for making this experience possible. I want to thank Professor Yanjun DAI especially for the guidance provided during my stay. I have enjoyed getting to know Chinese culture and I have made friends for life thanks to this opportunity.

Abstract

The building sector is responsible for 30% of the total global energy consumption and is a big contributor to emissions of greenhouse gases, causing global warming. Modern buildings are therefore expected to cover their energy needs with on-site energy production based on renewable sources. An energy balance analysis for a building, located in Shanghai, is conducted to conclude if it qualifies as a Net Zero Energy Building, producing as much energy as it consumes over a year. In-depth research is performed for the building in which the energy demand for heating, cooling and internal lighting should be fully provided by photovoltaic electricity production. The following study is aimed to develop an understanding of the building's energy usage and the conditions in which the building has a positive energy balance. An economic analysis has also been performed to examine the profitability of the on-site energy production.

The energy and the economic analysis has been done with the use of mathematical models and building performance simulation tools. The data comes from a currently utilized building that is part of Shanghai Jiao Tong University. The thesis starts with introducing the theory behind the research in a literature study before the methodology of how the research has been conducted is described. The development of the mathematical models is explained, creating the background for the results. The results are presented and analyzed and energy simulations at different scenarios and assumptions are compared and discussed and an in-depth sensitivity analysis. The research ends with a final conclusion and suggestions to further work.

The energy analysis found that the energy demand of the building depends to a large extent on the operation of the building. The building is heated up and cooled down by packaged terminal heat pumps (PTHP) that reduces the energy demand drastically compared to conventional electrical heating and cooling. The heat pumps utilizes renewable energy and reduces the energy demand for space heating by 75% and 67% for space cooling. To reach the goal of net Zero Energy Building standard, it was found that the building needs to run on scheduled operation. That is limiting the PTHPs to only operate when there is people present in the building. This shuts down heating and cooling at night, on the weekends and on public holidays. This has especially big effect on the heating purpose as the temperature tends to decrease at night. The scheduled operation reduces the energy demand by 62.2%. Table 1 summarizes the total energy balance. There is a total surplus of 672.6 kWh over a one year time frame, making it a net zero energy building under these conditions.

Table 1: *Total energy balance.*

	[kWh]
Energy production	17 758.0
Energy demand	17 085.4
Energy balance	672.6

The economic analysis found that the investments in the photovoltaic system are profitable and are likely to be even more so in the future. This is due to development of the technology and economic incentives from governments. They were found to be profitable in all the scenarios studied in this research. The PTHPs were found to be necessary to minimize the energy demand and thus create a positive energy balance. There are many different models and suppliers and investment costs can vary, but even the most expensive models were found to be profitable.

Sammendrag

Drift av bygninger står for 30% av totalt energiforbruk globalt og er en stor bidragsyter til global oppvarming. Bygningssektoren har derfor et stort ansvar når det kommer til å nå målene satt i Parisavtalen. Moderne bygninger er forventet å produsere energi lokalt ved å utnytte fornybar energi. En energi- og økonomianalyse er gjennomført for å undersøke om *Green Energy Lab* ved Shanghai Jiao Tong University består kravene til et netto nullenergibygg. Studien analyserer energiforbruket og energiproduksjonen for å avdekke om det produserer like mye energi som det forbruker iløpet av et år. Analyser er gjennomført for å konkludere hvor mye energi som kreves for oppvarming og nedkjøling av bygget som skal dekke hele sitt energibehov fra solcellepaneler. Det er undersøkt under hvilke omstendigheter og antagelser det er en positiv energibalanse og lønnsomheten av den fornybare energiproduksjonen.

Energi- og økonomianalysene er gjennomført ved bruk av matematiske modeller og energisimuleringene er gjort i bygningssimuleringsprogrammet EnergyPlus. Oppgaven er delt opp i flere deler og starter med en litteraturstudie som tar for seg teorien som ligger til grunn. Deretter følger et kapitell som beskriver metoden studien er gjennomført på og et kapitell som beskriver de matematiske modellene. Deretter er resultatene fra analysene presentert, analysert og diskutert før studien konkluderes. Til slutt følger en plan for videre arbeid.

Energianalysene fant ut at energibehovet til bygget avhenger i stor grad av driften. Bygningen er oppvarmet og nedkjølt ved hjelp av frittstående varmepumper som reduserer energiforbruket med 75% for oppvarming og 67% for nedkjøling. Disse installasjonene er nødvendige for at bygget skal kvalifisere som netto nullenergibygg. Et annet tiltak som er nødvendig for at bygget skal oppnå målet om positiv energibalanse er en planstyrt drift av varmepumpene. Ved å begrense bruken av varmepumpene til tider der det befinner seg mennesker i bygget reduseres energibehovet med 62.2%. Analysene avdekket at bygningen har en positiv energibalanse under disse forutsetningene. Totalt energiforbruk gjennom et år er 17 085.4 kWh og total energiproduksjon er 17 758.0 kWh. Dette gir et årlig overskudd på 672.6 kWh. Den årlige energibalansen er oppsumert i tabell 2 (Table 2).

Table 2: Total energi balanse.

	[kWh]
Energiproduksjon	17 758.0
Energiforbruk	17 085.4
Energi balanse	672.6

Økonomianalysene kom frem til at det er lønnsomt å investere i både varmepumper og solcellepanel. Varmepumpene har en investeringskostnad på mellom 39 000 - 91 000 RMB, avhengig av modell og leverandør, og en tilbakebetalingstid på mellom 3 - 6 år. Det er godt under den økonomiske levetiden på 15 år. Internrenten ligger på mellom 17.52% - 33.50%. Solcellepanelene har en investeringskostnad på omtrent 52 000 RMB i 2019. De bidrar til årlige besparelser og inntekter på tilsammen 9 234.2 RMB, noe som gir en tilbakebetalingstid på 7 år. Også dette er godt under den økonomiske levetiden på 25 år. Internrenten på denne investeringen er 16.52%.

Contents

1	Introduction	1
1.1	Background and motivation	1
1.2	Problem description	3
1.3	Goal	4
1.4	Structure	5
1.5	Limitations	5
2	Theoretical background	7
2.1	Energy	7
2.2	The law of conservation of energy	7
2.3	Heat transfer	8
2.4	Sustainable energy future	11
2.5	Net Zero Energy Buildings	12
2.6	Indoor environment and thermal comfort	13
2.7	Building Installations	17
2.8	Ventilation system	17
2.9	Heating and cooling system	19
2.9.1	Heat pump	19
2.10	Solar energy	21
2.11	Building automation	21
2.12	Economic analysis	21
3	Methodology	23
3.1	Building performance simulation tools	23
3.2	Data collection	24
4	Model	25
4.1	Location and climate	25
4.1.1	Laws and regulations	25
4.2	The building	26
4.3	Building Envelope	26
4.4	Zones	28
4.5	Usage	30
4.6	Internal loads	30
4.7	Design criteria indoor environment	32
4.8	HVAC system	32
4.9	Photovoltaics	33
4.10	Economic model	33
4.10.1	Electricity prices	33
4.10.2	Photovoltaics	33
4.10.3	Packaged Terminal Heat Pumps	34
5	Results	35
5.1	Energy demand	35
5.1.1	Ideal air loads	35
5.1.2	PTHP	37
5.1.3	Scheduled operation	38
5.2	Natural ventilation	39

CONTENTS

- 5.3 On-site electricity production 41
- 5.4 Energy balance 42
- 5.5 Economic analysis 43
 - 5.5.1 PV panels 43
 - 5.5.2 PTHP 48

- 6 Discussion 51**
 - 6.1 Design criteria 51
 - 6.2 Ventilation system 54
 - 6.3 Photovoltaics 55
 - 6.4 Economic Analysis 55

- 7 Conclusion 57**

- 8 Further work 61**

- 9 Appendix 63**

List of Figures

1.1	<i>CO₂ concentration in the atmosphere and global mean temperature compared to pre-industrial levels from 1980 to 2017 [10][13].</i>	1
1.2	<i>Total primary energy supply by source, 2015[2].</i>	1
1.3	<i>Global final energy consumption by sector, 2015 [2].</i>	2
2.1	<i>Heat balance in a building [18].</i>	8
2.2	<i>Thermal conduction through a one layer material.</i>	9
2.3	<i>Electricity demand by selected region [3].</i>	11
2.4	<i>Global average annual net capacity additions by type [3].</i>	12
2.5	<i>A building, including building installations with connection to electricity grid [25].</i>	13
2.6	<i>Load duration curve over a year [24].</i>	14
2.7	<i>Relation between PMV and PPD [28].</i>	15
2.8	<i>Optimum operative temperature category A [29].</i>	15
2.9	<i>United States Air Quality Index (US AQI) [35]</i>	18
2.10	<i>Heat pump cycle [23].</i>	19
2.11	<i>Relationship between COP and energy savings</i>	20
3.1	<i>Energy model work flow.</i>	24
4.1	<i>Average temperature in Shanghai by month [19].</i>	25
4.2	<i>South east view, concept drawing of GEL.</i>	26
4.3	<i>Concept drawing of facade panel.</i>	27
4.4	<i>South east view, Sketchup model.</i>	27
4.5	<i>Occupant schedule, laboratories and student offices.</i>	31
4.6	<i>Occupant schedule, conference rooms.</i>	32
5.1	<i>Energy demand for space heating and cooling using ideal air loads, compared to outdoor air temperature.</i>	36
5.2	<i>Load duration curve, ideal air loads.</i>	36
5.3	<i>Energy demand using PTHPs.</i>	37
5.4	<i>Energy demand, PTHP, scheduled operation.</i>	38
5.5	<i>Operative temperature (orange) March 1st - March 6th in room 203 with scheduled operation, compared to outdoor air temperature (blue).</i>	39
5.6	<i>Hourly electricity production from the PV system.</i>	41
5.7	<i>Monthly electricity production from PV panels.</i>	41
5.8	<i>Monthly comparison of energy consumption and PV electricity production.</i>	42
5.9	<i>Monthly energy balance.</i>	43
5.10	<i>Payback time for the investment on PV panels with investment cost 4 RMB/Wp.</i>	44
5.11	<i>Payback time with various inflation rates.</i>	45
5.12	<i>Payback time for alternative electricity prices given in RMB/kWh.</i>	46
5.13	<i>Sensitivity analysis alternative 1.</i>	47
5.14	<i>Sensitivity analysis, alternative 2.</i>	48
5.15	<i>Sensitivity analysis for various electricity prices, PTHP investment.</i>	49
6.1	<i>Difference in energy demand for different heating setpoints.</i>	51
6.2	<i>Average ACH and total energy demand at various minimum indoor temperature for natural ventilation, heating setpoint at 18°C.</i>	52

LIST OF FIGURES

6.3	<i>Time setpoint not met during occupied heating at various minimum indoor temperature for natural ventilation, heating setpoint at 18°C.</i>	52
6.4	<i>Increased energy demand at different relative humidity setpoints.</i>	53
9.1	<i>Average electricity prices for 36 cities in China, resident: 220v from January 2001 to March 2019 [39].</i>	80

List of Tables

1	<i>Total energy balance.</i>	v
2	<i>Total energi balanse.</i>	vii
2.1	<i>Thermal resistance interior and exterior surface.</i>	9
2.2	<i>Optimal operative temperature, category A, B and C, activity level: 1.2 met, Clothing level: 0.5 clo summer, 1.0 clo winter [6].</i>	16
2.3	<i>Optimal operative temperature, category A, B and C, activity level: 1.2 met, Clothing level: 0.5 clo summer, 2.0 clo winter [6].</i>	16
2.4	<i>Minimum required supplied airflow rate when occupied, TEK17 [36]</i>	19
4.1	<i>U-value requirements for new commercial buildings in hot summer cold winter climate zone, China [16].</i>	25
4.2	<i>U-values in the building envelope.</i>	27
4.3	<i>Function and dimension diagram</i>	28
4.4	<i>Function and dimension diagram, conditioned zones</i>	30
4.5	<i>Shanghai School Holidays 2019.</i>	30
4.6	<i>Nominal number of occupants in different rooms.</i>	31
4.7	<i>Design criteria for space heating, cooling and relative humidity.</i>	32
4.8	<i>COP of PTHP in different operation modes.</i>	33
5.1	<i>Energy demand for space heating and cooling using ideal air loads.</i>	35
5.2	<i>Peak energy demand for space heating and cooling using ideal air loads.</i>	36
5.3	<i>Energy demand using PTHPs [kWh].</i>	37
5.4	<i>Comparison of energy demand for space heating and cooling using ideal air loads and PTHP.</i>	37
5.5	<i>Energy demand, PTHP, scheduled operation, [kWh].</i>	38
5.6	<i>Comparison of energy demand for space heating and cooling using ideal air loads and PTHP.</i>	39
5.7	<i>Average and minimum air during occupied hours.</i>	40
5.8	<i>Average natural ventilation compared to TEK 17 requirements.</i>	40
5.9	<i>Electricity production from PV panels.</i>	42
5.10	<i>Total energy balance.</i>	43
5.11	<i>Investment cost for 13kW grid connected PV system.</i>	44
5.12	<i>Payback time for various investment costs.</i>	45
5.13	<i>Yearly cash flow, alternative 1.</i>	46
5.14	<i>Yearly cash flow, alternative 2.</i>	47
5.15	<i>Investment cost for PTHPs.</i>	48
5.16	<i>Economic analysis, PTHP, for various investment costs.</i>	49
6.1	<i>Energy demand for energy simulations including all thermal zones.</i>	54
7.1	<i>Total energy balance.</i>	58
7.2	<i>Payback time for various investment costs.</i>	59
7.3	<i>Payback time for various investment costs.</i>	59
9.1	<i>Calculation of U-value, wall.</i>	63
9.2	<i>Calculation of U-value, floor.</i>	63
9.3	<i>Calculation of U-value, roof.</i>	63
9.4	<i>U-values in building envelope.</i>	63
9.5	<i>Cost breakdown for a < 1MW building PV system [37].</i>	80

Abbreviations

ASHP Air Source Heat Pump

BIM Building Information Modeling

CAV Constant air volume

CO₂ Carbon dioxide

COP Coefficient of Performance

DCV Demand controlled ventilation

HP Heat Pump

Mtoe Million Tonnes of Oil Equivalent

NPV Net present value

nZEB net Zero Energy Building

PBT Payback time

PMV Predicted mean vote

PPD Predicted percentage of dissatisfied

PTHP Packaged Terminal Heat Pump

PV Photovoltaics

USD United States Dollars

VAV Variable air volume

Wp Watt power

Nomenclature

B Yearly balance [NOK]

I Investment costs [NOK]

n Economic lifetime [years]

Q Heat [kW]

r Real rate of return [%]

t_o Operative temperature [°C]

W Work [kW]

1. Introduction

1.1 Background and motivation

The global mean temperature on earth is increasing and has been since the industrial revolution that began in the 18th century. This increase in global mean temperature is happening at a more rapid pace than ever and is better known as global warming [13]. The temperature on earth depends on a great number of factors. One of the reasons the earth is habitable for human life is a phenomenon called the greenhouse effect. The greenhouse effect is the process by which radiation from the planet's atmosphere warms the planet's surface. This is possible due to greenhouse gasses that absorb reflected solar energy from the earth's surface and re-radiate the energy back to the earth. Greenhouse gases include water vapour, carbon dioxide (CO₂), methane, nitrous oxide, ozone and some artificial chemicals such as chlorofluorocarbons (CFCs) [8]. The problem occurs when humans increase the concentration of greenhouse gasses in the atmosphere due to energy production from fossil fuels, agriculture and land clearing. Increased concentration of greenhouse gases will lead to an enhanced greenhouse effect, in which more reflected solar energy will be absorbed, possibly resulting in an increase in global mean temperature.

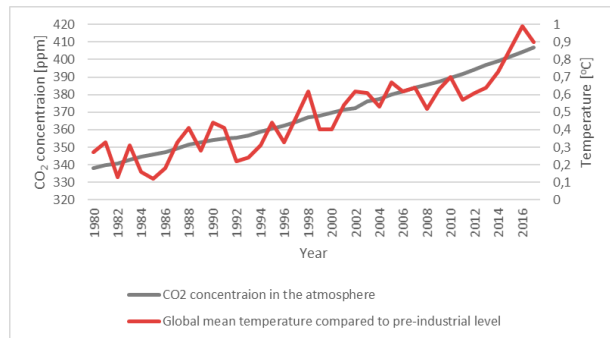

Figure 1.1: CO₂ concentration in the atmosphere and global mean temperature compared to pre-industrial levels from 1980 to 2017 [10][13].

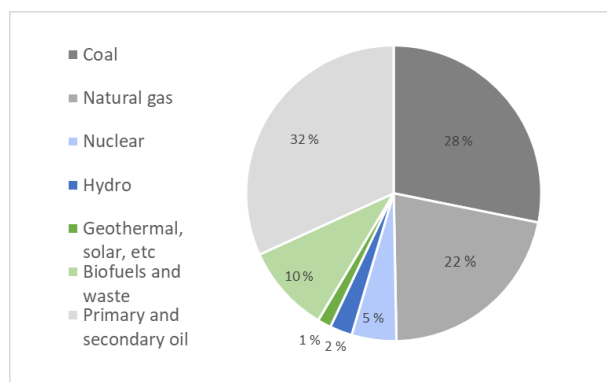

Figure 1.2: Total primary energy supply by source, 2015[2].

Energy production from fossil fuels results in emissions of CO₂. The global primary energy consumption was in 2015, 13 669 million tonnes of oil equivalent (Mtoe), and from figure 1.2, it can be seen that 81.5% of that came from the fossil fuels coal, natural gas and oil [12]. The global average CO₂ concentration was about 280ppm before the industrial revolution. By the end of 2017 it had increased by 44.6% to 404.97ppm [10]. Figure 1.1 shows a possible connection between the concentration of (CO₂) in the atmosphere and the global mean temperature. The concentration of CO₂ has increased approximately 1% yearly from 338.89 ppm in 1980 to 404.97ppm in 2017 [10]. The temperature has increased by 0.63°C in the same time frame, and was in 2016 a record high 0.99°C above pre-industrial levels [13]. A connection between the concentration of CO₂ in the atmosphere and the global mean temperature is hardly debatable. As the concentration of CO₂ continues to rise, the temperature on the planet is expected to do the same.

The consequences of a rise in global mean temperature are many and severe. The temperature in the sea will increase and expand due to a lower density as the temperature increase. Land-based ice such as glaciers will melt at a faster rate and will together with the increased sea temperature lead to a rise in the sea level. Higher and warmer sea levels means more frequent and more devastating storm surges that can reach further into land. It can also lead to cities and islands at sea level today, under water in the future [9]. Higher global mean temperature can also lead to more frequent heat waves, drought, more extreme weather and more intense rainfall at smaller areas, leading to floods. Extreme heat and floods will destroy crops and cause hunger crisis leaving million of people to suffer. This has already taken many lives and will cost many more in the future if nothing drastically is being done. Humans have the technology and knowledge to adapt to these rapid climate changes, the nature and its inhabitants are worse off. Species are going extinct and the coastal nature is being destroyed at a pace never seen before [7]. The magnitude of all of this depends on how much the global mean temperature increases. The difference between 1.5, 2 or even 3 degrees above pre-industrial levels are severe [14].

The Paris Agreement on climate change is an agreement signed by more than 190 countries, and the central aim is to reduce the damage of global warming to less than 2 degrees Celsius above pre-industrial levels and to pursue efforts to limit the temperature increase even further to 1.5 degrees Celsius[11].

An Intergovernmental Panel on Climate Change (IPCC) special report on the impacts of global warming states that emission of greenhouse gases needs to be reduced by 45% compared to 2010 by 2030 in order to achieve the goal of the Paris agreement [14]. There are four main approaches to obtain that goal. The first and most effective is reducing the global energy demand. The best saving measure is to not use the energy at all. The second is to replace energy produced by fossil fuels with energy from renewable sources. Solar-, hydro-, wind- and wave energy are examples of energy sources that are renewable. The third approach is to make energy production from fossil fuels more efficient. It is not realistic to cover the entire global energy demand by renewable sources within 2030, so it is important to make use of the energy from fossil fuels most efficient to reduce emissions of greenhouse gases. The last approach is to capture and store greenhouse gases such as CO₂ to reduce the levels of the gases in the atmosphere. This report is focusing on the first two approaches as they are most relevant to this topic.

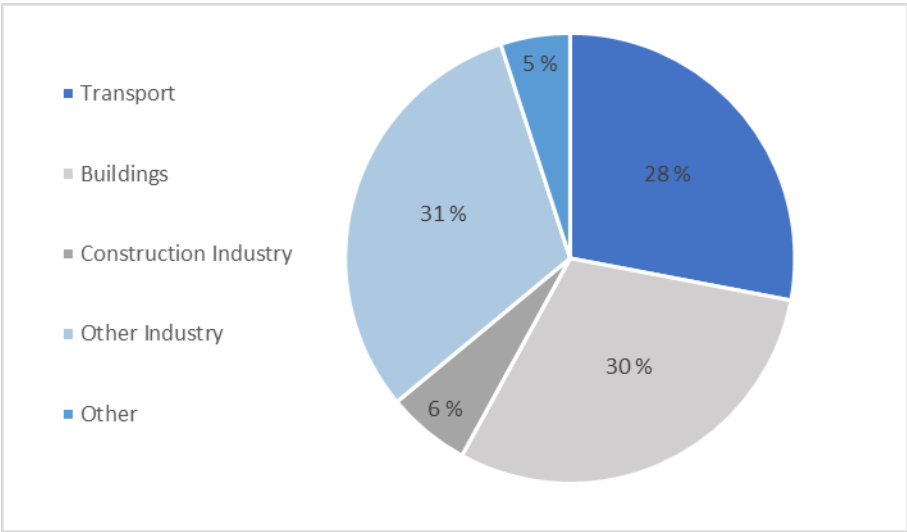

Figure 1.3: Global final energy consumption by sector, 2015 [2].

Figure 1.3 illustrates the global final energy consumption by sector and it can be noticed that the operation of buildings is responsible for 30% of final energy consumption globally [2]. To accomplish the target of the Paris Agreement, the building sector therefore has a huge responsibility. The energy demand of buildings in the future has to decrease and at the same time produce on site renewable energy.

1.2 Problem description

MASTER THESIS

for

student Håkon Hornburg Løken

Spring 2019

Energy and economic balance analysis for a Net Zero Energy Building with solar heating, cooling and PV electricity generation.

Energi og økonomisk analyse av en netto nullenergi bygning med utnyttelse av solenergi for oppvarming, kjøling og strømproduksjon.

Background and objective

Modern buildings are expected to cover their energy need with own on-site production based on renewable sources. In-depth research is expected for a net zero energy building for which the energy demand for heating, cooling and electricity are totally provided by PV systems. The energy and the economic aspects will be analyzed with mathematical model. The data may come from a real building in Shanghai.

The major part of the work should be performed as the Master thesis that is planned to be conducted at the SJTU during the spring semester 2019. This collaborative assignment is realized as a part of the Joint Research Centre in Sustainable Energy of NTNU and SJTU.

The following tasks are to be considered:

1. Review of the state-of-the-art progress in development of solutions for buildings where the energy demand for heating, cooling and electricity could totally be provided by building integrated solar thermal and PV systems. This should also take into account previous works performed at SJTU and NTNU.
2. Critical analysis of the existing models and simulation tools for building integrated solar thermal and PV systems that could cover buildings entire demand for heating, cooling and electricity. Consider application of the simulation tool Energy Plus in particular.
3. Build up an appropriate model for energy and economic balance analysis for a Net Zero Energy Building with solar heating, cooling and PV electricity generation.

4. Conduct preliminary analysis of a real case building by use of the developed model.
5. Conduct an energy and economic balance analysis for a Net Zero Energy Building with solar heating, cooling and PV electricity generation located in Shanghai. The work should also include a scientific paper. The work is to be performed during the Master thesis work in Shanghai.

The master thesis comprises 30 ECTS credits.

The work shall be edited as a scientific report, including a table of contents, a summary in Norwegian, conclusion, an index of literature etc. When writing the report, the candidate must emphasize a clearly arranged and well-written text. To facilitate the reading of the report, it is important that references for corresponding text, tables and figures are clearly stated both places. By the evaluation of the work the following will be greatly emphasized: The results should be thoroughly treated, presented in clearly arranged tables and/or graphics and discussed in detail.

The candidate is responsible for keeping contact with the subject teacher and teaching supervisors.

Risk assessment of the candidate's work shall be carried out according to the department's procedures. The risk assessment must be documented and included as part of the final report. Events related to the candidate's work adversely affecting the health, safety or security, must be documented and included as part of the final report. If the documentation on risk assessment represents a large number of pages, the full version is to be submitted electronically to the supervisor and an excerpt is included in the report.

According to "Utfyllende regler til studieforskriften for teknologistudiet/sivilingeniørstudiet ved NTNU" § 20, the Department of Energy and Process Engineering reserves all rights to use the results and data for lectures, research and future publications.

Submission deadline: 26 August 2019.

1.3 Goal

The goal of this research is to conclude if the *Green Energy Lab*, located in Shanghai Jiao Tong University, qualifies as a net zero energy building and if it is economically profitable. This will be done by performing energy simulation using building performance simulation tools. Different solutions for operation of the building will be analyzed and discussed to determine if there are ways to improve the energy performance of the building.

The profitability of the project will be investigated by performing an economic analysis. The energy and economic analysis will conclude what parts of the building saves the most energy, and what are most economic profitable. Finally the research will advise what can be done to improve the energy balance of the building. The goal is therefore to analyze the components separately and the building as a whole to conclude if the project is a success. The technology to achieve a net zero energy building is already existing and the main motivation of this study is to prove that it is not only possible, but also sustainable and profitable.

1.4 Structure

The thesis work is divided into 7 main chapters that are structured in the following way.

Chapter 1, *Introduction*, presents the background and motivation for the research, the problem description, the main goal, how the thesis is structured and limitations of the study.

Chapter 2, *Theoretical background*, introduces the technology that is studied and the theory it is based on. The chapter includes an introduction of the thermodynamic laws, heat transfer and energy management in buildings. The theory also defines indoor environment and how to achieve good indoor environment in the most energy efficient way. The chapter ends with an insight to how the economic analysis have been performed.

Chapter 3, *Methodology*, describes how the research has been conducted. The development of the model used for energy simulations is explained and the building performance simulation tools that has been used to perform energy simulations is presented and discussed. The chapter ends with information about the data collection and an discussion in regards of accuracy and limitations.

Chapter 4, *Model*, presents the building that is analyzed and the input settings for energy simulations. Detailed information of the building envelope and indoor environment design criteria are presented in this chapter. The chapter also includes information about the economic model and the different variables that needs to be accounted for.

Chapter 5, *Results*, presents the results of the study. The energy demand at various input settings are analyzed and compared. The electricity production from the PV panels is calculated and the result is compared with the energy demand, creating an energy balance. The results from the economical analysis is based on the energy analysis and is also presented in this chapter.

Chapter 6, *Discussion*, contains analysis and discussions of the results presented in chapter 5. The results will be discussed in regards of everything that has been presented and discussed previously.

Chapter 7, *Conclusion*, consists of the conclusion of the research.

A summary is included in the beginning of the report in Norwegian. The thesis ends with a plan for further work followed by an appendix.

1.5 Limitations

The building that is analyzed is a building with a complex energy structure, and the components analyzed does not include the complete system. The analysis focuses on energy demand for space heating and cooling and includes in addition energy demand for lighting. The energy demand for electrical equipment is not included which might result in a lower energy demand than the actual building. Some of the rooms that are listed as laboratories have large, energy demanding equipment that might have an impact on the indoor environment. The energy demanding equipment releases heat that might reduce the energy demand for space heating. The

effect of this is not studied in this research.

The building have rooms that are not in use or used different than how they were intended. Not all the rooms in the building are considered conditioned since they are not occupied. This might result in a lower energy demand than if the whole building was in use. They are still part of the model however to simulate the heat transfer between the zones more accurately. The energy demand for domestic hot water is also not included, leading to a lower energy demand. This is believed to not have significant impact as the building is used for laboratory work and student rooms for research proposes only.

The study is limited by assumptions about occupant behaviour and internal loads in the building that might lead to uncertainties in the results. The ventilation system in the building is dependent on opening of windows and assumptions have been made to recreate this. The results from natural ventilation are limited by these assumptions.

The building's shading facade is complex to recreate with a 100% accuracy in energy simulations, and has therefore been simplified. It is assumed to allow very little direct sunlight on the building facade so the simplification is believed to be of high accuracy in regards of heat transfer from solar radiation on the building envelope. The maximum allowed U-value by Chinese governmental regulations has been used where no other information has been available. This might result in a higher energy consumption than the real building.

2. Theoretical background

To fully understand the results presented in this study it is important to understand the underlying physical laws. This chapter introduces the most important physical laws in the contexts of the topic and the different technologies that are used in a literature study.

2.1 Energy

Energy is an abstract concept that can be difficult to define. A common definition is the capacity or ability of a physical system to do work. It may exist in potential, kinetic, thermal, electric, chemical, nuclear, radiant or other various forms. It is power derived from the utilization of physical or chemical resources, especially to provide light and heat or to work machines. Energy is measured in joules (J). Power is the rate of work or heat transfer, measured in Watt (W). Equation 2.1 describes the relationship between joules and Watt. Energy calculations from building performance simulations is usually of large values, and is therefore presented in kWh in this report.

$$J = W \cdot s \quad (2.1)$$

The different forms of energy have different qualities. The different qualities of energy can be divided into exergy and anergy. Exergy is energy that can be converted into other forms of energy, while anergy cannot. This leads to different classes of energy depending on the amount of exergy and anergy. First class energy is pure exergy that can be transformed to any other form of energy without limitations. Electricity is an example of first class energy. Second class energy is a mixture of exergy and anergy and can be transformed to other forms of energy to a limited degree. Third class energy is pure anergy that cannot be transformed to any other form of energy.

2.2 The law of conservation of energy

The laws of thermodynamics are some of the most important laws in all of physics. The laws are valid for a system within a boundary limit. The system can be defined as either a closed or an open system. It is defined to be open if a matter within the system can cross the boundary border, or closed if it cannot. Energy can be exchanged with the surroundings in both open and closed systems unless the system is defined as isolated.

The system studied in this research is the building, or certain rooms within the building, and the surroundings are the outdoor environment, or the rooms connected to a certain room. The system is defined as open, as air masses flows through the system boundaries.

The first law of thermodynamics is also known as the law of conservation of energy. This law states that energy is a conserved quantity, meaning it cannot be created or destroyed, only converted from one form to another. The law says that this can be done by either work, heat or

matter being passed into or out of a system, changing the internal energy of the system and its surroundings. The law of conservation of energy is described by equation 2.2.

$$\Delta E = q + w \quad (2.2)$$

where,

ΔE = Change in internal energy

q = heat that flows across the boundary

w = work done on the system by the surroundings

2.3 Heat transfer

Heat is second class energy that can be transferred to other forms through either conduction, convection, radiation or evaporation. In practice in a building it is a combination of conduction, convection and radiation and the heat balance is illustrated in figure 2.1. Heat will be transferred from one place to another as long as there is a temperature gradient, and the heat will always flow in the direction of decreasing temperatures.

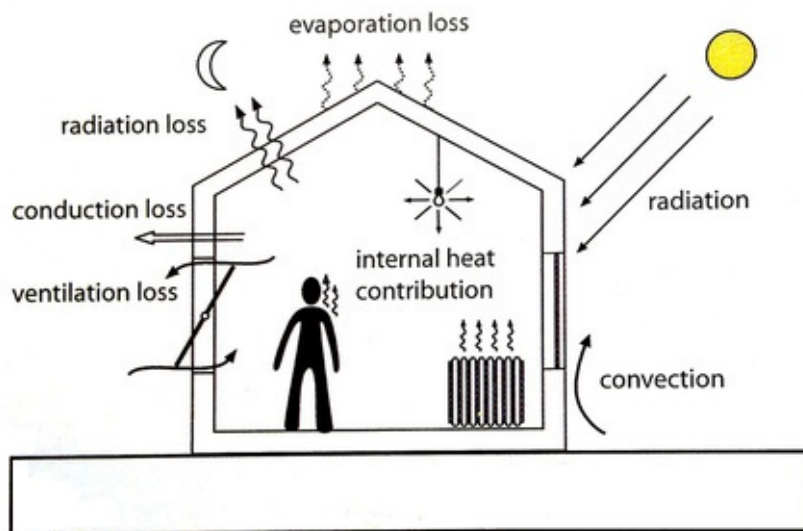

Figure 2.1: Heat balance in a building [18].

Conduction

Thermal conduction is heat flow within and through a body itself. Heat will be transferred through the building envelope when there is a temperature difference between indoor and outdoor air. Thermal conduction through a one layer material is illustrated in figure 2.2. The rate of the heat transfer depends on the size of the temperature gradient, the surface area and the thermal transmittance of the building envelope, also known as the U-value. Well insulated buildings

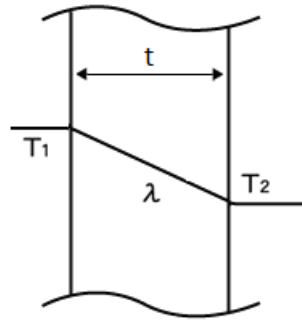

Figure 2.2: Thermal conduction through a one layer material.

have low U-values and transfers less heat through the building envelope. New buildings has to follow governmental regulations on maximum U-values. To calculate the U-value, the thermal resistance (R) needs to be calculated in each layer, and summarized to a total resistance through the building envelope. The thermal resistance in each layer is found using equation 2.3. There is in addition an interior and exterior surface resistance, which are summarized in table 2.1.

$$R = \frac{t}{\lambda} \quad [m^2K/W] \quad (2.3)$$

where,

t = Thickness of a layer [m]

λ = Thermal conductivity of the material [W/mK]

Table 2.1: Thermal resistance interior and exterior surface.

Layer	[m ² K/W]
Interior surface resistance, floor	0.17
Interior surface resistance, wall	0.13
Interior surface resistance, ceiling	0.10
Exterior surface resistance	0.04

The U-value of a building construction is calculated using equation 2.4 [1]. It can be noticed that a large thermal resistance gives a small thermal conductivity. This is achieved by having a high thickness or a low thermal conductivity of the materials.

$$U = \frac{1}{\sum R} \quad [W/m^2K] \quad (2.4)$$

The rate of heat transfer through conduction is given by equation 2.5.

$$Q = U \cdot A \cdot \Delta T \quad [W] \quad (2.5)$$

where,

A = Envelope area [m²]

ΔT = Temperature difference between outdoor and indoor air [K]

Convection

Heat transfer through convection can be described as heat transfer through movement of fluids. It occurs when there is a temperature difference between a solid and a fluid, like between the building envelope surface and the ambient air. The rate of heat transfer through conduction was first described by Newton and the relation is known as Newton's Law of Cooling, equation 2.6.

$$Q = h \cdot A \cdot \Delta T \quad [W] \quad (2.6)$$

where,

h = Convective heat transfer coefficient [W/m² K]

A = Envelope area [m²]

ΔT = Temperature difference between outdoor air and building surface [K]

Convection occurs either forced by external forces such as pumps or fans or naturally caused by buoyancy forces.

Radiation

Radiant heat transfer is thermal energy transferred by means of electromagnetic waves or particles. The most abundant example is the sun that radiates heat to the earth. Two objects radiates heat between each other and the net flow rate of heat between them is given by equation 2.7.

$$Q = \sigma \cdot A \cdot (T_1^4 - T_2^4) \quad [W] \quad (2.7)$$

where,

$\sigma = 5.670367 \cdot 10^{-8} \text{Wm}^{-2}\text{K}^{-4}$

A = Surface area [m²]

T₁ = Temperature of body 1 [K]

T₂ = Temperature of body 2 [K]

Heat transfer in a building

The total heat transfer in a building is complex and is a combination of all the different types of heat transfers. The occupants in the building, and the building installations and technical equipment inside is also contributing to the total energy balance.

2.4 Sustainable energy future

The total global primary energy demand growth has slowed down from an average of 8% yearly between 2000 and 2012 to less than 2% per year since 2012 [3]. Population growth and increased living standard in developing countries contributes to an increase in energy demand, but energy efficient regulations explains a large part of the decrease in growth rate.

There is a global shift in the energy system caused by among others, a rapid deployment and falling cost of clean energy and a growing electrification of energy. As the most populated country on the planet, China plays a huge role in determining global trends. Figure 2.3 shows the electricity demand in selected region for 2016 and an estimate growth to 2040. China had the biggest electricity demand in 2016, and is predicted to have the biggest growth to 2040 [3].

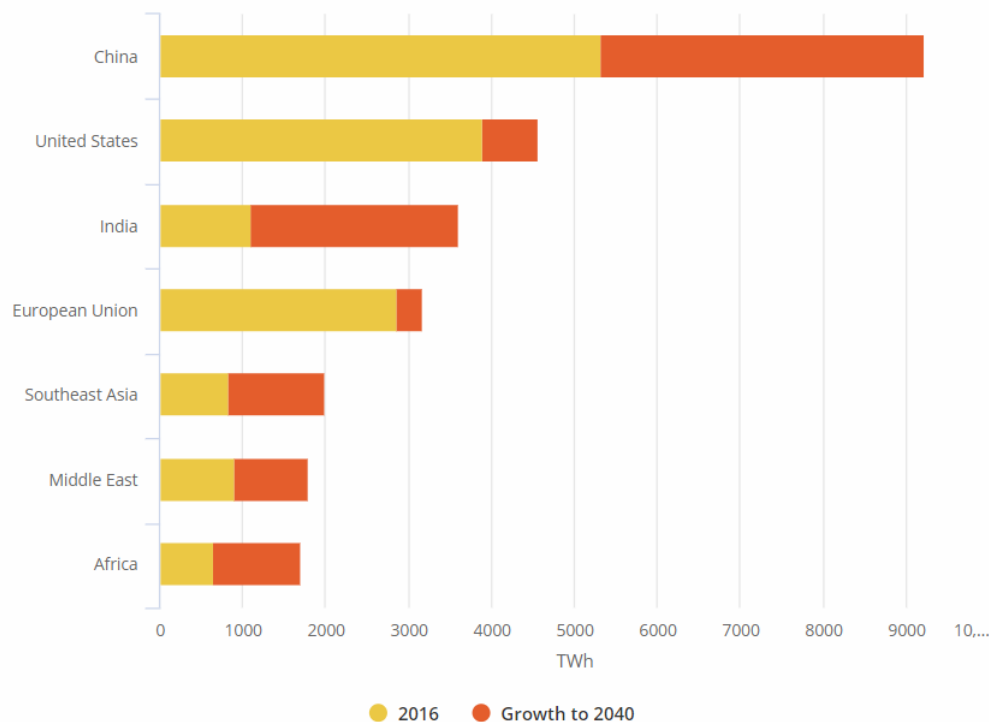

Figure 2.3: Electricity demand by selected region [3].

To cope with the enormous and increasing energy demand in a sustainable way, energy needs to be produced by environmental friendly sources. Nuclear power, biomass or renewable energy sources like hydro, solar, wind or geothermal are all examples of sources that does not contribute with emissions of greenhouse gases to the atmosphere. Rapid deployment of solar PV in China

in particular is the start of a phase the Chinese president calls for *an energy revolution*. Figure 2.4 illustrates the global average annual net capacity additions by type for the time frame 2010 - 2016, compared to an estimation of 2017 - 2040. [3]. Growth in energy produced by coal is decreasing in the next decades, and renewable sources are increasing rapidly.

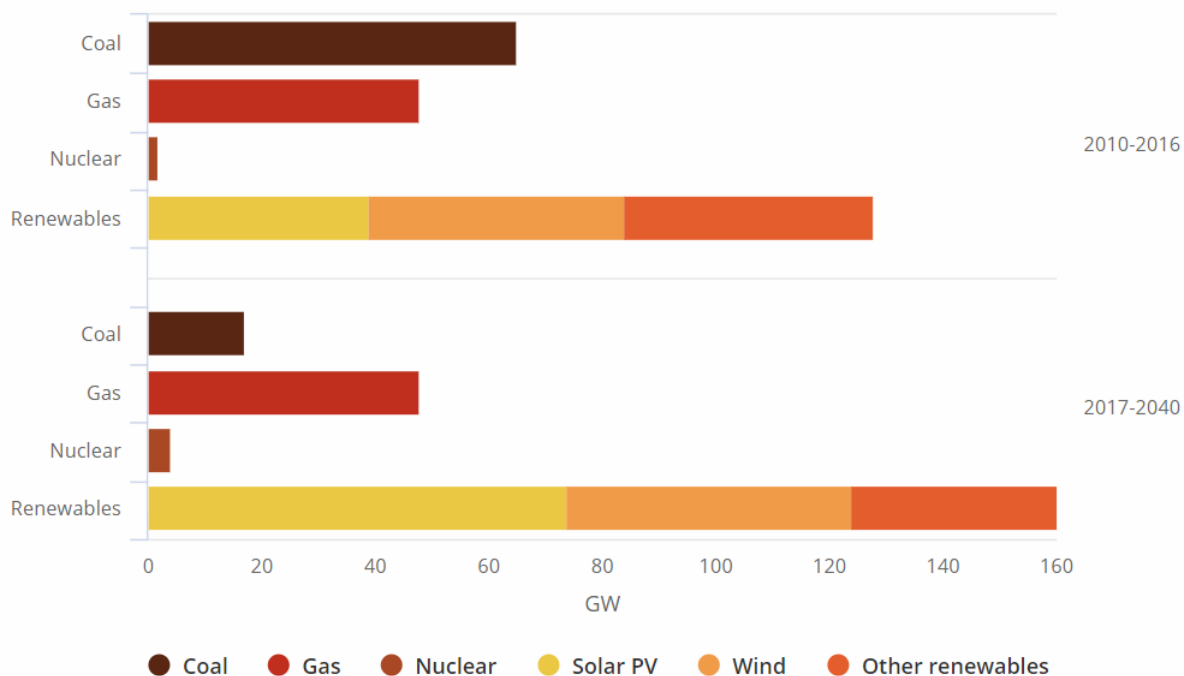

Figure 2.4: Global average annual net capacity additions by type [3].

2.5 Net Zero Energy Buildings

A building is defined as a permanent or temporary structure enclosed by a building envelope, including building installations. The main purpose for a building is to give protection against external climate and disturbances, and to provide a healthy and comfortable indoor environment [1]. This should be achieved without demanding too much energy and causing unreasonable high expenses in regards of investment and operational costs of the building. Net Zero Energy Buildings (nZEBs) are defined as buildings that aim to minimize the environmental impact by reducing the energy demand and producing on site renewable energy that compensates for the energy demand. The term net is used to refer to that the building is connected to the energy infrastructure and underlines the fact that there is a balance between energy taken from and supplied back to the energy grid over a period of time. This is due to uneven energy demand and production throughout the year. Zero Energy means that the energy production from building installations on site has to produce at least as much energy as the energy demand of the building. An illustration of a building including building installations is displayed in figure 2.5.

The energy consumption of a building depends on the external climate, the building envelope, technical installations, operation and maintenance of the building. The operation and maintenance is depending on the occupant behaviour and wanted indoor environmental conditions and are referred to as human influenced factors. External climate, the building envelope and

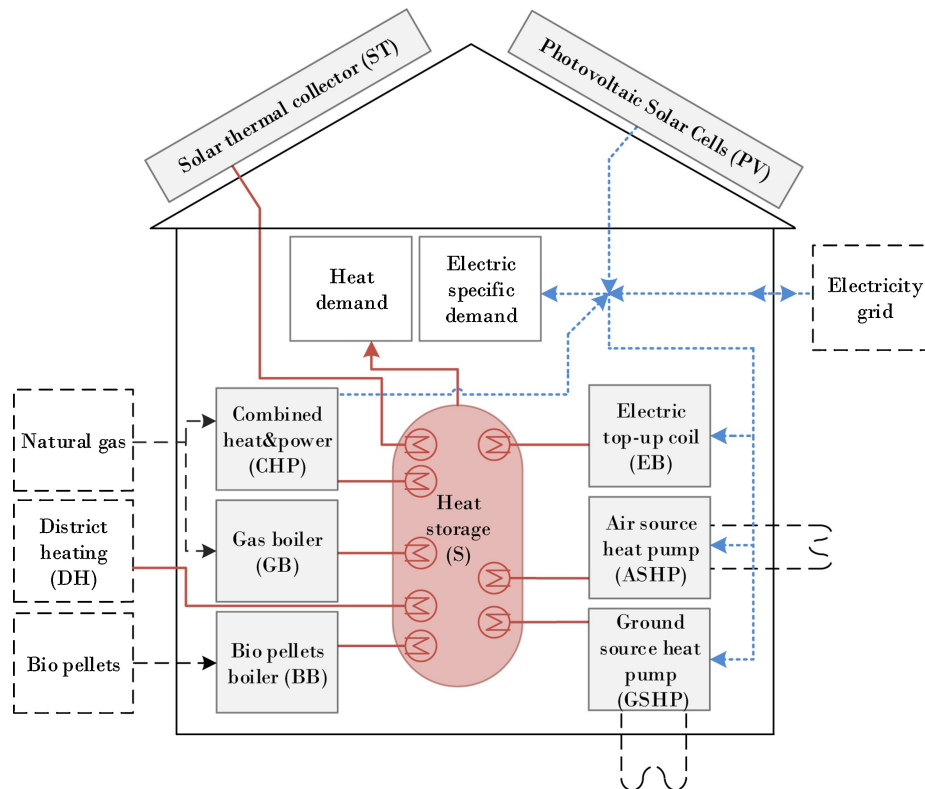

Figure 2.5: A building, including building installations with connection to electricity grid [25].

building installations are, unlike the human influenced factors, factors that can not be changed and controlled by humans as desired [1]. The energy demand of a building is the energy needed for space heating and cooling, ventilation, domestic hot water, lighting and equipment. The total energy balance of a building is complex and internal loads also needs to be accounted for when evaluating the complete energy calculation for a building. The internal loads and occupant behaviour is difficult to predict, and might lead to some uncertainties in the results.

Each building is unique and a load duration curve can be used to ensure correct sizing of the building installations. A load duration curve, illustrated in figure 2.6, is an estimation of total energy demand over a year and describes the size and duration of different heat or cooling demands. A load duration curve might reveal a high peak demand, for a short amount of time each year. A system with low operation cost could be installed to cover the base load which could cover between 90-95% of total energy demand. It is not always desirable to cover the entire energy demand by this system if the investment cost for the effect needed is high. Therefore a system with a low investment cost could be installed to cover the peak load demand, even though it has a higher operation cost [1]. As each building has a different demand, this has to be taken into consideration.

2.6 Indoor environment and thermal comfort

A study done in 2001 showed that people spend in average almost 87% of their life inside buildings, either at home, at school or at work [15]. The indoor environment has therefore an enormous impact on human health and well being. Productivity is related to the ability to per-

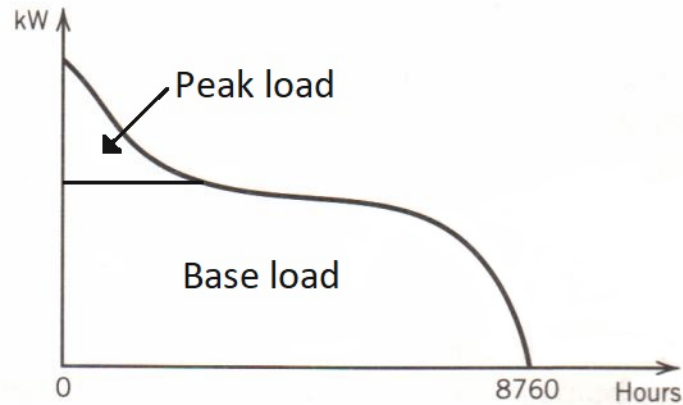

Figure 2.6: Load duration curve over a year [24].

form various tasks and studies have shown a clear connection between productivity and indoor environment [5]. The noise level, temperature and perceived air quality are all parameters that has an effect on the productivity level. Studies have shown that people perform tasks more accurately, faster and over a longer time with increased productivity. Other consequences are that people feel healthier, sustain stress more effectively and enjoy spending time at work [5]. Less sick leave and improved performance is very economically beneficial for a company, although difficult to put a number on. Indoor environment can be defined as a composite of the five elements; Thermal-, atmospheric-, acoustic-, actinic-, and mechanical environment [27]. The acoustic and mechanical environment has low impact on the energy use and operation costs and will not be discussed further in this report.

The thermal environment depends on the indoor air temperature, surface temperatures, temperature gradients, relative humidity and air velocity. The thermal comfort is defined as 'that condition of mind which expresses satisfaction with the thermal environment' [6], and depends also on the clothing level and activity level of the occupants. Clothing level describes the thermal resistance between the surface of the skin and the outer surface of the clothing, with the unit clo. Activity level is a measure of the metabolic rate from energy production by the human body with the unit met.

$$1 \text{ Clo} = 0.155 \text{ [m}^2\text{K/W]}$$

$$1 \text{ met} = 58 \text{ [W/m}^2\text{]}$$

Sedentary activities like office work is equal to 1.2 met, or 70 W/m^2 [27]. Average body surface area of an adult man is 1.9 m^2 and is used for energy calculations in this study. One person with an activity level of 1.2 met is equivalent of generating 132 W.

Thermal comfort is an individual perception which makes it difficult to please everyone. Predicted Mean Vote (PMV) is a 7-point scale from cold to hot, ranging from -3 to +3, where 0 corresponds to thermal neutral, that can be calculated for a given situation. Predicted Percentage of Dissatisfied (PPD) can be derived from PMV and is the predicted percent of people that are dissatisfied with the thermal comfort at each PMV [27]. Figure 2.7 illustrates the relation between PMV and PPD. A lower PPD means more people are satisfied with the thermal comfort, but might be more energy demanding as it demands a higher precision in operative temperature.

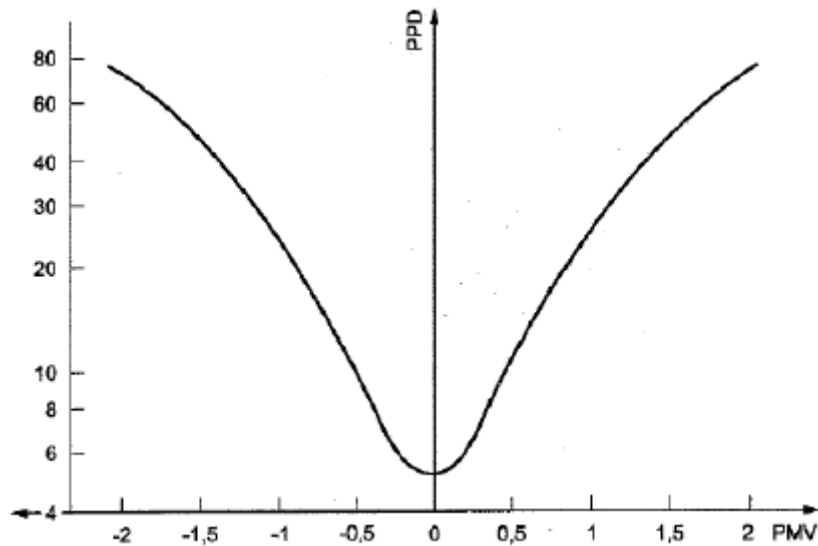

Figure 2.7: Relation between PMV and PPD [28].

Figure 2.8 shows the optimum operative temperature in category A for different activity and clothing levels. Clothing level 1 clo and activity level 1.2 met gives an optimum operative temperature of $22.0^{\circ}\text{C} \pm 1.0^{\circ}\text{C}$, and clothing level 0.5 clo and activity level 1.2 met gives an optimum operative temperature of $24.5^{\circ}\text{C} \pm 1.0^{\circ}\text{C}$. A summary of design conditions for category A, B and C are presented in table 2.2. Operative temperature (t_o) is defined as "the uniform temperature of an imaginary black enclosure in which an occupant would exchange the same amount of heat by radiation and convection as in the actual non-uniform environment" [6].

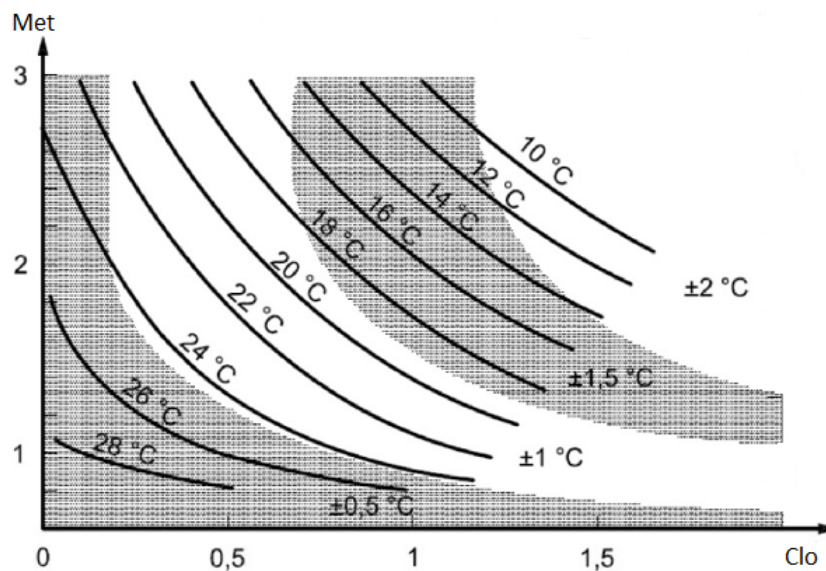

Figure 2.8: Optimum operative temperature category A [29].

With metabolic rates between 1.0 and 1.3 and air velocities below 0.10 m/s, operative temperature can be calculated using equation 2.8 [27].

$$t_o = \frac{(t_a + t_{mr})}{2} \quad (2.8)$$

where,

t_a = Air temperature [$^{\circ}\text{C}$]

t_{mr} = Mean radiant temperature [$^{\circ}\text{C}$]

Table 2.2: Optimal operative temperature, category A, B and C, activity level: 1.2 met, Clothing level: 0.5 clo summer, 1.0 clo winter [6].

Category	Operative temperature [$^{\circ}\text{C}$]	
	Summer	Winter
A PPD < 6	24.5 \pm 1.0	22.0 \pm 1.0
B PPD < 10	24.5 \pm 1.5	22.0 \pm 2.0
C PPD < 15	24.5 \pm 2.5	22.0 \pm 3.0

There are many factors that decides preferred operative temperature in addition to activity level and clothing level. Sex, age, health condition and culture are other factors. The difference between cultures becomes visible comparing Norway and China. It is normal to wear more clothes indoor in China, rather than turning up the thermostat. A summary of design criteria with clothing level equal to 2.0 clo in the winter is given in table 2.3. A higher clothing level leads to a lower heating setpoint temperature.

Table 2.3: Optimal operative temperature, category A, B and C, activity level: 1.2 met, Clothing level: 0.5 clo summer, 2.0 clo winter [6].

Category	Operative temperature [$^{\circ}\text{C}$]	
	Summer	Winter
A PPD < 6	24.5 \pm 1.0	18.0 \pm 1.5
B PPD < 10	24.5 \pm 1.5	18.0 \pm 2.0
C PPD < 15	24.5 \pm 2.5	18.0 \pm 3.0

Atmospheric environment indicates the perceived indoor air quality and depends on the concentration of air pollutants in the indoor air, amount of particles and smell. Ventilation is used to provide good indoor air quality by supplying fresh air and extracting contaminated air. The ventilation rate should be based on pollution load from occupants and materials. Concentration of CO_2 is a common way to control the quality of the air. The gas is not toxic for humans at low levels but gives a good indication of how good the air change per hour (ACH) in a room is [27].

Actinic environment is an indication of the quality of light inside the building and is described by the daylight factor. The daylight factor represent the amount of illumination available indoors relative to the illumination present outdoors at the same time under overcast skies [27].

2.7 Building Installations

To achieve good air quality and obtain acceptable thermal comfort in the building, systems for heating, cooling and ventilation needs to be installed. Building installations include all attached and fixed installations connected to a building. That includes systems for heating, cooling, ventilation and sanitary, which has the collective term HVAC systems. It is also consisting of all electrical and gas installations, fire alarms and fire extinguishing installations and access and intruder control. This research will focus on the systems for space heating and cooling, photovoltaic panels for electricity production, ventilation system and lighting as they are most relevant for an energy and economic analysis [1].

2.8 Ventilation system

The purpose of a ventilation system is to provide good indoor air quality by supplying fresh air and removing pollutants and odors. This can be achieved by natural forces like wind and pressure differences or by mechanical forces with the use of fans. It is also possible to combine the two methods to a hybrid ventilation system [1].

Natural ventilation utilizes natural forces and are the most economical in terms of installation and operation costs. It does not require any fan power and require very little maintenance. The fresh air supply depends on pressure differences caused by the wind or buoyancy because of temperature differences between indoor and outdoor air. Natural ventilation has limitations however in controlling the indoor environment. The fresh air is supplied without any use of filters, heating or cooling coils. This can cause unwanted draught that can feel uncomfortable. The filter is especially important in areas with bad outdoor air quality. A report including data from all over the world presenting PM_{2.5} concentration found that Asian locations dominating the most polluted cities. PM_{2.5} refers to particulate matter which measure up to 2.5 microns in size. It is regarded as the pollutant with the most health impact of all commonly measured air pollutants. Due to its small size PM_{2.5} is able to penetrate deep into the human respiratory system, causing a wide range of short and long term health effects. WHO recommends an annual mean exposure threshold of $10\mu\text{g}/\text{m}^3$ to minimize the risk of health impacts of PM_{2.5}. Figure 2.9 defines different levels of air quality [34].

China was in 2018 estimated to have an average PM_{2.5} concentration of $41.2\mu\text{g}/\text{m}^3$ based on available data. Shanghai had an average PM 2.5 concentration of $36.0\mu\text{g}/\text{m}^3$ in 2018. That is according to US AQI at a level which is unhealthy for sensitive groups, and above the recommended concentration levels from WHO. Using natural ventilation, without any form of air cleaning, on days where the outdoor air quality is bad can cause health risks [34].

The natural ventilation depends on windows or other openings to be opened, and this is often controlled by temperature by the occupants rather than the air quality. That might lead to less ventilation on colder days, reducing the indoor air quality [1].

A mechanical ventilation system is capable of obtaining the best indoor environment at all times, if designed properly. It is however more costly to install than natural ventilation and the most energy demanding in operation. It requires the use of fans and the filters and ducts needs







US AQI Level			PM2.5 ($\mu\text{g}/\text{m}^3$)	Health Recommendation (for 24hr exposure)
	Good	0-50	0-12.0	Air quality is satisfactory and poses little or no risk.
	Moderate	51-100	12.1-35.4	Sensitive individuals should avoid outdoor activity as they may experience respiratory symptoms.
	Unhealthy for Sensitive Groups	101-150	35.5-55.4	General public and sensitive individuals in particular are at risk to experience irritation and respiratory problems.
	Unhealthy	151-200	55.5-150.4	Increased likelihood of adverse effects and aggravation to the heart and lungs among general public.
	Very Unhealthy	201-300	150.5- 250.4	General public will be noticeably affected. Sensitive groups should restrict outdoor activities.
	Hazardous	301+	250.5+	General public is at high risk to experience strong irritations and adverse health effects. Everyone should avoid outdoor activities.

Figure 2.9: *United States Air Quality Index (US AQI)* [35]

more maintenance. The filters ensures clean air to be supplied to the room and the heating and cooling coil ensures that the air is supplied at the right temperature [1].

A hybrid ventilation system is the best of both solutions as it uses less energy than mechanical ventilation, and achieves better indoor environment than natural ventilation. The negative side is that it is more complex and therefore more expensive to install [1].

The most common ventilation methods are mixed and displacement ventilation. Mixed ventilation is based on the principle that all air inside a room is completely mixed with a uniform temperature and pollutant concentration. Fresh air is supplied into the room at high velocities to make that happen. Displacement ventilation utilizes buoyancy forces as colder air is supplied close to the floor before heated up by pollutant sources. The heated air then rise and bring contaminants away from the occupied zone before exiting the room close to the ceiling. Displacement ventilation is preferable to use in rooms that are high enough for the buoyancy effect to effectively carry the contaminants out of the occupied zone. One disadvantage of displacement ventilation is the risk of draft from supplying cold air into the occupied zone [1].

The ventilated air can be supplied and extracted at a constant air volume (CAV) or with a variable air volume (VAV) with the use of demand controlled ventilation (DCV). DCV can use temperature, occupancy or CO₂ concentration sensors to decide how much fresh air the ventilation system should provide to maintain good indoor air quality. DCV is a more complex system that has a higher investment cost, but can be cheaper and more accurate in operation. CAV is not as flexible as DCV but also has the possibility of supplying air at different rates according to predefined schedules [1].

Air flow is typically expressed in either [l/s] or [m³/h]. It can also be described in air changes

per hour (ACH), indicating how many times the entire volume of air has been changed in the time frame of one hour. The recommended ACH varies depending on the use of the room, the amount of people and the size of the room. The minimum requirements from TEK17 is listed in table 2.4.

$$1 \text{ [l/s]} = 3.5 \text{ [m}^3\text{/h]}$$

$$1 \text{ ACH} = \frac{V}{h} \text{ [m}^3\text{/h]}$$

Table 2.4: Minimum required supplied airflow rate when occupied, TEK17 [36]

	m ³ /h
Per person	26
Per m ²	2.5

2.9 Heating and cooling system

To achieve desired indoor air temperature, a heating and cooling system is necessary. There exists many ways of doing this but one of the most energy efficient ways of doing it is with the use of a heat pump.

2.9.1 Heat pump

A Heat Pump (HP) is a system that reduces the primary energy use by utilizing renewable energy and can be used for heating and cooling purposes. There exists many different types of heat pumps, with different working fluids, but they are all based on the same main principle. The heat pump consists of the four main components: A compressor, a condenser, an expansion valve and an evaporator. The evaporator extracts heat from a heat source and transfer the heat to a working fluid. The working fluid transfers thermal energy to the supply system by changing state throughout a continuous cycle driven by the compressor. A simple sketch is shown in figure 2.10 to illustrate the principle behind the heat pump [23].

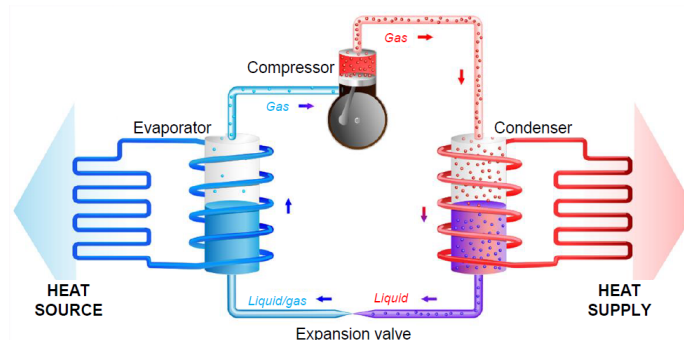

Figure 2.10: Heat pump cycle [23].

A heat pump has typically a coefficient of performance (COP) of between 2 and 5, depending on the type, which means it can reduce the energy demand for space heating and cooling by between 50-80%. The energy saving can be calculated using equation 2.9 and is illustrated graphically in figure 2.11 [23].

$$\text{Energy saved} = 100 - \frac{1}{\text{COP}} \cdot 100 \quad [\%] \quad (2.9)$$

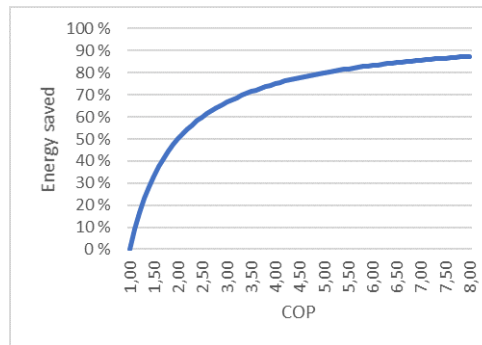

Figure 2.11: Relationship between COP and energy savings

Increasing the COP from 1 to 2 has an enormous impact on the energy demand, saving 50% of energy. The percentage of energy saved grows slower as the COP increases further. A COP of 3 results in 67.7% energy saved, and a COP of 4 results in 75% energy saved. The COP can be calculated using equation 2.10 where Q is the delivered heat, and W the necessary work done by the compressor [23].

$$\text{COP} = \frac{Q}{W} \quad (2.10)$$

Heat pumps can utilize different types of renewable energy depending on the location and availability of resources. Different sources are ground, ground water, sea water, gray water, sewage and air. Air source is the cheapest in installation and is a good option for small and medium buildings with a low heating and cooling demand. Air source heat pump is the type that will be analyzed and discussed in this report [23].

Air Source Heat Pump (ASHP)

Ambient air is the most available heat source for use in a heat pump, has the lowest installation costs and are for those reasons among the most commonly used in heat pumps. A similar heat source is exhaust air from the ventilation system, which has a slightly higher investment cost, but a lower operation cost and maintenance need. Exhaust air has a more steady, reliable temperature than ambient air. Exhaust air is however not the optimal solution when a heat recovery unit is installed, as they reduce the efficiency of each other [23].

2.10 Solar energy

For the building to qualify as a nZEB it needs to produce on-site renewable energy equal to, or greater than, the primary energy use. Solar energy is an important source of renewable energy, and has a potential greater than the total world energy demand [4]. It is however demanding to utilize more than a fraction of that incoming energy. Solar energy can be utilized in the shape of thermal energy by direct solar gains, or by solar thermal collectors. Solar energy can also be converted into electricity by photovoltaics (PV), or applied directly as daylight [1].

Photovoltaics

Electricity is generated from solar energy by transforming radiation into electricity using photovoltaic cells and storing the generated power in batteries. The electricity produced can be used directly or exported and sold back to the grid. PV panels produces and stores direct current (DC) electricity which needs to be converted by an inverter to alternating current (AC) used on the grid. Modules commercially available today has an efficiency in the range 15% to 20% of the irradiation, and can be installed on the outside of the building envelope [1].

2.11 Building automation

Building automation is the concept of controlling the building systems according to schedules or different sensors to optimize the indoor environment and reduce the energy demand. The main purpose is to provide the right amount of heating, cooling, ventilated air and lighting when people are present in the building. Temperature sensors ensure the right temperature and relative humidity sensors ensures the right level of humidity. Timers can be used to define different conditions during daytime when the building is in use, and at night time when the building is empty. This is referred to as night setback [1].

2.12 Economic analysis

Renewable, on-site energy is crucial to reach the goal of the Paris agreement. The technology and knowledge exists, but the transition to renewable energy will be slow if it is not profitable to invest in it. The profitability depends on the investment costs (I)[RMB], the life time (n) [years] of the system, real rate of return (r) [%] and yearly cash flow (B)[RMB/year] [1].

Net present value (NPV) is a technique that predicts future cash flow. It gives an estimation of how profitable the investment is at the end of the economic life time, and the calculation is given in equation 2.11. The investment is profitable as long as the NPV is positive [1].

$$NPV = -I + \sum_{i=1}^n \frac{B}{(1+r)^i} \quad [RMB] \quad (2.11)$$

where,

I = Investment cost [RMB]

i = Year []

n = Lifetime of investment []

B = Cash flow from investment [RMB]

r = rate of return that could be earned in alternative investment.

The calculation of NPV is a way of comparing your investment to an alternative investment. It is not even always enough that the investment is profitable, if another investment is more profitable. Comparing the investment to other investments is not that relevant to this study, as the goal is to be a net zero energy building. As the life time of the investments often stretches over many years, inflation has a big impact. The calculations of NPV should therefore take inflation into account. This can be done by calculating NPV with nominal cash flow.

$$B_{nom} = B \cdot (1 + inf)^i$$

Net present value calculated with adjustment for inflation is given in equation 2.12.

$$NPV = -I + \sum_{i=1}^n \frac{B_{nom}}{(1+r)^n} \quad [RMB] \quad (2.12)$$

Internal rate of return is the rate of return that results in a NPV equal to zero. That means the lowest rate of return an alternative investment needs to have to be more profitable.

Payback time (PBT) is a way of calculating the time it will take for the investment to break even. The pay back time is calculated using equation 2.13. If the payback time is shorter than the lifetime, the investment is considered to be profitable. Inflation needs to be accounted for when calculating the payback time.

$$PBT = \frac{I}{B_{nom}} \quad [Years] \quad (2.13)$$

3. Methodology

To perform the energy and economic analysis mathematical models have been used. A building performance simulation tool performed the energy simulations.

3.1 Building performance simulation tools

Building performance simulation is a computer based, multidisciplinary, and problem oriented mathematical model of a given aspect of building performance based on fundamental physical principles and engineering models. It assumes dynamic boundary conditions and is normally based on numerical methods that aim to provide a simplified and approximate solution of a phenomenon or object of the real world [26]. It has been adopted in this research to estimate the behaviour of a real building to improve the operation. Many different simulation tools exist and they vary in system layouts and degree of details in their approach. EnergyPlus has been used and discussed to simulate the energy demand in this research.

EnergyPlus

EnergyPlus is a whole building energy simulation program used to model energy consumption for heating, cooling, ventilation, lighting and plug and process loads. EnergyPlus is funded by the U.S. Department of Energy's (DOE) Building Technologies Office (BTO), and managed by the National Renewable Energy Laboratory (NREL). The program is available for free download for non commercial individual and educational use [17].

Building performance simulation tools obey to the law of conservation of energy. The energy simulation tool treats each room as an open system, with the walls, windows, floor, ceiling and doors being the boundary limit. The surroundings are the outside boundary condition defined.

Energy model work flow

The energy simulation is done in EnergyPlus. EnergyPlus however lacks a user friendly interface, so Building Information Modeling (BIM) work flow has been split up using several different software. Figure 3.1 illustrates the division of tasks performed.

SketchUp is a 3D modeling design software developed by Trimble Inc and offers a free version, SketchUp Free, that is available online. That version has been used to design the building geometry, assign thermal zones and create building shading facade.

OpenStudio is a cross-platform collection of software tools to support whole building energy modeling using EnergyPlus. The OpenStudio SketchUp Plug-in was used, as SketchUp geometry could be imported. The OpenStudio Application is a fully featured graphical interface to OpenStudio models including envelope, loads, schedules, and HVAC.

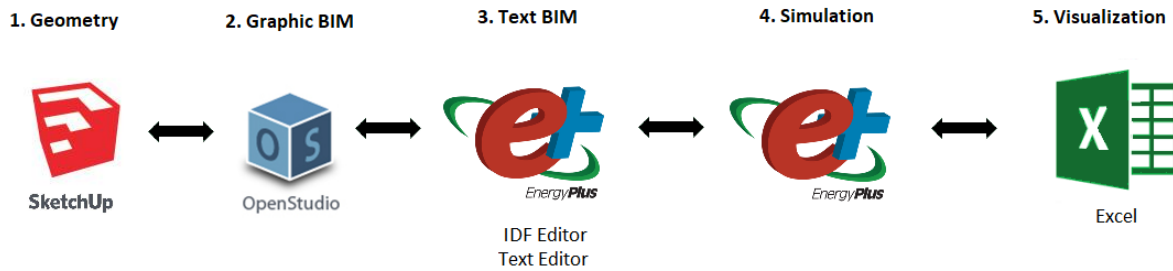

Figure 3.1: *Energy model work flow.*

The graphical interface of OpenStudio has been easier to work with than the textual interface of EnergyPlus, IDF Editor. It was however not always the case, as the EnergyPlus Text Editor and IDF Editor was especially valuable to find and solve errors.

OpenStudio and EnergyPlus generates some graphs and tables directly from simulations, that can be used displaying the results. They generate the results mostly however in kBTU and GJ respectively, and Excel has therefore been used to convert these values into SI units.

3.2 Data collection

The input data for the energy simulation has been collected from the development design documents of the building, discussions with professor DAI, and observations at the site. When there was a difference from the design drawings and the real building, the model has attempted to represent the real case. The weather data file *CHN Shanghai 583670 IWE*C has been used for energy simulation.

The focus for the energy simulation was on accurate U-values for the building envelope. This was believed to be of greatest impact on the energy demand. Professor DAI at Shanghai Jiao Tong University has been the main source for these values. When U-values were unknown or uncertain, a higher value was used to ensure that the real case is equal to, or better than the simulation.

Occupant schedule are meant to represent a typical student and research schedule. Human behaviour is difficult to predict and the schedule is likely to not represent the occupant behaviour with complete accuracy. There might be days where there are more people present, for a longer period of time. There might also be days where there are less people present, for a shorter amount of time. The only holidays that are included is the school holidays, between school semesters. Although the schedules and the predicted occupant behaviour possibly is inaccurate, the total average is believed to be accurate. The number of people in each room, and the use of each room is based on observations and discussions with people that are using the building on a daily basis.

Literature studies have been conducted to determine the economic analysis. Excel has performed the economic analysis based on the equations presented in section 2.12.

4. Model

This chapter describes in detail the building that is analyzed, the purpose of the building, the technical installations, assumptions and simplifications that are made for the model used in energy simulations.

4.1 Location and climate

The building analyzed is located in Shanghai, China, at Jiao Tong University, Minhang campus. Shanghai is in the south east of Asia at an latitude of 31.17° N and longitude of 121.43° E. This is in the category "hot summer and cold winter zone", according to Chinese regulations [30].

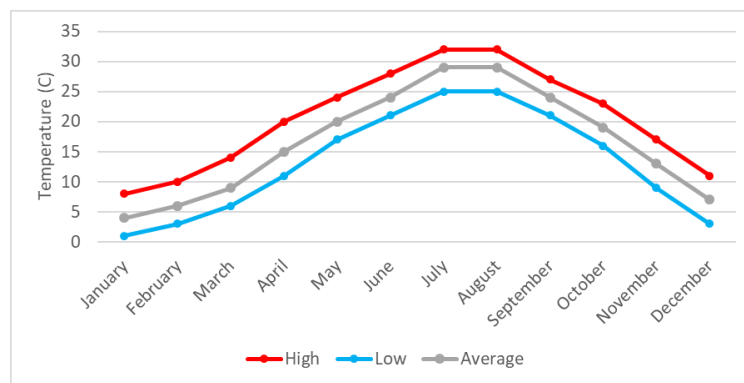

Figure 4.1: Average temperature in Shanghai by month [19].

Figure 4.1 illustrates average monthly temperatures in Shanghai. There is a demand for heating in the winter months, and cooling in the summer months to obtain an optimal indoor environment. Relative humidity levels are low in the winter and high in the summer in this region. Humidification and dehumidification is necessary to obtain desired indoor environment [17].

4.1.1 Laws and regulations

The authorities in China has decided design standards for U-values for new commercial buildings according to what climate zone the building is located. The values for climate zone *hot summer cold winter* are listed in table 4.1 [16].

Table 4.1: U-value requirements for new commercial buildings in hot summer cold winter climate zone, China [16].

Construction	U-value [W/m ² K]
Roof	0.7
Wall	1
Floor	1
Window	2.5
Other	3

4.2 The building

The building that is analyzed is Sino-Italian Green Energy Lab (GEL) at SJTU, Minhang campus. The building was opened in May 2012 and is a research, testing and demonstration platform for new energy and energy-saving technology in construction and it is a platform for international cooperation and exchange. The building is used by students, PhD candidates, professors and researchers at SJTU. Figure 4.2 illustrates a concept drawing of the building.

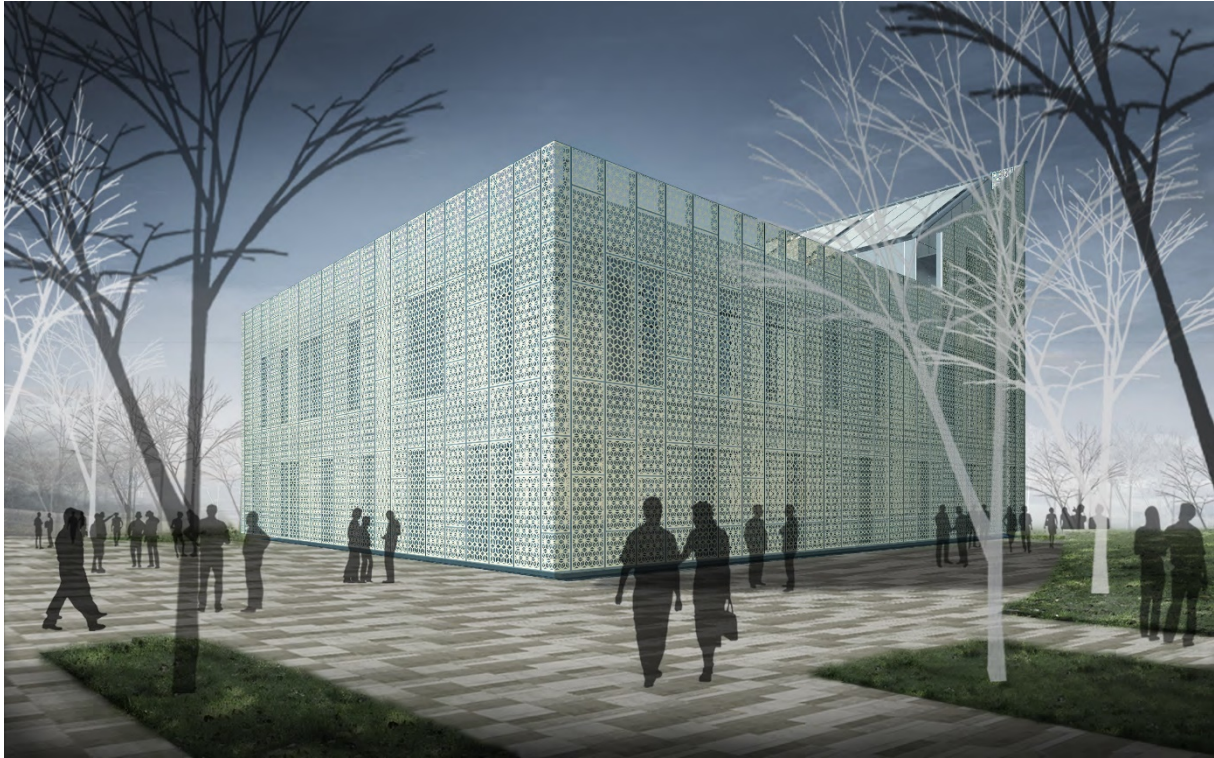

Figure 4.2: *South east view, concept drawing of GEL.*

4.3 Building Envelope

Building facade

The building is surrounded by a facade that's purpose is to provide shade from solar radiation and at the same time let illumination from the sun in, to naturally light up the inside of the building. A facade option similar to the real facade is illustrated in figure 4.3. Modelling a facade similar to that would demand considerable increase in computational power without increasing the chance of a more accurate result. The facade is therefore simplified by providing shade for most of the building surface that is covered by the facade. There are some areas on the facade that are opened to let even more sunlight in, and the model is designed in the same way. The building model, with its shading facade, is illustrated in figure 4.4. The entire tilted shading surface above the third floor is covered by PV panels.

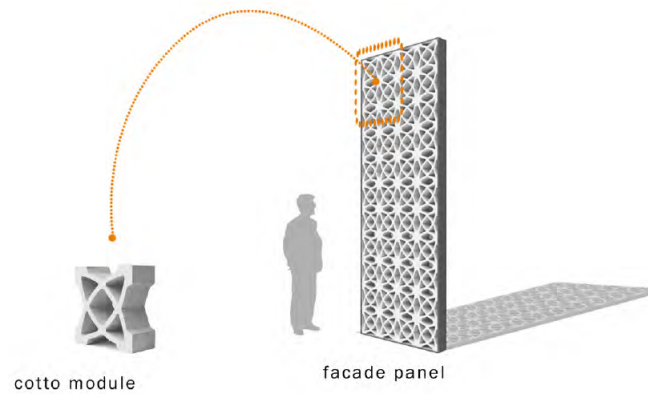

Figure 4.3: *Concept drawing of facade panel.*



Figure 4.4: *South east view, Sketchup model.*

U-values

The U-values of the building envelope is summarized in table 4.2. They are considered to be of most importance to the energy calculations and are therefore as close to the real case as possible. The materials used might divert from the materials used in the real building but are modelled as realistic as possible, with the information available. The U-values from table 4.1 are used as a minimum demand when no other information have been available. Detailed material description, and U-value calculations can be found in appendix.

Table 4.2: *U-values in the building envelope.*

Construction	U-value [W/m ² K]
Roof	0.615
Wall	0.591
Floor	0.735
Window	2.406
Window frame	1.000

4.4 Zones

Table 4.3: *Function and dimension diagram*

Floor and room description	[m ²]
First floor	606.42
1. 101 Control and monitoring room	27.90
2. 102 Mechanical room	12.86
3. 103 Desiccant dehumidification and cooling lab	77.08
4. 104 Smart home center	56.67
5. 105 Materials handling lab	31.40
6. 106 Heat pump lab	56.50
7. 107 High and low temperature environment lab	77.62
8. 108 Testing room for sorption chillers	71.82
9. 109 Restroom	12.41
10. 110 Woman restroom	8.92
11. 111 Man restroom	11.99
12. Elevator shaft	7.11
13. 100 Entrance	15.04
14. Courtyard area	117,95
15. Stairway	21.15
Second floor	581.73
16. 201 Thermal properties measuring lab	71.47
17. 202 Adsorption properties measuring lab	30.89
18. 203 Thermoelectric cooling and electric cooling control lab	30.89
19. 204 Engineering research center of solar power and refrigeration	56.37
20. 205 Student innovation center	46.87
21. 206 Office room for faculties and visiting scholars	41.33
22. 207 Lecture theater	77.62
23. 208 Desica VRV testing room	71.82
24. 209 Restroom	12.41
25. 210 Woman restroom	8.92
26. 211 Man restroom	11.99
27. Stairway	21.15
28. Courtyard area, balcony	117,95
29. Elevator shaft	7.11
Third floor	653.98
29. 301 Smart home	55.91
30. 302 Zero energy apartment	99.10
31. Stairways	21.15
32. 300 Hallway	13.32
33. Elevator shaft	7.11
34. Rooftop Classroom	30.00
34. Roof	352,40
35. Skylight	75.12
Total	1842.12
Thermal zones total	1489.74

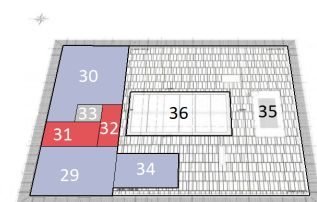
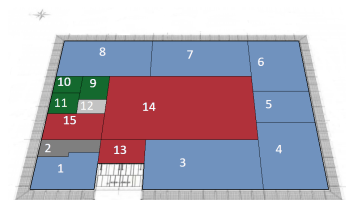

Table 4.3 lists up all thermal zones in the building model and their floor area. The roof does not have a thermal zone. These zones are created from the building description which can be found in the appendix, together with on-site observations and measurements of the building. All rooms in the building has their own thermal zone and the room height is set equal to internal measurements of 3.4 meters. Each thermal zone has in addition a ceiling space of 0.9 meters.

These ceiling spaces are not part of the floor area, and are all unconditioned. They are there to represent a more accurate picture of the volume in each zone and at the same time maintain the accuracy of the volume of the open space in the middle of the building.

Open areas

The open area in the middle of the building is referred to as courtyard area. There is no floor separating the first and second floor and the two areas are therefore combined into one single thermal zone. The stairway is also combined into one thermal zone, stretching over three floors. This might lead to some uncertainties to temperatures being accurate inside the thermal zones itself as the height is quite large. It is however concluded it has little to no impact on the results as these zones are not conditioned. The open areas are all connected to each other and separated in energy simulations using an air wall. The air wall has no thermal conductivity and allows air to flow freely between two zones, simulating the reality in a desired way. These zones are considered to be spaces where people are moving from one space to another or spend their breaks. These zones does not have PTHPs or internal lighting and are not conditioned.

Restrooms

There are restrooms in the first and second floor. They are of the same size in both floors and consists of a common space for men and women and two separated rooms for woman and men that contains toilets. The restrooms does not contain any heating or cooling sources. The zones are simulated using natural ventilation and energy for internal lighting.

Third floor

The third floor consists mainly of an open roof area and a skylight down to the open area. It also consists of a *Smart home*, a *Zero energy apartment* and a *Rooftop classroom*. None of these spaces was in use at the time of the study and are therefore not considered conditioned. They are a part of the model however to simulate the heat transfer in the building more accurately.

Other zones

Other spaces in the building is an elevator shaft, going from first to the third floor, with an entrance in each floor. This is for simplification simulated as one single zone that is not conditioned and never occupied. This simplification might result in an inaccurate result for the total energy demand, but the effect is considered to be negligible. The *Mechanical room* and the *Control and monitoring room* in the first floor are considered unoccupied at all times and therefore unconditioned with no internal loads.

Conditioned zones

There are 15 conditioned zones in the model. They are summarized in table 4.4.

Table 4.4: *Function and dimension diagram, conditioned zones*

Room description	[m ²]	[m ³]
3. 103 Desiccant dehumidification and cooling lab	77.1	262.1
5. 105 Materials handling lab	31.4	106.8
6. 106 Heat pump lab	56.5	192.1
7. 107 High and low temperature environment lab	77.6	263.9
8. 108 Testing room for sorption chillers	71.8	244.2
16. 201 Thermal properties measuring lab	71.5	243.0
17. 202 Adsorption properties measuring lab	30.9	105.0
18. 203 Thermoelectric cooling and electric cooling control lab	30.9	105.0
19. 204 Engineering research center of solar power and refrigeration	56.4	191.7
20. 205 Student innovation center	46.9	159.4
21. 206 Office room for faculties and visiting scholars	41.3	140.5
22. 207 Lecture theater	77.6	263.9
23. 208 Desica VRV testing room	71.8	244.2
Total	798.4	2714.4

All the conditioned zones have the same design criteria for room temperature and relative humidity.

4.5 Usage

The conditioned rooms that are in use consists of laboratories, student offices and conference rooms. The building is assumed occupied in the weekdays from 08:00 to 20:00 during the school semesters. The school holidays in Shanghai for the year 2019 has been used as basis for the analysis and is summarized in table 4.5. The building is assumed not in use during the school holidays.

Table 4.5: *Shanghai School Holidays 2019.*

School calendar	Starts	Finishes
Winter holidays	24 Jan 2019	19 Feb 2019
Summer holidays	01 Jul 2019	31 Aug 2019

4.6 Internal loads

The conditioned zones can be divided into the 3 categories: laboratories, offices and conference rooms. The number of occupants in these rooms are different and summarized in table 4.6.

The restrooms and the open area inside the building also has an occupant schedule as people are moving between the room and to the restrooms. These schedules have little impact on the

Table 4.6: *Nominal number of occupants in different rooms.*

Room type	Room numbers	Nominal number of occupants
Laboratories	103, 105, 106, 107, 108, 201, 202, 203	2
Student offices	204, 206, 208	9
Conference room	205, 207	8/20

energy demand of the building and will therefore not be presented further. The internal loads in the building are the people occupying the rooms, and internal lighting. The nominal number of occupants is given in table 4.6 and their schedules in figure 4.5 and figure 4.6.

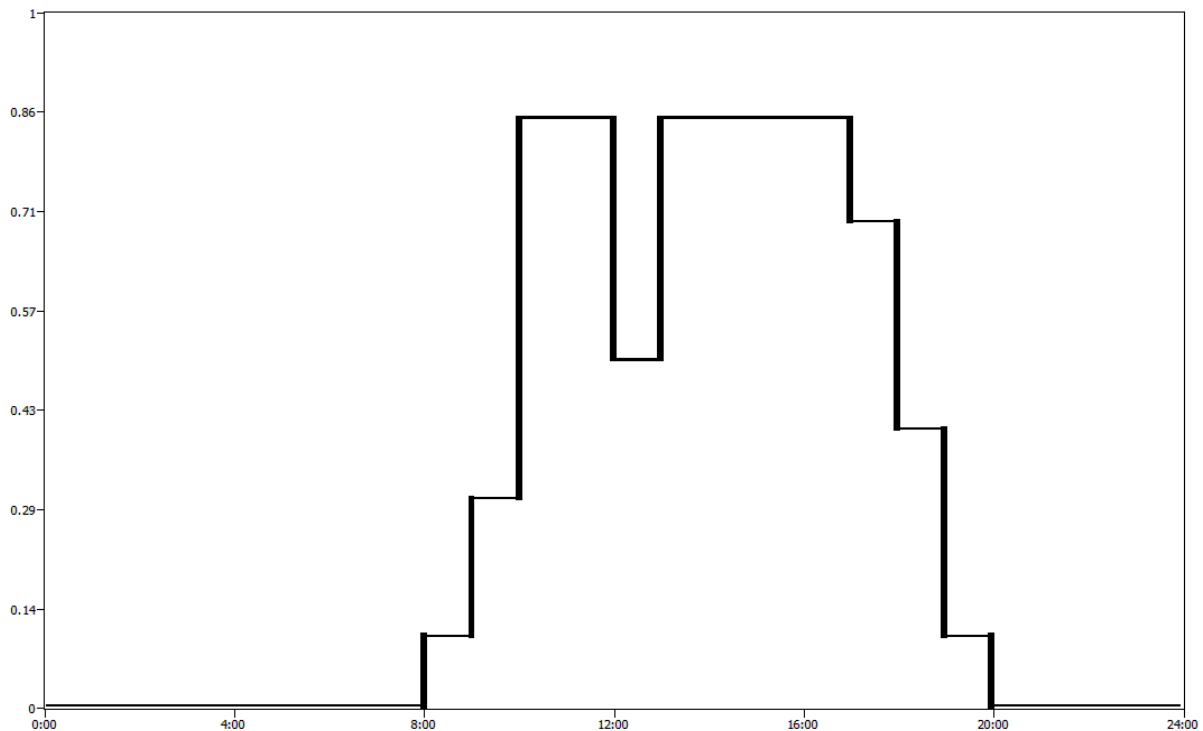
**Figure 4.5:** *Occupant schedule, laboratories and student offices.*

The schedules for laboratories and offices are valid between Monday and Friday, while the schedule for the conference rooms are valid every Wednesday. The rooms are assumed unoccupied outside these time frames. One person generates 132 W in energy simulation.

The building facade's purpose is to prevent direct solar radiation to reach the building envelope to reduce cooling demand in hot days. At the same time it has small openings to maximize the amount of light through the windows. The external walls in each room consists mainly of windows that takes up between 80% - 90% of the wall area. This means there is plenty of daylight inside the rooms and no need of internal lights during the daytime. Energy simulations are made using internal lights between 16:00 and 20:00 in the conditioned zones and the restrooms. This might not be completely accurate, as it may be used more in the darker, winter months, and less in the summer months. The energy demand from internal lighting as a total over a year is assumed to be of high accuracy. The internal lights have an energy consumption of 10.66 W/m².

The electrical equipment is not analyzed in this study. This might lead to a lower total energy

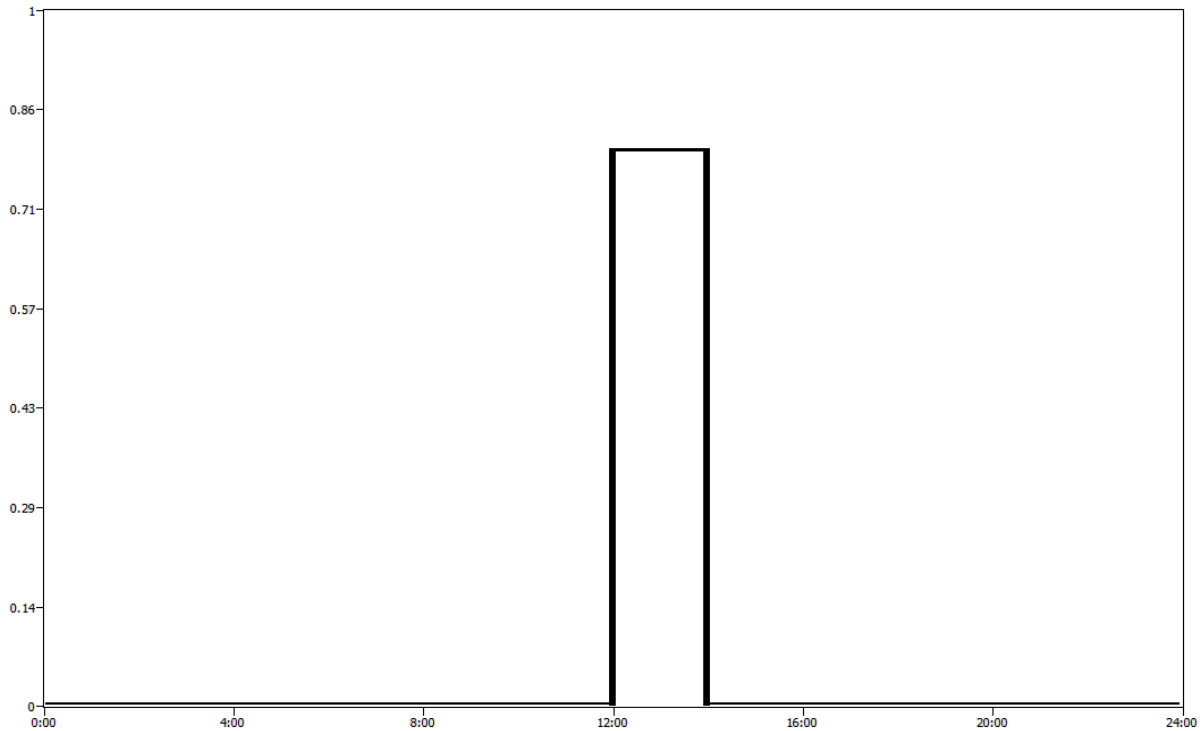

Figure 4.6: *Occupant schedule, conference rooms.*

demand than this study finds. It might also lead to uncertainties in the heating and cooling demand as electrical equipment produces heat. Domestic hot water is also not included in energy simulations. This is because it is assumed has very low impact on the energy demand in this case. This might lead to some uncertainties, but is believed to be negligible.

4.7 Design criteria indoor environment

The design criteria for indoor environment are set based on discussions in section 2.6. They are summarized in table 4.7.

Table 4.7: *Design criteria for space heating, cooling and relative humidity.*

	Operative temperature [C]	Relative humidity [%]
Min	18.0	30.0
Max	25.0	70.0

4.8 HVAC system

All the conditioned rooms are heated and cooled down by a Packaged Terminal Heat Pump (PTHP) unit. A PTHP is an air source heat pump, installed to meet desired operative temperature in the room. The COP for the PTHP's in heating and cooling mode is summarized in table 4.8. There exists heat pumps with better COPs than these, but these are believed to be realistic. They might not be completely accurate but the real case are likely to perform at least as good.

The energy demand for heating and cooling might therefore be even lower in reality. Humidifiers and dehumidifiers are installed in all conditioned rooms to make sure the relative humidity ratio is always within desired values. The building is utilizing natural ventilation as ventilation method. Requirements for natural ventilation is difficult to maintain but the simulated air flow is compared to requirements set by TEK17 [36].

Table 4.8: *COP of PTHP in different operation modes.*

Mode	COP
Heating	4.0
Cooling	3.0

4.9 Photovoltaics

The building has PV panels placed on the roof generating electricity. The system capacity of the PV panels is 13kW, and they are tilted towards the south in a 34 degree angle. They are estimated to have an overall efficiency of 16%.

4.10 Economic model

The economy analysis is calculated using the methods described in section 2.12. The investment costs and yearly cash flows from these investments are presented in the following sections.

4.10.1 Electricity prices

Electricity prices tends to vary with time and the average electricity price in 36 Cities for resident: 220v in China, between January 2001 and April 2019 is included in appendix A. From the opening of the building in May, 2012 to December 2016 the electricity price was equal to 0.53 RMB/kWh. Since January 2017 this has been equal to 0.52 RMB/kWh, and is assumed constant for energy prices in the future in this study [20]. This might lead to some uncertainties however, so sensitivity analyses, using alternative electricity prices is also included. 1 RMB is equal to 1.257 NOK (June 5th, 16.00, 2019) [32].

4.10.2 Photovoltaics

Installing photovoltaic panels is an investment and the price depends on the size of the system. The technology of PV panels is in constant development, making the panels more efficient at lower investment cost. Some government also subsidies investments including renewable technology. The investment cost of grid connected PV panels in China has decreased significantly the last years from around 10 RMB/Wp in 2012, to around 4 RMB/Wp in 2019.

The PV Panels that are installed on the GEL have a system capacity of 13 kW, and were installed in 2012. This creates the basis for the economic analysis of the existing system.

4.10.3 Packaged Terminal Heat Pumps

Packaged Terminal Heat Pumps (PTHPs) is offered by many different manufactures and there exists a big variety of models. They provide different heating and cooling capacity, different sound levels and different warranty times. The rooms in the building are of different size, and they all have different heating and cooling demand. For simplicity there is assumed to be similar PTHP's in each room. The energy demand in each room is found by dividing the total demand with number of conditioned zones. A comparison of three different suppliers have been made and an average price of models that fulfill the energy demand for space heating and cooling creates the basis for the economic analysis of PTHP's.

The price for PTHP's. shipping and installation might be different between different regions. International suppliers have been used in this study which might lead to uncertainties. Sensitivity analysis is conducted to analyze the impact of different investment costs, and different electricity prices.

5. Results

The results from the energy simulations are depending on a great number of input variables. First the energy demand for the building is calculated using ideal air loads, before the real HVAC system is analyzed. Finally the occupant behaviour is adapted to be as realistic as possible. The results from energy production is presented and compared to create an energy balance. The chapter ends with an economic analysis of the investment of the on-site energy system and HVAC system. The results presented in this chapter is the background for the discussion and conclusion of the study.

5.1 Energy demand

The energy analysis of the building begins with calculating the energy demand for space heating and cooling. That is done step wise, starting with simulations using ideal air loads, before a real HVAC system is implemented.

5.1.1 Ideal air loads

Ideal air loads is a way to calculate the energy demand for space heating and cooling using a fictional energy source. The method calculates the necessary energy demand for supplying or removing heat from the thermal zone to achieve specified design criteria. Ideal air loads also calculates the energy demand for humidification or dehumidification of the thermal zone depending on the relative humidity ratio. The total energy demand for space heating and cooling, using ideal air loads is presented in table 5.1. The design criteria is met every hour of the day for a whole year.

Table 5.1: *Energy demand for space heating and cooling using ideal air loads.*

Heating demand [kWh]	49 019.2
Cooling demand [kWh]	18 586.6
Total	67 605.8

Figure 5.1 presents the energy demand for space heating and cooling each month and shows the relationship to the outdoor air temperature. The energy demand for space heating is higher as the outdoor air temperature decreases. The energy demand for cooling is highest when the outdoor air temperature is highest.

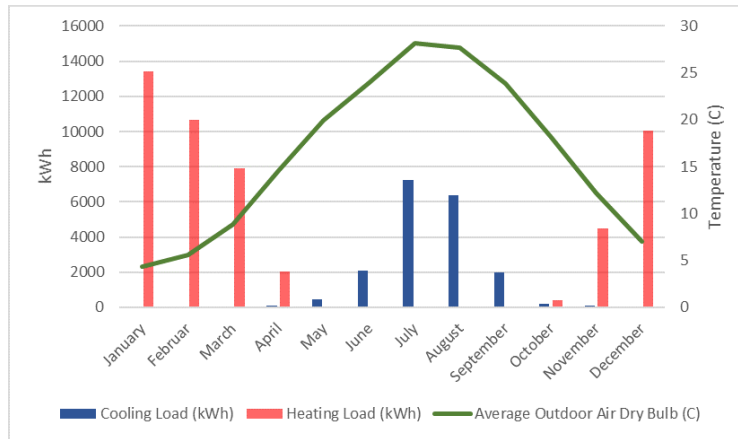

Figure 5.1: Energy demand for space heating and cooling using ideal air loads, compared to outdoor air temperature.

Simulations using ideal air loads are useful to find the total energy demand and the peak energy demand for space heating and cooling. A load duration curve is created from energy simulation using ideal air loads with a time step of one hour, and the result is displayed in figure 5.2. The energy demand for cooling is listed as negative to illustrate that there is a difference between supplying and extracting heat to the building.

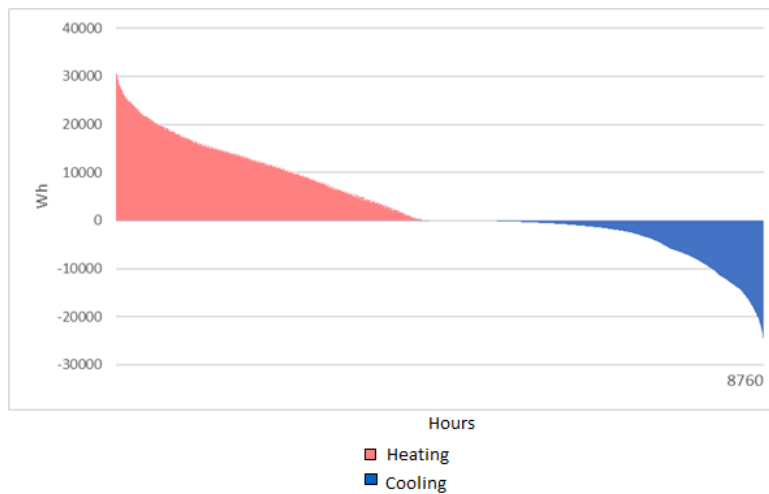

Figure 5.2: Load duration curve, ideal air loads.

The load duration curve in figure 5.2 displays the total energy demand and the peak energy demand for space heating and cooling. The peak energy demands are summarized in table 5.2.

Table 5.2: Peak energy demand for space heating and cooling using ideal air loads.

Heating demand [W]	31 664.1
Cooling demand [W]	26 243.6

The energy simulations using an ideal air loads have given some useful information regarding the energy demand. There is a larger energy demand for space heating than it is for space cooling, and the peak energy demand is larger for space heating. It also useful to compare the energy demand with a real case HVAC system.

5.1.2 PTHP

The GEL has a HVAC system as described in chapter 4. There is a PTHP installed in each of the conditioned zones. The ideal air loads is therefore replaced with a PTHP with specifications as described in section 4.8. Internal lighting, humidification, dehumidification and natural ventilation is also implemented. The results from the energy simulation is presented graphically in figure 5.3 and numerically in table 5.3.

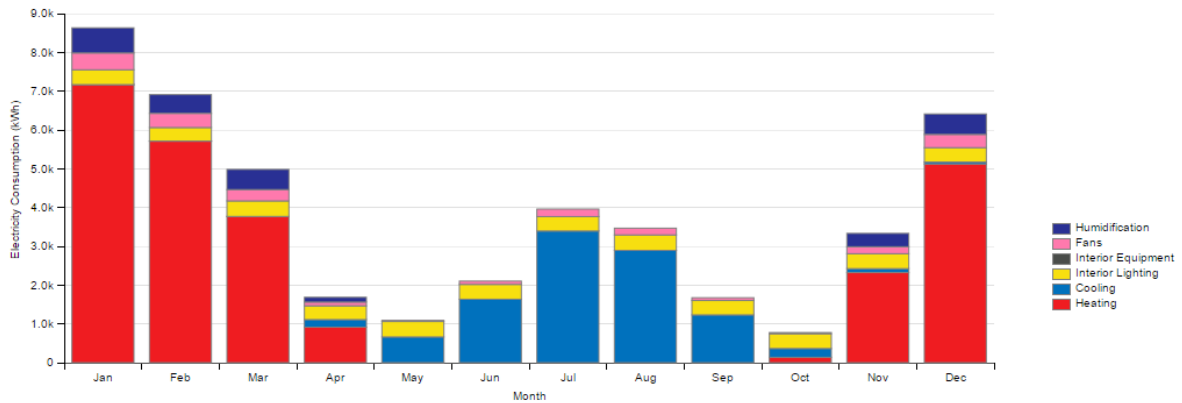

Figure 5.3: Energy demand using PTHPs.

Table 5.3: Energy demand using PTHPs [kWh].

	Jan	Feb	Mar	Apr	May	Jun	Jul	Aug	Sep	Oct	Nov	Dec	Total
Heating	7169.19	5712.36	3768.92	914.69	0.76					138.45	2323.51	5122.83	25150.72
Cooling	0.3	0.15	2.23	196.49	662.64	1636.24	3395.83	2894.5	1232.14	226.87	101.98	49.14	10398.5
Interior Lighting	382.04	349.88	399.45	355.63	399.45	382.04	371.71	399.45	371.71	382.04	383.37	371.71	4548.48
Exterior Lighting													
Interior Equipment													
Exterior Equipment													
Fans	433.62	365.92	292.82	96.53	28.03	85.12	192.77	174.03	70.71	29.25	180.59	341.39	2290.77
Pumps													
Heat Rejection													
Humidification	648.02	482.18	518.84	122.55							344.15	527.75	2643.49
Heat Recovery													
Water Systems													
Refrigeration													
Generators													
Total	8633.18	6910.49	4982.26	1685.89	1090.88	2103.4	3960.31	3467.98	1674.56	776.61	3333.6	6412.81	45031.96

A comparison of the energy demand for space heating and cooling, and the total energy demand is presented in table 5.4.

Table 5.4: Comparison of energy demand for space heating and cooling using ideal air loads and PTHP.

	Ideal air loads	PTHP
Heating demand [kWh]	49 019.2	25 150.7
Cooling demand [kWh]	18 586.6	10 398.5
Total [kWh]	67 605.8	45 032.0

The use of PTHP has decreased the energy demand compared to ideal air loads. The heating demand is reduced by 48.7% and the cooling demand by 44.1%. The reason it has not decreased even more because of the implementation of natural ventilation. Supplying untreated air into the building increases the energy demand for space heating and cooling.

5.1.3 Scheduled operation

The result from energy analysis in section 5.1.2 is the total energy demand given that the building is in operation 24 hours a day, every day of the year. As discussed in section 4.5 and 4.6, the building is however likely to not always be in use. An energy saving measure is to change the design criteria at times when the building is not in use, or to turn the HVAC system of completely at these times. Results from energy simulations using an availability schedule equal to the occupant schedule is presented graphically in figure 5.4 and numerically in table 5.5.

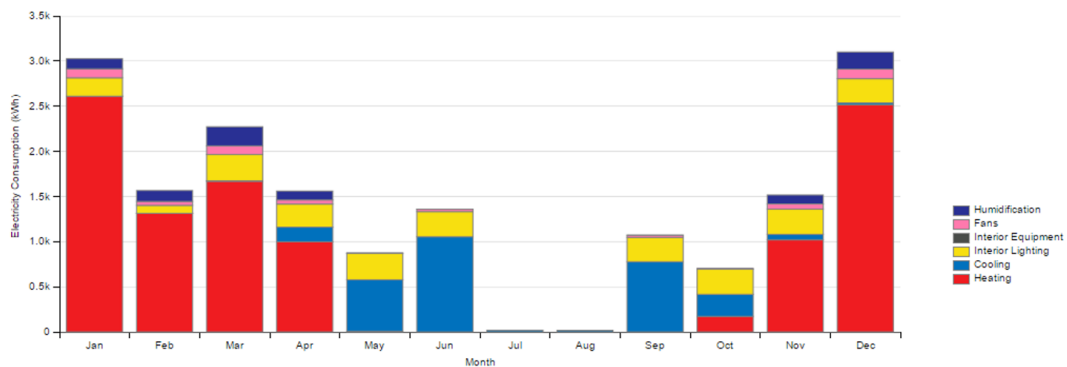

Figure 5.4: Energy demand, PTHP, scheduled operation.

The school holidays in the months July and August eliminates the energy demand for these months entirely. The school holidays in connection with Chinese new years in the end of January and beginning of February reduces the energy demand in these months. In general there is a large decrease caused by the implementation of night setback when the building is unoccupied.

Table 5.5: Energy demand, PTHP, scheduled operation, [kWh].

	Jan	Feb	Mar	Apr	May	Jun	Jul	Aug	Sep	Oct	Nov	Dec	Total
Heating	2610.68	1312.89	1669.16	998.34	7.32					171.82	1019.23	2515.24	10304.67
Cooling	0.17	0.23	3.86	161.66	569.48	1053.55	18.73	16.83	777.68	244.28	61.38	20.93	2928.77
Interior Lighting	203.14	88.2	292.14	255.82	292.14	279.05			268.11	279.05	279.85	268.11	2505.63
Exterior Lighting													
Interior Equipment													
Exterior Equipment													
Fans	99.72	44.19	95.8	45.86	3.55	26.28			23.85	9.28	56.76	106.0	511.3
Pumps													
Heat Rejection													
Humidification	111.64	120.05	211.37	98.66	1.4	0.68			2.2		99.19	189.82	834.99
Heat Recovery													
Water Systems													
Refrigeration													
Generators													
Total	3025.36	1565.55	2272.32	1560.34	873.9	1359.56	18.73	16.83	1071.84	704.43	1516.4	3100.1	17085.36

Table 5.6 summarizes and compares the energy demand for space heating and cooling, and the total energy demand of ideal air loads, PTHP operation and PTHP scheduled operation.

Table 5.6: Comparison of energy demand for space heating and cooling using ideal air loads and PTHP.

	Ideal air loads	PTHP	PTHP, scheduled operation
Heating demand [kWh]	49 019.2	25 150.7	10 304.7
Cooling demand [kWh]	18 586.6	10 398.5	2 928.8
Total [kWh]	67 605.8	45 032.0	17 035.4

The use of availability manager to control the operation of the PTHP is saving a total of 27 996.6 kWh in a year. This is equal to 62.2% energy saved.

The scheduled operation is simulated using an availability schedule for the PTHP equal to the occupant schedule, starting one hour before the first occupant would arrive. This is illustrated in figure 5.5 where the operative temperature in room 203, compared to the outdoor temperature, from March 1st to March 6th can be seen. The operative temperature is equal to 18°C between 08.00-20.00, between March 1st and March 3rd. That is the days Wednesday, Thursday and Friday. March 4th and 5th are during the weekend and the PTHP was shut off. The operative temperature is following the same pattern as the outdoor temperature. March 6th was Monday and the operative temperature is again 18°C between 08.00-20.00. This way of operating the HVAC system will result in a temperature and relative humidity outside desired setpoints at times where no one is present. As it is not in operation all the time, it reduces the energy consumption compared to an always on operation.

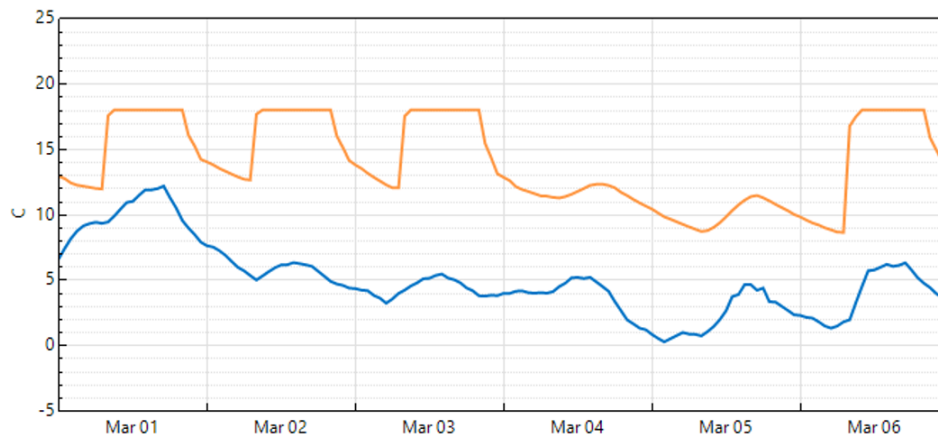

Figure 5.5: Operative temperature (orange) March 1st - March 6th in room 203 with scheduled operation, compared to outdoor air temperature (blue).

5.2 Natural ventilation

The natural ventilation depends on the opening area, the wind speed and temperature difference between outdoor and indoor air. The number of occupants in a room is decisive for the required ventilation rate. The natural ventilation in energy simulation is following the same schedule as the occupancy, resulting in a larger surface opening when there is more people present. Table 5.7

presents the average and minimum air changes in the conditioned zones in energy simulations with the use of natural ventilation.

Table 5.7: Average and minimum air during occupied hours.

Thermal zone	Average Number of Occupants	Nominal Number of Occupants	Zone Volume (m ³)	Avg. Infiltration (ach)	Min. Infiltration (ach)	Avg. Natural Ventilation (ach)	Min. Natural Ventilation (ach)
103 DESICCANT DEHUMIDIFICATION AND COOLING LAB	1.31	2.0	262.1	0.055	0.002	1.491	0.0
105 MATERIALS HANDLING LAB	1.31	2.0	106.8	0.043	0.001	1.896	0.0
106 HEAT PUMP LAB	1.31	2.0	192.1	0.074	0.002	1.666	0.0
107 HIGH AND LOW TEMPERATURE ENVIRONMENT LAB	1.31	2.0	263.9	0.043	0.001	1.436	0.0
108 TESTING ROOM FOR SORPTION CHILLERS	1.31	2.0	244.2	0.068	0.002	1.979	0.0
201 THERMAL PROPERTIES MEASURING LAB	1.31	2.0	243.0	0.086	0.003	1.699	0.0
202 ADSORPTION PROPERTIES MEASURING LAB	1.31	2.0	105.0	0.043	0.001	2.234	0.0
203 THERMOELECTRIC COOLING AND ELECTRIC COOLING CONTROL LAB	1.31	2.0	105.0	0.043	0.001	2.216	0.0
204 ENGINEERING RESEARCH CENTER OF SOLAR POWER AND REFRIGERATION	5.88	9.0	191.7	0.075	0.002	3.361	0.0
205 STUDENT INNOVATION CENTER	2.4	8.0	159.4	0.042	0.001	2.047	0.0
206 OFFICE ROOM FOR FACULTIES AND VISITING SCHOLARS	5.88	9.0	140.5	0.129	0.004	3.995	0.0
207 LECTURE THEATER	16.0	20.0	263.9	0.088	0.003	4.105	0.0
208 DESICA VRV TESTING ROOM	5.88	9.0	244.2	0.093	0.003	2.729	0.0

All the conditioned zones have a minimum ACH of 0. This can be because of times where there is no natural movement of air, or times where there is no windows opened in the room. One of the consequences of natural ventilation is that there is no guarantee that there will be sufficient ventilation at all times. Table 5.8 presents the average natural ventilation in the conditioned zones in m³/h and compares the ventilation rates with the ventilation requirements set by TEK 17. Chinese regulations might be different than these values, but it is believed to give a good indication of the quality of the natural ventilation.

Table 5.8: Average natural ventilation compared to TEK 17 requirements.

Room	Avg. natural ventilation [m ³ /h]	TEK 17 requirement [m ³ /h]	Percentage of requirement [%]
103	390.8	226.8	172.3
105	202.5	112.6	179.9
106	320.0	175.3	182.6
107	379.0	228.1	166.1
108	483.3	213.6	226.2
201	412.9	212.7	194.1
202	234.6	111.3	210.8
203	232.7	111.3	209.1
204	644.3	293.8	219.3
205	326.3	179.6	181.7
206	561.3	256.2	219.1
207	1083.3	610.0	177.6
208	666.4	332.4	200.5

The average ventilation rates are above the TEK 17 requirements in all conditioned zones with good clearance. The average ventilation rates are between 166.1% and 226.2%. of the require-

ments set by TEK 17. This is the average ventilation rates, which means that there might be times where the the minimum requirement are not met.

5.3 On-site electricity production

The on-site electricity production is generated in the 13 kW PV system that is installed on the roof. Figure 5.6 shows the hourly electricity production throughout a year.

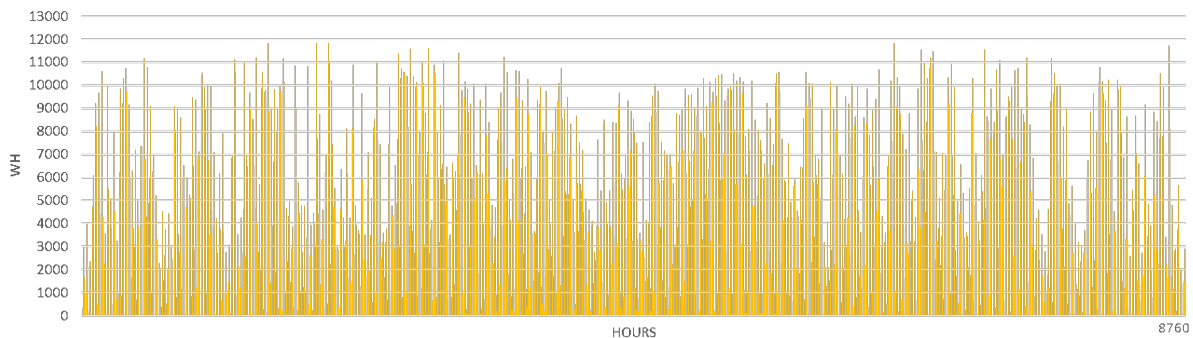

Figure 5.6: *Hourly electricity production from the PV system.*

There is electricity produced in all months of the year, and figure 5.7 summarizes the hourly electricity production each month.

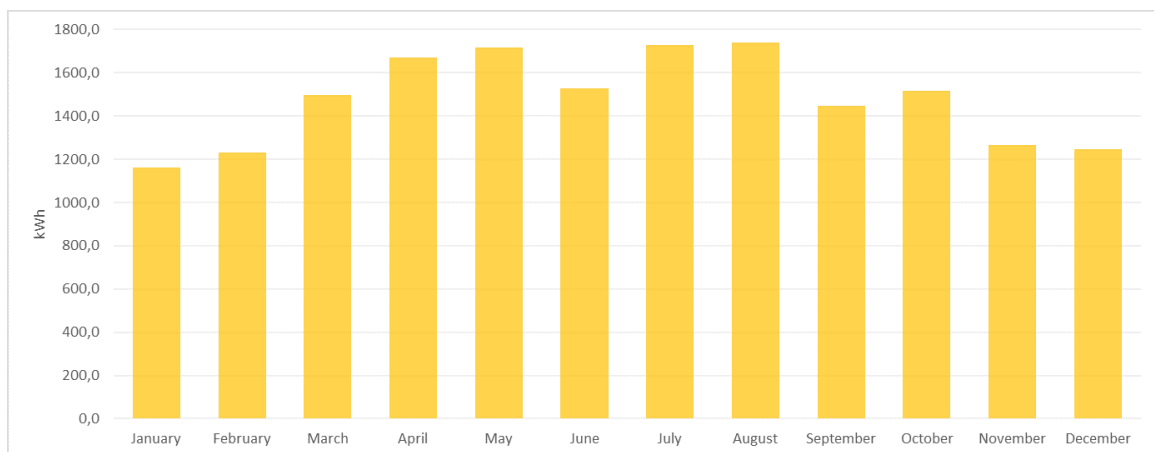

Figure 5.7: *Monthly electricity production from PV panels.*

Electricity is generated all year around but it can be noticed that there is a larger energy production in the summer months than the winter months. This is due to days having more hours of sunlight in these months, and that the sun has a different angle depending on the time of year. Table 5.9 summarizes the total electricity production each month numerically and the total produced in one year.

Table 5.9: *Electricity production from PV panels.*

	[kWh]
January	1 163.0
February	1 230.0
March	1 499.0
April	1 672.0
May	1 717.0
June	1 530.0
July	1 729.0
August	1 741.0
September	1 447.0
October	1 516.0
November	1 266.0
December	1 248.0
Total	17 758.0

January is the month with the lowest electricity production with a total of 1 163 kWh, and August is the month with the largest electricity production with 1 741 kWh. The total electricity production from the PV panels over a year is 17 758 kWh.

5.4 Energy balance

The total energy balance of the building is based on the results from section 5.1 and 5.3. Figure 5.8 shows graphically and numerically the energy demand and energy production each month of the year. The energy production is displayed in positive values, and the energy consumption with negative values.

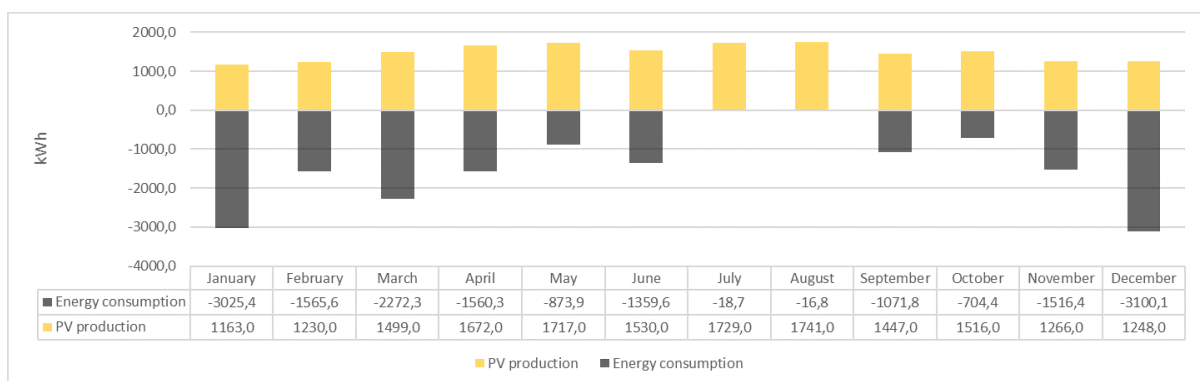

Figure 5.8: *Monthly comparison of energy consumption and PV electricity production.*

The energy balance is created subtracting the energy consumption from the energy production. Figure 5.9 shows this balance for all the months in a year. Red color and negative values indicates that the energy demand is larger than the energy production that month. Green color and positive values indicates that the energy production is larger than the energy demand that month.

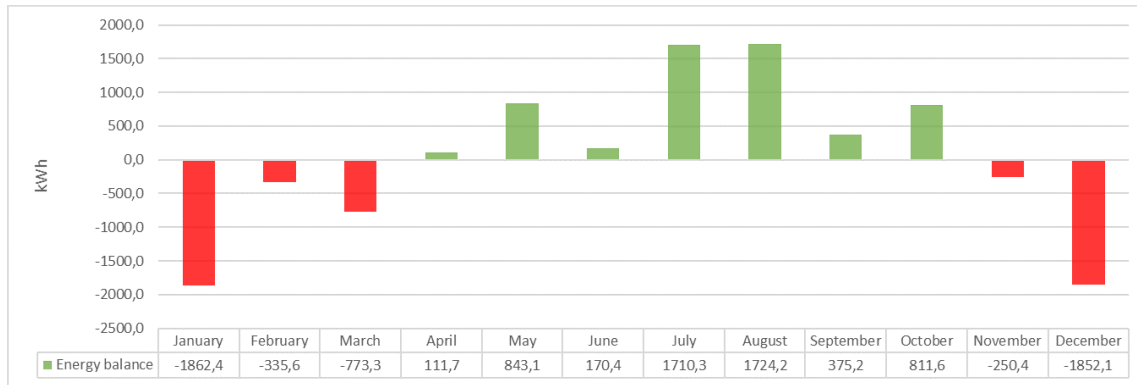

Figure 5.9: *Monthly energy balance.*

As it can be seen from figure 5.9 there is a negative energy balance in November, December, January, February and March, and a positive energy balance in the remaining months. The building needs to be connected to the electricity grid to meet the electricity demand in the winter, and to sell the excessive electricity in the summer. A summary of the total energy demand and energy production over a whole year is given in table 5.10.

Table 5.10: *Total energy balance.*

	[kWh]
Energy produced	17 758.0
Energy demand	17 085.4
Energy balance	672.6

The total energy balance shows a surplus of 672.6 kWh over a time frame of one year. That means the building qualifies as a net zero energy building under described circumstances. Different scenarios will be analyzed and discussed in chapter 6.

5.5 Economic analysis

An economic analysis of the PV panels and the PTHPs is done to determine if the investments are profitable. The economic lifetime of PV panels is 25 years and the economic lifetime of a PTHP is 15 years. The average electricity price for 36 cities in China has since January 2008 been equal to 0.52 RMB/kWh [39]. This is set to be standard electricity price when other is not specified. The electricity is assumed bought and sold at the same price.

The annual inflation rates in China has been between 0.5% and 3% the last 5 years, with an average of about 2% [33]. The inflation rate is assumed constant, equal to 2% for simplicity. Financial calculations are made at the end of each calendar year.

5.5.1 PV panels

The investment cost of PV panels have decreased significantly over the last decade. In 2012 average system price for typical grid-tied systems was 10 RMB/Wp. In 2015 the average price

was 4.04 RMB/Wp [38]. A price breakdown of an investment of a PV system is included in the appendix. The average price in 2019 and in the future are likely to be even lower. Table 5.11 presents the investment cost for a 13 kW grid connected PV system, at various investment costs.

Table 5.11: Investment cost for 13kW grid connected PV system.

RMB/Wp	Investment cost [RMB]
10	130 000
9	117 000
8	104 000
7	91 000
6	78 000
5	65 000
4	52 000
3	39 000

A 13 kW PV system generates a total 17 785.4 kWh each year. This is equal to 9 248.4 RMB/year, with an electricity price of 0.52 RMB/kWh. At a specific price of 4 RMB/Wp, the total investment cost would be 52 000 RMB. Assuming the PV panels would be in operation from 01.01.2020, they would have an economic lifetime until 31.12.44. Inflation rate is assumed constant at 2%. Financial calculations are made at the end of each calendar year. The payback time for the investment on the PV panels made in 2019 is shown graphically in figure 5.10.

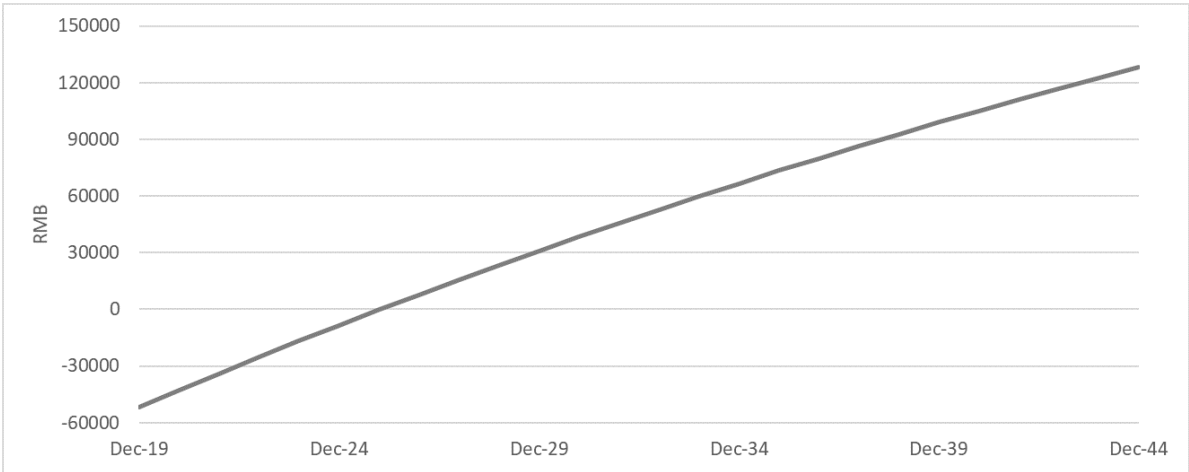

Figure 5.10: Payback time for the investment on PV panels with investment cost 4 RMB/Wp.

The investment has a payback time of 7 years. At the end of the economic lifetime, the investment is predicted to have generated 128 284 RMB in profits. Table 5.12 summarizes the payback time, profit at the end of economic lifetime and internal rate of return at various investment costs.

Table 5.12: *Payback time for various investment costs.*

RMB/Wp	Payback time [years]	Profits at economic lifetime [RMB]	Internal rate of return [%]
10	17	50 284	6.64
9	15	63 284	7.59
8	13	76 284	8.70
7	12	89 284	10.02
6	10	102 284	11.64
5	8	115 284	13.72
4	7	128 284	16.52
3	5	141 284	20.65

In 2012, when the building opened, a grid connected PV system had an average investment cost of 10 RMB/Wp. That results in a payback time of 17 years and an internal rate of return of 6.64%. Although less profitable than investments made in 2019, this is still considered to be a profitable investment.

Sensitivity analysis

The assumptions of a constant inflation rate and constant a electricity price can result in some uncertainties in the result. Therefore a sensitivity analysis have been conducted, analyzing the effect of various electricity prices and inflation rates. In these analysis the investment cost is set to be equal to 52 000 RMB. The results are displaced in figure 5.11 and figure 5.12.

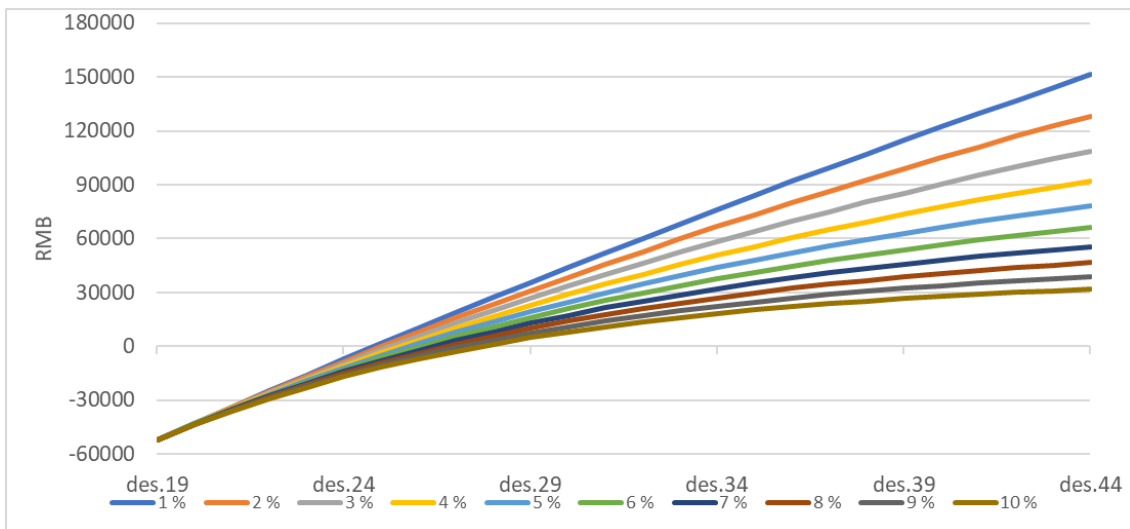
**Figure 5.11:** *Payback time with various inflation rates.*

The payback time increases as the inflation rate increases. The payback time is 13 years with an inflation rate of 10%. The internal rate of return decreases as the inflation increases. The investment is less profitable as the inflation increases.

The assumption of a constant electricity price for the entire lifetime of the PV panels might also lead to some uncertainties. A sensitivity analysis have been conducted to investigate the impact

on the payback time. The result is displayed in figure 5.12.

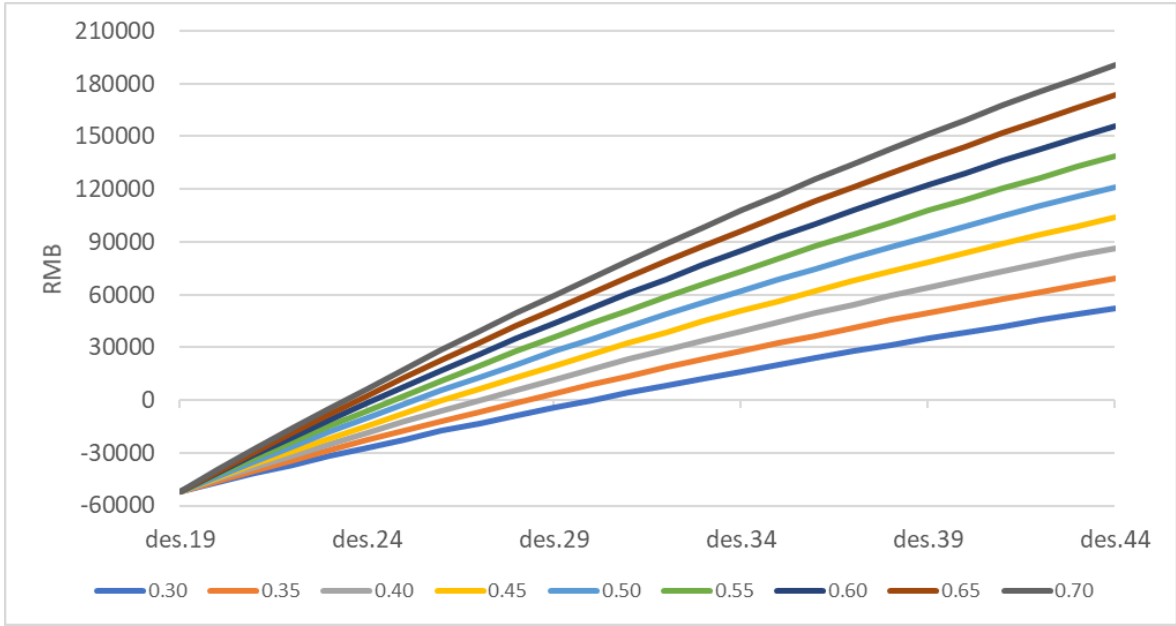

Figure 5.12: Payback time for alternative electricity prices given in RMB/kWh.

The payback time increases as the electricity price decreases. A lower electricity price would reduce the yearly cash flow. An increase in electricity price on the other hand would make the investment more profitable.

A change in inflation rate or electricity price would have a big impact on the profitability of the investments. It can be noticed however that the investments are profitable within all scenarios studied. There is also possible that there is a change in both inflation rate and electricity prices. An increase in inflation is likely to impact the rest of society as well however. The electricity price is likely to change as well if the inflation rate changes. This might lead to a different result. It is reason to believe that the investment would still be profitable within reasonable differences in both inflation rate and electricity prices based on the analysis made.

The electricity is assumed sold and bought at the same price. The electricity produced might be sold at a lower price than the electricity bought from the grid, which would make the investment less profitable. Analyzing this is complicated as it is difficult to say for certain how much of the electricity that is produced is consumed, and how much is sold. One way of analyzing this is to assume all electricity produced is sold, and all electricity needed is bought. This is referred to as alternative 1 and table 5.13 presents the yearly cash flow with different price for bought and sold electricity. The electricity bought is assumed constant at 0.52 RMB/kWh.

Table 5.13: Yearly cash flor, alternative 1.

Price sold electricity [RMB/kWh]	Yearly cash flow [RMB]
0.30	5335.6
0.35	6224.9
0.40	7114.2
0.45	8003.4
0.50	8892.7

Figure 5.13 displays the effect various electricity prices for the sold electricity has on the profitability in alternative 1.

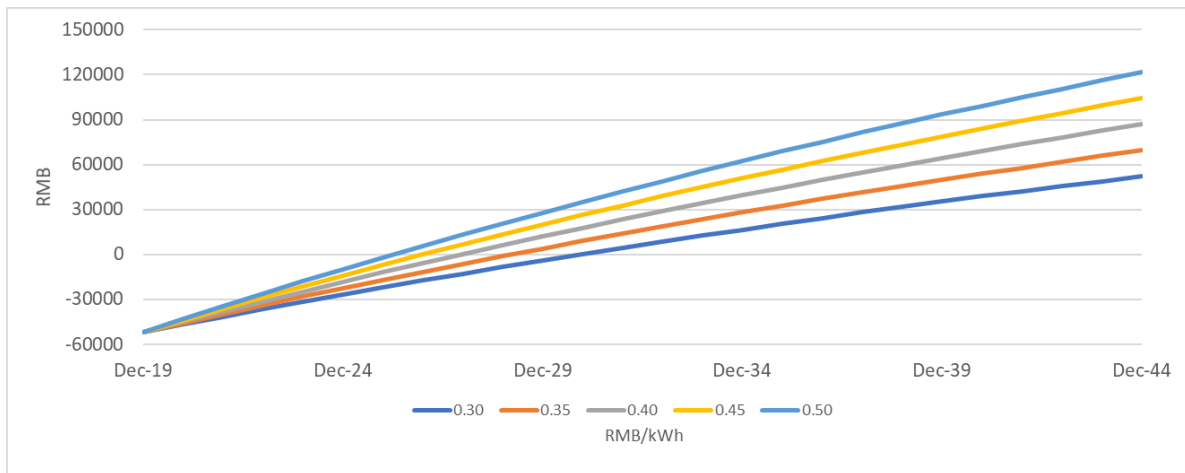

Figure 5.13: Sensitivity analysis alternative 1.

The reduction in electricity price for the on-site electricity production have a huge impact in alternative 1. Even though the lowest electricity price analyzed results in a big reduction in profitability, it can still be noticed that it has a payback time of less than half the economic lifetime.

Another way to analyze a difference in electricity price for bought and sold electricity is to use the monthly energy balance as a basis. For this analysis it is assumed all energy produced is consumed in months with a negative energy balance, and the surplus energy in months with a positive energy balance is sold. This is referred to as alternative 2 and table 5.14 presents the yearly cash flow in this analysis.

Table 5.14: Yearly cash flow, alternative 2.

Price sold electricity [RMB/kWh]	Yearly cash flow [RMB]
0.30	7969.8
0.35	8257.1
0.40	8544.4
0.45	8831.7
0.50	9119.1

Figure 5.14 displays graphically various electricity prices for the sold on-site electricity produced in alternative 2.

Comparing figure 5.13 and figure 5.14 it can be noticed that alternative 1 is more sensitive to a change in electricity price for the sold electricity. Alternative 2 is hardly affected by a difference in the difference in price for sold and bought electricity, and is also believed to be closest to reality. The analysis can conclude that the investment is profitable also with a difference in price for electricity bought and sold.

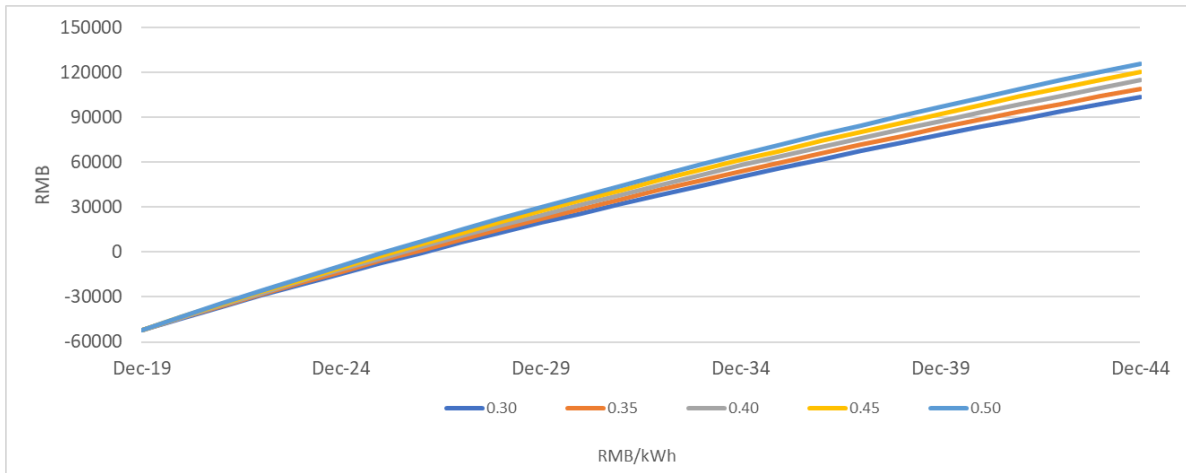

Figure 5.14: Sensitivity analysis, alternative 2.

5.5.2 PTHP

There exists a large number of PTHP manufactures and suppliers that all offers a wide variety of models. The investment costs depends on the supplier, the model you chose and transportation costs. Comparing a few different suppliers, models that would meet the heating and cooling demand were found to have an investment cost between 325 - 866 USD [40] [41]. That is equivalent to 2 292.4 - 6 108.2 RMB. Including transportation and installation costs, the investment cost of PTHPs are likely to be in the range of 3 000 - 7 000 RMB for each model. Table 5.15 summarizes the total investment cost for PTHPs, covering the entire energy demand for space heating and cooling of the building.

There are 13 conditioned zones, which all have a different heating and cooling demand. The most profitable solution would be to determine the correct sizing for each zone. They are in this research assumed to have the same PTHP in all conditioned zone for simplicity. This might not be the ideal solution, as some zones probably would have an oversized or undersized PTHP. As a total economic analysis it is however believed to be accurate, as some zones might need a cheaper model, and some a more expensive one. This is believed to equal each other out.

Table 5.15: Investment cost for PTHPs.

Investment cost/PTHP [RMB]	Total investment cost [RMB]
7 000	91 000
6 000	78 000
5 000	65 000
4 000	52 000
3 000	39 000

The heating demand at scheduled operation with the use of PTHP's with a COP of 4 is 10 304.7 kWh. A COP of 4.0 is equal to 75% energy saved. That means the heating demand would be equal to 41 218.8 with a conventional heating system. That is 30 914.1 kWh saved energy for space heating. The energy demand for cooling is 2 928.8 kWh with a COP of 3.0. With conventional cooling that would be equal to 8 200.6 kWh. That is 5 271.8 kWh saved. There is also an electricity demand for the fans in the PTHP's equal to 511.3 kWh.

$$\text{Energy saved} = 30\,914.1 + 5\,271.8 - 511.3 = 35\,674.6 \text{ [kWh]}$$

35 674.6 kWh/year is equal to 18 550.8 RMB/year with an electricity price of 0.52 RMB/kWh. Assuming the PTHP would be in operation from 01.01.2020, they would have an economic lifetime until 31.12.34. Inflation rate is assumed constant at 2%. Financial calculations are made at the end of each calendar year. Table 5.16 presents the results from the economic analysis of the PTHPs.

Table 5.16: *Economic analysis, PTHP, for various investment costs.*

Investment cost [RMB]	Payback time [years]	Profits at economic lifetime [RMB]	Internal rate of return [%]
91 000	6	147 364	17.52
78 000	5	160 364	20.08
65 000	4	173 364	23.30
52 000	3	186 364	27.54
39 000	3	199 364	33.50

The investment of PTHPs are considered profitable for the whole range of investment costs investigated. Even the most expensive investment has a payback time less than half the economic lifetime. The investment cost of 91 000 RMB is used in further sensitivity analysis to ensure the result represents the least favourable outcome.

Sensitivity analysis

The heat pumps would in reality get most of their energy demand covered by the on-site electricity that is produced. This makes them less dependent on a change in electricity price. The sensitivity analysis therefore investigates the heat pumps as a separate investment. In the sensitivity analysis for the heat pumps it is assumed all the energy needed is purchased from the electricity grid. Figure 5.15 illustrates the impact a change in electricity price has on the profitability.

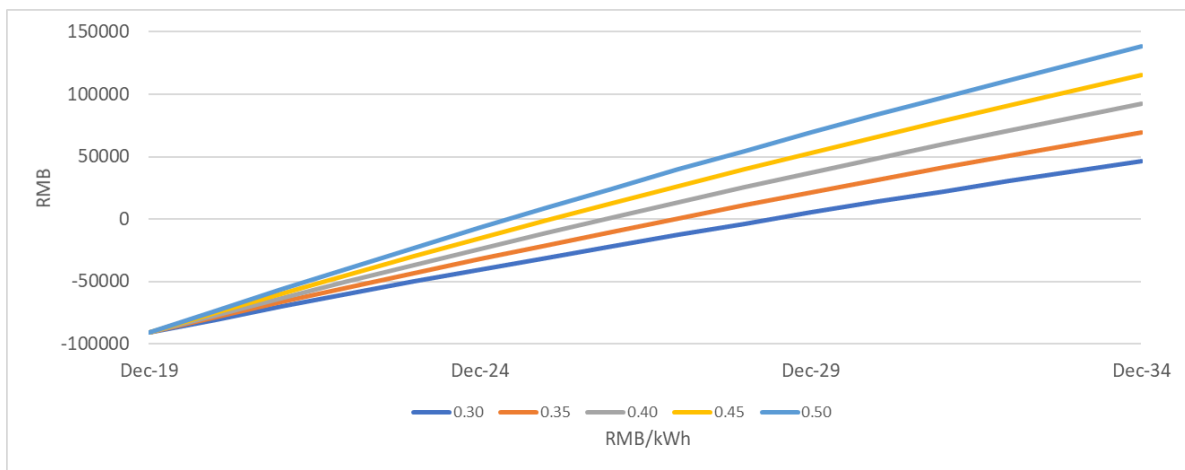

Figure 5.15: *Sensitivity analysis for various electricity prices, PTHP investment.*

A change in electricity price has a big impact on the profitability of the investment. A reduction of 40% in electricity price would reduce the profitability by 68.4%. An increase in electricity price on the other hand would make the investment more profitable. It can be noticed that the investment is however still profitable and have generated a total of 46 517 RMB at the end of the economic lifetime with an electricity price of 0.52 RMB/kWh.

A change in inflation rate has a similar outcome as the results found for a PV system. A higher inflation rate would make the investment less profitable. As discussed earlier would a change in inflation rate probably have an impact on the electricity price which is difficult to predict accurately.

Based on the results for various investment costs and a change in electricity price can it be concluded that the investment of PTHPs is profitable. Especially when taking into account that the heat pumps would consume the electricity produced by the PV system, making them less dependent on a change in electricity price.

6. Discussion

The results presented in chapter 5 are given certain assumptions and simplifications. Changing these would give a different outcome. Some of the most impactful assumptions are discussed and analyzed in this chapter.

6.1 Design criteria

Heating setpoint

The heating setpoint is, as discussed in chapter 4, set originally to 18°C. An analysis was conducted to find out the energy demand for different heating setpoints. The results of this analysis is displayed in figure 6.1.

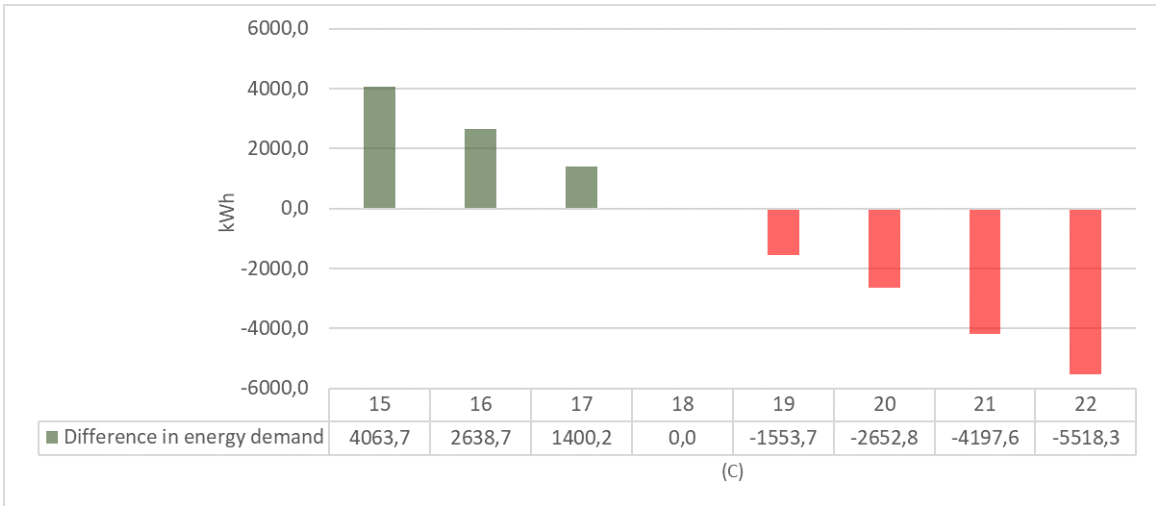

Figure 6.1: Difference in energy demand for different heating setpoints.

The energy demand is as expected lower at lower heating setpoints, and higher at higher heating setpoints. The energy demand increases in average with approximately 1373.4 kWh for each increased degree in heating setpoint. 18°C is a good operative temperature with the clothing level equal to 2.0 clo and activity level equal to 1.2 met. This requires however outdoor clothes to be used indoor at times with low outdoor temperature. The optimal operative temperature for activity level 1.2 met and clothing level 1.0 is 22°C. This would require 5 518.3 kWh extra energy each year. That would create a negative energy balance of -4 846.3 kWh, making the building not qualify as a net zero energy building.

Natural ventilation

The natural ventilation is designed to work by supplying fresh air into the occupied zone. This is happening, as discussed in chapter 2, based mostly on the thermal comfort. Natural ventilation does not preheat the air before entering the room, causing a possible draught at days with low outdoor air temperatures. Therefore the ventilation is designed to supply fresh air when the

thermal zone is occupied and the indoor air temperature is minimum at the heating setpoint. Allowing natural ventilation also when the heating setpoint is not met would have an impact on the energy demand of the building. The result of an energy analysis of minimum indoor air temperature for natural ventilation is displayed in figure 6.2.

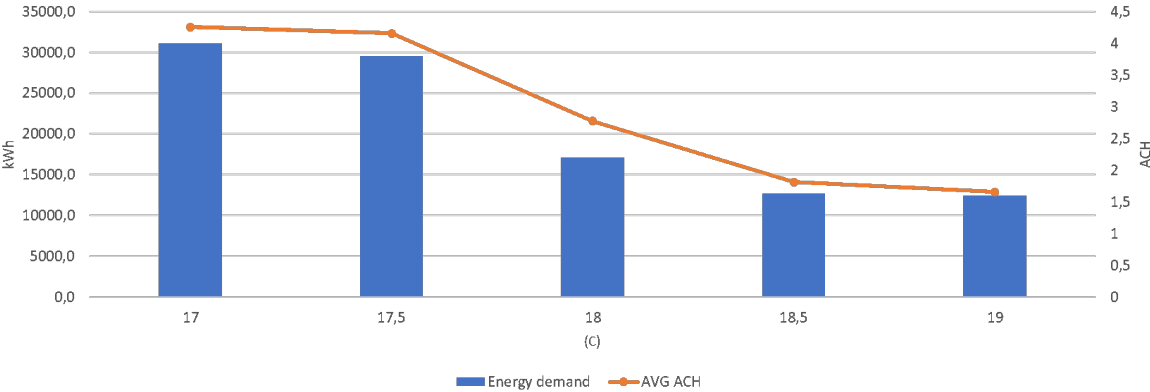

Figure 6.2: Average ACH and total energy demand at various minimum indoor temperature for natural ventilation, heating setpoint at 18°C.

By changing the minimum indoor air temperature for natural ventilation, the amount of supplied fresh air changes. There is a higher average ACH at lower minimum indoor air temperature for natural ventilation. At the standard setpoint the average ACH is 2.6. This increases to 4.4 at 17°C. A lower minimum indoor air temperature for natural ventilation is however also causing a higher energy demand. 17°C minimum indoor air temperature results in a total energy demand of 30 953 kWh. It is also causing a larger number of hours when heating setpoint is not met. This is illustrated in figure 6.3. For a temperature setpoint of 17°C, the unmet heating hours are increased to 283.

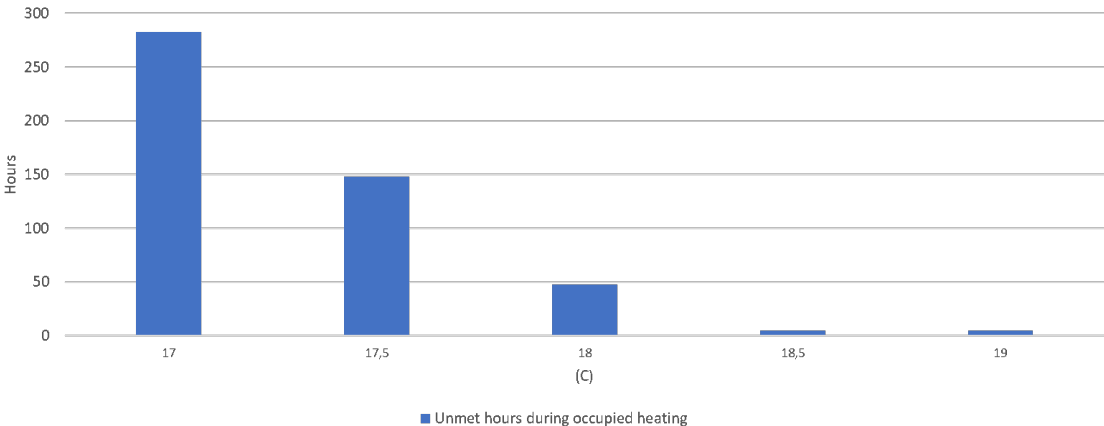

Figure 6.3: Time setpoint not met during occupied heating at various minimum indoor temperature for natural ventilation, heating setpoint at 18°C.

By increasing the minimum indoor air temperature for natural ventilation, the opposite effects compared to decreasing it occurs. The average ACH decreases to 1.8, the energy demand decreases to 12 572 kWh, and the hours of unmet heating setpoint is reduced to 5. Good ventilation rates and thermal comfort comes at the cost of an increase in energy consumption.

Humidity ratio

The importance of relative humidity ratio between 30%-70% was discussed in chapter 2. This is considered to be minimum requirements for good indoor environment. To obtain optimal indoor environment, one should seek to keep the relative humidity between 40%-60%. An analysis has been made to investigate how much more energy is needed to reach different setpoints for relative humidity. The result is displayed in figure 6.4.

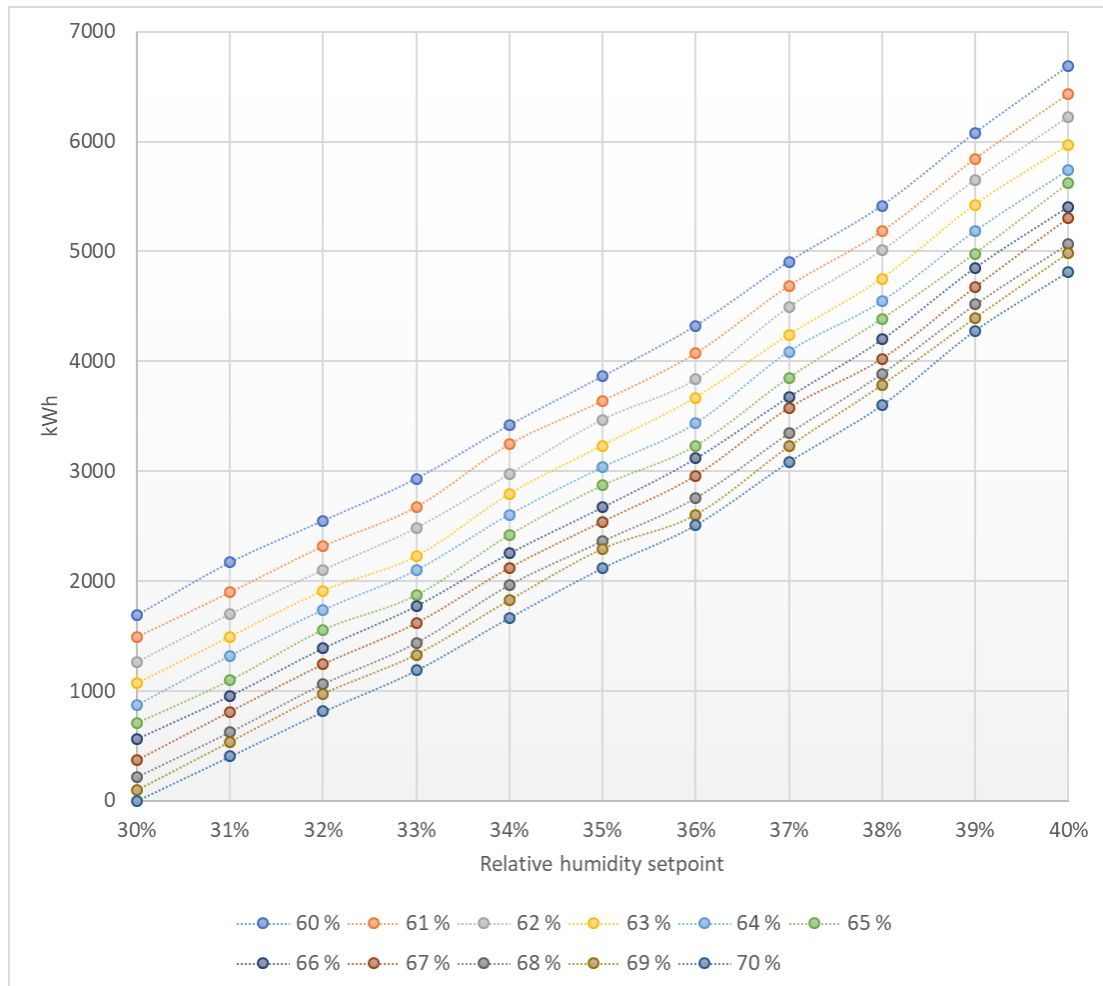

Figure 6.4: Increased energy demand at different relative humidity setpoints.

Figure 6.4 shows that to obtain the optimal humidity ratio it will demand an extra 6 683.9 kWh. This is an increase of 39.0% in energy demand compared to the minimum requirements. A compromise between optimal indoor environment and energy consumption with setpoints between 35%-65% would require an extra 2 870.6 kWh. That is an increase of 17.0%. In average it demands an extra 168.8 kWh for each percentage decrease in dehumidification setpoint, and 481.1 kWh for each percentage increase in humidification setpoint. Relative humidity setpoints between 31-68% would demand an extra 625.6 kWh, changing the energy balance to 47 kWh in surplus. This is the best conditions the building can obtain, concerning relative humidity, while still qualifying as a net zero energy building.

Conditioned zones

The research have studied the energy performance of the whole building, excluding a few rooms. The rooms located in the third floor, *301 Smart home* and *302 Zero energy apartment* and *104 Smart home center* in the first floor were not in use at the time of the study and was therefore not included in the study. An energy simulation including these spaces have been performed and the result is summarized in table 6.1.

Table 6.1: *Energy demand for energy simulations including all thermal zones.*

Energy demand all zones	[kWh]	20 592.6
Energy demand studied case	[kWh]	17 085.4
Increased energy demand	[kWh]	3 507.2

There is an increase of 3 507.2 kWh in energy demand as these zones are included, creating a negative energy balance. Conditioning all the other rooms and open areas in the building would increase the energy demand additionally.

Technical equipment

The technical equipment is not accounted for in this analysis. It can be debated whether or not technical equipment should be part of the balance analysis of building, but it is certainly increasing the energy demand of the building. It is also has an impact on the heat transfer in the building as technical equipment produces heat. Technical equipment is likely to increase the energy consumption by demanding electricity, but might also reduce the energy demand for heating, as it produces heat. The main focus of this research was to focus on the energy demand for space heating and cooling and internal lighting and did therefore not include the technical equipment. The building consists of many laboratories that have large, energy demanding equipment. It is reasonable to believe that the building would not be a net zero energy building, if technical equipment were included in the energy balance analysis.

6.2 Ventilation system

The ventilation system operating in the building at the time of the study was natural ventilation. The results showed a clear connection between amount of supplied air and energy demand. Natural ventilation has no possibilities of heating or cooling the air before it enters the building which is the reason for this. This is not only increasing the energy demand but also results in the risk of draught at cold days. This can be very uncomfortable and might lead to occupants rather having no ventilation.

An alternative to natural ventilation is mechanical or hybrid ventilation. This type of ventilation system will result in more predictable indoor conditions. It will however cost more energy in operation. But as this type of ventilation does not require any openings in the building envelope, it might reduce the energy demand for space heating and cooling. A mechanical ventilation system was installed originally in the building. The energy consumption of the system made it

however undesirable to keep in operation. This is the reason this option was not investigated further in this study. Comparing these ventilation systems are listed as an option for further work.

6.3 Photovoltaics

The PV system was found to be a profitable investment in the Shanghai region. Similar studies needs to be conducted at other locations to determine the profitability there. The only requirements for installing a PV system is a sun exposed area and funds to invest. The sun exposed area should preferably be in a place that is not in the shadow from neighbouring buildings or trees. This can be difficult in urban areas and it is typically the roof that is the best suited spot for a PV system.

The tilted part of the roof plus the edge around the roof was the area where PV panels were installed at the time when this study was conducted. The rest of the roof was used for other experiments, a temporary lecture room and an area for relaxing. Some of the space was not in use and could be used for a new investment in a PV system. This would increase the energy production and make it possible to improve the indoor environment and still be a nZEB. Depending on the size of the system could even more parts of the building be included, as well as the technical equipment, while still having a positive energy balance. It is proven to be a profitable investment regardless of changing design criteria of the building.

6.4 Economic Analysis

The economic analysis attempted to study most possible outcomes and to ensure the results covered the least favourable scenario. The profitability was found to depend on a great number of factors that was each studied individually. Changes in multiple different variables at the same time is complex and causes many uncertainties. A change in inflation rate is likely to create a change in electricity price. The impact of this is however difficult to predict. There is also reason to believe that the changes would equalize each other out, making the impact on the profitability smaller. An increase in inflation rate could cause an increase in electricity price or the other way around.

Making investments in reality often depends on other alternatives available and the real rate of return on that investment. Both investments had a large profit margin in all scenarios studied and are therefore believed to be profitable investments. Whether or not they are more profitable than other investments depends on the other investment.

7. Conclusion

Though the economic analysis depends on the results from the energy analysis, the conclusions are summarized separately to emphasize the most impactful results within the findings. The conclusions to the energy and economic analyses are summarized below.

Energy analysis

The energy demand of the building was found to depend greatly on the operation of the building, that is influenced by the occupant behaviour. The energy simulation indicated a clear correlation between the amount of fresh air supplied by natural ventilation and the energy consumption. A higher average ACH resulted in a larger energy demand. This is likely caused by an increased energy demand for space heating on days with low outdoor air temperatures, as the natural ventilation does not preheat the air before entering the conditioned zones. The studied case had a heating setpoint at 18°C and natural ventilation when operative temperature in the room was at the heating setpoint. Average ACH was found to be 2.6, which is within the minimum requirements set by TEK17.

As discussed it is often the temperature that is decisive for opening the windows in a room to increase natural ventilation. That means that the windows are likely to be opened less when there is a low outdoor temperature. This would reduce the energy demand but diminish the indoor environment. The result might be different than the reality as it depends on the occupants in the building and their behaviour. The analysis is approximating an average behaviour with natural ventilation at all times when people are present in the building. In reality there is likely to be days where no one is present in some rooms, which would reduce the energy demand in those rooms. There is also a high probability of some rooms having a larger number of occupants some days, that would require larger ventilation rates. As an overall energy analysis the results are believed to be reliable.

The building is heated up and cooled down using packaged terminal heat pumps. They are simulated with a COP of 4.0 in heating mode and 3.0 in cooling mode, reducing the energy demand by 75% for space heating and 67% for space cooling, compared to conventional heating and cooling. The heat pumps are crucial to minimize the energy demand by utilizing renewable energy. Scheduled operation of the heat pump was found to be the most effective measure to save energy. The energy consumption was reduced by 62.2 % when limiting operation schedule to the times the building was assumed occupied. The total energy demand for space heating, cooling and internal lighting was found to be 17 085.4 kWh.

The total energy production from the on-site PV system was found to be 17 758.0 kWh. The total energy balance with scheduled operation was a surplus of 672.7 kWh and is summarized in table 7.1. The building therefore qualifies as a net zero energy building under these assumptions. It is important to underline however that the building still needs to be connected to the electricity grid as there are some months in the year where there is a negative energy balance.

Table 7.1: *Total energy balance.*

	[kWh]
Energy produced	17 758.0
Energy demand	17 085.4
Energy balance	672.6

The building qualifies however as a nZEB at the cost of an improved indoor environment. The heating setpoint requires the occupants to wear more clothes at days with a low outdoor air temperature. Increasing the heating setpoint to 22°C would require another 5 518.3 kWh. This would create a negative energy balance.

The relative humidity ratio is kept within the minimum recommended values and there is therefore no health risks. If optimal conditions should be obtained, keeping the relative humidity within 40-60%, there would be required an extra 6 683.9 kWh. The building would then not qualify as a nZEB.

The energy analysis does not take into account the energy demand for technical equipment in the building. There are technical equipment in the laboratories that would most likely demand an amount of energy larger than the positive energy balance. To qualify as a net zero energy building, including the technical equipment, with an improved indoor environment, an additional PV system is required.

Economic analysis

The economic analysis found that the investment of PV panels are profitable in all scenarios analyzed. With investment costs for PV panels falling it is reason to believe investing will be even more profitable in the future. The profitability of a PV system however depends largely on the location of the system. The conclusion of profitability is therefore strictly valid for the Shanghai area.

The investment of a 13 kW PV system generates a total of 17 758.0 kWh/ year, equal to 9 234.2 RMB/year, with an electricity price of 0.52 RMB/kWh. An investment made in 2012 costed approximately 130 000 RMB. That gives a payback time of 17 years and an internal rate of return of 6.62%. That is regarded as a profitable investment. The investment cost for a grid connected PV system has decreased significantly since 2012 and is in 2019 in the range between 3-5 RMB/Wp. The investment cost with a specific price of 4 RMB/Wp would be 52 000 RMB for a 13 kW system. This gives a payback time of 7 years, and an internal rate of return of 16.52%. A decreasing investment cost would mean increased profitability. Table 7.2 summarizes the payback time and internal rate of return for realistic investment costs in 2019. They are all regarded as profitable.

Investing in PV panels requires sun exposed space. The GEL building has already installed PV panels on the tilted part of the roof, but has approximately 350 m² still available. Investing in a new PV system could not only generate an increased income, but also allow improved indoor environment while still qualifying as a nZEB.

Table 7.2: *Payback time for various investment costs.*

RMB/Wp	Payback time [years]	Internal rate of return [%]
5	8	13.72
4	7	16.52
3	5	20.65

The most important installations to minimize the energy demand, making it possible to qualify as nZEB, was the PTHPs. The economic analysis concluded that they are also profitable investments. Heat pumps are proven to be one of the most energy efficient ways to heat up and cool down a building. The large amount of energy saved every year can be translated directly to economic profits.

The PTHPs have an investment cost between 39 000 and 91 000 RMB, depending on models and supplier. The heat pumps were found to reduce the energy demand by 35 674.6 kWh/year. This is equal to 18 550.8 RMB/year, with an electricity price of 0.52 RMB/kWh. An investment cost of 91 000 RMB gives a payback time of 6 years, and an internal rate of return of 17.52%. That is less than the economic lifetime of 15 years, and an internal rate of return that high makes the investment very profitable. Investment costs in the range 39 000 - 91 000 is summarized in table 7.3, together with payback time and internal rate of return.

Table 7.3: *Payback time for various investment costs.*

Investment cost [RMB]	Payback time [years]	Internal rate of return [%]
91 000	6	17.52
78 000	5	20.08
65 000	4	23.30
52 000	3	27.54
39 000	3	33.50

Even the highest investment cost has a payback time lower than the economic lifetime, and an internal rate of return that is considered high. The sensitivity analysis concluded that they are also profitable with a lower electricity price or a higher inflation rate. The electricity price is likely to be affected by a change in inflation rate, but the effect of this has not been studied. An analysis looking at a reduction of 40% in electricity price discovered that the investment would still be profitable.

8. Further work

The study found that the building qualifies as a net zero energy building, given certain assumptions. There is however still possibilities of improving the indoor environment, utilizing the whole building and investing in a new PV system. There is, as discussed in the report, several ways of obtaining some of these goals. A proposal for further work for the Green Energy Lab, and students associated to the building is listed in this chapter.

- Compare the energy demand for space heating and cooling using natural ventilation to mechanical or hybrid ventilation.
- Conduct an energy analysis for the technical equipment.
- Investigate the possibilities of installing another PV system.
- Conducting an energy and economic balance analysis, including the technical equipment, improved indoor environment and an additional PV system.
- Conduct an energy and economic balance analysis for the same building at other locations.

9. Appendix

Table 9.1: Calculation of U-value, wall.

Layer	t [m]	λ [W/mK]	R [m ² K/W]	U [W/m ² K]
Interior surface resistance			0.10	
1 inch stucco	0.0253	0.6918	0.0365	
8 inch concrete HW	0.2033	1.7296	0.1175	
Wall insulation	0.0566	0.0432	1.3102	
1/2 inch gypsum	0.0127	0.16	0.079375	
Exterior surface resistance			0.04	
Total	0.081		1.714	0.584

Table 9.2: Calculation of U-value, floor.

Layer	t [m]	λ [W/mK]	R [m ² K/W]	U [W/m ² K]
Interior surface resistance			0.17	
Carpet			0.1	
Floor insulation	0.05	0.049	1.02	
Floor slab	0.1016	1.311	0.0775	
Exterior surface resistance			0.04	
Total	0.152			0.71

Table 9.3: Calculation of U-value, roof.

Layer	t [m]	λ [W/mK]	R [m ² K/W]	U [W/m ² K]
Interior surface resistance			0.10	
Metal decking	0.0015	45.006	0.00003	
Roof insulation	0.07	0.049	1.4286	
Roof membrane	0.0095	0.16	0.0594	
Exterior surface resistance			0.04	
Total	0.081		1.628	0.614

Table 9.4: U-values in building envelope.

Construction	U-value [W/m ² K]
Roof	0.614
Wall	0.584
Floor	0.710
Window	2.406
Window frame	1.000

Client:



Italian Ministry for the Environment, Land and Sea

Shanghai Jiao Tong University



Project:

Green Energy Laboratory - GEL

Doc. Title:

Development Design _ Final issue

Rev.	Date	Issued for	Pages	by	Approved	Authoriz.
0	24/04/08	CD	43	MZ	MA	SF
1	16/03/09	DD	34	MZ	MA	SF
2	16/04/09	DD	43	MZ	MA	SF

1. Foreword | 前言

On November 3rd, 2007, Shanghai Jiao Tong University and the Italian Ministry for Environment, Land and Sea signed an agreement to cooperate on the construction of a centre of research, testing and dissemination of efficient and "low carbon" technologies in the building and housing sectors, hereinafter called the "Green Energy Laboratory (GEL)", at the Minhang Campus of Shanghai Jiao Tong University.

GEL will be equipped with Italian and Chinese up-to-date environmentally-sound and energy efficient technologies.

2007年11月3日，上海交通大学和意大利环境，土地和海洋部签订合作协议，就建立关于建筑能耗研究与测试及“低碳”技术研究中心项目达成共识。项目名为“绿色能源实验室”（GEL），位于上海交通大学闵行校区。

GEL 将配备由中国和意大利提供的具有环境和能源方面领先技术的相关设备。

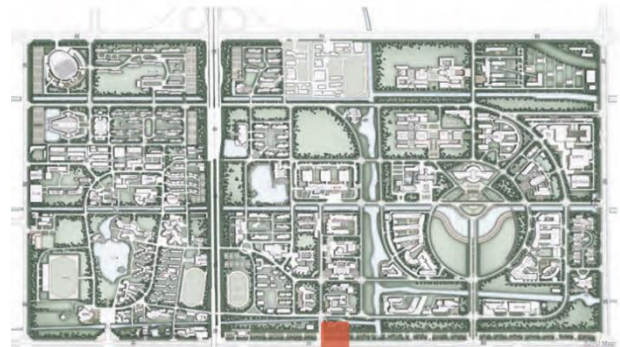

Minghang Campus Masterplan

2.1. Architectural DD Description | 建筑概念设计

The Green Energy Laboratory (GEL), as its name itself suggests, is a "green" building dedicated to research activities on sustainable indoor HVAC technologies, inside the Minhang Campus of Shanghai Jiao Tong University.

The selected construction area is located close to the gate n°5 of the campus, nearby Dongchuan Road. The area is currently used as a garden.

On the North side of the area, there is a small river, which can be used for the application of water source heat pump systems.

The area can be accessed from the existing road on its west side.

An internal road will run all around the building to comply with the fire brigade regulations. Car and bicycle parking lots will be located around this road.

GEL's main walking entrance for visitors and staff is also positioned on the west side of the building.

GEL is designed as a typical courtyard house, with an internal circular corridors system.

This is actually one of the most functional solutions in terms of traffic organization.

The building is composed by three elevation floors and a basement technical floor, with a total above the ground surface of 1600 sqm and a maximum height of 15.1 m. The first two floors will host laboratories, a meeting room, a control room, student rooms and an exhibition hall. Each room is double facing, looking both outside the building and inside the courtyard.

The third floor is designed like a residential space, and it is divided into two independent apartments: one apartment has a bedroom and a living room, the other has two bedrooms and one living room. This area will be a platform to simulate residential living conditions and to perform tests on energy efficient facilities and envelopes. For the

maximum flexibility of this floor, all the partition walls and the façade panels shall be easily removable.

The basement floor will contain the main facilities equipments.

All the laboratories at ground floor are directly and separately accessible from the outside. Also the basement is directly accessible from the street with a car ramp.

The orientation of the building and the simple rectangular shape, together with the façade and the internal glazed courtyard, are designed to maximize the natural ventilation and the solar control, so to get the maximum internal comfort with the minimum energy consumption:

- The internal courtyard is covered by an openable glazed skylight, which shall be closed during cold seasons and opened during warm seasons. Photovoltaic panels are located on a canopy above the internal courtyard, in order to integrate them efficiently with the architectural design.

- The West, East and South façades consist of two skins: an internal weatherproof insulated glazed layer and an outer satin glass louvered skin. The rotation of the louvers is designed to provide optimized sun shading at daytime and natural ventilation. The space between the two façade layers is accessible in order to provide easy cleaning and maintaining of the two façade skins.

- The North Façade is more opaque and insulated, to reduce the total energy consumption.

The structure of the building will be made mainly by steel, which is a recyclable material.

The HVAC system will be designed considering a main system (CHPC/WHP) and smaller dedicated plants, according to the tests and research to be performed in the different laboratories.

2.2. Plot technical index and reference code I 经济技术指标及规范

项目 Content	单位：平方米 (sqm)		
规划建筑用地面积 Site area	4855		
总建筑面积 Total gross floor area	1500	地下 Underground	0
		地上 Above ground	1500
建筑基地总面积 Footprint area	816		
道路广场总面积 Road & Square area	1902		
绿地面积 Green area	2137		
建筑高度 Building height	20.11m		
建筑层数 Floor No.	地下 Underground	0 F	
	地上 Above ground	3 F	
容积率 Plot ratio	0.31		
建筑密度 Building coverage	17%		
道路广场率 Road & square area ratio	39%		
绿化率 Greening rate	44%		
机动车停车位(单位：个) Parking lots for car	10	地下 underground	0
		地上 Above ground	10
自行车停车数量(单位：个) Parking lots for bicycle	40		

Function and dimension diagram | 功能和尺寸分析

Cover area | 建筑占地面积 (900 sqm)

F1 gross floor surface | 一层建筑面积 (675 sqm)

function net surface | 功能区面积

- 1. office | 员工办公室 (69 sqm)
- 2. lab | 实验室 (71 sqm)
- 3. desiccant technology lab | 干燥技术实验室 (62 sqm)
- 4. fluid dynamic lab | 流体动力实验室 (29 sqm)
- 5. component lab | 成分分析实验室 (55 sqm)
- 6. advanced heat pump center | 高级热泵中心 (72 sqm)
- 7. entrance | 入口 (29 sqm)
- 8. reception & guard house | 接待&保安 (19 sqm)
- 9. changing room | 更衣间 (12 sqm)
- 10. recycle room | 回收房 (07 sqm)
- 11. man rest room | 厕所 (15 sqm)
- 12. woman rest room | 厕所 (13 sqm)
- 13. courtyard area | 中庭 (153 sqm)

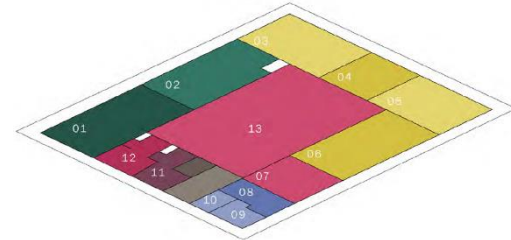

F2 gross floor surface | 二层建筑面积 (625 sqm)

function net surface | 功能区面积

- 14. innovation and exhibition center | 创新展览中心 (69 sqm)
- 15. meeting room | 会议室 (71 sqm)
- 16. student room | 教室 (55 sqm)
- 17. indoor environment lab | 室内环境实验室 (43 sqm)
- 18. ventilation lab | 通风实验室 (55 sqm)
- 19. control room 01 | 控制室 01 (29 sqm)
- 20. control room 02 | 控制室 02 (27 sqm)
- 21. solar energy lab | 太阳能源实验室 (69 sqm)
- 22. balcony | 水平交通 (101 sqm)
- 23. man rest room | 厕所 (15 sqm)
- 24. woman rest room | 厕所 (13 sqm)

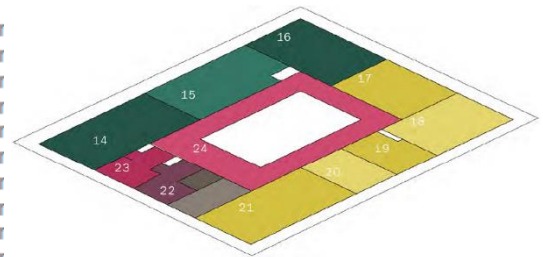

F3 in door gross floor surface | 三层建筑面积 (200 sqm)

function net surface | 功能区面积

- 25. APT 01 | 公寓01 (55 sqm)
- 26. APT 02 | 公寓02 (95 sqm)
- 27. landing | 楼梯间前厅 (12 sqm)

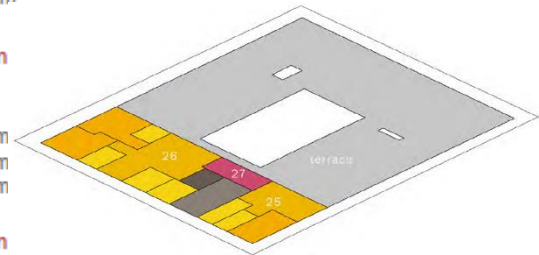

Terrace gross floor surface | 屋顶平台总面积 (393 sqm)

2.3 Master plan and traffic plan | 总平面及交通体系

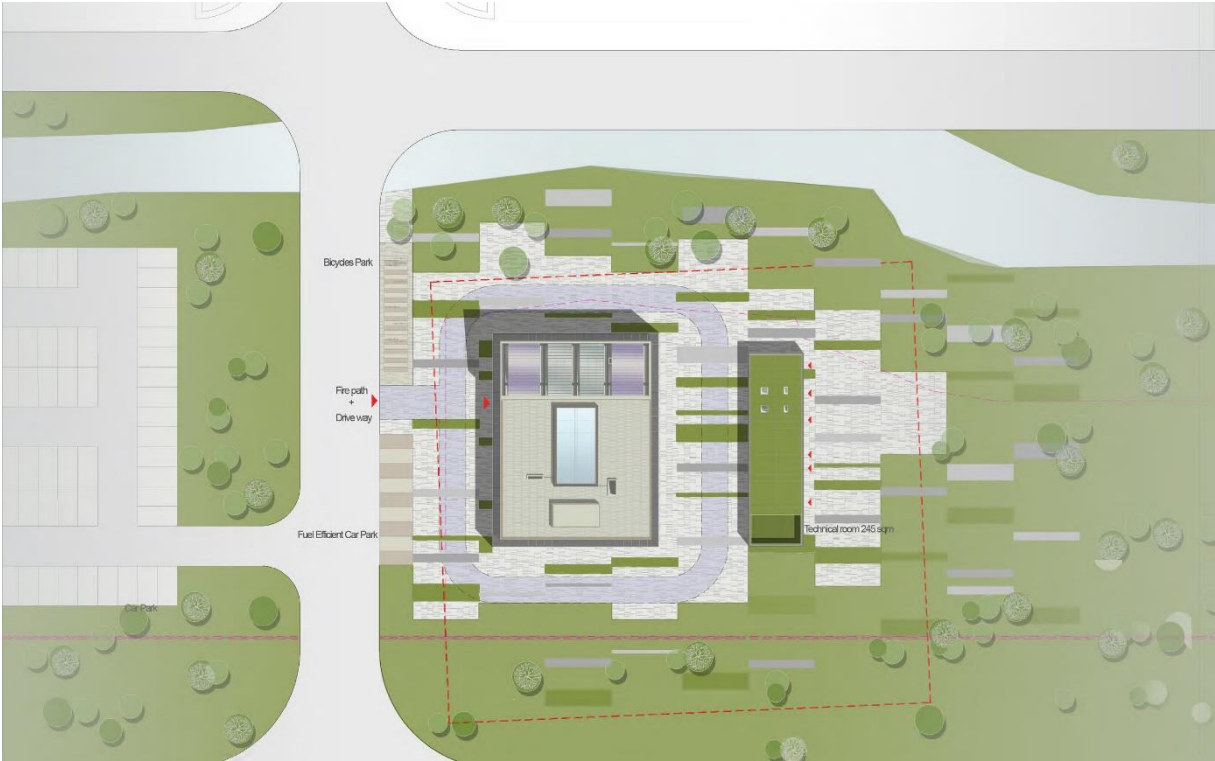

2.4 general layout | 平面

F1 plan | F1平面

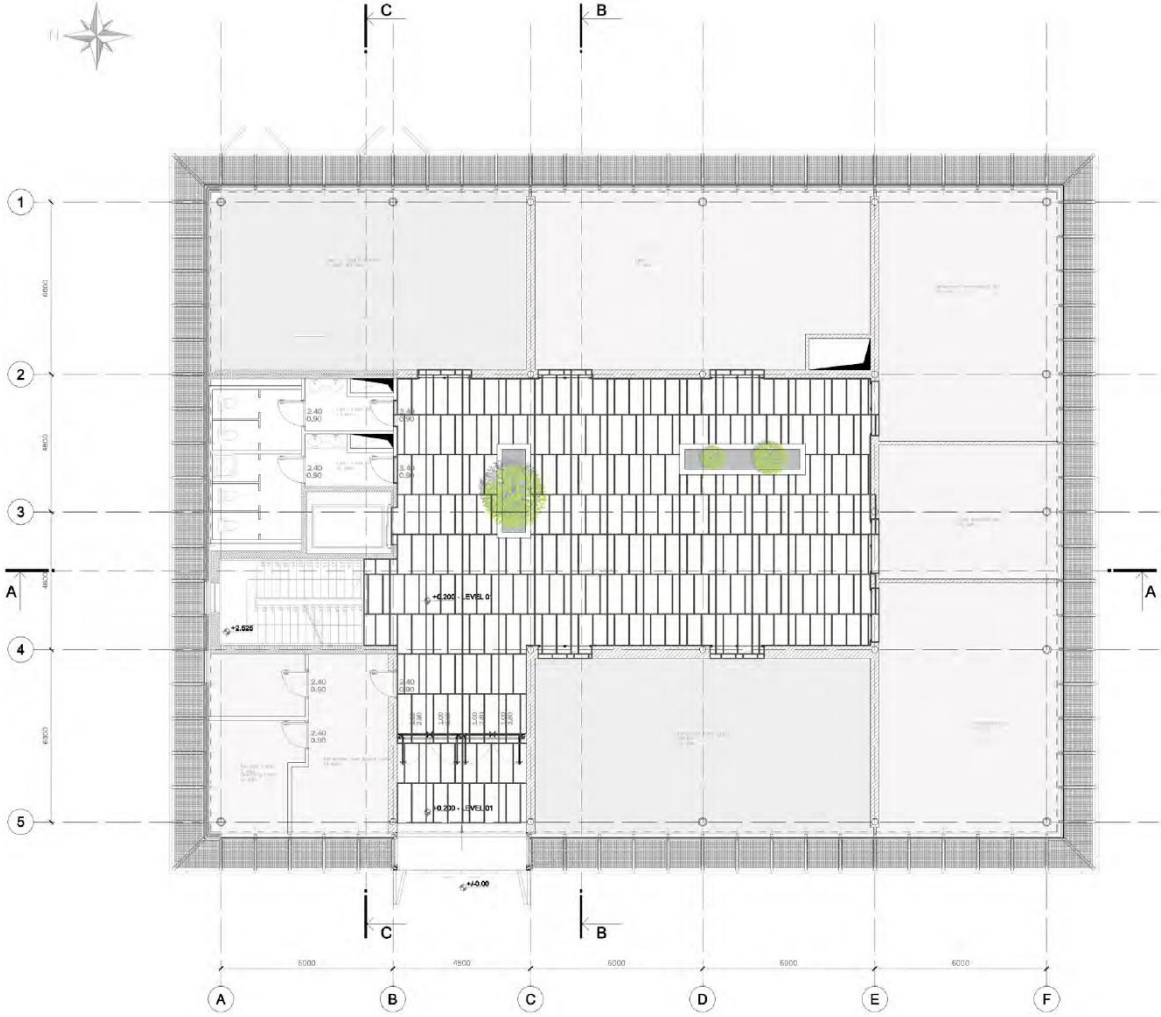

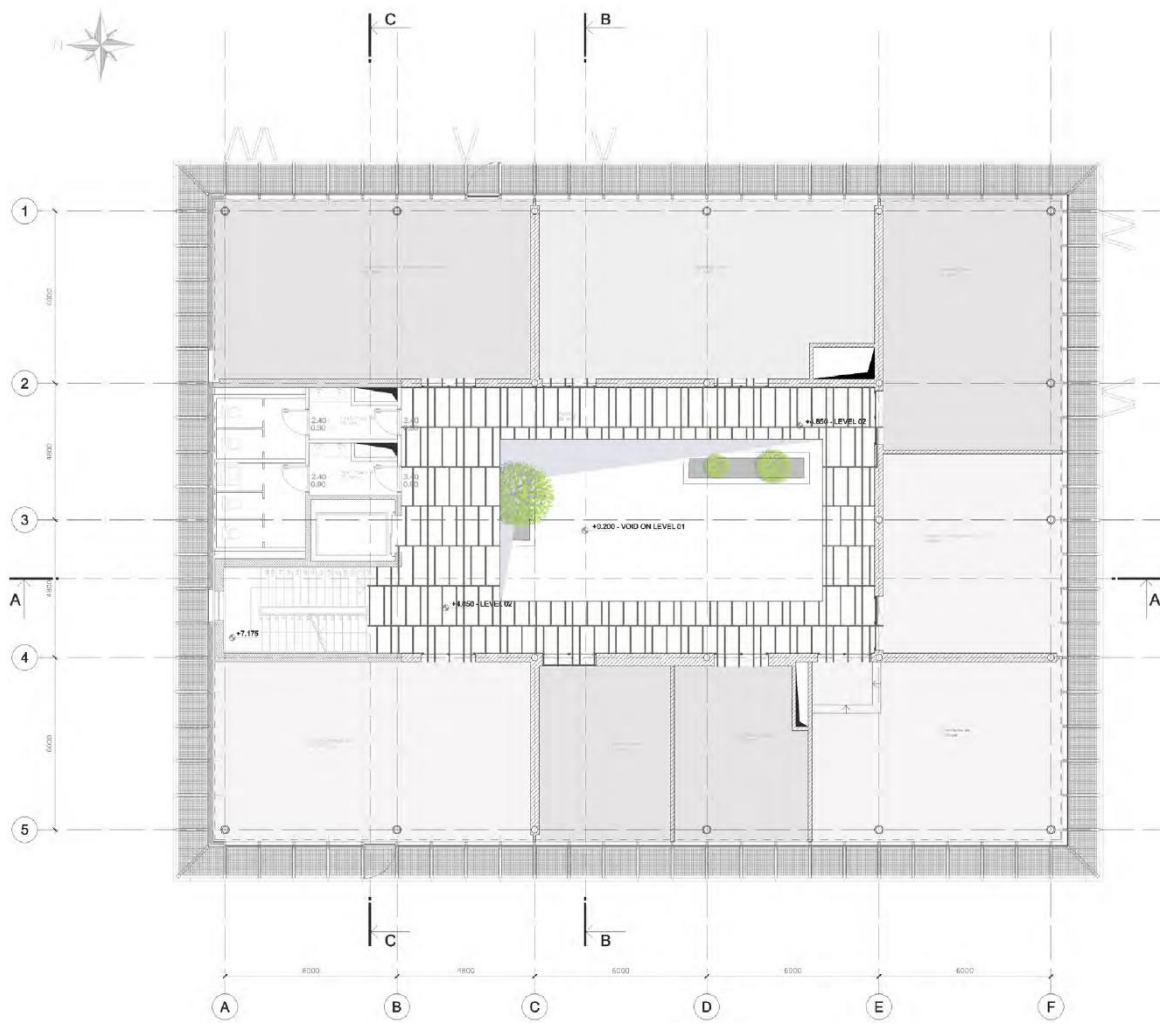

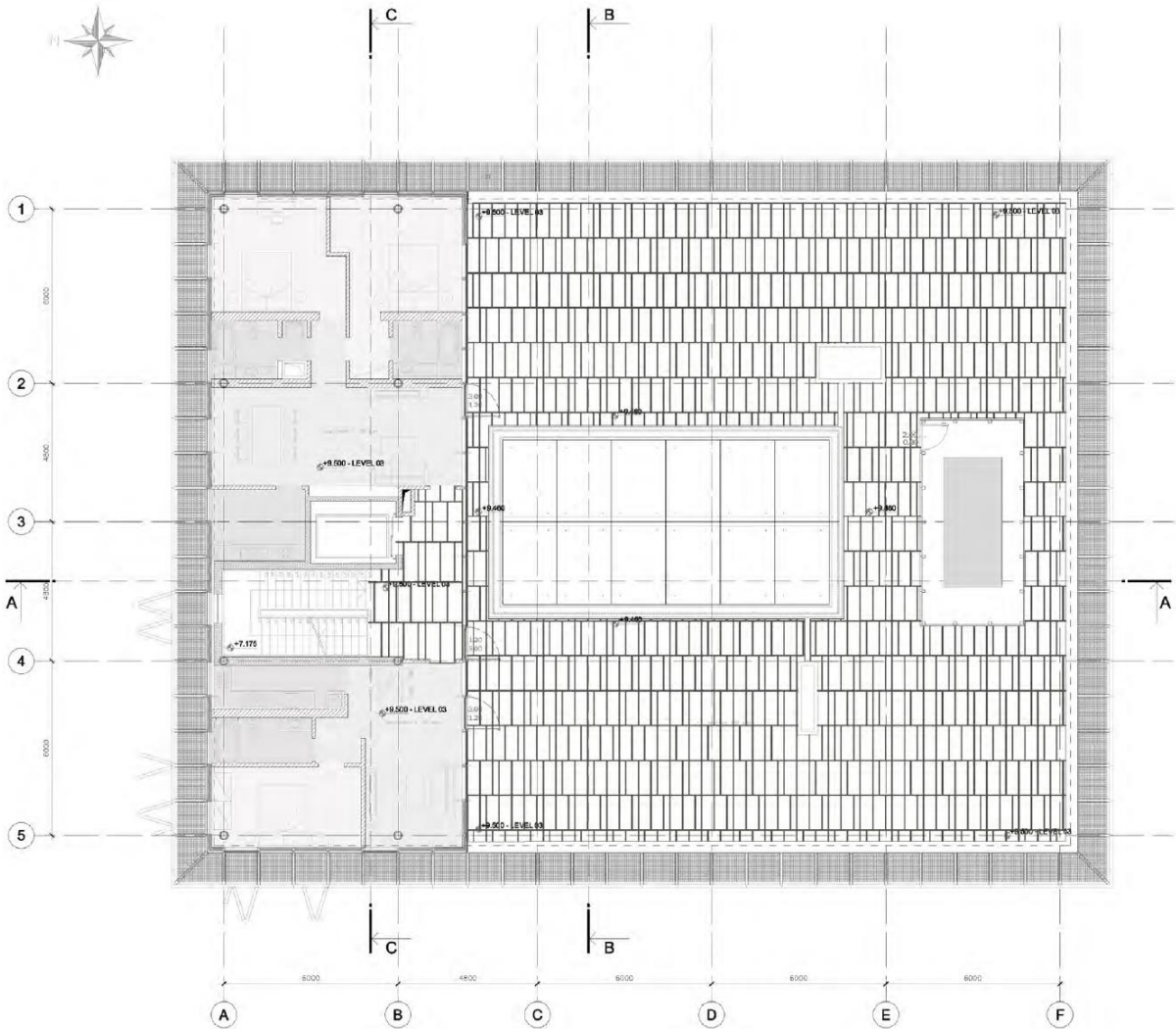

roof plan | F4平面

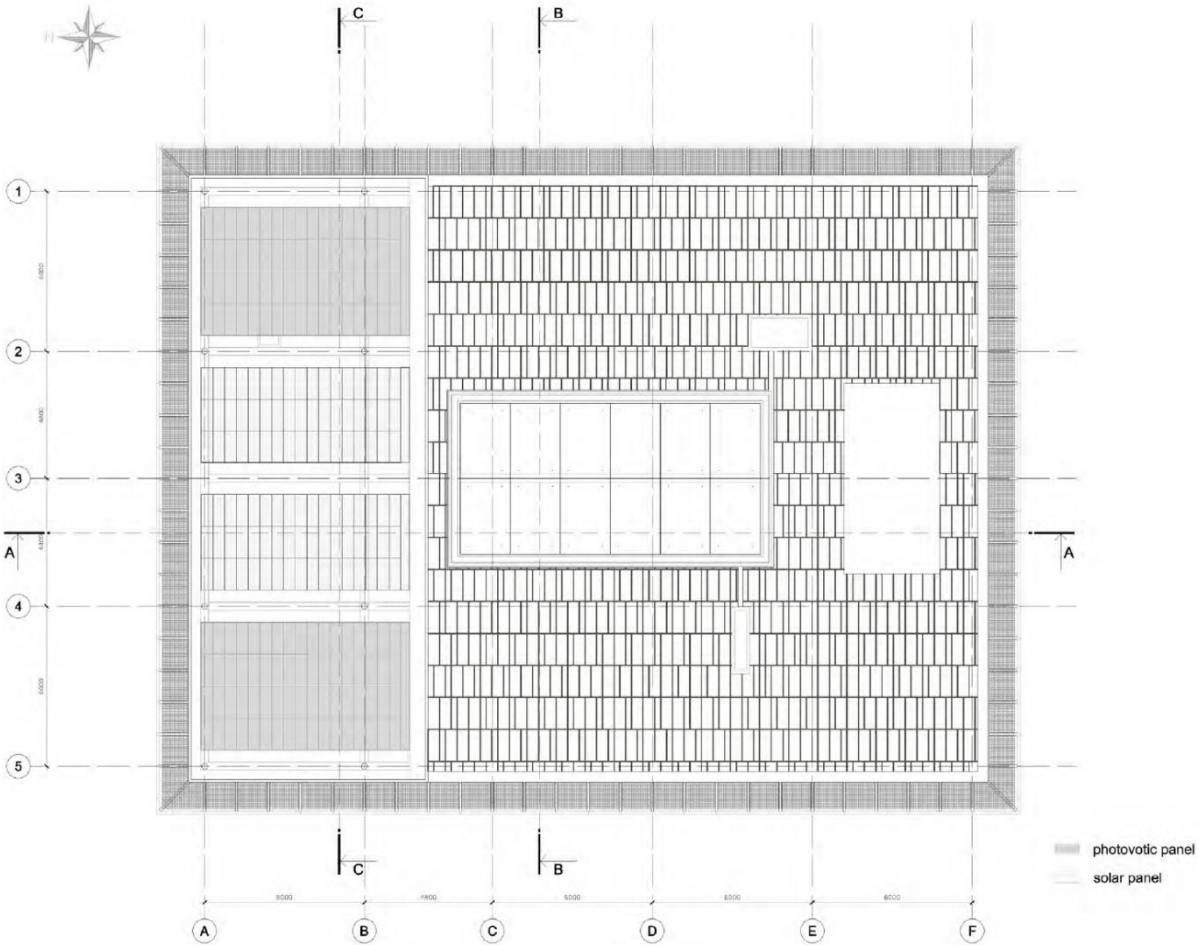

section AA | 剖面 AA

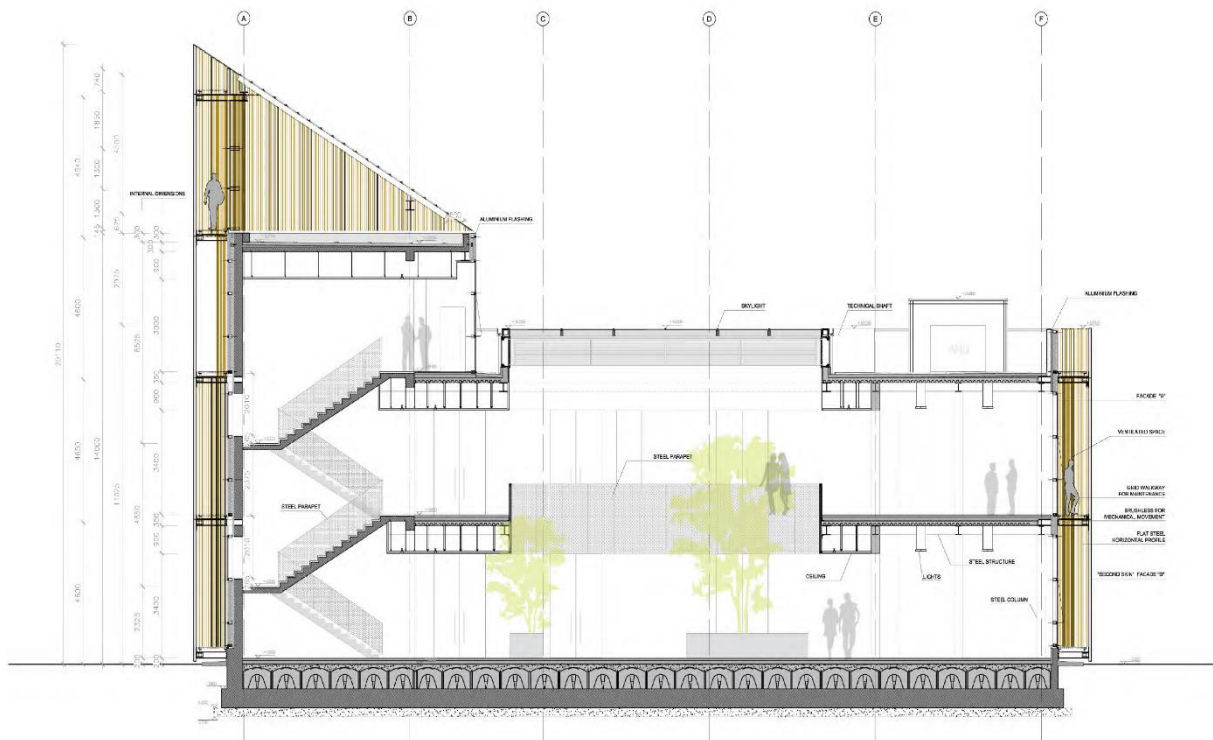

2.5 facade option I 外立面方案

2.5.1 cotto facade I 外挂釉陶板外立面



North West view | 西北透視

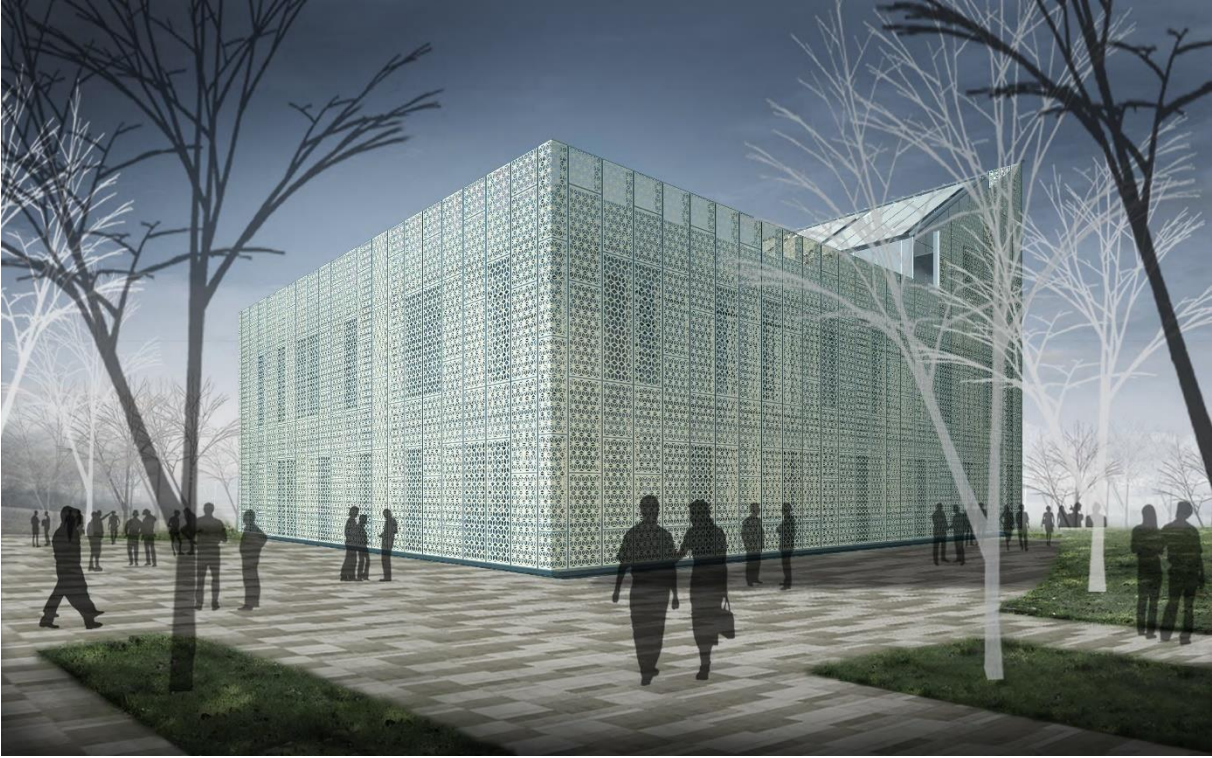

South East view | 东南透視

East cotto facade 01 | 东立面 01

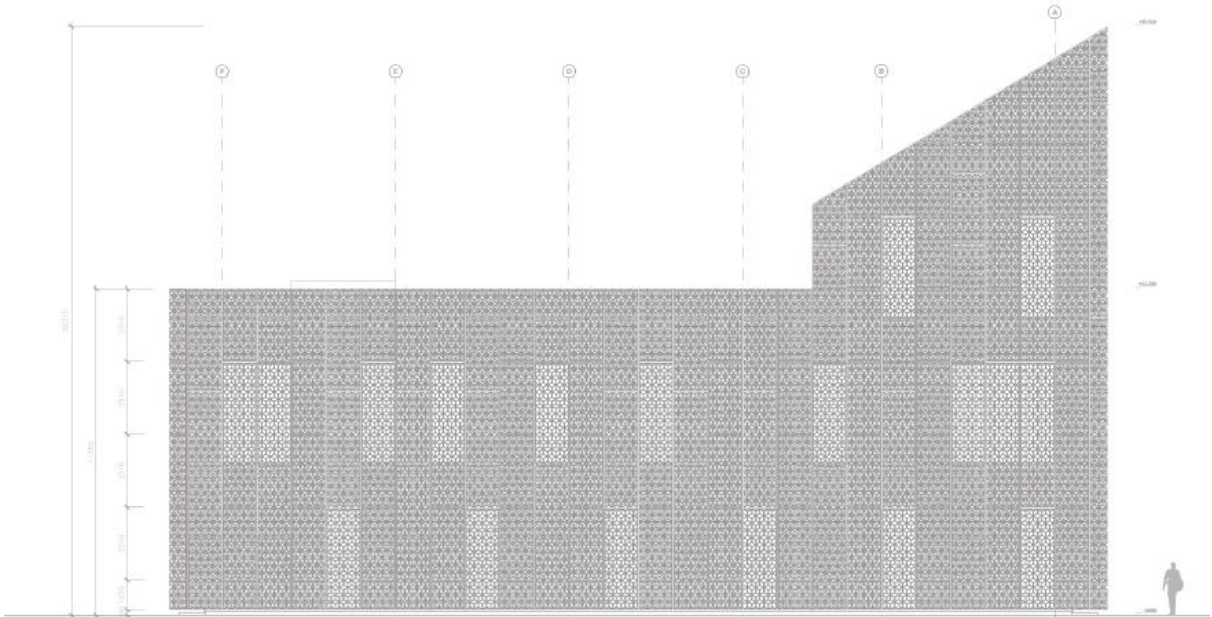

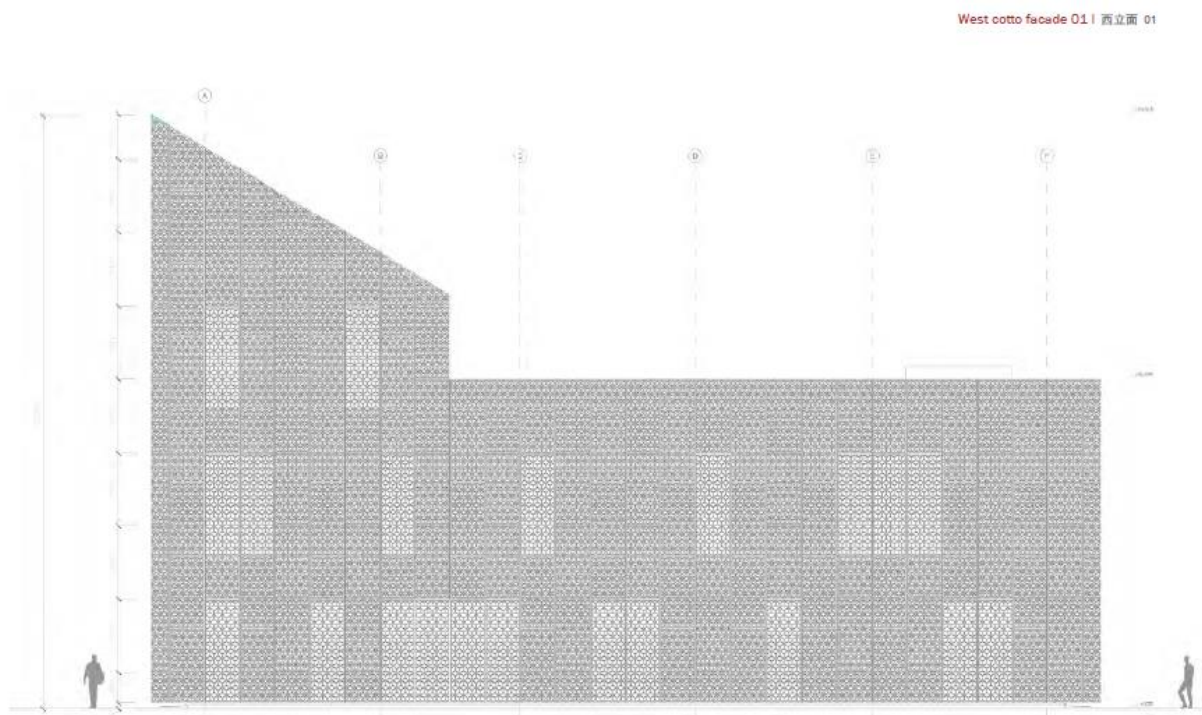
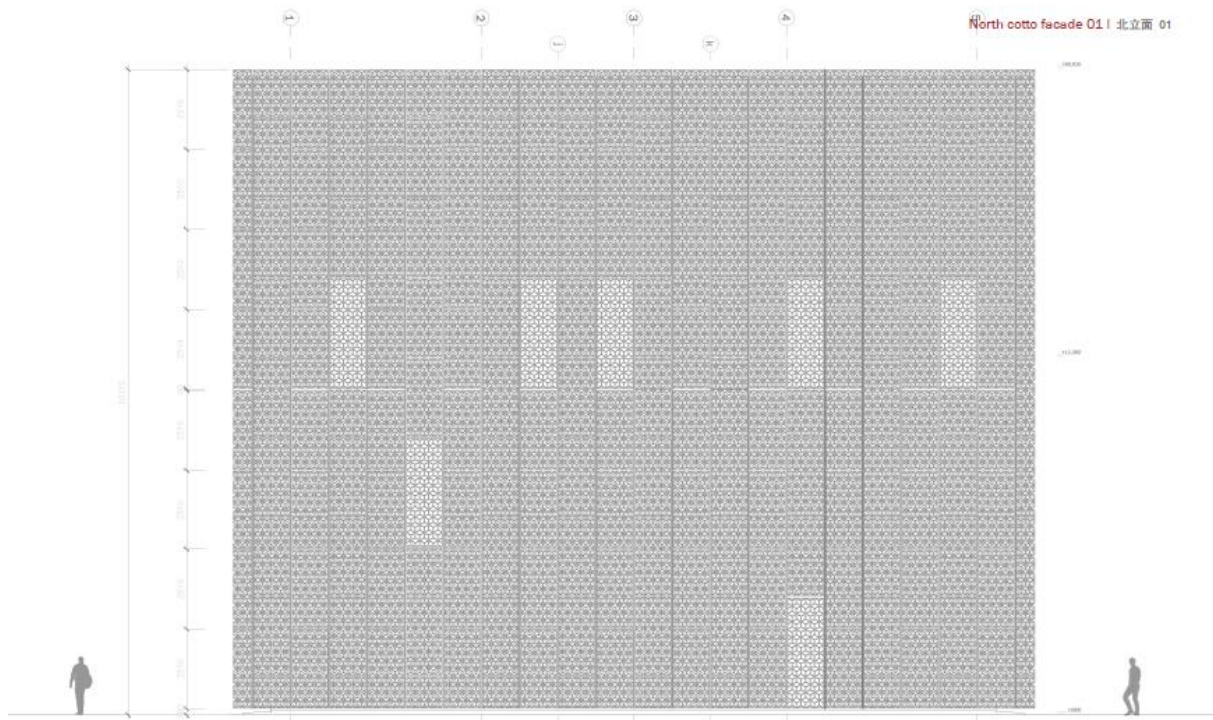

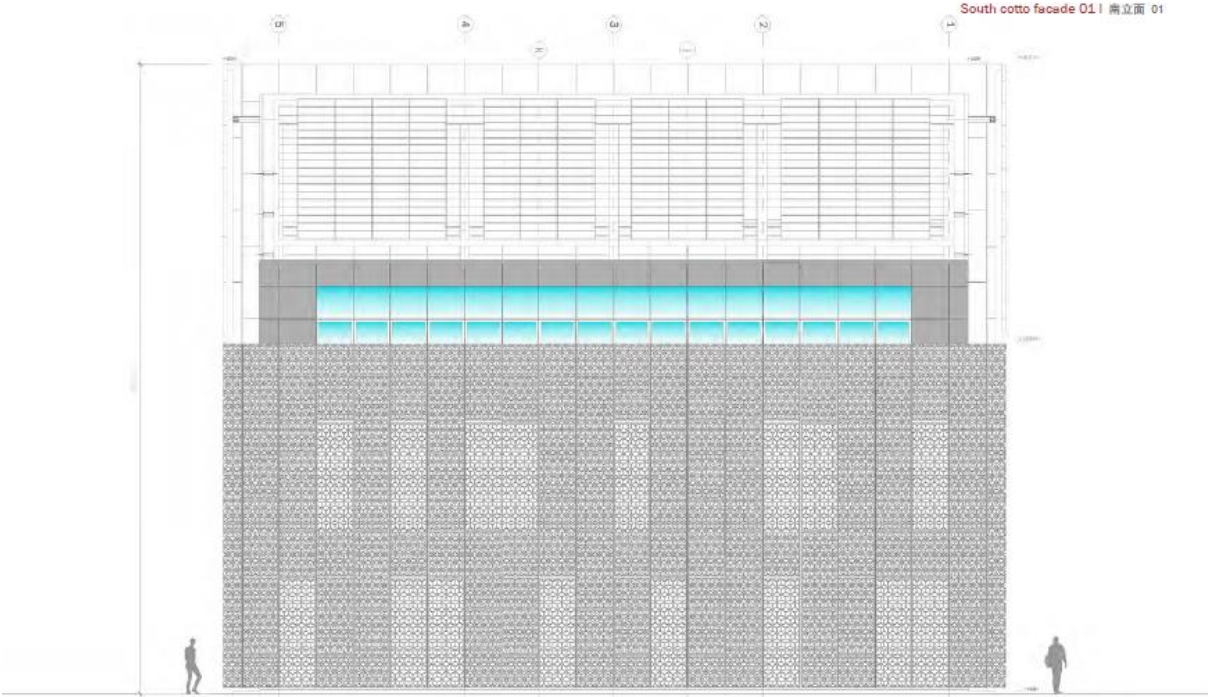

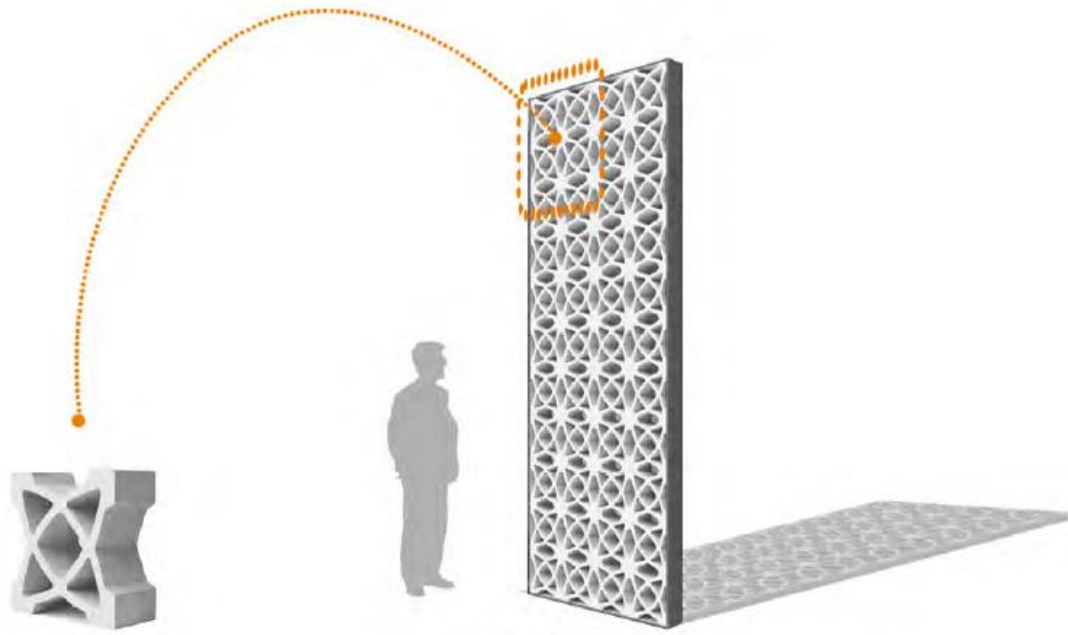

cotto module

facade panel

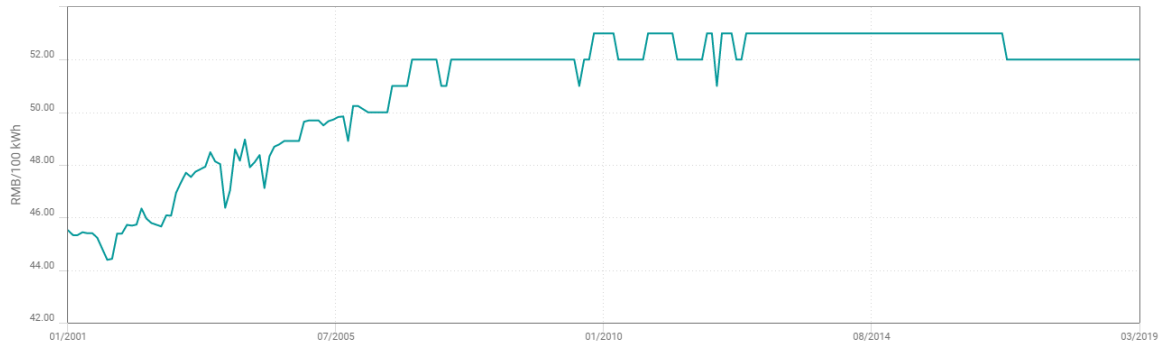

Figure 9.1: Average electricity prices for 36 cities in China, resident: 220v from January 2001 to March 2019 [39].

Table 9.5: Cost breakdown for a < 1MW building PV system [37].

No	Items	Equipment	Installation	Others	Total	Share
A	Equipment & Installation	450	27		477	66.11%
1	PV Modules	340	16		356	49.34%
2	Inverters	50	5		55	7.62%
3	Monitoring & Control Equipment	30	3		33	4.57%
4	Other Equipment	30	3		33	4.57%
B	Construction	100	80		180	24.95%
1	Roof Pre-Treatment		10		10	1.39%
2	Supporting Structure	50	10		60	8.32%
3	Cable & Installation	50	10		60	8.32%
4	Grid-Connection		20		20	2.77%
5	Transport & Warehouse		30		30	4.16%
C	Others			50	50	6.93%
1	Survey & Design			30	30	4.16%
2	Management			20	20	2.77%
	A~C Total	550	107	50	707	97.99%
	Budget Reserve				15	2.01%
	Static Investment	10 ⁴ Yuan			721.5	100.00%
	Unit Static Investment	Yuan/kW			7215	

Bibliography

- [1] Novakovic, V., Hanssen, S.O., Thue, J.V., Wangensteen I., Gjerstad, F.O., et al.(2007) *Energy management in buildings*. 3. Edition. Gyldendal Norsk Forlag AS
- [2] International Energy Agency (2017) *Energy Technology Perspectives 2017 Catalysing Energy Technology Transformations* <https://www.iea.org/buildings/> (accessed September 3rd, 2018)
- [3] International Energy Agency (IEA) *World Energy Outlook: A world in transformation* (2017).
- [4] International Energy Agency (IEA) *Technology Roadmap, Solar Photovoltaic Energy* (2014)
- [5] R. Wiik (2011). *Indoor productivity measured by common response patterns to physical and psychosocial stimuli*. IRIS International Research Institute of Stavanger, Stavanger, Norway.
- [6] Norsk standard (2005). *Ergonomics of the thermal environment - Analytical determination and interpretation of thermal comfort using calculation of the PMV and PPD indices and local thermal comfort criteria (ISO 7730:2005)*
- [7] Intergovernmental Science-Policy Platform on Biodiversity and Ecosystem Services (IPBES) *Global Assessment Summary for Policymakers* (2019)
- [8] Australian Government, Department of the Environment and Energy. *Greenhouse effect* <https://www.environment.gov.au/climate-change/climate-science-data/climate-science/greenhouse-effect> (accessed may 7th, 2019).
- [9] National Ocean Service National Oceanic and Atmospheric Administration (NOAA). U.S. Department of Commerce. *Is sea level rising?* <https://oceanservice.noaa.gov/facts/sealevel.html> (accessed may 7th, 2019)
- [10] Dlugokencky, E (5 February 2016). *Annual Mean Carbon Dioxide Data*. Earth System Research Laboratory. National Oceanic & Atmospheric Administration. (accessed September 30th, 2018)
- [11] United Nations (2015). *Paris Agreement*
- [12] International Energy Agency (2017). *Key world energy statistics*.
- [13] NASA's Goddard Institute for Space Studies (2017) *GLOBAL LAND-OCEAN TEMPERATURE INDEX*. Retrieved 30 september 2018 <https://climate.nasa.gov/vital-signs/global-temperature/> (accessed September 13th, 2018)
- [14] Intergovernmental Panel on Climate Change (2018) *SR 1.5*
- [15] Nature Publishing Group (2001). *The National Human Activity Pattern Survey (NHAPS): a resource for assessing exposure to environmental pollutants*
- [16] Ministry of Housing and Urban-Rural Development of the People's Republic of China (2005). *Design Standard for Energy Efficiency of Public Buildings - GB 50189-2005* <http://www.gbpn.org/databases-tools/bc-detail-pages/china-public#Energy%20Covered> (accessed September 27th, 2018)

BIBLIOGRAPHY

- [17] The U.S. Department of Energy's (DOE) Building Technologies Office (BTO), managed by the National Renewable Energy Laboratory (NREL) *EnergyPlus* <http://www.energyplus.net/> (accessed may 5th, 2019).
- [18] Dahl T., Albjerg N, et. al., (2010) *Climate and Architecture*. Routledge.
- [19] Holiday weather <https://www.holiday-weather.com/shanghai/averages/> (accessed September 9th, 2018)
- [20] CEICData *China Electricity Price China CN: Service Price: 36 City Avg: Electricity: for Resident: 220v* <https://www.ceicdata.com/en/china/electricity-price> (accessed November 13th, 2018)
- [21] Valuta FX Online Currency Converter. <https://www.valutafx.com/CNY-USD.htm>
- [22] Ran Fu, David Feldman, Robert Margolis, Mike Woodhouse, and Kristen Ardani (2017) *U.S. Solar Photovoltaic System Cost Benchmark* National Renewable Energy Laborator.
- [23] Stene, J. 2018. *Thermodynamics for the Heat Pump Cycle* TEP4260 Varmepumper for bygningsklimatisering. <https://ntnu.blackboard.com> (accessed September 19th, 2018)
- [24] Electrical Academica. *Load duration curve*. <http://electricalacademia.com/electric-power/electrical-power-system-components/attachment/load-duration-curve/>
- [25] Hamdy, M. 2017. *Energy Management in Buildings* TEP 4235 Energy Management in Buildings. <https://ntnu.blackboard.com> (accessed September 23rd, 2018)
- [26] Hamdy, M. 2018. *Building Performance Siumulation* TBA 4166 Building Performance Siumulation. <https://ntnu.blackboard.com> (accessed September 23rd, 2018)
- [27] Guangyu, C. 2018. *Thermal comfort and indoor air quality* TEP4315 Indoor Environment. <https://ntnu.blackboard.com> (accessed September 13th, 2018)
- [28] https://www.researchgate.net/figure/PPD-as-the-function-PMV-16_fig1_276837794 (accessed September 13th, 2018)
- [29] https://www.researchgate.net/figure/Optimum-operative-temperature-as-a-function-of-clothing-and-activity-for-PPD-6-ISO_fig18_266470236 (accessed September 13th, 2018).
- [30] http://cms.ashrae.biz/weatherdata/STATIONS/583620_s.pdf (accessed October 19th, 2018).
- [31] Purnendra K. S., Brijesh P., Kalpit P. K. (2016) *COST ANALYSIS OF SOLAR WATER FLAT PLATE COLLECTOR FOR INDIA* International Journal For Technological Research In Engineering Volume 3, Issue 5, January-2016 ISSN (Online): 2347 - 4718.
- [32] Norges Bank. <https://www.norges-bank.no/tema/Statistikk/Valutakurser/?id=CNY> (accessed June 6th, 2019)
- [33] Trading economics *China Inflation Rate* <https://tradingeconomics.com/china/inflation-cpi> (accessed June 6th, 2019)
- [34] Air Visual. <https://www.airvisual.com/> (accessed July 16th, 2019)

- [35] Air Visual (2018) *2018 World air quality report*
- [36] Byggtknisk forskrift (2017) *TEK 17* <https://dibk.no/byggereglene/byggtknisk-forskrift-tek17/> (accessed July 16th, 2019)
- [37] Lv Fang, Xu Honghua, Wang Sicheng (2016) *National Survey Report of PV Power Applications in CHINA*
- [38] Xiangrong Liu (2016) *Power, Promise and Problems: The Solar Photovoltaic Industry in China*. Bridgewater State University.
- [39] CEIC Data (2019) *China Electricity Price China CN: Service Price: 36 City Avg: Electricity: for Resident: 220v* <https://www.ceicdata.com/en/china/electricity-price> (accessed May 2019)
- [40] PTAC Crew <https://ptaccrew.com/ptacs?dir=desc&limit=60&order=price> (accessed August 2019)
- [41] Kanionco <https://kanionco.en.made-in-china.com/product/CsKEtISHEkcu/China-New-Ptac-Packaged-Terminal-AC-with-Heat-Pump-R410A-60Hz-North-America-Air-Conditioner.html> (accessed August 2019)

