

Lessons from involving students in producing learning aids. Student perceptions and reflections on learning through project-based assignments

The following document contains the final reports from the digitalization project assignment.

Supervisor:

Bassam Hussein

NTNU



Norwegian University of
Science and Technology

TPK 5100 - Project Planning and Control

Project Report : Animated real- life case on Development and Implementation of an Ordering Portal

Group number: 01

Names	Candidate No.:
1) Sadman Shahriar Alam	10123
2) Mohamed Farooq	10133
3) Sarunas Juskenas	10143
4) Chenchen Yuan	10125
5) Arslan Zahid	10102

Submission Date: November 19, 2019

Norwegian University of Science and Technology (NTNU)

Preface

This report was written during the autumn of 2019 as a part of the course, *TPK/5100 Project Planning and Control* at Norwegian University of Science and Technology(NTNU). This course is made to heighten the students when it comes to project management, planning, risk management and cooperative skills. This report is a part of project product that counts for 40% of the final grade for this course. The report was written Sadman, Farooq, Sarunas, Chenchen and Arslan.

The group who wrote this project report was a part of the project and had a target of making a product, this could be animation project based on real-life cases, including the use of Powtoon website and text to speech website. Each group member has equally contributed both for final product and report.

1. Digitalization projects

This digitalization project is completed as a part of the course, *TPK 5100 -Project Planning and Control*. The main objective of the animation project is to build a data-base that contains the best animation, and to use these animations in teaching the subject to facilitate learning process. This project is conducted in group of five students and the group has selected case 2.4 from the reference book '*The Road to Success: Narratives and Insights from Real-Life Projects [1]*' in order to develop and produce a short animation video (2.57 minutes) that demonstrate in the best possible way the challenges, the efforts made and insights gained from the project case.

This report reflects on the group development from the first day to the end of the project's work. The interdisciplinary in the group and the ease and difficulties encountered because of it during the period of the project. Moreover, the report also focuses on the type of project, project characteristics, stakeholders, initiation, success factors, planning, risk management, involvement and commitment in the group and how these factors affect the success or failure of the project.

From the beginning of the project planning, workload is evenly divided among the group members. Tasks are not specific member's sole responsibility. One can ask other members to help in process and they are expected to help. The aim of the team is to achieve grade A and to develop project management skills, and also to build up the ability to overcome the risk management throughout the project period. Group members are the stakeholders of the project. More precisely, the group is punctual in meeting times as well as maintaining the deadlines. Facebook messenger is used as a communication platform to work remotely when they are not together. The group made a Messenger Group namely TPK5100, which was used for sharing links and make conversation about project work. In addition, Google doc is applied as database where the group uploaded their respective tasks and reports. Usually, group members have attempted to take tasks they are expert in to try learning new disciplines.

In this project, the objective is to design an animation based on case 2.4[1] which is 'Development and implementation of an ordering portal'. In brief, the case demonstrates the outcomes of the inadequate project planning, insufficient description of the scope of the work, and proper documentation. In addition, the case also demonstrates how a committed leadership can have a positive effect on the final result [1]. The story line emphasizes the important and critical situations and events in the real-life case 2.4. The sequence of the animation is based on the case and demonstrated through image processing, subtitles and voices respectively. This concises the description of what happened in the project.

As each group member comes from different ethnicity, nations and technical backgrounds, it was expected from the beginning to have a lot of differences. According to the ABC group reflection [2], the group can thus be categorized as a heterogeneous group. One of the symptoms of being heterogenous was that the group spent a long time on discussing ideas about the project and while doing so, it was difficult to understand and accept each other's opinions.

After releasing the project assignment announcement in the Blackboard, the group worked on finding an idea for the project. First and foremost, all were agreed to develop a brainstorming App for encouraging and learning aid. That App could be available on Google Play Store and it could be user friendly and beneficial for all. The group members discussed with Prof. Bassam about this idea, and he advised to switch to another idea because it will be not be completed within the allocated project duration. Eventually, the group worked and completed this digitalization project of animation that demonstrate the core problems and solutions based on real-life case.

When it comes to group reflections, it is crystal clear from their individual reflections that they have acquired a lot of knowledge and new experiences from Digitalization Project of the *course TPK5100*. The team feels that everyone involved and worked hard for the project, coordinated with each other and supported each other to solve the problems that arose during the process. As they did not select or elect a leader in the team, the working structure of their team can be inferred as Flat Structured. As the theory of *Flat structured* suggests [3], each of the members had more or less the same amount of responsibility. Each member in the group had different roles, but the roles were more informal than formal.

A group is a collection of different people who coordinate their individual efforts. A team is a group of people who share a common goal and face the challenges together. The members of the team are mutually committed to the goals and to each other. This mutual commitment also creates joint accountability that leads to form a strong bond and motivation to perform [4]. The group feels they have developed into a team in order to accomplish their digitalization project in due time successfully.

2. Self-evaluation of the project management effort in the project, success or failure? And why?

A) The group should make an overall evaluation of their own project. This is an evaluation of how well the group managed the project, how well was the organization of the project group. How well the group identified and managed risks. Did the group managed to deliver the project results according to your originally stated success criteria (according to your original plan)? Is there any deviations between the stated success criteria and your final evaluation of the project (300-600 words) (1-2 pages)

The overall group management was very effective; leading to project success ultimately. From the very beginning of this project, all the available resources were viewed by project team in terms of their own personal skills related to IT, computer skills required for digitization project. For example, all the members of the project team had necessary basic computer skills and knowledge which could be used for making animation video. But none of them had advanced, professional IT skills which could have been used to make advanced digitalized product such as interactive learning website or mobile app. In addition, time constraint of project delivery and the stakeholders interest also played a vital role in deciding the project to be made in the form of an animation video of a case study. This also helped the group in identifying the potential risks associated with the digitization of the project.

Moreover, all the members of the project team were being made responsible related to certain activities, tasks in the project. Furthermore, schedule meetings were held every week during the entire project duration. This helped the project team to keep track of the project progress and also its members progress related to their assigned responsibilities. In addition, this also minimized the uncertainty of being deviated from project outcome and it's associated goals. So this resulted in the project been made what was originally planned.

Furthermore, the group also used the messenger chat group effectively other than scheduled meetings for better communication and information flow. This also leads to clarify some misconceptions about the project to the stakeholders, individuals involved and also kept the members updated in real time about any changes related to project.

However, there were some delays in project due to uncertainty about the type of software/program to be used to make the animated video and to learn that software/program interface and tools. Furthermore, there was a risk of paying high cost to use the software which was not addressed during the risk management process. But, luckily the tools required for making the animations were free of cost and the output video was of good standard quality.

B) Please evaluate the degree of your support to the following statement (group-based evaluation):

We evaluate our project management effort as successful

Scale	Strongly Disagree	Disagree	Neither agree nor disagree	Agree	Strongly Agree
Your response				As a team, we planned our project to execute perfectly, but there were some shortcomings as we had some lacking to make time for group meetings in a schedule based manner.	

3. Self-evaluation of the value to the learners? (evaluation of project success) Can you document your assessment?

A) Our target audience for this project was mainly students that are taking this subject and are looking for an alternative method of learning about one of the cases presented in the book. Even though our product was mainly targeted towards other students, we were fully aware throughout the course of the project that any person with any interest towards project management could get use out of our product.

B) To evaluate our final product we surveyed several people with different educational backgrounds. The reasoning behind that was mainly to see if our way of presenting the case and information about it were understandable for everyone, not only people who have experience with project management. During these surveys we asked some questions to the people regarding our animation. The questions and results we received will be discussed later in this section.

C) Two reviewers were picked at random from different study fields namely from business studies and engineering background to assess the final product. The reason why we have selected these informants from a diverse background is that we wanted to see if it is understandable for everyone no matter which study area they belong to.

D) From the first reviewers comment, it was certain that he was not very clear about the success criteria of the case. What we understand from that is that, we should have specified the criteria for project success in the case.

The second reviewer find the speech of the animation a little bit fast and little bit difficult to understand. Both of the reviewer found the quality of the animation to be very good.

E) Please evaluate the degree of your support to the following statement (group-based evaluation):

	Our product is of high quality and we recommend it to be used as a learning aid in project management				
Scale	Strongly Disagree	Disagree	Neither agree nor disagree	Agree	Strongly Agree
Your response					We are really confident that our product successfully represents the whole idea of the case 2.4 and thus makes it digitalized to use for further study in project management.

4. Factors that have contributed to failure / success.

The most significant factor that has contributed to success is clarity of roles and responsibilities. In order to make sure that each group member understands his duties, we made a detailed work breakdown to clarify every task we would face and assigned them to the group members clearly when working on the project planning at the first place. One of the biggest challenges in this project is that some group members had to work on other projects simultaneously from time to time. However, we successfully avoided priority confliction by early planning. At this stage, we spent plenty of time to discuss about the capabilities and available time we have to guarantee that all the group members could be assigned the proper tasks. As a result, every group member was loyal to the assignment during the implementation. But meanwhile, we are willing to help each other through the whole period, which is also a basis of good cooperation. Although some of us were not able to attend every meeting, we still did our tasks well and conducted our project on schedule in the critical path.

Adequate risk management is also a success factor of this project. It is one of the key factors that influenced our decision about the form of our product. We chose to take a more conservative approach, which ensured that we can make a relative complete product on time. At the beginning of planning, passions and ambitions made us want to design a learning tool with a wider range of applications, such as an application for brainstorming. However, after inquiring Bassam who have experience on this project in the last few years and more discussion at the practical level, we did a risk assessment including highly probable delays, lack of specificity for learning tasks, difficulty of competing with similar products in the market and etc. We realized that it was not a wise choice and turned our direction to the animation, which has already proved its possibility of success. When looking back and reviewing now, we know this may not be the best strategy to deal with the risks. But in another way, through this we avoided risks and made a qualified product.

During the production stage, proper resource and tool selection can be considered as a success factor in this project as well. Since the majority of the group did not have experience of professional animation making, we chose an online program called 'Powtoon' after comparison with several popular animation programs. Its user-friendly interface makes sure it is easy for amateurs like us to get started with while offering creators enough operating possibility. Moreover, it is essential for our decision making that it has an enormous library which is able to provide diverse materials. By using this program, the process of animating went very smoothly.

There are also shortcomings. Insufficient participation of other stakeholders is a significant factor that limits the project. It directly caused the project purpose was made in a narrow scope and cannot totally avert biases in the whole period. At the planning stage, we did not establish any routines for change controls with our other stakeholders. In terms of content, just investigation among competitors and successful examples online is inadequate. We only involved the project owner into discussion as well. The most important thing is that we were supposed to make our research based on a broader population of end-users for seeking requirements. Instead, we basically play roles of both end-users and project manager at the same time to simplify this process. In the production stage, we also miss the chance to adjust our directions since we rarely ask other stakeholders' opinions. The only formal feedback we got is in the final test stage. However, we were only able to polish some details due to the time limit.

Lacking professional knowledge and skills is a negative factor in this project as well. On the one hand, although we took the advantages of the program 'Powtoon', our final product was still rough when evaluated by professional animation standards. We unavoidably reduced the attraction and narrative that an animation was supposed to have. On the other hand, we were only capable to transform the case to a script from the perspective of a student because of lacking teaching or script-writing experience, which is not an ideal solution for making a learning media or tool.

Comparing with the form 'Summary of the success factors from the examined project cases', what we did best is highlighted in blue and what we almost ignored is highlighted in yellow. Besides the factors mentioned before, it is still worth mentioning that we did realize the importance of factors like 'Clarity of purpose and objectives' or 'Selection of optimized solutions/deliverables' and devoted our efforts on it, but because of the limit of our experience and scope, we still have a lot of room for improvement. Moreover, since we did not have a particular head of our group due to the small size, everyone participates in the management tasks. The good side is that all the members are included in each steps while the bad side is that no one actually took the ownership of management and took the responsibilities to control everything. Therefore, the assessment of some factors related to top management or line management is not clear.

Table 1. Summary of the success factors from the examined project cases [1]

Commitment (project manager, team, top management, project owner)	Adequate early planning	Oversight / follow up by top management
Clarity of roles and responsibilities for those involved in the project	Loyalty to decisions	Use of appropriate project execution model (agile, adaptive, plan driven)
Project manager / management has adequate business insights (understand the needs of various group, understand the impact of the project on the users)	Project manager with adequate decision-making authority / appropriate project organization structure	Collaboration between stakeholders/ contractors / line management and project
Inclusive project manager	Honesty in reporting	Follow-up and feedback by project manager
Mobilization and provision of support from project owner / line management / top management	Clarity of priorities and structured requirements process	Creativity of the project manager / team
Mindfulness about biases, heuristics such as overoptimism, narrow focus and assumptions	Experience (project manager, contractor, and team)	End-user/ client/stakeholders involvement
Skills, knowledge and competence (project manager and team)	Use of lessons learned from previous projects	Clarity of purpose and objectives
Alignment of organization to project purpose/ Communicate the importance of the project to the entire organization	Structured risk management process	Transparency (open and inclusive communication on all levels)
Motivation of project team / project manager	Flexibility (adaptability, autonomy, address problems as they arise)	Proximity to end-users, management and human resources
Adequate documentation and reporting	Adequate and timely information flow between project and stakeholders	Established routines for deviation / change control
Trust (within team or between client and contractor)	Stability / continuity of project organization	Collaboration within the project organization (One team)
Continuity of project development (short waiting time between phases)	Balanced project group that represent the interests of all the units/ stakeholders that will be affected by the project	Selection of optimized solutions/deliverables

5. Most important lessons from your project

A project work of this sort is surprisingly demanding and will require a lot of precise planning and thinking ahead to be able to successfully both lead the project and manage to deliver a project that satisfies the requirements of the project.

First and foremost, the group should study the requirements and expectations for the final product before deciding what the product is going to be. A familiarization like this will help you a lot in both designing and producing the final product. A thorough analysis of the expectations and requirements makes the whole course of the project significantly less viable to any major changes.

During the planning stage of the project most of the weight should be put into detailed explanations, especially in the description of the product itself and in the expectations for the group members. Avoiding ambiguity is an important thing for the whole duration of the planning stage which the group will benefit greatly from during the later stages of the project. Clear and descriptive explanations of what is expected from the different members, the deadlines and the vision of how the product is supposed to be will help greatly to every single member involved with the project.

Finally comes the production stage. In my experience, possibly the easiest part of the whole project. If the design and planning stages went ideally, the production stage will be a breeze to go through. There are however still a couple of potential problems that may appear during this stage. One of them could possibly be lacking the knowledge or skills assigned to you during the planning stage.

The final point worth mentioning is the importance of constant communication between the group. The importance of keeping the rest of the group up to date with where the project is, is vital for the success of it. In addition to that, the aforementioned potential problem of lacking knowledge may be fixed or at least have its effect on the course of the project minimized by informing the rest of your group about it. Keeping your group up to date with whatever is happening on your end of the project could potentially save the group a lot of time and make the final product significantly better than it otherwise would be.

6. References

- [1] Hussein,B.(2018). The Road to Success: Insights and Narratives from Real-life Projects.
- [2] Berg-Nielsen,T.S (2015). The ABC Group of Psychology.
- [3] Colette L. Meehan (2019). Flat vs. Hierchical organizational structure.
- [4] Jim Sisson,J(2013) The difference between a group and a team.

Peer-review report

What is the name of the group you are assigned to evaluate: Group 8

Strengths

Whilst the idea for the project may not be something revolutionary or groundbreaking, it is nonetheless a product that has a use and will potentially provide great value to learners that prefer learning through visual or aural methods. Regarding the technical quality of the project it is of a higher than enough quality. The animation slides backed the text being read very well and were varied enough not to make the whole thing feel stale. The addition of info graphs and bullet points on some of the slides helped a lot to underline some more difficult points of the case. The group also deserves extra credit for not opting for a text-to-speech device which in most cases leads to a boring and difficult to follow audio.

Weaknesses

As mentioned before there is nothing special about the idea behind this project. It is something that has been done before a plethora of times leading to the video and most importantly its content being barely memorable. Another point worth mentioning is that whilst extra credit for not using text-to-speech is deserved, the reader was still fairly monotone and therefore somewhat difficult to follow along with.

	The product we reviewed is of high quality and we recommend it to be used as learning aid in project management				
Scale	Strongly Disagree	Disagree	Neither agree nor disagree	Agree	Strongly Agree
Your response				The lack of creativity in the idea behind the project and the small technical shortcoming regarding the voice bumps the score down from strongly agree	

On a scale from 0 to 10. **What grade would you recommend for this product?**

As a group we agreed that the product produced by group 8 is worthy of a grade *7.5 out of 10*.

TPK5100

Project Management

An interactive webpage to aid self-testing and review



Group 2

Preface

This report contains an evaluation of the execution of a digitalization project in the course Project Management (TPK5100). The project is aimed at creating a digital aid for people to learn more about project management. The end users are primarily students enrolled in the course, but several secondary end users have been identified, from other people that want to learn more about project management, to a company that works in a project-based manner who can use this tool to teach their employees about methodology in project management.

The project group has evaluated the whole project life cycle, from project initiation and planning to delivery of the final product. The final product has been evaluated through user testing and reflection by the project group, and the most important factors leading to success or problems have been described.

The project group would like to thank Bassam Hussein and Kristin Helene Hafselid for assistance in the planning and evaluation phase of the project.

Group number: 2

Student names and student number:

- 1) Dan Godhei 497960
- 2) Inthujan Rasalingam 258680
- 3) Ingrid Marie Rennan 258652
- 4) Mari Elida Tuhus 769524
- 5) Solveig Askevold Ulsund 253228
- 6) Anne Pernille Wulff Wold 769517

1. Digitalization projects

1.1 The product

The group created a website, consisting of a series of multiple-choice questions from the topic Project Management. These questions are divided into chapters, making it easier for the user to manually choose the chapter he/she desires to study. A feedback system was developed, which will suggest what subject or subchapter he/she should look more into to achieve a better score on the quiz. The idea was to give the user a more thorough feedback than only a quiz score. The user can always monitor the progress by clicking at “progress” on the tool bar, where they can see how many percent of each test they have completed.

The main purpose of the product was to design an interactive learning tool for the students to use for exam preparations and/or achieve a better understanding of the course Project Management. By keeping the website informal, it should be easy for students to use as a learning tool and not worry about the score she/he gets as it is not monitored by the professor or teaching assistants. They should also use the feedback to understand where they lack knowledge and study these subchapters to achieve a better score on the quiz and the final exam.

The group decided to pursue the idea of creating an interactive learning tool, as a result of the heavy digitalization occurring in almost all sectors, especially within schools and universities. The user immediately gets a feedback on what knowledge he/she lacks, compared to a paper quiz where it can take several days before getting any feedback.

1.2 Small-scale projects

Small-scale projects are known to have small teams, short duration of time, low person hours and small budgets. For a small-scale project the project group will have a dual role. (Larson, R. (2004)) The group had to stand for both the project management, but also the project delivery. Therefore, the time used to deliver the project and for managing the project had to be well balanced and planned. The group consisted of two students studying IT and four students studying Energy and Environment. Therefore, the group agreed that the two students with more experience within programming would take the lead in the project and create the work packages.

For this project the main stakeholders were the professor, teaching assistant and students who will use the learning tool. It was challenging to identify all stakeholders with great accuracy and find the relationship between each stakeholder and the project, but also the relationship between

the stakeholders. We had to adapt from the feedback from our stakeholders and consider the feedback to customize the project so it would gratify the stakeholders needs. The stakeholder management should therefore be flexible, since people's opinions and perceptions of the project could change at any time.

During these types of projects, some minor tasks could be neglected or invisible during the project planning and then emerge after the project was started. This was avoided by using a work breakdown structure. By breaking down the project into work-packages, each of the participants could work with their own work-package. This made it easier to distribute the work evenly, and the students could manage work-packages where they felt comfortable and had the knowledge needed to fulfill the work with great quality. By breaking down the project the complexity of the project was reduced, and it was easier to continuously monitor and measure the progress. (Nizhebetskiy, D. (2017))

The time schedule of such projects can be short, which needs to be taken under consideration when creating a timeline for the project deliverables. To avoid falling behind schedule, a buffer of six days was added in the end of the development phase in order to be flexible in case of unexpected events. For small-scale projects with limited time, the standard quality management approach is not always possible to use. Therefore, it is necessary to be creative while maintaining a high-quality standard. Quality could also be difficult to define while working with the project and easier after completion when looking at the completed project. Regular quality controls are therefore a must, even for small-scale projects. (Abhijit, et. al. (2016))

2. Self-evaluation of the project management effort in the project, success or failure? And why?

The project was overall planned well. All the team members knew their area of responsibility and what was expected from them. The schedule was clearly defined, and the work was divided into work packages, or *backlog items*. These items were placed in three sprints.

In spite of thorough project planning work, the product did not end up as envisioned. This is due to technology challenges faced along the course of the development, specifically the lack of technical experience addressed in the technical risk assessment combined with the “Technology” item in the risk assessment plan. In order to create a login page and save user statistics, a database was needed, which turned out to be a too complex task to complete in the time frame of the project. Implementation of a database is a requirement of backlog items T6-T9. Hence, these were not completed in the prototype of the product.

The success criteria were defined as a successive chain of statements, as illustrated in figure 5 in the project plan. The first decision was which medium to use. A website with multiple choice questions was chosen, which is also what was delivered as the end product. The second item was to create a project plan to make sure all the team members had the same understanding of the product. The resulting project plan is found in the appendix of this report. Then the responsibility and tasks were distributed among the team members. Both planning and task delegation was carried out and the team members knew what was expected of the end product prototype and their own responsibility/tasks. During the course of the product development, the group managed to meet up for updates three times as required in the fourth success criterion. The two last success criteria are test of the prototype and an analysis of the result, and that the product is delivered on time. The test and analysis can be consulted in the next section, and the product was delivered on deadline, on the 12th of November.

Overall, despite the fact that the prototype did not have all the functionality defined in the product backlog, the project itself is considered a project management success.

The project management effort is considered as successful

Scale	Strongly Disagree	Disagree	Neither agree nor disagree	Agree	Strongly Agree
Your response				X	

3. Self-evaluation of the value to the learners?

To evaluate the final product, the team developed a Usability Test Plan to test the webpages functionality and figure out what measures that needed to be taken to provide a good user experience. In addition, the team created a Google Survey in order to get feedback on how relevant the webpage would potentially be in the course and what learning outcome it could provide to students.

Before finalizing the webpage, the team, as mentioned, developed a Usability Test Plan. It is valuable to arrange user tests, since other people might notice bugs and elements that can be improved to create a seamless user experience. This is because a user often has different perceptions of the webpage than the developers, who usually have too much knowledge about the final product. User-based evaluations are methods where the users are invited to do typical tasks with the product, and their behavior are observed to identify design flaws that potentially can cause errors. (Bastien, JM Christian. (2010))

The usability test plan is summarized in the table below. In addition to the participants, the team also used hallway testing to provide feedback from random individuals with different technical skills and backgrounds.

Usability Test Plan	
Product under test:	A prototype of our webpage, Quizme.
Test objectives:	Determine design inconsistency and usability areas within the user interface and content areas. Locate different types of errors on the webpage, such as navigation errors, presentation errors and usage problems
Equipment:	A computer with a prototype of our webpage, Quizme.
Surroundings:	University environment.
Participants:	Chosen students will attempt to complete a set of task scenarios presented to them and provide feedback regarding the usability in the user interface.
Tasks:	Student: Complete a couple of questions, navigate to the feedback page in order to get their progress in the course. Read the feedback comments and navigate to the correct page in the course book and read the relevant curriculum.
Roles:	Datalogger and test observer: The member of the team responsible for the current test. Test participants: Wenche Kjæmpenes, dean at the Artic university.

	Eivind Keil, experience with software development, Student at NTNU.
Usability goals:	<p>Completion rate: High percentage of the test participants successfully complete the tasks without critical errors. A critical error is defined as an error that results in an incorrect or incomplete outcome.</p> <p>Time on task (TOT): High percentage of the test participants successfully complete the tasks at a reasonable time.</p>

Table number 1: Usability Test Plan

Second, the team created an online survey to see how other students value the final product. The team wished to get the students' feedback on aspects regarding its value, usefulness and see if students will find it useful when preparing for the final exam. It was also interesting to get feedback on the final product from the professor, to see if he would find it valuable to see students' progress if a new software update with additional functionality should be launched in the future.

When developing the Google Survey, the project team focused on feedback from two of the stakeholders, students taking PM and anyone who is new to PM. Students taking PM were defined as stakeholders where interest was high, and their influence was critical. Feedback from this group was very important for evaluating the success criteria of the final product. The second group was less important. They were classified with low interest and marginal influence, as illustrated in figure 1 in the project plan.

The Usability Test was conducted on a total of 4 people. Given the range on different age groups and technical background, this was evaluated to be a sufficient amount of people. The purpose of the test was to gain insight to the user's perception, as the functionality on the webpage is quite limited. As mentioned, random hallway participants were also asked for the Usability Test. There were 20 answers in total from the survey, 15 answers from students enrolled in the course and 5 from students not enrolled but engaged in project management. The students that were asked to take the survey after class were randomly selected. The remaining 5 were friends of the team members who plan to enroll in the course in the near future.

User Feedback Report		
Participant:	Feedback/Quotes:	Taken measure:
Hallway participant	“Wish it was possible to create a new user, so my progress can be saved.”	The team have a wish to create this functionality in the future, by using Feide login and a connected database, in order to save each students progress. Due to the restricted timeline in the course this was not implemented.
Kjæmpenes	“Hard to get an overview of all the functionality on the webpage “	Created an introduction page to give a brief introduction to the webpage and its functionality.
Keil	“The chosen colors for the layout are too bright, which makes the text unclear. The statistics charts are hard to understand. “	Changes in the front-end technology. Design of the webpage improved to make it more intuitive. Changed the way the statistics/progress are displayed.
Hallway participant	“Wish the webpage gave me feedback on the questions I answered incorrect”	The team aim to implement this functionality in the future, and is not implemented p.t due to the time restrictions.

Table number 2: Feedback of the Usability Plan

After analyzing feedback and results from the User Test measures were made, regarding simple functionality, front-end of the product and some bugs the users detected. The results from the Usability Test can be seen in Table 2. Examples of changes that were made after conducting the User Test were the creation of a welcoming page explaining the purpose of the product, changing colors creating a better user experience and changing the way the progress bars were visualized. By conducting such a test in the finalizing phase of the product the team was able to deliver an improved product.

The online survey was conducted after the improved product was finalized. The main goal was to map the interest and how useful the developed tool was for students who are participating in the TPK5100, and if it could be utilized by others who takes interest in the respected field. It was also questioned if the website was easy to manage after the improvements, to gain insight if there would be need for a new re-structuring.

The results from those who participate in the course, illustrated in figure 1 and figure 2, clearly displays that the overall interest for a learning tool like this is useful, and that most of the students participating in this survey are likely to or most likely to use this tool when preparing for the exam. A marginal part of dissatisfaction is expected, as people have different strategies to gain knowledge (Busato et al., 1998).

Did you find the learning outcome after taking the quiz useful, by following the feedback that was given?
15 svar

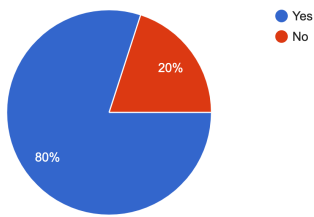

Figur 1: Results Google Survey

Would you like to use this tool for preparing to the exam?
15 svar

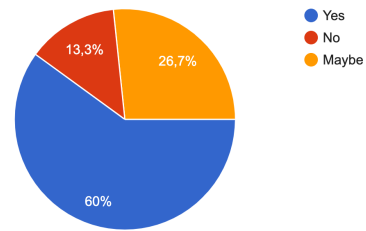

Figur 2: Results Google Survey

There was also an interest to see how usable the tool was for those who are not participating in the course but takes an interest in project management. The result from this group was mainly “negative”, as illustrated in figure 3. After analyzing the result, the reason why people were dissatisfied were likely that the basic knowledge of the course before taking the quizzes. Also, the feedback given is based on lectures from the course and the assigned book, “The Road to Success”. If the participants do not hold this material, the tool would not be as useful.

Did you find the learning outcome after taking the quiz useful, by following the feedback that was given?
5 svar

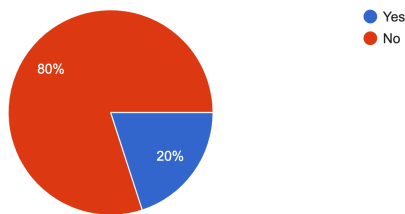

Figur 3: Results Google survey

Figure 4 shows website satisfaction level. The participants of the survey rated how easy the website was to manage on a scale from 1-6. The team had decided beforehand that ratings from 4-6 was categorized as satisfactory, and everything bellow was unsatisfactory. The average result of satisfaction was 4.25, which meant the site was satisfactory.

Did you find the webpage easy to manage? Rate your satisfaction from 1 - 6 (where 6 represent the highest satisfaction)
20 svar

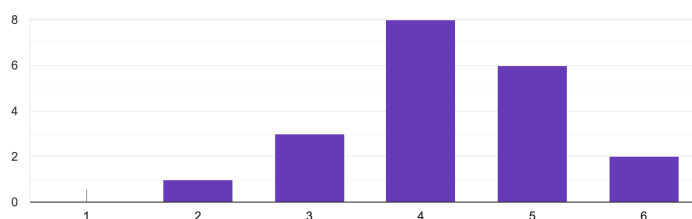

Figur 4: Result Google Survey

As a final measure the team also asked the professor about his view on the final product. Professor Bassam Hussein was the project owner i.e. an important stakeholder, and his perception were both valuable and crucial for further development of the project. The professor was positive to the main idea behind the product, but critical to the fact that questions were gathered from already existing “Kahoots”, which is a game-based learning platform. Functionality such as guidance and comments about student progress should also have been implemented to fulfill the main purpose of the product. The team aim to implement such functionality in the future. The product can still function as a supplying tool for exam preparation as it is.

Our product is of high quality and we recommend it to be used as learning aid in project management					
Scale	Strongly Disagree	Disagree	Neither agree nor disagree	Agree	Strongly Agree
Your response			X		

As a conclusion, the team answered “Neither agree nor disagree” to the question whether the product is of high quality and if it should be recommended as a learning aid in the course. Mainly because of the lack of desired functionality (i.e. having a log-in page, a database making it possible to save your progress and providing more detailed feedback tot the student). The product can be used as an additional learning tool besides the main lectures given in the course for exam-preparation, but not as a stand-alone learning aid. Based on the survey it was clear that such a product is desired and valuable, and that products developed in this course can be helpful learning tools.

4. Factors that have contributed to failure / success.

The project management success was a result of factors, which can be distinguished in the three categories of success factors; Case-specific factors, Structural factors and Cultural factors (Hussein, 2018, p. 93). The project group had a structural and clear plan from the beginning. Different areas of responsibility were assigned within the team, based on experience. As a result, all group members worked dedicated on their part of the project and the project progression followed the schedule. The team members communicated well and discussed problems consecutively throughout the project work. All of the factors described above can be categorized as structural factors.

An important case-specific factor was that the vendors of the product were students in the same situation as the project group. As a result, the product was developed based on the project team members own perception of could be a useful aid for the course. The cultural factors that influenced the project management were not directly correlated to the product, but important for the motivation and working environment, which again are vital in order to succeed. It was important for project management success that all team members were committed to the project. The group members let other members know how they were progressing with their responsibilities, and it was clear that everyone showed an effort. The project was highly prioritized, and all participants cleared their schedule to be able to attend team meetings. The dedication to the project made the team members trusted in each other's work, for which made the working process efficient.

Factors listed in Table 14, and p. 92 in (Hussein, 2018), matches the success factors described above. The most important success factors (Hussein, 2018) are early planning, clear roles from the beginning, and communication. These factors are fundamental to be present from the beginning for a project to succeed. The different factors correlate; commitment and trust are a result of structural planning and communication, which again results in higher motivation and dedication. These factors are also mentioned in Table 14 (Hussein, 2018). If these factors are present from the beginning, the project group will most likely experience that all group members prioritize the project. Thus, early planning, clear roles and communication are three key factors that should be in focus early in the project.

Additionally, mindfulness about biases, heuristics such as overoptimisms, narrow focus and assumptions also found in Table 14 (Hussein, 2018) are success factor that helped the group to accomplish a satisfactory product. As mentioned in chapter 2, during brain storming and development of the product, there was planned more functions that was initially preferred to be included. However, by carrying out a re-evaluation with the time scope of the project in mind, it was determined that the product would need to be simplified, despite the initial ambitions. The re-

evaluation was done to make sure that the time would not be an obstacle in order to make a satisfactory product within the deadline, rather than an unfinished and unusable product.

The factor that contributed to the largest challenge of the project was the lack of prior technical knowledge as discussed in the risk assessment in the project plan. The team did not possess much knowledge about website development and other tools and libraries required for the defined product prototype. In the product backlog, the tasks were ordered in terms of complexity, where the easiest tasks to implement were placed on top of the list, i.e. should be developed first. This caused problems in Sprint 2, when the group approached the more challenging tasks and there was not much time left. These tasks required implementation of a back end, a database that could store user data. It did not take long before the team realized that it did not have enough time to finish the remaining tasks. In retrospect, the ideal solution would have been to have a task in the backlog concerned with setting up a database that could start in Sprint 1 and continue in Sprint 2 and 3 (as long as necessary). Then, one or two team members could have worked on this task from the beginning which increases the probability that more items in the backlog would have been completed.

The factor related to failure discussed above can be related to two factors listed in (Hussein 2018), “Skills, knowledge and competence” and “Project manager has adequate business insights”. Since the team did not possess enough technical knowledge to know the scope of the packages, the items were not ideally ordered. This could have been avoided if the team had done more thorough research. The group should have considered the “Project Manager knowledge” item in the planning phase. It would probably have been uncovered that more extensive domain knowledge was required. The team could have reached out to a person with this knowledge that could have revised the project plan and evaluated if any changes should be made.

5. Most important lessons from your project

This product has challenged the group on a technical and social level. It has required the group to frequently communicate to make sure that everyone is on board with what the product is supposed to be. This chapter will describe what the group have learned and give a recommendation for people who wish to do a similar project.

First, one should identify the learning objectives of the final product. This is necessary to do in the beginning of the project, to reduce confusion and have some concrete goals to compare product ideas to. The teams' advice is that the whole group should be gathered to do this, to make sure everyone understands the goal. This turned out to take a short amount of time because everyone was present and focused on the task at hand.

Second, is to have one or several meetings where you decide on a product and break it into smaller tasks. These tasks, or work packages, are assigned to the group members, with the goal of dividing the work equally. The work packages should be concrete, and it is the person who performs the task's responsibility to make sure he/she understands what is required. This should be done very thoroughly and be planned in detail. By planning in detail, the room for misunderstandings is smaller, which shortens the time spent on clearing up errors later. The planning process takes a very long time, as one person's perception of the product, is not necessarily shared by the other members.

This type of product has required technical competence. It has been important to map what type of job each group member is able to participate in. In hindsight the group should have spent more time to evaluate how much each group member would be able to contribute on making this type of product. As a result, lead lack of experience of web design to some people having to work more than others. Of course, this is often the case in a project, but by planning more and setting other goals, some of this inequality could have been prevented. Maybe this problem could have been handled by doing a project more suitable for each group members background knowledge. Another solution could have been for a couple of the inexperienced group members to learn some web design.

A general lesson the team learned from this project is the importance of deciding on a standard base of communication. As this has been a relatively small group (6 people), that base was Messenger, a chatting app presented by Facebook. This medium allowed people to talk directly and made sure that everyone was able to read what other people discussed. This resulted in that everyone showed up to meetings well informed on the latest agreements. Additionally, this allowed the group to hold meetings on short notice, which was perfect as all of us have busy schedules. It is recommended that other groups decide on a written communication platform as fast as possible.

6. References

Hussein, B. (2018). The Road to Success: Narratives and Insights from Real-Life Projects, Fagbokforlaget.

Parviainen, P et. Al. (2016). Tackling the digitalization challenge: how to benefit from digitalization in practice, <http://www.sciencesphere.org/ijispm/archive/ijispm-0501.pdf#page=67>

Bastien, JM Christian. (2010): "Usability testing: a review of some methodological and technical aspects of the method." *International journal of medical informatics* 79.4 e18-e23.

Nizhebetskiy, D. (2017, October 24). Simple Project Management Framework for Smaller Projects. Retrieved from <https://pmbasics101.com/smaller-projects/>.

Larson, R. (2004). The critical steps to managing small projects. Paper presented at PMI® Global Congress 2004—EMEA, Prague, Czech Republic. Newtown Square, PA: Project Management Institute.

Mukherjee, Arijit & Chakraborty, Abhijit & Garai, Sujit. (2016). Essence of Quality Control in Small Manufacturing Industry. *IRA-International Journal of Technology & Engineering* (ISSN 2455-4480). 3. 10.21013/jte.v3.n3.p12.

Busato, V., Prins, F., Elshout, J. and Hamaker, C. (1998). The relation between learning styles, the Big Five personality traits and achievement motivation in higher education. *Personality and Individual Differences*, 26(1), pp.129-140.

Your peer-review evaluation report

What is name of the group you are assigned to evaluate: Group 18

First and foremost, the group overall found the animated video lucid and easy to follow. The group found the chosen case, the construction of the Sydney opera house, very interesting. The case had a lot of interesting aspects and factors, and if highlighted this could potentially have given a significant learning outcome for the students enrolled in the course Project Management. As for the user experience, the content was communicated to the viewer in a clear, neat and structured way and it is easy for the viewer to get a grasp of the timeline of the construction of Sydney Opera house. The content is communicated in a way that does not feel rushed for the viewer; hence the group found the length of the video to be sufficient.

However, the main weakness of the video is that the learning outcome is not significant. As stated previously, the case is very interesting, but the group sees it as more of a storytelling of an interesting case rather than discussing why it was a project/project management success or failure. Group 18 states the reasons why the project is a success/failure but does not let the end-user know in advance which factors should be evaluated, when you analyze a project or a project management effort. If the end-user is someone learning about project management, it would have been relevant to include this information.

Another weakness of the video is that, when it was actually attempted to use knowledge from the curriculum, the definitions were way too long, and the end-user does not have time to take in the information that they provide. Maybe a list of bullet points could have been beneficial?

Lastly, the video is seen as a little childish at times. Mainly, this is only the feeling one is left with after watching the video, but there is also an example from the end of the video: a list of “notable” moments in Sydney opera house is listed, which the group thinks is irrelevant to the case. The whole video ends with the looney tunes ending (in bad quality), which in our opinion does not belong there either.

The product we reviewed is of high quality and we recommend it to be used as learning aid in project management					
Scale	Strongly Disagree	Disagree	Neither agree nor disagree	Agree	Strongly Agree
Your response			X		

What grade would you recommend for this product?

As a final evaluation the group chose to give team 18 the grade 6.0. This is based on the evaluation given in the previous section. To shortly summarize the team found the video to be interesting, but the fact if the construction of the Sydney Opera house was a success or failure should have been discussed in detail, in order to gain significant learning outcome for the students.



Norwegian University of
Science and Technology

Project assignment: Digitalization Project

Project plan

TPK5100

Group 2

Dan Godhei

Sara Sofie Lindegård

Inthujan Rasalingam

Ingrid Marie Rennan

Mari Elida Tuhus

Solveig Askevold Ulsund

Anne Pernille Wulff Wold

Product Description

To increase the learning outcome of TPK5100 Project Management, Group 2 will develop a website. The website will present the user with a series of multiple-choice questions, in the topic Project Management. These questions shall be divided in subcategories, or chapters, so the student will be able to choose what subject he or she wants to focus on. The thought is that these questions will make the user prepared for the exam and achieve a better understanding of the subject. In addition, the user will get feedback on which subject he or she struggles with and what pages of the course literature you would need to read. The initial layout of the website will be simple. The thought is to create a pilot website, where the user is only able to answer questions and track their own score to map the understanding of the subject. The website will not require a user account, which means, that all data will be lost after the tab is closed.

After the pilot has been tested by a group of students, the project team will meet up to evaluate feedback and discuss future development of the site. In advance of the project, the team have made a plan on what the site will contain when the project is finished. This plan is that the site will:

- Contain a log in data base to store data
- Allow the user to see test score history
- A student can compare its score to their classmates
- Professor can be able to see student score which will give him an understanding of what subject the class finds easy/hard

Expected Benefits

The idea of creating an app or a digital platform with multiple choice questions is to map the students' progress in the digital form. The questions will be directed more towards students conceptual understanding than student's capacity of memorization.

One of the benefits with this product is to gain better understanding of the topic "Project Management". How to manage this is to give the user guidance and instructions during the utilization of the platform and to make a summary of the learning outcome, when the user has finished the questions.

By tracking the users answer, the product will give a guidance to a chapter in the book “Road to success” or other learning material available, which will make the student more aware of their strengths but mostly where there is a gap in the knowledge, so it can be successfully and efficiently closed by having the right guidelines for the right information.

The trick here is to find the right questions to ask, to actually map if the students conceptual understanding of the course. The purpose of the product is that the user will be able to see its own progress and knowledge in the subject so the user can direct its focus right to optimize the learning outcome of the subject. “Project management”.

In a wide aspect, this product is intended to collect and save data, utilized by the users of the product. This will be useful for the student, but it is seen as most useful for the professor. One of the improvements wanted for the website is to make a login platform which can collect and store data, unique for the user. By this measure, the user is able to track its own progress over time. This can be a very helpful learning tool, and also a motivator for the user, to see that the studying is helpful, and progress is achieved. For the professor, the data collected, is a unique opportunity to gain exclusive access to its students’ understanding of the subject. The professor can tailor the lectures by the data collected by this platform to make the learning outcome even better for the students attending the class.

Stakeholders

Potential stakeholders are listed in Figure 1. The project owner, which in this case is the professor and teaching assistant in the course TPK5100 at NTNU, is an important stakeholder as he/she provides the information about what is expected/desired by the project. Communication through e-mail correspondence and personal conversations will be important to assure that the vision of the project owner and the project team agree.

The target group of the product is students studying Project Management. Their acceptance and willingness to use the product therefor becomes essential for the success of the product. As the purpose of the project is to enhance learning significantly, it is assumed that the students will have great interest in the project as it aims to improve their learning outcome and final result in the subject.

Students of Project Management will play an important role in the development of the product and its user interface. Interviews with a representative group of students will be conducted to clarify what type of features they would desire from this type of product and how they could see themselves using it. It will also be considered testing a prototype.

Professors teaching Project Management should want to use the product as a part of their teaching methods or at least acknowledge it as a helpful tool and recommend it to the students. In other words, the support of the professors in the subject is important.

Interviews/conversations will therefore be conducted to figure out what is considered important features from a professor’s point of view. Also, the professors have great knowledge of Project Management. Having a good relation to this stakeholder can be a big asset. To be able to conduct the project, the skills of the project team is important, making them a stakeholder with big influence.

Other possible stakeholders could include anyone who is new to Project Management, wanting to learn about the subject without necessarily following a course, and professors teaching other courses as they could use the same interface and adapt the multiple-choice questions to their desired topic.

		Interest	
		Small	Large
Influence	Critical	The students evaluating the end product	Project owner Students taking PM Professors teaching PM Project team
	Marginal	Anyone who is new to PM Professors teaching other courses	

Figure 1 : Potential stakeholders classified along interest-influence dimensions

Risk Assessment

During the different phases of this project facing risks in inevitable, hence risk management is a very important key to all project success. In our Risk Assessment plan, presented in figure 2, we have addressed the process behind risk management, and we have identified and categorized possible risks and can therefore manage to avoid these ahead of time.

Project management risks

Given that all the team members enroll in different classes, conflicting schedules might become a problem. This is an aspect we tried to consider both in the risk assessment plan, and when planning the project development in detail. The team's lack of necessary technical competence might also become a challenge throughout the whole project, and something we need to address in an early phase.

Technical risks

According to the Schrum method, backlog items are a short description of all functionality desired in the product. When creating our backlog items which can be found in our Project Breakdown structure, as shown in figure 3, our lack of technical experience was considered. We made sure not to create the backlog items too extensive and inconsistent, to make sure the development of the project will run smoothly where every team member has a clear vision and understanding of the project. Our product depends on an internet connection, and information from an external API – which is a technical risk that might create problems in the future. Defined in the Risk Assessment plan is our predefined plan to handle such obstacles. Our code will most likely be complex, which means we might also have a complex testing environment which also is a technical risk.

Business risks

A big part of the functionality of the product is directed to the students, which might be a potential business risk. There are already several similar products on the market, and it is essential that the students find this particular product applicable and useful. Another major business risk is that our product is first and foremost a website, and we need to take into account that “learning on the go” is trending, and it is important that the interface is suitable for a phone browser.

Risk Assessment Plan			
Risk	Means to Prevent	Action and Responsible	Probability
Estimation	Always monitor the existing project so that we can reconsider if a task is taking too long. Anticipate the worst-case scenario from the beginning.	Team leader needs to keep the bigger picture in mind and always keep the team's priorities straight. Make sure that the time is well spent.	Medium
Inefficient team structure	Make sure everyone knows their responsibilities and their tasks.	Team leader has to make sure everyone is doing their job. Plan extra meetings to discuss the team structure if necessary.	Low
Sickness	Team members should try to not get overworked. The scope should be such that the workload is not too extensive.	Reassign tasks to other team members.	Low/Medium
Technology	Get to know all of the planned technology early in the working process. Make sure all team members get extra time to learn unfamiliar software tools	Seek assistance when necessary. Do testing all the way to discover problems early.	High
Travelling	Plan ahead of time. Long travels for one of the team members need to be taken into the activity plan.	The team member who is travelling needs to do his/her work by the time he/she is travelling, so the rest of the team doesn't get extra work.	Medium
Scheduling	Regular meetings with all the team members every week.	Team leader plans meetings that fit everyone's schedules, and makes sure everyone knows when the next meeting happens.	Low
Stakeholder involvement	Begin every task early so we have enough time to consult the stakeholders about questions before every due date.	Team leader has an additional responsibility to inform stakeholders regularly.	Medium

Figure 2: Risk Assessment Plan

Skills acquired to produce the project

In order to produce this project, skills about how to create a web site including a multiple-choice test (HTML, Javascript, CSS) are essential. These skills will be acquired by using the interdisciplinary and experience within the team. In addition, literature review and trial and error will be conducted where the team has lack of knowledge and experience. Testing and improving the product will be a big part of producing the final project.

To be able to make the function of the project with questions and feedback, acquiring knowledge of project management is important. This will be obtained by using theory from already taught lectures and studying the literature and learning objectives of the subject. Additionally, conversations with the professor and responsible teaching assistant will be conducted. Knowledge about teaching strategies and how learning can be optimized will improve the end result. That can be acquired by doing research.

Project breakdown structure

The project has three main phases: Project Planning, Development and Project Report based on the three deliverables. Figure 4 illustrates the scheduled time estimated on the three different parts. The project planning phase is a week long, and the main task is to define and plan the project. It ends on the due date of the first delivery. The development phase is the most extensive and is described in more detail in the following paragraph.

The last part of the project is the Project Report, which lasts from product delivery to report delivery. That phase consists of documenting and evaluating the project. As shown below is our project backlog items (work packages), which is a breakdown of the development phase. The product deliverables are divided into smaller components and belong to one of three sprints (see Figure 4). A work breakdown structure is an important key to success, where we have organized the team's work into manageable sections.

Product Backlog			
Story ID	Story	Estimate	Priority
T1	As a student, I would like to be able to test my skills in TPK5100 by taking a test	5	1
T2	As a student, I would like to choose the topic/ chapter of the test	3	2
T3	As a student, I would like to see if my answer is correct or not	6	3
T4	As a student, I would like to be able to track my progress	9	4
T5	As a student, I would like to choose random questions (from any topic)	2	5
T6	As a professor, I would like to add content to the website	6	6
T7	As a student, I would like to be able to log in to save my progress	10	7
T8	As a user, I would like to have a scoreboard to see who's completed the most questions	5	8
T9	As a professor, I would like to see the progress of the students	2	9

Figure 3: Product Backlog

Project Schedule

The project consists of three main parts, Project Plan, Development and Project Report. Each of the parts have been given a time estimate due to the complexity of the phase. As it is a development project, the project team has decided to use an agile approach during the development. The product and its functionalities have been divided into nine different tasks, as seen in the previous section. Due to the uncertain nature of development projects, a buffer of six days was added in the end of the development phase in order to be flexible in case of unexpected events.

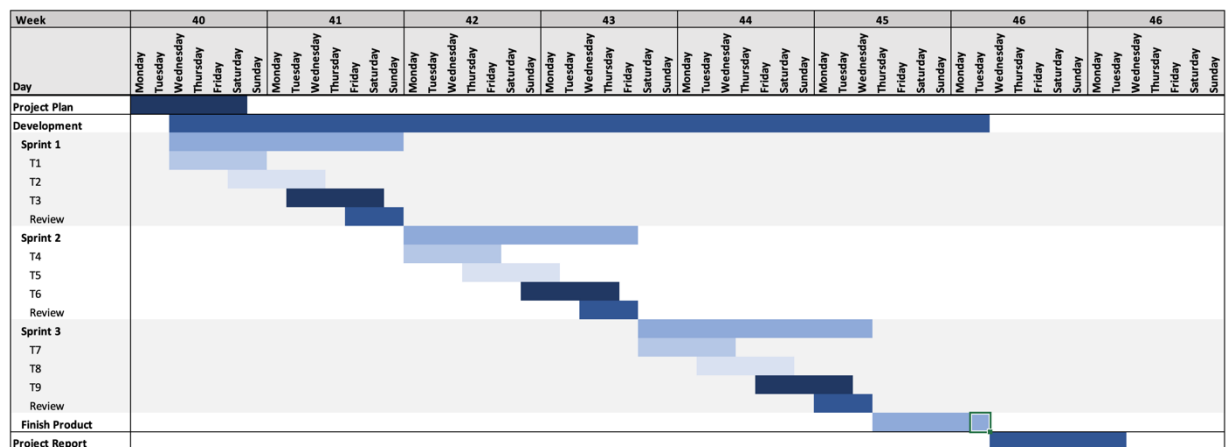

Figure 4: Gantt Chart for the execution of the project

Success factors

This is an IT project with few influential stakeholders. For this to be a project success it will have to be a clear connection between the problem statement and the product. Rather the project is a success or not, will depend on if the end user is willing to use the product. The user should also feel that they have gain better understanding of Project management, by using this web site. Student learning outcome is how one would calculate the value of the product. As this is a class project will the product need to be delivered in time to get a grading, which makes time a vital success factor.

The factors which decides if this project can be regarded as a project management success can be established in the beginning of the project. In the startup of the project, the most important factor will be to decide what medium to use, which in our case is a website, to teach project management. And how we are going to use that medium to present compendium to best better learning outcome. For this project will we present the compendium as a multiple-choice test. The next process, which is important when working in groups, is to make sure that everyone has the same understanding of what we are going to make. To define some limitations and set expectations. When everyone is “on the same page” it is time to make a plan, so we know what we have to do, and delegate the work. At this stage it will be important to make sure that everyone has something to do, as one of the criterions for this project is that everyone must contribute.

To make sure that the project will continue to be a project management success, the group will need to arrange frequent meetings, especially in the beginning, to make sure that everyone is able to deliver their part.

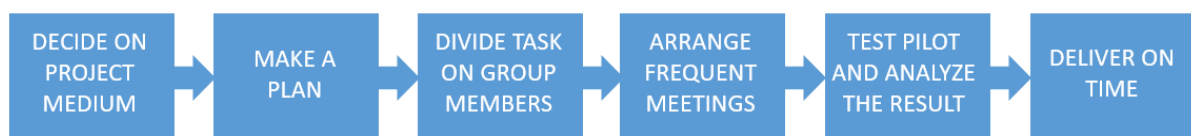

Figure 5: Success factors

Digitalization Project

Digitalization is defined as the adoption or increase in use of digital or computer technology by an organization, industry, country, etc. Digitalization is about value creation in the process. Improvement of product/process, automation of the process, simplification of communication are the main goals by implementing digitalization into project. The purpose of digital transformation is to redesign the organizational business through the introduction of digital technologies, achieving benefits such as increased productivity, reduced costs and innovation.

For digitalization projects it could be an advantage to divide the project into different parts, by having frequent small deliveries and not doing everything at once. Continuous follow-up of the project throughout all the project phases is also very important. Product development projects with digitalization needs support by the top management, which is one of the most important success factors for the project, but also from the users of the product who must be willing to use the technical devices.

One example of heavy digitalization is within the oil and gas industry, where the focus on digitalization has increased rapidly the last years. Digitalization brings several benefits to daily operations. For condition monitoring, specific, industry, historical and real-time data lets operators improve maintenance and inspection regimes. Real-time data from wells allows timely decisions on underperforming wells and other high-cost issues.



Projects natch:

The new form of hand-
in assignments

PROJECT FINAL REPORT

Professor: Bassam Hussein

19.11.2019

GROUP 4

Manuel Pérez Bravo
Erik Stenseth Gómez
Ignacio Toribio Robles de Acuña

Preface

With this report, we give detail of the group we have developed in the course of *Applied Project Management (TPK5100)*, in the Norwegian University of Science and Technology (Autumn 2019). With this project, we have experienced first-hand the project management challenges and paradoxes that arise during the development of any project, and in the case of digitalization projects in particular. Our project has consisted in the development of an interactive film where the student can relate to the narrative of one of the cases of study (*3.4 Planning and construction of a new upper secondary school*) included in the book by Bassam Hussein (2018) in which we have based this course. The project has concluded with a fully functional product that other students have had the opportunity to test and give feedback on, and we are quite satisfied with the outcome even if the project management has been as challenging as enriching.

The address to our product is: <http://folk.ntnu.no/manuep/Presentation.html>

Group number: GROUP 4

Student names and student number:

- 1) Manuel Pérez Bravo (519779)
- 2) Ignacio Toribio Robles de Acuña (519243)
- 3) Erik Stenseth Gómez (519809)

Contenido

Preface.....	ii
1. Digitalization projects.....	1
2. Self-evaluation of the project management effort in the project, success or failure? And why? ...	3
3. Self-evaluation of the value to the learners? (evaluation of project success) Can you document your assessment?.....	5
4. Factors that have contributed to failure / success.	7
5. Most important lessons from your project.....	9
6. References	10
Annex I: Peer-review evaluation report.....	11
Annex II: Gantt Diagram (post-product)	12
.....	12

1. Digitalization projects

A. Describe your product, its intended purpose and why you have selected to produce this product.

The product we have developed is an interactive film that intends to substitute one of the compulsory hand-in assignments in order to create and test a new form of assignments where the student can relate to the narrative in a more visual and interactive way, devoting less time than before. This idea has been inspired on the original and acclaimed production of *Black Mirror: Bandersnatch* by Netflix, released in December 2018, in which the spectator can choose the destination of the main character and watch the consequences. In this interactive film, entitled *Projectsnatch*, the student will be actor of the management and will watch and assess the consequences of his decisions.

The interactive film presents the narrative of case 3.4 *Planning and construction of a new upper secondary school* from the book by Bassam Hussein (2018). The students, from their devices, can at several points of the narrative take decisions on the management being presented with scenes that recreate the case with the help of simulation game *The Sims 4*. Each clip of video will lead to a new dichotomy, and up to 8 different endings in which the students must assess the success or failure of the project based on the final outcomes. The student's answer on the success assessment and a brief explanation of the answer will constitute the submission for this hand-in assignment. Total estimated time is around 10 minutes, and it is an individual work that can also be brought to as a resource in class (the students vote for options from their phones on Kahoot and the presenter chooses on screen).

An explanatory diagram is hereby presented, where the yellow circles are the clips on which the students base their decision regarding the following dichotomy. To the right, a screenshot of what the HTML web looks like at the point of taking one of the decisions:

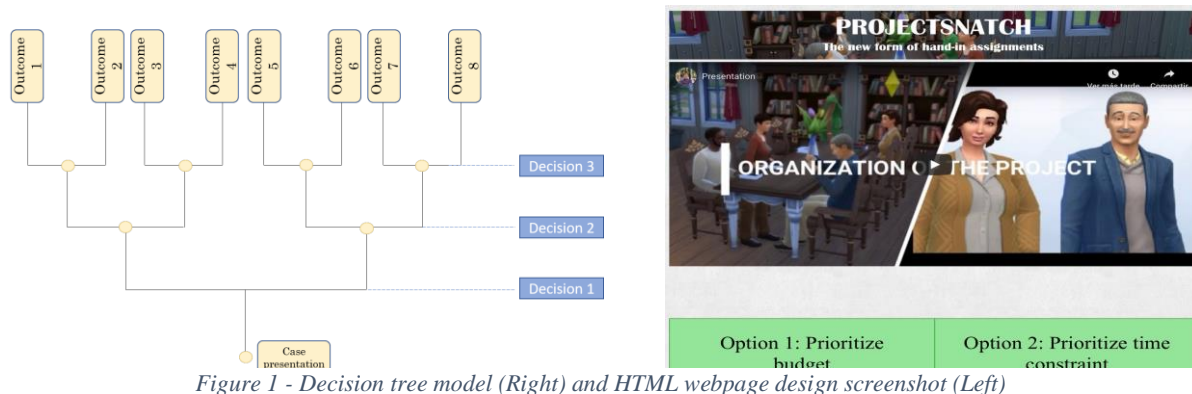

Figure 1 - Decision tree model (Right) and HTML webpage design screenshot (Left)

With the increase in use of technology in education, we thought that a relevant digitalization project concerning the teaching of the course TPK5100 would be to change the traditional form of document-written hand-in assignments to a more interactive form where students can more easily relate to the narrative and give an answer within the same platform and from any device. The classes of TPK5100 already make an extensive use of technology with in-class participation, simulation games and multimedia material; however, the assignments are still just a digital form of what a traditional written assignment would be, and it motivated us to try a new form. It could be said that the *rationale* of the project was the willing to change the long time we have devoted to hand-in assignments in this course and make them a less tedious task. The *purpose* would, in that case, be the creation of the interactive and individual form of assignment that doesn't require the formatting of a document.

The use of computers for work is being gradually replaced by the all-time use of portable tablets and phones, and that is why we determined that our product would have a better acceptance among students if the platform was accessible from any device. To do so, we have developed an adaptive HTML website, hosted in NTNU servers, for the sake of preserving a formal and ad-free experience for

students with the resources that NTNU provides. Among the numerous possibilities of interactive learning multimedia, we thought this format is still innovative among learning and streaming platforms, and it produces a greater involvement than a plain video or a static simulation game by combining video with multiple-choice paths that lead to different outcomes.

After dedicating some time to consider how and at which point to collect the answers from students during the film, we thought that justifying every choice would make the assignment tedious and may cause the loss of the thread in the story. Furthermore, students can very quickly restart the game from the beginning and try different paths of the managerial decisions so that they can relate to the different outcomes. For that reason, we decided to only include an answer form at the end, when the outcome is presented, and the student will submit an assessment on the success or failure of the project.

Without the need of creating a formatted document, the assessment on the project and the brief explanation will be sent to the professors or will be a downloadable file that the student can upload to Blackboard. We are aware that this project only covers only of the main topics treated in the course, the success assessment in projects and the identification of the success and failure factors. The intention with this assignment, if the acceptance is high, is that other students copy the format and recreate other cases alike so that the production phase is both a constructive and learning phase for students.

B. After having the opportunity of working on a small-scale digitalization project, what are, in your, opinion the main challenges that your group has experienced with this type of projects?

Regarding on the main challenges our group has experienced, there are some traits that are transferrable among digitalization projects. Digitalization projects' main focus lies on successfully managing the expectations of stakeholders. Stakeholders, especially the end users, will be who determines if the project was a success or a failure, and that is why it is important to adequately communicate with them, both professors and students in this case. For that purpose, we conducted a survey in class, where students could express their feeling about the current form of the assignments and towards which form they would like to see changes. Results show that around 75% of the sample (35 students) would be willing to change towards an individual and interactive form of assignment that requires less time. However, accomplishing a product that lives to the expectations hasn't been easy, as digitalization projects incur in several other difficulties that mainly relate to the lack of knowledge/competence and biases.

Digitalization projects have a strong component and intention of transformation. The transfer of users (professors and students) from the previous form to the new one can be difficult due to organizational resistance to change. A majority of the students asked (63%) indicated that they were very satisfied with the current form of assignment, and then would require introducing a sufficient improvement for them and for the professors to transfer. We tried to make a user-friendly interface that adapts to any device and takes little time to go through the narrative, but reading on the video might be hard to follow and less attention-catching than we thought (according to the feedback we have received).

Also due to the high degree of transformation that this kind of project implies, the lack of knowledge and expertise in digitalization has been a challenge for us, since none of the three integrands was very familiar with HTML coding or video editing. We have had to change the way we were going to produce the videos to computer simulations, as the lacked the skills and material to follow the initial proposal. The project life cycle has therefore required to re-adapt and re-define some of the goals established in the beginning, always trying to not affect the success criteria for a project like this, but only the means. The project, as usual transformation projects, had a very short temporal window to be developed. In real life, the constraints are not as tangible as in construction projects, but the market window for a digitalization project has a very short duration and the product has to be in place very soon before it is no longer ahead of the innovation or loses the customer it previously had.

2. Self-evaluation of the project management effort in the project, success or failure? And why?

A) *The group should make an overall evaluation of their own project. This is an evaluation of how well the group managed the project, how well was the organization of the project group. How well the group identified and managed risks. Did the group managed to deliver the project results according to your originally stated success criteria (according to your original plan)? Is there any deviations between the stated success criteria and your final evaluation of the project?*

In first though, we evaluate our project as a success, since the final product achieves the main goals we had set during the project initiation phase. Nevertheless, the management has been quite *ad hoc* and we could say it was a management failure.

We could say that our project faced a major challenge when our group was downsized from five students to only three, after two of them dropped out of the course. However, the three remaining students were from the same nationality and communication flow became easier and faster than in a group where international complexity is a factor. Organizational complexity was replaced for resource shortage, but the origination of the project has been smooth and flexible, by simply dividing the tasks among the three of us and always giving each other feedback. We could then state that we followed a project structure even if the size of the group makes it difficult to even identify ourselves within a given structure of **project organization**.

Regarding the **project planning**, the major deliverables for this project were: The decision tree on which we had to foresee outcomes for each of the paths taken, the production of the scenes themselves, and the design and building of the adaptive HTML web page (*cf* the WPS we established in the plan, Figure2).

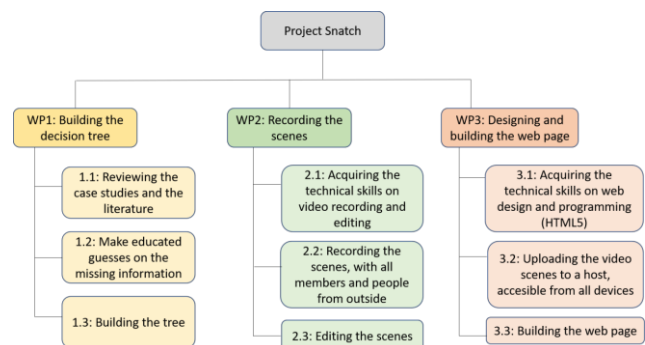

Figure 2 - WPS breakdown (from Project Plan)

These deliverables were put into a Gantt diagram in the plan, where we stated the desired progress pace regarding the main milestones has been modified during the development of the project, as we have had to change several features of the initial project proposal (without affecting its purpose). It is fair to say that we hadn't clearly identified the dependencies between tasks, as during the project, we found out some tasks were blocked while awaiting for others to be finished. A final Gantt diagram is presented in Annex I, but we have considered more relevant the **network diagram** that we finally found realistic for the project, and that we think could have been useful to have from the beginning:

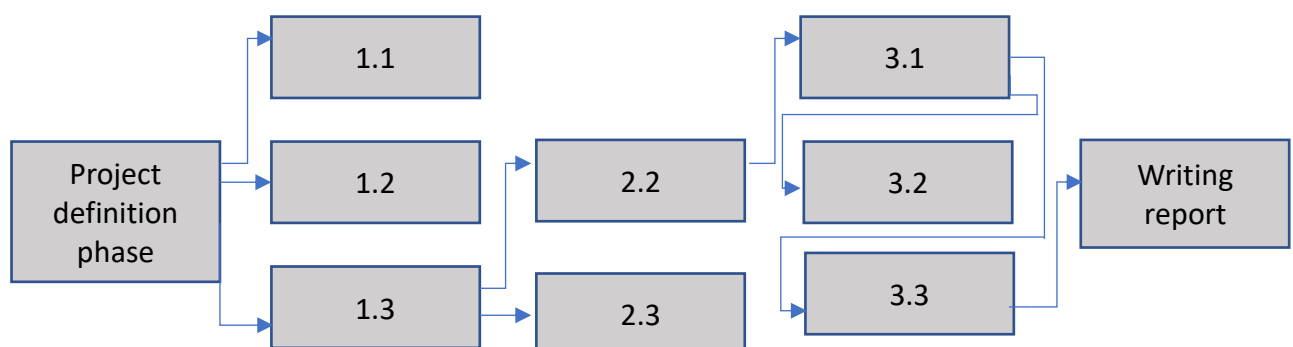
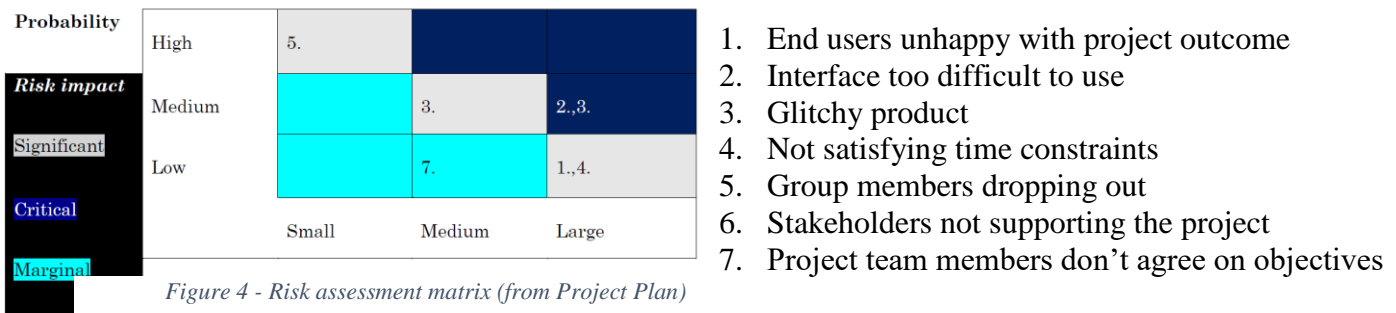

Figure 3 - Network diagram (post-project)

It is possible to say that the project planning has been changed during the project in order to make it follow the current progress at each stage.

Even the most carefully planned project can run into trouble. It is firstly evident that our previous experience in project management was nonexistent, but it is necessary to accept that some situations cannot be foreseen. For that reason, we tried to define the potential risks in the project and thought how to mitigate or deal with them if they finally happened. We can see the **risk assessment** matrix (PMBOK, 2013) we had defined in the initiation phase, and outline some risks that actually happened, and others than were not identified and also took place:



Risk identified as [5] took place at the very beginning of the project, when two of the project members dropped out of the subject, and the consequences, as identified, were small thanks to the early timing. None of the other identified risks have happened, as the feedback on our product has been positive by those who have tested it, and stakeholders have seemed satisfied with the outcome. However, some other challenging situations have taken place and they hadn't been identified as risks, such as the delay due to the lack of expertise in the technological skills (video editing and HTML coding mainly). Their consequence has been small too, as we have mitigated it by spending more hours than planned in the development of the web and its videos and the result is finally satisfactory.

Finally, regarding the **success criteria** we initially established, we can say that we have accomplished most of them. Among the key factors (Murphy, Baker and Fisher, 1974) to pursue of chances of success, we accomplished the following:

- Good coordination with stakeholders – Yes: good response interaction with other students.
- Adequate project planning – Poor: Not clearly identified dependencies between tasks.
- Proper choice of projects – Yes, according to the feedback on our product. Very visual.
- Agreed success criteria – Yes, they were established by consensus.
- Good project start-up process – Fair: Underestimated impact of lack of skills and experience.

Using the literature, we could find other critical success factors that specially apply for this kind of project (Hussein, 2018) in our initiation phase, such as: clarity of purpose and objectives, end-user involvement, balanced project group, adequate early planning, established routines for deviation or flexibility. All these success factors were followed even if to different extents, and agrupping by **success factors**, it is fair to say:

- Project management: Failure – Understimated required time and skills for some of the tasks. Project management quite *ad hoc* at some points, even if the objectives were agreed on.
- Process success: Success – We were able to satisfactorily interact with other students during and after the competition of our product, so that we could have feedback to work on.
- Project success: Success - The project has achieved to create a value on the manner that project management is learnt. It is too soon to assess the transformation our project has caused, but the students who have assessed it have seen potential in it.

B) Please evaluate the degree of your support to the following statement (group-based evaluation):

We evaluate our project management effort as successful

Scale	Strongly Disagree	Disagree	Neither agree nor disagree	Agree	Strongly Agree
Your response				X	

3. Self-evaluation of the value to the learners? (evaluation of project success) Can you document your assessment?

The group should make an overall evaluation of the impact of their own product on learners. The group should provide and support the evaluation with documentations. These documentations could include:

A) Describe your target audience and the learning objectives of your product

The target audience of this project was mainly the students who are being introduced to the course and the students who want a different assignment from time to time to break the inertia of the hand-in assignments being alike.

B) A description of the method used to evaluate the final product.

The evaluation of the interests of end users was made beforehand in a survey. When we had all the information from the survey we could go on and complete the project knowing what the end user would want. Once it was finished, we could fully evaluate it and we; the project team, were the first to do so. Since this is an interactive story of a case, we will simply try out the program going through all the different options.

We asked the members of the group 5+12 to evaluate it to have an objective opinion from someone in the course since ours could be considered a bit subjective. They go through the story making their own decisions and report back to us with their feedback of the project.

We also got in contact with the team who had done the peer review of our project to ask them for their evaluation.

Another method we used to evaluate the finished project is presenting it to our respective flat mates. The objective of this evaluation is to try out this project as a tool to introduce project management to people who haven't done it before. They also go through the story making their own choices and we try to explain in simple terms the reasons why the project is successful or not. After this we asked if they learned something new about project management.

C) The number of informants who have contributed to the evaluation, and how these informants have been selected.

The informants will be the members of group 5+12 plus some of our flat mates. We selected these two groups to get information from two different types of people: those who have taken the course and have experience with project management and on the other side, those who have no experience whatsoever with the matter.

This is done so we can better assess which group will have a better reaction to the project and find it more useful. Knowing this we can be more comfortable assigning who the end user will be.

D) Results of tests, surveys or interviews with students or persons who have reviewed the final product

The first survey we did was when deciding what to do for the project. We set up a number of questions and asked people in class to answer them. We wanted to know what people thought of the current assignments, how they worked on them and proposed other options. These are the answers we got.

Would you prefer to have an interactive form of hand-in assignments instead of the current written form? Scale from 1 to 5 your agreement.
34 respuestas

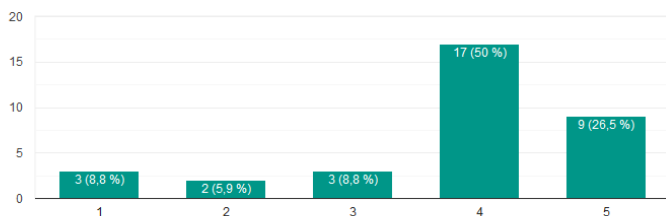

How satisfied are you with the current form of Hand-in assignments?
35 respuestas

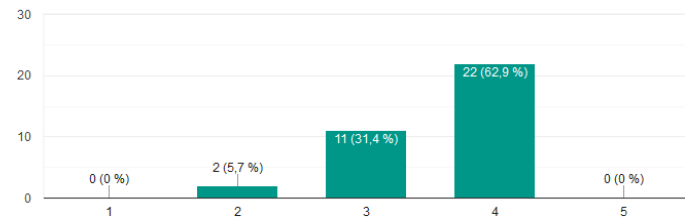

For the hand-in assignments, do you usually work in group or by yourself (dividing the work)?
34 respuestas

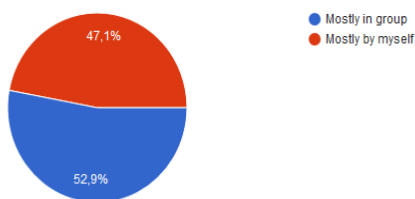

Would you rather have shorter assignments that you can do by your own? If the time was reduced at least by half.
34 respuestas

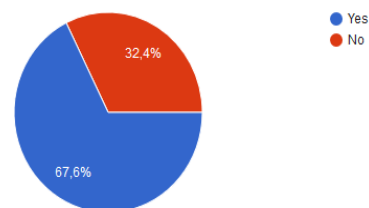

Figure 5 - Results from the survey to the students (sample of 35)

In total we got 35 submissions which is an adequate sample of the class. The answers were mixed, but mostly positive. But the most important answer we got was the last one which showed that students were for the most part open to the idea of an interactive form of hand-in assignment. This survey also helped us recognize the scope that our project should have. The answers show that a lot of students enjoy working in groups and don't really want to give that up which contradicts our project plan. That's why we decided our project would be really useful as a tool to introduce the students to the course as an assignment done in the first week, before groups are formed. This would be an entertaining way of being introduced to the course and getting in touch with the different aspects that constitute Project Management.

Our initial evaluation was centered around things working. Being this a digitalization project, which wasn't our strong suit, we had to acquire the tools needed to edit the videos and program html for the web page in a reduced window of time, so having bugs or glitches in the web page was a pretty probable risk factor. It was important that if that was the case, we would be able to fix them. Luckily everything worked as intended on the first try and didn't find any errors, so we didn't need to fix anything.

Next its time to talk about the evaluations we received from the different informants we previously mentioned. Feedback was mostly positive, mainly because of the project design and for it being entertaining.

Group 5+12 liked the project very much and found the idea useful but felt the educational value of it would be better suited for someone just starting the course since the story didn't delve to deep into technicalities. Apart from this, they enjoyed the creative effort of the different videos and options.

Group 8, the one in charge of the peer review evaluation also liked the finished project. They showed their approval on the idea of having to spend less time on an assignment that was done individually and being able to see the consequences of your decisions in the project. However, they pointed out that you could pass to the next step without seeing the video and that sometimes the subtitles were too fast and couldn't follow the story that well. Luckily that would not be that difficult to fix.

Finally, our flat mates liked the product on different levels. A couple of them were actually interested in the course and after experiencing a "simulation" of what it is to be project manager and what plays into it they were eager to look into it further. Others weren't that interested but were kind enough to try it out and ended up enjoying it. It helped that we were there to shortly explain why things happened how they happened. All of them said that they definitively learned something new about project management.

E) Please evaluate the degree of your support to the following statement (group-based evaluation):

	Our product is of high quality and we recommend it to be used as learning aid in project management				
Scale	Strongly Disagree	Disagree	Neither agree nor disagree	Agree	Strongly Agree
Your response				X	

4. Factors that have contributed to failure / success.

In this section students should list and elaborate on all the factors that they believe have contributed to the success or to problems of their project. Which factor was the most significant and why? Compare your identified factors with the factors listed in (Hussein 2018) pp-92.

The project management of this assignment was a bit chaotic on our part, that's why we would classify it as a project management failure.

The project managements really starts with the formation of the groups. At first, we were a group of five out of a maximum of 6, all international students. But shortly after, one of our team members had

to leave the team because as an international student he had to rearrange the courses he was going to take and couldn't assist anymore to TPK5100. This happened a week after we arranged the group, so we really had no time to assess the risk of that happening. We were also very slow to start thinking about the final project, centering all our efforts on the weekly assignments. And then, before handing in the preliminary project, another team member left, leaving only three of us.

In the risk assessment, revolving mainly on product and people factors, especially after losing one of the team members. We concluded that a faulty and difficult to use product was the main risk for the project management, as it was a high probability risk factor with critical consequences. Luckily, a great job was done on the programming department, making the whole program easy to use and bulletproof. One risk we should have taken more seriously was the availability of each one of us. We all had different responsibilities outside the course, and at different times, which made working as a team all together really difficult. This also made having meetings to discuss the planning and the direction of the project almost impossible.

The success factors we laid down were also followed as closely as we could but not perfectly. The first step was to agree on what we were going to do for the project (purpose and objectives) and on the success criteria when making the project description. Being the reduced group we were, that wasn't difficult to achieve. We then focused on the communication with stakeholders with a simple survey asking various questions regarding the satisfaction with current assignment work and our digitalization project. It provided a considerable positive feedback which gave us the green light to continue with the initial idea we had, but make some slight chances nonetheless.

Despite this, there was a clear lack of communication between team members during the initial weeks after the initial plan was submitted, which meant that the initial Project Schedule was not followed. Since we started late, we had to combine working on the three packages at the same time, building the tree of choices and the story while preparing the web page and acquiring the necessary video editing skills to do the project. After this was done, the videos were done and uploaded as the webpage was being finished. This left little time to troubleshoot, luckily it all worked without problems. It can definitively be said that part of getting the project done in time is in part thanks to being flexible as a team and being able to successfully adapt to the situation.

The most significant factor was, without a doubt, the lack of communication because it in turn affected all of the project. We hardly ever had meetings to discuss the project and hardly ever met each other in class since some of us had conflicting courses at the same time. This handicapped the project from the beginning, we agreed on what we wanted to do but had no time to plan and organize properly. Luckily, we were able to put down the time and made it to the due date after some days of hard work and prioritizing.

Comparing these factors with what is present in (Hussein 2018) pp-92. We have listed a couple of factors that are on the table, such as commitment, collaboration with stakeholders, clarity of purpose and objectives and a structured risk management process. Some of the listed factors missing in our project would be adequate early planning, continuity of project development and most importantly experience and use of lessons learned from previous projects. These last ones are very important and obvious since this project was our first real taste of project management. The only "experience" we had before was reading about cases, which of course helps, but you don't learn as much as when you are presented with a real-life situation. This was a factor that definitively showed and affected the outcome of the project.

To conclude it is safe to say that even though the project itself wasn't a failure, the project management could be called as such, since in the end we failed to have the streamlined process we planned and hoped for. Lack of commitment and experience are the two main factors for this happening, but even

with the problems we faced since the beginning of the project we still managed to pull through thanks to the flexibility and problem solving of the team.

5. Most important lessons from your project

If you should give clear-cut advice to other students on how they should work on similar projects what you will say to them? Formulate your lessons like the following:

- 1) You should first identify the learning objectives of your final product before deciding on the type of product*
- 2) My advice*
- 3) I learned that*
- 4) My experience suggests*

We learned that it is very important to meet face to face with the rest of the team and discuss the roles of each person and the check points along the way. We would say that it is advisable to follow these as much as possible, and if for any reason it can't be done, one should discuss solutions in one of the regular follow-up meetings. It's also critical to be transparent and involve your stakeholders as much as you can, especially end users, since they will determine if your project is a failure or a success.

Our experience also suggests that it is necessary to take into consideration the skills needed to complete a project. A project will be no good if we lack the skills to complete it, and the failure to recognize this will lead to project failure. In case we don't have the necessary skills, one should take into account acquiring them in your project planning, since that will take time. Underestimating the need to acquire proper technical or managerial skills is something common when there is lack of expertise, and it can most certainly lead to management or project failure.

Our experience also suggests that an early planning can help identify the dependencies between tasks and the need to add/change existing tasks to acquire the skills or involve the end users in our case. However, during the project, it is always necessary to update the most immediate goals with the current development of the project and that must be done frequently with defined follow-up time.

But our best advice is that one should get along well with your team. No one wants to work as a team if you don't enjoy each other's company. This will also keep the team motivated which is something often overlooked but still critical. Projects sometimes incur in a project success in terms of success criteria, but the management is not satisfactory due to the lack of proper communication and understanding between the members of team.

6. References

- [1] Hussein, B. (2018). The Road to Success: Narratives and Insights from Real-Life Projects, Fagbokforlaget.
- [2] Prabhakar, Guru. (2009). What is Project Success: A Literature Review. International Journal of Business and Management. 3. 10.5539/ijbm.v3n9p3.
- [3] Turner, J.. (2014). The Handbook of Project-Based Management. 92.
- [4] Project management Institute (2018). Guide to the project management body of knowledge.
- [5] Howard Tiersky, CIO (2017). 5 Top challenges to digital transformation in the enterprise.

Annex I: Peer-review evaluation report

What is name of the group you are assigned to evaluate: **GROUP 7**

A) *Based on your evaluation (as a group) please indicate the strengths and weaknesses of the final product.*

Strengths

- In our opinion this project adds value as it very well clarifies cases of study that are relevant for the course.
- It can be used in self learning when studying for this course, or even used in class to present a case and discuss the related question at each paragraph.
- The interface is very clear, easy to use and attractive. It is focused in the teaching and it is accessible from any device.

Weaknesses

- The interface could be considered as too simple, can be complemented with other related multimedia sources or links that direct the user to the content.
- The interface could include a system to count total points of the user so that he can revisit the sections on which they did worse.

B) *Please evaluate the degree of your support to the following statement (group-based evaluation):*

	The product we reviewed is of high quality and we recommend it to be used as learning aid in risk assessment in project management. Easy to use, clear, attractive.				
Scale	Strongly Disagree	Disagree	Neither agree nor disagree	Agree	Strongly Agree
Your response					X

C) *On a scale from 0 to 10. What grade would you recommend for this product?*

We would definitely recommend this product for the learning of project management, so it satisfies the goal of the digitalization project that was proposed. It shows a clear degree of maturity when it comes to the proposed answers in each question, and the interface is both easy to use and attractive. However, we consider that, in terms of digitalization effort, it was a quite simple solution to the already existing content, not that it doesn't merit less.

We would grade this project with an 8.

Annex II: Gantt Diagram (post-product)

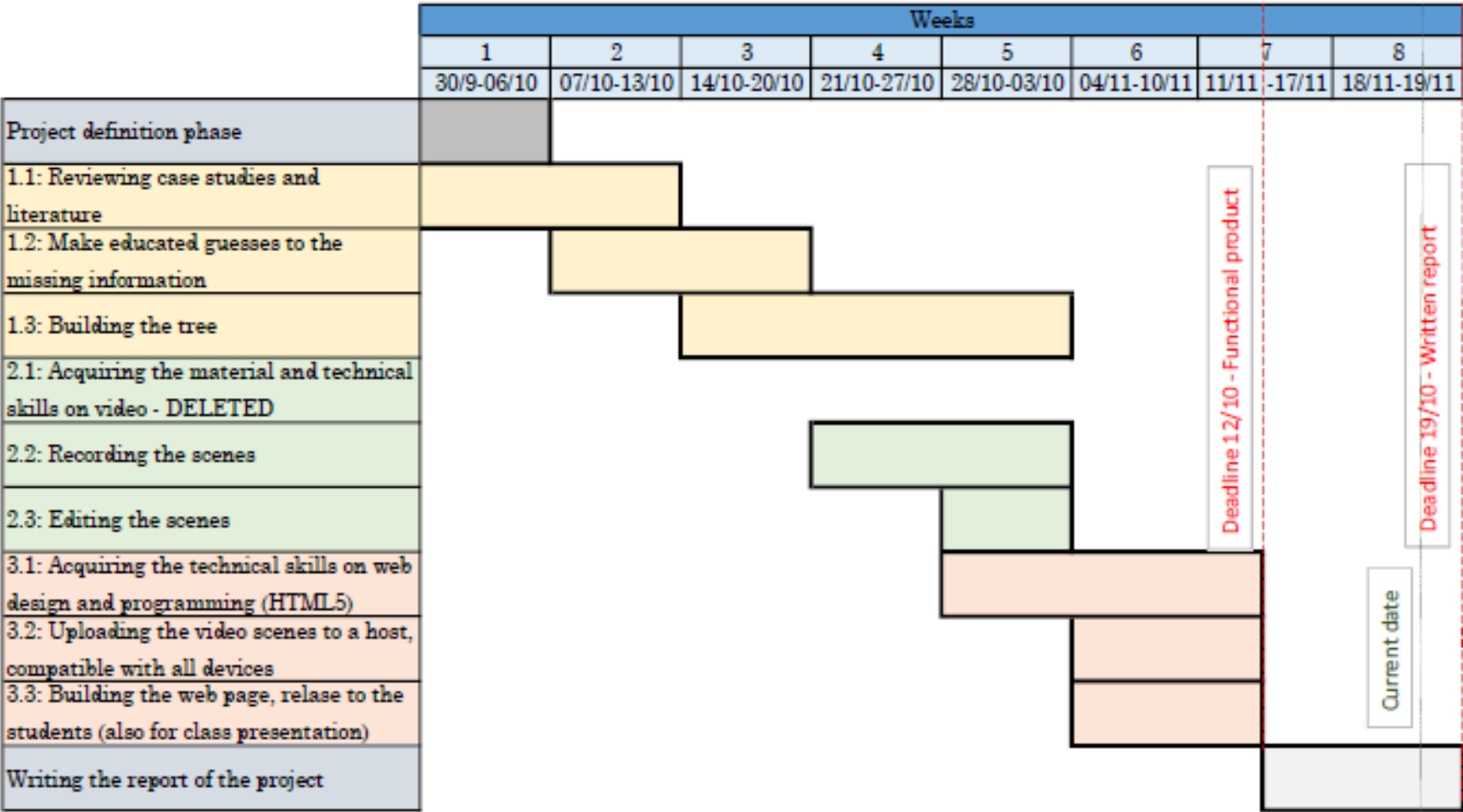

TPK5100 - Applied Project Management Project Assignment

Animated real-life case project.
Renovation of a municipality's maritime
museum

Preface

In the following report, an animated real-life case project was realized. The case was extracted from the course textbook [1] and has been the means by which our group had the chance to get involved in a Project Management life cycle. Our purpose was to use the selected case to illustrate how a construction project can be carried out by pointing out warts and all during the implementation times.

Group number: 5+12

Student names and student number:

- 1) Clement Arbillot, 519265
- 2) Paula Gilabert Prieto, 519576
- 3) Merlijn Enrico Hunik, 519102
- 4) Hugo David Eric Leone, 519176
- 5) Curro Polo Castellano, 519532
- 6) Vittorio Triassi, 518969

1. Digitalization projects

Before going any further it might be worth spending a couple of words on the main aspect of our project. We are trying to convert a real-life case into a digitalized version. Digitize and digitalize can look the same but in the end there is a small but still important difference between the two terms. When we refer to digitize we mean the process of moving from analog to digital, converting images, sounds, documents into a digital version. On the other hand, when referring to something that is digitalized, we are actually allowing the use of digital technologies that can provide us better business models and allow to create value with our product.

In our case, we developed a digitalized project, whose aim was to challenge ourselves with the management of the life cycle of a project, combined with skills that we did not have since the beginning and for this reason we needed to acquire. More specifically, in our group, everybody had a very different background and that is why one of the first challenges has been trying to make ourselves as much clear as possible without using very technical explanations since the others might not have been able to totally understand them.

But before actually starting talking and deciding, several have been the hesitations. We came up with different ideas and not by chance everybody was slightly biased from what they studied. In the end, this was a good thing. We reckon that if everybody would have had the same background, we would have probably thought just in one way. We listed different project ideas and filtered them out according to a few criteria. We initially thought about building an app but in the end we understood that not everybody would be equally involved during the implementation of this. Furthermore these are skills that are not so easy to learn in such a short amount of time as that we had. Then we thought about something that had a more visual impact and agreed on making a video. The nice thing in this case has been that everybody could actively be involved in the work and even if they were not doing it first-hand, they had been giving advice according to their tastes. Something we had to cope with, has been the lack of knowledge of video editing software though. In fact, we have experienced that the lack of knowledge in these cases, can really affect the time it takes to realize what it is required, although the product itself was not particularly complicated.

2. Self-evaluation of the project management effort in the project, success or failure? And why?

A) The goal of the project was to make draw-my life video about a real-life case before the deadline of 12 november. We have delivered this video well in time. However we have downgraded the quality of the video. We have made certain adjustments to the video. For example the initial idea was to buy the software. However due to budget constraints we have used the free version. This has not affected the success criteria but has had an affect on the quality. Furthermore due to time-constraint we have made the recording using the built-in microphone in our mobile phones. Although these deviations have affected the end result we still consider the end product a success.

In the project plan we mentioned certain success factors. Of these we would like to highlight a few. Let's start with openness. Although we could never meet with the whole group we have kept each other up to date via whatsapp. Not being there all the time also forced the present people to divide all the tasks. This also did not pose any problems and the task division was reasonable and fair. Deviation control served as a major factor to success. As we were not able to fully follow the project plan we had to deviate from the plan. However we were fast with adapting to these sudden challenges. Furthermore we stayed extremely focussed on the project goal. The organization turned out to be very sophisticated. We had manpower on the video-editing and a team on recording. Lastly we experienced some troubleshooting which caused the group to make changes in the project plan. All in all the success factors were predominantly met and the project can be considered a success. The only regret we have is that we could not find the money to buy the professional software needed to make a high-definition video.

B) Please evaluate the degree of your support to the following statement (group-based evaluation):

We evaluate our project as successful

Scale	Strongly Disagree	Disagree	Neither agree nor disagree	Agree	Strongly Agree
Your response				X	

3. Self-evaluation of the value to the learners? Can you document your assessment?

A) We have used two methods to evaluate the value to the learners. First of all we have showed the video to some of our friends that did not follow the course. We asked them if they thought the video was useful and if they understood the message without them following the course. The second method was a google survey in which we asked the participants to answer 4 questions. Namely:

- Did you learn anything from the video?
- Do you think this video is a better leaning tool than reading the case in the book?
- Did the video contribute to your knowledge of project management?
- Would you advice this type of video to be used for other cases?

The first question speaks for itself. The second option was the essential reason for this project. The expected benefit of the project was that it would improve the learning process of the course by visualising the cases. The third question shows us if people not only learned about the course but also about project management as a whole. The last video should answer our question if we chose the right case for the video. We explicitly chose the case because it was a visual story.

B) We showed the video to three friends. We did this before uploading the project. Maybe these outsiders would spot some minor improvements. They saw a grammatical error for example. These three persons do not follow the project. This was a choice made so they would look at it unbiased. For the survey we just asked some students in class to fill out the survey as well as some roommates.

C) Now we will get to our results. For the casual showing of the video to the three friends we have no written record. However they generally really liked the video. It was not too long and not too short. They enjoyed watching it and although they do not follow the course they really had the feeling they learned something. As said before we also asked them to look for minor improvements in the video as we conducted this step before we had to hand in the assignment. They showed us a typo and a grammatical error. They also helped us improve the timing of the voice-over.

Now we will look at the results of the Google survey. The first question may not seem

that significant. However the answer is unanimously yes. All ten participants answered

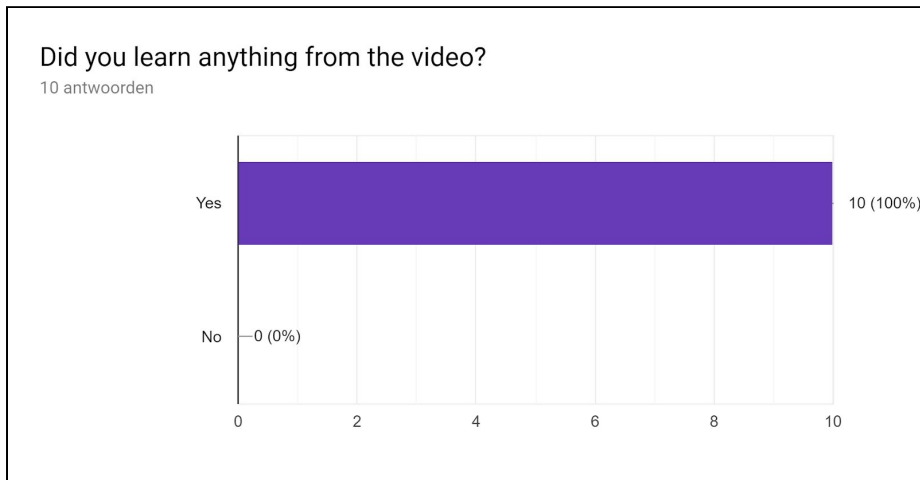

the question with yes. It shows that the video was not made for nothing. The reason of the video was to make it easier to familiarize yourself with a case. This question shows that many people preferred the video over reading a case in the book. It must be said that maybe not all participants read the same case in

the book. Still the results are significantly saying the video is better than reading the book.

Now we will have a look at the third question. This is the most important question as it visualised the value to the watcher/user of the product, the essence of this self-evaluation. I think we could safely say that the project is indeed improving the knowledge and understanding of the course. Although it did not do this very good. In our opinion it could have been that the viewer learned more about the case than they did about project management. However in the end the result was positive.

The last question is more a question for our own understanding. We chose a visual case to make the video about. We wanted to know if we could have chosen any video. This is not the case. It is quite clear that the visual cases have a preference to be visualised. Most participants thought the video could only be helpful for visual cases.

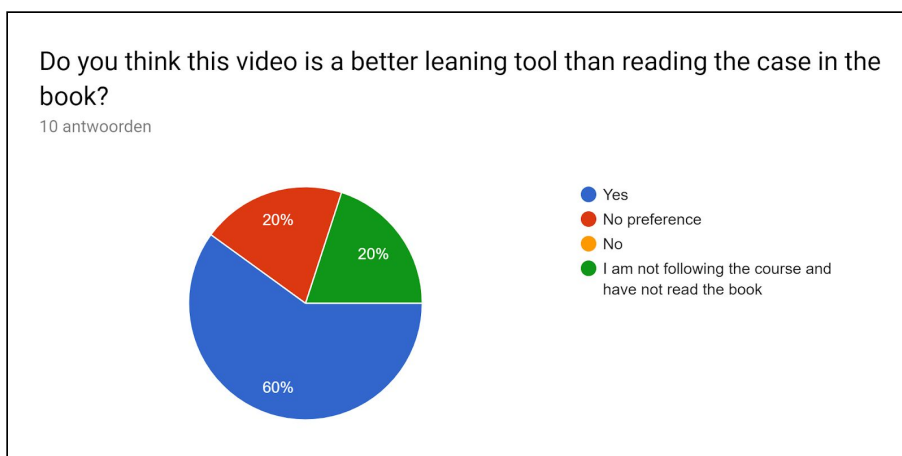

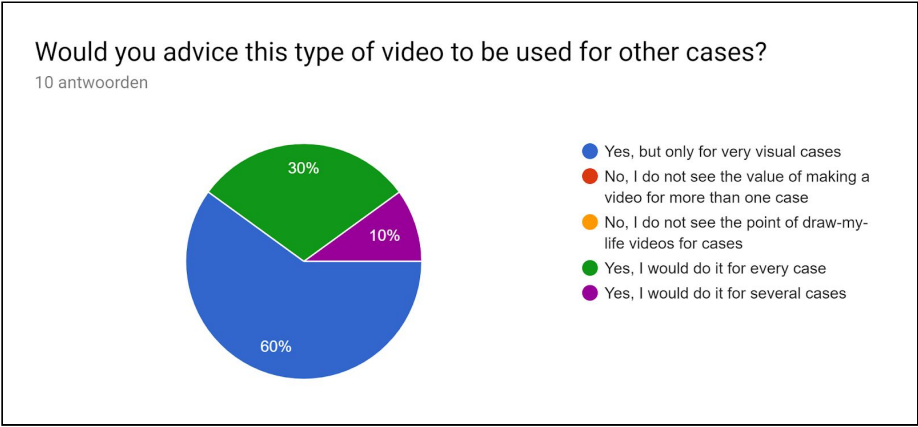
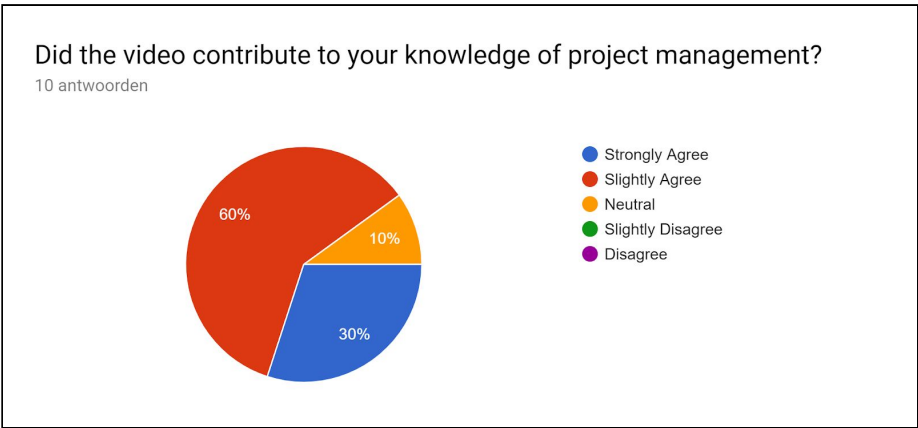

D) Please evaluate the degree of your support to the following statement (group-based evaluation):

	Our product is of high quality and we recommend it to be used as learning aid in project management				
Scale	Strongly Disagree	Disagree	Neither agree nor disagree	Agree	Strongly Agree
Your response				X	

4. Factors that have contributed to failure / success.

In the first section of the following report, a few success and failure factors have been unwittingly mentioned. It is our goal here to say a few words more on the real factors that have accompanied us along the project. Something that was important since the beginning was the *realistic schedule* that our group had to respect. This is because we had clear deadlines in order to succeed with the course and could not run into any delay. The *different backgrounds* really helped to have varied ideas. Although nobody had directly a background coming from Project Management, a couple of us had already joined some projects in the past, where coordination with other people was required. In our team we did not really have a specific *leader*. Probably for such a small project it was better in this way. We reckon that for bigger projects, it is very advisable to have a clear hierarchy otherwise team members can easily get lost in the workflow. Thanks to the small size of our team, we could experience a better *communication* among each other and that is also the reason why it was possible to cooperate by remote with not so many difficulties. We had only a couple of meetings in which we divided the roles and the tasks, but in the end everybody could work independently, respecting at the same time the deadlines required. Unfortunately, we could also experience some cons in our planning phase. In the beginning, when selecting the tools we would use to create our product, we were not really sure about the budget we were supposed to invest on our project. In fact, we had the chance to buy the premium version of the tool we actually used to make the video, but in the end we decided to sacrifice the high-quality of the video itself in exchange of a save in terms of money. We are not stating that it was necessarily a good idea to do so but it has been formative forcing ourselves to deal with a lack of budget. So, if we could sum this aspect up, we would definitely say that *adequate budget* is clearly an important factor that determines a better product. As stated in the beginning of this section, everybody had different backgrounds. It turned out that in order to build something all together, it was necessary to reach a compromise. That is why we decided not to develop any app or particular service that required specific skills not easily gainable in such a short time. Also, it was important that everybody could feel part of the project and the workload had to be equally distributed. Also in this case, if we could better formalize this aspect, we can say that it is pretty important to have a qualified team in order to succeed. In fact, another thing we experienced was that when we finally decided the tools we had to use, some time was necessary to learn the tool itself. It was not as demanding as it would have

probably been building an app from scratch, but still, considering the strict deadlines, it was important to be as fast as possible to bridge the gaps. As regards to the tool itself, we can say that we were quite satisfied with the built-in functions. It was really helpful not to draw anything from scratch considering our skills; and this really saved a lot of time. Having to compare our aforementioned factors with the ones shown on the textbook, it would definitely be worth spending a few words on the first phase, which according to us is the most crucial. An *adequate early planning* is very important and depending on how well this phase is performed, the project can turn into a success or into a complete failure. Something that we might have spent more time on, is probably the collection of feedback from the end-users. Another very important factor is the *trust (within team or between client and contractor)*. Luckily, in our team, everybody really cared for the project and we did not have problems, neither in submitting our work nor among the members. That is why, if we had to choose the most significant factor, it would probably be the trust in the team, without that, there would have probably been another atmosphere. Along the course, we have learned about the main differences between an agile execution and a waterfall approach. Considering the size of our team, it is not so easy to appreciate the differences between the two models but still, we think we were closer to the agile approach, that requires periodical briefings and keeping the others updated on the news about the product in development. It is also true that we did not have figures like Scrum masters in our team (as mentioned before we did not recognize a specific leader) but in any case, it was a good exercise to challenge ourselves in dividing responsibilities and tasks with respect for the others.

5. Most important lessons from your project

- 1) It is very important to perform an adequate early planning otherwise you have to change too many things along the project.
- 2) Try to use tools that do not require too long before they can actually be used, especially if you have strict deadlines, unless your project requires a very specialized team and in this case you must use only specific software/technological stack.
- 3) It is important to have clear documentations when the project gets bigger, otherwise you lose track of the new implementations, important steps and specific changes.
- 4) It is advisable to have different background in the group otherwise you will be biased from what you study (or you already know) and will not be able to get the best insights to build a new (and useful) product.
- 5) It is better to ask to people (also known as end-users) what they really want rather than trying to find something that seems to be useful for you just because you know how to do it.
- 6) It is important to be realistic on the schedule. Putting off the exact date of when something is going to be achieved is not a good idea. You will be late.
- 7) We experienced that it is possible to work by remote too. So, it is better to be productive when you are really free and focused on what you are doing rather than meeting up with the team and having no goals or attention.
- 8) Try to estimate since the beginning if you need more/less (usually more) money to achieve what you want. In our case, we were not sure whether or not to buy the premium version of our tool in order to have better performance. We should have decided this from the start.

6. References

[1] Hussein, B. (2018). The Road to Success: Narratives and Insights from Real-Life Projects, Fagbokforlaget.

Peer-review report

Each group is assigned a peer-review group. The list of the assigned groups is shown in the following table. The table shows for instance that the product produced by group 1 will be reviewed by group 11, and the product produced by group 2 shall be reviewed by group 22.

Before writing this review report, you need first to view/test the product produced by your test group. In your evaluation you should be **objective, fair and use to time to fill in the report**. The grade you assign based on your evaluation is **a guide** to the instructors when they grade the project assignment.

Product produced by Group (Test group)	Shall be Peer-reviewed by group (Peer-review group)
1	11
2	22
4	8
6	5+12
7	4
8	1
9	10
10	12
11	13
12	14
13	15
14	16
15	17
16	18
17	19
18	2
19	20
20	24
22	25
24	26
25	27
26	33
27	34
33	36
34	6
36	7
5+12	9

Your peer-review evaluation report

What is name of the group you are assigned to evaluate: We evaluate group number 9.

A) Based on your evaluation (as a group) please indicate the strengths and weaknesses of the final product.

Group number 9 has created an educative website with some videos about different topics of the course (project characteristics, stakeholders, project life cycle...). For each video, they also created a quiz to evaluate if the viewer has well-understood the subject of the video. This website is very useful during the review period before the exam because the different videos well summarize the more important point of the course.

Strengths

About the strengths, this product allow to learn and understand some real and concrete project management concept by basing and explaining a real project management case.

The product's form is also really good, with some videos that explain project management topics and after that it is possible for the user to check if he has understood the differents concepts explained in the video. This provides a real value to the learner (user). The combination of explanatory video, quiz of knowledge and presentation of a real case allow to maximize opportunities for learning and understanding.

Weaknesses

But we can also notify some weaknesses in this project. A voice should be added in each video. In fact, it could be more educative if a teacher talks during the video. Sometimes, it is hard to understand particular points of the course by just watching some drawings or graphs, we really need a voice to explain it. Moreover, this website is not optimised for phone. We can only use it on a

computer. This group puts a picture of clothes in the background, we can also add the lack of graphical design in the website form.

B) Please evaluate the degree of your support to the following statement (group-based evaluation):

	The product we reviewed is of high quality and we recommend it to be used as learning aid in project management				
Scale	Strongly Disagree	Disagree	Neither agree nor disagree	Agree	Strongly Agree
Your response				X	

C) On a scale from 0 to 10. What grade would you recommend for this product?

According to the strengths and weaknesses explained above, we can give 7 out of 10 grading.

Reenacted real-life case project

A demonstration of speech-recognition software, and the consequences following lack of end-user involvement.





Table of contents

Preface	3
1. Digitalization projects	4
1.1 Our product	4
1.2 Purpose	4
1.3 The main challenges the group experienced with this project	4
2. Self-evaluation of the project management effort	6
3. Self-evaluation of the value to the learners	8
4. Factors that have contributed to failure / success.	11
5. Most important lessons from our project	13
6. References	14
7. Peer-review report	15
7.1 Evaluation	15





Preface

The purpose of this report is to give an understanding of what we learned during the development of this project. We would like to thank all of the test subjects that wanted to participate in our process.

Group number: 6

Student names and student numbers:

- 1) Hanne Brynildsrud 493403
- 2) Anniken Syvertsen 493429
- 3) Marius C. Sjøberg 494272
- 4) Thomas A. F. Ramirez 473540





1. Digitalization projects

1.1 Our product

Our product is an informal real life reenactment of case 2.1 - Downsizing by introducing speech recognition software from Bassam Hussein's "The Road to Success".

1.2 Purpose

The intended purpose of the product is to be an informal learning aid, that can both help students understand the case, but also help develop a better understanding of what factors differs a partial successful project from a successful one.

The group chose to produce this product because we thought that this case was the most interesting one. When choosing between the cases, the group ended on this case by several reasons. First of all, the fact that it was a digitization project was of high relevance to the group, since all the members are studying within the technology field. Secondly, the group found the case really interesting and were triggered by the fact that the product was only partial successful, and we wanted to dive deeper into the case to understand what factors contributed to the partial success.

We made a real life reenactment of the case, because the group agreed that this was the best way to represent and reproduce the case, as well as the most interesting way to teach others about it. The group knew out of own experience that it is easier to learn something if the way of learning is fun and/or interesting, and therefore we wanted to challenge ourselves to make something different that could be kind of fun, but at the same time would encourage learning.

1.3 The main challenges the group experienced with this project

When we discussed the different challenges that we encountered in the group we discovered that constraints was a big factor. As "The Road to Success" states; "another important feature of project assignments is that they are accomplished within one or several constraints, such as time constraints, budget constraints, specifications or resource constraints" ¹.

This project was accomplished within all these constraints:

- Time: one of the most limiting constraints was the time. The group consisted of four students, all with a tight schedule. The group therefore experienced some problems with finding available time to work with the project, since this class was only one of four classes this semester. In addition, different deadlines was due during the semester, hence it was important with good time management among the members.

¹ Bassam Hussein 2017, p.22



- 
- Budget: the project was a ‘zero expenses’ project, and therefore the group had to be creative and use already available resources only. This is a very limiting constraint when making a movie, since you need both equipment and locations.
 - Resource: the group had limited resources, and could only “work with what we had”. Therefore, planning was extremely important, so that the group could establish and find all the necessary resources, and find out what we had and what we needed. As an example, the group needed a camera to record all the scenes, and therefore it was important to plan ahead, so that the group could locate a camera, and make sure it was present at filming day.

Many of the potential challenges was already addressed in the project plan, where it was made a risk analysis as well. The analysis was really helpful, since the group was able to map most of the risks, and plan how to avoid, or in the worst case, handle them.

Challenges in the risk management process

Nevertheless, there was some challenges in the risk management process as well. The risk management process is a human-based process with some associated problems. People who are involved in the project form their own subjective perceptions of risk, based on habits, work culture, expectations, experiences, and skills.² One of the issues was within lack of experience. When the group planned the project, the idea was that the project should be an animation, but the fact that the group later on had a change of mind and decided to make a real-life movie instead, was not addressed as a risk at all. When this happened, a lot of re-planning had to be done, and therefore some extra time was needed.

General challenges in the project

- Uncertainty: as the project literature states, uncertainty is an inevitable aspect of most projects. Both when it comes to estimates, associated with people and associated with managing each stage in the project life cycle. The group had little or none experience with projects like this, and therefore there was a great concerns around the project.
- Change of mind: one of the main challenges the group experienced with this type of project was that the group first decided to make an animation of a case, but later on had a change of mind. The group discussed a lot back and forth, and it was difficult coming to a conclusion on what type of project to go for. Four different team members with different opinions is absolutely a challenge in a group project, and the group solved it by laying out all the arguments and then deciding it over a vote.
- Lack of experience: none of the group members had any experience with video production, so one of the main challenges was to plan and then produce without the necessary knowledge and experience. It therefore ended up being kind of a “learn as you go”-project.

² Bassam Hussein 2017, p.104





2. Self-evaluation of the project management effort

The group is in general satisfied with the project, and we feel that the management of the project went well. Not only because of the detailed project plan that worked as a guideline for the entire period, but also because of the comprehensive risk analysis which helped the group avoid potential pitfalls in advance. The project started with addressing its purpose, which was to make a digital learning aid. In order to make a good base for the project we focused on the initiation phase. We made sure to define our project goals and objectives. The objective of the end product was to introduce the end users to the concepts of case 2.1. By doing this we wanted to achieve an understanding of the conditions needed in order to manage digitalization projects effectively, and to avoid different pitfalls in these kind of projects.

In the first group assignment (the project plan) we made a risk assessment plan. This was very helpful when we encountered different problems. An example of this was conflicts/disagreements between members of the group where we had come to an agreement on how to handle this before it even happened. A problem that we did not address in the assessment plan was changing from animating a movie to recording a movie. Regardless, it was identified quite early and therefore the extra time to make the transition was not any problem.

In the early stages of the project, it wasn't a lot of success criterias that addressed the end user of the product. Therefore we felt that we had to focus a lot more on that than expected. The biggest deviation in the project was that instead of focusing on not allocating too much time on each task, we focused on how to make it optimal for an end-user. Therefore we had a dialogue with other students along the way on how to optimize the product. Overall, the group is quite satisfied with how the success factors were fulfilled. Still, it is important to mention that we did learn how important it is to find good success factors in the early stages of the project. If these are incomplete, it is hard to know what to do in order to create a successful project.

2.1 Deviation between success criteria and final evaluation.

Statement: *"We evaluate our project management effort as successful"*

Scale	Strongly disagree	Disagree	Neither agree nor disagree	Agree	Strongly Agree
Your response					X





The group managed to finish on time, and feel that the project ended up being a high quality learning aid, based on the feedback we received the thoroughly testing process. The group is in general very happy with the finished product, and therefore strongly agree that the project management effort was successful. We had to add some more focus around the end user, and we could have been better at defining the success criterias in the beginning of the project. But after we made sure to focus on the end-user we were satisfied with the results.





3. Self-evaluation of the value to the learners

During the planning, the group agreed that the main target audience would be students taking the course or people using the book “The road to success” by Bassam Hussein. The objective of our product is to make it easier for users to understand the most important aspects of the case we chose. In the start of the subject, the group members was what we would now call ‘the end users’. The group had not heard of the case before, and was relatively unfamiliar with success factors when the class got an assignment where the case 2.1 was to be reviewed. Since all the team members had been in the same position as the now expected end users, the group had valuable knowledge on how to approach them in the best way. We wanted to create a medium that would give the end user as much information as possible. Therefore we thought that presenting the case in a video would achieve this.

The group made a usability test, where the purpose was to map how much the end user learned after watching the case video. The usability test was as follows: the test subject watched the video without interruption from the team, and later on the group followed up with some pre-decided questions that would help determine whether or not the user acquired the expected learning outcome of the product.

We designed questions about the case, the main topic of the case, how entertaining it was watching it, and the overall quality of learning.

Question 1: “What happened in the case?”

Question 2: “What did you learn from the case?”

Question 3: “If you were to start a new project tomorrow, is it something that you learned from this case that you would focus on in your project?”

Question 4: “What do you think went wrong in this case? Why do you think it was only a partial success?”

Question 5: “Can you mention some positive and negative aspects of the video?”

Question 6: “Did you find the video informative/helpful?”

Ten people took the test, and all of them had no previous knowledge to the case. It was important not to choose previous nor current students of this subject, so that the test results data quality would not be corrupted.





Under follows the most informative test results:

The examples:

TEST SUBJECT 2:

Found the video very entertaining, thought it was a video that was well done. The test subject understood the content of the movie, and what the group wanted the end user to learn from it. Found it easy to keep the concentration even though the duration of the video surpassed 7 minutes. The main cause, in their opinion, was that the video overall was funny and entertaining.

TEST SUBJECT 6:

Found the movie entertaining. The test subject received learning outcome from the movie. The test subject remembered a lot of the information that was given, and managed to retell almost the entire case after watching the video. When asked what went wrong with the project, it was said that the project wasn't a success because the management did not pay attention to the end users, and that this should have been changed if the project were to be carried out again.

TEST SUBJECT 9:

When the test subject was asked about what happened in the case, the subject replied amongst other how the video portrayed the health system as functionally ineffective for new products and how the speech recognition didn't work. The test subject understood the case, and managed to explain the success factors as well as what made the project only partial successful after watching the video. It was also stated that the video was funny to watch and the angle of camera recording was changed a lot creating a funny effect. The volume of sound changed during the video, making it difficult to hear at some points of the movie.

Overall the test results were promising and the group was satisfied. The final feedback had this in common:

- *Funny and entertaining content*
- *Informative and easy to understand*
- *The user was left with a good overview of the case.*

One of the areas that was pointed out by a test subject was the volume level. It changed throughout the video making it challenging to hear sometimes. The group therefore decided to change the end product by adding a subtitle making it easier to understand what was said in the video. By carrying out these tests, the group received valuable data which gave us an opportunity to enhance the quality of the product.



The results also showed that the subjects was left with a lot of information about the project as well as project experience after the test was done, which was the main purpose of the project.

	Our product is of high quality and we recommend it to be used as learning aid in project management				
Scale	Strongly Disagree	Disagree	Neither agree nor disagree	Agree	Strongly Agree
Your response					X

On the basis of our tests carried out on our target audience, and the feedback we received by carrying out the tests, we will argue that our product is of high quality and that we would recommend to use this as a learning aid. Since video delivers knowledge through characters, sound and pictures, knowledge can be presented in a better way than text, using rhetorical devices, and help express emotions and empathy.³

³ Guo W., Li Y., Gao J. (2015)



4. Factors that have contributed to failure / success.

In the project plan, the team came up with some success criterias that the members wanted to achieve in order to be able to call this project a success. As it is stated in the book, the first problem of evaluating projects, is how to define success. We decided to determine the success criterias for this project in advance, as a tool for managing our development process, to avoid disagreements along the way, which the book states to be a good approach⁴. Our success factors ended up being:

- Finish the project before deadline
- Make sure everyone is happy with the final result
- Not use more than the allocated time on each task
- Manage to deliver a film which can be used as a digital learning aid for project planning
- Satisfy the project owner

We have completed the criteria regarding submission of the project before the deadline. It's also a common agreement that the members of the group are very satisfied with the project that has been delivered. As the project changed into an reenactment instead of an animation film, we had to use time on filming instead of animation of the project. We had a schedule to follow, and since the filming involved all of the group members we had to change the time schedule a bit, as we did filming and voiceover at the same time. The fact that the group really liked and believed in the approach we ended up with, was a key factor to the project success as it was easy for us to set aside time to finish it.

In retrospect the group realized that the project owner wasn't directly involved in the process. The group followed and fulfilled all the criterias that the project owner set for the project to try to satisfy him, but should have involved him more. For future projects we will definitely focus on this, but we did not feel that it affected to which extent this project was a success or not.

As the book states; projects are evaluated by two clusters, project management success, and project success⁵. For us to say that the requirements of the project management success was satisfied, we would have to stay inside the time constraints, deliver the project according to the specification we had set for the product, which we did.

As to deliver the product according to the specification that was set, we changed our approach during our development process. Therefore we also had to change our specifications for the projects to match the product we were to make, but this did not affect our success criterias in any decisive matter.

⁴ Bassam Hussein 2017, p.50

⁵ Bassam Hussein 2017, p.52





Within the project success cluster there are several factors, such as the stakeholders and participants of the projects, and how satisfied they are with the project. We said that the project would be a success if we were able to deliver a product that could be used as a digital learning aid for project planning. To satisfy this criteria we would have to test the product on our target group, which was mainly students. As we did our testing we discovered some flaws with our project we were able to improve before the deadline. All the test objects had a common agreement that they gained learning outcomes from the video we made, and therefore we can say that we have satisfied this criteria as well.

Compared to the success factors listed in the book we feel that we have managed to cover the scope of the factors listed. Before we started the project we were acquainted with the ones that were listed in the book, and this was a great starting point for planning and development of the product. The success factors listed in the book are as follows⁶:

- Good coordination with stakeholders
- Adequate project planning
- Proper choice of projects
- Agreed success criteria
- Realistic estimates
- Good project start-up process.

As we have elaborated in previous paragraphs, we feel that we have done adequate project planning in advance, by writing a project plan, stating risk factors and time estimates amongst other things.

We will say that this project has been a success. The most significant thing that lead to this success, was that the group was really positive and had a had a joint idea of how we wanted the product to be. As stated earlier, the project went from being an animation movie to becoming a reenactment, which was really fun to direct and record. Therefore the whole process went a lot quicker, as it was easier for us to set time aside to work with something we thought was fun to work with.

⁶ Bassam Hussein 2017, p.54





5. Most important lessons from our project

1. First of all the group should decide what case you want to make a project out of. This is because it will be easier to choose a fitting form for the project, once you know what type of project you are creating.
2. Our second advice, is that the group should use some time in the beginning to discuss how the form of the project should be (animation, movie, website etc...). Our group chose animation first, without really considering the alternatives and what would fit most for our team and case. Therefore the group lost some time when deciding to make a real-life reenactment instead later on.
3. A good project plan is key! This makes it much easier to follow the progress during the project. And if you set goals on the way (finish plan by end of september, start manuscript by november 12th, etc...) you always have something to work on, and will achieve a high degree of effectiveness.
4. We learned that if you make a good risk analysis before your start the project, and identify possible risks, you will reduce the probability of the project being affected by these risks. A risk analysis will give you the knowledge of what kind of risks the project has, how to prevent the risks, as well as how to handle the risks if they were to occur.
5. Our experience suggest that it really helps to consult former students which have taken the subject. Learning from their good and bad experiences, as well as getting some useful tips and tricks was very valuable and saved us from some mistakes.
6. Make sure the entire group shares the same goal and vision of the project. If the entire group knows what they want to accomplish and what end product the group aspires towards, it is much easier to motivate the team members. If the group has a common goal, you also know that all the members works towards the same end product.
7. Something we wish we had done more, was to locate the end users of our product, and to confront them about what their expected learning outcome was. If we had been more focused on this, it would have been easier to make a product that would satisfy the end users demands, which is an important factor of having a successful project (factor 7, “10 factor instrument of project success by Pinto and Slevin”)⁷.

⁷ Bassam Hussein 2017, p.54





6. References

Guo W., Li Y., Gao J. (2015) Learning with Video: The Digital Knowledge Representation and Digital Reading. In: Cheung S., Kwok L., Yang H., Fong J., Kwan R. (eds) Hybrid Learning: Innovation in Educational Practices. ICHL 2015. Lecture Notes in Computer Science, vol 9167. Springer, Cham

Hussein, B. (2018). The Road to Success: Narratives and Insights from Real-Life Projects, Fagbokforlaget.



7. Peer-review report

Group 34

Strengths

- When we understood the purpose of the product, we thought it was clever. If we understood it correctly, it is supposed to be an alternative to reaching your hand up in class. This would make it easier for people that normally wouldn't ask a question to actually write one. In other words it was a good idea
- If developed properly, we think it could solve a problem (it covers a need)
- If used correctly, it can provide real value to a learner, but this demands that there is a person in the chat that actually can learn something to the others
- Cool with an out-of-the-ordinary project

Weaknesses

- Lack of aiding text: difficult to understand the purpose of the product, should be a description somewhere. Could be an information box or an information button or similar
- The assignment states that you should develop “a digital learning aid”, but it is hard to understand how this can be a learning aid for someone
- If it is for teachers to answer questions without students raising their hands, there should be names so that you can see that it is the teacher that answers your questions, and that you are not being fooled by another student
- Difficult “Classroom-system”. It is hard to tell if you are in the right chat room since all you have is a 7-digit code. It would have been a lot more intuitive to use subject codes.
- It is missing a significant part to be a learning aid - something that teaches the user anything. On the contrary, if you do have a professor or something in the thread, it can be a good learning aid
- Should be restrictions on the platform since any user could “spam” the chat.
- Nothing controls if every person in the room is a student

7.1 Evaluation

	The product we reviewed is of high quality and we recommend it to be used as learning aid in project management				
Scale	Strongly Disagree	Disagree	Neither agree nor disagree	Agree	Strongly Agree
Your response		X			





We disagree because it is difficult for us to understand how this can be used as a learning aid in project management. The product itself is not a source of significant impact on learning, but if you combine it with a class-setting we think that a lot of people would benefit from having a product like this.

What does the product lack to be “a high quality learning aid in project management”?

The concept and the idea of the application is great, but unfortunately it seems like an unfinished product that doesn't fulfill the criterias. It is difficult to see the product being used today as a learning aid. It has too many flaws to make it a high quality product, and we miss an informal part as well as how we can learn from it.

If it is improved it would have been a very good information-sharing platform, and we think that a lot of shy students could benefit from this. So the idea is great, but it lacks some functionality.

On a scale from 0 to 10, we would recommend 5 for this project.



An interactive webpage about risk assessment to aid self-testing

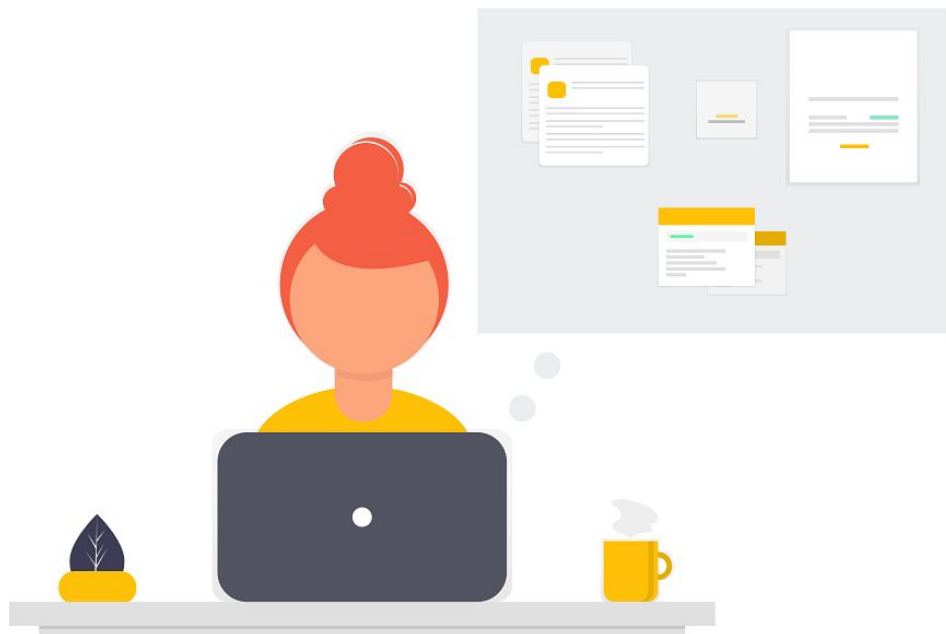

Table of Content

1. Digitalization projects	3
2. Self-evaluation of the project management effort in the project, success or failure? And why?	5
3. Self-evaluation of the value to the learners? (evaluation of project success) Can you document your assessment?	8
4. Factors that have contributed to failure / success.	11
5. Most important lessons from your project	14
6. References	16

Preface

The purpose of this report is to evaluate our final product and discuss why it was a success or failure. We also discuss how much value our product gives to the learners, with documented assessment. It report also contains an evaluation of the most significant factors that have contributed to success or problems. We have also made a summary of the most important lessons learned from our project.

Group number 7

Student names and student number

- 1) Anders Bergesen - 493417
- 2) Kaja Sofie Lundgaard- 493395
- 3) Alis Wiken Wilson - 486769
- 4) Erika Åsberg - 493434
- 5) Tor Berre - 493411

1. Digitalization projects

The product

For this project, we decided to make an interactive webpage. The main intention of the product is that it can be used as a learning platform within practical project management.

The website specifies on the subject risk assessment, which is one out of nine knowledge areas within project management. Hussein [1] mentions in his book that Pinto [2] “defines risk management in projects as the art and science of identifying analysing, and managing risks throughout the project life cycle to achieve its goals”. It is also written that “According to several researchers, having moderate levels of risk management increases the chances of project success”.

Product purpose

The website consist of different cases. In each of these cases the user will both encounter some informative text related to risk management, from real-life projects, and some relevant questions. It is not that hard to find good sources and material when it comes to project management, but to learn it is something different. We believe that reading a book or watching a movie is educational in the moment, but after a while one forgets. The purpose of choosing interactivity is that it, hopefully, will make the users more likely to remember the content they learn, long term, since they have to think about and submit questions. The purpose with this product is to motivate and activate the users, and make learning more fun and fulfilling.

Why an interactive website?

When it came to deciding what kind of product to make, the group was unanimous that it had to be something we would like to use for ourselves as a learning platform. At the same time, we wanted to challenge ourselves, and make it more or less relevant to some of our interests. We found out that almost everyone in the group shared an interest and some experience within IT, and decided that a website would be a good product for us to build. The internet is available almost everywhere at any time, which means that our website is easily accessible anywhere, anytime. It requires little energy to enter a phone or a computer, and visit our site.

Main challenges

We had a lot of minor issues during this project, especially in the beginning, which lead to confusion and disorientation. The main challenge was a slow start to the project. This was caused mainly because of poor communication, and the fact that we were not able to decide

what kind of product to make. At first, we decided to make an educational movie, we even wrote our project plan as if this was our final product. We later found out that this wasn't of big interest within the group. After some discussions, we switched our plans and went for an interactive website, as mentioned initially. The main reason for this change was the motivation in the group.

Making a video seemed a little bit too easy, boring and common, as to what the project description asked for. The description was so vague we just had to take advantage of it, and make something really good, and what we believed to be better than a movie. Though this led to some new issues, we were ready to deal with them, because we now knew something we did not take into consideration the first time. That was the awareness of not only stating the risk assessments, but also be aware of them. We therefore took this more seriously ahead of creating our webpage, and put into consideration all the things that could go wrong.

The first risk and challenge we encountered was the experience and knowledge within technology, but the group was aware of this risk, and the extra time it demanded. Everyone in the group also had other subjects during this semester, and some of us had bigger projects to work on. Following made it a bit hard to find time to meet were everyone had time, but we managed to find a common meeting time, every week. Another challenge was the risk of not finishing the product, but the motivation and work ethics were high.

2. Self-evaluation of the project management effort in the project, success or failure? And why?

Overall we would say our project was a success. We managed to produce a fully functioning product which mostly satisfies all the criterias set by the project task. We had some obstacles along the way that lead to our project not being as complete as we wanted to.

However, there were a few factors that slowed down our progress. We did not have the time needed to produce the product we talked about in the planning process. Because we decided to code a website this became a lot more work than we anticipated and naturally where our primary focus was located. The coding and framework of the site is therefore what we are most satisfied with.

To manage our project we made a timetable of when which parts of the website should be completed. Every week we had a meeting to update each other on our work and help each other if necessary. We also had a group chat to help us communicate more urgent information or problems.

A lot of time was spent on teaching and helping each other so that we all understood the entirety of the code. If this was a work-project or of a bigger scale this might not be as important, but because we are in the process of learning these things, we wanted to make sure we all got the most out of it. To help with that we did a bit of pair programming to lift the less experienced.

A few of the risk factors we thought about in advance was the time and experience. We have all had other big projects this semester, as well as volunteer work for our student organization and the student festival UKA. This meant that we had to be effective and make a good plan for how to make the best possible product in limited time. Looking back we worked really hard to achieve these goals, but there were a lot of other functions we wanted to add, but did not have the time to. The lack of experience was dealt with in a really good way. The chat was a really good way to connect and ask questions, as well as the pair programming and weekly meetings.

The main reason why things didn't go exactly as planned was the change in product. After we delivered the project plan we decided we wanted to make a website instead of an animation. There were a few incidents of sickness in the group as well which resulted in a bit additional work on the rest which again held us back a bit. But all the way through we focused on

producing the most essential parts of the site first so that we had the best possible product to deliver.

Because we decided to make a website instead of an animation there is quite a lot of differences between the project plan and the actual product. We kept the content and purpose of the project which was to teach fellow students about risk assessment via information and cases.

Aside from the obvious schedule being all wrong, we also did not follow the project plan on the entire content. Our plan was to include more content about risk assessment in general. Unfortunately we did not have time to complete this as developing the website took more time than expected. Our new project plan on the website included a page about general risk assessment and how to set up a risk assessment plan. This also included some questions to make sure the user understood what he/she had read. We would also like to add some more cases and questions as well as make the language easier to read by splitting it up in smaller sections.

Another addition to our site that we did not have time to implement was that you should not be able to read on before you answer the next question. That would make the site more interactive as well as testing the user more extensively. Unfortunately, that was our plan when the questions were being made, which means that some of them would benefit more from being a roundup-question or to make sure the reader is fully paying attention to what they are reading.

We evaluate our project management effort as successful

Scale	Strongly Disagree	Disagree	Neither agree nor disagree	Agree	Strongly Agree
Your response				Based on the reasons listed above we would say this project was a success. We had some obstacles and the result was not as good as we planned it to be, which is why we do not strongly agree with this statement.	

3. Self-evaluation of the value to the learners? (evaluation of project success) Can you document your assessment?

Our primary audience group are students that want to learn about risk assessment in project managing. The product gives tasks based on a text, and in that way, it can be useful for both students with little knowledge of project management and students that already have some knowledge. However, this product can be useful for everyone that want to learn more about project management. It felt natural to tailor our product to students, as we could easily access co-students for their opinions and evaluations. The product is meant to give the users a basic knowledge of risk assessment and allow them to reflect and understand the importance of it. After using our product, the participants will be able to identify risks in project management.

To evaluate our product idea, we first made a mockup test to see what others thought of our ideas and concept. In order to complete a mockup test, we needed to have a clear plan of what our product would look like. Then we drew the different pages of the website on paper and different scenarios based on the interaction of the participants. For each participant we gave them a set of tasks and watched them interact with our mockup product to see if they were able to understand how it was used. Afterwards, we had a short interview where they got the chance to comment on the product and criticize it. For this part, we only had six test subjects, as the goal was to see if our idea was good. To find the informants, we went to A4 at Realfagsbygget, where the IT students have their study rooms. As we wanted to test our concept of a website, we figured this was where we could get the most constructive feedback. The response on our design was overall very good. All participants found our site easy to navigate through and liked the simple design. People were also generally positive about the different functionalities. This was early in project however, and we had many ideas at this point that sadly was not implemented in the actual product. As the cases at this point very not fully functional, it was difficult to get an evaluation of the learning outcome, but the participants were all positive about the potential that the product could have.

As the product was nearing completion, we decided to make a new user test, to see how if we achieved what we wanted with our product. We figured this would also be relevant for making final adjustments and see if we could make changes to increase user functionality. This test had many similarities with the mockup test, the participants to give us relevant feedback on navigation, functionalities, design, general user experience and learning outcome. For this test, users would also give us response about the different cases. In this test we could send out a link to the product and the test form, so it made it easier for us to reach a larger test group. Our informants were mainly co-students and friends, but also a few family members of different ages. We also made sure to include a lot of IT students, because we

viewed their response and knowledge as extra valuable for the product. 14 people did the test in total.

Compared to the mockup test, this user test lacked the same personal touch. In order to compensate for this, we had to thorough with the questioning in the test form. The first part of the form asked for asked for a general opinion of different features and design, to see what how the participants felt about our product and if they liked our concept or not. In the second part, we asked more specific questions to map what parts of the product we potentially could improve. Finally, we asked for comments, where the informants could give a long length answer and comment on things had discovered during the test. In retrospective, we should probably have focused more on evaluating the learning outcome of the product by testing students in this class instead of mainly IT students. Also, our questions should have been more pointed towards the learning impact this product have. At this point in the project, we were all so obsessed on completing the programming part that we lost sight of the purpose of this product.

The response was still generally very good in terms of design and navigation, but we had mixed responses when it came to learning outcome and the cases. Several people thought that texts were too long compared to the short questions and therefore made it a dull exercise. Overall, people found our concept great, but the content was not there yet. But the few cases we had, helped a lot of the informats to gain knowledge of risk assessment in project management. The test was also very useful for us in terms of bug fixes, as some of the participants was able to discover bus that we were not aware of. We ran this test a bit late in the project, so we were not able to take all the feedback into consideration before we delivered, but the test definitely helped us improve the product.

Although we ran two tests, the majority decisions have been based on our own personal evaluation. As we met once a week, we were able to share our individual evaluations and discuss it in a group. This helped us identify and adjust ideas we about the product.

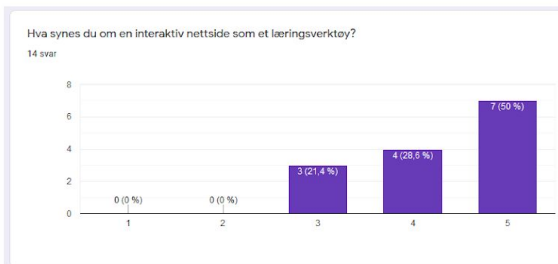
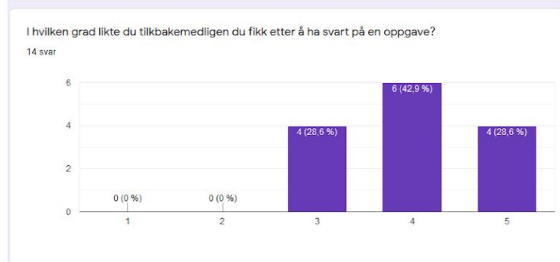
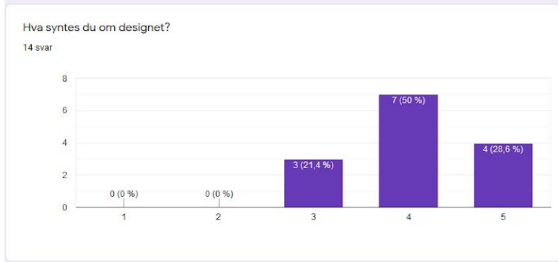
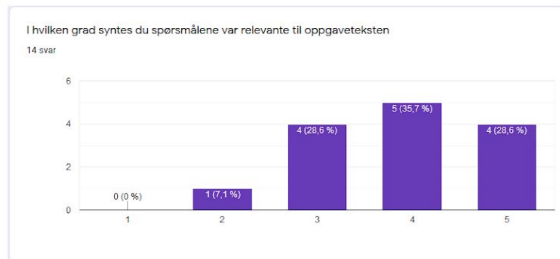

Generell kommentar til nettsiden
14 svar

Flott desgin, kunne kanskje vært litt mer snacks. Greie caser, men ble litt kjedelig.)

Veldig bra jobba!

Flott og grei nettside! Hadde vært enda bedre om flere funksjonaliteter hadde blitt lagt til, da dette skal være en interaktiv nettside. Kan bli litt ensformig å lese en tekst å svare på spørsmål.

Oversiktlig og fin. Lærte masse

Fine illustrasjoner

Supert!

Bra nettside, men holdt på å sovne av å gjøre dette! Er vel ikke helt relevant for meg

Bra jobba, stå på! Elsker ideen bak siden. Enkel og grei side

Skulle gjerne hatt litt bedre spørsmål

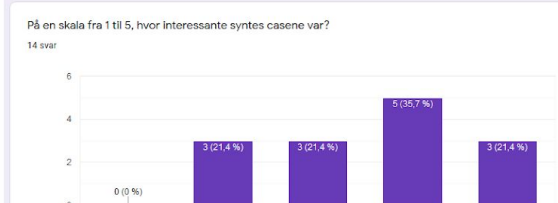

	Our product is of high quality and we recommend it to be used as learning aid in project management				
Scale	Strongly Disagree	Disagree	Neither agree nor disagree	Agree	Strongly Agree
Your response			Although we are happy with the fundamentals of our product and the concept, we still feel that it needs more content before it can be used as learning aid.		

4. Factors that have contributed to failure / success.

We have made a table to list and elaborate all the factors we believe have contributed to success or to problems for our project.

Renewing the project plan	Since we were not satisfied with our old projectplan, we had to renew it. Because of lack of time and poor teamwork we did not ensure that everyone was happy with the plan. Not all of us wanted to make an animation, and wanted to show our technical skills instead. After we changed the project plan and the whole group were satisfied, it became a success.	Success
Everybody is happy with the product	Since we all study computer-technology we were automatically more happy with developing a website than making a movie.	success
Quality of the product	After we changed from making a animated movie to an interactive website, it was important to us that we were satisfied with the quality of the finished product. In the start of the project, we did not think the quality of the animated movie would be as good as a website. Despite the fact that we wish we had more time to implement several features to our product, we are now satisfied with the result.	success
Finish the project	We lost some time to work with our product since we did not followed the original project plan, but we worked hard and finished the product in time.	success
Good teamwork	In the start of the project, the teamwork were not very good. It was due to lack of time and poor motivation because everyone were not satisfied with the old projectplan. After we changed it the group were much more motivated and effective since everyone had more to contribute with.	success
Time	As we mentioned above, we lost some time because we renewed our projectplan. If we have had more time we would probably added some	problem

	more features to the product so it could be even better.	
Errors in code	We chose to make a website since its more relevant to our study, but it was still a challenge. It's very common to get bugs and errors while developing something, and it took some of our time. It is also a good example of an important problem in context with making our product.	problem
Other student activities	It is common that students have a social life besides study, and that can have a big impact on working with the project. Throughout October the UKA-festival happened, which several of us participated on and one of us worked there the whole arrangement. The working was therefore not so good three weeks during that month.	problem
Sickness among the students	It was always a risk that some of the group members got caught by the flu or other illnesses. It happened to some of us, but did never do any big harm on the project. It was still a problem sometimes.	problem
Other subjects and projects	All the members of the group have at least three other subjects to work with beside this course. Like this course, the others also have different submissions that has to be handed in before deadline. Some subjects also have projects, so sometimes some of us had to prioritize which subject and project to work with. In the end it went well, but we often had problems with prioritize our time.	problem

Our most significant factor was definitely the renewing of the project plan. It was absolutely decisive related to the motivation of our group. If we had not changed the type of product, we would probably have ended up with a bad result. We have learned that it's important with good communication and teamwork, and it's never too late to make a change for the good of the team and project.

We have compared our own identified factors with some generic success factors conducted by Murphy [1 (page 54)]:

Murphy's key success factors:	Coordinating with our own success factors:
Good coordination with stakeholders	We coordinated this successfactor with “good teamwork”. If we think of ourselves as the stakeholders, the coordination was not good enough in the start of the project, but it became better in the end. When we changed the product to a website, it became much easier to delegate tasks and responsibility to each of the members of the group. It resulted in a much better coordination.
Adequate project planning	Our first project planning was definitely not adequate in the start. We have learned a lot from that. After we decided to renew the project plan, the project planning went much more adequate and effective.
Proper choice of projects	We compared this factor with our “everybody is happy with the product”, since everyone was not happy with what we chose to develop in our first project plan. If the time and communication was better in the start, we would probably had chosen a more proper project to make.
Realistic estimates	When we made our first project plan, we forgot to estimate the factor “other student activities”, which seemed to become a significant factor. But we quickly understood that we had to plan our work around it, and after that it went well.
Good project start-up process	Considering the factors “time” and “good teamwork”, we had a problem with both of them in the start of the project. If we had given more time to the project-planning, we probably would have achieved a good project start-up process from the beginning.
Agreed success criteria	According our own factor “Everybody is happy with the product”, we were not agree of the success criterias in the beginning, since we made a decision to make a product not everyone on the group wanted to develop. Luckily everyone agreed to the criterias when we changed the product to a website instead of a movie.

5. Most important lessons from your project

Good preparations and communication

Something that is important when working on projects similar to this are good preparations, and even more important, good communication. We learned that making a quick decision, based on poor and little communication, about what type of product we were going to make was a bad choice. It is important not to rush this decision, but take the time to figure out and identify the learning objectives of your final product before deciding on the type of product.

Be flexible

Another important factor is to always be flexible, and prepared for changes. We learned that this was very helpful, as we had to make a lot of changes to our original project plan. Our advice is not to get stuck in one lane, and always focus on developing the product for the better. It is important though to have in mind that this may cause some challenges and disadvantages, but as long as they are taken into consideration ahead it will not be a huge problem. Changes will in most cases lead to an improvement on the product, rather than an aggravation.

Focus and identifying the context of use

Focusing on the context of use, and who the audience is, is also important to early take into consideration. We learned that the focus was too much on the technical part of the project (programming and writing code), and less on the actual usage and quality of the final product. Our experience is that it is easy, if the team chooses an advanced technology to develop their product, that the product loses its main focus which is to be a learning platform. We learned that it is important to predispose the work, and figure out what is most important, and what is less important, and prioritize tasks in consideration to this. We experienced that we should have focused more on the content of the product, minimizing the text, and making more questions.

Be better at prioritizing the project

Since the group was not very motivated in the start of the project due to the old project plan, it was hard to foresee different risk factors that came up. For example we did not assume the four week long UKA-festival that took a lot of our time. We should have written it down as a risk from the beginning so we could be a little more prepared. It is important to include the students' social life.

6. References

[1] Hussein, B. (2018). *The Road to Success: Narratives and Insights from Real-Life Projects*, Fagbokforlaget.

[2] J. K. Pinto. (2013). *Project Management: Achieving Competitive advantage*, Third Edition ed.: Pearson.

7. Peer Review

What is name of the group you are assigned to evaluate: 36

A) Based on your evaluation (as a group) please indicate the strengths and weaknesses of the final product.

Strengths:

- A really good and innovative idea!
- The potential to learn a lot while having fun
- Great that the questions come in random order every time you click on the series
- Good that you can not go back to change your answer after you have delivered it
- Great styling

Weaknesses:

- Better feedback for right answer than an alert message. It looks a bit amateur
- The red colour looks a bit misleading
- More questions per TV-series
- When you complete a quiz, clicks submit and the text “try another series” appears. When you then click start it starts the quiz you just took all over again. It should return you to the main page
- You should have a page where all your scores are saved.
- The snippets should automatically start on the time when it is relevant. You should not have to fast forward to relevant scene.
- when you can check multiple answers on one question it should count as one question in the summary at the end
- It might ruin your favourite TV-series
- maybe more information generally about what project management is? Maybe have an introduction text or film?

B) Please evaluate the degree of your support to the following statement (group-based evaluation):

	The product we reviewed is of high quality and we recommend it to be used as learning aid in project management				
Scale	Strongly Disagree	Disagree	Neither agree nor disagree	Agree	Strongly Agree
Your response					It is a really good idea and with some development it could really help out. Very fun to use!

C) On a scale from 0 to 10. What grade would you recommend for this product?

Grade: 9

It is a great product, but needs a bit more bug-fixing and a bit more information. Well done!

PROJECT ASSIGNMENT: ANIMATION OF CASE

TPK-5100 - APPLIED PROJECT MANAGEMENT

November 19, 2019

Ole Tobias Lode
Håvard Linnerud
Tayab Hussain
Syed Hamza Tariq Bukhari
Daniel Gauermann
Ida Ganji

NORWEGIAN UNIVERSITY OF SCIENCE AND TECHNOLOGY
FACULTY OF ECONOMICS AND MANAGEMENT
INSTITUTE FOR INDUSTRIAL ECONOMICS AND TECHNOLOGY MANAGEMENT



Preface

The paper is written by six students at the Norwegian University of Science and Technology. It is written as the term paper in Applied Project Management (TPK5100) for Bassam Hussein. The group has worked on a product to aid learning by digital tools. As humans we are powerful tools with vast amount of processing power. Limiting our learning to only the ability of recognizing words is limiting the student. As students who has worked on the project not only for the sole purpose of the subject but also because of the potential for future students.

We would like to thank Bassam for our meetings, they helped us to clarify his needs so we could act respectfully. Without his involvement the product would not have the same quality and ease of use for the end-users as it has today.

Group number: 8

Student names and student numbers:

- | | |
|-------------------------------|--------|
| 1) Tayab Munir Hussain - | 517501 |
| 2) Syed Hamza Tariq Bukhari - | 520666 |
| 3) Daniel Gauermann - | 519228 |
| 4) Ole Tobias Lode - | 476080 |
| 5) Håvard Linnerud - | 516060 |
| 6) Ida Ganji - | 520660 |

Contents

1	Digitalization project	1
2	Self-evaluation of the project management effort in the project	2
3	Self-evaluation of the value to the learners	4
4	Factors that have contributed to failure / success.	8
5	Most important lessons from this project	11
6	Peer review of group 4	13

1 Digitalization project

The digitalization of learning processes provides several benefits as ease of learning, accessibility and ease of use. While the benefits are many there are also some issues tied to the process of digitalization. The challenges the team encountered where the use of digital tools, the compatibility between digital files and the extensive availability of the project. The common factor of these challenges is that they require a certain degree of knowledge and experience to master. Making smaller digitalization projects a bigger issue than large ones, because of the relatively time consuming process of learning the program instead of producing with it.

The use of digital tools is one of the most obvious challenges within digitalization. Whether it is to use audio, video, formatting, animation, writing or other tools. Since the group decided to animate a case, we used audio, formatting and animation tools, and the final report is written using latex writing tool. The group found that a large extent of the time schedule of the project went into learning the digital tools, but still deemed it necessary to complete the project within the pre-specifications of the project. It has proven challenging and instructive to use multiple unfamiliar programs for the group. The relatively small scope and time frame of the project have on the other hand made it hard to develop the necessary skills for such a project.

While having to learn new tools which evidently was a major challenge, there where more subtle challenges arising throughout the project. Communication between the programs did not prove easy, as the format of the audio and photos we used had to be compatible with the animation software. At the same time even the availability of a digitalized project provides issues. In the lack of a local popular academic forum at NTNU, the best solution was to publish the product on YouTube. YouTube provides the product with a whole different audience than initially planned. The public online users are with only a few exceptions spread across vast geographic areas, cultures and religions. This audience cannot be expected to have the same values and thereby not the same view on the product. This problem got addressed by being a geographically diverse group from Norway, Germany, Iran and Pakistan. This provided more diverse opinions and lowering the chance of misinterpretations.

2 Self-evaluation of the project management effort in the project

Overall evaluation of the project

The group is made up of six members with diverse nationality and age difference. The amount of members have made the workload doable. At the same time the diversity has provided the group with a invulnerable insight of cultures and age differences. Furthermore, the group were divided into two groups, one group of two members for writing and formatting, and another one for the animation consisting of three members. The last member, Håvard Linnerud, have been the group leader. Thereby contributing to the group in need and at the same time managing the groups to get a viable product.

Risks can be harmful both to the project and the team handling it, and it is therefore crucial to address this matter sufficiently. The process of handling risk can be divided into four processes: risk identification, risk assessment, risk response planning, and risk monitoring and control [Hus18]. The risk identification and assessment can be found in the project plan. The downsides of having a relatively large group is averted largely by having a formal group structure, pre-defining risks, good timing and a free flow of communication within the whole group. This gave us the opportunity to deal with the pre-defined measures once the issues surfaced. In the mid of October there were a dispute in the group related to work conditions and methods. The dispute harmed the group's working ability and dynamics short term, but was resolved the following week by the team leader. There was also irregular time delays but these were mainly not a problem due to a generous time schedule. The project were in the end not without issues, but with a moderate amount handled to a large extent.

The project has multiple factors to increase its likelihood of success, and these are called success factors [Tur09]. The success factors can in term be divided into three categories, project management, project and organizational success [Coo02]. The success factors are explained in the project plan, and mainly focus on the project's success factors because of the project's short duration and scope. All factors from the project plan haven't been

fulfilled but the majority has, like shown in table 1. The group would also in retrospective insist that the initial success factors should be adjusted.

Table 1: Fulfillment of success factors

Number form project plan	Success factor	Amount of fulfilment
	<i>Project</i>	
1	Complete tasks within deadlines.	Medium
2	Involve project owner.	Medium
6	Focus on adding superior value to product.	High
7	Focus on how the product will benefit the users	High
8	Project scope is covered.	Medium
9	Keep product as consistent and comprehensive as possible.	High
10	Reduce time to understand the case.	High
11	Make learning fun and interesting.	High
	<i>Project management</i>	
3	Involve all members and divide work evenly.	High
4	Encourage communication and discussion among team members.	Medium
5	Ensure opinions are evenly weighted.	High
	<i>Projec organization</i>	

Evaluation of group management process

We evaluate our project management effort as successful:

Scale	Strongly Disagree	Disagree	Neither agree nor disagree	Agree	Strongly Agree
Your response				X	

3 Self-evaluation of the value to the learners

In order to have a clear understanding of what we are about to do and to prepare the group for cooperation, it was important to identify what we are doing and who we are doing this for. An important part of this task is defining your target audience. This provides a clear idea of the people you're working for and provides the necessary information for a good start to the project. The purpose of this project was to target our fellow students in the upcoming years to take a part of the curriculum and make it easier to understand and quicker for task completion. we wanted to make a product that was comprehensible and would provide a more efficient solution than to read the case from the book of Bassam Hussein.

Description of the method used to evaluate the final product

Getting feedback from the users is vital. This is something we were taught in the class and real life cases depicted that getting feedback from the end users is very important. This makes the difference between the success and failure of the product or service. An idea might sound very promising in theory but there is no surety that it will fit the target audience until you test it on the audience. Hence we made sure that this gap is properly filled out as the basic purpose of our project is to create value for the users. One of the main goals was to compare our product with other alternatives and see if they yield a better or worse result. We did this to see if there really is a need for the product we are building. Also it is a better way to check the practicality of a project rather than just rushing into it. As surroundings and external factors change they have a profound affect on the project. Furthermore, we had a meeting with our lecturer, Bassam Hussein. As he is the project owner, his opinion holds great importance for us. After making the first video, we met him, showed him the video and asked for his opinion. Some of his comments on the video were as follows:

1. The background music in the video was distracting so that should be removed.
2. There were way too many animations in the video which shifted the focus from the content of the video.
3. There was way too much detail than required in the video, should be simplified to make it more effective.
4. The audio was not clear enough, it would be better if the audio was recorded in a controlled environment using AV equipment.

All these comments were subsequently incorporated in the video. It was also one of things that we were taught in class that it is better to ask the owner who has high influence what their needs are in the middle of the project. That way we won't end up with something the owner does not want. And it is a good way to keep check on the project. We wanted to have a simplistic and straightforward approach throughout the project. Hence the simplest method we could think of was to ask a group of friends in our program who are taking, and who have taken this course and ask them for their opinion on the product we created. We did not choose a complicated or verbose method because of the following reasons.

1. Often people don't have enough time to respond to surveys and forms. Even if we managed to force someone to respond to a survey they would do so thinking of it as a burden hence the essence of the survey is lost.
2. Talking to someone face to face is much more effective than a survey. Also we could vary our questions about the product constantly according to the person reviewing the video making the process flexible and easy.
3. It is an easy and simple method to get feedback that anyone can do or understand, it does not require any special knowledge.

Our informants

To better our understanding and to widen our minds we, as previously mentioned we asked

some fellow students if they could take a look at our product and give us feedback. During this process we asked six students with different academic backgrounds to comment and give feedback on our product. These informants were selected during our off time and by asking if they could read the case from the book and then watch our video. We quickly figured out a way to increase the reliability of our testing and asked one person only to either read or watch, not both. This way we could ask direct questions about the case and find out who understood more, those who read, or those watching our video.

Results of tests, surveys or interviews with students or persons who have reviewed the final product

After conducting the feedback from our target audience it was important to list it down properly. The result of feedback from the target audience is listed in the table 2, this is gathered from conversations with our informants.

Table 2: Feedback and Response

Informants Specializations	Feedback	Response
Chemistry	This is somewhat relevant for me since i am usually in a hurry, but maybe the video could have something in general, alongside the case	This would be our priority if we were making a follow-up video, including reflections and some proposed solutions
Economics	Great work, could improve the detailing, otherwise nice and simple	By your answers in our discussions we could see that you got the important part of the case, by watching our video
Mechanical	Unclear what the project actually was supposed to fix	We will make adjustments to current video and clear up these things at the start

Construction	How is this better than reading the case?	By watching our video which should provide same the necessary insight as the read, you get the information in just over 3 minutes
Mechanical	I like the information given in the video, but some of the animations could be improved	We agree, but this is the downside of having to use free and or limited programs to create our product
Construction	Is this needed? have you asked stakeholders if this is something that will be used?	We have had continuous conversations with the project owner to fit the product to his needs

Before feedback was given and responded to, we asked our informants about certain aspects of the case both for those who read and those who watched the video. After the conversations we could conclude that those watching the video could answer the same questions as those reading the case, which proves that our product is at least to some extent useful for in the time saving aspect.

4 Factors that have contributed to failure / success.

Primary factor

The a vital success factor of our project was the project owner's, Bassam Hussain, involvement and his full commitment to the project. The owner was involved in our project twice.

First, during the front-end phase of the project, to fulfill the needs of our project owner and to increase our motivation we contacted the owner at an early stage to get him involved. The owner; however, did not really like the idea implying that it was irrelevant to the main purpose of the project and that it would not create the significant impact on learning that he was looking for and also that it would not be practical. We therefore changed the concept showing our capability for being flexible to address problems as they arise. Our flexibility during the initial phase of the project also contributed to success.

The second time we asked for the project owner's reflection was during the implementation phase when we showed the animation. This time the feedback we received was vital in our project's success because the main message of the case became more clear. For example, in our case, plain language in the Norwegian public roads authority, it was critical for the owner that the end users of our project, the students, would get the essence of the case. If a change is implemented, the project culture must adjust itself accordingly before the execution phase.

The owners feedback also concerned the technical aspects of the animation including the poor quality of the voice and its speed. We used this to change our product to ensure success and improvements to grant end users a viable product. At first we thought that recording the narration with a mobile phone could be sufficient, but after learning about the owner's dissatisfaction, we adjusted and recorded the video with a high-quality microphone and made changes regarding the talking speed of the narrator. We found this method of feedback as a success since this led to a product more suitable for the end users and successful for the project owner.

Second factor

The second factor contributing to project success was adequate collaboration and communication between the project organization members. In order to facilitate transparent and inclusive information sharing between all team members, we created a group chat enabling us to keep in touch with each other and to inform each other about the meeting dates and times. In addition to this free flow communication we established a Latex report that is always up to date and easily reviewed by all members. These tools were used to cope with the group members different time schedules and provided us with a platform that mitigated the problems surfacing due to scheduling and timing issues.

Third success factor

The third success factor was the presence of an encouraging and positive working atmosphere. The project team members were friends even before the project initiation, therefore cultural elements such as trust, openness, loyalty and commitment contributed to increased unity among project team members. In conclusion, instead of power struggles or even indifference, the sense of ownership and knowledge sharing and cooperation was visible.

Forth success factor

The forth success factor that contributed towards project success was done at the very start, as we assembled the team. We created a a shared culture to reduce uncertainties and include every member of the team. A contract was written and signed to provide clear roles and understanding of different outcomes. This escalated motivation to finish tasks on time and with the right quality, since it was rewarded with positive feedback from the remaining members.

Undesirable factors that hindered success

Lack of sufficient competence on how to make animations was the biggest obstacle regarding project completion. Since none of the project team members had any prior experience with making animations, the whole concept was ambiguous and unfamiliar for the members and

this contributed to partial disappointment and partial loss of motivation. However, through researching similar projects that have been implemented in the past, valuable information was collected.

The second problem could be mentioned as lack of the necessary resource for the project implementation. After evaluating the different softwares for animation making, the Powtoon software was chosen; however, it had many shortcomings. The budget for using the premium version of the software which was \$50 was not allocated so we had to use the free version. The free version had many limitations for instance, the timing of the video was restricted to three minutes which was not the proper amount of time that was needed to cover all the main points in the animation.

5 Most important lessons from this project

This project has given the team a lot of challenges. Challenges that will make us more prepared for even bigger projects we partake in the future. We assumed this project's main goal was to build our cooperation skills and have therefore focused on teamwork. Before the project started we discussed a lot of different approaches, but since this project is to be completed by six members we found out that everybody should be understanding about the depth of our of project choice. Hence, all uncertainties regarding scope and rationale were mitigated before project execution. Our advice is therefor to invest time in the planning phase of the project, to clarify the project itself, possible issues and divide work among team members.

During the beginning of this project we met up to discuss how to go about, and to map out our skills so that task delegations were done as optimal as possible. We quickly found out that none of us had the required skills to make an animation, but some of the team members were ready to face that challenge, and were able to deliver as promised. In retrospective we realized that we should of looked for someone with some skills or background in animation or coding. We would therefore advice another project to contact technical expertise, as we felt that the lack of animation knowledge amputated our project to some extent.

Delegation of tasks is not always as simple as one might think. We have learned that even though tasks are given to someone in particular, we are still a team, and team members are there to help each other out when aspects gets unclear. Most noticeably, we learned the importance of being able to inform the other team members in a direct and understandable manner, when the project tasks or structure change.

As a final summary we would advice to communicate in a professional manner and to make the overview of the project as simple as possible. This way even though team members sometimes do their parts separately, they always have a group to lean on. It would also be recommended that any given project would ask the stakeholders what benefits they are looking for, to secure that they produce a desirable product.

References

- [Coo02] Terry Cooke-Davies. “The “real” success factors on projects”. In: *International Journal of Project Management* 20 (2002), pp. 185–190. DOI: <https://www.sciencedirect.com/science/article/pii/S0263786301000679>.
- [Tur09] J. Rodney Turner. *The Handbook of project-based management*. The McGraw-Hill Companies, 2009.
- [Hus18] Bassam Hussein. *The road to success narratives and Insights from real-life projects*. Fagbokforlaget, 2018.

6 Peer review of group 4

Projcetsnatch: The new form of hand-in assignments

Group 4 has made a product that introduces a new form for hand-in assignments. They have acted out a case from Bassams book in what seems to be SIMS. Furthermore, they included options for the participants to get involved as a project manager and make decisions of his/her behalf.

Initially we found the idea to be compelling and quite creative, and that this could be used in conjunction with the lectures and could provide a deeper understanding impact for the student. The product involves the user since its interactive which keeps it interesting and focus must be kept. The visualization of the case is solved in a creative way and shows different aspects in the case. The websites layout was quite easy to follow and everything seemed to be working as intended. The idea creates opportunities for the student to test their own understanding and knowledge of the subject which is quite helpful during the exam preparations.

The limited options of program software seems to be a issue for this group, even though they solved it in a adequate way its evident that other programs could do a better job visualizing the case, since it was a little bit laggy and sounds were at times a bit off. We missed some kind of audio aid, maybe someone could of read the text as audio and added it to the videos. The obvious limitations granted shortage of movie animation, but the product was still fun to use, and to somewhat extent useful. We feel that the method used for solving this project could be switched, since their idea is very good and handy, but the limitations created by the method kind of put out the initial sparks.

	The product we reviewed is of high quality and we recommend it to be used as learning aid in project management.				
Scale	Strongly Disagree	Disagree	Neither agree nor disagree	Agree	Strongly agree
Our response			X		

On a scale from 0 to 10. We grade this product as a 6.

Interactive Webpage Providing a
Project Management Online Course
for Beginners with Animation Videos
and Quizzes for Self-Testing

Preface

The purpose of this project report is to look back at the process and results of the project we executed for the course Applied Project Management at NTNU in Trondheim. We discuss our efforts, the challenges we came across and the things we take away after the execution of this digitalization project. We would like to thank the professor of this course, Bassam Hussein, for the valuable input and knowledge that lie at the basis of the final product. In addition, we would like to thank all the testers who have taken the time to test and evaluate our product.

Group number: 9

- 1) Jules Balcaen - 519922
- 2) Lander De Jonghe - 520007
- 3) Gijs De Smet - 519902
- 4) Nadine Kittler - 519393
- 5) Jonas Stefan Langmann - 519376

1. Digitalization projects

A. *Describe your product, its intended purpose and why you have selected to produce this product.*

The product is a website available as both desktop and mobile version. It provides several animation videos which describe six topics of the NTNU course “TPK5100 Applied Project Management” in a simple way. It is meant for beginners, so the information included is kind of an introduction to each topic with some of the most important parts of the topic. On the start page, an introduction video is included, which describes the website’s purpose and functionality and the basics of an example case. The following animation videos are using this case as an example to describe the specific topics. After each animation video, the user has the chance to answer three multiple choice questions to check his or her knowledge after watching the video. At the end, the user has the chance to give feedback about his or her learning outcome. Therefore, he or she can enter his or her profession and previous experience. The learning outcome can be entered through a 5-star rating. Additionally, the user can enter how likely he or she will attend the NTNU course. This feedback information is saved in a database in order to document the product usage. If necessary, additional content can be added or the existing contents of the website can be changed.

We chose to create this product, because we want to help people who have no understanding of project management. The user gets basic information about key points of project management. After using the product, the user got an overview of some of the content of “TPK5100 Applied Project Management”. If the user is a student at NTNU, he or she is more able to decide whether to attend the NTNU course after using the website.

B. *After having the opportunity of working on a small-scale digitalization project, what are, in your opinion, the main challenges that your group has experienced with this type of projects? You should base your statements on your own reflections and preferably support these reflections using project management literature.*

After working on our digitalization project, we have experienced some challenges during project implementation. At the beginning, we were worried about how we ensure that our learning tool fits to the end users. This circumstance is also described in Basham Hussein’s book “The Road to Success”. He says, that “the main challenge in IT projects is to capture and manage successfully the expectations of (...) those who will use the new IT solutions” [Hussein 2018]. Our learning tool can be categorized as a kind of digitalization project, but also as a software and IT project.

Therefore, this statement supports our own sensation. We decided to create a tool for beginners who do not have any knowledge about the basics of project management. So, it was easier for us to trace out the content and the potential learning outcome, as we were also beginners before we took the course at NTNU. Nevertheless, our product includes different topics of project management. So, even partly experienced people can get a value of our product.

At the beginning, we recognized that some of us already had some basic experiences in a software tool we used to create our animation videos (*powtoon.com*), but the most of us never worked with such tools before. Hence, there were differences in our skill levels we had to balance, so that every project member was able to create an animation video with almost the same level of quality. This was necessary because due to the limited time we split the video creation part. So, every group member had to create a video on its own with final test and feedback of the other group members.

In addition to the animation video creation we had to create a webpage, but nobody of our project group did this before or had skills in this field. So, it was challenging to find a good and especially free software tool (we used *wix.com*) for our application. It had to be both fast to understand and containing the features we needed. For instance, the webpage contains a feedback tool. Therefore, we had to take care that the website tool allows us, to implement this feature with a free database for the feedback storage in the background.

For the decision process where we selected the technology and the tools to use for the implementation of the website we at first had the challenge to get knowledge about the state of technology these days. This is a crucial step in a digitalization process. As mentioned before, all of us had none or just basic knowledge of website and video creation. So in addition, to analyse the needed versus the available competences was our second challenge in the decision process for the used tools. All these steps are key factors in digitalization processes, as mentioned in [Päivi Parviainen, Jukka Kääriäinen, Maarit Tihinen, Susanna Teppola (2017), page 71].

After the decision, which software tools we would use, another challenge came up. The fact, that we only used free software tools led to some constraints about the features of the tools. Therefore, we had to adapt our ideas and plans depending on what we were able to implement in the tools. For example, the free version of the animation video creation tool (*powtoon.com*) limits the length of a video to three minutes. Furthermore, this version only includes limited animation features regarding the characters, gadgets, animations, transitions and so on. So, we had to find a good way to get the most out of it.

2. Self-evaluation of the project management effort in the project, success or failure? And why?

A) *The group should make an overall evaluation of their own project. This is an evaluation of how well the group managed the project, how well was the organization of the project group. How well the group identified and managed risks. Did the group manage to deliver the project results according to your originally stated success criteria (according to your original plan)? Is there any deviation between the stated success criteria and your final evaluation of the project?*

Delivering a good project with students you have never met before can be a major challenge. All of us were very aware of this and that is why we put a lot of effort into the project plan in order to set clear goals and make good arrangements. We had great confidence in this plan, especially after the excellent feedback we got, confirming our thoughts. This plan was a big contribution to the project management success which we feel we have accomplished. By sticking to the plan, we were able to deliver our product within time, costs and scope requirements. We even had additional time in the end to add an extra feature to the website in the form of a feedback system.

The risk factors that could have harmed our organizational success appeared to be no problem at all thanks to:

- a sufficient amount of meetings after lectures
- good communication through *WhatsApp* and *Trello*
- keeping each other responsible even though there was no single project manager
- good time management from all team members regarding other courses/assignments

Additionally, risk factors with regards to people were overcome. The required technical skills to make our product and the lack of experience regarding this kind of project could be seen as a risk factor in the beginning. However, we feel like this helped us in staying motivated throughout the assignment since we are all very eager to learn new skills. Another critical risk that stated 'test users could not be available' was overcome thanks to reliable friends and a great network. Furthermore, we did not face any other risk factors that were not anticipated which indicates excellent (rather pessimistic) risk assessment.

Looking at the predefined success criteria, our statement that we achieved project management success is once again confirmed. Although a lot of work was done individually, we feel like we have become a great project team that can rely on each other and knows each other's strengths and weaknesses. The product has been delivered in time, we all feel like we have learned a lot through it and we are still motivated to study for the exam which indicates that the project was finished with quite ease.

B) Please evaluate the degree of your support to the following statement (group-based evaluation):

We evaluate our project management effort as successful.

Scale	Strongly Disagree	Disagree	Neither agree nor disagree	Agree	Strongly Agree
Your response					X

3. Self-evaluation of the value to the learners? (Evaluation of project success) Can you document your assessment?

The group should make an overall evaluation of the impact of their own product on learners. The group should provide and support the evaluation with documentations. These documentations could include:

- A) Describe your target audience and the learning objectives of your product*
- B) A description of the method used to evaluate the final product*
- C) The number of informants who have contributed to the evaluation, and how these informants have been selected*
- D) Results of tests, surveys or interviews with students or persons who have reviewed the final product*
- E) Please evaluate the degree of your support to the following statement (group-based evaluation):*

	Our product is of high quality and we recommend it to be used as learning aid in project management.				
Scale	Strongly Disagree	Disagree	Neither agree nor disagree	Agree	Strongly Agree
Your response					X

Target Audience and Learning Objectives

Our product is meant for users who are not experienced in project management. It provides general basic knowledge in simple animation videos with simple questions for self-testing. The topics are oriented on the NTNU course «Applied Project Management». The user gets an overview of this course.

The target audience consists of two different groups. The first group contains people who want to learn or refresh some basic knowledge about project management. They just want to get in touch with project management or forgot some basic points which they want to refresh. The second group consists of students which want to decide whether they want to attend the NTNU course

«Applied Project Management». They can use the website as kind of an introduction to the most important topics and a course overview. After using the website, a student is more able to decide whether he or she want to attend the NTNU course.

The website could also be useful for students of the NTNU course learning for the exam, but this was not our main objective and therefore not evaluated due to the limited time.

Interview Method

We wanted to know how potential end users react to our product. Our product is meant for users who are not experienced in project management. Therefore, it was necessary for us to know our interview partner and his or her personal experiences and background to get applicable feedback. So, we decided to make personal interviews where we can observe the reactions, emotions and behaviour of each test user in every situation while they are using our website. This interviews where either done in a personal meeting or via video chat. The users were directly confronted with the website and did not get any advice in advance. We wanted to have a realistic use case, where end users have nothing but the website. Since we did not know the usability of the website, we helped them out, if there was any question.

The most results of the personal interviews were positive. So, we quickly went over to non-personal testing, where the test user got nothing but the website link. After the test users tested the website on their own, they gave us a feedback on video chat, telephone or in written form. This was the most important test with the most test users, because the actual end users will also have nothing but the website link.

Choosing Participants

We decided to not chose evaluation participants from the NTNU course «Applied Project Management», because the website is meant for beginners who do not have any experience in project management and never attended the course before. The website could also be useful for students in the NTNU course, but it was not our main objective. If there was more time available for the project, we would also have chosen students from the NTNU course. This could be a possibility in further steps if anybody will continue working on the website in the future.

Additionally, we wanted to test the website on different age groups. As we did not get access to many people older or younger than us in that short amount of project time, we decided to test the website within our families by for instance asking our parents and siblings. For the tests within our age group we asked some of our friends as they were available, motivated and not experienced in project management.

In addition to the test principle described above, we needed test participants with excellent English language skills to be able to specifically test the texts written on the website. We had no chance to get support from a narrative English speaker. Luckily, we had some friends with very good knowledge of the English language. So, we asked them to have a look especially on our texts on the website.

For the interviews with personal meetings or video chats we had four participants. These tests were very time consuming, so we decided to not make too many of them in the short amount of time. The participants were in our age, because we found no older or younger persons fitting to our needs and available for such a detailed test during the evaluation phase.

For the second interview method, the non-personal testing, we had fourteen participants during the evaluation phase. During these tests we also got some feedback from persons who are older or younger than us.

Before the evaluation phase we had more test participants. But these tests were made to improve our product, not to evaluate the final product. After each of these tests we changed our product until the test participants had only little recommendations. In this section of our report, only the evaluation of the end product is asked. So, we can only mention the positive feedback given in the tests from the time before the evaluation phase. The negative feedback was already eliminated through improvement our website before the evaluation phase.

Evaluation Result

Most aspects of the test user's feedback repeated. So, we decided to write down a summary of all the feedback we got in the table below without naming single test persons. The age of the users made no specific difference in the feedback. So, we have summarized the feedback over all ages in this one table, too.

Positive Feedback	Neutral and Negative Feedback
<p><i>Functional / Website</i></p> <ol style="list-style-type: none"> 1. The website has a very good structure. 2. All the functionalities are working. There is no bug in the implementation. 3. The website is clear and easy to use. 4. Every text written on the website is clear and readable. 5. Very good animations in the videos supporting the content. 6. Very good English language, which is understandable with basic knowledge of the language. <p><i>Learning / Outcome</i></p> <ol style="list-style-type: none"> 7. The website is interesting. Some of the participants wanted to attend the NTNU course even though they did not have any interest in project management, before. 8. It is a great idea to have short animation videos for each topic and not one large video or a text. With these short videos, the content does not overstrain and is very understandable. 9. The website gives a good overview over project management. People with no previous knowledge felt educated after using the website and felt like they now know what project management is about. People with a little previous knowledge about project management found it very good to have a little overview for refreshing their knowledge. 	<p><i>Functional / Website</i></p> <ol style="list-style-type: none"> 1. At some moments in the videos you need to have good English skills to follow the speed of the written text. 2. The texts in the videos are not bad, but an additional speaker would be a little better. 3. Video suggestions from Youtube.com after the videos are a little bit suspect. <p><i>Learning / Outcome</i></p> <ol style="list-style-type: none"> 4. One additional last quiz with the most important points of all topics would be a good close-up.

4. Factors that have contributed to failure / success.

In this section students should list and elaborate on all the factors that they believe have contributed to the success or to problems of their project. Which factor was the most significant and why? Compare your identified factors with the factors listed in (Hussein 2018) pp-92.

In this part we will go through all the factors that have contributed to our, as we have concluded above, project success. So, as it is defined in Hussein's book 'The Road to Success', we will have a look at the factors that increased the likelihood of a project success. However we will also take into consideration the factors that decreased the chances of a success.

Let's kick this off with a basic but fundamental factor, namely a good coordination with our stakeholders. What is our stakeholder looking for? In our project this was very clear and that is a crucial thing. Our stakeholder was looking for a digitalization project and so we could start with brainstorming. Right there we have a second success factor, a proper choice of project. This is something you do not know at the moment itself. However we felt comfortable with the project idea and we decided as a group to go for it. We defined a clear project purpose and we set some objectives together. In this way we knew in which direction we had to go.

Another important factor that certainly increased the likelihood of our project to be a success was to start as early as possible. Right after we knew about the instructions, every member of our group was motivated, which can be seen as a success factor on its own, and started thinking about various project ideas. In this way we had our idea quite fast and then we could make an adequate project planning where we clearly stated what to do and by when.

It was already mentioned, but we really want to name it again, because personally we think this was one of our key factors or maybe the one key factor that led us to a success: our motivation. Everyone felt attracted by the project and motivated to let it work out. In addition, we were not only motivated, but also dedicated enough to fulfill our tasks by the time we agreed upon.

To be able to complete our project we had to dispose of the technological knowledge. Most of us had to learn how to use *powtoon.com*, the website where we made the animation videos. All of us succeeded in doing so. Then we got the knowledge about how to make our own website through days full of motivation to search, try and learn important functions of the website creation tool we used. This made it possible to complete our project successful in time.

A last and overall success factor we really can't forget to mention is the communication. After each lecture we did a meeting. Some of the meetings last for a few minutes and others several hours. Next to these meetings we created a group on *WhatsApp* and a working space on the online management tool *Trello* for further communication. Without any doubt we can say we had a very effective and good way to communicate with each other.

There is no real factor that brought our project almost to a failure, but if there is something we would do in another way next time, it is to listen more to our end user. We had test users and a good testing and evaluation phase, but we only did that at the end when the project was almost finished. Next time we would ask their opinion in the beginning as well.

Next thing to talk about is the most significant factor that led us to our project success. This is a difficult one, because we are convinced that we excelled in quite a few factors. But if we have to choose one, we would go for the motivation of our group. Motivation is something really important and crucial. Your project team can have a really good communication system and a perfect project planning system, but if none of your team members is motivated to make the project a success, things won't go optimal. But this was not the case in our project team. Every single one of us was motivated to make this project a success. Even after it was finished we still thought about how we could improve it.

Having a look at the factors listed in the book «The Road to Success» (Bassam Hussein) on page 92, most of them are similar to the ones we have. The list in the book is quite extensive and in the part above we did not mention all of the success factors, but only the most important ones, the ones that increased the likelihood to make our project a success the most. A lot of the factors in the list are applicable to our project as well and then we are thinking of: Trust within the team, creativity of the project team, clarity of roles and responsibilities for those involved in the project,... On the other hand we can mention success factors that we did not have in our project. For example we did not learn lessons from previous projects.

As a conclusion we can say that we had way more factors that improved the likelihood of a project success than factors that would turn our project in a failure. The way we tackled this project can be seen as a paragon for future projects, and we enjoyed it!

5. Most important lessons from your project

If you should give clear-cut advice to other students on how they should work on similar projects what you will say to them?

1. Communicate with the other team members and don't be afraid to tell when you do not agree with certain points, this will eventually contribute to the overall quality.
2. Make sure you all agree on the actual goal of the project before you start to produce content.
3. If something is not clear about what is expected in the assignment, don't be afraid to ask the professor (project owner) or other stakeholders for clarifications.
4. We underestimated the value of testing the products with the end users. The testing gives you extremely valuable input as people outside of the project group may see things differently than you would.
5. Try to speak to each other on a regular basis. This does not have to be long, but it is important that at each point in time, you still agree on the responsibilities and expectations of the project. We, for example, reconciled our thoughts weekly after the lectures.
6. Try to be original and take time to think about something other groups probably would not have thought about. This helps you to stand out from the crowd.
7. We strongly recommend to be strict on deadlines. This will reduce the amount of frustration and gives you the feeling that the project is evolving in a systematic matter. One or two days later might not seem big of a deal, but it will make the way of working a lot more enjoyable if every one is on time.
8. Try to define a purpose that makes every team member happy and highly motivated, so that everybody can enjoy and does his or her best. Most important: Have fun!

6. References

[1]

Hussein, B. (2018), The Road to Success: Narratives and Insights from Real-Life Projects, Fagbokforlaget.

[2]

Päivi Parviainen, Jukka Kääriäinen, Maarit Tihinen, Susanna Teppola (2017), Tackling the digitalization challenge: how to benefit from digitalization in practice, ISSN (print): 2182-7796, ISSN (online): 2182-7788, Available online at <http://www.sciencesphere.org/ijispm/archive/ijispm-0501.pdf#page=67>

[3]

Jeffrey K. Pinto (2016), Project Management – Achieving Competitive Advantage (Fourth Edition), Pearson Education Limited

We have found and read some more literature on digital transformation and IT projects, but the above ones fit best with our product, our reviews and our reflections in this report.

Your peer-review evaluation report

We were assigned the combination of groups 5 & 12 for the peer-review.

Strengths

Overall, the final product has a professional look and you can see the group put effort in thinking how they should tackle the problem. Next to that, they deal with a lot of aspects relevant to the course and try to include the most important concepts. The final product is also coherent and the same elements return, which is not easy when working together with multiple people. Moreover, it gives a visually attractive description of a case, which is easier to comprehend than a long, written text. The format, a video, is also very user-friendly and can be distributed through a lot of available media. In this way it is also easy to include in the courses. This is reinforced by the fact that the video is not too long for people to lose attention or take up too much of their time. As a user it is very pleasant that a voice-over guides you through the story and we personally had no problems of having to stop the video because you missed something.

Weaknesses

Even though we feel the product is of high quality, we do have some remarks. For us as a user it was sometimes difficult to follow the overall structure. The video deals with different concepts, but these are not really introduced by the voice-over which makes the transition between the different parts not as clear as hoped-for. Sometimes, the pause between the sentences should also be a little bit longer to make a more clear distinction. Next to that, the video now already has a short results section, but maybe there should have been a higher emphasis on the implications of the different presented characteristics and issues to enhance the effect of learning. However, the video might in this light be used by students to do the analysis themselves. Finally, the watermarks should be removed in order to be used in a professional context, but we fully understand that this expense was not relevant in the light of this assignment.

	The product we reviewed is of high quality and we recommend it to be used as learning aid in project management.				
Scale	Strongly Disagree	Disagree	Neither agree nor disagree	Agree	Strongly Agree
Your response				X	

We would recommend a grade of **7 out of 10** for this final product.

Attachment

Information about the tools used to develop the product

The website <https://digitalwebpm.wixsite.com/learn> is the output of the digitalization project. It is made with the online tool [wix.com](https://www.wix.com). For the login, a Google account was created. With this Google account you can login on *wix.com*. There you are able to edit the website or have a look on the feedback data from users (see next page). This Google account can be provided by the project group after the course grading for further development.

For only viewing the feedback given by users of the website, a second Google account was created (see below). With this, the feedback database is accessible, but editing the website is disabled in this account.

The animation videos on the website were created with the free version of the online tool *powtoon.com*. The first Google account can also be used to login into this online tool and create new videos.

The existing learning videos are saved in the *youtube.com* account connected to the first Google account. They are marked as “unlisted”, which means, that they cannot be found via the search bar on *youtube.com*. They only can be watched through their direct links. These direct links are implemented in the website.

Second Google Login Credentials (For Viewing Feedback Data On Wix.com)

E-Mail: digital.web.pm.data@gmail.com

Password: xyHA33-#GOforWARD

User feedback data

The user of the website is able to give a feedback on the learning outcome. This feedback is logged and saved in the *wix.com* account. You can find it through the following steps:

1. Select “Database” on the left side after login on *wix.com*.

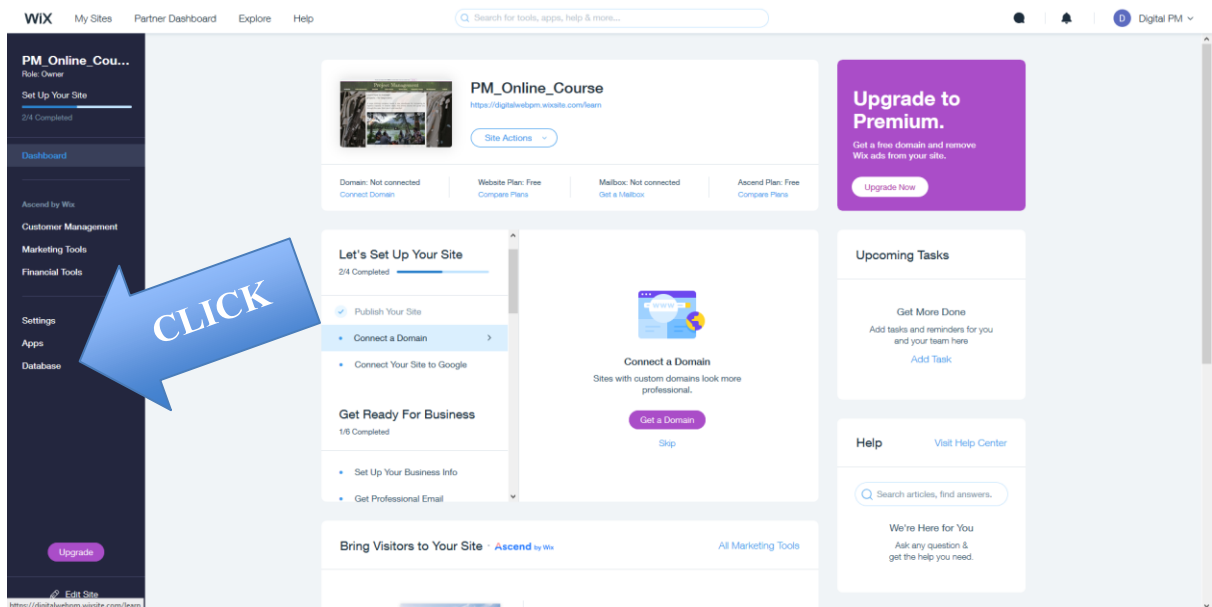

2. Select the database “UserSatisfaction” to view it.

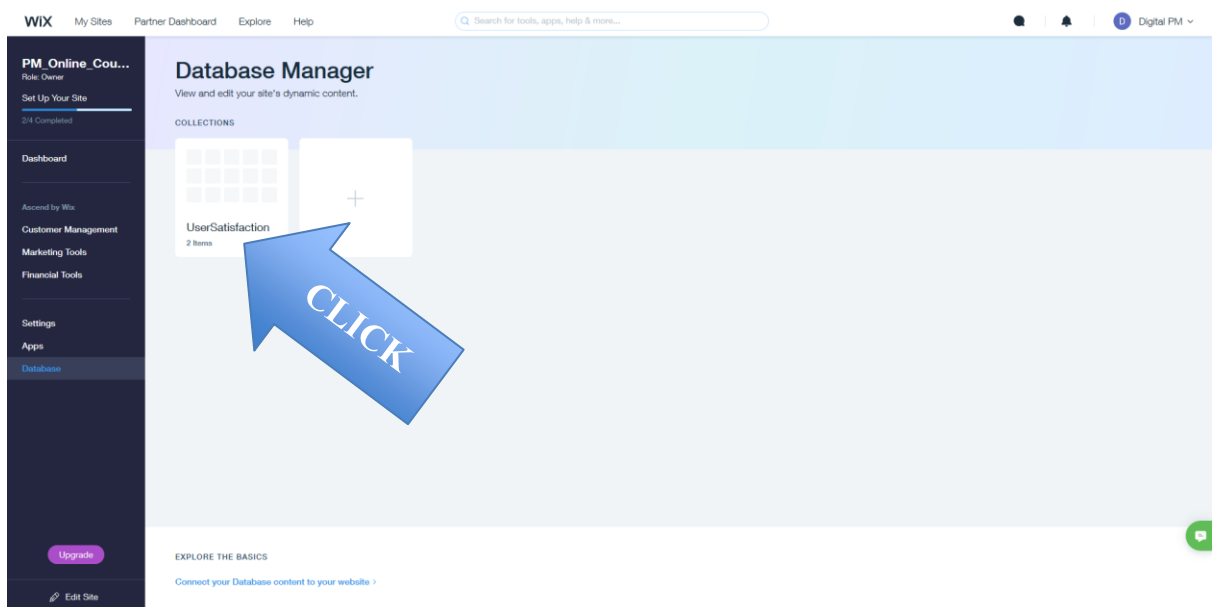



En webside for læring av prosjekttyper og grunnleggende teori innen prosjektledelse

Semesteroppgave i TPK4115 - Praktisk prosjektledelse

Av gruppe 10

Innlevering: 19. November 2019

Norges teknisk-naturvitenskapelige universitet

Forord

I faget TPK4115 - Praktisk prosjektledelse ved NTNU Trondheim høsten 2019, skal studentene gjennomføre et digitaliseringsprosjekt i gruppe. Denne rapporten er skrevet som en del av prosjektet, av følgende gruppe-medlemmer nevnt nedenfor. Formålet med prosjektet er at studentene skal lære å anvende prosjektledelsesmetoder i de ulike prosjektfasene. Gjennom prosjektet skal studentene planlegge, utvikle og produsere et digitalt læringshjelpemiddel i prosjektledelse. Hensikten med denne rapporten er at gruppen skal reflektere over prosjektarbeidet og utfordringene som har oppstått i arbeidsprosessen. Og de skal vurdere egen læringsutbytte, innsats, prosjektstyring, prosjekthåndtering og produkt.

Vi ønsker å rette en takk til faglærer og produkteier, Bassam Hussein, for å ta seg tid til å møte oss, svare på spørsmål og gitt oss gode tilbakemeldinger og veiledninger underveis i prosjektarbeidet. Og studentassistenten, Kristin Hafsel, for veiledning og tilbakemelding, og medstudenter og eksterne personer som har vært med på å teste produktet og svart på våre spørreundersøkelser. Videre vil vi takke systemutvikleren, Mei Jain Fung, for å ha gitt oss råd, støtte og hjelp med å utvikle produktet.

Gruppe 10 - medlemmer og studentnummer:

- 1) Mei Yain Fung, 10015
- 2) Karina Helle, 10126
- 3) Hanne Kjerpeseth, 10120
- 4) Charlotte Hjelmseth Larssen, 10131
- 5) Emilie Låstad, 10115

Innhold

Forord	i
1 Digitaliseringsprosjekt	1
2 Selvevaluering av prosjektledelsen	3
3 Produktets innvirkning - Evaluering av prosjektets suksess	4
4 Faktorer som har bidratt til suksess	6
5 Anbefalinger	8
Referanser	9
Evaluering av gruppe 9	10
A Vedlegg: Rapport del 1	I
B Vedlegg: Student survey	XIX
C Vedlegg: Final product survey	XXII

Figurer

1	Kolbs Læringssyklus	8
---	-------------------------------	---

Tabeller

1	Utfordringer i prosjektarbeidet	2
2	Prosjektteamets vurdering på prosjektledelsen	3
3	Selvevaluering av produktets effekt	5
4	Identifiserte suksessfaktorer	6
5	Samsvar mellom prosjektspeifikke suksessfaktorer og Hussein (2016) sin liste med suksessfaktorer funnet i andre prosjekter	7
6	Gruppens grad av støtte	10

1 Digitaliseringsprosjekt

Det ferdige produktet er en nettside som kan brukes for å finne informasjon om forskjellige typer prosjekter, samt grunnleggende teori innen prosjektledelse. Nettsiden har også et interaktivt verktøy for å hjelpe brukeren å identifisere prosjekttype, basert på typisk karakteristikker. Formålet er at nettsiden skal ha betydelig effekt på læring knyttet til kunnskap om forskjellige prosjekttyper, deres karakteristikker, suksesskriterier og fallgruver. Det aktuelle produktet ble valgt ettersom det knytter sammen ulike deler av pensum fra faget «praktisk prosjektledelse». Dette kan gi et stort læringsutbytte for studentene, og gjør det lettere å se sammenhenger i faget. Det kan også benyttes av personer utenfra, som prosjektledere, for å friske opp grunnleggende kunnskap.

Prosjektet er utført i en veletablert arbeidsgruppe, som innad anses som fleksibel og dynamisk. Dette har fra et prosjektstyringsperspektiv medført både fordeler og ulemper. I et teamarbeid kan det være vanskelig å identifisere utfordringer. Dette er spesielt utfordrende i team som har jobbet mye sammen og er vant til den “vanlige” teamdynamikken, som normalt fungerer godt. For å ha en analytisk tilnærming, ble det derfor systematisk gjennomgått generiske lister med suksessfaktorer og fiaskofaktorer fra faglitteraturen hvorav relevans for hvert faktor ble diskutert i en refleksjonsrunde (Hussein, 2016, s.59-60). Basert på dette ble det identifisert utfordringer som alle ble håndtert fortløpende under arbeidet, uten at årsak eller konsekvens ble diskutert. Etterfølgende utfordringer ble identifisert og en sammenfatning med tilhørende konsekvens, teori, håndtering og lesson learned kan ses i tabell 1.

Feilestimering av ressursbruk

Under initierende fase ble det foretatt flere grove tidsestimat basert på tidligere erfaring fra gruppearbeid. Disse har slått feil av flere grunner. Det ble i liten grad tatt høyde for parallelle aktiviteter, og heller ikke tap av ressurser, i form av forskningstur til utlandet som var kjent i flere uker i forveien. Dette medførte at gruppen måtte vike fra oppsatt plan med arbeidsmøter en gang i uken, og sette opp flere møter. Dette har også gått på bekostning av utvikling av produktet både fordi det ikke ble lagt inn tidsbuffer for teknologiske utførelser, samt ringvirkninger fra at øvrige arbeidspakker som ikke er slutført. Styring av ressurser gjennom verktøybruk i tidlig fase underbygges også av faglitteraturen, da suksessfaktoren “tidlig planlegging” settes i sammenheng med prosjekter med strenge tidsrammer som svarer med det aktuelle prosjektet. Dette kan videre gjennom teorien settes i sammenheng med en svak prosjektleder, som kanskje ikke er overraskende da teamet bestemte å ikke utnevne en person til denne rollen. Utfordringen med ressursbruk kan også knyttes til neste punkt, uklare mål, -rammer og avslappet kultur (Hussein, 2016, s.59-60).

Uklare mål, uklare rammer og avslappet kultur

Ressursbruken ble også påvirket av uklare mål og rammer. Den uformelle og avslappede kulturen har gjort at hvert enkelt medlem i stor grad har styrt selv når det er mest effektivt å utføre ulike arbeidsoppgaver. Dette har medført at arbeidsmøtene ofte mangler deltakere, samt at de som er til stede i møtene prioriterer det som haster mest. Diskusjoner og avklaringer som burde blitt tatt i møtene ble dermed ofte tatt av et fåtall, og kommunisert over mindre effektive kommunikasjonsmidler. Dette har videre hatt konsekvenser som at det var uklare rundt hvor mye ressurser som skulle anvendes på utforming av innhold til nettsiden, på tross av at tidsfrist ble overskredet lenge i forkant. Basert på litteraturen er uklare mål et punkt teamet burde vært observante på da digitaliseringsprosjekt kan settes i sammenheng

med endring, som videre kan settes i sammenheng med suksessfaktoren tydelige mål. Litteratur tilknyttet matrisestruktur blir også relevant med tanke på parallelle aktiviteter og uklare rammer som videre, igjen, kan brukes for å argumentere for en kompetent og sterk prosjekt leder.(Hussein, 2016, s.59-60)

Mangelfull involvering av interessenter

Det ble utført en spørreundersøkelse på et tidlig stadie for å identifisere interessenes behov. Ved å ta undersøkelsen på et senere tidspunkt kunne man samtidig fått innspill på produktideen, som ville medført høyere kvalitet på informasjonsinnhentingen. Prosjektteamet opplevde også utfordringer tilknyttet lavt antall respondenter. Basert på statistikk ville det vært fordelaktig med en svarprosent på over 60%. Med en lav svarprosent er det ukjent om svarene er representative for resten av interessentgruppen, eller om de utgjør en subgruppe med egne ønsker og behov. Dette er en aktuell problemstilling for alle prosjekttypene, men spesielt viktig i digitaliseringsprosjekt da sluttbruker utgjør en kritisk interessentgruppe basert på karakteristikken endring (Hussein, 2016, s.33 og. 60).

Lite læring av feil tilknyttet prosjektstyringen i tidlig fase

Som nevnt i introduksjonen til kapittelet, ble det identifisert utfordringer som ikke ble tatt tak i under arbeidet. I en vassekte HMS gruppe menes det forøvrig at svaret på alle problemer naturligvis er kontinuerlig læring og forbedring. Denne grove feilen settes dermed som teamets hovedutfordring. Årsaken er at læring av feil, og kontinuerlig refleksjon kunne ha medført at årsakene til utfordringene ble håndtert på et tidligere tidspunkt. På denne måten kan konsekvenser av utfordringer reduseres, samt at teamet blir mer robust for møte med uforutsette utfordringer i fremtiden.

Tabell 1: Utfordringer i prosjektarbeidet

Tema	Utfordring	Konsekvens	Teori	Håndtering	Lesson Learned
Resursser	Tid generelt, Ble ikke tatt høyde for parallelle aktiviteter	Utforming av nettsiden ble nedprioritert	Typisk matrise-struktur problem.	Flere arbeidsmøter	Mer nøyaktig og nøye planlegging i initierende fase.
	Tid/kompetanse utfordring i utviklingen av websiden.	Endringer ble gjort etter milepælen "frist for endring"	Teori viser til viktighet av ground rules og suksessfaktorene se vedlegg A	Involverte fagperson. Fordi tidsfrist er regid, ble resurser tatt fra utviklings steg i prosjekt	Benytt AON for å identifisere critical path. Ha fokus på så styre denne arbeidsprosessen.
Involvering av interessenter	Lav svar prosent, Kvaliteten lav ?	Mer og bedre informasjonsflyt	IHT. interessenteori, (Andersen and Fagerhaug, 2001) er det viktig med god dialog (Hussein, 2016)	Mer involvering i siste fasen av prosjektet	Legge mer ressurser ned i utvikling av skjema
Uklare mål	fokus på mengde innhold. vs. nettside-funksjonalitet vs. prosjektstyring	Utforming av nettsiden ble nedprioritert	Digitaliserings prosjekt ->transformasjon -> typisk fallgruve.	Måtte arbeide utfor fredagsmøtene	Sette spesifikke og klare mål i felleskap med alle involverte parter tidlig, spesielt for critical path.
Klare rammer, kultur	Lite fokus på å holde GANTT	Det ble ikke fanget opp før sent i prosjektet at vi hadde tidspress.	Teori viser til viktighet av ground rules og suksessfaktorene se vedlegg A	Ingen tiltak implementert	Respekt for planlegging-verktøy. praktisere prosjektleder rolle

2 Selvevaluering av prosjektledelsen

En god prosjektplan er et viktig redskap for å oppnå mål, og for å gi føringer og prioriteringer for prosjektet. Prosjektteamet la derfor mye vekt på planleggingen, og definerte klare mål og rammer for prosjektet. Dette ga gruppen et godt grunnlag for å gjennomføre prosjektarbeidet.

Prosjektplanen ble fulgt de første ukene. Etter hvert ble det flere parallelle aktiviteter og innleveringer i andre fag, og prosjektteamet gikk bort fra fastsatte aktiviteter og tidsfrister i prosjektplanen. Oppgaver som hastet ble prioritert. Mål og rammer for prosjektet ble mindre klare iløpet av prosjektet. I prosjektplanleggingen ble det utarbeidet en risikovurderingsplan for prosjektet. Noen av risikoene som tas opp i planen var konflikter med andre prosjekter og sykdom/fracfall. De identifiserte risikoene ble ikke tatt høyde for i prosjektarbeidet, og dette har vært med på å forårsake enkelte av de utfordringene som har dukket opp, og bidratt til forsinkelser og utsatte tidsfrister i prosjektplanen. Prosjektteamet har møtt på flere utfordringer underveis i prosjekt, men i en presset situasjon har enkelte av de kritiske suksessfaktorene som ble identifisert i prosjektplanen, se vedlegg A, bidratt til prosjektledelsesuksess.

Prosjektteamet har vært løsningsorientert når det har oppstått produkt relaterte problemer, og effektivt og målrettet løst og utført arbeidsoppgavene. Effektiv team er en kritisk suksessfaktor når prosjektet var preget av begrensninger, Hussein (2016) presenterer flere caser hvor effektive team har bidratt til prosjektsuksess. Produktet ble raskt implementert og utviklet av prosjektteamet og eksterne støttepersoner, som gruppen hadde identifisert som en nødvendig ressurs i tidlig fase. Tidlig planlegging av prosjektet kan i følge Hussein (2016), ha gitt prosjektteamet de nødvendige ressursene. Gruppemedlemmene hadde også jobbet mye sammen i tidligere prosjekter og hadde mye tillit til hverandre. Dette har ført til at gruppen kommuniserer godt og deler kunnskap med hverandre, i tillegg til at det øker motivasjonen og effektiviteten. Tillit er en av de viktigste verdiene som må oppfylles for å skape et positivt og godt arbeidsmiljø (Hussein, 2016, s. 70).

For prosjektledelsen var det satt tre suksesskriterier; 1) alle innleveringer skal levere før fristen, 2) produktet skal ha null defekter, 3) prosjektteamet skal oppnå god karakter på prosjektet. Selv om det har vært forsinkelser klarte prosjektteamet å fullføre arbeidsoppgavene før innleveringsfristen. Produktet har ingen synlige defekter og er blitt testet av studenter, hvor det har fått positive tilbakemeldinger. Produkteier har også gitt gode tilbakemeldinger. Gruppen har ikke noe grunnlag for å vurdere prosjektet, men gruppen har troen på en god karakter. Prosjektteamet ble utfordret underveis i prosjektet og etterlevde ikke de syv suksessfaktorene for prosjektledelse, men mener de har oppnådd de tre satte suksesskriteriene. Selv om prosjektet ikke ble gjennomført som planlagt kan det likevel oppnå de forventede effekter (Hussein, 2016, s. 43). Prosjektteamet klarte å innfri hovedmålene og effektmålene for prosjektet, men det finnes forbedringspotensiale for prosjektledelsen. Prosjektledelsen vurderes dermed som en suksess, ”enig” i tabell 2.

Tabell 2: Prosjektteamets vurdering på prosjektledelsen

Prosjektledelsen var vellykket	Helt uenig	Uenig	Hverken enig eller uenig	Enig	Helt enig
Prosjektteamets respons				X	

3 Produktets innvirkning - Evaluering av prosjektets suksess

Produkteieren ønsket et digitaliseringsverktøy som kan støtte læringen i faget Praktisk prosjektledelse. Formålet med produktet er at det skal ha en betydelig effekt på studentenes læring i faget. Etter en kartlegging av ønske og behov fra bruker og en idemyldring og evaluering av prosjektteamets kapasitet og ressurser, valgte gruppen å lage en webside som viser deler av pensum på en god og oversiktlig måte. Teamets produkt er mest rettet til studenter, da de har mest behov for læring, og har spesiell fokus på kunnskap om de forskjellige prosjekttypene og deres kjennetegn, suksesskriterier og fallgruver. Produktet kan også brukes av personer i næringslivet eller andre som har et ønske om å friske opp kunnskap, eller lære noe nytt innen prosjektledelse. Effektmålet er, som beskrevet i vedlegg A, å vise litteraturen om prosjekttypene på en forenklet og engasjerende måte, spare tid for brukeren å finne informasjonen de trenger, og rask oppfriskning på grunnleggende kunnskap om prosjekter. Suksesskriteriene er at brukerne skal få læringsutbytte ved bruk av produktet, og at brukerne og produkteiere skal være fornøyde. For å sørge for et produkt som møter krav og behov og for å måle produktets effekt, har prosjektteamet brukt følgende metoder:

- *Interessentanalyse*

I prosjektplanleggingen var det gjennomført en interessentanalyse. Å finne ut hvem interessentene er, hvilke forventninger de har, og hvordan de kan bidra til prosjektet, kan gi prosjektteamet en indikasjon på hvilke interessenter prosjektet trenger for å oppnå suksess (Hussein, 2016, s.36). De identifiserte interessentene for prosjektet ble i vedlegg A klassifisert og plassert i en inndeling etter sin grad av innflytelse og interesse i prosjektet. I analysen ble produkteier, prosjektledelsesstudenter og faglærere i prosjektledelse identifisert som kritiske interessenter. Disse interessentene har derfor prosjektteamet fulgt opp, kommunisert med og/eller involvert i prosjektutviklingen.

- *Møte og samtale med produkteier*

Prosjektteamet hadde et møte med produkteier/faglærer i begynnelsen av prosjektet for å kartlegge hans behov og ønsker. Tilbakemeldingene fra møtet har vært med på å forme produktet, og prosjektteamet har også underveis i prosjektet hatt samtaler med produkteier for å følge opp behovene. Dette har hjulpet prosjektteamet å utvikle et produkt som møter forventningene.

- *Kartlegging av studentenes ønske, preferanser, og metode for læring - spørreundersøkelse*

I starten av prosjektet ble det også sendt ut en spørreundersøkelse til studenter, for å kartlegge deres behov, ønsker og læringsmåte. Det er valgt å kartlegge studentenes behov fordi de representerer den største målgruppen for prosjektet, og betraktes som sentrale interessenter. I følge Hussein (2016) kan prosjektet ha behov for input og informasjon fra sluttbrukerne og det er viktig at de involveres i prosjektutviklingen. Prosjektteamet fikk 26 svar fra spørreundersøkelsen, se vedlegg B. Av undersøkelsen ser prosjektteamet at det er et behov for et digitalt verktøy som kan samle informasjon i faget, slik at det kan brukes som et verktøy for repetisjon og rask overblikk over pensum. Resultatet fra undersøkelsen har også vært med å forme produktet.

- *Jevnlig intern testing og kvalitetsikring av produkt*

For å sørge for at produktet møter krav og behov er det blitt jevnlig testet av prosjektteamet og andre medstudenter. De jevnlig testene er blitt brukt som beslutningspunkter (decision-gates) for prosjektet. Disse beslutningspunktene kan brukes for å vurdere status, sørge for oppfølging, revurdere målene, justerer ambisjonsnivået, terminere prosjektet, gå videre til neste stadium eller utsette prosjektet for å vente på ny informasjon (Hussein, 2016, s. 42). Prosjekteier har også fått innsyn til produktet underveis. Prosjektteamet har etter tilbakemelding fra studenter og prosjekteier gjort endringer og forbedringer på produktet.

- *Ekstern testing av endelig produkt - spørreundersøkelse*

Etter ferdigstillelse og leveranse av produkt, målte prosjektteamet produktets innvirkning på brukernes læring. Dette gjorde prosjektteamet ved å sende ut en test med spørreundersøkelse til studenter, og andre personer fra næringslivet. Spørreundersøkelsen kartlegger brukernes mening om produktets konsept, design og bidrag til læring. Prosjektteamet fikk 14 svar på undersøkelsen, hvor det har fått gode resultater, se vedlegg C. Det var svært god respons på produktets konsept. Dette viser at prosjektteamet har gjort gode undersøkelser på behov og ønsker i målgruppen. Produktet fikk også gode resultater. Det var noe variasjoner i navigering og design, men dette er veldig avhengig av enkeltpersoners preferanser. 70% av respondentene svarte at de ville ha lært noe og brukt websiden.

Av muntlige tilbakemeldinger fra studenter og prosjekteier, samt resultat fra den siste spørreundersøkelsen, indikerer det at prosjektteamet har oppnådd de satte suksesskriteriene. Prosjektteamet vurderer derfor produktet som en suksess. I spørreundersøkelsen ved spørsmål om brukerne tror de ville ha lært noe av websiden, ga ingen av respondentene nei til svar. De fleste respondenter var fornøyd med produktet, men av forslagene som kom fram i spørreundersøkelsen ser prosjektteamet at produktet har forbedringspotensialet. Selvevalueringen i tabell 6 er derfor kun satt til ”enig”.

Tabell 3: Selvevaluering av produktets effekt

	Produktet vårt er av høy kvalitet, og vi anbefaler at det brukes som læringshjelp i prosjektledelse.				
Skala	Helt uenig	Uenig	Hverken enig eller uenig	Enig	Helt enig
Prosjektteamets respons				X	

4 Faktorer som har bidratt til suksess

Suksessfaktorer er ifølge Hussein (2016) et sett med faktorer som prosjektet må etterleve for å øke sannsynligheten for suksess. I prosjektplanen, se vedlegg A, har prosjektteamet identifisert en rekke suksessfaktorer, men gjennom prosjektets gjennomførelse har parallelle aktiviteter vist seg utfordrende. Og dette var en risikofaktor undervurdert i prosjektplanleggingen. En annen utfordring har vært evnen til refleksjon og håndtering av utfordringer underveis. Også her anses parallelle aktiviteter å ha hatt en innvirkning, med et mindre antall fulltallige prosjektmøter underveis. Dette til tross lykkes prosjektteamet i å levere det digitale produktet til fastsatt tid, og som møter de fleste interessenters forventninger. Tabell 4 viser faktorer som ansees å ha bidratt til denne suksessen.

Tabell 4: Identifiserte suksessfaktorer

Suksessfaktorer	Bidrag til suksess
Godt miljø	Det gode miljøet i prosjektgruppen tilrettela for effektiv kommunikasjon og samarbeid tidlig i prosessen, og dette bidro til en rask oppstart.
Motivasjon	Medlemmene hadde fra oppstart en høy motivasjon for prosjektets sluttprodukt, og startet derfor tidlig opp med alternative løsninger.
Fleksibilitet	Når oppmøte ved oppsatte arbeidsmøter ble utfordrende i møte med parallelle aktiviteter, var gruppen rask på omstilling for å finne alternative plattformer for kommunikasjon og beslutningstaking, og sette opp arbeidsmøter andre dager.
Kreativitet	Prosjektgruppen hadde høy grad av kreativitet som sikret en rask oppstart ved utarbeidelse av produktide, og nye alternativer da enkelte planlagte elementer for hjemmesiden viste seg utfordrende å gjennomføre.
Involverende prosjektprosess	Gruppens medlemmer var alle involvert i etablering av produktide, og et fokus på involvering av interessenter ble ivaretatt, både i form av de to spørreundersøkelsene, samt kontakt med emneansvarlig og læringsassistenten med prosjektansvar.
Engasjement	Nijhof et al definerer engasjement som en følelse av lojalitet og tilhørighet (Hussein, 2016, p.70). En faktor som i følge Gutierrez og Hussein, har positiv innvirkning på effektivitet, motivasjon og endringsmotstand (Hussein, 2016, p.70). I det veletablerte teamet kan engasjementet ha styrket gruppens evne til å arbeide effektivt utenfor oppsatte arbeidsrammer, opprettholdelse av motivasjon gjennom prosessen på tross av enkelte utfordringer og tilrettelagt for endring av produktet underveis.
Tillit	Tillit defineres av Hussein som viljen til å akseptere risiko. En faktor som derfor er avgjørende for beslutningsprosesser (Hussein, 2016, p.70). Tillit innvirker i henhold til Gutierrez og Hussein, på motivasjon, kommunikasjon, effektivitet, samt håndtering av usikkerhet og kunnskapsdeling (Hussein, 2016, p.71). I en veletablert gruppe med høy grad av tillit til hverandre, vil derfor motivasjonen opprettholdes på tross av manglende arbeidsrammer og mindre effektive kommunikasjonsmetoder. Håndtering av utfordringer har trolig også blitt styrket gjennom den høye graden av tillit i gruppen, da medlemmene til tross for forsinkelser har hatt tillit til at gruppens medlemmer vil levere sine oppgaver i tide, samt overholde forventet nivå. Samtidig kan den høye graden av tillit i gruppen ha skapt en illusjon av større kontroll i prosjektet enn det som reelt var tilfelle, og dermed bidratt til utilstrekkelig refleksjon og lærdom i prosjektet.

De myke faktorene antas å ha hatt en signifikant innvirkning på prosjektets suksess, både i form av høy grad av engasjement og tillit innad i prosjektgruppen. Faktorer som har styrket gruppens evne til å opprettholde effektivitet og motivasjon i møte med parallelle aktiviteter, samt en styrket evne til å håndtere utfordringer underveis i prosjektet og anses derfor som de mest signifikante faktoren.

Suksessfaktorer i litteraturen

Det har blitt gjort flere forsøk på å studere og kartlegge suksessfaktorer i prosjekter. Basert på en gjennomgang av dokumentasjon og rapporter fra ulike suksessfulle prosjekter, ble et sett med suksessfaktorer identifisert av Hussein (2016).

Prosjektets identifiserte suksessfaktorer kan alle til en viss grad finnes igjen i litteraturen. Tabell 5 viser samsvar mellom prosjektets og Husseins suksessfaktorer.

Tabell 5: Samsvar mellom prosjektspeifikke suksessfaktorer og Hussein (2016) sin liste med suksessfaktorer funnet i andre prosjekter

Suksessfaktorer	Samsvar med faktorer fra litteraturen
Godt miljø	Et godt miljø i prosjektgruppen finnes ikke direkte som en faktor identifisert i studiet, men påvirker faktorer som kommunikasjon, erfaringsdeling, åpenhet, motivasjon. Suksessfaktorer kartlagt som en faktor i velykkede prosjekter.
Motivasjon, kreativitet, tillit og engasjement	Motiverte medarbeidere, kreativitet, tillit og engasjement finnes direkte omtalt i listen. Faktoren engasjement omtales på flere nivåer, både for ledelse, leverandør og bestiller. Faktorer som alle tyder på å ha positiv medvirkning til sannsynlighet for prosjektsuksess.
Fleksibilitet	Løsningsorienterte grupper og evne til problemløsning ble identifisert som suksessfaktorer i prosjektene benyttet i Husseins (2016) forskning.
Involverende prosjektledelse	Involvering av berørte personer listes også opp som en felles faktor identifisert i Hussein (2016) sitt studie.

Samsvaret indikerer at de identifiserte faktorene i prosjektet kan ha vært avgjørende for suksess. Til tross for samsvar kan det også vises til enkelte suksessfaktorer gruppen ikke hadde tilstrekkelig fokus på. Særlig faktorer relatert til tydelig og motivert prosjektleder, som omtales i flere av suksessfaktorene i litteraturen (Hussein, 2016). I studiet ble imidlertid ulike typer prosjekter dekket, der kartleggingen tydet på en sammenheng mellom suksessfaktorer og prosjekt karakteristikk. Dette tyder på at ikke alle av studiets identifiserte suksessfaktorer er kritiske i like stor grad for vårt prosjekt.

5 anbefalinger

En viktig del av prosjektarbeid, er å ta lærdom av sine erfaringer. Denne lærdommen kan tas med videre i andre prosjekter, og på den måten skape en læringscyklus. Figur 1 viser Kolb (2014) sin modell for læring. Denne viser hvordan erfaringer kan benyttes til å forbedre seg ved neste prosjekt.

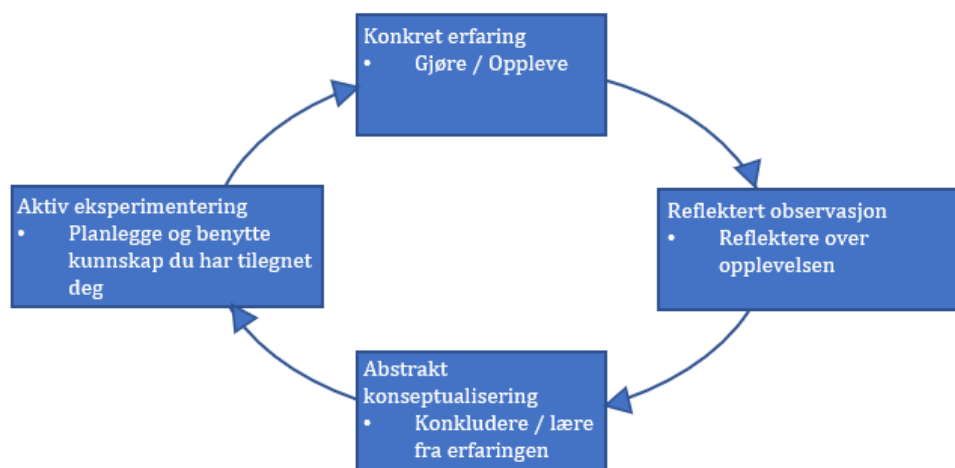

Figur 1: Kolbs Læringscyklus

Etter gjennomføring av prosjektet har gruppen gjort seg enkelte erfaringer, og tatt lærdom av disse. Her er det oppsummert anbefalinger og erfaringer som andre studenter kan tenke over, om de skal gjennomføre et lignende prosjekt.

1. Siden hovedleveransen ved digitaliseringsprosjekter ikke er det digitale produktet, men effekten det har, er det veldig viktig å tenke godt gjennom den ønskede effekten før man definerer produktet i seg selv.
2. Det er også viktig å ha en klar plan for prosjektet, da involvering av interessenter er en sentral del av prosjektet. Det er derfor viktig å ha en klar plan for hvordan dette skal foregå, og hvordan dette skal bidra til et best mulig produkt. WBS og AON er gode verktøy i planleggingen.
3. Det kan også være lurt å velge seg en prosjektleder, som tar litt overordnet ansvar for å drive prosjektet fremover.
4. Om det er ting som er uklar eller usikker, er det lurt å avklare dette. Gruppen har hatt god dialog med faglærer og læringsassistent i faget gjennom oppgaven. Dette har bidratt til at det har vært klarhet i forventninger og krav til oppgaven.
5. Tilegnet erfaring tilsier at dette er et fagfelt man ikke kan pugge seg god på. Prosjektledelse må erfares, føles på, og reflekteres rundt. Prosjekter endrer seg fra gang til gang. Hvert prosjekt har sin egen natur, uavhengig av de generelle likhetstrekkene. Dette gjør det vanskelig å bare lese ut fra en bok hvordan et spesifikt prosjekt skal håndteres. Det kan tenkes at dette er et fagfelt hvor det gjelder å få både kvantitet og kvalitet, og hvor man må strebe etter å bli bedre til enhver tid.

Referanser

Andersen, B. and Fagerhaug, T. (2001). *Performance Measurement Explained: designing and implementing your state-of-the-art system*. Asq Press.

Hussein, B. A. (2016). *Veien til suksess: fortellinger og refleksjoner fra reelle prosjektcaser*. Fagbokforl.

Kolb, D. A. (2014). *Experiential learning: Experience as the source of learning and development*. FT press.

Evaluering av gruppe 9

Gruppe 9 har laget ei hjemmeside med videoer av ulike temaer fra prosjektledelse med tilhørende quizer for hvert tema. Styrkene og svakhetene til hjemmesiden og ideen er blitt vurdert.

Styrken til siden, slik gruppen ser det, er at det er en interaktiv side. Brukeren har mulighet til å teste kunnskap innen temaene som gjennomgås, ved å utføre en quiz for hvert tema. Gruppen opplever at dette gjør at en i større grad følger med på videoene som gjennomgås. Hjemmesiden dekker også en rekke ulike temaer som oppleves som relevante for faget. Prosjektgruppe 9 har lyktes å trekke ut viktige læringspunkter for hvert tema. Det er også bra at videoene ikke er for lange.

Svakheten, vil gruppen si, er at videoene tidsmessig noen ganger går for fort til at man får med seg det som blir sagt, websiden har en bug (men gruppen ser at feilen er rettet etter innleveringsfristen), og andre ganger går det for sakte så man blir litt lei. Det kan også være litt slitsomt å høre på den samme musikken i lengden. En annen svakhet er at man kommer til Youtube i slutten av videoen, og kan dermed bli lett distraheret til å se på urelevante videoer.

Tabell 6: Gruppens grad av støtte

	Produktet som gruppen har vurdert er av høy kvalitet, og vi anbefaler at det brukes som læringshjelp i prosjektledelse.				
Skala	Helt uenig	Uenig	Hverken enig eller uenig	Enig	Helt enig
Prosjektteamets respons					X

Totalt vil vi gi gruppen en karakter på 9 for dette produktet.

A Vedlegg: Rapport del 1



Digitaliseringsprosjekt

Semesteroppgave

Mei Yain Fung

Karina Helle

Charlotte Hjelmseth Larssen

Hanne Kjerpeseth

Emilie Låstad

Innlevering: 5. Oktober 2019

Norges teknisk-naturvitenskapelige universitet
Institutt for industriell økonomi og teknologiledelse (IØT)

Innhold

1	Introduksjon	1
1.1	Hensikt	1
2	Digitaliseringsprosjekt	2
3	Beskrivelse av produkt	3
4	Prosjektets tidsplan og WBS	4
5	Suksesskriterier og suksessfaktorer	5
6	Interessenter	6
7	Risikovurderingsplan for prosjektet	8
8	Organisering, roller og ansvar	9
	Referanser	10

Figurer

1	Endringsledelse (Frahm, 2017)	2
2	Konseptskisse av nettsidens forside	3

Tabeller

1	Prosjektets utløsende faktor, formål, effektmål og objektmål	1
2	Beskrivelse av funksjon.	3
3	Prosjektets suksesskriterier	5
4	Prosjektets suksessfaktorer	5
5	Interessenter	6
6	Klassifisering av interessenter (Hussein, 2016, s.37)	6
7	Risikoanalyse	8
8	Risikomatrise	8
9	Roller og ansvar	9

1 Introduksjon

I faget TPK5100 Praktisk prosjektledelse skal det gjennomføres en semesteroppgave om digitaliserings prosjekter, som teller 40% av karakteren i faget. I prosjektet skal studentene bli kjent med konsepter som digitalisering og digital transformasjon, ved å gjennomføre et digitaliseringsprosjekt som har som formål å ha en effekt på læringseffekt innen tema prosjektledelse. Gjennom gruppearbeidet skal man få forståelse for hvilke betingelser som skal til for at digitaliseringsprosjektet skal ledes effektivt, og forstå utfordringer assosiert med slike prosjekter.

1.1 Hensikt

Prosjekteier for prosjektet er faglærer i TPK5100, Bassam Hussein. Følgende er definert av prosjekteier: *Prosjektteamet skal planlegge, utvikle og produsere et digitalt verktøy for læring innen prosjektledelse.* Det er også satt krav om at resultatet må ha en **signifikant** effekt på læring. Produktet må kunne brukes på PC, mobil eller I-pad. Prosjektet har 3 innleveringer; Innlevering av prosjektplan (05.10), innlevering av produktet (12.11) og innlevering av endelig rapport (19.11). Prosjektets utløsende faktor, formål, effektmål og objektmål er nærmere beskrevet i tabell 1.

Tabell 1: Prosjektets utløsende faktor, formål, effektmål og objektmål

	Webside for læring i prosjekter
Utløsende faktor	I en hektisk skoledag må man lære mye, fort. Erfaringer tyder på at læringseffekten øker med teknologi som baner vei for nye pedagogiske metoder, for eksempel spillbasert læring.
Formål	Prosjektet skal ha en betydelig effekt på læring knyttet til kunnskap om forskjellige prosjekttyper, deres kjennetegn, suksesskriterier og fallgruver.
Effektmål	<ul style="list-style-type: none">• Forenklet og engasjerende måte å tilegne seg kunnskaper om prosjekter.• Tidsbesparende for brukeren å finne den informasjonen de trenger• Verktøy for prosjektledere (deltagere) for å friske opp på grunnleggende kunnskap som kan være nyttig ved oppstart av nytt prosjekt
Objektmål	Det skal utvikles en webside hvor studenter, faglærere, prosjektledere eller andre kan finne anbefalinger, veiledninger, suksesskriterier og informasjon om fallgruver for forskjellige prosjekter.

2 Digitaliseringsprosjekt

Fitzgerald et al. har definert digitalisering (digital transformasjon) som *Bruk av ny teknologi (sosiale media, mobile-, analytiske-, eller innebygde enheter) for å muliggjøre større forretningsforbedringer; for eksempel å forbedre kundeopplevelsen, effektivisere driften eller lage nye forretningsmodeller.* (Fitzgerald et al., 2014)

George Westerman, en forsker ved MIT Sloan Initiative, tydeliggjør at hensikten med digitalisering ikke er innføring av mye ny teknologi, men måten denne teknologien muliggjør positive endringer.

«Alle» snakker om digital transformasjon, og antall registrerte Google-søk omkring temaet har økt betraktelig de siste årene. Likevel er det klart at mange ikke helt har forstått hva det egentlig handler om. Nøkkelordet er ikke «digital», men «transformasjon». Å ha fokus på teknologien kan lede mange på villspor. Den skaper i seg selv ingen verdi for forretningen. Teknologiens verdi ligger i dens evne til å muliggjøre nye måter å drive forretning på. (Westerman, 2018)

Digitaliseringsprosjekter har altså til hensikt å skape en ønsket **endring**. Digitaliseringsprosjekter har derfor ofte mye til felles med omstillingsprosjekter. Omstillingsprosjekter kjennetegnes av at de ikke har en håndfast leveranse, og endring er et sentralt resultat. Mennesker og arbeidsprosesser står sentralt og hovedutfordringene handler om tilrettelegging for aksept, implementering og realisering. For å lykkes med dette er involvering og medvirkning av berørte parter viktig grunnet mulig motstand til endringen (Hussein, 2016, s.25). Endringsledelse søker å håndtere endringsprosesser på best mulig måte, og ideer fra endringsledelse (figur 1) kan benyttes inn i dette prosjektet for å gi et best mulig produkt for kunden. Formålet med endringsledelse er å implementere strategier for å gjennomføre endring, kontrollere endring og hjelpe personer å tilpasse seg endringen. Dette er ideer som burde tenkes gjennom ved gjennomføring av dette prosjektet (Rouse, 2019).



Figur 1: Endringsledelse (Frahm, 2017)

3 Beskrivelse av produkt

Produktide

Project Assistant tool - En nettside som gir opplysninger om ulike typer prosjekter.

Beskrivelse av produktet: Nettsiden er et verktøy for å finne informasjon om ulike typer prosjekter. Gjennom dette verktøyet kan brukerne finne anbefalinger, veiledninger, suksesskriterier og informasjon om fallgruver for prosjekter de jobber med. Verktøyet kan brukes tidlig i en prosjektfase for å støtte prosjektplan, valg og beslutninger. Figur 2 er en konseptskisse på forsiden.

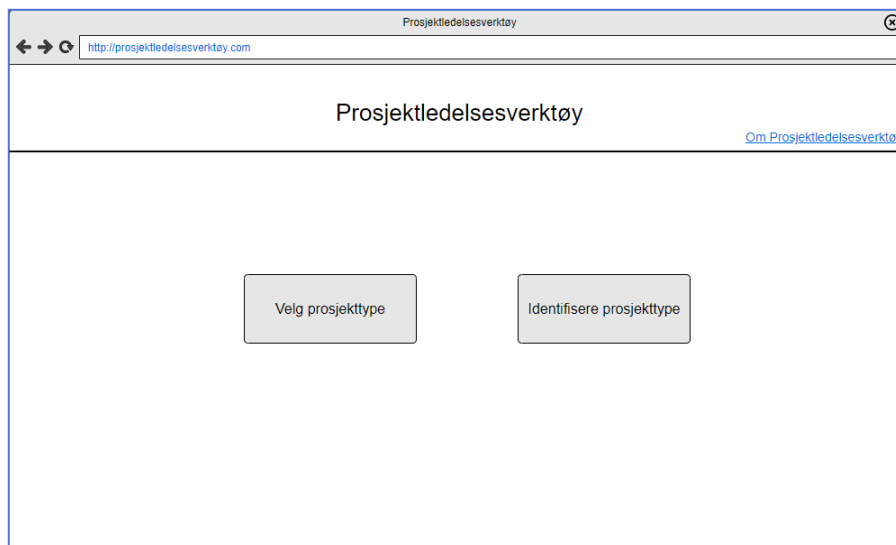

Figur 2: Konseptskisse av nettsidens forside

Beskrivelse av funksjon

Nettsiden har tre hovedfunksjoner; valg av prosjektttype, identifisering av type prosjekt og informasjon om prosjekttyper. Tabell 2 beskriver hovedfunksjonene.

Tabell 2: Beskrivelse av funksjon.

Funksjon	Beskrivelse
Valg av prosjektttype	Det skal vises en liste med prosjekttyper. Brukere skal få muligheten til å velge blant listen og få informasjon om valgt prosjektttype.
Identifisere type prosjekt	Systemet skal kunne identifisere hvilken type prosjekt brukeren har, basert på valgte kjennetegner som kan velges fra en liste.
Informasjon om prosjekt	Det skal vises informasjon om typen prosjekt, suksesskriterier, anbefalinger, veiledninger og fallgruver for valgt eller identifisert prosjektttype.

4 Prosjektets tidsplan og WBS

Det er produsert en prosjektnedbrytingsstruktur (WBS) og en tidsplan for prosjektet. Disse er lagt ved i vedlegg da de er for store til å legge ved her.

En WBS er et hjelpemiddel for å kunne bryte prosjektet ned i uavhengige oppgaver og aktiviteter. Dette gir en enkel og strukturert visualisering av prosjektet (Hussein, 2016, s.87-88). I vår WBS har vi 4 faser;

- Initiating
- Planning
- Execution
- Evaluation

Disse fasene er videre brutt ned i en rekke delleveranser og arbeidspakker. Utvikling av WBS ga et godt grunnlag for å sette opp prosjektets tidsplan, da den gjør alle enkelt oppgaver kjent. Tidsplanen til prosjektet er satt opp som et Gantt-diagram i Excel. Gantt-diagrammet viser alle faser, oppgaver og aktiviteter, samt milepæler i prosjektet, plottet mot tiden. I vårt Gantt-diagram kan man finne igjen de samme fasene som er definert i WBS, og oppgaver og aktiviteter innenfor disse. Det er også plottet inn milepæler som prosjektets start- og sluttdato, innleveringer underveis og siste dag med mulighet for endringer. Gantt-diagrammet gir god oversikt over hvor prosjektteamet skal være fremdriftsmessig til enhver tid. Dette gjør det lettere å allokere ressurser (personer) til prosjektet, og fordele oppgavene mellom medlemmene. På grunn av andre prosjekter som går parallelt med prosjektet i dette faget, er det ikke fordelt ansvar blant teammedlemmene på forhånd. Dette vil gjøres underveis på en hensiktsmessig måte, slik at alle har tid til å fullføre andre arbeider.

Det er tatt høyde for at det kan forekomme endringer i tidsplanen. Det vil blant annet bli vurdert om endringer må gjøres etter tilbakemeldinger fra forskjellige interessenter. Disse kan være med å forbedre produktet, men kan også føre til endring i omfang av oppgaven, og gruppen må derfor være fleksible for eventuelle endringer.

5 Suksesskriterier og suksessfaktorer

Viktige suksesskriterier for digitaliseringsprosjekter er ikke implementeringen av teknologien i seg selv, men at denne teknologien utnyttes på en gunstig og givende måte. Dette prosjekt har som formål å forbedre måten vi lærer på, gjennom å benytte digitalisering. Det er dermed ønskelig å endre måten personer lærer på. Tabell 3 viser suksesskriterier for prosjektet.

Tabell 3: Prosjektets suksesskriterier

Suksesskriterier		
ID	Prosjektledelsessuksess	Prosjektsuksess
1.	Alle innleveringer skal leveres før fristen	Brukerne skal ha læringsutbytte av produktet
2.	Produktet skal ha 0 defekter	Brukerne skal være fornøyd med produktet
3.	Prosjektteamet skal oppnå god karakter på prosjektet	Prosjekteier fornøyd med produktet

Suksessfaktorer er faktorer som må etterleves i prosjektet for å øke sannsynligheten for suksess (Hussein, 2016, s.57). Suksessfaktorene garanterer ikke suksess, men vil ved etterlevelse mest sannsynlig påvirke prosjektet positivt. Suksessfaktorene hjelper oss å oppnå suksesskriteriene våre. Identifikasjon av suksessfaktorer kan ha positiv påvirkning på interessenters støtte og bidrag til prosjektet. Det er viktig at produktet som utvikles utgjør en bedre (lettere) måte å lære på, slik at brukerne ønsker å endre måten de lærer på. Hvis løsningen er komplisert og ikke gir noe særlig utbytte, vil den ikke benyttes. Tabell 4 viser kritiske suksessfaktorer for vårt prosjekt, delt etter oppnåelse av prosjektledelsessuksess og prosjektsuksess. Disse suksessfaktorene setter retningslinjer for hvordan prosjektteamet skal gå frem gjennom planlegging og gjennomføring av prosjektet.

Tabell 4: Prosjektets suksessfaktorer

Suksessfaktorer		
ID	Prosjektledelsessuksess	Prosjektsuksess
1.	Oversiktlige prosjektplaner	Involvering av sluttbruker
2.	Klare formål og effektmål	Involvering av prosjekt eier
3.	Strukturert risikohåndtering	Støtte fra prosjekt eier
4.	Effektiv problemløsning og funksjonstesting	Funksjonstesting
5.	Effektivt team	Fokus på håndtering av endring
6.	Klare roller og ansvar innad i prosjektteam	
7.	Tillit blant medlemmene i prosjektteamet	

For prosjektledelsessuksess er det satt 3 kriterier (se tabell 3). For oppnåelse av disse er det definert 7 suksessfaktorer som prosjektteamet ønsker å etterleve. Suksesskriterie 1 for prosjektledelsessuksess blir mer sannsynlig oppnådd ved at prosjektteamet etterlever suksessfaktor 1, 5, 6 og 7 for prosjektledelsessuksess. Kriteriet 2 blir mer sannsynlig oppnådd ved etterlevelse av suksessfaktor 4 og 7 for prosjektledelsessuksess. Det siste kriteriet for prosjektledelsessuksess vil bli mer sannsynlig ved etterlevelse av alle suksessfaktorer.

For projektsuksess er det også satt 3 kriterier (se tabell 3). For disse er det definert 5 suksessfaktorer. Suksessfaktor 1, 4 og 5 er spesielt viktig for å øke sannsynligheten for å oppnå suksesskriterier 1 og 2. Alle de 4 suksessfaktorene er viktige for å oppnå suksesskriterie 3.

6 Interessenter

Interessentene er prosjekteier, prosjekt-teamet og brukerne av systemet. Nettsiden er et verktøy for alle som vil ha mer informasjon om type prosjekter. Brukerne vil primært være personer som jobber med eller som er involvert i prosjekter. Disse personene kan være studenter som har prosjekter i fag, faglærere og prosjektledere i næringslivet. Verktøyet kan også brukes av personer som er interessert i fagfeltet og som vil lære om de ulike typer prosjekter. Tabell 5 viser en oversikt over interessentene.

Tabell 5: Interessenter

Interessent	Forklaring
Prosjektteam	Designer, utvikler og implementerer produktet.
Studenter (som tar prosjektledelsesfag)	Bruke nettsiden som en læringsressurs. Identifisere og finne informasjon om de ulike typer prosjekter.
Faglærere (i prosjektledelsesfag).	Kan inkludere nettsiden i faget og bruke det som en læringsressurs.
Prosjektledere	Bruke nettsiden for å finne informasjon om type prosjekt de jobber med.
Prosjekteier	Prosjekteier har initiert prosjektet, og har spesifisert problemet prosjektet skal svare på /løse. Prosjekteier setter retningslinjer og begrensninger for prosjektet.

Tabell 6: Klassifisering av interessenter (Hussein, 2016, s.37)

		Interesse (Uttrykt som krav og forventninger)	
		Liten	Stor
Innflytelse	Kritisk	Gruppe 2	Gruppe 1
	Marginal	Gruppe 4	Gruppe 3

Hvordan man skal forholde seg til en interessent vil variere. For å få en oversikt over hvilke typer interessenter man har, og strategier for hvordan disse skal håndteres, kan man klassifisere interessentene. Tabell 6 viser klassifiseringen benyttet her, hvor interessentene plasseres etter sin grad av innflytelse og interesse i prosjektet.

- **Gruppe 1:** Prosjektet har behov for bidraget fra denne kategorien. Deres bidrag er kritisk for prosjektet. De uttrykker også store krav og forventninger til prosjektet. Strategien for å ivareta denne gruppen er tett oppfølging, involvering og medvirkning. Man burde ta i bruk gode prosesser for kartlegging av krav og forventninger (Hussein, 2016, s.38).
 - *Prosjekteier* klassifiseres innen denne gruppen. Under prosjektet vil det opprettholdes nær kontakt med prosjektleder gjennom møter, for å få tilbakemeldinger og godkjenninger underveis. Dette for å følge opp krav og forventninger, samt involvere prosjekteier i prosjektet.

- **Gruppe 2:** Deres bidrag til prosjektet er kritisk og viktig, men de stiller i utgangspunktet ikke store krav eller forventninger til prosjektet. Disse interessentene er prioritert. Man burde innføre tiltak for å opprettholde deres støtte og bidrag til prosjektet (Hussein, 2016, s.38).
 - *Prosjektteamet og systemutvikler* klassifiseres innen denne gruppen. For å opprettholde bidrag og støtte er det satt klare mål teamet kan jobbe mot (når det kommer til resultat av prosjektet). Disse målene skal hjelpe å motivere til å bidra til at prosjektet blir bra. For systemutvikler vil det være god kommunikasjonsfly, og kompensasjon for hjelp ved slutten av prosjektet.
- **Gruppe 3:** Denne kategorien omfatter interessentene som ikke har noe signifikant bidrag, men har store forventninger eller krav til prosjektet. Denne gruppen bør også prioriteres. Kommuniser at deres krav etterfølges, og ha gode prosesser for å kartlegge deres forventninger og krav (Hussein, 2016, s.38).
 - *Studenter, faglærere og prosjektledere* er alle klassifisert innen denne gruppen. Dette er mulige sluttbrukere (kunder) av produktet. Disse vil ha en del krav til funksjonalitet, faglig innhold og hvordan dette er presentert på nettsiden for å forbedre læringsutbytte. Det vil kommuniseres med disse gjennom mulige funksjonstester underveis når utviklingen av nettsiden begynner. Deres krav og forventninger vil kartlegges.
- **Gruppe 4:** Denne kategorien omfatter interessentene som ikke har noe signifikant bidrag til prosjektet, og ikke forventer noe av prosjektet. Disse interessentene krever minimalt med innsats, og det er nok å overvåke dem i tilfelle de skulle endre sin posisjon (Hussein, 2016, s.38).

7 Risikovurderingsplan for prosjektet

Risikofaktorer burde håndteres gjennom hele prosjektet gjennom en risikostyringsprosess. Det er viktig å begynne tidlig med identifikasjon av risikoer, og komme med gode forslag til tiltak som kan redusere eller fjerne risikoer. Nye risikoer kan dukke opp iløpet av et prosjekt, og disse burde håndteres fortløpende (Hussein, 2016, s.109). Risikostyringsprosessen består i hovedsak av 4 grunnleggende prosesser; identifikasjon av risikoer, vurdering av risiko, risiko og responsplanlegging, samt risikoovervåking og - kontroll (Hussein, 2016, s.110).

Tabell 7 viser risikoer identifisert for vårt prosjekt, samt vurdering av risikoen etter risikomatrixe i tabell 8, og planlagte tiltak. Risikoen er identifisert for oppgavene som er definert i prosjektnedbrytingsstrukturen (WBS) som ligger i vedlegg.

Tabell 7: Risikoanalyse

Beskrivelse av risiko	S	K	Alvorlighetsgrad	Innvirkning på prosjektet	Tiltak	Ansvarlig person	Status/konsekvens av tiltak
Manglete kompetanse og/eller ferdigheter innen programmering/utvikling av nettside	H	L	Betydelig	Kvalitet på produktet, tilfredshet.	Finne eksterne ressurser (utviklere).	Prosjektteam	Ekstra tid går med på å finne eksterne ressurser.
Teknisk feil	M	H	Kritisk	Tilfredshet	Ekstra sjekk på nettsiden før innlevering.	Prosjektteam	Bruker mer tid på å kvalitetssikre nettsiden.
Konflikter med andre prosjekter.	H	L	Betydelig	Kvalitet på produktet	Bedre planlegging, sette av en dag der teamet fokuserer på dette prosjektet.	Prosjektteam	Kan ikke jobbe med andre prosjekter på avtalt tidspunkt.
Sykdom/fracfall	M	L	Marginal	Forsinkelser	Andre medlemmer i teamet tar over arbeidsoppgavene til medlemmer som ikke kan være til stede.	Prosjektteam	Ekstra arbeid for andre medlemmer.
Produktet tas ikke i bruk av sluttbruker	M	H	Kritisk	Påvirker prosjektsuksess	Innvolvering av sluttbruker gjennom utvikling. Fokus på endringsledelse.	Prosjektteam	Sluttbruker involveres allerede i planlegging.

Tabell 8: Risikomatrixe

		Konsekvens		
		Lav	Medium	Høy
Sannsynlighet	Høy			
	Medium			
	Lav			

Risiko	
	Marginal
	Betydelig
	Kritisk

8 Organisering, roller og ansvar

Prosjektorganisasjonen har ansvar å initiere, definere, planlegge og gjennomføre prosjektet. I dette digitaliseringsprosjektet består prosjektoranigasasjonen av studenter og faglærer i faget Praktisk prosjektledelse. Tabell 9 viser en oversikt over de sentrale rollene og deres ansvar og oppgaver. Prosjekt-teamet består av en tverrfaglig studentgruppe med bakgrunn i data, energi og miljø, marin, kjemi og HMS.

Tabell 9: Roller og ansvar

Roller	Rolleinnehaver	Ansvar og oppgaver
Prosjekteier	Faglærer i Praktisk prosjektledelse	<ul style="list-style-type: none">• Initiativtaker• Beslutningstaker• Sørgе for at prosjektet blir planlagt og gjennomført iht. rammene og forventningene.
Prosjekt-team	Gruppe 10 i Praktisk prosjektledelse	<ul style="list-style-type: none">• Planlegge og gjennomføre prosjektet.• Framdrift i prosjektet• Implementere prosjekt-produktet
Referansegruppe	En annen gruppe i faget Praktisk prosjektledelse	<ul style="list-style-type: none">• Gi faglig innspill på utformingen av prosjekt-produktet.

Nødvendige ressurser

For at prosjektet kan gjennomføres er det nødvendig å ha ressurser med kompetanse i prosjektledelse, datateknologi og systemutvikling.

- Prosjektledelse:
Handler både om prosjektstyring og prosjektorganisering. Kompetanse innen prosjektledelse er nødvendig for framdrift i prosjektet og måloppnåelse.
- Systemutvikling:
Prosjektet involverer utvikling av en nettside. Kompetanse i systemutvikling er nødvendig for implementering av nettsiden.
- Datateknologi:
Datakunnskaper er nødvendig for å forstå teknikkene og metodene for å utvikle data-systemer. IT-kunnskaper kan støtte valg og beslutninger for implementering av nettsiden og estimering av tidsbruk for utviklingen.

Annen støtte og ressurser utenfor prosjektgruppen

De fleste medlemmene i prosjektorganisasjonen har ikke kompetanse eller erfaring med prosjektledelse, digitaliseringsprosjekter og systemutvikling. Prosjektorganisasjonen har behov for hjelp og støtte fra følgende ressurser:

- Systemutviklere:
Gi råd og hjelp med implementering av nettsiden.
- Prosjektledere:
Gi råd om prosjektgjennomføring, suksesskriterier, fallgruver osv.

Referanser

- Fitzgerald, M., Kruschwitz, N., Bonnet, D., and Welch, M. (2014). Embracing digital technology: A new strategic imperative. *MIT sloan management review*, 55(2):1.
- Frahm, J. (2017). *What is change management?* Tilgjengelig fra: <https://conversationsofchange.com.au/change-management/>. (Hentet: 27.09.2019).
- Hussein, B. A. (2016). *Veien til suksess: fortellinger og refleksjoner fra reelle prosjektcaser*. Fagbokforl.
- Rouse, M. (2019). *Change management*. Tilgjengelig fra: <https://searchcio.techtarget.com/definition/change-management>. (Hentet: 27.09.2019).
- Westerman, G. (2018). Your company doesn't need a digital strategy. *MIT Sloan Management Review*, 59(3):1–5.

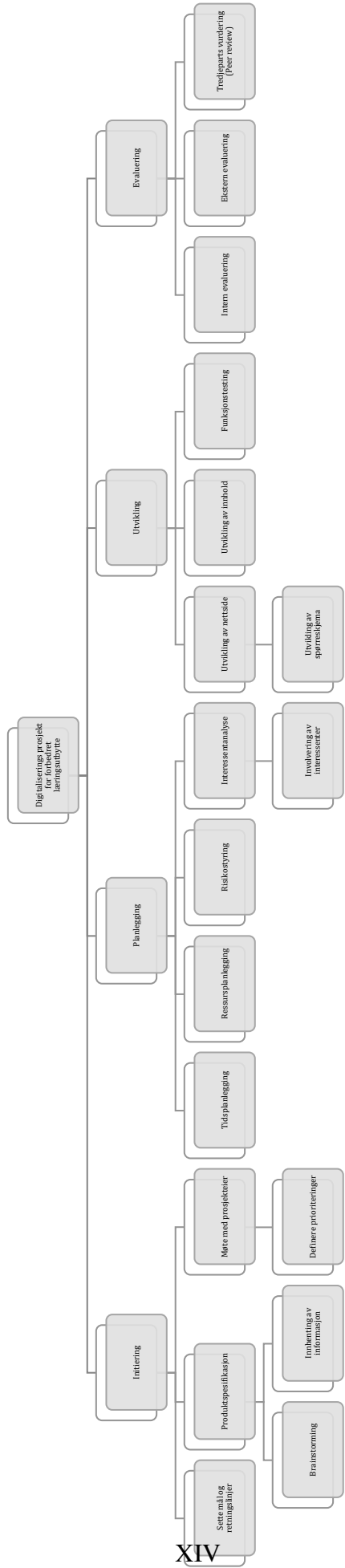

Digitaliseringsprosjekt

Gruppe .10

Opptstartsdato 10.09.2019

Scroll increment 0

Legend:

Fase

Aktivitet

Møte

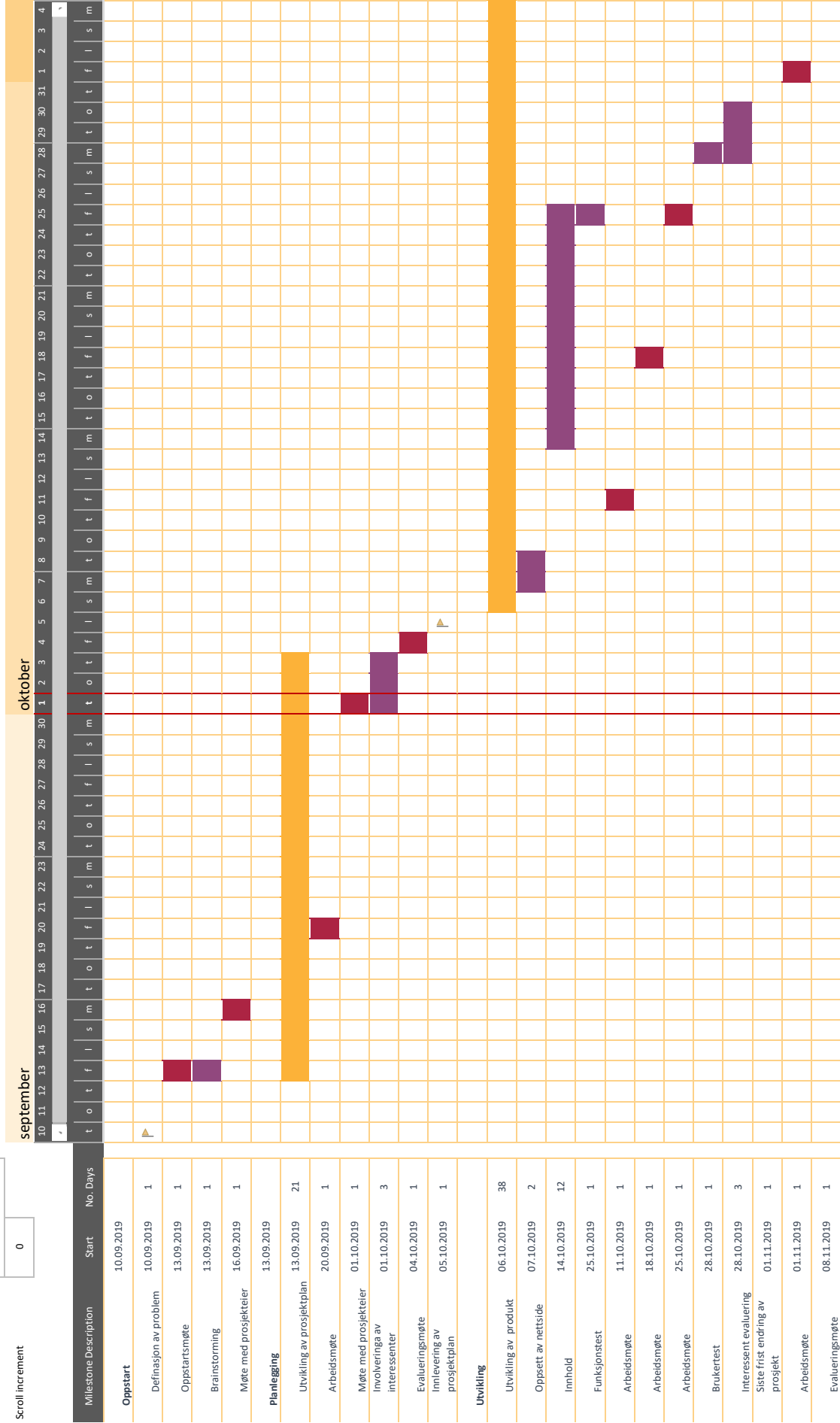

Digitaliseringsprosjekt

Gruppe .10

Oppstartsdato 10.09.2019

Scroll increment 32

Legend:

Fase

Aktivitet

Møte

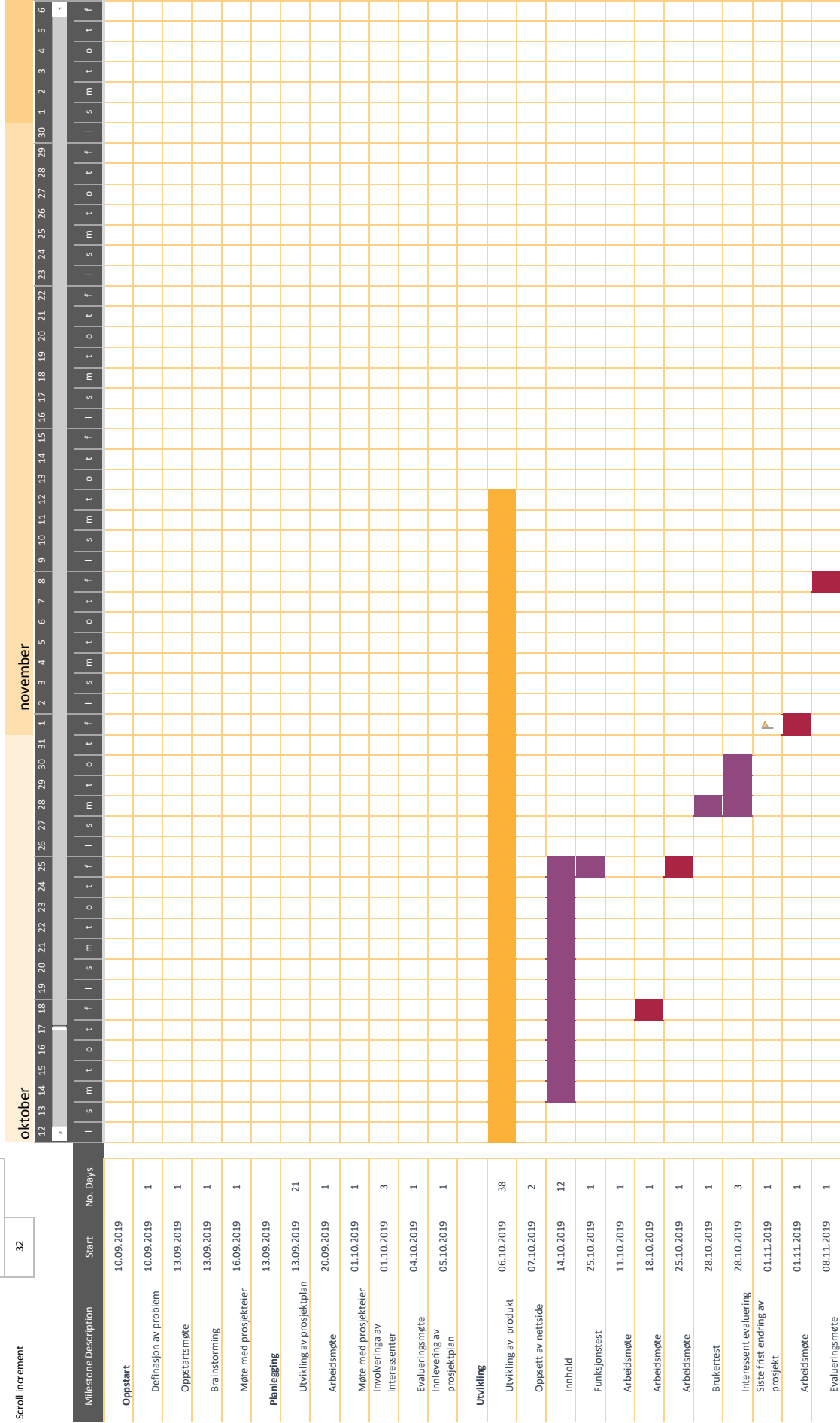

32

Scroll increment

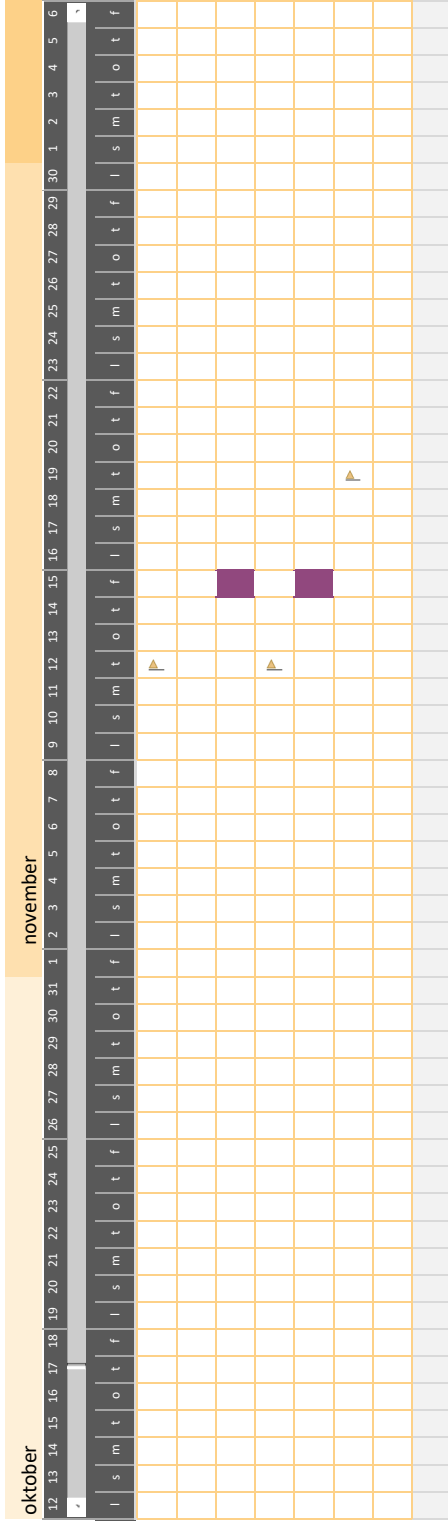

Milestone Description	Start	No. Days
Imnlevering av produkt	12.11.2019	1
Evaluering		
Intern evaluering	15.11.2019	1
Ekstern evaluering	12.11.2019	1
Tredjeparts evaluering	15.11.2019	1
Imnlevering endelig rapport	19.11.2019	1

To add more data, insert new rows ABOVE this one

B Vedlegg: Student survey

Students needs and demand – Survey

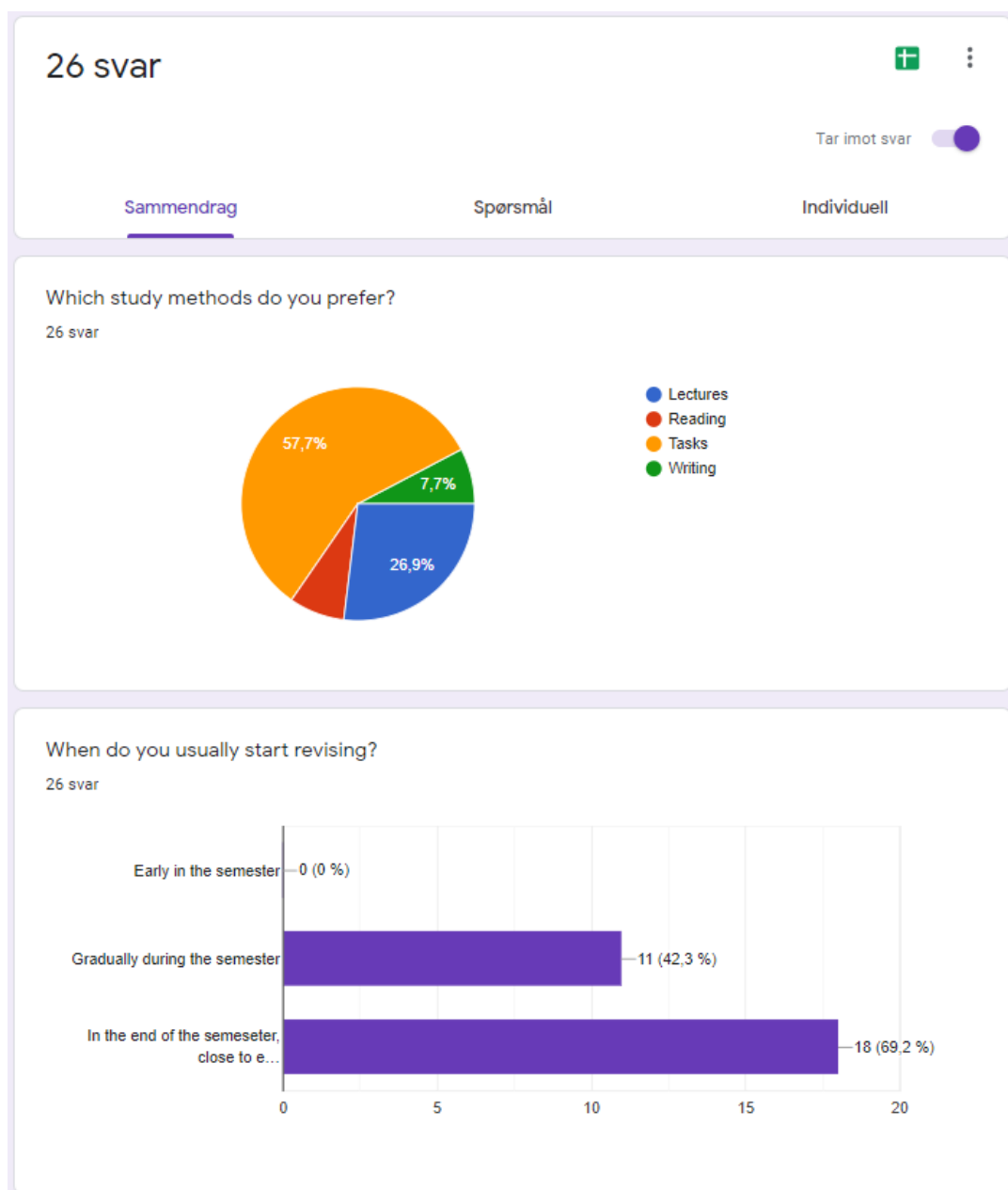

How do you collect information in the course?

26 svar

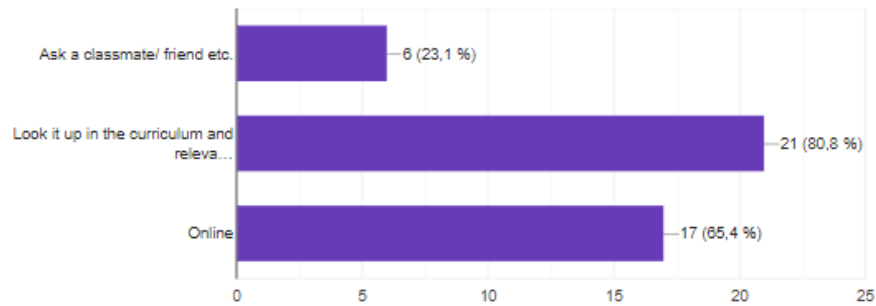

Do you agree with the following statements....

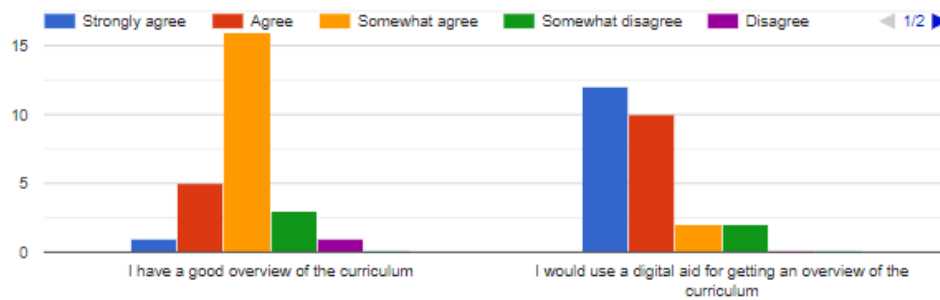

Choose one or more of the following statements. A digitalized aid....

26 svar

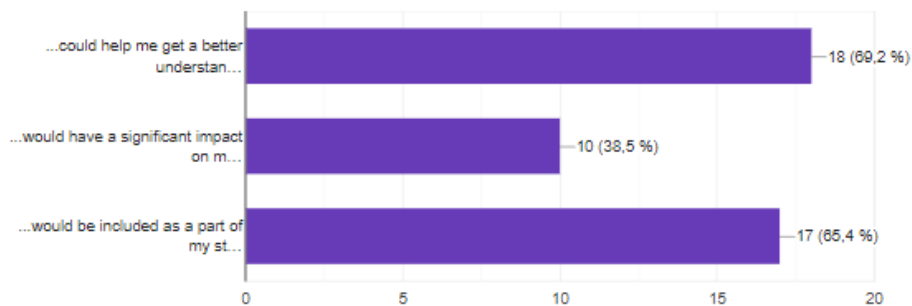

Do you agree that your learning ability would be improved by;

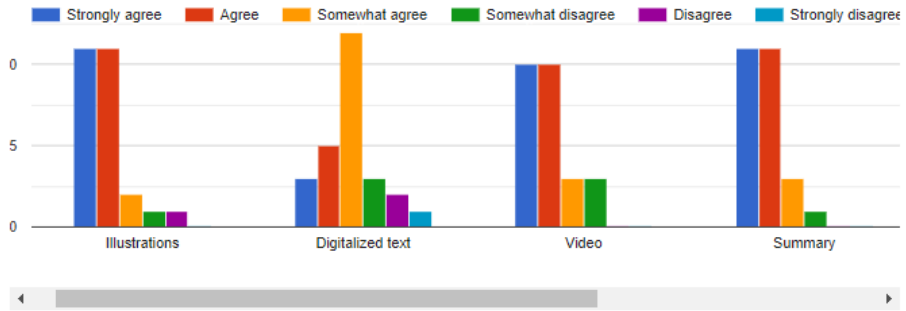

Do you agree that your learning ability would be improved by;

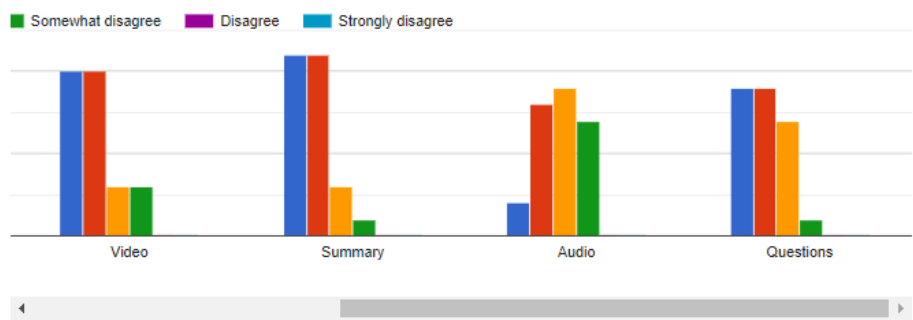

C Vedlegg: Final product survey

Final product – Website survey

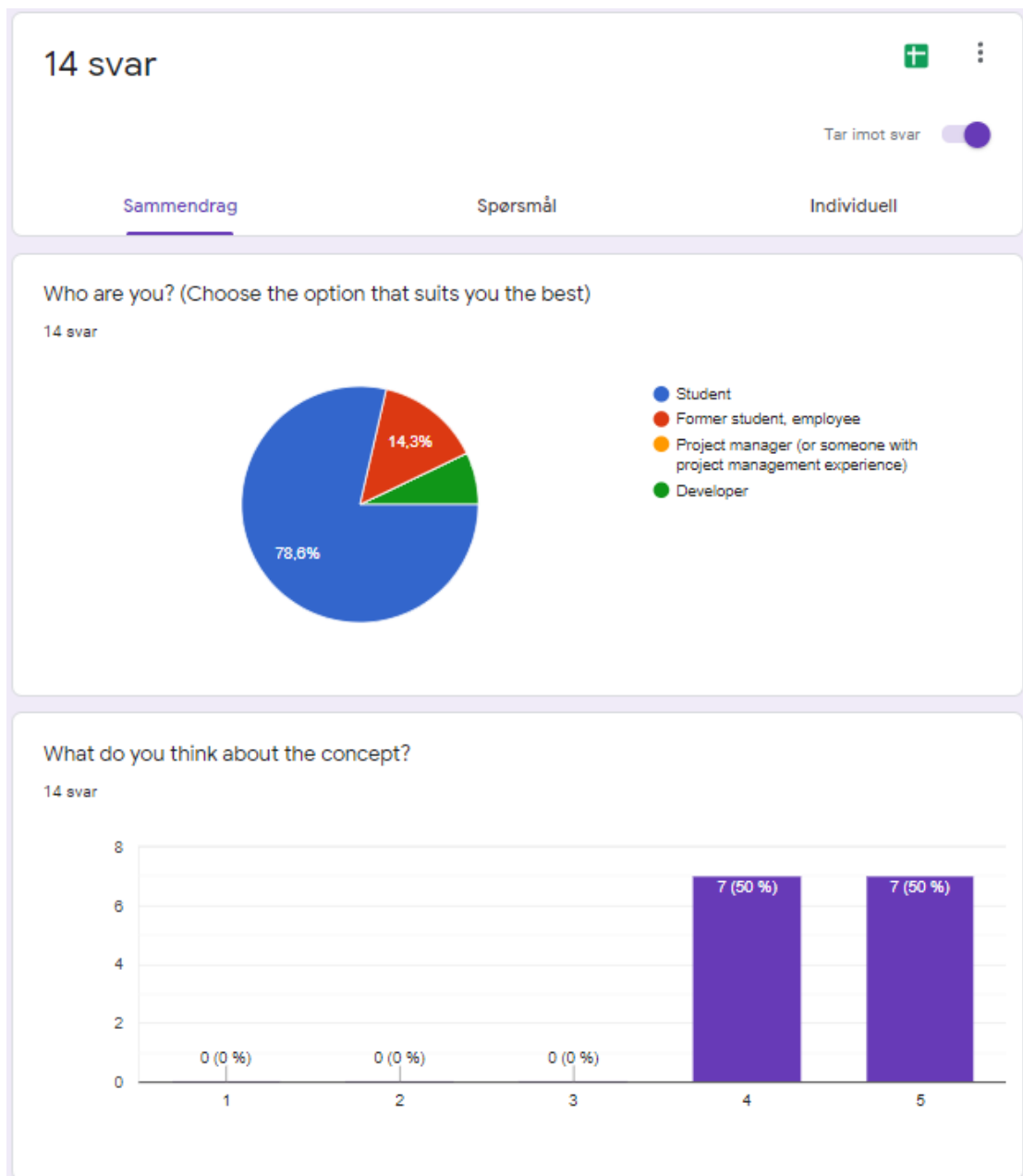

Other feedback on concept?

2 svar

Bra og nyttig! Mye bra informasjon som er komprimert ned i setninger

I liked the concept of the grades, and having the content on a web page with definitions. But I would like to see references to the chapters.

How was the navigation?



14 svar

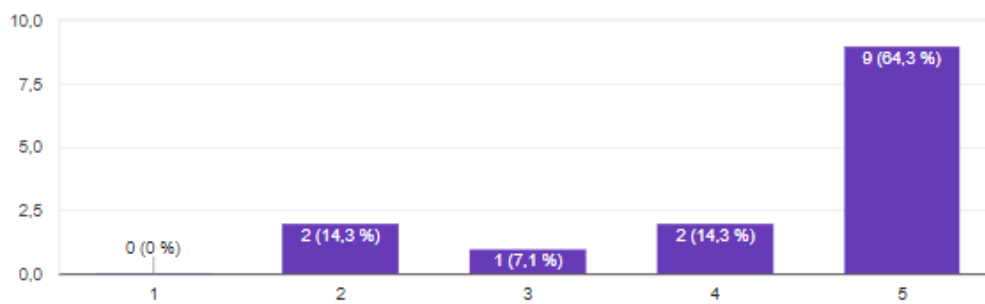

Other feedback on navigation?

2 svar

It took me some time to understand that scrolling or using the top right menu was the same thing.

easier if at the end of each section it is possible to go back to the top

How was the design?

14 svar

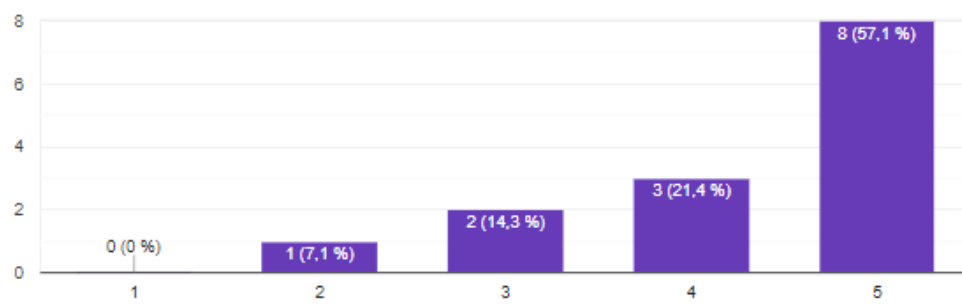

Other feedback on design?

4 svar

More colors would be nice!

I like the design

Good design

everything was just a block, not really clear

Was the content clear?

14 svar

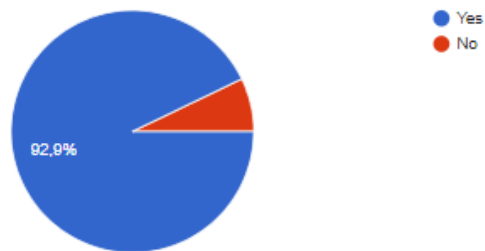

Do you think you will learn about projects/project management through this page?

14 svar

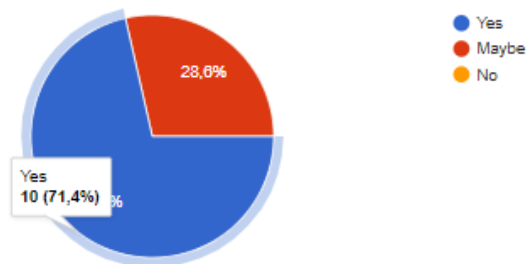

Other feedback on page content and learning outcome?

4 svar

Kan inneholde ulike prosjektmaler. Prosjektene burde heller komme på ny side, enn at alle er på samme. Var litt vanskelig å se hvor neste prosjekt startet

More animations or pictures between the text

Maybe a lot of texts

In order to use that tool for revision it would have been grade to organize the content per chapter.

Would you use this page?



14 svar

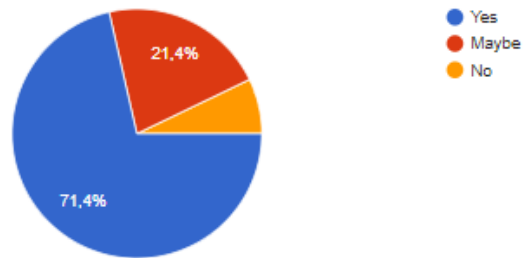

Other feedback?

1 svar

Kan ha andre farger enn svart/hvitt for å "fange" leseren mer. Var litt kjedelig. Tydeligere avgrensninger mellom prosjektene om alle skal være på én side

An interactive game for enhanced learning

Group 11

Vsevolod Karpov	- 74801
Marie Hernæs Larsen	- 767601
Viljar Ness	- 477695
Kristine Owe	- 767524
Sondre Tagestad	- 477712

Preface

The purpose of this report is to analyze how the digitalization project in TPK5100 have been carried out and how the project management part of it was handled. This will be done by going through important aspects of project management, and reflect on how they were handled in this project. We would like to thank the people who helped us with testing our product and for providing us with valuable feedback.

1. Product description and digitalization projects

Our product is a simple game that lets the student learn curriculum in an active and fun way. The game starts with a given amount of resources and have ten turns. For each turn the player/student has to make a choice for a scenario in the project and the resources gets affected based on the choices the player makes. The goal is to do the best choices to deliver on time, within budget and with proper quality. We decided to make this game because all in the group thinks that a game is a fun and good way to learn, and that we had two good programmers who has the required skills to make a game.

The goal of a digitalization project is to use digital or computer technology to increase value in an organization, country, class and so on. Digitalization is not the same as digitization which is the process of turning something analog to digital, nor digital transformation which is the process of using digitalization to change a business model. There are many different types of values that can be increased through digitalization. Cost of production can be decreased, communication can be improved, quality of products can be increased, competence can be learned, and many other improvements. Today digitalization is a very important topic as technology is changing at a rapid rate, and to stay competitive it is important for businesses to implement new technology. It is also an important part in making processes more eco-friendly (Nerja, 2019).

A factor that is important in digitalization is the customer experience. It is always important that the digitalization gives a good experience for the targeted customer group, and some digitalization projects has “improved user experience” as their main goal (Nerja, 2019).

In this project the focus was on how to improve learning by using digital technology. We found the most challenging part of the project was to identify how exactly to make the digitalization valuable as a learning tool. We focused on making the project interactive for the user to make it more involving for the user. A lot of learning is passive, and digitalization can help making it active learning instead. In order to make it active in a way that interests the student, it was important for the group to make game mechanics fun and to make a case story that is both involving the user and at the same time gives a large learning benefit. In order to enhance the learning benefit we decided

on giving immediate feedback to the users after each question when it was fresh in mind, instead of a summary at the end of the game.

Another main challenge of a digitalization project is the digital competence of the group. In order to make a digital product you need to know the tools you are using well enough. Before we decided which product to make, all members of the team shared their experience and competence with various digital tools. It became clear that all members had programming experience, but only a few felt they had enough to make a product. The more experienced programmers expressed an interest in creating a game, and because this also was seen as a potential fun way to learn we decided on this product. The other team members that did not have enough competence to contribute to the programming was given the other tasks that was needed for the project.

2. Self-evaluation of the project management effort in the project

We managed to organize the project group very well. We divided the team into three groups where each group had one main responsibility on the project. We had one group that focused on programming the game mechanics, one that focused on making a case story for the game, and one that focused on the management part (planning, communication and so on). We choose the programmers based on experience to minimize the risk of not being able to develop the game mechanics. For the other two groups we choose based on preferences. This worked well as the programing group did a good job, with almost no bugs in the first implementation, and the other groups did a good job since they were motivated for the task.

The project team managed to identify most of the risk in the planning phase. One risk that were not considered in the planning phase where the risk of group dedication, considering we used a project matrix approach. Another that is tied up to the first is the risk of people leaving the project. One of the members dropped the subject and left the project team. This was a risk we had not thought of in the planning phase, but we handled it well. He was a part of the management group, so to compensate for him leaving we made the two other groups help out the management group. The rest of the risks where much as predicted and were handled well. We did not have much problems with development of the game mechanics, nor with making a suitable case for it. The fact that we identified them in the planning phase and choose how to approach the project to minimize them helped.

We managed to fulfill the success criterias as we delivered a learning game on time that students learned from. We do however see improvement potentials to many aspects of the game, but for a proof of concept solution the project delivered on the success criteria stated in the plan.

Statement: We evaluate our project management effort as successful

Scale	Strongly Disagree	Disagree	Neither agree nor disagree	Agree	Strongly Agree
Your response				We managed to plan and execute the project. But since we had to treat it as a project matrix because of other subjects there is room for improvement.	

3. Self-evaluation of the value to the learners

There are multiple scientific studies on videogames that shows that they create a value to the learners (Griffiths, 2002) (Saghir, 2016). The studies imply that videogames gives a more direct involvement of the ones playing them, instead of a more traditional passive learning environment. For us it was important to test if the game we made had any of these learning benefits. But before we tested the learning benefits of the project it was very important for us to test the technical aspect of the game.

To test a digital project is very important. A lot of digital developments, and especially games, might have many unforeseen bugs on release. A classic example of this is the release of Assassin's Creed Unity (Kelion, 2014), which got a huge amount of backlash. It was important to us to first test the game for bugs. This testphase we only did ourselves. We wanted to have a product that was bugfree before we tested it with other students. For this testing we tried every way of answering and saw if the results were logical. We also tried if there were any unexpected things you could do that would break the game. We found no game breaking bugs, and decided to move on to test the game for learning potential.

We discussed in the group how we should approach this. We saw that other groups had reached out to the class to make them test it out. After some discussion we decided that we would rather try it on other students we know so we could actually test if they learned something, since that they have not studied the subject before. We had each group member find 3-4 students that were willing to try the game and give feedback on it. For feedback we asked questions from the subject that the game covered (5 questions), if they found the game interesting to play as a learning tool, and if they had any comments to the game we could use in the report. In total we had 17 students try out the game and giving feedback.

On the answering subject questions the results was varying. All the testers were able to answer at least one question about the subject matter correctly. The worst result was two students only getting one question correct, while nine of the students got all questions correct. On average the students answered correctly on 3.8 of the questions. This is a good indicator that the students learned something from the game. In hindsight we should have taken the questions with the students before

they played the game as well to map their previous knowledge. Other factors that can explain differences in performance from the test group is dedication of test subjects and how fast learners they are.

On feedback on how interesting they found the game we got mixed feedback. In general the students liked the concept, but saw room for improvement to get them more involved in the game. Asking further questions from the feedback we found out that many of the students would like more graphics and features in the game. As commented by one of the students, “It is a little lifeless. Would be more fun with some animations. At least on the responses to the choices.”. This is something we discussed in the planning face and something we would like to implement. The reason we did not do this in this proof of concept is that we wanted to minimize the risk of not being able to develop a product for the hand-in date.

One of the comments we got that we reflected the general feedback quite good was:

“I think it is better than reading it in a book or going to class, but it didn’t feel like it was something I really wanted to play for fun. I guess it is good as an additional way to learn and test your knowledge, but I think it could need some more interesting stuff happening to be really fun as a game” - Iqran Iftikhar (Answered 5/5 questions correctly after playing)

All in all we are satisfied by the feedback from testing and think it shows that there is learning value in the game, but that there still is features in it that could improve it and increase the learning value.

	Our product is of high quality and we recommend it to be used as learning aid in project management				
Scale	Strongly Disagree	Disagree	Neither agree nor disagree	Agree	Strongly Agree
Your response				We saw that most of our test students learned subject curriculum from playing the game. We still see that there is	

				improvement potential that can both improve the learning potential of the game.	
--	--	--	--	---	--

4. Success factors

Time requirements

It was important to follow a timeframe that gave us enough time for each of the tasks and time to test the product. One of the key time requirements was that the case, and the main game code would be done at approximately the same time so they could be integrated. In all we were able to keep to our timeframe and complete the project.

Communication

In all projects communication is key. The primary communication for us was between the project team members. We also had to have communication with Bassam Hussein (project owner) and the students (end users). For communication within the project team we used a common line of communication through message group. Because the members of the project team are from different lines and studies it was sometimes complicated to find meeting time. We solved this by having some few meetings where we went through the concepts of each part of the project and dividing into smaller task that could be solved individually or with little direct communication with the team. This worked most of the time, but communication and division of labor became a little harder when one of the project team members dropped the subject and left the project. We solved this by having a meeting and dividing the remaining of his task over the rest of the project team. For communication with Bassam Hussein we had an early meeting where we went through our idea and got feedback from him on what we should focus on. This gave us a red-thread to how we should work forward to make a good product. We didn't involve many end users before the testing phase, as we as students of the subject also worked as a representation of the end users. Although a biased one. In the test phase we communicated with end users by letting students try the game and hear their feedback, as well as testing if they learned anything.

Documentation

In a digitalization project, especially one that has a lot of new code, it is important to document and comment on what is done. This is important to make debugging and further development possible. It is also important to keep everyone on the project team up to speed on how everything is developing and what progress is made. This was one of the success factors we were not so good in making sure was followed. Luckily this project and project team was small enough that we didn't

encounter many problems as a result. But we still see that this is an area that we have to improve on. If we were to upscale this project and keep developing on the lack of proper documentation would create problems.

Sub-system integration possibilities

For this project it was very important that the case was made in a way that made it easy and logical to implement as a game. It was also important that the game mechanics was made in a way that made it easy to integrate the case into it. We managed this without many problems

Choosing project structure

When choosing a project structure we had to consider all the other subjects the members of the project team are taking. This consideration forced us to choose a project matrix approach. This had some drawbacks that we did notice through the project. When all members worked on it like a project matrix with different matrices it resulted in different working times and making it quite difficult to find meeting times that worked for everyone. We also noticed that many of the members had subjects that was very demanding, making them not prioritizing this project. Even with these challenges we found ways to get the work done, and manage to create a game within the timeframe. The quality of the final game did not get as good as it could have been if we had the possibility to choose a different project structure. We could have added more options and gameplay factors.

Managing risks

An important part of every project is to identify potential risks and finding a way to minimize or otherwise handle them. Early on we discussed and identified different risks in this project and how to handle them.

One of the major risk factors in developing a game is if the competence of the team is adequate for managing the coding challenges of game development. We decided to leave the task to do the programming to the two most experienced programmers on the team, where one had previously used Unity (a game engine). As the project developed we found this to be a wise choice as the programmers handled the task of making the game very well and did not end up with a lot of bugs. Another risk factor was if the case was relevant for the subject and to make sure all the answers matched with the theory. This was quite a challenge as it is hard for us to evaluate our own

understanding of the subject. The case team solved this by focusing on making questions that could find reference directly from the book. This made sure the answers were correct and relevant to the subject.

We also discussed how we should evaluate the learning potential of the game. We found out that a good way to test this was to try the game on students that doesn't take the subject and ask them some questions from curriculum to see if they learned anything from the game. We found that most of the test users learned some key points from the curriculum.

One major risk we had to discuss was the risk if we didn't manage to follow the timeframe and get a product ready for the presentation. We found that the best way to make sure this didn't happen was to start small and build on from there. This made it possible for us to keep the timeframe and get a product ready.

The last risk we discussed was the dedication of the group. We decided to divide task to make people directly responsible for their job. Then everybody has direct ownership of one part of the project and could be held responsible if it didn't get done. This worked pretty well, but we got some problems as one of the team members left the subject and project. Since he had a clear task it was still easy to divide these and find a way to make it work even with him leaving.

We think the most important factor was communication. This is because almost all the other success factors are dependent on how well we manage to have good communication. It is very hard to fix problems and make good progress if we don't have communication within the group. It is also hard to make a product that is beneficial and can be a learning tool if we do not communicate with the end users and project owner.

5. Most important lessons from your project

- 1) You should use a lot of effort on the planning phase. If you got a good plan that covers risk and gives a good starting point.
- 2) You should define the responsibility of the group members early on. This makes it easier for group members to do work individually and can discussions in the group later on.
- 3) You should find out who has what competence early on so it is easy to discuss possibilities and easy to divide tasks.
- 4) Our advice is to actively communicate with the group. Make sure everybody is up to date and on board on the project.
- 5) We learned that it is possible to handle a project member leaving if the rest of the team is dedicated and communicate on how to handle it.
- 6) We learned that doing a project like this with students from many different lines of study can be a challenge because of finding meeting time that works for everyone, but is still doable with good communication.
- 7) We suggest to keep good documentation from the start. This makes communication easier, and makes it easier when to write a good report.

References

Griffiths, M. (2002) The educational benefits of videogames, *Education and Health Journal*, 20(3), p. 47-51. Available from: <https://sheu.org.uk/sheux/EH/eh203mg.pdf> (Downloaded: 02.11.19).

Hussein, B. (2018). The Road to Success: Narratives and Insights from Real-Life Projects, Fagbokforlaget.

Kelion, L. (2014). Ubisoft apologizes for Assassin's Creed Unity Bugs, *BBC News*. Available from: <https://www.bbc.com/news/technology-30226586> (Downloaded: 28.10.19).

Negerja, B. (2019) Digitalization projects, *Praktisk prosjektledelse*. Available from: <https://www.blackboard.com/> (Downloaded: 25.10.19).

Saghir, A. (2016) Influence of Video Games in Learning, *Journal of Emerging Trends in Computing and Information Sciences*, 7(8), p. 338-342. Available from: <https://pdfs.semanticscholar.org/878e/8549348c445bc36b558c0a481dbf5e3eb9c9.pdf> (Downloaded: 02.11.19).

Peer-review evaluation report

Name of the group we are assigned to evaluate: Group 1

Strengths

The idea of the product is very good, and it is a nice variation from reading text in a book which can become a little boring at length. It can also be a nice way to break up the lectures in the course. The visualization tool used is of very high quality, and has a funny vibe to it. The duration of the video is also very good, as you want to receive as much information as possible over as little time as possible.

Weaknesses

The product had some weaknesses that reduced the quality. The most prominent weaknesses was that the voice in the video was too monotone, robotic and fast. This made it difficult to catch the essence in the case. We had to see the movie several times to catch all the important information. The voice that is too fast and monotone is the main reason for the decreased quality. We recommend that a real person is the voice in the video. Another weakness was that the case-text in the book was more informative than the video.

	<i>The product we reviewed is of high quality and we recommend it to be used as learning aid in project management</i>				
<i>Scale</i>	<i>Strongly Disagree</i>	<i>Disagree</i>	<i>Neither agree nor disagree</i>	<i>Agree</i>	<i>Strongly Agree</i>
<i>Your response</i>				Idea is very good, but the product needs higher quality	

A) On a scale from 0 to 10. What grade would you recommend for this product? 6

Project Plan

Group 11

Vsevolod Karpov

Marie Hernæs Larsen

Viljar Ness

Kristine Owe

Sondre Tagestad

Jakob Alexander Weiss

Description of the product

We will be making a text based game where the player is a project manager. The goal of this game is to give students a more fun and interactive way to practice project management.

The goal for the player is to make the project succeed by making the right choices. The player starts with a budget and timeframe. Choices of the player will affect the budget, timeline, and the player has to balance these to reach the best possible score. At the end of the game there will be an outcome based on the choices the player makes. This is meant to make the student think about how different choices affect simple factors in the project.

There has to be some kind of feedback during/at the end of the game so that the player knows how to improve his/her knowledge of project management. The consequence of each decision could be presented so that the user knows what went right and wrong, maybe along with some relevant theory and real-world experience.

Structure of the game:

The game begins with the player getting a project case and measure for resources used, time used of the project. There are limits on each of these parameters which the player has to try to keep within. There is a predetermined number of turns. For each turn the player will be presented with a situation where the player will need to make a decision. Each decision will have an impact on the parameters as well as give the player a feedback on the choice. This feedback will help the player reflect on the choice. If the parameters goes far over their limit the game can be ended early as the simulated project gets cancelled by one or more of the major stakeholders. This will give an endgame text explaining why the project got cancelled. If the player makes it all the way through the game the endgame will give them a score based on which choices the player makes. The goal for the player is to get as high a score as possible. The score is determined by the combined parameters. This means it can be ok to for example go a little over budget if the project is finished before estimated time.

Overview of the project case in the game:

The project case is inspired by the case "Construction project B4" from the course textbook (Bassam, 2018). This case is chosen because a construction project is something the end user probably can relate to. It is also motivating to have a tangible end product. Another reason for the choice of case is that a construction project can easily be written as a

storyline. The case is modified and adjusted to make it more interesting and appealing for the user.

In the project case the user is a project manager that is going to construct a luxury hotel in Trondheim. Construction of the hotel has a timeframe of 2 years and a budget of 750 million NOK. In addition the construction process has to be environmentally friendly and the end-result is to be of high quality since it is a luxury hotel. Timeframe, budget, quality and environmental friendliness are the success criteria of the project. The user also has to manage the stakeholders of the project. The stakeholders in this case are the owner, Trondheim municipality, contractors (builders, electricians, plumbers, etc.), neighbours, hotel management and external suppliers needed for the daily hotel operation. The construction team has previously completed a similar project that failed on some of the success criteria. This resulted in bad morale among the construction team. The project manager will therefore need to increase the morality among the workers and contribute to a better work environment.

Learning goals of the game:

The learning goal of the game is to let the students try themselves as a project manager and get an understanding on how choices affect parameters in the project. By playing this game students should reflect around choices in a project and what consequences they have. The game will help the students reflect by giving feedback on their choices.

Benefits of the product

We have experienced that a lot of theoretical subjects can be a little one sided where one just read about project and reflects on choices made. While this definitely has learning potential it doesn't necessarily make the students reflect on how they would make choices as they come up. This game will try to make the students use what they learn by analyzing an other project to use when they themselves have to do them. This will help them reflect more on choices and consequences. It is often easy to think post-project when the consequences are displayed that "of course that was a bad decision", but it might not be that easy when one is presented with the choice mid project. Often choices have consequences the project team doesn't consider which might greatly affect the project.

Many studies show that practical experience is a really effective way to learn. By making an interactive game we create a close to practise experience that will help students learn from doing, not just reading.

Another benefit is that an interactive story where your choices matter are often more intriguing and fun than plain reading about it. This can help the students get more motivated to learn and be active in the subject.

Stakeholders

Bassam Hussein: As the teacher of this subject he is a major stakeholder. A good product can help him in making the subject better. We will try to actively include him by talking to him throughout the project to get feedback to make a successful project.

Students: Students are the end users and if they find the product useful and learn from it is what decide if the project is a success. We will try to involve and ask other students than ourselves what they think and how they would like the product.

Project team: It is the project team's task to make the product. We have divided the group into three "departments"; management, IT and creative. We need good communication through the project.

Potential other user: It might be possible to make the product adaptable for other subjects. We will not put too much effort on this before we know if it will be easy or not.

Risks

A video game is ambitious and the main risk is therefore that there will simply not be enough time to reach the specified goals. Generally in programming the task might often be more difficult than the estimates. To lower the risk we will keep it simple in the start and build on it from that. This will make sure that we have a working product at the very least.

The storyline has a risk of being too complex or abstract for the end-users, resulting in loss of interest and reduced learning outcome. In addition, there is a risk the storyline doesn't appeal to the end-users. The storyline will take root in one of the cases from the course literature. To make the case more appealing the storyline will be modified, and the language will be simplified where possible. Also, we will test the interest and complexity to the storyline by having other students, both in the course and outsiders, review it before the final product.

There is also always a risk when working with a completely new team that the cooperation doesn't work as planned. People might have other goals and values than one thinks. To avoid problems here we will focus on good communication.

Needed skills

- Game development, Unity
- Content for the game, thorough understanding of a project case and the background theory
- End user testing, someone should learn how to do this properly in order to test our system

The IT-crew need to learn how to make a game in Unity. One of the project team has already used it. He will need to share his experience with the other person in the IT-crew. Other than that they will need to use the internet to read on how Unity is and how to make games. They will also need to use the internet to search up problems as they come.

The storyline-crew need to have a thorough understanding of the theory of the course in order to create a game that covers a large part of the course curriculum. To acquire these skills the storyline-crew will use a lot of their time studying the theory of the course and implementing this in the storyline. Since the game is for learning-purposes, there needs to be a lot of theory in the game, both as part of the questions and comments. In addition they need to be creative. This is a skill that is difficult to attain over such a short time-frame, but with their background combined with research and inspiration from others it should be enough for an interesting story.

We also need to do research on how an end user test in a product like this should be performed properly and how to qualify the feedback to make improvements.

Project breakdown structure indicating the major deliverables, sub-deliverables and work packages

The projects major deliverable is a ready to use game that offers its users (e.g. students) the opportunity to significantly improve their understanding of project management in a fun and interactive way. It should offer the opportunity to improve lectures and/or use it in a private learning environment.

To achieve this the project has to deliver two sub-deliverables. On the one hand, its underlying structure (the program) has to work without issues that prevent the user to play the game as it is designed. The IT-crew will focus on that sub-deliverable.

On the other hand, the storyline has to stick to the case while offering a stack of choices that feel natural to the user and make sense in a project management way. The storyline has to be consistent. Furthermore, the offered explanations on why a made choice was good or bad and why it affected the course of action in the way it did must be presented in a user-friendly and understandably way. The Creative-crew will focus on achieving this.

Finally, it is the managements task to ensure good communication between these two teams two come up with a working product in the end. To achieve this, it will be necessary to enable the IT-crew and the Creative-crew to come up with solutions for:

- 1) Main concept of the game - the flow, goals e.t.c.
- 2) Case scenario, storyline, questions and answers.
- 3) System architectures
- 4) Integration of cases into game
- 5) Fault testing

Project schedule

To provide a working product after the relatively short time frame it is necessary for all teams to work at the same time. Therefore the IT-crew works on the programming while the Creative-crew focuses on the storyline from the very beginning. This makes additional time for combining game and storyline necessary and adds some potential risks. However, it is essential to succeeding.

The project schedule for the Creative-crew:

- Case definition 24.09.2019 - 08.10.2019
- Drafting 05.10.2019 - 15.10.2019
- Completing Storyline 10.10.2019 - 20.10.2019
- Fitting storyline for game 20.10.2019 - 27.10.2019

The project schedule for the IT-crew:

- Main concept of game 24.09.2019 - 01.10.2019
- Game system architecture 01.10.2019 - 15.10.2019
- Case scenario, storyline, Q&A 01.10.2019 - 15.10.2019
- Integration of case/storyline 15.10.2019 - 27.10.2019

Finally, there will be the necessity for testing which involves all team members and end-users:

- Fault testing 22.10.2019 - 01.11.2019
- End-user testing 30.10.2019 - 08.11.2019

The following Gantt chart gives an overview on the schedule. The red lines mark the different deadlines for the project.

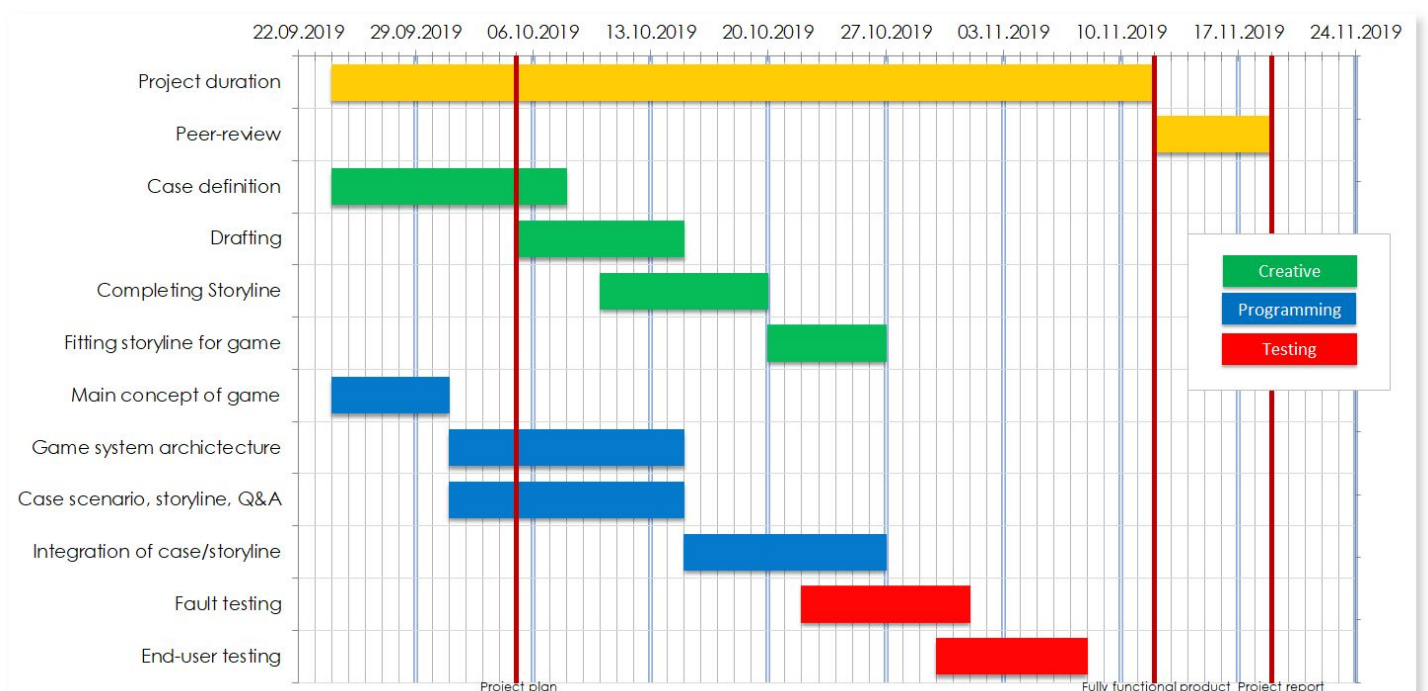

At all times it is most important for the Management-crew to ensure the flow of necessary information between the IT-crew and the Creative-crew.

Most important success factors

- Commitment by all team members - to come up with a working game within the given time frame every team member has to be committed to the project and its goals.
- Continuous communication at all levels - communication between the subgroups is very important because of the parallelly executed tasks. It is crucial that the subgroups run important changes and such by each other before implementing them.
- Sticking to the schedule - as there are predefined deadlines, needing more time is not an option. Therefore, it is most important to stick to the schedule as much as possible. Otherwise proper testing before delivering the product would not be possible anymore which would result in a potentially not working final product.

Characteristics of digitalization projects

In a world that got overrun by the internet, computers, mobile phones and electrical devices in general in the last few decades, digitalization is happening around us all the time. We might even be so used to it happening that we do not notice it anymore.

There seem to be four major characteristics of (successful) digitalization projects:

- **A focus on customer experience**

It is crucial for companies to completely understand who their customers are, how they think and how they act. This is the key for being able to offer a satisfactory customer experience.

- **Well defined operational processes**

To allow for a successful digital transformation, the company needs clearly defined operational processes. That is very important for generating data needed for decision making. This data is also enabling the company to better recognise their customers needs and allows for good knowledge flow within the company.

- **Clear data and process integration**

Because of the data the company gets from well defined operational processes decisions can be made based on facts, not feelings. This leads to better decision making and offers the opportunity to improve not only operational decisions but strategic decisions as well.

- **Value instead of activities**

Digital transformation enables a company to rethink how it delivers value to the customer. It challenges the status quo and provides opportunities to deliver value in new innovative ways. This often even leads to new business models.

The institute for digital transformation offers a good article for first steps into that topic.

<https://www.institutefordigitaltransformation.org/four-characteristics-digital-transformation/>

References

Bassam, H. (2018) *The road to success*. First edition. Bergen: Fagbokforlaget.

Tedder, D (2016) *The Four Characteristics of Digital Transformation that Deliver Spectacular Results*

<https://www.institutefordigitaltransformation.org/four-characteristics-digital-transformation/>

Animated real-life case
project. Cost Optimization of
a Product

APPLIED PROJECT MANAGEMENT
GROUP 13



Contents

1.	Preface.....	3
2.	Digitalization projects.....	4
3.	Self-evaluation of the project management	5
4.	Self-evaluation of the value to the learners.....	6
5.	Factors that have contributed to failure / success.	9
6.	Most important lessons from your project.....	11
7.	Peer-review report.....	13
8.	References.....	14

1. Preface

Our project is based on a video that exposes a case related in the production of a new product in order to improve the opportunities in the market of technology. The main purpose of the video is to give an objective point of view of the situation and to help the spectator to understand the case and all the phenomenon that happened during the project management and the execution of it.

At the beginning, we manage that as we said at the description of this project. We divide our product (the video) in groups.

One of them was the responsible of the video script, this group had to read carefully the case and explain in the best possible way. In the script we included the pictures and the scenes to improve the comprehension. This group was formed by Alex and Aleix.

Once we had written the script, we divided the video in two parts. The first part of the video was in charge to Zain and Samad and the second part to Oscar and Jose.

Zeeshan recorded the voice of the video, and finally Alex edited the video joining the two parts and the voice, using the VideoScribe Software purchased by the group, as the trial version was not effective.

- **Group number: 13**

- 1) Alejandro Bergillos Rivas 519777
- 2) Oscar Ivanez Encinas 502064
- 3) Zeeshan Ali 502344
- 4) Zain Munir Bin Tariq 521976
- 5) Jose Paulino Peris Sastre 502063
- 6) Aleix Garsot 519747
- 7) Samad Ashfaq 499055

2. Digitalization projects

As we said before, our project is a video. We selected this product because we thought that would be the best tool for express what we want to describe. But at the beginning we discussed about which kind of format we should, at least, contemplate.

We had some ideas like a webpage, mobile application, interactive game, and an eBook format.

We made a brainstorming with advantages and disadvantages for each product format, for example: the webpage is a good way to inform accurately, you can write large information and keep it all organized and clear. But it is hard to keep the attention of the consumer. It is right that if the design of the webpage is pleasant you can achieve more audience, but in a conclusion is not easy to get.

We discussed a lot about mobile application, nowadays everyone has a mobile, so this makes more easier the accessibility. You can write in a clear way the information, might be not like the webpage but similar, avoiding larges texts and make it visually attractive. The strong point is the dynamics, in the mobile phone there is a huge dynamic, you can take advantage of this and ensure that the attention of the consumer would be high. Unfortunately, none of us know how to develop an app. We could learn how to programme it and how to verify the app in the app store, but the main was: It will be worth? For sure that this will takes us a lot of time, also we will assuming a lot of risk and a lot of possibilities to failure. Will be worth to put a lot of effort doing an app for first time? Might be, we can achieve a video with a nice performance putting the same effort. As you can guess, finally we dismissed the application for a mobile.

To be honest, the video was our first idea and once analysed, the best. In a video you can explain the message and at the same time adding pictures and some other tool for make it easier and clearer. Furthermore, this images also are working in keeping the attention all the time. It is really hard to stop looking the screen when this is showing graphs and pictures every time without interruption. Another good reason to consider the video is that the consumer has the power of time, they can pause, go back and go slowly whenever they want. If they do not understand something or they want just to settle the knowledge, it is possible to repeat it the times that they prefer.

To sum up we saw in the video a great opportunity to transmit what we want to transmit, since we said, finally we chose this product to develop our digitalization project.

In our case the challenge was the digitalization itself, none of us have the knowledge for programming a complex code. We know the basis of some programming language, but we do not have enough experience to transform this knowledge into a product. So that was the first and the main challenge that we met, and we solved this meeting several times, and talking between us, exposing all the capabilities and weak point that everyone could bear. Once that we had known our limitations, we could refine in the best way our goal.

Another challenge for us was the management, at the beginning we were a little bit late respect to the plan that we design for the project. Basically, we started one week late because nobody realized that we had to start at this date. That is possible the only problem that we had in terms of management and organization. Although, we have to say in our defence that we could manage the timing, it is true that we started a bit late, but we put extra effort in order to accomplish the deadlines that we according by ourselves.

3. Self-evaluation of the project management effort in the project, success or failure? And why?

The final delivery has been different that the original one. We have kept the video format, but we change the way to produce the video. Our first idea was a video recorded with a normal camera, using printed pictures to support the information. The camera would be in a zenithally position and the pictures would appear manually in due time. We realized that this would not the best way to produce a video. We thought that this kind of format would not be formal and also would not be visually pleasing. For that reason, we look for similar videos on *YouTube*, we saw many formats and finally we choose our favourite. We wanted to get a formal format but enough pleasant and dynamic to keep the attention of the consumer.

The software to produce the video was new for all the group members. That is one of the risks that we had to deal with. But this risk was smaller in comparison the problems that we would have to take making an application for mobiles. So finally, we take the risk of the video software and we started our product. The truth is that we thought that

we will have to put extra effort to understand the software but in fact, was not so difficult, we quickly understood the way that the program works.

Where we had more difficulties was when we were joining the two parts of the video and the audio. To put everything together and well-coordinated we use another video editing program, and that did cost us more to understand and to use it. We had to spend more time than we thought in order to get the final video, but as we were doing good in terms of time and planification, this did not become a problem.

We consider that we have got a nice success in terms of project management. It is clear that is not perfect but we achieve all the goal in our planification. Obviously, we had to change some things regarding the original project, and we found some points to overcome, but in general we are satisfied. The only point we would improve was the start, as we said before we went one week late, this could have caused us problems, but we knew how to fix it fast by working hard, and that is what we did. We respected all the deadlines imposed by ourselves, and the little changes that appear in our project were easily solved thanks to our good communication and good time management.

We evaluate our project management effort as successful

<i>Scale</i>	Strongly Disagree	Disagree	Neither agree nor disagree	Agree	Strongly Agree
<i>Your response</i>					X

4. Self-evaluation of the value to the learners? (evaluation of project success) Can you document your assessment?

Identifying the target audience, you make a power move to your business prosperity. Before starting an advertising campaign, you should clearly imagine who these people are. Lots of people make a mistake considering their product to be desirable to all. By and large, this is not true. In our case we chose target audience as university students, professors, researchers depending upon their background, experience and connection with the project management field as well as engineers or layman who have experience from any field.

There are many things to consider when discussing the learning potential for our product, including the ability to produce value at the ultimate scale. Formal research tools like concept testing, prototype testing, test markets and focus groups can help determine the market viability of our product. However, these can be complex, expensive and time-consuming.

So the group decides to make a Google Form to assess the final product which includes the 5 questions asked about the key concept in the video, animation performance and overall case concept mentioned in the video.

The 10 respondents submitted the response after watching the video.

The principal and most complicated task for is a definition of the target group. To evaluate the overall value of the product, respondents were chosen from different areas depending upon their background, experience and connection with the project management field. Although the topic of the video is very wide, and number of fields can gain a good knowledge about the topic, but we make our scope narrower due to the cost as well as study hours of the project course. We limited our informants to the people having direct connection with the project management field or the engineers from the different fields.

Who are you? (Choose the best option that suits you)
10 responses

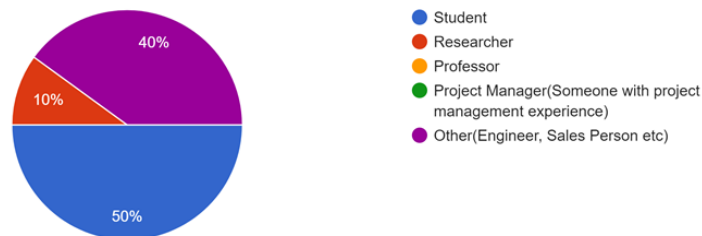

What do you think about the main concept in the video?

10 responses

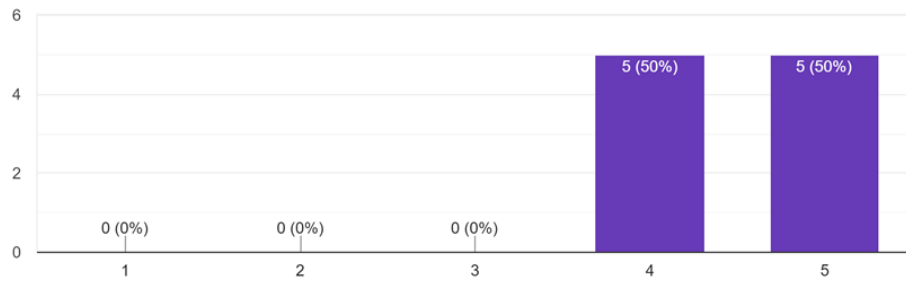

How was the quality of the video?

10 responses

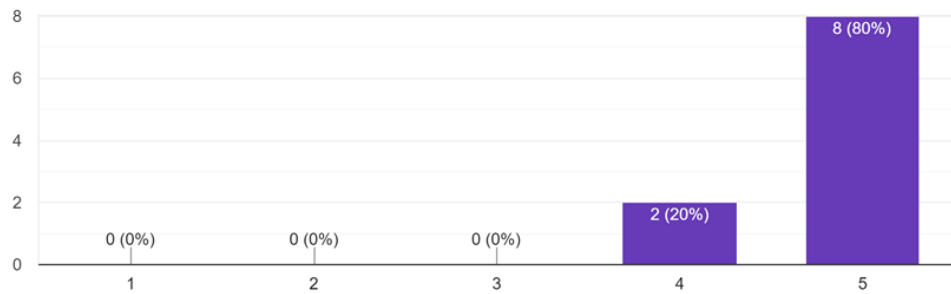

Animations were good enough to explain the concept?

10 responses

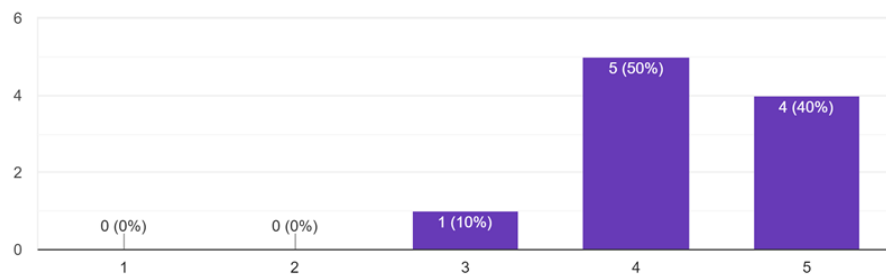

Do you think these type of videos are effective for students to understand the concepts?
10 responses

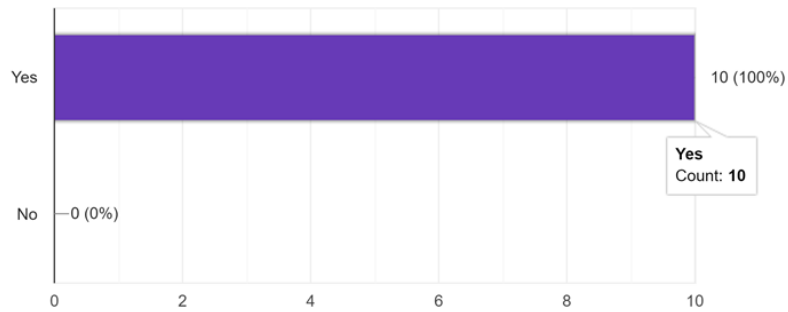

Our product is of high quality and we recommend it to be used as learning aid in project management

<i>Scale</i>	Strongly Disagree	Disagree	Neither agree nor disagree	Agree	Strongly Agree
<i>Your response</i>					X

5. Factors that have contributed to failure / success.

Top 5 factors found in successful projects are:

1. User Involvement
2. Executive Management Support
3. Clear Statement of Requirements
4. Proper Planning
5. Realistic Expectations

The report concludes that these were the elements that were most often pointed to as major contributors to project success. Will these elements alone guarantee success? But if these are done well, we will have a much higher probability of success.

The next category that proved to be challenged that is they were completed buy were over budget, over time, or did not contain all functions and features originally required.

Top 5 indicators found in Challenged projects are:

1. Lack of User Input
2. Incomplete Requirements & Specifications
3. Changing Requirements & Specifications

4. Lack of Executive Support
5. Technical Incompetence

And finally, a list of all the top factors found in Failed projects:

1. Incomplete Requirements
2. Lack of user involvement
3. Lack of Resources
4. Unrealistic Expectations
5. Lack of Executive Support
6. Changing Requirements & Specifications
7. Lack of Planning
8. Didn't Need it Any Longer
9. Technical Illiteracy

The first thing is to understand what this term refers to when it comes to determining needs. Generally speaking, 'needs assessment' is a phrase about evaluating the resources needed to complete a task or project. It is used in project management to determine the time, financial commitment and personnel needed to complete a project.

Needs assessment and project management go hand in hand with project managers undertaking this process to make a project's objectives a reality. Conducting an objective estimate of the resources needed for a given project would help prevent future complications and provide a basis for calculating the budget necessary for the project. The method of determining needs will proceed.

There are some basic steps that you can work through to determine what assets will be needed to complete a project and conduct an evaluation of needs.

1. The first step in performing needs assessment is to gather information on what is needed and consult with staff whose expertise will be integral to the project. It is also useful to discuss which technology, tools or other resources are required to perform the required tasks.
2. The second step is to identify the problem that needs to be addressed and prioritize the processes that need to be undertaken to create a resolution.
3. The third step in the evaluation of needs is to decide which solutions might be necessary if unexpected situations arise.
4. The fourth step is to reach consensus and agree on what is needed with the project's senior management. They will need to be informed about what is

needed and they will have to agree to the allocation of funds and resources outlined in the need's assessment.

6. Most important lessons from your project

Prior to begin the lessons learned from the management of project, is important to highlight some facts. Since the initial stages of the project, it is important to realize the importance of the organization. All the students have different schedules and activities they must do. Besides, it is difficult to divide the workload of the project for making everyone in the group contribute for not getting bored but not in huge amount to get the group members overwhelmed. The group learned that writing a cooperation agreement, determining the organization and the possible rewards and penalizations, in the early time of the project is an excellent idea to fix these problems.

Regarding the lessons of the project itself, the first thing useful to do, my advice is brainstorming about what kind of project is more suitable for your group. Having group members with knowledge in programming will make easier the development of an app. However, recording an animated real-case video will be easier if the group members specialized in video editing. Nevertheless, if any of the group members have any specific background for this kind of project, we learned that there are several tools and programs accessible for beginners that will make the project easier. Search and find these programs and get familiarized with them as soon as possible is critical for the success of the final product

Once the category of the project is selected, it is time for planning the development of it. If the first two points were fixed, you should have organized time for work in the project, and the project should be well defined. In our opinion, analysing the project and divide it into smaller pieces will make the workload reduced and the motivation of the group will increase due to the feeling of being finishing some part of the project.

If you follow these bullet points, the progress of the final product will be faster and easier.

However, at the last stages of the project, normally approaching the exams, the up and down emotions of the students can make the teamwork difficult. We learned that, even though it is difficult to control it, having periodic meetings and communicate the

schedule problems of each member will reduce the possible complications and lead to better results.

To conclude, we think that the most important advice we can make is trying to make all members involved and motivated with the project is the easiest way to success.

7. Peer-review report

Group 11 Product Review.

A) Based on your evaluation (as a group) please indicate the strengths and weaknesses of the final product.

Unfortunately we could not manage to open the game file.

B) Please evaluate the degree of your support to the following statement (group-based evaluation):

The product we reviewed is of high quality and we recommend it to be used as learning aid in project management

<i>Scale</i>	Strongly Disagree	Disagree	Neither agree nor disagree	Agree	Strongly Agree
<i>Your response</i>	X				

C) On a scale from 0 to 10. **What grade would you recommend for this product?**

0. (Because we could not be able to open the file, we tried with different pc's)

8. References

1. **Hussein, Bassam.** *The Road to Success> Narratives and Insights form Real-life Projects.* s.l. : Fagbokforlaget, 2018. 9788245024449.
2. **Parviainen, M. Tihinen, J. Kääriäinen and S. Teppola,** “Tackling the digitalization challenge: how to benefit from digitalization in practice,” *International Journal of Information Systems and Project Management*, vol. 5, no. 1, pp. 63-77, 2017.



Norwegian University of
Science and Technology

Advancing learners' engagement and retention level through an enhanced e-book.

Project Assignment for TPK5100, Group 14

Preface

This report serves as an aid in understanding the process and progress of the given assignment of group 14. The intention of this report is to reflect around and evaluate the process that culminated in the deliverable, submitted in early November. The deliverable is an enhanced E-book, with added functionality, compared to the printed version. All of the included enhancements are designed to help the reader engage with the learning material, furthering their understanding of the subject. As the e-book is a one chapter book, it should be seen as a *proof of concept*. Turning the entire book into an e-book is possible, but due to limitations in time, it was decided to stick with just one chapter and make that work. We would like to extend our gratitude to the Professor, Bassam Hussein, for providing us with access to the learning material utilized in finishing the project and the video, uploaded to youtube, we are utilizing in our E-book. In addition we would like to thank Kristin Hafseld for guiding us through the assignment and Bertha Joseph Ngerja for introducing us to digitalization projects.

Group number: 14

Student names and student number:

1. Jakob Oseid (492311)
2. Emil Karlsen (492304)
3. Tausif Ahmed Ishtiaque (520663)
4. Joris Megret (518993)
5. Ikram Mouchrik (519212)
6. Stine Arctander (509169)

1. Digitalization projects

For our project we decided to create an interactive version of a portion of the book “The Road To Success”. An interactive ebook allows the reader to become immersed in content and allows them to think outside the traditional linear format. They let each bit of content function as a stand-alone part of the whole.

In digitalization projects, the main objective is to transform processes, by adopting or increasing the use of digital solutions. This is done in order to increase efficiency and overall improve the lives of the users. In order to produce a finished product there are a lot of steps and potential pitfalls.

For our project the main challenge was to get to grips with the tools needed to help bring life to our vision. None of the group members had any previous knowledge or experience with transforming a book into an E-book. For a short amount of time we were at a loss of how to achieve the goal. Luckily this ended up being solved fairly quickly, because a team-member came across a tool that would be crucial in the development of our deliverable. With the use of an off-the-shelf solution (and a bit of customization of course) we were able to create a final deliverable.

Many of our experiences, which we will elaborate in the next paragraph, are typical for digitalization projects.. First of all there are almost always technical difficulties that present themselves. They may manifest through trouble with integration of code, limitations that ends up disrupting the timeline and a need to scale back ambitions, or simply, trouble for the end-users. Many of the problems that project management literature addresses with digitalization projects, such as employee pushback and limited budget, were not valid for our project. The only real issue the team encountered, resource wise, were limitations in time.

Deadlines were the “bane” for us in this project, and a source of relentless and worrying pressure. Of course as in every project, we faced some bumps in the road when creating our ebook. Digitalization is difficult, and full of lessons learned the hard way. But in spite of challenges, it’s worth the trouble. Growing interest in primary source material, an increasing impatience with manual searching, space savings, the need to preserve and archive in multiple formats, and the

expectations of students are driving a need for digitalization. The problems that we faced, in no particular order:

1. Compiling and managing the raw data
2. Editing the book itself
 - 2.1. Getting notes to work and look nice
 - 2.2. Editing typos and making corrections
 - 2.3. Creating Norwegian content that is a concise and accurate representation of the original text
3. Making sure the figures, tables, etc. embedded are of a correct resolution.
4. Ensuring compatibility of the game widget (crossword puzzle) with the e-book (epub file) without any complications.
5. Converting a word file to a tolerable ebook

Making an ebook can be overwhelming. Not only do you have to write the content, but you also need to design and format it into a “professional-looking” document that students will want to download and read. Although students of the TPK5100 course were assumed to be the primary beneficiaries of this digitalization work, it seems apparent now that this can be considered to be a very handy tool to introduce anyone into the concept of stakeholder analysis and management.

2. Self-evaluation of the project management effort in the project, success or failure? And why?

The term effort refers to what we need, what it is required in the attempts to arrive at completion of a phase of a particular schedule activity and/or work breakdown structure component (WBS), a distinct control account, or the project as a whole. In our case, for this project, the unit to quantify the effort is in hours worked per week. Indeed, the effort put in the project can be quantified by this way. But at the end, the whole effort must be counted over months, from the beginning of the project and the end (August - November). A helpful way to view the definition of effort would be to

directly contrast the term effort with the term duration. Effort can be measured in terms of individuals or in terms of the team as a whole and anticipated effort can ultimately be measured compared to the ultimate efforts expended. In our case, since we divided the task to be more efficient, but we still worked as a group, with the same dynamic, the measure of the effort is here both in terms of individuality and in terms of a team.

Our organization is a small with a flat organisation structure. This type of structure is made possible by the small size and frequent communication. All the information were accessible to everyone. So, it was quite easy to manage and organize group meeting each week to achieve our goal. About the evaluation of the group concerning the effort, we were all of us involved to success this project, with always new/good ideas to avoid some lacks of competences or some misunderstanding, to try to make the project as easy as possible.

As a flat hierarchy group we will use the available resources in dealing with risk. Therefore we will not commit a member of the group as the responsible person, but rather commit an available member, should problems arise. See the appendix 1 to see how to deal with the risks we can encounter. Basically, we identified the risks during the project plan, in order to apprehend and to deal with it as best as possible.

According to our schedule, from the project plan, we were a bit late because we planned to finish the product on the 7th of November, and deliver it the 12th of November. But we finish it and deliver it on the 12th of November. So, our safety margin was necessary because we didn't manage to follow the program planned due to all the risks we encounter.

A) Please evaluate the degree of your support to the following statement (group-based evaluation):

We evaluate our project management effort as successfully

Scale	Strongly Disagree	Disagree	Neither agree nor disagree	Agree	Strongly Agree
Your response				X	

At the end, we can say that our management effort is a success because we overcame the risks incurred in the given time thanks to our good risk analysis at the beginning of the project. So we managed the effort well.

3. Self-evaluation of the value to the learners

In order to evaluate the impact of the eBook, documentation of the evaluation from the end users is needed. To prove the value of the eBook for the relevant end users, a survey was given to a number of the students attending TPK5100 before and after trying out the eBook, both surveys are given in the appendix. The survey was made with google forms, and shared via browser link.

The main focus in the survey given before trying out the eBook was to understand the study habits, and the use of digital aids today for the students. Another thing that was interesting for us was the matter of cost for the product, as well as what features would be important for the students to have access to. In total 33 out of 50 students, selected from the class list, answered the survey given before trying the product. We consider this a legitimate result and considered it when designing our eBook.

From this survey we can tell that 60% of the students finds digital aids important for their learning ability, and the fact that 67% of all the students uses digital aids to a great extent today. This makes a great basis to support what we think is a need for a digital aid in this subject. When we asked about the price of the ebook, there was a great agreement that most of them think it should be available for free, which is something we considered when choosing what software to use for building the eBook. From the total result in the survey given before trying the eBook, it is clear that an aid like this can be adding another dimension from a learning perspective. The features that was most demanded was doing interactive quizzes and videos, which are features that a textbook are not able to include, adding extra value to using an eBook instead or in addition to a textbook.

After completing the eBook, the same group of students received an invitation to review it, and also give us feedback by doing a survey with the same format as they did before receiving the product. In total we got 30 responses in this survey, and we consider this a great response in order to rate the

success of the project.

The first question, and maybe the most important question on the survey given after, was how likely they were to use this eBook for the course. The students had to rate the likeness in a scale from 0-5, where 5 equals very likely to use the product. The results show that most students rated the likeliness from 3-5, where the highest score 30% was at likeliness 4. This means there are still room for improvements to make sure this is a very demanded product for the students. However, we also asked if they would recommend this eBook to their peers, which 67% answered that they would. This means that there are students that are less likely to use the eBook themselves, still would recommend it to others. Also 73% answered that they would rather use this eBook rather than a textbook. This shows that the students are leaning more towards the use of digital aids for studying, if they are given a choice between traditional textbooks and in our case, eBooks. This can be seen in relation to the fact that society is now more digital and computer dependent than ever, both for professional and for private situations, increasing the demand for equal digitization when it comes to textbooks. This can also be seen in the survey as we asked for other platforms the eBook should be launched at, where iOS for handheld apple devices is the most desired platform for the students. The choice of software for building the eBook was crucial for the matter of price as the students close to unanimously stated the importance of the eBook being free. However, the survey given after stated that 33% of the students would pay the lowest cost range 0-100kr for the product. As expected, most of the students still wanted the eBook to be free, this group counted for 57% of the total. This exceeds our expectations for the demand of the product, and proving it is desired to some extent.

At last we asked the students to give us some general suggestions for improvements. Added functionalities such as definitions, off-line mode and dark-mode were requested by different individuals. There was also a request to add more pictures, making the design more pleasing to look at. This is great feedback for taking the eBook to the next step in different formats, making it even more desired by all students in TPK5100. From the total feedback from the surveys we conclude that more digital aids in universities are desired by the students, as well as the eBook we have created for TPK5100 have smart functionalities and can be helpful for studying and achieving a greater understanding for the course.

	Our product is of high quality and we recommend it to be used as a learning aid in project management				
Scale	Strongly Disagree	Disagree	Neither agree nor disagree	Agree	Strongly Agree
Your response				x	

4. Factors that have contributed to failure/success.

Success-factors	Factors that lead to failure.
Good communication	Technical limitations
Dedicated team	Limitations in tech knowledge
Adequate risk assessment	Limitations of 3rd party software
A dedicated set of hours each week	Limited time scope
A realistic project plan	Budget
Dispute resolutions	Offline availability

The success factors and the factors contributing to a project failing are imperative to identify. By doing so, the evaluation of the project immediately becomes more valuable, because the information gathered in the evaluation can be utilized in other projects.

In the evaluation of our project, we have identified these factors and below the factors are shown with an additional explanation on why they are important and their impact on the project.

One of the contributing factors to the success of the group was good communication. Throughout the course of the project, there have been few to none misunderstandings, leading to precious time being wasted. In addition to this, good communication meant that each group member always had an understanding of what was required of them until the next work session, and also the current status of the project.

A project is dependant on dedicated team members. In order to achieve the purpose of the project it required a dedicated team with an understanding of what the end-goal was. Included in this factor is also the understanding that each member committed sufficiently of their time in order to meet the

timeline outlined in the project plan. Actually, wise selection of technologies prevents technical failure of the project.

Adequate risk assessment is a very crucial point. Knowing what risks to minimize and focus on can save tremendous amount of resources, such as time. The most valuable resource during this project was time. Although we were on a tight budget, the project was completed on a pro-bono basis and therefore the costs relating to the project are insignificant. Time, therefore, played a key role in the resource mix.

A dedicated set of hours each week. This ties in with the dedication of the team. Early on in the project the team agreed to meet at a set time each week. This meant that the project gained continuity and that the progression followed the path set forth in the project plan. It also ensured predictability for the times that the team members worked individually.

Any project needs a proper project plan to outline the ambitions and progression of the project. It is supposed to be an aid throughout the entire project. Our project relied heavily on the project plan for guidance. Using it to actively manage time. In addition to this, the plan was essential for deciding what functions to implement. During the course of the project very little revision to the plan was necessary, because it was a realistic plan. The team invested a lot of effort into making the project plan as achievable as possible, which it ultimately ended up being.

During a project of this nature there are bound to be some disputes, but through good communication, differences were hastily be resolved, limiting the impact it had on the project.

Even on simple, straightforward projects like ours there are many areas that can cause the sorts of problems that can eventually manifest themselves in failure. Add to the many possible causes of failure any level of complexity and problems can rapidly escalate into disasters.

There are three potential causes of project failure that are the most important of all and, if dealt with fully and completely, can help to avoid project failure. Those are the Time Scope, Risks and Key assumption. Also important is retaining the skills already available within our group and developing existing and new talent through project management training.

Also, time management is important in a project, as it defines the management of the time spent, and progress made, on project tasks and activities. Excellent time management in project management requires planning, scheduling, monitoring and controlling of all activities. A project, by definition, has an official start and end dates. In order to meet this date, the project needs a schedule. And this is exactly what we did in this project with a Gantt diagram that we fully followed.

As a possible cause of project failure we also have the problem of unfamiliar technology. At first, we didn't know how to use the tool we have chosen for our project but we made sure to pre practice the tools and to see what are their limits. We have also opted for a plan B (another platform/technology).

In addition to that, no or poor risk management is also a reason for project failure. At present, we have to deal with some actual facts in project management. Project failure is the worst case of poor risk management. The goals are not reached and all the investment is wasted along with time and efforts that have been put into the project. In our case, we made sure to anticipate all risks and we

defined the measures to take for each of them, and even the consequences of them so that we know how and what to do if we want our project to succeed.

5. Most important lessons from your project

- 1) Our best advice is to first of all, make a considerate and realistic project plan.
- 2) We learned that continuously relying on and revising the project plan was vital for the entire group to understand the status and the next step of the project.
- 3) We learned that to have good channels of communication is essential.
- 4) Have a contingency plan in place to make sure the “essential” deliverables are always on track despite the additional features being delayed.
- 5) One key takeaway is that, when dealing with a project that has a major element of uncertainty (in our case, it was the use of a new technology that we were not previously familiarized with)

6. References

[1] Hussein, B. (2018). The Road to Success: Narratives and Insights from Real-Life Projects, Fagbokforlaget.

Peer-review evaluation report

Group you are assigned to evaluate: 12

A) Based on your evaluation (as a group) please indicate the strengths and weaknesses of the final product.

Strengths of the project-

A video is a good format, and can be useful for different types of learners. For example dyslectic learners that find aid in having a voiceover and other visual learners. In addition to this a video can serve as a nice break with reading when revising for an exam, in terms of format this project can be very useful.

The project is finished with a 3rd party software, that has been used cleverly. The illustrations are nice and clear, and the quality of the video is excellent. The combination of illustrations, voiceover and text-on-screen, works wonderfully in order to convey the project to the watchers and listeners.

This project is also a great example of digitization, in that it has taken a written source and turned it into a video.

Weaknesses of the project-

Lack of relevant theory: This case introduces a case out of the blue without any hints about what we are supposed to take away from video, which might be a bit disarraying for a novice reader.

Horrible voiceover: The use of computer generated voice over is a bit tedious to get used to and we unanimously agree that a natural voice would be much more appealing.

No elaboration over the book: This is basically an electronic version of a case featured in the original book with no additional features to address.

Ambiguity about project aim: Not sure about the lessons learned at the end of the project or the key takeaways. Also, the “bonus part” starting at 4:30 is not quite clear. Perhaps it was a work in progress that was not completed?

B) Please evaluate the degree of your support to the following statement (group-based evaluation):

Because of this projection being a digitization of a case in the book “The road to success”, it does not add a whole lot of new value to the students. As discussed above, it can increase the value for students having difficulties with reading, and would rather have text visualized. However, the pictures given in the video can be somewhat confusing together with what information is given by voice. This can cause the listener to not being able to focus their attention on the information being delivered to them.

As the video can be confusing for some students, as well as being helpful for students with learning disabilities, the conclusion is that we neither agree nor disagree that we would recommend the video as a learning aid.

	The product we reviewed is of high quality and we recommend it to be used as a learning aid in project management				
Scale	Strongly Disagree	Disagree	Neither agree nor disagree	Agree	Strongly Agree
Your response			X		

C) On a scale from 0 to 10. What grade would you recommend for this product?

5 out of 10

Appendix

Appendix 1: Table risks management (part 2):

Description of risk	Risk severity	Measures/when	Responsible person	Status update/ consequence of measure
Unfamiliar technology	Critical	Pre practice the tools and see what are their limits. Opt for a plan B (another platform/technology) During the execution phase.	The whole group	Project delay. Unwanted extra stress
Dependency on one key vendor	Significant	Pre-qualify new vendors. During execution and initiation phases	The whole group	Mastering a second platform
Copyright infringement	Marginal	Review and read the licensing terms to avoid issues. Understand the copyright laws or rights. During the execution phase	The whole group	Financial restitution
Acceptability of end-users	Marginal	Earlier diagnosis and organisation of surveys During the initiation phase.	The whole group	High dependability on external users
Non respect of the deadline	Marginal	Have a start and complete date for each step. Allow for problems (things don't always go to plan). Get the right resources. "Completion date".	The whole group	Customer dissatisfaction. Negative reputation Bad grades Project management failure

Appendix 2: Survey given before trying the product (Part 3)

How do you usually study?

33 responses

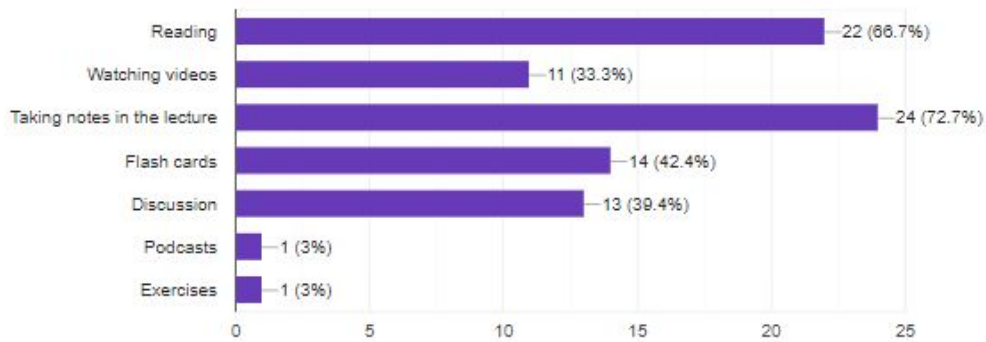

How would you rate your study intensity? (5 is highest)

33 responses

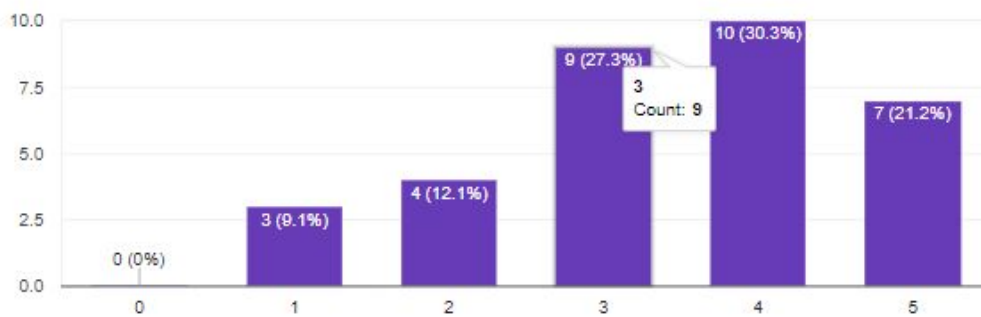

To what extent do you use digital aids today?(5 is alot, 0 is none)

33 responses

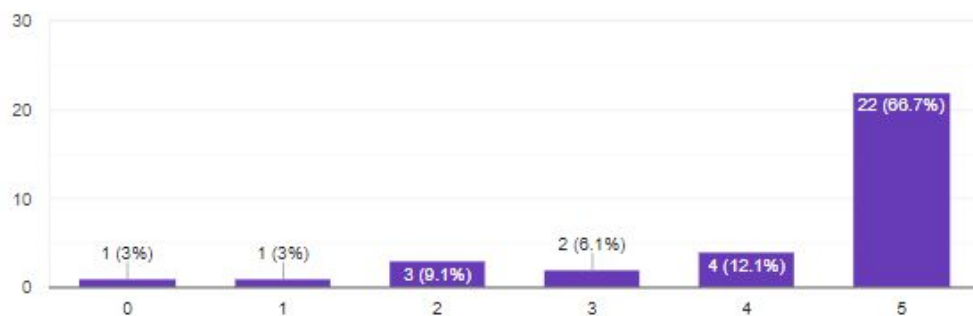

How important do you think the use of digital aids is for your learning?

33 responses

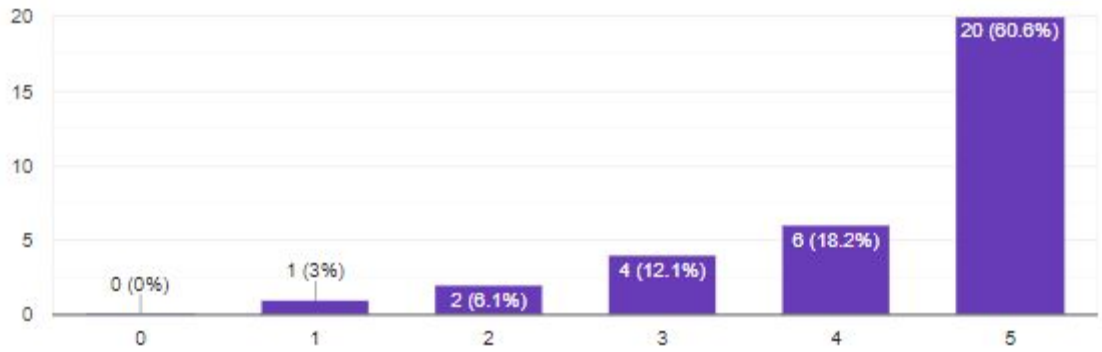

How important is it that the same digital aid is available on both computer and mobile phone?

32 responses

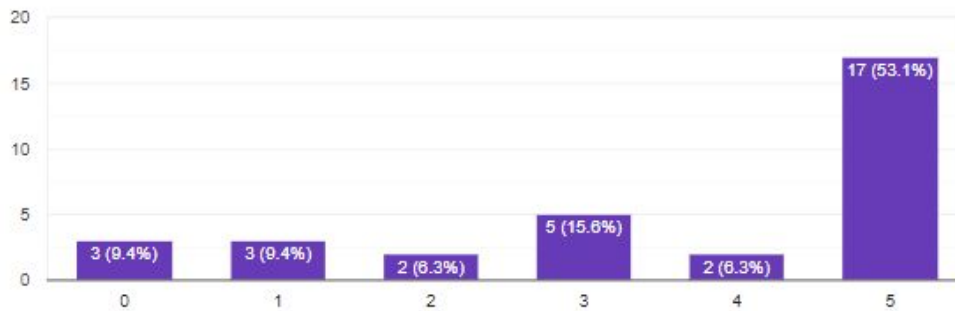

How important is it for you that digital aids are available for free?

33 responses

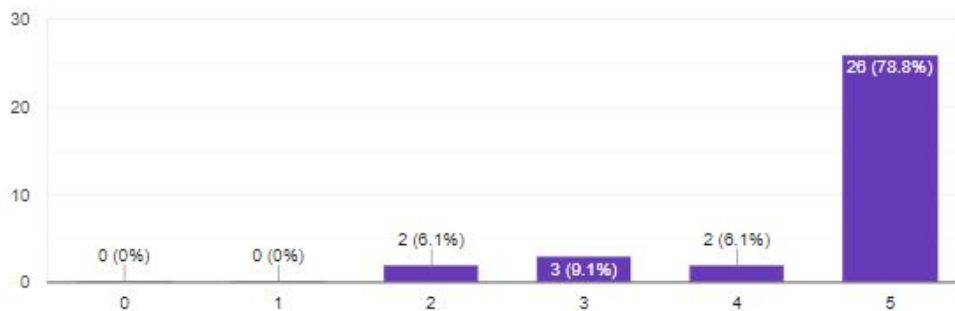

What feature would you value the most in a digital aid?(Choose as many as you like)

33 responses

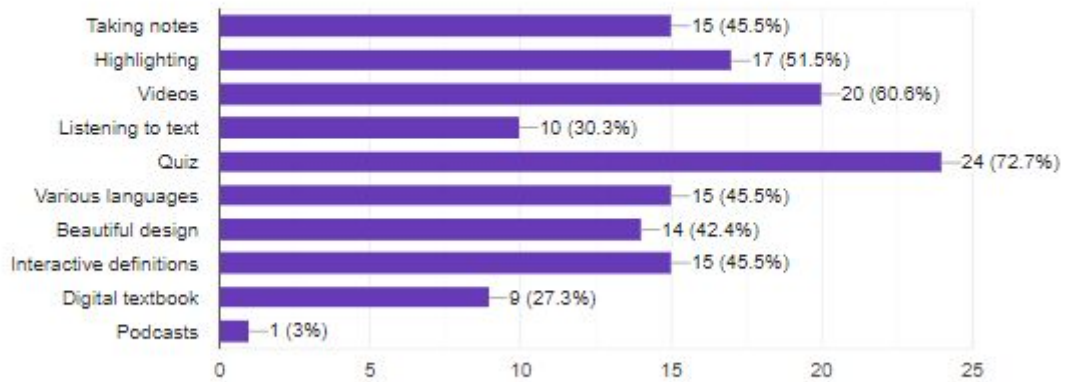

How would you like textbooks being available as eBooks?

33 responses

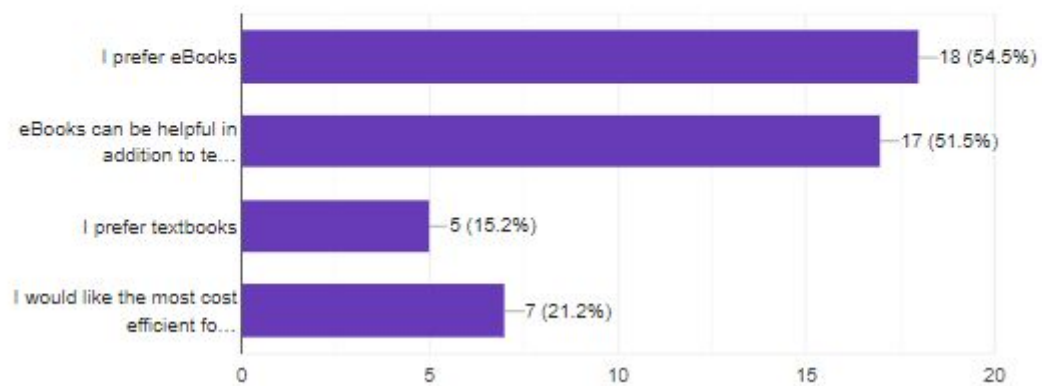

Have you bought Husseins book "The road to success"?

33 responses

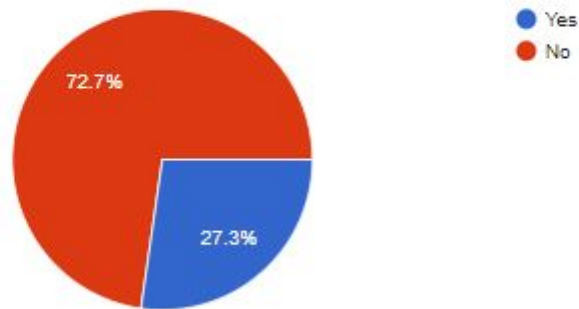

If "no" why?

25 responses

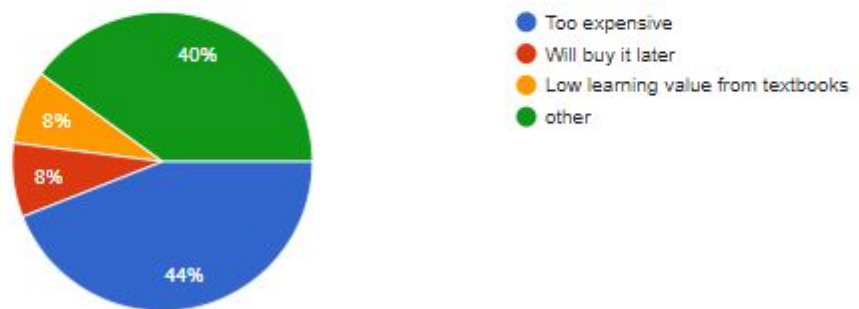

Appendix 3: The survey given after trying the product (Part 3)

How likely are you to use this eBook for TPK5100

30 responses

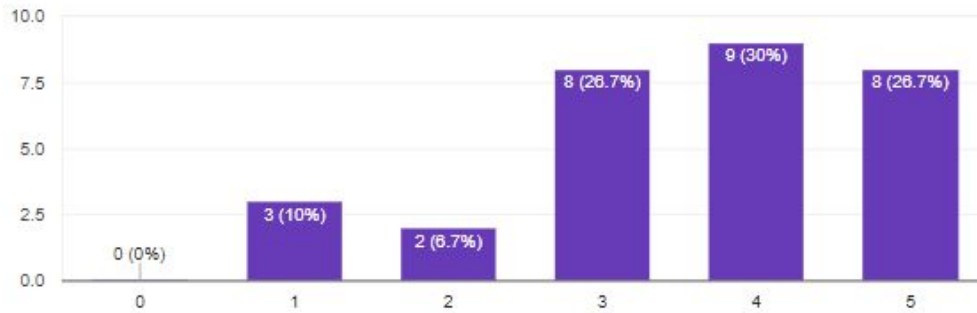

Would you rather use this eBook than the paper textbook?

30 responses

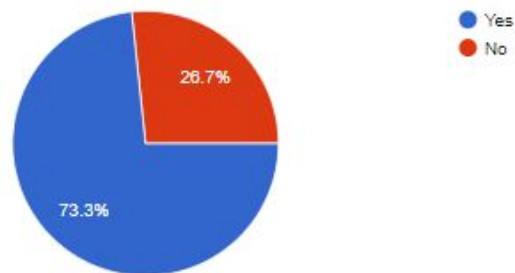

What do you think about the added functionalities available?

30 responses

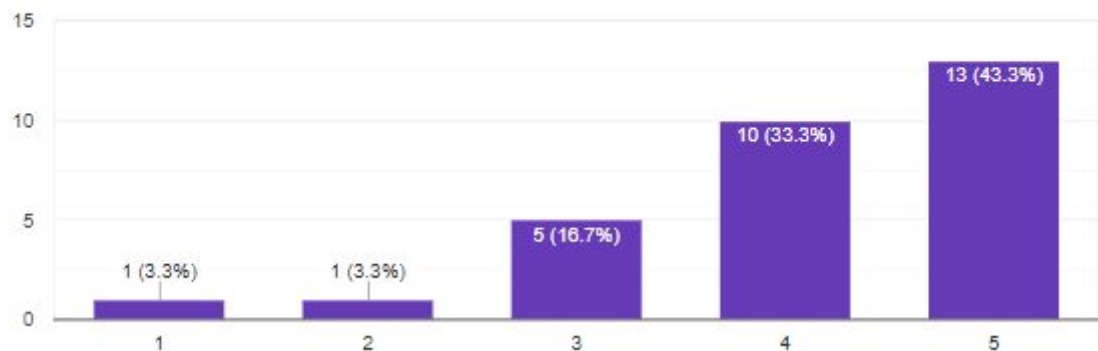

How much would you pay for this eBook?

30 responses

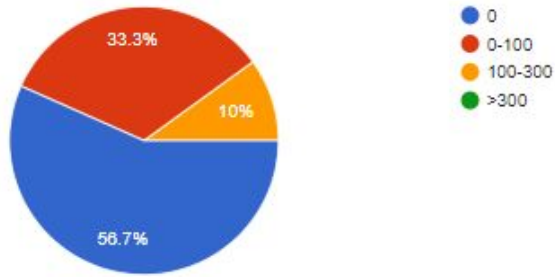

In what degree do you think this eBook will improve your final grade? 5 is the highest improvement

29 responses

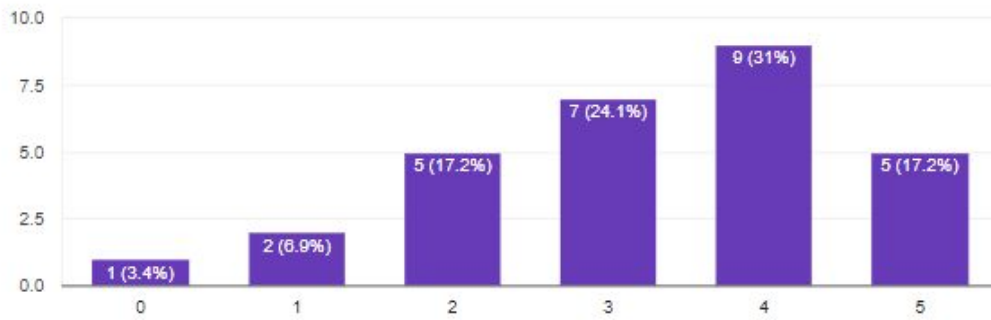

What other platforms would you use this eBook on?

23 responses

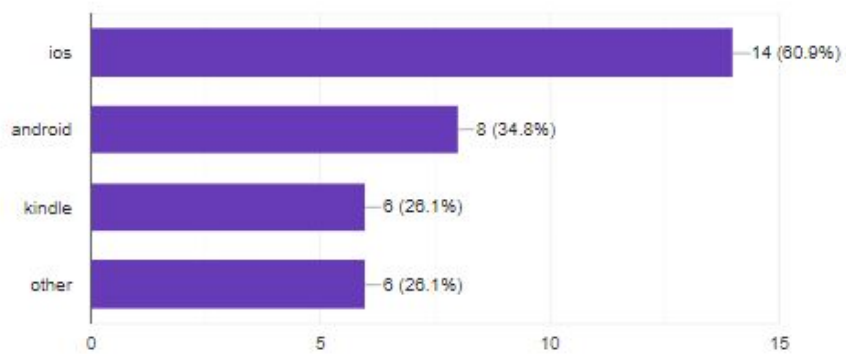

Would you recommend this eBook to your classmates?



30 responses

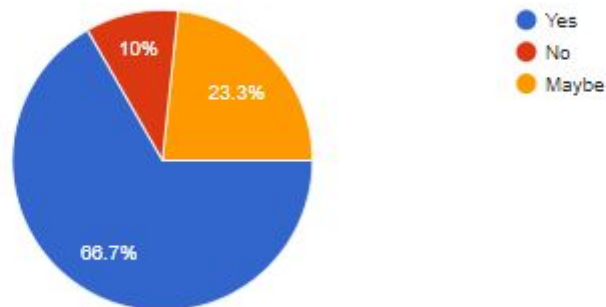

(If maybe please elaborate) General suggestions for improvement:

9 responses

IOS = BAD

It needs to be the entire book.

Added functionality such as definitions would be helpful

I really like the book, but it needs darkmode. It is too bright.

Make an offline version

Nice eBook. Maybe you can add more pictures

If this would be available for download on Kindle, I would like it. But it is better to read on paper than screen.

I really like the book!

The layout is really nice!

Animated real-life case project
Explaining the roots of the failure

Preface

This report is written as a part of the course TPK5100 Applied Project Management. We designed and produced a short video to explain a case from the book Road to Success (Husseim, B). In this case, the project fails. Our product aims to help students understand this case and the reasons for the failure.

We only used software *Explee* to make this video. It was challenging for us as we had to learn how to use the software and produce the video at the same time. The overall result is satisfying as both a survey and the average watch time of the video are above expectations.

This report will go through several aspects of the project as its characteristics, the evaluation we do of our project management or the gain for further learners.

Group number: 15

Student names and student number:

- 1) Baptiste Pavarani - 519255
- 2) Eduardo Rodrigues - 519290
- 3) Francisco Marques - 519419
- 4) Marta Batalha - 519287
- 5) Mayeul de Butler - 519064
- 6) Thibault Compain - 519427

1. Digitalization projects

Once we were developing a digitalization project, there were several options for the product to produce. As a project team, we set together and discussed about pros and cons of each option. Having in mind our knowledge and our study field, we thought that developing an app or website could be too ambitious and would consume more time than the one we actually had available. So, the solution seemed clear to everyone, our product should be a video animation of a real-life project case. The software used to produce the video, *Explee*, was one of many available. We chose this one because the type of videos you can produce with it was similar to what we wanted to do. After taking all these decisions we were able to start to develop and produce a digital learning aid in project management, which is was the main purpose of our project.

We know that digitalization is the adoption or increase in the use of digital or computer technology by an organization, industry, etc. The main purpose of our project was to develop and produce a digital learning aid in project management. We wanted to create value. So that, we decided to do a video animation of the case from the book. However, we can't neglect the fact that there are a lot of ways to animate the case.

The first main challenge was to find a way to animate the case by having a significant impact on learning. Indeed, one of a typical characteristic of digitalization project is to improve the way of working.

The second main challenge was to work on getting handle of the software. Integrate digital technologies is not a straight forward path. The use of advanced technologies require some skills. In our project, we have needed one week to be confident with the video software.

Another challenge was to cause disruptive change without affecting too much the students and the teacher organization. We wanted to adapt our product with the way the teacher is working.

By working on a digitalization project, you always need to focus on the consequences of your product. The use of digital can be harmful for some people that's why we add at the end of the video some questions in order to interact with the users. For us, one of the main challenges on working on this kind of project was to improve the way of working for both the students and the teacher. We think that a digitalization project can be a real game changer if it keeps some interactions with the human. Our aim was to create value from the used technologies and we are sure that thanks to that the learning efficiency will keep on strengthening.

To conclude, we have experienced many challenges by working on this digitalization project. In our world, we know that digitalization will increase and that we are going to work more and more

using digital. We have tried to develop and produce a digital learning aid in project management and we hope that we have created value in learning.

2. Self-evaluation of the project management effort in the project, success or failure? And why?

In our opinion this project is a case of management success.

Looking at the product we think that all the required specifications given to us by the project owner and client were fulfilled. We also tried to always have in mind the expectations of every stakeholders, such as present and future students and teachers, the University and, of course, ourselves, not only as students, but also as project managers.

When looking at our projects success we also mind the fact that the final product was ready and delivered before the deadline accorded with the project owner. The good team organization is also a factor, since, as agreed by us on the project plan, weekly meetings were held in order to track the progress of the product as well to plan the next steps in its development. The productivity of each session was also a key factor to the projects success.

Looking at the risks identified in our project plan, we think most of them were handled successfully. One of our main preoccupations when looking at the project realization was the incompatible team members schedule. This problem was solved, as planned, through the use of communication tools, such as messenger and Skype. Not fulfilling the deadline was also a big concern, but, as previously mentioned, through the establishment of checkpoints and weekly meetings we managed to finish the final product within the established deadline. As for the risks that minded the product itself, like not being able to comprehend the case or get the right idea across the video to the viewers, we produced surveys that helped us to understand how captivating and clear the video is.

As conclusion, we can say that since the deadline was met, the project teams good productivity and commitment and how well, from our point of view, as well as minding the surveys we ran, our final product came out we see the developed project as a case of project success

We evaluate our project management effort as successful

Scale	Strongly Disagree	Disagree	Neither agree nor disagree	Agree	Strongly Agree
Your response					X

3. Self-evaluation of the value to the learners? (evaluation of project success) Can you document your assessment?

One of our goals with this project was to create some value to the learners. With a focus on that we asked for some opinions while we were developing the project. It was important for us to have that feedback in that phase as we managed to make a few changes that definitely made the case clearer. However, this was some informal feedback, which we got from brief conversations with our colleagues in the class breaks. Thus, in order to really understand what the impact of our product was and to make a proper evaluation of our project, we created a short google survey consisting on 4 questions.

To evaluate our project, we thought it would be important to have feedback from three main groups. To get the feedback from the present learners, we asked some colleagues and their groupmates to answer the survey. We think this is the most important feedback because they are also developing a learning aid in the same context. We also asked some people that are not taking the course TPK5100. We want the video to be useful for as many users as possible, and that includes people interested in project management that are nor taking this course. Actually, no better way to understand if the video is clear for everyone than asking people from the outside for feedback. We wanted to have feedback from students from previous year, as they have taken this course and already have the knowledge. However, we didn't manage to get feedback from this last group due to the difficulty of reaching them. In total, we got 18 answers to our survey, which we believe is enough to make a proper evaluation of the project and its impact.

The first question is “Are you taking the course TPK5100 - Applied Project Management?” and the answers were the following:

Are you taking the course TPK5100 - Applied Project Management?
18 respostas

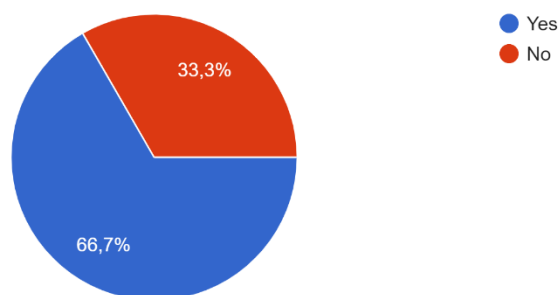

This question doesn't properly tell us a lot about the impact of our project, however we think it is important to know how many of our informants are/are not taking TPK5100 course. This ratio between people who are and people who are not taking the course seems adequate once for us the most important feedback is from our current colleagues.

The second question is "Are the reasons for the failure clear?" and the answers were the following:

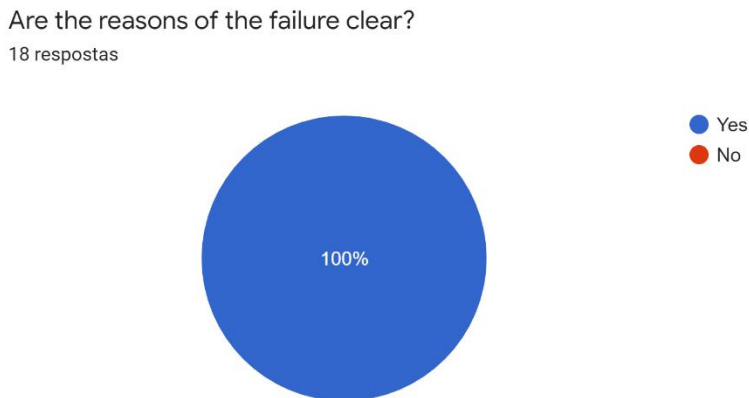

The results of this question are really satisfying because it shows the case was understandable. One of the risks mentioned in our risk assessment plan was about misunderstanding the case and, therefore, explaining it wrongly in the video. Another risk was about being or not able to get the right idea across the video. Knowing that all the informants understood the reasons of the case failure, we can conclude that not only did we understand the case, but we were also able to convey it properly.

The third question is "How interested in the case were you?" and the answers were the following:

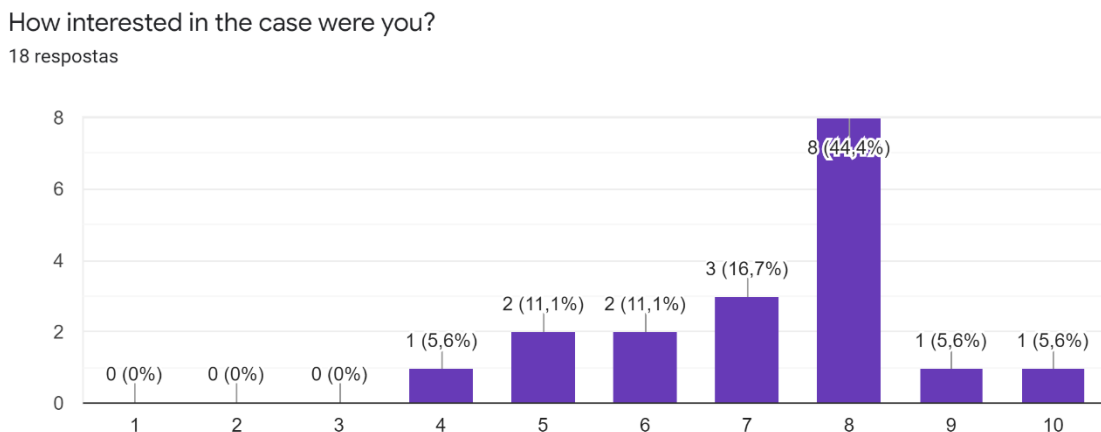

More than half of the informants answered 8, 9 or 10 and we see that as a really positive sign. Most of the people were interested in the case and this means that we managed to produce a captivating video. We were afraid the video would get to technical and tedious but, having that in mind, we tried to avoid it. These results show us that we successfully avoided it.

The fourth question is “Would you recommend watching the video to understand this case?” and the answers were the following:

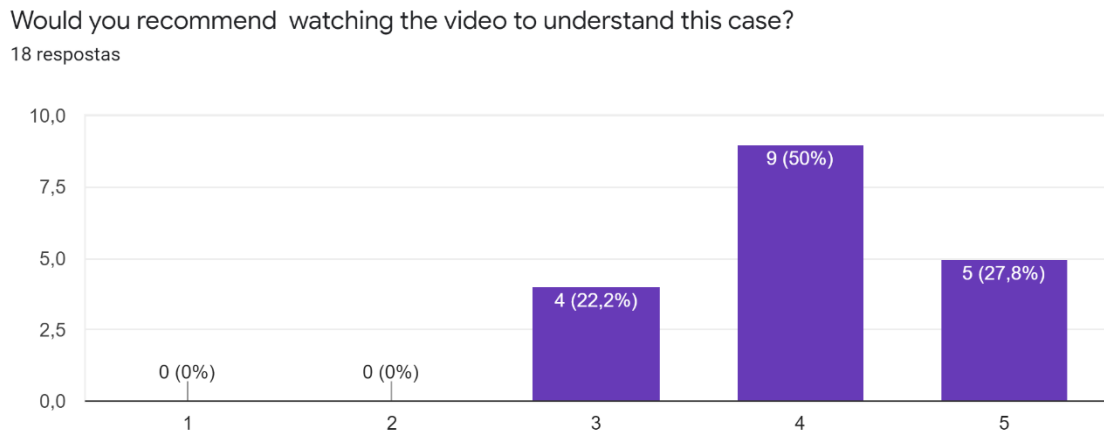

With an overwhelming majority of answers between 4 and 5, these results are extremely positive. The whole idea with our project was to smooth the case comprehension and make it faster. The results show that people would rather watch the video than reading the case or, at least, use the video to better comprehend it. This was one of our goals and therefore we are happy to meet it.

These were the survey results that helped us to reflect about the impact of our product on learners. We are pleased with the results obtained because they show we handled the project well and developed a good product. We strongly believe we met the project purpose (produce a digital learning aid in project management) and hence we believe the project was a success, and the results prove it.

Our product is of high quality and we recommend it to be used as learning aid in project management.

Scale	Strongly Disagree	Disagree	Neither agree nor disagree	Agree	Strongly Agree
Your response				X	

4. Factors that have contributed to failure / success.

The project's success always depends on a great deal of factors and it is not only determined by crucial factors, such as an adequate early planning or a water clarity of priorities and requirements, but it is also overwhelming relying on people's communication and relations. Indeed, each one of us plays a pivotal role in the project, people are the ones behind everything, we as workers are the motor of a working machine so called project team. Thus, it is crucial to ensure that every and each gear of this machine is running synchronize with all other gears, communication is therefore a most determining factor to achieve the project's goal.

As a matter of fact, one of the very first implemented measures was to fix weekly meetings to discuss the projects' development and any other unexpected factor that might appear. Plus, we kept constantly in touch with everyone of the project team through a network, which in our case was Messenger. Afterwards, the fixed objective was to understand what was being proposed to develop. We clearly identified one of the most important stakeholders, the project owner, and it become a top priority to sit with him and discuss the project's nature, purpose and goals. We realized that the project was to select a management study case and develop a successful digital form to learn the studied case. The next challenge was to identify the remaining stakeholders and understand in each way they could affect the project as well as how could we cope with them. A list of stakeholders was discussed and the main conclusion was that students who are going to take the course or even just people that are studying similar subjects may find the project a great help to learn and understand easier how to apply the theory into practical and real situations, which happens to be the point of learning - learning is a process of embrace theoretical knowledge, putting it into practice and transform something intangible into something tangible with real consequences. As it is pointed in Hussein's book, clarity of purpose and objectives is an important success factor which we made sure to fulfill. Moreover, digital tools are pivotal to achieve the final product so exploring and finding new tools that may be at our disposal is a really an unavoidable task that must be performed with the most of commitment and interest.

Thus, it was possible to realize that the project's success depends on three main factors. First of all, it is imperative to ensure that information and conclusions about the case are correct and accurate. Then, having useful and innovative digital gadgets is inevitable to transform the case into a digital product. At last, creativity and clarity of the final product are determined to stimulate the viewer attention and to focus one learning skills in the product. Therefore the next task was selecting a case to develop. This is an extremely important part of the project and, even that it costs a lot to admit, the truth is that we weren't ambitious enough. We ended picking a relatively simple case, which part of it was already discussed in class plus it was already picked for other students from previous years. The temptation was huge - from far, it seemed the better case to succeed as it provided

us with a lot of accurate and detailed information, plus we had digital examples from previous years to inspire us. Nevertheless, there is another error that must be point out. The stakeholders were indeed identified but according to the lectures it is a success factor to keep track of the main stakeholders, such as the project owner, and we did not fulfilled that factor. The project owner, the teacher of the course, was only regarded in the very first beginning and in the project's plan derivable - having his opinion about the project more often could have been a significant help to keep the project's development in a successful direction.

Indeed, as mentioned before having a clear and well structure early planning is pivotal to keep to achieve the project's goals. One must organize a working schedule filled with milestones and deliverables in order to really understand the work in hands. Plus, understanding the amount of work to deliver is crucial to perform a productive, accurate and fair distribution of roles and responsibilities for those involved in the project. However, according to the lectures it is also important the distribution to be as clear as possible, assuming the point of that is to avoid workers performing the same tasks does not contributing for a high rate of productivity and, more dangerous, leaving work to be done. Happily, a situation like this never happened during the project development, thus it is true to say that this factor mentioned in Hussein's book has been fulfilled.

To produce the video, we distributed tasks. A smaller team (2 members) were in charge of producing the video and understand how to work with the chosen software and the other team (4 members) developed the storyline for the video. This approach contributed to success as we saved time by splitting tasks. However, we admit this approach might have lead to some misunderstandings, because the ones developing the storyline didn't know if all the ideas were possible to implement on the software.

Also, having an early planning provided an unexpected asset that proved to be one of the key factors during all along of the project. In projects that take very long time until achieve the final product or in our specific case, a project being developed by students who have other courses to attend, maintaining the motivational levels high can be really tricky and challenging. Thus, keeping track of the project's schedule and therefore watching all the milestones and deliverables being fulfilled and overcame proved to be a real boost to the teams' moral, attitude, and motivation towards achieving the final goal.

All in all, it is possible to see there are more success factors than failure factors which is determined for the projects' success. Yet, the most important key factor is that communication between the working team was simply perfect. Indeed, not only it provided a productive working environment, crucial to deliver the sub tasks before the deadlines, but it also enhanced a great feeling of trust reflected in ones confidence and motivation to perform the assigned tasks - which, step by step lead to the final product.

5. Most important lessons from your project

We have learned several different lessons from this project. The first one is to clearly define the specification wanted by the client. At the beginning you may have the feeling that you have said all there was to say and probably that you're going to lose time but it's very important that each teammate understand well what the customer wants because it's the purpose of the project, this is the base of the further work and it will make you save time in the future.

We have also learned that it's really important to plan the work to do, in order to try to avoid delay or doing the job in a rush. Plan the work to do helps each member to organise himself and find time to work on the project between the meetings. Concerning the meetings we have seen the power of holding weekly meetings. Define a regular weekly meeting is a very efficient way to have all the members at the meeting. It allows us to organise ourselves by finding a routine and make sure some work is developed.

Another lesson that we have learned is that it's extremely difficult to do a good planning, especially if it's the first time you did this kind of job. So an advice that we can give to other students is that sometimes it's OK to change the project schedule during the development of the project if you think it will result in a better final product. But don't become excessive, and try to respect the project plan when it is defined.

And also, we have learned that it's essential to have a good communication between the teammate in the project development to keep everybody motivated during the development of the project, to talk to the other members if there is any problem or to exchange views on different subjects between the weekly meeting.

And finally we will give two little advice. The first one is about oversight: make sure what are the deliverables of the project and their deadlines. It's easy to forget to submit the deliverable when the work is done. And the second one is: "don't look too small", we may have taken a too simple case in our project because we were not very confident at the beginning. Don't hesitate to think big at the beginning, you will feel more and more confident and you can do some great things with a little bit of organization and work.

6. References

Hussein, B. (2018). The Road to Success: Narratives and Insights from Real-Life Projects, Fagbokforlaget.

Peer-review report

Each group is assigned a peer-review group. The list of the assigned groups is shown in the following table. The table shows for instance that the product produced by group 1 will be reviewed by group 11, and the product produced by group 2 shall be reviewed by group 22.

Before writing this review report, you need first to view/test the product produced by your test group. In your evaluation you should be **objective, fair and use to time to fill in the report.** The grade you assign based on your evaluation is a **guide** to the instructors when they grade the project assignment.

Product produced by Group (Test group)	Shall be Peer-reviewed by group (Peer-review group)
1	11
2	22
4	8
6	5+12
7	4
8	1
9	10
10	12
11	13
12	14
13	15
14	16
15	17
16	18
17	19
18	2
19	20
20	24
22	25
24	26
25	27
26	33
27	34
33	36
34	6
36	7
5+12	9

Your peer-review evaluation report

What is name of the group you are assigned to evaluate: Group 13

Group 13 developed an animation video about case 4.1 – Cost optimization of a product. After watching the video carefully, our group found some really positive aspects.

One of the product strengths is its very good video quality. It is also well animated and the case is described with many details. The images are nicely chosen and help to understand the case. The conclusions about decision making are very clear.

However, there were a few weaknesses in the product. The video is too long, it lasts more than 8 minutes and after 4 we start to lose concentration. The background music is a bit too loud and maybe not of the right style, a bit too funky. It leads to misunderstanding of the speaker whose accent may be challenging sometimes.

Afterall, it is a really good product that can be used as a learning aid in project management.

The product we reviewed is of high quality and we recommend it to be used as learning aid in project management.

Scale	Strongly Disagree	Disagree	Neither agree nor disagree	Agree	Strongly Agree
Your response				X	

On a scale from 0 to 10, we recommend this project to be graded with 8.

**A tutoring video for
stakeholder mapping in
projects**

Preface

This report is an assessment for group 16, done by group 16 of their project in TPK5100 Project Management and Control. The report will assess the entire project from the project process to the product.

We would like to give a special thanks to the NTNU Multimedia center and especially Jonas Hustad who were kind enough to let us borrow their studio and give us tutoring. They were very supportive and service minded throughout our project.

Group number: 16

Student names and student number:

- 1) Johnny Molander: 520781
- 2) Florian Senft: 519418
- 3) Johanna Jachmann: 519280
- 4) Léonie Rochaix: 519435
- 5) Josef Eder: 519441
- 6) Carlotta Berberich: 519079

1. Digitalization projects

A. Description

The product is a video describing stakeholder mapping in projects. The video is posted on YouTube and we hope the teacher would like to post it on his YouTube-channel to make it accessible to later students. The purpose of the project was to give an easy description of stakeholder mapping in projects and make sure the content is approved by the teacher. Our intended purpose was to make the information accessible to other students, and also have the required background information accessible at the same location. We decided to use a project described on the teachers YouTube-channel for our examples to use already accessible data.

B. Main challenges

We successfully finished our work on a digitalization project which had the aim to produce a digital learning aid with a value for the end-user. Compared with digitalization projects in a more professional environment, for example in an existing company, our project had a very small scale and did not have to create a monetary value. But even in a digitalization project with a very manageable size some challenges will occur.

The first challenge was to get an idea of what possible options are for a feasible digital learning aid which creates a significant impact on learning. To develop such a tool we had to understand the needs of the end-users. These demands were then the basis for possible approaches that would provide an additional value for the end-users. We decided to visualize stakeholder mapping in a video which we upload on YouTube to provide it and enable easy access. We chose that topic in light of the fact that stakeholder mapping is an elementary part of successful project management. To make sure that a video is a good way to provide knowledge we performed a survey which approved that assumption.

A second challenge were the technical skills of the group members and the required equipment to create a video. None of the group members had experiences of recording or animation of videos. We decided to draw the content of the video by hand. That had in our opinion several advantages. On the one hand there is no need of animation skills and on the other hand there is the option of a creative, aesthetic and personal solution. Using a smartphone with a suitable app provides an easy and good solution for the equipment issue of recording the visual part of the video. For the audio part we had to gain knowledge about available technologies. We found out that the NTNU provides a sound studio and learned how to use it so we were able to perform the audio recording in a good quality.

Like all projects also a digitalization project requires organizational work. The issues which are connected to organization were pointed out in the second part of this report.

The above mentioned challenges are the personal opinion of our group which challenges we had experienced. But there are some challenges of digitalization projects mentioned in the literature. HUSSEIN provides as main challenge of these projects the capture and management

of the expectations of the different stakeholders with a focus on the end-users.¹ We considered that when we thought from an end-user view about which content with which method we want to provide.

SHIVAKUMAR points out as challenges in digitalization projects the importance of the right set of tools, the right team and the right execution technology. Other aspects are the availability of the right skill-set, cross-team collaboration and the duration between project start and access to the market. He mentioned as well challenges like the management of the stakeholders and the expectations of the customers. Further issues are related to the organizational culture of the institution like silo thinking within the several departments. Another field of challenges can be caused by multiple technologies, products and standards.² Some of these above mentioned challenges we also had discovered in our project, but many of them fortunately didn't occur or even can't appear by reason of the small size, the comparatively slight complexity, a non-commercial orientation of the project and at least that we aren't members in a big company with several departments and many interdependencies.

¹ HUSSEIN, B. 2018. The Road to Success. Fagbokforlaget

² SHIVAKUMAR, KS 2018. Complete Guide to Digital Project Management. Apress. Berkeley

2. Self-evaluation of the project management effort in the project, success or failure? And why?

A. Overall evaluation

We started solving this project by identifying what skills existed in our group. This was to get the best possible base before starting the project and it was essential to know what kind of product we could manage to produce. This was also to reduce the risk that we started a project that we couldn't handle.

For risk management we identified some essential questions we needed to get answered. We figured one of us was a decent drawer, but we made a test video to check if this was a manageable project. We started early to figure out if there were some sort of studio at NTNU we could use for voice recordings. This was because we figured at least the voice recordings should be done with very good quality. Since we haven't done voice recordings before, we set up two sessions at the recording studio where a person with experience were available during our studio time. We set up the sessions with some distance apart so we could adapt if the recordings and drawing didn't fit each other. This way we could make changes to the drawings and the recordings if necessary. We believe this was one of the success factors to do some sort of iterative process.

The project organization became a matrix organization where different persons had responsibility for their own part or work package. This was mostly because the project group didn't have any experience in digitalization projects and no one had a clear definition on how the product should end up. Everyone also wanted to try different project manager tasks, so we ended up switching tasks within the group. In hindsight we could have clearly elected a director who had extra management responsibility to make the group more effective. This is a school project so we wanted to give management tasks to different persons in the group. This was to ensure that no one missed out on learning values. We also defined experience in project management as one of our success-factors, so we feel that we found an equilibrium between having good control of the project and giving everyone in the project group a possibility to do director tasks. We could have stated the responsibility between us better than we did in advance and made some sort of plan on who was responsible for what during the project. Almost no one in the project group follows the same courses so we had some problem with the availability of all personnel in time and space.

B. Group-based evaluation

We evaluate our project management effort as successful

Scale	Strongly Disagree	Disagree	Neither agree nor disagree	Agree	Strongly Agree
Your response				X	

3. Self-evaluation of the value to the learners? (evaluation of project success) Can you document your assessment?

- A) Describe your target audience and the learning objectives of your product*
- B) description of the method used to evaluate the final product maybe asking questions before and after watching the video*
- C) The number of informants who have contributed to the evaluation, and how these informants have been selected take some key questions, The Multimedia Center replied with positive feedback.*
- D) Results of tests, surveys or interviews with students or persons who have reviewed the final product*

Before we started the project, we made a short survey to get an opinion from other students attending the course about our initial project idea. As our target audience we wanted to make sure we made a product suited for them. In the survey we asked what's important to them regarding their study preferences. We already had the idea of making a short video, so we asked specific questions how they would like to have the content presented, and if they would use it if it was available. 24 out of 29 participants thought it would be helpful having additional tools referring to the cases of the book, and even more (27 of 29 students) thinks a short video explaining the course content is a good idea. Also for more than half of the students (22 of 29) it was important that the information is officially approved by the teacher. Because we wanted to find a way to publish our final product and make it available, we decided YouTube was an easy way to do it. We asked the student if they would use YouTube if the content was available there, and 20 out of 29 students said they would. The response from the other students about our idea to make a video was good, so we started and kept their opinions in mind. We the decided to try to make the video uploaded to the teachers YouTube channel.

After we finished the first version of the video, we made a second survey to make sure that we were heading in the right direction. We asked the students about the quality, if they would change some parts and also their general opinion. We got really good feedback, most of them answered that they liked that the video was entertaining and also thought the academic content was good. We also got the feedback that the animations are well drawn and the video by itself has a logical structure. For the sound we got a comment that it wasn't loud enough, so we increased the volume a bit. For the long term usage, the response of our classmates was that they might use the video in their study.

We also have different methods to evaluate our final product. One was to sent the video to our teacher before submitting, and asked about his opinion. We got positive feedback that we understood the content correctly and our explanations were understandable. Doing this is not just a good way of quality checking because our product is evaluated by a person who has much more experience, but also to ensure the content is approved by the courses teacher. One of the results of the survey, as mentioned above, was that most of the students wants the information officially approved. With the results from the survey we took this into account by including the teacher.

For our long-term evaluation we decided to not only use the feedback from our classmates, but rather chose YouTube for publishing our video. By using built-in functions in YouTube, we can monitor the amount of views, see how many likes the video gets and also comments from YouTube users can be used to improve a possible next project.

E. Group-based evaluation

	Our product is of high quality and we recommend it to be used as learning aid in project management				
Scale	Strongly Disagree	Disagree	Neither agree nor disagree	Agree	Strongly Agree
Your response				x	

4. Factors that have contributed to failure / success.

In order to evaluate the different factors contributing to success or failure, we will go back to the factors identified in the beginning of the project, based on the three major groups according to Hussein³.

The first group, project management success, has already been discussed to a certain extent in chapter 2. It refers to objective requirements and constraints regarding the project and product and how they are met.

The most important factor that was identified here was to finish the project within the given time frame. This was accomplished by dividing the project into smaller work packages and setting up sub-deadlines to allow for a time buffer towards the project deadline in case of any unexpected difficulties. At times, the project could have benefitted from a clearer distribution of management responsibilities to handle the difficulty of scheduling important project steps in a project team where every member follows a different university course. Another factor that could have led to problems, is that crucial work packages relied heavily on single members of the project team. This was based on the fact that for example the drawings required specific skills that only one team member possessed. It did not end up leading to failure but was a risky decision because it did not leave room for any downtimes by these members of the team.

Another factor that we had identified prior, was time investment by the project team. We consider this factor to be rather successful since we were able to stick to the schedule we had set up and none of the team members had to compromise other obligations in order to complete the project.

Lastly, an important success factor for project management success was to comply with product specifications given by the project owner and operator of the YouTube channel. The most critical specification here was the required sound quality. We identified this to be the most difficult requirement to meet right from the start, which gave us the necessary time to organize time slots at the multimedia center. We consider this to be one of the most important success factors because no one in the project team had prior experience with sound recording which meant there was a lot of uncertainty connected to this work package. Planning for two separate recording sessions to leave time for trials and adjustments was extremely important to achieve project management success.

The second group of success factors, the process success, concerns the stakeholders' conception of how the project was implemented.

The most important stakeholder was the project owner, Bassam Hussein, who had given the technical requirements for the product. We consider the collaboration with him to be

³ HUSSEIN, B. 2018. The Road to Success. Fagbokforlaget

successful, since he expressed his willingness to upload the video on his YouTube channel which indicates that he felt that the technical requirements were met.

Another stakeholder that was crucial for process success, was the multimedia center. We contacted them as early as possible to set up two separate appointments and offered them multiple time slots to make sure that it fit their time schedule as well. The team was extremely helpful and gave us a quick introduction into voice recording in the course of the first session. The project team perceived the collaboration as very positive and the multimedia team even expressed an interest to see the final product when it was done.

The last group of success factors is project success which has already been covered in chapter 3. It concerns the achievement of the larger overall goal like high user satisfaction.

The most important success factor of our project, which is also listed in *The Road to Success*⁴, p. 92, was adequate early planning with regard to the voice recording. It was the most uncertain part of our project and planning these sessions in the beginning of the project, allowed us to schedule the prior work packages early enough and leave room for unforeseen difficulties.

The factor that could have been improved to achieve a higher level of project management success, was the clarity of roles and responsibilities for those involved in the project. Certain steps of the project relied on single members taking the initiative to further the project because the responsibility had not been assigned in time. This was compensated by the fact that the whole project team showed steady commitment to fulfill their assigned tasks once someone had taken the lead.

There are further factors that we identified in our project and that can also be found in *The Road to Success*⁵, p. 92. The collaboration between stakeholders and the project, especially in regard to the multimedia center team. Also, clarity of priorities and structured requirements process in relation to identifying the critical product requirements early on in the project and prioritizing their fulfilment.

An important factor that we had not previously identified, turned out to be the creativity of the project team. Several of the work packages included very creative tasks and a crucial factor for user satisfaction turned out to be how aesthetically pleasing the video is and whether it is entertaining.

⁴ HUSSEIN, B. 2018. *The Road to Success*. Fagbokforlaget

⁵ HUSSEIN, B. 2018. *The Road to Success*. Fagbokforlaget

5. Most important lessons from your project

1. My experience suggest that the one of the most important things is, to make sure before the project even starts that the collaboration in your project group is good and all members are motivated to give their best for the team. The group climate will also affect you, positive or negative.
2. You should take your time to figure out the specific skills and interests of each group member before you make the decision about what product you want to create within the project. Your skills and interests will guide you to the right decision.
3. My experience suggest that you should carefully select stakeholders who are able to support and guide you during the project. If you're at a point where you need support, you're glad to have it.
4. I learned that putting slightly more effort into your project planning prevents a lot of stress during the project.
5. You should always plan a little bit more time for your tasks than you have in mind at first. Unexpected circumstances can often cause delays.
6. My advice is to split the tasks according to the personal skills and interests of the group members. Working on something that is interesting for you or that you are good at is always more satisfying.
7. My experience suggests that regular meetings in person with all group members are crucial for decision making and to clarify important topics regarding the project. During an eye to eye discussion things are suddenly way easier.
8. I learned that the opinions and the requests of the user/customer are always more important than your own. The user/customer has to be satisfied, not you in the first consequence.
9. My experience suggests to start better early than late with any task, although the deadline might be far away. Problems and questions arise always when you're already in a hurry. Save yourself the stress.
10. You should always show respect for the work of other group members. Searching for compromises is always better than harsh criticism. You're working together, not against each other.
11. My advice for you is to keep the product idea you want to create as simple as possible, it will get more complicated anyway. Sometimes less is more, especially for the user/customer.
12. I learned that you should be happy with your final product at a certain point. Endless research for further optimizations and adaptations leads to stress for you and the total team, but does not necessarily result in a better product.

6. References

Hussein, B. (2018). The Road to Success: Narratives and Insights from Real-Life Projects, Fagbokforlaget.

Shivakumar, KS (2018). Complete Guide to Digital Project Management. Apress. Berkeley

Peer-review report Group 14

Product produced by Group (Test group)	Shall be Peer-reviewed by group (Peer-review group)
1	11
2	22
4	8
6	5+12
7	4
8	1
9	10
10	12
11	13
12	14
13	15

14	16
15	17
16	18
17	19
18	2
19	20
20	24
22	25
24	26
25	27
26	33
27	34
33	36

34	6
36	7
5+12	9

We are assigned to evaluate: Group 14 eBook

A. Strengths and weaknesses

Strengths :

The eBook is a great idea. The content is the same as in the book so the information has been approved by the teacher. In the beginning of our study no one had bought the book yet so we struggled on the first assignments until we got the book. Many students prefer to use digital aid for their study and many courses don't require books, so many students don't buy the book until they know for sure they need it. This makes the first lectures harder to grasp when the book is required. In a textbook we can't search for specific content but in this eBook we can. The norwegian version can be a good way for better understanding for norwegian students. We like that the group try to use already available content to further explain the content. In this information era there can be to many instruction videos or papers. Finding the right one is tricky, but if there are videos and products approved by the teacher it's easy to trust the content. We also liked that it was so easy and there is no need to use time to understand the user interface. With interactive games where you can win trophies is a great simple way of boosting the motivation for students during tedious exam studies.

Weaknesses :

We felt that the eBook could need some more work to be aesthetically smoother? The quiz part were at the end of the chapter. We would want the quiz to be at a different location to distinguish between the reading part and self test part. The quiz position works now, but if you want to expand the eBook with the entire textbook, it might get messy. When navigating using the previous and next buttons on the bottom we wished that you go to the next or previous chapter in the book. Now you go up and down the table of content. There is no clear separation of the norwegian and the english book. We don't know if this is because there is only one chapter/subject implemented or if this was the purpose. If we chose english we want to stick with english until we choose norwegian. When using firefox or Microsoft edge browser we jumped right back to the table of content when we chose some other page. We understand this

as a proof of concept, but the idea is great and the implementation is good. We would rather use this than a pdf version of the book.

B. Group-based evaluation

	The product we reviewed is of high quality and we recommend it to be used as learning aid in project management				
Scale	Strongly Disagree	Disagree	Neither agree nor disagree	Agree	Strongly Agree
Your response				X	

With some more work we would strongly agree, but this is based on the current state. We only assessed the part of stakeholder in projects, not the missing part.

B. Grade

On a scale from 0 to 10 we evaluate this project to 7.



**An animation project demonstrating the
consequence of changing the purpose, scope,
and complexity without facilitating the changes**

**Group 17
Reyhaneh Raja Beheshti
Tonje Guttormsen
Saeid Morovvati
Sajad Daliri**

Preface

In this report, we are going to give a brief explanation about digitization projects and the challenges we faced when making an animated video. Also, we will evaluate our project and describe the success or failure factors in our project and the constraints that we had in processing the animated video.

Group number: 17

Student names and student number:

- 1) Reyhaneh Raja Beheshti 520653**
- 2) Tonje Guttormsen 521922**
- 3) Saeid Morovvati 520665**
- 4) Sajad Daliri 520662**

1. Digitalization project

A) The reason for producing the product

In this project, we decided to make an animated video of a real-life case from the book “*The Road to Success - Narratives and Insight from Real-life Projects*”. The case is about a project that went from being a small cost optimization project to a large complex project. It shows the consequences of changing the purpose, scope and complexity without facilitating the changes by providing sufficient resources to the project. The purpose of making the animation was to make learning easier and more efficient for students taking the course “Project Planning and Control”. We decided to make an animated video because we thought this could be a fun and interesting way to present this case, instead of having to read it. With illustrating pictures and a voice explaining the case, the only thing you have to do is to press play and pay attention to the video. This way of presenting the case could also be helpful to those who feel they have the best learning outcomes of listening rather than reading.

B) Main Challenges

Access to complex systems for training is usually limited, risky and costly. According to (Guttormsen-Schar and Krueger, 2000), interactive simulations can demonstrate the conditions of actions and events in the real world and support a constructivist learning approach within Multimedia Learning (Holzinger, 2002a). With simulations, developers attempt to provide a rich environment wherein students can explore freely (Holzinger and Edner, 2003).

Digitization brings many new producers to the market because digital content is less expensive to produce and relies on software that integrates functions which were previously only available by employing skilled professionals. (Picard, 2011)

Since the digitalization project was a new experience for the team members, we experienced some challenges. Some of the main challenges that the group had with this type of project were:

- 1- Choosing the best digital learning aid
- 2- Different ideas about choosing a suitable project case from the book
- 3- Not having enough skills in making any type of digitalized project before.
- 4- Finding a proper software to make the animation
- 5- Spending time to learn how the software worked
- 6- Variable options in the software
- 7- Losing one of the members of the group that led to putting more pressure and extra workload on the remaining members of the group.
- 8- Time waste because we spent a lot of time doing the project in other ways and changed the decision to do the rest in a completely different way in the middle of the project.
- 9- Getting a schedule is just one important step in the process of project management. The real work begins when circumstances cause delays and pressures mount to revise the schedule

(Smith, 2002). We had time constraints for team members and some problems with group meeting schedule because of other assignments and projects that the group members had to hand in on time.

But based on Edmondson (2012) people who had worked on terms with greater task novelty and product complexity, more diverse colleagues, and more boundary spanning, learned more than people on terms that faced fewer of those challenges.

2. Self-evaluation of the project management effort in the project

The group consisted of five people. First, we had to choose what type of digital learning aid we wanted to create. After some brainstorming sessions, it was decided to make an animation of a real-life project case. We had different meetings to select a proper case. Since there were a lot of cases in the book, members had different opinions. Finally, we came to the conclusion to choose a case from the chapter “Product development projects”, case 4.1 “Cost optimization of a product” in the book *The Road to Success* (Hussein, 2018). Since none of the group members had any experience with making an animation, we started making it by taking pictures and videos were the group members performed as actors to show the different scenes of the case. We had a lot of innovative ideas and started filming, but we met some barriers and challenges such as not having a professional camera to take high-quality pictures and videos, not finding an empty and quiet room to shoot the scenes and a time-consuming process of filming over and over again. It was then decided to change the plan of filming and acting to make an animation using a software instead. An unforeseen event and big risk was that one of the group members left the group and there was a need for rescheduling the whole project tasks. The rest of the members had to take all the effort to finish the project on time, a good project coordination the commitment of all the other members lead to a successful project at the end, despite all the concerns that group had with other courses.

According to Steven et al. (1993), project evaluation is a combination of a number of activities ranging from setting indicators, developing model, defining measurable outcomes, identifying key stakeholders and their interests, selecting methodology for evaluation, collecting information, analyzing data and disseminating evaluation results for further learning.

To finish and upload the project before the 12th of November was a crucial success criteria in the project. So we tried to keep pace with our rescheduled time table and deliver it on time. Since we had to do the rest of the project with 4 people, we decided to divide the tasks into two parts: the software part and the report part. The software used in this project is called Video Script. Two of the group members tried to learn the software and do the editing part and the remaining members spent more time on writing the report. The video had to be in good quality, so a professional software was needed to make the best possible outcome. It was also required to satisfy the stakeholders and meet their needs and expectation of producing a useful learning aid. We believe all the requirements were fulfilled in the project with our motivated, committed and knowledged team members and their good project planning.

As mentioned before, the only deviation was the good team-building and effective communication among the group members that started to weaken as one of the members left the group, but a good team spirit helped the member to keep strong and continue the project better than before.

B) We evaluate our project management effort as successful

Scale	Strongly Disagree	Disagree	Neither agree nor disagree	Agree	Strongly Agree
Your response				X	

3. Self-evaluation of the value to the learners? (evaluation of project success)

A) Target audience and the learning objectives

Generally, digitization projects have benefits in terms of direct transformation of information or ideas without any human intervention and the audience can remotely get access to the information in a short time. Also, these types of projects can give a better and clear understanding of the whole idea by using simple tables and drawings in comparison with solid books or other methods of learning.

The objective of our product is to provide an easy and attractive aid for learners to give them a better understanding of their course materials and subjects and help them visualise the information written in their books. Students are the main target audience of this project. This product can also be useful for teachers to apply in their method of teaching to make boring subjects more appealing for the students.

B) Evaluation method

In order to evaluate the product, we needed a sample of people to show the product to and get feedback. The target group of the project are students who are receiving the digital learning aid and since there are a lot of students at NTNU, we decided to use a sampling model to choose some people among those students. In this case, the most relevant one was Convenience sampling because it was a quick model to collect data, we could easily collect data and there were fewer rules to follow, unlike the other probability sampling techniques.

Convenience sampling (also known as Haphazard Sampling or Accidental Sampling) is a type of nonprobability or nonrandom sampling where members of the target population that meet certain practical criteria, such as easy accessibility, geographical proximity, availability at a given time, or the willingness to participate are included for the purpose of the study (S & Given Lisa, 2008).

Convenience samples are sometimes regarded as ‘accidental samples’ because elements may be selected in the sample simply as they just happen to be situated, spatially or administratively, near to where the researcher is conducting the data collection (Etikan, 2016).

C) The number of informants and selection method

Using the convenience sampling method, we sent a link of our animated product to individuals and our fellow students by using the contact list on our phones, and some of the students connected to us via social networking websites such as Facebook and to individuals whom we know in person at our dormitories. This was the easiest and the most convenient way of recruiting the sources of the primary data for our research.

The project link was sent to 33 students who are currently studying at NTNU and 7 students of our friends who have finished their PhD or Master’s degree in the last five years at NTNU. To expand the scope of our product evaluation, we asked 4 friends studying at different universities

abroad to give their opinion on how much the product could help them understand the case in comparison with reading the case from the book and asked them to give their answers within the 3-point Likert scale of Helpful, Unhelpful, and Neutral.

D) Results of the survey

Among all 44 participants, 37 people found it helpful to understand the case instead of reading the book. 3 people preferred the traditional way of studying by reading the book, because of the psychological effect reading the book gave them so that they could make sure that every detail were covered in the book but not in a short animated video and hesitated to use the digitalized aid of learning.

Participants	Number	Helpful	Unhelpful	Neutral
NTNU Students	33	27	2	4
Former Students	7	6	1	0
International Students	4	4	0	0
Total	44	37	3	4

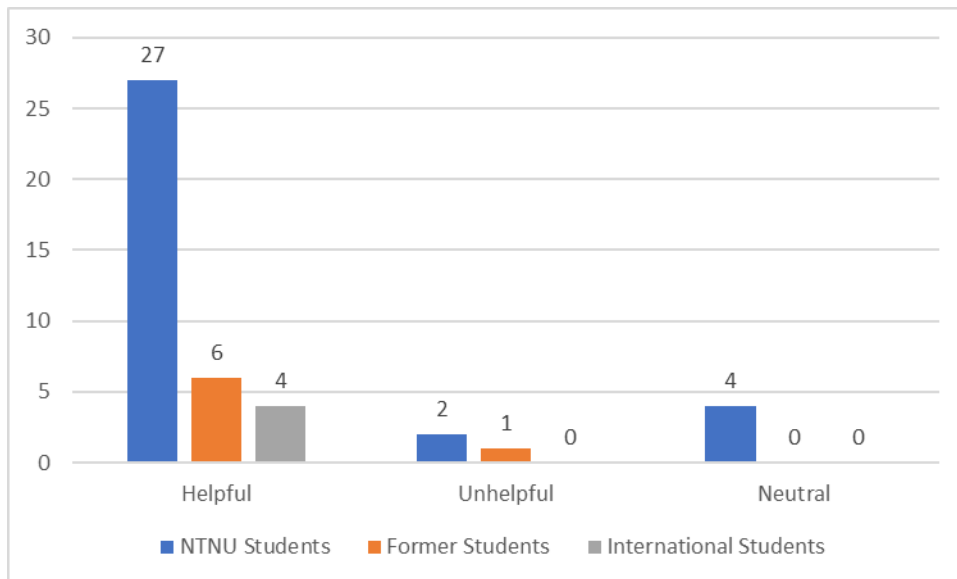

In general, 84% of the audience found the product a successful method for learning and 8% preferred reading books and 9% were neutral or didn't give any response.

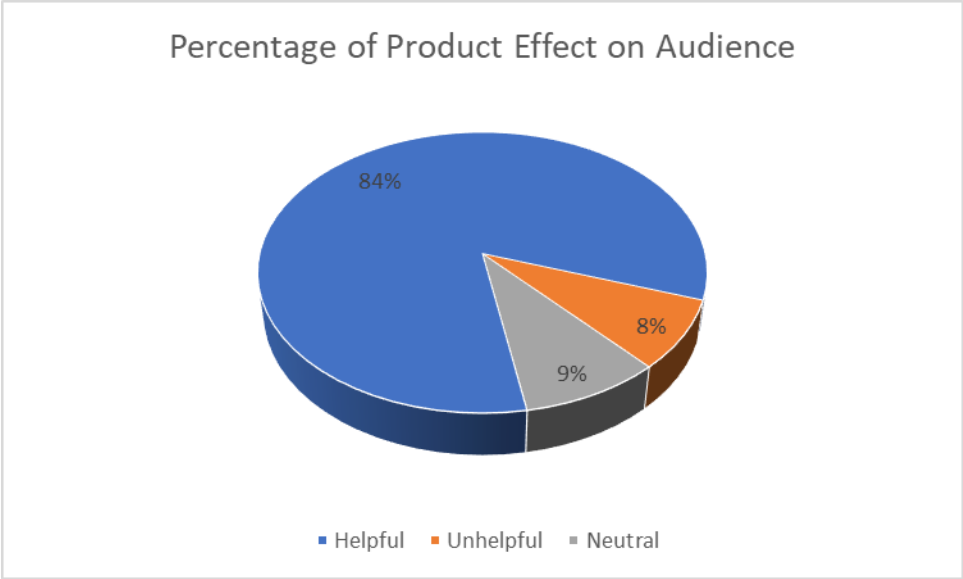

D) Evaluation of the degree of our support to the following statement (group-based evaluation):

	Our product is of high quality and we recommend it to be used as learning aid in project management				
Scale	Strongly Disagree	Disagree	Neither agree nor disagree	Agree	Strongly Agree
Your response				X	

4. Factors that have contributed to failure/success.

The definition of success in projects has changed from being limited to the implementation phase of the project life cycle to encompassing the complete life cycle of the project and its results (Hussein, 2018). People say that a project is successful as far as project management is concerned if the project is completed within time, within the given budget and meets the customer requirements with the specified quality (Bodicha, 2015).

There are several factors that the group think has contributed to the project being a success, the most important being trust and respect to each other in terms of finishing the tasks you were given in a good way and to have an open mind toward new ideas and suggestions, and that we managed to be flexible and adaptable if challenges occurred and we had to think new. A list of success factors are mentioned and evaluated below:

- Commitment

In the work of making the animation, all the group members were dedicated in the process, coming up with several ideas to increase the quality and striving for a good result.

- Clarity of purpose and objectives

When we first started the project, we had meetings and discussed, among other things, what our goal was and the purpose of this project. By discussing this in advance, we made sure that everyone's voices were heard when defining the purpose and the goal of the project.

- Trust and responsibility

Before we started working on the project assignment we already had some experience with how we functioned as a group by doing the exercises. This meant that even before the start of the project assignment, we relied on each other to finish the work we were given in a good way. Trust was also important in the creative process of planning the animation. All the members of the group shared their ideas and opinions on how the various parts of the animation could be performed, and there was no such thing as stupid ideas. The result became a mix of everyone's contributions.

- Flexibility

The members' ability to be flexible was an important success factor. We faced several changes in the making the animation and we had to make compromises and adapt in order to go on with the project. Also, the fact that none of the group members had any

experience with making animations before, made us be adaptable in learning about new software and how to use it.

Another case that demonstrated our ability to be flexible was when a previous member had to leave the group unannounced. After the planning phase the member did not show up as planned and we could not reach him. Then we had to be flexible and think again, and we had to divide the work between the remaining group members.

- Openness

In the creative process, there was great acceptance for new ideas, to ask for help and to share your thoughts within the group. This created a truthful and honest atmosphere.

- Adequate early planning

After defining the objectives of the project, we made a plan and used it as a tool to achieve the objectives. By having a plan we got a good overview of the project, what needed to be done, the estimated duration of the different tasks and who was responsible for what.

- The same level of ambition

The group soon found that the level of ambition and expectations were somewhat the same. By having the same level of ambition we avoided frustration and a bad mood within the group because of people not showing up as planned and not finishing the work they were assigned. When a group consists of people with the same expectations, things tend to run more smoothly.

We have also identified some factors that were challenging during the project. These challenges are something we are now aware of, and if we ever experience similar difficulties in future projects or group work we have a better chance of handling them in a good way.

When we decided we wanted to make an animation, none of the members had any experience with making or editing movies or animations. We split the tasks so that some of the group members had the main responsibility of the animation. It was time-consuming to learn how to use the animation program and make the animation.

Another challenge we faced was when a group member had to leave the group unannounced. We had to redo the plans and schedule, and this also led to increased workload on the remaining members. We also experienced difficulties in finding a time during the week where all group members were available. With four different schedules, it was sometimes challenging to find a suitable time to meet, but the members showed flexibility in making time in a busy schedule.

Initially, we decided to make a movie instead of an animation. During the filming process, we were not happy with the quality and our acting skills, which caused us to change our minds and make an animation instead. This was a stressful part of the project, finishing it until the deadline.

5. Most important lessons learned from your project

If we were to give future students in this course some advice regarding the Project Assignment, we would suggest the following:

- 1) You should first identify the learning objectives of your final product before deciding on the type of product you want to make. If you want the end users to have a "learning by doing" approach, the group might consider making a computer game or a simulation. If you want to create something where the end user only has to pay attention and not do anything themselves, maybe you should consider making a movie, an animation or an interactive e-book. In this process it is important that the group think about what experiences they have and use this experience to decide which product to make and the development of it. We believe that the more innovative you manage to be, the better.
- 2) Our advice is to start the project with brainstorming where everyone is present after you have chosen the type of product you want to create. In some parts of the project it might be a good idea to work individually or in smaller groups to make the most out of your time, but this is not one of those parts. This part of the project should not be delegated to a few people. A lot of good ideas are introduced in this process, and our opinion is that it will make the end result better.
- 3) We learned that it is important to:
 - make a plan to coordinate available dates the different group members are free to meet
 - have somewhat the same level of ambition among the group members, this makes the whole process easier for all parties involved
 - be aware that unexpected changes may occur, try to identify these changes and, if possible, make a plan of action that involves handling such changes
- 4) Our experience suggests that you should find someone with the same level of ambition as yourself. If everyone is determined to spend the necessary time on completing the product, the process will run more smoothly.

6. Reference

Bodicha, H. H. (2015). How to Measure the Effect of Project Risk Management Process on the Success of Construction Projects: A Critical Literature Review. *The International Journal of Business & Management*, 3(12), 99-112.

Etikan, I. (2016). Comparison of Convenience Sampling and Purposive Sampling. *American Journal of Theoretical and Applied Statistics*, 5(1), p.1.

Edmondson, A. (2012). Teamwork on the Fly. [online] *Harvard Business Review*. Available at: <https://hbr.org/2012/04/teamwork-on-the-fly-2> [Accessed 6 Nov. 2019].

Holzinger, A. (2003), Interaction and Usability of Simulations and Animations: A case study of the Flash Technology. In: Rauterberg, M.; Menozzi, M.; Wessons, J. *Human-Computer Interaction INTERACT 2003*.

Holzinger, A. (2002a), *Multimedia Basics, Volume2: Learning Cognitive Fundamentals of multimedia Information System*, Laxmi, New Dehli

Hussein, B. (2018). *The road to success*. 1st ed. Trondheim.

Picard, R.G.,(2011). *Digitization and media business models*. Mapping digital media.

Schar, S. and Krueger, H. (2000). Using new learning technologies with multimedia. *IEEE Multimedia*, 7(3), pp.40-51.

S. K., & Given Lisa M. (2008). Convenience Sample. In *The SAGE Encyclopedia of Qualitative Research Methods*. Thousand Oaks, CA: Sage.

Smith, K. (2002). *Project management and teamwork*. New York: McGraw-Hill.

Stevens, F., Lawrenz, F., & Sharp, L. (1993). *User-friendly handbook for project management: Science, Mathematics, Engineering, and Technology Education*. Washington DC: National Science Foundation.

Group 17

Reyhaneh Raja Beheshti

Tonje Guttormsen

Saeid Morovvati

Sajad Daliri

Peer-review evaluation report

We were signed to evaluate group 15.

A) Strengths:

The video is created with the same software that we used to produce our product so we know that was time consuming, skill demanding and needed patience. The case is taken from the book and it is easy to compare the two learning materials. The way of narrating the story is attractive. They have used relevant pictures with funny concepts which made it more appealing. The scenes are in proper sequence with clear and understandable concepts. It contains most of the essential details of the case and seems that the audience can easily get the idea.

B) Weaknesses:

Some of the negative points are:

- The quality of the video drops off at the beginning (0:24'')
- Some of the pictures are repeated more than once.
- It was better to add some short text to the images so that the audience could follow the voice better.
- We guess that they used artificial intelligence for the voice, but the tone of the voice was slow and boring to some extent. It could be more attractive to use the voice of one of the group members.

The product we reviewed is of high quality and we recommend it to be used as learning aid in project management

	The product we reviewed is of high quality and we recommend it to be used as learning aid in project management				
Scale	Strongly Disagree	Disagree	Neither agree nor disagree	Agree	Strongly Agree
Your response				X	

C) The grade on a scale from 0 to 10:

Since they make a great effort to produce a high quality learning aid, we would like to consider 9 for their project.

Animated real-life case project

**Sydney Opera House: A Lesson in project
management failure**

Preface

This project report was made as a part of the project assignment in TPK5100, Applied project management, to document our product. This report contains the details of the product, evaluation of project management in the project and project success, factors for project success and finally, the main message from the project.

Firstly, we would like to thank the professor, Bassam Hussein, for allowing us to work on this digitalization project. We learnt a lot of valuable lessons during the project journey and gained some invaluable experience. Next, we would like to thank our colleagues and friends for reviewing our product and giving useful feedback. Lastly, we would like to thank each member of our group for successfully finishing the project. We had lots of fun working together on the project and enjoyed the journey thoroughly.

Group number: 18

- 1) Fabian Statz - 519936
- 2) Tim Wrobel - 519157
- 3) Marta Hernandez Perez - 519730
- 4) Wangqiao Zhang -
- 5) Stefan Andreas Gust - 519117
- 6) Abhilash Ramanathapuram Anand - 502173
- 7) Ali Akbari - 502172

1. Digitalization projects

- A. Describe your product, its intended purpose and why you have selected to produce this product.
- B. After having the opportunity of working on a small-scale digitalization project, what are, in your, opinion the main challenges that your group has experienced with this type of projects?

A. Product Description: Our group has made an animation video for the digitalization project assignment in the course TPK5100, Applied Project Management. The animation video is about a real-life case study of the construction of Sydney Opera House. It is known as a globalized symbol of Australia and is also one of the world's most recognized and foremost architectural wonders. The animation video was made using the VideoScribe software as we found it to be easy to use for beginners.

Intended purpose: Sydney Opera house was chosen as the case-study topic because it is an example of project management failure but a project success. We believe that this case is quite unusual, and it helps the end-users of the product to understand the main characteristics of a construction project and the importance of risk management and project planning.

Reason for making the product: The animation video is made mainly to facilitate eLearning and to utilize the benefit of picture-superiority effect (Stenberg 2006). The **picture superiority effect** is the phenomenon where pictures and images are more likely to be remembered than words (Whitehouse, A. J et al. 2006). The animation video aids the end-user to understand the concept better and faster, and it is retained in their memory for a more extended period compared to a verbal lecture. The animation video creates a significant impact on the learning methodology of the end-users.

- B. The first and foremost challenge that the group faced was the type of software application to be used to make an animation video. Since none of the group members had prior experience in animation, we had to find a software application that would be easy to use and gives the desired output. After trying out around 6 different software applications, we finally decided that the group will use VideoScribe. The reason being, it satisfied our needs and was very easy to use for beginners. Thus, the risk of not using a sophisticated software application was eliminated at the early stages of the project.

The second challenge that we faced was when creating the video. The requirements kept changing during the process of creation. We had to determine the access/use restrictions or copyright, condition of records and copy status of digital resources while browsing for the required images from the web (Initiative 2009). We divided our group into sub-groups, and sub-group 2 (consisted of 3 members) was in charge of video creation. The members of sub-group 2 broke down the video creation task into 3 mini-projects (or work packages), and each one of them worked on their part according to the planned work breakdown structure (Hussein 2018).

The next challenge we faced was quality checking and validation of the animation video. We reviewed our own product and tried to ensure that the video transition and audio were appropriately synced. Sub-group 3 which consisted of 1 member, was responsible for audio recording and syncing the audio with the video. Finally, we had to make sure that the video was accessible to everyone. So we exported the digital resource in an appropriate format from the software application and uploaded it online (Initiative 2009). A shareable link was also created, which enables the end-users to access and view our product.

2. Self-evaluation of the project management effort in the project, success or failure? And why?

- A) The group should make an overall evaluation of their own project. This is an evaluation of how well the group managed the project, how well was the organization of the project group. How well the group identified and managed risks. Did the group managed to deliver the project results according to your originally stated success criteria (according to your original plan)? Are there any deviations between the stated success criteria and your final evaluation of the project?

In total it was a project management success, but few things could have been better.

The reasons for this statement were discussed in the following paragraphs:

The project was started to find out what kind of product we want to deliver. This decision was based on the knowledge of our team members. Since nobody of us was an expert in programming, an animation video was the best solution. Because of that, we reduced the risk that we won't have a running product at the end. On the other side, we were able to create an interesting video where we teach a topic which is relevant for the course TPK 5100 and creates value. But first of all, our group was too big and therefore we had a small organizational problem. It was hard to find a date, where all of us had time. For that, clear responsibilities in our project team lead to

high project management success. We were able to break our project down into three main separate parts. Thus, we worked in small groups on our tasks together to profit from mutual ideas and discussions. Furthermore, no overlapping of the three parts saved time. We assigned the task according to the strength in the group. We addressed the animation part to guys who had already little experience in the creation of an animation video. The script part to people who are creative and already had a good idea about the chosen topic. Finally, we assigned the audio to the best English-speaking person. We also took care of our individual schedules and made sure that the small groups were able to meet during the week. After we had fixed our time problems, we made too many meetings. The preparation time for the meetings was too little. We found out that short jure fix via Whatsapp were more efficient if the tasks were not too complicated. The small groups kept always in touch to tell the status quo. Parallel working was also great identified. For example, during the script development, the animation team tested and decided which software is the best. In addition to that, suggestions for specific animations from the script group were useful to have a good handing over. Even though we had small problems during the creation phase, the project was finished on time. That was possible because all risks were identified in advance. In the following, it is shown how our group managed the upcoming risks.

To avoid choosing the wrong topic, we spent a long time to find a suitable topic and asked the former students which topic would be useful to teach. Their suggestion was to combine theory with an exciting story. Therefore, we used a famous example to teach our topic.

To avoid having a boring video, we asked people who already made an animation video, what nice animation could be. We considered their points, for example, to make sure to show only the images and texts on the screen which are relevant.

We only spoke with few people to get intensive and useful feedback with suggestions in the creation phase instead of hosting an anonymous survey. Then real discussions about what could be improved were possible.

Wrong facts were excluded due to good and different literature.

The highest risk was that in the end, our video will not work. To minimize this risk to a minimum we took a software which other groups already used and were highly satisfied. In addition to that, we tested it in advance to know if it is also useful for us. We were rewarded with no complications and a running video.

The project results could be delivered. As described in the last paragraphs most of the success criteria could be fulfilled. In contrast, we had one deviation from the success factors because we did not stick to the project plan to 100%. Only one person made the audio and the synchro because sometimes he had to create a new audio file to make it fit. That lead to more efficiency. Sometimes it is better to have flexibility in the project plan and not fixed everything, especially for IT-projects were requirements can change quickly.

B) Please evaluate the degree of your support to the following statement (group-based evaluation):

We evaluate our project management effort as successful

Scale	Strongly Disagree	Disagree	Neither agree nor disagree	Agree	Strongly Agree
Your response				✓	

3. Self-evaluation of the value to the learners? (evaluation of project success) Can you document your assessment?

The group should make an overall evaluation of the impact of their own product on learners. The group should provide and support the evaluation with documentations. These documentations could include:

A) Describe your target audience and the learning objectives of your product

The main target audience and stakeholders of our animation project are the students of the course TPK5100 - Applied Project Management. However, whoever, interested in learning the concepts and methodologies of project management can also be the target for this product. As one of the requirements of the project, the product must have an influential and positive impact on learning, and therefore our animation video tries to communicate the importance of project management in projects.

B) A description of the method used to evaluate the final product.

In order to gather data for evaluating our project, we decided to conduct a survey. For doing so a questionnaire was prepared in which for understanding our target audience, we first asked whether they are students from TPK5100, students from other courses, employees, or individuals with project management experience. Then, by getting information about their level of knowledge about project management methodologies, we asked about their feedback for the concept and design quality of the work, as well as the level of impact it might have on conveying its desired points.

C) The number of informants who have contributed to the evaluation, and how these informants have been selected

After distributing the survey (through the Blackboard) between the students of TPK5100 as our main customers, all group members tried to share it with their own families and friends so that we can target different community segments. As a result, 49 participants took part in the survey and helped us in creating a solid data resource for evaluating our project.

D) Results of tests, surveys or interviews with students or persons who have reviewed the final product

The surveys were sent out to students, after the video was done. In all 49 individuals answered the survey. Among the people who took the survey, most of them (63.3%) are students from TPK5100. Students from outside of this class take 30%. It was also sent out to individuals with experience in project management, they take up 8.2% of the participants. Among all the people 75.5% of them had a course related to project management. When asking how familiar they are with the project management methodologies are, most answers ranged between 4 and 6 (range from 1 to 6 from not familiar to expert level.) And nearly half of the participants believe the film does a good job in delivering the message of how importance a proper project management is for a large-scale project like the Sydney Opera House. When it comes to the quality of group 18's final product, the majority of people held a positive view.

In all the variety of the participant is great. People from both inside and outside of the course answered the survey. They also came with different background related to project management. Some people have little to no knowledge of project management and there are also answers form the professional level individuals. In all there are generally a good understanding related to project management within the survey group. People without knowledge introduced great dynamic of the survey. When it comes to the quality of the animation, people in general gave a positive feedback. In all 70 % of the people think the main message was delivered successfully and quality of the product is decent. Within the group 7 people took extra steps in the survey and left group 18's product their precious comments.

Result graphs and other feedbacks are shown below:

Who are you?

49 responses

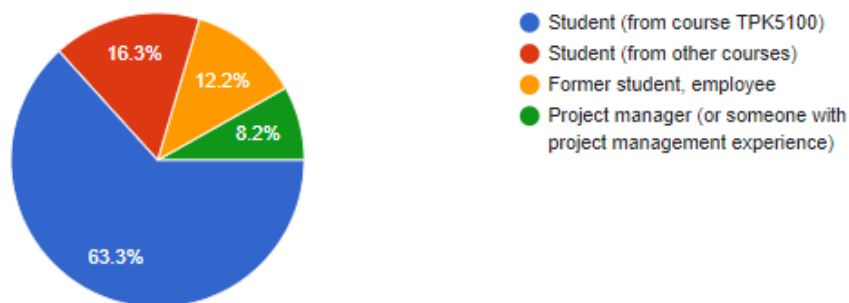

Have you ever had a course related to project management?

49 responses

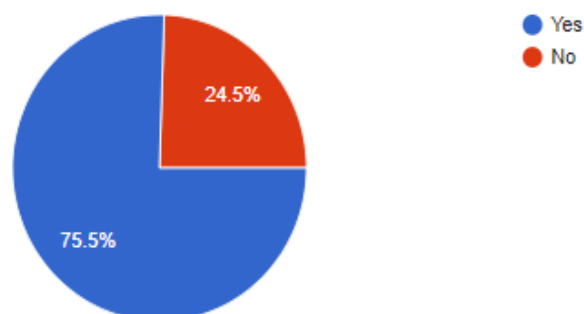

How familiar are you with project management methodologies?

49 responses

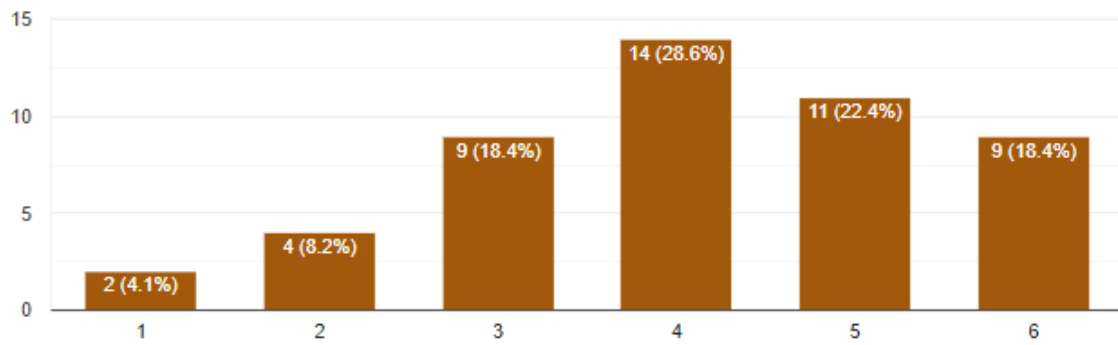

How useful was this tool in communicating the importance of project management in such big projects like the Sydney Opera House?

49 responses

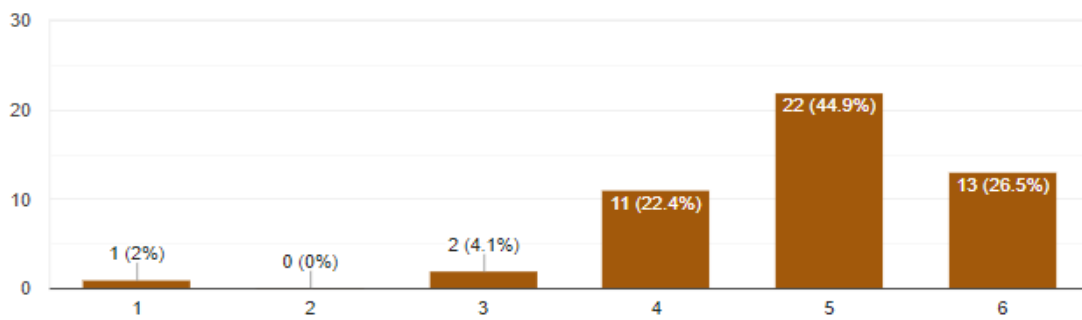

How was the quality of the animation work?

49 responses

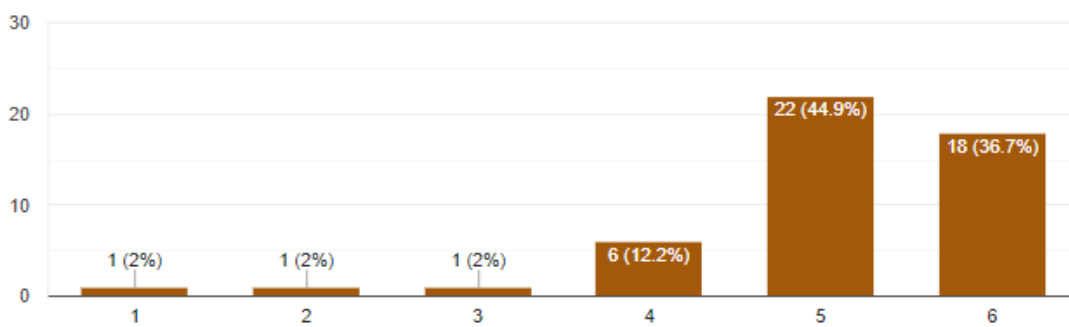

Any other feedback?

7 responses

Amazing!! It was very informative

Ideas on PM seemed to be deeply internalized. Animation was concise, had a good pace, well narrated. I enjoyed it and learnt about one of my favourite buildings in the world. Congrats to you all.

That voice.... can't take the smoothness!

Good work

Very informative

Very clear message. Simple and useful. Good job.

Easy to understand the concept

E) Please evaluate the degree of your support to the following statement (group-based evaluation):

	Our product is of high quality and we recommend it to be used as learning aid in project management				
Scale	Strongly Disagree	Disagree	Neither agree nor disagree	Agree	Strongly Agree
Your response				✓	

As a group we believe the main objective of the project was delivered. Not only the video was delivered on time, the group was on track with the project plan made previously. As for the quality of the product, the message was delivered clearly, as can be shown in the participant's answers. Our script is clear and easy for viewers to understand, it follows the building of famous opera house chronologically, which brings views along with the struggle of the project. The film is within a great time frame. The animation was clear and was of high quality along with the well-synced audio.

4. Factors that have contributed to failure / success.

In this section students should list and elaborate on all the factors that they believe have contributed to the success or to problems of their project. Which factor was the most significant and why? Compare your identified factors with the factors listed in (Hussein 2018) pp-92.

First, the project team made a project plan which supposed an early planning. The report included the description of the main stakeholders and their influence, a project risk assessment, the roles of every member in the project group and other important aspects for the project. The most important thing was the clarity of roles and responsibilities. The group was divided in three different teams. Two groups of three people (script and video editing, respectively) and another group of one person (audio).

Since the project started there was a dependency on every team but dividing the project group into three smaller teams gave us flexibility within the group. The dependency followed was a finish-to-start dependency. The first group did the script and the second group was dependent on the end of the script. Nevertheless, the second group started the research for a good video animation software before the end of the first task (script).

The first group divided the script in two meetings. After the first meeting, they created a 'google docs' document to share the intermediate result. This developed a good communication and gave feedback to other teams.

The second team had several meetings to discuss requirements, testing and decision. Furthermore, they met one entire day to create the animation video. Afterwards, the group members made improvements on their own. The third team added the audio at the end of the second task. A minor problem appeared with the communication between groups. A group member of the video-editing team asked the script team to arrange a meeting to create the animation video together. The script team explained to him that it was a task exclusive of the video team and roles were explained again to the whole group, so the problem was solved within one day.

The whole group worked well together without complaining about the structure of the teams and the roles they had. At the beginning, the whole group had one, and the only, meeting together. It was a problem for the group to find spare time because every group

member has a different study program. To solve this problem, the group created an excel document with the spare time of every single member on every single weekday. The three groups were created based on this excel table. The requirement for applying the spare timetable was that everyone was able to work together with different group members to perform the task. Trust and loyalty were created thanks to the different assignment of roles.

The purpose of the team was to create a learning aid to give some impact on end-users (future students). Nevertheless, the motivation of the group was to pass the course and have a good grade. Thus, the group paid for an animation software tool, in order to create a good product.

Other problem that appeared was the lack of experience and skills producing an animation video and audio recording. The team worked hard to solve this obstacle and they were able to deliver a good quality video on time. Furthermore, all the group members put a lot of creativity in producing the video and writing the script. For instance, to write the script a lot of different videos about the topic of the project were analyzed and discussed. The group project also watched some learning aid videos of previous years. Several methods to produce the video were considered.

The lack of project manager could have posed a problem but the good working climate of all the group members reduced the risk. Moreover, there was no involvement with the stakeholders, mentioned on the project plan report, during the project development. It posed an obstacle to get feedback for the survey of question 3 at the beginning. Nevertheless, during the last week, the group managed to get enough answers through the survey published on blackboard and some other external stakeholders.

To conclude, it can be said that it was a successful project and a successful project management with minor problems that were solved during the development of the project. The team worked well together, and a good communication existed in all phases. The most significant success factor was the structured organization with clarity of roles. It gave the project group the possibility to solve problems and work together with a good communication, as explained above.

To summarize, a table is attached with the most significant factors and problems that contributed to the success of our project. The list consists of the factors listed in (Hussein 2018) pp-92.

FACTORS TO SUCCESS	PROBLEMS
Early planning	Little knowledge at the beginning: Solved with hard work
Clarity of roles and responsibilities	No experience
Loyalty to decisions	Proximity: Difficult to communicate with other groups. Solved with the feedback from the survey.
Impact on users: learning aid	
Appropriate project organization structure	
Honesty on reporting	
Clarity of priorities and structures requirement process/ purpose and objective: Pass the course and have some impact on future students. Make a good animation video.	
Creativity of the team	
Use of lessons learned from previous projects: book, videos of past years and video of Opera House	
Structured risk management process: first report (Project Plan)	
Good communication but with some problems	
Motivation of the team: pass the course and get a good grade	
Flexibility: Division of the group in smaller groups and follow a finish-to-start dependency	
Adequate report at the beginning	
Trust: friendship	
Stability/continuity of project organization	
Continuity of project development: smooth transition among tasks	

5. Most important lessons from your project

Working on projects in a team is always associated with a number of challenges. To help students who will be working on similar projects in the future, I would like to give some advice below. The advice is all based on the experience we have gained while working on our project.

At the beginning of the project, it is important to obtain comprehensive information about the goals and basic conditions of the project. I recommend that you ask the client at an early stage if something is unclear, so that you do not lose time on that during the project. When deciding on a product type, you should consider which type has the greatest benefit for the end user. Keep in mind that complex products are not always the best. In my experience, even simple products can be very useful.

After you have decided on a product type, you should start working on the project as early as possible. From experience, too little work is often done at the beginning of a project because there is still a lot of time left. This leads to time pressure at the end of the project and there is no buffer time for unexpected things. My recommendation is to set up a time schedule at the beginning, which should be checked regularly during the project. In addition, you should designate a project manager who will, for example, organize team meetings. My experience is that the lack of a project manager results in nobody taking the initiative and everyone waiting for someone else to do it.

In order to work efficiently, I recommend dividing the team into small groups. When dividing up who works in which group, it makes sense to consider the previous knowledge and talents of the individual team members. Decisions of minor importance should be made in the small groups. Questioning the entire team every time is often not really necessary and only leads to time delays.

I suggest you make clear arrangements. Everyone in the team needs to know clearly his tasks. The processing of subtasks should always be associated with a time schedule. It does not make sense to hold a team meeting for presenting intermediate results if not everyone has completed the own tasks by this deadline.

Finally, I advise you to not only see the project as work, but also to consider the learning effect. Of course, working on a project means more work than just sitting in a lecture. However, in practical project work you acquire important skills for your later professional life. Through the project I have not only trained working in a team, but also solved a problem about which I did not know in the beginning whether and how we should solve it. Looking back, I consider the experience I gained on the way to the final product to be very valuable.

6. References

Hussein, B. (2018). The Road to Success: Narratives and Insights from Real-Life Projects, Fagbokforlaget.

Initiative, F. A. D. G. (2009). Digitization Activities: Project Planning and Management Outline.

Stenberg, G. (2006). "Conceptual and perceptual factors in the picture superiority effect." European Journal of Cognitive Psychology **18**: 813-847.

Whitehouse, A. J., Maybery, M. T. and Durkin, K. (2006), The development of the picture-superiority effect. British Journal of Developmental Psychology, 24: 767-773.
doi:[10.1348/026151005X74153](https://doi.org/10.1348/026151005X74153)

1) Peer-review report

Each group is assigned a peer-review group. The list of the assigned groups is shown in the following table. The table shows for instance that the product produced by group 1 will be reviewed by group 11, and the product produced by group 2 shall be reviewed by group 22.

Before writing this review report, you need first to view/test the product produced by your test group. In your evaluation you should be **objective, fair and use to time to fill in the report**. The grade you assign based on your evaluation **is a guide** to the instructors when they grade the project assignment.

Product produced by Group (Test group)	Shall be Peer-reviewed by group (Peer-review group)
1	11
2	22
4	8
6	5+12
7	4
8	1
9	10
10	12
11	13
12	14
13	15
14	16
15	17
16	18
17	19
18	2
19	20
20	24
22	25
24	26
25	27
26	33
27	34
33	36
34	6
36	7
5+12	9

Your peer-review evaluation report

What is name of the group you are assigned to evaluate: Group 16

A) Based on your evaluation (as a group) please indicate the strengths and weaknesses of the final product.

Strengths (what are the good things about the product) this might include; the idea, there is a need for that, you believe that the product provide real value to learner, or that the product is of high technical quality (for example excellent video quality)

- Good concept
- Creative
- Good narration
- Good handwriting
- Easy to grasp the concept of stakeholder mapping in construction industry

Weaknesses (what are the features in the product, that you believe has impacted negatively your evaluation) that might include quality issues, lack of aiding text, lack of user-friendliness, tedious, and so on

- Background music was a bit loud and is distracting
- Writing was illegible to read in the beginning
- Hard to follow in some parts of the video because the narration was fast

B) Please evaluate the degree of your support to the following statement (group-based evaluation):

	The product we reviewed is of high quality and we recommend it to be used as learning aid in project management				
Scale	Strongly Disagree	Disagree	Neither agree nor disagree	Agree	Strongly Agree
Your response				✓	

C) On a scale from 0 to 10. **What grade would you recommend for this product?**

8/10

Projectify

An interactive learning app to become a professional in project management

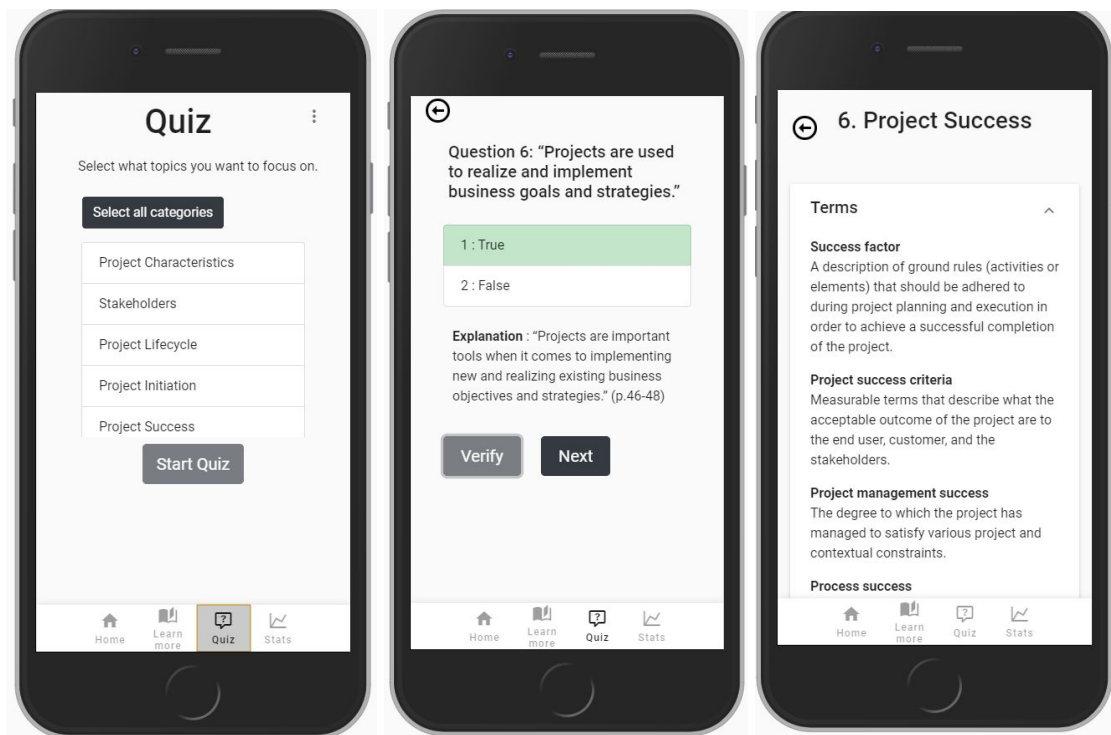

TPK5100

Group 19

Preface

The purpose of this report is to evaluate our project: creating Projectify, an interactive learning app in project management. The report discusses common challenges related to digitalization projects and assess our project, in terms of project management, project process and project success. At the end, we conclude with what we have learned throughout the project, that others working on similar projects might find helpful.

We would like to say thank you to all that took their time to complete our surveys, our student assistants for feedback on our project plan, as well as Bassam Hussein, the project owner, for giving us guidance throughout the project.

Group number: 19

Student names and student number:

- 1) Anders Høgset Hove, 478130
- 2) Emilie Kristine Schack von Fyren Kieler Kvam, 478036
- 3) Henrik Knudsen ,477633
- 4) Jakob Rognlien, 478129
- 5) Ragnhild Hjermstad, 999688
- 6) Ulrik Eriksen, 478145

1. Digitalization projects

Describe your product, its intended purpose and why you have selected to produce this product.

The purpose of the project was to develop a digital learning aid that has a significant positive impact on learning. The group has created a learning application, allowing students to read summaries and term definitions from essential topics within project management. In addition, the users may test their knowledge in the quizzes for each topic. The main motivation for using a web app as the platform for our product is centered around accessibility. As most modern digital devices employ some sort of internet browser, our users will be able to access the product regardless of whether they are using their PC, Mac, tablet or smartphone.

After having the opportunity of working on a small-scale digitalization project, what are, in your opinion, the main challenges that your group has experienced with this type of projects? You should base your statements on your own reflections and preferably support these reflections using project management literature. Scope is 400-600 words (1-2 pages)

After working on a small-scale digitalization project in this project management course, we have gained some experience with the challenges one can encounter in this type of project.

Teamwork and collaboration are important soft factors of project management that have proven to be necessary in order to achieve success in digitalization projects (Ngereja, 2019). When analyzing the results from the initial end-user survey, it became evident that the project group did not convey the technical limitations in the application and with the chosen platform before the survey was created. Some end-users specified that they wanted videos illustrating and explaining the topics. The developer in the project team indicated that this option would take a considerable amount of time, possibly jeopardizing the project deadline. From this challenge, it is possible to derive two missteps we encountered. Firstly, the limitations of the application were not elaborated before involving the end-users within the project group. Secondly, the limitations of the application were not communicated through the survey, giving them a distorted image of the possibilities in the application. The two missteps could have been avoided if the project developer and the rest of the project group elaborated on the technical limitations of the application before creating the survey,

and conveyed the result to the stakeholders. Consequently, one might have been able to obtain more valuable insights from the surveys as they would express the stakeholders' needs and wants subject to project constraints.

Another challenge we faced was to construct and execute a network design that would optimize the project's process. The developer started developing a prototype before the project group took the final decision about the layout and design of the app. This led to several suggestions regarding changes in the design and layout to be raised after the developer had started to create a prototype. Depending on the extent of the changes suggested, it could take significant time implementing the suggested changes. The challenges could possibly have been avoided by having a more clear set of decision gates.

The project team later on discovered that the textual content did not fit to the screen size intended for the application, and it resulted in a notable amount of time spent on adapting the content. For the project team it was also evident that the quality and learning impact of the content could potentially be reduced when the format of the content needed adaptation. This challenge highlights the importance of the content makers being familiar with the format requirements of a digital solution before creating the content, possibly requiring more collaboration to ensure consistency with the needs of the stakeholders and the exploitation of opportunities in comparison with other types of projects.

In light of the imbalance between end users' preferences, project duration and the required format adaptation, one may conclude that the digitalization project had several constraints requiring trade-offs. It is therefore relevant to question if the application is a suboptimal solution given the limited time to implement the wants from the participants in the survey. However, the answers from the second survey, where end-users were asked to share their views on the application, imply that the end-users are satisfied with the content in the application, its quality and its significance on learning impact.

2. Self-evaluation of the project management effort in the project, success or failure? And why?

The group should make an overall evaluation of their own project. This is an evaluation of how well the group managed the project, how well was the organization of the project group. How well the group identified and managed risks. Did the group managed to deliver the project results according to your originally stated success criteria (according to your original plan)? Is there any deviations between the stated success criteria and your final evaluation of the project.

Project management success is concerned with the degree to which the project has been able to satisfy the project and contextual constraints. As outlined in the project plan, the constraints surrounding this project were a vital characteristic of the project itself, and included a short timeframe, 0 kr budget and limited digitalization competence within the project team.

The short timeframe of the project was dealt with by the early creation of a schedule, with dated milestones reflecting the most important tasks that were to be handled. This allowed us to gain an overview of the workload and complexity of the project while ensuring continuous progress.

Although this proved to be a great advantage in dealing with the time constraint of the project, it also restricted the creativeness of the project group and its ability to receive new ideas from the end users, as the implementation of some features were considered to be infeasible within the deadlines indicated in the plan. The strict budget and limited experience in creating an application put further restrictions on the features and design of the application. In the project planning phase, several risks were identified and measures were created to avoid, mitigate, transfer or accept these risks.

Although, most of the measures proved to be efficient, the mitigating action, as well as the severity of technology being out of scope, were evidently underestimated and insufficient. Consequently, desired features such as illustrations and videos were ignored, as we did not have a plan to deal with requests that required extensive time commitment and additional learning and development of our technical skillset. The measure would have been sufficient if the goal was merely to create a functional app, but as the objective was to create a learning tool, additional measures should have been made to deal with this scenario.

Throughout the project, we have organized ourselves using a non-hierarchical structure, with equal formal influence and shared responsibility for project progress. Despite this, the responsibilities and

formal and informal roles of the team members have evolved differently. This facilitated for an effective group dynamic, maintained continuous progress and kept the workload relatively steady throughout the project. We decided to take advantage of the skills and capabilities that one of our team members had from computer programming, who became the project’s developer. The others gathered qualitative data through surveys and wrote the content of the application, thus shared the responsibility for the lion’s share of the learning outcome of the application. We developed good routines and were frequently communicating our concerns for the project, in order to manage possible risks. The final product was constructed using an iterative development process, where feedback was given at the group’s weekly meetings.

Although the project group faced some challenges related to the technicalities of the application, the project can be considered as a project management success, as the project was completed on time and according to budget. The application met the functional and contextual requirements that we as a group decided upon, thereby fulfilling several of the success criteria defined in the planning phase of the project.

Based on these observations we evaluate our project as successful.

Scale	Strongly Disagree	Disagree	Neither agree nor disagree	Agree	Strongly Agree
Your response				X	

3. Self-evaluation of the value to the learners

Describe your target audience and the learning objectives of your product.

The purpose of the project was to develop a digital learning aid with a significant positive impact on learning regarding project management. The intended outcome was to deliver a functional product that students would want to use and would improve their overall learning experience. In light of this, we decided to develop an interactive, educational web app. As the content of the app was to be related to project management, the target audience was current and future students in the subject TPK5100. We chose to base the content on the curriculum of this subject and designed it for high

exam relevance. In the project plan, we presented the intended learning outcome for the various stakeholder groups, herein the end-users. This will be analyzed in this chapter.

A description of the method used to evaluate the final product.

To evaluate our product, we made a survey to gather feedback through peer-review. The result from the product survey was compared to the stakeholder survey that was executed in the initial phase of the project. By using this as a baseline, we were able to compare the needs with the produced output and this way assess the achievement of our success factors. In addition, an internal review was made to both gather experience and to evaluate learning outcome from the team process in the project. This was done as an oral discussion in one of the final meetings, where learning experiences from all aspects of the project were assessed. In the meta-perspective, where the project was implemented as a learning tool in TPK5100, the project team members are the end-users. Therefore our evaluation will also be addressed in this chapter.

The number of informants who have contributed to the evaluation, and how these informants have been selected.

The number of respondents to the app review was 26, while 29 respondents completed the initial survey. The initial survey was sent to students for whom it was considered relevant and posted in a number of facebook-groups for students with some level of project management related to their degree. The review-survey was posted on Blackboard by the professor on our behalf, to reach the enrolled students. For the review, we wanted to seek out experts in addition to the expected end-users. Therefore, a number of project managers, consultants and former students of the course were asked to complete the review as well, to give expert assessment on the relevance for both the project management profession and the curriculum/exam.

Are you a current or former student in the course TPK5100 Project Planning and Control?
26 svar

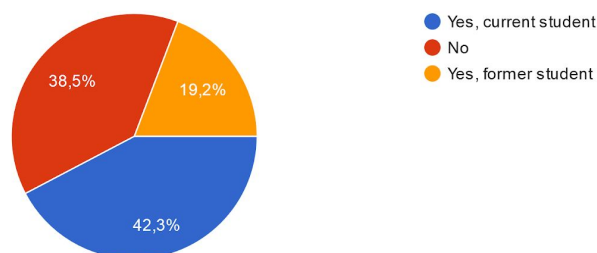

Figure 1: Distribution of respondents.

One issue we came across when analysing the results, was the ratio of currently enrolled students to the expert segment. The distribution is shown in figure 1. Ideally, we envisioned only a few experts as quality assurance, but the expert segment proved more willing to test the application than the students, resulting in a more even distribution. Still, we consider all the respondents' assessments to be valuable, and do not believe the experts' assessment of learning outcomes and relevance is far from the students' own, despite little knowledge of the selected curriculum. In addition, the previously enrolled students made up 19,2 % of the respondents and could be considered to have a foot in both camps.

Results of tests, surveys or interviews with students or persons who have reviewed the final product.

The expected learning outcomes were established in the initial phase and presented in the project plan, and will be used as a basis for the analysis. The outcomes were allocated to specific stakeholder groups and the possibility of cross effects and ripple effects were taken into account.

Users: students and other end-users

- Increased understanding of the characteristics of a project and how it should be managed in order to achieve success.
- Acquisition of knowledge, skills and general competencies that are considered to be essential in the course “TPK5100 Applied Project Management” during the fall of 2019.

In order to achieve the purpose of major impact on learning, getting students to actually use the application was a prerequisite for success. An important question in the review was therefore if the respondents would use it as a learning tool to learn about project management and/or prepare for the exam.

The response was positive, with a majority, 53,8 %, answering ‘Yes’. Only 7,7 % answered ‘No’. Considering the narrow scope and that the initial survey indicated solving old exams as the dominant study technique, this can be considered as a sign that the quality, accessibility and content of our application is largely appreciated. 24 out of 26 respondents rated the quality of the content as a 4 or 5 on a scale from 1 to 5, with 1 being very bad and 5 being very good. In the following question, where the respondents rated the relevance from 1, being not the right type of content, to 5, being excellent content, 20 out of 26 respondents gave a rating of 4 or 5. We consider these great results, especially considering the amount of respondents being professionals and therefore not directly related to the course, nor its curriculum.

Do you agree with the following claims?

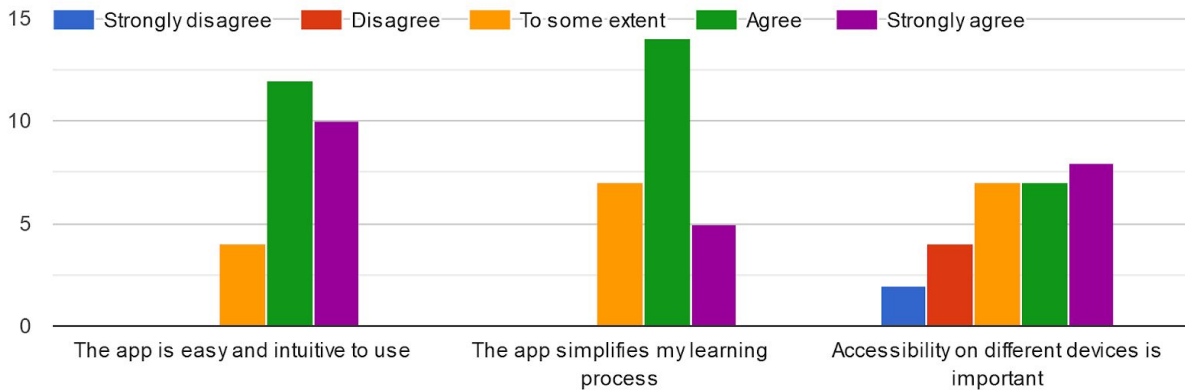

Figure 4: The feedback on user-friendliness and learning simplification was only positive. Accessibility on different devices was considered less important.

Comments on the best features of the app mainly revolved around being easy, orderly and intuitive to use. Some respondents also showed appreciation for statistics and explanations on the quizzes, while others commented that they found the content to be satisfactory. An important question, shown in figure 4, made it clear that the respondents believed the application simplified their learning process. On this note, we conclude the user objectives as fulfilled.

Please evaluate the degree of your support to the following statement (group-based evaluation)

In the project review, we specifically asked for what the respondents considered to be strengths and weaknesses. The strengths have already been presented. As for the weaknesses, user feedback mainly revolved around the application's visual design, being quite simple, a necessary tradeoff given the project's strict constraints. A few comments also pointed to bugs or flaws, such as the back button not working properly, but these were immediately handled. The project team considers it a weakness of apps in general that the content has to be customized to fit the interface, thereby limiting the type of content, possibly affecting its quality and impact on learning outcome. However, a learning application like ours is to be considered as a learning aid rather than a replacement of the existing curriculum and teaching methods, such as lectures and assignments. Even though there are flaws and weaknesses to our application, the quality of the existing content is high. Therefore, we consider Projectify as a good tool and would recommend it as a learning aid.

	“Our product is of high quality and we recommend it to be used as a learning aid in project management”				
Scale	Strongly Disagree	Disagree	Neither agree nor disagree	Agree	Strongly Agree
Your response				X	

4. Factors that have contributed to failure / success.

In this section students should list and elaborate on all the factors that they believe have contributed to the success or to problems of their project. Which factor was the most significant and why? Compare your identified factors with the factors listed in (Hussein 2018) pp-92.

Hussein (2018) divides factors contributing to the success of a project into three categories: case-specific, structural and cultural factors. All of these categories are to some extent represented in the success factors defined in our project plan. The factors we defined initially were:

- Develop a project plan that outlines the activities, tasks and timeframes
- Efficient team (implying common goal, mutual dependence, solidarity, mutual trust, motivation and dedication)
- Good communication among group members
- The establishment of a functional group culture
- Troubleshooting expertise
- Access to and expertise in functional technology
- Involvement of end users in the product development
- Effective utilization of the expertise of group members
- Ability to map the requirements of the stakeholders and translate it into functional and process requirements

In order to call our project a success, these factors should to some extent be considered fulfilled, through our work on the project.

Dividing the factors into the categories established by Hussein (2018), expertise within troubleshooting and functional technology could both be considered case-specific factors. These of

course apply to all digitalization projects, but in our case of bigger importance than usual, as most team members lacked knowledge of the technical aspects of the project. As mentioned earlier, only one team member possessed the sufficient programming skills to create the app. However, the technical competence was still sufficient to fulfill these success factors, as was indicated in the end-user reviews.

The development of a thorough project plan was an important structural factor. Deliverables were divided into work packages with dates for deliveries. Apart from a single deliverable, which was delayed by a day, these were all adhered to by all team members. This was however, not a threat for the success of the project, as several extra days were accounted for as a buffer in the original plan. Progress in accordance with the project plan was, among other things, a result of an efficient team working towards a common goal, defined initially. The intended outcome was agreed to be the development of a functional product that students would want to use and would improve their learning experience. By utilizing our members' knowledge and skills in a resourceful way, we managed to make a product we consider as a helpful tool for learning project management. As previously mentioned, we were unable to implement all the desired ideas and functions, but the final review suggests that the product still is satisfactory for our end-users.

Another structural factor was the stakeholder mapping and an analysis of the stakeholders' wants and needs. The mapping revealed that some of our most important stakeholders, in addition to the end-users, were our professor and those responsible for grading our work. The survey and review also allowed the end-users to give feedback; related to learning tools, content and the prototype. This enabled us to make changes underway to customize the product to its purpose and the end-users. The results of which can definitely be seen as successful, based on the previously mentioned end-user feedback.

The last important structural factor defined in our plan, was having good communication among group members. The group met regularly throughout the whole project. As a result, all members present were updated on progress, challenges and ideas. Team members who were unable to meet physically were given updates digitally. However, more formal meeting reports and templates regarding content structure should have been created. Most misconceptions along the project was related to content structure and technical limitations. By formalizing these, several misconceptions

might have been avoided and improved the overall efficiency of the group, freeing up time for other tasks.

Looking at the cultural factors, the group culture was for the main part a result of the openness and trust between the group's members. As we were all mutually dependent and affected by each other's work, this developed naturally from the beginning. It made us avoid limiting the creativity and enthusiasm of the group, which could have led to a decrease in the overall satisfaction of end-users.. Lastly, the environment facilitated quick response time, allowing the group to efficiently deal with both technical and formal challenges. We therefore feel that it is safe to say that the cultural success factors of the project were fulfilled.

The success factors of our project coincide with those extracted from the case studies by Hussein (2018, p. 92). A well conducted planning phase, and loyalty to the decisions made in it, provided us with a predictable execution phase. However, in an attempt to be agile, the group responded to feedback from end-users and problems detected along the way, adapting to them without deviating from the final goal. The team collaborated well, resulting in a good utilization of each member's knowledge and experience. Even though the group might have benefitted from having more members with technical competence, the final product ended up in a way that was satisfactory, both for us as a group, and our end-users.

5. Most important lessons from your project

If you should give clear-cut advice to other students on how they should work on similar projects what you will say to them?

Throughout this project, we have encountered several challenges related to digitalization projects and project management. Based on this experience, we hope to provide others who are planning to work on similar projects with some advice.

When building a learning tool, it is important to early identify the learning objectives, as it enables you to deduce various factors that the product must satisfy in order to be successful. These factors define the identity of the product, providing structure for the project. In a way, the product should be built based on the criterias of the learning objectives. Starting with the product, rather than the

objectives, makes it difficult to reach a satisfactory endpoint, as you will continuously find learning objectives that your initial product idea does not satisfy. This approach is risky, time and resource consuming, and will most likely not fully meet the stakeholders expectations.

Our advice is to create a structured and detailed, written project plan. Our group put a lot of effort into our project plan, which worked to our advantage. Having a complete Work Breakdown Structure (WBS) simplifies the assignment of work packages to team members, while improving communication within the group. Our risk analysis was satisfactory concerning the human and organizational factors of the project, but somewhat lacking in terms of the technical factors of the project. Having a more extensive risk analysis might have better prepared us for technological challenges during the project, improving our overall efficiency.

During the project, we also learned that communication with the end users is an important project success factor. Initially, we wanted case-based questions as part of the app, as we thought that students preferred these types of questions when studying for the exam. The survey however showed that this was not the case. This was a clear indicator of the value of involving stakeholders early in the project, clearing up misconceptions about the desired product.

Our experience concerning digitalization projects suggest that the group should have a thorough discussion regarding the expectations of the project. During the planning phase, we agreed on what kind of effort that was expected by the members, as all of us had high ambitions for the course. The group agreed to create an application as our product, but did not discuss the expectations and constraints of the project explicitly. A consequence of this was that people had different perceptions of how the app would look like. A solution to this issue might be to create a functional layout, before creating the prototype and the content to the application. This could enable the group to determine and agree upon the design and format of the application, earlier in the execution phase.

References

Hussein, B. (2018). The Road to Success: Narratives and Insights from Real-Life Projects, Fagbokforlaget.

Ngereja, B. (2019). Digitalization Projects. *TPK5100 Praktisk Prosjektledelse*. Available from: https://ntnu.blackboard.com/webapps/blackboard/execute/content/file?cmd=view&content_id=_716607_1&course_id=_16098_1 [Accessed: 10.11.201

Peer-review report

Each group is assigned a peer-review group. The list of the assigned groups is shown in the following table. The table shows for instance that the product produced by group 1 will be reviewed by group 11, and the product produced by group 2 shall be reviewed by group 22.

Before writing this review report, you need first to view/test the product produced by your test group. In your evaluation you should be **objective, fair and use to time to fill in the report**. The grade you assign based on your evaluation is a **guide** to the instructors when they grade the project assignment.

Product produced by Group (Test group)	Shall be Peer-reviewed by group (Peer-review group)
1	11
2	22
4	8
6	5+12
7	4
8	1
9	10
10	12
11	13
12	14
13	15
14	16
15	17
16	18
17	19
18	2
19	20
20	24
22	25
24	26
25	27
26	33
27	34
33	36
34	6
36	7
5+12	9

Your peer-review evaluation report

What is name of the group you are assigned to evaluate: 17

A) Based on your evaluation (as a group) please indicate the strengths and weaknesses of the final product.

Strengths (what are the good things about the product) this might include; the idea, there is a need for that, you believe that the product provide real value to learner, or that the product is of high technical quality (for example excellent video quality)

- In general nice and intuitive illustrations and images (good visuals): good animation
- Calm and clear voiceover
- Good walkthrough of the case
- Provides value for learners that prefer videos over texts

Weaknesses (what are the features in the product, that you believe has impacted negatively your evaluation) that might include quality issues, lack of aiding text, lack of user-friendliness, tedious, and so on

- Should have been more clear on the lessons from the case. Could have been some text with the key takeaways
- Could have provided additional reflections to provide the viewer with insights that are not described in the book(so that this video would not just be digitalization of a case in the book)
- Could have introduced the relevant theory to give a better understanding of the take-aways.
- Limited scope, not the best learning tool for everyone
- Some illustrations were not relevant to the case and situations i.e robustness/bodybuilder

B) Please evaluate the degree of your support to the following statement
(group-based evaluation):

	The product we reviewed is of high quality and we recommend it to be used as learning aid in project management				
Scale	Strongly Disagree	Disagree	Neither agree nor disagree	Agree	Strongly Agree
Your response			X		

C) On a scale from 0 to 10. What grade would you recommend for this product? 6

This product can be a supplement to discuss cases in the course. This is supported by the high technical quality, such as a clear voice and nice illustrations. However, some of them were found to be less relevant for the visualisation of the case. Given the limited scope, lack of introduction to the relevant theory and additional reflections about the case and its results, we believe that it might not have a significant impact on learning, and we therefore give the product grade 6.

TPK5100 APPLIED PROJECT MANAGEMENT

AN INTERACTIVE WEB-PAGE FOR SELF-TESTING

November 19, 2019

Group number: **20**

Norwegian University of Science and Technology
Department of Mechanical and Industrial Engineering

Contents

1 Digitalization project	3
1.1 Product	3
1.2 Challenges	3
2 Self-evaluation of Project Management	4
3 Self-evaluation of value to the learners	5
4 Success & Failure	7
4.1 Success factors	8
4.2 Failure factors	9
4.3 Key factor	9
4.4 Relevance to literature	9
5 Lessons learned	10
6 References	10
7 Appendix	12
7.1 <i>A. Results from the survey</i>	12
7.2 <i>B. Codes</i>	13
7.3 <i>C. Link to Product</i>	13
7.4 <i>D. Interview with the course representative, Bassam Hussein</i>	13
7.5 <i>E. Peer-Review of Group 19</i>	14
7.5.1 Strengths	14
7.5.2 Weaknesses	14
7.5.3 What grade would you recommend for this product?	14

Preface

This report will discuss the evolution of the final product "The road to knowledge". It will cover topics like evaluation of the product and the project management. Further on it will discuss digitalization and it's problems and possibilities. An appendix with an interview with the professor, a link to the HTML- and Javascript files for the website and further illustrations will also be attached. The peer-review is also attached in the appendix. The project team would not be able to finish the product without help from other people. The team would like to thank the professor Bassam Hussein and the student assistants for being factual and constructive when answering questions. The group is also thankful for being able to use the professors literature. The project management will also thank the members of the class and other students for answering our google survey and questions about the final product. At last the group would like to thank our friend and computer science student Ole Bøe which helped us in choosing format for the website and programming language when the team was in need of guidance regarding what was achievable with their current knowledge and skill sets.

Group number: 20

1) Ole Tobias Tveit, 10064.

2) Trygve Mikal Viga Skretting, 10058.

3) Gaute Hånsnar, 10013 .

4) Henrik Ågrau, 10036 .

1 Digitalization project

1.1 Product

The product is a web-page with four windows. Front page, about, quiz and a link to TPK5100s website. The quiz consists of questions related to the literature in TPK5100-Project management with questions from all chapters. All questions are multiple choice and after answering you get a complementary answer. The product was selected because of the groups experience with using similar products. The product is easy to use, recognizable and productive.

Figure 1 below displays an example of how the page could look like in the quiz.

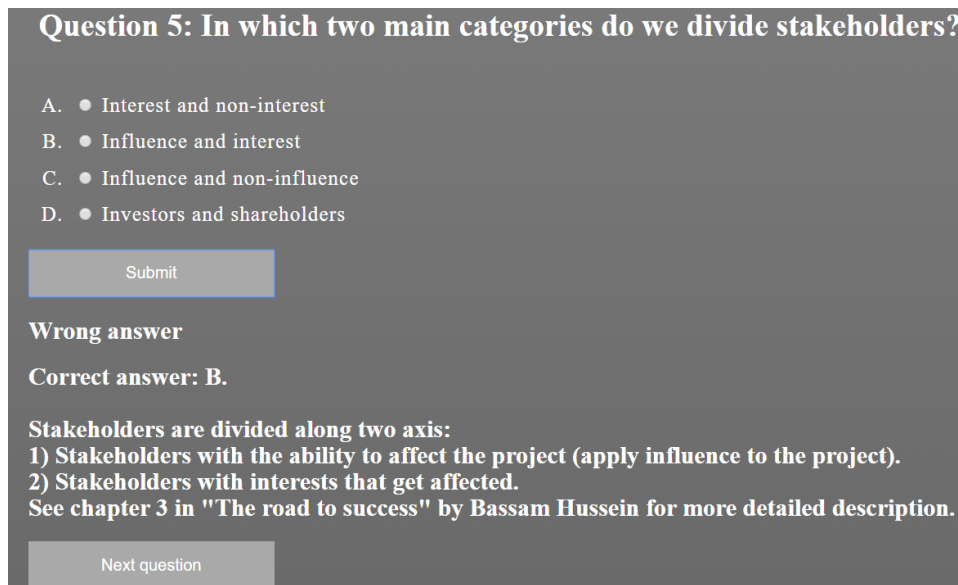

Question 5: In which two main categories do we divide stakeholders?

A. Interest and non-interest
B. Influence and interest
C. Influence and non-influence
D. Investors and shareholders

Submit

Wrong answer
Correct answer: B.

Stakeholders are divided along two axis:
1) Stakeholders with the ability to affect the project (apply influence to the project).
2) Stakeholders with interests that get affected.
See chapter 3 in "The road to success" by Bassam Hussein for more detailed description.

Next question

Figure 1: Layout of a question from the web-page.

1.2 Challenges

Digital transformation is the integration of digital technology into all areas of an organization, fundamentally changing how you operate and deliver value to the consumer. It's also a cultural change that requires organizations to continually challenge the status quo, experiment, and get comfortable with failure.

In this case the task was to plan, develop and produce a digital learning aid in project management. First challenge that occurred was how to get the literature from the book over to a digital platform. Digitization is representation of a document, image, object, sound, signal, or measurement as digital data. An analysis of the most important literature in the textbook was completed, and developing of questions that would give the most learning outcome was made.

The task was to challenge the students to develop a digitalization project that benefits the development of learning in the course. The whole world is affected by a digital revolution. Digital platforms make the life of ordinary people easier with simplifying everyday tasks. Digitalization is known as an increase in the use of digital- or computer technology and includes improvement of the product/process, automation of the processes and simplification of communication. The challenge here is to make this digital learning aid in a way that make

learning easier, is practical to use, gives motivation for further learning and easily available for all students.

Change is inevitable and for it to be successful it must be accepted. Soft factors are a very important factor in digital transformation and therefore an important challenge to overcome to ensure project success. Digital technology is all about connecting people and machines. For the past three decades it has been evident through various project management research that these factors are more important than technical factors in ensuring project success. The main target audience for the project are the students enrolled in the course. Students today have a lot of experience with digital tools. Everyone has a computer and know how to search the internet and use this as a learning tool. An advantage the group had was that all the members are students in the same class. This advantage included insight in the course, own desires for improvement and test group for quality assurance of the digital learning aid. The web page consists of existing technology and a learning model that many students have former experience with. The benefits of the simplicity and recognition factor is that students don't have to have a long habituation period and can put the web page to use right away. The web page will make an impact in essentially the internal efficiency. It creates a improved way of working via digital means. Because of the way the page is build, external opportunities can also become an impact. With some easy customizing, people outside the course can also use this an an learning aid.

Figure 2 below illustrates the three phases of the process that all came with different challenges.

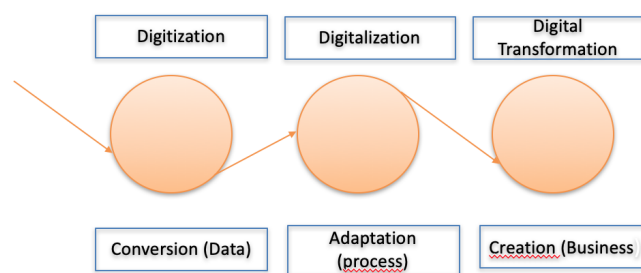

Figure 2: Process digitalization project

Another challenge in the digitalization project was to develop the web page. Because of the lack of programming knowledge inward the group, external actors and searching the internet became the solution. This process challenged the project group to acquire knowledge and create a working environment with collaboration. These people related factors is another example of soft factors implemented in the digitalization project.

2 Self-evaluation of Project Management

A full self-evaluation has to include an evaluation of all the work done from the idea was decided to the project was completed and delivered. The group sat down at first to identify risks when designing and developing a web site. As the group acknowledged lack of significant programming skills, a risk of not being able to develop the web-site was avoided. After speaking to Ole Bøe with a computer science background, the group concluded that it was feasible to use HTML and JavaScript to create a website as these computer languages aren't too complicated for people creating their first website. By doing this examination, the group made sure that one of the main success factors was achieved: Development of a fully functional web-site.

The group stayed organized by putting one person responsible for their own section of the project. The

responsibilities were a project manager, a digital responsible, a syllabus responsible, and a report responsible. Despite this the tasks has not been fixed to only one person and the group have collaborated on the tasks, but this has helped the group getting an overview of the status of each of the different areas of the project. For example the digital responsible have had the opportunity to focus on learning how to set up a website. This is often a one-man-job, so the other group resources could be used for other tasks like making questions or preparing the report. All in all the organization of the project group were successful.

The project group made a time-schedule with weekly meetings and work-sessions at specific times. At these meetings the group discussed how the stakeholder management were going and if some interaction with a stakeholder were needed. An example of an interaction is the interview with the professor (**subsection 7.4**). A risk that was not taken into account was the fact that two of the four group members had other voluntary work outside of school that lead to absence at the agreed sessions. This led to some setbacks, but was not a problem that led to failure at any point. Further on, the group did a good job in mapping all the important work-packages and thus avoided underestimation of workload.

An important part of the project that was not taken into consideration at the planning phase of the project was how to test the success of the product. When the product was completed the group realised that the product had to be tested in various ways, and also document how good the product was. First of all the website had to be stress tested to see if the server managed high traffic, and secondly the page had to be tested to see if it was simple enough for the users to use. This had to be done, but since the group did not realise this until a late phase of the project, it was only a moderate amount of time left to do this and possibly do some changes as a result of the testing.

We evaluate our project management effort as successful :

Scale	Strongly Disagree	Disagree	Neither agree nor disagree	Agree	Strongly Agree
Group response				X	

Table 1

3 Self-evaluation of value to the learners

As this is a question website made for the course TPK5100 it is obvious that those with the highest benefit from the product are the students enrolled in the course. One might argue that the page is targeted for the teachers of this course, as the site is also made with the intention of being a tool that can be used by both the student assistants and also the lecturer. It is probable that they will yield great benefits from utilizing a product such as this one. However, the purpose of the site is so make it easier to learn the basic terminology of the course, and that means that the group of people that probably will use the site the most are the students.

To evaluate the value to the learners, it is important to reach out to a representative amount of people. The easiest way to do this is to reach out to them on their student mail. This was not found very effective in the project management phase as not too many answered. Therefore the project group decided to reach out to the students in person during classes. The students were approached with the web-page and asked to fill out a survey afterwards. The same thing was done with a few students that had the course last year to get a few more

objective answers. Answer options in the survey were disagree, slightly disagree, neither/or, slightly agree and agree.

For this product to be reliable and a success, it is important that it can handle great traffic. To stress test the product, the project management sent a link to 30 associates and asked them to use the web-page for a few minutes at a specific time. The project management found this a representative number of people, as there will likely not be more than 30 users at the web-page at the same time.

The number of students that were reached with the survey in class was 21. This was not the number the management hoped for, but with only 15-minutes break between lectures, and the fact that this method is time-consuming this number can be accepted. When it comes to the stress test, the persons to execute this was selected based on who was easiest to contact and reliable to perform the test at the planned time. This sums up to a total of 51 contributors to the testing and evaluation of the product.

The result of the stress test were as expected. The project team decided to use Netlify, which is a free to use service as long as the user promotes them through the web-link with their domain ".netlify.com". This decision was made because it is a free service, and because Netlify is a reliable source trusted by for example Facebook and Nike.

One of the main focuses of the product development was to come up with an easy to use web-page. This was important to make it user-friendly and because the group saw a lack of competence in programming. The results shown in **Figure 3** backs up the fact that the project management team reached this goal.

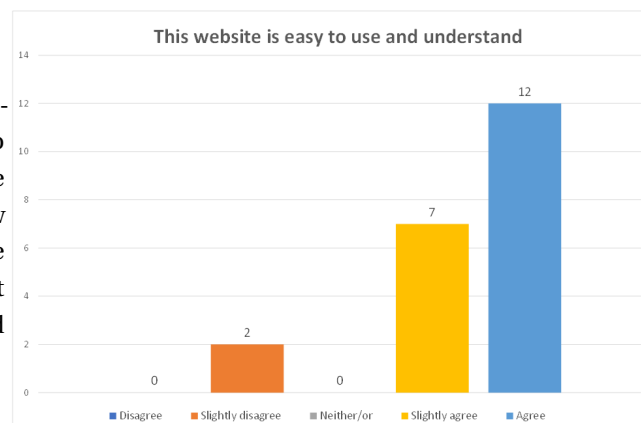

Figure 3: Easy to use.

Having relevant content on the website is really important for the success of the project. Relevant questions on the quiz is essential in order to get the users to test their knowledge and maybe learn something new if they get the question wrong. The results from the survey shown in **Figure 4** imply that the questions were on point academically, meaning that the users that answered the survey feels like they've learned something. This is of course good, as one of the goals of this website is to make it easier for students to learn the terminology.

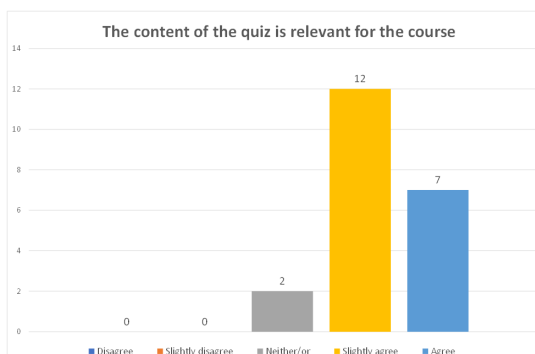

Figure 4: Relevancy of the content.

The main reason for digitalizing is to simplify and enhance learning. This was also one of the main reasons for initiating the project. As this is a digitalization project this is considered of great importance and should be expressed from the results from the survey. **Figure 5** shows that on average the users are relatively agreed that this product simplifies the learning.

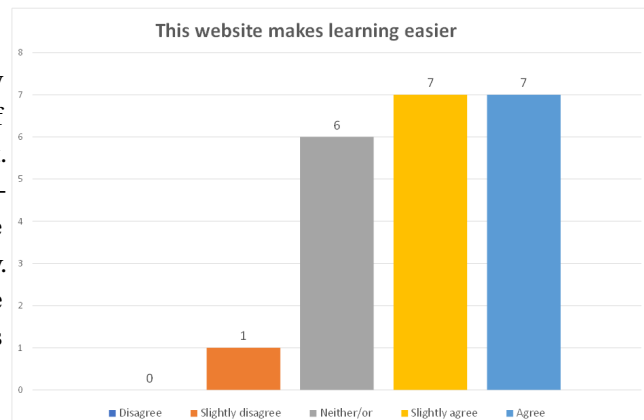

Figure 5: Makes learning easier.

One easy way of quantifying learning in a university course is by looking at the grades. So one way of looking at the effect of e.g. a websites contribution on learning is to look for a change in the grades. On the survey in **Figure 6**, the students answered that they would use a tool as this one for preparing for the exam. This might mean that students prepare better for the exam than they would without a website. This is of course all hypothetical, as the course is currently not using a website like this, but judging by the results of the surveys conveyed for this project it can definitely be speculated that if there was a website like this one, it could have an effect on the average grades in this course.

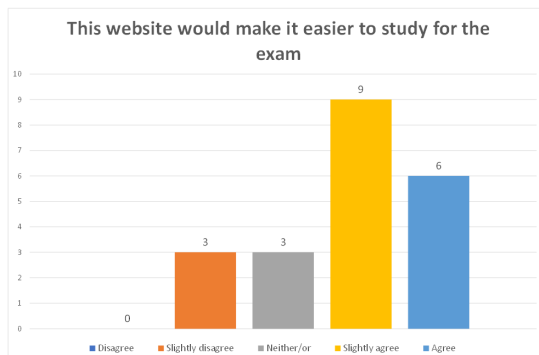

Figure 6: Use the website as a tool before the exam.

All the results from the survey can be found in the appendix, in **subsection 7.1**.

Our product is of high quality and we recommend it to be used as learning aid in project management:

Scale	Strongly Disagree	Disagree	Neither agree nor disagree	Agree	Strongly Agree
Group response				X	

Table 2

4 Success & Failure

A typical digitalization project consists of different stages. The project life cycle often includes initiation, execution or development, and project determination. All the different stages consists of factors that will cause the achievement of a successful project. This project are now in the last phase and this chapter will list the factors which has emerged during the process.

For the project to become a success, success factors should be carried through. Failing in implementing

this factor could cause the project to fail. A success factor is a term used as a description of the ground rules that should be adhered to during project planning and execution. These rules are usually identified on the basis of former experience, understanding of context, and understanding of existing limitations on resources or budget. Identification of these ground rules has positive impact on various stakeholders commitment and dedication to the project.

It is important to separate success factors and success criteria. Success criteria are those things identified by stakeholders e.g. sponsors and end users, that must be achieved in order for the project to be a success.

4.1 Success factors

The following is a list of factors that have contributed to success or problems for the project:

1. Self-knowledge

As stated earlier in the report the group did not have required skills in programming and therefore an important factor were to realize lack of competence in programming and compensate for this.

2. Common understanding of purpose and goals

The project group made sure that a common, clear understanding of reason for initiating the project was developed and agreed on. By defining this understanding, it is a lot easier to come up with and decide a set of goals and sub-goals. To define a clear set of goals and sub-goals is important to have specific goals to achieve, and a specific way of achieving these goals. By doing so, the progression of the project was time-effective.

3. Communication with stakeholders

There has been a big focus on mapping the stakeholders requirements, and this has been done by sending mail to student assistants and the lecturer, as well as conducting surveys. In these surveys the users give feedback on the product-idea or the product itself. By doing the surveys the project group can get approval or disapproval from the end user, which are one of the main stakeholders. The surveys have been conducted in the beginning to map the demand from the users, and at the end to ensure sufficient quality of the product.

4. Detailed plan kept up to date

The project group made a detailed plan before initiating the project. As well as this, each group session started with a discussion of what the group wanted to do/ work on during that session. The detailed plan and these discussions made sure that there is no issue about what each individual of the group is working on. All members of the group was aware of the most critical work-packages. The content and design of the product was decided in these group sessions and agreed upon by the group as a whole.

5. Familiarity within the group

The project should be completed while having three other courses competing with time during the semester. Therefore the group gained on the fact that the group members knew each other beforehand. It made work processes smoother. An example of this is that the group started quite fast on the project work.

6. Risk management process

The earlier mentioned project plan included an assessment of the risk that the project could face. These risks have to be dealt with either when they happen, or they have to be actively prevented preemptively.

7. Time estimate

Estimation of time is key to produce and deliver a product according to a specific deadline. By setting up a schedule for the different work-packages and deadlines for these, the group knew how to distribute their time to deliver a final product by the final deadline.

4.2 Failure factors

1. Technical focus

As the main goal of this project was to develop a web-page, it was easy to narrow the focus down to actually programming this page. This led to ignorance of several other important work. Gathering of content to the page was not thought of, as well as quality checking the content and language. Setting of time to quality check the web-page with the users after it was developed was not thought of either. That caused a stress situation where this had to be done in a short amount of time.

2. Unproductive prioritisation

In a semester many things happen, all from UKA to other courses. As said earlier some group members had voluntarily work at UKA and therefore this were sometimes prioritized above the project work sessions. This led to a split in the group sometimes when doing project work.

3. Sinking motivation in group

As the semester reaches the end exams gets closer and the group had tendency of thinking more about exam studying than the project. This lowered the motivation for the work sessions.

4.3 Key factor

The most essential success factor for this project is the detailed project plan. Having the group work unanimously towards achieving the end product in an effective manner is key for any project. As the product was outside of the groups scope of competence it is especially important to remain focused on what work actually need to be done, and minimize the time spent on tasks that don't really offer any value to the project or product.

4.4 Relevance to literature

According to "The Road to Success" by Bassam Hussein a lot of these success/failure seems common, as they occur in the cases mentioned in the last part of the book. The factors from the book that fit with this project are:

- Success factors:
 - Good information flow
 - Realistic plans
 - Clarity of the goals
 - Trust and respect within the group
 - Good communication

- Failure factors:
 - Lacking prioritisation
 - Sinking motivation
 - Too focused on technical solutions
 - A lack of competence
 - Underestimating the risk factors
 - Overoptimism

5 Lessons learned

It is the first time the project group members have done a project like this and therefore there are many lessons learned that could be helpful for other students. The team advice to not underestimate the theoretical part of the project. This means that it is easy to get carried away with the making of the product and forget other parts like reading up on theory on digitalization projects.

The group also advice to consult with other students or professionals on programming if the members of the team do not have sufficient background. It might seem overwhelming to program a website or an app, and therefore difficult to get started. By asking a data-student this process got easier. This also hold for other difficulties or uncertainties as well. Asking the professor and project coordinator when something were unclear. This removed difficulties and secured further progress.

The group experienced that when they met in real life it were more progress than when they delegated tasks through online chat. In an perfect world this should not be the case, but the experience from this project is clear. Small misunderstandings is cleared up much faster and the work process is much smoother.

The team advice to write a good plan and put effort into it. Although the deadline for the plan might feel quite abrupt it will be very helpful later in the project to have a good plan. The group used the plan often when writing the report and starting up each work session as a reference for what that were needed to be done.

The project team learned that getting feedback from students can be challenging. When 20+ groups are asking for feedback it can be difficult to get answers. Getting feedback from the users of the product is crucial when evaluating the project and product. The main plan was to send out surveys on mail to the students. This did not result in many answers and therefore the group had to ask people to answer the survey in the breaks of the lecture.

6 References

Hussein, Bassam. *Veien til suksess. Fortellinger og refleksjoner fra reelle prosjektcaser* Fagbokforlaget (2016)

Pinto. *Project management, achieving competitive advantage*. Pearson Prentice Hall (2015)

Power point - Digitalization projects. Handout from lecture in digitalization. Link to blackboard:

https://ntnu.blackboard.com/webapps/blackboard/content/listContent.jsp?course_id=_16098_1&content_id=_751547_1

The Enterprisers Project Author: Red Hat, inc. Accessed: 06.11.2019. Link to web-page:

<https://enterpriseproject.com/what-is-digital-transformation>

7 Appendix

7.1 A. Results from the survey

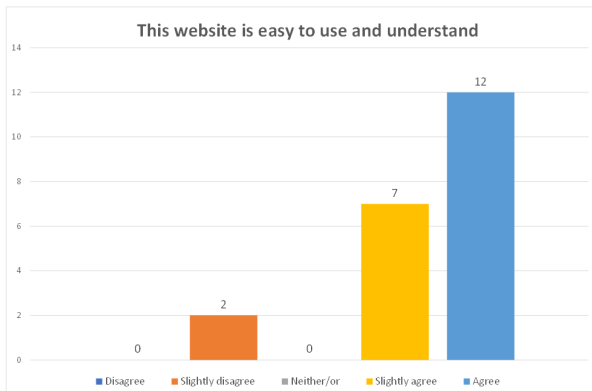

Figure 7: Survey result 1

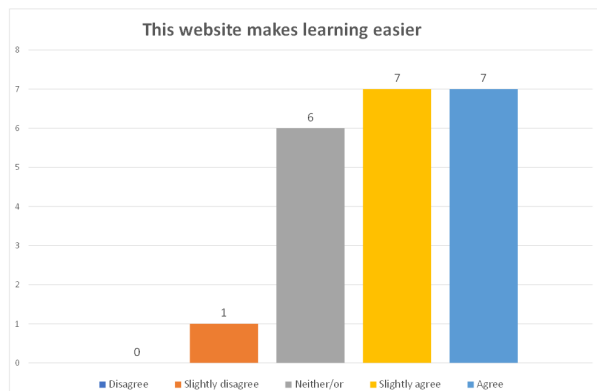

Figure 8: Survey result 2

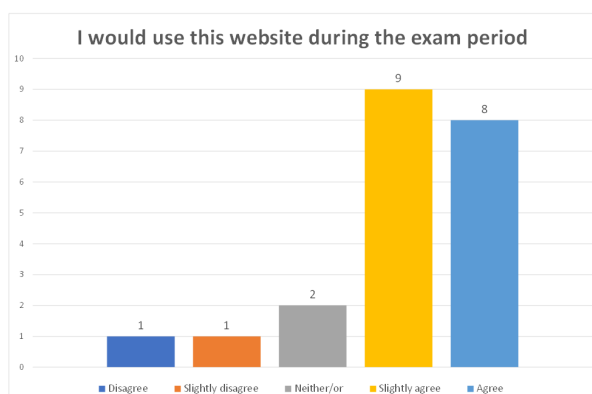

Figure 9: Survey result 3

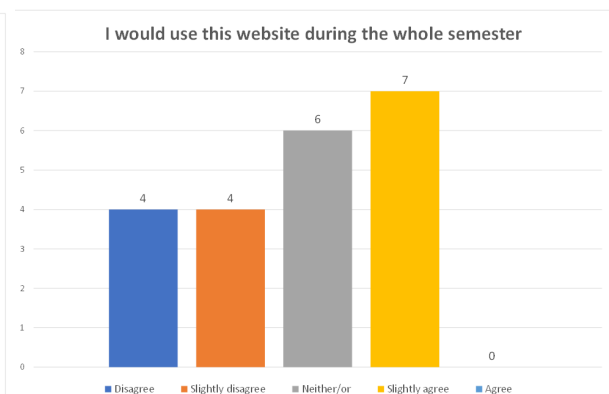

Figure 10: Survey result 4

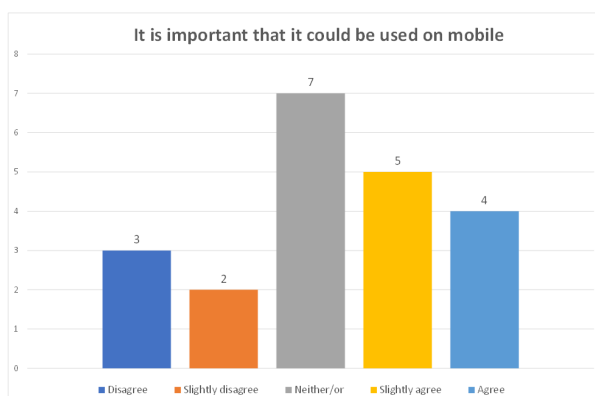

Figure 11: Survey result 5

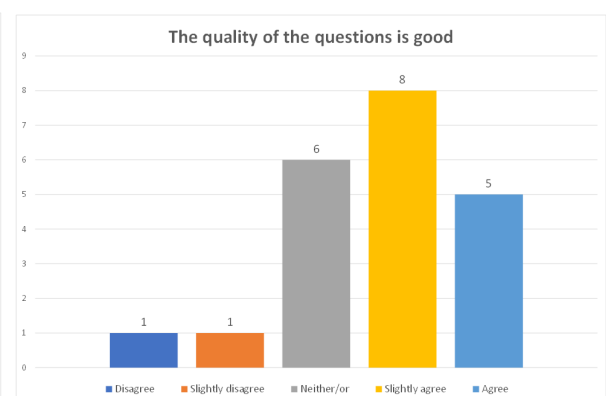

Figure 12: Survey result 6

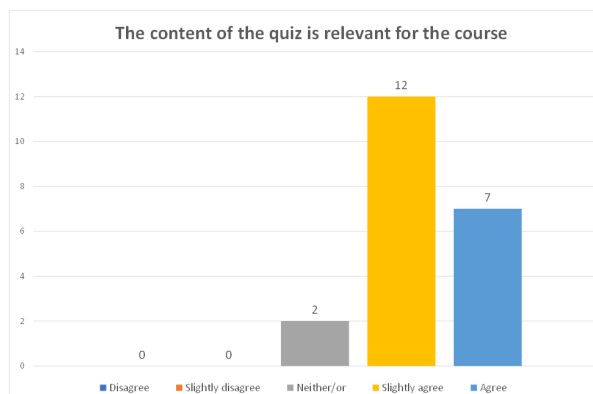

Figure 13: Survey result 7

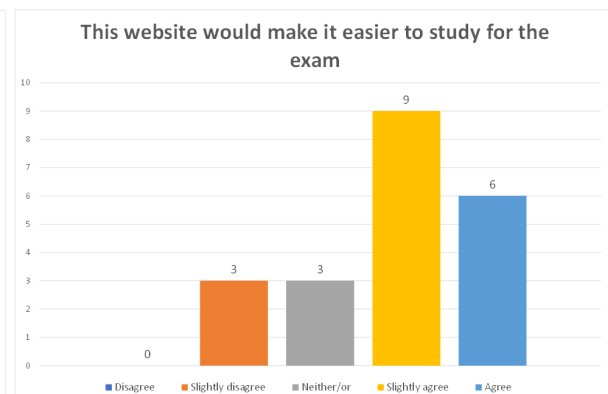

Figure 14: Survey result 8

7.2 B. Codes

Link to the codes on GitHub:

<https://github.com/haagrav/TPK5100-Group-20>

7.3 C. Link to Product

<https://roadtoknowledge.netlify.com>

7.4 D. Interview with the course representative, Bassam Hussein

With the students at the top, the professor comes close behind as an important stakeholder. Therefore it is important to have a dialogue with him. The project team therefore scheduled a meeting with him the first of October. It was a 15 minute session where relevant questions were asked.

First of all the professor were very positive to the idea and felt that this was something he could use in his course. Concerning his rights for the course syllabus it was alright to use as long it was referred to.

Will the professor manage to be categorized as a big interest, critical influence stakeholder?

It was asked for confirmation that the professor would be a stakeholder with big interest and critical influence. The project team was concerned that the professor would not have time to follow up each group and therefore not have critical influence. This was dismissed by the professor.

How much should the stakeholder mapping cover?

The group were not sure how wide the stakeholder mapping should be and asked about this. The answer were that one should mainly focus on the class and not exaggerate.

Is it enough to make a prototype or must it be a complete product?

The product should ideally cover the entire course syllabus, but this would take long time to implement and the product would be quite extensive. The professor agreed that around 15 minutes review time would be

alright and therefore the product is just a prototype with questions not covering the entire course syllabus.

How much should the future potential of the product be discussed?

The product is a prototype, but it is interesting to highlight the potential and further evolution of it. To discuss the further potential was alright to do according to the professor. One big part of the evolution of the product would be adding new questions. An idea is that next years students would be asked to suggest a relevant question for each exercise and then the student assistants or the professor could add the best questions to the website. This is off course an idea in the initial phase, but the professor was not negative to add this to his exercises.

7.5 E. Peer-Review of Group 19

7.5.1 Strengths

The product group 19 have developed is a clear and easy to understand website. The website also work perfectly as an app on your mobile device. The website is not groundbreaking, but a simple idea that people recognize and easy understands. A lot of similar learning aids have been seen to help the student achieve better results. Over to the app itself. The information is put in a clear system. Positive things that can be highlighted on the website are that it is easy to maneuver, stats over your results, good layout on mobile device and the possibility to read about the chapters before you take the quiz.

7.5.2 Weaknesses

There are two weaknesses on the product produced by group 19. First the front page is a bit boring with only black and white. It does not catch your attention, but the rest of the layouts works good. The other weakness is lack of information about their sources. There are no stated sources on the page. They refer to page numbers in the book on the quiz. This is probably "The road to success", but this should have been made clearer. Good information about the sources is important to make the web-site reliable.

Our thoughts on using this product as an learning aid in project management is shown in **Table 3**

The product we reviewed is of high quality and we recommend it to be used as learning aid in project management:

Scale	Strongly Disagree	Disagree	Neither agree nor disagree	Agree	Strongly Agree
Group response					X

Table 3

7.5.3 What grade would you recommend for this product?

From 0-10 this product gets 8.

An interactive mobile application as a digital learning aid which has a significant impact on learning in project management.

Preface

This report summarizes the evaluation and reflection of our digitalization project. It includes a short literature review on digitalization projects, a self evaluation of the final product, an evaluation whether it was a success or a failure and a summary of the most important lessons learned from the project.

Group number: 22

Student names and student number:

- 1) Bobeau, Antonin - 519277
- 2) Kaandorp, Paul - 520010
- 3) Keller, Jonas - 519301
- 4) Namink, Susan - 519125
- 5) Verhoijesen, Jessica - 519366

1. Digitalization projects

A.

At the end of this project, a mobile application (app) will be delivered. This application is targeted at master students and future project leaders. The goal of this application is to introduce the concept of project management, and create understanding what project management entails. Furthermore, the app will introduce fundamental project management terminology and focus on the required teamwork and its importance during a project. This focus will hopefully encourage the end-users to work together in an early stage, and help them to develop an important skill set that can be used throughout their lives and careers. In addition to providing the end-users with project management information, the app will provide tests in the form of quizzes to the end-users. Therefore, the users can test their knowledge and identify which elements of project management need further attention. The users will learn about project management in an interactive, modern way.

B.

A digitalization project is a project which aims at increasing the use of digital or computer technology by for example an organization, industry or country. Digitalization projects are complex and require effective project management (Lopatin, 2006). Factors that should be taken into account in digitalization projects are the management of budgets, staffing, determination of technical specifications and metadata creation. All these factors are important for a successful digitalization project. Literature provides several guidelines for managing digital projects. For example Chapman (2000) states the three phases of a digitalization project, namely: setting goals, planning and budgeting, and managing workflow. Every phase contains various issues and tasks. Digitalization projects also involve management issues, which can be countered by well organized project planning and resource delivery (Grout et al., 2000).

In our project we also applied the three phases of a digitalization project. We started with the first phase, setting goals. This is an important phase of the project since this phase determines the product we are going to work on. We brainstormed about ideas and finally came up with the application idea. We set some functions and goals that the final product had to meet. After this, we started planning the process. This worked quite well for our group. We had a few meetings during the project and in every meeting we discussed what still needed to happen and we set some deadlines. The last phase, managing workflow was sometimes a bit challenging for the project. It is difficult to find times at which everybody is available, since we all have different schedules and courses. Therefore, we were sometimes forced to work on the application alone. This means that after finishing the whole team needs to be updated about what has been done and what still needs to be done. In addition, team members might have different ideas on how to proceed with the application and it is difficult to discuss this if we are not able to meet frequently.

Since digitalization projects are complex projects, it is important to take into account the generic success factors of projects as stated by Murphy et al. (1974). Examples of key success factors of projects are good coordination with stakeholders, agreed success criteria realistic estimates, adequate project planning and good project start-up processes (Hussein, 2018). To ensure project success the project characteristics like organizational complexity, level of transformation, level of impacts on business, constraints and uncertainties should be analyzed and understood in order to put more focus on critical success factors that increase project success.

In our experience adequate project planning and good project start-up processes were very important in this project. As stated before it was not always possible to meet frequently due to different schedules, therefore we needed to plan well in advance. Also the start-up of the project is important, all member should agree on what we are going to product and be on the same page. Furthermore, the project owners (us) need to be on the same line regarding success criteria, so even when we work on the project by ourselves we should try to achieve the same goals.

A. Self-evaluation of the project management effort in the project, success or failure? And why?

First a distinction is made between project success and project management success in order to evaluate whether the project can be considered as a success or failure (De Wit, 1988) (Baccarini, 1999). Project success is defined as the ability to satisfy the overall objectives of the project, which is the effectiveness of the results. For this digitalization project, project success measures whether purpose of the project is achieved as well as whether the end users are satisfied. The purpose of this project is to plan, develop and produce a digital learning aid in project management, which must have a significant impact on learning. This purpose is achieved during the project, since a project plan is developed and delivered. Furthermore, a mobile application (app) is developed for master students and future project leaders. This mobile application introduces the concept of project management and helps them understand what project management entails. This mobile application contributes to a more easy and funnier way of learning. Thus, it can be concluded that these aspects contribute to the project success. However, it should be noted that the mobile application is launched in Norway but developed in the English language. Since the app is not available this could decrease the end-user satisfaction. However, it is assumed that the language is not a problem because the end-users should be fluent in English.

Project management success is another way to evaluate the project. Project management success measures success in terms of performance criteria such as costs, time and quality (Baccarini, 1999). Project management success is thus concerned with the efficiency of the project management effort. This project can be considered as a success by looking at the aspects of costs and time. The mobile application is developed by using free software available on the internet, thus there is no risk of costs. Furthermore, all project owners worked voluntarily on the project and did not receive any compensation during the project. Thus, no costs are involved for the implementation of the

product. In addition, all project deliverables are delivered before the deadlines and every project owner executed their tasks according to the project schedule developed in the project plan. By looking at the quality of the app, it can be said that this aspect can still be improved. For example, when the end-users changes to another main category in the app (eg from Home to Quiz or to Schedule) the “progress” is lost. This could be improved but since the app is still functional and achieves its purpose, it is not considered a “big” problem.

Hussein (2018) suggests an additional measurement of success, which is process success. Process success is about the emotions, perceptions and experience of all the involved stakeholders during the implementation of the project. The risk of usefulness and understanding of the app by all stakeholders is mitigated by capturing process success. This project can be considered as process success since all project owners were engaged to the project. Furthermore, project presentations are held among all students of the applied project management course, which implies involvement of students to each others projects. Furthermore, the emotions, perceptions and experiences of end-users are captured through surveys and the results indicated that these stakeholders are satisfied.

All in all, the project adhered to almost all success criteria (except for quality) and managed the risk. This project can be considered as mostly successful among the different dimensions of project success, project management success and process success.

A) Please evaluate the degree of your support to the following statement (group-based evaluation):

We evaluate our project management effort as successful

Scale	Strongly Disagree	Disagree	Neither agree nor disagree	Agree	Strongly Agree
Your response				X	

B. Self-evaluation of the value to the learners? (evaluation of project success) Can you document your assessment?

The notion of success is among a few topics in the field of project management that are frequently discussed but rarely agreed upon (Müller and Jugdev 2012). Success represent the expression of the value of the project, the benefit for the client and the business success. Evaluation of the project success is an important part of the project as it permits to evaluate the effectiveness of the project results.

The evaluation may turn out to be complex, since a lot of criteria in our case are ambiguous and can be interpreted in different ways such as the user satisfaction, the quality of being intuitive in use, user friendliness and ease of use. (Hussein 2012)

A.

In order to evaluate our project, we first had to select a target audience. As described in the part *digitalization project* in the goals of the application, the app is intended for master students, therefore our target audience should be master students. However, the app could be used by other customer but their interest and influence on the project is small. The learning objective of this app is to introduce the concept of project management and explained what project management entails. We also want to introduce fundamental project management terminology and provide test and quiz to evaluate the progress of the user, all this in a fun and interactive way.

B.

We decided to use a google form survey, as it is easy to create a survey, easy to use, widely available and provide a good overview of the survey result. This survey needed to give us information about our result according to several indicators of success (*The road to success* Bassam Hussein): achievement of the targets, achievement of the purpose, user satisfaction, customer satisfaction, achievement of strategical goals, economic aspect, gaining levels of higher competence and higher reputation. In our case the economic aspect will not be discussed as we did not define a cost for the app and the project cost is zero.

The question proposed to the audience were the following:

-How likely would you be to recommend our product as a learning aid for project management? (On a scale of 1 to 5)?

This question allows us to access the customer satisfaction, if they liked the product and think it is a good learning aid for project management

- How satisfied are you with our application based on the following criteria (going from very unsatisfied to very satisfied)?

Overall quality: this criterion will evaluate the quality of the app: the design, the effectiveness...

Value: this will evaluate the value created as a learning aid (the content, the quiz...)

Usage experience: This will assess the ease of use and the user friendliness

Entertainment: This is to evaluate the interactive part of the project as it is an important part of the app

- Do you feel that the application will help you to study this course (going from strongly disagree to strongly agree)?

This will evaluate the usefulness of the learning material we created.

- Do you think that this format app can be useful for other courses?

This question is important because we need to know if there is potential business opportunity using the same concept with other courses or if this app is only restricted to project management

We tried to ask as few questions as possible whilst getting enough information, in order to save time and get a good pool of informants

C.

We ask to people from the course TPK5100 during the break to have a quick look at the app and a demonstration video of how the app worked and we also explained what the app consist of. We also tried to get answer from people which were not from this course in order to have some answer from people who didn't know about project management. All the informants were master student. In the end we were able to get 20 answers which is not a lot but should be enough to represent the variety of end-user.

D.

Results of the survey:

How likely would you be to recommend our product as a learning aid for project management?

20 réponses

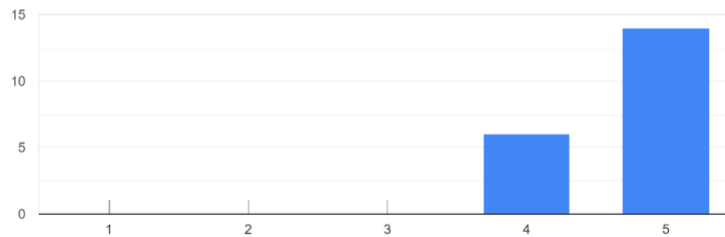

How satisfied are you with our application based on the following criteria:

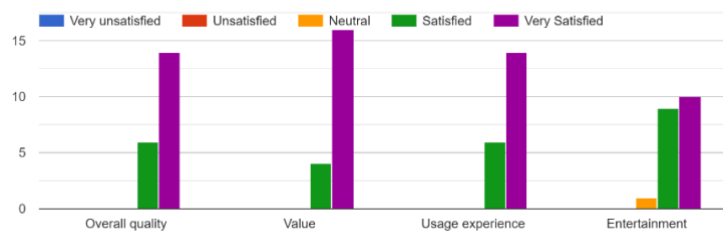

Do you feel that the application will help you to study this course

20 réponses

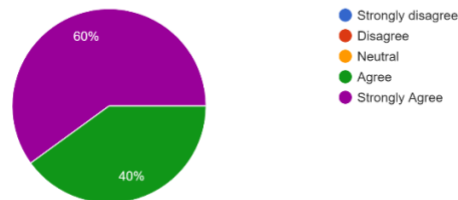

Do you think that this format app can be useful for other courses

20 réponses

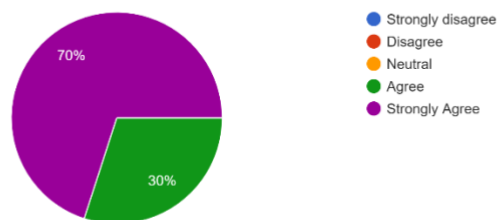

Overall, we can see our app is appreciated by the informants. From the first question we can conclude that this app is a good learning aid for project management, all the participant agreed to this statement and most of them strongly agreed. The second question gives us more details about the different aspect of the app: its weakness and strength. Although there are no unsatisfied answers to all the question, we can see that the entertainment part of the project was

less appreciated by the user than the other aspect. This could have been of course easily improved with more time, by making the app a little more playful, following the idea of the monkey giving you the quiz.

The overall quality and the usage experience have been well perceived but might have been impacted by the problem we talked about earlier with the loss of progress when we change main menu.

The value created is the aspect that satisfied the most the informant: the quiz and the ability to follow your progress were well perceived.

Most people also agreed that the app will help them study this course which was one of the intended outputs of the project.

Most of them also strongly agreed that this app could be used in other courses, which is a good sign for other business opportunities, this app could be implemented for a lot a course and help student study in subject as Science, English, History...

A) Please evaluate the degree of your support to the following statement (group-based evaluation):

	Our product is of high quality and we recommend it to be used as learning aid in project management				
Scale	Strongly Disagree	Disagree	Neither agree nor disagree	Agree	Strongly Agree
Your response				X	

C. Factors that have contributed to failure / success.

Critical success factors can be categorized in roughly three categories, namely: case-specific factors, structural factors and cultural factors (Hussein, 2018).

Case-specific factors cannot be generalized to other situations and are factors that are relevant to the specific situation under consideration. Not a lot of case-specific factors can be mentioned that contributed to the success or failure. The reason for this can be that there is not a lot of organizational complexity as well as constraints involved in this project since this is only a small project. But one case-specific factor that can contribute to the failure of the project is the language used in the mobile application. Since the project is executed in Norway and the project owners are exchange students from all over Europe, the mobile app is only available in English with the result that the app can only be used by English speaking persons. Another case-specific factor that contributed to the success of the project is the skills acquired to develop the app. If the project members were not able to obtain this skill, the project would have failed to deliver its output (the app).

Structural factors include factors such as communication, information exchange, planning, and project organization. The first deliverable, the project plan, contributed to the success of the project since adequate early planning is a critical success factor. The project plan is a document that explains the type of product, the expected benefits of the product, required skills, critical success factors, risk assessment plan, and project schedule. This document was a good starting point and provided a clear direction for every project owner. By means of this document, consensus was achieved about the type of the product that would be developed during the project. Furthermore, clarity of roles and responsibilities is a critical success factor that contributed to the success of this project. Every project owner was assigned a task and it was clear to every member who was responsible for the different tasks as well as the time available for every task. However, it should be noted that skills, experience, knowledge and competence had to be acquired in order to successfully develop the mobile application. This is because no project member ever developed such an app before. This factor could have resulted in a project failure, however, learning and skills about how to develop an app are acquired during the implementation. Timely information exchange also contributed to the project success. During the implementation several gatherings and meetings were held in order to get everybody in the same direction. Lack of end-user involvement in the beginning of the project can be seen as a critical factor that contributes to a failure of the project. However, the prototype is tested several times during the development by the project owners, who are also master students and possibly future project leaders. Furthermore, a survey is held among end-users and project presentations are held in the course applied project management to increase the understanding and acceptance of end-users. From this it became clear that the end-users were satisfied with the app and reaped the benefits of this app.

The cultural factors that contribute to success or failure are shared values such as commitment, involvement, respect, trust and openness. These factors have considerable impact on knowledge sharing among project members, cooperation, motivation, creativity, and sense of ownership.

Consequences of not being able to comply with these shares values can result in resistance to change, power conflicts, indifference, and eventually project failure. The environment in which this project is executed by the project owners is characterized by respect, trust and openness. This is created due to earlier collaboration between the project owners in the course of applied project management. The collaboration started with the in-class assignment of building a tower of paper. This in-class assignment contributed to development of the relationship between all project owners. In addition, all project owners contributed to the project by performing their tasks which indicates that there is involvement and commitment of all members. Furthermore, group meetings were arranged to ensure everybody was on the same level and this also contributed to the engagement of all project owners. Informality is another factor that contributed to the success because, in this way, an open environment was created where everybody could express their ideas and challenges.

The most significant factor for success is considered to be commitment of the project owners to the project, which is also considered an important critical success factor by Hussein (2018). When there is no commitment of project owners, they are not motivated to work together and to execute the different tasks with the consequence that the project would have failed to develop and deliver a mobile application to master students or future project leaders. The case specific factor of skills is mentioned in the book of Hussein (2018). This does not apply for the case specific factor of language, but this could be because this factor is case specific. The structural factors that apply to this project (commitment, end-user involvement, adequate early planning, clarity of roles and objectives, clarity of purpose and objectives) are also included important the critical success factors according to Hussein (2018). Lastly, all cultural factors of this project (collaboration, transparency, involvement, trust) are mentioned by Hussein (2018). It should be noted that the critical success factors listed by Hussein (2018) is more extensive than the factors listed above. According to our perception, the most factors that contributed to the success of our project are mentioned above.

D. Most important lessons from your project

Since we executed the project ourselves and have practical experience with project management, we can give some advice to other students on how to work on similar projects. Firstly, our advice

is to start early on the project. Since you need to create something it takes some time to come up with ideas and brainstorm. It is better to give this part of the project some more time than to hurry and start off badly.

Secondly, make sure that all project owners are on the same page regarding project goals and learning objectives. Since it is sometimes hard to meet with the whole group due to different schedules and other projects, it is important to have a clear understanding of the goal of the project. In that way it is possible to also work on the project alone, or in smaller groups, without working in different directions.

Thirdly, we learned that updating each other frequently about the progress of the project is really useful. By doing that all project members know where we stand and have an idea if we need to work faster or have more time.

Lastly, introduce deadlines for yourself during the project. Also set some slack at the end of the project, so you are sure you will finish in time even when things do not go your way immediately.

E. References

Baccarini, D. (1999). The logical framework method for defining project success. *Project management journal*, 30(4), 25-32.

Chapman, S. (2000), "Considerations for project management", in Sitts, M. (Ed.), *Handbook for Digital Projects: A Management Tool for Preservation and Access*, Northeast Document Conservation Center, Andover, MA

De Wit, A. (1988). Measurement of project success. *International journal of Project Management*, Vol. 6

Grout, C., Purdy, P. and Rymer, J. (2000), *Creating Digital Resources for the Visual Arts: Standards and Good Practice*, Oxbow Books, Oxford.

Hussein, B. (2018). *The Road to Success: Narratives and Insights from Real-Life Projects*, Fagbokforlaget.

Lopatin, L. (2006). Library digitization projects, issues and guidelines: A survey of the literature. *Library hi tech*, 24(2), 273-289.

Murphy, D. C., Baker, B. N., & Fisher, D. (1974). Determinants of project success.

2. Peer-review report

Each group is assigned a peer-review group. The list of the assigned groups is shown in the following table. The table shows for instance that the product produced by group 1 will be reviewed by group 11, and the product produced by group 2 shall be reviewed by group 22.

Before writing this review report, you need first to view/test the product produced by your test group. In your evaluation you should be **objective, fair and use to time to fill in the report**. The grade you assign based on your evaluation **is a guide** to the instructors when they grade the project assignment.

Product produced by Group (Test group)	Shall be Peer-reviewed by group (Peer-review group)
1	11
2	22
4	8
6	5+12
7	4
8	1
9	10
10	12
11	13
12	14
13	15
14	16
15	17
16	18
17	19
18	2
19	20
20	24
22	25
24	26
25	27
26	33
27	34
33	36
34	6
36	7
5+12	9

3.

Your peer-review evaluation report

What is name of the group you are assigned to evaluate: 2

A. Based on your evaluation (as a group) please indicate the strengths and weaknesses of the final product.

Strengths

The website produced by group 2 has several strengths. Firstly, the website is understandable and easy to use. Secondly, the 'random question mix' is a very good addition to the website. In this way you can not only practice the materials of the course per chapter, but also get questioned in a random sequence. This is the same as at the final test of the course, so it is a good practice. Thirdly, the 'progress' tab is very handy. It gives a clear overview of how far you are on practicing the materials. Lastly, there is a 'review' tab that gives the opportunity to review the website. It is always good to provide the possibility of giving feedback.

Weaknesses

A weakness of the website is maybe the lay-out. It looks like the lay-out needs some finishing touches. It could for example be more colorful or interactive to interest the user even more. This is however just a prototype, so it is not strange that the website is not perfect yet. Another weakness of the website is that it does not provide any theory. It just provides us with tests. It would be nice if it could also have a tab with 'theory' so you can read back into the theory when you for example got a question wrong.

B. Please evaluate the degree of your support to the following statement (group-based evaluation):

	The product we reviewed is of high quality and we recommend it to be used as learning aid in project management				
Scale	Strongly Disagree	Disagree	Neither agree nor disagree	Agree	Strongly Agree
Your response				x	

C. On a scale from 0 to 10. **What grade would you recommend for this product?**

Grade: 8

Assignment: Digitalization project – project plan

Course:

TPK5100

Applied Project Management

Autumn 2019

Submitted by Group 22:

Bobbeau, Antonin

Kaandorp, Paul

Keller, Jonas

Namink, Susan

Verhoijssen, Jessica

Submitted on:

05/10/2019

Introduction - Characteristics of a digitalization project

A digitalization project is a project which aim adoption or increase in use of digital or computer technology by an organization, industry, country, etc.

Digitalization is about value creation in the process. In our case the goals of the digitalization is the simplification of communication: we want to provide the master students with information regarding project management in an easy and entertaining way. The project should deliver an application which teaches students about project management by means of information and quizzes. This type of project requires that we take into account the “people” related factors: master students might react differently to the implementation of the app. We need to take this into account so that the application is accepted and appreciated, this means clear and easy interface that can be understood and easily used by all master students.

Type of product

At the end of this project, a mobile application (app) will be delivered. This application is targeted at master students and future project leaders. The goal of this application is to introduce the concept of project management, and create understanding what project management entails. Furthermore, the app will introduce fundamental project management terminology and focus on the required teamwork and its importance during a project. This focus will hopefully encourage the end-users to work together in an early stage, and help them to develop an important skill set that can be used throughout their lives and careers. In addition to providing the end-users with project management information, the app will provide tests in the form of quizzes to the end-users. Therefore, the users can test their knowledge and identify which elements of project management need further attention.

The mobile application will be available on both Apple’s iOS and Google’s Android. In addition to these operating systems, the application will also be available in the Windows Store for Windows laptop/desktop users.

The expected benefits of the product

The mobile application will support students and future project leaders to get familiar with project management terminology and project management procedures. After using the app for one semester (20 weeks), the users are expected to:

- Be familiar and understand basic project management terminology and concepts (e.g. project managers, work-break-down structures, Gantt charts)
- Be able to form a small project team, and understanding the different roles within a project team
- Be able to produce a basic work chart-break-down structure
- Be able to produce a basic Gantt based on the work-break-down structure
- Be familiar with the advantages and disadvantages of project management

Potential stakeholders and plan to involve these stakeholders during project development.

A stakeholder is an organization, group or individual who can affect, can be affected by, or perceives itself to be affected by the outcome of a project. The management of stakeholders plays an important role in project management, since they have to perform as required in order to successfully complete a project. Stakeholders of a project can be divided into several categories, and there is a bond between the project and the stakeholders of the project. Our project influences several stakeholders. Underneath a summation of all the stakeholders and an explanation of how they are involved or affected by the project of the digital learning aid.

- The project owners. In this project we are the project owners. We start, execute and finish the project and in the end have the final responsibility that there is a working digital learning aid for children developed.
- End users. In this project, students and future project leaders are the end users. They will be the users of the app, and they will use it to learn about project management in a fun and interactive way. It is important to take the end users into perspective during the execution of the project. They will also be the evaluators of the project and decide whether the product is successful for them or not.
- Teachers of the end users. In addition to the children who will use the digital learning aid, their teachers and educators are also important stakeholders. They teach the students in university and could be the way to introduce the app to the students. They have the responsibility over the introduction of the app. If they are not willing to use the app during their classes, or they are not familiar with the app, the app will not have any end users and therefore no purpose. They need to make time in their classes to use the app, or reserve some time to introduce it.
- Norwegian universities. Furthermore, Norwegian universities are also a stakeholder in the project. They have to be informed about the new available app that teaches students about project management. They need to be made aware of the app and its positive value to the students. If Norwegian universities are not open to a new learning aid, the app will not be introduced to the teachers and then the app will not be introduced to its end users.
- Peer reviewers. In order to decide whether this project is a success or not the product will be evaluated by peer reviewers. The review of the peer reviewers will be an important factor whether our project and product is perceived as successful or not.

Depending on their characteristics, stakeholders can be grouped into different categories. They are classified according to their degree of influence regarding the project, and their interest in the project. Depending on this classification, there are different strategies for dealing with the different categories of stakeholders. Underneath (Table 1) the stakeholders described above depicted in the stakeholder classification matrix.

	Interest	
	Small	Large

Influence	Critical	Peer reviewers, Norwegian universities	Project owners, Teachers
	Marginal		End users

Table 1 Stakeholder matrix

The peer reviewers and the Norwegian universities have a critical influence on the success of the project. If the peer reviewers do not like the project, our project will be evaluated as unsuccessful. In addition, the Norwegian schools have the responsibility to introduce the app to the students. However, the interest of these stakeholders in the app is small. They do not have major expectations or requirements. The best strategy to deal with these stakeholders is to maintain their support and satisfy their minimal expectations.

The project owners and the teachers have both a critical influence and a large interest in the app. These stakeholders are the key stakeholders of the project. The best strategy to deal with the stakeholders in this group is based on involvement and cooperation. It is important to involve all the project owners in the group and to listen to the teachers of the students. They have a good image of how to teach students and what is needed to grab their attention. It could be a good idea to organize a meeting and discussion between the project owners and a group of teachers and brainstorm on ideas on how to successfully develop the app.

The last group of stakeholders in this project are the students, the end users. They are placed in the marginal influence, but large interest group. They do not have a lot of influence on the project. They are, however, highly interested in the project since they are the end users that are given a new, digital learning aid in their classrooms.

Project risk assessment plan

Project risk management in projects is the identification, analyzation and management of risks throughout the project life cycle in order for the project to achieve its goals. Therefore, it is important to indicate the main risks of a project and to address how to tackle these risks. Underneath an identification of the possible risks to the digital learning aid project, and strategies on how to decrease and respond to these risks.

Firstly, availability of devices to use the digital learning aid is a possible risk to the project. If there are no phones or laptops available to the students, the application cannot be used. In addition to this availability of devices the project also requires devices with the software and a working internet connection. These are requirements of the project to succeed and the application to be used. A university could be really interested in using the application for their children, but if they do not possess the required equipment the application cannot be used. This risk can be tackled by executing some research in Norwegian universities. By analyzing if the schools possess the proper equipment the risk can be mitigated. However, if the research shows that only a few schools possess the proper equipment it might be a smart move to change the project and find a way around the needed equipment.

Secondly, the reactions of teachers to the new learning aid can influence its outcome. If the teachers are not convinced by the application they will not dedicate time to the use of the application. If the application conflicts with other tasks, the teachers will not implement it. To tackle this risk it is important to inform the teachers about the importance and usefulness of the application. If the teachers are made aware of the low implementation costs (like time) of the application, they will be triggered more easily to implement the application. To tackle this risk, it is important to inform and collaborate with the teachers.

Thirdly, the understanding and usefulness is of great importance for the outcome of the project. If the application is implemented and students do not understand how to use the application or they do not find it useful, it has not met its purpose. To deal with this risk it is important to discuss with teachers on ways to make the digital learning aid understandable and useful. In addition, it can be helpful to do some research on existing digital learning aids for children. By investigating how these accepted learning aids are built, you can learn how to build an application for students yourself.

Lastly, the costs related to the application can influence the project. If the costs of purchasing the application are too high, schools will not invest in it. Universities do not have an infinite budget and therefore have to make decisions on where to spend their money. By writing a cost expectation plan upfront of the project this risk can be tackled. By calculating the costs of producing the application and a maximum acceptable price for the application, it can be calculated how much money can be spent on building the application. By calculating the expected costs versus profit it can be avoided to spend too much money on building the application, which will result in too high purchasing costs for the universities.

Project skills

To turn our project into reality and in this case into a real App we have to acquire certain skills. Our plan is to use Marvel Prototyping which is an website-based software to create Apps. Therefore we have to get to know how this software works and how to make a quiz-like application with it. The software is very intuitive, there is a help center and Paul Kaandorp also had previous experience with it. As a plan B if Marvel should not work there are plenty more of similar app building software on the internet.

Project breakdown structure

In order for the project to succeed a project breakdown structure should be prepared in advance. A project work breakdown structure is a graphical representation with helps to break down the project into manageable small autonomous tasks and work packages. The work breakdown structure of this project is represented in Figure 1. The digitalization project is the main deliverable and can be split up into three main components, which are also the three sub-deliverables of this project. These sub-deliverables are: a project plan, the implementation of the functional product and the evaluation/reflection report. These three sub-deliverables can be further decomposed into smaller, autonomous tasks in order to manage the project. Eventually the work packages are depicted in the figure. These work packages are, for example, a description of the product type and the product benefits. A work breakdown

structure is a tool that helps to visualize the tasks, reduces complexity and gives guidance in determining the scope.

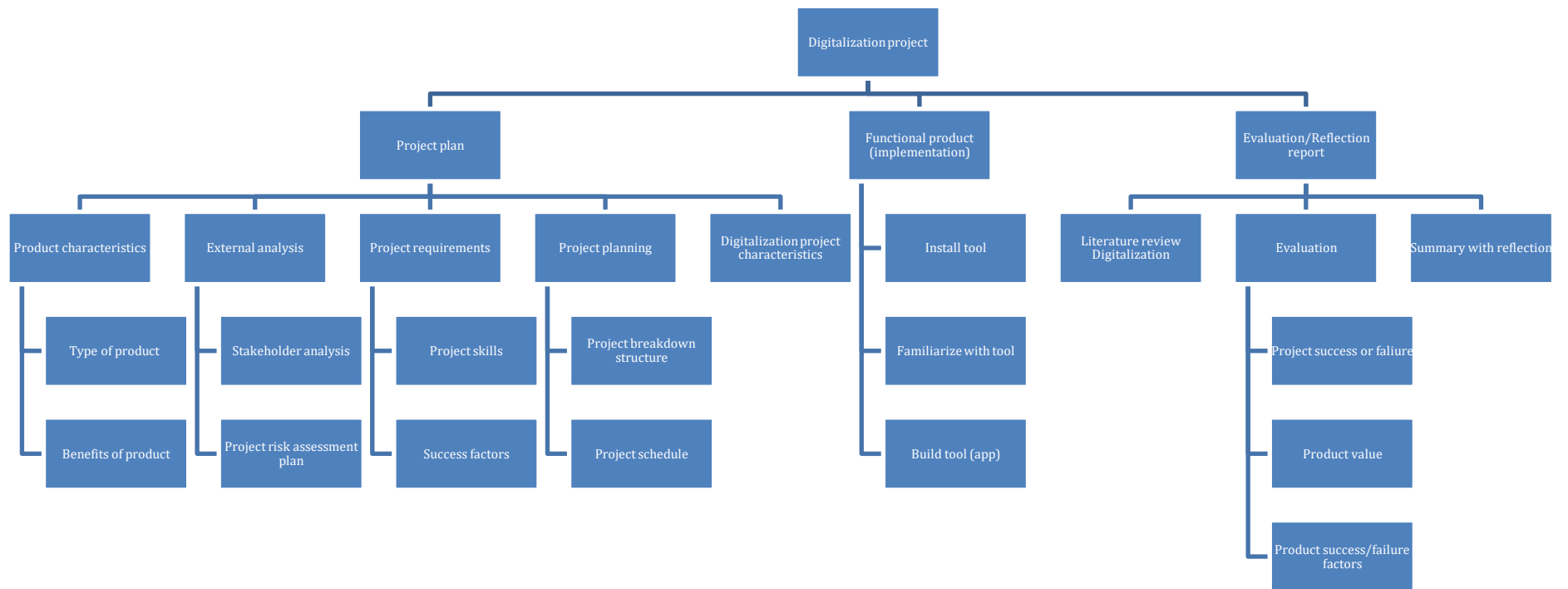

Figure 1 Project breakdown structure

Project schedule

Next to the work breakdown structure a project schedule is developed. Microsoft Project is used as software to develop the project schedule. First, all the tasks as well as main deliverables are filled into the program which is represented by Figure 2. This figure is similar to a work breakdown structure since it decomposed the project into main deliverables, sub-deliverables and work packages. However, an additional feature is added by showing the start dates and end dates of the tasks. Every task within the project plan takes shorter than 1 day. All tasks can only be executed after the project plan as well as the project schedule is prepared. Furthermore, the tool can only be built after the tool is installed and when we are familiarized with the tool. Building this tool/app requires most of the time since this is the actual implementation of the project. 37 days are available for building the tool/app. Moreover, the evaluation can only take place after the project plan and functional product is delivered. The table in Figure 2 is then translated into a project schedule which shows the start dates and end dates of the sub-deliverables as well as the work packages. Figure 3 shows the project schedule. The small blue bars indicate when one single work package should be executed. Since these bars are so small, no task name is included but the start dates and end dates can be found in Figure 2.

	Task Mode	Task Name	Duration	Start	Finish	Predecessors
1	🚀	🔺 Digitalization project	46 days	Tue 17.09.19	Tue 19.11.19	
2	🚀	🔺 Project plan	15 days	Tue 17.09.19	Sat 05.10.19	
3	🚀	🔺 Product characteristics	10 days	Tue 17.09.19	Sat 28.09.19	
4	🚀	Type of product	1 day	Tue 17.09.19	Tue 17.09.19	
5	🚀	Benefits of product	1 day	Wed 18.09.19	Wed 18.09.19	
6	🚀	🔺 External analysis	15 days	Tue 17.09.19	Sat 05.10.19	12
7	🚀	Stakeholder analysis	1 day	Mon 30.09.19	Mon 30.09.19	12
8	🚀	Project risk assessment	1 day	Mon 30.09.19	Mon 30.09.19	12
9	🚀	🔺 Project requirements	15 days	Tue 17.09.19	Sat 05.10.19	12
10	🚀	Project skills	1 day	Wed 02.10.19	Wed 02.10.19	12
11	🚀	Success factors	1 day	Wed 02.10.19	Wed 02.10.19	12
12	🚀	🔺 Project planning	10 days	Tue 17.09.19	Sat 28.09.19	
13	🚀	Project breakdown structure	1 day	Tue 17.09.19	Tue 17.09.19	
14	🚀	Project schedule	1 day	Tue 17.09.19	Tue 17.09.19	
15	🚀	Digitalization project closure	1 day	Mon 30.09.19	Mon 30.09.19	12
16	🚀	🔺 Functional product (implementation)	41 days	Tue 17.09.19	Tue 12.11.19	12
17	🚀	Install tool	1 day	Tue 17.09.19	Tue 17.09.19	
18	🚀	Familiarize with tool	4 days	Wed 18.09.19	Sat 21.09.19	17
19	🚀	Build tool (app)	37 days	Mon 23.09.19	Tue 12.11.19	18
20	🚀	🔺 Evaluation/reflection report	6 days	Tue 12.11.19	Tue 19.11.19	2
21	🚀	Literature review digitalization	1 day	Mon 07.10.19	Mon 07.10.19	2
22	🚀	🔺 Evaluation	6 days	Tue 12.11.19	Tue 19.11.19	2
23	🚀	Project success or failure	1 day	Thu 14.11.19	Thu 14.11.19	2
24	🚀	Product value	1 day	Thu 14.11.19	Thu 14.11.19	2
25	🚀	Product success/failure	1 day	Thu 14.11.19	Thu 14.11.19	2

Figure 2 Project schedule in textual description

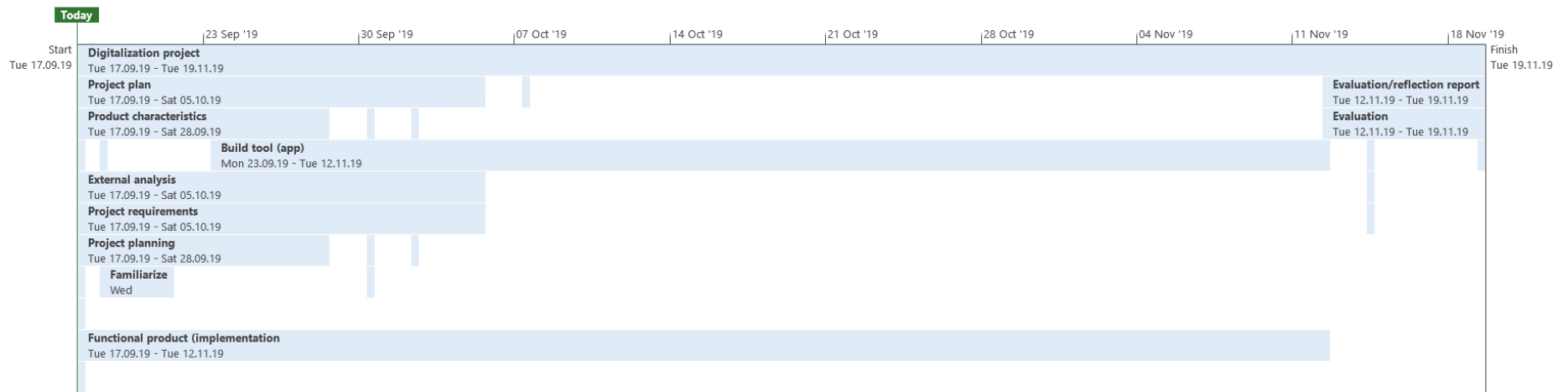

Figure 3 Visualization project schedule

Success factors

Identifying the success factors is considered a good practice for achieving a good impact on the various stakeholders' commitment and dedication to the project. The success factors can be defined as ground rules that we should adhere to, during the project planning and the execution phase. But these ground rules are useless unless we translate them into concrete actions or decisions. Each success factor should correspond to various decisions/action during the planning and execution phase.

One of the key success factors we can adhere to, is having a good communication with stakeholders. The importance of communication with stakeholders has been described previously, and we also discussed how we should involve them.

It is also important to have an effective communication between the members of the group, since the project contains critical deadlines. We can achieve this by having meetings at the different phases of the project, especially for the creation of the app so that we can all agree on what it should look like.

Furthermore, the quality of the application is an important success factor. It should strive to contain as less errors and bugs as possible. This makes it easier to use and avoids frustrations while using the application.

We also need to agree on the success criteria and risk factor of the project. This will help us know which way to go and what decision we need to make to fulfill the success criteria. To attain this we made early meeting to define these criteria and risk factor and tried to agree on them. They need to be understood by all the members of the group. For instance the availability of devices to use the digital learning aid, is an important risk factor that all members should be aware of before the execution phase.

Another important success factor for our project is to define realistic estimates. Indeed this project contains critical deadlines that we absolutely need to respect. This is why the project has to be complete before the deadline. To do so we will need to be realistic when defining the objectives of the app and how much time it will take to achieve them.

It is also crucial, and this might be the most important success factor, to consult the end-users during the project. This project is very uncertain since the novelty dimension is important (No other example of this project) This means that consulting the end-users is crucial because we need to know if they are interested and what we can improve.

Project evaluation

The final product will be evaluated by both us as project owners and peer reviewers. The peer reviewers are peer students that will try out the app and state strengths and weaknesses. Furthermore, the degree of support of the application in the project management course is assessed. This will lead to a final evaluation of the project and the product.

Interactive website to aid the
revision of project management

Preface

The aim of the report is to describe and evaluate the digitalization project of G24. It will detail the product we have made and why, as well as the challenges involved in its production. It is a self-reflection of our project and its successes and failures. This report will describe how we actualised our initial ideas from concepts to a fully functional product. It will explain the key decisions, activities and strategies involved in conducting this digitalization project, as well as the methods used to validate its effectiveness. It will investigate the factors behind the project outcome, both in project management and the end value created and justify why we consider our project to have been successful.

Group number: 24

- 1) Arefhsadat Seyedmehdijasbi - 520230
- 2) Camille Mascles - 519838
- 3) Charlotte Labous - 519200
- 4) Lia Minty - 519693
- 5) Liam Hedges - 519377

Great thanks to Bassam Hussain for providing and authorising many of the learning resources used in our revision tool.

1. Digitalization projects

The product is a revision website for students of Project Management to use to assist them with revision of the course content. Its purpose is to improve the user's understanding of lecture content and project management terminology. The product is intended to provide the user with all the tools they need to revise in one platform. From early user research, we learned about study habits and tools currently used by students. We discovered most students only start revising towards the end of the course, so our product is intended for use at this time. The most popular tools currently used by students are lecture slides, past exam papers and summary sheets, we wanted our product to build on this rather than replace them. Our intention was to combine all these methods into one central platform to simplify the revision process. We learned about different learning styles within the class, the most popular being 'visual', 'doing' and 'writing', so we tried to create features that complemented these styles. We also discovered more detailed information about difficulties with the course, largely with definitions and the clarity of information - particularly when English is their second language. We wanted to address these needs and provide an improvement on current tools. Our website contains re-formatted lecture slides, summaries of content, a collection of key definitions, quizzes, video content related to the course and downloadable past exam papers.

The main challenges experienced by the group in working on a small-scale digitalization project was in the limitations of our own digital skills. We didn't have access to specialists in programming or web design, and were limited to using free web builder sites, restricted by their capabilities. We found that we could not include every feature we had brainstormed. For instance, including a text-hover feature to show definitions in an aesthetic manner was not possible on the web builder we decided to use. Another feature we wanted to include, which we were unable to implement, was a summary sheet builder section. We envisioned a section of the website which a user could choose things to add to a downloadable and printable sheet, building a personal summary sheet containing aspects of the course they needed further study on. These challenges could not be overcome, instead, substituted with less interactive alternatives. In a full-scale development project these issues could be rectified with access to programming experts, or more professional website building technologies. Another challenge we faced was ensuring our digitalization would be an improvement on current tools. It's seen in the literature that a project that is difficult to use, or that has issues, will not be adopted as intended. This is specifically seen in the case 2.1 'downsizing by introducing speech recognition software', where the sub-optimal functionality led to wide rejection of the technology. After looking at this case, we wanted to ensure that our product would be adopted by the end user, so we aimed to make it as smooth and intuitive as possible to use. We chose to create a website because it was familiar to the user and could integrate existing revision resources without complications.

The overall project did not have any major challenges, we were able to work through minor challenges effectively without any real setbacks in the overall project timeline. We credit this to the steps we took to avoid failures seen in other projects. An aspect which often leads to a failed project in the literature, is a lack of stakeholder communication. Case 2.1 exhibited this failure as the users were not included in design or testing. We deliberately took steps to avoid this situation by including stakeholders at all important points in the project. Similarly, a lack of communication of requirements and deadlines within the project team can cause project delay or failure. In case 2.2, automated file processing, there was a much greater project duration than planned due to a lack of communication. In this case the project manager was inexperienced and thus was not skilled at communicating the requirements and ensuring they were met which led to time lost waiting for

important contributors to finish different parts. In order to not make these same mistakes, our group created a project plan with internal deadlines which we were able to keep to. These tasks were generally small, so were met with ease. Project literature continually presents the importance of communication in order to succeed, the case 'The Ticketing System' from the Case Studies in Project, Program, and Organizational Project Management book, similarly demonstrates effective communication processes within large teams and across different departments. We managed to effectively maintain communication and avoid the potential issues which arise from a lack in communication. We managed to do this in our group through planned weekly meetings and continuous online communication. This allowed the project to be completed within our own deadlines and then finished with spare time for the final deadline.

2. Self-evaluation of the project management effort in the project, success or failure? And why?

The project was overall a success as we were able to stick to the majority of the originally stated success criteria. As stated within the success criteria 'it is critical that there is open communication between team members. While each member has a defined role within the project, the roles are very reliant on the progress of other departments. It is important that ideas, progress and limitations are communicated regularly and dealt with in a constructive manner'. Evaluating the project management after the completion of the project, we were very strong in these aspects of the project development. We kept to the defined roles and maintained a good level of communication online, between regular scheduled meetings. Every meeting throughout the process was attended by all members showing commitment to the project. In this way we were able to easily keep to the schedule we agreed on, and even managed to finish ahead of time. This was also one of the success criteria, as the deadline was very rigid, and we were working with an unfamiliar platform. We had planned in the criteria to allow extra time to ensure problems that may have arisen during the project were met with. For this project the extra time was not required, however allowed for a comfortable completion of the project, well within the required deadlines. We were late on only one of our original internal deadlines, which was for the completion of the prototype. We were 3 days later on this, however we had realised at the time it was going to be pushed back, and was not a critical task, thus not changing other deadlines. The final criteria we detailed was that the project had value to the user and that it did not contain glitches or errors that made it difficult to use. The first way we ensured value to the user by including as many stakeholders at each step as possible. We managed this through surveys completed at major steps in the project timeline, as well as continued contact with the project owner. All in all we met the criteria as listed for success in the project plan, we utilized these criteria in decisions throughout the project and referred back to them often to ensure that the project would eventuate as a success.

Scale	Strongly Disagree	Disagree	Neither agree nor disagree	Agree	Strongly Agree
Your Response					X

3. Self-evaluation of the value to the learners? Can you document your assessment?

Our product is designed for the students of the class TPK5100. It is a learning tool that is intended to help students revising the course in preparation for the exam. The website will provide the students with all the resources they need to revise the course content. The aim is for students to have a clearer understanding of concepts and terminology used in the project management course.

In order to evaluate the product, we decided to gain feedback from the end users at the middle of the development phase as well as at the end. This was an opportunity to do a mid-term evaluation of our product prototype, so we had time to reflect on any negative feedback and make adaptations for the final product. This was integrated into our initial schedule, as we felt this iteration was key to creating value. We had also carried out user research at the beginning of our project, which we build the product on.

The first user engagement was by far the most popular, achieving 43 responses. This initial 'user research' survey was posted on blackboard at the start of the project - before the other teams - and was available anonymously to all students on the course. This timing was a key part of its success - facilitated by the announcement of the client - as we were the first, and students were not fed up with surveys yet. The second user engagement was to test the prototype of our product, we got 14 responses. We first gained permission from the client to use this content before sharing it with anyone else. We selected random students from the lecture hall during the breaks, and asked them to view our website and fill in a digital survey. The third and final user engagement was during our presentation, where we asked the students to follow the navigation during our presentation - as we had posted the link on blackboard with the help of the client - and fill out the survey when they were finished. This was open to everyone in project management but unfortunately only 7 students engaged. We also received verbal feedback from the client after this presentation, which was very positive.

The timeline of this process is below :

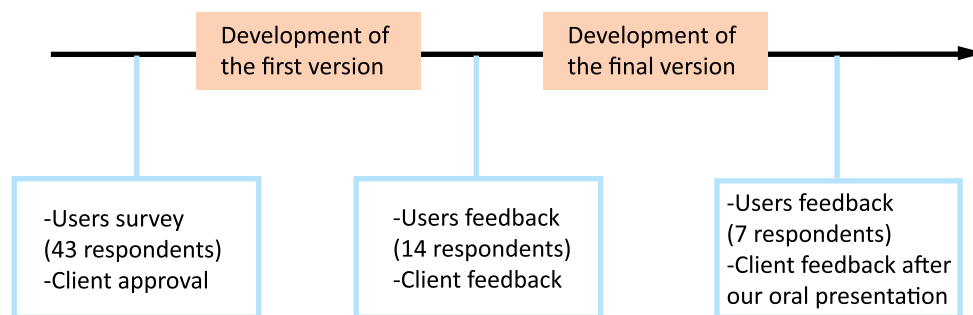

Mid-term feedback

The results of the mid-term feedback were as follows:

Question	Average Grade (on 10)	comments
On a scale of 1 to 10, how fast did you understand how to use the website?	9.3	“Slightly hard to see that I could scroll in the boxes of a quiz.”
Was the navigation smooth?	9.4	“It is well organized.” However by looking, the people testing our website we saw some people not navigating as we had intended and were using global navigation instead.
What do you think about the design of the website?	9.4	
Was the content clear ?	9.2	“Really useful the definitions section!”
Was the content relevant?	9.4	“Relevant content to study for the course. Another nice section might be "exams from previous years".
Did you find enough info?	9	“The site is still in construction. But for the lecture available, the content seems enough.”.
Is it a helpful tool for you?	9.4	“Really nice and well-structured website that gives you a great overview of project management!!! Very helpful”

As a whole, we can conclude from this survey that the users liked the first version of our product.

After this feedback we decided to:

- Modify the navigation process
- Add more content : videos from last year and external content + quiz on this external content, link to download past exams.

Final feedback and comparison with the mid-term results

Question	Average Grade (on 10)	Previous grade
Was the navigation smooth ?	7.9	9.4
What do you think about the design of the website ?	9.1	9.4
Was the content clear ?	8.7	9.2
Was the content relevant?	8.9	9.4
Did you find enough info ?	7.1	9
Is it a helpful tool for you? Will you use it for your revisions ?	8.1	9.4

We also asked them to write what their liked about our product and what can be improved. Here is a summary of the main comments;

What their liked: 4 specified that they liked the design, 2 the concept, 2 the content, 1 said it was easy to navigate, 2 liked everything.

What can be improved: 2 said we could provide more content, for example more of Bassam's videos. 2 replied the navigation could be improved

Analysis of the survey and self-evaluation

The results of both surveys were very positive, with grades higher than 7/10 for all the questions. However, we noticed that the grades are all lower in the final survey than in the mid-term survey. In our analysis, we concluded that this variation in results may be due to the way the surveys were conducted rather than representing a real deterioration of the product. For example, the design of the website hadn't been modified between the two surveys and we still got a lower grade

for that. In our opinion, some factors that may have influenced this are:

- The respondents are not the same in both survey
- The number of respondents was much lower in the second survey and may not represent the same data that a larger number would have given.
- During the mid-term survey, we were asking them to reply to the survey and were near them during the entire process. Thus, they may feel more pressure to give good grades.
- The timing of the second survey was after seeing several other projects, so it is possible that this made the results more critical

However, we noticed a real degradation on one point: we had lower grades but also a higher number of negative feedbacks on the navigation. During the first survey, we had only one negative feedback on that and very good grades, but we still decided to modify it by including the menu for lectures on each page and additional navigation at the bottom of the page. The effect of this was not as positive as we had hoped, and maybe would have benefitted from additional testing. Thus, we evaluate this modification of the navigation as a failure.

The idea of the product is based on the results of an initial survey we have done with students to understand their needs. Of course it is difficult to fully understand the needs of our future users through a survey but we tried to cater to them and create a product that solves the identified needs. Thanks to this method, we think our product will create value for the students because it has been designed around real needs. In the end, students agreed that the final product was useful for revision, with an average grade of 8/10. With only the partial failure of improving navigation, we consider our website to be of good quality. We had a lot of positive feedback regarding the design, and our client Bassam told us that the website looked very professional.

To summarise, our final product received very good feedback from both users and client but could have benefitted from further testing to improve the navigation. Therefore we consider our product to be of high quality and very useful for students.

	Our product is of high quality and we recommend it to be used as a learning aid in project management				
Scale	Strongly Disagree	Disagree	Neither agree nor disagree	Agree	Strongly Agree
Your Response				X	

4. Factors that have contributed to failure / success.

Our project was successful in both the management and the outcome, as it created value and met all of the success criteria we had set for the project. This criteria was:

- Open communication
- Strategy for adaptation
- Time management and planning
- Quality of end product

The most significant success factor was the open communication between team members. We divided the team into content creators, digitalization specialists and research and development, the communication within and between these departments were critical to the success of the project. There were regular discussions about our intentions for the website, making sure everyone was involved in the decision making to have a shared sense of ownership of the project. All big decisions were made during team meetings, with the advantages and disadvantages thoroughly discussed and compared to the purpose of the project. There were discussions about the extent of the course we would prototype, how to organise our pages and navigation, who would manage our website after we were finished, which functionalities we wanted to include and general feedback about the website and progress.

As we were working with unknown technology, we had to adapt our strategy at many points in the project. We had regular meetings to evaluate our project process, which we used to raise concerns and make adaptations to our project. This allowed us to discover problems at an early stage and make changes when it was easy to do so. There was a very fluid attitude towards adaptation and there were constant iterations of content, functionality and navigation. We were aware of our own limitations and prepared to adapt features. There were certain functionalities that we had wished for but failed to deliver, such as a pop up definitions and a 'build your own summary sheet' tool. We adapted these into 'key content' and 'definitions' sections instead, which offered similar information, but in a far less interactive way. There were also unknowns about the capabilities of our web-builder tools. For a time, we were unsure whether to use google sites or WIX as we did not know which was better at delivering the features we desired. We started prototyping on google sites as we believed it was better at integrating external features and documents. We then discovered a variety of interactive features on WIX, which made the team re-evaluate their decision and start prototyping on WIX instead. This switch caused us to miss an internal deadline but this was non-critical and did not affect the overall project.

The time management and project planning was also a key success factor in our project. Due to the adaptability we needed in our project, we worked with an adaptive model where we started with a general project plan and made specifications of work packages each week based on the needs that arose. We set internal deadlines at the beginning of the project, which were incredibly useful to measure our progress against. These internal deadlines were realistic and we managed to meet them in all occasions except the 3 day delay in the completion of the first prototype, due to web-tool change. We planned for time to 'test' our prototype which allowed us to improve our product and create value, it also minimized risk of failing to meet the external deadline. After the testing we had time to make final adjustments - mainly in navigation - and have our project completed comfortably before the deadline. As part of our plan, we held weekly meetings with the team to discuss progress, problems and next steps. We would end every meeting by allocating work packages to be complet-

ed by the next meeting. This was a very useful strategy as the team would make progress together rather than individuals doing large portions of the work.

The quality of our end product was essential to the success of our project. We wanted to create value for the user and ensure we were solving real needs. We included the stakeholders at many points in the project to ensure that their needs were being taken into consideration. Our decision to create a revision website came from user research at the start of the project, where we learned about study habits and areas of difficulty. We discovered the tools currently used by students and decided to build on these to create a resource that combines all the existing resources in one place. It was important to build on the work of others to give the learner all the necessary tools to succeed in project management. The content of our website is varied and easy to navigate, which we have seen keeps the user interested and engaged. From our final presentation and feedback throughout the process, we received many positive comments, leading us to be confident that our product has created value.

Comparing our success criteria with those on page 92.

we find that these key factors are shared. We see as well, many other factors in the table that were present in our project. The ideas of open communication, collaboration and adequate planning are fundamental to the success of a project. The main factors not seen in this project were those related to larger and more experienced project teams. We had little previous experiences or insights to work from, so were unable to benefit from this. The team was also small enough that 'top management' problems did not exist. Judging our own project in terms of success factor categories:

case-specific factors: For our digitalization project, the quality of the end product was very important as we wanted the product to be easy to use but also keep user interested with varied content.

structural factors: The most important one was open communication within the team, as discussed thoroughly above. Defined roles within the team helped us to work more efficiently, as the work packages were clear and there was a shared understanding of what tasks each team member was responsible for. In terms of project structure, our process was flexible and had established routines for deviation control, defined by internal deadlines and weekly evaluations. We were aware of the risks of our project and planned for possible deviations during the process. Our work packages were defined weekly and provided a structured opportunity to adapt the project, while taking regular documentation of decisions and delegations. The information flow was regular and across all levels, including stakeholders at important points in the project.

cultural factors: The first one is the commitment of all members. Our roles were interdependent and so commitment from all members was crucial to success. Moreover, we also wanted openness and trust during our work: everyone was free to say what he thinks without being judged or criticized. There was excellent transparency within the team and its departments.

5. Most important lessons from your project

You should first make internal deadlines and try to meet them. It is really helpful to have internal deadlines so you know what you have to achieve and when. Our experience is that it sets a good pace for the project and provides an excellent tool for evaluating your progress.

We would advise setting weekly tasks for people to work on at the end of each meeting. If everyone is aware of what other people are working on and have targets to achieve by next meeting, the team is able to progress together and you will be assured to meet the final deadline. Our experience was that this allows all team members to contribute, and everyone is aware of the progress that is being made.

We have also learned that the initial phase is very important to identify the real needs of the users. In order to create a useful tool, you have to insure that your idea will fit what people want and need. Our experience is that a product that solves real needs will be much more successful.

Our fourth advice is that you have to involve the stakeholders in the project so you know if they like what you are doing. Gaining clear data and feedback from stakeholders will ensure that the project you are making has value.

Finally, our last advice is that you should produce a prototype of the product and allow time to test it with users. Gaining insights at this stage will allow you to make specific adjustments so your final product is as valuable to your user as possible.

6. References

Hussein, B. (2018). *The Road to Success: Narratives and Insights from Real-Life Projects*, Fagbokforlaget.

Milosevic, agan Z, Sabin Annaboon, and Peerasit Patanakul. 2013. *Case Studies In Project, Program, And Organizational Project Management*. Hoboken, N.J.: Wiley.

Accessible by: <https://saidnazulfiqar.files.wordpress.com/2008/04/case-studies-in-project-program-and-organizational-project-management.pdf>

Peer-review report

The Group we are assigned to evaluate is group number 20

Strengths (what are the good things about the product) this might include; the idea, there is a need for that, you believe that the product provide real value to learner, or that the product is of high technical quality (for example excellent video quality)

- Quizzes are a good idea. There is a need for a quiz like this, as we don't have access to kahoots after the class.
- Like explanation of correct answer - find this helpful to improve on weaknesses
- Easy to follow
- Easy to read (size, colour, font, spacing)
- Questions were relevant and covered the whole course

Weaknesses (what are the features in the product, that you believe has impacted negatively your evaluation) that might include quality issues, lack of aiding text, lack of user-friendliness, tedious, and so on

- Repetitive - similar format of question, got boring after a while
- Not interesting enough visuals - colour, repetition, lack of images
- Too long - could maybe divide quiz into topics as 30Q is too long
- Not clear what/when quiz is intended to be used - revision? Sections? Does it continue to more revision?

Idea: a review of the questions you got right/wrong at the end. Possibly include case studies in the questions as they are a key element of the course.

We feel that this a lot of work was put into this project and there is definitely a need for quizzes/evaluation as a revision tool. However we found the experience of using the website was repetitive and not 'finished'. The quality was not as high as it should have been, there was little innovation or consideration of the user experience, and the product had not been proofread as there were still errors in spelling and grammar. We understand that making a website from scratch is difficult and takes a lot of time, so then maybe the choice of the technology was not optimal for the purpose of this project.

	The product we reviewed is of high quality and we recommend it to be used as learning aid in project management				
Scale	Strongly Disagree	Disagree	Neither agree nor disagree	Agree	Strongly Agree
Your Response			X		

The grade we would recommend for this product is 6.

TPK 5100 - APPLIED PROJECT MANAGEMENT

**A NARRATIVE REAL-LIFE PROJECT ILLUSTRATING
HOW THE INFLUENCE OF SOFT FACTORS COULD SHAPE
THE PROJECTS' SUCCESS**

SUCCESS OF IVAR AASEN PROJECT



DEPARTMENT OF MECHANICAL AND INDUSTRIAL ENGINEERING,
NORWEGIAN UNIVERSITY OF SCIENCE AND TECHNOLOGY

November 19, 2019

Preface

This report was written in Autumn 2019 semester, as a part of the course project for the course TPK5100 - Applied project management. This report discusses some characteristics of digitalization projects through a digital product developed by the members in the project. In addition, the report discusses the challenges faced during the development of the product, rationale behind critical decisions during the product development, products' critical-assessment in terms of the value it creates to its customers, factors that contribute to the success of failure of the project and the lessons learnt while the product was being developed.

We, the members of group 25, would like to thank the professor of the aforementioned course, Bassam Hussein, for providing us with a detailed report on the real-life project in question. In addition, we would also like to extend our gratitude to AkerBP AS and Sembcorp Marine Pte. Ltd., Singapore for the actual images and visuals of Ivar Aasen project utilized in this project. The image in the title page is credited to Aker BP.

	Student Name	Student Number
1.	Joachim Jahr	767749
2.	Tom Krznar	520231
3.	Saikrishna Govindarajan	487745
4.	Wenz Marvin Muni	520690
5.	Abraham Kwame Richman	520692

Contents

- 1 Digitalization projects** **2**
- 1.1 Our product 2
- 1.2 Challenges 2
- 2 Self-evaluation of the project management effort in the project** **4**
- 2.1 Overall evaluation 4
- 2.2 Evaluation of project management effort 5
- 3 Self-evaluation of the value to the learners** **6**
- 3.1 Target audience 6
- 3.2 Method used to evaluate the final product 6
- 3.3 The number of informants who have contributed to the evaluation, and how these informants have been selected 6
- 3.4 Results of the survey of the final product 7
- 3.5 Degree of our support (group-based evaluation): 8
- 4 Factors that contributed to the project’s success.** **9**
- 4.1 The planning phase 9
- 4.2 The execution phase 10
- 4.3 The completion phase 11
- 5 Most important lessons from the project** **12**
- Bibliography** **I**
-
- A Peer-review evaluation report** **I**
- B Feedback questionnaire** **III**

List of Tables

- 1 Self-evaluation of the actual end deliverables 4
- 2 Stages involved in Ivar Aasen case video development 9
- 3 Success factors at various stages of product development 10

1 Digitalization projects

Digitalization is a term that is becoming more and more relevant in today's world as technology and computers keep evolving. It is a replacement process of converting or modifying traditional ways into digital ways. For example paper in the world is slowly losing its usability meaning due to the increase of digital devices. In order to complete any of these replacement processes, a digitalization project often comes into place.

Digitalization occurs in many different areas of our life. These areas range from digitalization in business, entertainment, transportation, education, etc.. In our project's case, we have created a digital project within the area of education, (Janetta, 2018). Even more specifically, our project consisted of converting a number of traditional text sources into a digital and visual format with the goal of illustrating these sources in a clear and easy-to-understand way.

1.1 Our product

Our product is a video about Ivan-Aasen oil drilling project illustrating how soft-factors can influence a project. It shows how a Norwegian oil drilling company managed to turn a failing megaproject into a definite success. Most projects fail or succeed considering only the hard factors like effective communication, considering risk assessment, clearer division of responsibilities, competence effective planning and execution of plans, team work and unity but rarely due to soft/ cultural factors. These soft factors may include trust, openness, commitment, respect, motivation, sense of ownership, and knowledge sharing.

1.2 Challenges

In today's world where technology has taken us over, digitalization seem to be the hour of need in almost every industry owing to its practical, efficient and reliable aspects compared to the traditional paper-based techniques. As defined in most of the search engines and studies carried out, digitalization is the use of digital technologies to change a business model and provide new revenue and value-producing opportunities, in other words, it is the process of moving to a digital business, (Glossary, 2019). From basic clerical works in health care to enormously scaled oil gas industry, digitalization has started making every work-day much easier and enjoyable to humans.

Having assigned a task to come up with a digital product that would be of some assistance to stakeholders of the course, TPK5100-Applied Project Management, the first challenge was to form a group consisting of fellow students, herein referred to as a "Project organization" or a "Project team". At first place, this was hard to come by as is the case with formation of any project team in any possible course at NTNU. Through necessary communications and self-introductions, the project organization was formed consisting of five members, hailing from various backgrounds.

The next big challenge was the "Time", wherein the project team hardly had two months as the project deadline. This race against time necessitated that the first of the efforts towards choosing the right kind of digital-product to develop had to be handled well. "Budget" was another constraint as the product had to be developed with zero costs. Yet another major constraint was the challenge to choose a project which could be well perceived and understood by all the members in the project organization, given the fact that they had different backgrounds. These aforementioned challenges made choosing the product type difficult than how the team members thought it would be.

Then came the biggest question to be answered which was "**What is the product we should develop?**". The team agreed to come up with one idea from each of the project member within a specific time schedule. There were no other boundaries attached to this first level of filtering

the project ideas. The criteria of search for ideas was that the product should fit into realistic time schedule of two months and that it shall not be too strenuous to achieve. One of the options that the team considered was to animate a case from the book utilized in the course, *The Road to Success*, (Hussein, 2018). However, since the project team members were from different backgrounds, only one of member was experienced with creating animations. Since creating an animation with the given deadline could prove to be too taxing and unfair to just one of the team members to work with, the project team decided to think of other alternatives.

The second option was that of a re-enactment of a case study found in the aforementioned book. This idea was a result of being inspired by the students from previous semesters who had taken the same course. The products that they had come up with were posted on a YouTube channel owned by the professor of the course, (Hussein, 2012). Although it sounded great, the project team was not convinced on the terms on how to do it and on which topic we should select since most of the cases were already performed by the previous students.

The final product idea that the team had in hand was that of a narrative video of the Ivar Aasen case study, which was put forward by one of the members during the lecture. That team member was fascinated about the project since he happened to work with a company that build the oil platform in the Ivar Aasen project. The project member explained the important lessons learnt from that mega project and he was also confident enough that we could succeed as a project team by taking up this case to create a narrative video. The case factors also intrigued the other members of the team on choosing the topic. Considering that the case was about a growing company tackling a huge project for the first time, going against the odds and emerging as successful gives an interesting appeal. Finally, the project team agreed on creating a narrative video of Ivar Aasen case project. This could also prove to be the best bet for the team since task allocations for script writing, narration and video editing could be easier as many team members had some basic experience prior to this.

With this project, the objective of the project team was to communicate the influence of soft factors such as commitment, trust, loyalty, freedom to innovate, freedom to express ideas etc., in creating significant differences to the attitude of the project organization as a whole and contribute to project's success.

2 Self-evaluation of the project management effort in the project

In this section of our report, we are presenting our feedback on the result of this digitalization project. But because one may not be able to judge themselves completely accurate, our opinion about the end success may result in being inaccurate. Nonetheless, we are stating our opinion on the matter in the spirit of helping others to judge our work and achievements more easily.

2.1 Overall evaluation

From the beginning to the end, we have planned this project carefully and tried our best to make it as good as possible within the constraints of our knowledge and time frame. Although it may seem at first glance that the product we have produced might not look very professional, or extremely entertaining. Nonetheless, we feel that we have achieved our main goal. Therefore, our general feeling about this project is a positive one. We believe that we have successfully managed to visualise most of the important facts about the Ivar Aasen oil drilling project management case.

In our project plan we have defined a selection of deliverables that would have to be considered. To illustrate our general opinion of our project management success, we can present a table showing a comparison of the planned and the actual deliverables.

Planned deliverables	Self evaluation scale of our actual end deliverables from score 1-5				
	1 (project sabotage)	2 (major faults)	3 (minor faults)	4 (as planned)	5 (better than planned)
Digitalization of a project management success case				x	
Educational nature of the video				x	
Communicate all of the most important points of the case				x	
Length up till 5 min			x		
Carefull crafted script				x	
Quality narration				x	
Quality visuals					x
Quality audio			x		
Media would be available online to everyone.				x	

Table 1: Self-evaluation of the actual end deliverables

To additionally clarify the reasoning behind our self evaluation we can list some more details behind our planned and achieved deliverables:

Positive deliverables:

- We knew that we faced a challenge with the narration side. But, the narration has been done unexpectedly good by one of the project team member, due to this being his first ever narration.
- When assembling the visual material for the video, we have stumbled across an abundance of very high quality footage of the project that has been produced by the project managing

company. This has made easy for us to produce a visually impressive video. Perhaps even more than planned.

- We are very satisfied with the script and the information it provides. We feel that all the data that we prioritized has been communicated accordingly.

Negative deliverables:

- Due to lack of audio recording resources we have not managed to achieve the desired quality of the narration sound.
- The length of the video ended up 6 minutes, which is one minute more than planned. We knew that the focus of the average audience starts dropping after that five-minute mark, so we wanted to make it short. But our main script goal has not allowed further shortening. The reason being: we had so much critical data about the Ivar Aasen project which we found too difficult to remove. Hence the narration speed ended up being a bit fast and the video longer than five minutes.

Although there were some minor disappointments, we believe that none were so significant that would compromise our project. Furthermore, we believe that positive deliverables have outweighed the negative ones. That is why we are generally satisfied with our end result.

2.2 Evaluation of project management effort

Scale	Strongly Disagree	Disagree	Neither agree nor disagree	Agree	Strongly agree
Your response				X	

Upon subjecting our project management effort to a critical assessment of positives, negatives and potential areas where we could have fared better, we evaluate our project management effort as successful in a reasonably practical order of magnitude.

3 Self-evaluation of the value to the learners

Over the years, the world of project management has been bombarded with cliched understanding such as “project management is all about good project planning, meeting schedules, completing milestones, accommodating variations etc.”. Although one cannot deny them, there has been no great deal of emphasis given to the soft factors in project management and that is what makes the “**Ivar Aasen**” case one of a kind. This was the primary motive for us to choose this case to make a video, thereby communicating the importance of “soft-factors” in project management, which we felt has been under valued over the years.

3.1 Target audience

The core target audience of our product are the students undertaking the course TPK5100-Applied Project Management or any similar courses demanding an understanding of project management. That being said, our product developed shall also be extended to customers seeking an understanding about the success factors or the enablers to facilitate a projects success. In that way, the target audience category is extended beyond just the students taking TPK5100 or similar courses at NTNU.

3.2 Method used to evaluate the final product

The method chosen to evaluate the developed product is through survey. Upon several discussions within the project team, in order to have opinions about how well a person could understand the message that the video tries to convey, we decided to survey not only some random students in the course, but also some randomly chosen friends of the team members who has no connection to the course TPK5100. In this way, we tried to capture the products’ level of understanding to someone who has no real idea about what project management is all about.

Once that decision had been agreed by everyone in the team, the next question to be answered was “How are we going to survey? Is it just by verbal enquiry? or a questionnaire?”. Herein again, upon discussions, we ended up choosing a questionnaire as the medium to survey. The rationale is that the questionnaire could give the surveyee a few extra minutes to think about what he/she perceived from the video and answer accordingly and also that it could be easier to document the survey, if it were through a survey form. This decision was agreed and eventually finalized by the project team.

The above decisions necessitated preparation of a questionnaire. The questionnaire was the prepared based on the project concept, product construction, product quality, viewer engagement, quality of visuals, quality of narration and perception of information, which the surveyee could either strongly disagree or strongly agree based on their opinion. The survey questionnaire utilized has been attached to Appendix B.

3.3 The number of informants who have contributed to the evaluation, and how these informants have been selected

We approached a total of 32 persons for our survey. The surveyees include students in the course TKP5100, house mates of the project team members and some random friends of the project team members. The platform used for survey approach was through direct conversation, sending the link of the product and the feedback form over email or via social networking platforms. We managed to receive 24 responses out of the 32 who were approached. As explained before, the informants were chosen to be a generic mixture of persons. The rationale was that we shall also get opinions from personnel who had no idea about what the video was all about and this would eventually give a holistic result picture.

3.4 Results of the survey of the final product

To give better insight about the responses received, the survey responses have been summarized and presented in a visual format in the figure below.

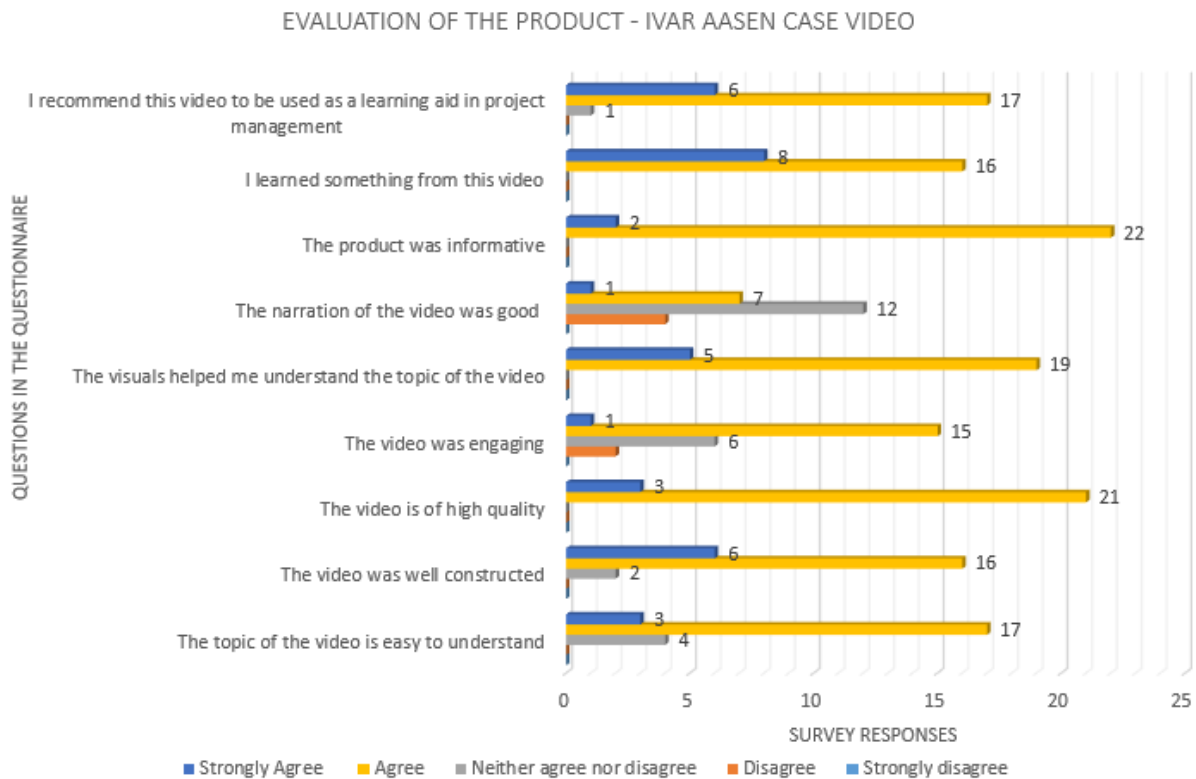

Figure 1: Results of the survey for product evaluation.

From Figure 1, it is observed that the narration in the video was not satisfying. This is something we did expect. It could be attributed to unavailability of professional recording devices and indeed, the lack of experience with narration. An additional reason is that the case project, Ivar Aasen, had heaps of valuable information to be conveyed through narration and the video wouldn't look complete if such information had been deleted. Hence, the narrator had ample amount of text to narrate within his quota of time agreed upon. These are the contributing factors for the narration to end up slightly faster than it ideally should have been.

Most voters have either strongly agreed or agreed that the “video was well constructed” and that “the product was informative”. This conveys a message that the content was simple and understandable even to outsiders who were not a part of TPK5100 course. This was one of our primary objective, to reach as many audience as possible in a clear and concise manner. Secondly, the project team’s decision to use actual visuals from the case project for the video seemed to have reached wider range of audience as they could visually see the scale of the project that we are talking about. So here again, the product seem to have reasonably succeeded.

The questions regarding “understandability of the project video” and “how engaging was the video” is interlinked to each other in a way. It is understandable that for some people who are totally from different background could have found the case-project as a whole not easy to understand. The reasons for “disagreement” and “neutral” responses for the question related to engagement could also be related to people from different background, who would have naturally felt that there was no entertainment value in the video, which again is understandable. In a case-project as humongous as Ivar Aasen, the information to convey was so much that the project

team hadn't figured out a way to squeeze in some entertainment value targeting neutral audience.

On the positive side, the responses to the questions regarding the "quality of the video", "informativeness of the video" and "learning element in the video" has been significantly high. This suggest that the product, one general note, has some sort of a new learning element in it, irrespective of the backgrounds of the viewers. The quality and information aspect could have possibly emerged from using the actual visuals from Ivar Aasen case project, which the project team believes, could have left some of the viewers impressed about how the project team managed to gather actual visuals from the case-project.

In line with the views of the project team members, the surveyees also feel that the product in question has some value to contribute to appropriate lectures in project management and hence also recommended to be used as a learning aid for the same. On the whole, despite some negative feedback received, the product shall be a quick-fix to those craving to understand that not only hard factors assist to a project's success but also some soft factors, provided they are used appropriately.

3.5 Degree of our support (group-based evaluation):

	Our product is of high quality and we recommend it to be used as a learning aid in project management				
Scale	Strongly Disagree	Disagree	Neither agree nor disagree	Agree	Strongly agree
Your response				X	

We, Group 25 believe that this product has the potential to give the future students of TPK5100, a clear understanding about the influence of soft factors in project of any scale. This belief of ours has also been strongly supported by over 90% of the reviewers of the product who also believe that the product was "very informative".

4 Factors that contributed to the project’s success.

Instead of diving directly into the success factors that the project organization adhered to, it would be interesting to understand how the project organization was formed. As inevitable as it could get, the formation of the project organization, which is also a project team did involve going through different stages of team development. According to the theory put forward by Bruce Tuckman, the project team went through the phases of Forming, Storming, Norming, Performing and Adjourning, before being successful, (Tuckman and Jensen, 1977). This section attempts to capture the journey of how the project organization transited from just a newly-formed team to working its way up to the projects’ success in terms of various stages of team developments involving some unique success factors.

The term “Success factor” refers to a set of factors that the project must comply with in order to enhance its probability of success, (Hussein, 2018) (Turner, 2009). By the time the project team reached a phase where they had to draw some ground rules to undergo the process of product development, the team had already gone through the phases of forming and storming in team development frontier. Hence, by this stage, the team was very much aware of what was expected of them by the project owner. As the project transited through various stages, there were some new success factors emerged and sustained. In order to demonstrate how this took shape, it would be desirable to understand the various phases in the product development that was adopted by the project organization, as presented in Table 2.

Ivar Aasen case video - Product development phases		
Planning	Execution	Completion
Coming up with different product ideas	An individual detailed reading of different sections and writing up a script	Compiling the video track
Discussing all the project ideas and agreeing upon one	Editing and developing a final version of the script	Group assessments and feedbacks
Reading up on the case project and understanding its key-elements	Recording the script	Obtaining external reviews and addressing the comments received for the product
Coming up with a report for the project plan	Finding and filtering the actual images and visuals of the case-project for product development	Completion and submission

Table 2: Stages involved in Ivar Aasen case video development

4.1 The planning phase

During the first week of the planning phase of the project, there was no special interest shown by the team members. It was quite understandable as the team hadn’t figured out anything regarding the project. During this stage, it was “effective communication” that steered the team into a certain way of approaching the project goal. At this stage, the team members came up with various product ideas. But there were two ideas that sustained through various filtering processes and reached decision-making point. One product was to develop a instructional video regarding some etiquette’s to be adhered by students in the class room and the other was to develop a case video of “Ivar Aasen” oil field project’s success. The project team spent almost an hour discussing on the pros and cons of both the suggested projects. Since one of the team member had been a part of “Ivar Aasen” project, the team was convinced by a detailed briefing given by that member. The very reason that Ivar Aasen project is one of a kind project wherein

the project successful hugely due to the “soft factors” namely trust, sense of ownership, freedom to innovate etc., convinced the team to decide upon making a video of Ivar Aasen project’s success as the project goal.

Having crossed this phase, it was “support from project team”, “sufficient client consultation” and “adequate project planning” that got the project team to realize that they are involved in developing something meaningful. By this phase, when the project team had to come up with a project plan, we came up with a very “realistic project schedule”, when then served to be a guiding torch to the team, helping us to monitor and control the time aspect of the project.

At the end of this stage, it is fair to say that the team was narrowing down from the storming phase and entering the norming phase of team development wherein the group starts to settle into a groove. This was when the team decided to define some ground rules, in other words, success factors before dwelling deeper into the execution phase. For convenience, the Table 3 summarizes the success factors that proved to be beneficial to the team at various stages of product development.

Planning	Execution	Completion
Effective communication	Clarity in project purpose	Experience of project team members
Support from project team	Designation of clear roles and responsibilities	Creativity
Sufficient client consultation	Transparent communications	Trust
Adequate project planning	Honesty	Involvement
Realistic schedules	Regular project meetings	Feedbacks

Table 3: Success factors at various stages of product development

4.2 The execution phase

The project team ventured into the execution phase of the project with high clarity in the project purpose. Credits goes to some transparent communications within the project team on how to proceed from there on. It was in this stage that a skill-check among the team members were desirable to take a call on further proceedings. Transparent communications played a major role there as well as the team pitched out honestly about who is capable of what. It was this discussion that played a vital role in how the product shaped up at the end. Some of the questions that were answered during this discussion are

- Does anyone have any experience with creating animation videos/ video editing?
- Has anyone done a professional voice recording before?
- What are the software and hard ware tools required? Do we have them?
- Who among the project team members has a voice that is suitable for narration?
- If one person works on recording and another works on video editing, what could other members contribute with?
- Which comes first? Audio or Video?

Answering all the above questions demanded honest and transparency among the project organization. This discussion at the beginning of the project execution phase helped to assign

very clear roles and responsibilities to every person in the team. This ensured that every member worked simultaneously on the assigned tasks and stuck to the schedules which enabled a smooth flow of events during the project execution phase. It was this phase where the team transitioned into the “performing” stage of team development wherein everyone was on the same page and driving full-speed ahead towards the final goal. Another major debate during this stage was whether to animate the video or to use actual pictures and visuals from the project. Since the actual visuals of the project were available to the project team and since the use of actual visuals would impart a real-feel of the extent and complexity of the project, the team agreed to stick to actual images and visuals for the video.

4.3 The completion phase

Upon entering the completion phase, the factors of experience and the creative skills of a project team member played a vital role. Since one of the project team members volunteered to compile the case video citing his experience of working with professional software editing tools, an atmosphere of complete trust and involvement from other project members kicked in. The rest of the team volunteered to help with the video compilation but since the experienced person was very confident that he could do it himself and for a reason that video editing is a task that gets tougher if many people involve, the team agreed that the experienced team member shall do that and believed in his abilities.

Once the first version of the product was done with, it was first shared to the team members and then to some external individuals who had no idea about what the video was all about. Upon receiving some constructive feedback from both aforementioned parties, they were re-assessed by the project team before incorporating them into the product. In this way, the product was finished well within the realistic deadlines set aside by the project team for themselves.

If we were to pick few success factors that the team felt they contributed to the project management success, it would be "**Effective communication**", "**Designation of clear roles and responsibilities**" between the members of the project organization and finally, the creation of a "**Trust**" embedded environment which propelled the team forward with confidence. Comparing the mentioned factors with that proposed in (Hussein, 2018), many common factors have served as an enabler from start to the completion of this project, as discussed in the sections above.

Finally, reflecting back on the team composition and the experience of being a part of a digital product development, the group felt that the diversity in skills within the project team also more played significant role in making the project management efficient, which otherwise would have been much more stressful.

"Diversity has the potential to either disrupt group functioning or, conversely, be the source of collective creativity and insight"

-Catarina R. Fernandes and Jeffery T. Polzer

5 Most important lessons from the project

Despite the fact that there couldn't be any hard and fast rules to manage projects, it is definitely beneficial to apply some methods, strategies, theories or calculations which could serve as an enabler to minimize the critical factors such as time, effort, money or a combination of all. In this section, some of the most important lessons learnt by the project team through their project management effort in producing the "Ivar Aasen case video" are summarized.

- You should first identify the learning objectives of your final product before deciding on the type of product you wish to create.
- You should make sure everyone in the team agrees on the importance of deadlines.
- You should make sure everyone in the team agrees on the importance of allocated meeting times.
- You should make sure everyone in the team agrees on the work distribution .
- You should make sure everyone in the team knows what they are expected to do.
- You should make sure no tasks are left unallocated, or are not clearly allocated.
- You should make sure you have the equipment and skills required to create your product.
- If you are making a video, make sure you have enough content to fill the video.
- You should make sure your product is not too long, as it can make the end users lose interest.
- You should make sure you product has a clear focus, or topic of discussion.
- You should make sure you know your target audience.
- You should make sure you get feedback about your project from your target audience during the creation of the product, as well as after the product has been finished.
- You should try to get feedback which can be used to further improve the project, or similar projects at a later time.
- During the initial phases, all the team members should come to an agreement about which of the suggested projects should be followed through.
- The team should set up a fast, efficient, and reliable form of communication.
- The roles to be distributed should be done so early and in a clear and agreed upon fashion.
- It is vital to establish trust between the team members, along with other soft factors.
- If applicable, a team with a diverse skill set and background should be formed.

References

- Gartner Glossary. Digitization, 2019. URL <https://www.gartner.com/en/information-technology/glossary/digitalization>.
- B Hussein. Video lectures in project management by associate professor bassam hussein. ntnu- trondheim norway, 2012. URL <https://www.youtube.com/channel/UCXoj1yDHthOb0eBXTToFj0qg>.
- B Hussein. The road to success: Narratives and insights from real-life projects, 2018.
- A Janetta. Digitization of education in the 21st century, 2018. URL <https://elearningindustry.com/digitization-of-education-21st-century>.
- Bruce W Tuckman and Mary Ann C Jensen. Stages of small-group development revisited. *Group & Organization Studies*, 2(4):419–427, 1977.
- John Rodney Turner. *The handbook of project-based management: leading strategic change in organizations*, volume 452. McGraw-hill New York, NY, 2009.

A Peer-review evaluation report

The group that had been assigned to us for evaluation: **Group 22**. The product developed by Group 22 is an app which is currently supported by Apple Inc. products operating with “ios” platform. This app is a platform that links all the lectures from the course TPK5100 for the students taking the course. In addition, there is a platform for a quiz which enables the users to test their understanding about any lecture that they read.

a) Strengths and weaknesses of the final product

Strengths

- **Quality** - In general, the quality of the product is good and has a pleasing look.
- **Functionality** - The app is fairly interactive to an extent that the user will not be frustrated by using it. In that respect, the app is quiet balanced.
- **Concept** - Undoubtedly, the concept grabs much of the credits. It would be very useful for the current as well as future stakeholders of the course, if utilized fully.
- **Interface** - Th app has a good interface for now and navigation is quick as well.
- **Quiz** - In terms of the small element of entertainment, the quiz sections contributed to it.

Since the app has presented only a platform and not the complete product with all data, it is difficult to understand all the strengths that this product could bring about upon completion. Yet, the potential outcome of the finished product would be better than what it is now and provide high value to the stakeholders.

Weaknesses

- **Redundant** - As there are other similar and completed products presented, we felt that this product could be partially redundant. Additionally, as customers, we would prefer a fairly completed product over a product with just the platform.
- **Basic features** - Notification features for assignment deadlines, lecture plans etc., if present, could have been a better unique selling point for the product in question.
- **Additional features** - In addition to the quiz section, the app could provide links to Kahoots and video lectures of that particular lecture or topic from the Youtube channel of the professor.
- **Completeness** - The product being not fully developed, it is difficult to accurately judge how useful it would be for its customers, especially students.

Finally, the product could reach more customers if the product could be extended to be supported by other operating systems. At the moment, it would be fair to say that the product is a very good attempt by the developers with enormous positive potentials to students and the professor but the extent of positives is difficult to be predicted as the product is not 100% developed.

b) Evaluation of the degree of your support

	The product we reviewed is of high quality and we recommend it to be used as a learning aid in project management				
Scale	Strongly Disagree	Disagree	Neither agree nor disagree	Agree	Strongly agree
Your response				X	

c) On a scale from 0 to 10. What grade would you recommend for this product?

We would recommend a grade of 8 for this product. The reason is that the product is incomplete and has no real data of the lectures or books yet. But nevertheless, it has a very high potential to be used as a learning aid for the course TPK5100, upon completion.

B Feedback questionnaire

GROUP 25 PRODUCT FEEDBACK

(IVAN AASEN VIDEO)

	Strongly Disagree	Disagree	Neither agree nor disagree	Agree	Strongly Agree
The topic of the video is easy to understand					
The video was well constructed					
The video is of high quality					
The video was engaging					
The visuals helped me understand the topic of the video					
The narration of the video was good					
The product was informative					
I learned something from this video					
I recommend this video to be used as a learning aid in project management					

If you have any suggestions for improvement, please comment below

Figure 2: Feedback questionnaire for product evaluation.

“What kind of influence do we have?”

An animated project management case with an interactive video-quiz about stakeholders to aid student’s self-testing and lecturer’s evaluation.

GROUP 26

Preface

This report is an evaluative report about the digitalization project within the course ‘Applied Project Management’ (TPK5100) at NTNU in Trondheim in autumn semester 2019. The task was to plan, develop and produce a digital learning aid in project management. The product is supposed to have a significant impact on learning and must be usable on phone, tablet or PC.

Contributions to the project have been solely made by the members of the group, but we would like to thank some classmates, friends and the teacher’s assistant, who have answered some questions for getting feedback. Also, we would like to positively emphasize the websites and facilities like Educaplay and Powtoon, which have made it easier to find solutions and results for the project.

Group number: 26

Student names and student number:

- 1) Domenico Marra (519409)
- 2) Cristina Martinelli (519913)
- 3) Patricia Marto (519912)
- 4) Jorge Puyuelo Roy (519357)
- 5) Capucine Reverseau (519304)
- 6) Inken Terjung (519975)

1. Digitalization projects

Our digital learning aid is an interactive video-quiz, which explains one case of the lecture - namely the 'Ruben case' of the lecture about stakeholders - combined with a learning test. This video should be a facility for the students to better understand and memorise the content of the lecture.

The video-quiz should be used after the lecture so students can have feedback on what they have understood of the lecture, making them aware of the knowledge that they have already acquired on the one hand, but on the other hand in which areas they are still lacking knowledge. Another opportunity that our project provides is letting the teacher know whether the students have understood the content of the lecture or if he should revise and explain some concepts again, because sometimes students do not feel confident enough to ask when having questions.

In order to clarify why we have decided on this specific product, it is useful to introduce 'digitalization' more in detail. This term is defined as the adoption or the increase of the use of digital or computer technology by an organization, industry, country, etc. It is about value creation in the process, on which the goals of digitalization are based: they are first the improvement of the product or of the process, the automation of the processes and the simplification of the communication (Parviainen et al., 2017).

We have chosen to produce this specific learning aid within the digitalization project, because it digitalizes the Ruben case from a normal text into a video leading to an increased use of computer technology by NTNU as the organization in this context. In our opinion, it creates value by facilitating to get the content of the Ruben case by the animated video and supports learning by the integrated quiz. It automates the process of providing the content of the Ruben case and simplifies communication between lecturer and students. Indeed, the lecturer gets feedback about the learning success of the students by the quiz results without the need to talk to everyone. The last decisive factor for choosing this digital product was the fact that it was within the scope of our technological skills.

This leads over to our main challenges that arose during the project. There was on the one hand the lack of technological skills regarding IT and digitalization, since all members of the group are students in management and economics fields. On the other hand, combined with the latter restriction, it was difficult to create a product that adds value for the students, which was demanded by the task instructions and which is also a feature of the above mentioned definition of

digitalization. So we had to think of something that was technically not too advanced and within our limited capabilities but at the same time useful, easily usable and responding to student's needs.

Other challenging factors - after we have finally decided on creating a video-quiz implemented in an animated case - were the time limit and working with a budget of 0. These constraints resulted from the restrictions of the task instructions of this project, namely the final deadline of 11/12/2019, and the nature of university assignments, where usually no budget is provided.

These facts resulted in the following sub-challenges: it took a lot of time to acquire the necessary know-how to use Powtoon as a video creating website and Educaplay as a tool for implementing the questions into the video. It was inevitable to work through tutorials and user guides (for instance https://mahfuzah.weebly.com/uploads/1/1/7/5/117591906/powtoon__1_.pdf by Mohamad, n.d.) before finally starting to work. This contributed to the time-related stress. Plus, there were limitations due to the usage of free demo versions as consequence of the missing budget: firstly, not all the background slides and features, that were offered in the video animation programme Powtoon, were included in the demo version. Secondly, the video could only have a maximum length of three minutes and thirdly, the download of the video was not for free, which was unluckily detected during the execution of the project. For these challenges, we had to either stay within the restrictions or search for other solutions.

Finally, it was also challenging to find a good virtual voice to record the whole video that is clearly understandable and sounds as natural as possible. We aimed for finding a good male as well as a good female voice in order to make it easier for the listener to distinguish between the dean character and the narrator speaking.

So all in all, our challenges were mainly based on limited technical capabilities rather than on managerial or planning issues.

This can be transferred to the context of companies. As a result of the ongoing digitalization, they have to fill the talent gap of employees with excellent technological skills, which is vital for digital change, and which are still lacking in the majority of companies. The companies have to attract talents by offering a work package with compelling value proposition. (Caimi & Lancry, 2018)

2. Self-evaluation of the project management effort in the project: success or failure?

We think that the organization of the project group has been optimal; we have respected project breakdown structure (WBS) and our original plan project.

In our opinion, we have done a fully functional product which could be used in lectures of different study fields related to project management. We also think that this product is well comprehensible and easy to use, for both teachers and students.

Each member was equally involved in the work. We did not have any argument between group members because every member had the same objective and motivation. Even if at the beginning we had some difficulties to find the proper product, we all shared our intentions and ideas to deliver the perfect product at the end. We identified some **risks** that could occur throughout the project:

1. The idea might be not realisable within the framework of our skills. We tried to minimize this risk by doing enough research before deciding on this project idea. Thereby, we found the website www.powtoon.com for the creation of the video and the website www.educaplay.com, where we could insert the quiz questions in the video. We had the challenge of downloading the final video because we could not do it within the free trial version, so we came up with the idea of recording the screen. Furthermore, because of this version, we could not properly add the voices and the music according to the action in the video, so we used another software (iMovie) to do this.
2. A second risk that we identified was to create an equal or really similar product made by another group, and this might represent a lack of uniqueness. However, we assessed the likelihood that another group would use the same case and would also combine the features of animating a video and integrating a quiz to be very low. And even in this case, the questions and the animation would probably be different. Moreover, the fact that every single student has to register on the platform of educaplay, might be a barrier to take part in the quiz. However, only a few data have to be filled in, so that the registration should not keep the students from participating in the quiz. During the project, it turned out that a participation without registration is still possible, however the teacher does not receive any feedback of the results of those participants.
3. Another risk is that the questions might provide incorrect content since we as “project manager” are students ourselves and have just learned the content a few weeks ago. But the

currently available slides of lecture 2 about stakeholders have helped us to provide only correct questions and to give the correct answer.

In addition to these risks that were already identified during the project planning, there are also a few **limitations** of the final product:

1. One question of the quiz is an open question so it is impossible for the student to answer it correctly (since you cannot name ALL of the stakeholders exactly as Educaplay expects that for the correct answer). But the focus lies on the learning: the students will see the correct answers and can evaluate themselves, how well they have answered.
2. Finally, one other limitation is the use of Educaplay with mobile phones because it has not any app so it may provide some difficulties not work correctly sometimes.

The final result of the project is mostly as we expected. The way of evaluating the result of our project was defined in the project plan with the following **success criteria**:

1. The quiz should be done by 80% of the attending students during the lecture and by 60% of the students who are registered for the exam before it. The number of attempts of each single student should at least be 2 (once during the lecture, and once before the exam).
2. The score of an individual student should increase within each attempt to show that the video quiz has helped him to improve his knowledge.
3. The quiz should be implemented into the lecture and for this, it has to be accepted by the lecturer.

This is not possible to evaluate at this point in time because the product is not yet implemented into the lecture.

The degree of our support to the statement “We evaluate our project management effort as successful” can be seen in the following table:

Scale	Strongly Disagree	Disagree	Neither agree nor disagree	Agree	Strongly Agree
Your response				X	

All in all, the project management can be seen as success.

3. Self-evaluation of the value to the learners: success or failure?

In order to get the most truthful feedback and use an appropriate evaluation method, we have decided on providing simple and brief questions to students attending the Project Management course. It should be noted that we did not use the classic tools such as Google or Kahoot questionnaires, but rather showed our project work directly to the respondents under our distant supervision. We provided the questions at the same time like in a classic interview.

In this way, we received immediate answers that, according to our opinion, reflect what the interviewees sincerely thought without any filter or uncertainty.

Our target were fellow students from the same course as they might better understand the purpose of our digital product and could give feedback contentwise. This is why we did not ask for further opinions from students coming from other courses because their subject may not fit with this type of learning tool.

We also provided our questions to both the teacher of the course and his assistant in order to try to get authoritative feedback from another main stakeholder group of our project.

The questions that we provided in our survey were:

- Do you think this facility is useful for students?
- Do you think this facility helps to explain the lecture?
- Would you use it/participate in your lectures?
- Is it understandable?

The choice of questions was not simple: finding indicators (the questions in this case) that could give an objective evaluation without influence of any environmental factor proved to be a difficult challenge. The general goal was to formulate questions without incompleteness, ambiguity and narrowness. We believe that we have succeeded in this task.

In particular, by asking the above mentioned second question, our intent was to try to understand if the interviewees perceived an addition of value to their condition, a simplification of their learning and teaching habits with the help of a digitalized and easily usable system, both for students and teachers.

We have received 24 feedbacks. We are aware that this is not enough and cannot be a complete indicator to have a significant overview of our work, but several factors have affected this. For example, having only one week available, the absence of many people in the classroom during the

penultimate lesson of the course and the rejection of some individuals to contribute to our evaluation for unknown reasons lead to this low number of answers.

The proportion of the participating students is around 14%, comparing the number of responses to the number of students enrolled in the course last year (under the assumption that the number of students attending is constant). This obviously cannot allow us to verify what the common thought of the class, which is an important stakeholder, relative to our work is. However, the responses provided by the interviewees, who all seemed satisfied with the product, were highly positive.

First of all, the responsible teaching assistant for this project, Kristin Hafsel, appreciated our product and made us satisfied regarding our work. She stated:

“I liked this product very much. From my (the teacher’s) point of view, I believe your video quiz could function well as a teaching aid. It is short and “to-the-point”, covering a specific topic (stakeholders), is engaging and interactive. From my perspective, it will be a useful tool to use at the end of the lecture (as the students can test themselves).”

The fact that an important stakeholder has fully understood our initial purpose and supports our product makes us satisfied but also eager to finally implement a project like this in the future; or we can suggest future students in the Project Management course to support an implementation of this idea that we have undertaken.

Going on with some relevant comments of the interviewees, Vittorio T. considers *“this tool useful for providing instant feedback both to the teacher, testing the students’ attention, and also for the latter as they can verify what they have learned during the lesson”*. Furthermore, he adds: *“I would use it as an additional material along with a textbook”*, being a proof of the fact that obviously this is a complementary learning aid in addition to further material. Then, Abilash A. states *“This idea is unique as it helps the student to pay more attention and allows him to grasp the main points of the lesson quickly”*, confirming our positive sensations about the product.

Among all the answers received, the testimony of Marta B. best reflects all the pros and cons of our work:

- 1) I think this facility is useful for students because it is interactive. It is also useful because it supports the student.*
- 2) I think it can be good for a few minutes. As this is different from the class, the students will show more interest.*

3) *If I was giving a lecture about this topic, it is really likely that I would use this.*

4) *I think the video is well done. The voice is understandable and not too fast. The pictures are nice. It is very important for me that the main information shows written on the screen. The only thing I found less understandable was how to answer the first question (about the stakeholders). I made a list separated by ',' with some stakeholders, but the hole answer was wrong. Apart from this, really intuitive to use.*

The degree of our support to the statement “Our product is of high quality and we recommend it to be used as learning aid in project management” can be seen in the following table:

Scale	Strongly Disagree	Disagree	Neither agree nor disagree	Agree	Strongly Agree
Your response				X	

We would like to recommend our product as a support element but not a substitute for the textbook, as the purpose of our tool is primarily to provide a practical and fast solution to classic learning methods. To summarize, the product successfully adds value to the learners.

4. Factors that have contributed to success

First, it must be considered that at this point of time, the project is not fully completed, since there was no implementation phase yet. However, the product itself is completely designed and ready for use. After reflexion, we have identified some factors that have contributed to the success of our project, but also a few problems.

In project management, there are different success clusters: project management success, process success and project success.

We can explain these three **success clusters** with the following definitions. The project management success measures the degree of satisfaction that the project has managed to achieve. The process success is about how certain stakeholders such as participants, line-managers, end-users and suppliers, has perceived or experienced project implementation phase. Lastly, the

project success measures the project ability to achieve the intended goal, and the ability to create an impact on business. (Hussein, 2018, pp. 92)

Project Management Success

Firstly, the time management of the project was a success. We have respected the planning and even finished one week before the deadline, that permitted us to clarify a few details. So we were good on the estimation of the time that we needed for executing our project.

Another factor was the clarity of project purpose and objectives. Before starting Ruben's case video, we had clearly identified the purpose of our video and the objectives of it. We all agreed on the following points that the video must fulfill:

- Very clear illustrated animation of the Ruben case
- The Ruben case should then be perfectly understandable
- The student should then be able to answer the questions about the Ruben case
- The video should be of high quality in order to facilitate the lecture about stakeholders next semester/year
- Exploiting the digital tools available

Process Success

We had a cooperative and collaborative team, that permitted us to produce a good work during harmonious team meetings. We never had any arguments about taking decisions for the project. Everyone's ideas were highly appreciated and were further elaborated in objective discussions. Everyone was highly involved and committed in the project. We were glad to work together and benefited from this group work with members of four different countries. It helped us to get inputs and ideas from different points of view.

Project Success

Thanks to the different factors mentioned in the paragraphs about project management success and process success, we have achieved the goal of our digitalization project: animating the Ruben case to facilitate the teaching and understandability of the lecture about stakeholders. However, we will not know whether this product will finally be implemented and thereby impact future teaching methods.

On the other hand, we identified two different categories that could contribute to **problems**. These are: final evaluation by the end-users as well as technology knowledge and tools, which are part of the success factors by Pinto and Slevin's literature. (Hussein, 2018, pp. 92)

Concerning the first one, we only tested our project by ourselves, by other classmates and by one teaching assistant. So evaluation is covered only by a small and homogenous sample. Since the product is not yet implemented, we cannot determine if we have entirely achieved project success. The evaluation needs to be continued, in case this product will be applied next semester, in order to observe the long-term success.

The second factor that could contribute to potential problems is about the technology knowledge and tools used. At first, as already mentioned, we had limited technological abilities. We met some difficulties also because we were restricted to the demo version of our digital tool Powtoon, that only allowed us a 3 minutes video, 20 seconds per slide, and not all the possibilities to design the slides were included. However, we still managed to finish the product properly. We also had troubles with adding the voice according to the text and action in the video. We tried to record by ourselves but it was not well audible, so it took us a long time to find an appropriate and understandable voice.

About the problem for the downloading, a solution with screen recording was found. Another problem, which could not have been fixed, is the adaptability of our video on mobile phones. It is possible to use it on the phone but however with some problems (for example, the questions could appear not at the right time). Finally, the teacher can get the report about student's answers only if the student has logged in. Otherwise, a group in Educaplay can also be created to facilitate the access and to collect comments, discussion and results.

To sum up, we can say that most of the problems were fixed. The most important cluster was the project management success. The teamwork was efficient and productive and could profit from the adequate project planning and realistic estimates.

Comparing to Pinto and Slevin's success factors, we are also coherent for instance with the clarity of project purpose and objectives. However, the technologies, on which the project was based, the evaluation and approval by the end-users are part of our factors that have triggered us some problems.

5. Most important lessons from the project

During the project, we have gained first experience regarding project management.

In our group, no one had any technological skills applicable in a digitalization project. So, we thought about what we could do with our previous knowledge and capabilities. Indeed, we tried to remember some similar projects or tools that we have used before in order to get some ideas. Since no one of us had done anything like this before, we decided to reread the slides and the book in addition to follow the lectures of the course for knowing some tools that we could use in the project. We can recommend this because it was very useful: it is always better to study the content of the lecture before applying it to a case.

First of all, we wanted to create something with value for teaching and at the same time helpful for the students. In fact, with our product they can better understand the lesson that they have already attended and they can find out how much they acquired and what they should review.

We focused on the second lecture about the stakeholders, in particular on the Ruben case. In our product we tried to merge all the types of learning: visual, listen, reading, logic... However, a quick poll within the course has revealed that the visual and logic learning methods are the mostly used ways to acquire knowledge on which we have focused in our project. Precisely for this, our product is divided into two parts: the first one is the video about the Ruben case (visual); the second part is related to the logic part that is about questions and answers suited to the video, in order to make it more understandable.

This division has brought us to try to find one “expert” per each work task: one was focused on Powtoon and another one on Educaplay in order to comprehend how the respective tools work. Indeed, before starting to do something, in our opinion, it is better to know if you are really able to do it. Therefore, after understanding how the websites works, we had to figure out if it would be feasible and we did some tests to verify it. Our advice is to do a test of the product before finally deciding on it in order to minimize the risks and wasted time on something that you are not able to realise. It is better that the final work is simple and well done rather than badly made because it is too complicated for your skills: from this we learned to do not exceed our limits.

Another thing that we learned from this project work was to think about possible risks and problems that might occur in advance and try to avoid them or to limit the risks before deciding on the final product and starting to create it. We found this problem at the end of the first part, when we finished the video on Powtoon and had to download it to use it for the second part: we had to pay (and we

had no budget). The tests we had done in advance were to verify our ability to create the video, but obviously we had not considered all the risks. For this and the other difficulties that we have encountered, our experience highly suggests regular group meetings. They are really useful because there are many ideas to rely on and so, it is easier to find a solution. For the example of the download problem, we decided to record the video from our computer's screen: it was not a huge challenge, but being in a group helps you to solve many kinds of problems.

6. References

Caimi, G., Lancry, O. (2018). How can we build a workforce for our digital future?, World Economic Forum, Available at:
<https://www.weforum.org/agenda/2018/09/what-employees-today-future-really-want-personalization/> (Accessed: 11/13/2019)

Educaplay, Available at: <https://www.educaplay.com> (Accessed: 11/05/2019)

Hussein, B. (2018). The Road to Success: Narratives and Insights from Real-Life Projects, Fagbokforlaget.

Mohamad, S. N. M. (n.d). Powtoon. Available at:
https://mahfuzah.weebly.com/uploads/1/1/7/5/117591906/powtoon__1_.pdf (Accessed: 10/17/2019)

Parviainen, P., Kääriäinen, J., Tihinen, M., Teppola, S. (2017). Tackling the digitalization challenge: how to benefit from digitalization in practice. International Journal of Information Systems and Project Management, 5, 63-77.

Powtoon, Available at: <https://www.powtoon.com> (Accessed: 11/02/2019)

The peer-review evaluation report

Name of the group we are assigned to evaluate: Group 24

Based on our evaluation, we identified the **strengths** and the **weaknesses** of the final project of the group 24. The digital project is a revision tool for the students to supplement the course. More precisely, it provides support to review the content of the lectures with key contents, it gives important definitions and it allows students to have access to quizzes to test themselves before the exam.

We found interesting the fact that the group has asked students about their learning habits before building up the tool. They identified the needs through a practical way to better satisfy the final users, and that is a good point to start a project. Indeed, it gives more credibility and facilitates success of the final digital product. It is even more interesting to see that this project was built on previous digitalization projects: they took different learning tools to make it one. We could finally say that the starting point of the digital project is a **strength**: we believe that the project might provide a real value to the learner because it apparently responds to student's needs.

By going further into the digital tool, we identified some **other strengths**. Separated by chapter/lectures, we can see the main elements highlighted to master a specific lesson. In fact, by using "course materials", it provides an overview of the most important things to know about the chosen lesson. In this way, we could imagine that this kind of tool reassures students. It makes sure that all students registered in the course get all the elements provided by the teacher, and it is especially useful when a student could not attend a specific lesson (due to sickness or personal reason for example). We regard the "key content" section as really useful that synthesis the objectives and the main elements that students should know and understand about the lesson and more precisely, they clearly identify what the teacher expects from them. It is a good tool to be updated with the lecture, to be sure that everyone get the same chance to succeed for the exam.

Moreover, this tool is a good way to challenge student's knowledge. With the "quiz" section, users can challenge themselves on specific subjects mastered or not by the student and be finally prepared for the final exam. There is a really good training in this section with different exercises and even a case study. This training section is a perfect way to have a good command on the subject if students are rigorous and use all elements that the product delivers.

We think that changing the way to learn and review lectures could be motivating for users. Students get access to a different learning tool and they will be more likely to go deeper into a subject or simply be well prepared when the tool provides them a new appreciable experience of learning.

In the meantime, we found some **weaknesses** that can negatively impact this new experience of learning. The main element that we identified is the use on mobile phones that is not comfortable. If we compare it with the use on computer, it is quite different and less qualitative. Some visual elements are missing. For example, the titles for the different section disappeared and only the description of each section is presented, which makes the comprehension more difficult. It does not catch the eyes. In this way, the visual interface could be better. Speaking about visual elements, we think that adding more colours or simply highlighting important key words, bold titles or words could be useful, especially in the “course materials” section. Moreover, having the possibility to add personal notes could be a significant added value for the product.

We could question if it is a fully functional product because it delivers only one completed lecture so far, even if we noticed 4 others lectures but they are not yet accessible. Therefore, what is the capacity of the product? Is there only space for 5 lectures maximum or will the student have access to all of the lectures?

Finally, we can say that the product provides a great helping tool for students with a lot of advantages. The negative elements correspond to the visual presentation interface that could be improved with more quality.

The degree of our support to the statement “The product we reviewed is of high quality and we recommend it to be used as learning aid in project management” can be seen in the following table:

Scale	Strongly Disagree	Disagree	Neither agree nor disagree	Agree	Strongly Agree
Your response				X	

This product is a really solid but not completed product, which is useful, has a friendly interface for users (on computer), full of the main key words and sentences which allow to refresh the course’s content in an easy and not superficial way. The purpose of the digital product led by group 24 is clear. We would recommend to work on improving the product aspect: visually attractive, user-friendly on phone. According to our evaluation, the grade we would recommend for this digital project is a **7/10**.

Attachment

Project plan (as submitted on 10/05/2019)

1 – Type of product you will be producing:

We will produce a video quiz, in which we will combine an animation of the Ruben case with a learning control for students in the form of a quiz. Questions will appear during the video at the respectively fitting position in the video (the video will stop for the question).

To be used in the lecture, the teacher has to send the invitation to all the students, who are registered for the course, via email by selecting the 'invite' button (unfortunately, before participating, every student has to register on the website www.educaplay.com). The students have to click on the link in the email for joining the group. Then, they can see the video and can reply to the questions on their own. Finally, the teacher can see the results of every single participant and also the average result of the total group (further information on this in the 'success criteria' part).

The digitalization project step by step :

Step 1:

The teacher has to register in educaplay to create a profile.

Step 2:

The teacher has to create a group and decides all the specifications related to this group.

Name: e.g. Project manager

Private or public group: private group with all the students attending Project Management courses.

Description of the group: explain the goal of the group

Who can comments the videos: everyone, nobody or only the administrator

Step 3:

The teacher has to send an email to all the students to give them the access to the group - send them an invitation by email to join the group. It's very important that the teacher is inviting the students first because otherwise they will all have to request the access to him, then it could get very messy because the teacher has to accept all the request one by one.

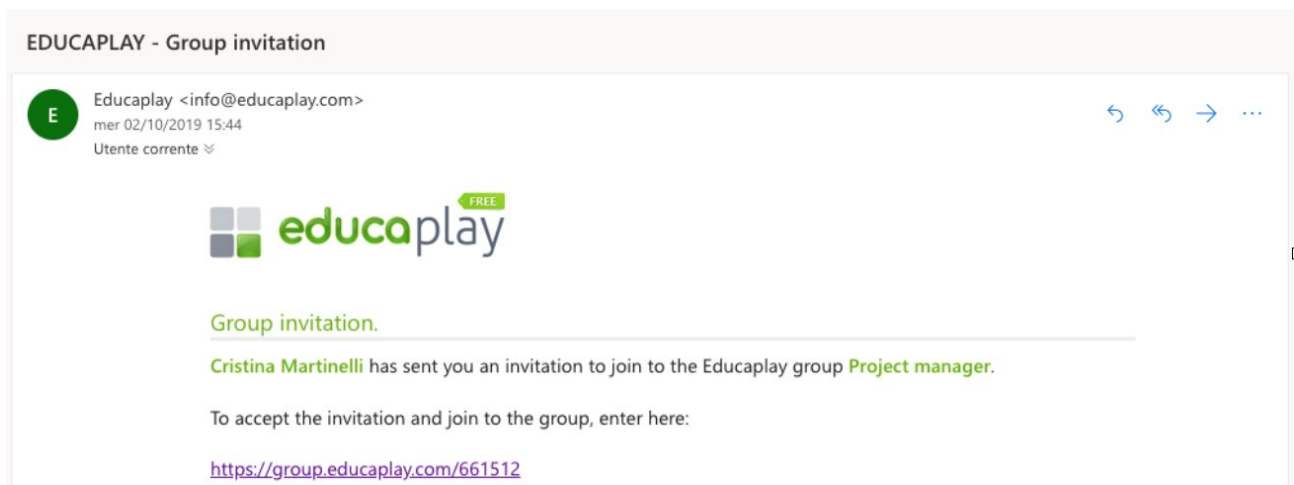

Figure 1: Email invitation received by the teacher to join the group.

Step 4:

All the students have to register - create their own profile to have access to the “Project manager” group and accept the teacher’s invitation.

Step 5:

The students have to click on “My groups” and choose “Project manager”. Then they have two options to have access to the teacher’s quiz : either they click on the link that the teacher posted in the chat; or they go in “Members”, click on the name of the teacher, and click on the quiz (“Ruben Case Quiz”). If the chat is too crowded, they can still see only the teacher’s chats and see the link.

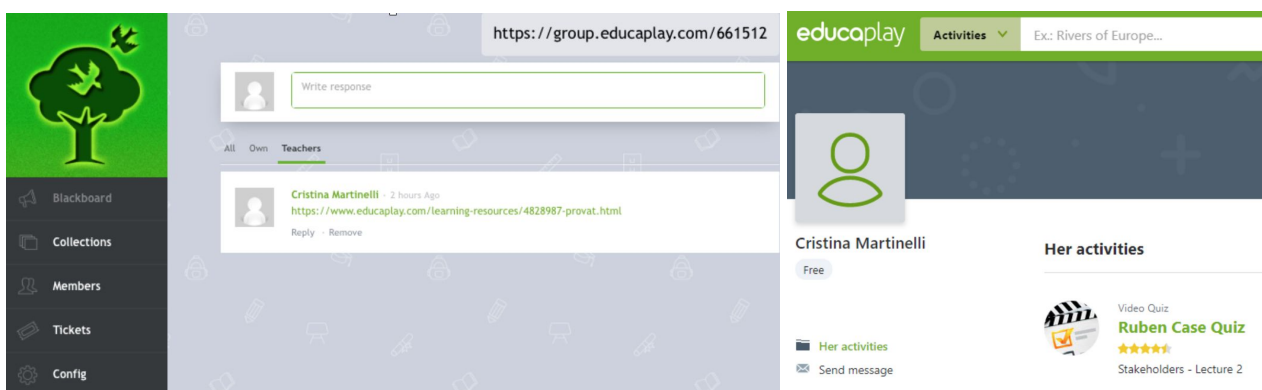

Figure 2: Two option to have access to the quiz

Step 6:

The students can do the video quiz.

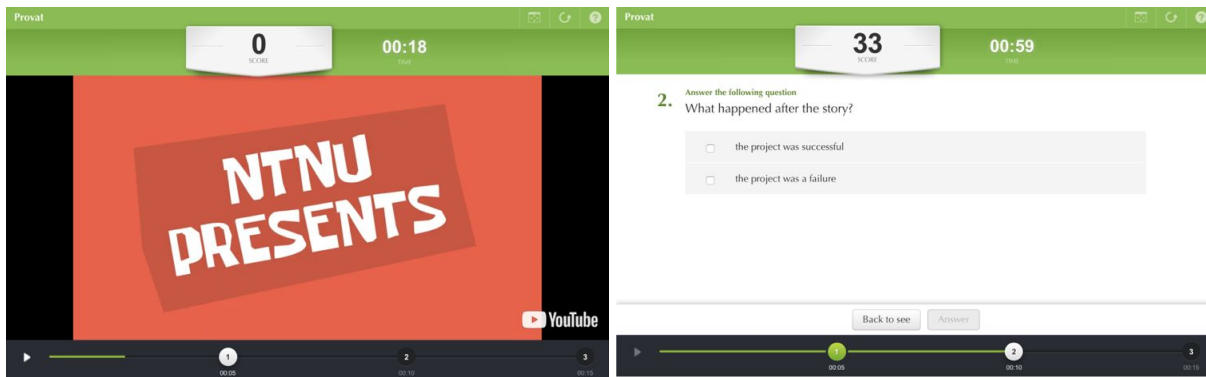

Figure 3: Presentation of the quiz structure.

Step 7:

The teacher can have access to the results (average time of, total players, average score, date and so on).

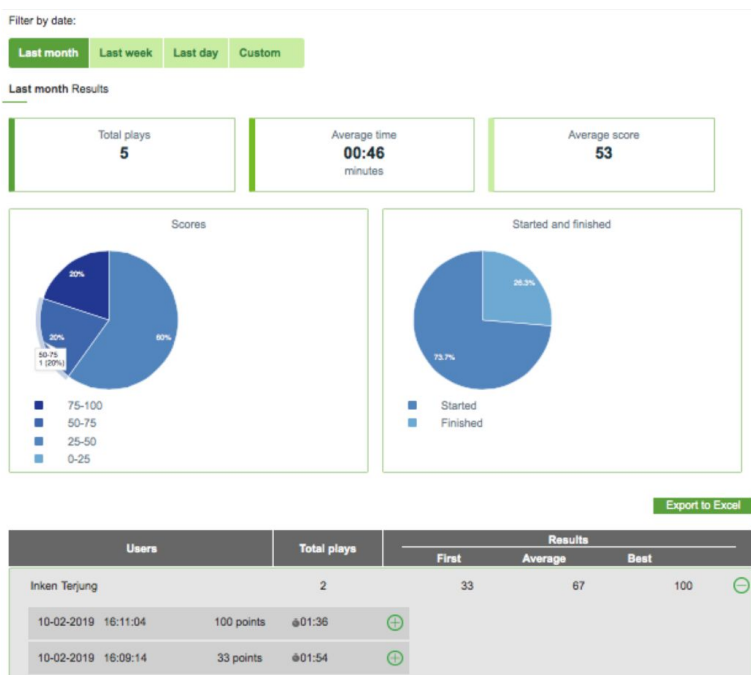

Figure 4: Representation of the results after each students answered the quiz.

2 – The expected benefits of the product (the learning outcome):

The students of the course Applied Project Management will profit from the video, since the case of Ruben will be reproduced and summarized in the video, so that the student does not have to read through all the slides and at the same time, the student can get feedback about his level of learning and understanding of the course content.

Since the six members of this group are predominantly visual learners (and the Kahoot that another group within the course 2019/20 carried out showed the same tendency for the whole course), the video provides a helpful learning aid.

Plus, the lecturer can see whether the students have understood the content of the lecture about Stakeholder and are able to apply the newly gained knowledge.

3 – Potential stakeholders and your plan to involve these stakeholders during project development:

Students attending Project management courses.

The lecturer who will present Ruben's case in the course "Applied Project Management".

Department of Mechanical and Industrial Engineering which could be interested in feedbacks about the quality and progress of the course.

4 – A project risk assessment plan, indicating the main risks and how are you going to address these risks:

One risk is that this idea is not realisable within the framework of our skills. We tried to minimize this risk by doing enough research before deciding on this project idea. Thereby, we have found the website www.powtoon.com for the creation of the video and the website www.educaplay.com, where we can insert the quiz questions in the video.

A second risk could be the creation of an equal or really similar product by other groups, and this could represent a lack of uniqueness. However, the likelihood is very low that another group will use the same case and also combines the features of animating a video and integrating a quiz. And even in this case, the questions and the animation will be different.

Moreover, the fact that every single student has to register on the platform of educaplay might be a barrier to take part in the quiz. However, only a few data have to be filled in, so that the registration should not keep the students from participating in the quiz.

Another risk is that the questions might provide incorrect content since we as “project manager” are students ourselves and have just learned the content a few weeks ago. But the currently available slides of lecture 2 about stakeholders will help us to provide only correct questions and to give the correct answer.

5 – What skills do you need to acquire in order to produce your project? How you will acquire these skills?

First of all, we need video maker and photo editing capacities to create the planned final product. These abilities are already owned by some members of the group, so we believe we will not face many difficulties during its development. In any case, we will learn and improve the above mentioned abilities by ourselves and collaborate within the group. Moreover, the realization of this type of product also requires creativity and understanding the students’ needs in order to create a friendly platform for students and for teacher as well. Since the time framework is quite narrow, we will need good skills in time management in order to finalize the product until the 12th of November. Here, the project schedule will help us to keep track about which task has to be fulfilled until which date so that we finish the project in time.

6 – Project breakdown structure indicating the major deliverables, sub-deliverables and work packages:

Finding a suitable video animation tool (done)

Preparation of creating the video animation

Acquiring video animation skills

Collecting idea about how to animate the case

Creating/animate the video of the Ruben case

Finding the right questions (and also figuring out the correct answer)

Loading up the animated video on educaplay.com and integrating the questions

Doing the organizational part (creating the group on educaplay.com, inviting all the students and telling them to register)

7 – Project schedule. Produce a time-estimate of each task (build and produce) in the project:

- 17.09-26.09. Individual reflexion about a project idea
- 27.09. Collection of the group members' ideas - "brainstorming" process
- 02.10. Deciding on a Project Idea and writing the base of the project plan
- 02.10. Creating a test video quiz
- 04.10. Finalization of the Project Plan
- 05.10. Upload the Project Plan
- 05.10.-30.10. Animation of the Ruben case (including several group meetings)
- 31.10.-05.11. Uploading the video in educaplay.com and implementing the quiz questions
- 12.11. Presentation of the final product

8 – A list of the most important success factors that you should adhere to in order to succeed in the project:

Number of students who use the video quiz (not only during the lecture but also before the exam):
during the lecture 80% of the attending students

before the exam: 60% of the students who are registered for the exam

The number of attempts of each single student should at least be 2 (once during the lecture, and once before the exam).

The score of an individual student should increase within each attempt to show that the video quiz has helped him to improve his knowledge.

The quiz should be implemented into the lecture and for this, it has to be accepted by the lecturer.

(see Figure 4: Representation of the results after each students answered the quiz)

9 – Your project can be classified as Digitalization project. Reflect on the characteristics of this type of projects (use the literature):

The literature about digitalization suggests 3 main features of digitalization projects (Berha Presentation - Digitalization Projects) :

1. Improvement of the product/process: our digital project can improve the content of the lesson by helping to better understand the subject of the course. Moreover, it gives feedback about the level of learning and also about the ability of applying the gained knowledge (to the student and also to the lecturer) → see expected benefits of the project
2. Automation of the processes: So far, the case of Ruben was just presented by a text and some figures on the lecture slides. By the video, this will be automatized and processes easily managed and controlled.
3. Simplification of communication: Communication is made possible by the overview of results which the 'teacher' of the video quiz can see. He gets feedback of the comprehension of the students and can react by giving more explanations in case the answers are predominantly false.

TPK5100
Digitalization Project - Report
An interactive webpage to aid self-testing and review:
The Highway to Success

November 2019



Kunnskap for en bedre verden

Norges teknisk-naturvitenskapelige universitet

Preface

The purpose of this report is to show an outline of the product group 27 has produced for the project assignment in TPK5100 and how it contributes to digitization and learning. The report also shows what the group considered the sites' main function for its users, as well as what the group considered a success/failure and what was learned about project management. Link to the website: praktisk.azurewebsites.net
We would like to thank everyone who gave us feedback on our new interactive learning website. A special thank you to Bassam Hussein for great feedback and help during the project.

Group number: 27

Student names and numbers:

1. Jørgen Anker Olsen - 999375
2. Simen Theie Havenstrøm - 501793
3. Fredrik Hoel Bevreng - 501787
4. Ole Martin Brokstad - 501789
5. Wilhelm André Mangersnes - 758252
6. Casper Nilsen - 501786

1 Digitalization Projects

The project presented in this report is a digitalization project. Essentially, it is a restructuring project where software is developed and implemented to improve the way students learn about the course Applied Project Management. In this segment, challenges experienced by the group with this type of project is presented and discussed, in relation to project management literature.

The group experienced several challenges in the project. The main challenges related to digitalization projects are presented below:

- Handle expectations from different stakeholders, especially the end users of the interactive learning website.
- Define achievable specifications for the learning website.

The first bullet point describes a challenge related to expectations from stakeholders. An important factor contributing to the success of the project is to satisfy the expectations of the end users. As time was limited, a thorough stakeholder analysis was deprioritized, and the group had to make several assumptions on the expectations from

the end users. Several assumptions were made based on expectations of the group itself, as the group members are potential users of the product themselves, as students taking project management course. However, the entire group are students with thorough technological experience. It is not a given that all the other students learning about project management understand the website user interface as well as the group members do.

This challenge was also experienced in the restructuring project called "Staff reduction after introduction of speech recognition tool" [1]. This project failed because the end user of the speech recognition tool did not having the adequate knowledge to use the tool properly. This shows the importance of understanding the end users expectations when developing a digital tool.

The second bullet point describes a challenge related to defining achievable specifications for the learning website. Some features discussed had high uncertainty regarding the time needed for implementation. As an example, features like speech recognition and narrated questions were discussed, but was more difficult to implement than expected. Due to limited time these features were discarded.

Challenges like these are common in digitalization projects as new digital solutions are affected by high level of uncertainty. An example is the project "Common system for case processing". In this project they have challenges related to defining the project and clear achievable specifications.

It is difficult to completely remove challenges related to high levels of uncertainty in a digitalization project, as most digitalization projects includes developing new technological solutions. A strategy to deal with this uncertainty could be, in the planning phase, to review similar solutions done previously in order to get an understanding of whether the tasks are achievable within the time limit.

2 Self-evaluation of the project management effort in the project, success or failure?

According to the expected learning outcome from the project plan [2] we wanted to produce a website application to help each student increase their learning outcome from the lectures in Applied Project Management. This is achieved by repeating some of the taught knowledge using an interactive game experience, thereby tackling the problem of learning from a different angle.

To accomplish this we developed a multiple-choice quizzing website. At this website students and others interested in project management can take interactive quizzes and read summaries from the book *The Road to Success* [1].

The website was launched [3] with all the critical functions we deemed necessary. The front page, as seen in Figure 1, gives a short introduction to what you can expect to get

out of using the website. As of launch on 23.10.19, that is questions from each chapter as well as a short description of the expected learning outcome.

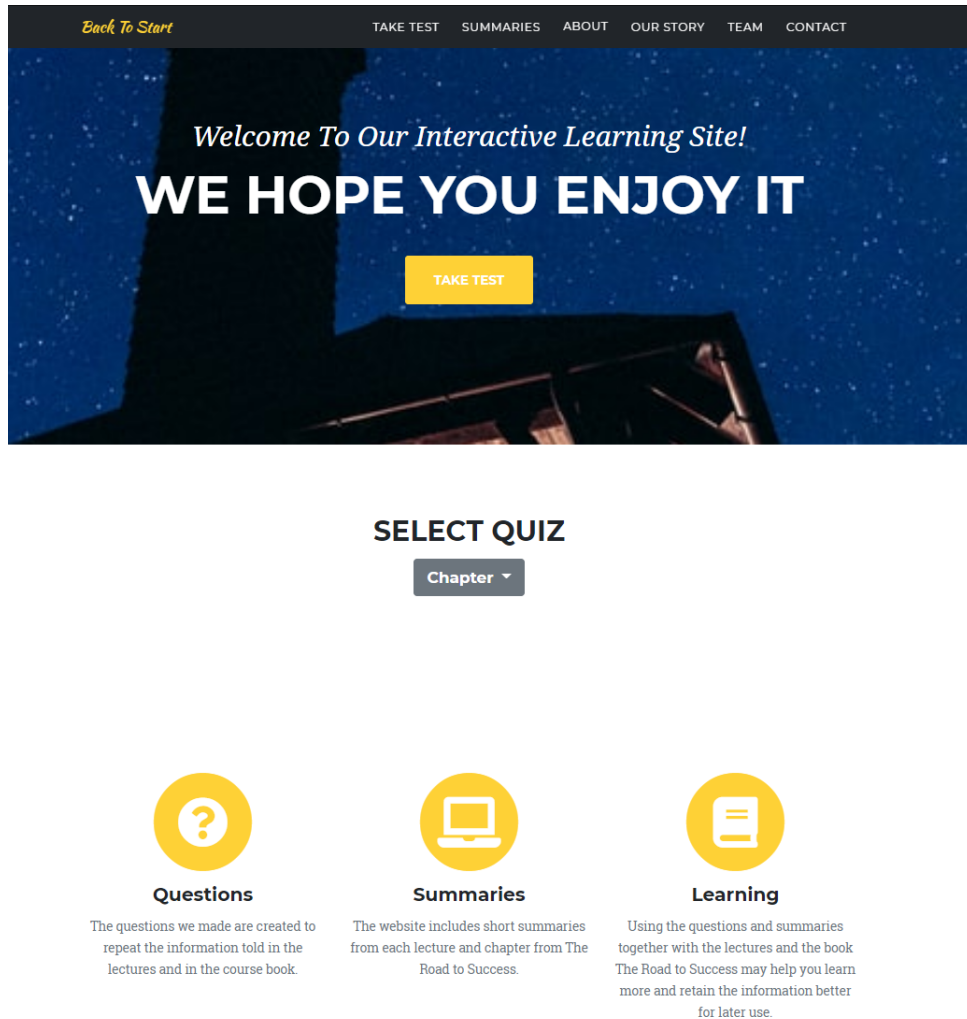

Figure 1: The front page gives a short introduction to what the student can expect from the web application, as well as letting the student choose which chapter to be quizzed on.

Every chapter has 3-4 questions each with 4 alternatives where only one of them is correct. The student is also presented with two aids; "50/50" reduces the number of alternatives to 2 while "Ask an expert" presents a hint for the question. A typical question can be seen in Figure 2 along with the result page of the same question.

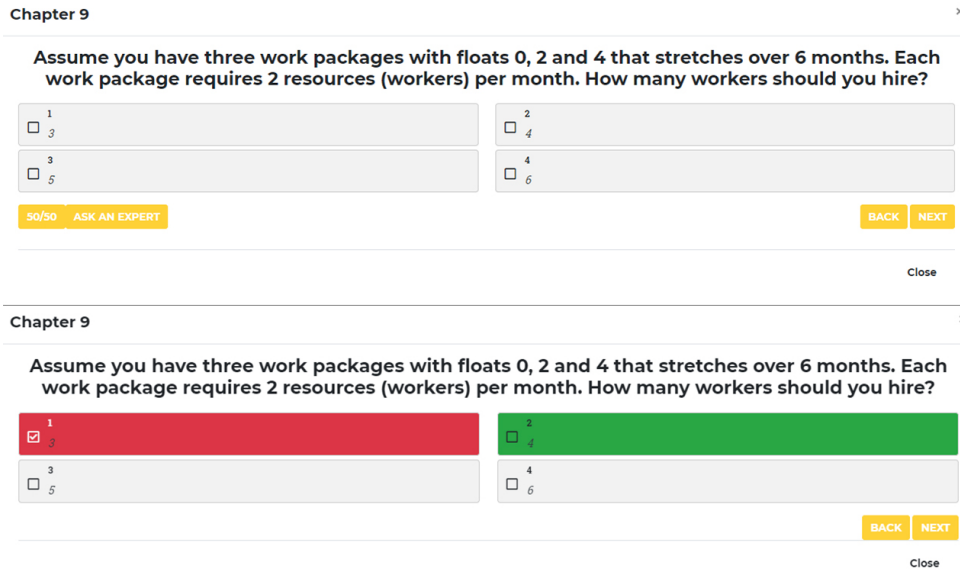

Figure 2: There are 3-4 questions from each chapter with 4 alternatives. The student can choose from two aids: "50/50" or "Ask an expert". At the end of the quiz the student can view the results.

There were some minor success criteria that were included in the work breakdown schedule (WBS), such as "Narrated Questions" and "Speech Recognition Software" that were not completed. At one point during the project we did a new evaluation of the project scope and realized that more work than necessary was needed to complete these work packages. This was tied to risk number 4 in the risk management plan and we acted accordingly. A decision was made to exclude these success criteria as we deemed them as not important. In hindsight these work packages could have been omitted from the project plan or clarified as extra work.

The project group is quite satisfied with both the outcome and the process. Other risk owners did not need to take any actions and the rest of the work packages were completed within the allotted time frame.

We evaluate our project as successful					
Scale	Strongly disagree	Dissagree	Neither agree nor disagree	Agree	Strongly agree
Your response					X

3 Self-evaluation of the value to the learners and documentation

The following section will disclose the group’s assessment of the project and its value created to the learners.

Based on the feedback gathered we evaluate the experience and learning to our target audience to be of eminent value. From the various responses of the participants we conclude that the overall product fulfills its purpose as stated in the project guidelines for the course.

3.1 Evaluation method

The different evaluation methods used to determine the product value to the learners (students) were:

- **Contact form:** The website implemented a working contact form that provided users the opportunity to send feedback directly. The form enabled the user to leave their names, email, phone number and their feedback message. The message is delivered to *praktisktest@hotmail.com* and the user receives a confirmation email stating that the message has been sent. An example of a feedback from the contact form is shown in the figure below.

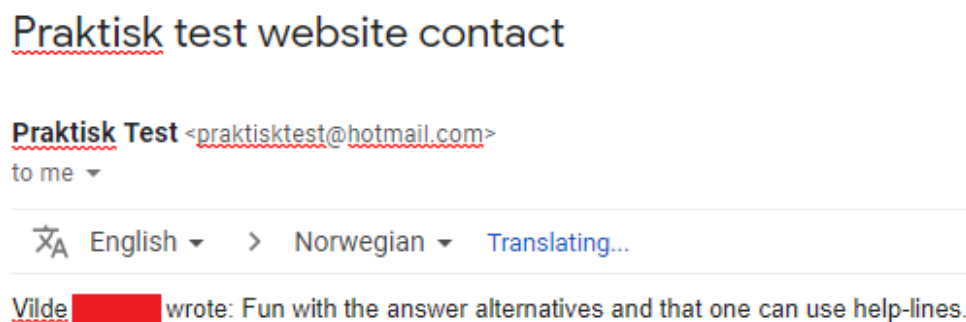

Figure 3: Example of feedback from the contact form.

- **Direct feedback:** Another source of data on the value created was gathered by surveying students in our class as well as students who took the class last year.

These informants were selected with emphasis on individuals that have taken the course in earlier years as their feedback naturally holds more weight because they have a clearer overall picture on how they would want to improve the course if given the chance, and which tools could help benefit their learning experience. Intuitively, their opinions are of higher importance, especially in terms of professional and subject directed feedback.

9	25.10.2019	N/A	I think this is a very good idea, would love to have something similar within what I have studied earlier		
10	28.10.2019	N/A	I think the idea is good and the website is simple and clear.	I would have used this if the questions were exam relevant.	"Take Test" and "Select Quiz" buttons can be merged.
11	29.10.19	N/A	Creative idea and looks like a helpful tool.		Perhaps add an alarm reminder to take the quiz after class?

Figure 4: Example of direct feedback.

While former students provide an invaluable resource in terms of feedback, we also sought out people who were not connect to academia in order to assess our work from different perspectives. This proved to be very useful as we received feedback that addressed minor issues and improvements that we hadn't thought of or which didn't seem clear to us previously. There were also direct issues being addressed, for example that the 50/50 powerup was usable infinite times. For future work, we agree that we could flesh out more of the functions and concentrate on smaller enhancements that would improve the overall experience of the site like merging the "Take test" and "Select Quiz" buttons as one, like one interviewee pointed out.

We believe the finished product, the interactive learning website: The Highway to Success, has a significant impact on learning as it enables the future students taking the course to test their knowledge in short succession of the lectures on the subject held in class. By doing this, the students are reinforcing what has been just taught in an interactive and fun manner engages them personally. Repeating key points of the lectured material within minutes or hours the same day will have a tremendous impact on the student's performance on learning and remembering the curriculum. Additionally it creates value for learners by giving them a way to read summaries and providing acquiring knowledge from the book in a shortened and concise form.

Our product is of high quality and we recommend it to be used as learning aid in project management					
Scale	Strongly disagree	Dissagree	Neither agree nor disagree	Agree	Strongly agree
Your response				X	

4 Factors that have contributed to failure / success

In this section the factors that contributed to success are evaluated. The success factors are divided into project management, process and project success factors. Although, the factors are somewhat coupled as, for example, management success greatly contributed to the project success.

A credible evaluation of whether the project is a success requires a lot of data on the achievement of the success criteria like user satisfaction, which is more accessible after releasing the product. However, a sample of user feedback on the website where gathered, as explained in Chapter 3. The feedback was positive which strengthens the assumption of project success.

4.1 Project Management Success

Success factors for project management success:

- Distribution of roles and responsibilities in the initiation phase
- Trello, a digital platform for assigning and following up tasks and work packages
- Risk assessment
- Early planning

One of the most significant success factors was the use of Trello. Trello made assigning tasks and following up progress easy after the weekly meetings. There is no excuse of not completing the tasks assigned as expected if it is written on a common website used by the team. The use of the digital collaboration platform further established clear roles and responsibilities which was one of the other important success factors. Clear roles and responsibilities is also listed in the book "The Road to Success" as an important success factor in the cases presented in the book [1]. A huge advantage of achieving this success factor is the reduced need of follow up by the project leader as well as creating a sense of ownership for the individual. This again makes working individually and flexibly easier, which is positive when team members have other ongoing projects.

Another success factor contributing to project management success, was the early start of the planning phase. Just after project assignment was posted, the group was formed and discussion on project outcome and product started. Once product and outcome was determined, roles and main responsibilities were distributed and team members could start working individually in and together in smaller groups early in the project lifespan. One of the activities performed in the initiation of the project was a risk assessment, which is another of the success factors experienced in this project. In this assessment "last ditch effort" were mentioned as a serious risk. The early planning and working with the projects was done as a measure to prevent this risk. As a result, the risk assessment together with

the measure of early planning is one of the important success factors contributing to the project success.

4.2 Process success

Success factors for process success:

- Project meeting each week
- Inclusive project manager
- Stakeholder involvement
- Continuity of project development
- Loyalty to decisions

When the process began we implemented weekly meetings so our project manager could do a check up on the individual work. At these meetings we created smaller work packages that everyone needed to complete until the next meeting. This contributed to a quick development of the web application.

The project manager also made sure to include himself in the tasks and worked closely with the technical team. This was a huge contribution to the success because the project manager could always see the progress of half of the team making him able to put pressure where needed.

An important lesson learned from the early chapters of Hussein's book is the involvement of stakeholders. We identified multiple stakeholders such as our professor, students taking the course and earlier students. We made sure to test our application on these stakeholders and used their feedback to improve and tweak the website so it could meet the specified requirements for this assignment.

A success factor that we did not maintain was loyalty to all our decisions. As mentioned earlier we cut out some of the work packages created in the planning phase due to a better understanding of the scope. This did create some confusion and reduced ownership for the members associated with these work packages, but with risk management we were able to reduce this impact by finding new tasks.

4.3 Project success

Success factors for project success:

- Sufficient resources
- Sufficient competency

- Communication with project owner

The availability of sufficient competency for web development was another important success factor. It was a key factor contributing to the completion of the product, and therefore a key factor to the project success. It would be difficult to achieve project success if the product was not completed in time since the project had a strict deadline. This success factor is similar to one listed in the book "The Road to Success" as an important success factor [1]. In the book expertly skilled project group is listed as a success factor experienced in one of the cases presented in the book.

Since we had decided to create a web based application it was very important that we had the correct competency in the group. Before we decided on what to create we took note of what background competence the group had. When we figured out that multiple people had previous experience with creating web pages we quickly began to steer the project in that direction.

As this project is part of an assignment we realized that it was extremely important to have a good communication with our professor, which is also the project owner. He set the expectations and criteria for the project and we had to make sure that we did not misinterpret anything. Even though we had a good communication throughout the process we managed to neglect the details for our report and had to rewrite a lot of parts when the report requirements were later shared.

5 Lessons learned

Since the group was comprised of students in the last year of their respective study programs, all the team members had decent experience with project and team work from earlier courses. Still, using the literature and material from TPK5100, one becomes more aware of the dynamics and factors that impacts a project. In this project, the most important lessons learned was:

- **Resource Planning:** In the early planning stages of the project, it was decided to split the group into two groups: a development team and a content creation team. There was several reasons for this choice, but most importantly it was done because the scope of the technological challenge in this project did not require 6 developers. In addition, some team members was more experienced with website development. This allowed the groups to become more specialized and have them utilize their skill set to greater effect. We recommend to identify your group members strengths and weaknesses, and use this knowledge before landing on a project idea and during execution.
- **Utilizing different project models:** During the project, the teams worked under a combination of a plan-driven and an adaptive model. The project plan illustrates the plan-driven approach, where clear milestones and deadlines are specified. The

adaptive model was implemented and updated weekly, granting the project team the needed flexibility during development. To facilitate this approach, we used a Kanban board which lists the issues that is currently being worked on - as well as future and completed tasks - and assigns these issues to a specific programmer. GitHub was used for source control and as the collaboration workspace. Furthermore, we used the typical workflow with branching and code reviews before new features got implemented, providing quality assurance and follow-up between the team members. If you decide to develop an app or need some kind of programming collaboration, we recommend looking into these tools.

- **The importance of involving stakeholders:** Because this project had clearly defined stakeholders, such as the project owner and the end-users, the importance of involving these parties was evident through the whole project life-cycle. In the initiation phase, we discussed different ideas internally, before landing on a concept we deemed to have a reasonable scope and complexity. Then this idea was discussed with the project owner, and with his feedback the idea matured and yielded both a purpose and a rationale. During the execution and control phase, including software development, we maintained the dialog with the project owner, keeping him informed of the progress and eventual deviations from the project plan. If the group was unsure, or disagreed internally, we discussed the problem with the project owner and resolved the issue. The end-users were more involved during the latter stages of the project, when the website was more finished and could be tested. Their feedback was valuable when determining if the product created value or if there were problems with the application that we had missed. Our experience suggest that the group should be conscious of when and how to involve the stakeholders.
- **The utility of project management tools:** Actively using the WBS to facilitate communication during meetings was of great use. When we realized that we had to reduce the scope, we used the WBS to quickly determine which work packages that was non-critical. This strategy was also in accordance with the deviation control assessed in the risk management plan. Our suggestion is to actively use these tools during the project.

References

- [1] B. Hussein, *The Road to Success*. Fagbokforlaget, 2018.
- [2] F. H. Bevreng, S. Theie, J. A. Olsen, W. A. Mangersnes, C. Nilsen, and O. M. Brokstad, "Tpk5100 - project plan," 2019.
- [3] F. H. Bevreng, S. Theie, J. A. Olsen, W. A. Mangersnes, C. Nilsen, and O. M. Brokstad, "Highway to success." <http://praktisk.azurewebsites.net>, 2019.

Appendices

A Direct Feedback

No.	Date	Hidden		COMMENTS			
		Full Name	User Experience	Learning Value	Improvements	Issues	Other Comments
1	11.10.19	N/A	I liked the look of the website, the quiz boxes were a bit small. But overall it looks very	I think the website could be useful if it was worked on a bit more, if the questions were exam related I could see myself practicing on it.	I don't know which questions I got wrong or right.	The 50/50 powerup was bugged. I could use it many times.	I liked the website layout but there's some bugs and there is some places without any text.
2	15.10.2019	N/A					I would have used the website. It was clear and easy to navigate and worked well
3	16.10.2019	N/A					Yeah, it worked really well that
4	16.10.2019	N/A	It was interactive and easy to		The font for the chapter names could be larger	Sometimes the scaling of the different objects were suboptimal.	
5	19.10.2019	N/A	Good overview, easy to understand everything				
6	20.10.2019	N/A	You have made a really user-friendly website. I would have	There's lacking summaries in some of the chapters.	Is it understood that summaries is related to the book used for the course?		Perhaps drop refuting questions in a quiz?
7	21.10.2019	N/A	Fun with answer				
8	22.10.2019	N/A	Very nice website! Also on mobile!	The quiz itself seems good, not a huge fan of the pop-up style you chose but other than that it is functional and effective.	I am a bit confused in the beginning of what exactly is the website's focus as the first impression is a vague site		
9	25.10.2019	N/A	I think this is a very good idea, would love to have this				
10	28.10.2019	N/A	I think the idea is good and the nice	I would have used this	"Take Test" and "Select Quiz" could be one button		
11	29.10.2019	N/A	Creative idea and looks like		Perhaps add an alarm reminder		
12	29.10.2019	N/A	Looks good and professional	This could have been usefull in some of the classes i teach if it was available to modify to fit other classes.			Use bombed with Canvas/blackboard

Figure 5: Feedback with names hidden

TPK5100 - Project Plan

Fredrik Hoel Bevreng 501787
Ole Martin Brokstad 501789
Wilhelm André Mangersnes 758252
Casper Nilsen 501786
Jørgen Anker Olsen 999375
Simen Theie 501793

October 2019



Kunnskap for en bedre verden
Norges teknisk-naturvitenskapelige universitet

1 Type of product

The product we are producing in this project is a website application to increase the learning outcome each student has from the lectures in TPK5100, Applied Project Management. This is done by helping the students repeat the learned knowledge from the lectures.

2 Expected learning outcome

The expected outcome of this project is that students taking the course TPK5100 Applied Project Management may learn more from the lectures and retain the information learned in class for later use.

This is accomplished by motivating the students to repeat the information that is taught in class, and enabling them to test their knowledge through fun and interactive questions and answers, with some game features.

The overall outcome of the project is:

- Increase the number of students who review the given curriculum after lectures
- Encourage students to work evenly through the semester with the written curriculum
- Decrease the amount of students who cram for the exam at the end of the semester

To reach the desired project outcome, we propose to develop a web application that offers students several assisting services, such as:

- Series of questions for each lecture to test the students knowledge about the relevant information in that lecture
- Summary's from the lectures and chapters in the course
- Enable students to log their score for future use

3 Stakeholders; influence and importance

Several stakeholders are interested in the project.

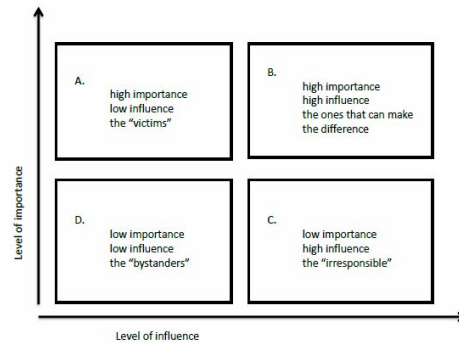

Stakeholder matrix. Source: APMAS Knowledge Network

The future students taking *Practical project management* are the primary target group and would be categorized in the high importance, low influence group according to the stakeholder matrix figure. They are free to influence the outcome and direction of several aspects of the project but are ultimately left with little power.

The course lecturer is another obvious stakeholder that maintains a strong influential grip in how the development of the app is going to take shape, and in which directions. They will naturally hold a great amount of interest in the project too, making sure it is a reasonable and obtainable goal within the boundaries that were agreed upon. Just like a real project.

With a broader perspective on stakeholders, there will surely be an interest for older students that have taken the course before, perhaps due to different new life situations such as a new job position that requires particular knowledge or skill set from project management. The app can easily aid in refreshing knowledge for this group and will serve as a valuable tool.

Finally, the app's developers are the last obvious stakeholders that both hold a great amount of influence and power. Every member of the group has motivation on several levels regarding the outcome of the project and due to the group's size, every member possesses a great amount of power in controlling how the end result will be. That is time invested into the project, but also how proactive each member is. How well a team member partakes in the scheduled meetings and contributes to the project.

Risk Management Plan

Risk #	Risk	Impact	Initial risk rating	Risk treatment strategies		Residual risk
				Action	Risk owner and timeframe	
1	<p>Risk:</p> <ul style="list-style-type: none"> Poor attendance <p>Source:</p> <ul style="list-style-type: none"> Poor planning Unmotivated workers 	<ul style="list-style-type: none"> Contributes to bad mood in the group Setback in work schedule 	<p>Consequence: Medium</p> <p>Likelihood: High</p> <p>Risk rating: Critical</p>	Not meeting at given time results in a warning. Less than 80% attendance results in more work under supervision from PM.	Project manager, full time period.	<p>Consequence: Medium</p> <p>Likelihood: Low</p> <p>Risk rating: Marginal</p>
2	<p>Risk:</p> <ul style="list-style-type: none"> Last ditch efforts <p>Source:</p> <ul style="list-style-type: none"> Unmotivated workers Poor planning 	<ul style="list-style-type: none"> Poor result Stressed workers 	<p>Consequence: Big</p> <p>Likelihood: High</p> <p>Risk rating: Critical</p>	Internal due date 1 week before the normal due date. Set up weekly goals.	Project manager, full time period.	<p>Consequence: Medium</p> <p>Likelihood: Medium</p> <p>Risk rating: Considerable</p>
3	<p>Risk:</p> <ul style="list-style-type: none"> Updating our application without contacting stakeholder <p>Source:</p> <ul style="list-style-type: none"> Forgetfulness Overeagerness 	<ul style="list-style-type: none"> Misunderstanding the project requirements 	<p>Consequence: Big</p> <p>Likelihood: Low</p> <p>Risk rating: Considerable</p>	Whenever new ideas are implemented or introduced that makes big changes, the stakeholder manager contacts project owner to keep the project on the right track.	Stakeholder manager, full time period.	<p>Consequence: Medium</p> <p>Likelihood: Low</p> <p>Risk rating: Marginal</p>

Risk Management Plan

Risk #	Risk	Impact	Initial risk rating	Risk treatment strategies		Residual risk
				Action	Risk owner and timeframe	
4	Risk: <ul style="list-style-type: none"> • Making the application too complex Source: <ul style="list-style-type: none"> • Overeagerness 	<ul style="list-style-type: none"> • Scope may become too large for this project. • Time to complete project may become too much. 	Consequence: Medium Likelihood: Low Risk rating: Marginal	Project manager initiates discussion before implementing suggestions.	Technical manager, full project period.	Consequence: Medium Likelihood: Low Risk rating: Marginal
5	Risk: <ul style="list-style-type: none"> • Resistance from team members Source: <ul style="list-style-type: none"> • Unmotivated team members • Project manager with iron fist 	<ul style="list-style-type: none"> • Our product may suffer and receive bad reviews by users. 	Consequence: Medium Likelihood: Low Risk rating: Marginal	Project manager initiates discussions with the resisting members and makes sure they are heard.	Project manager, full project period.	Consequence: Low Likelihood: Low Risk rating: Marginal
6	Risk: <ul style="list-style-type: none"> • Communication and information flow Source: <ul style="list-style-type: none"> • Team members don't work closely from before. 	<ul style="list-style-type: none"> • Expectations might get mixed. • Misunderstandings might happen. • Messages might not be received by the intended recipient. 	Consequence: Medium Likelihood: Medium Risk rating: Considerable	The team meets once a week during exercise hours to discuss and work on the project.	Project manager, full project period.	Consequence: Medium Likelihood: Low Risk rating: Marginal

4 Skills

We can divide the skills that are essential to produce our project into two categories: The hard skills required to develop the website and the Work Breakdown Structure, as well as the soft skills required for properly managing the project. For the website and WBS, hard skills in the following computer tools are expected:

- Microsoft Visio (Computer Program)
- Microsoft Azure (Cloud Service Platform)
- HTML (Programming language)
- CSS (Programming language)
- Javascript (Programming language)
- Python (Programming language)
- C# (Programming language)
- Microsoft SQL Server (system software)
- Microsoft Visual Studio (Computer Program)
- Microsoft Visual Studio Code (Computer Program)

The soft skills include but are not limited to: Leadership, communication, scheduling, critical thinking, decision-making, teamwork, creativity and time management.

For the hard skills we will delegate responsibilities to tools for different team members following their competence level and ambitions. This ensures that every team member can use previously learned knowledge and gain new knowledge if desired. The soft skills will hopefully improve throughout the project from participating in lectures, reading learning materials and delivering assignments.

5 Work Breakdown Structure & Project Schedule

The Project is divided into individual controllable tasks colored blue in figure 1. The tasks are distributed under bigger deliveries colored in light blue. These deliveries are distributed under the corresponding project phases colored in orange.

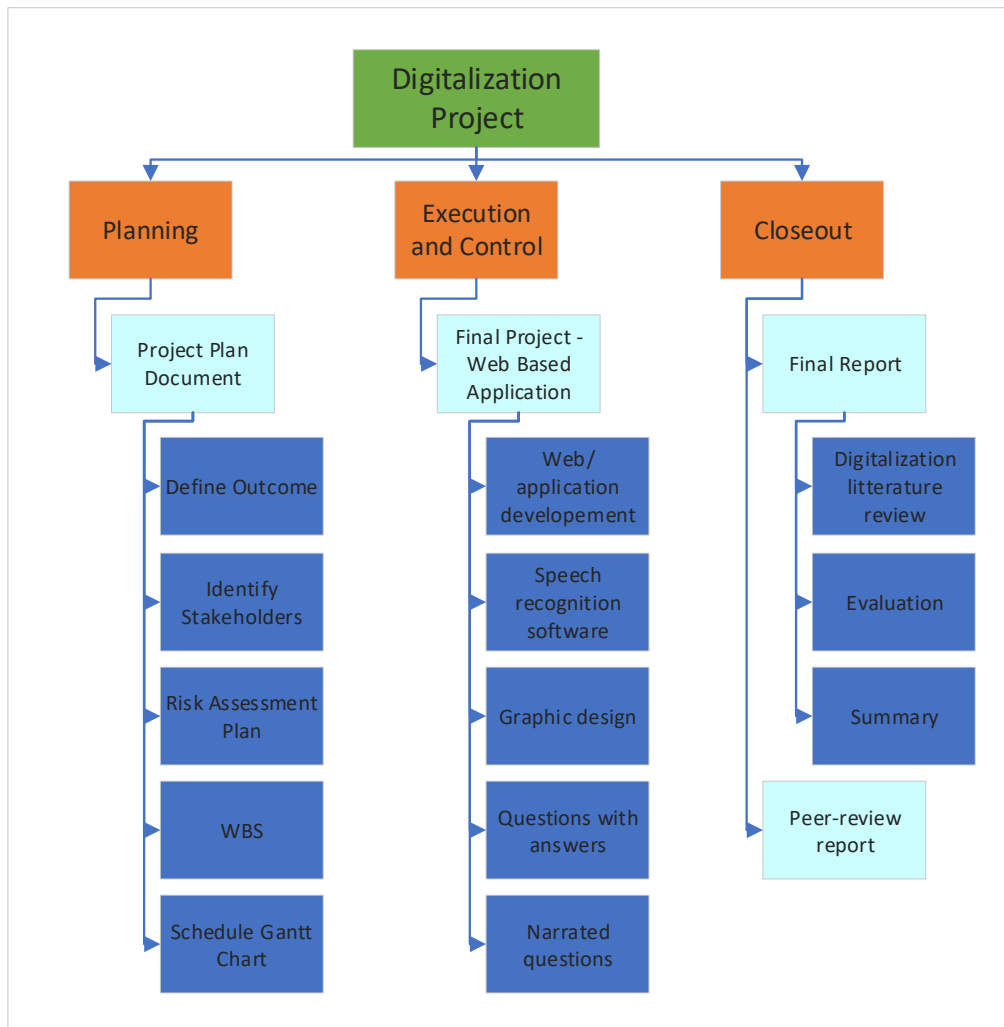
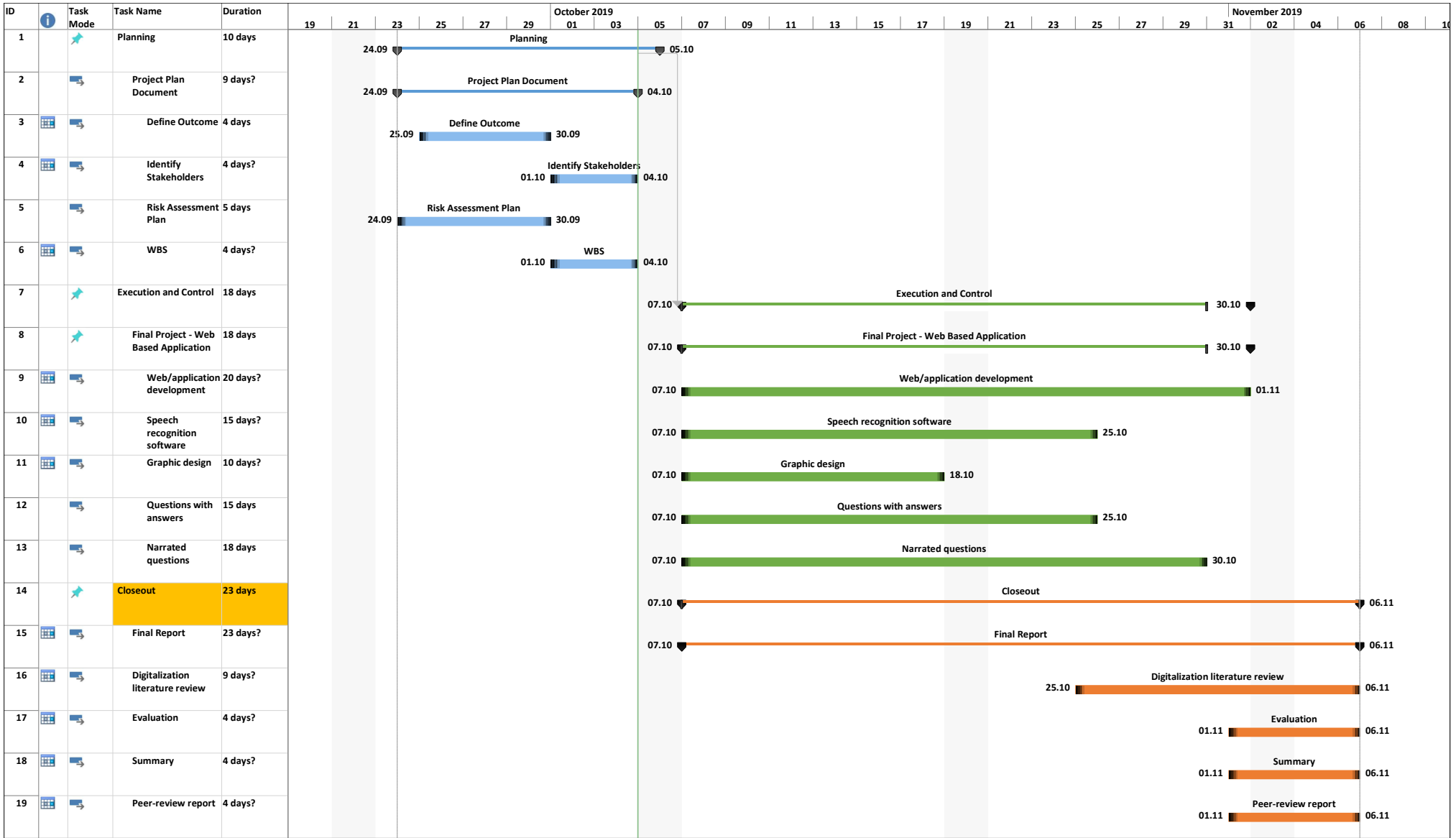

Figure 1: Project Work Breakdown Structure.



Project: Web Based Application Date: Sat 05.10.19	Task		Inactive Milestone		Start-only		Path Driving Predecessor Summary Task	
	Split		Inactive Summary		Finish-only		Path Driving Predecessor Normal Task	
	Milestone		Manual Task		External Tasks		Progress	
	Summary		Duration-only		External Milestone		Manual Progress	
	Project Summary		Manual Summary Rollup		Deadline			
	Inactive Task		Manual Summary		Path Driving Predecessor Milestone Task			

6 Success factors

Most of the success factors for this project is related to organizational complexity, restrictions and uncertainty due to the nature of the task. The team consists of members from various fields of study and backgrounds, and we therefore need to reduce chance of assumptions and conflicts. We have also decided that our project requires a certain level of technical skills and the project manager must therefore be careful to properly utilize and follow up key members with the correct expertise. A list of success factors follows:

- An effective communication channel
- Clear and realistic objective
- Clear roles and responsibilities
- Careful risk management
- Establishment of a project leadership
- Make sure all team members elicits commitment and gains a level of ownership
- An agreed upon process for conflict resolution
- Goals agreed upon by all members and a clear view of the scope
- Distributing internal expertise
- Establish a good relationship within the team
- Stakeholder involvement
- Flexibility (ability to address problems as they arise)
- Trust within the team

7 Characteristics of a Digitalization Project

Digitalization projects are very similar to restructuring projects in the way that the main goal is to change how people operate or re-structure work processes. However, in a Digitalization project the deliverables are more concrete because this must be driven by some technological transition - such as acquisition or development of new IT solutions. The deliverable is a tangible asset and the change is the main outcome [1]. According to the Gartner IT glossary [1], digitalization is defined as such:

"Digitalization is the use of digital technologies to change a business model and provide new revenue and value producing opportunities; it is the process of moving to a digital business" [2]

In other words, digitilization must produce value - it must deliver something useful for the project owner. Sometimes the project owner's interest aligns with that of the end-users, which could be customers or employees (or students, as in this project). In a typical digitalization project there is a wide array of stakeholders, which can lead to the interests being divided. This could in turn be a contributing factor to project failure, because major stakeholders holds differing views as to what constitutes project success. [3]

Another key feature often seen in digitalization projects is the agile work process, especially during a software development stage. Because of the inherent uncertainties in such a project, it is almost infeasible to imagine the waterfall approach working out. Instead, the *fail early, fail often* mantra is adapted, re-calibrating the course forward as new challenges emerge. This key concept maintains the project teams flexibility, but requires close follow-up and involvement of the stakeholders throughout all project phases. [4]

Even though the main driver in the project is the technical transition, experience have shown that soft factors, or more specifically human factors, are imperative in ensuring project success. Because of the organizational complexity, namely the diversity of the stakeholders, getting management and workers to collaborate can become a challenge. The adaption, from the human point of view, can cause internal growth pains because people are reluctant to change. In this project we do not believe that these soft factors are so important; Because our solution offers **extra** learning assistance, people should not have to change their current learning habits in order to use it.

¹www.gartner.com

References

- [1] B. Hussein, *The Road to Success*. Fagbokforlaget, 2018.
- [2] J. Bloomberg, “Digitization, digitalization, and digital transformation: Confuse them at your peril,” 2018.
- [3] F. Hartman and R. A. Ashrafi, “Project management in the information systems and information technologies industries,” *Project Management Journal*, 2002.

TPK5100
Digitalization Project - Peer-review evaluation Report

November 2019



Kunnskap for en bedre verden

Norges teknisk-naturvitenskapelige universitet

Preface

Group number: 27

Student names and numbers:

1. Jørgen Anker Olsen - 999375
2. Simen Theie Havenstrøm - 501793
3. Fredrik Hoel Bevreng - 501787
4. Ole Martin Brokstad - 501789
5. Wilhelm André Mangersnes - 758252
6. Casper Nilsen - 501786

1 A) Evaluation

A) Based on your evaluation (as a group) please indicate the strengths and weaknesses of the final product.

Strengths

- Looks professional and excellent video quality
- Good learning aid for blind and visually impaired.
- A lot of information.
- A detailed presentation of the case.
- Many different shots and good video transitions from clip to clip

The video created by group 25 tries to illustrate for the viewer how soft factors influenced the Ivar Aasen oil drilling project. They have managed to create a Youtube video that is visually stunning and gives us a documentary feeling. The audio quality is also high which helps.

This is a great way to introduce the concept to people with visual impairments. Any written case that is recorded is great for those who can not read.

The video presents the case detailed orally. This is good if the learner want to attain a deeper understanding of this case and its learning outcome, without reading.

Weaknesses

- The video contained a lot of typos, it should have been proof-read more thoroughly.
- There were no subtitles, which could've been useful.
- A significant part of the video is the sound. The pronunciation could have been better.
- There are no references to the source material from which the script is based on.
- The idea can arguably be called unoriginal.
- The narrator should speak louder and clearer or use better recording equipment suited for the task.

The video looks very professional, but a part of the impression one obtains is ruined by the amount of typos in the credits and the text that covers the video footage from Aker BP. This should have been double checked before uploading the video.

It is sometimes hard to follow the narrator, which is not a native English speaker. Because of this, it would have been useful to include the script as subtitles. It could also help to add the sources for the script material, such that interested students could look up further information about this project.

2 B) Support

The product we reviewed is of high quality and we recommend it to be used as learning aid in project management					
Scale	Strongly disagree	Dissagree	Neither agree nor disagree	Agree	Strongly agree
Your response			X		

3 C) Grade

On a scale from 0 to 10: 7

Recommended grade: C/B

Preface

This report is made by group 33 as a summary analysis of the digital project, which was done by us. In the report we explain the aim and main characteristics of the digital project, made a self-evaluation of the management efforts, evaluation of the final digital product, and finalised it with the success factors and most important lessons learned.

We can identify our project group as a self-organizing group sharing the common goals of producing the digital product. As a self-organizing group we did not have a particular determined roles for each of the member, but have the motivation of working together to fulfil the project and to reach the same quality. All group members are listed below.

Group number 33:

- | | |
|------------------------|--------|
| 1) Irene Buijing | 520664 |
| 2) Friso Mous | 531401 |
| 3) Patrick Penacerrada | 520656 |
| 4) Anita Amati | 520651 |
| 5) Anastasia Dvorova | 520661 |
| 6) Torstein Hellebust | 509999 |

Contents

1. Digitalization projects	4
2. Self-evaluation of the project management effort in the project, success or failure? And why?..	5
3. Self-evaluation of the value to the learners? Can you document your assessment?	7
4. Factors that have contributed to failure / success.	9
5. important lessons from your project	11
6. References	12
7. Peer-review report.....	13
8. Attachment	14
Product Description	14
Recommendations for distribution.....	14
Project Plan	15
The product.....	15
The expected benefits of the product.	15
Required skills	16
Stakeholders	16
Risk assessment	17
Project breakdown structure	18
Project schedule.....	19
Success factors	20
Digitalization	21

1. Digitalization projects

Based on our experience from working with this project we have identified three key challenges with digitalization. These challenges relate to identifying needs, lack of skills in the project organisation and distribution of the end product.

1. Identifying needs.

In order to identify the needs that were the basis for the project, we first needed to identify the different stakeholders. We assessed that the three major stakeholders were the project owner, the project organisation (us) and the end user. The end user was very vaguely described. Therefore we needed to figure out which group the project owner wanted to target. Based on discussions with the project owner and assessment of similar projects conducted by the same owner, we decided to target students enrolled in Applied Project management at NTNU. After identifying the target group we analysed the needs of this group. We did this through creating a survey that we performed for our class. The analysis provided us with information about the study patterns and the challenges the students are experiencing while learning project management. According to Bassam Hussain managing stakeholders plays a fundamental role in project management, because they add to the uncertainty of projects through their potential to create increases in organisational complexity. In order to handle this increase in complexity he suggests following three steps: identification, assessment and implementation of communication strategies. (Hussain, 2018) In our experience the process of identifying stakeholders and their needs, helped us to create a product that serves the stakeholders needs in a better way.

2. Lack of skills.

After analysing the needs of the end-users we needed to develop a product that could cover these needs. When deciding what kind of product to create, we had to consider our skill level. Our project organisation consists of engineers with little experience within IT and digitalization. As a result, we had to adjust the scope of the product so that we could create it with the resources available. We needed to use a large amount of time to acquire relevant skills. This meant that there was less time left to product development. We think that our project could have achieved better results if we had a higher skill level in the relevant disciplines. According to Ngereja, this is typical for digitalization project as 73 of employees report that there is a shortage of digitalization skills in their industry (Ngereja, 2019).

3. Distribution.

In order for our project to give value to the target group, we need to make easy to access and understandable. An animation without viewers will not have any impact on the learning experience. In order to ensure the target group will see the animation we created a recommendation for distribution that was attached to the product when delivered. This attachment describes several ways of distributing the in order for it to reach the target group. It is meant as a tool to transfer the project from the implementation phase to the operation phase, and to ensure that the product stays relevant.

2. Self-evaluation of the project management effort in the project, success or failure? And why?

The project management efforts exerted in the project has been evaluated per success factor. A tabulation of is written below.

Success Factor	Evaluation	Reason
Clarity of project purpose and objective	Success	Identification of the project goal and its expected benefits was done and kept in mind during the project execution.
Adequate project planning	Success	As shown in our gant chart which is found in the project plan, almost 30% of the project timeline was dedicated to project planning. The time period might not represent everything, but a lot of planning was put into the planning phase i.e. end-user analysis, owner analysis, risk analysis, stakeholder analysis, time planning, and success criteria.
End-user consultation and analysis of their feedback	Success	A survey in the form of a <i>kahoot</i> questionnaire was done in class. This served as the group's end-user consultation and analysis of their feedback. The group based the product decision from the result of the survey – which is a product that gives them additional explanation to the lesson, can be studied alone, and presented visually.
Technology to support the project	Success	Since the project is a digitization project, a software to deliver the deliver the product is needed. This was done successfully by using the best and easiest software that can deliver the planned result.
Approval by client	Success	Aside from the end-users, the client was also consulted prior to finalizing the product. The client did not suggest a specific product, but a list of requirements and targets were laid down which was also made basis by the group.

Good communication between the project team members and motivation	Success	A good working environment was set in every meeting and working session. A reason for this is that everyone is on the same page and understands the motivation in making the product successful.
Skills, knowledge and competence	Success	In order to gain competence and knowledge about the program that was used, time was spent to learn how to create and edit the video.

Table 1: Success Factors

We evaluate our project as successful.

Scale	Strongly Disagree	Disagree	Neither disagree	agree nor	Agree	Strongly Agree
Your response					X	

Table 2: Project evaluation

3. Self-evaluation of the value to the learners? Can you document your assessment?

To evaluate the final product, it is critical to find out if the product has the desired outcome. In the project plan, the following factors were discussed:

- Is the product informative?
- Is it possible to understand the topic without attending the lecture?
- Is the material available at any time and any place?
- Does it improve the students learning process?
- Is the material flexible and adaptable in the future?
- Is the material a good supplement tool for teachers to prepare the students for the day after the lecture?
- Is this a possible new learning method to introduce in the entire NTNU education system?

Description of the method used to evaluate the final product

To make an evaluation we decided to conduct a **three-step evaluation of the product**.

First, **evaluation by focus group**. A focus group is a small, but demographically diverse group of people and whose reactions are studied in guided or open discussions about a new product or something else to determine the reactions that can be expected from a larger population (merriam-webster, 2016)

. We made a presentation for focus group (7 people) with the interviewing afterwards, to get a feedback about our product and to have a possibility for final corrections.

Secondly, we made a *Kahoot* on a project presentation for all students, taking Applied Project Management class. Since, these students represent **the target group for the project**. We decided to hold the Kahoot during the presentation, since therefore we can reach more students. Third was **evaluation from project owner**. During the project presentation we got the overview and raw assessment of the product from the owner, in the meaning of subsequent usage of the product.

The number of informants who have contributed to the evaluation, and how these informants have been selected.

The focus group consists of 7 people, with the following characteristics:

- Our fellow classmates, who are taking class of Applied Project Management and second-year students who took this class last year. Since they represent the future target group, they are interested in the end product, they will benefit from the product, thus they can make a fair assessment and feedback.
- The age of the participants ranged between 22 - 29 years. We got students with different backgrounds and experience for assessment the final product. People in different age have different expectations of the methods of learning and ways of getting information, thus we got the broader overview of our product.
- We also involved people from different countries to provide an ethical diversity of the feedback. Since, they had a various education experience, based on which they can provide more extensive feedback.

Kahoot was made on a project presentation for all students, taking Applied Project Management class. Since, these students represent the target group for the project. By making a Kahoot we got an overview of students' reactions to the product, the main purpose was to find if students can evaluate the end product as valuable for their learning process. (Approximately 51 Students) Norwegians and international.

The project owner was involved in Kahoot survey and in providing overall review during the presentation.

Results of tests, surveys or interviews with students or persons who have reviewed the product.

Results from interviewing the focus group: the respondents find the end product as a “good introduction to the risk management, giving the overall understanding of the topic”- 100%, all respondents agreed that they “could use the product in their learning process”-100%. Most of the respondents agreed that “the product could be used during the exam preparation”-85%.

Overall grade for the project was still “very good”, but some details which should be clarified in an animation script were pointed up. In addition, we got a recommendation about more detailed disclosure of the topic, thus could “contribute into the wider usage of the product in the learning process”.

Results from Kahoot for the target group:

Results of project owner evaluation: Project owner appreciated the idea of using animation as an introduction to the upcoming lecture, “it can give a good overview for students about upcoming lecture”. In addition, he especially appreciated the recommendation for distributions, which accompanied the final product.

The results of the Kahoot are encouraging. A total of 87% of the participants found the video informative. Also, a total of 84% found the video to be an addition to understand the subject of the lecture better. 78% of the participants found that this video would improve the overall learning experience and 86% found it a good way to study before the lecture. Finally, 88% of the participant would like to see NTNU implement similar video’s in different subjects throughout the course of study. In Table 3 are Table 3 all the results from the Kahoot.

Was this video informative?	Yes(64%)	No(7%)	Mostly(23%)	Partly(7%)
Will you be able to understand the subject better without going to the lecture?	Yes(39%)	No(16%)	Maybe(45%)	
Do you think this product will improve your learning experience?	Yes(57%)	No(5%)	Mostly(21%)	Barely(17%)
Is this product a good way to study before the lecture?	Yes(69%)	No(7%)	Mostly(17%)	Barely(7%)
Do you think NTNU should implement more of these products in the courses?	Yes(88%)	No(12%)		

Table 3: Kahoot results

In conclusion, the project seems to be a good fit for students who want to study the subject before a lecture, as can be seen in question 4. These kinds of animations give the students a great first impression about the subject and enables them to know what the lecture is going to be about and to start thinking about the subject. For exam training these videos are less suitable, as an exam preparation needs more in-depth analysis of the subject and more interaction between the subject and the student.

Based on the results from evaluation methods mentioned above, we **agree** with the statement that *our product is of high quality and we recommend it to be used as a learning aid in project management course.*

Our product is of high quality and we recommend it to be used as a learning aid in project management							
Scale	Strongly Disagree	Disagree	Neither disagree	agree	nor	Agree	Strongly Agree
Your response						X	

Table 4: recommendation

4. Factors that have contributed to failure / success.

Success factor refers to a set of factors that the project must comply with in order to increase its likelihood of success. After the project is finished the project can be assessed as a project failure or a project success. The success factors can be used to come to this conclusion. Therefore, they can be seen as the most important lessons learned from executing a project. (Hussain, 2018)

In chapter 2 is already explained why we see our project as a success. Different factors have led to this success. The success factors in table 5 are from the book 'The Road To Success'. (Hussain, 2018) We have discussed which factors we observed in our project and the process when we reflected on our project. Besides the success factors, the explanation why this factor contributed to our success is also listed in table 5.

The most important factor for success in our project was the collaboration. All our team members were not having the right skills for executing the project. Therefore we needed to require the right knowledge. We needed to support each other and help each other out to make this project a success. By collaborating as a team, in the way we did, we have the opinion that this was the critical success factor in our project.

In addition, was the adequate planning, involving the project owner and the end-user in the early phases (Kahoot) very useful to come up with a right product.

Success Factors	Explanation
Commitment	As a team we were committed to the project, since we all wanted to make it a success. The fact that it will be graded was for us a good motivation and made us commit to the project.
Clarity of roles	In the beginning we discussed and decided which team member would do which part of the project. This made us give an overview on who was working on the project and when and if everything was goes as we planned.
Skills, knowledge	This was a little bit a setback. We did not have the required skills or knowledge of animation. This is the reason that our development/video making process took a bit longer than planned because we had to acquire the necessary skills
Alignment of project purpose & Clarity of purpose and objectives	From the start we made sure we were all aligned and on understood what the reason was why we made the animation. In addition, we made sure we all had the same commitment. We aligned from the beginning for what we were striving, through discussions.
Trust	When we created the project team, we chose each other because we knew we could trust each other (we knew each other from before) This enabled us to trust each other in the project and spread the tasks/workload (by knowing one would fulfil his/her task)
Adequate planning	The plan of product had to be handed in on time, therefore we planned on time and we tried to stay true to this planning. This helped us in finishing the project on time.
Honesty in reporting	We were honest to each other about the status of the project process when we had meetings. This enabled us to see if we were on schedule and to make sure everyone did what was expected of them.
Flexibility	The whole product was very open to own interpretation. We could do what we wanted, within very large boundaries. This gave us a lot of autonomy, but also it made it difficult to narrow down to one product. By the means of would it satisfy the product owner.
End-user/stakeholder involvement	We tried to fulfil the project-owner requirements. Since they were very open, we involved the end-user from the start to find out where they would be satisfied with. We tried to go back and forth, especially in the beginning, between end-user and project owner, so we could make a product that would be perceived as value-adding to the end-customer and fulfil the project-owner requirements.
Collaboration within project organization	Even though everyone had their own tasks, we tried to help each other out when we needed help and made sure we knew the status of the project. We worked well as a team together, which was necessary in a project where the needed knowledge was not in our field.

Table 5: Success factors in our projects

5. important lessons from your project

My first advice is to have a group in which all the members have common goals and want to achieve the same quality of the final product, with people that commit in every activity of the project, otherwise it would create discomfort and frustration within the group and excessive workload for some members.

Therefore, it is important to start the project as soon as possible in order to have the time to carry out all the activities, without rushing and avoid delivering a mediocre project. In order to achieve the objectives, a detailed schedule can be made in which internal deadlines can be included to feel yourself more under pressure and don't postpone the work.

As for all the assignments made during the course our approach was to set meetings, understand the objectives of the work, reason on that and split the work, and depending on the complexity of the tasks work alone or with other members.

When we started to work on the project, we noticed that we needed to collect more information in order to develop the work, therefore we involved some of the stakeholders in the project asking questions directly as towards the teacher (project owner) and with a Kahoot towards the class (end users).

What we learnt from this work is that the first meetings have to be used to understand the learning objectives of the final product, to identify who has to be the target of the project and the skills mastery by the group in digitalization field, and only after to have considered all these elements what product to produce.

A good plan, complete and well structured, is useful because it can be used as a checklist and guideline to follow carefully by the group also, to present the project to the stakeholders involved.

With a good plan you can get a successful project but not the other way around.

Due to the lack of digitalization skills, we had thought and included in the plan as well a contingency, a sort of Plan B if we had not succeeded in the creation of the animation, and that would lead the involvement of a person outside the group.

The plan also included how the product was evaluated and how we incorporated the feedback received into the project prior to delivery, as also appropriate changes due to possible errors.

To sum up, the lessons we learnt during this work are grouped on the list below:

- 1- Have a consolidate and committed group;
- 2- Work without conflicts;
- 3- Respect the schedule and start the project as soon as possible;
- 4- Collect all the information;
- 5- Stakeholders are important and have to be involved;
- 6- Identify and clarify the learning objectives;
- 7- Frequently meeting to follow-up the work;
- 8- The plan of the project has to be complete and structured;
- 9- Consider a Contingency;
- 10- Ask someone to evaluate the project before to hand-in.

6. References

Hussain, B. (2018). *The road to success*. Trondheim: fagbokforlaget.

merriam-webster. (2016, may 4). *Definition of FOCUS GROUP*. Retrieved from merriam-webster:
www.merriam-webster.com

Ngereja, B. (2019). *Digitalization projects*. Trondheim, Norway.

7. Peer-review report

The peer-review is executed for group 26. They made a video with question in between, which you can answer.

Strengths

We found that this group had a good idea and execution. The video contained interaction though first explaining the case and asking relevant questions afterwards. A good point with that is that you get feedback immediately, therefore increasing the learning experience.

Secondly, we found that the technical aspect, i.e. the animation quality and voice over to be good and to the point. Also, the group managed to include some humour in the animation and the colours used makes it visually pleasing.

Weaknesses

While watching the product, we saw that proper introduction was missing. In the middle of the video, there were moments when we wanted to replay a specific part but couldn't because the product doesn't have the capability for this: you need to replay the whole video. This may result in more time usage when someone wants to review a part of the video. Lastly, the first question requires you to write specific answers, and when someone uses other terms with the same idea/meaning, the product will mark them wrong.

The product we reviewed is of high quality and we recommend it to be used as learning aid in project management					
Scale	Strongly Disagree	Disagree	Neither agree nor disagree	Agree	Strongly Agree
Your response				X	

Table 6: Recommendation for group 26

Because of the above description of the product we would recommend the grade **8** to this product.

8. Attachment

Product Description

The product is a visualisation of chapter 10 'Risk Management' of the book of Hussain. (Hussain, 2018) The video was made using animation techniques and has voice over to explain the different subjects in the chapter 'Risk Management'. It can be used as a way for the audience to get an introduction in the subject before the start of the lecture of risk management, to create interest. .

The video was designed to be watched on tablets, smartphones, laptops and pc's. It is a .mp4 file, therefore it can be distributed through multiple media platforms, like blackboard and YouTube.

Recommendations for distribution.

This document is an attachment to group 33's end product.

In order for our product to give added value to the students it needs to be distributed in a proper way. It needs to be easily accessed and advertised in order to maximize the product value.

For proper distribution, we recommend the following three steps:

1. Upload on Blackboard.

By uploading the product as a part of the learning materials on blackboard one will assure that the product is accessible at a platform widely used by the target group.

2. Use as an introduction to the lecture on Project Risk Management.

By presenting the product at the start of a lecture or as a reading instruction to a lecture the product will become known to the target group. Our assessment is that this strategy will increase the number of viewers.

3. Upload on YouTube.

This strategy ensures that the video is easily accessible for everyone with internet access.

Project Plan

The product

In order to find out what product we should create we assessed three main factors:

- End user needs
- Project owner needs
- Project group strengths.

In order to find the end users' needs we choose the students of Applied Project management as our focus group. We then made a survey in the form of a Kahoot in order to figure out their preferences on learning. The results for this survey was:

- Most students are visual or logical learners.
- Most students prefer to study alone
- Most students would like better or additional explanations of the curriculum.

Further we interviewed the project owner on his preferences regarding the project. We found that the project owner emphasised three things.

- Use of digital technology.
- Giving added value to learners of Applied Project management.
- Have a long enough lifetime in order to give value to future students.

At last we assessed the strengths and weaknesses of the project group. In order to figure out how we could utilize our resources in the best way. Our group does not posse advanced computer skills, but some of the members have basic knowledge of video making and editing. We assess that the end-product will benefit from playing on these strengths.

Based on these assessments we have decided to make a video where we summarize Chapter 10 in “The road to success” (Bassam 2018)

The expected benefits of the product.

The term benefit refers to the outcome that the project will produce after the project output are in operation. It includes benefits to the owner, users, society, and so on. The outcome is characterized by a high level of uncertainty and many conditions must be met in order to achieve the intended outcome. The main principle is that the benefits can be accomplished only if the purpose is achieved.

In this case the benefits are:

- Informative product that clarifies the students doubts inherent to different topics;
- Possibility to understand a topic even if it is missed the lecture;
- Available material at any time and at any place;
- Improving the students’ learning process thanks to digitalization that makes the learning faster and simpler;
- High students’ satisfaction;
- Flexibility and adaptability of the material in the future;
- Supplement tool for teachers to prepare students for the day after the lecture;
- Possible new learning method to introduce in the entire NTNU university system.

Required skills

In order to produce our project, we need to acquire several skills like:

- Video Making;
- Production;
- Editing;
- Knowledge of the material to explain within the video (in our case chapter 10);
- Communication and collaboration inside the teamwork;
- Problem solving;
- Creative;
- Best learning method.

After doing the Kahoot and having understood the major threats of the students we will use the internet and our personal knowledge as a tool to research the best learning methods for students.

For some of the skills listed above like, editing, video making and production we are going to collaborate with a third person that will help us to digitize our project and introduce us in the animation world. Furthermore, we will also use the internet and YouTube tutorials to maybe acquire directly these skills.

In order to realise a product useful and that fulfilled the students' needs, through the study of literature and books we will have a deep knowledge of the topic that we are going to explain in our product.

During this teamwork we will need to achieve a good communication and collaboration within the group, we are a small and well organized group that means we don't have a leader but we choose to have a coordinator that help us to set up meetings and to respect the deadlines.

Stakeholders

Involving stakeholders during project development is an important step that needs not to be skipped. We first identify the stakeholders:

- Project owner
- End-users (Students / Classmates)
- Project team
- Supplier – Platform
- Supplier – Competence
- Other learners
- NTNU Administration

Next step is we to conduct stakeholder mapping:

		Interest	
		Low	High
Influence	High	<i>Group 2</i> Supplier - Platform	<i>Group 1</i> Bassam Hussein End-users Project team
	Low	<i>Group 4</i> Other Learners NTNU	<i>Group 3</i>

Table 7: Stakeholders map

As learned through Bassam’s class, below are actions to be taken by us with regards to the stakeholders.

Stakeholders in group 1 should be collaborated with:

- Owner – will be interviewed, ask for input, identify what creates value for him
- End-users – will conduct survey, identify what is valuable for them, will conduct proof of concept test with them
- Project team – will discuss internally to learn what are the competence needed and plan the project development

Stakeholders in group 2 should be made satisfied:

- Supplier of the Platform – will comply to their terms of licensure agreement

Stakeholders in group 3 should be informed, but based on the stakeholder mapping, we found out that there are none in this group.

Stakeholders in group 4 should be monitored and observed:

- Other learners, NTNU Administration – will observe if they have ideas that can bring more value to the project.

Risk assessment

In order to assess the risk of the project the project team had a collective brainstorming. In this session we addressed different incidents that can affect our project. After identifying the incidents, we assessed them with regards to consequence and probability. We used the risk assessment matrix presented under to do this. After assessing the risk, we came up with measures to reduce the risk. At last we made a new risk assessment with the measures taken into consideration. Our risk assessment is presented in the risk assessment table.

Risk assessment matrix			
Consequence/ Probability	1.Low	2.Medium	3.High
1 Unlikely	1	2	3
2 Probable	2	4	6
3 Likely	3	6	9

Minimal risk
 Significant risk
 Critical risk

Risk assessment table								
What	P	C	R	Measures	P	C	R	
The project will not meet the requirements of the project owner	2	3	6	Interviewing the project owner. Involving the project owner in the process.	1	3	3	
The project will not meet the needs of the end users	2	3	6	End user survey. End user 1.st version evaluation.	1	3	3	
The project cannot find a suitable platform for its product	1	2	2	No measures needed	1	2	2	
The end-product will not function as intended	2	3	6	Soft deadlines→ Time to improve built inn in the project schedule	1	3	3	
The project group will lose its motivation	3	2	6	Regular work sessions and meetings	2	2	4	
Arguments in the project group will reduce its performance	2	2	4	Addressing problems early. Appointing project coordinator.	2	1	2	
The project members will not prioritize enough time on the project.	3	3	9	Regular meetings and work sessions. Soft deadlines.	1	3	3	
The project will to large according to the available manpower	2	3	6	Proper project planning. Dividing the project into work packages	1	3	3	
The value of the project will be reduced by similar products	1	1	1	No measures needed	1	1	1	

Table 8: Risk assessment for this project

Project breakdown structure

A project breakdown structure shows the key project deliverables, the sub-deliverables and the work packages. In a WBS the above 3 aspects are organised in a hierarchical decomposed structure. It shows and explains the different parts that has to be executed and completed to have fulfilled the project. For our project there is decided to make a video. This is the major deliverable of the project. To realize this deliverable, it is divided in four sub-deliverables:

- Learning design - In what way is the video useful as learning material?
- Produce product - Which steps are undertaken to produce the video?
- Manage project - What has to be done to manage the project as a whole?
- Evaluation - Does the video satisfy the CSF?

The deliverable, sub-deliverables with their work packages are visible in schedule 6.1. The work packages cover all that has to be carried out to deliver the sub-deliverable and therefore to deliver the main deliverable.

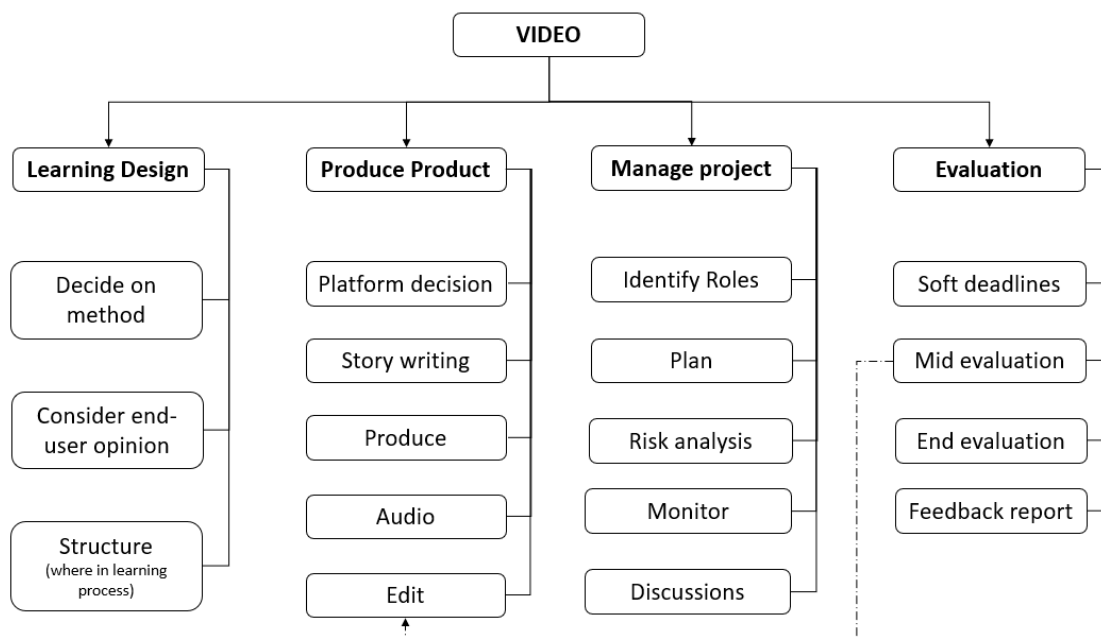

Figure 1: Work package

Learning Design

Decide on method: *In what way is the video bringing the learning material to the end-users.*
 Consider end-user opinion: *Communicate with the end-user what their learning preference is.*
 Structure: *In what way can the video be used, what would be the structure of the learning period.*

Produce Product

Platform decision: *Compare platforms and find the best fit for our video.*
 Story writing: *Summarize the learning material in a script which can be followed when to produce the video.*
 Produce: *Produce the video by following the script.*
 Audio: *Record the audio (conversations, explanations, music, etc.)*
 Edit: *Add video and audio together and edit it to make it one.*

Manage project

Identify Roles: *Assign roles within the project team.*
 Plan: *Plan the project by timing deliverables.*
 Risk Analysis: *Define the possible risks and find a way to address them.*
 Monitor: *Keep track on the execute phase of the project (goes everything follow the plan?)*
 Discussions: *Have meetings and discuss the progress and solve encountered problems together.*

Evaluation

Soft deadlines: *Create deadlines within the project team to stay on schedule.*
 Mid evaluation: *Retrieve feedback from a pilot group to revise before the hard deadline. Improve the product.*
 End evaluation: *Evaluate on the project.*
 Feedback report: *Evaluate the end product.*

Project schedule

In order for the project to be finished in the designated time, a time schedule is made. This time schedule includes the general time frame set by the project owner. The blocks in the schedule represent the different major deliverables, sub-deliverables and work packages from the previous chapter. The time schedule is as following:

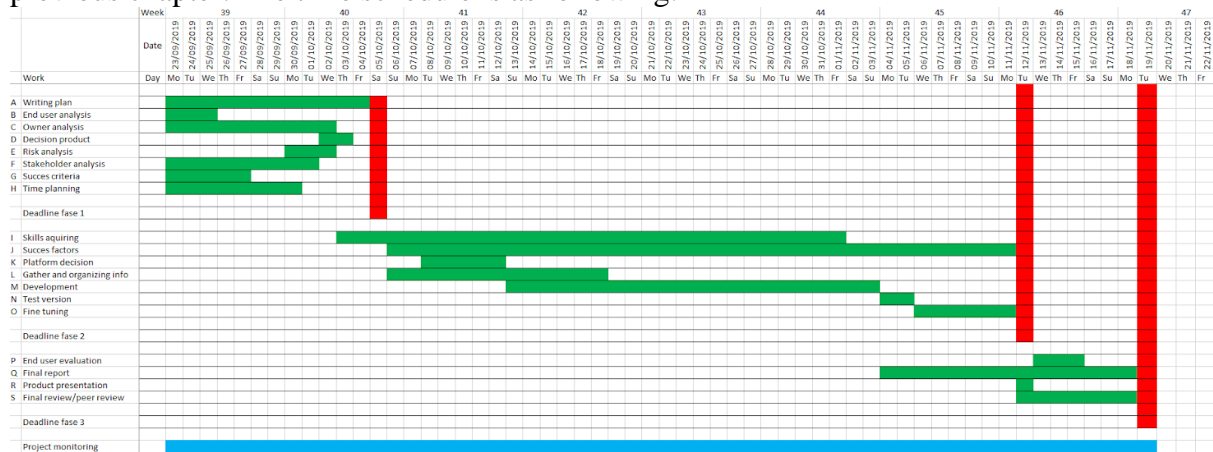

Figure 2: Time schedule

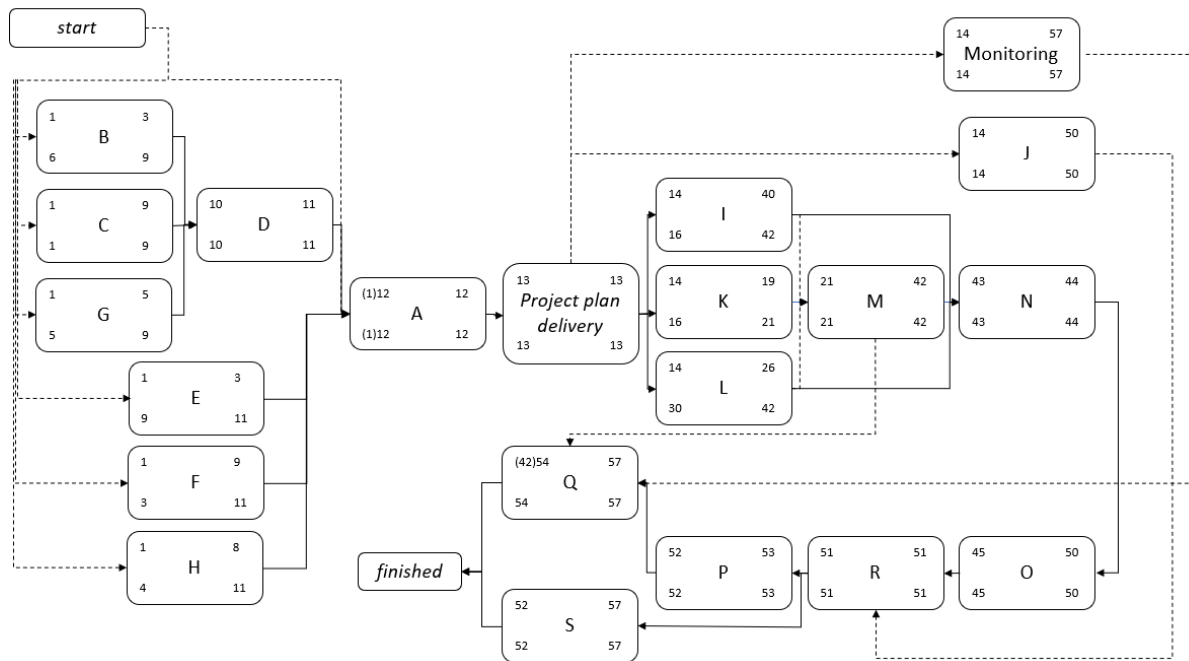

Figure 3: Network Diagram

The network diagram is based on the time schedule. Therefore, the duration of the activities displayed are in days.

The dotted lines indicate that the task does not completely rely on the previous task, but it should be done from the activity before and till the activity it ends. It can't be done before or after the task, but the other activities do directly rely on these tasks. In addition, there are a couple activities (A and Q) which can only be finished after the activity before but can already be started on before this activity is finished. The digits in between the parentheses indicate the time that these should be started, without having the last information of the last necessary activity.

Success factors

The term 'success factor' refers to a set of factors that the project must comply with in order to increase its likelihood of success (Turner 2009). Based on our acquired knowledge and expertise, several main success factors, as well as, the activities which have to be implemented and decisions which have to be made in order to fulfilment these factors are listed below:

- Clarity of project purpose and objective**
 Examining literature, handouts and assignments task, clarification on any issue with the project owner, in order to determine the main function of the product (purpose) and objective.
- Adequate project planning**
 Development a detailed plan kept up to date with agreed deadlines, timetable. It will help to understand the scope and complexity of the project, determine the milestones (deadlines for reports, approvals, delivering dates), make work visualization, defining the dependents between the tasks, indicates the availability of resources and requirements for making decisions.
- End user consultation and analysis of the end users feedback**
 Collecting and analyses information (data) from end-users, to clearly understand the End user needs and willingness in the new digital product and to avoid any

underestimations. Since the End users are well familiar with kahoot.it application, a decision was made in favour of conducting a survey via this application.

- **Effective monitoring and control of the project**

Based on the project plan and timeline was made a decided to milestones and organized regular meetings on Mondays and several additional meetings close to the due dates. As well as keeping track of all requirements for the project and its results (including requirements at the operation phase, for approval, for implementation, technical and functional requirements).

Since the project team is relevant small and self-organised, there is no need for a project leader, but to execute the monitoring and control functions the project coordinator was chosen.

- **Technology to support the project**

Since the project is a digitization project, technologies are required. Several programs for video production, editing and animation were analysed and the most relevant to the project, costs and availability were chosen to be used.

- **Approval by client**

To increase the chance the project will be approved by the client, was scheduled several references to the client during the project to get feedback and to have a chance to make changes in the product, as well as to provide a testing pilot version to the client during the implementation phase.

- **Troubleshooting expertise**

Since the project is run in parallel with other tasks and projects of the same project team, and it is difficult to prioritize one particular project, was decided to address problems as they arise.

- **Good communication between the project team members and motivation**

The project coordinator is in charge of creating a trustful and friendly atmosphere, possibility to ask questions, work on the project together.

- **Skills, knowledge and competence**

Examining the literature, acquired knowledge implementation. Involvement of external Stakeholders with the relevant skills and competence into the project to decrease the level of uncertainty.

- **Flexibility**

Providing some countermeasures to handle uncertainty, managing the risk factors. ‘Group thinking can reduce the project team's ability to request answers to critical questions about implementing, context, or other factors’ (Janis 1977), thus the autonomy for team members to work in accordance with the deadlines is provided. This increases intellectual stimulation, motivation and self-learning.

Digitalization

“**Digitalization** is the use of digital technologies to change a business model and provide new revenue and value-producing opportunities,” according to Gartner’s glossary. In relation to our project, digitalization increases and transforms studying process efficiency, improves data availability, and creates more value by leveraging digital technologies and digitized data.

1. Applying of digital technologies and digitized data, to achieve better results with less effort.
2. Innovations in the product/process
3. Improvement of the product/process - automation, optimization, autonomy, increasing flexibility and individuality of product/process.

4. Creating value in the product/process.
5. Starting point for the project creation - the end result. Continuous communication with client to be aware about his current needs and expectation.
6. Requires fast actions because of high competition in the market.

The value of digitalization for the project:

1. Students will get a better understanding
2. Students will have easier access to information
3. Everyone is online, it is the future
4. Students can access it at all times
5. Students have all the information in one place
6. It does not take up any more space

En interaktiv nettside for kommunikasjon i klasserommet

Gruppe nummer: 34

Studentnavn og studentnummer

- 1) 493397 - Andreas Langnes
- 2) 493441 - Katarina Gjenrem Murphy
- 3) 473688 - Silje Marie Savland Moksnes
- 4) 755167 - Simen Bjørkhaug
- 5) 493420 - Simon Eide
- 6) 493425 - Toralf Tokheim

Innholdsfortegnelse

Forord	2
1. Digitaliseringsprosjekter	3
1.A - Produktbeskrivelse	3
1.B - Hovedutfordringer med teamets digitaliseringsprosjekt	4
2. Egenevaluering av prosjektledelsesinnsatsen i prosjektet - suksess eller fiasko? Og hvorfor?	6
3. Selvvurdering av verdien for elevene - evaluering av prosjektets suksess	8
4. Faktorer som har bidratt til fiasko / suksess	11
Teamet må tilegne seg ferdigheter for å lage produktet	11
Tildeler nok tid til arbeidet	11
Har god samarbeidsevne	12
Gjensidig mål og avtale om hva sluttprodukt er	12
God kommunikasjon med interessenter	12
Motivert prosjektteam	13
Evne til å spre arbeidet over tid	13
Egenskaper til å autonomt håndtere arbeid	13
Faktorer vi ikke har identifisert på forhånd:	13
Den mest signifikante faktoren - Fiasko	14
5. Den viktigste lærdommen fra prosjektet	15
6. Referanser	17
Peer-review report	18
Styrker	18
Svakheter	18

Forord

Denne rapporten presenterer digitaliseringsprosjektet «No Hands Up», og i hvilken grad dette prosjektet har vært en suksess eller en fiasko. Rapporten skal vise til de viktigste faktorene som har bidratt til prosjektets status, og hvilken verdi det ferdigstilte produktet gav til elevene. Rapporten diskuterer også de viktigste leksjonene fra prosjektet.

1. Digitaliseringsprosjekter

1.A - Produktbeskrivelse

Produktet «No Hands Up» er en interaktiv, engasjerende og dynamisk nettside for kommunikasjon i klasserommet. Produktet fungerer som et virtuelt klasserom hvor enten elevene eller læreren kan stille anonyme spørsmål underveis i undervisningen. Det digitale klasserommet brukes ved at lærer åpner et «rom» som gir en unik romkode som elevene kan bruke til å gå inn på «rommet».

Formålet med prosjektet er å skape verdi for lærere og studenter ved å senke terskelen til aktiv deltakelse i klasserommet. Hvor aktivt en elev deltar i en time varierer basert på hvor komfortabel eleven er med seg selv og egen intelligens, hvor komfortabel de er med læreren og elevene, og om de har hatt positive eller negative tidligere erfaringer. Elever som svarer riktig på spørsmål og får positiv tilbakemelding på dette vil ofte delta mer i timer senere. Derimot kan elever som svarer feil oppleve dette som ubehagelig og flaut, og dermed trekke seg tilbake fra videre deltakelse (E. M. Hammond, 2015). For å øke sannsynligheten for at elever deltar i timen skal produktet gjøre kommunikasjonen mellom lærer og elev anonym. Dette burde fjerne mye av elevenes frykt og bekymringer knyttet til å svare på spørsmål i timen, siden de andre elevene og læreren ikke vet hva hver elev svarte. Dette burde også sørge for at elever kan svare feil uten å demotiveres fra å prøve igjen senere, siden de ikke blir flau overfor klassen eller læreren. Produktet skal også kunne gi elever bedre tid til å besvare spørsmål læreren stiller, slik at elevene kan demonstrere dybdekunnskap, som diskutert i «*Working Inside the Black Box: Assessment for Learning in the Classroom*» (2004).

Teamet valgte å lage akkurat dette programmet etter en samtale med en nyutdannet lærer. Her ble konseptet «No hands up» trukket frem som noe de hadde sett på en god del i pedagogikken. Ut i fra dette ble det foreslått en løsning hvor læreren kunne opprette en unik portal for hver

time, hvor elevene anonymt kunne stille spørsmål i sanntid og læreren hadde mulighet til å stille/forberede spørsmål og øvingsoppgaver til elevene. Dette er alle funksjonaliteter som kan knyttes til sosiokulturell- og kognitiv læringsteknologi, men som i en tradisjonell «setting» er begrenset av sosial kompetanse og trygghet. Basert på teamets bakgrunn innen informatikk/utvikling falt valget fort på å lage en webapplikasjon. Teamet valgte å utvikle en nettside, og ikke en app, ettersom en nettside vil fungere på et mangfold av enheter, og derfor er svært tilgjengelig.

1.B - Hovedutfordringer med teamets digitaliseringsprosjekt

En av utfordringene teamet møtte i dette digitaliseringsprosjektet var å definere produktet, og hvilken funksjonalitet som skulle implementeres. Dette gikk i stor grad ut på å komme til enighet om hvilket format produktet skulle utvikles i. Teamet vurderte ulike former som podcast, video og nettside, med eller uten oppfølgingsspørsmål, og kombinasjoner av disse. Derfor var det mange muligheter å vurdere, men vanskelig å si hvilke løsninger som ville ha en betydelig påvirkning på læring. Å skille mellom læringsverdien i de forskjellige løsningene krever en god forståelse av både hvordan mennesker lærer og de foreslåtte løsningene. I tillegg må beslutningen støttes av relevant faglitteratur. Årsaken til at denne beslutningen ble komplisert var kanskje at gruppa hadde betydelig erfaring med programmering, og så etter hvordan denne ekspertisen kunne brukes best i prosjektet. Det var først når løsningen sprang ut i fra teorien at gruppa klarte å si seg enige.

Planen som gruppa produserte før de startet på produktet var gjennomført og inneholdt mye av det den skulle. Derimot avslører et tilbakeblikk at det var elementer som ble oversett som kan ha hatt stor effekt på prosessen som en helhet.

Roller eller ansvarsområder manglet før arbeidet startet, og dette hadde negative konsekvenser for produktiviteten. Medlem i teamet kan ha følt fraskrivelse til motivasjon og ansvarsområde som følge av mangel på dedikerte roller, dermed kan dedikasjonen til prosjektet ha blitt svekket.

Lav dedikasjon er identifiserbar som en viktig suksessfaktor, så det er relevant utfordring for sluttproduktets kvalitative egenskaper.

Prosjektet foregikk parallelt med normal arbeidsmengde i emner på NTNU og alle gruppemedlemmene fant det tidkrevende å prioritere. Utfordringen lå i å finne tid til å jobbe og å prioritere arbeidet høyt nok og konsekvensen var at utviklingen falt bak planen. Heldigvis klarte en fragmentert motivert del av gruppa å fullføre en versjon av produktet, med nok av den planlagte funksjonaliteten til å motta data fra brukertesting.

Det var ikke nok tid til å implementere alle de ønskede endringene basert på tilbakemeldingene fra studentene på grunn av sen testing. Selv om produktet ble klart for brukertesting i tide, sviktet teamet i prosjektorganiseringen underveis. Konsekvent ble arbeidsfordelingen skjev, og dermed måtte noen medlemmer utføre en uforholdsmessig mengde av arbeidet.

En faktor som kan ha bidratt til at gruppemedlemmene ikke dedikerte nok tid til prosjektet kan ha vært en mangel på roller og ansvarsfordeling. Når planleggingsfasen var over var ikke gruppa flink nok til å fordele roller og ansvar for oppgavene som skulle gjøres. Dette førte til usikkerhet på hvem som skulle gjøre hva og en mangel på følelse av eierskap og ansvar for oppgaver. Om det hadde vært tydelig hvem som var ansvarlig for at de diverse delene av prosjektet ble gjennomført, er det mer sannsynlig at disse personene hadde trukket fram problemer innenfor sine områder etter hvert som de dukket opp.

2. Egenevaluering av prosjektledelsesinnsatsen i prosjektet - suksess eller fiasko? Og hvorfor?

Teamet definerte tidlig hvordan prosjektet skulle gjennomføres, og utarbeidet en god strategisk plan. I denne planen definerte teamet først et løst utkast, før de ulike interessentene og deres behov i større grad ble inkludert og kartlagt. Like etter fulgte en endelig plan for produktet, med forventet utfall. En klar produktplan ga basis for vurderinger av de ulike risikofaktorene ved prosjektet, og utviklet en plan for hvordan de best kunne bli håndtert. Hver risiko ble vurdert med sannsynlighet som lav, middels eller høy risiko, med en effekt som enten tolererbar, seriøs eller katastrofal.

Flere av faktorene som ble identifisert førte til at teamet kunne ta høyde for flere fallgruver underveis i prosjektet, derav kunne en ta høyde for potensielle fallgruver som for eksempel problematikk i forhold til personvernloven. Her valgte teamet å gjøre all data anonymisert og starte hvert «rom¹» med en advarsel mot å legge ut personlig informasjon. Løsningen var ikke perfekt, men graden av risiko for sluttbruker ble langt lavere, dermed også lavere risikomoment for sluttprodukt.

Det var enkelte ting teamet ikke hadde sett som potensielle problemer på forhånd, men som viste seg å være problematiske underveis. Problemene handlet i større grad om hvor mye, eller nærmere hvor lite tid gruppemedlemmene hadde til å bidra til prosjektet. Dette faget krever i seg selv ukentlige leveranser, samtidig som samtlige gruppemedlemmer hadde mye arbeid på andre områder. I etterkant kan en derfor se at dersom dette hadde vært identifisert i forkant, kunne det blitt lagt opp en plan som tok høyde for dette. Problematikken rundt dette diskuteres mer i punkt 1B.

For å gjennomføre prosjektet effektivt og innenfor fristen valgte teamet å bruke smidige metoder for utviklingsprosessen. Teamet valgte å dele prosjektskyklusen i tre iterasjonssykluser,

¹ Rom menes med her egne opprettede chat rom.

altså tre mindre leveranser av prosjektet, der hovedleveransen var summen av de tre underleveransene. Teamet opparbeidet en buffer med tid og fikk mulighet til en ekstra nødvendig sprint². Resultatet ble implementasjoner som inneholdt noen viktige endringer i produktet, der slutfase inkluderte en demonstrasjonen for resten av klassen. Sprintene førte til god organisering av arbeidsmengde og bidro til struktur i utviklingen av produktet.

I den smidige prosessen legger en opp til tett samarbeid, men kommunikasjon mellom teamet og interessentene har vært mangelfull under utviklingsprosessen. Ønsker og behov påvirket risiko i lavere grad underveis i prosjektet, men per nå ser ikke gruppen at gruppens evne til utførelse av produktet har latt seg påvirke. I hvilken grad det har påvirket sluttproduktet er vanskelig måle objektivt i etterkant. I del 4 kan en lese mer om suksessfaktorer for prosjektet og i hvilken grad vi har oppnådd dem.

We evaluate our project management effort as successful

Scale	Strongly Disagree	Somewhat Disagree	Neither agree nor disagree	Agree	Strongly Agree
Your response		X			

² Pseudonym for iterasjon, mye brukt i arbeidsmetodikk som Scrum.

3. Selvvurdering av verdien for elevene - evaluering av prosjektets suksess

	Our product is of high quality and we recommend it to be used as learning aid in project management				
Scale	Strongly Disagree	Disagree	Neither agree nor disagree	Agree	Strongly Agree
Your response				X	

Målgruppen for prosjektet er todelt, siden det vil være underviseren som bruker produktet i sin undervisning, for å tilrettelegge og muliggjøre en høyere grad av læring, gjennom interaktivitet mellom underviser og elever. Dette gjør at vi ender opp med to (delvis) separate brukergrupper: elever/studenter og underviser. Mer spesifikt kan det sies at de som får mest utbytte av produktet er studentene som ikke er komfortable med å rekke opp handa i løpet av forelesningen, men som ville hatt høyere læringsutbytte ved å delta aktivt og svare på spørsmål. Det vil si at formålet med produktet er, og verdien som skapes for brukerne, en mulighet til å delta aktivt i forelesninger, selv for elever med lav intellektuell selvsikkerhet (Harrison & Howard, 2009) som ikke ønsker å vise sine potensielle misforståelser (Elliot, Hufton, Willis & Illushin, 2005). Dette vil føre til økt læringsutbytte, da det er en viktig faktor for læring å internalisere informasjonen, noe aktiv deltakelse er med på å gjøre (Arranz, 2017).

Ved hjelp av lek og en interaktiv økt fikk vi avdekket flere brukerkrav i systemet underveis. I slutfase ønsket vi en kvalitativ vurdering på produktet og har derfor gjennomført en SUS-undersøkelse.³ I denne undersøkelsen prøver en oppnå et resultat over 68, hvorav vårt resultat var 86 poeng. Dette viser at produktet har gode bruksegenskaper.

System Usability Scale

Instructions: For each of the following statements, mark one box that best describes your reactions to the website *today*.

		Strongly Disagree				Strongly Agree
1.	I think that I would like to use this website frequently.	<input type="checkbox"/>	<input type="checkbox"/>	<input checked="" type="checkbox"/>	<input type="checkbox"/>	<input type="checkbox"/>
2.	I found this website unnecessarily complex.	<input checked="" type="checkbox"/>	<input type="checkbox"/>	<input type="checkbox"/>	<input type="checkbox"/>	<input type="checkbox"/>
3.	I thought this website was easy to use.	<input type="checkbox"/>	<input type="checkbox"/>	<input type="checkbox"/>	<input type="checkbox"/>	<input checked="" type="checkbox"/>
4.	I think that I would need assistance to be able to use this website.	<input checked="" type="checkbox"/>	<input type="checkbox"/>	<input type="checkbox"/>	<input type="checkbox"/>	<input type="checkbox"/>
5.	I found the various functions in this website were well integrated.	<input type="checkbox"/>	<input type="checkbox"/>	<input type="checkbox"/>	<input type="checkbox"/>	<input checked="" type="checkbox"/>
6.	I thought there was too much inconsistency in this website.	<input checked="" type="checkbox"/>	<input type="checkbox"/>	<input type="checkbox"/>	<input type="checkbox"/>	<input type="checkbox"/>
7.	I would imagine that most people would learn to use this website very quickly.	<input type="checkbox"/>	<input type="checkbox"/>	<input type="checkbox"/>	<input type="checkbox"/>	<input checked="" type="checkbox"/>
8.	I found this website very cumbersome/awkward to use.	<input checked="" type="checkbox"/>	<input type="checkbox"/>	<input type="checkbox"/>	<input type="checkbox"/>	<input type="checkbox"/>
9.	I felt very confident using this website.	<input type="checkbox"/>	<input type="checkbox"/>	<input type="checkbox"/>	<input checked="" type="checkbox"/>	<input type="checkbox"/>
10.	I needed to learn a lot of things before I could get going with this website.	<input checked="" type="checkbox"/>	<input type="checkbox"/>	<input type="checkbox"/>	<input type="checkbox"/>	<input type="checkbox"/>

Her er SUS skjema avbildet fra en av de testede tenkte sluttbrukere.

Resultatet av testet produkt under en presentasjonen, ga mye positive tilbakemeldinger. Tilbakemeldingene ble gitt i selve chatten, men også i et spørreskjema vi gav ut i etterkant. Et sterkt flertall mente at dette verktøyet ville føre til at sannsynligheten var høyere for at de kom til å stille spørsmål i løpet av forelesninger, og alle mente at produktet var enkelt å bruke. Det ble også stilt spørsmål direkte til oss, under presentasjonen av produktet, noe vi følte hjalp mye

³ System usability scale, se <https://www.usability.gov/how-to-and-tools/methods/system-usability-scale.html>.

på å rette opp uklarheter rundt produktet. Det ble foreslått funksjonalitet som spam-kontroll og ord-filter, to funksjonelle krav vi allerede har diskutert internt og kunne ha videreutviklet til en senere versjon av produktet.

Evaluering av sluttproduktet har tatt utgangspunkt i hvorvidt vi oppnådde suksessfaktorene, samtidig som tilbakemeldingene fra brukertestene har gitt verdifull innsikt. Det ble dessverre oversett å lage suksesskriterier i planen, men fordi vi har såpass grundige suksessfaktorer og vi har gjort brukertester, blir det ikke galt å danne et helhetlig bilde av prosjektets suksess basert på dette.

Med gode tilbakemeldinger fra testbrukere og etter å ha vist gode samarbeidsevner og at teamet er tilpasningsdyktig, kan prosjektet sees i et veldig positivt lys. Til tross for opplevd tilfredsstillelse av produktet, er det visse ting som ikke er like positivt, som at prosjektet ligger bak skjemaet eller forsinkelser for utviklingen; dette blir videre diskutert i del 4. En kan derfor argumentere for at det er en «project success» men «project management» svikt, da produktet i seg selv er tilfredsstillende, men selve utviklingsprosessen var noe mangelfull, og var preget av dårlig utførelse fra teamet sin side. Sluttresultatet er bra, men for at produktet skal bli tatt ordentlig i bruk må det videreutvikles først, med utvidet funksjonalitet som for eksempel spam-kontroll og diverse verktøy for foreleser, eksempelvis sletting av kommentarer og at underviser vet hvem som har skrevet upassende innhold - dette for å forhindre misbruk av anonymiteten mellom elevene.

4. Faktorer som har bidratt til fiasko / suksess

I begynnelsen av prosjektet fokuserte teamet på å utarbeide mål for prosjektets suksess, samtidig som teamet etablerte gode kriterier for hvilket type produkt prosjektet skulle resultere i. Da prosjektplanen ble utarbeidet inkluderte teamet et sett med suksessfaktorer, for å kunne gjenkjenne og sammenligne karakteristikker for suksessfulle prosjekter med gruppens eget. Det ble derfor utarbeidet en enighet om hvilke kriterier som kunne bevisstgjøre hva god kvalitet var.

Følgende underoverskrifter identifiserer våre suksessfaktorer og sammenligner disse med suksessfaktorer identifisert i tidligere prosjekt hentet og inspirert fra Hussein, B. (2018). Merk at all tekst i kursiv er oversatte suksessfaktorer fra tabell på side 92, i Hussein, B. (2018).

Teamet må tilegne seg ferdigheter for å lage produktet

Kunnskapen i teamet er bestående av studenter som studerer IT, derfor er det en naturlig balanse i tekniske ferdigheter for å utvikle produktet. Hyppig tilnærming til ferdigheter som kreves for utarbeidelse av leveranse har vært en suksess, der vi har lånt teknikker fra XP og Scrum som metodikk. Ser vi til suksessfaktorer identifisert i tidligere prosjekter og tidligere erfaringer kan man finne eksempel på dette i for eksempel skjemaet presentert av Hussein, B. (2018) gjennom suksessfaktorene *Erfaring fra tidligere prosjekt* og *Ferdigheter, kunnskap og kompetanse*, samtidig også *Rene ferdigheter*. Smidig arbeidsmetodikk identifiseres som: *Bruk av rett prosjektutførelses metodikk*.

Tildeler nok tid til arbeidet

Prosjektsyklusen har til tider vært uorganisert og ukoordinert da medlemmene i teamet har hatt forskjellige arbeidstider Dette har vært et problem av lavere grad assosiert med suksess. Grunnlaget for at dette har vært lite problematisk baseres på de klare målene utviklet i prosjektplanen og beskrivelsen av prosjektets produkt. En av fallgruvene til teamet kan være mangel på bevisstgjøring av timeføring og detaljert rapportering. Konsekvent ville dette gitt

bedre innsikt for analyse slik at vi kunne håndtert distribusjon av tid mellom teammedlemmer bedre. Suksessfaktorer identifisert i Hussein, B. (2018), viser til *ærlighet i rapportering og Kontinuitet i prosjektutviklingen*.

Har god samarbeidsevne

Teamet har ikke hatt utfordringer med samarbeid, til tross for tidvis skjev arbeidsfordeling er det kun graden av involvering av interessenter som burde vært bedre. Hussein, B. (2018) oppgir «*God nok kommunikasjon til rett tid mellom prosjektet og interessenter og transparenthet*» som suksessfaktorer. «*Samarbeid innad i prosjektorganisasjonen og balansert prosjektgruppe som representerer alle deler av interessenter som påvirkes av prosjektet*» er også andre kriterier teamet håndterte svakt. Grunnlaget for påstanden kommer også fra manglende innflytelse fra interessenter som kan leses mer om under punktet «*God kommunikasjon med interessenter*».

Gjensidig mål og avtale om hva sluttprodukt er

Dette er en av de klareste suksessfaktorene teamet har gjennomført innad og utarbeidet. Klarhet i mål har en klar sammenheng til *Klarhet i prioriteringer strukturerte mål, prosess*. Et av kriteriene vi kan klassifisere som fiasko innad er strukturering av oppgaver mellom teammedlemmer. Her kunne medlemmene hatt større innflytelse, og Hussein, B. (2018) har identifisert dette som viktig gjennom faktoren *Klarhet i prioriteringer og en strukturert krav prosess*.

God kommunikasjon med interessenter

Tidligere nevnt i «*Har god samarbeidsevne*» viser vi til at manglende kommunikasjon med interessenter har forekommet. Dette kan sies å være vår fiasko, da kartlegging av ønsker har vært noe for lite objektiv og vanskelig gjennomføre. Hussein, B. (2018) sin tabell viser til følgende:

- *Nærhet til sluttbrukere, ledelse og HR.*

- *Samarbeid mellom interessenter og prosjektteam.*
- *Sluttbruker, intressenter involvering*
- *Samarbeid med ledelse i interessent organisasjon med prosjektteam*

Motivert prosjektteam

Teamet har ikke opplevd problemer med motivasjonen for prosjektet, noe av dette ligger i suksessfaktoren *Klarhet om mening og mål i prosjektet* forutenom at faktoren er en faktor i seg selv identifisert i tabellen. En annen grunn til at dette forekommer kan også være at vi ikke har kommet over i normeringsfasen i prosjektet⁴.

Evne til å spre arbeidet over tid

Suksesskriterie er identifisert som godkjent, hvorav teamet viser til dette med å benytte rett metodikk. Hussein, B. (2018) kan vise til dette gjennom *tidlig og grundig nok planlegging* og også *structured risk management process* på bakgrunn av at de er ulike faktorer som hjelper med god planlegging og struktur. Suksessfaktoren Hussein, B. (2018) nevner som direkte er i relasjon til dette beskrives; *Kontinuitet i prosjektutviklingen (korte iterasjoner)*.

Egenskaper til å autonomt håndtere arbeid

Hussein, B. (2018) nevner eksempel på *fleksibilitet* som en suksessfaktor, hvorav teamet evner dette. *Fleksibilitet* kan sammenlignes med «Egenskaper til å autonomt håndtere arbeid», samtidig som den drar klare paralleller til opprettelse av konkrete mål, som beskrevet under «Gjensidige mål og avtale om hva sluttprodukt er».

Faktorer vi ikke har identifisert på forhånd:

- *Klarhet om biases, heuristikk som overoptimisme, for trangt fokus og antakelser.*
- *God dokumentasjon og rapportering*

⁴ Hellriegel, Don; Slocum Jr., John W.; Woodman, Richard W. (1988)

- *Rutiner for håndtering av avvik- og endringskontroll*
- *Lojalitet til valg*
- *Forbigåelse av krav*

Den mest signifikante faktoren - Fiasko

«God kommunikasjon med interessenter» - Vi tror det er stort forbedringspotensiale i produktutviklingen med å tettere interessent samarbeid, der teamet kunne identifisert og forbedret flere andre ledd av prosjektets suksessfaktorer på bakgrunn av identifiserte fiasko.

Relasjoner til 4 ulike andre suksessfaktorer, presentert i dybde i litteratur som Hussein, B. (2018), viser at interessentsamarbeid er en kritisk suksessfaktor. En akkumulert liste på 63 publikasjoner presenter graden av viktighet, hvorav 31 av disse siterer klare og realistiske mål og 24 siterer til brukerinvolvering som suksessfaktorer i prosjekter.

Uten tidligere erfaringer ville ikke prosjektet hatt like stor grad av funksjonalitet, noe teamet har høstet godt av dette underveis. Ser en til andre analyserte fiaskoer som prioriteringer av oppgaver er det ikke vanskelig å trekke antakelser om ringvirkninger fra denne fiaskoen, derav er «God kommunikasjon med interessenter» trukket frem som mest signifikante suksessfaktor.

5. Den viktigste lærdommen fra prosjektet

Erfaringer fra dette prosjektet er bundet opp mot graden av involvering av interessenter i prosessen. Vi vil anbefale andre som skal begi seg ut på lignende prosjekter å involvere interessenter tidlig. Dette er viktig for den iterative prosessen, dermed også vår valgte metodiske tilnærming og gir ifølge Hussein, B. (2018) et bedre sluttprodukt. En undersøkelse rundt produktet kunne vært gjennomført før utviklingen begynte, dermed kartlagt interessentene sine ønsker og krav. Dette ville latt oss tilpasse og prioritere arbeidet i et slikt prosjekt, for å lettere kunne tilfredsstille så mange interessent ønsker og krav som best mulig.

Resultatet av tidligere og mer involvering av interessenter ville gitt et mer polert produkt, og om ikke bidratt til en bedre strukturert plan for videreutvikling. Videre har teamet erfart at å se på klassiske suksessfaktorer nevnt i faglitteratur og jobbe mot dette er nyttig, da man unngår med dette å havne i vanlige fallgruver for prosjektledelse og produktutvikling.

Det er kritisk at alle teammedlemmer er involvert i planleggingsfasen. Valg av teknologiske løsninger og annet burde gjennomføres plenum med teamet slik at eierskapet til de teknologiske utfordringer eies av et helt team og ikke av én person alene. Utvikling burde også foregå med klare funksjonelle og ikke-funksjonelle mål, som er brutt ned i enkle oppgaver. Disse oppgavene burde være utformet slik at hele teamet forstår de.

Graden av teknologisk gjeld⁵ blir høy om ikke deling av kode forekommer mellom gruppemedlemmer. Det er mange strategier for hvordan gruppemedlemmer kan arbeide sammen effektivt i team på mindre og større kodebaser med tilhørende paradigmer. Adopsjon av en slik teknikk muliggjør trinnvise prosesser som lar en fordele samme ansvarsområde på flere personer, slik at en får et mer enhetlig produkt og mindre grad av gjeld ved sykdom. En av disse prosessene en kan adoptere, som er trinnvis beskrevet i XP, er:

- Parprogrammering, utføre programmering i par slik at en samarbeider

⁵ Teknologisk gjeld betyr graden av uforståelig eller mengde kode som andre må sette seg inn som er lite dokumentert, svakt strukturert eller bærer stort preg av subjektivitet.

- TDD (Akronym for testdrevet utvikling), utfører minimale implementasjoner med tilhørende kjørende enhetstester
- Refaktoring, tilpasser koden til standard satt av teamet og kvalitetssikrer
- Pull requests, versjonskontroll historikk hvorav hver forandring må godkjennes av en annen i sitt team for å bli en del av sluttprodukt

Teknikkene nevnt over er eksempler på metodikk for å skape mer helhetlig prosess rundt utviklingen, få god informasjonsflyt og sikre involvering av interessenter i prosess. Vi ser at slik planlegging kan motivere medlemmer av teamet i større grad, derav løse en av våre hovedutfordringer innad i teamet.

Avslutningsvis har prosjektet vært en positiv opplevelse for teamet, selv om ikke alt har gått helt på skinner. Teamet har hatt stort læringsutbytte fra selve prosessen i å utvikle et produkt som teamet selv hadde muligheten til å utforme.

6. Referanser

Please use (Author-date) style when you writing your references as follows:

Elliot, N.R., Hufton, W., Willis, L. & Illushin, J.G. (2005) Motivation, Engagement, and Educational Performance. UK: Palgrave Macmillan.

Hussein, B. (2018). The Road to Success: Narratives and Insights from Real-Life Projects, Fagbokforlaget.

Hellriegel, Don; Slocum Jr., John W.; Woodman, Richard W. (1988), Organizational Behavior, 8th ed., South Westen College Publishing, Cincinnati, Ohio Pages (228 - 266)

Hammond, E, M. (2015). «*My hand is up, therefore I am a good learner: A study into Year 4 pupils' perspectives on voluntary classroom participation*»

<https://jotter.educ.cam.ac.uk/volume7/107-136-hammondem/107-136-hammondem.pdf>

University of Cambridge - Faculty of Education

Arranz, Ainhoa (2017). «Significant learning: How do we internalize information?»

<https://blog.cognifit.com/significant-learning/>

https://www.eduhk.hk/apfslt/download/v12_issue1_files/ates.pdf

<https://www.usability.gov/how-to-and-tools/methods/system-usability-scale.html>

Peer-review report

What is the name of the group you are assigned to evaluate: **Group 27**

Styrker

Gruppe 27 sin idé om en side med sammendrag av de ulike kapitlene fra læreboken samt mulighet for brukeren å teste sine kunnskaper gjennom en quiz fungerer svært godt. Brukeren får en god oversikt over de ulike mulighetene som finnes på siden og den har alt i alt et svært godt og intuitivt design som er lett å sette seg inn i.

Verdien i siden er stor ettersom den tilbyr mulighet til å både lese pensum samt teste ens kunnskaper gjennom quizer som er spesielt utviklet for sammendragene på siden. Produktet er også av svært høy teknisk kvalitet og demonstrerer høy kompetanse innenfor webutvikling og design.

Svakheter

Hovedmålet med digitaliseringsprosjektet var å gi elever tilgang til et produkt som gir signifikant påvirkning på læringen. I dette tilfellet er det implementasjonen av pensum og quiz som gjør at prosjektet møter kravet satt i oppgavebeskrivelsen. Grunnen til at dette trekkes frem er at det er flere forekomster av manglende pensum (kapittel 4 - 10) i forhold til hva prosjektet legger opp til. Nederst på siden er det en del innhold på som beskriver prosjektet, hvordan det er laget og av hvem. Siden dette er innhold som ikke vil ha noen signifikant påvirkning på læringen til studentene, kommer det opp et spørsmål om vurderingen av ressurser var helt riktig. Mulig implementering av pensum skulle kommet over implementasjonen av punktene «About», «Our Story» og «Team». Det er også et spørsmål om de nevnte punktene kan virke noe forstyrrende for enkelte studenter.

Utenom dette kunne også brukergrensesnittet hvor man velger hvilken quiz man ønsker å ta, vært noe mer intuitiv. Det er et veldig stort problem, men det følger ikke helt satte designprinsipper og sedvane for bruk av nedtrekksmeny.

B)

Please evaluate the degree of your support to the following statement (group-based evaluation):

	The product we reviewed is of high quality and we recommend it to be used as learning aid in project management				
Scale	Strongly Disagree	Disagree	Neither agree nor disagree	Agree	Strongly Agree
Your response				X	

C)

On a scale from 0 to 10. What grade would you recommend for this product?

Vi vurderer produktet til **8** på en skala fra 0-10

Quotes based on the truth of selected journals and magazines:

“How project management became the best
class of NTNU”

NTNU Magazine

“A unique experience”

The New York Times

“This is a true game changer”

IGN

“The new era studying has arrived”

Washington Post

“After seeing this app, I knew I made the
right choice of becoming a teacher”

Bassam Hussein

Content list

1.	Preface.....	iii
2.	Digitalization projects	1
3.	Self-evaluation of the project management effort in the project, success or failure? And why?	5
4.	Self-evaluation of the value to the learners? (evaluation of project success) Can you document your assessment?	7
5.	Factors that have contributed to failure / success.	12
5.1	Communication	12
5.2	Project team.....	13
5.3	Project schedule and WBS	13
5.4	Programming skills of two members	13
5.5	Project Management Skills of two members.....	14
5.6	App creation	14
6.	Most important lessons from your project	15
7.	References.....	16
8.	Peer-review report of Group 33	17

1. Preface

This report shows a short and general overview of digitalization projects and the main challenges that arise when digitalization projects are realized. The purpose of this paper is the examination of the projects, which we carried out. Firstly, a short description of the project will be presented as well as its main goals. Additionally, it will be discussed thoroughly, if the project can be seen as a failure or as a success. The evaluation of the project is based on the success criteria mentioned in the project plan. Moreover, an elaboration on all the factors that contributed to the success or to the problems will be given.

Furthermore, this report includes the evaluation of the impact, the created product had on test-subjects and a peer-review report of the product produced by other students.

In addition, this report also includes a chapter where “lessons learned” are being discussed and if there were any present.

Lastly, the evaluation of a different group (33) is conducted at the end of the document.

Group number: 36

- 1) Jeljer de Boer 519313
- 2) Kelwin Koets 519184
- 3) Elisabeth Peitl, 519903
- 4) Luisa Riedlinger, 518962
- 5) Markus Sturl, 519188

2. Digitalization projects

A) *Describe your product, its intended purpose and why you have selected to produce this product.*

The type of product will be an **interactive app** (Project FIX) containing content targeted at the specific user, in this case students. Studying is made exciting and interesting again with real examples taken from their favourite content, like *Scrubs*, *Master Chef Australia* or *Friends*. When studying *Project Management*, the topic could be *stakeholders*, *success factors* or many more. The app works as the following:

- In the home screen you have the option to enter different menu's. For instance, information, contact information or external websites. In addition, you can choose your favourite series or movie.
- When you click on the content of your choice you will start a quiz. Each quiz consists of multiple video fragments.
- After watching each video, you have to answer a question about the video. All the questions are related to Project Management.
- When you have answered all questions of a quiz you can submit your results and see if you passed or not.
- When done with a quiz you can go back and choose another series or movie!

The purpose of the Project is to create a learning aid, in form of an interactive App, that conveys basic project management principles and guidelines in combination with suitable examples in order to improve the studying output of the users.

We detected the necessity of the App as we took part in project management courses in university. Although the lectures were good and the learning material was decent, the connection to real-life examples where missing or done poorly. Out of this reason we decided to bridge the gap between theory and practice with the ProjectFix App.

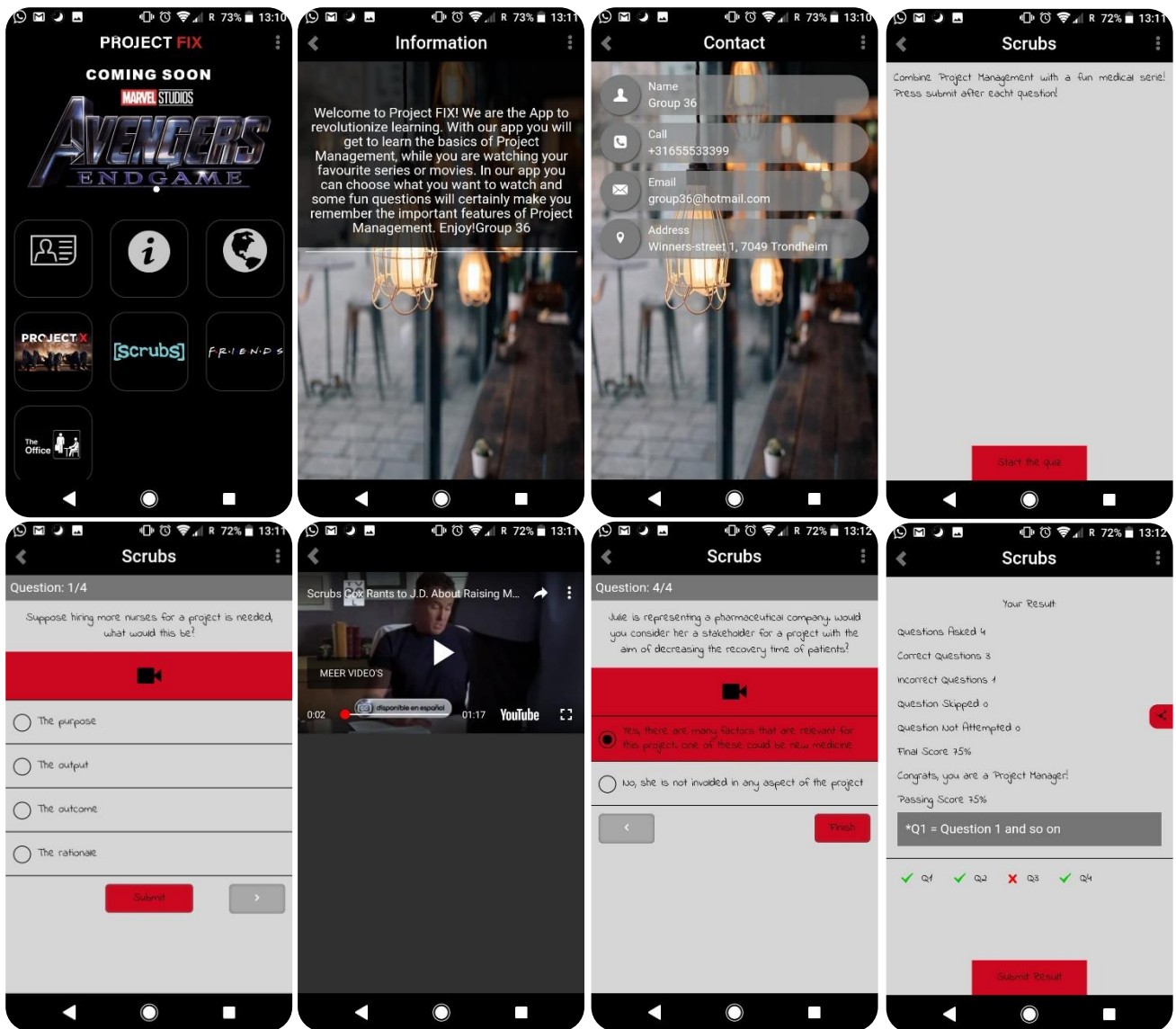

B) *After having the opportunity of working on a small-scale digitalization project, what are, in your, opinion the main challenges that your group has experienced with this type of projects? You should base your statements on your own reflections and preferably support these reflections using project management literature.*

IT and software projects can be categorized as digitalization projects. It restructures social and work life around digital communication and media infrastructures. Digitalization projects' main challenge is to capture and manage successfully the expectations of diverse stakeholders, especially those of the end-users. One success factor of digitalization projects is to plan on small deliveries instead of doing everything at once. Additionally, it is important to continuously follow-up the project outcome throughout all project phases [Hussein, B. (2018) p. 15].

Our first challenge as a group was to find **a way of how to learn project management with an interesting, new touch**. Our goal was to find something special, that makes project management more fun than it already is and to combine different styles of learning – watching and reading – within one platform. We wanted to create something that was tangible and also feasible because spending resources on creating something no one can use, doesn't make any sense. There is no company or project in the world, which goal it is to waste time. And we wanted to work on something that is fun for us too. That makes work easier. Because of this, we created an app where we could integrate our free time activities.

Another main challenge we have experienced as a group when we were working on a digitalization project was to find an **appropriate software**/program/app for the idea we wanted to bring to life. As we had one specification of our customer – a product that can be used on i-phone, i-pad, or PC and must have a significant impact on learning – we knew that we either have to invest quite a lot of money so that a third party would create the App through coding, or we would have to teach us the necessary skills ourselves.

That led us to our next challenge: **financial resources**. As full-time exchange-students busy with studies we don't have the possibility and network to get our project funded or to ask qualified programmers. We could have asked our instructor for help, but that did not come to our minds. Therefore, we decided to find a solution, which didn't have an impact on our budget.

This resulted in our next challenge: **time**. Finding a suitable software with which we could design the App for our needs and specifications was difficult but doable. After we cleared this hurdle, we had to make our self familiar with the software and how we can operate with it.

Additionally, the time spent on finding appropriate input material (videos combined with project management literature) must not be forgotten.

These facts combined with the different backgrounds and knowledge of the members, made it difficult to schedule meetings.

The “resource conflicts” applies here in terms of the project team-members, which also have compulsory work and assignments to do for other courses, that they are attending.

Another main challenge of our project is the stakeholder satisfaction (with reference to Hussein, B. (2018) p. 15: to capture and manage successfully the expectations of diverse stakeholders).

To understand the needs of the stakeholders, they have to be identified and examined thoroughly. Due to the fact, we weren't able to contact our stakeholders and ask them about their needs and wishes, regarding the project, we tried ton empathizes with the stakeholders

and decided on their needs and wishes on our own. The priorities are listed below (regarding their importance, whereas 1 has the highest importance and so on):

1. Finished product
2. Complying with the timeframe
3. App can be downloaded in the App-stores
4. No bugs in the App
5. Customer friendly interface
6. Easy to use/handle
7. Being on Budget

3. Self-evaluation of the project management effort in the project, success or failure? And why?

After the launch of our product we can now reflect on the project management effort and how we approached the best version of our final product by meeting the success factors we set in the planning phase. A Self-evaluation is the best way to make sure what pitfalls can be avoided and to figure out what we can do better in the future.

One of our most important objectives was to make our Stakeholders happy and to provide them a good result. We did our best by holding meetings every two weeks where we discussed the progress and any hurdles we had. We asked them throughout the project if they want any changes or if the main goals changed. We additionally created and evaluated surveys, to find out what kind of person our stakeholders were.

Our stakeholders had certain requirements which we tried to meet. The main idea/requirement was a digital learning platform to teach the basic principles of project management. To us, it was very important that the final product not only provided the theoretical principles but gave the users the opportunity to apply them in real life situations. We were able to accomplish this goal, by implementing short-stories into the app and providing the user with a realistic situation. This enables the user to adapt the gained knowledge to the certain situation at hand.

Another important success factor was to meet the set budget of our client. Due to the fact that it was a low budget project we had to achieve all the deliverables intern and had to avoid outsourcing at all cost. There we faced a big challenge because we worked with an app building program that could only provide a prototype/ test version of the final product for 5 days. In the end, we had to buy the extended version of the program to make sure the app can be used respectively longer than the 5 days. This issue caused quite some trouble in the end because we had to evaluate if it is worth blowing the budget. We decided that a functioning App was more important than the budget regulations and invested the money nonetheless.

In the end, the budget regulation issue caused a little delay within the final milestone-plan because we had to discuss how we would solve the problem. But we were able to get back on track as we extended our scope of work and took an all nighter, so that we were in time.

The quality requirements were very important and mandatory for the clients, since the stakeholder's satisfaction had a great importance throughout the project. Therefore, we tried to implement all of the customers proposals in the final product.

Finally, the team satisfaction was of great value. We had a good working environment where every individual had the opportunity to state its opinion, that always were respected and appreciated. Communication always went well and there were no misunderstandings while working on the project.

Considering the self-evaluation, the project was a success. We almost met all the success factors we wanted to achieve, and the number of pitfalls were marginal.

A) *Please evaluate the degree of your support to the following statement (group-based evaluation):*

We evaluate our project management effort as successful

Scale	Strongly Disagree	Disagree	Neither agree nor disagree	Agree	Strongly Agree
Your response					

We conclude, that the project is a success based on the final product. Throughout the project there have been some bumps in the road, but we were able to overcome them and create the amazing App for ProjectFix. The Apps works just the way we wanted it too and we were able to finish the App on schedule which meant no delays for our customers. The peer review, that we conducted in order to analyze if the App is suitable, came back with the average grade of “good” and with some really nice suggestions for improvement, which we included in the final product. As we presented the final product to our client, they were really satisfied and approved the App.

The reason why ProjectFix is not a total success (see the table above) is due to the fact that the budget was blown, and we weren’t able to comply with the set costs.

4. Self-evaluation of the value to the learners? (evaluation of project success) Can you document your assessment?

A) Describe your target audience and the learning objectives of your product

The target group of our product are students who have just started to study project management or related fields, project management interested individuals, people who are in contact with project management in their line of work, individuals who are trying to get a grasp of the project management principles and people who want to polish their general knowledge and maybe even their resume.

The main objective of ProjectFix is to provide a learning aid for all aspiring project managers. By using real life situations, the App provides the user with several possibilities, from which they must choose. Linking them to the project management literature, resulting in theoretical and practical knowledge gained. The situations are project management related and should enable the users to understand the vibe of the situation. After choosing an option (1 out of 4) the App elaborates the user if the answer is correct or not.

This process should enable the user to understand the main principles of project management and how they can be used and applied in real-life situations.

B) A description of the method used to evaluate the final product

For the evaluation of the product we decided on involving project management students and possible future project management students as these could be users of our product. Additionally, we sent some surveys to project management companies, explaining our project and providing them with an overview of the product and ask them to let their juniors, apprentices and trainees answer the questions.

We decided on creating a questionnaire as it is a popular method and therefore, it is easy to understand by the people which are answering the questions. Due to the limited budget, we decided to go with a questionnaire because it has low costs, is conducted easily and even trainees can be used in order to gather the wanted information. Moreover, respondents have adequate time to respond and can be anonymous on request (Annotation: no one wished to remain anonymous). There is no need to visit testers personally as a questionnaire can be easily sent by e-mail. Some respondents were asked in person, at universities, at companies and somewhere contacted through e-mail.

In the end, we were able to receive 73 filled out surveys which we were able to analyze, detect similarities and target issues more precisely.

To evaluate our product for the end-users needs we decided on asking testers the following questions:

1. How would you describe the installation process?
2. How do you like the visual appearance of the learning App?
3. How is the handling of the App?
4. Do you generally like the idea of a project management learning aid?
5. Would you use the App in order to improve your skills?
6. Would you purchase the App?
7. Would you recommend the App to aspiring project managers?
8. Is there anything else you'd like to share, regarding the App?

With these questions we were able to understand how the end-users feel about the product and gives us a chance to discover flaws or improvements. Furthermore, we reviewed the goals and standards, that were set by the customer, and compared them with the final product. A checklist was used in order to analyze the product and the requirements.

C) The number of informants who have contributed to the evaluation, and how these informants have been selected

A total of 150 surveys have been handed out or were sent by email. Out of these 150, 73 surveys got returned filled out, 13 were inadmissible and 64 haven't responded at all. As explained earlier, the survey was conducted by trainees and people who are doing apprenticeships in project management related companies. Furthermore, the surveys were sent to universities, especially to project management departments, with the request to let their students answer the question.

All participants who agreed to fill out the survey, received a temporary link, which enabled them to download a test version of the App to their phone, which was free from charge throughout a 7-day-trial period. It was asked of the participants to spend some time on the App, play around with it and get to know it. After they reviewed the App and its features, they filled out the survey and forwarded them to us. The participants had a time frame of three weeks in which they could return the questionnaire to us.

Due to the fact, that the App was designed for individuals who are just getting started with project management and need some help understanding the basic principles of it, we chose young project managers and mainly students for the survey. There was no differentiation between gender or race. The only criteria that had to be met, was the interest in project management.

D) Results of tests, surveys or interviews with students or persons who have reviewed the final product

The results of the surveys were rather positive (see chart below). Most of the participants were happy about the installation process, satisfied with the appearance and the handling of the learning aid. 46,66% have a positive attitude towards an App that helps you understand the basic principles of project management and 63,71% would download the App in order to improve their knowledge and skills.

How would you describe the installation process?		
Fast & easy	Complicated	Needed help
94,00%	4,00%	2,00%

How do you like the visual appearance of the learning aid?				
Excellent	Good	Ok	Improvable	Horrible
36,12%	23,91%	29,27%	7,82%	2,98%

How is the handling of the App?				
Excellent	Good	Ok	Improvable	Horrible
31,10%	19,30%	45,43%	3,10%	1,07%

Do you generally like the idea of a project management learning aid?		
Yes	Not sure	No
46,66%	39,45%	13,89%

Would you use the App in order to improve your skills?		
Yes	Not sure	No
63,71%	19,56%	16,73%

Would you purchase the App?		
Yes	Not sure	No
45,35%	31,28%	23,37%

Would you recommend the App to aspiring project managers?		
Yes	Not sure	No
41,05%	36,89%	22,06%

Is there anything else you'd like to share, regarding the App?

Apart from the closed questions, the open question at the end of the questionnaire enabled the participants to add any information, they felt were important. As a result of that, we received some interesting suggestions and feedback:

- I really enjoyed the simplicity of the App and how knowledge is transferred in a easy and fun way.
- The videos are a nice idea and provide a hands-on learning. Great!
- Id wish there would be levels, in terms of knowledge levels that you can wok up to, over some time. So, a beginner, intermediate and pro level

- There are some bugs that need to be fixed (starting time)
- Would be nice if you could watch the video several times, in case you missed something or got distracted
- Subtitles would be amazing, so accents don't present a problem

These insights gave us quite a motivational boost along the way, but also pointed out, areas that still needed improvement. After the surveys have been analyzed, we added subtitles to the videos, corrected the mentioned bugs and presented a level system to our customers. Especially the idea with the different skill levels provides us with a great opportunity for follow-up projects, after this one is finished.

E) Please evaluate the degree of your support to the following statement (group-based evaluation):

	Our product is of high quality and we recommend it to be used as learning aid in project management				
Scale	Strongly Disagree	Disagree	Neither agree nor disagree	Agree	Strongly Agree
Your response					

The members of the project management team are certain that they produced an App that can help individuals to understand the basic principles of project management and are able to apply this theoretical knowledge onto real-life situations. It's definitely a good and sufficient tool, for individuals who are just getting the hang of project management.

5. Factors that have contributed to failure / success.

Throughout every project, a team was confronted with hurdles that they had to overcome in order to deliver a successful project. Our project-team consisted of five people with a total of three different nationalities (two Austrians, one German and two guys from the Netherlands). After we joined forces, we sat down together and talked about our goals, our ambitions and the amount of time we want and can invest into the project. After the guidelines and ground rules were set, we started to divide the task and the workload between each other. Regarding the skillset of every team-member, we chose to assign task that would fit the individual members in order to evade the overload of team-members. The next couple of subchapters will elaborate all the factors that played a role in the success of Project Fix.

5.1 Communication

Since the course was being held in English, we decided to communicate and collaborate exclusively in English. Due to the reason that all team members got along really well, right from the start, there weren't any miscommunications throughout the project. We scheduled a total of five meetings, where we discussed the project thoroughly and solved all upcoming questions. We helped each other out, brainstormed together, collaborated with the main purpose of producing an amazing product. Luckily all of our team-members had the same goal in mind, so everyone did their best, in order to succeed. In order to create a good working environment within the team, we undertook several activities as a team. We had dinner together, met for coffee, went on a cabin trip and even held a cook-off. These activities really helped the team to grow and also to bond at the same time. We got to know each other better and became friends along the way. This helped the project immensely, in terms of working together and helping each other out, to create the best possible outcome.

Regarding the ground rules for communication, all members had the same in mind: everyone can share their thoughts, everyone is being heard, there are no bad ideas or contributions, everyone is being treated respectfully and no one is being left out.

5.2 Project team

As elaborated in the chapter before, the project team was a great success. All the five members understood each other right of the bat and worked together without any problems. The working environment was always relaxing and understanding and the good thing about it was, that the members didn't only meet up to discuss the project but also to hang out and enjoy some quality time together. Due to this fact, the understanding of each other grew dramatically and therefore the collaboration took place, even smoother than expected. The respectful interaction between the members promoted everyone to think and speak freely without having to be concerned about mockery. This led to quite a lot of ideas and finally created the idea of the Project Fix App.

5.3 Project schedule and WBS

One of the biggest hurdles, our team had to face, was the deadline of the project. Due to the fact that all members were also taking other courses, were busy with assignments and also travelled around the country, time was always an issue. To conquer this hurdle, all members sat down together and planned the project thoroughly (milestone-plan and WBS). An Excel sheet was created, where every member marked free dates to plan meetings and jour fixes. In these meetings the members determined the scope of the project, how many hours have to be invested, who is responsible for which parts, when the WBS have to be finished and which members would collaborate.

The deadline was set by the customer and a postponement was not possible. Therefore, the members had to define the schedule of the project at the start, so that no one would be overstrained with the workload.

This worked out quite well and the workload was dealt with, without anyone struggling or being under pressure.

5.4 Programming skills of two members

One of the biggest success factors was that two of the members had some experience in creating an App. This saved the team quite some trouble and time at the same time. These two members took it upon themselves to create the App alone while the other members supported them and took care of the other tasks.

5.5 Project Management Skills of two members

It was a real advantage for the team to be equipped with two members that are studying Project management and have knowledge about it. They both have certifications in the area and helped the team out to understand the basic project management guidelines and rules. They knew what tasks need more effort and which ones can be done with less attention and workforce.

5.6 App creation

During the App creation process everything looked fine and no problems appeared. But due to the fact that we used a freeware software to create the App, there was a limited timeframe in which the App would work. After five days the App stopped working and the progress was about to be lost. The team-members decided to purchase the software in order to present a working product to the customer. All members approved the purchase of the software. This enabled the team to own a working software that the customer most certainly will be happy with.

Summed up there were quite some success factors for the project team that enabled them to produce an amazing product and deliver it on time, although not on budget (due to the software purchase). Since the deadline of the project was set in stone from the start and the additional costs weren't the biggest issue of the client, it was necessary to produce a working product within the timeframe! The communication of the members was excellent, if not exceptional and made the project a great success. Hurdles and problems were overcome due to teamwork and cooperation.

6. Most important lessons from your project

Before deciding on the type of product to create, you should first identify the learning objectives of your final product. After that my advice is to write a project handbook. It has all project plans included and specifies the steps of the project. We learned that carrying out an IT project requires skilled project team members. Having all needed resources within a team and not being dependent on outsourcing or external help, saves time and money.

We were lucky to have app developers (beginners, but still) and project managers (beginners, but still) in our team. Moreover, the project team members shared the same culture/humor, which made collaboration easier and more fun. (This may also be a result of going out together, only to grow together as a team, which is very important for projects.) Additionally, it is very important that the team members show commitment. This serves as a motivation for everyone involved.

Furthermore, it is essential to trust each other and to know that the tasks will be carried out. Another “lessons learned” is, that communication is the most important factor in projects. WhatsApp is a great tool for small groups to stay in contact, however, it is inevitable to meet in person to proceed with tasks. Regular communication and contact are essential to have an overview of the progress of the project and helps with planning. When it comes to projects, time is always a rare resource. Our experience suggests planning in the beginning of a project helps to get things done in time. It is also an advantage to have a person taking care of the progress and of deadlines. As perfect as a project schedule seems, projects never stick to the plan. Either deadlines are postponed, or tasks are left undone. Although we postponed deadlines and tasks, we were able to submit the product in time.

7. References

Hussein, B. (2018). The Road to Success: Narratives and Insights from Real-Life Projects, Fagbokforlaget.

8. Peer-review report of Group 33

A) *Based on your evaluation (as a group) please indicate the strengths and weaknesses of the final product.*

Strengths

The idea of the digital learning aid is innovative and up-to-date. Additionally, it combines different ways of learning: watching, reading and listening, which increases the efficiency of learning and remembering. Furthermore, the distribution and access of the learning aid to the learners can be easily provided. The quality of the product is excellent. The different topics of project management (referring to the type of the learning aid) can be learned/watched on different devices (mobile phone, laptop) and this makes this product even more valuable for students as it is possible to study wherever they are. Additional learning material is possible. An additional advantage is that this type of studying does not consume a lot of time. Finally, the presentation with the combination of Kahoot is a very good idea how to advertise the learning aid and to get feedback for it immediately.

Weaknesses

The video may include a lot of information (reading and listening), however, there is no studying without input material. As an extra, there could have been an introduction to the learning aid.

B) *Please evaluate the degree of your support to the following statement (group-based evaluation):*

	The product we reviewed is of high quality and we recommend it to be used as learning aid in project management				
Scale	Strongly Disagree	Disagree	Neither agree nor disagree	Agree	Strongly Agree
Your response					

C) On a scale from 0 to 10. **What grade would you recommend for this product?**

9