

The Insulation of HVDC Extruded Cable System Joints.

Part 1: Review of Materials, Design and Testing Procedures

Prepared by the IEEE DEIS HVDC Cable Systems Technical Committee

G. Mazzanti, Chair

Dept. of El. Energy Engin. Information
University of Bologna
Viale Risorgimento 2
Bologna 40136, Italy

J.Castellon

Institute of Electronics and Systems –
University of Montpellier
860 rue de Saint Priest
Montpellier 34090, France

G. Chen

Electronics and Computer Sciences
University of Southampton
University Road, Highfield
Southampton SO17 1BJ, UK

J.C. Fothergill

Professor Emeritus, City University
London, Northampton Square
London EC1V 0HB, UK

M. Fu

Electric Power Research Institute
China Southern Power Grid
Guangzhou 510080, China

N. Hozumi

Dept. El. & Electronic Inform. Engin.
Toyohashi University of Technology
1-1 Hibarigaoka, Tempaku-cho
Toyohashi 441-8580, Japan

J.H. Lee

Dept. of Electrical Engineering

Hoseo University
Asan, Chungcheongnam-do
Asan 336-010, South Korea

J. Li

Dept. High Voltage & Insulation Eng.
College of Electrical Eng.
Chongqing University
Chongqing 400044, China

M. Marzinotto

TERNA
Engineering Department
Via della Marcigliana 911
Roma 00138, Italy

F. Mauseth

Norw. Univ. of Science and Tech.
Dept. of Electric Power Engineering
O.S. Bragstads Plass 2E
Trondheim 7491, Norway

P. Morshuis

Solid Dielectric Solutions
Herensteeg 17
2311 SG Leiden, The Netherlands

C. Reed

USA Consultant
Private Consultant
Scotia, New York 12302
USA

I. Troia

Prysmian Cables & Systems
Research & Development Headquarters
Via Ansaldo
Milan 20100, Italy

A. Tzimas

Advanced Energy
High voltage products group
Unit 10, Hawthorn Road,
Littlehampton, W. Sussex,
BN177LT, UK

K. Wu

State Key Lab. of Electr. Insul. Power
Equip., Xi'an Jiaotong University
28 Xianning West Road
Xi'an 710049, China

ABSTRACT

This position paper by the DEIS HVDC Cable Systems Technical Committee provides a review of existing diagnostic electrical and dielectric techniques for testing the insulation of polymeric extruded HVDC cable joints in the present Part 1. Here, the state of the art on the insulation of HVDC extruded cable system joints is covered with reference to types, design and testing techniques. This helps to identify routine tests as the first target for the onset of new testing procedures, AC-PD measurements as the readily-available measurement from manufacturers' practices for quality control of the insulation of accessories during routine tests and VHF/UHF wireless sensors as the best tool for performing such measurements on joints in the noisy factory environment. Thereby, a novel protocol for the measurement of partial discharges using AC voltages and VHF/UHF sensors, for quality control during routine tests on such joints, is derived in the next Part 2. This protocol is the main novelty of this investigation.

Index Terms - HVDC insulation, power cable joints, partial discharges, power cable testing, wireless sensors, VHF/UHF electromagnetic sensors

1 INTRODUCTION

HIGH Voltage Direct Current (HVDC) cable systems with extruded insulation are relatively new, but they are becoming increasingly attractive vs. the traditional Mass Impregnated Non-Draining (MIND) HVDC cable systems [1]. Indeed, polymer insulated cables have some major advantages: 1) they are much more environmentally-friendly; 2) the maximum permissible conductor temperature in normal operation is higher; 3) splicing is much easier [1, 2].

As a consequence, thanks to extensive R&D activities, mostly published in IEEE DEIS Journals and Conference Proceedings, several HVDC extruded cable systems at 320 kV-rated voltage have been commissioned or are being installed worldwide [3], and a 400 kV/1000 MW XLPE HVDC cable system – the submarine “Nemo Link” – is under construction between UK and Belgium [4]. In addition, DC extruded cable systems have been qualified and are now commercially available at voltages ≈ 500 -600 kV and power ≈ 1 GW and above; in particular, a ± 640 kV HVDC extruded underground cable capable of transmitting staggering power levels up to at least 3 GW is claimed to have been fully qualified according to the CIGRÉ recommendations [5-8].

Moreover, today extruded insulation for DC cables does not necessarily mean XLPE, since new thermoplastic compounds are being developed, which are recyclable (being not cross-linked), can bear higher temperature and voltage, and possibly even voltage polarity reversal [7, 9, 10].

HVDC extruded cable systems still have weak points.

One is accumulation of space charges under DC voltage application. The IEEE DEIS Technical Committee (TC) on “*HVDC Cable Systems (cables, joints and terminations)*” has addressed this issue by developing IEEE Std. 1732-2017 entitled “*Recommended practice for space charge measurements in HVDC extruded cables for rated voltages up to 550 kV*” [11-13]. IEEE Std. 1732-2017 recommends a protocol for space charge measurements in load cycle qualification tests of HVDC extruded cables based on the experience gained from space charge measurements on real full-size cables during HVDC cable system projects.

Another is the development of long-lasting and reliable accessories, namely joints and terminations: due to the peculiarities of HVDC cable systems, this requires extra-care, knowledge and skills compared to the already difficult task of designing, testing and installing HVAC cable system accessories [1, 14-17]. In fact, test and service experience shows that joints, whose number is huge in long HVDC links, are the components which mostly affect the reliability of the whole cable system, for many reasons i.e. [14]:

- they are made of many sub-components featuring a number of interfaces between different materials where adverse chemical-physical phenomena may take place that put the duration of accessories at risk [1];
- service stresses (electric stress due to voltage, thermal stress due to temperature, mechanical stress due to bending, expansion/compression, ambient stresses) may reach critical levels in accessories if they are improperly designed, manufactured and/or installed;
- field joints in particular are usually assembled partly in

the factory and partly in situ exposed to environmental contamination, with a consequent reduction of reliability. Thus, the lifetime of joints – both those installed in the laboratories for qualification tests and those installed in the field – is strongly depending on the skills of the installing crew. This requires a sound training of the crew personnel to avoid installation mistakes.

The TC HVDC Cable Systems has analyzed joints in the *Workshop on HVDC cables and accessories*, held at IEEE CEIDP 2016, and in the IEEE Electrical Insulation Magazine Jul./Aug. 2017 Special Issue (vol. 33, no. 4) devoted to this Workshop. The analysis has shown that only a few tests exist today on joints and there is a lack of standardization. Thus, following the suggestions by CIGRÉ Technical Brochure (TB) 496 [18] and IEC Standard 62895 [19] about developing new tests for HVDC cable system joints, the TC has decided that its next main task should be the identification and development of new techniques to characterize joints for qualification and routine tests. To accomplish such task making best use of the expertise and skills of its members, the TC focused on the following possible electrical techniques:

- space charge (SC) measurements, which are still very challenging when we consider full-size accessories, due to practical difficulties (see Section 3.2);
- partial discharge (PD) measurements, fostered in [18, 19].

As a consequence, in the present Part 1 of this paper the state of the art on the insulation of HVDC extruded cable system joints is covered first in Section 2, with reference to types and design, and in Section 3 with reference to the few existing tests and the many more suggested in Standards. This analysis leads to Part 2 of this series of two papers, where the focus will be on the development of a new testing procedure for AC voltage routine test with PD measurements on factory and prefabricated joints for HVDC extruded cable systems.

2 INSULATION SELECTION FOR HVDC EXTRUDED CABLE SYSTEM JOINTS

2.1 TYPES OF JOINTS

A joint (or “splice”) is defined as the “*insulated and fully protected connection between two (or more) cables*” [20]. The basic tasks a joint must perform are as follows [20]:

- 1) even distribution of voltage (electric stress) between the conductor and ground, requiring a proper electric field grading for all pertaining cable operating conditions;
- 2) elimination of voids at the interfaces between the cable and the joint body;
- 3) conduction of charging/fault currents to ground. To do so, joints must contain the cable metallic screen/sheath;
- 4) physical protection against outer environment.

Joints for HV cable systems can be classified into different categories. A first classification is relevant to the place where the joint is installed, i.e. [18]:

- a) Factory joint = a joint between extrusion lengths manufactured under controlled factory conditions.
- b) Repair joint = a joint between two cables that are

completed with all construction elements.

- c) **Field joint** = a joint between two cables that are completed with all construction elements and in a state as installed in the field in the actual cable system.

A second classification is relevant to the way the main insulation of HV cable system joints is realized, namely:

- **Taped joints**, where the insulation is realized by taping insulation strips. If insulating strips are polymeric, no impregnant is needed, while for paper insulating strips an impregnant (fluid oil, viscous mass) is needed;
- **Pre-moulded (or prefabricated) joints**, where the main insulation is elastomeric (typically EPR, EPDM, SiR) and is moulded prior to its application onto cable ends.

Another classification is relevant to the cables connected by the HV cable system joints, i.e. [18, 19]: a) **Straight joint** = joint connecting two cables of the same type; b) **Asymmetric joint** = joint connecting two cables with the same insulation system, but of different design, e.g. different conductor, insulation or screen size; c) **Transition joint** = joint connecting two cables with different insulation systems.

HVDC links are typically very long, thus they contain many joints and, depending on the cable stretch, different types of joints. **Factory joints** (Figure 1 [1]) are required in long submarine cables (typically longer than 100 km, directly loaded onto the cable laying vessel) since extrusion filtration packs need to be replaced after, say, a ~20 km-long cable core length has been continuously produced [21]. Hence factory joints are realized for having overall diameter quite close to – or even the same as – that of the cable core, thereby implying thickness of insulation and semicon, as well as mechanical properties and flexibility, very close to those of the cable core. This makes factory joints less prone to mechanical injury than the more massive pre-moulded joints, thus the best option for submarine links. Factory joints are realized by exposing the cable conductor ends, welding them to each other and recreating the semicons and insulation by moulding or extruding the same semicon and insulating compounds as for the cable core. The whole manufacturing process requires time (several days), controlled factory conditions and high cleanliness in the different production steps [2, 15].

Field joints only (Figure 2 [16, 22]) are found in land cable interties, as cables longer than 1-1.5 km would require excessive weight and size of the drums needed to carry them on both roads and railroads [1]. Conversely, field joints are few in submarine cable links, where they are also called “**repair joints**” (Figure 3 [1]) because the same type of joint and installation procedure is commonly set up both for field and repair joints. On the other hand, submarine field/repair joints are realized aboard the cable laying vessel through a rather cumbersome procedure, which might take many days even with good weather [1, 23]; therefore, they are much more critical than land joints. For field joints, to shorten the production/mounting time of factory joints, the joint body is typically pre-moulded (or prefabricated), which employs insulation preformed and tested in the factory. The to-date usual method of manufacture is to

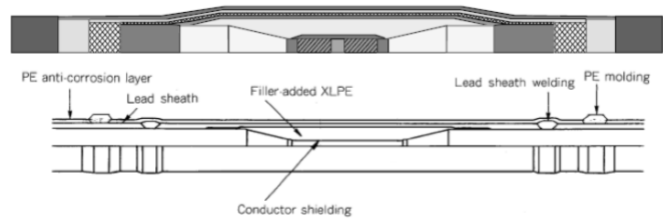

Figure 1. Factory joint of moulded type for HVDC XLPE submarine cable (± 250 kV, 800 mm^2 conductor cross section, courtesy of VISCAS; after [1]).

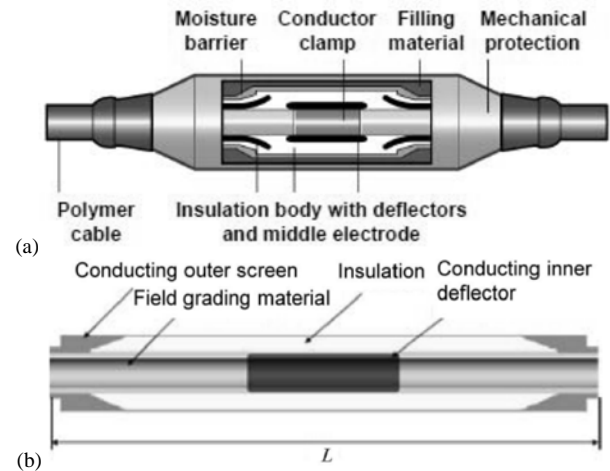

Figure 2. Typical designs for field joints of the prefabricated type for HVDC land extruded cable systems; (a) design with geometric field grading (after [22]), (b) design with field grading material (FGM) layer (after [16]).

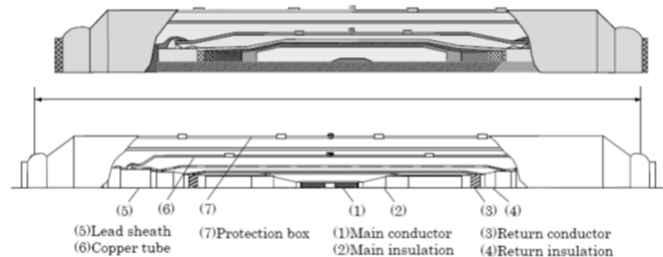

Figure 3. Repair joint for ± 250 kV/180 MW HVDC coaxial extruded cable (courtesy of VISCAS; after [1]).

mould the elastomeric insulation into one single pre-moulded elastomeric sleeve that forms the insulation: this is the so-called “**pre-moulded one-piece joint**”, complete with insulation, connector screen, stress control profile screens, insulation screens and – where applicable (sectionalized joints) – screen interruption [20]. The pre-moulded joint is installed on site and mounted onto the exposed insulation of the two cable heads by sliding it onto the cable. Thus its diameter is much greater than that of the cable, its mounting time can be one/two days and more joints can be mounted at the same time within huts built on site so as to keep a high level of cleanliness and control [15].

In summary the two most common joint types in HVDC extruded cable systems are: **factory joints** and **pre-moulded joints**. Thus focus is on these joints hereafter.

2.2 INSULATION MATERIALS AND DESIGN

Factory joints, made in the factory in tightly-controlled conditions to connect the various cable core lengths, are much less prone to contamination and much more reliable than field

joints. Furthermore, as the joint has the same insulation as the cable, problems such as matching different dielectric materials on the interface are avoided. Thus, when comparing HVDC vs. HVAC extruded cable systems, the design of factory joints is almost the same, while that of pre-moulded joints can differ by much, mostly because of the problems arising at the many insulation/insulation and insulation/semicon interfaces. Interfacial problems are the most critical and affect the selection of materials, as well as the electrical, thermal and mechanical design of joints [15-17, 22, 24].

The body of HVDC pre-moulded joints is made of three insulating or semiconducting layers, i.e. (Figure 2 [15, 22]): 1) conducting inner deflector, made of semiconducting rubber, acting as live electrode and electric screen of the connector; 2) main insulation, made of insulating rubber; 3) conducting outer deflector/ screen, made of semiconducting rubber, acting as earth electrode. SiR and EPDM are the two most-common materials for the main insulation of pre-moulded joints. A comparison shows (Table 1) that SiR has higher breakdown strength, longer lifetime under AC voltage and much wider temperature range of stability of electrical and mechanical properties. Moreover, SiR fits joint insulation onto extruded cable surface better than EPDM, which improves the contact pressure on this critical interface. Thus, SiR is mostly used for HVAC joints. For HVDC joints, EPDM is mainly used, since – due to its lower volume resistivity related to its more complex and compounded terpolymer structure – it reduces space charge accumulation in HVDC joints especially at higher voltage levels and at dielectric interfaces [22, 24].

Indeed, another key issue is the charge dynamics at the interface of cable and joint insulation, where charges tend to accumulate under high DC electric stress. The Maxwell-Wagner-Sillars (MWS) polarization [25] provides a first-order approximation of the charge dynamics at the interface, whereby it can be shown that the charge accumulation at the interface is proportional to the divergence of the permittivity/ conductivity ratios in the two dielectrics. The ratio depends on the temperature, thus any changes of the cable load affects interfacial charge and electric field distribution. Accordingly, the insulation material of the joint should be compatible with that of the cable, primarily in terms of temperature dependence of the insulation resistivity, otherwise field at the interface might be distorted, particularly after polarity reversals, leading to accelerated ageing, reduced breakdown strength and possibly premature failure. However, at electric fields above the threshold for space charge accumulation and under operating conditions quickly-varying with time, the values of the parameters in the MWS model at the cable-joint insulation interface need to be checked by space charge measurements, although so far this can be done on small-size specimens only (Section 3.2) [26, 27].

The design of the pre-moulded joint body is focused on electric field control both at the cable/joint interface and in the bulk dielectric, not only under DC voltage with varying load, but also under switching and possibly lightning impulses superimposed to DC voltage, as well as turning on/off and

Table 1. Some Properties of EPDM and SiR; after [22].

	EPDM	SiR
Chemical Structure	C-chain as basic	O-Si chains as basic
Range of temperature at which electrical and mechanical properties remain stable	-40°C ~ +100°C	-50°C ~ +180°C
Corona and ozone stability	None	High
Elasticity	Limited	High
Mechanical strength	High	Medium
Lifetime factor n^1	≈ 20	>40
Breakdown Strength	≈ 20 kV/mm	>23 kV/mm

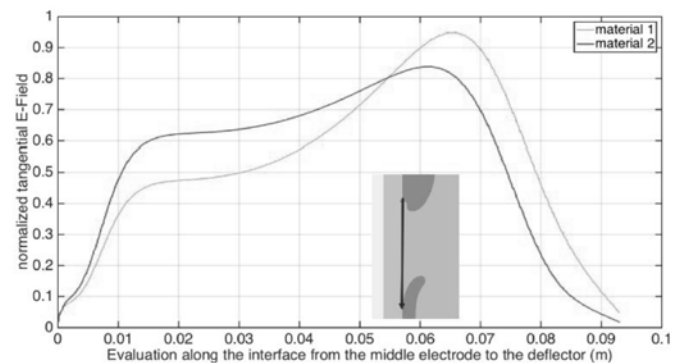

Figure 4. Normalized tangential electric field at steady state in a HVDC joint with two different insulation materials; material 2 has temperature dependence of conductivity more similar to XLPE than material 1. After [22].

reversing the polarity of the voltage. Special attention needs to be paid to the tangential field along the insulation materials of joint body and cable under varying load. In fact, the electric field in HV cable joints is distributed non-uniformly, with severe field enhancement at the semicon edge, where the electrical ground layer of the cable ends [15]. To achieve a reasonable tangential field distribution along the interface, the temperature and field dependent conductivities of both insulations should be matched. However, this is quite difficult, since the pre-moulded joint body has to be a rubber to apply the proper surface pressure to the cable and avoid PDs and breakdown. This effect is shown in Figure 4 where the tangential electric field distributions in a simplified 150kV HVDC joint is simulated [22]: the joint with the material 2, with temperature dependence of conductivity more similar to XLPE than material 1, has a better tangential electric field distribution along the interface compared to material 1. Hence, a matching of the dielectrics and a reduction of the temperature dependence of the conductivity leads to a better design. Besides, an increase in the thermal conductivity of the insulation material is beneficial because it reduces the temperature gradient in the insulation leading to a more uniform electric field distribution and reduces the probability of the thermal instability [22].

A typical approach for field control (field-grading, FG) is the use of a deflector made of conductive rubber (Figure 3a), but this “capacitive” or “geometric” FG requires more space and material and is of course “static” even under time-varying field distributions (e.g., load cycles) [28]; thus it has to be designed for a worst case. Hence, geometric FG may lead to an overdesign of the entire device which, especially for HV, could significantly increase the cost. In fact “geometric” FG is used

satisfactorily in EPDM joints up to 320 kV, the current operating limit of HVDC extruded cable links (see Section 1).

An alternative FG solution employed also to reach higher voltages (500-600 kV and above, see Section 1), with only small effects on size and weight, and an additional dynamic self-adjustment of the stress control properties, is the use of nonlinear resistive Field Grading Materials (FGMs). FGMs are obtained adding to the polymer matrix specific fillers with nonlinear conductivity under combined stresses [24]. These materials reversibly change their electrical state from highly insulating to highly conductive, in regions where the field exceeds a (critical) value [15, 29]. Hence the latest generation of pre-moulded joints for HVDC extruded cables may include a fourth continuous layer of FGM between inner and outer deflector (Figure 2b) [15]. The geometric shape of the joint insulation is designed considering impulse test requirements, while the field distribution at DC is governed by the non-linear FGM between the two insulation layers, making the joint less sensitive to variations in conductivity of the two layers due to production variations, temperature etc. [30]. More in detail, the strong field dependence of FGM conductivity σ can be divided into regions corresponding to the design fields at nominal (E_N), surge (E_S), and pulse (E_P) conditions on the one hand, and on leakage current and temperature conditions on the other hand (Figure 5 [30]). The FGM has also a high permittivity ϵ , thus it will determine the field distribution after a time $\tau = \epsilon/\sigma$ that has to be compared to the time of the applied voltage. In addition, the high ϵ will give the FGM refractive stress control properties [30].

The state of the art of FGMs is based on SiC or ZnO micro-varistor-filled polymers. By tuning these additives via a proper choice of process parameters, the characteristics of the FGM can be adjusted to achieve the wanted field distribution at all type of stresses [15, 24, 30]. However, such FGMs have a strongly frequency-dependent permittivity, which abruptly decreases as frequency increases, thereby making in some cases their performances satisfactory under impulse voltage, but unsatisfactory at power-frequency AC voltage. For this reason, the applicability of AC testing to HVDC cable system joints employing FGMs (suggested by [18, 19], see Section 3.1, and encompassed in the new proposal made here, see Section 3.3) has to be carefully checked case by case, according to manufacturer's specifications.

3 TESTING HVDC EXTRUDED CABLE SYSTEM JOINT INSULATION

3.1 TESTS PRESCRIBED IN STANDARDS

The existing electrical tests to be carried out on the insulation of HVDC extruded cable system joints are very few and appear in the two International Standards for testing HVDC extruded cable systems issued so far, i.e.: 1) CIGRÉ Technical Brochure (TB) 496 [18], relevant to both land and submarine cables; 2) the newly-released IEC 62895:2017 Standard [19], relevant to land cables only (hence here prescriptions about factory and repair joints cannot be found).

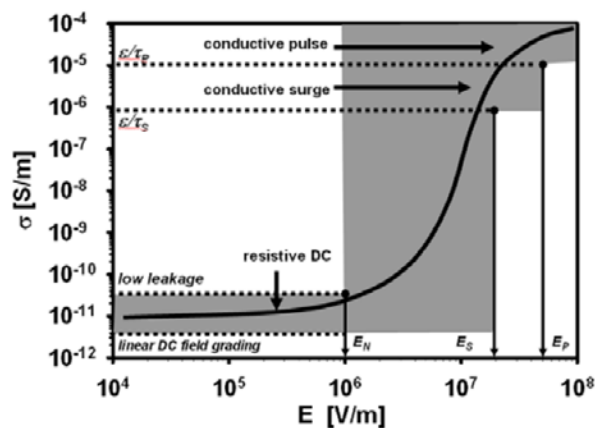

Figure 5. Typical FGM conductivity graph (courtesy of ABB); after [30].

Both TB 496 and IEC 62895 prescribe the pre-qualification (PO) test and the electrical type tests (TT) on complete cable system loops. They also recommend/prescribe tests on joints – mostly the factory and pre-moulded joints this paper focuses on – at the routine test and/or sample test stages, as follows.

3.1.1 ROUTINE TESTS ON THE JOINT INSULATION

After suggesting an AC voltage test on cables at § 5.1, TB 496 at §5.2 highlights that “*the experience of using DC voltage for routine testing of accessories for DC cables is limited and the efficiency of DC testing for prefabricated joints is arguable*” and “*it may not be sufficient to prove the quality of the accessory... Testing with AC voltage could be considered as an integration or alternative test, provided that the insulation system and the cable design allow AC testing*” [19]. Then, for prefabricated joints TB 496 at §5.2.1 recommends the DC test voltage applied to the main insulation of each prefabricated joint as specified under §5.1, and points out that “*the following additional tests may be carried out according to the quality assurance procedures of the manufacturer: AC voltage test, if applicable; PD measurement, if applicable*” [18].

In agreement with TB 496 at §5.2.1, IEC 62895 at §9.2 prescribes that “*... each prefabricated accessory shall be submitted to a negative DC voltage equal to the test voltage defined for the heating cycle test $U_T = 1.85 \times U_0$ and applied between conductor and sheath for 1 hour at ambient temperature. An AC test combined with PD measurement is recommended - where suitable. Test parameters to be agreed between customer and supplier*” [19].

Coming to factory joints of submarine cables, TB 496 at §5.2.2 points out that “*... all joints in the complete delivery length shall be DC voltage tested in the high voltage test described in §5.1. However, a screening DC or AC voltage test directly after jointing would reduce the time delay in case the joint were to fail at a later stage in the production*” [18].

3.1.2 SAMPLE TESTS ON THE JOINT INSULATION

For submarine cable factory joints TB 496 §6.2 recommends the following electrical sample tests: 1) PD measurement and AC voltage test, only if applicable to the insulation system; 2) - impulse voltage test (see §6.2.3); 3) hot set test for insulation

where applicable (see §6.2.4). Coming to IEC 62895, it extends what said in §9.2 for routine tests on prefabricated joints by stating in §11.2 that “...for accessories where the main insulation cannot be routine tested ..., the voltage test (see 9.2) shall be carried out by the manufacturer on a fully assembled accessory. Examples of main insulations that are not routine tested are insulations ... moulded on site”.

3.1.3 THE FIELD FOR NOVEL TESTING

In summary, it can be argued that new tests on factory and prefabricated joints suggested by International Standards refer either to the qualification or to the sample/routine test stage. This is the reason why the TC on “HVDC Cable Systems” has identified qualification or sample/routine tests as the field for application of novel electrical techniques to characterize the insulation of such joints. Moreover, since new vs. existing electrical test techniques are searched, space charge and PD measurements appear as possible candidates.

3.2 SPACE CHARGE MEASUREMENTS ON JOINTS

As pointed out in Section 2.2, space charge (SC) may accumulate at the many interfaces of HVDC extruded cable joints, thereby distorting the field and possibly leading to premature failure. Hence it would be desirable to measure SC particularly at the cable-joint insulation interface.

3.2.1 PEA AND TSM FOR CABLES

In the literature about SC measurements on dielectrics for cable systems, most papers are relevant to flat thin specimens, as inherent difficulties - mainly related to cable geometry, length and thick insulation - make measuring SC on cables more difficult than on flat samples. Good results have been obtained on full-size cable insulation with the Pulse-Electro-Acoustic (PEA) technique and the Thermal Step Method (TSM) [31-38]. For this reason, the PEA and TSM appear as the two most promising techniques for joints, although SC measurements on joints are even more difficult than on cables.

As for the former, when the so-called PEA cell is applied for SC measurements in coaxial power cables [1, 11, 31-34] the thermoplastic outer-sheath and the metallic screen are removed and the so-called “pulse electrode” is realized by laying onto the bare outer insulation semicon two metallic layers consisting e.g. of wrapped metallic tapes. The PEA cell (Figure 6) is clamped onto the outer semicon in between the two sheaths of the pulse electrodes. It consists of:

- a ground (or detecting) electrode, typically in Aluminum, also working as low-losses acoustic delay line;
- a piezoelectric transducer, typically a Poly-Vinylidene Fluoride (PVDF) film;
- a layer of acoustic absorber, which prevents possible reflections of pressure waves generated within the dielectric after crossing the piezoelectric transducer. Such reflections may induce disturbances in the PEA signal.

The pulse electrode is connected to the PEA pulse generator: thus the cable capacitance is exploited to apply the PEA pulse field $e_p(t)$ to the cable insulation thickness, which translates into a force acting on stored SC. Hence two acoustic (pressure) waves are generated, travelling to either electrode. Waves

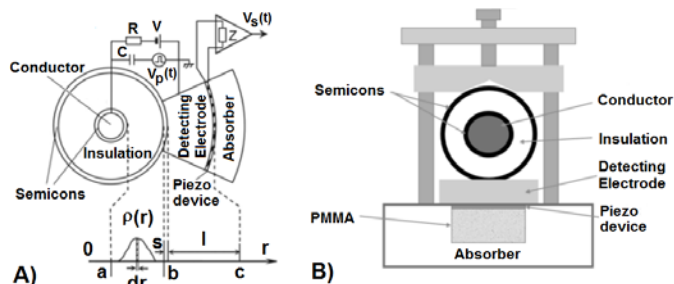

Figure 6. Sketch of the PEA cell for cables: (A) coaxial PEA cell with curved ground electrode, transducer (piezo-device) and acoustic absorber block (from [11]), (B) flat PEA cell.

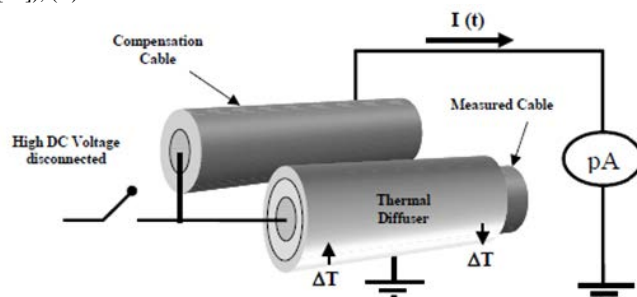

Figure 7. TSM space charge measurements on cables in double capacitor configuration: the measurement is performed on the measured cable after disconnecting the DC source; after [38]).

crossing the ground electrode reach the piezoelectric, being converted into a voltage proportional to the stored charge (PEA signal).

Basically two kinds of PEA cells have been developed [11]:

- coaxial PEA cell, with curved ground electrode, transducer and acoustic absorber (Figure 6A), quite good for cables of various sizes, even with interfaces [11, 31, 35];
- flat PEA cell, with a flat ground electrode satisfactory for cable insulation thickness up to ~6 mm (Figure 6.B) [36].

The TSM relies on the application of a thermal step (TS) through a dielectric. The system consisting of the dielectric, the electrodes and the external circuit is at equilibrium, electrostatically; consequently, the SC within the dielectric will induce charges (influence charges) at the internal and external electrodes [37]. When the thermal balance of the cable is affected by a thermal step, the electrostatic balance of the system changes. This is due to the contraction, or expansion, of the cable insulation, which causes a slight and reversible movement of the SC within the sample, and to the weak variation of the permittivity of the insulation with temperature. As the system tends to rebalance, the influence charges on the electrodes are redistributed. Hence, charge transport occurs from one electrode to the other in the external circuit, leading to a current between the short-circuited electrodes: when properly processed, such current gives the charge and field distributions within the insulation.

For power cables, the TS can be created by [38]:

- the inner heating technique (IHT), aiming at monitoring the average electrical condition of the whole cable insulation, whereby the TS is created via a high current (several kA) flowing in the cable conductor;

- the outer cooling technique (OCT), aiming at a local analysis of the cable over small lengths (~20 to 40 cm), whereby the TS is generated via a cold liquid flowing in the diffuser, a radiator in touch with the measured cable.

Focusing on the latter – in the prospective application to joints – measurements under DC voltage require the TSM in “double capacitor” configuration, namely a “compensation cable” (identical to the measured cable) is connected as sketched in Figure 7 (see details in [38]). Then, the SC measurement is split in two stages.

1st stage = conditioning: the DC voltage is applied to the middle electrode and the current amplifier is short-circuited. Now, the two cables are equivalent to two equal capacitors in parallel to the HVDC supply.

2nd stage = measurement: the HVDC generator is disconnected for avoiding that induced charge at the electrodes may flow through the HV source rather than through the current amplifier. The TS is applied to the measured cable and the TS current is monitored with the current amplifier linked to the compensation cable, so that the two cables are in series with the current amplifier and are in short-circuit, as needed by the TSM.

3.2.2 MEASUREMENTS ON JOINTS

SC measurements on full size joints has inherent difficulties relevant to: 1) the huge thickness of joint insulation, which leads to a dramatic attenuation of SC related signal; 2) the complexity of joint insulation and overall structure; 3) the hard access to joint insulation for installing measurement cells, both with PEA and TSM techniques. For these reasons, it is not possible to perform SC measurements on full size joints to date, although some researchers are trying to overcome such difficulties, e.g. by improving the width and the height of the PEA pulse [1, 12]. Thus, so far such measurements are mainly done on flat specimens or on small-size cables with a multi-layer insulation that simulates the much thicker and complex insulation of joints [26, 27, 39].

For instance, in [26] SC measurements with the TSM were made on degassed XLPE model cables (95 mm² conductor cross section, 5.3 mm-thick insulation), where - to simulate the XLPE/EPDM interface of a joint - the copper wire screen and the outer HDPE sheath was locally removed and a 4 mm-thick EPDM sleeve (graphite-painted on the outside to ensure electrical continuity of the cable screen) was fitted (Figure 8). During 1170 h of poling, a voltage of -50 kV-DC was applied between cable conductor (at 70°C) and ground; temperature drop across the XLPE was kept at 20°C. The field distribution across the two-layer insulated model cables, computed from the TSM currents measured between 48 h and 667 h, showed a steady decrease of the electric field and a slight electric field discontinuity at the EPDM/XLPE interface [26].

In [27] SC measurements with the PEA technique were made on the two-layer insulated minicables of Figure 9: inner/outer insulation layer is EPR/XLPE in specimen #1, XLPE/EPR in specimen #2. Most measurements were performed in isothermal conditions, with test temperature from 25°C to

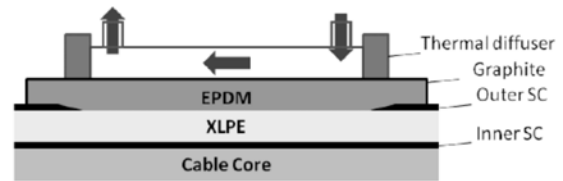

Figure 8. Two-layer insulated model cables tested in [26] (courtesy of Jicable). The three arrows indicate the flow of the cooling fluid in the diffuser

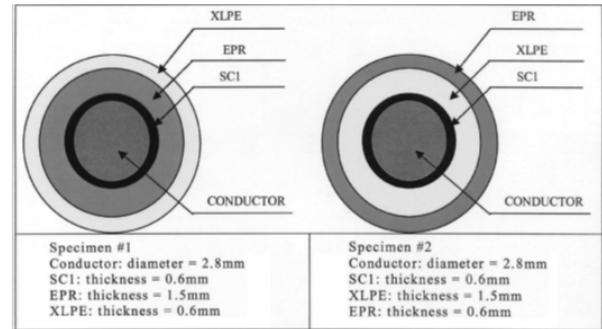

Figure 9. Two-layer insulated minicables tested in [27]; after [27].

70°C, and poling voltage from 21 to 60 kV. Typically poling lasted 10,000 s, followed by 3600 s depolarization. The electric field profiles computed at 70°C for test specimen #2 of Figure 9 after 10000 s poling at +60 kV-DC voltage showed a sharp electric field discontinuity at the EPR/XLPE interface (for details, see [27]).

These investigations confirm on the one hand the need of performing SC measurements at the interface between joint and cable dielectrics, and on the other hand the above-mentioned inherent difficulties to carry out SC measurements directly on full-size joints.

3.3 SUMMARY OF PD MEASUREMENTS ON JOINTS

Having verified the lack of feasibility to date of using SC measurement techniques in qualification and routine tests for joints, the TC has focused on PD measurements, as suggested in [18, 19]. After a thorough analysis, detailed in Part 2 of this paper, as a first, feasible step in the direction of developing Standards relevant to accessories, the TC on “HVDC Cable Systems” has decided to focus on AC voltage routine test with PD measurements on factory and prefabricated joints. This is not only in line with the suggestions after TB 496 and IEC 62895 (see Section 3.1) but also in agreement with quality control practices already implemented by major cable manufacturers worldwide.

4 CONCLUSIONS

In a continuation of its work on advanced practices for electrical and dielectric diagnostic techniques for testing and characterizing the insulation of polymeric extruded HVDC cable systems, the DEIS Technical Committee on “HVDC Cable Systems” has presented in this Part 1 paper a review of state-of-the-art joint technologies, with reference to types, design and testing techniques. From this analysis, it is concluded that – among advanced electrical and dielectric diagnostic techniques – the obstacles to the application of PEA and TSM to full-size joints are such that SC measurements cannot be used for the insulation of full-size joints so far.

However, the need remains for a strong effort in developing these techniques as they are able to provide information that no other technique can.

In the next Part 2, an assessment of VHF/UHF electromagnetic PD sensors for advanced characterization and quality control of the insulation of the joints is proposed, as the different polymer dielectric materials typically used in modern joint construction make them specifically amenable for high sensitivity (= void-free) PD measurement using VHF/UHF electromagnetic sensors.

REFERENCES

- [1] G. Mazzanti and M. Marzinotto, *Extruded Cables for High Voltage Direct Current Transmission: Advance in Research and Development*, Power Engineering Series, Wiley-IEEE Press, 2013.
- [2] G. Mazzanti, "Editorial," *IEEE Electr. Insul. Mag.*, vol. 33, no. 4, pp. 4-5, 2017.
- [3] CIGRÉ SC B4, Compendium of all HVDC projects, Available: <http://b4.cigre.org/Publications/Other-Documents/Compendium-of-all-HVDC-projects/>
- [4] Press Release, J-Power Systems wins contract with NEMO LINK, Available: <https://global-sei.com/company/press/2015/06/prs044.html>
- [5] Y. Murata, M. Sakamaki, Y. Tanji, T. Katayama, T. Igi, and O. Matsunaga, "400kV DC-XLPE cable and accessories," *Asia-Oceania Regional Council of CIGRÉ (AORC) Technical meeting 2014*, Paper B1-1095, 2014, pp. 1-6.
- [6] A. Gustafsson, M. Jeroense, H. Ghorbani, T. Quist, M. Saltzer, A. Farkas, F. Axelsson, and V. Mondiet, "Qualification of an extruded HVDC cable system at 525 kV," *Int. Conf. Insulated Power Cables (Jicable'15)*, Paper A7.1, 2015, pp. 1-6.
- [7] A. Bareggi, P. Boffi, S. Chinosi, S. Franchi Bononi, L. Guizzo, G. Lavecchia, M. Marzinotto, G. Mazzanti, and G. Pozzati, "Current and future applications of HPTe insulated cables systems," *CIGRÉ Paper B1-307*, 2018, pp. 1-8.
- [8] World's most powerful underground power transmission cable system, Available: <https://www.nkt.com/about-us/innovation/640-kv-extruded-hvdc-cable-systems>
- [9] M. Albertini, A. Bareggi, L. Caimi, L. De Rai, A. Dumont, S. Franchi Bononi, G. Pozzati, and P. Boffi, "Development and high temperature qualification of innovative 320 kV DC cable with superiorly stable insulation system," *Int. Conf. Insulated Power Cables (Jicable'15)*, Paper A7.3, 2015, pp. 1-6.
- [10] T. Andritsch, A. Vaughan, and G.C. Stevens, "Novel insulation materials for high voltage cable systems," *IEEE Electr. Insul. Mag.*, vol. 33, no. 4, pp. 27-33, 2017.
- [11] G. Mazzanti, G. Chen, J. Fothergill, N. Hozumi, J. Li, M. Marzinotto, F. Mauseth, P. Morshuis, A. Tzimas, C. Reed, and K. Wu, "A protocol for space charge measurements in full-size HVDC extruded cables," *IEEE Trans. Dielectr. Electr. Insul.*, vol. 22, no. 1, pp. 21-34, 2015.
- [12] Recommended Practice for Space Charge Measurements in HVDC Extruded Cables for Rated Voltages up to 550 kV, *IEEE Standard 1732*, 2017-06-26.
- [13] G. Mazzanti, "Space charge measurements in high voltage DC extruded cables in IEEE Standard 1732," *IEEE Electr. Insul. Mag.*, vol. 33, no. 4, pp. 27-33, 2017.
- [14] G. Mazzanti, and M. Marzinotto, "Advanced electro-thermal life and reliability model for high voltage cable systems including accessories," *IEEE Electr. Insul. Mag.*, vol. 33, no. 3, pp. 17-25, 2017.
- [15] H. Ghorbani, M. Jeroense, C.-O. Olsson, and M. Saltzer, "HVDC cable systems—Highlighting extruded technology," *IEEE Trans. Power Del.*, vol. 29, no. 1, pp. 414-421, 2014.
- [16] A. Gustafsson, M. Jeroense, P. Sunnegardh, M. Saltzer, H. Ghorbani, and H. Rapp, "New developments within the area of extruded HVDC cables," *11th IET Int. Conf. AC and DC Power Trans.*, 2015, pp. 1-5.
- [17] F. Mauseth, and H. Haugdal, "Electric field simulations of high voltage DC extruded cable systems," *IEEE Electr. Insul. Mag.*, vol. 33, n. 4, pp. 27-33, 2017.
- [18] Recommendations for Testing DC Extruded Cable Systems for Power Transmission at a Rated Voltage up to 500kV, *CIGRÉ Technical Brochure 496*, 2012-04-01.
- [19] High Voltage Direct Current (HVDC) Power Transmission Cables with Extruded Insulation and Their Accessories for Rated Voltages up to 320 kV for Land Applications - Test Methods and Requirements, *IEC Standard 62895*, 2017-05-11.
- [20] Accessories for HV Cables with Extruded Insulation, *CIGRÉ Technical Brochure 177*, 2001-02-01.
- [21] Extruded Dielectric DC Cable Development, *EPRI Project 7828-1 final report*, 1980.
- [22] H. Ye, Z. Han, Y. Luo, Q. Zhuang, T. Fechner, H. Wang, and X. Lei, "Design aspects on HVDC cable joints," *12th Int. Conf. Prop. Appl. Diel. Materials (ICPADM 2018)*, 2018, pp. 300-304.
- [23] T. Worzyk, *Submarine Power Cables*, Springer-Verlag, 2009.
- [24] J. Li, B.X. Du, X.X. Kong, and Z.L. Li, "Nonlinear conductivity and interface charge behaviors between LDPE and EPDM/SiC composite for HVDC cable accessory," *IEEE Trans. Dielectr. Electr. Insul.*, vo. 24, no. 3, pp. 1566 - 1573, 2017.
- [25] R.W. Sillars, "The properties of a dielectric containing semiconducting particles of various shapes," *Journal of the insulation of electrical engineers*, vol. 80, no. 484, pp. 378-394, 1937.
- [26] L. Boyer, J. Matallana, J.F. Brame, P. Mirebeau, J. Castellon, P. Notingham, S. Agnel, and A. Toureille, "Electric field measurements on XLPE/EPDM 2-layer insulation systems under DC stress," *8th Int. Conf. Insulated Power Cables (Jicable'11)*, Paper B.4.2, 2011, pp. 1-6.
- [27] S. Delpino, D. Fabiani, G.C. Montanari, C. Laurent, G. Teyssedre, P.H.F. Morshuis, R. Bodega, and L.A. Dissado, "Polymeric HVDC cable design and space charge accumulation. Part 2: insulation interfaces," *IEEE Electr. Insul. Mag.*, vol. 24, no. 1, pp. 14-24, 2008.
- [28] G. Mazzanti, "Including the calculation of transient electric field in the life estimation of HVDC cables subjected to load cycles," *IEEE Electr. Insul. Mag.*, vol. 34, no. 3, pp. 27-37, 2018.
- [29] T. Christen, L. Donzel, F. Greuter, "Nonlinear Resistive Field Grading Part 1: Theory and Simulation," *IEEE Electr. Insul. Mag.*, vol. 26, no. 6, pp. 47-59, 2010.
- [30] T. Sörqvist, T. Christen, M. Jeroense, V. Mondiet, and R. Papazyan, "HVDC-Light® cable systems - highlighting the accessories," *21st Nordic Insulation Symposium (NordIS)*, 2009, pp. 1-6.
- [31] T. Takada, "Acoustic and optical methods for measuring electric charge distributions in dielectrics," *IEEE Trans. Dielectr. Electr. Insul.*, vol. 6, no. 5, pp. 519-547, 1999.
- [32] K. Fukunaga, H. Miyata, M. Sugimori, and T. Takada, "Measurement of charge distribution in the insulation of cables using pulsed electroacoustic method," *Trans. IEE Japan*, vol. 110-A, no. 9, pp. 647-648, 1990.
- [33] T. Takeda, N. Hozumi, H. Suzuki, K. Fujii, K. Terashima, M. Hara, Y. Murata, K. Watanabe, and M. Yoshida, "Space charge behavior in full size 250 kV DC XLPE cables," *IEEE Trans. Power Del.*, vol. 13, no. 1, pp. 28-39, 1998.
- [34] N. Hozumi, H. Suzuki, T. Okamoto, K. Wakanabe, and A. Watanabe, "Direct observation of time dependent space charge profiles in XLPE cable under high electric field," *IEEE Trans. Dielectr. Electr. Insul.*, vol. 1, no. 6, pp. 1068-1076, 1994.
- [35] H. Mori, H. Niinobe, and Y. Yagi, "Space charge measurements and characteristics of HVDC XLPE cable," *Jicable-HVDC'13*, Paper P05, 2013, pp. 1-6.
- [36] M. Fu, L.A. Dissado, G. Chen, and J.C. Fothergill, "Space charge formation and its modified electric field under applied voltage reversal and temperature gradient in XLPE cable," *IEEE Trans. Dielectr. Electr. Insul.*, vol. 15, no. 3, pp. 851-860, 2008.
- [37] P. Notingham, Jr., S. Agnel, and A. Toureille, "Thermal step method for space charge measurements under applied dc field," *IEEE Trans. Dielectr. Electr. Insul.*, vol. 8, n. 6, pp. 985-994, 2001.
- [38] J. Castellon, P. Notingham, S. Agnel, A. Toureille, F. Brame, P. Mirebeau, and J. Matallana, "Electric field and space charge measurements in thick power cable insulation," *IEEE Electr. Insul. Mag.*, vol. 25, no. 3, pp. 30-42, 2009.
- [39] R. Bodega, G. Perego, P.H.F. Morshuis, U.H. Nilsson, and J.J. Smit, "Space charge and electric field characteristics of polymeric-type MV-size DC cable joint models," *Annu. Rep. Conf. on Electr. Insul. Dielectr. Phenom. (CEIDP)*, 2005, pp. 505-510.