

# Experimental investigation of the influence of temperature on the reinforcing effect of graphene oxide nano-platelet on nanocomposite adhesively bonded joints

H.Khoramishad<sup>a</sup>R.S.Ashofteh<sup>a</sup>H.Pourang<sup>a</sup>F.Berto<sup>b</sup>

## Abstract

In this experimental work, the effect of graphene oxide nano-platelets (GONPs) on nanocomposite adhesive joint strength tested at elevated temperatures was investigated. For this, adhesive joints were manufactured with neat and nanocomposite adhesives and tested under different testing temperatures ranging from room temperature to the glass transition temperature of the adhesive. It was found out that the presence of GONPs in the adhesive layer changed the joint strength considerably differently depending on the testing temperature. The experimental results indicated that by increasing the testing temperature, the improving effect of adding GONPs decreased. Then, by increasing the testing temperature beyond a critical level, adding GONPs even degraded the adhesive joint strengths compared to the neat adhesive joint. This critical temperature level was found to be dependent on the weight percentage of GONPs added to the adhesive. This critical temperature was obtained as 60 °C for the adhesive reinforced with 0.1 wt% of GONPs, while for the adhesive with 0.3 wt% GONPs, the critical testing temperature was reduced to 40 °C.

- **Previous** article in issue
- **Next** article in issue

## Keywords

Nanocomposite adhesive

Shear strength

Elevated temperature

Graphene oxide nano-platelets

## Nomenclature

Terminology

DSC

[differential scanning calorimetry](#)

GONPs

graphene oxide nano-platelets

SEM

[scanning electron microscopy](#)

SLJs

[single lap joints](#)

wt%

weight percentage

## 1. Introduction

[Adhesive joints](#) have been increasingly employed in various industries due to their advantages such as lower [structural weight](#), better stress distribution and having the ability of joining dissimilar materials compared with other conventional joints. However, polymeric materials such as polymeric adhesives and composites suffer from some shortcomings. One of the important weak points of such materials is their susceptibility to [high service temperature](#). The mechanical behavior of adhesive joints can be significantly influenced by the service temperature. There are many studies (e.g. [1], [2], [3], [4], [5], [6]) that investigated the effect of temperature on the mechanical behavior of adhesive joints.

Adding [nanofillers](#) into the polymeric materials such as polymeric adhesives and composites is an efficient method of improving the [mechanical performance](#) of such materials [7]. There are different nanofillers with different shapes and materials such as nano-clay [8], nano-rubber [9], [carbon nanotube](#) [10], [nano-silica](#) [11] and [graphene oxide nanoplatelets](#) [12], [13] that can be used for reinforcing adhesives and [composite materials](#). The [graphene nanoplatelets](#) have attracted considerable attentions in the recent years because of their unique chemical and physical properties and [potential applications](#) [14], [15]. The superior thermal and mechanical properties of graphene nanoplatelets including the [high thermal conductivity](#) [16], [17] and extremely high mechanical strength caused this [nanofiller](#) to be considered as an appropriate candidate for reinforcing the polymeric materials. Several researchers [12], [13], [18], [19], [20] studied the effects of graphene nanoplatelets on mechanical behavior of composites and adhesive joints.

Rafiee et al. [12] compared the reinforcing effects of graphene [platelets](#), [single-walled carbon nanotubes](#) and [multi-walled carbon nanotubes](#) on various mechanical properties of epoxy [nanocomposites](#). They found out that the graphene platelets had superior improving effects on all of the mechanical properties they studied including the Young's modulus, the ultimate [tensile strength](#), the [fracture toughness](#), the [fracture energy](#) and the material's resistance to [fatigue crack propagation](#) compared with the single- and multi-walled carbon nanotubes. They referred the superior behaviors of graphene platelets to the higher [specific surface](#)

[area](#), better adhesion/interlocking between the matrix and nanofillers and [two-dimensional](#) geometry of the graphene platelets.

Gültekin et al. [21] studied the effect of graphene reinforcement on the strength of single lap adhesive joints. They reported about 20% improvement in the [joint strength](#) by addition of graphene nanofiller into the [adhesive layer](#). Akpinar et al. [22] studied the effect of adding graphene nanofillers and carbon nanotubes to three adhesives with rigid, flexible and toughened characteristics on the [failure loads](#) of the single lap adhesive joints. They reported the maximum improvement in the joint failure load for the addition of the graphene nanofillers to the rigid adhesive. Lee et al. [18] studied the effect of silane-functionalized [graphene oxides](#) on the [bonding strength](#) of carbon fiber/epoxy composites. They tested [single lap joints](#) and found that the bonding strength of the specimens was increased by 53% by addition of the silane-functionalized graphene oxides that contained amine groups.

Saeimi sadigh et al. [19] studied the effects of [reduced graphene oxide](#) additive on the tensile strength of [adhesively bonded joints](#) tested under different rates. They found that incorporating 0.5 wt% of nanofillers into the epoxy based adhesive increased the ultimate tensile and compressive strengths of the bulk specimens by 30% and 26%, respectively, when tested under a [strain rate of](#)  $5 \times 10^{-4}$  1/s. Whereas, the joints fabricated with the adhesive reinforced with graphene nanofillers exhibited 27%, 20%, and 19% higher [ultimate strengths](#) compared with the neat adhesive joints when tested under the strain rates of  $5 \times 10^{-4}$ , 0.02 and 0.05 1/s, respectively. It should be taken into consideration that the level of reinforcing effect of nanofillers can be depended on many factors. This is the reason of why different researchers reported sometimes completely different levels of improvements in the properties of polymeric materials by incorporating similar nanofiller into the material. One of the factors is the temperature level at which the adhesive joints are tested. Moreover, it is worth noting that although there is usually a preferred working temperature range suggested by the adhesive supplier within which the adhesive has appropriate strength and performance, in real [engineering applications](#) sometimes the service temperature might be out of control and due to many reasons it may rise unexpectedly. The strength of adhesively bonded joints can be considerably reduced under [elevated temperatures](#) especially when the service temperature is close to the adhesive glass [transition temperature](#) level. Therefore, the aim of this paper was to study the effect of elevated temperature on the reinforcing effect of GONPs in nanocomposite adhesive joints and to answer to the question that whether adding GONPs to the adhesive layer always imposes similar effects on the adhesive joint strength at different temperatures. This was accomplished by testing the reinforced

and unreinforced adhesive joints under different controlled [testing temperatures](#). Further, [scanning electron microscopy](#) (SEM) [fractography](#) was carried out to assess the [fracture surfaces](#) and the micro-mechanisms involved in the strength variations.

## 2. Experimental procedures

To study the effect of [elevated temperature](#) on the reinforcing effect of GONPs on the [failure loads](#) of [nanocomposite adhesive joints](#), single lap adhesive joints were fabricated using the neat and nanocomposite adhesives having different weight percentages of GONPs. Then, the specimens were subjected to quasi-static loading at elevated temperatures for determining the strength of the adhesive joints.

### 2.1. Materials

[Aluminum alloy](#) 6061-T6 was utilized as the substrates of the adhesive joints. The substrates were cut from a 4 mm thick aluminum sheet with the dimensions of  $100 \times 25 \text{ mm}^2$ . The [Young's modulus](#), the ultimate shear and [tensile strengths](#) of the substrates were 69 GPa, 200 MPa and 300 MPa, respectively [23]. To manufacture the adhesive joints, a bi-component paste [epoxy adhesive](#) named Araldite 2011 [24] was used for bonding the substrates. Moreover, 6–10 layered GONPs with the purity of 99%, the [outer diameter](#) of 10–50  $\mu\text{m}$  and the thickness of 3–7 nm [25] were used for reinforcing the epoxy adhesive.

### 2.2. Specimen fabrication

In order to improve the adhesion between the substrates and adhesive, the [aluminum substrates](#) were pretreated in a sulfuric acid etching solution followed by [anodizing](#) according to ASTM D2651 standard [26]. Then, for manufacturing the neat adhesive joints, the [binder](#) and [hardener](#) with a weight ratio of 100 to 80 was mechanically mixed and the prepared [paste adhesive](#) was applied to the substrates. To investigate the effect of the presence of GONPs in the [adhesive layer](#) and study the influence of elevated temperature on the reinforcement obtained by GONPs, the [nanofillers](#) were added to the adhesive layer using a procedure. To fabricate the nanocomposite adhesives, first GONPs were added to the binder part of the adhesive and the mixture was mechanically mixed for 10 min at 180 rpm. Then the mixture was ultra-sonicated for 1 h at a power of 70 Watt and a work cycle of 1 sec on/off. Due to the [sonication](#) device capacity, in each sonication process, 15 gr of the mixture of binder and GONPs were sonicated. For producing nanocomposite adhesives with 0.1 and 0.3 wt% of GONPs, 0.027 gr and 0.081 gr of GONPs were used, respectively.

In order to reduce the [mixture temperature](#) in the course of sonication, the mixture was placed in a container filled with ice and water during the sonication process.

After sonication, the hardener part of the adhesive was added to the mixture with a weight ratio of 100 to 80 for the binder to hardener followed by stirring for 10 min at 180 rpm. Then, the same procedure used for manufacturing the neat adhesive joints was employed for manufacturing the reinforced adhesive joints, except that the nanocomposite adhesive was used instead of the neat adhesive. A fixture as shown in [Fig. 1](#) was utilized for manufacturing the specimens. By using this fixture, a controlled pressure was applied on the joints, the [adhesive thickness](#) was maintained fixed and constant and the substrates were kept aligned in the course of curing.

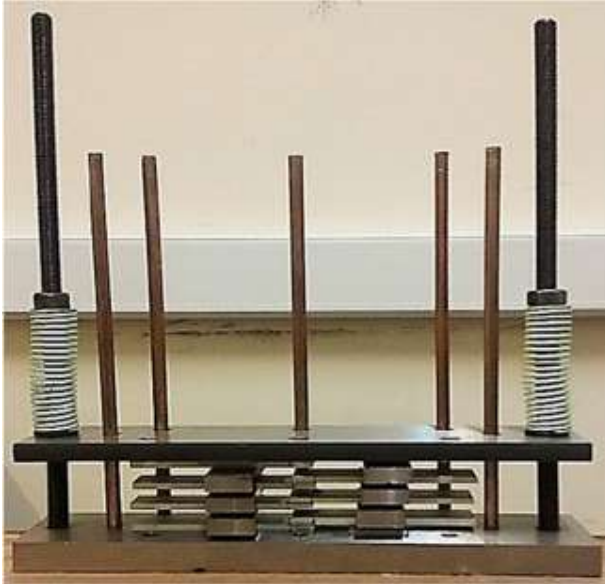

1. [Download high-res image \(128KB\)](#)
2. [Download full-size image](#)

Fig. 1. The fixture used for manufacturing the specimens.

Using the fixture, several [single lap joints](#) (SLJs) could be fabricated at the same time. The SLJs were cured in an oven under a temperature of 40 °C for 16 h according to the [data sheet](#) of Araldite 2011 adhesive [24]. The dimensions of the adhesive joints are shown in [Fig. 2](#). As seen in [Fig. 2](#), the adhesive thickness and the [overlap length](#) and width of the joints were 0.3, 12.5 and 25 mm, respectively.

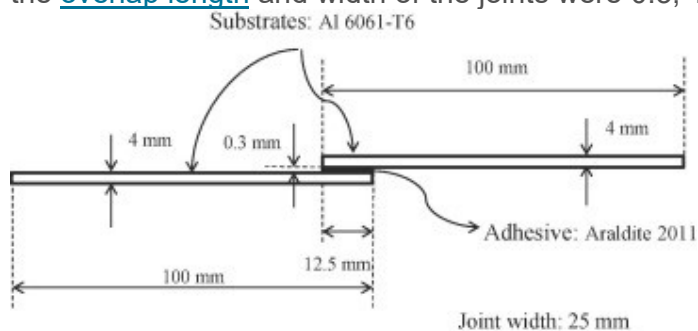

1. [Download high-res image \(85KB\)](#)
2. [Download full-size image](#)

Fig. 2. The dimensions of SLJs.

### 2.3. Experimental tests

First, a [differential scanning calorimetry](#) (DSC) test was performed on the adhesive according to ASTM D3418 standard [27] to determine the adhesive glass [transition temperature](#). The DSC measurement was performed using a Mettler Toledo DSC [calorimeter](#) (Switzerland). The glass transition temperature of the adhesive was determined as 60.2 °C. It should be mentioned that adding graphene oxide nano-platelets can increase the glass transition temperature of the adhesive.

To investigate the detrimental influence of elevated temperature on the reinforcing effect of GONPs on the strength of nanocomposite adhesive joints, [quasi-static tests](#) were conducted using the SANTAM universal [testing machine](#) under four different [testing temperatures](#) of 23 °C (room temperature), 40 °C, 50 °C and 60 °C. These four testing temperature levels were considered in order to have temperatures below and equal to the glass transition temperature of the base adhesive. To supply the elevated temperatures, an oven was used during testing. [Fig. 3](#) shows the single lap joint specimen before and after [tensile test](#). The tensile tests were conducted under displacement control with a [displacement rate](#) of 0.5 mm/min. Each test was repeated at least four times to ensure the [repeatability](#) of the results.

(a)

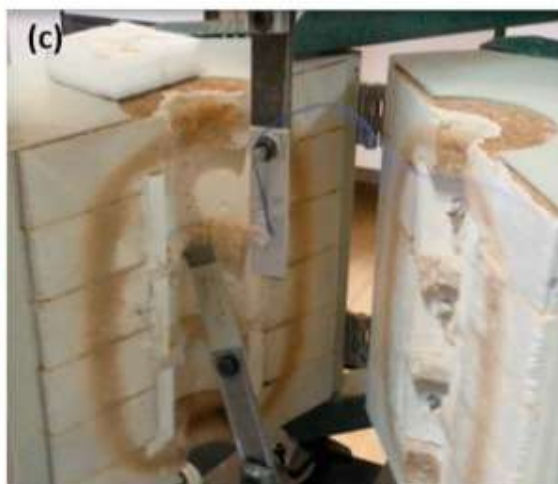
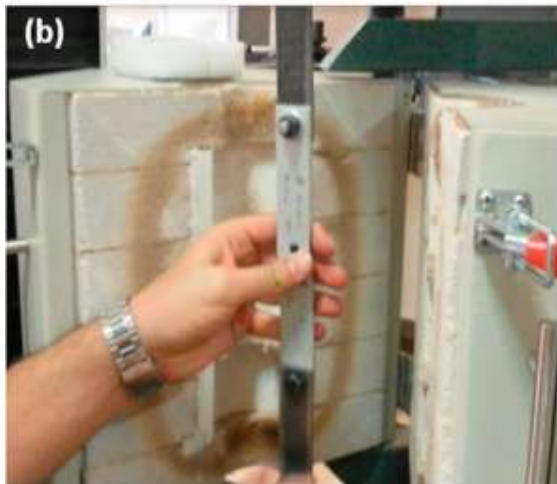

1. [Download high-res image \(185KB\)](#)
2. [Download full-size image](#)

Fig. 3. The [single lap joint](#) specimen (a) before testing, (b) preparing for testing and (c) after testing.

### 3. The adhesive joints strength

The [failure loads](#) of the neat and [nanocomposite](#) SLJs with different weight percentages of GONPs under four different temperature levels were obtained from the [quasi-static tests](#) and compared in order to investigate the effect of GONPs on the strength of single lap [adhesive joints](#). Fig. 4 shows the [load–displacement curves](#) of the adhesive joints tested at four different temperatures of 23, 40, 50 and 60 °C with different weight percentages of GONPs.

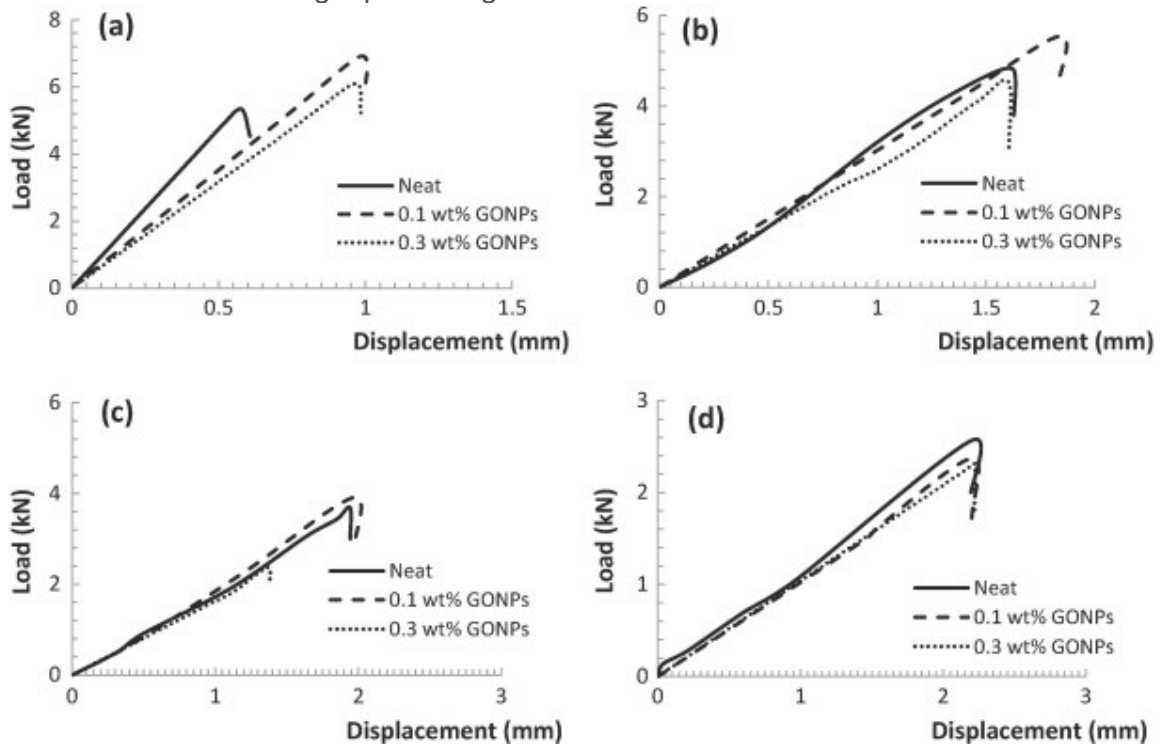

1. [Download high-res image \(313KB\)](#)
2. [Download full-size image](#)

Fig. 4. The [load–displacement curves](#) of the neat and reinforced [adhesive joints](#) tested at different [testing temperatures](#) of (a) 23, (b) 40, (c) 50 and (d) 60 °C.

[Fig. 5](#) presents the strengths of the neat and nanocomposite adhesive joints with different weight percentages of GONPs tested under four different temperatures. The strengths were calculated as the failure loads of the joints divided by the bond area.

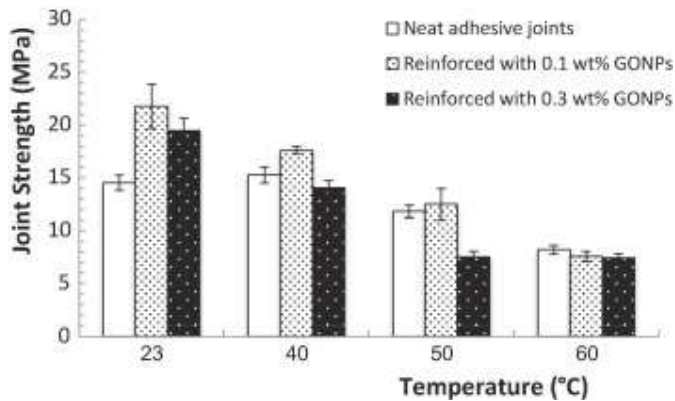

1. [Download high-res image \(150KB\)](#)
2. [Download full-size image](#)

Fig. 5. The effects of [testing temperature](#) and GONP weight percentage on the [adhesive joint](#) strengths.

The results showed that changing [testing temperature](#) affected the [joint strength](#). For the neat adhesive joints, by increasing the testing temperature from room temperature to the temperature level of 40 °C (the adhesive curing temperature), the adhesive joint strength was not decreased yet the average strength was slightly increased by 6%. However, by further increasing the temperature, the adhesive joint decreased accordingly. This trend was similarly observed by other researchers (e.g. [28]). As can be seen in [Fig. 5](#), the maximum strength of the neat adhesive joint was obtained as 15.3 MPa, when the joint was tested under the adhesive [curing temperature](#) (i.e. 40 °C). For the nanocomposite adhesive joints, the maximum strength occurred at 23 °C testing temperatures. Afterwards, the [shear strengths](#) of the neat and nanocomposite adhesives were reduced by increasing the testing temperature indicating the detrimental influence of [elevated temperature](#) on the mechanical strength of adhesive joints.

The percentage differences between the neat and nanocomposite adhesive joints with different weight percentages for four testing temperatures are presented in [Table 1](#).

Table 1. Percentage difference between the strengths of the neat and [nanocomposite adhesive joints](#) at different [testing temperatures](#).

Temperature (°C)	% difference in strength compared with the neat adhesive joints			
	23	40	50	60
0.1 wt% GONPs	50.3%	15.0%	5.9%	-7.3%
0.3 wt% GONPs	34.5%	-7.8%	-36.4%	-9.7%

As presented in [Table 1](#), adding GONPs into the [adhesive layer](#) had different effects on the strength of adhesive joints when tested under different temperatures. As a general trend, increasing the testing temperature decreased the [strength](#)



[improvement](#) caused by GONPs in nanocomposite adhesives. As can be seen from [Table 1](#), this negative influence of elevated temperature on the effect of GONPs continued to the extent that even adding GONPs caused the joint strength to drop down the strength of the neat adhesives at elevated temperatures. For instance, adding 0.1 wt% GONPs into the adhesive layer increased the joints strength by 50.3%, 15.0% and 5.9% when tested under 23, 40 and 50 °C temperatures, respectively, whereas decreased by 7.3% when tested under the temperature of 60 °C. By increasing the amount of added GONPs to 0.3 wt%, the strength of nanocomposite adhesive joints was increased by 34.5% at 23 °C temperature compared to the neat adhesive joint. However, the strength improvement was not observed for the joints tested under the elevated temperatures above the room temperature level. This means that although adding GONPs into the adhesive layer can improve the joint strengths at temperatures around the room temperature level, it can decrease the [adhesive strength](#) at elevated temperatures. Moreover, the temperature level above which adding GONPs has [degrading effect](#) on the adhesive strength diminishes when the amount of [nanofillers](#) increased in the nanocomposite adhesive. [Table 2](#) presents the displacements at failure for the neat and nanocomposite adhesive joints with different weight percentages of GONPs tested at four different temperatures. As seen in [Table 2](#), by increasing the testing temperature, the displacement at failure of the adhesive joints increased.

Table 2. Displacements at failure for SLJs tested at different temperatures.

Temperature (°C)	Displacement at failure (mm)			
	23	40	50	60
Neat	0.61	1.63	1.94	2.19
0.1 wt% GONPs	1.00	1.83	1.97	2.20
0.3 wt% GONPs	0.99	1.60	1.38	2.22

### 3.1. The fractography

After conducting quasi-static tests on the adhesive joints, the [fracture surfaces](#) of the adhesive joints were assessed visually and using SEM. As seen in [Fig. 6](#), the [failure modes](#) were adhesive or close to the interface. As seen in [Fig. 6](#), the appearance of the fracture surfaces changed with temperature. [Fig. 6\(c\)](#) shows more adhesive [deformation](#), indicating that the adhesive became more ductile. The SEM images were taken from the fracture surfaces of the joints to further evaluate the fracture surfaces. For this purpose, the samples were cut and sputter-coated with a [thin layer](#) of gold to increase the conductivity of electrons on the surfaces and to prevent the build-up of electric charge. A 15 kV [accelerating voltage](#) was applied to accomplish the desired magnification.

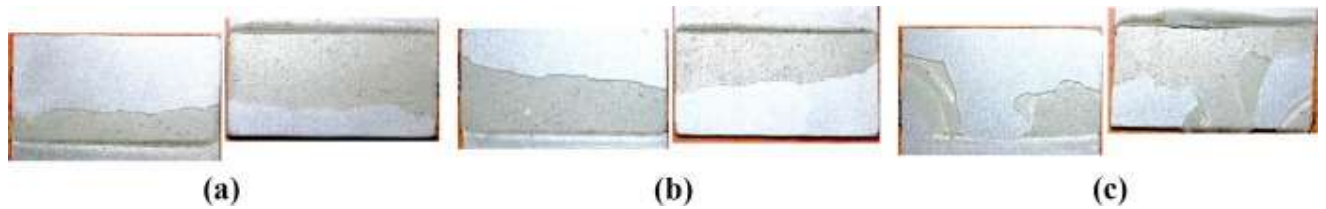

1. [Download high-res image \(277KB\)](#)
2. [Download full-size image](#)

Fig. 6. Typical [failure modes](#) of [adhesive joints](#) at different temperatures of (a) 40, (b) 50 and (c) 60 °C.

[Fig. 7](#) compares the fracture surfaces of the neat and nanocomposite adhesive joints with different GONP weight percentages tested under different elevated testing temperatures of 40 °C, 50 °C and 60 °C. As can be seen in [Fig. 7](#), by increasing the testing temperature, relatively more voids were formed due to the increased ductility and that caused the strength of the adhesive joints to decrease. It is obvious that formation and [coalescence](#) of voids can accelerate [crack growth](#) in the adhesive layer. Previous studies [\[29\]](#), [\[30\]](#) have also reported that voids have [detrimental effect](#) on mechanical properties of [polymers](#) such as the strength. Due to the mobility of the [polymer chains](#) in adhesives at elevated temperatures, polymeric materials tend to deform more easily at high temperatures. It should be noted that the size of voids in the nanocomposite adhesives was larger compared to the neat adhesive. This may be attributed to the [void formation](#) from entrapped air and incomplete wetting of GONPs by adhesive. Moreover, as seen in [Fig. 7](#), the fracture surfaces of the joints with nanocomposite adhesives were found to be rougher compared with the neat adhesive joints. The roughness of fracture surfaces can be considered as an [important factor](#) in improving the mechanical behavior of polymeric materials [\[31\]](#), [\[32\]](#).

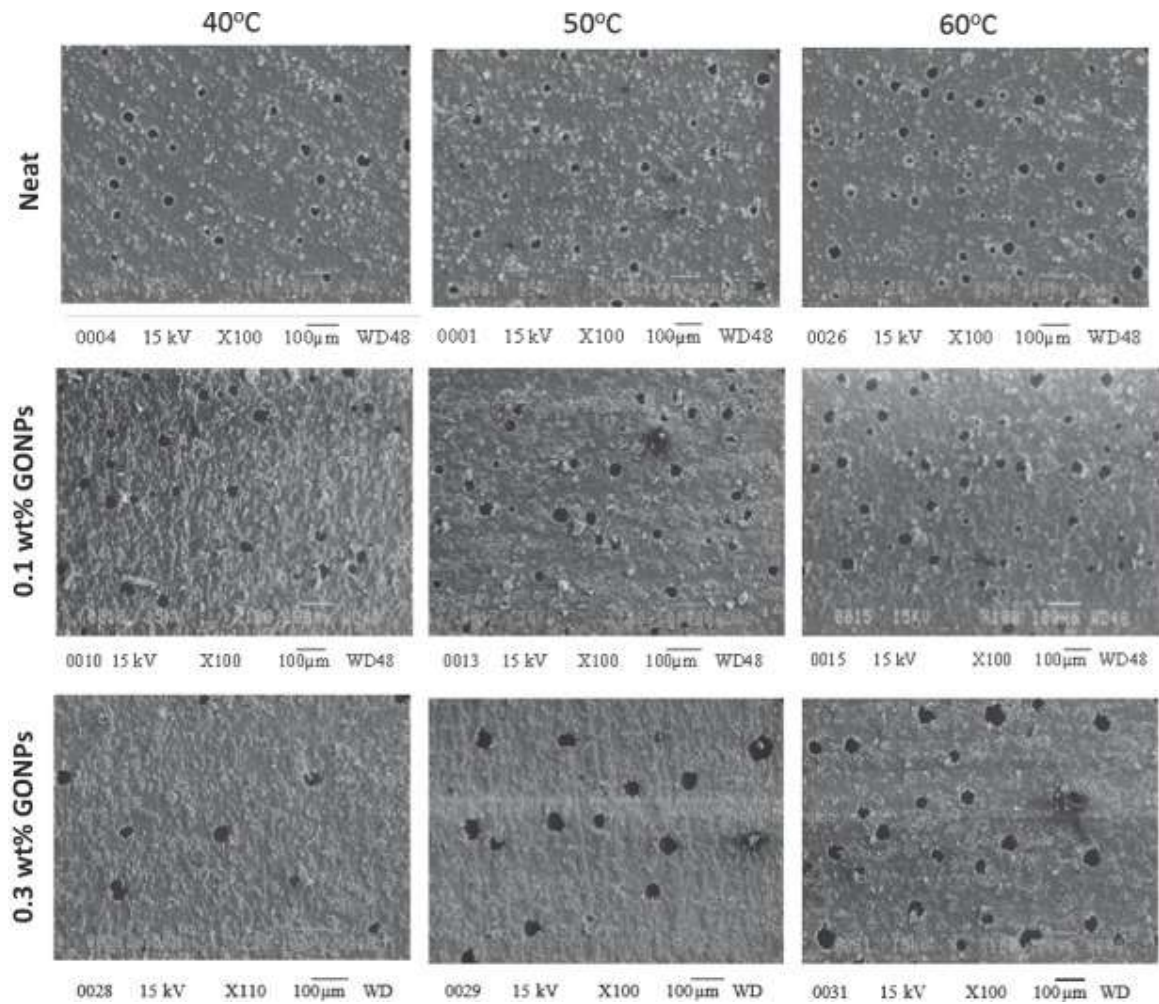

1. [Download high-res image \(846KB\)](#)
2. [Download full-size image](#)

Fig. 7. Comparison between the [fracture surfaces](#) of [adhesive joints](#) with different wt% of GONPs tested under [elevated temperatures](#).

Furthermore, as seen in [Fig. 8](#), dimples were observed on the fracture surfaces of the joints tested under 60 °C temperature indicating [ductile fracture](#) [33]. Indeed, these dimples were formed by nucleation and growth of micro-voids.

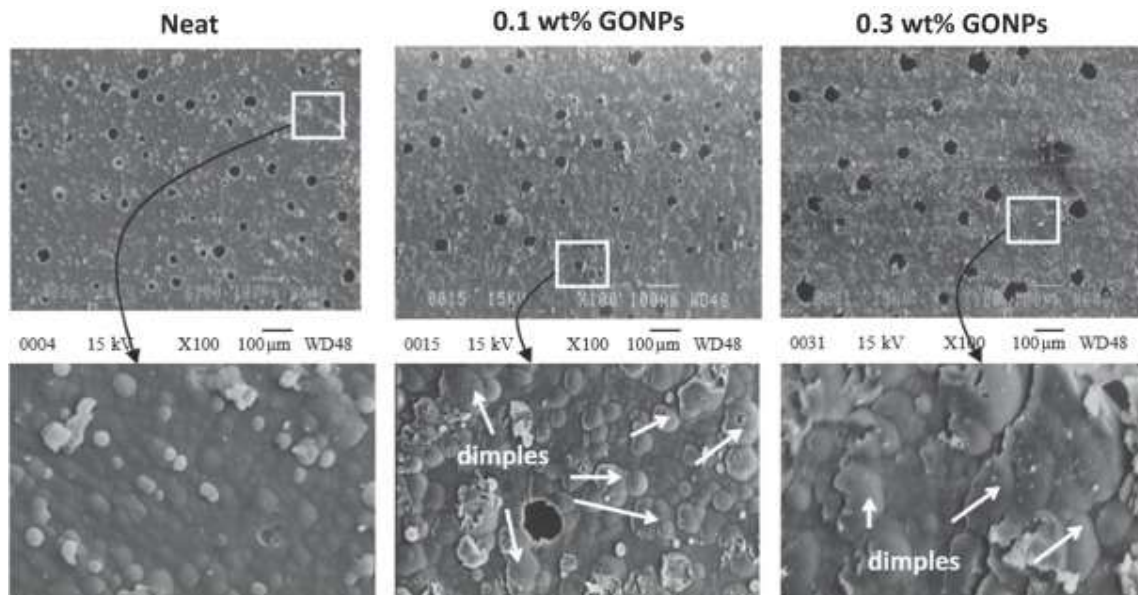

1. [Download high-res image \(446KB\)](#)
2. [Download full-size image](#)

Fig. 8. Dimples on [fracture surfaces](#) of [adhesive joints](#) tested under 60 °C.

Moreover, agglomerations of GONPs were observed on the fracture surfaces of reinforced adhesives with 0.3 wt% GONPs, as seen in [Fig. 9](#). When nanofillers are aggregated in the adhesive layer, the capacity of nanofillers in retaining the [polymeric chains](#) will decline and further they become loci of [stress concentration](#). This causes the strengths of the adhesive joints reinforced with higher amount of GONPs (0.3 wt%) to decrease in comparison with other joints tested under the same temperature.

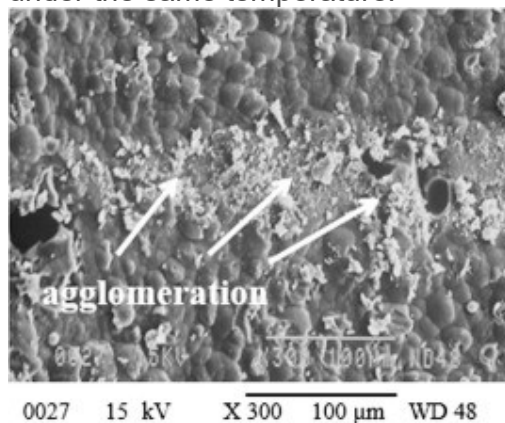

1. [Download high-res image \(99KB\)](#)
2. [Download full-size image](#)

Fig. 9. GONPs agglomeration observed on [fracture surfaces](#) of the [adhesive joints](#) with 0.3 wt% GONPs.

#### 4. Conclusions

In this research, it was aimed to study the influence of [testing temperature](#) on improving effect of adding graphene oxide nano-platelets into the [adhesive layer](#) of [adhesive joints](#) on the [joint strength](#). For this purpose, single lap adhesive joints were manufactured with neat and reinforced adhesives with different weight percentages of GONPs. Two different weight percentages of GONPs including 0.1 and 0.3 were added to the adhesive layer and the joints were tested under quasi-static loading at different testing temperatures of 23 °C, 40 °C, 50 °C and 60 °C. The results indicated that by increasing the testing temperature, the improving effect of adding GONPs decreased. Furthermore, by increasing the testing temperature beyond a critical level, adding GONPs even degraded the adhesive joint strengths compared to the neat adhesive joint. Moreover, this critical temperature level was dependent on the weight percentage of GONPs added to the adhesive layer. This critical temperature was obtained as 60 °C for the adhesive reinforced with 0.1 wt% of GONPs, while for the adhesive with 0.3 wt% GONPs, the critical testing temperature was reduced to 40 °C.