

The Cost of meeting Bandwidth Demand

Anders Christian Staude

Master of Science in Communication Technology

Submission date: June 2006

Supervisor: Leif Arne Rønningen, ITEM

Co-supervisor: Bjarte Kvarme, Telenor
Kurosh Bozorgebrahimi, Telenor

Problem Description

The capacity requirements for residential access networks increase each year. For Telenor, this serves as a basis when assessing future access network technologies. xDSL and fiber-based solutions are so far among the most probable solutions. This thesis aims at answering the following questions:

Which applications and bandwidth requirements are to be expected in the Norwegian broadband market the next 5 to 10 years?

Which access technologies will best support these requirements?

Based on an economical analysis, which access technologies should be chosen for future deployment.

Assignment given: 20. January 2006

Supervisor: Leif Arne Rønningen, ITEM

Preface

This thesis is carried out as part of the MSc degree at the Norwegian University of Science and Technology (NTNU), Department of Telematics. It is conducted in collaboration between NTNU and Telenor Nordic. The work has been carried out during the winter and spring of 2006, both at NTNU and at Telenor's facilities at Tyholt.

I would like to thank my advisors at Telenor, Bjarte Kvarme and Kurosh Bozorgebrahimi. In addition, I would also like to thank and my academic advisor at NTNU, Professor Leif Arne Rønningen. Together they have all provided excellent help and advice. Thanks!

Through my work, I have also received valuable information and guidelines from various other Telenor employees. Erik Meltzer has been in particular helpful.

Trondheim, November, 25 2005

Anders Staude

Preface.....	I
Figures and tables	IV
Abbreviations and definitions.....	VII
Abstract.....	VIII
1 Introduction.....	- 1 -
1.1 Motivation.....	- 1 -
1.2 Problem definition	- 1 -
1.3 Limitations	- 2 -
1.4 Readers guide.....	- 3 -
2 Related work	- 4 -
3 Access networks.....	- 5 -
3.1 Today's access network	- 5 -
3.2 Competition.....	- 7 -
4 Bandwidth demand drivers	- 9 -
4.1 Current applications	- 9 -
4.1.1 Classic Internet applications	- 9 -
4.1.2 Entertainment and broadcast.....	- 11 -
4.1.3 E-services and other trends	- 13 -
4.2 Emerging and Future trends.....	- 14 -
4.3 Bandwidth demand estimations	- 16 -
4.3.1 Other attempts.....	- 16 -
4.3.2 Contributing estimates	- 18 -
4.4 Demand summary	- 20 -
5 Access technology	- 21 -
5.1 Copper based solutions	- 21 -
5.1.1 xDSL.....	- 21 -
5.1.2 xDSL summary	- 23 -
5.2 Optical access networks.....	- 24 -
5.2.1 Point to point (P2P).....	- 26 -
5.2.2 Point to multipoint (P2MP).....	- 27 -
5.2.3 Fiber summary	- 32 -
5.3 Access technology summary.....	- 33 -
6 Cost and Revenue figures	- 34 -
6.1 Capital expenditures (CAPEX).....	- 34 -
6.1.1 Basic building blocs.....	- 34 -
6.1.2 PON equipment costs.....	- 37 -
6.1.3 P2P equipment costs	- 38 -
6.1.4 Equipment used in both P2P and PONs.....	- 39 -
6.1.5 VDSL2 equipment costs	- 39 -
6.1.6 Further CAPEX.....	- 41 -
6.2 Operational expenditures (OPEX)	- 41 -
6.3 Revenues.....	- 42 -
7 Motivation behind area selection	- 44 -
8 Business case assumptions.....	- 46 -
8.1 Network assumptions.....	- 46 -

8.1.1	General assumptions	- 46 -
8.1.2	PON.....	- 47 -
8.1.3	P2P	- 49 -
8.1.4	VDSL2	- 51 -
8.2	Residential assumptions.....	- 55 -
8.3	Assumptions regarding cable needs and digging.....	- 55 -
8.3.1	PON.....	- 55 -
8.3.2	P2P	- 58 -
8.3.3	VDSL2	- 60 -
8.4	Assumptions regarding green-field deployment.....	- 61 -
9	Results.....	- 62 -
9.1	How to interpret results.....	- 62 -
9.2	Area results	- 63 -
9.2.1	Angeltrøa.....	- 63 -
9.2.2	Granåslia	- 65 -
9.2.3	Othilienborg.....	- 67 -
9.2.4	Nedre Elvehavn.....	- 69 -
9.2.5	Kvammen.....	- 71 -
9.2.6	Spondal	- 73 -
9.3	Technology results.....	- 75 -
9.3.1	PON.....	- 75 -
9.3.2	P2P	- 79 -
9.3.3	VDSL2	- 82 -
9.4	Green-field results.....	- 84 -
10	Sensitivity analysis and risk assessment.....	- 86 -
10.1	Financial risk.....	- 86 -
10.2	Technological risk.....	- 92 -
10.3	Operational risk.....	- 95 -
11	Conclusions.....	- 97 -
12	Future work.....	- 104 -
13	References.....	- 105 -
Appendix A: Explanation of constants and assumptions.....		- 109 -
Constants and assumptions used in the models		- 109 -
Constants and assumptions used in NPV analysis.....		- 110 -
Appendix B: Explanation of Excel spread sheets.....		- 112 -
Appendix C: Other access technologies		- 113 -
Radio-based solutions: WiMAX.....		- 113 -
Cable TV access.....		- 113 -
Appendix D: Optical network elements and their functions.....		- 115 -
Appendix E: Multiple access methods.....		- 116 -
Appendix F: Lyse Energi AS.....		- 117 -
Appendix G: Security considerations in PONs.....		- 118 -
Appendix H: Maps.....		- 119 -

Figures and tables

Figure 1: Thesis structure.....	- 3 -
Figure 2: The access network in context with other network entities.....	- 5 -
Figure 3: Overview of Telenor's copper based access network used for voice	- 6 -
Figure 4: Overview of Telenor's copper based access network used for voice and data..	- 6 -
-	
Figure 5: Internet traffic sorted by type, modified from [3]	- 10 -
Figure 6: Popularity of online games [9]	- 12 -
Figure 7: Nielsen's law of Internet Bandwidth [6].....	- 17 -
Figure 8: "Out-of-sample" test of Nielsen's law	- 17 -
Figure 9: Plotting predictions against Nielsen's law	- 20 -
Figure 10: Principles of xDSL [13]	- 21 -
Figure 11: Bit rates and reach for different xDSL technologies.....	- 23 -
Figure 12: Basic building blocks in a FTTH solution.....	- 24 -
Figure 13: Combining fiber and copper using a forward fiber node	- 25 -
Figure 14: Point-to-Point optical access network	- 26 -
Figure 15: Active Star, modified from [31]	- 27 -
Figure 16: Point-to-Multi-Point optical access network.....	- 28 -
Figure 17: Network topologies [22].....	- 29 -
Figure 18: New PON topology in relation with old copper entities FIKS SUPER-co.	- 48 -
Figure 19: New P2P topology in relation with old copper entities.....	- 50 -
Figure 20: Correct deployment of new VDSL2 DSLAMs	- 52 -
Figure 21: Two HF areas sharing one DSLAM.....	- 53 -
Figure 22: Achieving 70 Mbit/s with VDSL2	- 54 -
Figure 23: Achieving 30 Mbit/s with VDSL2	- 55 -
Figure 24: Overview of a hypothetical business case area with PON deployment	- 56 -
Figure 25: Overview of a hypothetical business case area with P2P deployment.....	- 58 -
Figure 26: Cost per customer (initial CAPX divided by assumed initial number of customers).....	- 64 -
Figure 27: Cost per customer as a function of the assumed initial number of customers ...	- 64 -
Figure 28: Net Present Value for the four different solutions	- 65 -
Figure 29: Cost per customer (initial CAPX divided by assumed initial number of customers).....	- 66 -
Figure 30: Cost per customer as a function of the assumed initial number of customers ...	- 66 -
Figure 31: Net Present Value for the four different solutions	- 67 -
Figure 32: Cost per customer (initial CAPX divided by assumed initial number of customers).....	- 68 -
Figure 33: Cost per customer as a function of the assumed initial number of customers ...	- 68 -
Figure 34: Net Present Value for the four different solutions	- 69 -

Figure 35: Cost per customer (initial CAPX divided by assumed initial number of customers).....	- 70 -
Figure 36: Cost per customer as a function of the assumed initial number of customers ...	- 70 -
Figure 37: Net Present Value for the four different solutions	- 71 -
Figure 38: Cost per customer (initial CAPX divided by assumed initial number of customers).....	- 72 -
Figure 39: Cost per customer as a function of the assumed initial number of customers ...	- 72 -
Figure 40: Net Present Value for the four different solutions	- 72 -
Figure 41: Cost per customer (initial CAPX divided by assumed initial number of customers).....	- 74 -
Figure 42: Cost per customer as a function of the assumed initial number of customers ...	- 74 -
Figure 43: Net Present Value for the four different solutions	- 74 -
Figure 44: Initial CAPEX figures split into categories.....	- 76 -
Figure 45: Distribution of CAPEX figures among categories.....	- 76 -
Figure 46: Illustrating how initial CAPEX figures can be grouped according to location..	- 77 -
Figure 47: Initial CAPEX figures grouped according to where in the network they occur. -	- 78 -
Figure 48: Distribution of CAPEX figures among locations.....	- 78 -
Figure 49: Initial CAPEX figures split into categories.....	- 79 -
Figure 50: Distribution of CAPEX figures among categories.....	- 80 -
Figure 51: Illustrating how initial CAPEX figures can be grouped according to location..	- 80 -
Figure 52: Initial CAPEX figures grouped according to where in the network they occur. -	- 81 -
Figure 53: Distribution of CAPEX figures among locations.....	- 82 -
Figure 54: Initial CAPEX figures split into categories.....	- 83 -
Figure 55: Distribution of CAPEX figures among categories.....	- 83 -
Figure 56: Cost per customer, scenario 1 vs. scenario 2.....	- 84 -
Figure 57: Differences between CAPEX per customer in an established area vs. an area under construction.....	- 85 -
Figure 58: CAPEX per customer for VDSL2 scenario 1 as a function of modem prices ...	- 87 -
Figure 59: The importance of digging price per meter.....	- 88 -
Figure 60: The importance of digging price per meter.....	- 89 -
Figure 61: Sensitivity analysis regarding OPEX figures	- 90 -
Figure 62: Sensitivity analysis regarding revenues	- 91 -
Figure 63: The NPV for different solutions at Kvammen as a function of cost of capital ...	- 92 -
Figure 64: The difference between using "large and "small" fiber cables in PONs	- 94 -
Figure 65: The difference between using "large and "small" fiber cables in P2P	- 95 -
Figure 66: Initial CAPEX per customer for all solutions in all areas	- 100 -
Figure 67: A typical cable TV network. Modified from [23] [42]	- 114 -

Figure 68: Angeltrøa.....	- 120 -
Figure 69: Granåslia.....	- 121 -
Figure 70: Othilienborg.....	- 122 -
Figure 71: Nedre Elvehavn.....	- 123 -
Figure 72: Kvammen.....	- 124 -
Figure 73: Spongdal.....	- 125 -
Table 1: Bandwidth usage for SDTV and HDTV depending on codec.....	- 16 -
Table 2: Predictions of future bandwidth demand.....	- 20 -
Table 3: Overall efficiency EPON vs. GPON [36].....	- 32 -
Table 4: Fiber prices.....	- 35 -
Table 5: Digging prices.....	- 35 -
Table 6: Prices of splicing or terminating fiber.....	- 36 -
Table 7: Copper prices.....	- 36 -
Table 8: Splitter costs.....	- 37 -
Table 9: Prices for PON OLT equipment and installation.....	- 38 -
Table 10: Prices for PON ONT equipment and installation.....	- 38 -
Table 11: Prices for P2P OLT equipment and installation.....	- 39 -
Table 12: Prices for P2P ONT equipment and installation.....	- 39 -
Table 13: DSLAM hardware, housing and installation prices.....	- 40 -
Table 14: Yearly OPEX figures.....	- 41 -
Table 15: One-time initial OPEX figures.....	- 41 -
Table 16: Components in monthly service fee and sign-up fee.....	- 42 -
Table 17: Revenue summary.....	- 43 -
Table 18: Key figures and demographics for Angeltrøa.....	- 64 -
Table 19: Key figures and demographics for Granåslia.....	- 66 -
Table 20: Key figures and demographics for Othilienborg.....	- 67 -
Table 21: Key figures and demographics for Nedre Elvehavn.....	- 70 -
Table 22: Key figures and demographics for Kvammen.....	- 71 -
Table 23: Key figures and demographics for Spongdal.....	- 73 -

Abbreviations and definitions

ADSL	Asymmetric Digital Subscriber Line
APON	ATM Passive Optical Network
ATM	Asynchronous Transfer Mode
BPON	Broadband Passive Optical Network
CAPEX	Capital Expenditures
CO	Central Office
CPE	Customer Premises Equipment
DSLAM	Digital Subscriber Line Access Multiplexer
EF	Drop distribution point
EPON	Ethernet Passive Optical Network
FTTH	Fiber-To-The-Home
DSL	Digital Subscriber Line
GIS	Geographic Information System
GPON	Gigabit Passive Optical Network
HDTV	High-Definition Television
HF	Main distribution point
HFC	Hybrid Fiber Coaxial
IEEE	Institute of Electrical and Electronics Engineers
IP	Internet Protocol
IPTV	Internet Protocol Television
ITU	International Telecommunication Union
MPEG	Moving Picture Experts Group
NOK	Norwegian Kroners
NPV	Net Present Value
OPEX	Operating Expenditures
OLT	Optical Line Termination
ONT	Optical Network Termination
ONU	Optical Network Unit
ORN	Optical Remote Node
P2MP	Point-to-Multi-Point
P2P	Point-to-Point
PON	Passive Optical Network
PSTN	Public Switched Telephone Network
SDTV	Standard-definition Television
STB	Set-Top-Box
VDSL	Very high bit-rate DSL

Bandwidth

In the strictest sense, the word bandwidth only describes the range of frequencies used for transmission. In this thesis the word will however be used, less strict, as a synonym for bit-rate channel capacity.

Abstract

Telenor is faced with complex decisions regarding their access network strategies. Competitors are given the right to use Telenor's copper access network through LLUB (Local Loop Un-Bundling) regulations. Competition is also seen from alternative access networks. Both implying lost customers and lost revenues. At the same time, the accumulated demand for bandwidth is increasing to a level beyond what can be accommodated by Telenor's current access network. Failing to meet this demand will result in further lost revenues.

This thesis uses the expected growth in bandwidth demand to motivate an upgrade of Telenor's access network. Several schemes and technologies are considered. Finally three different solutions are chosen for an in-depth business case analysis. As part of this analysis, a set of models are created. These models can be used to calculate investment costs of an arbitrary area. The models are used on six different areas in and around Trondheim.

New applications and services such as Peer-to-Peer, Streaming and Video-on-Demand are increasing the demand for bandwidth among home users. There is also a trend towards an access network convergence. Traditionally, basic services would have dedicated access networks. This is changing. The product called Triple Play (3P) is perhaps the best example. This is telephony, TV and Internet access all offered on one access network with one bill.

Various fiber based solutions or an improvement of current xDSL technology are those options relevant to Telenor Nordic. A point-to-point (P2P) fiber solution, a passive optical network (PON) and a VDSL2 solution are chosen for a business case analysis. The two former solutions are considered capable of meeting long term demand. The latter solution is considered capable of meeting medium to long term demand.

By applying the models created and using a Telenor GIS (Geographic Information System) tool for measurements, results are obtained. They indicate that a VDSL2 solution is the cheapest way of providing bit rates above 70 Mbit/s to all customers. In urban and sub-urban areas VDSL2 is approximately 50 % cheaper than fiber-based solutions. In rural areas, the difference between a PON solution and VDSL2 is reduced. A P2P solution remains the most expensive, but now by far. The net present value analysis show positive values for all solutions in urban and sub-urban areas. The rural areas seem unprofitable according to any standard.

The presence of available fiber becomes a crucial factor in determining deployment costs for PONs. In the case of a P2P solution, existing available ducts are highly desirable. The fear of high deployment costs related to expensive civil work in urban areas, seem needless. The high population density and availability of existing infrastructure in these areas easily compensates expensive civil work.

1 Introduction

1.1 Motivation

The demand for a high speed access network is greater than ever. Terms like online gaming, video-on-demand and IPTV are heard more and more often. The common denominator for these services and application is fast Internet access.

As of today, Telenor relies on their old copper based access network, when providing Internet access. In terms of being able to deliver high bit rate access to support the services mentioned above, this network is becoming obsolete. Competitors are beginning to offer more advanced access solution and Telenor is losing customers. An upgrade of Telenor's access network is inevitable, but specific plans are few or missing.

The motivation for this thesis is to analyze how Telenor can meet the future access demand in a cost-efficient way. Hopefully, this will help in retaining or increasing their current market share.

1.2 Problem definition

This thesis aims at giving strategic advice on improving Telenor's access network. It is the access network targeted towards home-usage that is investigated. First we give reasons **why** the access network needs to be upgraded. This is done through an analysis of the expected future bandwidth demand. The next part describes **how** an upgrade can be realized. This is done by reviewing the most likely alternatives for an access network upgrade. Last we look at **how much** these upgrades will cost and their ability in becoming profitable. It is the last of these three questions that will receive the most focus. The two others are, however, still necessary in order to motivate an analysis.

Creating a model

In context with the last of the three questions presented above, it has been the author's intention to construct a general model that can be used to calculate investment costs for a given area. Depending on the technology analyzed, the model will take in different input parameters and calculate costs. Such a model would be valuable in locating profitable areas for access network upgrades. In addition, it would indicate the preferred technology to use.

The investment costs depend strongly on several parameters specific to each area. Geography, population density, take rateⁱ and the presence of infrastructure such as fiber and ducts are examples of key parameters. The large number of parameters motivates a

ⁱ The take rate is defined as the percentage of households subscribing to the service.

model-based approach. There is however a big trade-off between making the model easy to use and the precision of the results. The most precise estimate would obviously be obtained by making no assumptions or generalizations. It would however be highly desirable to have a quasi-general model that could predict upgrade costs of an arbitrary area, based on the input of key parameters and a few case specific decisions

Instead of analyzing an area totally separated from others, a systematic approach is followed. This means making some general decisions and assumptions on how to quantify certain parameters. Nevertheless, some parameters and decisions are case-specific. This means that the model will require some effort from the user, but much less compared to analyzing an individual business case from scratch.

In this thesis three models are constructed. There is one model for each of the technological solutions studied. The models are implemented through three different Excel spread sheets backed by a set of rules and assumptions. The spread sheets are included as attachments to the thesis. The rules and assumptions are given in chapter 8. Appendix B provides a quick guide to the different spread sheets.

In order to use the model developed, six areas in and around Trondheim have been chosen for study. These areas will be studied through a business case analysis.

1.3 Limitations

The technological solutions studied in this thesis are assessed on two main criterions. These are their ability in meeting future bandwidth demand and their cost level. Aspects such as security, reliability and protocol efficiency are not treaded.

Although focusing on deployment costs, it is not the aim of this thesis to predict future equipment prices. This is a science of its own and thoroughly treated elsewhere. Current price levels are used to obtain the results presented. If desirable, the models constructed here can easily be fed with future price estimates.

Take-rate is an important factor in any calculation of deployment costs. A lot of effort is being put into the science of predicting take rates. Predicting such rates has however not been the focus of this thesis. As with the equipment costs, take rate is just left as a parameter in the models created. For the results presented here, a naïve take rate of 40 % is chosen.

1.4 Readers guide

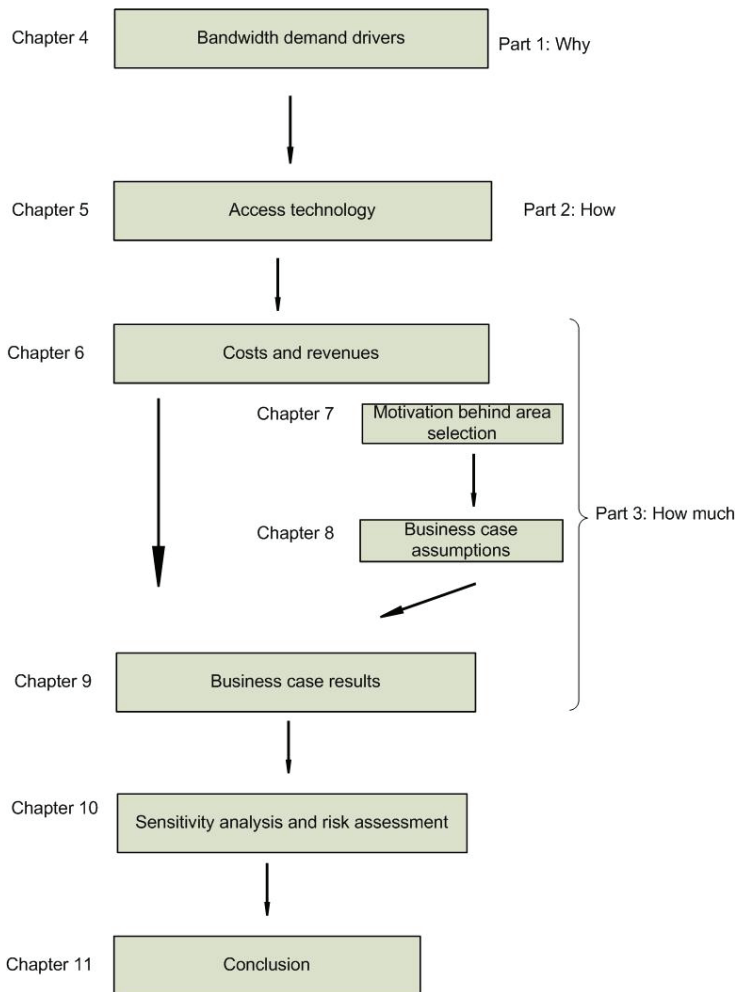

Figure 1: Thesis structure

The following chapters make up the main structure of this thesis. Chapter 4 is meant to give reasons for the increasing bandwidth demand among residential users. Chapter 5 presents access technologies considered by Telenor and thought capable of meeting the demand estimations set forth in chapter 4. Chapter 5 ends by selecting three access solutions chosen for further investigation. Chapter 6 provides costs and revenues associated with these solutions. Chapter 7 and 8 motivate and explain how results are obtained. Chapter 9 presents the results. Risk factors are pointed out in chapter 10, before conclusions are given in chapter 11. With respect to the three questions initially set forth, the thesis can also be divided into three main parts. All this is illustrated in Figure 1.

Technical books, research papers and standards are the main sources used in part 1 and 2. Telenor is the primary source in part 3. The author has also been granted access to Telenor's map database. All geographic measurements are extracted from these maps.

2 Related work

This thesis is special in that it combines the estimation of future bandwidth demand with the evaluation of several new access network technologies. In addition to this, costs and revenues associated with deployment in Norway are analyzed. Some previous work has been done relevant to this combination of topics. A short review of these attempts is given next.

[12] from 2003 evaluates different fiber-to-the-home solutions. Without further investigations, PONs are assumed to be the far superior solution. A hypothetical scenario is then used to estimate the profitability of a PON deployment. Operational costs are however not included. Since only a hypothetical scenario is used, no real world geographic measurements are made. The equipment costs are also highly simplified.

[38] from 2004 evaluates the U.S. with respect to a fiber-to-the-home deployment. Reasons are given why major roll-outs are delayed. This is done both through demand estimations and through the construction of a hypothetical business case.

[41] from 2004 assesses broadband strategies after ADSL. ADSL2+ and VDSL are studied. The total upgrading costs are estimated in an extremely crude way. Instead a thorough sensitivity analysis is performed with respect to key parameters. It is also shown how a real options approach only can add value to a potential upgrading project.

[40] from 2004 tries to establish a ten-year access roadmap. The areas in focus are Norway, Poland and France. Advanced models are made in order to predict take rates and equipment prices. In addition, a techno-economical assessment is made with respect to different access technologies. Fiber, cable and xDSL are studied, but the primary focus is towards radio based solutions.

[39] from 2004 makes a time-independent estimation on bandwidth needs based on a Triple Play (3P) service. A fiber based solution is assumed to be best suited in delivering 3P. By comparing an active star solution to a PON solution, PONs are found to be more profitable. As with [12], the results provide limited insight. No operational costs are included and equipment costs are overly simplified. No efforts are made in trying to incorporate parameters such as population density and existing infra structure. [39] also discusses various access network ownership models.

3 Access networks

3.1 Today's access network

The access network is defined as the set of equipment and infrastructure needed to perform the connection between the user's equipment and the carrier premises. [21]. Figure 2 shows the concept of an access network.

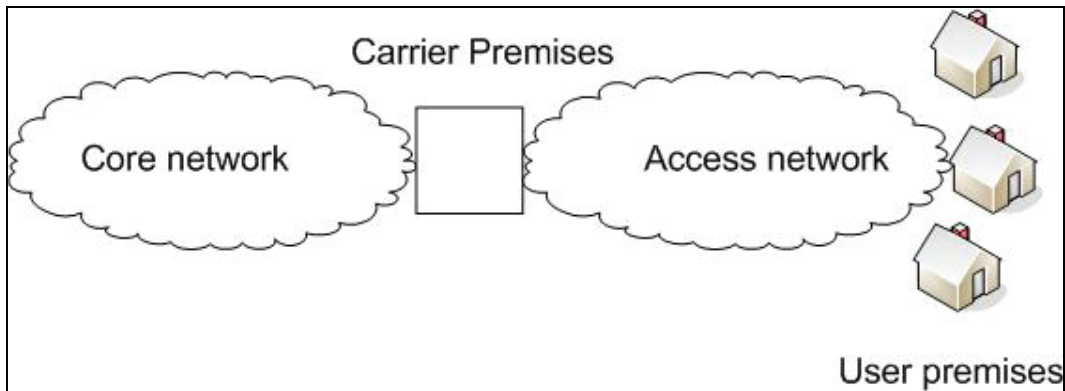

Figure 2: The access network in context with other network entities

The access network is often also called "the local loop", "the last mile" or "the first mile". Traditionally access networks were designed to support a specific service. Copper lines were laid out to support telephony while coax cables made up the access network for cable TV. Telenor's access network falls into the first category since originally being a telephony operator.

Within a copper based access network used for telephony, several components are present. The central office (CO) takes the role of the carrier premises in Figure 2. The CO, is not really defined as part of the access network, but plays an important role. It is the aggregation point of end-user traffic. Typically a CO will serve between 20 and 20.000 customers.

Figure 4 shows a schematic overview of the typical configuration of Telenor's telephony access networks. The main-distribution-points and the drop-distribution-point are just passive intermediate nodes where several copper lines are bundled and follow a common path towards CO. Through out the rest of this thesis, they will be called HF and EF for shortⁱⁱ.

ⁱⁱ The Norwegian words for these two entities are "Hoved-Fordeler" and "Ende-Fordeler" respectively.

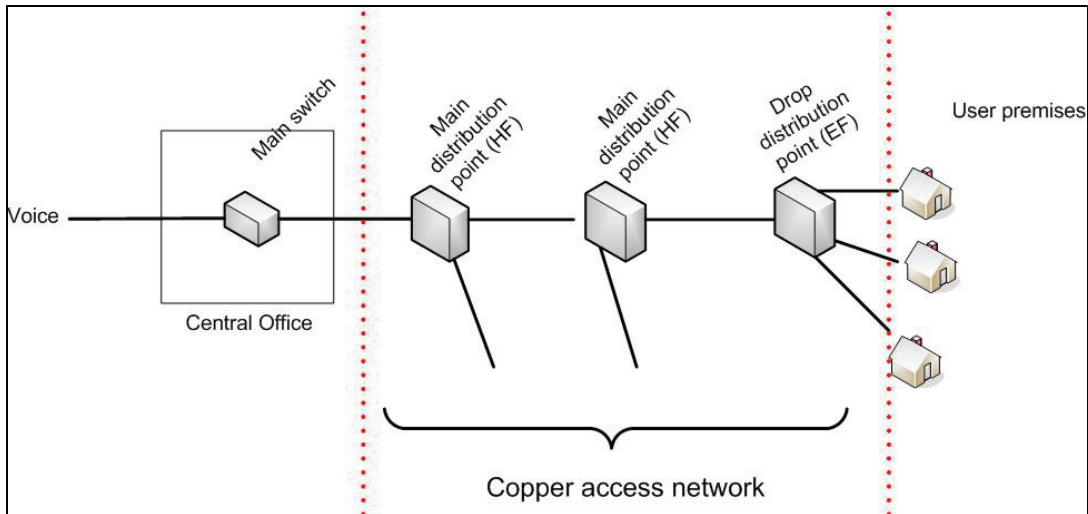

Figure 3: Overview of Telenor's copper based access network used for voice

Through xDSL technology, telephony operators have also started to offer internet access over copper lines. This requires a device called the DSLAM to be installed in the CO. DSLAMs aggregate data traffic from end-users. DSLAMs and their functions will be covered in chapter 5 and 6. Figure 4 shows the addition of DSLAMs into the CO.

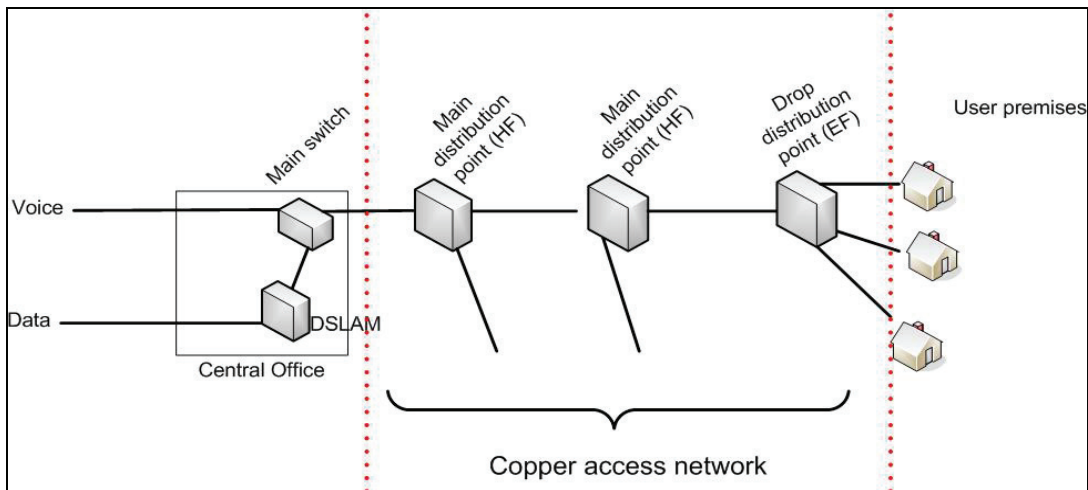

Figure 4: Overview of Telenor's copper based access network used for voice and data.

As will be explained later, several xDSL technologies exist. They differ in the bit rates they provide at different line distances. The xDSL variant offered depend on which type of line cards are placed in the DSLAM. As of today, Telenor offers ADSL in mainland Norway. It has maximum downstream capacity of 7 Mbit/s. Even though still running in ADSL mode, all new cards installed today are ADSL2+ enabled. ADSL2+ is an improvement to the ADSL standard.

As mentioned above, access networks were traditionally set up to support a specific service. The trend today is however a convergence. [46] Multiple services are offered over the same access network. Classic examples are Internet access over a cable-TV network or IPTV over a copper xDSL line. The ultimate goal is often referred to as Triple Play (3P). This means data, voice and video over a common access network with only one bill to pay.

In addition to the infrastructure described above, Telenor also owns large quantities of fiber and ducts. These are not usually part of a public access network. Instead they may serve business customers or be part of some back haul link. When such fiber and ducts are deployed, it is common to lay down more than what is actually needed then and there. This is done because digging the ditch is the primary cost factor. In comparison, fiber and ducts are cheap. Laying down a little extra is hence an inexpensive way of preparing for future demand.

Though not physically part of the access network, the fiber and ducts described above may run along side or close to the existing access network. Especially in densely populated areas, the availability of fibers and ducts is significant. By utilizing such available infra structure, the cost of upgrading or replacing the current access network can be reduced greatly.

3.2 Competition

As of today, Telenor offers Internet access over its copper network. With respect to this service, they face serious competition from several actors. These actors may or may not use a copper access network. As will be explained shortly, other access network types also exist.

In order to make competition even more complicated, the product portfolios being offered among competitors also differ. In addition to Internet access, telephony and TV may be offered.

This section is meant to give a brief overview of which types of competitors exist. These are grouped according to the kind of access network they use. The common denominator is however that Internet access can be offered. Section 10.3 will further discuss the implications of competition.

Copper

Through federal regulations, Telenor has lost its copper access network monopoly. Competitors are given the right to rent spare capacity in the access network in order to provide their own competing services. This regulation is called local loop un-bundling (LLUB). LLUB results in competitors setting up their own DSLAMs at Telenor COs. From these they are able to offer xDSL access. Main competitors in this category are

various utility companies and NextGenTel. The latter of these is already offering Triple Play services to some of its customers.

Cable TV

Cable TV operators have long been offering Internet access, over their network. Some are also offering telephony. Large competitors in this category are Canal Digital and UPC. In terms of offering Triple Play, these operators have an advantage. Since TV is already their core business, there is no extra cost in acquiring TV capabilities. Internet access through the cable TV network is described further in Appendix C.

Fiber

In some areas, various operators are also offering a fiber based access network. In terms of market share, fiber based access is still small. In mid 2005, it was estimated that only 4% of all broadband access connections were through fiber. [33] Despite being small, fiber based competitors are the most interesting with respect to this thesis. Lyse Energi with its franchise partners are maybe the most well known fiber based access operators. In 2005 Lyse and its partners had 30.000 Triple Play customers. [34] Lyse is described further in Appendix F.

4 Bandwidth demand drivers

Predicting the future home bandwidth demand is crucial when advising on new access network technology. What services and applications will home users have 10 years ahead and how much capacity will they consume? As a starting point, one can look at the applications seen today. By also trying to see into the future and extrapolating the current trend, it is possible to make an educated guess about the future needs. This section begins by first describing current applications. Next we look at emerging and future trends requiring high capacity networks. More futuristic applications are also described. At last we make some final estimates on the requirements of a future access network. The considerations made here should be seen in context with the convergence towards one common network described in the previous chapter.

4.1 Current applications

4.1.1 Classic Internet applications

WWW, E-mail and file transferring mechanisms are the most important in this category. The first two are considered well known with modest capacity demands. They are hence not further discussed. File transferring mechanisms are however important. The possibility to obtain movies, music and other media is probably what most people associate with high speed Internet connections.

The ability to download music and video efficiently, are today reckoned as a primary requirement when buying Internet access. Traditionally downloading was done from central servers, using FTP (File Transfer Protocol). Today a Peer-to-Peer scheme is typically used.

Peer-to-Peer

A peer-to-peer computer network is a network that relies on the computing power and bandwidth of the participants. This is in contrast to a more traditional client-server model. Peer-to-peer connections are typically made ad-hoc. These connections are then used for sharing content containing audio, video or anything else in digital format. [42]

A significant factor in the growth of Internet traffic is peer-to-peer activity. Services such as Kazaa, Napster and Gnutella are based on this concept. Music is the most popular type of media being shared. Compared to traditional browsing, these files consume a lot of bandwidth and traffic volume because of their size. The average website has a size of 70-100 KB. On the other hand, an MP3 song is usually about 4 Mb. According to [4], 50-70% of Internet traffic can be traced back to peer-to-peer activity. This number is likely to increase as file sharing shifts from MP3s to DVDs (700Mb).

Most peer-to-peer users download and share already existing files. Less than 10% upload new content to the peer-to-peer servers. Schools and Universities are currently the biggest content providers and also heavy users. [3] Figure 5 shows traffic sorted by type from Cornell campus network. Campus networks have traditionally been high speed networks offering short downloading times. This indicates that traffic should only rise when the same bandwidth becomes available in private homes.

Peer-to-peer traffic is also an example of why upstream Internet capacity is becoming just as important as downstream. The time needed to obtain a file, is only limited by the slowest connection, upstream or downstream.

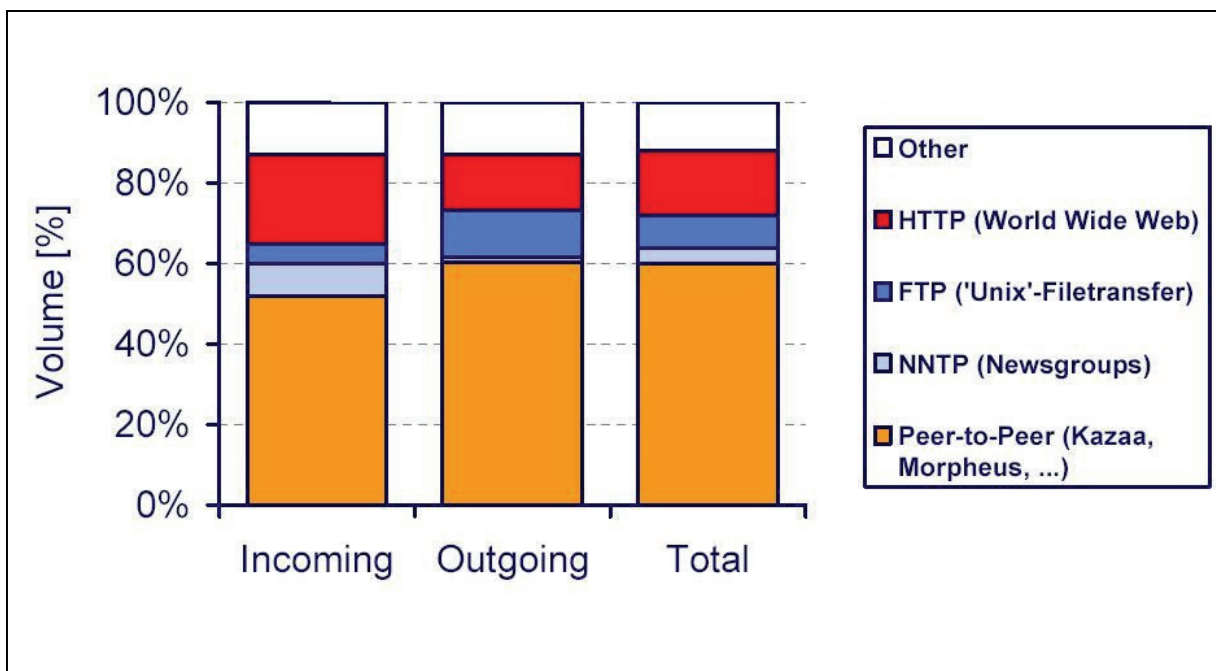

Figure 5: Internet traffic sorted by type, modified from [3]

There is a risk involved in estimating future bandwidth needs based on today's downloading activity. There is an ongoing struggle between downloaders and the music/movie industry regarding digital rights and illegal sharing of files. The outcome of this should be monitored, but in the author's opinion, this will not have a large impact. Two reasons are given:

- Laws regarding digital rights are very hard, if not impossible, to enforce.
- Services where users pay to download music or movies are already becoming popular. This indicates that there is a significant willingness to pay for such files. In the case of strict law enforcement, traffic would hence still be high.

4.1.2 Entertainment and broadcast

Streaming

This means to hear, read or view some kind of media content as it is being delivered. Listening to the radio on-line is one example. Media streaming is becoming very popular. [1] estimates music to be the most popular media being streamed. It has a share of 34%. News and Internet TV are second and third with 20.4% and 15.1% respectively.

Video on Demand (VoD)

A service thought to become very popular is Video on Demand (VoD). With VoD, the user can choose when, where and what to watch. VoD can be delivered by streaming or download. The user will typically pay a small fee per show or fixed monthly fee allowing unlimited use.

The concept of VoD, is placing movies or premium television content in a central storage facility. This content can then be ordered by individual subscribers. Video on Demand is different from regular pay-per-view not only due to instant delivery, but also because it allows for VCR-like controls such as pause, fast forward and rewind.

The ultimate goal is of course to allow people to watch exactly what they want whenever they want. The ever more hectic everyday life and the need for personal flexibility are reasons assumed to boost the uptake of VoD technology

Digital TV and IPTV

With the emergence of high speed data connections through xDSL or fiber, TV can now be delivered digitally over networks originally dedicated for data. If using the IP protocol and IP broadcasting, this is known as IPTV.

A big advantage of IPTV is that it allows point-to-point distribution. This means each viewer can view individual broadcasts. Another advantage is the two-way capability lacked by traditional TV distribution technologies. This enables stream control (pause, wind/rewind etc.).

SDTV vs. HDTV

These terms just refer to the resolution of TV-images. SDTV refers to standard definition TV and HDTV refers to high definition TV. Using today's MPEG-2 standard, digitally broadcasted SDTV requires from 4 to 8 Mbit/s. For HDTV the figures would be from 15 to 30 Mbit/s.

Video conferencing and video telephony

A videoconference is a set of interactive telecommunication technologies which allow two or more locations to interact via video and audio transmissions simultaneously.

Traditionally, video conferencing has been used in a business to business setting. It is however not hard to imagine a future where the concepts of video conferencing and video telephony melt together and replace traditional telephony. Imagine for instance a scenario where kids use video telephones to “help” each other do homework. Such a scenario would obviously require high bit-rate capacities.

Games

Broadband enables the ability to download conventional games easier. In terms of bandwidth consumption, online gaming is however more important. Figure 6 show these games taking up more and more of our time. Traditionally, gaming has been thought of as an activity for kids and teenage boys. Recent studies have however showed that this is wrong. According to the Consumer Electronics Association (CEA), the average player actually turns out to be 29 years old. [2] estimates that 54% of US households connected to broadband have someone in their house playing online games. Current and future game consoles are also being equipped with broadband connection facilities, further increasing demand for high speed access. [10]

Growth in Online Games	
Year	Portion of Gamers Who Play Online At Least One Hour Per Week
2002	31%
2003	37
2004	43

Figure 6: Popularity of online games [9]

Within online games, there are two main categories, basic low-tech casual games and more advanced games. Both categories are in growth. The first requires little bandwidth, but has the most users. The second category uses significantly more bandwidth, but also requires more time and effort from users. Advanced online games are typically multi-player games. Playing together with others add an extra dimension and increase popularity. User experience strongly depends on fast connections between players.

4.1.3 E-services and other trends

E-learning

Providing different kinds of training through the use of computers is often described as E-learning. This could be anything from handing in assignments electronically to attending classes through the use of video conferencing.

Today, students in the age group between 18 and 22, make up less than 20% of all students attending higher education. The fastest growing group is those older than 25, working and studying part time. This group is mainly motivated by career advancements and increased salary. [3] Since this group is already in work, E-learning with its ability to deliver education at home, should be very appealing. Knowing this, it is reasonable to believe that the adoption of E-learning will only increase. As the use of advanced methods, such as video conferencing, increases in E-learning, so will the demand for high speed home access.

E-health

In many industrialized countries the percentage of senior citizens is expected to grow. This will create a demand for more efficient healthcare solutions. E-health could be one of them. If so, the need for increased bandwidth among private homes will grow. E-health is often split into two main applications. [10]

- Remote diagnosis and treatment and collaboration between physically separated medical personnel. This could be a dermatologist giving a diagnosis facilitated by web cams and a live chat session. An example of collaboration would be two doctors far apart, discussing the same x-ray images using video conferencing equipment.
- High quality in-home interaction and monitoring of patients.

The latter is often seen in connection with the emergence of sensor networks and ubiquitous computing. As these technologies evolve, one can imagine a scenario where almost any aspect of our life can be monitored by interconnected sensors placed around the house. Senior citizens can for instance have their homes set up to constantly measure pulse and body temperature and transmit this to a monitoring unit at the nearest hospital. This kind of machine to machine communication offers tremendous possibilities.

E-commerce

E-commerce is the term used to cover online sale. [3] The popularity of E-commerce is only expected to grow. One can easily imagine a future where the facilities of on-line shopping grow beyond anything we know today. Through the use of in-store cameras and video conferencing, one could virtually walk along the shelves in a local grocery store

and mark off desired items. Few home Internet connections would support such applications today.

Teleworking

In essence this means the possibility to let employees work somewhere else. Often, somewhere else means home. The idea is to improve quality of life for employees by avoiding wasting time commuting to the workplace. The key to achieving this is to make the network performance at home similar to that at work. This often means increasing home bandwidth capabilities. [10]

IP-telephony

Using IP networks to transport voice conversations is already quite common. Instead of sending analog signals over a copper wire, voice is digitalized and put into IP packets right from the start. There is nothing new about IP telephony and the capacity requirements are modest. IP telephony is however an important factor in “Triple Play” which is described next.

Triple play

Triple play (3P) has long been considered the holy grail of service providers. The idea is to offer high speed internet, television and telephony in one package with one bill. Both cable television operators and telecommunication operators are potential suppliers of 3P. The main constraint has so far been available bandwidth. Estimates of what is needed diverge, but around 20 Mbit/s seems to be the mean. This will typically allow for 2-3 TV channels running in parallel, a 2 Mbit/s Internet line and two IP-based telephone lines. As time passes, these requirements are likely to increase.

4.2 Emerging and Future trends

Smart home

Great efforts are being put into making our homes more or less remote controllable. One can for instance imagine a future where the average home has advanced electronics build into it. This could be sensors allowing a central unit to set attributes like light and temperature according to the owner’s preferences or in the presence of humans.

Smart appliances would also be part of such a house. A refrigerator that senses when it is empty and orders more is the classic example. The key point is however to acknowledge that in the future, machines will be talking to other machines. Such communication can easily accumulate and hence increase the bandwidth requirements of a future access network.

Home networks

One PC per family is no longer enough. As Internet access becomes important for all family members, the concept of home networks arise. Multiple PC's and other electronic devices are connected, in order to allow easy sharing of content. According to [9], 52% of all US households will have a home network installed by 2008. The ability to access content remotely will then also arise, giving need to more upstream capacity.

Media Servers

Resulting from the digital shift, people are now accumulating more and more digital music, video and photos at home. Such files are however only available on the location where they are stored. Media servers are a way of overcoming this limitation.

In Essence, a media server contains a hard disk for storing digital content and a means to distribute the content to other devices located elsewhere in the home. [9] The distribution takes place over some kind of home network, wired or wireless. As described above it is expected that 52% of all US households will have a home network installed by 2008.

The introduction of media servers in private homes is a result of increased downloading and peer-to-peer activity, but also a driver for more bandwidth. As consumers learn to appreciate home media servers, the need for new content will grow. This will add further strength to the popularity of peer-to-peer activity.

Video Monitoring and Surveillance

Web-enabled cameras are already becoming very affordable. With higher upstream capacities available in private homes, owners could have several web-cams installed. This would allow for convenient monitoring while being away.

Compression

So far, everything mentioned has been factors working towards greater demand. Compression works the other way around. When processing media, compression and later de-compression is used to lower the bit rates produced. The software or hardware doing this is called a codec. The codec samples the media and defines the data rate of digital output.

MPEG-2 has been the industry standard digital video broadcast codec for many years. The need for an improvement to this standard has been addressed over the last years by both ITU-T and ISO/IEC organizations. These organizations are the producers of the H.26x and MPEG-x standards respectively. A combined effort has led to the standard MPEG-4 AVC (Advanced Video Coding), also know as H.264. [46]

MPEG-4 AVC focuses on the need for greater compression while maintaining broadcast quality. MPEG-4 achieves its goals by effectively cutting MPEG-2 bit rates in about half for digital video. This is done without loss in quality. [46]

MPEG-4 is expected to go into widespread use within a few years. The effects in terms of typical bandwidth usage are summarized in Table 1.

Codec	SDTV	HDTV
MPEG-2	4-8 Mbit/s	15-30 Mbit/s
MPEG-4	2-4 Mbit/s	8-10 Mbit/s

Table 1: Bandwidth usage for SDTV and HDTV depending on codec

4.3 Bandwidth demand estimations

Putting a number on home access bandwidth demand 5 to 10 years from now is hard. New and current applications will increase demand, but new compression algorithms will to some extent slow the process down.

4.3.1 Other attempts

Several attempts have been made in order to quantify the future need for bandwidth in typical home access networks. Nielsen's law of 1998, states that a high-end user's connection speed will grow by 50% per year. [6] This implies an exponential growth curve, or with a logarithmic y-axis the line presented in Figure 7. The curve was first produced by plotting connection speeds from 1984 to 1996 and then using linear regression to draw a line. Obviously such a relation is not meant to provide deterministic future predictions, but so far the curve fits amazingly well. In 1998 however, many believed this was outrageous.

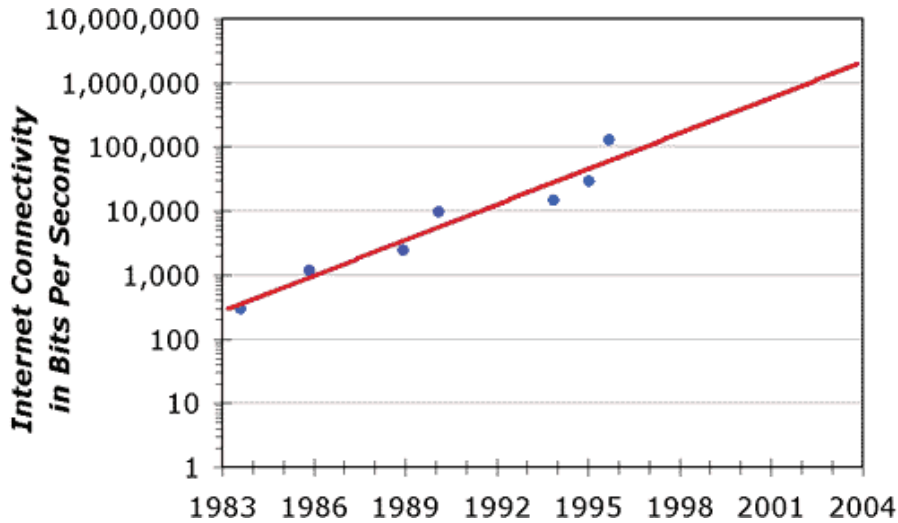

Figure 7: Nielsen's law of Internet Bandwidth [6]

Nielsen's law addresses a normal high-end user who is willing to pay a premium, but still wants well-tested equipment that can be bought in a regular shop. In 1998, this was a user typically having an ISDN line.

In order to really check the validity of Nielsen's law, and informal "out of sample" test is done. By continuing the plot where Nielsen left off, one can see how well his model has predicted the future. The numbers used are from Nextgentel's Bravo ADSL plan, now known as Classic. [11] The fit is amazing. The result can be seen in Figure 8. If we are to believe that Nielsen's law will apply also in the future, high-end users will have a connection of 100 Mbit/s around 2013. Fiber to the Home (FTTH) is probably the most realistic way of achieving this.

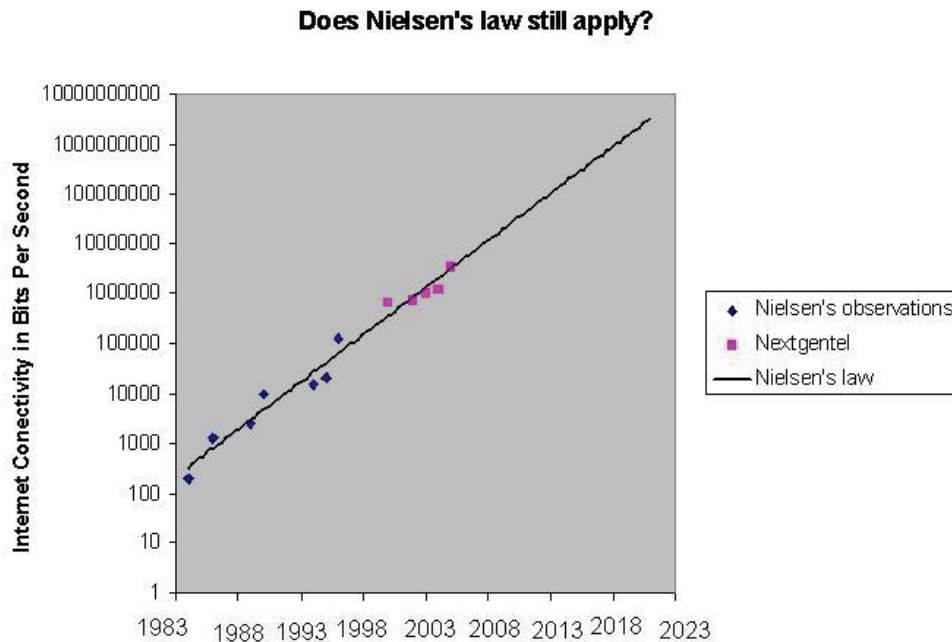

Figure 8: "Out-of-sample" test of Nielsen's law

[7] presents a different method for finding an upper bound on the long term growth in network access speeds. The transfer of live images is considered one of the most demanding Internet applications with respect to bandwidth needs. This is used to determine a limit beyond further growth would be absurd. The limit is derived from an analysis of the human capacity for utilizing bandwidth. The bandwidth needed to experience a full virtual experience in real time becomes the upper bound. The answer lies in the range of several petabits per second (10^{15}) and would be 4-5 decades away following today's growth rate.

Sweden as a country has taken a more direct and proactive approach in planning for future demand. In 2001, The Swedish ICT commission published a "General guide to a future-proof IT infrastructure". The goal was to have a fine meshed fiber optical network, reaching all inhabitants by 2005. The network was to be available within 100 meters of all buildings. The basic service was to have a capacity of at least 5 Mbit/s between any two points in Sweden. After 2005, the goal was to double that capacity every year, solely by changing end equipment. [8]

4.3.2 Contributing estimates

Using Nielsen's law blindly to predict the future demand for the access network capacity is naïve. A better way would be to try adding up the needs of an average family in the future. Since some Norwegian service providers [34] [35] are already offering triple play today, we assume that this will be required in the near future. Estimates with explanations are given below.

In 3 years:

- Following today's trend in Internet access speeds, it is reasonable to believe that at least 10 Mbit/s downstream must be offered, just to keep up with competitors. Upstream, 5 Mbit/s is assumed adequate.
- Most homes now have 2 TV sets. In order to watch different shows on each, assuming SDTV and MPEG-2, about 2×8 Mbit/s will be needed
- Most homes will only need one phone line, but with its relatively modest bandwidth requirement, we assume two are offered. This requires 2×100 kbit/s

In 6 years:

- 25 Mbit/s in both directions is now required for Internet access. The popularity of VoD is a primary driver for this requirement.
- HDTV is now assumed required, and the capacity needed for TV and Video is increased to 3×10 Mbit/s using MPEG-4
- We assume no demand for more phone lines

- Smart home devices and some home monitoring applications are becoming popular and requires 10 Mbit/s to operate

In 12 years:

- 50Mbit/s is now required for Internet access in both directions. Peer to peer applications take up vast amounts of capacity, as DVDs are expected to be downloaded on demand rather than in a “collect and watch” manner. New online games have become so advanced; they now offer 3D effects and close to HDTV-quality graphics.
- An average house now has about 6 different TVs. The reason for this is that TVs are being integrated into other devices such as refrigerators, beds and tables. This will require 6x10Mbit/s
- We assume no demand for more phone lines
- Machine to Machine communication is now a fact. Most electrical home devices are equipped with an IP address and report to different servers regarding function, maintenance and other needs. 30Mbit/s is required.

In 3 years	
Internet (down/up):	10/ 5 Mbit/s
TV/Video:	16 Mbit/s
Telephony (IP):	200 kbit/s
Total (downstream):	26.2 Mbit/s
Total (upstream):	5 Mbit/s
In 6 years	
Internet: (in both directions)	25 Mbit/s
TV/Video:	30 Mbit/s
Telephony (IP):	200 kbit/s
Smart home:	10 Mbit/s
Total (downstream):	65.2 Mbit/s
Total (upstream):	25 Mbit/s
In 12 years	
Internet: (in both directions)	50 Mbit/s
TV/Video:	60 Mbit/s

Telephony (IP):	200 kbit/s
Smart home:	30 Mbit/s
Total (downstream):	140,2 Mbit/s
Total (upstream):	50 Mbit/s

Table 2: Predictions of future bandwidth demand

4.4 Demand summary

Plotting the downstream estimates back in the chart displaying Nielsen’s law, we get Figure 9. The estimates for year three and six turn out to follow Nielsen’s regression quite well. The twelve-year estimate is however significantly lower than what predicted by Nielsen’s law. Why should Nielsen’s law suddenly not apply when it has been valid for so long? One answer could be that the regression naturally has a larger expected error this far away from the original samples. In the author’s opinion, the trend of increasing speeds will most probably slow down at some point. At some point, our lives simply don’t become more pleasant, by just adding bit rate capacity. In any case, the conclusion is clear: More capacity is needed in today’s access network in order to meet future demand.

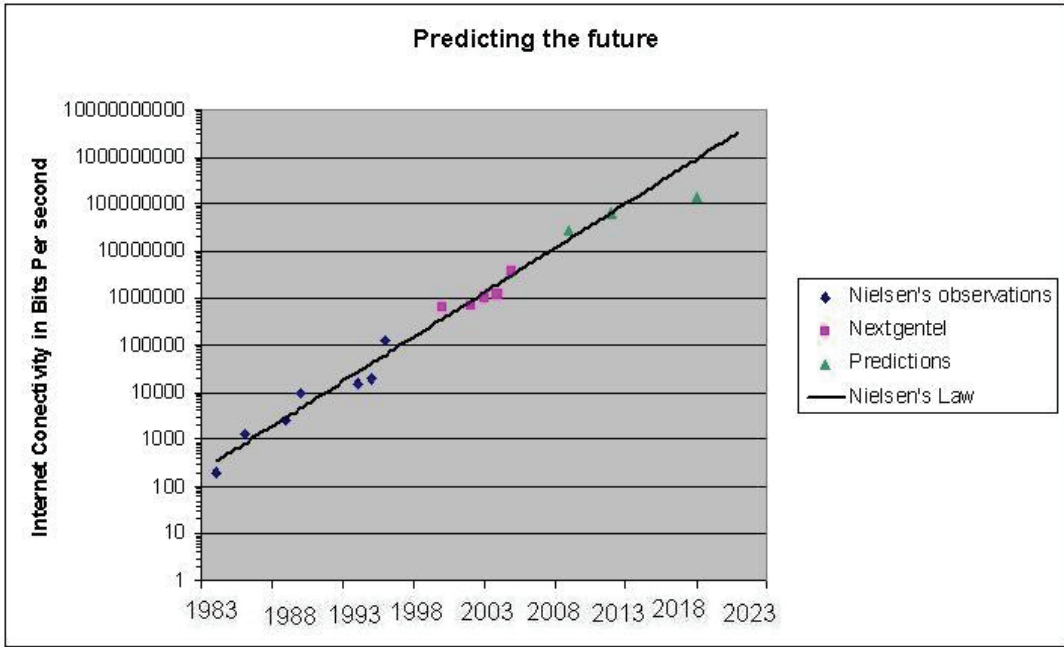

Figure 9: Plotting predictions against Nielsen's law

5 Access technology

The purpose of this section is to give a short presentation of some future access technologies considered by Telenor Nordic. These include various xDSL and fiber solutions. Beyond their ability in meeting the demand estimations found in chapter 4, no evaluation of the technologies are made here. Further evaluations can only be made after a solid business cases analysis has been presented in chapter 9. Other access solutions such as cable-TV networks and radio based schemes are not considered. A short overview is never the less included in Appendix C.

5.1 Copper based solutions

The wired access technology offered by Telenor to private customers today is mainly ADSL (Asymmetric Digital Subscriber Line). The word asymmetric refers to the ratio between up and down-link. ADSL utilizes the twisted pair copper cables traditionally used for POTS (plain old telephone service). ADSL is only one version of several technologies using copper cables. These are often termed DSL (Digital Subscriber Line) technologies or just xDSL. ADSL, SDSL, HDSL, SHDSL and VDSL are some examples. These differ in their balance between uplink and downlink capacity and the way they solve the tradeoff between high bit rate and long reach.

5.1.1 xDSL

The success of DSL technologies can be explained by a few key points. The most important is maybe the fact that DSL runs on existing copper cables. The capital cost of upgrading to DSL services is hence quite low. Another advantage is the ability to allow voice and data transmissions simultaneously. Data traffic can be directed to a packet-based network while circuit switched voice traffic is sent to the PSTN. This reduces congestion on voice switching systems. [13]

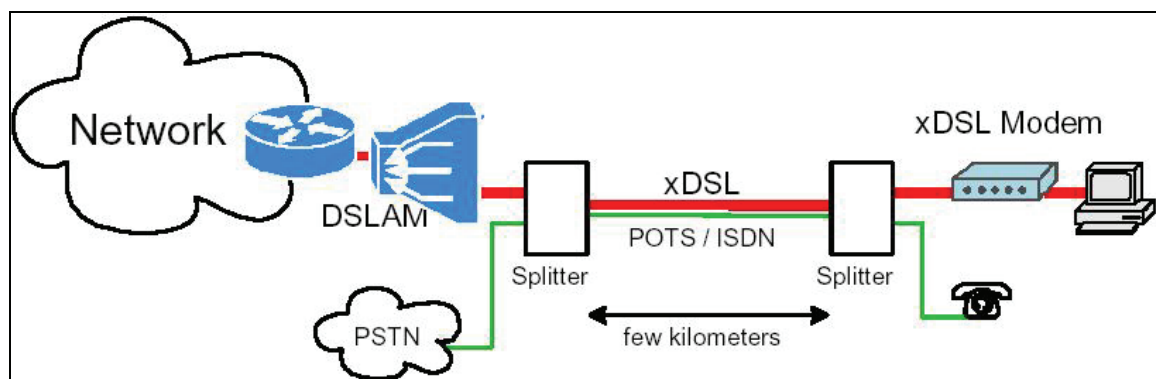

Figure 10: Principles of xDSL [13]

Very simplified, the concept xDSL is depicted in Figure 10. In the service provider's end, the transmission is controlled by a line card inside a DSLAM (Digital Subscriber Line Access Multiplexer). A DSLAM aggregates the user-signals onto a high-speed backbone line using multiplexing techniques. In the user end a DSL modem is required. The splitters separate voice and data traffic.

ADSL

ADSL is specified by ITU in G.992.1 and provides a maximum downlink of 7 Mbit/s. The maximum uplink capacity is 800 kbit/s. A great advantage of ADSL, is its far reach. From a capacity of a round 7 Mbit/s at 200m, the capacity has only decreased to about 4 Mbit/s at 2600m. Of all the xDSL and other broadband access types, ADSL is by far the most popular. It has a world market share of over 60%. [18] [19]

ADSL2

ADSL2 is an enhancement to the plain ADSL standard. ADSL2 is specified by ITU in G.992.3 and G.992.4. The main improvements compared to plain ADSL are higher data rates and increased reach. This is achieved through improved modulation efficiency, reduction of frame overhead, higher coding gains and enhanced signal processing algorithms. ADSL2 can typically provide downstream rates of up to 12 Mbit/s for distances less than 2.5 km. [20]

ADSL2+

ADSL2+ makes even further improvements to the basic ADSL technology. Compared to ADSL2, the downstream bandwidth is doubled. This is due to a doubling of the frequency band used. This effectively increases the data rate for distances shorter than 2.5 km. For longer distances, the data rate is assumed equal to that of ADSL2. An optional mode that doubles upstream bandwidth is also possible.

Under optimal conditions, ADSL2+ can provide downstream rates of up to 24 Mbit/s for distances less than 1.5 km. ADSL2+ is specified in the ITU standard G.992.5. [20]

VDSL

VDSL (Very-high-data-rate DSL) is a DSL technology adding even higher data rates than those mentioned above. As much as 52 Mbit/s downstream and 15 Mbit/s upstream is theoretically achievable, through the use of high frequencies. Both a symmetric and an asymmetric configuration are possible. The tradeoff for increased speed is loop length. For distances longer than a few hundred meters, data rates drop significantly. [14] VDSL is specified in the ITU standard G.993.1.

Because of its short reach, VDSL will require its service providers to deploy fiber optic cables closer to end users. VDSL will then be used only for the very last distance. This set-up is often called Fiber-to-the-Neighborhood (FTTN) [13]

VDSL2

VDSL2 is specified by ITU in G.993.2. It is the newest and most complex xDSL standard so far. By extending the frequency band being used to 30 MHz, much higher bit rates can be achieved. On distances shorter than 500 m, as much as 100 Mbit/s is feasible. VDSL2 can be configured in both a symmetric and asymmetric fashion. Few deployments of VDSL2 are yet seen. [29]

5.1.2 xDSL summary

Based on real world observations made by Telecom Italia, Figure 11 depicts observable downstream bit rates plotted against reach for different xDSL technologies. The observations are done under average traffic load, using standard equipment. For VDSL2, only a prediction is included. No observations were made for distances longer than 3 km, but the converging trend is obvious.

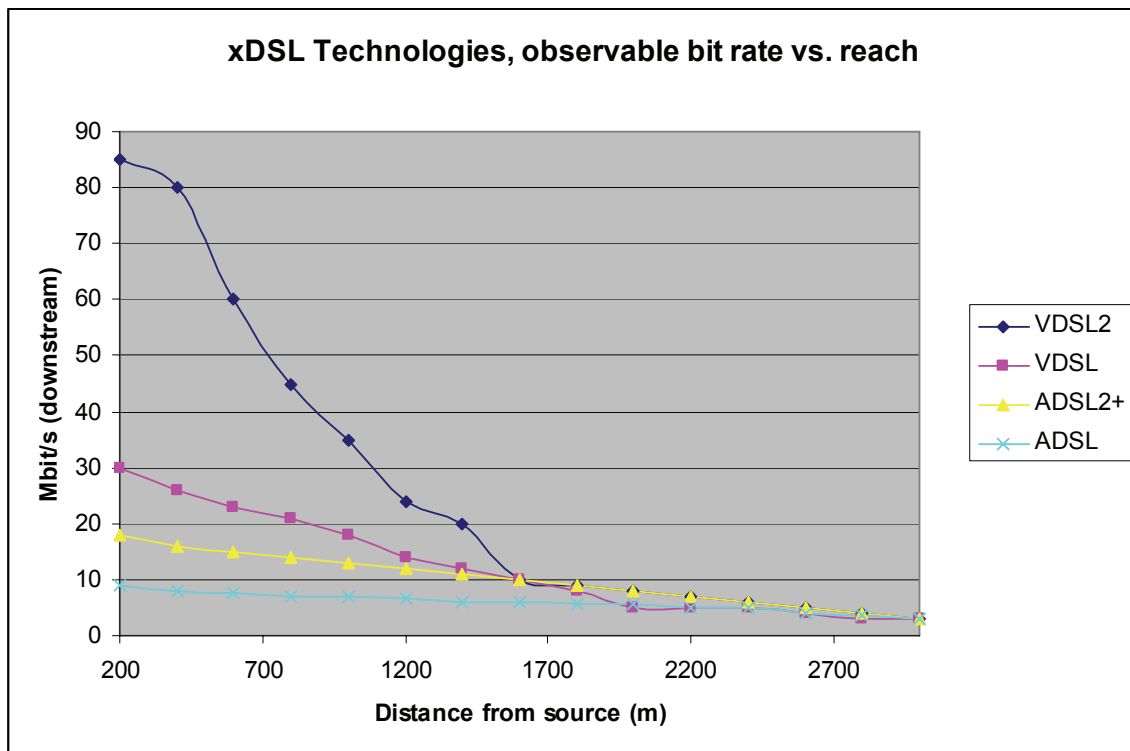

Figure 11: Bit rates and reach for different xDSL technologies

Having Figure 11 available and recalling the estimates made in section 4.3.2, one is in position to comment on which access technologies are “future proof” with respect to demand alone.

Recall that in three years, downstream demand is expected to be around 26 Mbit/s. The upstream figure is 5 Mbit/s. The only xDSL technologies fully capable of meeting this demand are VDSL and VDSL2. In both cases, DSLAMs will likely have to be brought closer to the end-customer. This is to overcome the problem of reduced capacity due to long line lengths. To support the DSLAMs with a sufficient up-link, fiber is needed.

In six years, the expected downstream demand is 65 Mbit/s. The upstream figure is 25 Mbit/s. Relying on copper based solutions, one can only hope that VDSL2 will be in place and capable of delivering. Also with this solution, fiber will have to be drawn closer to the user to overcome short reach. If VDSL2 is to follow a VDSL deployment, this may however already be taken care of.

With the xDSL solutions known today, it is hard to see how a copper based solution could meet the estimated demands 12 years ahead. One will likely have to rely on fiber technology brought all the way to the end-user or at least very close to him/her. In the latter case, copper might still be used inside buildings or between apartments.

5.2 Optical access networks

Fiber optic cables have long been used in the transport network. They are known for huge capacity and very low error rates. Fiber is now also often being considered for access network use. Already a few such deployments exist in Norway. Having fiber optic cables run all the way to the end user, is often called a fiber-to-the-home (FTTH) solution. A simplified schematic overview of FTTH is given in Figure 12. The basic building blocks are described next.

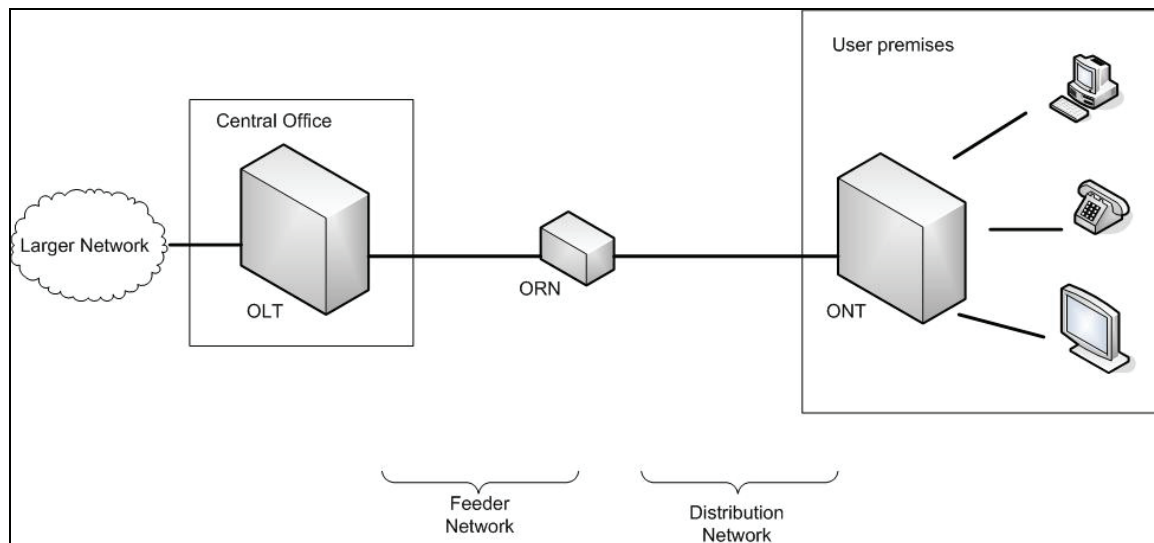

Figure 12: Basic building blocks in a FTTH solution.

The OLT (Optical Line Termination) is the entity connecting the access network to a larger network such as a metropolitan network or the core network. Typically the OLT is a Ethernet switch or a Media Converter platform. The OLT will often be co-located with a CO (Central Office). The ORNs (Optical Remote Nodes) will re-distribute the information from the CO to the ONTs. The ONT (Optical Network Termination) terminates the fiber network and resides at the customer premises. It is in charge of the signal processing. A more thorough explanation of functions performed by these units can be found in Appendix D. [21]

The model described above is a pure fiber solution. Access networks using fiber combined with another technology is also possible. Combining fiber with copper or radio are common examples. Such solutions are often termed FTTx. This means Fiber To The x where the x could be B (Building), C (Curb), Cab (Cabinet) and many others. The basic difference is how close to the end-user the fiber runs. Figure 13 shows an example of a combined solution using fiber and copper. The fiber equipment is still the same, but the ONT is now often called ONU (Optical Network Unit) instead.

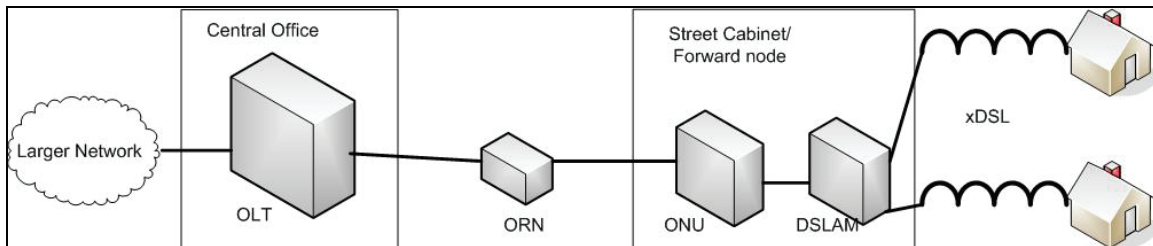

Figure 13: Combining fiber and copper using a forward fiber node

It is common to further divide optical networks into a feeder part and a distribution part. The feeder network runs between the OLT and the ORN. The distribution network runs from the ORN to the ONT.

The feeder network

The feeder network can basically be set up to operate in two ways. The total bandwidth can be split between all ONTs in a static fashion or be shared using a medium access (MAC) protocol. If traffic is bursty, which it usually is, the latter is more efficient. The former is however more easily combined with different Quality of Service (QoS) arrangements. [21]

The distribution network: Active vs. Passive

Distribution networks can be either broadcast or switched. Active networks are switched, while passive networks are broadcast. The terms active and passive refers to whether the ORN need power of some sort. In an active network, the ORN will process the received data and only forward data to the intended ONT. In the passive case, the ORN forwards all information to all ONTs without any electronic processing. Each ONT then has to sort out the information intended for him. [21]

Two basic deployment strategies exist when creating optical access networks. These include point-to-point (P2P) and point-to-multi-point solutions (P2MP). Both are described below.

5.2.1 Point to point (P2P)

Home run

This is the simplest, but also the most “fiber-expensive” solution. A separate fiber pair is used all the way to the end-user. In effect the OLT has one optical port per customer. The ORN is now called a fiber distribution point. This is merely an aggregation point, from where a common fiber path runs to the OLT. The concept of active and passive does not apply. In effect, all costs related to equipment and installation has to be amortized by one user. A schematic overview of a typical P2P home run system is seen in Figure 14.

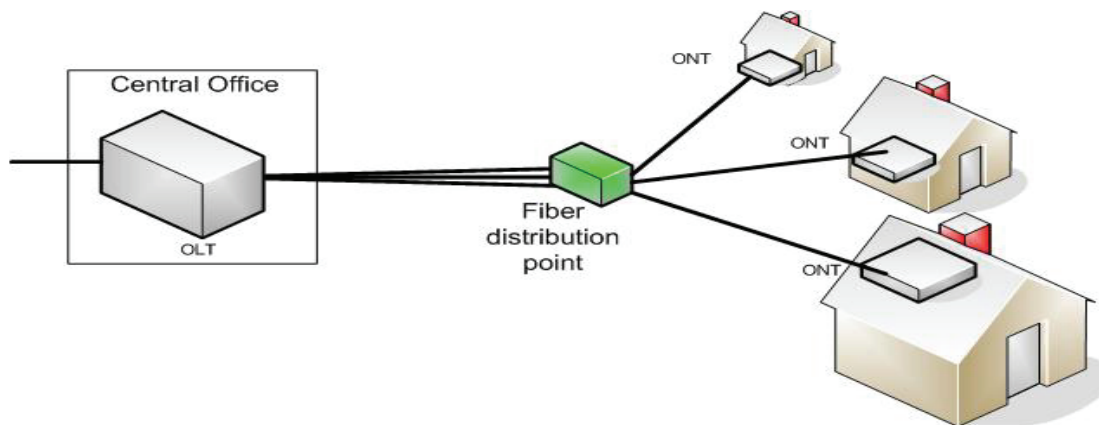

Figure 14: Point-to-Point optical access network

P2P solutions are usually based on the IEEE 802.3ah standard. This standard is also known as Ethernet in the First Mile (EFM). This standard does not only cover home run fiber as the physical layer. A complete suite of physical layers are supported. In the case of fiber, capacities are usually 100Mbit/s or 1Gbit/s. The reach is typically less than 80 km. The reach of a P2P EFM link is limited of the power and wavelengths of the optics being used. Fiber quality also plays a big role. A Gigabit Ethernet link longer than 100 km is in fact feasible should the need ever arise. [28]

Active Star

This scheme uses a single fiber to carry all traffic from the CO/OLT to the ORN. From the ORN, dedicated fibers run to each building or cabinet. Unlike passive solutions, the ORN is an active switch that forwards traffic only to the correct ONT. Figure 15 illustrates the concept. Intuitively one could maybe see this as a P2MP solution. The active switch does however have a separate laser for each ONT. This one-to-one relation makes it a P2P solution.

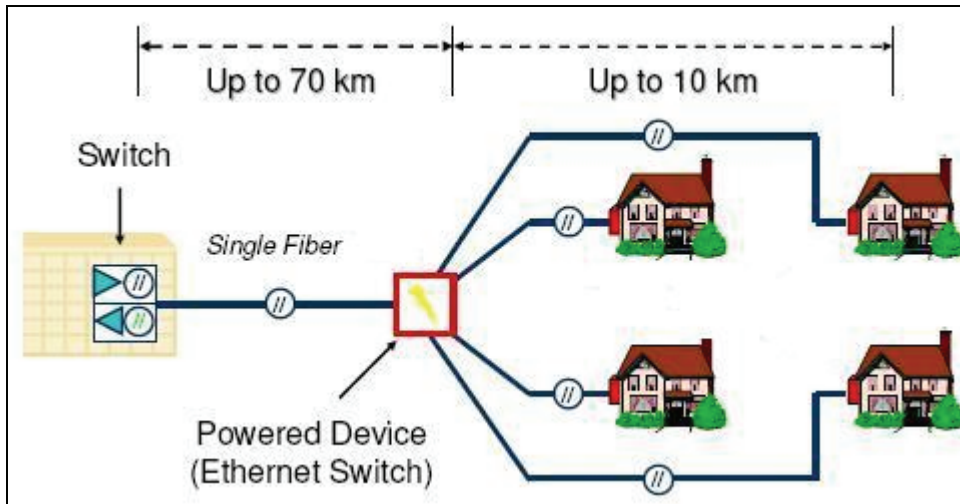

Figure 15: Active Star, modified from [31]

As for the home run solutions, the Ethernet specification is used at the physical and data link layer. Typically 100 Mbit/s is provided in both traffic directions. The reach between CO/OLT and ORN can be as much as 70 km and from ORN to ONT 10 km. The number of subscribers is only limited by the switches used and not by a specific split ratio. [31]

5.2.2 Point to multipoint (P2MP)

By letting the ORN be a passive optical splitter, parts of the fiber can be shared among several users. This is called a point-to-multi-point (P2MP) solution or a passive optical network (PON). A typical example can be seen in Figure 16. A single fiber is used between the OLT and the ORN, which is often just called the splitter. From the splitter, a single fiber is needed for each home. The next section provides more information on different P2MP-PON schemes.

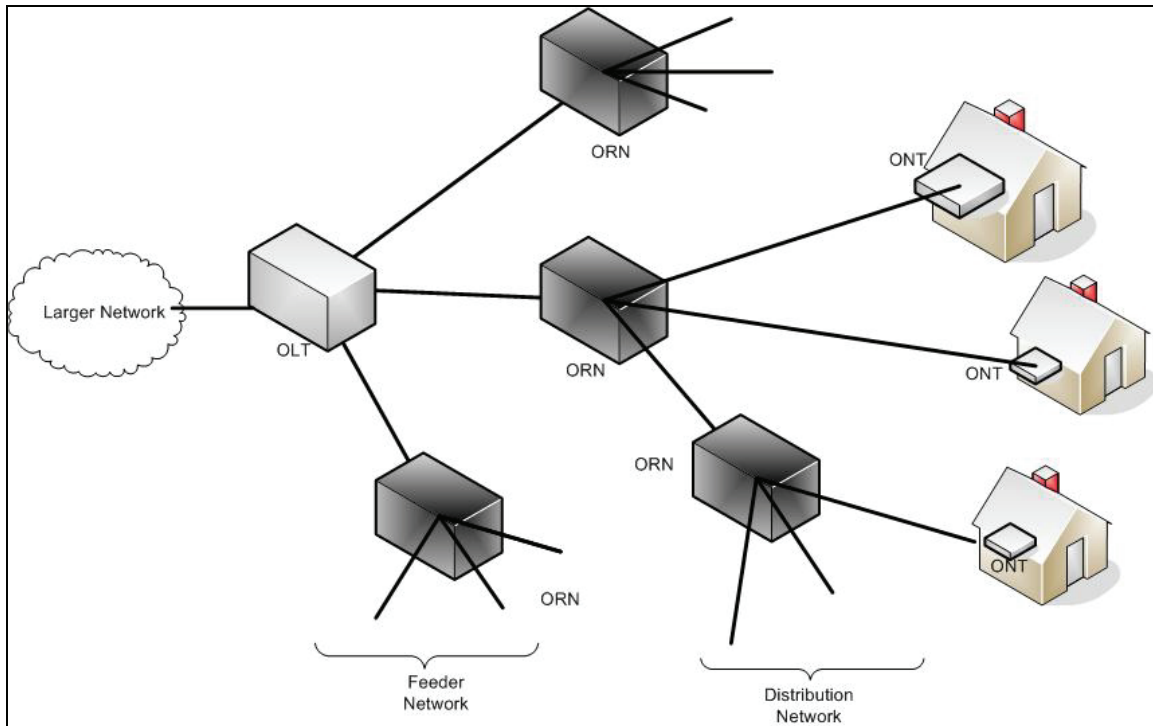

Figure 16: Point-to-Multi-Point optical access network.

Passive Optical Networks (PON)

The difference between an active and a passive distribution network was explained above. In the case of PONs, the ORN/splitter will forward all information to all ONTs without any electronic processing. Each ONT then has to sort out the information intended for him. Obviously this scheme will require some sort of security mechanisms to prevent a malicious ONT from reading other's traffic. The aim of this thesis is not to address such mechanisms. Some basic security concepts are however given in Appendix G.

PON supporters claim substantial cost savings can be achieved using this scheme. The sharing of fiber is perhaps the most obvious. It is also claimed that PONs have low operational costs. Passive components can withstand demanding environment conditions without the need for energy or special housing. Splitters can be placed in small underground "fox holes". This is beneficial in terms of low maintenance costs. Upgrades are also inexpensive, since only end-equipment needs to be replaced. [27]

PON topologies

Several physical topologies can be used in PONs. The concept of feeder and distribution network may not apply for all. Figure 17 illustrates the main topologies.

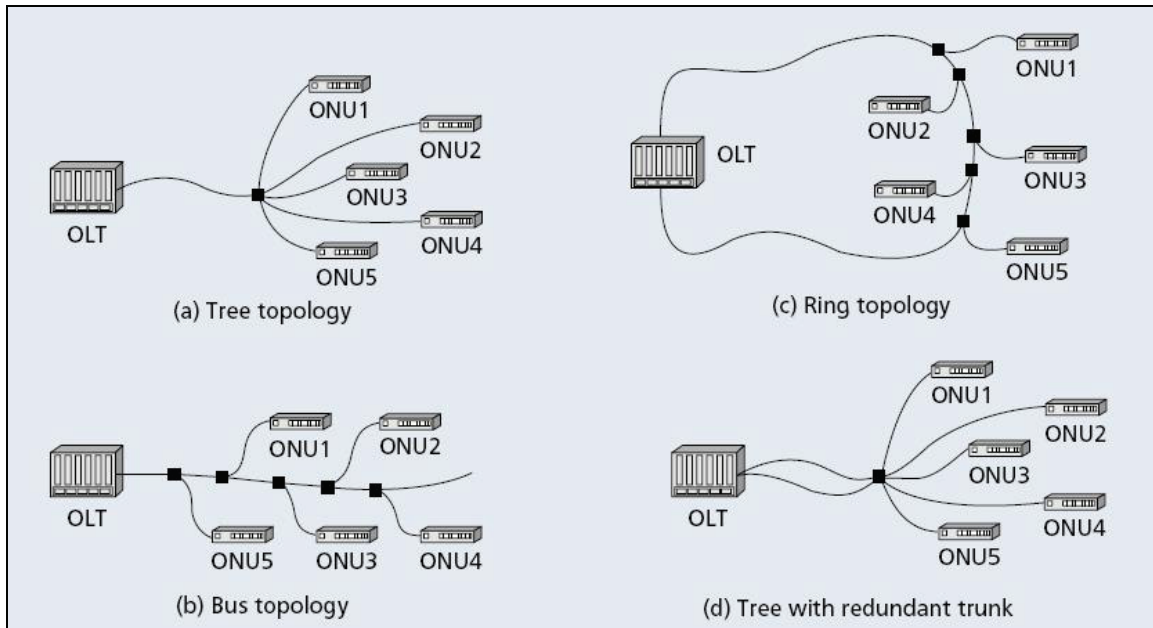

Figure 17: Network topologies [22]

Tree

In this topology each ONT is connected to an ORN by a separate fiber. Several ONTs will then share the feeder line from the ORN to the OLT. This topology is intuitively appealing because of its cost efficiency and scalability. New ONTs can easily be added and the costs can be shared among an increased number of users. A downside to this topology is however its fault tolerance. A fault in OLT, ORN or in the feeder link could bring large parts of the network down.

Bus

In a bus topology, all ONTs are connected to the OLT by a shared link. No ORN's are used.

Ring

As for the bus topology, this topology uses a shared link between the OLT and the ONTs. This link does however form a closed loop, increasing the fault tolerance. Since traffic can go both ways, a single link failure can be handled by rerouting.

Hybrids

Combinations of the topologies mentioned above are also possible. Redundant links can also be added to increase fault tolerance. Figure 17, part d, illustrates this.

Multiple access methods

Data in the upstream direction will only reach the OLT and not other ONTs. Data segments from different ONTs can however still collide if sent simultaneously. A multiple access method is hence needed to support sharing of the fiber capacity and resources. Four major categories exist: [23]

- Wavelength Division Multiple Access (WDMA)
- SubCarrier Multiple Access (SCMA)
- Optical Code Division Multiple Access (OCDMA)
- Time Division Multiple Access (TDMA)

Each of these is described closer in Appendix E. TDMA is however the method used in all the major PON standards. These are described next.

PON standards

APON

APON (ATM Passive Optical Network) was the first passive optical network standard. It is specified in ITU-T's G.983 standard as well as within the FSAN (Full Service Access Network) group. ATM is used as the layer-two bearer protocol. Downstream bit rate is either 155.52 or 622.08 Mbit/s. The upstream rate is in any case 155.52 Mbit/s. APONs use a time division multiple access (TDMA) scheme to avoid colliding upstream traffic. APONs are now seldom deployed. [24]

BPON

BPON (Broadband Passive optical network) is an improvement of the APON standard. BPONs are still based on ATM, but offer broadband services including Ethernet access and video distribution mechanisms. 622 Mbit/s is added as an upstream capacity and 1.244Gbit/s is now possible downstream. Using BPONs, three wavelengths are available. This allows for a downstream channel for overlaid TV/Video. [24] [25]

APONs and BPONs are considered obsolete, and are not considered for deployment. No further studies of these technologies are therefore made.

EPON

EPON (Ethernet Passive Optical Network) is specified through IEEE 802.3ah. In EPONs all data is carried in traditional Ethernet frames. Since downstream traffic is broadcasted, each ONT uses its MAC address to extract frames intended for him. Unlike ATM which uses a fixed size cell (53byte), Ethernet uses variable size frames (max 1518 bytes). This flexibility provides higher efficiency when handling IP traffic.

Gigabit Ethernet speed is now achievable, providing data rates as high as 1.25 Gbit/s. The IEEE standard specifies two minimum distances of 10 and 20 km between OLT and

ONT. Both are commercially available today. The splitting ratios commercially available today are 1:16, 1:32 and 1:64

EPONs rely on a mechanism called Multi-Point Control Protocol (MPCP) for access control. This mechanism is defined as a function within the MAC-control sub-layer. MPCP uses messages, state machines and timers. Each ONT will have an instance of the MPCP protocol communicating with an instance placed in the OLT. The result is a Point-to-Point emulation. [23] [24] [36]

GPON

In 2001, the FSAN group began standardizing PONs operating at bit rates of above 1 Gb/s. The result was GPON (GigaPON). It is an evolution of the BPON standard and is specified in ITU-T's G.984 standard.

Two main modes of operation are supported in GPONs, ATM or GPON Encapsulation Mode (GEM). Of the two operation modes, the GEM mode is by far the most popular. A GEM frame supports full service. This includes voice (TDM, both SONET and SDH), Ethernet (10/100 BaseT), ATM and leased lines.

The physical reach of GPONs is at least 20 km. The logical reach supported within the standard is 60 km. The standard also allows for several bit rate options, including symmetrical 622 Mbit/s, symmetrical 1.25 Gbit/s, 2.5 Gb/s Downstream and 1.25 Gb/s Upstream.

The GPON standard provides strong Operation Administration and Maintenance (OAM&P) capabilities offering end to end service management. Because of the multicast nature of downstream traffic, increased security is added. Advanced Encryption Standard (AES) is part of the GPON standard. [24] [25] [32]

The splitting ratios commercially available today are 1:32 and 1:64. A splitting ratio of 1:128 is planned. GPONs also come with various Quality of Service (QoS) mechanisms. Negotiation of Service Level Agreements (SLA) between OLT and ONT are enabled by a special ONT Management and Configuration Interface. [23]

Efficiency in EPONs and GPONs

It is worth noting that GPONs are considered much more traffic efficient than EPONs. In EPONs as much as 50% of the available bandwidth is used for overhead. [26] Table 3 illustrates the efficiency of EPON vs. GPON given different mixes between data and voice/TDM traffic.

	Overall efficiency 100% data	Overall efficiency 10% TDM 90% data	Overall efficiency 20% TDM 80% data
EPON	48%	49%	49%
GPON	93%	93%	93%

Table 3: Overall efficiency EPON vs. GPON [36]

Capacity considerations on PONs

In the case of P2P solutions, the bit rate available to the end user is easily understood. No sharing is done. In the case of PONs, finding the available bit rate is a little more complicated. If the capacity is to be shared equally, a theoretical maximum per user can be found by simply dividing total capacity by the number of splits used. For GPON using full split ratio, this would be $2500/64 = 40$ Mbit/s. At first this may seem little compared to xDSL. In practice, the available bit rate per customer is much larger. Let us assume a worst case scenario where there exist 128 different HDTV channels each requiring 10 Mbit/s (MPEG4). If all the 64 homes are watching 2 different channels at the same time, and no one is watching the same channel, all 128 channels would have to be sent over the PON. This would take up 1280 ($2*64*10$) Mbit/s of the available 2500. The remaining 1220 Mbit/s can be shared among all users for Internet and other data services. This equals 20 Mbit/s for each home. This figure alone is a lot when video services have already been accounted for. In reality, people tend to watch the same channels, making this figure much bigger.

Wavelength division multiplexing (WDM) can also be used to add further bandwidth to a fiber system beyond those rates mentioned above. This is done through what is known as a video overlay scheme. By adding WDM equipment in OLT and ONT, an extra wavelength can be used for downstream broadcast of TV. This is done in parallel to the data transmission specified by the standards mentioned above. Video overlay schemes are not treated further in this thesis.

Any fiber solution, also has the advantage that the fiber itself has almost unlimited capacity. [45] It is only the end equipment that limits the available bit rates. By only changing the end equipment, future bandwidth demands can be accommodated.

5.2.3 Fiber summary

In terms of meeting the demand estimations found in section 4.3.2, all fiber solutions are considered adequate. By upgrading end-equipment, fiber solutions are also able to meet even higher demands further into the future. Being future proof like this is a highly desirable property.

A P2P home run solution is simple, but will require more fiber. More equipment is also needed since an optical port is needed in the CO for every end-user. A P2P active star

scheme has the disadvantage of needing active ORNs, but it reduces the number of optical ports in the CO to one per each ORN. Both P2P-home-run and P2P-active-star have the advantage of very long reach.

PON technology has limited reach compared to the two solutions above. 20 km is however still very good compared to copper. PON technology seems promising in terms of lower promised operational costs. Even though the capacities available in PONs are shared among all users, capacity is not considered a restricting factor. Intuitively, a tree topology seems to be economically favorable, though somewhat less fault tolerant. [21] Choosing one PON-technology superior of the others is however hard. The choice between GPON and EPON is not obvious.

As of today GPON equipment is more expensive than EPON equipment. The reason is GPON being a more complex technology. GPONs do however provide higher capacity and longer reach. GPONs also have the advantage of much higher bandwidth efficiency.

The critical factor in selecting PON standard is the development in equipment price. If GPON becomes the preferred choice for most service providers, GPON prices will fall significantly. In the opposite case, EPON equipment will be preferable. As of today, GPON seems to be the preferred choice of the majority. A big player like China Telecom is lobbying strongly for GPON and both in Europe and North America, GPON seems to attract the most interest. [30]

5.3 Access technology summary

Among the xDSL solutions, VDSL is considered adequate in meeting short term (3 years) bandwidth demand. VDSL2 can be used to prolong the life of copper even further. In both cases it is however necessary to bring DSLAMs further into the access network in order to overcome the very limited reach of VDSL and VDSL2. Among the schemes using fiber all the way to the end-user, all solutions are considered future proof and able to meet long term demand.

Unfortunately, deployment is not justified by meeting demand alone. Costs and revenues also play an important role. In the next section, several business cases are presented. VDSL2, P2P-home-run and PON-GPON are chosen as technologies investigated. P2P-home-run will from now on only be called P2P. Hopefully this investigation will provide further insight into strengths and weaknesses among the different solutions.

6 Cost and Revenue figures

Costs can be divided into capital expenditures (CAPEX) or operational expenditures (OPEX). CAPEX are expenditures used by a company to acquire new, or upgrade existing, equipment. OPEX are costs associated with standard operations and maintenance. Section 6.1 will present the CAPEX figures associated with the three selected access solutions. Section 6.2 will then present OPEX figures. Last, a revenue scheme is presented in section 6.3.

All costs and price figures presented are provided by Telenor. They are based on quotes from industry suppliers or on industry experience.

6.1 Capital expenditures (CAPEX)

6.1.1 Basic building blocs

Some costs are independent of end-equipment or technology. These are summarized next.

Fiber

The fiber cable itself is bought on reels with fixed lengths. Lengths usually range from 500m to 5000m. [37] Cables can be dug directly into the ground or placed in ducts before being dug in. Cables can also be mounted on traditional poles or submerged in water.

Placing cables in ducts and digging them into the ground is the only deployment method currently being evaluated by Telenor. In many areas this is also the only method permitted due to esthetic considerations. For the rest of this thesis, all cables not already deployed are assumed to be placed in ducts and dug into the ground. Though more expensive, ducts are considered more strategic. Ducts reduce the costs of future upgrades significantly. Existing ducts can be used instead of re-digging the entire path.

The cost of fiber cable depends on the number of fibers included in the cables. Typical prices are given below.

Number of fibers	Cost per meter NOK
12	6
24	7
48	10
96	17

192	35
Hybrid cable ⁱⁱⁱ	4

Table 4: Fiber prices

Ducts and fiber insertion

Several duct schemes exist. Ducts can be acquired on reels or in fixed length sizes. As of today the preferred choice for Telenor is to use 50mm wide ducts available on reels. This allows for fiber to be air-blown into the duct. The price for such duct is typically 10 NOK per meter. Laying down the ducts is another 25 NOK per meter. Blowing the fiber into place is 20 NOK per meter. The total cost of ducting and fiber insertion is hence approximated to 55 NOK per meter.

Civil Work

Digging down fiber cables is a major cost factor. The cost does however strongly depend on the local surface. Digging up a field in rural areas is significantly cheaper than digging up a paved, inner city street. In order to simplify the calculations presented in the business cases, three surface categories are used. All areas studied will contain a linear combination of these three categories.

Open field: This is the cheapest case. Heavy machinery can be used and no special care must be taken when digging.

Average surface: As the name indicates, this is the average case. It will typically consist of mostly lawn and field, but some tarmac may be present when crossing roads etc. This combination is typically found in suburbs.

Urban tarmac: This is the most expensive case and typically found in cities. Tarmac, sidewalks and pavement are likely obstacles to meet. These may require cutting and subsequent repair.

Surface type	Estimated cost per meter (NOK)
Open field	150
Average surface	200
Tarmac	500

Table 5: Digging prices

Typically, ducts are dug down 50 to 100 cm below ground. The prices given above also include cutting and repair of tarmac. Installment of access foxholes is also included.

ⁱⁱⁱ Hybrid cable consists of 4 copper pairs and 1 fiber pair

Fiber installment

This includes splicing or termination of fibers. The cost of splicing or termination depends on the number of fibers running in the cable. In the case of splicing a splice box is also needed. Fibers can terminate in racks or inside houses. The estimated costs are given in Table 6.

Number of fibers	Cost of splicing/termination
2	1.700
12	3.200
24	4.800
48	6.700
96	12.000
192	22.000
Splice box	2.500

Table 6: Prices of splicing or terminating fiber

Copper

In the case of VDSL2, some new copper cables may be needed. This will be explained later. Copper cables come in a range of different categories. The number of pairs included and the thickness are key parameters. In this thesis we will only consider cables with a thickness of 0,6mm. Typically one pair is used per customer. Approximated prices are given in Table 7.

Number of pairs	Cost per meter (NOK)
10	5
50	20
100	30
200	60
300	90
500	150

Table 7: Copper prices

As for fiber, copper cables are also dug down. Ducts are however not used.

Copper termination and splicing

As for fiber, the cost of either terminating or splicing copper cables are considered equal. The price is approximately 400 NOK per every 50 pair.

Set-top box

In the case where television is to be offered over an xDSL or fiber solution, a Set-top box (STB) will also be needed. A set-top box is a device that enables a television set to

receive and decode digital television. STBs will typically also provide a return channel enabling interactive services. More advanced STBs can also allow a television set to become a user interface to the Internet. As of today, STBs typically have a price tag of 500 NOK. One STB is required for each television set used.

6.1.2 PON equipment costs

Splitters

Splitters make up the optical remote node (ORN) in PONs. As explained earlier, this unit will re-distribute the incoming signal and pass it on to all users. Only 1:64 splitters are used in the business cases. The cost of such a splitter is approximately 10.000 NOK. In addition to this, there is an installation cost. This installation cost is assumed to be similar to that of a small DSLAM. This is approximately 26.500 NOK. The total cost of splitter and installation is hence set to 36.500NOK. This is summarized in Table 8.

Unit	Cost (NOK)
Splitter equipment cost	10.000
Splitter installation cost	26.500
Total splitter cost	36.500

Table 8: Splitter costs

Splitter cabinets

As said before, splitters are small enough to be dug into the ground. For easy access, splitters are however placed in cabinets. Multiple splitters can be placed in one cabinet. The cost of such a cabinet is 7000 NOK.

OLT aggregation point

As explained before, the OLT is the termination point of the PON. One OLT aggregation point will serve multiple PONs. This allows for substantial cost sharing between all users. Common equipments include a rack, two network termination cards, a control unit and necessary software. This common equipment can support up to 32 PONs. Since OLT aggregation points are likely to be co-located with existing equipment, housing costs are not included.

The job of installing an OLT aggregation point is considered similar to that of installing a large DSLAM. The installation costs are hence approximated to 29.000 NOK.

In addition to this, each PON will need to be terminated in a line termination card. Each card can terminate two PONs. The price tag of such a card supporting the GPON standard is approximately 41.400 NOK. This is summarized in Table 9.

Unit	Cost (NOK)
Equipment costs per 32 PONs	263.000
Installation costs per 32 PONs	29.000
Total shared OLT costs per 32 PONs	292.000
GPON Line Termination card per 2 PONs	41.400

Table 9: Prices for PON OLT equipment and installation

ONT

The ONT is the customer premises equipment (CPE) needed. In a PON solution this unit has a current price of about 1550 NOK. For every customer, the fiber needs to be terminated at the user's premises. The average cost of this job is assumed to be 2500 NOK. This is summarized in Table 10.

Unit	Cost (NOK)
ONT equipment cost	1.550
ONT installation cost	2.500
Total ONT cost	4.050

Table 10: Prices for PON ONT equipment and installation

6.1.3 P2P equipment costs

Fiber distribution point

The fiber distribution point is simply a large cabinet where all fibers are terminated in and out. This eases the process of adding or removing new customers. The price of a cabinet is again assumed to be 7.000 NOK. The cost of termination will depend on the number of fibers being used.

OLT aggregation point

As for PONs one OLT aggregation point can support many users. This allows for equipment and costs to be shared. In practice a P2P OLT is built in several layers with each layer aggregating more users. In this thesis we will consider the OLT aggregation point as one unit with one price. An OLT capable of accommodating 1056 customers has a total price tag of approximately 710.600 NOK. The installation and housing costs are assumed similar to those used in for PONs. All prices are summarized in Table 11.

Unit	Cost (NOK)
Equipment costs	710.600
Installation costs	29.000
Total shared OLT costs	739.600

Table 11: Prices for P2P OLT equipment and installation

ONT

The ONT is the customer premises equipment (CPE) needed. In a P2P solution this unit has a current price of about 1200 NOK. For every customer, the fiber needs to be terminated at the user's premises. The average cost of this job is assumed to be 2500 NOK. This is summarized in Table 12.

Unit	Cost (NOK)
ONT equipment cost	1.200
ONT installation cost	2.500
Total ONT cost	3.700 NOK

Table 12: Prices for P2P ONT equipment and installation

6.1.4 Equipment used in both P2P and PONs

Drop points

Drop points are placed along the road and are the last common points, before each household is given its own dedicated fiber(s). One drop point can serve 4 households. The total cost of one such drop point is set to 600 NOK. In reality the price per drop point is lower, but in this thesis it is set higher due to the reason given below.

In practice, one will often buy the whole cable segment running from splitter/distribution point to and including the drop point. Such a custom made segment will have a higher price per meter than plain cable. All calculations presented here, will however assume plain cable is used. The 600 per drop point used here will hence cover the extra (above regular cable) cost of custom made cable. The cost of termination in and out of drop points and out of splitter/distribution points is also included in the drop point costs.

6.1.5 VDSL2 equipment costs

A big advantage of a VDSL2 solution is that it can greatly benefit from existing copper infrastructure. Compared to the current ADSL configuration, some changes are however necessary. In order to achieve high bit rates with VDSL2, DSLAMs need to be closer to the end customer. This calls for pushing the DSLAM further into the access network. The

DSLAM itself must be connected by fiber to ensure a fast up-link. The costs related to fiber and digging can be found above.

DSLAM

A DSLAM's primary task is to split and aggregate voice and data traffic. DSLAMS differ in the number of lines they support. Two sizes will be considered here. Except for line cards, the cost of a DSLAM includes housing, installation and equipment.

DSLAMs need to be placed in housing with adequate facilities. This includes power capabilities, ventilation, proper security and so on. Telenor uses small custom build units for this need. Such a unit is capable of holding one large DSLAM or two small. The cost of each house is estimated to 100.000 NOK. In addition, each house has to be installed. Housing installation costs are estimated to another 100.000 NOK. Total costs are approximated in Table 13

Unit	Cost (NOK)
Large DSLAM equipment (max 15 line cards)	43.000
Large DSLAM installation	29.000
Housing	100.000
Housing installation	100.000
Total Large DSLAM	272.000
Small DSLAM equipment (max 4 line cards)	30.700
Small DSLAM installation	26.500
Housing	100.000
Housing installation	100.000
Total small DSLAM	257.200

Table 13: DSLAM hardware, housing and installation prices

Line cards

Line cards interface the lines coming from subscribers to the rest of the access network. VDSL2 line cards offered today will typically support 24 lines per card. For the cards considered in this thesis, the price tag is approximately 7.600 NOK.

Modem

Modems turn digital signals into sound, so that it can be transmitted over a copper telephone line. All users opting for increased service will need a new modem. Bought in large quantities, VDSL2 modems have a price tag of about 1500 NOK. This figure is expected to drop significantly during the next few years due to increased production and

competition. No installation costs are included for VDSL2 modems. It is assumed that users can do this without difficulty.

6.1.6 Further CAPEX

As will be described later, it is assumed that take rates will increase during the first seven years of operations. This will call for some further CAPEX. This will however only be customer premises equipment (CPE), installation and in the case of fiber, fiber and digging from drop points to houses. All prices are assumed constant except for CPE. These are assumed to fall by 10% each year.

6.2 Operational expenditures (OPEX)

OPEX are those expenses needed to cover standard operations. Based on ADSL experience, Telenor has obtained approximate OPEX figures for VDSL2. In the case of PON and P2P solutions, their figures are based on estimates and deployments made in neighboring countries.

For simplicity, the figures given here are aggregated into three different categories. These are: operations, administration and repair. Operations include network operations, customer support and marketing, Administration cover data and IT costs, billing and general customer administration. Repair includes fixing errors reported by customers and network administrators. All figures are shown in Table 14.

OPEX category	PON (yearly NOK per customer)	P2P (yearly NOK per customer)	VDSL2 (yearly NOK per customer)
Operations	370	370	520
Administration	620	620	620
Repair	230	250	390
Total yearly	1.220	1.240	1.530

Table 14: Yearly OPEX figures

In addition to these costs, there is an extra OPEX occurring when customers sign up for service. This includes delivery, initial customer support and sales. This extra initial OPEX factor is called Start-up OPEX. This figure is approximated in Table 15.

	PON (NOK per customer)	P2P (NOK per customer)	VDSL2 (NOK per customer)
Start-up OPEX	1.100	1.100	1.660

Table 15: One-time initial OPEX figures

6.3 Revenues

There would be no point in deploying new access network technology, if no revenues were thought to be generated. These revenues will come from customers signing up for service. All the solutions studied in the business cases are capable of offering triple-play. The estimated revenues will hence assume a combined service of telephony, Internet access and TV. The revenues are assumed independent of technological solution.

Before a real deployment, more work will have to be done towards finding an optimal pricing scheme. A very important decision is whether or not to bundle the services. An un-bundled scheme means that TV, telephony and Internet access are sold separately. A bundled scheme will require the customer to buy all three together. Fine tuning the price levels will also be important. For simplicity, this thesis will use a single monthly figure reflecting the average revenue per user. In addition a sign-up fee is required for each user. This simplification leaves out the bundling decision.

Details about the service are also not specified. No bit rates, TV channel selections or user agreements are included. It is beyond the scope of this thesis to make such specifications. It is only assumed that a triple play service, equal or better than current versions, can be offered.

In order to find reasonable price figures to use in the business cases, competitors have been studied. Based on the average rates among those operators currently offering triple play, a pricing plan is constructed. This plan is presented in Table 16.

Component	Fee NOK
Internett access	240
Telephony	120
TV	120
TV-content price (subtracted)	60
Total monthly fee per customer	420
Sign-up fee	4500
Set-top-box price (subtracted)	500
Total sign-up fee	4000

Table 16: Components in monthly service fee and sign-up fee

The content price is what Telenor would pay for being able to offer the TV content. This figure is highly uncertain and will likely need to be negotiated with each individual TV channel. On average it is expected that at least half of what is earned goes back to the content owner. It is further assumed that Telenor provides the set-top boxes. If more set-top-boxes are required by a family, the sign-up fee will be increased accordingly.

The total revenues can now be summarized in Table 17. For simplicity these figures are assumed constant in time.

Revenue type	Cash flow NOK
Sign-up fee	4.000
Yearly fee (12 x Monthly fee)	5.040

Table 17: Revenue summary

Revenue cannibalism

It is crucial to remember that some of these revenues are not "new". Many of the customers will already be paying for ADSL, telephony or both. Taking all revenues into account here, means they have to be removed somewhere else. This is what is often called revenue cannibalism.

The conservative approach would be to only account for "new" revenues here, and base our analysis on that. Only then the question of profitability will be truly answered. This approach does however fail to realize key issues. If no upgrading projects are undertaken just because of short term un-profitability, all customers will sooner or later be lost to competitors offering a better technological solution.

The approach used in this thesis is to include all revenues, but at the same time being aware the implications. It is especially the net present value (NPV) figures that must be treated with care. These should not be interpreted as "pure" profit but more as an indicator of profitability. Negative NPVs will clearly indicate an unprofitable case. The concept of NPV will be explained further in section 9.1.

7 Motivation behind area selection

The business case areas are constructed by choosing some adjacent HFs, currently serving residential customers with a fixed telephony service. The idea is to cover the same set of customers with an improved access network. It is assumed that the number of households in an area correspond to the number of current fixed telephony customers.

The six areas chosen to be analyzed by a business case are:

1. Angeltrøa
2. Granåslia
3. Othilienborg
4. Nedre Elvehavn
5. Kvammen
6. Spongdal

These areas display different characteristics that a priori are considered critical to the profitability of an improved access network.

Population density

Population density is thought to play a major role in determining total cost per customer. High population density should mean more cost sharing, both of equipment and civil work. By Norwegian standards, the first four areas display a high population density. The two last areas are much more rural. The average distance between each house is much higher here.

Surface

For fiber based solutions, the cost of civil work (digging) has long been the dreaded cost factor. The price of digging strongly depends on the surface type present in the area. Open fields are obviously the cheapest. The two last areas contain an above average value for this surface type. Nedre Elvehavn, is part of down-town Trondheim, and is totally covered by tarmac. The average digging price in this surface is much higher.

Housing

The deployment cost per customer should reflect the dominant housing type present in the area. Multi-storey apartment buildings are thought to increase cost sharing and hence reduce the overall cost per customer. Othilienborg and Nedre Elvehavn consist almost only of such housing. The rural areas of Kvammen and Spongdal will only contain single unit houses.

Existence of available fibers and ducts

Independent of the technology being used, it is very interesting to see how much one can benefit from existing infrastructure. All the areas have some available fibers or ducts running near by. Angeltrøa and Granåsli are special in that they have plenty of both. Nedre Elvehavn has plenty of available fiber.

Distance from centralized equipment

For fiber based solutions (PONs, P2P) it is often considered an advantage that customers are located near centralized equipment. This is thought to lower the costs significantly due to a reduced need for fiber and digging. Depending on where it is decided to place centralized equipment, the different areas will be from 1-20 km away from the OLT.

8 Business case assumptions

It is time to investigate the deployment cost of new access technology. This is done by analyzing six business case areas. GPON, P2P-Home Run, and VDSL2 are studied. As explained earlier, the analysis will be done by applying a set of models to the chosen areas. The next section will present the rules and assumptions used to create the models. The goal is obviously to make the models as accurate as possible. Some generalizations are however necessary.

Appendix A contains further clarification of key assumptions. The reasoning behind all constants used is also presented here.

8.1 Network assumptions

8.1.1 General assumptions

The different business cases are constructed by choosing several HFs located in a specific area. The idea is to provide the population currently being served by these HFs with an upgraded access network.

Even though HFs don't play a role in fiber networks, these locations are used as aggregation points for the different fiber solutions. In the case of PONs, this means that splitters can be placed here. In the case of P2P, a fiber distribution point can be placed here. This is shown in Figure 18 and Figure 19 respectively.

There is however not a one-to-one relationship between the old HF locations and the new aggregation point. One old HF location can for instance be chosen to "serve" all households previously served by 4 different HFs. This "merging" of locations is done to increase equipment utilization and ease error corrections. The goal of a merging decision is to aggregate more households in one site while keep digging lengths low.

For VDSL2, old HFs will be the typical location for new DSLAMs. But again, there will not be a one-to-one relationship between old HFs and new DSLAMs. The physical DSLAM location will be decided in each individual case.

Even when only a small number of fibers are needed for a stretch, we will make the assumption to always use 192-fibers-cables wherever new cable has to be deployed. The cost of this is higher, but it is a cheap way of preparing for a future P2P solution. Compared to digging costs, the price difference per meter is anyway small.

For PONs and P2P, the stretch between drop points and ONT is called the last drop. This stretch is exempt from the decision above. On these stretches, 12-fiber cable is used.

Section 10.2 will enlighten the savings that could have been made by using “smaller” cables.

The total deployment cost will of course depend strongly on take rates. It is however important that the access network is scaled so that new customers can join in later. The costs presented, reflect the cost of equipment needed to accommodate all households in the area. There is however two exceptions from this rule:

- For fiber based solutions (PON, P2P), the last drop is only included for a percentage corresponding to the assumed initial take rate.
- Customer equipment is only bought for a percentage corresponding to the assumed initial take rate.

This initial take rate is set to 40 %. Reasons for this number are given in Appendix A.

During the first six years after deployment, the take rate is assumed to increase gradually towards 60%. This calls for a further investment to accommodate new customers. As explained above, this will only require CPE and fiber from drop point to house. The rest is already in place.

8.1.2 PON

Even though multiple splitting levels are possible, it has been decided to only use one splitter per PON. This is done to ease the task of finding and correcting system failures.

Depending on each case, the households belonging to several HFs can be merged. This implies that all splitters serving these households become co-located. This is done to improve utilization of splitter capacity. This again will reduce the number of OLTs needed. It is also in accordance with the general guideline to reduce the number of sites to manage. Because of this merging, only 1: 64 splitters will be used. It is assumed that all splitters at a splitting location can be placed in one common cabinet.

For each such splitter location the number of splitters (PONs) needed, will simply be the number of households covered, divided by 64 and rounded upwards.

For PONs it is assumed profitable to try to centralize as many OLTs as possible in one location. There are several reasons for this. Typically OLTs are scaled to handle many PONs. If many OLT locations were used, this would likely result in a poor utilization. From a maintenance point of view, it is also desirable to have as few locations as possible to administrate. Drawbacks are of course longer distances between OLT and splitter. In most cases this is however not a problem because existing fiber or ducts are available. Centralization also means that the whole system becomes more vulnerable because of a single point of failure. This is discussed further in section 10.2.

In today's network, traffic from several COs are aggregated into a superCO. In the Trondheim region, two such superCOs exist. Lerkendal is the location of one of them. Since all the business case locations chosen here are within 20 km of Lerkendal, all OLTs are assumed to be placed here. This will allow OLT equipment to be amortized by all customers. It is assumed that the capacity leading away from the superCO is not a limiting restriction.

Reach is not considered a limiting factor since all business case areas are within 20 km of the chosen OLT location.

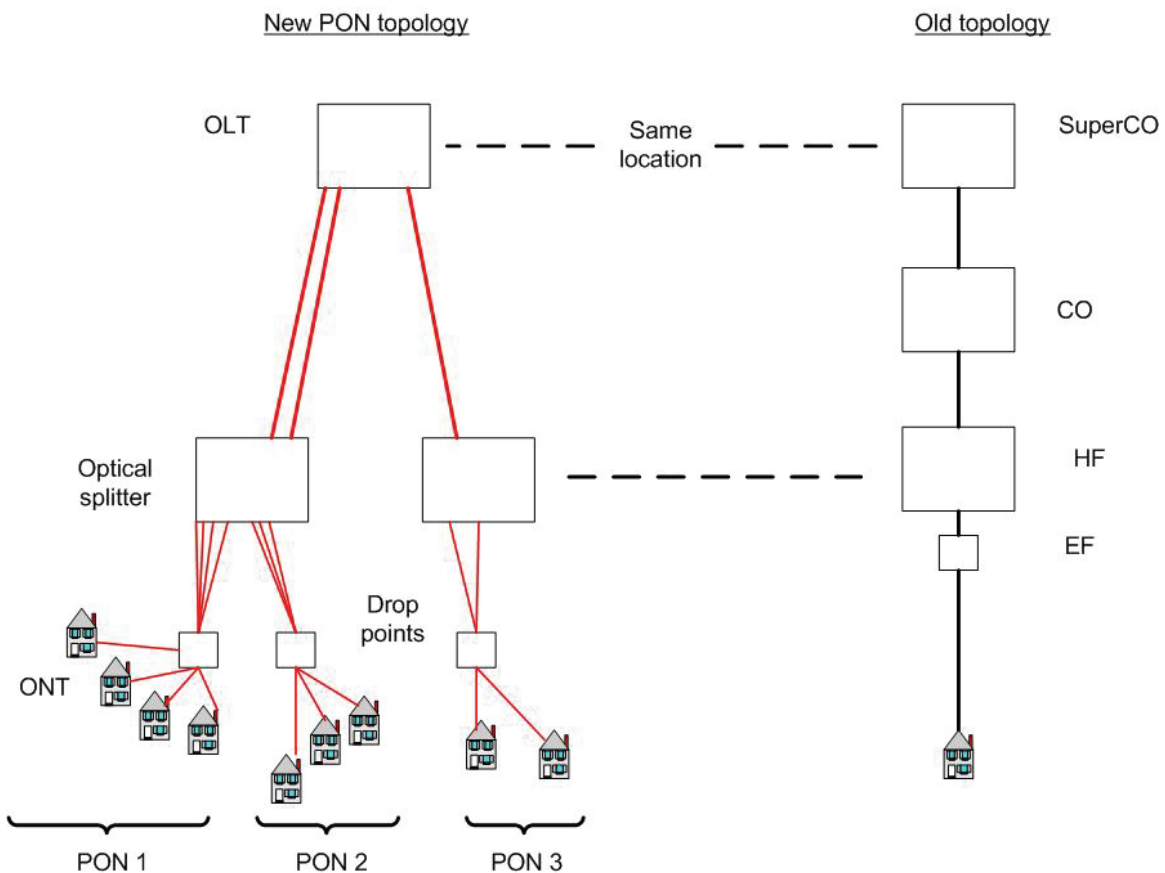

Figure 18: New PON topology in relation with old copper entities FIKS SUPER-co

One drop point can serve 4 households. Because of a likely suboptimal layout, it is however assumed that on average, one drop point is needed for every 3 households. The initial customers are assumed to be spread equally among the existing drop points

In order to reduce investment costs, it is important to try to utilize existing fiber and ducts. When connecting PONs to existing fiber, splicing is necessary. For every PON it is

hence assumed that one 2-fiber splice and one splice box is needed. (Connecting to existing fiber)

When fiber enter into a node (OLT, splitter, drop point, ONT), the fiber is terminated. For every PON it is assumed that one 2-fiber terminations is needed. This will cover the termination of the fiber in the OLT and in the splitter.

The cost of termination of fiber in and out of drop points and out of splitter is included in the price of a drop point. This may seem strange, but is explained in section 6.1.4.

The cost of terminating fibers in ONT by the end user is included in the ONT installation cost.

8.1.3 P2P

For a P2P solution, two fibers are needed for every customer. It is considered inefficient to terminate all these fibers in one centralized OLT aggregation point like what is done for PONs. For our business cases, two locations are used. The OLTs are co-located with old COs. These are Leangen and Lerkendal. For the COs chosen, the capacity leading into the core network is not assumed a limiting factor.

The last assumption above can obviously not hold in all cases. Some COs are for instance now connected to the rest of the core network through very limited radio or ATM links. Telenor are however in the phase of connecting\upgrading many of their existing CO\DSLAMs to a new IP-based aggregation network called BRUT. This will greatly increase capacities. When choosing Leangen and Lerkendal as the OLT aggregation points it is because these are likely to become BRUT-nodes.

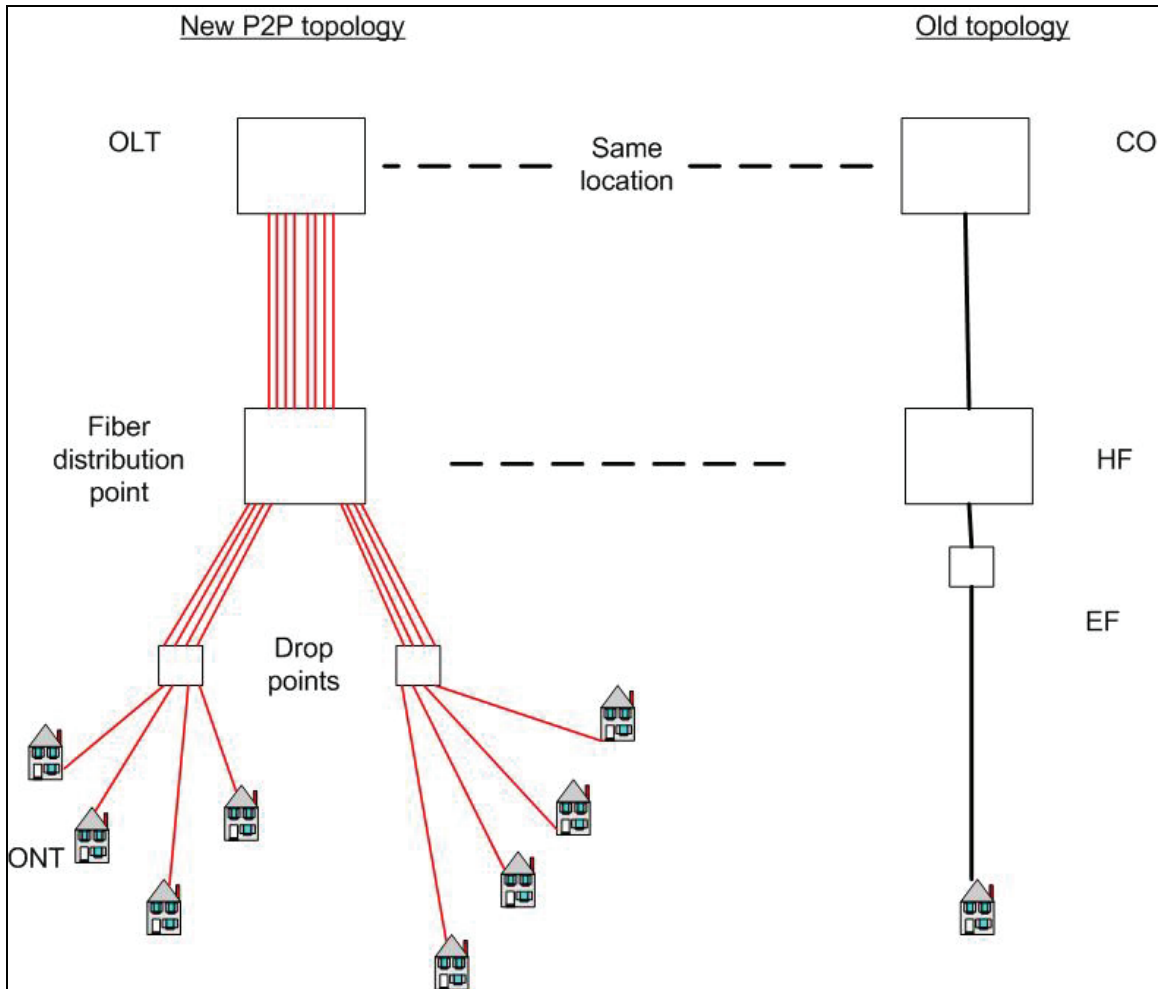

Figure 19: New P2P topology in relation with old copper entities

Figure 19 displays the P2P topology in relation to the old copper network. As explained above, there is not a one-to-one relationship between old HFs and new fiber distribution point locations. The same is true for CO and OLT locations.

The fiber distribution point in Figure 19 will just split the fiber path coming from the OLT into “smaller” paths running to the drop points. In order to make it easy to add new customers, all fibers will be terminated at this point.

Depending on each case, the households belonging to several HFs can be merged into sharing a common fiber distribution point. As for PONs this will reduce the number of sites to manage. Each fiber distribution point will require one cabinet.

One drop point can serve 4 households. Because of a likely suboptimal layout, it is however assumed that on average, one drop point is needed for every 3 households. The initial customers are assumed to be spread equally among the existing drop points

For every 192-fibers leading from the OLT into the fiber distribution point, two 192-fiber-terminations are needed. (One in each end)

The cost of termination of fiber in and out of drop points and out of splitter is included in the price of a drop point. This may seem strange, but is explained in section 6.1.4.

The cost of terminating fibers in ONT by the end user is included in the ONT installation cost.

8.1.4 VDSL2

In the case of VDSL2, the old copper network is kept, but new DSLAMs need to be deployed. Depending on the geography and population density of the business case area, different numbers of DSLAMs may be necessary in providing an upgraded access network. These DSLAMs are assumed deployed at strategic places specific to each business case. Through the use of fiber, the DSLAMs will be connected to a higher node with an adequate up-link capacity. It is assumed that adequate capacity can be found as soon as the new DSLAM is connected to existing available fiber.

As explained earlier, the bit rates provided by xDSL depend on the line distance between DSLAM and end user. By choosing a bit rate and finding the corresponding line length, one can draw up a circle using this line length as a radius from the DSLAM. Theoretically, all users within the circle will have bit rates equals to or faster than the chosen rate.

Using the method above, it is tempting to try to place the circles so that the most households are covered. This will however provide a false answer. The reason lies in how the existing copper network is laid out. The copper network is laid out like a tree. From different aggregation points, the tree spans out in different directions. In order to benefit from existing infrastructure, it is important that this tree structure is maintained. In practice this means that DSLAMs must be placed at “root” or at a “branch root”. As before, the customers will then make up the “leaves” of the tree. Figure 20 is an attempt to illustrate this concept. It would be tempting to just place one DSLAM in the center of the area. This is however wrong. Instead, three DSLAMs are needed. As can be seen in Figure 20, the three DSLAMs also cover large areas that are not included in the business case. In many cases, this will provide a bonus in the form of a capability to reach customers outside the business case area. These bonuses are not included in any calculations.

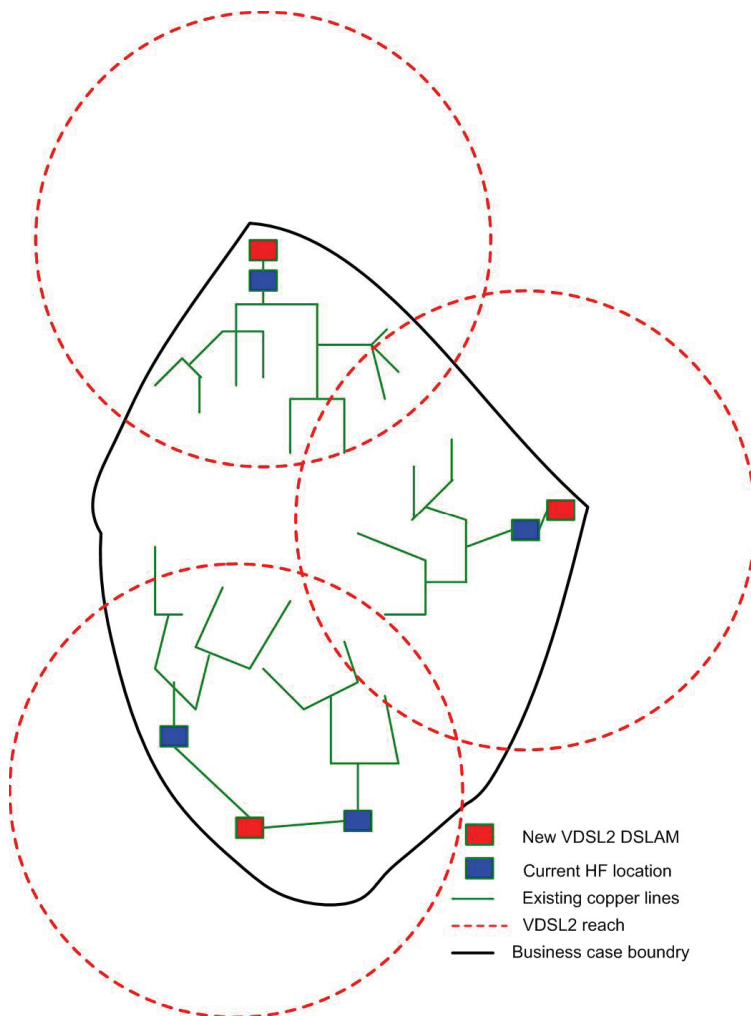

Figure 20: Correct deployment of new VDSL2 DSLAMs

In addition to the issues described above, there are further complicating factors. In some cases the OLD HFs are placed so close, that with respect to reach, one DSLAM could theoretically serve both areas. The problem is however that each HF forms its own tree, and re-configuration these trees come with a cost. Figure 21 tries to illustrate this problem. In the luck case, the two HFs may only form logically separated trees, but share a common physical path towards the CO. In this case, no special reconfiguration is needed. If the two HFs don't share a common path, one can be constructed if considered profitable. This will require digging new ditches, deploying new copper and splicing all cables.

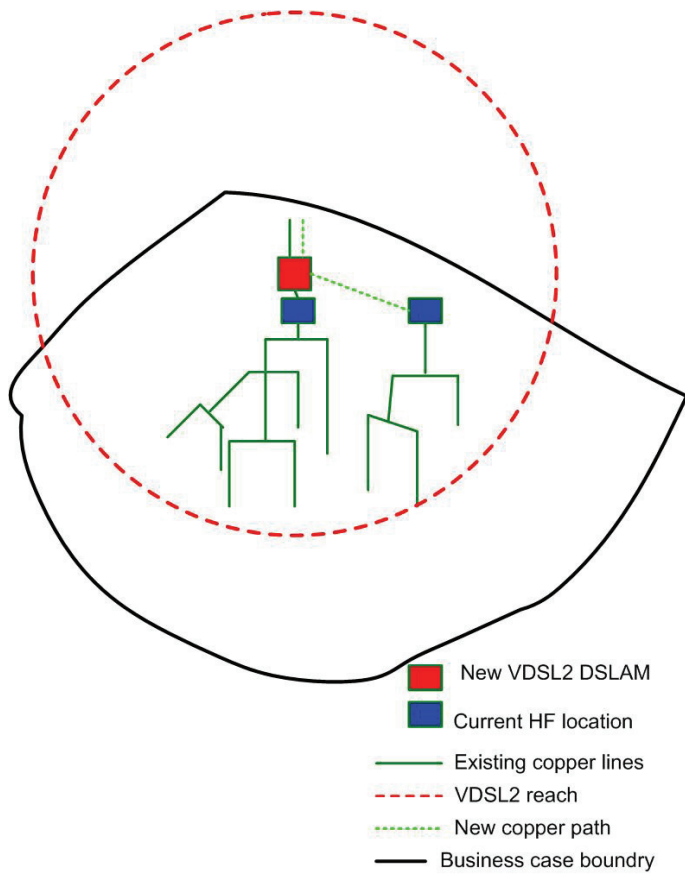

Figure 21: Two HF areas sharing one DSLAM

In practice, the deployment of VDSL2 is even more complicated. Several other issues are also relevant. If new equipment is deployed or the existing network is reconfigured, this may or may not affect the service of other operators offering for instance ADSL. The effects could be technical or administrative. Technical effects could for instance be reduced quality due to increased crosstalk^{iv}. An administrative effect could be the need to declare a network re-configuration to other service providers. These last mentioned side effects are not treated in any of the business cases.

The availability of near by fiber is also an important factor when choosing the new DSLAM locations. All new DSLAMs need to be served by a fiber link. Only one fiber pair is needed to connect each DSLAM.

For every DSLAM it is assumed that two 2-fiber splices and one splice boxes is needed. (Connecting to existing fiber)

For each DSLAM, one 2-fiber termination is needed. (Connecting DSLAM)

^{iv} An undesired effect in one transmission circuit caused by concurrent transmissions on a neighboring circuit

If necessary, copper termination and splicing may be necessary. This will be specific to each case.

Two scenarios are studied:

Scenario 1

In order for VDSL2 to be able to “compete” with fiber based solutions, the following restriction is made:

All customers should be offered at least 70 Mbit/s. In order to achieve this, no lines can be longer than 500m. Since lines seldom follow the shortest path, this will typically mean that customers must be within 300m of the DSLAM. Figure 22 attempts to illustrate this.

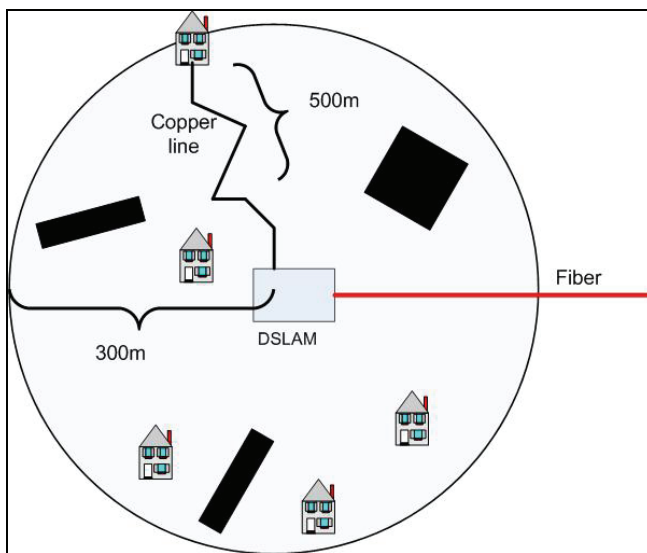

Figure 22: Achieving 70 Mbit/s with VDSL2

Scenario 2

This scenario is similar to scenario 1, except that copper lines are now allowed to be 1000m. This will provide a capacity of about 30 Mbit/s. Since lines seldom follow the shortest path, this will typically mean that customers must be within 600m of the DSLAM. Figure 23 attempts to illustrate this.

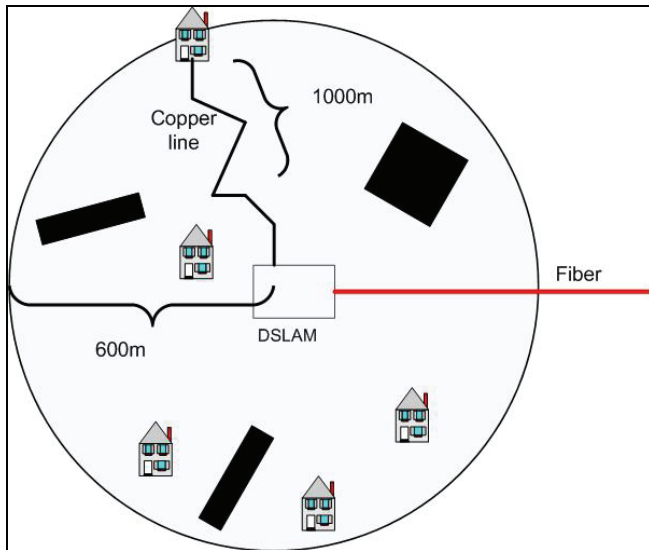

Figure 23: Achieving 30 Mbit/s with VDSL2

8.2 Residential assumptions

Profitability is likely to vary with population density and type of housing. Three housing categories are used in the business cases. These are:

- Single homes
- One-Storey apartment buildings
- Multi-storey apartment buildings.

The areas analyzed in the business cases are thought to contain a linear combination of these three categories. Rural areas will typically have more single homes, while a city may have mostly multi-storey apartment buildings. An example of a linear combination would be 60 % single homes, 30 % one-storey apartment buildings and 10% multi-storey apartment buildings. It is further assumed that customers are distributed equally among the different housing types.

8.3 Assumptions regarding cable needs and digging

8.3.1 PON

Figure 24 is included to help motivate the decisions made below. It show an area currently served by a HF. This old HF location is chosen to hold the splitters.

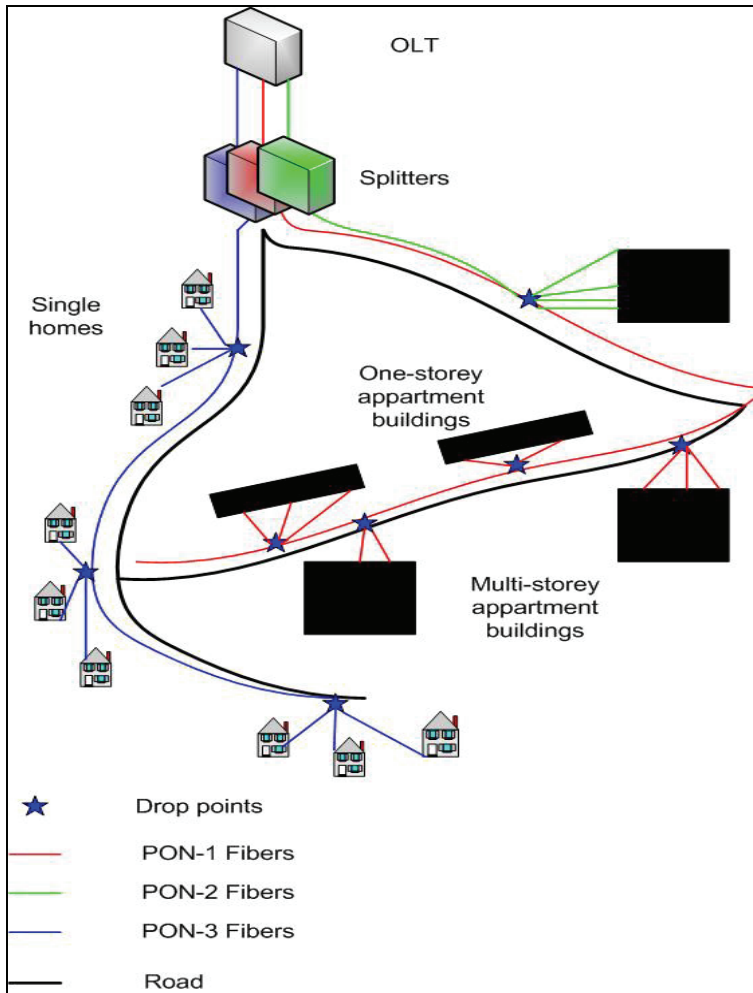

Figure 24: Overview of a hypothetical business case area with PON deployment

Connecting splitter (chosen old HF) and OLT (superCO)

Two options exist for connecting the splitters and OLT.

- Use existing available fibers. This implies:
 - Fiber length = air distance from splitter to existing fiber + 20%
 - Digging length = air distance from splitter to existing fiber + 20%
- Use existing available ducts. This implies:
 - Fiber length = air distance from splitter to superCO + 30%
 - Digging length = air distance from splitter to existing duct + 20%

When using existing available fibers or ducts it is important to ensure that these can accommodate our needs all the way. The 20% is added to compensate for a likely suboptimal digging path. The 30% is added to compensate for a likely suboptimal ducting path.

If no intermediate available fiber or duct is available, a new fiber path has to be constructed the whole way.

The cheapest option will be used.

Reaching old HF locations from splitter (merging)

Two options exist for reaching those old HF locations not chosen to hold the splitters.

- Use existing available fibers. This implies:
Fiber length = air distance from splitter to existing fiber + 20%
Digging length = air distance from splitter to existing fiber + 20%
- Use existing available ducts. This implies:
Fiber length = air distance from splitter to old HF + 30%
Digging length = air distance from splitter to existing duct +20%

When using existing available fibers or ducts it is important to ensure that these can accommodate our needs all the way. The 20% is added to compensate for a likely suboptimal digging path. The 30% is added to compensate for a likely suboptimal ducting path.

If no intermediate available fiber or duct is available, a new fiber path has to be constructed the whole way.

The cheapest option will be used.

Reaching drop points from the splitters

For each old HF, the cost of fiber and digging is approximated like this:

Total 192-fiber length = total road length covered by HF

Total digging length = total road length covered by the HF

Reaching homes from drop points

Total 12-fiber length = (
-30m per household for single homes
-20m per household for 1-storey apartment buildings
-15m per household for multi-storey apartment buildings) *take rate

Total digging length = (
-20m per household for single homes

-2m per household for 1-storey apartment buildings
-0,5m per household for multi-storey apartment buildings) *take rate

Digging lengths are shorter than fiber lengths, because some fiber will run inside the house. Buildings holding multiple households have shorter digging distances per household. However, by summing over all customer households in a building, the appropriate distance is assumed correct. A more thorough explanation is given in Appendix A.

8.3.2 P2P

Figure 25 is included to help motivate the decisions made below. It show an area currently served by a HF. This old HF location is chosen to hold the fiber distribution point.

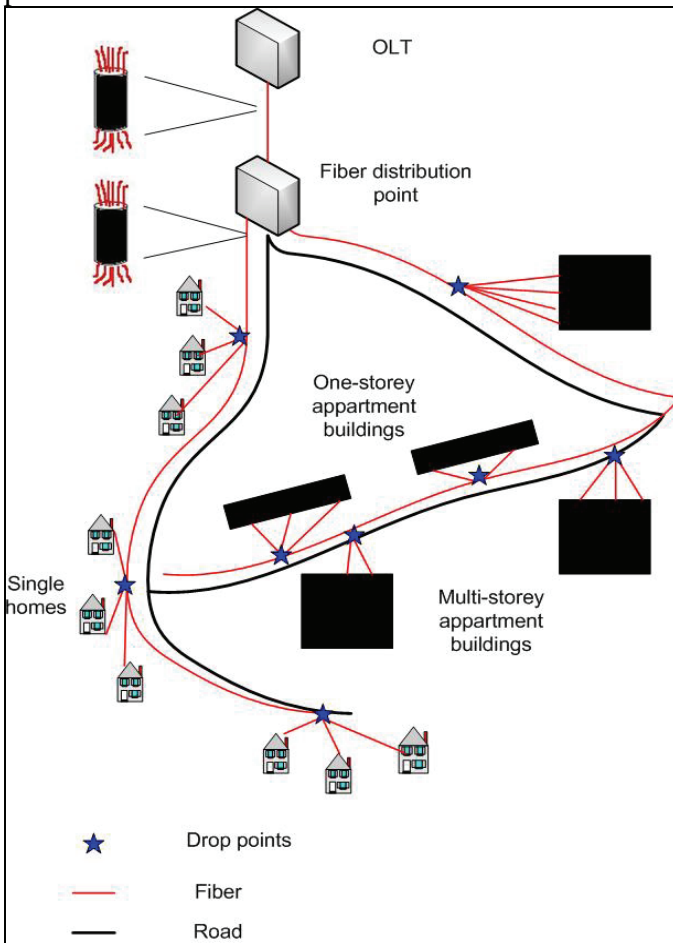

Figure 25: Overview of a hypothetical business case area with P2P deployment

Connecting fiber distribution point (old HF) and OLT (CO)

It is assumed that the OLT is placed in the CO, and that all fibers run through a fiber distribution point. This point will be placed in one or more of the old HF locations. This

implies that for each household, two fibers are needed for this stretch. In contrast to a PON solution where few fibers are needed, a P2P solution requires a vast number of fibers. It is assumed that this number is much greater than what can be found of available fibers near by. This leaves us with two options:

- Establish new fiber path between OLT and fiber distribution point:
Fiber length = air distance from fiber distribution point to OLT + 20%
Digging length = air distance from fiber distribution point to OLT + 20%
- Use existing available ducts:
Fiber length = air distance from fiber distribution point to OLT + 30%
Digging length = air distance from fiber distribution point to available ducts + 20%

When using existing available ducts it is important to ensure that these can accommodate our needs all the way. The 20% is added to compensate for a likely suboptimal digging path. The 30% is added to compensate for a likely suboptimal ducting path.

The cheapest option will be used.

It is previously stated that only 192-fiber-cables are to be used. If the number of households belonging to a fiber distribution point is greater than 96 (192/2), additional cables of this size will be used.

Reaching old HF locations from fiber distribution point (merging)

As above, two options exist for reaching those old HF locations not chosen to hold the fiber distribution point.

- Establish new fiber path between fiber distribution point and old HF:
Fiber length = air distance from fiber distribution point to old HF + 20%
Digging length = air distance from fiber distribution point to old HF + 20%
- Use existing available ducts:
Fiber length = air distance from fiber distribution point to old HF + 30%
Digging length = air distance from old HF to available ducts + 20%

When using existing available ducts it is important to ensure that these can accommodate our needs all the way. The 20% is added to compensate for a likely suboptimal digging path. The 30% is added to compensate for a likely suboptimal ducting path.

The cheapest option will be used.

Reaching drop points from the fiber distribution point

For each old HF, the cost of fiber and digging approximated like this:

Total 192-fiber length = total road length covered by HF

Total digging length = total road length covered by the HF

Reaching homes from the drop points

Total 12-fiber length = (
-30m per household for single homes
-20m per household for 1-storey apartment buildings
-15m per household for multi-storey apartment buildings) * take rate

Total digging length = (
-20m per household for single homes
-2m per household for 1-storey apartment buildings
-0,5m per household for multi-storey apartment buildings) * take rate

Digging lengths are shorter than fiber lengths, because some fiber will run inside the house. Buildings holding multiple households have shorter digging distances per household. However, by summing over all customer households in a building, the appropriate distance is assumed correct. A more thorough explanation is given in Appendix A.

8.3.3 VDSL2

Fiber

The fiber length needed is just the distance from DLAM to existing available fiber. As usual 20% is added to compensate for a likely sub-optimal path.

Copper

In the case of VDSL2 there might also be a need for more copper cables. This is in the case where one DSLAM is to serve more than one HFs not sharing the same physical copper path towards the CO. This is explained above in section 8.1.4.

One will need copper equal to the length between the two HFs and if necessary also from the DSLAM-HF to the CO. As usual 20% is added to compensate for a likely sub-optimal path. The number of pairs used will depend on the number of customers served

Digging

The digging length needed will just be the sum of fiber and copper lengths needed.

When using existing available fibers or ducts it is important to ensure that these can accommodate our needs all the way. The 20% is added to compensate for a likely suboptimal digging path.

8.4 Assumptions regarding green-field deployment

Until now, all assumptions have been towards deployment in established residential areas. Such areas are called brown-fields. The solutions may perform differently in areas that are in the process of being established. Such areas are called green-fields. Since none of the business case areas is a green-field, a hypothetical approach is taken. One of the areas is assumed temporarily to be under construction. In order to analyze, the same approach as described above is used, but now with some modifications.

Except for two modifications, the cost of PON and P2P solutions will be approximated as usual. It is assumed that digging costs occurring between splitter/fiber distribution point and CPE will now be reduced by 50%. The reason for this is that a common ditch can be used by multiple actors. Having electricity and communications sharing the same ditch is common. It is further assumed that CPE installation costs can be reduced by approximately 20%. It is assumed that installation personnel are already present for other assignments. This lowers the number of man hours needed.

In the case of VDSL2, a green-field deployment provides new challenges. So far it has been assumed that a copper access network is already in place in all areas. Depending on the scale of the green-field project, different amounts of existing infra structure will be in place. In this thesis, it is assumed that HFs and all equipment inwards (towards CO) are already present.

In order to approximate full deployment costs, network construction costs have to be added to those previously found. It is assumed that the digging distances needed between HF and CPE is equal to the one needed between fiber distribution points and ONT/CPE for P2P brown-field solutions. This is reasonable since fiber distribution points are co-located with old HFs. As for the fiber based solutions, digging costs can be reduced by 50% due to cost sharing.

Copper lengths are assumed to equal fiber lengths needed between fiber distribution point and ONT/CPE in a P2P brown-field solution. 200-pair copper cables replace 192-fiber, while 10-pair copper cable replaces 12-fiber. Copper prices are given in section 6.1.1. It is further assumed that one EF is needed between HF and CPE. The average number of households per EF is today approximately 7. The price per EF with installment is approximately 1.000 NOK. It is assumed that copper is terminated in all households. For each household the approximate termination cost is 500 NOK.

9 Results

The results of the business case analysis are presented below. The complete analysis is included in the Excel spread sheets. It is highly recommended to study these to get a full understanding of the obtained results.

In all cases, an initial take rate of 40% is assumed. It is further assumed that this figure will grow to 60% during the first 7 years after deployment. Obviously this is a major simplification. Predicting take rates is a science of its own. Very complex models can be constructed. It is however beyond the scope of this thesis to do so. Instead, there will be various graphs showing the initial investment per customer as a function of the assumed initial take rate. This way the, the job of predicting take rates can be left to others while the results found here can still be used.

9.1 *How to interpret results*

CAPEX

In the author's opinion, the CAPEX figures are the most interesting results. Revenues are assumed identical for all technologies (PON, P2P, VDSL2) and the OPEX figures are very similar. It is hence the CAPEX figures that really separate the different solutions. The CAPEX figures are provided below as cost per customer.

As explained in the chapter regarding the business case assumptions, the CAPEX results include the following: In the case of PON and P2P, all costs from drop points and inwards (towards OLT), reflect a network (with equipment) capable of accommodating all households in an area. From drop point and outwards (towards customer), costs are governed by the take rate. In the case of VDSL2, the assumption is similar. DSLAMs are scaled to accommodate all households, while only user equipment is bought for the assumed initial customers. Equipment needed in order to provide the different services are not defined as part of the access network and are not included. Taxes and depreciations are also not included.

In reality one would of course install in stages not only in the user end, but to some extent also at centralized points. This would however be highly specific to each case and is not modeled.

When also adding OPEX figures and revenues, a net present value for each business case area can be calculated.

Net Present Value (NPV)

So far the only argument for upgrading the current access network has been to meet future demand. Another indicator on whether or not to take on such a project is the net present value (NPV) of the whole project. The NPV will also indicate which technological solution is the most profitable. The net present value is the sum of cash flows, discounted at an appropriate cost of capital. The mathematical expression is given in Equation 1. C_t is the cash flow received in time period t and i is the cost of capital. C_t will be negative if incoming cash flows are smaller than the outgoing.

$$NPV = \sum_{t=0}^N \frac{C_t}{(1+i)^t}$$

Equation 1

The cash flows will contain the initial CAPEX figures described above. In addition there will be some further CAPEX figures related to arriving customers. OPEX figures and revenues are also included. In context of NPV, it is recommended to review the section on revenue cannibalism found in section 6.3.

The project life time is set to 7 years. The cost of capital is set to 12%. A discussion of these parameters is presented in Appendix A. It is also important to remember that even though the NPV of each business case area is presented separately, it assumes that some centralized equipment (PON-OLT and P2P-OLT) can be shared by multiple areas. This is not the same as saying that all areas must be chosen. In reality one would replace the areas considered unprofitable.

9.2 Area results

Maps of all areas can be found in Appendix H. The spread sheets with all measurements are included as attachments to the thesis. The spread sheets and the maps will together explain the physical deployment decisions made. For each area, some essential background information is given before the actual results are presented.

9.2.1 Angeltrøa

Angeltrøa is a small residential area a few kilometers south east of downtown Trondheim. Except for some open fields here and there, the area is largely dominated by houses, gardens and roads in between. The households studied are a mix of single houses and one-storey apartment buildings.

Number of households	732
Number of HFs in service today	5

Single unit home %	46%
1-storey apartment building	54%
Multi-storey apartment building	0 %
Surface (field-average-urban tarmac)	30% - 70% - 0%

Table 18: Key figures and demographics for Angeltrøa

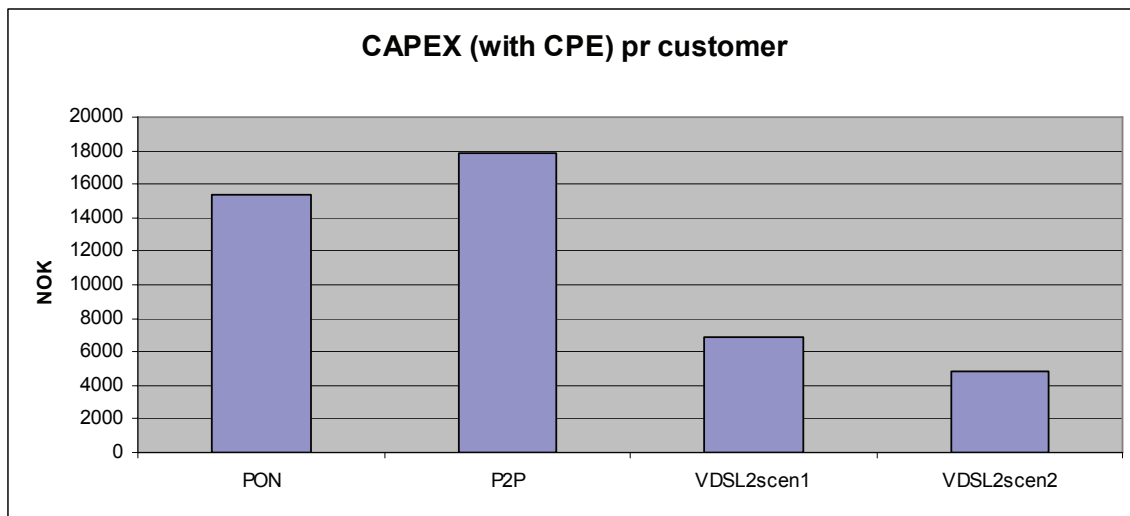

Figure 26: Cost per customer (initial CAPX divided by assumed initial number of customers)

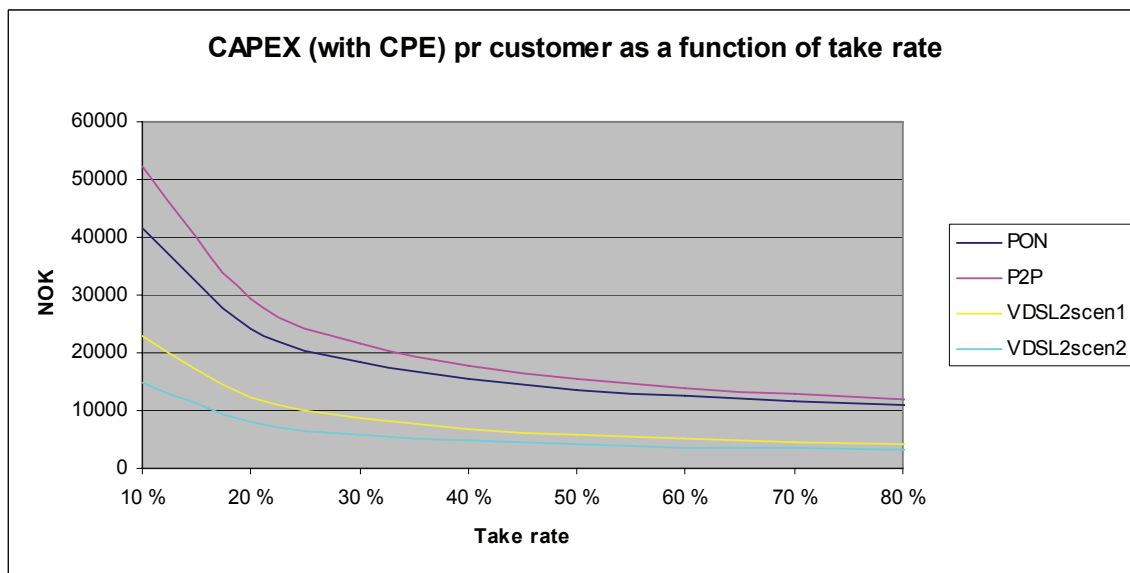

Figure 27: Cost per customer as a function of the assumed initial number of customers

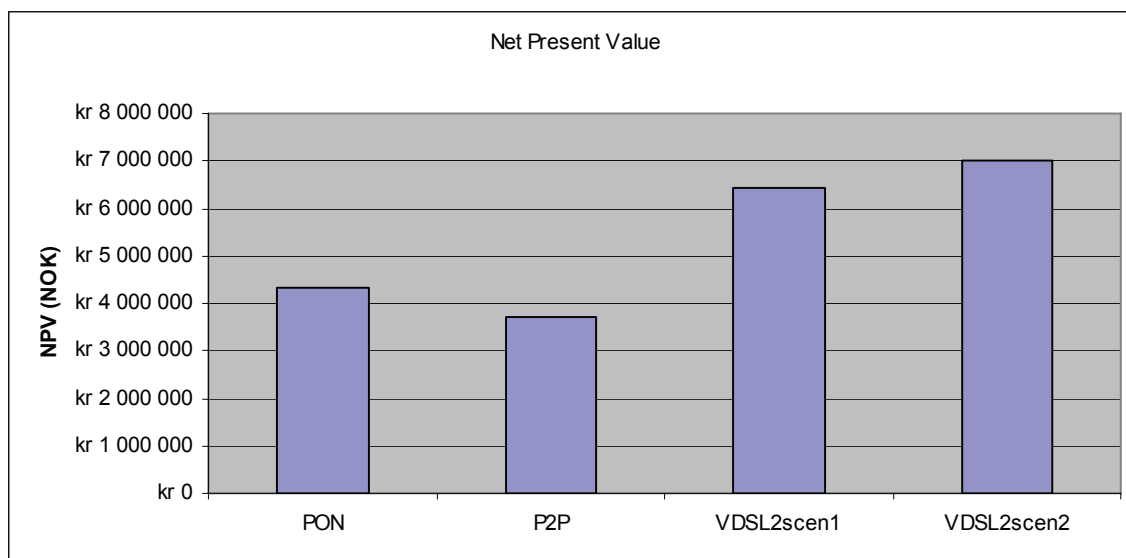

Figure 28: Net Present Value for the four different solutions

Comments

Figure 26 shows that P2P has the highest cost per customer and hence the highest initial CAPEX figure. Next is a PON solution. Not surprisingly, the VDSL2 solutions prove to be the cheapest. Despite the slightly higher OPEX figures, the VDSL solutions also prove the most profitable according to the NPV analysis. This is seen in Figure 28. Figure 27 shows how the cost per customer would change depending on the number of assumed initial customers. For the fiber based solutions, the cost decreases towards approximately 10.000 per customer. For the two VDSL2 scenarios the figures are between 3.000 and 4.000.

Independent of technical solution, Angeltrøa seems to be a desirable area for access network upgrading. The NPV is positive for all solutions. This can largely be explained by a fairly high population density. In addition the area allows for some use of existing fiber and ducts.

9.2.2 Granåslia

Granåslia is the neighboring area to Angeltrøa. Unlike Angeltrø, the area studied at Granåslia contains only single unit homes. In terms of digging surface the areas are very similar. The two HFs that currently exist in the area are only placed a few hundred meters apart.

Number of households	172
Number of HFs in service today	2
Single unit home %	100%

1-storey apartment building	0%
Multi-storey apartment building	0 %
Surface (field-average-urban tarmac)	20% - 70% - 10%

Table 19: Key figures and demographics for Granåsliå

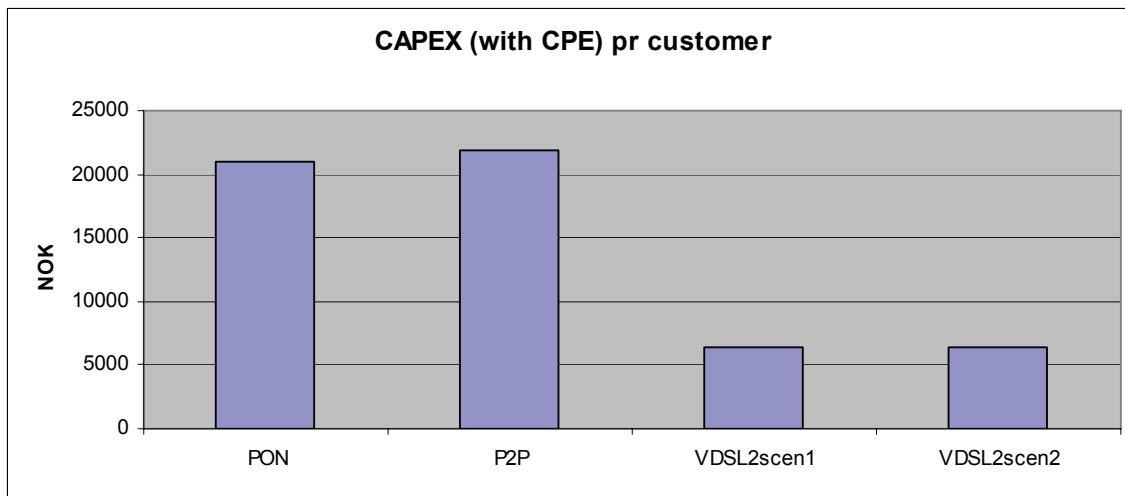

Figure 29: Cost per customer (initial CAPX divided by assumed initial number of customers)

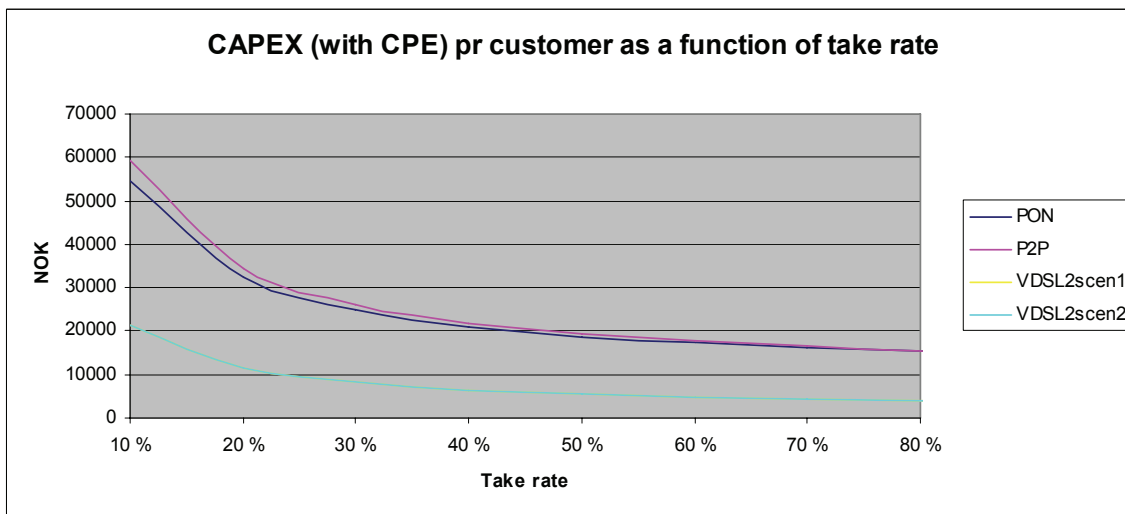

Figure 30: Cost per customer as a function of the assumed initial number of customers

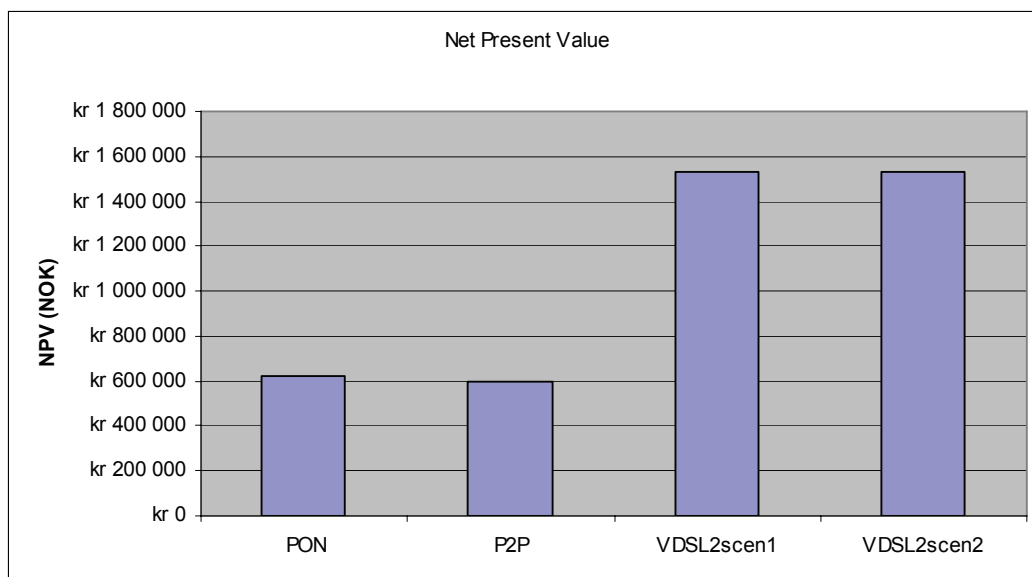

Figure 31: Net Present Value for the four different solutions

Comments

The first observation here is that VDSL2 scenario 1 and scenario 2 are identical. This is because the entire area can be covered by one DSLAM under scenario 1. The relaxation in the bit rate restriction under scenario 2 therefore has no effect. Another interesting observation is how PON and P2P are almost identical in terms of cost per customer and NPV. As usual, P2P is the most expensive, but the difference is only about 1.000 NOK. Figure 30 shows that as the assumed initial take rates increases, the difference in cost per customer falls to around 3.500 NOK for VDSL2 and about 14.000 NOK for the fiber based solutions.

9.2.3 Othilienborg

Othilienborg lies a few kilometers south of Trondheim. The area to be studied is currently served by two HFs. In terms of housing, multi-storey apartment buildings are in almost total dominance. The digging surface is dominated by the categories “average surface” and “open field”

Number of households	310
Number of HFs in service today	2
Single unit home %	5%
1-storey apartment building	5%
Multi-storey apartment building	90 %
Surface (field-average-urban tarmac)	35% - 65% - 0%

Table 20: Key figures and demographics for Othilienborg

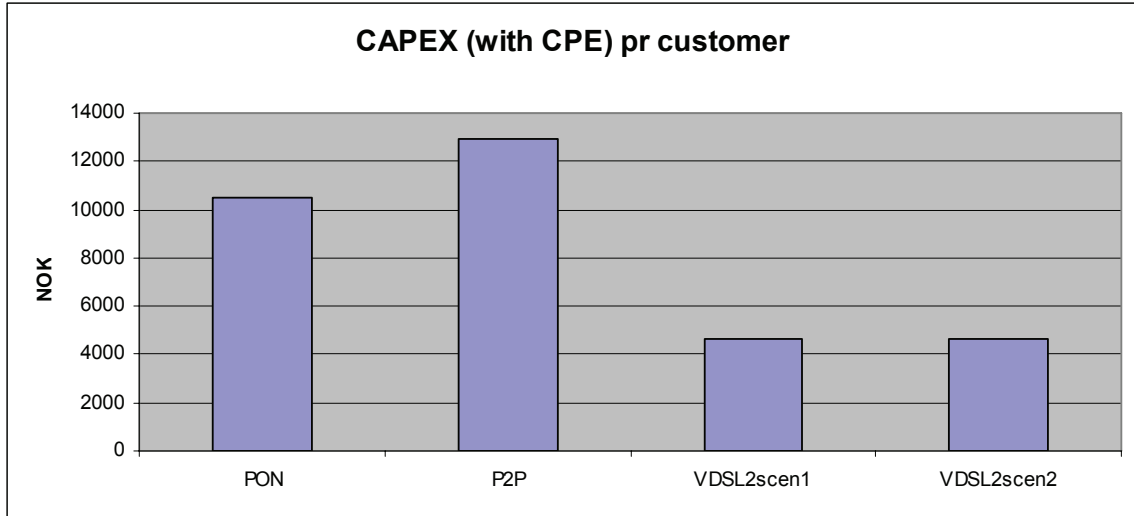

Figure 32: Cost per customer (initial CAPX divided by assumed initial number of customers)

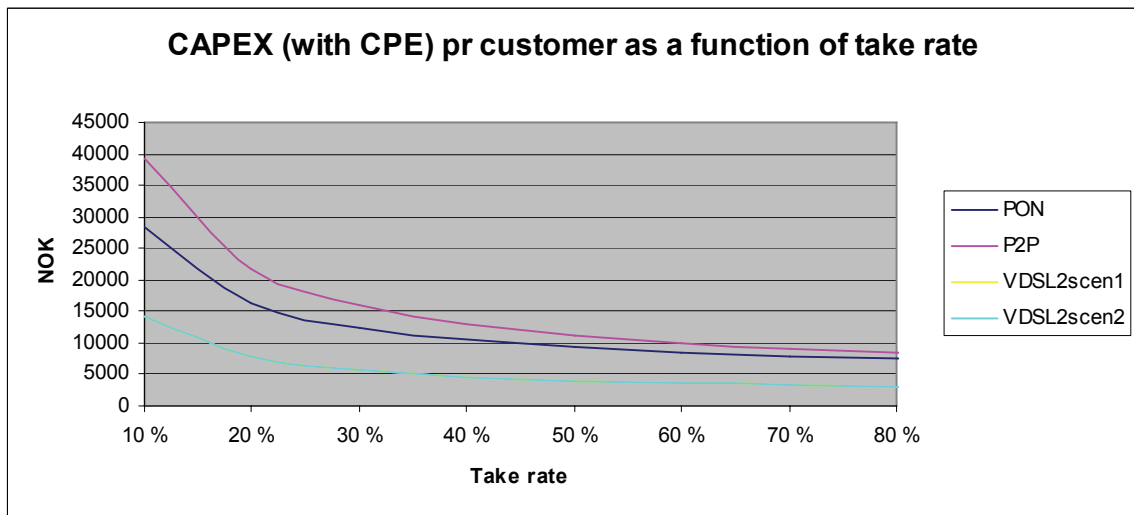

Figure 33: Cost per customer as a function of the assumed initial number of customers

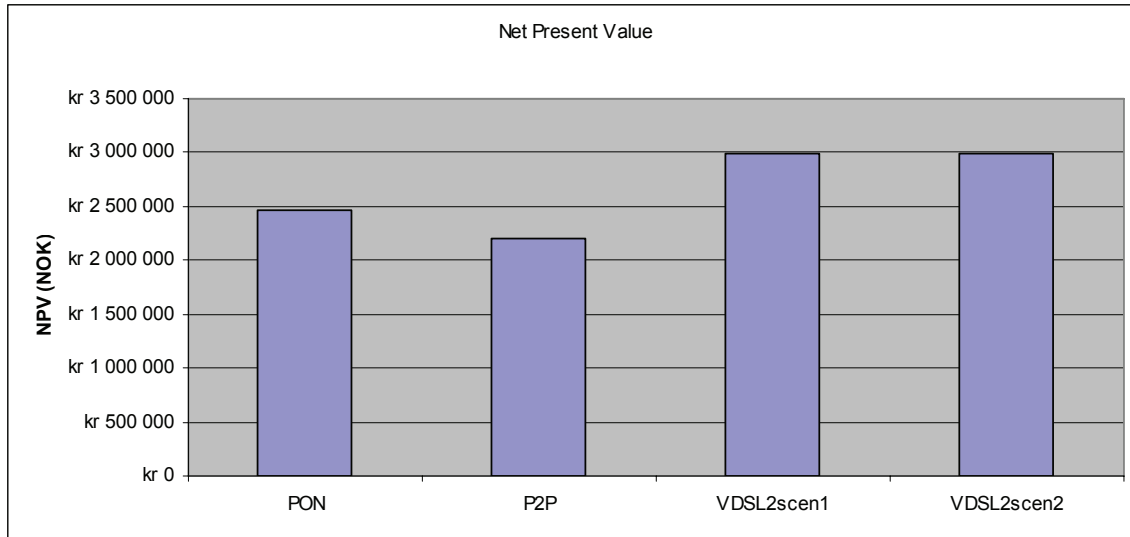

Figure 34: Net Present Value for the four different solutions

Comments

Again we see that scenario 1 and scenario 2 are identical in the case of VDSL2. The explanation is the same as above. As usual, P2P displays a slightly higher cost than PON. VDSL2 is by far the cheapest solution. Compared to all the other areas, Othilienborg has the lowest cost per customer for both a PON and a P2P solution. The high percentage of multi-storey buildings is the main reason for this. In addition, Othilienborg is positioned near to the chosen OLT locations. Existing fibers and ducts are also near by. Figure 33 indicates that the difference in cost per customer at high take rates is relatively small at Othilienborg compared to other locations.

As an interesting anecdote, it should also be mentioned that in the case of VDSL2, a large bonus is well within reach. A new HF, not originally defined as part of the business case is fully reachable by the DSLAM considered. This is true under both scenario 1 and 2.

9.2.4 Nedre Elvehavn

Nedre Elvehavn is part of downtown Trondheim. During the last ten years the area has become tremendously popular both for living and hosting business offices. Most buildings are younger than ten years old. In this thesis, ten different HFs and their customers are chosen for study. As of today, eight of these HFs are served by the CO termed NEH. The two last are served by the CO termed TD. These two are however in the process of being attached to NEH. It is hence here assumed that all ten are served by NEH. All of the HFs, serve multi-storey apartment buildings. The digging surface at Nedre Elvehavn is extremely challenging. It is classified as 100% “urban tarmac”. This may contain paved roads.

Number of households	458
Number of HFs in service today	10
Single unit home %	0%
1-storey apartment building	0%
Multi-storey apartment building	100 %
Surface (field-average-urban tarmac)	0% - 0% -100%

Table 21: Key figures and demographics for Nedre Elvehavn

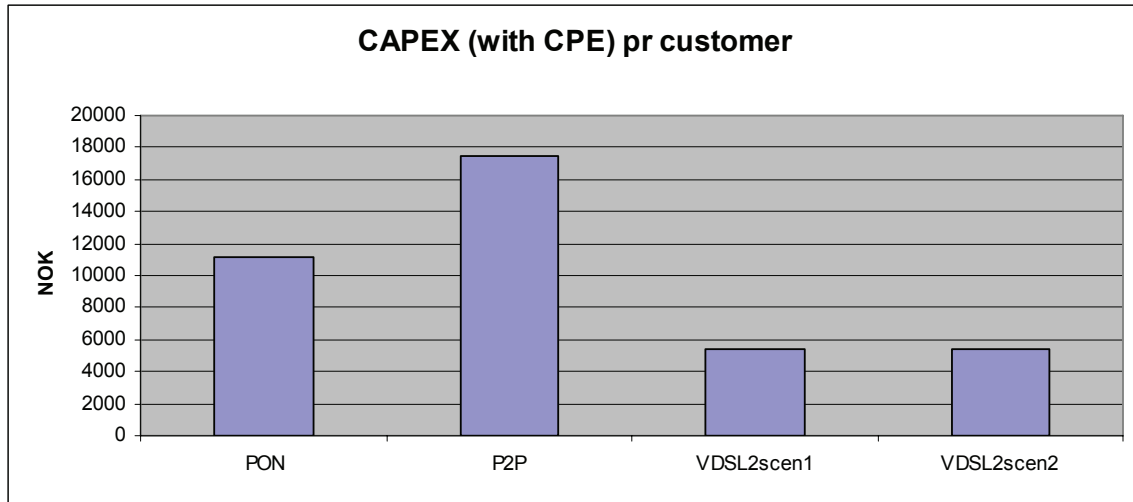

Figure 35: Cost per customer (initial CAPX divided by assumed initial number of customers)

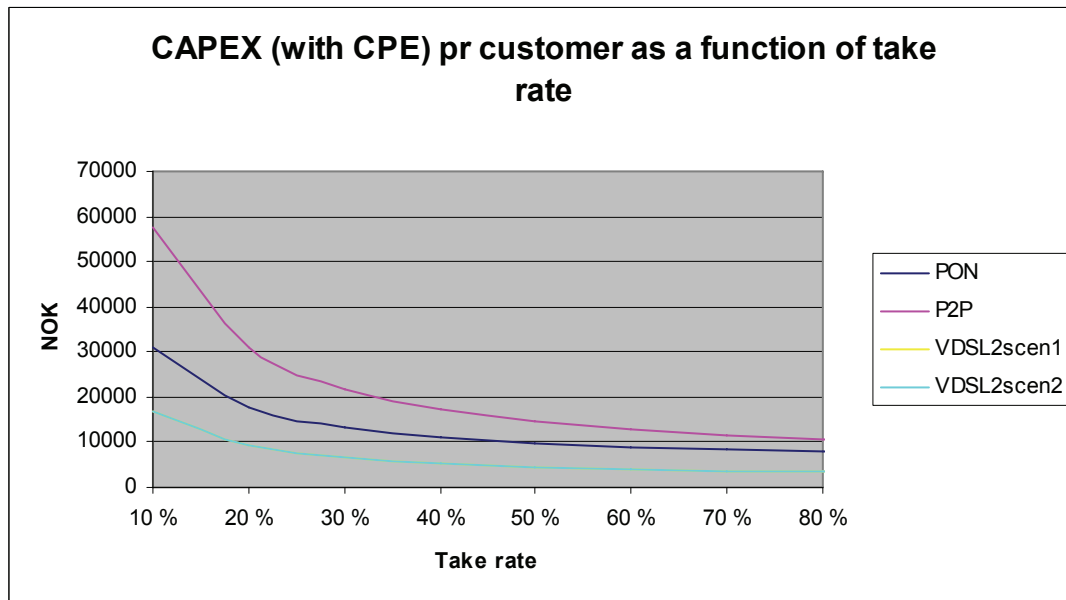

Figure 36: Cost per customer as a function of the assumed initial number of customers

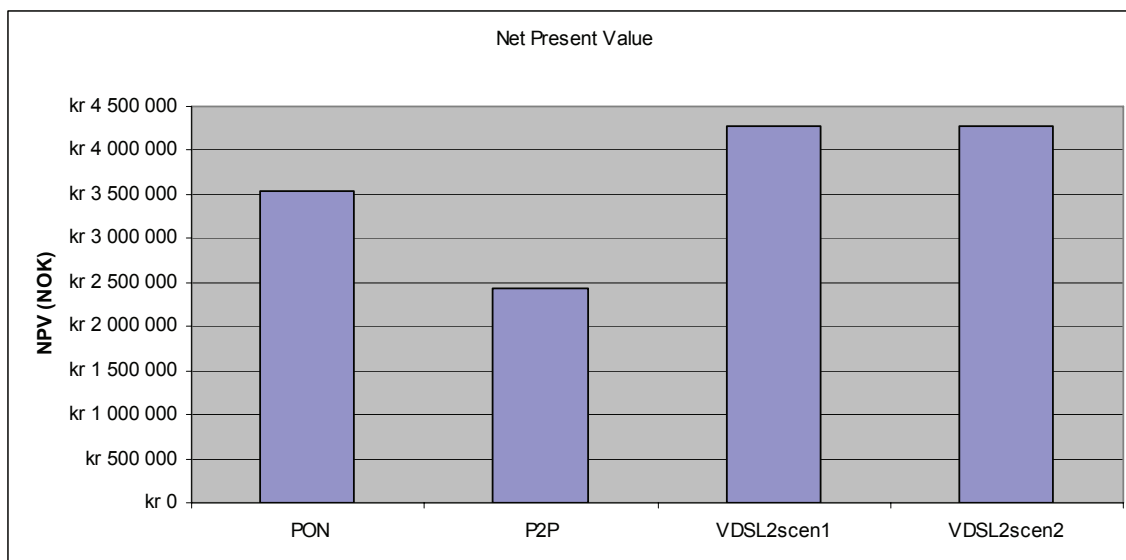

Figure 37: Net Present Value for the four different solutions

Comments

Again we see that scenario 1 and scenario 2 are identical in the case of VDSL2. The explanation is the same as above. Nedre Elvehavn is the most urban of all the areas studied. So far, the difference in cost per customer for PONs and P2P has been very low. In this area however, the difference is quite large. This can largely be explained by the lack of available ducts in the area. This means more digging in an already expensive surface. In the case of VDSL2, two large DSLAMs are needed. Following our assumptions from section 6.1.5, this requires two DSLAM houses. If this could be avoided, great savings can be achieved. The physical location chosen for these DSLAMs is a current CO. Chances are, this place has available room, and the savings can be realized.

9.2.5 Kvammen

Kvammen is a small rural area about 12 kilometers south of Trondheim. The households to be studied are scattered around a large area. Only single unit homes are present. The digging surface is an even mix between “open field” and “average surface”.

Number of households	114
Number of HFs in service today	3
Single unit home %	100%
1-storey apartment building	0%
Multi-storey apartment building	0 %
Surface (field-average-urban tarmac)	50% - 50% - 0%

Table 22: Key figures and demographics for Kvammen

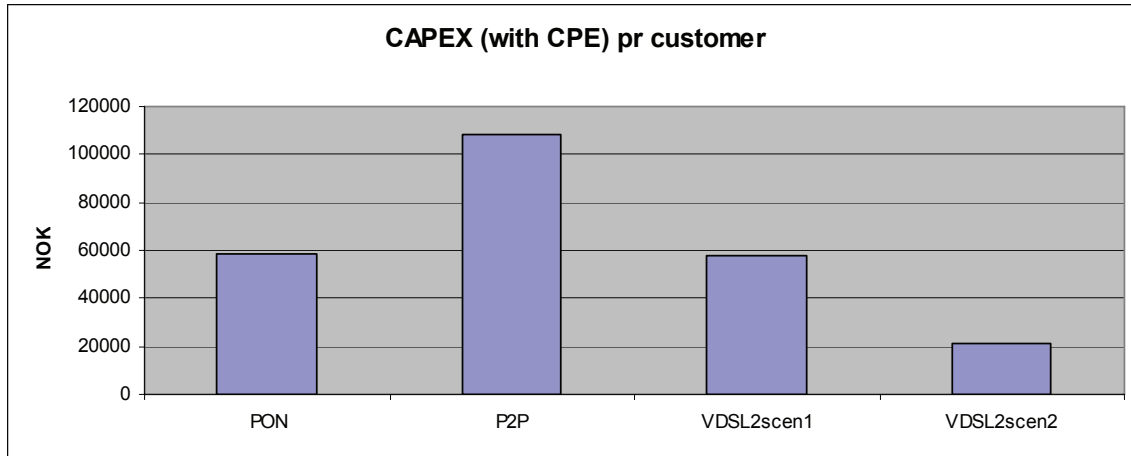

Figure 38: Cost per customer (initial CAPX divided by assumed initial number of customers)

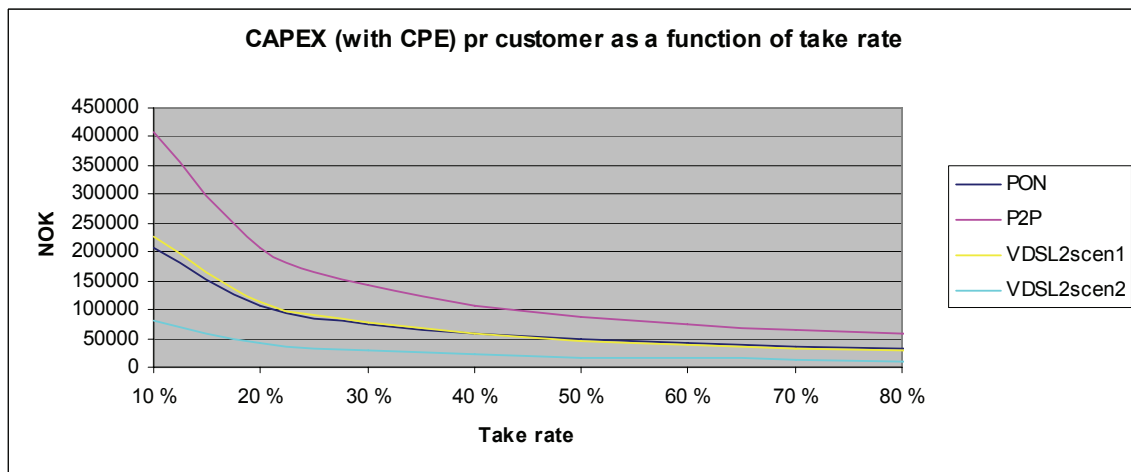

Figure 39: Cost per customer as a function of the assumed initial number of customers

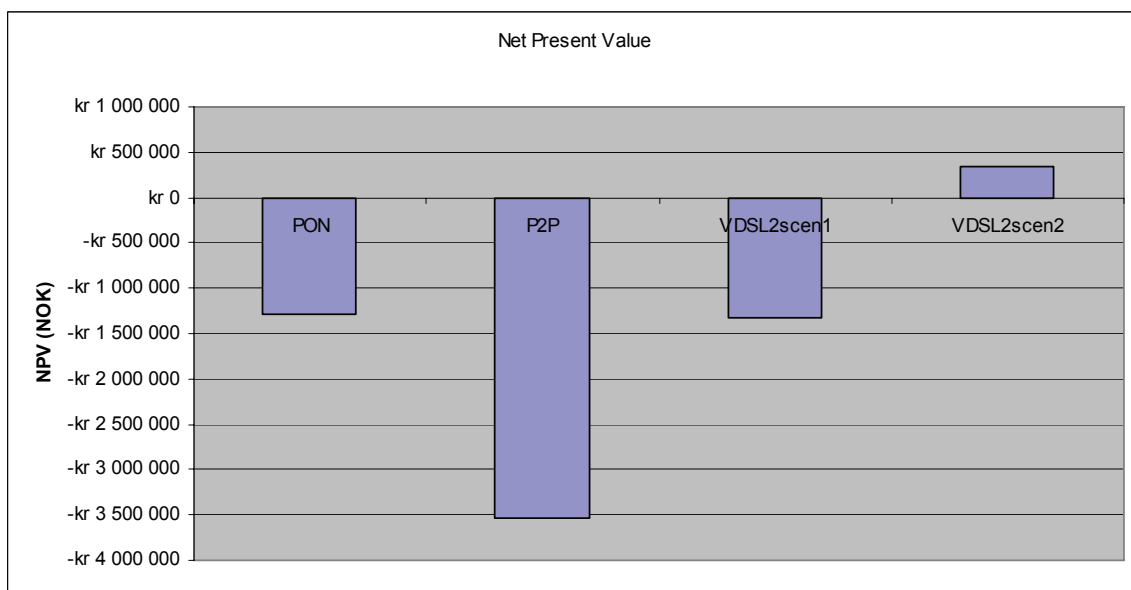

Figure 40: Net Present Value for the four different solutions

Comments

Except for VDSL2 scenario 2, Kvammen seems hopelessly unprofitable in terms of NPV. The expected cost per customer is also tremendously high. Never the less, Kvammen does provide some very interesting results. Figure 39, shows the cost per customer as a function of take rate. In all areas studied so far, the ranking within the different solutions have been the same for all assumed initial take rates. P2P has been the most expensive, followed by PONs, followed by VDSL2. At Kvammen, a PON solution actually seems cheaper than the VDSL2 scenario 1 for initial take rates lower than approximately 45%. After that, the usual ranking reappears. This phenomenon can be explained by few customers spread far apart, resulting in the need for many under-utilized DSLAMs under scenario 1. The large percentage of open fields also makes the usual costs of digging less painful then in other areas.

9.2.6 Spongdal

Spongdal is also a small rural area. It is located about 15 kilometers south west of Trondheim. Unlike Kvammen, Spongdal does however have a very small town center. Here some houses are placed close together. In the rest of the area, houses are spread far apart. The area to be studied is totally dominated by single unit homes. These are currently being served by one HF. The digging surface is a mix of “open field” and “average surface”.

Number of households	290
Number of HFs in service today	1
Single unit home %	100%
1-storey apartment building	0%
Multi-storey apartment building	0 %
Surface (field-average-urban tarmac)	40% - 60% - 0%

Table 23: Key figures and demographics for Spongdal

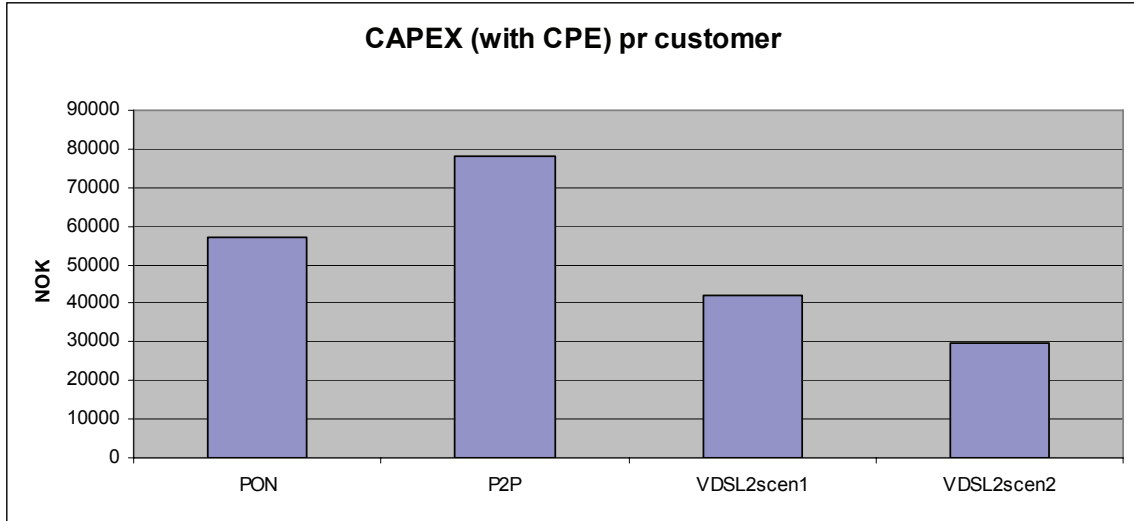

Figure 41: Cost per customer (initial CAPX divided by assumed initial number of customers)

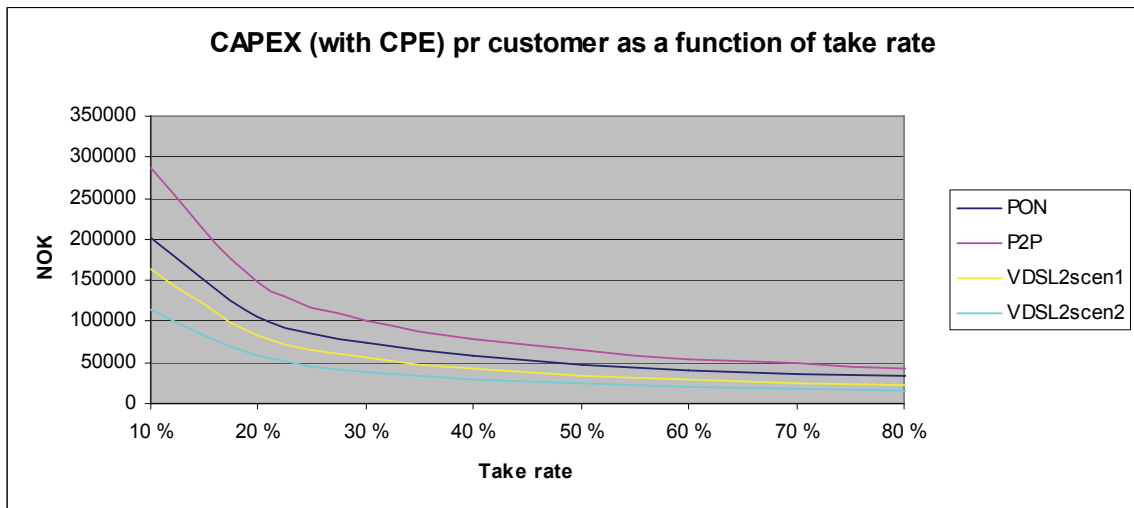

Figure 42: Cost per customer as a function of the assumed initial number of customers

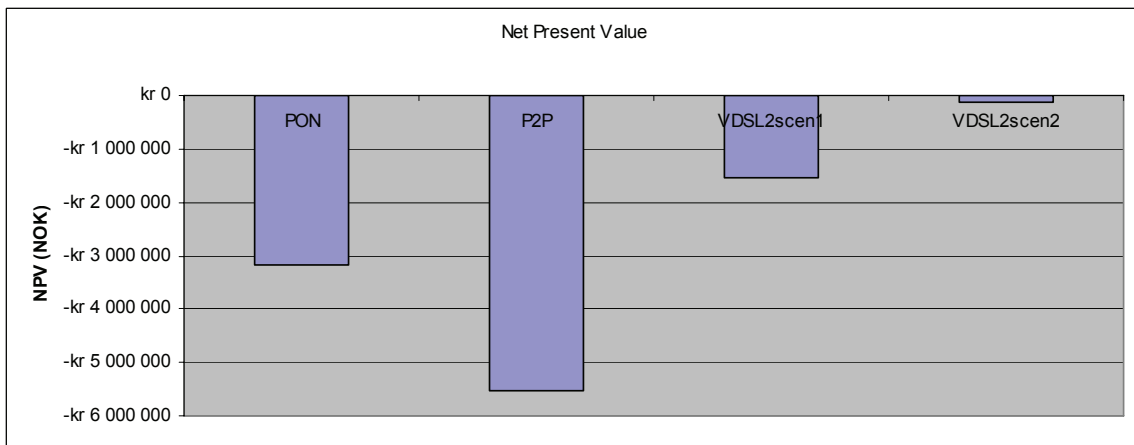

Figure 43: Net Present Value for the four different solutions

Comments

Providing high bit rate capacity to the people of Spngdal, would be very expensive using any of the solutions studied here. Even under VDSL2, scenario 2, the NPV is negative. These results are not surprising. Spngdal is far away from the chosen OLT locations. The population density is low and only single unit homes are present. In addition to all this, Spngdal is further hurt by the lack of available fibers or ducts near by. There is currently 6 fiber pairs running from the area towards Trondheim. These are however all being used. This results in the need for constructing a whole new fiber path in order to accommodate our needs.

9.3 Technology results

The previous section presented results associated with each area. Further insight can be gained by comparing initial CAPEX figures for the same technology, but deployed at different locations.

9.3.1 PON

In order to better understand which cost factors dominate, initial CAPEX figures are split into categories. Figure 44 shows this. Figure 45 shows the percentage distribution among categories. Three categories are explained below while the others are considered self explaining.

CPE: This includes both the price of the actual ONT box as well as well as installation of it. In practice, installation means having an installer come and terminate the fiber.

Fiber: This is fiber cable, either 192-fiber, or 12-fiber. The former type is used between OLT and drop points. The latter is used between drop points and ONT.

Civil work: This is digging and filling the ditch in witch the cable and ducts run.

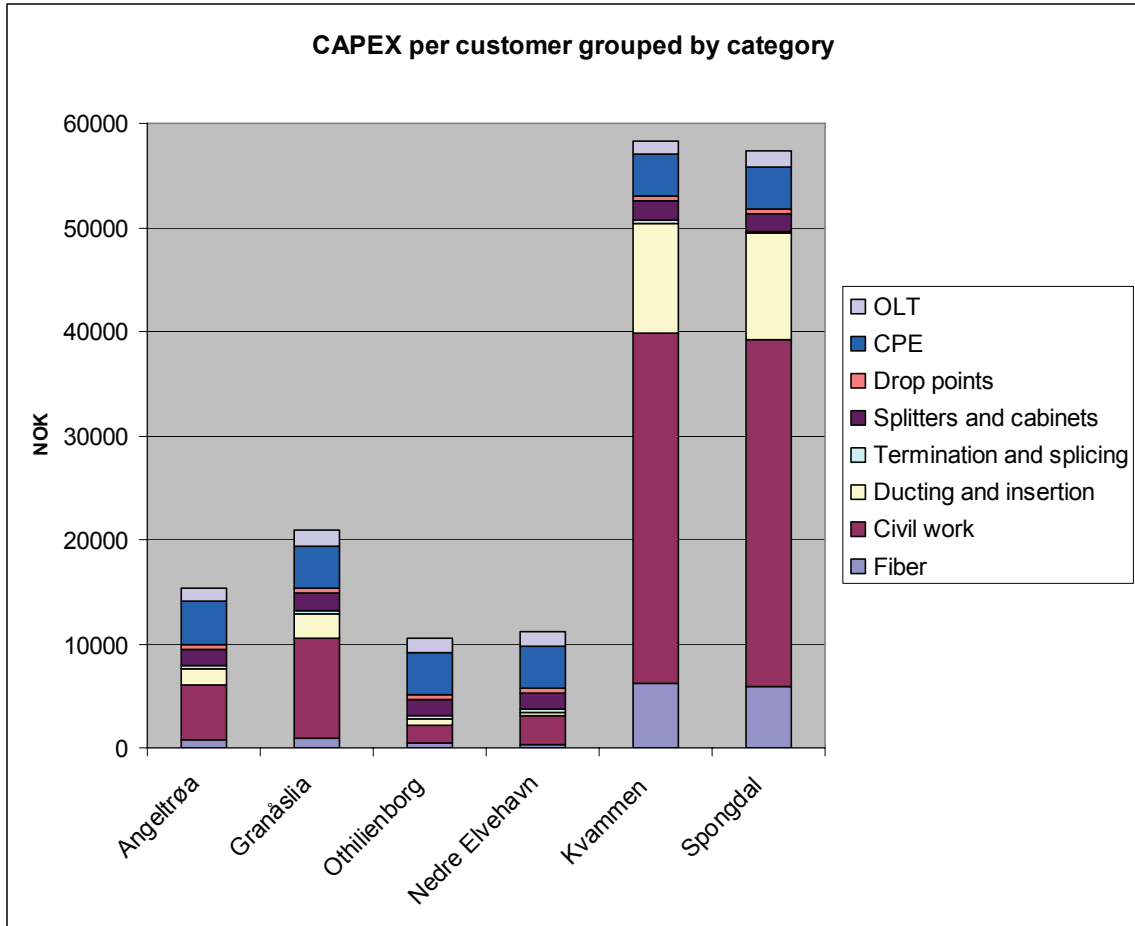

Figure 44: Initial CAPEX figures split into categories

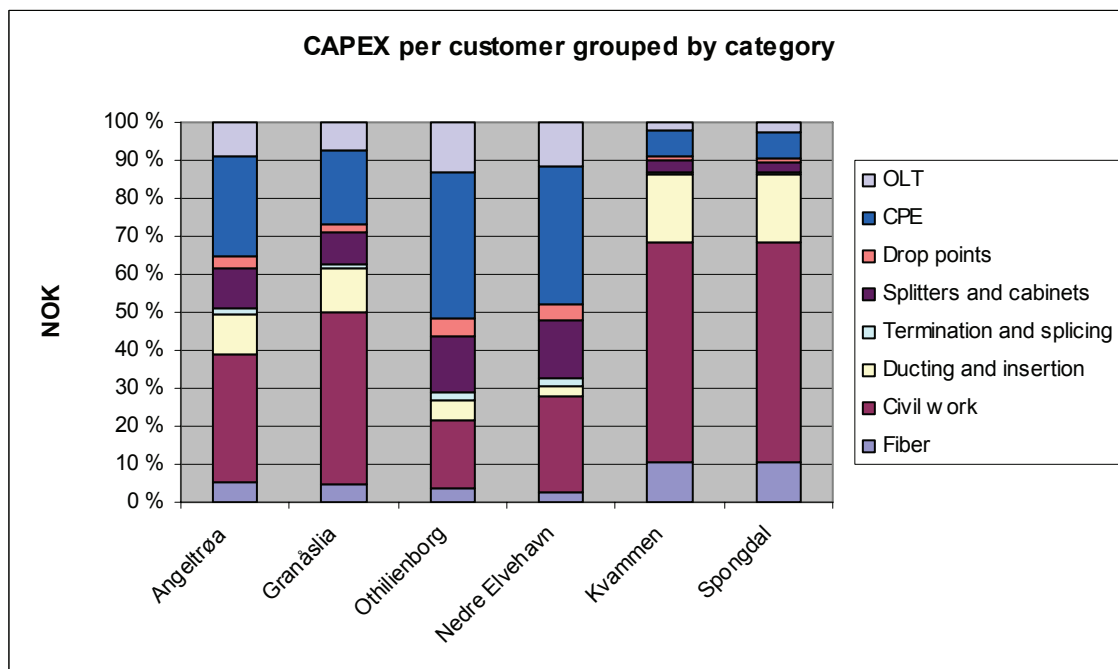

Figure 45: Distribution of CAPEX figures among categories

Comments

In advance, it was feared that civil work was going to be the main cost contributor. As Figure 44 reveals, this is only partly true. Even if ducting and insertion is added on to civil work, it only accounts for 20-30 % at Othilienborg and Nedre Elvehavn. In the more remote areas of Kvammen and Spongdal, the picture is different. Here civil work plus ducting and insertion accounts for more than 60% of all costs.

The cost of fiber is surprisingly low. This is interesting, taken into account that we are using overly “large” fibers. Many places 192-fiber could have been replaced by “smaller” fibers. The model also assumes 12-fiber is used from drop point to house. This is major over-provisioning. Section 10.2 will further investigate the possibilities of reducing costs by using smaller and cheaper fiber cables.

The cost of CPE, which includes installation, is surprisingly large. The ONT price of 1.550 NOK per customer plus the 2.500 NOK in installation, hits hard. Costs related to termination and splicing can almost be neglected.

Costs can also be grouped by the location where they occur. This is seen in Figure 47. Figure 48 shows the percentage distribution among locations. The grouping is explained by Figure 46. The costs associated with each link will also contain any splicing or termination needed. The ONT/CPE is exempt from the rule above. Here, ONT installation is included. This is in practice fiber termination.

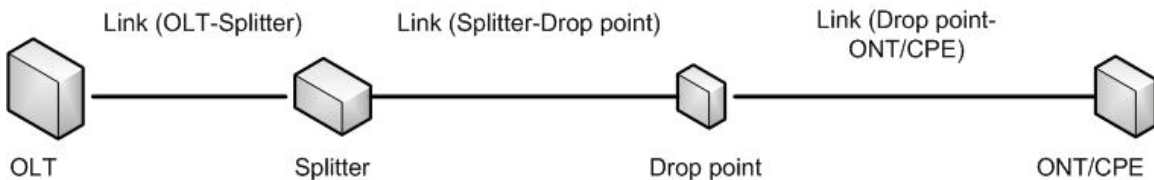

Figure 46: Illustrating how initial CAPEX figures can be grouped according to location

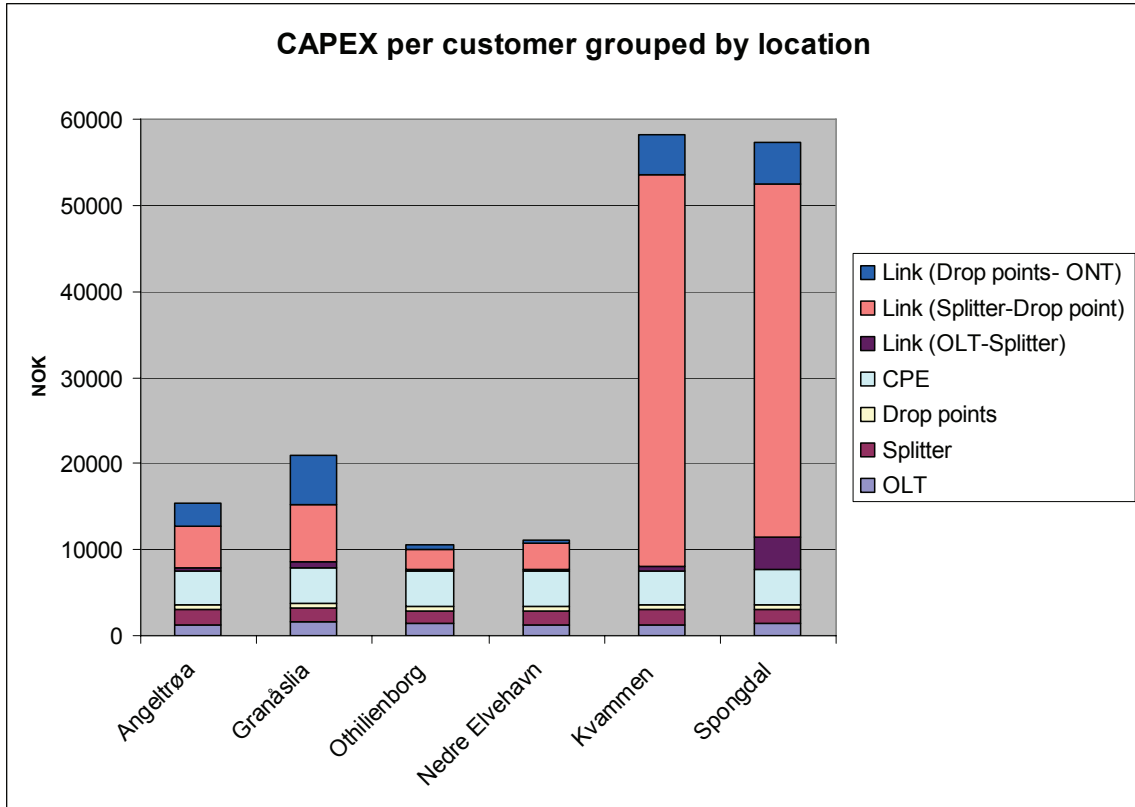

Figure 47: Initial CAPEX figures grouped according to where in the network they occur

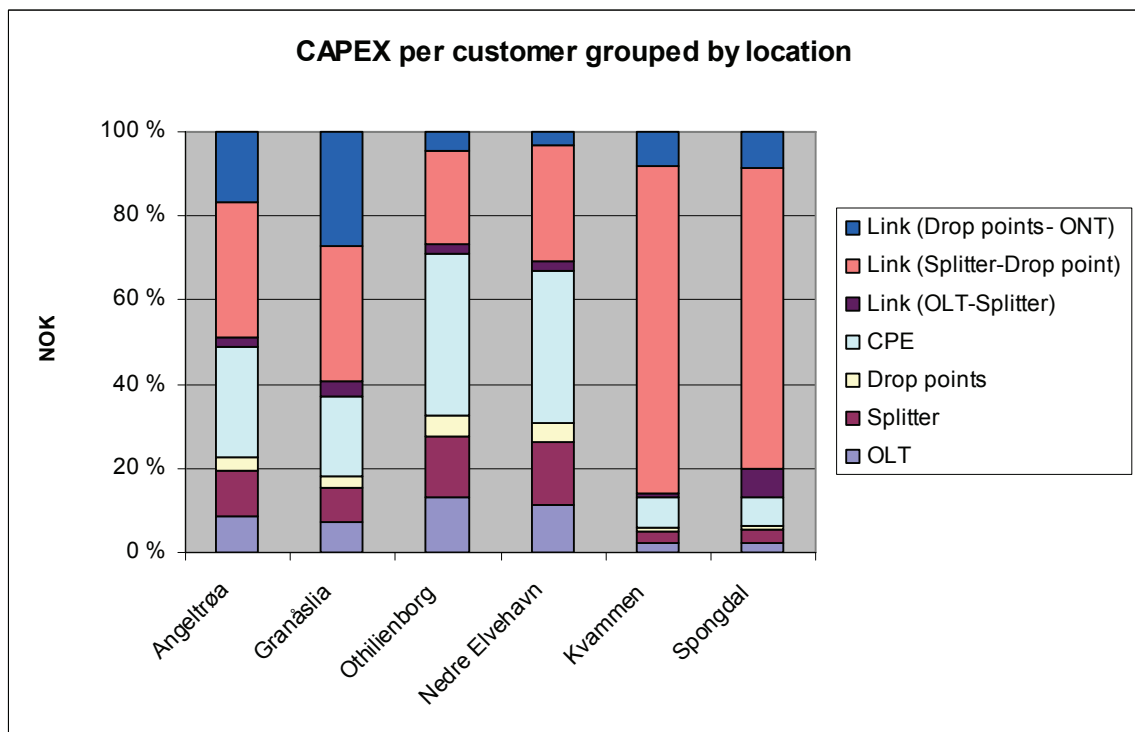

Figure 48: Distribution of CAPEX figures among locations

Comments

Figure 47 and Figure 48 provides interesting results. Othilienborg and Nedre Elvehavn are the two areas with the highest population density. Here, multi-storey apartment buildings are in almost total dominance. In both of these areas, the CPE cost is the largest cost contributor. In the rural areas, the link between splitters and drop points is the most expensive. The link between OLT and splitter is surprisingly “cheap”. This is even true for the rural areas of Kvammen and Spondal. These are also the two areas where the distance between OLT and splitter is the largest.

9.3.2 P2P

As for PONs, the initial CAPEX figures can be split into categories. This is seen in Figure 49. Figure 50 shows the percentage distribution among categories.

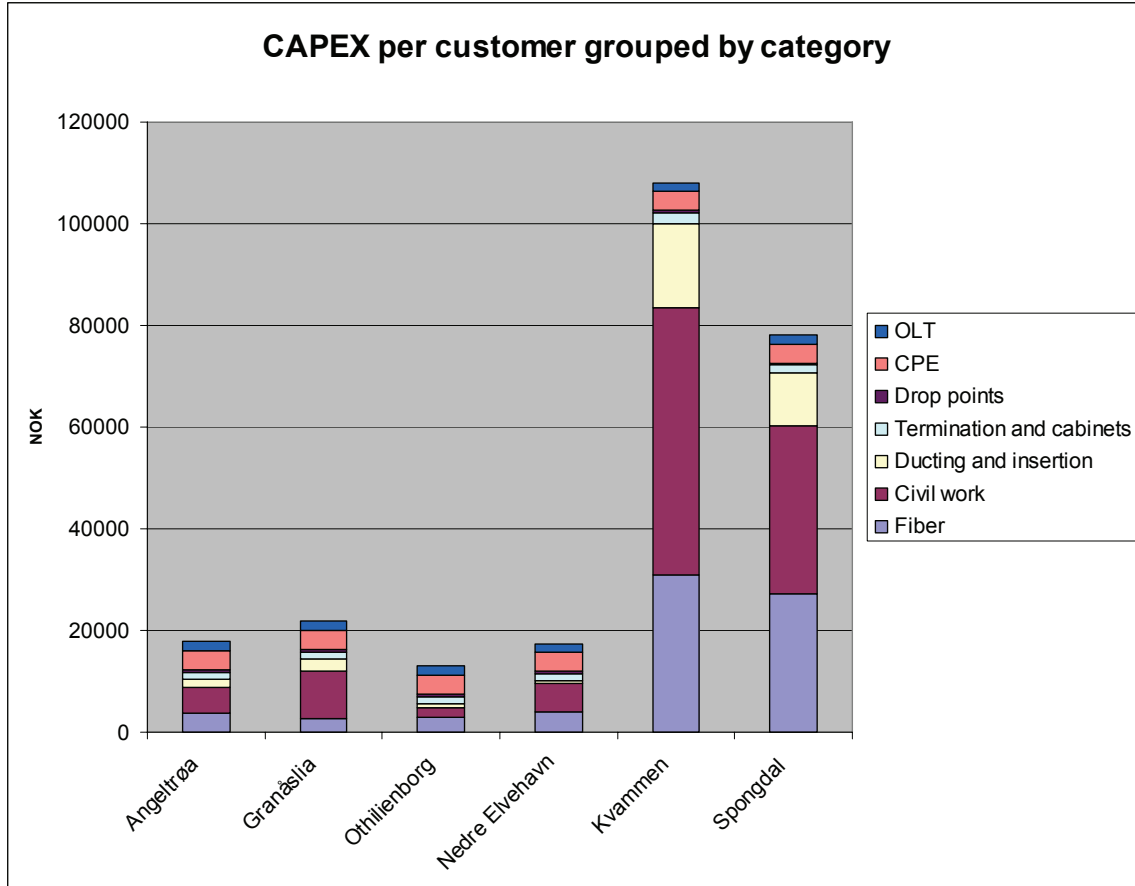

Figure 49: Initial CAPEX figures split into categories

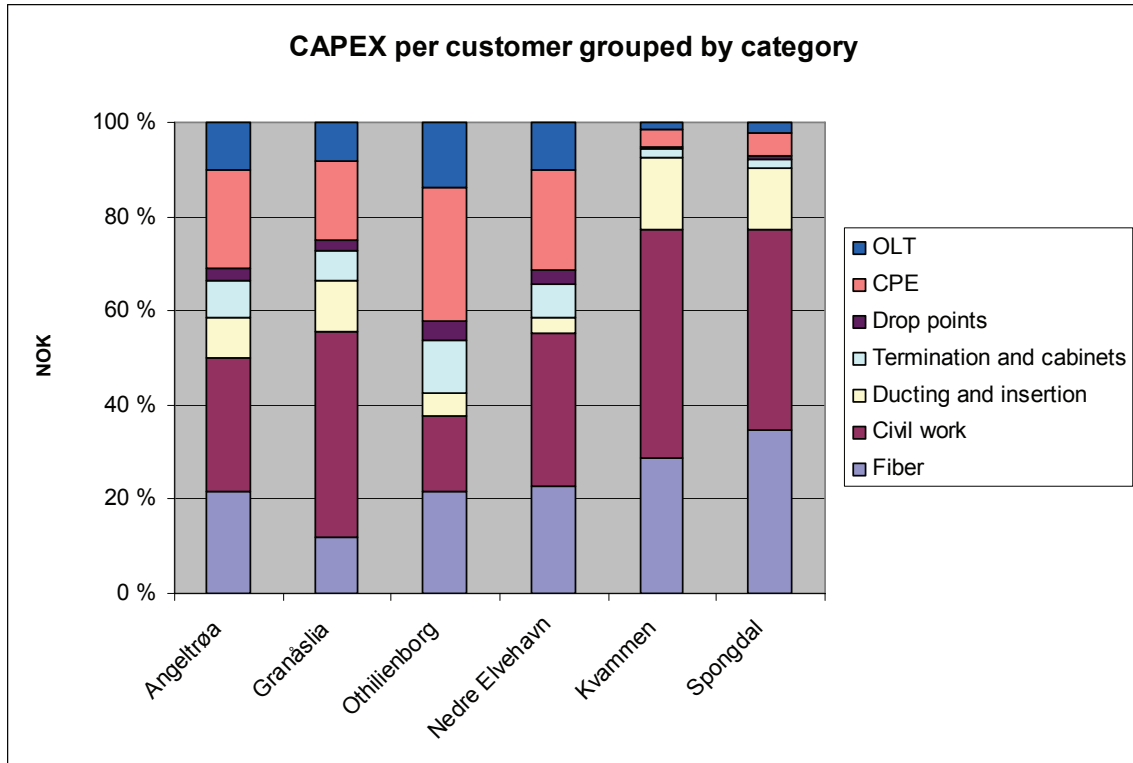

Figure 50: Distribution of CAPEX figures among categories

Comments

From Figure 49 one can see that the cost of fiber is larger for P2P than for PON. This come as no surprise since a P2P solution requires a separate pair of fiber for each user. With the need for more fiber, comes also the need for more fiber terminations. Compared to a PON solution we see that with P2P, termination accounts for a larger cost percentage. As for PONs, the costs of CPE and civil work are again large.

Costs can also be grouped by the location where they occur. This is seen in Figure 52. Figure 53 shows the percentage distribution among locations. The grouping is explained by Figure 51. The costs associated with each link will also contain any splicing or termination needed. The ONT/CPE is exempt from the rule above. Here, ONT installation is included. This is in practice fiber termination.

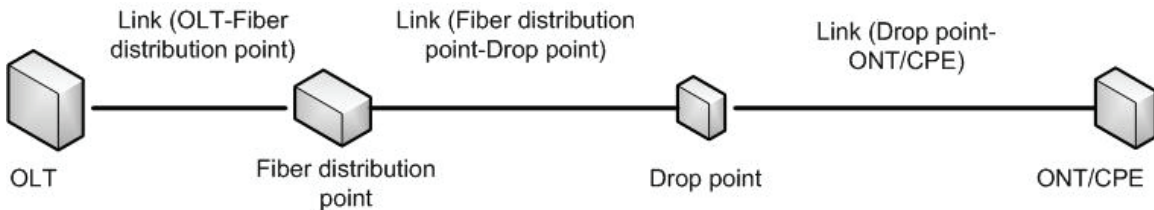

Figure 51: Illustrating how initial CAPEX figures can be grouped according to location

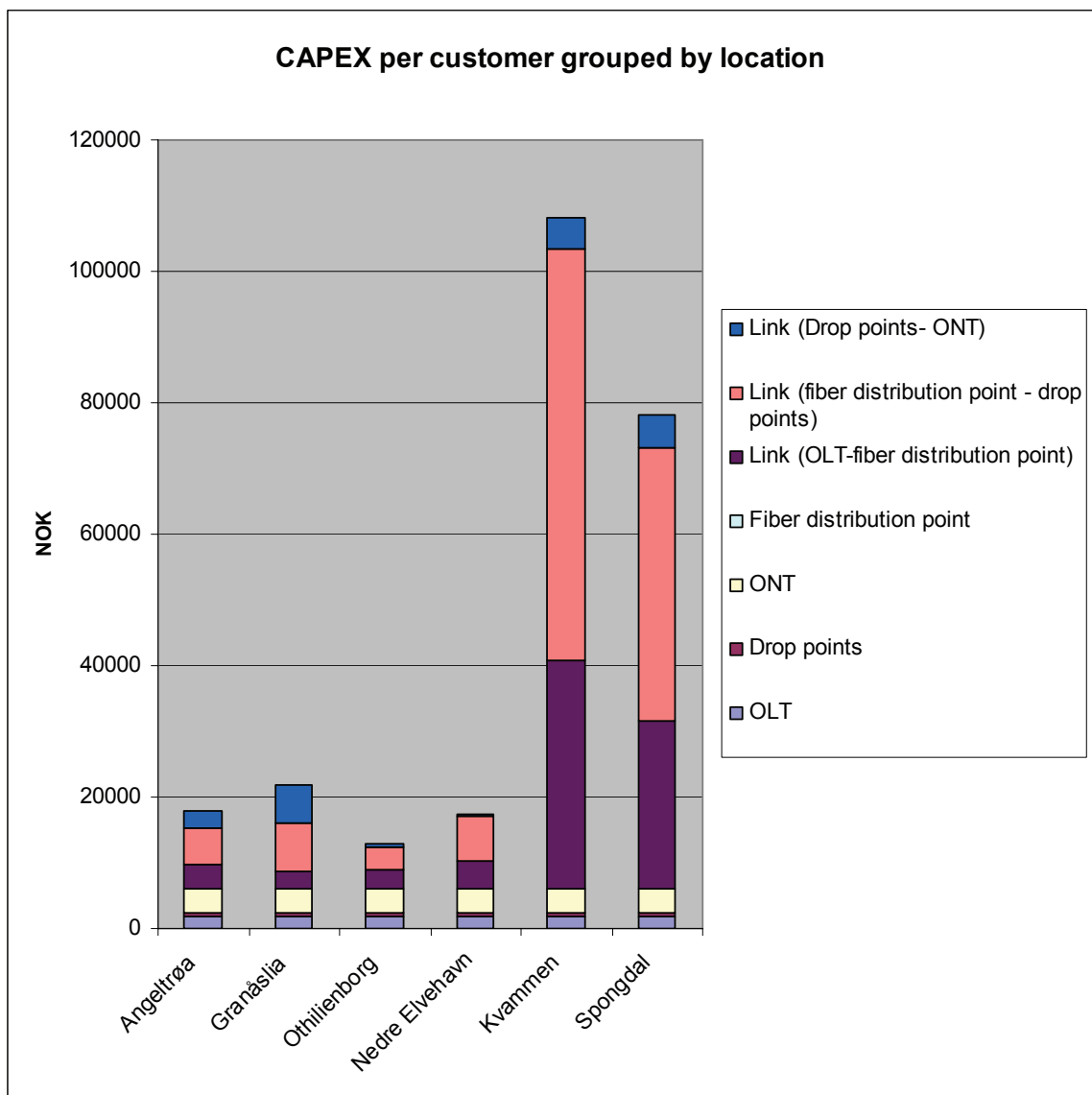

Figure 52: Initial CAPEX figures grouped according to where in the network they occur

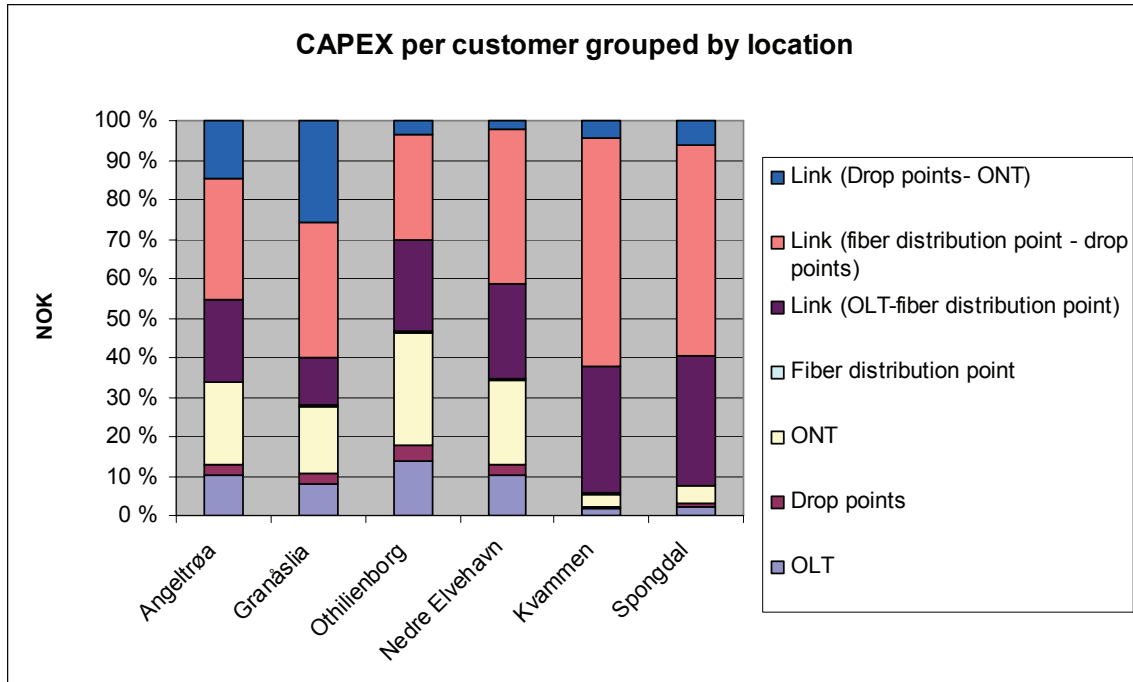

Figure 53: Distribution of CAPEX figures among locations

Comments

Many interesting observations can be drawn from Figure 52 and Figure 53. It can be seen that the link cost between OLT and fiber distribution point is now a significant factor. This is especially true in the case where OLT and fiber distribution point are far apart. This is in contrast to what was seen for PONs. There the distance between OLT and splitter had little impact.

Regarding the link between fiber distribution point and drop point, Nedre Elvehavn, Kvammen and Spondal seem to be especially expensive. Why is this? The important factor is the availability of ducts. In the areas mentioned, there are little or no ducts available. This results in costly constructions of new ducted fiber paths.

The relative high percentage cost of the link between drop points and ONTs in Granåslia is a direct result of housing type. Granåslia has only single unit homes. These allow for no cost sharing of digging expenses from drop point to building.

9.3.3 VDSL2

As for PONs and P2P, the initial CAPEX figures can be split into categories. This is seen in Figure 54. Figure 55 shows the percentage distribution among categories.

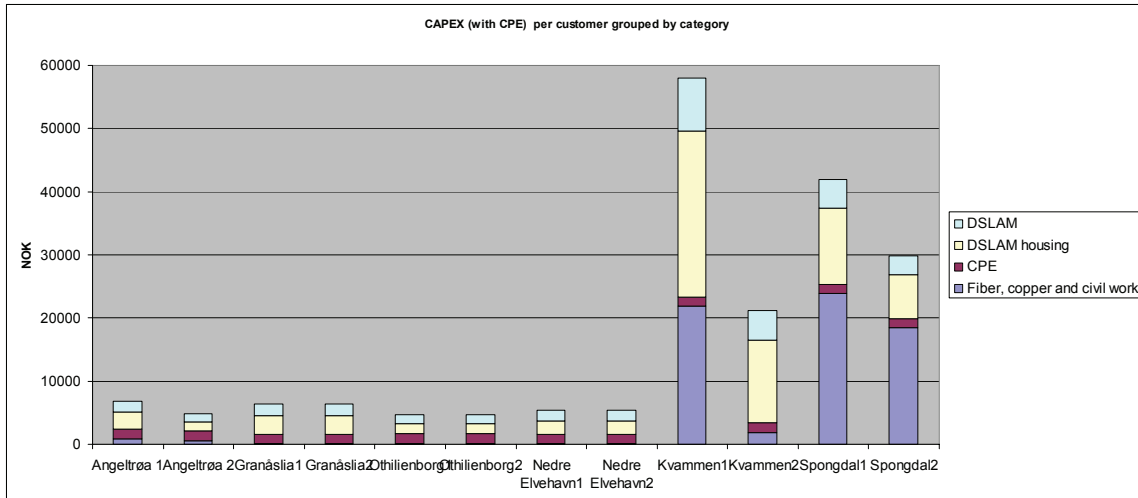

Figure 54: Initial CAPEX figures split into categories

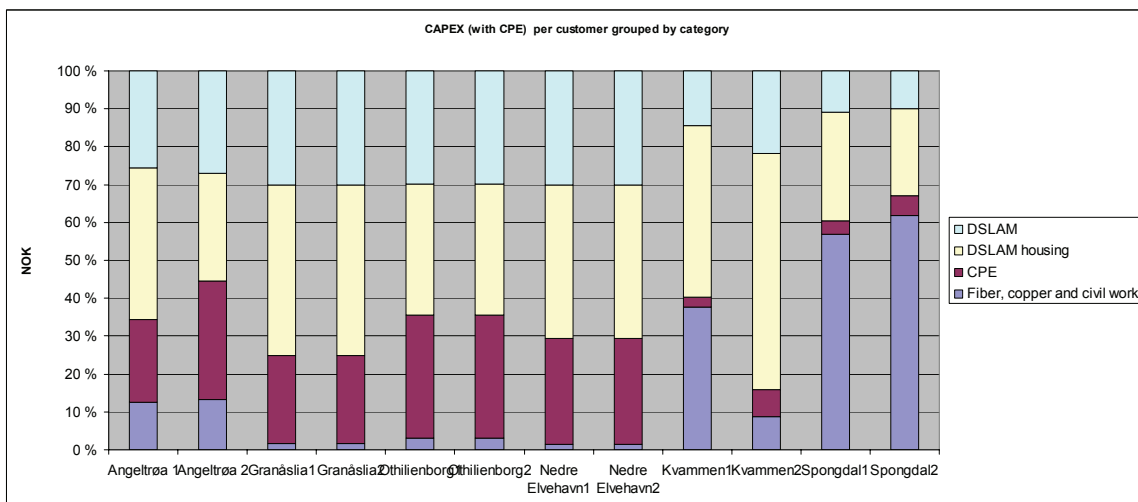

Figure 55: Distribution of CAPEX figures among categories

In the case of VDSL2, it does not make sense to group costs according to location. Instead it is interesting to compare scenario 1 to scenario 2. This can be seen in Figure 56.

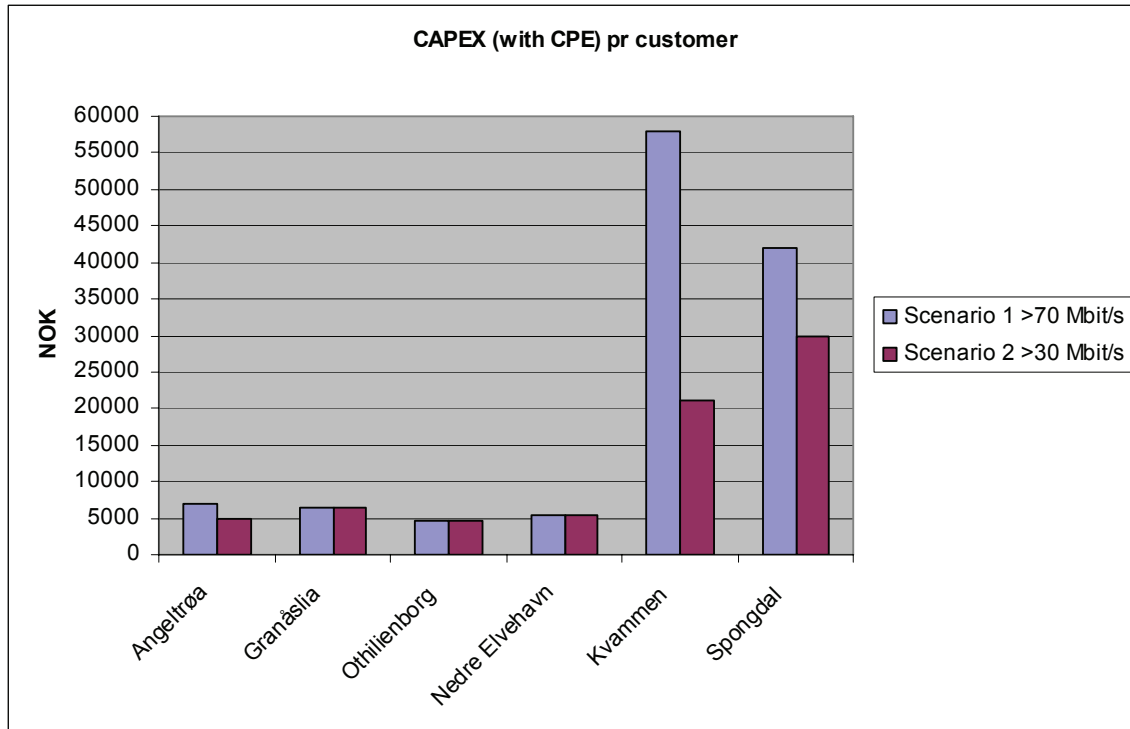

Figure 56: Cost per customer, scenario 1 vs. scenario 2

Comments

As seen previously, there is no difference in scenario 1 and 2 for Granåslia, Othilienborg and Nedre Elvehavn. Figure 54 shows that cost of fiber, copper or digging in these areas are very small. This indicates that existing fiber has been used, which is true. In all areas the cost of DSLAM housing contributes heavily. This includes both the actual housing with necessary equipment and the installation of this. If this number could be reduced, it would have a large impact. Fiber, copper and civil work is the dominant factor in the two rural areas, Kvammen and Spongdal. The spread sheet reveals further that civil work is the dominant factor. This is not surprising as most DSLAMs in these areas are placed far from existing available fiber.

Figure 56 shows the cost per customer for scenario 1 and 2. The impact of reducing the required bit rate from 70 to 30 Mbit/s is significant in those areas where more than 1 DSLAM were required in scenario 1. Kvammen is the area where the cost is reduced the most. Under scenario 1, this area required 6 small DSLAMs. Under scenario 2, the same customers were covered by 3 small DSLAMs.

9.4 Green-field results

Angeltrøa was chosen as the area to be temporarily converted into a green-field. According to the assumptions and modifications described in section 8.4, CAPEX costs were re-calculated. These are presented in Figure 57.

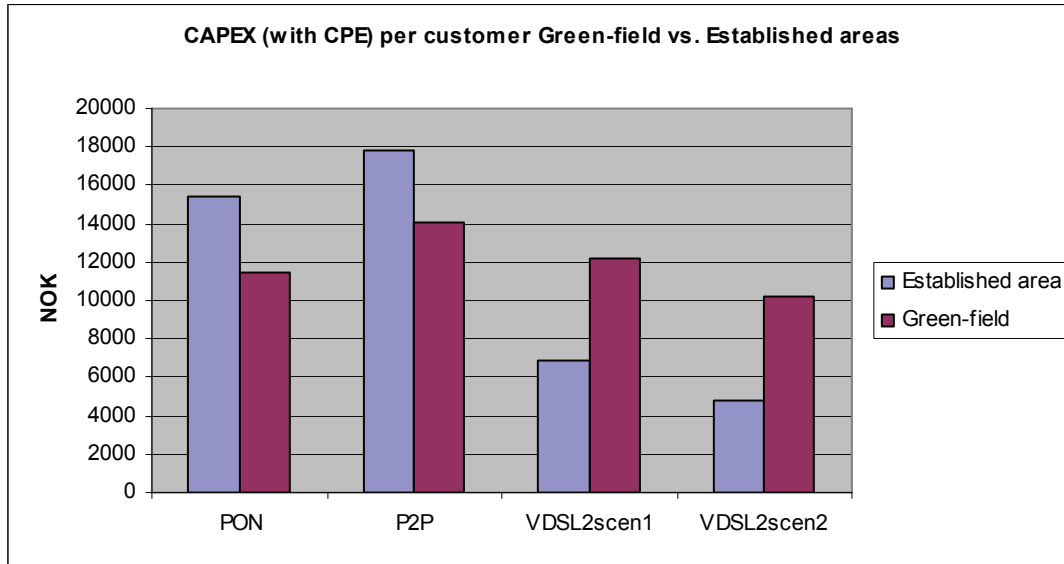

Figure 57: Differences between CAPEX per customer in an established area vs. an area under construction

Comments

Figure 57 shows that the differences between fiber and copper solutions are much smaller in a green-field scenario. This is explained by the reduction in digging costs for fiber and the added cost of copper for VDSL2. VDSL2 scenario 2 is still the cheapest, but if excluded, a PON solution actually becomes the cheapest option. A P2P solution is still the most expensive, but only by about 2.000 NOK.

10 Sensitivity analysis and risk assessment

The previous chapter provided the expected results as if there was no uncertainty or risk associated with deployment. The goal of this chapter is to identify risk. Different risk factors are grouped according to their source of origin. Implications are given for each category. In addition to this, the author has given an assessment of how likely it is for each factor to occur. Where considered appropriate, the significance of key parameters is also checked through a sensitivity analysis. This is done by expressing the end result as a function of the parameter in question. Sensitivity is not shown for all areas here, but is available through the spread sheets.

10.1 Financial risk

Equipment costs

Risk: There is always uncertainty associated with equipment prices. Prices may vary and supplies are not guaranteed. Prices are also subject to change. As explained earlier, this thesis has not made a big point out of predicting future equipment prices.

Implications: If equipment prices are underestimated, CAPEX figures will become higher. This will again make the up-front payments higher. As was reviled in chapter 9, CPE equipment accounts for a large portion of total CAPEX. This was especially true in the case of VDSL2. Figure 58 show how the initial cost per customer in Angeltrøa will depend on modem prices. All other parameters are as before.

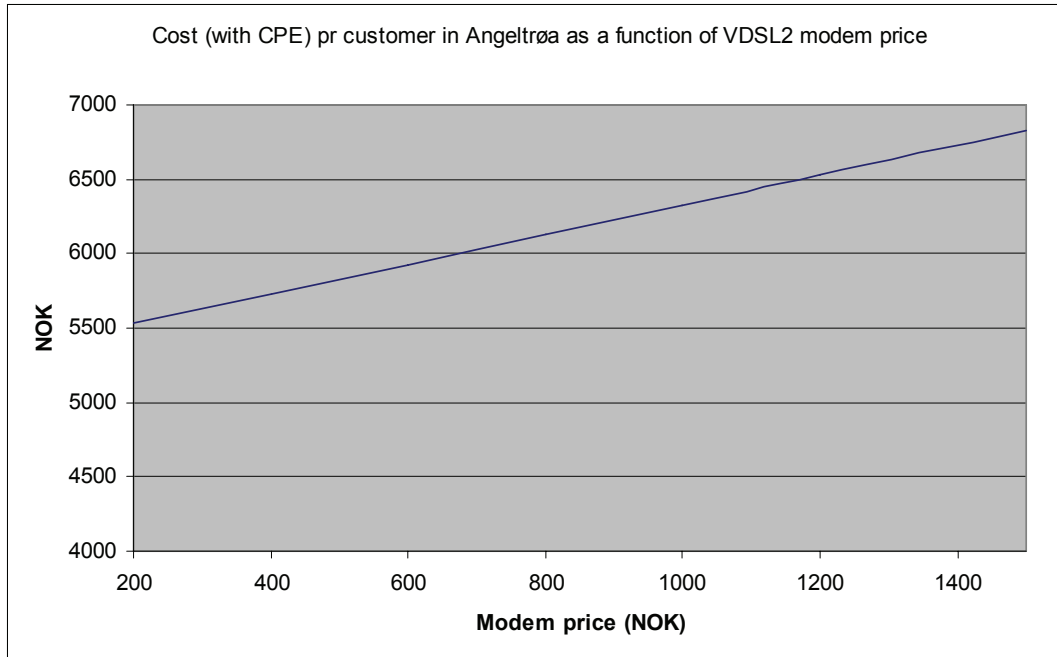

Figure 58: CAPEX per customer for VDSL2 scenario 1 as a function of modem prices

Likelihood: The likelihood of underestimating equipment prices are considered low. Considerable work has been put into finding these prices. There is also a significant chance of prices actually being lower than what is predicted here.

Fiber and digging needs

Risk: Chapter 8 presented several assumptions on how the need for fiber and digging where to be approximated. There is a risk that these assumptions underestimate the real needs. The cost of fiber and digging also depend strongly on digging surface and the mix of apartment buildings versus single unit houses. These parameters are chosen based on personal observations.

Implications: If the need for fiber and digging is greater than what has been approximated, CAPEX figures can rise significantly.

Likelihood: The likelihood of miscalculating the needs for fiber and digging is present, but considered low. After all, the assumptions used are deliberately set conservative.

Digging costs

Risk: Once the digging lengths are found, digging costs have to be calculated. This is done through surface classification. For each surface type a fixed digging price per meter is used. Miscalculating digging costs is a big risk factor. The approach used here his crude, but simple. In reality, digging prices may deviate, and the concept of surface categories does not exist.

Implications: If the digging cost per meter is higher than expected, CAPEX figures will rise. This will result in a higher cost per customer. A few examples of the sensitivity to this parameter are given below.

Both Angeltrøa and Granåslia are classified to contain 70% of “average surface”. The expected price per meter for this kind of surface is 200 NOK. Figure 59 shows how the price per customer changes depending on this figure. This is shown both for a PON and a P2P solution. As can be seen, the implications are large.

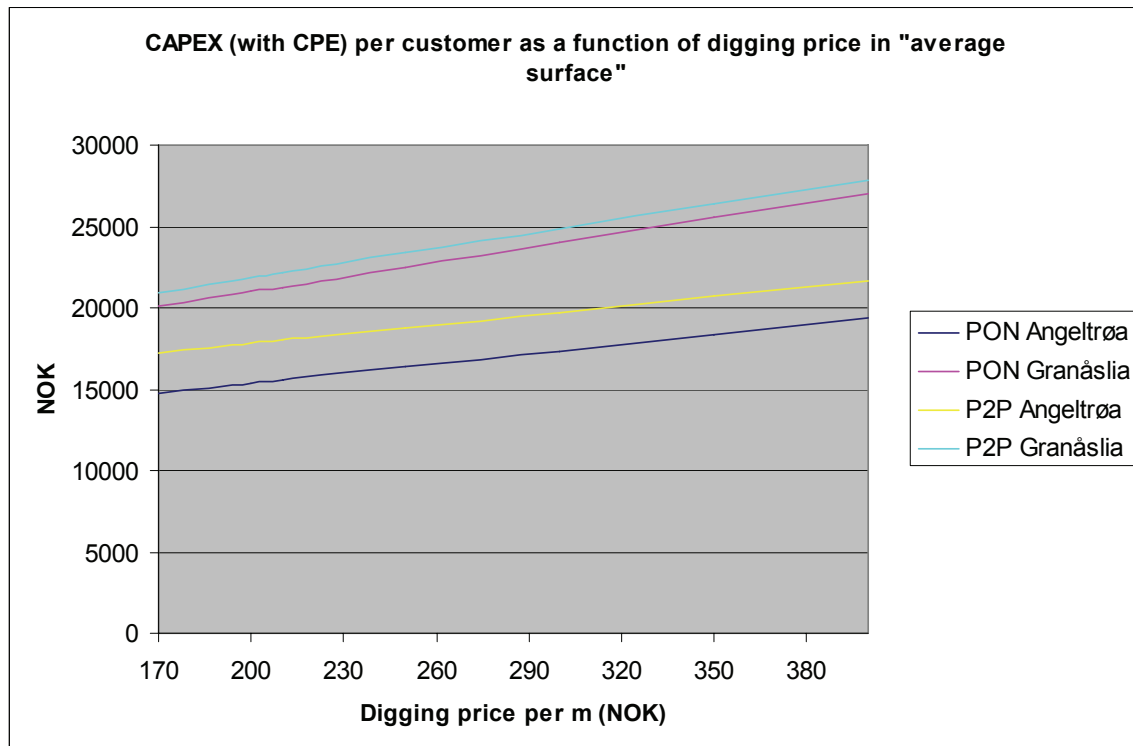

Figure 59: The importance of digging price per meter

Nedre Elvehavn contains only the surface type “urban tarmac”. The expected price per meter for this kind of surface is 500 NOK. Figure 60 shows how the price per customer changes, depending on this figure. This is shown both for a PON and a P2P solution. Figure 60 shows that the cost per customer can increase by several thousands if digging costs are miscalculated by 100 NOK per meter.

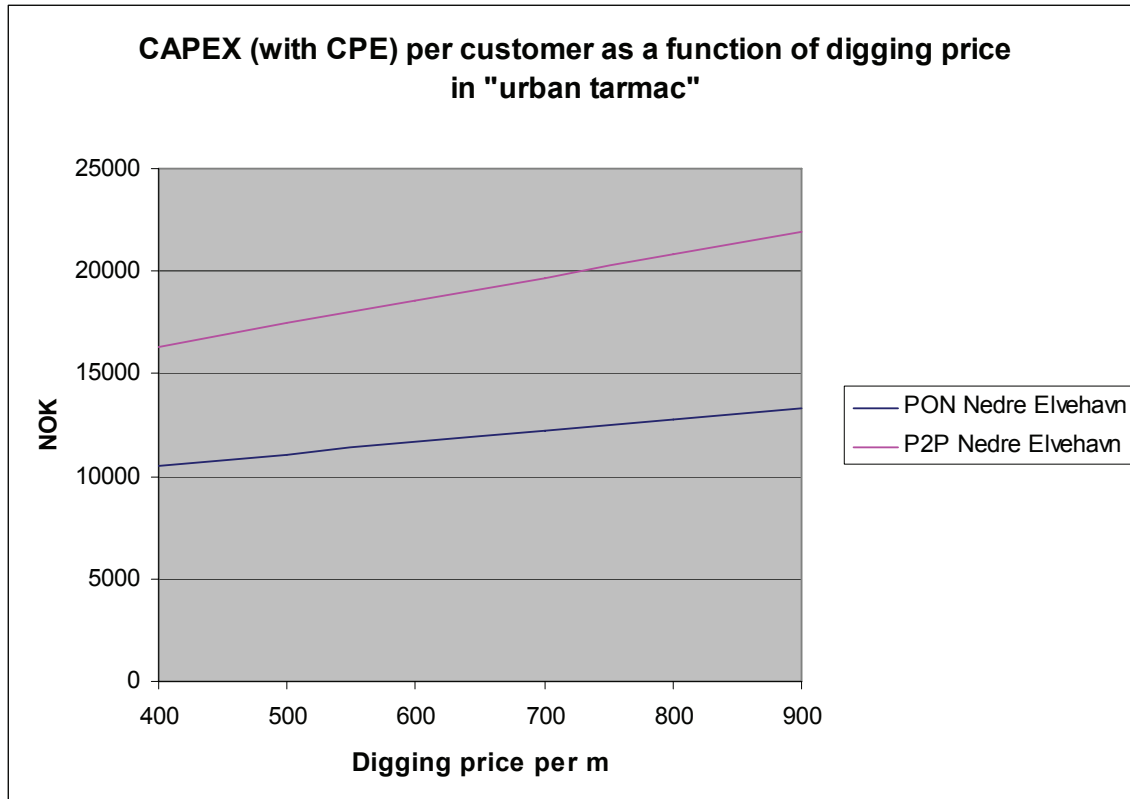

Figure 60: The importance of digging price per meter

Likelihood: Based on industry experience the likelihood of miscalculating digging costs are medium to high.

OPEX figures

Risk: OPEX figures may be higher than expected. Since a VDSL2 solution would be similar to today's ADSL solution, these figures are less prone to uncertainty. The OPEX figures for PONs and P2P are however only best-guess estimates. They are based on fiber deployments outside Norway.

Implications: Higher OPEX figures will require more man-hours in operations, administration and repair. This will ultimately reduce future cash flows which again will reduce the net present value (NPV). Othilienborg is used to illustrate the NPV's sensitivity to OPEX changes. This is shown in Figure 61. The flat lines represent the expected NPV. As can be seen, the NPV of a P2P system could outperform PONs if OPEX figures were significantly lower than expected for P2P and all other parameters remained unchanged.

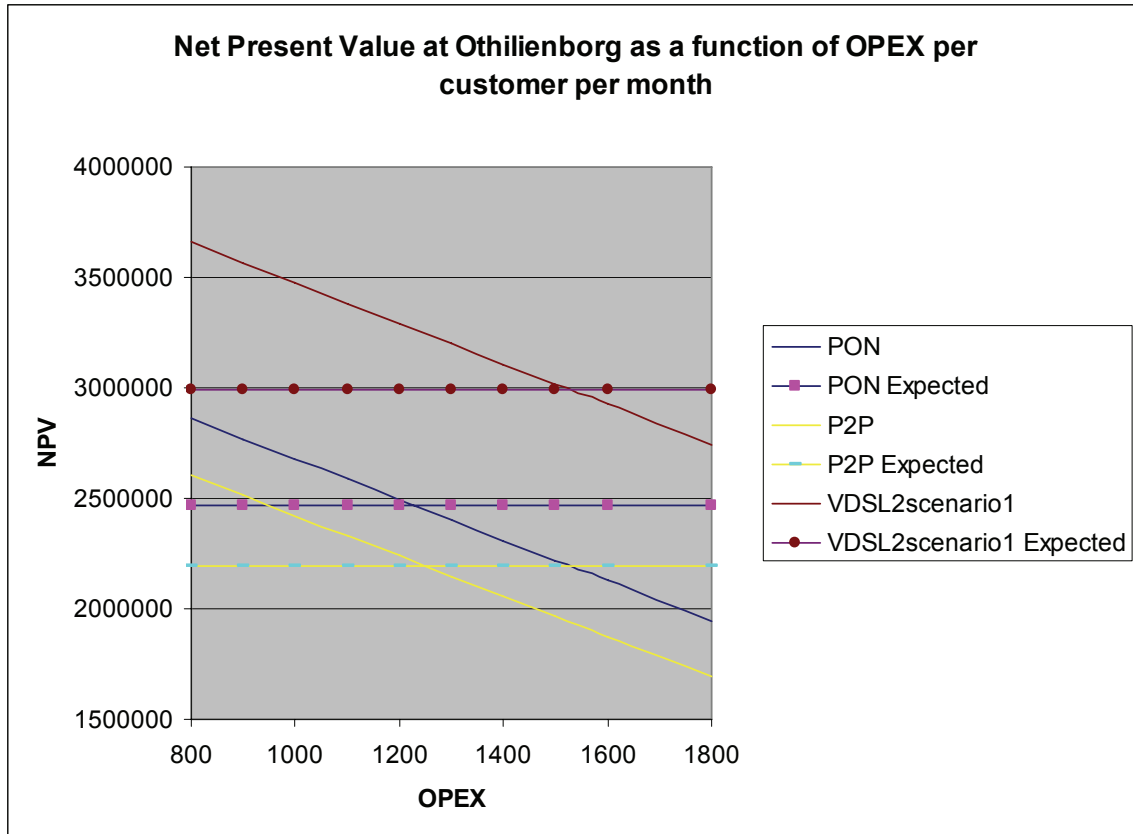

Figure 61: Sensitivity analysis regarding OPEX figures

Likelihood: As said above, the likelihood of higher OPEX figures are considered low for VDSL2 due to long experience with ADSL. For PONs and P2P, the likelihood is set to medium. Even though Telenor has no prior experience with these solutions, fiber is known for its high reliability and low maintenance costs.

Revenues

Risk: Revenues may be lower than expected. This can happen in two ways. If the take rates are lower than expected, revenues will obviously fall. Revenues may also fall if competition forces Telenor to reduce the monthly fee charged.

Implications: Revenues that are lower than expected will reduce future cash flows and hence obviously reduce the NPV of the whole project. The term average revenue per user (ARPU) is often used about the monthly from each customer. Figure 62 illustrates the NPV's sensitivity to ARPU for Granåsli. The flat lines represent the expected NPV for each solution. Since originally having a higher NPV, a VDSL2 solution could handle lower ARPU, but still display a positive NPV.

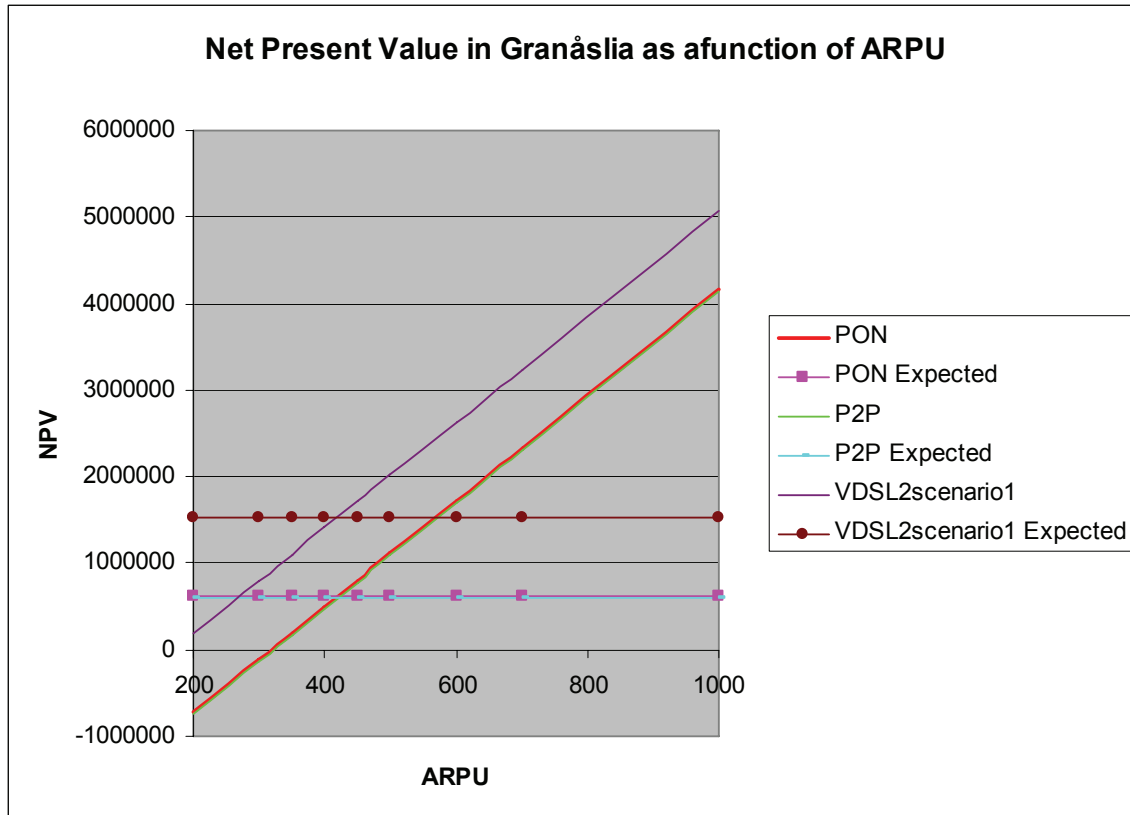

Figure 62: Sensitivity analysis regarding revenues

Likelihood: All in all, the likelihood of reduced revenues is assumed medium. Prices will likely have to be reduced, but hopefully this can be compensated by higher take rates.

Cost of capital

Risk: The cost of capital parameter should reflect all risk and uncertainty associated with the expected cash flows. The risk of using the wrong cost of capital parameter is always present.

Implications: The implication of using the wrong cost of capital parameter will be a wrong net present value (NPV). Figure 63 shows how the net present value of the different solutions deployed at Kvammen. All solutions have high initial investment costs and high revenues thereafter. As seen from the graph, a higher cost of capital reduces the impact of future revenues. This lowers the NPV for all solutions. With the expected cost of capital of 12 % it is only VDSL2 scenario2 that shows a positive NPV. In terms of withstanding a higher cost of capital, this solution still displays a positive NPV at 20 % cost of capital. Similar graphs are found for all solutions for all areas.

Likelihood: There is no exact answer to what the cost of capital should be. It must be up to each investor to decide on this parameter.

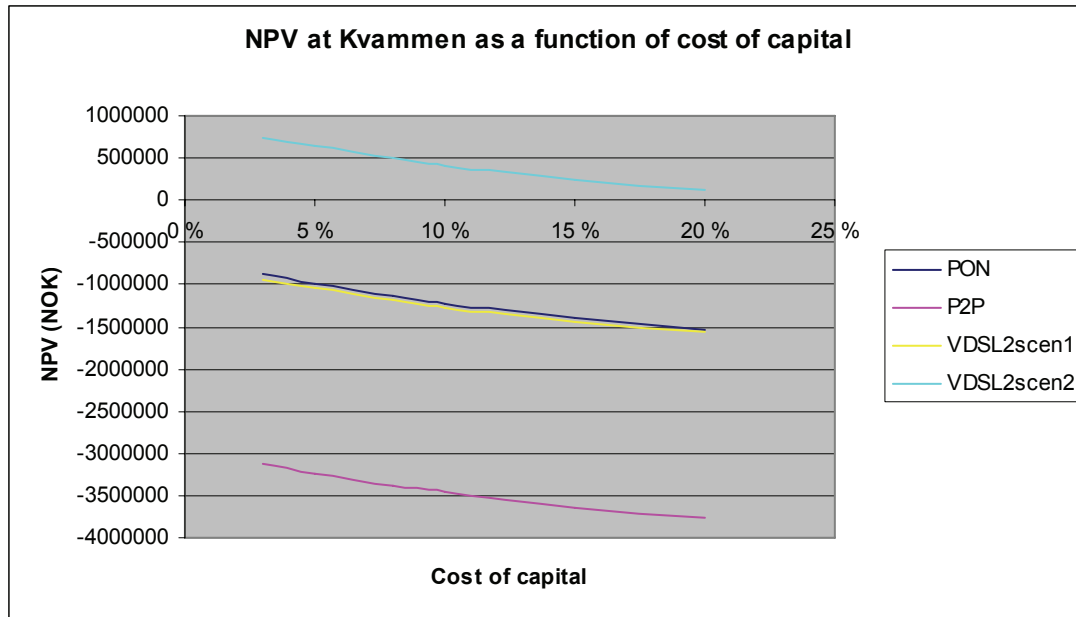

Figure 63: The NPV for different solutions at Kvammen as a function of cost of capital

10.2 Technological risk

Transition

Risk: Chances are that problems will occur when new equipment is to replace old equipment. In the case of VDSL2, some problems are already mentioned in section 8.1.4. Today DSLAMs are co-located with the CO. If VDSL2 is to be deployed, DSLAMs will need to be placed closer to the end customer. Making this transition go smooth will be essential. For fiber based solutions (PON, P2P), one can not really talk about a transition. This would be a brand new network deployed in parallel to the old copper access network.

Implications: Problems occurring during transition are likely to cause higher OPEX figures. This again will reduce the NPV and prolong the payback period. A delayed deployment could also cause a loss of market share as new competitors may enter.

Likelihood: For fiber based solutions the transition risk is considered low, since no real transition takes place. It is merely a deployment of a parallel access network. For VDSL2, the risk of transition problems is considered high. This does however not mean they can't be solved.

Equipment faults

Risk: Since the technologies analyzed are relative new, there is also a chance that equipment will be error prone and require high maintenance. This could either be on centralized equipment or on customer equipment.

Implications: The immediate effect of faulty equipment is the loss of service. In the long run, faulty equipment will result in higher OPEX costs. This is due to higher maintenance and more customer support. A side effect could also be a reduction in the speed at which the take rate increases. In the worst case it could even cause take rates to decrease.

Likelihood: The likelihood of faulty equipment is considered low. Such equipment is well tested and Telenor will not be the first ones to use it.

Bandwidth delivered

Risk: One can also imagine a scenario, where the bandwidth available is much less than originally thought. This is most likely in case of VDSL2, where too long lines or bad line quality, may strongly reduce the bandwidth.

Implications: If the available bandwidth is too low to offer the services promised revenues will be strongly reduced. This would also have a very negative effect on customer relations.

Likelihood: For fiber based solutions the risk of not being able to provide enough bandwidth is very low. For VDSL2 the likelihood is considered medium since line quality is subject to decline.

Bandwidth demand

Risk: What if the demand for access network capacity stagnates at a level where VDSL2 is sufficient? This would remove the primary motivation for deploying fiber based solutions.

Implications: This would result in a tighter competition. If there is no need for the bit rates available through fiber, having such a network will not give the owner a competitive advantage. If it is assumed that competitors will be pushed away as soon as demand grows beyond xDSL levels and this does not happen, profitability is in jeopardy.

Likelihood: The likelihood of this scenario is set to medium. Nielsen's law presented in chapter 4 proved to give descent "out of sample" estimates. In addition to this, there is also a kind of feedback mechanism involved. If a high speed access network was present, this fact alone could result in the development of new services requiring very high bit rates.

Single point of failure

Risk: In the case of fiber based solutions, the OLT location may easily become a very vulnerable spot. It is a "single point of failure" and all customers connected will be affected by a system failure. In terms of cost efficiency it is however desirable to have as many customers as possible associated with each OLT location. This calls for a trade-off

between cost and reliability. It has however not been the aim of this thesis to address such tradeoffs.

Implications: The implications of OLT failures could be anything from a few lines temporarily being down or all lines being down. The direct effect would be higher OPEX figures. Indirect, anything is possible.

Likelihood: The likelihood of OLT failures is very low on a day-to-day basis. OLT equipment is well tested and the mean time between failures is high.

The use of “large” fiber

Although not a risk factor it is interesting to see how the decision to use overly “large” fibers affects investment costs. In all results presented so far, 192-fiber is used everywhere, except for the last drop. 12-fiber is used here. This may seem strange both for PONs and P2P solutions.

Only one fiber is needed for each PON between splitter and OLT. In the last drop, only one fiber is needed for every customer. In a P2P solution, large fibers are often necessary between OLT and the fiber distribution point, but for the last drop, only 2 fibers are needed for each customer. The argument used in defense of using “large” fibers was to prepare for future needs.

Figure 64 shows CAPEX per customer for PON solutions if 48-fiber is used instead of 192-fiber, while hybrid cable replace 12-fiber in the last drop.

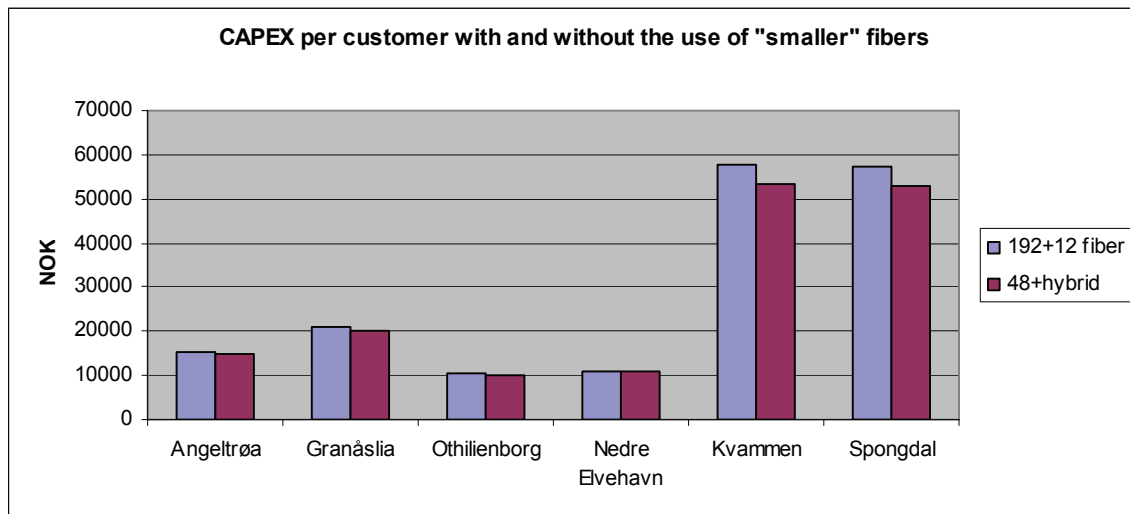

Figure 64: The difference between using "large and "small" fiber cables in PONs

Figure 65 shows CAPEX per customer for P2P solutions hybrid cable replace 12-fiber in the last drop.

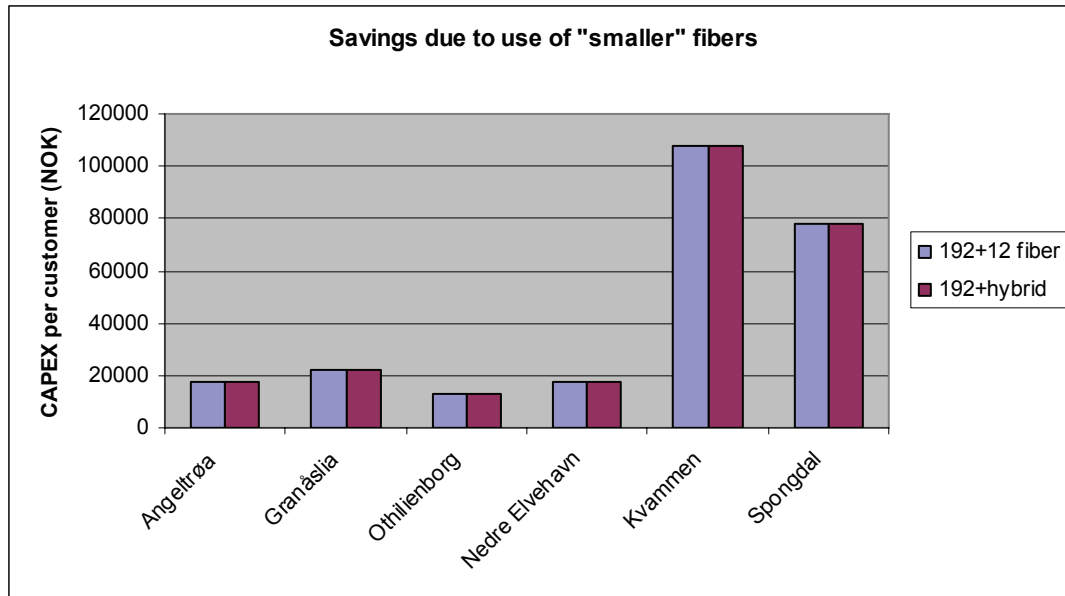

Figure 65: The difference between using "large and "small" fiber cables in P2P

As can be seen the differences are small. For PONs, the change makes some difference in the rural areas. Relative to the high costs in these areas, the difference is still small. In P2P systems, the replacement of 12-fiber is insignificant. These results are easily explained by the minor differences in cable prices, combined with the frequent use of existing available fibers in PON systems.

Drop points

Although not a risk factor, some comments are necessary regarding drop points. The drop points used in this thesis, both for PONs and P2P, are able to accommodate 4 users. Despite the fact that other drop point sizes are not known it becomes clear that this is also an important factor in calculating investment costs. If "bigger" drop points are used, the average distance between drop point and house must increase. This would again increase digging costs for the price of fewer drop points. The cost summaries presented in section 9.3.1 and 9.3.2, does however show that drop point costs are already low. It is hence little to save from reducing the number of drop points. On the other hand, there is a lot to lose on having to dig more. All in all it seems that smaller drop points are the most profitable.

10.3 Operational risk

Competition

Risk: Competition may be fierce. As explained in chapter 3, there are already multiple other service providers offering broadband access of some sort. As the demand for bandwidth increases among the average household, technology will become more important in the fight for customers. Those service providers limited by a copper based access network will often have a serious handicap compared to those offering fiber.

Cable-TV networks may also evolve to become superior to copper. Appendix C sheds more light on this.

Implications: The result of competition is a reduced market share. This will lower revenues, and reduce profitability.

Likelihood: In the near future, the likelihood of competition is assumed high. During this period, the demand for bandwidth is within what can be achieved by today's solutions. As the demand increases beyond this level, there will however be a need for a whole new access network. This will likely be based on fiber or a modified version of the cable-TV network. The deployment costs of such a network are high. It is hence assumed that two such networks will not be deployed in parallel in the same area. Assuming no regulations, only one service provider will hence be present in each area. This implies low risk of local competition in a long run perspective.

Regulations

Risk: If Telenor ever decides to deploy a nationwide, or at least a large, fiber based access network, there is a chance that federal regulators take action. If Telenor is perceived to be in a situation where monopoly is near by, regulation is likely. As explained in section 3.2, this happened with the copper access network through LLUB. Regulations may give competitors the right to use the new access network initially acquired by Telenor.

Implications: The implications of new regulations are hard to predict. In general they are likely to reduce the competitive advantage of Telenor. If regulations occur within the life span of the NPV model, cash flows are likely to decrease. This happens because revenues decrease as a result of increased competition.

Likelihood: Regulations are often slow to implement. The likelihood of any negative regulations happening within the seven year project life span assumed here, are hence set to low.

11 Conclusions

Why improve the access network

The goal of part one was to establish why an upgraded access network is needed. The approach was to study both current and future trends in technology used at home.

Within the classic Internet applications such as web browsing, e-mail and file transfer, it was established that file transferring was a major driver for increased bandwidth demand. Peer-to-peer activity was especially seen as an important factor within this area. As the primary content being exchanged shifts from MP3 to DVD, bandwidth capacity becomes crucial.

More and more, Internet is being used as a source of entertainment. Streaming, on-line gaming, IPTV and video-on-demand (VoD), are popular terms in this category. These are all bandwidth hungry applications. As always, it is the transfer of live imagery that consumes the most bandwidth. Resolution also plays an important role. Using the MPEG2 codec, the required bandwidth almost doubles when moving from SDTV to HDTV.

Triple Play (3P) is a product combining Internet access, TV and telephony all delivered through a single access network. Such a product will be able to accommodate all the services mentioned above and more. Since 3P is more a product than a service, it is not really by itself a driver for increased bandwidth. It is however an important concept. In many ways, it forms the benchmark of what an improved access network should be able to deliver.

The development of new compression algorithms and new codecs is a factor working against the increasing bandwidth demand. Such efforts will reduce the required bandwidth by lowering the produced bit rates. This is especially important in digital video broadcast. Until now, MPEG2 has been the preferred industry standard. This is changing. With MPEG4, the required bit rate for digital video is cut in half without loss in quality.

Part one left no doubt on whether or not the demand for home access was growing. The increasing popularity of video transfer showed to be the strongest factor. The high bandwidth requirements needed for this type of traffic, calls for an improved access network. A set of future bandwidth demand estimates, were set forth in section 4.3.2. These were also backed by a regression approach first presented in Nielsen's law. It states that a high-end user's connection speed will grow by approximately 50% per year.

How to meet future demand

Based on the future bandwidth estimates set forth in chapter 4, several different technological solutions were studied in chapter 5

At first sight, the xDSL technologies seem very appealing. Through the use xDSL, the existing copper access network can be further utilized. It is the actual network and not the end equipment that is considered expensive to upgrade. By keeping the old network, costs can be kept down. The problem with any xDSL solution is however the reach. As the line lengths between DSLAM and customer increases, bit rates fall.

Among the different xDSL versions, VDSL2 seems the most promising. Bit rates as high as 70 Mbit/s can be achieved with a line length shorter than 500m. Line lengths used in today's ADSL service are usually much longer than this. It is hence not enough to just replace the old ADSL line cards with new VDSL2 cards and then keep the old DSLAM locations. New DSLAMs will need to be deployed further into the access network and be served by a fiber up-link. In terms of delivering the bandwidth estimates set forth in chapter 4, VDSL2 is only partly able to fulfill the requirements. With a line length of 500m, VDSL2 is expected to be adequate for 6 years. After that, new improvements would be needed.

Fiber based access solutions have the advantage of being able to provide very high bit rates on fairly long distances. In terms of flexibility, a P2P home run configuration would be the ultimate solution. This way each user would have its own dedicated link. An active star solution or a passive optical network (PON) provides more sharing, but at the cost of higher complexity and in the case of PON, reduced security. PON technology also benefits from the fact that the intermediate splitting node needs no power and very little maintenance.

Within PONs, several standards exist. Compared to EPON, GPON has higher efficiency, and better capacity, In the long run, GPON is considered favorable to EPON. This is despite the fact that GPON equipment is currently considered somewhat more expensive than EPON equipment.

In general, all the fiber based solutions have many highly desirable properties. First and foremost is their ability to deliver high bit rates. The capacity on a fiber link is in theory almost unlimited. It is the end-equipment that provides the limit. In practice this means that once a fiber link is in place, one need only change the end equipment to upgrade capacity. Due to this fact, fiber based solutions are considered highly future proof. Reaches ranging from 20 to 80 km is also a very desirable property.

Costs and profitability

CAPEX

Analyzing deployment cost through the use of real-world business cases, has been the main goal of this thesis. Finally it is time to conclude on this issue.

In terms of capital expenditures, the general picture is clear. See Figure 66. VDSL2 seems to be the least expensive alternative in all areas. In short, the main differences between VDSL2 and the fiber-based solutions can be explained by higher CPE costs and the high cost of civil work associated with fiber deployment.

Within VDSL2, scenario 2 is obviously the cheapest. In terms of available bit rates, it is however only scenario 1 that is comparable to the other solutions. Because of this, we will for now only concentrate on scenario 1 when mentioning VDSL2. Scenario 2 will then be treated separately below. In most areas VDSL2 is not only a little bit cheaper; it is usually about half the price of the other solutions. In the non-rural areas of Angeltrøa, Granåslia, Othilienborg and Nedre Elvehavn, price per customer range from 4.600 to 6.800 NOK. In the rural areas of Spongdal and Kvammen, the price per customer is 42.000 and 58.000 NOK respectively. In comparison, the average deployment cost per customer for ADSL (without CPE) is according to Telenor approximately 1.300 NOK.

Somewhat surprising is the fact that it is in the rural areas (Kvammen, Spongdal) that the difference between VDSL2 and the other solutions is the smallest. At Kvammen, it is even expected that a PON solution would be slightly cheaper than VDSL2. It turns out that the cost of having to deploy multiple DSLAMs is just as large as providing fiber to each home. Independent of how the solutions are ranked, it is worth noting that the deployment costs in the rural areas are tremendously large for any solution. As of today, a Telenor deployment is highly unlikely in these areas.

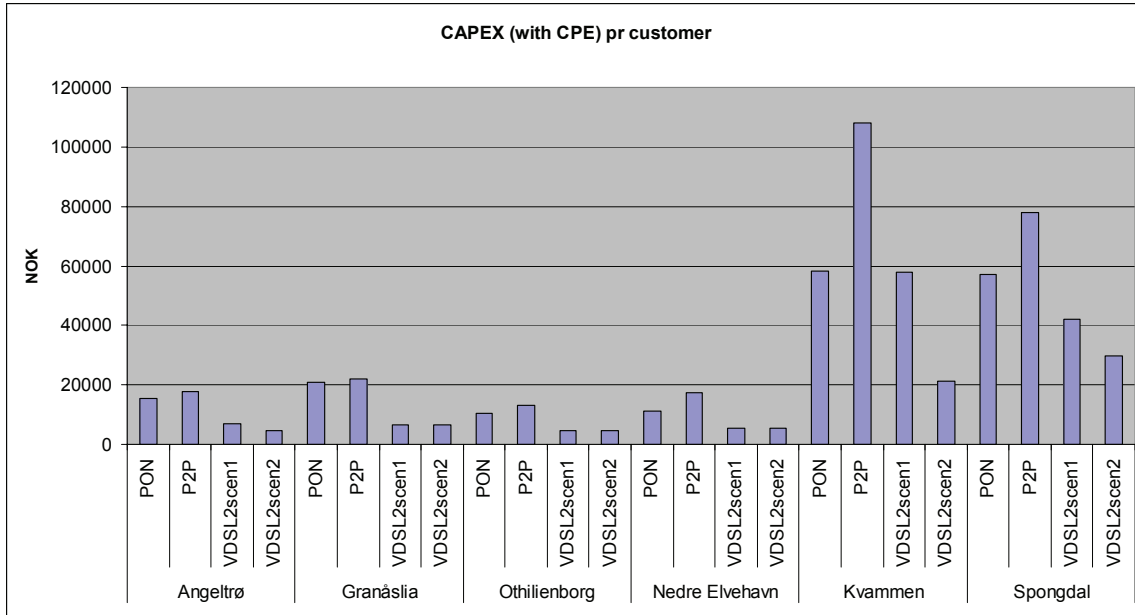

Figure 66: Initial CAPEX per customer for all solutions in all areas

For VDSL2, it is usually the combination of DSLAM and DSLAM housing costs that make up the largest cost factor. This should work as a strong incentive to try to find cheaper housing options. If the rural areas are excluded, CPE costs are also a significant cost factor.

As can be seen from Figure 66, PON and P2P deployments will result in higher initial costs per customer. There are several reasons why PON and P2P come out worse than VDSL2. The extra cost of fiber and civil work is obvious. Excluding the two rural areas, digging alone accounts for about 30% of total costs on average. The sensitivity analyses performed in chapter 10, showed that cost per customer will change dramatically if digging prices become larger than expected. The job of estimating digging prices is hence very important. The extra cost of using “large” fibers was shown to be insignificant.

PON and P2P solutions are also punished extra by large CPE costs. Installations at the customer premises are also included here. It is not the actual equipment that hurts, but rather the installation fee of 2.500 NOK per customer. This fact should stress the importance of including internal fiber cables and terminations when building new houses.

There is obviously a relationship between population density and presence of multi-storey apartment buildings. Both of these parameters were expected to be important in keeping deployment costs low. The results from Othilienborg and Nedre Elvehavn confirmed this belief.

Initially, it was feared that fiber deployments would be extremely costly in urban areas due to an expensive digging surface. This turns out not to be true. It seems there is a relationship between expensive digging surfaces and high population density. This relationship helps to keep the overall costs low because expensive digging is offset by short distances between houses.

As initially expected, it turns out that the availability of existing fiber and ducts plays an important role in keeping costs low. For PONs, available fiber running towards the OLT location is very desirable. PONs require few fibers between OLT and the splitter location and can therefore often utilize existing infrastructure. In the case of P2P, the solution requires more fiber than one can hope to find available. Existing available ducts are however highly desirable. This will save large amounts of digging.

For the two fiber-based solutions it was initially assumed that the distance between OLT and splitter/fiber distribution point would have great impact on deployment costs. This proved only to be true in the case of P2P. In the case of PONs, there are so few fibers needed for this stretch that one can often utilize previously deployed, but available, fiber. This is not the case for P2P solutions. Even if existing ducts are used, long distances between OLT and fiber distribution point will require significant amounts of fiber.

The investigation of VDSL2 scenario 2 was not done in order to compare it to the three other solutions. Instead, 30 Mbit/s was chosen as a bit rate where basic Triple Play could be offered now, independent of future needs.

In the areas where there is a difference between scenario 1 and scenario 2, the number of DSLAMs is reduced significantly under scenario 2. On average a little less than half the number is needed. At Angeltrøa, it reduces the cost per customer from 6.800 NOK to 4.800 NOK. At Kvammen the number is reduced from 58.000 NOK to 21.000 NOK. In Spongdal the number is reduced from 42.000 NOK to 30.000 NOK. Kvammen and Spongdal are obviously expensive, but as we have seen from the other solutions, these locations are going to be expensive no matter what. The good thing about a deployment according to scenario 2 is that many will be given bit rates far above 30 Mbit/s. These customers can then be used to test if there is really a demand for higher rates. All in all, scenario 2 proves to be the cheapest way of providing 3P capabilities for all, and even higher rates for some.

Concerning green-field areas, the results presented in section 9.4, left interesting results. Although only one area was investigated, it seemed that PONs and VDSL2 were now almost equal with respect to CAPEX. A P2P solution was also significantly cheaper, but still about 2.000 NOK above the two others. When knowing that fiber-based solutions are considered much more “future proof” than xDSL, fiber should be the preferred choice in areas under construction. The choice between PONs or P2P is addressed below.

OPEX

In advance it was believed that the operational expenses (OPEX) were going to be significantly lower for fiber based solutions compared to xDSL. This seemed to be the general consensus in industry. The operational expenses presented in section 6.2, soon revealed that the differences were minor. In the case of VDSL2, operational expenditures are expected to be around 1.500 NOK per customer per year. PONs and P2P are expected

to be about 300 NOK lower. Section 10.1 showed that the net present value of any deployment is highly sensitive to changes in OPEX.

NPV

The net present value (NPV) merges CAPEX, OPEX and Revenues into a single time adjusted figure. As explained earlier it is however dangerous to interpret this figure as pure profit. See section 6.3. Never the less, it is safe to say that the NPV ranks the different solutions. In addition it strongly indicates whether deployment would be profitable in an area or not. Based on this, it is fair to say that from a pure financial point of view, Kvammen and Spongald seem unprofitable independent of the solution studied.

Future strategies

What about the other areas? Should one chose a VDSL2 solution in all cases just because this gives the higher NPV? Such questions call for a more strategic assessment. Even though VDSL2 has the higher NPVs, the fiber solutions still show positive values. From section 5.1 one can recall that VDSL2 has an upper bound on achievable capacity. Fiber based solutions on the other hand, are only limited by the end-equipment. If preparing for the future was the ultimate goal, a fiber based solution would therefore be preferable.

Within a fiber solution, the choice between PON and P2P is not easy. As the results show, PONs are always somewhat cheaper, but the difference is small. Despite showing higher CAPEX and lower NPV, it is tempting to go for a P2P solution. This would require some initial “pain” in terms of higher up-front expenditures, but truly secure the future. On the other hand, if PONs are deployed with care and ducts are used everywhere, the transition from a PON to a P2P system is not huge. One could therefore choose the cheaper PON solution now, and later upgrade to P2P without large transition costs.

So what should Telenor do? This thesis alone, can not answer the question, but a few recommendations are provided.

One could of course say that positive NPVs are just caused by a revenue cannibalism and that any upgrade is likely unprofitable. In a very short run such a conservative approach might be correct. However, in the long run something has to change. If an upgrade is postponed for ever, demand for bandwidth alone will push customers over to competitors. An upgrade of some sort is therefore recommended.

What kind of upgrade? – Mix and match. By using the model developed in this thesis, one can easily spot areas that seem profitable. In this quest one should look for areas with a high percentage of multi-storey apartment buildings, plenty of existing fiber and ducts and also the absence of competition. Depending on these parameters, a solution should be chosen with care. If there is plenty of existing ducts, a P2P solution should be chosen. Despite the higher investment cost, this will likely secure the area from any future competitor as was explained in section 10.3. If ducts are rare, but some existing available fiber is present, a PON solution is to be recommended. Again this will likely secure the

area from future competition. If little or no fiber is present, but the area still seems promising a VDSL2 solution is likely the answer. If however competitors are present or within “range of attack”, special care must be taken.

If competitors are present with a solution that is considered future proof, there should be special reasons for deployment. Such a network could be a parallel fiber network or maybe an advanced cable-TV network. In these areas the risk of deployment becomes much higher. Expected take rates must be thoroughly analyzed and reviewed. If however the competition is only close by or present only through xDSL, deployment should be heavily considered. In these cases, a strong fiber based deployment could halt competitor advancement. Even if this would prove unprofitable locally, it could prove valuable in the long global run.

In the case of green-fields, a fiber based solution should always be chosen. Although somewhat more expensive, a P2P solution is recommended. This will likely remove the need for any future network upgrades. It is hence expected that the slightly higher investment cost will be compensated for by the removal of future upgrade costs.

In the cases where VDSL2 has to be chosen, the possibility of a future fiber-to-the-home solution should be kept in mind. Plenty of extra fiber should be laid down, when DSLAMs are given their uplink. This will greatly reduce the cost of a later P2P deployment. In the best case, more fiber will then only be needed in the already short distance between DSLAM and home.

By using the model developed in this thesis, one can easily spot areas that are hopelessly unprofitable. These should be left out or other technological solutions should be considered. Most likely, these areas will be considered too expensive by competitors also. The fight for these customers will have to won on other issues than those discussed here. This could be price, quality or something else.

The question of timing is also an important one. As seen, waiting will make equipment cheaper. On the other hand, this will allow competitors to move in and start acquiring customers. It is likely that the most profitable areas will be “captured” first. It may prove hard to win these customers back, due to the high sign-up fees usually associated with 3P services. Based on this, it is recommended to move forward now in those areas considered most profitable. This will also provide valuable experience that can be used for later deployments.

12 Future work

The technologies studied in this thesis have been evaluated based on economy and their ability in meeting bandwidth demand. A technical evaluation of efficiency, scalability and reliability would also prove valuable.

Although deploying a cable-TV network is not currently an option for Telenor Nordic, more effort should be put into analyzing deployment costs for this solution. This would provide valuable information in forecasting competition.

In many cases fiber-based solutions are considered too expensive. It would hence be interesting to investigate the possibility of splitting deployment costs between other stakeholders. This could be local government, private interests or others. Such an investigation would likely also involve a study of different ownership models.

With respect to the models created in this thesis, it would also be interesting to directly incorporate competition as a set of input parameters. One could for instance imagine a scheme where the assumed initial take rate was discounted according to local competition.

It would obviously also be very interesting to test the accuracy of the models developed through a real world deployment. Only time will show if this is ever done.

13 References

- [1] iMedia Research AccuStream, "Streaming Media 2004 – 2007: Market Development and User Data Analysis" 2004
<http://www.chicagoima.org/EXECUTIVE%20SUMMARY%20-%20STREAMING%20MEDIA%202004%20-%202007.pdf>
- [2] Consumer Electronics Association, Parks associates, "Connections conference summary", 2004
http://www.internethomealliance.com/events_mkting/docs/Connections_04_Wrap_up.pdf
- [3] P Bakki et al, "User and Service requirements" Broadwan, Deliverable D6, May 2004
http://www.telenor.no/broadwan/publ/BROADWAN_public_deliverables.htm
- [4] Bob Whitman, "Fibre Access Deployment Worldwide: Market Drivers, Politics and Technology Choices", ECOC Sept 2004
<http://www.corning.com/docs/opticalfiber/CM6315.pdf>
- [5] Jens Myrup Pedersen et al, "Reliability Demands in FTTH Access Networks", 7th International Conference on Advanced Communication Technology, 2005
- [6] Jacob Nielsen, "Nielsen's Law of Internet Bandwidth" Nielsen's Alertbox, April 1998
<http://www.useit.com/alertbox/980405.html>
- [7] Thomas p. Knudsen et al "A Method for Upper Bounding Long Term Growth of Network Access Speed", Proceedings of Communication Systems, Networks and Digital Signal Processing (CSNDSP) 2004
[http://vbn.aau.dk/research/a_method_for_upper_bounding_on_growth_of_network_access_speed\(167562\)/](http://vbn.aau.dk/research/a_method_for_upper_bounding_on_growth_of_network_access_speed(167562)/)
- [8] The Swedish ICT Commission, "General guide to a future proof IT infrastructure", Report 37/2001, June 2001
<http://www.itkommissionen.se>
- [9] CEA Consumer Electronics Association, "Technologies to watch 2005", 2004
http://www.ce.org/PDF/5tech_Watch-2005.pdf
- [10] Michele Jackson et al, Broadband Demand Study, Final Report, Telecommunications Research Group, University of Colorado, Boulder, Nov 2002

- http://newsroom.cisco.com/dlls/Broadband_Demand.pdf
- [11] NextGenTel, “Ny dramatisk hastighetsøkning – same lave priser”, Promotion article, Nov 2005
http://www.ngt.no/privat/artikler/dramatisk_hastighetsokning.php
- [12] Gisle Ølmheim Raa, “Når blir Fiber-to-the-home (FTTH) lønnsomt?” Student project, Department of Telematics, NTNU, November 2003
- [13] I Tardy et al, “Interconnected networks architecture” Broadwan, Deliverable D14, November 2004
http://www.telenor.no/broadwan/publ/BROADWAN_public_deliverables.htm
- [14] IEC, “Very-High-Data-Rate Digital Subscriber Line (VDSL)”, International Engineering Consortium, 2004
<http://www.iec.org/online/tutorials/vdsl/>
- [15] Ole Grøndalen, “Wi-Fi, WiMAX, and what comes next”, Telenor R&D, November 2004
http://www.telenor.no/broadwan/publ/BROADWAN_publications.htm
- [16] S J Vaughan-Nichols, “Achieving Wireless Broadband with WiMAX”, IEEE Computer Society, Computer Vol 37, Issue 6, June 2004
<http://ieeexplore.ieee.org/iel5/2/28995/01306375.pdf?tp=&arnumber=1306375&isnumber=28995>
- [17] Andrew Orłowski, “AT&T lifts kimono on WiMAX trials”, The Register, October 2004
http://www.theregister.co.uk/2005/10/27/wimax_world_att_trial/
- [18] DSL Forum, “Asymmetrical Digital Subscriber Line, tutorial slide show”, DSL forum, 2005
http://www.dslforum.org/learndsl/ppt/ADSL_Slideshow05_updated.ppt
- [19] Luigi Liccardi, “Inovation in the access network evolution”, IEC Broadband World Forum Europe, Madrid 2005
http://www.iec.org/events/2005/bbwf/pdfs/wrk-4_luigi_licciardi_telecom_italia_lab.pdf
- [20] Aware, “ADSL2 and ADSL2+ The new ADSL standards” Company whitepaper, 2002
<http://www.dslprime.com/a/adsl21.pdf>
- [21] Oscar Diaz et al, “Fiber-to-the-Home Technologies”, Kluwer Academic Publishers, 2002

- [22] Glen Kramer, Gerry Pesavento, "EPON: Building a Next-Generation Optical Access Network", IEEE Communications Magazine, Feb 2002
<http://www.rle.mit.edu/cips/documents/EPON.pdf>
- [23] Ton Koonen, "Fibre-optic techniques for broadband access networks", Telektronikk Volume 1001 No. 2 2005
- [24] PON Forum, "PON Technology", PON Forum Technologies
<http://www.ponforum.org/technology/default.asp>
- [25] Motyuki Nakamura et al, "Proposal of Networking by PON Technologies for Full and Ethernet Services in FTTx" Journal of Lightwave Technology, Vol. 22, No. 11, Nov 2004,
<http://ieeexplore.ieee.org/iel5/50/29736/01353395.pdf?isnumber=&arnumber=1353395>
- [26] FlexLight Networks and BroadLight, "Comparing Gigabit PON Technologies: ITU-T G.984 GPON vs. IEEE 802.3ah EPON", Whitepaper, May 2004
http://www.techonline.com/community/ed_resource/tech_paper/36685
- [27] Jani Saheb Shaik, N R Patil, "FTTH Deployment Options for Telecom Operators", Published at IETE's National Seminar on Broadband Communications in the Indian Scenario, August 6-7, 2005
<http://www.sterliteoptical.com/pdf/050807%20IETE%20Pune%20OFC%20Paper.pdf>
- [28] Light Reading, "Ethernet in Access Networks" Light Reading Networking in the Telecom Industry, June 2005
http://www.lightreading.com/document.asp?doc_id=71865&print=true
- [29] Peter Leblanc, "ADSL Technology Evolution", DSL Forum, 2005
http://www.dslforum.org/learnDSL/ppt/ADSL2plus_Tutorial05.ppt
- [30] Tom Van Caenegem, "B-PON, G-PON, and EPON A guided tour", Alcatel R&I Antwerp Belgium, 2004
http://www.alcatel.com/bnd/fttu/FTTH_Conference_paper_final.pdf;jsessionid=ZNCYPWEIWQTNMCTFR0HHJHAKMWHI0TNS
- [31] Allied Telesyn, "PON vs. Active, FTTx Technology Choices" Company Whitepaper, 2004
<http://www.alliedtelesyn.co.uk/site/files/Documents/TechnicalBrief/PONvActiveFTTxTechnologyChoices.pdf>
- [32] ITU, International Telecommunication Union, "Gigabit-capable Passive Optical Networks (GPON): General characteristics, G.984.1, March 2003

- [33] Jan Helge Høgvoll et al, "Bright Future, prosjekt for fiber i aksessnettet", Internal Telenor project summary, Telenor, 2005
- [34] Lyse's homepage, last visited 15.04.06
<https://www.lyse.no/produkter/bredband/>
- [35] Nextgentel's homepage, last visited 18.05.06
www.nextgentel.no
- [36] Kurosh Bozorgebrahimi, "Optiske aksessnett", Internal Telenor report, 2005
- [37] Uninett, "Kostnadsbetraktninger ved fibernettutbygging" Fiberskoleprosjektet, bredbåndsyttbygging i norske kommuner, Instruction materiell from Uninett.
<http://www.uninett.no/nln/fiberskoler/veiledning/kostnadsbetraktninger.html>
- [38] Nicholas Frigo, Patrick Iannone, Kenneth Reichmann, "A view of Fiber to the Home Economics", IEEE Optical Communications, August 2004.
<http://ieeexplore.ieee.org/iel5/35/29269/01321382.pdf?isnumber=&arnumber=1321382>
- [39] Thomas Jelle, "Fremtidens Informasjonsforsyning – modeller for fiberrealiseringer", Master thesis, Department of Telematics, NTNU, June 2004
http://www.uninettabc.no/dok/hovedoppgave_fiberrealiseringer.pdf
- [40] R Montagne et al, "Broadband access roadmap based on market assessments and technical-economic analysis" Broadwan, Deliverable D15, December 2004
http://www.telenor.no/broadwan/publ/BROADWAN_public_deliverables.htm
- [41] Maria Fleischer Fauske, "Techno-economic evaluation of broadband strategies after ADSL", Master thesis, Department of Telematics, NTNU, June 2004
- [42] Andrew S. Tanenbaum, "Computer Networks", fourth edition, Prentice Hall 2003
- [43] Alan Breznick, "CableLabs Preps DOCSIS 3.0 for Prime-Time", Cable digital news, June 2005
<http://www.cabledatacomnews.com/jun05/jun05-6.html>
- [44] Lyse Energi AS, "Fra E-verk til I-verk, Forretningsutvikling og produktutvikling I Lyse Energi" Presentation for MMI, 1st September 2005
http://www.mmi.no/dokumentasjon/fagdag-2005/lyse_toril_nag.pdf
- [45] Roger L. Freeman, "Fiber-optic systems for telecommunications", Wiley-Interscience, 2002
- [46] Gennady Yanovsky, "Convergence in ICT", Lecture slides given in the course TTM7 Convergence in ICT at NTNU, September 2005
<http://www.item.ntnu.no/fag/ttm7/lectureplan.html>

Appendix A: Explanation of constants and assumptions

Constants and assumptions used in the models

Several constants and assumptions are used in order to create the desired models. These are explained and hopefully justified next.

Fiber and digging lengths needed to get from A to B

Several specific conventions are used for calculating fiber and digging lengths. These are described further below. In addition to this, a general convention is used when reaching a node or connecting to existing infrastructure. An example could be connecting a splitter to existing fiber.

When constructing a fiber path between A and B. The following convention is used for calculating the needed fiber and digging lengths:

Fiber length = air distance from A to B + 20%

Digging length = air distance from A to B + 20%

It is seldom the case that the shortest distance can be used. 20% is hence added to account for the likely sub-optimal path. The number 20 is based on experience and map trials.

Fiber and digging lengths between old HF location and drop points

The fiber (192-fiber) and digging lengths needed between the old HF locations and drop points were approximated by using the road lengths covered by the old HF. At first this may seem like a very crude estimate. It is however a fact that paths often tend to follow streets and roads. This is often easier than for instance to cut through private gardens.

Fiber and digging lengths between drop points and houses

The fiber (12-fiber) distances between drop point and houses were approximated like this:

- 30m per household for single homes
- 20m per household for 1-storey apartment buildings
- 15m per household for multi-storey apartment buildings

In general single homes/ private residences are thought to be pushed back further from the street than what 1-storey or multi-storey apartment buildings are. Assuming that 10 meters of fiber are used inside, 30 meters seems like an appropriate number based on local observations. The two other distances are derived by discounting this number.

The digging distances between drop point and houses were approximated like this:

- 20m per household for single homes
- 2m per household for 1-storey apartment buildings
- 0,5m per household for multi-storey apartment buildings

The reasoning behind these numbers is twofold. First, the digging distances are shorter than fiber distances, because some fiber (10m) is assumed to run inside the buildings. Next, digging distances are much shorter for buildings holding multiple households. This is because, the multiple households together are assumed to generate the correct distance.

As an example, a 1-storey apartment building is assumed to initially have 5 paying customers. This will give 10m (5*2) meters of digging. If 10 meters of fiber is used inside each household, it becomes clear why 20 (10+10) meters of fiber is needed.

Fiber and digging lengths when using existing ducts

When trying to connect A and B with fiber and using existing ducts, the fiber and digging needs are calculated like this:

$$\begin{aligned}\text{Fiber length} &= \text{air distance from A to B} + 30\% \\ \text{Digging length} &= \text{air distance to existing duct} + 20\%\end{aligned}$$

The digging distance is straight forward and just an example of the first convention. The fiber length is a crude approximation. Obviously, the distance can not be shorter than the distance from A to B. No intermediate available fiber is used. The 30% extra is to cover the likely sub-optimal path that the use of existing ducts will require. The number 30, is based on several local observations and map trials.

Take rate

Predicting take rates has not been the focus of this thesis. As with the equipment costs, take rate is just left as a parameter in the models created. For the results presented, a naïve take rate of 40 % is chosen. Based on Telenor's current market share and ADSL experience, this is not an unrealistic number.

Constants and assumptions used in NPV analysis

Project life time

What should be considered the economic lifetime of an upgraded access network? At first one might argue that an access network can be in service for decades and model the cash flows accordingly. Mathematically this approach is not problematic, but it fails to realize key points. Even tough ducts and cables will last for decades; end equipment will have to be changed as technology evolves. In this thesis 7 years will be used as the project life

time. Considering the rate at which xDSL technology has evolved, this is not an unrealistic life time.

Cost of capital

The cost of capital reflects the profit that could be earned on another project with similar risks. Deciding on this parameter could have been a thesis by itself. When evaluating similar projects, Telenor has used 12% as their cost of capital. The same will be done in this thesis. The spread sheets also include graphs showing the NPV as a function of cost of capital. This shows the NPV's sensitivity to this parameter.

Appendix B: Explanation of Excel spread sheets

The models created to calculate investment costs are implemented in Excel spread sheets. Operational expenses and revenues are also included in order to find net present values (NPV). There is one Excel file for each of the three technological solutions studied.

PONresults.xls
P2Presults.xls
VDSL2results

Within each of these files there is one worksheet for each area, and one worksheet combining results across all areas. All measurements are provided in the top part of each area-worksheet. This is where most of the assumptions from chapter 8 are applied. Here, each of the original HFs are treated in a separate row. Several HFs can be merged so that they share a common splitter/fiber distribution point. The HF chosen as the merging location will be treated in a purple row. Based on the measurements, CAPEX costs will be calculated.

In addition to this, there are two other Excel files.

CombinedResults.xls
GreenfieldResults.xls

CombinedResults.xls is just a collection of all the results found in the three files mentioned above. GreenfieldResults.xls, gives results for all three technological solutions in a hypothetical green-field area.

In all files, various sensitivity analyses are performed.

Appendix C: Other access technologies

Radio-based solutions: WiMAX

WiMAX stands for Worldwide Interoperability for Microwave Access. It is a certification mark for products that conform to the IEEE 802.16 standard. In essence WiMAX is a way of providing a wireless broadband access network. WiMAX is similar to WiFi, but works over much greater distances.

The range of WiMAX depends on several factors. Spectral efficiency, transmitted power, topography, availability requirements, coverage requirements and antenna characteristics all play an important role. For capacity, channel bandwidth, cell size and customer distributions are important. [15]

The initial IEEE 802.16 standard operates in the 10 to 66 GHz frequency range. Newer extensions have however also included the range from 2 to 11 GHz. Theoretically the standard allows for ranges up to 50 km and capacity as high as 70 Mbit/s. [16] In practice these numbers are however much lower. New filed tests conducted by AT&T show the range to be only between 5 to 8 km and the capacity only around 2 Mbit/s. [17]

WiMAX has the advantage of being able to provide broadband access to remote areas without a costly ground-cable deployment. Low capacity does however make it an unattractive technology for most future access networks.

Cable TV access

Cable TV networks are often called hybrid fiber coax (HFC) networks. This is because the network consists of both optical fiber and coax cables. Coax is used in the outer parts (towards customer) while fiber is used in the inner parts. In addition to TV, HFC networks can be used for carrying FM radio, voice telephony and most importantly data. The frequencies between 5 and ca 750 MHz are used. Within this range, different bands are set aside for TV, upstream data, downstream data and radio. Each channel typically takes up 8 MHz into which one analog, or multiple digital, TV-channels can be placed. In the case of data, 30-50 Mbit/s can be accommodated depending on amplitude-modulated technique used. These rates are shared among active users on the cable segment. As of today, up-stream bit rates offered to customers are typically below 2 Mbit/s. Down-stream rates are typically between 0,5 and 15 Mbit/s. [23] [42]

The usual network configuration can be seen in Figure 67. The central location is called the head-end. This is where the cable modem termination system (CMTS) resides. From the head-end, fiber runs towards aggregation points called fiber nodes. The fiber nodes act as the interface between the fiber (optical) and the coax (electrical). One fiber node will typically serve ca. 2000 homes and can feed multiple coaxial cables. Between the

fiber node and the customer, several amplifiers may be necessary in order to maintain an adequate signal. [23] [42]

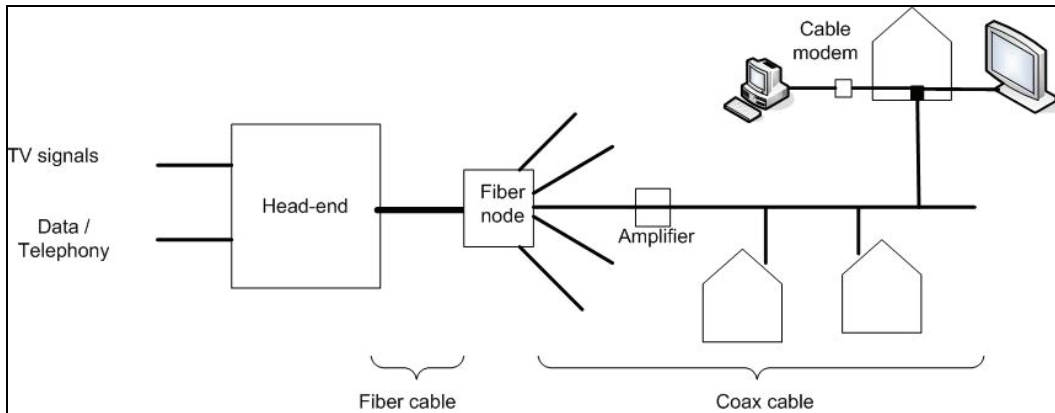

Figure 67: A typical cable TV network. Modified from [23] [42]

In order to use the HFC network for data traffic a cable modem is needed at the customer premises. The modem acts as an interface between the cable network and the computer. Traditionally, each cable TV provider would have its own cable modem. Today most companies follow a common modem standard called DOCSIS (Data Over Cable Service Interface Specification). [42] The newest version of this standard is DOCSIS 3.0. It is expected to greatly boost data rates in both traffic directions through a concept known as channel bonding. Channel-bonding works by spreading data packets over numerous virtually linked channels. Data packets will then be recombined once they reach their destination. [43]

Appendix D: Optical network elements and their functions

Optical Line Terminator OLT

This entity is in charge of optical reception and transmission. This includes control functions such as:

- Control over transmitted and received power
- Forward error correction
- Interleaving

The OLT also does bandwidth arbitration if a MAC protocol is used. In addition to this the OLT can do higher level functions such as address resolution, address assignment, tunneling etc. [21]

Optical Remote Node ORN

In a passive network this entity is simply a passive splitter/coupler. The signal arriving from the OLT is simply broadcasted on all splits. In the opposite direction, traffic is merged. In an active network, the ORN acts as a switch, forwarding traffic only to its intended ONT.

Optical Network Unit\Termination ONU\ONT

As for the OLT, this entity is in charge of optical reception and transmission, but now in the user end. Signals must be changed from optical to electrical and vice versa. The ONU\ONT also cooperates with the OLT to control transmitted power from user to operator. Other responsibilities include forwarding of error correction and interleaving. If a MAC protocol is used, this must also be supervised. [21]

In cooperation with a residential gateway, the ONT will also do multiplexing\de-multiplexing from multiple sources (voice, data, video) to accommodate different end services.

Appendix E: Multiple access methods

Wavelength Division Multiple Access (WDMA)

Using this scheme, a different wavelength is assigned to each ONT. This effectively provides the ONT with its own channel. Each ONT may then use whatever signal format it desires. No time synchronization is needed. [23]

Sub-Carrier Multiple Access (SCMA)

Under this scheme, each ONT will modulate its packet stream using a different electrical carrier frequency. This will again modulate the light intensity of ONT's laser diode. The effect is that each packet stream has its own frequency band as its channel. Again this allows for multiple signal formats. [23]

Optical Code Division Multiple Access (OCDMA)

This method resembles the CDMA scheme used by many mobile phone systems. Each ONT will use a different signature sequence made up of optical pulses. In the OLT the received signals are correlated with known signature sequences in order for de-multiplexing to happen. [23]

Time Division Multiple Access (TDMA)

TDMA is a well know multiplexing scheme used in many communication systems. Upstream packets are time-interleaved at the splitting point. This requires precise synchronization of packet transmission from the ONTs. Synchronization is achieved by sending grants from the OLT on when the ONT should send. TDMA is the multiple access method used in most commercial PONs. It is used in APON, BPON, EPON and GPON. [23]

Appendix F: Lyse Energi AS

Lyse Energi is a company specializing in both utilities (electricity) and telecommunications (broadband). Deployment of infrastructure is a core activity within both areas. Most of the customer base is located in Sør-Rogaland. In this setting it is the broadband service that is interesting. By deploying an active fiber solution, Lyse is capable of offering triple play to their customers. [39] [34]

Lyse also allow other utility companies, local governments and housing companies to enter into a franchise agreement. This agreement lets other parties build, maintain and operate a fiber based broadband network, while Lyse provides the actual triple play service.

By 2005, 16 local governments and utility companies had signed long term agreements with Lyse. At that time, Lyse and its franchise partners had 30.000 Triple Play customers. In addition to this 15.000 customers had signed up as interested in having Lyse Broadband deployed in their neighborhood. [44]

Among the broadband services offered by Lyse are TV, Video-on-Demand, Programs-on-Demand, games, radio. Several “extras” such as Internet firewalls, email notification and so on are also offered. Internet access is obviously also included. The bit rates offered are as high as 50 Mbit/s downstream and 25 Mbit/s upstream.

Appendix G: Security considerations in PONs

In downstream direction, PONs are broadcast. This implies that the channel is shared between non-cooperative users. Each ONT sees all traffic, but should only read traffic intended for him. A malicious ONT can however be placed in promiscuous mode and read all downstream traffic. Because of this, encryption is needed. Encryption may be implemented on the physical layer, or above the data link/MAC layer.

In the MAC layer case, the payload of a MAC frame will be encrypted while headers are left in plain text. This prevents malicious ONTs from reading the payload, but enables learning of MAC addresses. Knowledge of such addresses can later be used in other types of attacks.

If encryption is used on physical layer, no information can be learned by malicious ONTs. The OLT will encode the entire bit stream. Since encryption keys are different from each ONT, a malicious ONT will not be able to decrypt and hence reject the packet. The problem is however that the physical layer per definition is connection-less. Introducing a different key for each ONT violates this property. Decryption on physical layer is also more resource intensive for the ONT. [22]

Appendix H: Maps

As explained earlier, all measurements and network planning is done using a proprietary Telenor GIS tool. For the sake of illustration, screen shots of all the areas studied have been included below. The sizes of these screen shots are however limited to only include the areas studied. Having the GIS tool, it is however possible to move around and check intermediate stretches between business case area and central locations (OLTs etc).

For each map the scale is given. The following symbols are used:

Green lines: Existing copper access network
Red lines: Existing fiber paths
Blue lines: Existing ducts
Black cross: HFs that are part of business case analysis.

The codes that are printed on top of the green lines are names for aggregation points. The first letters indicate the CO, under which the aggregation point belongs.

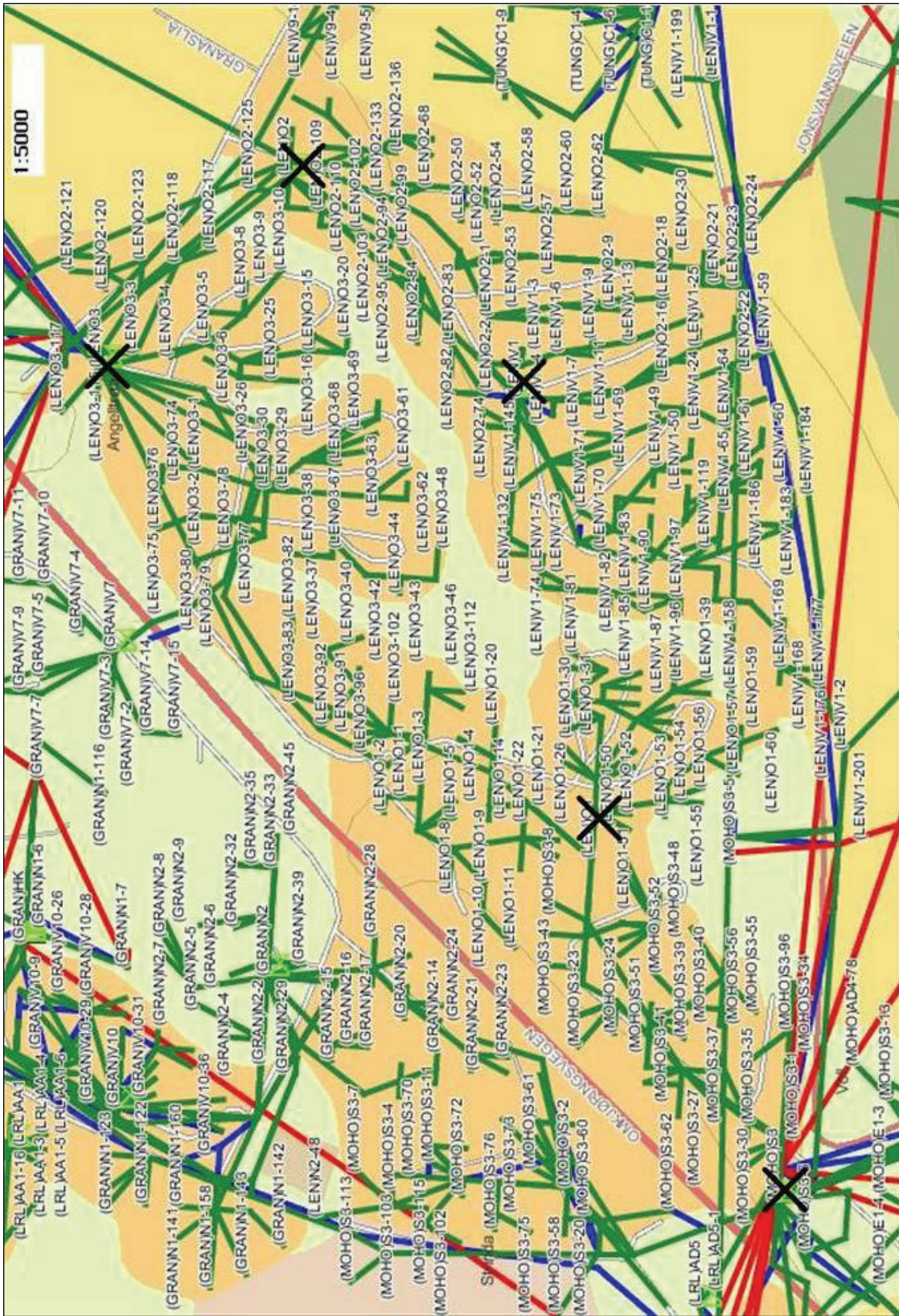

Figure 68: Angelträa



Figure 69: Granåslia

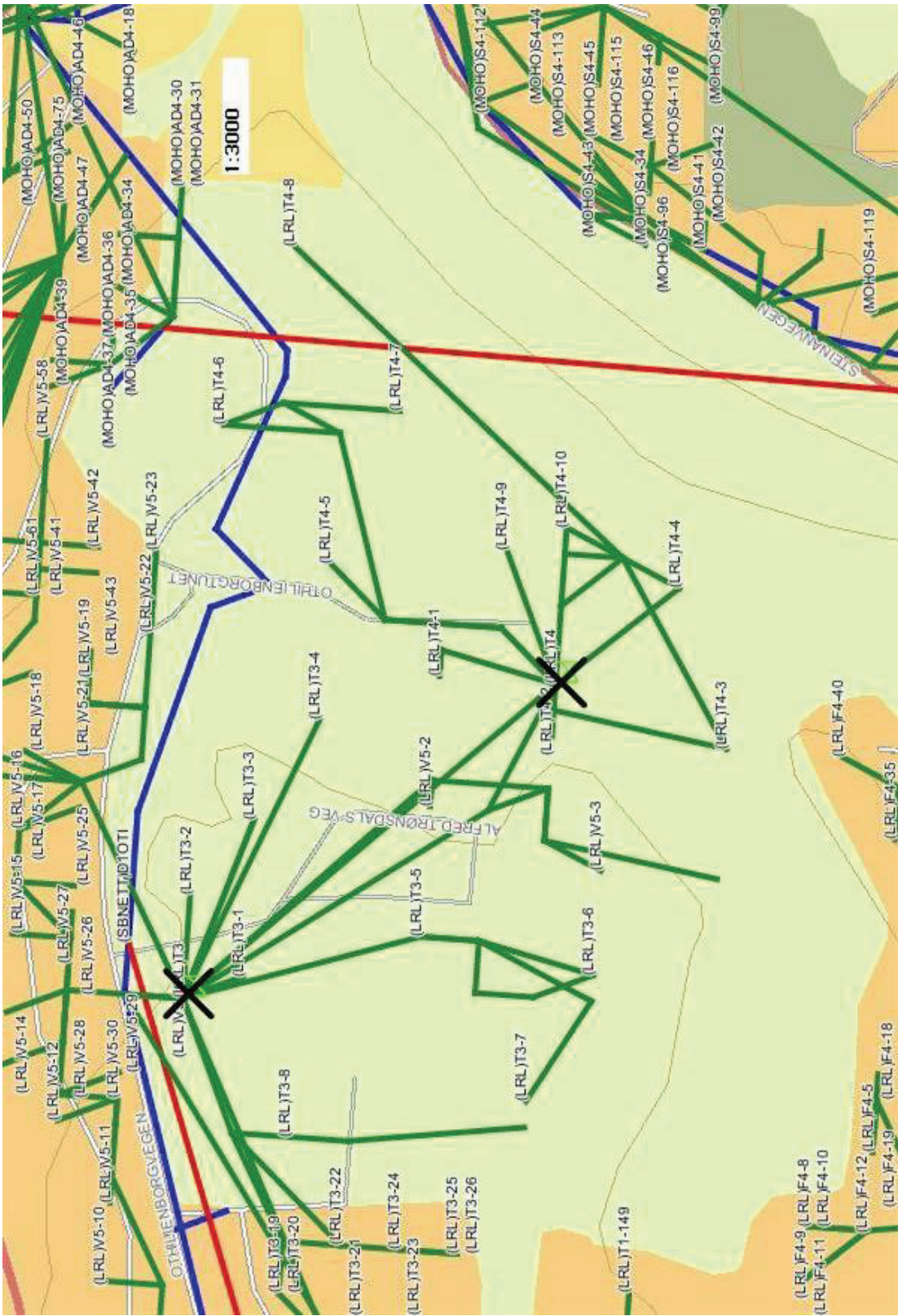

Figure 70: Othilienborg

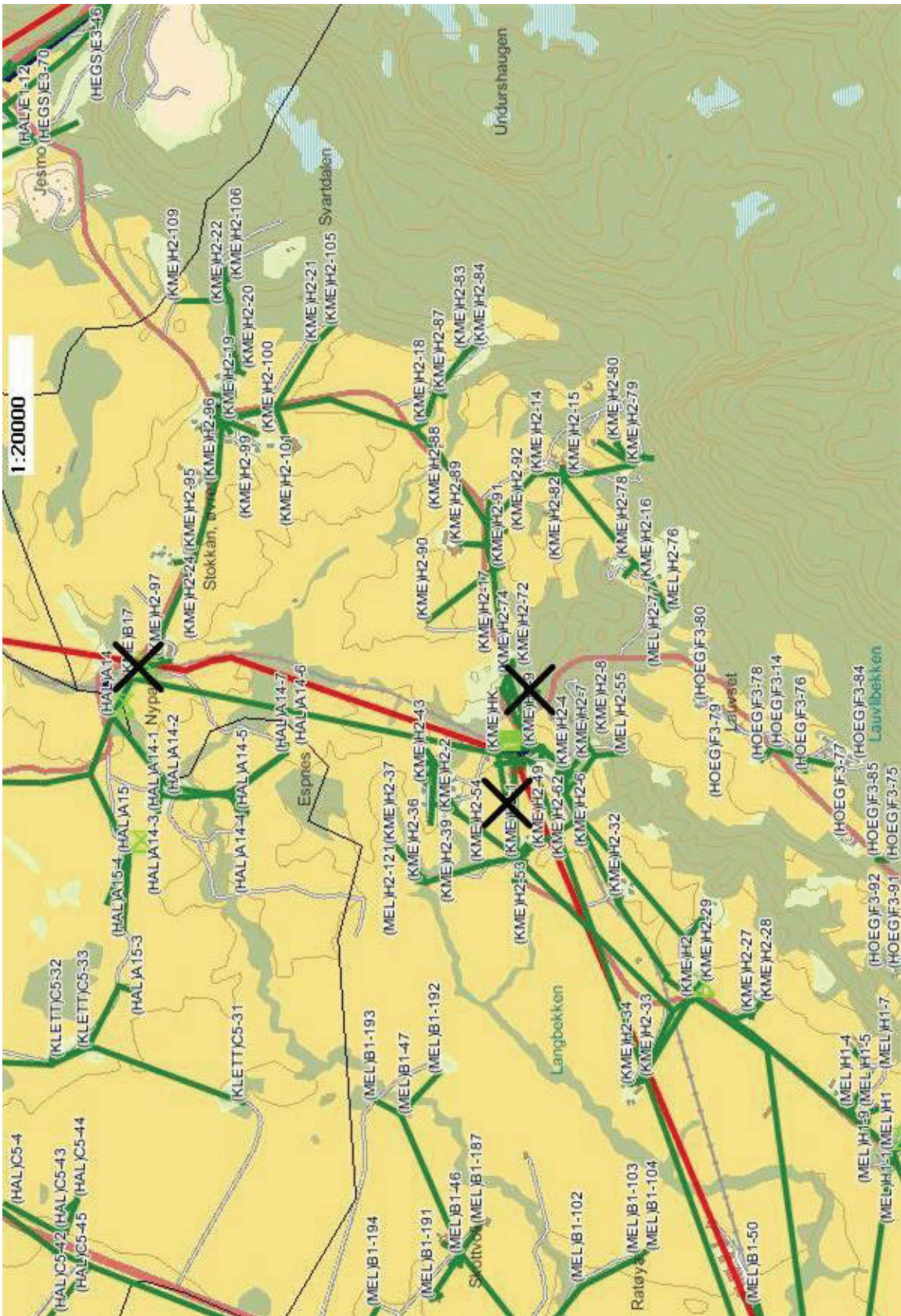

Figure 72: Kvammen

