



NTNU

Norwegian University of  
Science and Technology

# Splicing and Coil Winding of MgB<sub>2</sub> Superconductors

Frode Sætre

Master of Science in Energy and Environment

Submission date: June 2008

Supervisor: Magne Eystein Runde, ELKRAFT

Norwegian University of Science and Technology  
Department of Electrical Power Engineering



# Problem Description

## Splicing and Coil Winding of MgB<sub>2</sub> Superconductors

Aluminium extrusion billets (massive Al cylinders) are preheated to around 500 C before they are extruded to profiles. The heating is usually accomplished by using electromagnetic induction heaters operating at 50/60 Hz.

SINTEF Energy Research is leading an EU sponsored project where the goal is to build a full scale induction heater with superconducting (i.e. lossless) coils. Two coils with an inner diameter of more than 1 m and each consisting of around 9 km of MgB<sub>2</sub> superconductors are crucial parts of this device and will be designed and built at SINTEF.

A semi-automatic system for putting on electric insulation on the superconducting tape and winding the tape into coils has been designed. A "wet-winding" technique is used, i.e. the epoxy impregnation is applied during the winding process.

Each coil is built by stacking and joining 16 discs or "double pancake" sub-coils. Making reliable and low loss electrical joints between the superconductors of each of these discs is crucial in keeping the operating temperature sufficiently low.

The student should take part in the project work, and will get the main responsibility for matters related to the joints, and will also take part in developing and modifying the procedures and techniques used for the coil winding. Hence, the assignment includes a number of primarily experimental tasks:

- A study of superconductors in general, and in particular of the electrical and mechanical properties of MgB<sub>2</sub> tapes and their use in the induction heater application.
- Design, development and testing of tools and procedures for making low-loss electrical joints between MgB<sub>2</sub> conductors.
- Improving and streamlining the set-up for insulation and wet-winding of MgB<sub>2</sub> tapes, and applying this for making the sub-coils.

Assignment given: 08. January 2008  
Supervisor: Magne Eystein Runde, ELKRAFT



## Abstract

Conventional induction heaters for extrusion purposes have an efficiency of only 55 – 60 % due to the resistive losses in the copper coils putting up the magnetic field. By using superconductor and DC current these losses can be minimized and the overall efficiency can be increased to as much as 90 %. DC current requires a new design of the induction heater where the billet has to rotate with the magnetic field perpendicular into the billet. A 200 kW induction heater is to be built by using the superconductor  $MgB_2$  which was discovered in 2001. The heater consists of two coils with 16 discs in each coil. Each disc has 75 turns inwards and 75 turns outwards with a total length of 550 metres wound in two layers. The operating temperature in the coils is 20 – 22 K and the current is 200 A.

The discs in the coils have to be joined together in a resistive overlap joint. The joints will generate heat which must be cooled away and will decrease the critical current (highest current the superconductor can conduct). It is important that the joints have low resistance and can be made in fairly reproducible way. A tool to make these joints was therefore made and tested. The overlap joints had a length of 10 cm and had a resistance of maximum 71 n $\Omega$ . When increased the force pressing the conductors together the highest resistance was 48 n $\Omega$  which will generate 2 mW of heat each if a operating current is 200 A. The critical current was decreased due to the joints. The critical current was found to be 238 A at 30 K and approximately zero magnetic field density. The expected critical current for the joints are approximately 400 A at 25 K. With an expected reduction in critical current of 15 % due to the magnetic field in the joints can still conduct the operating current of 200 A with a large safety limit.

To be able to determine the performance of the joints the temperature has to be measured with a certain degree of accuracy. This was a problem in the work with testing the joints and the accuracy of the thermometer itself had to be carried out. The thermometer was the temperature dependency of the resistance in a 0.1 mm copper wire. The deviation from the given resistance ratio increased at lower temperatures and caused a misreading of as much as 5 degrees at 21 K. It was determined that the thermometers are not recommended to use at temperatures below 35 K and that they need a calibration before use at higher temperatures if high accuracy is required.

The superconducting tapes are insulated in polyimide film before they are wet-wound in an epoxy with high thermal conductivity. The insulation and winding of these discs have been going on in parallel with the joint testing and the process is described in this report.



## Preface

This report is a Masters thesis written at the Department of Electric Power Engineering, Norwegian University of Science and Technology (NTNU) during spring semester 2008. The project had a lot of practical work related to joint testing and coil winding in close collaboration with the on-going ALUHEAT project at SINTEF Energy Research.

The subject was suggested by my supervisors and SINTEF researchers Magne Runde and Niklas Magnusson. I am thankful for all help during the past five months, for introducing me to the exciting world of superconductivity and for letting me be part of such a cutting edge project. I wish you the best of luck with the project completion. I also like to thank the guys in the workshop for all help.

Trondheim, 4<sup>th</sup> of June 2008

---

Frode Sætre





# Contents

1	Introduction .....	1
2	Background .....	2
2.1	What is superconductivity? .....	2
2.2	Type 1 and type 2 superconductors .....	4
2.3	The MgB <sub>2</sub> superconductor .....	5
2.4	The ALUHEAT Project .....	6
Part 1: Splicing of MgB <sub>2</sub> superconductors .....		8
3	Making the joints and the soldering tool .....	8
3.1	Making the joints .....	8
3.2	Cooling the joints .....	9
3.3	Making the soldering tool .....	11
4	Testing the joints .....	13
4.1	Equipment .....	13
4.1.1	Cooling equipment .....	13
4.1.2	Temperature measurements .....	14
4.2	The tests performed .....	18
	Test nr 1: First joint test .....	19
	Test nr 2: Second joint test .....	20
	Test nr 3: Third joint test .....	20
	Test nr 4: Test of continuous superconductor .....	20
	Test nr 5: Test of copper thermometer .....	21
	Test nr 6: Fourth joint test .....	21
5	Results from the joint testing .....	22
5.1	First test .....	22
5.2	Second test .....	26
5.3	Third test .....	27
5.4	Test of continuous superconductor .....	29
5.5	Calibration test of copper thermometer .....	30
5.6	Fourth joint test .....	33
5.7	Result summary .....	37
6	Discussion .....	40
7	Conclusion .....	42

Part 2: Insulation and wet-winding of MgB <sub>2</sub> tapes .....	44
1 Introduction .....	44
2 The process step by step.....	44
Step 1: Insulating the tape .....	44
Step 2: Removing half of the insulated superconductor .....	45
Step 3: Winding the first layer .....	47
Step 4: Winding the second layer.....	48
3 Discussion/Conclusion of insulation and wet-winding of MgB <sub>2</sub> tapes .....	50
References .....	51
Appendices .....	52
Appendix A The soldering device.....	52
Appendix B Tables for temperature calculation .....	53
Appendix C First joint test .....	54
Appendix D Second joint test.....	55
Appendix E Third joint test.....	56
Appendix F Test of superconductor without joints.....	57
Appendix G Thermometer calibration holder .....	58
Appendix H Fourth joint test.....	59
Appendix I Temperature calculations first test .....	60
Appendix J Temperature calculations second test .....	62
Appendix K Temperature calculations third test.....	63
Appendix L Temperature calculations test of superconductor.....	65
Appendix M Best fit curves for first, second and third test .....	66
Appendix N Resistance ratio for the copper wire .....	68
Appendix O Results from calibration test.....	69
Appendix P Best fit curves last test.....	70
Appendix Q Picture of the surfaces with soldering tin .....	73
Appendix R Equipment list.....	74

# 1 Introduction

This Masters thesis is a part of the on-going ALUHEAT project which SINTEF Energy Research is leading. The main objective in the ALUHEAT project is to make a more energy efficient large scale induction heater. Such induction heaters have power ratings that can exceed 1 MW and they are used in extrusion plants to preheat aluminium around the world. The traditional heaters have a very poor efficiency of only 55 - 60 % due to the resistive losses in the hollow, water-cooled copper coils /9 p.1/. In the ALUHEAT project a 200 kW induction heater is going to be built with the coils are wound of the superconductor  $MgB_2$  instead of copper. The heater will use DC current in the coils instead of AC which requires a new design of the induction heater were the billet has to rotate with the magnetic field perpendicular into the billet. The heater will consist of two coils with 16 discs (9 km of superconductor) in each coil. These discs have to be joined together in series by using a resistive overlap joint. The resistance in the joints are caused by the non-superconducting metals in the embedding of the superconductor which the current has to travel through. During operation this resistance will generate heat which will cause the temperature to rise in the joint. The increase in temperature will cause a reduction in the critical current which is the highest current a superconductor can conduct before it exits the superconducting state at the current temperature. It is therefore very important that the joints have low resistance to make the heat generation as low as possible. One poor joint and the current has to be reduced in the whole coil. The heat generated will in addition reduce the overall efficiency of the machine due to increased cooling power consumption. Each watt that has to be cooled away at 20 K requires 48 W with an ambient temperature of 30 ° C and an efficiency of 30 % for the cooling machine /11 p.2/.

In Part 1 of this report a method for making these low-loss joints and the results will be carried out. The joints need to have as low electrical resistance as possible and they must be made in a reproducible way. After the description of how the joints were made a part about the testing of the joints and the test results will follow. During testing of the joints unexpected problems occurred with measuring the temperature on the joint samples. Time therefore had to be spent on testing and calibrating the thermometers.

In addition to the joint testing the author has contributed in winding several of the discs made during this time period. The insulating and wet-winding process will be described in Part 2 of the report.

## 2 Background

### 2.1 What is superconductivity?

Superconductivity means that the electrical resistance of a substance drops to zero when it is cooled sufficiently as shown in Figure 2-1. Zero resistance implies no loss of energy when the material is conducting an electric current and once started a current will thereby flow forever in a closed loop of superconducting material /1/.

Superconductivity was discovered in 1911 by H. Kamerlingh Onnes in Leiden who discovered that the resistance of various metals such as mercury, lead and tin disappeared completely when cooled to a temperature of only a few degrees Kelvin. Three years earlier Onnes had managed to liquefy helium, which gave him required refrigerating possibility /7 p.2/.

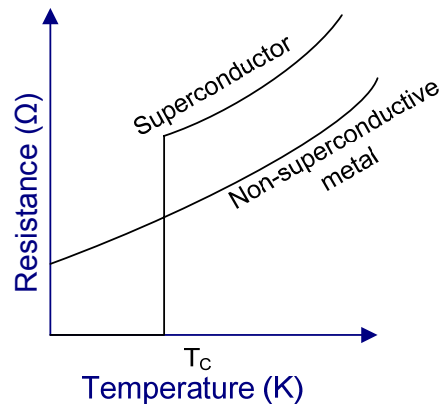
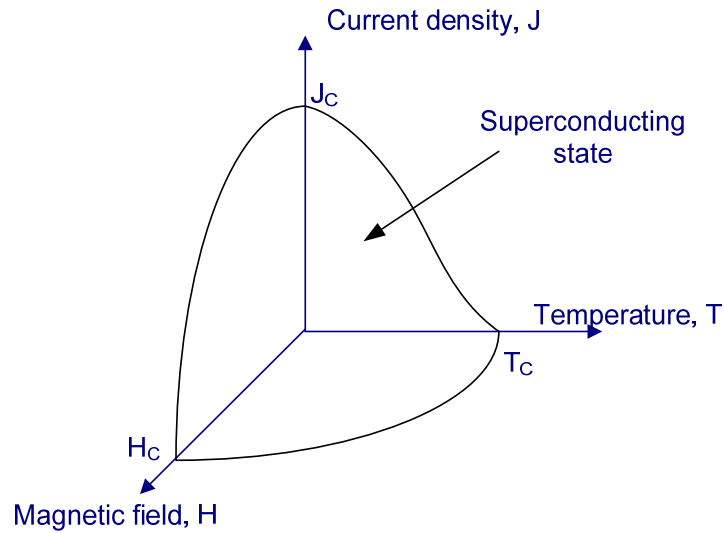

Figure 2-1: Typical behaviour of superconductive and non-superconductive materials.

The superconducting state can only occur when the superconducting material has a temperature below a certain value. This temperature is called the critical temperature  $T_C$  as shown in Figure 2-1. The superconducting state is in addition to the critical temperature defined by two other parameters: critical magnetic field ( $H_C$ ) and critical current density ( $J_C$ ) as shown in Figure 2-2.



**Figure 2-2: Superconducting state**

If for instance the temperature is close to  $T_C$  the magnetic field and current density has to have a correspondingly value close to zero or else the material will no longer be in the superconducting state.

In addition to the zero resistance property a superconductor is perfect diamagnetic which means that there is no magnetic field inside the superconducting material. The magnetic flux is being expelled by the superconducting material when it is in the superconducting state as shown in Figure 2-3. This is called the Meissner effect and was discovered in 1933 by Walther Meissner and Robert Ochsenfeld [7 p.2-3/.

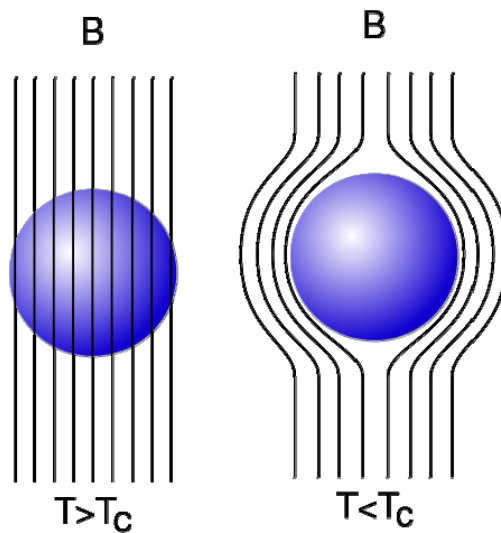

**Figure 2-3: Perfect diamagnetic superconductor to the right.**

For more details about the phenomenological descriptions see [7/ or [8 /.

## 2.2 Type 1 and type 2 superconductors

When the critical magnetic field is exceeded the superconductivity ceases to exist. The transition state between superconductivity and normal conductivity can be characterised in two ways. These two groups called type 1 and type 2 divides the superconducting materials. Type 1 is mostly pure metals like Pb, Hg, In and Al. From Figure 2-4 it can be seen that for small external fields the internal field is zero. This means that the currents that are induced generate a magnetization in opposite direction to the applied external field and of equal magnitude. For  $B < B_C$  yields:

1

$$B_i = B_a + \mu_0 M = 0$$

If the external field is increased the superconductor will not be able to expel the magnetic field and a transition to normal state takes place. The shape of the superconducting leader determines the exact value of when this transition starts to take place. Before the conductor becomes normal there will be a state where both normal and superconducting domains exist. This state is called the intermediate state [8 p. 350-351/].

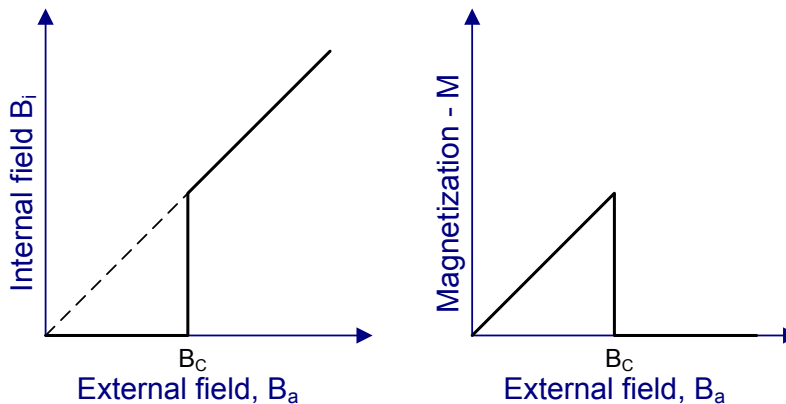

Figure 2-4: Left: Magnetic field inside type 1 superconductor. Right: The magnetization generated in a type 1 superconductor [8 p. 350/]

Alloys, transition metals, metallic glasses and the novel high temperature superconductors are type 2 superconductors. As for type 1 superconductors the external applied magnetic field is expelled until a certain value of the field strength, see Figure 2-5. The main difference between type 1 and type 2 is that in type 2 superconductors normal conducting areas are formed within the superconducting material. This allows penetration of magnetic field in the form of thin filaments, called flux lines or vortices. For magnetic fields below  $B_{C1}$  type 1 and 2 behave in the same way, but for fields lower than  $B_{C2}$  and higher  $B_{C1}$  the external magnetic field is only partly expelled by the type 2 superconductor. The phase between  $B_{C1}$  and  $B_{C2}$  is called the mixed state [8 p.354-355/].

The resistivity in a type 1 superconductor will be zero until a sudden transition to normal conducting state occurs. The superconductor in Figure 2-1 is therefore a type 1 superconductor. Type 2 superconductors have a transition region called mixed state between normal and superconducting region as shown to the right in Figure 2-5. The critical temperature is defined as the temperature when the resistance is reduced to half the value it had when it started decreasing. A common way of determining the critical current is the current which makes the voltage rise to  $1 \mu\text{V} / \text{cm}$  [11 p.27/]. All the superconductors which have any practical interest are of type 2.

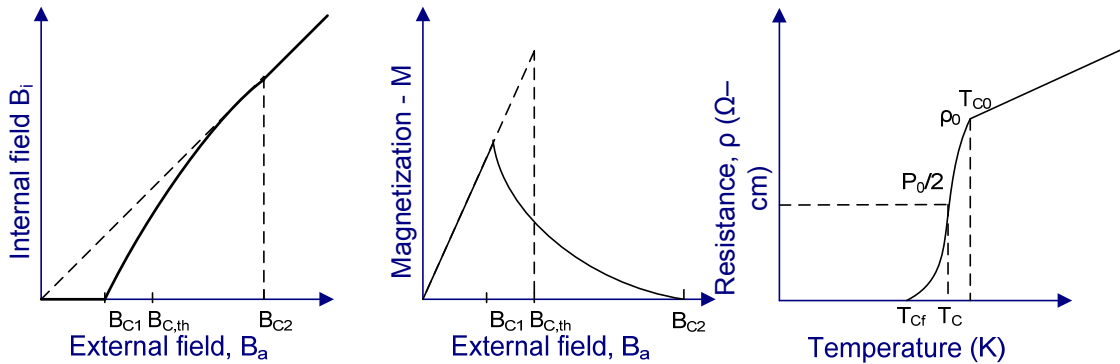

Figure 2-5: Left: Magnetic field inside type 2 superconductor. Middle: The magnetization generated in a type 2 superconductor /8 p. 355/. Right: Resistance in low magnetic field /12 p. 56/.

When operating a type 2 superconductor in the mixed state the superconductor generates losses since the resistance no longer is zero. In the mixed state normal conducting areas called vortices are formed within the superconductor. These vortices do not expel the external magnetic field, but conduct one flux quantum each. The vortices are held in position by a force called the pinning force. Due to the current flowing perpendicular to the magnetic field the vortices are being exposed to another force called the Lorentz force. When the current or magnetic field gets high enough the Lorentz force exceeds the pinning force and the vortices starts to move. This movement generates losses in the superconductors in the mixed state.

### 2.3 The $MgB_2$ superconductor

The superconductor in the ALUHEAT project and in this thesis is magnesium diboride,  $MgB_2$ . This superconductor was discovered in 2001 and has a critical temperature of 39 K /4/. The molecular structure is quite similar to graphite with layers as shown in Figure 2-6. Since boron atoms have fewer valence electrons than carbon the lattice vibrations are larger which results in strong electron pairs /1/.

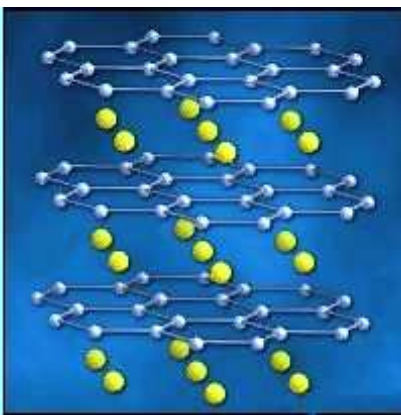

Figure 2-6: Molecular structure of  $MgB_2$ . Magnesium atoms are the yellow large ones /1/.

$MgB_2$  exist as powder and the superconductor is therefore produced by the powder-in-tube (PIT) method /1/. The  $MgB_2$  superconductor can be combined with a large variety of metals except for copper. In the embedding of the superconductor copper is usually used to protect the superconductor thermally and electrically in case of sudden loss of superconductivity /14/. In the superconductor used in this project (produced by Columbus) copper is used, but it is separated from the superconductor with a layer of iron as shown in Figure 2-7 /14/.

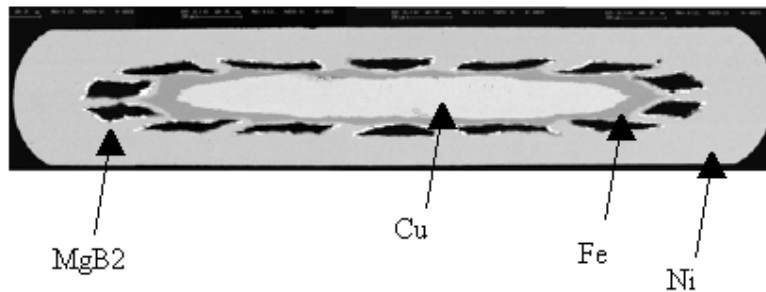

Figure 2-7: Cross section of the MgB<sub>2</sub> superconducting tape.

Table 2-1: Specifications of superconducting MgB<sub>2</sub> tape.

Thickness (mm):	0.65
Width (mm):	3.8
Tot.Cr.Sect.(mm <sup>2</sup> ):	2.444
Sup.Cr.Sect.(mm <sup>2</sup> ):	0.247

The main advantage with this superconductor is the low price on magnesium and boron compared to other superconductors. The extreme low temperature is the main obstacle against a more widespread use of superconductivity. In recent years commercial refrigerators (cry-coolers) have been made more efficient and reliable and are now capable of cooling bigger and bigger devices /14/.

Other applications were superconductors improve the energy efficiency are superconducting motors, generators, power cables, magnetic levitation and medical devices. In addition devices such as superconducting fault current limiters (SFCL), resonance imagers (MRI), and weak magnetic field sensors (SQUID) are on the market /14/.

## 2.4 The ALUHEAT Project

The ALUHEAT project which this master thesis is a part of is making a 200 kW prototype of an industrial induction heater with coils made by the superconductor magnesium diboride (MgB<sub>2</sub>) instead of traditional copper. The traditional type of induction heaters have an efficiency of only 55 -60 % and are typically used in extrusion plants to preheat aluminium billets to 450 - 500 ° C /9 p.1/. The purpose of the project is to increase the overall efficiency by reducing the losses caused by the resistance in the copper coils in the conventional induction heater by replacing the copper with superconductor. This project is sponsored by EU and nine different parties in six different countries are participating.

Induction heating means that currents are being induced by a varying magnetic field which then generates heat due to the electrical resistance in the material. The alternating magnetic field can be achieved in two ways; either by letting the workpiece be standing still and use AC current to put up the magnetic field or by moving or rotating the workpiece within a constant magnetic field put up by a DC current. When using AC current there are losses in the superconductor which require higher cooling capacity. In the ALUHEAT project DC current will be used in the superconducting coils to put up the magnetic field. The aluminium billet then has to be rotated to make the magnetic field through the billet alternating. This will induce currents which generate heat in the aluminium (see Figure 2-8). Each coil is made of 16 discs placed upon each other and soldered together. Each disc contains approximately 150 turns where 75 is wound inwards and 75 wound outwards with a length of 550 metres of



continuous superconductor. The total superconductor length is then close to 9 km in each coil. The operating current and temperature is 200 A and 20 -22 K /13 p.3/. The magnetic field over the billet will be about 0.4 - 0.5 T and the maximum field over the superconductor coils will be 1.5 T /9/

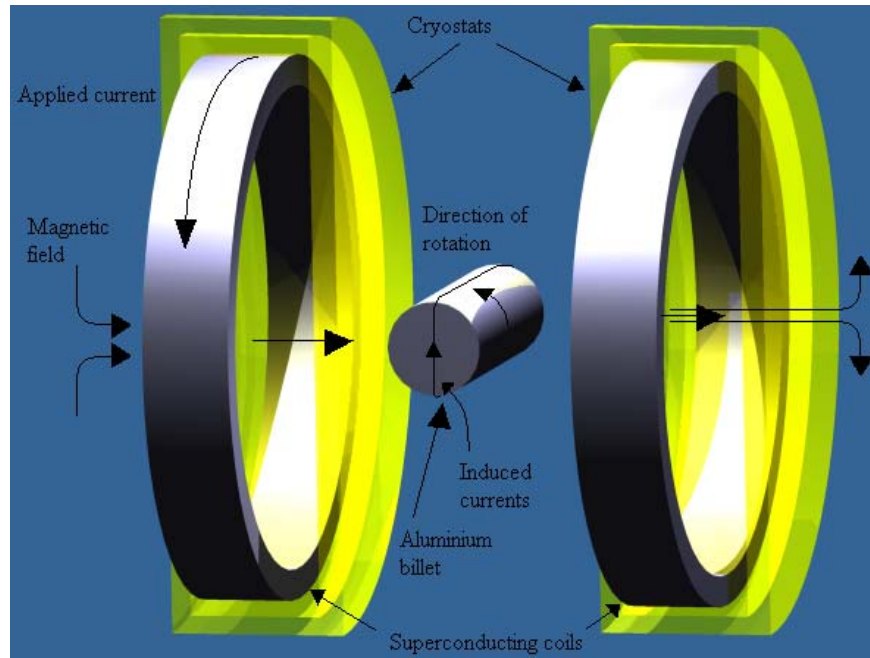

Figure 2-8: Sketch of the superconducting induction heater with the cryostats “opened”.

## Part 1: Splicing of MgB<sub>2</sub> superconductors

### 3 Making the joints and the soldering tool

#### 3.1 Making the joints

A resistive overlap joint is going to be used. The task is to find a way to make these joints and to investigate how weakened the superconductor is after inserting a joint. The joints were made by the following steps:

- Remove polyamide film (insulating tape)
- Roughly polish the surface with sandpaper
- Make sure the surface is clean (wash with acetone or use soldering water and wipe off)
- Wet the surface with soldering water (Stannol)
- Heat the surface while adding melted soldering tin (Multichoice, Sn50Pb49Cu1) in a thin layer covering the whole surface
- Make an overlap joint by putting the superconductor surfaces with soldering tin together.
- Apply heat while forcing the tapes together (Figure 3-1 )
- Firmly press the surfaces together while the tin is cooled and hardens.

The difficult part with making the joints by hand was that both heat and pressure only gets applied to a small area close to the tip of the soldering iron. When moving the soldering iron along the joint the pressure has to be kept firm were the soldering tin still is liquid. This is difficult since the item that is used to apply press with also have to be moved. This might cause movements in the joint during hardening which again might cause crystallisation of the soldering tin.



Figure 3-1: How the first joints were made

The method would in addition be both risky and difficult to perform vertically on the prototype coils specially since there is no table to press against. The problem is illustrated in Figure 3-2.

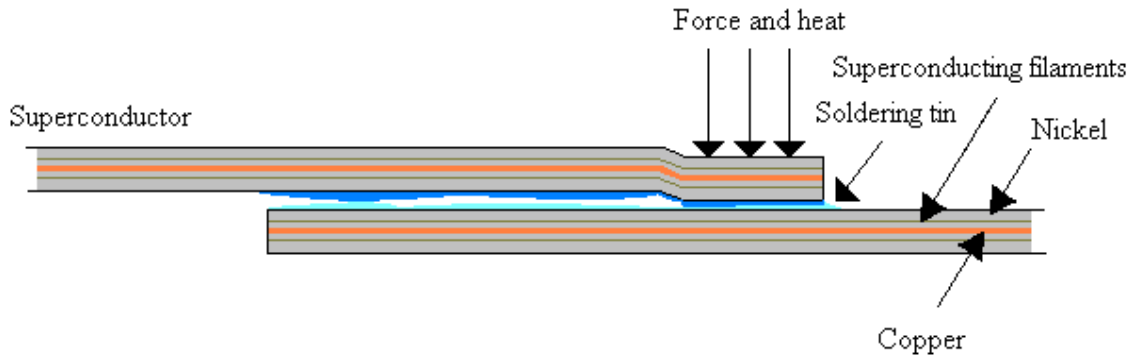

Figure 3-2: How the first joints were made.

To avoid this problem later on it was therefore desirable to make a tool which applies both pressure and heat to the whole length of the joint at once. In addition to reducing the risk of damaging the superconductor in the process the joints would hopefully be both reliable and reproducible by using this tool.

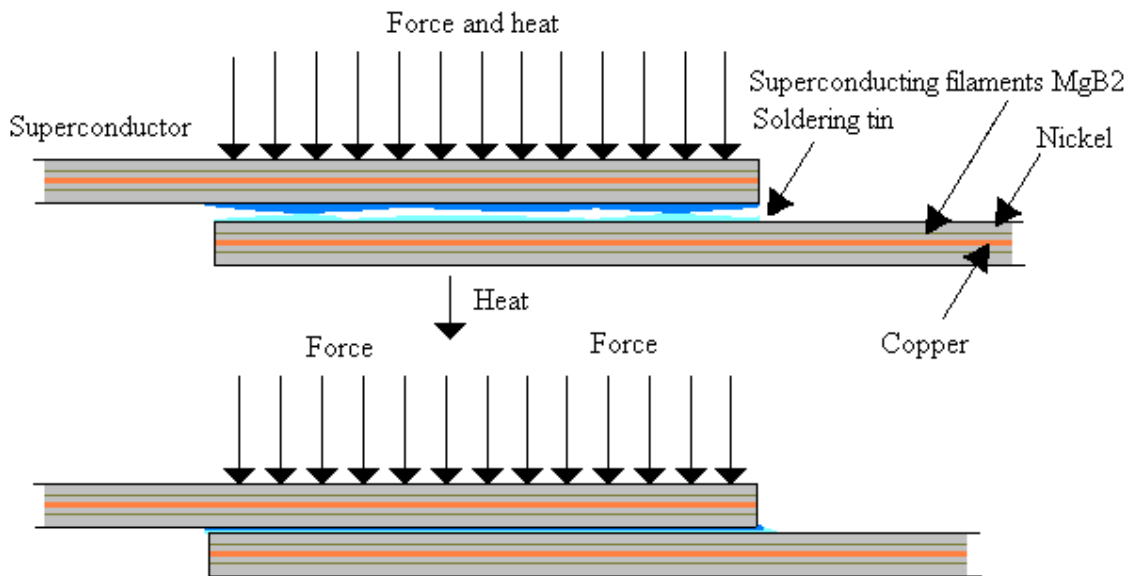

Figure 3-3: The preferred way of making the overlap joints was to apply both heat and pressure to the entire length of the joint at once.

### 3.2 Cooling the joints

There are many different ways of making these joints which were never tested due to the time-frame of this thesis. Two of them are shown below. To conduct the heat generated by the resistive metal in the joint a copper sheet could have been added between the tapes for extra conductive cooling. This sheet must be able to conduct more heat than it is generating to work as intended. Copper has increasing thermal conductivity when cooled as shown in Figure 3-5.

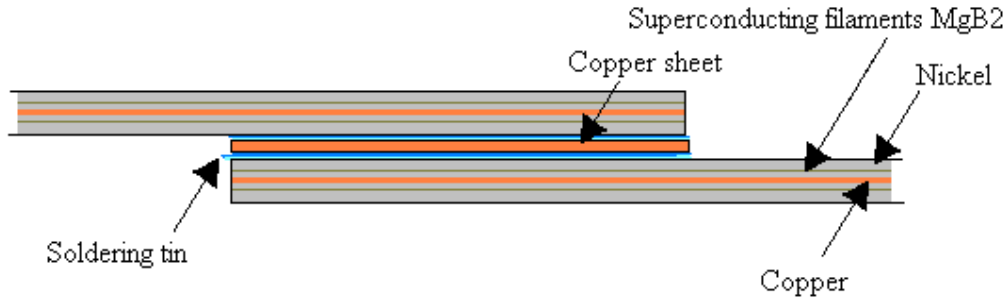

Figure 3-4: To remove heat from the joint one could put a copper sheet inside the overlap joint.

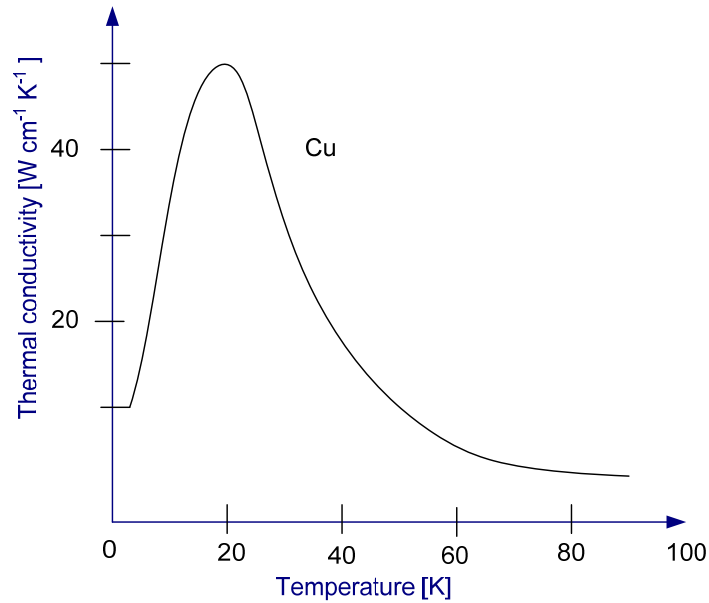

Figure 3-5: Thermal conductivity of copper. A pronounced maximum is observed at 20 K.

According to Appendix B the resistivity of copper is approximately reduced by factor of 0.0119 when cooled to 20 K which gives  $\rho = 1.92 \cdot 10^{-10} \Omega \cdot m$  if  $\rho = 1.72 \cdot 10^{-8} \Omega \cdot m$  at 20 ° C. For a 1 mm thick copper sheet, 3.8 mm wide conductor and a 10 cm long joint the resistance will be:

2

$$R = \rho \cdot \frac{l}{A} = 1.92 \cdot 10^{-10} \Omega m \cdot \frac{1 \cdot 10^{-3} m}{0.10 m \cdot 3.8 \cdot 10^{-3} m} = 5.06 \cdot 10^{-10} \Omega$$

With a current of 300 A the heat generated is approximately:

3

$$P = V \cdot I = R \cdot I^2 = 5.06 \cdot 10^{-10} \Omega \cdot (300 A)^2 = 4.55 \cdot 10^{-5} W$$

If we assume 2 degrees temperature difference and a distance of 10 cm between the joint and the heat sink and a thermal conductivity of copper of 50 W/cm K the maximum heat possible to transfer away with this copper sheet is:

4

$$P = \Lambda \cdot A \cdot \frac{\Delta T}{L} = 5000 \frac{W}{mK} \cdot 1 \cdot 10^{-3} m \cdot 0.1 m \cdot \frac{2 K}{0.1 m} = 10 W$$

The copper sheet will probably very effectively cool the joint from the middle. The heat generated in the outer layer of the overlap joint does not have to travel through the inner superconducting layer. The temperature gradient across the joint will therefore be smaller.

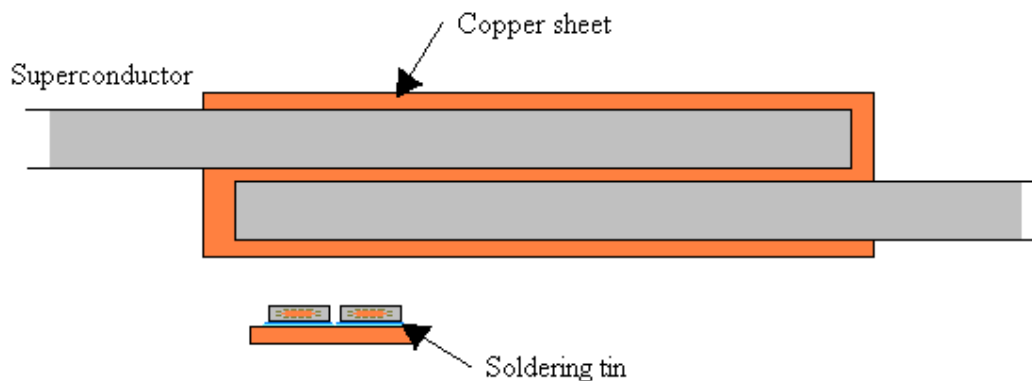

Figure 3-6: Joining the superconductors together using a copper sheet.

In this joint the superconductor is soldered laying flat to a copper sheet. If it is assumed that the average current path is 4 mm and the copper sheet is 1 mm thick and 10 cm long the heat generated by the copper sheet is then  $73 \cdot 10^{-5}$  W and the formulas above is used. The soldering tin layer is then neglected. If copper sheets are used on both sides the area doubles and the heat generated is halved. These two joint types have not been tested in this project, but are mentioned since they might be considered later.

### 3.3 Making the soldering tool

The motivation of making the tool was to be sure that the joints were reliable, reproducible and that they could be made with low risk of damaging the superconductor tape. It is necessary to apply both heat and force at the same time to ensure that the soldering tin is melted on the entire surface while a uniform force is pressing the conductors firmly together during heating. When the temperature is high enough the heating can be turned off, but the conductors have to be pressed together until the soldering tin has hardened. Four different ways of making this tool were considered:

- I. Using **gas** to heat the joint while applying pressure with a tool made of a heat resistant material. Alternatively use gas to heat copper which conducts heat to the joint.
- II. Generate heat by applying a **current** through the joint while putting pressure on the joint for example by modifying a tube welding tool
- III. Create a soldering tong by **modifying a clamper or a pipe tong** and use a high resistance conductor as heating element in contact with metal to generate heat.
- IV. **Modify a high power soldering iron** by making a special designed copper piece which is heated from the heating elements in the soldering iron.

To exploit the superconductor for a gas flame or high current was really not an alternative due to the high risk of damaging the conductor either by current or heat. Alternative three were unnecessary complicated when a high power soldering iron for alternative four was available. The soldering iron had two heating elements which heated a thick copper piece. By substituting this piece with specially designed copper piece for the joint soldering, soldering tool could easily be made. Pressure could then be applied by using spring force on another flat piece of copper which is laying parallel on top of the other one with the superconductors to be joined together in between. The tool that was made is shown in Figure 3-7 and Figure 3-8. A more detailed drawing of the tool is put in Appendix A.

The tool is usually connected directly to the grid. Since there were no problem melting the soldering tin with heat applied from only one side of the joint the heat in the soldering tool is only applied from the lower copper sheet. The tin first melts at the hottest spot in the middle and then the rest of the joint immediately afterwards. When the tin becomes liquid the force applied from the springs will force the conductors together and the surplus of tin will be squeezed out of the joint. There have been no problems related to soldering the superconductor to the copper parts probably due to the oxidation layer on the copper surfaces. When the current is switched off the copper cools down and the tin hardens. The temperature is measured with a digital thermometer and the heating current can be switched off when the temperature is high enough. This requires close attention with the thermometer and one have to remember that there is a certain thermal delay in the copper sheet. Alternatively one can use an adjustable power supply to control the current and thereby the heat. The maximum temperature of approximately 470 ° C was reached after 45 minutes with 230 V. A short test was performed by using different voltages and the results are listed in the table in Appendix A.

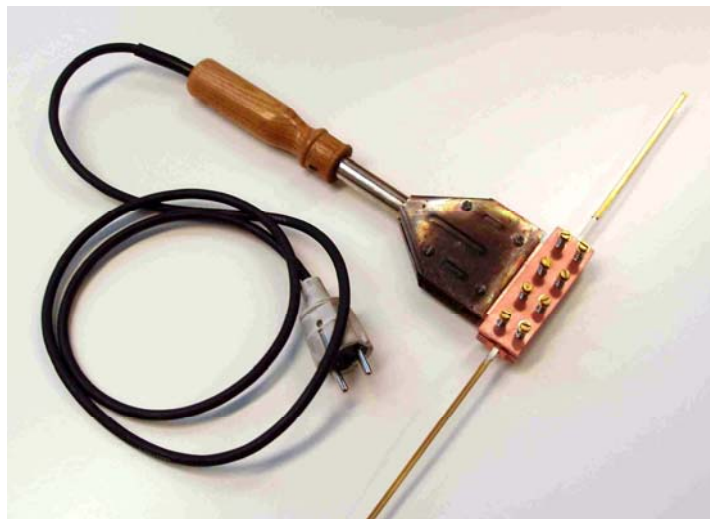

**Figure 3-7: Soldering tool made for making this type of joints**

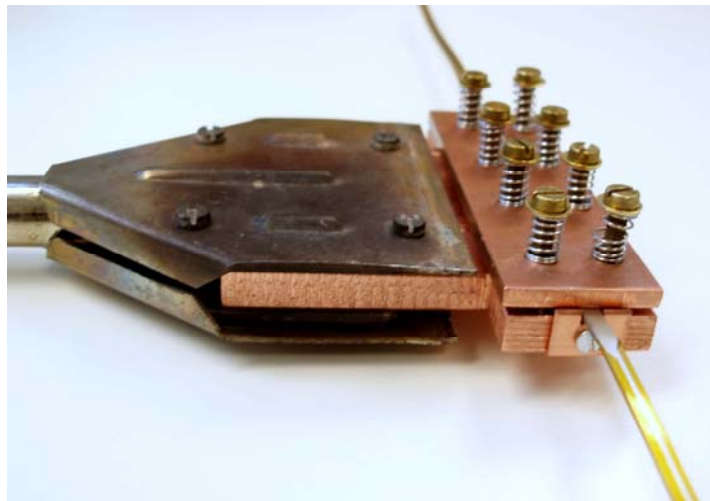

**Figure 3-8: Detailed picture of the soldering tool used**

After the first test when these snapshots were taken some modifications were performed on the soldering tool. New stiffer springs were made which increased the pressing force. The

screws were replaced with longer ones and inserted from the other side. Wing nuts were then used to tighten the springs and shaped washers were used to prevent the springs from jamming between the washers and the screws. The soldering tool was also equipped with a digital thermometer with the sensor attached between the thick copper sheet and one of the copper bushings. The holder for the tool makes it possible to solder superconductors at a lower level than the placement of the holder which is convenient on the prototype coils. The joints described in 3.2 can also be made with this tool.

## **4 Testing the joints**

### **4.1 Equipment**

#### **4.1.1 Cooling equipment**

A cryostat, see Figure 4-1 with vacuum and a cold pump and liquid nitrogen was used for cooling. New copper sheets to provide thermal contact between the cold head and the superconductor samples had to be made. This sheet, called the holder in the report, is screwed to the cold head by the eight screws in the middle of the plate. The cold head is cooled by a helium refrigerating machine. Liquid nitrogen is used to cool most of the heat from the surroundings by pouring it into the upper cryostat half and into a thermal insulated bucket placed under the lower cryostat half. In the lower cryostat half the current leads are entering. The main current leads are made of regular copper and are cooled by liquid nitrogen in the bucket to avoid too much conductive heat transfer into the cryostat.

There are several layers of radiation shields. The outer most is made of aluminium foil. The shield within the aluminium shield is made of copper and is cooled by the liquid nitrogen in the upper cryostat half. In addition to this two the superconductor holder was usually wrapped up in several layers of aluminium foil.

The leads to the sample are made of four BSCCo superconductors in parallel which is cooled from the cold head directly. To make sure that the superconductor sample has a bit higher temperature than the leads some layers of paper is put between the sample holder and the cold head.

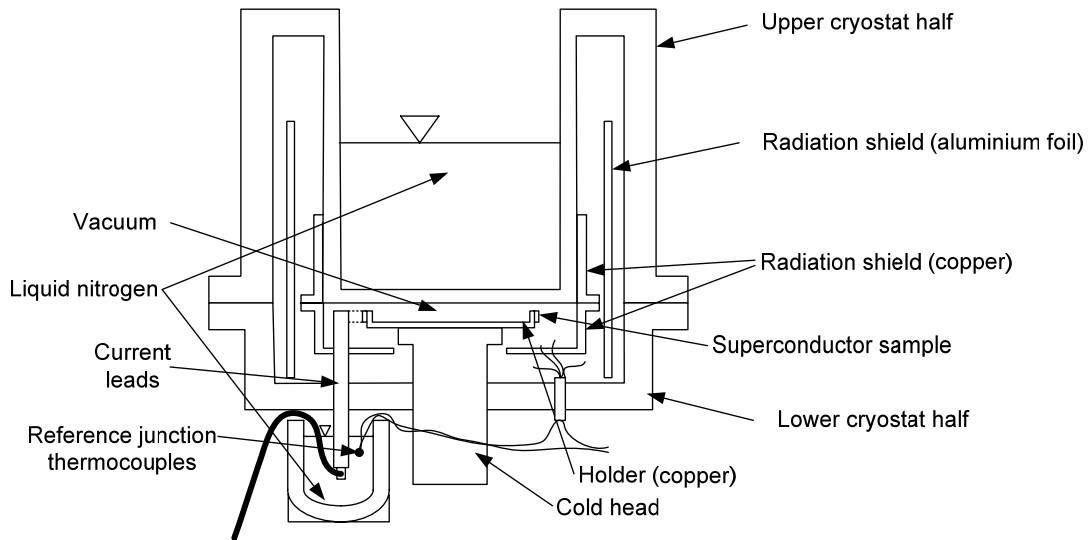

Figure 4-1: Cryostat

The inlet to the vacuum pump is on the lower cryostat half. The wanted pressure was less than 0.001 mbar after cooling, but in the last two or three tests the pressure was approximately minimum 0.02 mbar which caused an increase in temperature of approximately 5 degrees.

#### 4.1.2 Temperature measurements

Temperature influences all natural physical phenomena and is both a thermodynamic property and a fundamental unit of measurement. By observing different physical phenomena which are dependent on temperature numerous ways of measuring temperature have been found. The most used phenomena are volumetric expansion, vapour pressure, spectral characteristics, electrical resistance and electromotive force.

The superconductor,  $\text{MgB}_2$  is operating at temperatures roughly between 20 and 40 K. The superconductors are mounted inside a cryostat and the most appropriate temperature sensors are therefore resistance thermometers or thermocouples. Resistance thermometers utilize the temperature dependency of the electrical resistivity in different materials such as platinum and copper. Thermocouples utilize the internal electromotive force in different materials.

##### 4.1.2.1 Resistance temperature detectors (RTD)

The most common and best-characterized thermometers for very low temperature measurements are those that relate temperature to electrical resistance [3 p. 9]. In Figure 4-2 two measurement bridges are shown. When using two-lead measurement scheme the voltage measured with the instrument is the sum of the temperature sensor voltage and the voltage drop across the two leads. With four-lead measurement scheme the leads used to measure voltage are separated from the current carrying leads. The latter method is preferably since the uncertainties associated with the resistance in the leads are avoided.



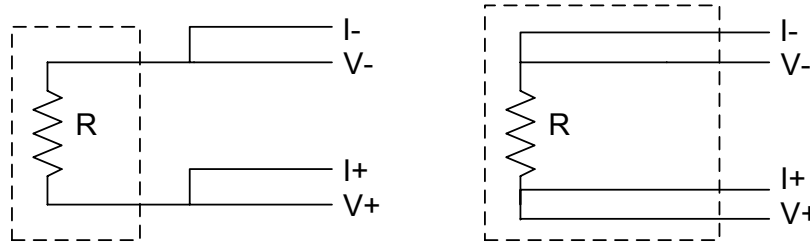

Figure 4-2: Two simple resistance bridges. Stapled lines indicate low temperature location and  $R$  is the temperature sensor. Left: Two-lead measurement scheme. Right: Four-lead measurement scheme.

There are several different metals that can be used. The higher resistivity the physically smaller the temperature sensor can be made. High resistance temperature coefficient ensures a high sensitive thermometer. The metals used should also have stable physical properties, high resistance to oxidation and corrosion and have sufficient mechanical strength. They also need to be easy reproducible and have a continuous temperature resistance dependency /6 p. 89/.

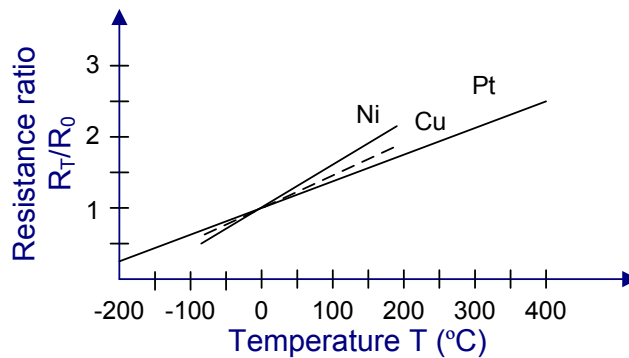

Figure 4-3: Resistance  $R_T$  at temperature  $T$  related to  $R_0$  at  $0$   $^{\circ}\text{C}$  for Ni, Cu and Pt /6 p.89/.

The most widely used metals and their temperature ranges are listed below:

- Copper:  $-100$   $^{\circ}\text{C}$  to  $+100$   $^{\circ}\text{C}$  /2 p. 145/
- Platinum:  $-260$   $^{\circ}\text{C}$  to  $+1000$   $^{\circ}\text{C}$  /2 p. 145/
- Nickel:  $-60$   $^{\circ}\text{C}$  to  $+180$   $^{\circ}\text{C}$  /2 p. 172/
- Rhodium-iron:  $0.5$  K to  $30$  K /3 p.7/
- Germanium:  $1$  K to  $100$  K /3 p.7/
- Carbon:  $0.5$  K to  $30$  K /3 p.7/
- Carbon-glass:  $4$  K to  $30$  K /3 p.7/

The materials can be used outside these temperature ranges, but this might require calibration in a more narrow temperature range. Copper and nickel are low in cost, but have limited linear temperature range /2 p. 145/. The resistance of copper is quite low which means that the sensor has to be a long thin wire or a thin film. One popular application of copper resistance is temperature measurements of the windings of transformers and electrical machines where the windings themselves are the resistance element /6 p.90/.

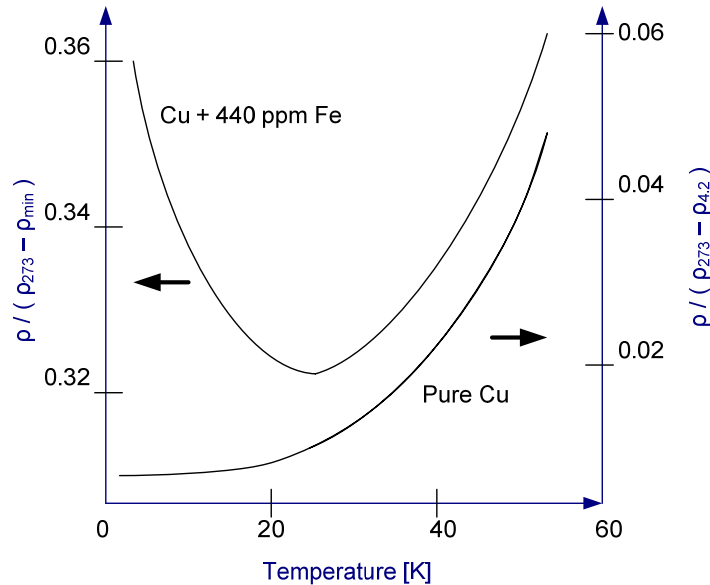

Figure 4-4: Reduced electrical conductivity is the effect of doping copper with iron /8 p.225/.

The effect that impurities have on copper can be seen in Figure 4-4. The metals behave nearly identical before the resistivity in the doped copper rises again below 27 K. This is known as the Kondo effect and typical metals that show this effect are simple metals containing a small amount of transition metal or impurities atoms. Since one usually only observe the ratio between the resistance before and after cooling, i.e. one do not compare the resistance of the copper with the reference value, impure copper might be unfortunately be used. Nickel has higher resistivity, but is more sensitive to strain and corrosion /2 p. 145/. Platinum has six times higher resistivity than copper. It is stable and non reactive and has a well established temperature coefficient which makes it well suited for temperature measurements /2 p. 145/.

In this project 0.1 mm copper wires will be used as resistance thermometers. The table of the resistance ratio for electrolytic copper can be found in Appendix B. The copper wires were calibrated against a temperature sensor called Cernox and the results are given in 5.5.

#### 4.1.2.2 Thermocouples

Thermocouples utilize the phenomena that cause a current to flow in a closed loop of two dissimilar metals when their junctions are at two different temperatures. This effect was discovered in 1821 by T. Seebeck and is called thermal electromotive force, emf. /6 p.37/. To use the Seebeck effect in practical temperature measurements it requires connection of a voltage measuring instrument were the leads will introduce a third metal. As long as the joints attaching the third metal are at the same temperature the third metal will not effect the resulting emf /6 p.40/. The measuring joint between metal A and B can be soldered (hard or soft), welded (arc or flame) or twisted together. The presence of a third metal in the joints will not affect the electromotive force as long as the entire joint has a uniform temperature /6 p. 50/.

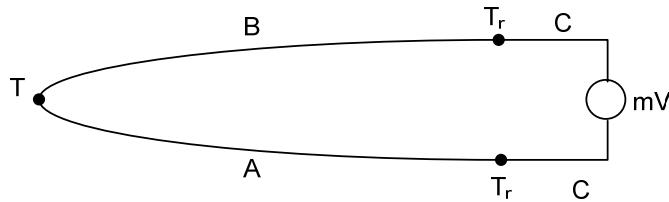

Figure 4-5: Thermocouples of material A and B with material C as leads.

The combination of low cost and a very large temperature range from  $-272^{\circ}\text{C}$  to  $2000^{\circ}\text{C}$  have made thermocouple widely used in both industry and research relations.

The joints to the third metal are called the reference junctions and they have to be at a certain reference temperature. In this project the thermocouples of type E are used with the reference junctions placed in boiling liquid nitrogen with a temperature of  $77.3\text{ K}$ . The type E thermocouples are nickel-chromium and copper-nickel metals. These two metals give the highest emf of all thermocouples. The temperature range is from  $-270^{\circ}\text{C}$  to  $800^{\circ}\text{C}$ .

#### 4.1.2.3 Installation of temperature sensors and heating elements

The copper and heating wires were attached to the samples with epoxy in three different ways. The heating wires are stretched out to heat an area typically  $10\text{ cm}$  long and the temperature will be highest in the middle as illustrated in Figure 4-7. With the copper wires stretched out the resistance measured will relate to the average temperature in the wire.

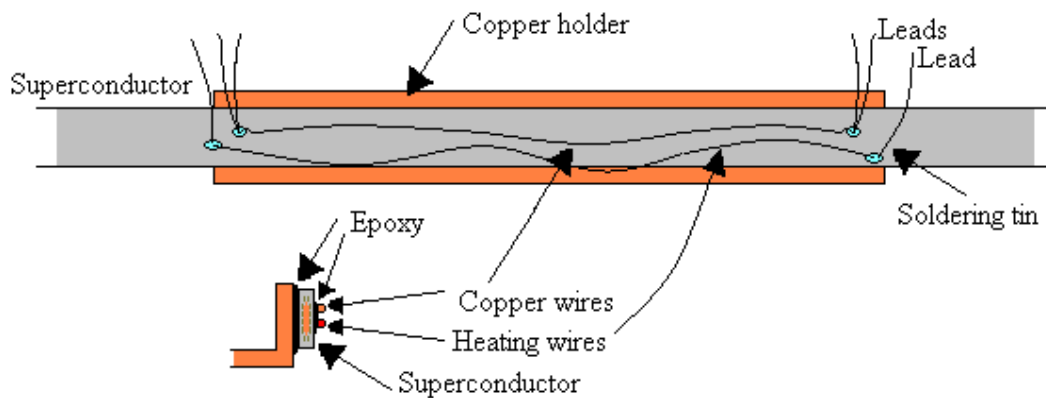

Figure 4-6: Installation of copper wires and heating element to a joint or superconductor.

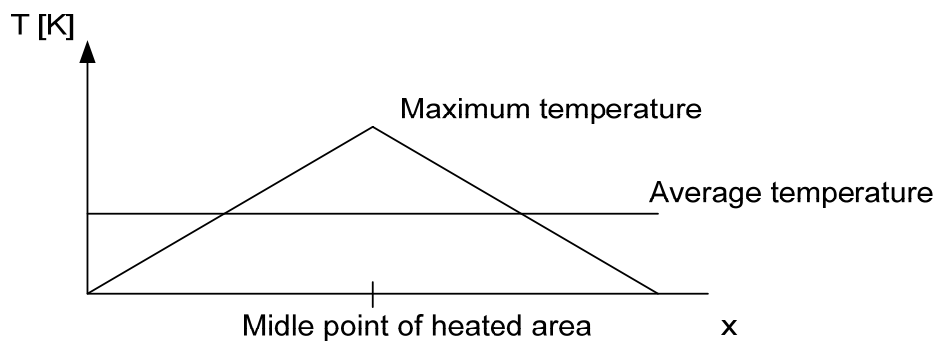

Figure 4-7: Assumed temperature profile of the heated area.

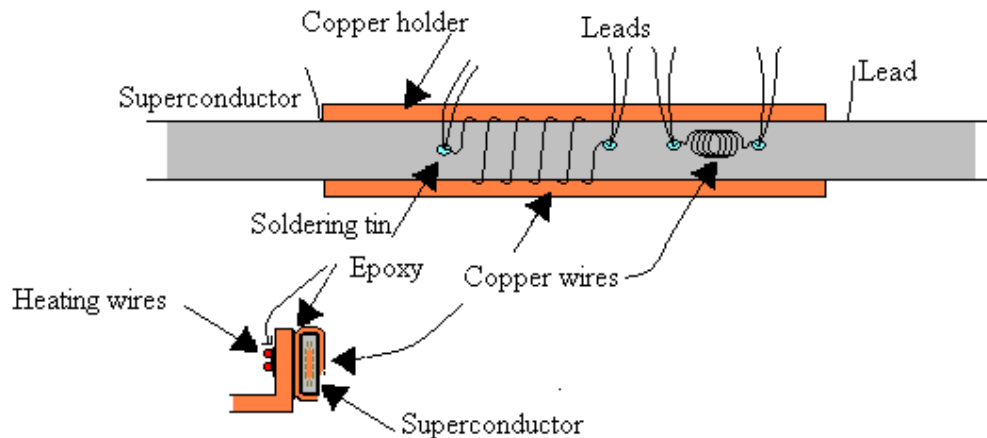

Figure 4-8: Installation of copper wires for temperature measurement.

To measure the temperature in a smaller area one has to make sure that the whole copper wire has the same temperature as the point you want to measure. This was either done by winding the copper wire in a coil before gluing it to the superconductor or it was wound around the superconductor itself. To avoid having many wires hanging around it was simpler to wound it in a coil than around the superconductor. The winding direction of the copper wire was switched half way to avoid setting up a magnetic field. There were not noticed any exceptional differences in these two ways of installing the copper wire, but in the second joint test the temperature in the middle was measured to be 1 K higher than what the stretched out wired measured.

It is also recommended to let the soldered joints to the leads be moulded together to the rest of the coil or sample to avoid loosening of wires. Another tip is also to use paper tape as a casting frame for the epoxy. The wires are then held in place during hardening without to much mess.



Figure 4-9: Simple way of attaching wires to the samples by using paper tape.

## 4.2 The tests performed

In this chapter there will be descriptions of the different tests performed on the joints, superconductor and copper wires. The result from each test is presented in chapter 1 and a summary of the results in chapter 5.7.

In all the tests a copper holder was used to ensure conductive cooling of the superconductor sample. The sample was glued on to the holder at the outside of a bend. This was done by using an epoxy called Stycast 2850 with a hardener agent called Catalyst 24 LV. To control the temperature one could increase the temperature by using heating elements of high resistive

wire glued to an area of the sample with the same epoxy. Copper wires and thermocouples were used as thermometers and were also usually glued to the sample with this epoxy. The wires were thermally anchored to provide a heat sink either by gluing some centimetres of the wires to the middle of the sample or squeezing them between two copper sheets together with Apiezon Grease. Current was applied from a DC source and the voltage across different parts of the superconductor was registered. The current leads into the cryostat are copper cooled with liquid nitrogen. The copper is joined to four BSSCo superconductors in parallel which is superconducting for temperatures up to 110 K. The sample to be tested is then soldered to these conductors. The measuring wires were 0.2 mm copper wires soldered directly to the superconductor.

**Table 4-1: Summary of the tests performed:**

Test nr	Purpose:	Jointlengths:	Comments joints:	Comments thermometers:
1	Resistance in the joints and critical current	2.5 - 2.5 - 5 - 5	Soldered manually, 390 - 400 °C, with sand paper polishing	Heating and copper wires attached on the outside of the holder bend. Stretched out.
2	Critical current in continuous superconductor	2.5 - 2.5 - 5 - 5	Same joints as nr 1, added heating area on the continuous SC	Same as nr 1. New copper wire wound in a coil added to the area on the continuous CS
3	Test the tool, resistance and critical current in superconductor with joints	10 -10	Soldering tool used, 290 - 300 °C, no polishing of surfaces, four soft springs	Heating wires on the inside of bend and copper wires on the outside wound around the CS
4	Critical current in continuous superconductor	No joints	Test of superconductor without joints	Heating wires on the inside and copper wires on the outside wound around the CS
5	Copper thermometer check with Cernox sensor		Test of copper wires	Mounted on an 8 mm copper block along with the Cernox sensor. Thermally anchored two places
6	Resistance in the joints and critical current. Compare copper thermometer with Cernox	10 - 10 - 20	Eight stiff springs, with sandpaper polishing, 290 - 300 °C	Heating wires on the inside and copper wires in coil on the outside. Cernox and one copper wire attached close to the cold head.

### Test nr 1: First joint test

The purpose of the first joint test was to determine the resistance in the joints and to investigate if the critical current gets reduced and if so by how much. It was also desirable get some experience in handling the tape and to find a procedure of how to make the joints on the prototype coils. After the resistance in the joints had been determined the length of the overlap could be calculated and the soldering tool could be designed.

There were made four joints to investigate how large the expected resistance and then also the heat generation in each joint will be. The joints were made by the steps described in 3.1 without the mentioned tool and with a temperature during soldering of approximately 390 – 400 °C. The copper holder is 0.1 mm thick and with a 1 cm high bend on the outer edge. Both

copper and heating wires are stretched out and attached on the outside of the bend. The measurement set-up and a sketch can be found in Appendix C and the results from this test can be found in 5.1.

### **Test nr 2: Second joint test**

The first test did not compare the joints with a part of the continuous superconductor and since the temperature measurements were not very accurate it was hard to decide if the superconductor had been weakened by the soldering or not. Therefore some new measurements were prepared on the same sample. In the second test the joints were compared to some centimetre of the continuous superconductor to see if there was any significant difference. To measure the voltage across a piece of the continuous superconductor a voltage probe had to be moved. In addition the copper wires were made in one small coil instead of being straightened out as in the first test. The temperature could then hopefully be measured more accurately. The heating wire was glued on the outside of the bend. The measurement set-up and a sketch can be found in Appendix D and the results for this test can be found in 5.2.

### **Test nr 3: Third joint test**

In this test it was desirable to test the functionality of the soldering tool that had been made after the two first tests. In the third joint test the joints were made with a temperature of 290 – 300 °C which is approximately 100 °C lower than in the previous tests. To be able to compare the joints with a continuous piece of the superconductor the two samples must have the exact same temperature. By using two turns the joint can be compared to a piece of the superconductor which is placed very close on the same copper piece as the joint. The two samples will then have the exact same temperature and it can be determined if the joint has a lower critical current than the continuous superconductor. The copper plate this time is 1.5 mm thick and the outer edge is 1.5 cm high since it has to be enough space for two turns. The heating elements are glued on the inside of the copper holder and the superconductor is glued on the outside with the copper wires wound around it.

The two joints were made with the new tool, but without using sandpaper or acetone. This is because less work with the superconductor tape is wanted because this means less risk of failure during soldering on the prototype coils. Four springs were used on the soldering tool, but during soldering it was stated that this force should have been higher. The measurement set-up and a sketch can be found in Appendix E and the results are given in 5.3.

### **Test nr 4: Test of continuous superconductor**

Since only one value for the critical current at this low magnetic field was listed from the producer it was desirable to find the critical current for several temperatures. These could then help determine how weakened the superconductor is after inserting a joint. This test should therefore investigate the critical current in a piece of superconductor without any joints. The heating elements and copper wires were installed in the same way as in test nr 4 with the heating wires moulded on the inside and the copper wires wound around the conductor on the outside. The measurement set-up and a sketch can be found in Appendix F and the results are given in 5.4.

### Test nr 5: Test of copper thermometer

Since there had been some uncertainty in the temperature measurements with the copper wires a test which compared this method with a reliable thermometer was necessary. Six copper wires were wound in small coils and soaked in epoxy to get good thermal conduction. Four leads were attached to each copper wire before it was mounted on to a copper sheet with spring forced clamps. A thick copper sheet was used as holder for the thermometers as shown in Appendix G. Two thermal anchors at each set of leads were used were one of them was on the copper holder itself and the other one on the copper screen encapsulating the thermometers. The wire used as resistor is a 0.1 mm copper wire and the leads are 0.2 mm copper wire. The thermometer purchased from Lake Shore Cryotronics was a Cernox 1070-SD-4B which is calibrated between 4 and 40 K. The design of the copper holder can be found in Appendix G and the results can be viewed in 5.5.



Figure 4-10: Test of copper wires

### Test nr 6: Fourth joint test

Since the spring force was too weak last time the soldering tool was tested two 10 cm joints and one 20 cm joint were made with eight stiffer springs. The surfaces on the superconductor were polished with sandpaper before adding soldering tin. The temperature used was approximately 290 - 300 °C during soldering. Only one heating wire was glued on the inside of the bend of the 1.5 mm copper holder. Two of the copper wires (nr 1 and 2) used in the calibration test of the copper wires were glued on the outside of the superconductor joints. The Cernox thermometer and another copper wire (nr 6) were glued with a distance of only 3 - 4 mm apart on a 1 mm copper sheet. This copper sheet is mounted between the copper holder and the cold head and should therefore reach a lower temperature than the sample. In addition were there used only two layers of paper to achieve a lower temperature. To determine if the difference in measured temperature by the Cernox sensor and the copper wires could be because of too short heat sink length the length of this are was increased. The length was increased from approximately 3 cm to 10 - 15 cm for the Cernox sensor and the copper wire for comparison. For the copper wires attached to the joints the heat sink length was approximately 8 cm. The thermal anchoring in the heat sink area was made by gluing the 0.2 mm copper leads to the copper sheet by using the Stycast epoxy. The copper wires on the joints were attached with epoxy and the two on the lower copper sheet was attached with Varnish. The measurement set-up and a sketch can be found in Appendix H and the results are given in 5.6.

## 5 Results from the joint testing

The purpose of these tests was to find the resistance in the joints and to determine how weakened the superconductor is after inserting a certain joint. The resistance is required to determine how much heat that will be generated in the joints during operation.

When determining the resistances in the joints a sufficiently low current at the yielding temperature so that the superconductor still acts in the superconducting state. It is the voltage drop caused by the resistive metals in the joints that has to be found not the voltage drop caused by the superconductor itself in the mixed state. These measurements are usually done when the sample is cooled to the lowest possible temperature. The current is increased in steps to get a proper amount of values which then is plotted and the resistance can be determined by a linear curve fitted to the measured values. The best fit function in Grapher 4.00 is used to find the best estimate for the resistance.

The DC critical current is defined as the current which causes 1  $\mu\text{V} / \text{cm}$  superconductor [11 p.27]. When measuring across a resistive joint the measured voltage will be the sum of the voltage caused by the non-superconducting metal in the joint and the voltage which occurs when the superconductor enters the mixed state. The voltage representing the resistive metal is a linear function of the current. When the superconductor enters the mixed state the voltage increases nonlinear. To determine the critical current when measuring across a joint the voltage representing the resistive part must be therefore be subtracted. To be in control over what part of the sample that enters mixed state first an area of the sample is heated which causes this area to have lower critical current than the rest of the sample. It is then important to have accurate measurements of the temperature in this area. Both in deciding the resistance and the critical current it is assumed that the measured voltage occurs only across the joint itself and not the continuous superconductor before and after the joint. This assumption could have been avoided by attaching the voltage probes as close as possible to the joints, but this would require almost twice as many voltage measuring wires which was not available.

The temperatures were first calculated by use of the copper resistance ratio given in Appendix B, but they have later been recalculated by use of the results from the calibration results in 5.5 and 5.6. This chapter includes the results from all the tests. In chapter 5.7 the results are summarized in one table. The details concerning the installation etc of the samples are written in 4.2.

### 5.1 First test

At first the superconductor sample was cooled down to an appropriate temperature for measuring the resistance in the joints. The temperature was then approximately 30.5 K. The calculations of the temperatures are described in Appendix I. The voltage across the joint for currents up to 40 A is shown in Figure 5-1. The voltage is quite linear and the two pairs of joints behave in pretty much the same way. The best fit curves used to determine the resistance can be viewed in Appendix M.



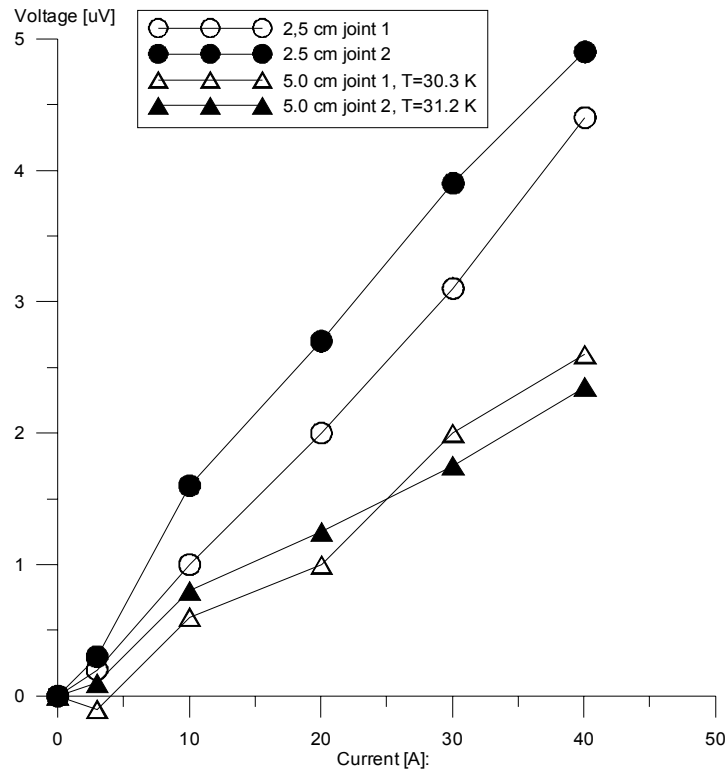
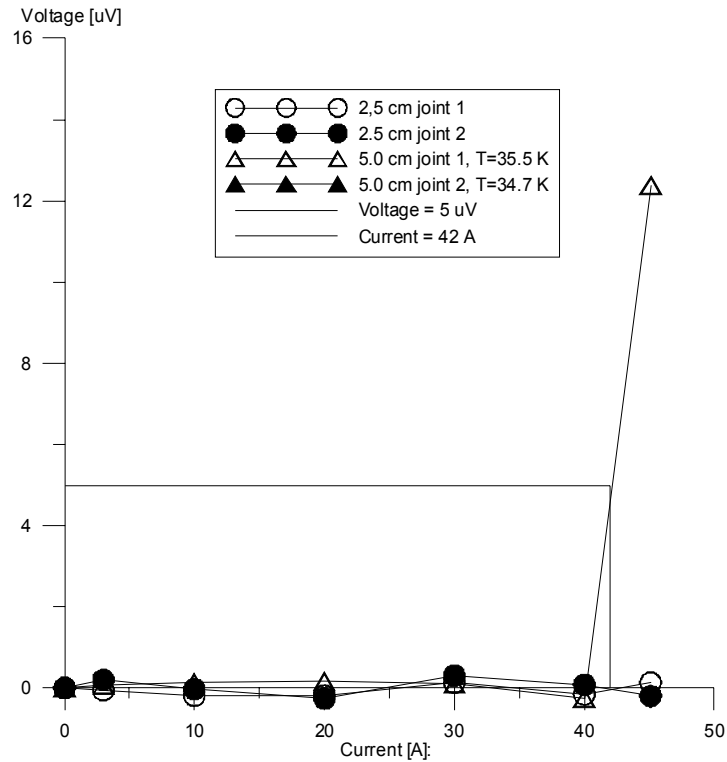

Figure 5-1: Results resistance measurements

For the two 2.5 cm long joints the resistances were 106 and 127 n $\Omega$  and for the two 5.0 cm joints the resistances were 63 and 60 n $\Omega$ . The resistance doubles as expected when the length of the joint gets reduced by a factor of two. This gives an average value of 0.3  $\mu\Omega$  if the resistance is recalculated to a 1 cm long joint.

To determine the critical current in the first 5 cm joint the temperature had to be increased in this area. It was therefore applied a current to the heating element glued to this joint. Joint 1 had a temperature of 35.5 K and joint 2 was about 1 degree colder with a temperature of 34.7 K. It is therefore expected that the 5 cm joint 1 will quench first. The results are shown in Figure 5-2.

Critical current is defined as the current when the voltage exceeds 1uV per cm of superconductor. This means that when the voltage exceeds 5 uV for the 5 cm long joint the critical current can be found. In this case it is necessary to subtract the voltage caused by the resistive part of the joint. This resistance was found by using the best fit function on the values registered before the voltage rise occurred. Probably because of the increase in temperature the resistance increased from 63 to 76 n $\Omega$ . From Figure 5-2 the critical current in this case is between 42 A.



**Figure 5-2: Voltage across the 5 cm joint 1 when the voltage from the resistance of 76 nΩ is subtracted**

The heating was then turned of to lower the temperature again so that another measurement of the critical current could be done. The values for the temperatures are 32.1 K for the first joint and 32.3 for the second joint. The results are shown in Figure 5-4 below.

By observing Figure 5-3 it can be seen that the voltage across the first 5 cm joint starts to diverge from the second 5 cm joint after 70 A. When observing Figure 5-1, this behaviour was not expected. Since the current used in this measurement was much larger than in the first it is difficult to decide if the reason for the diverging behaviour has occurred after the resistance measurement or not.

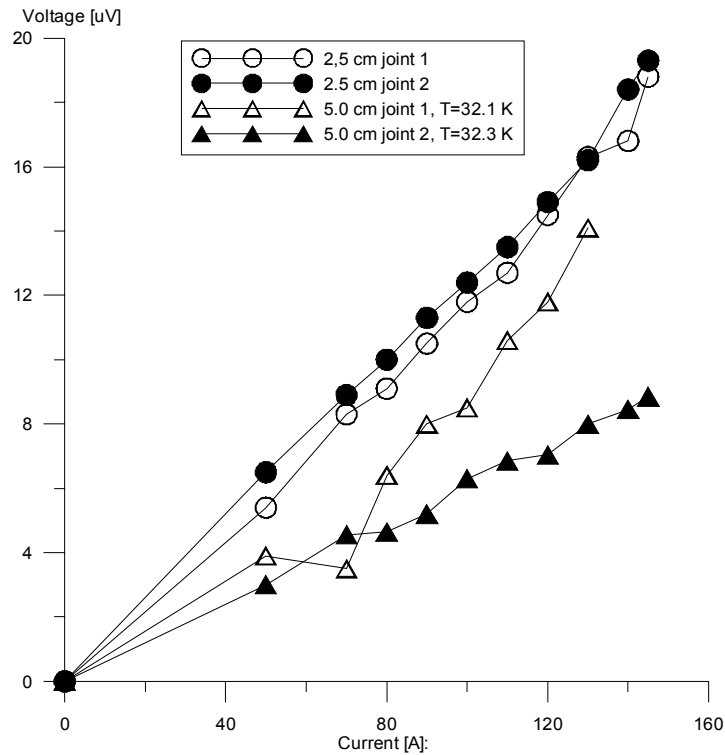

**Figure 5-3: Diverging behaviour of the first 5 cm joint. The measured resistance is 92 nΩ.**

By using the best fit function for the linear area a reasonable value for the resistances can be calculated. For the 2.5 cm joints the values are 121 and 127  $\mu\Omega$ . For the 5 cm joints the values are 92 nΩ for joint 1 and 61 nΩ for joint 2. Since it is only the joint which got quenched that has a different value it might be possible that either the superconductor or the joint has been damaged because of the quenching. The same procedure as in Figure 5-2 is used to determine the critical current. From Figure 5-4 it can be seen that the critical current is approximately 133 A.

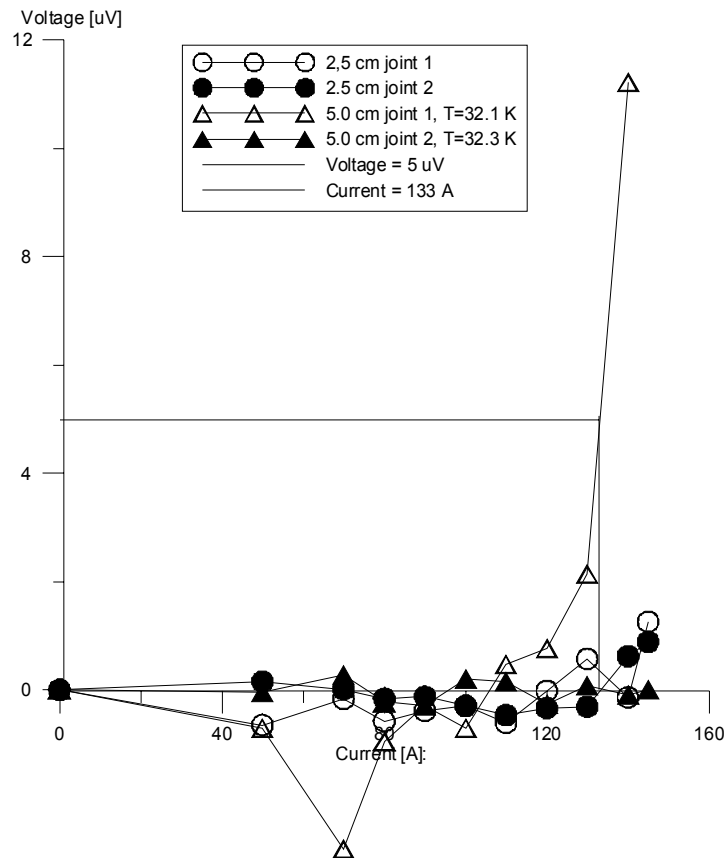
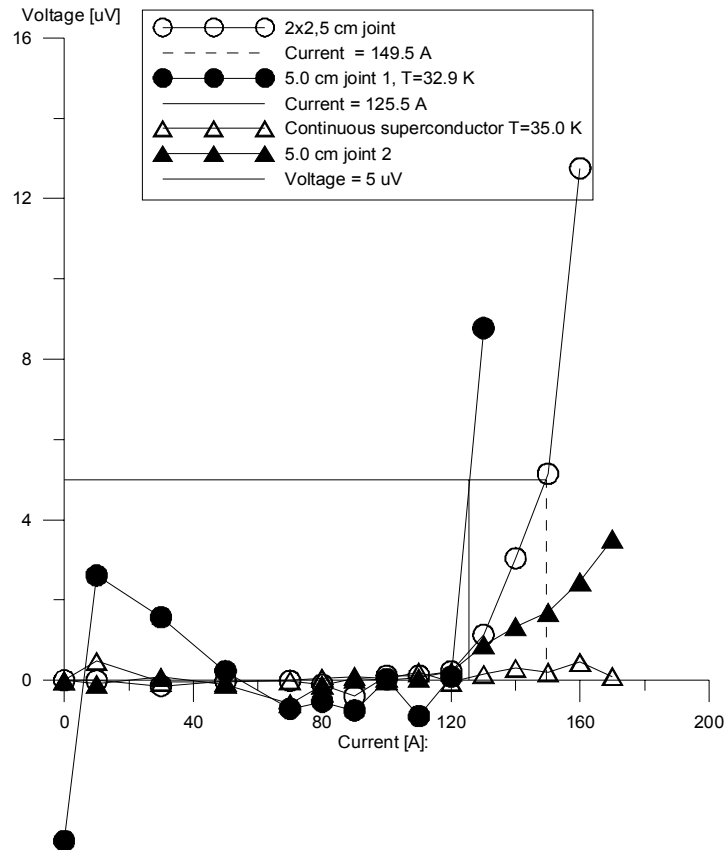

Figure 5-4: Voltage across the 5 cm joint 1 when the voltage from the resistance of 92 nΩ is subtracted

## 5.2 Second test

In this test the joints were compared with a piece of continuous superconductor to see if there was any difference in the critical current values. The voltage measurements are still across four pieces of conductor. There voltage measurements are across both the 2.5 cm joints, each of the two 5 cm joints and across one piece of superconductor. There are three different temperature measurements; one copper wire at the 5 cm joint 1 and two new copper wires, one at the 5 cm joint 1 and one at the continuous superconductor. The two new copper wires are wound in coils to measure the temperature in the middle were it is hottest and not the average temperature like the ones in the first test did (see 4.1.2.3).

The resistances calculated from the linear area this time were 239 nΩ for the two 2.5 cm, 64 nΩ for 5 cm joint 2 and 132 nΩ for 5 cm joint 1. The two first values are as expected since there now are two 2.5 cm joints in series. For joint 1 on the other hand the values did not follow a straight line as previous of unknown reasons so the resistance was found in a limited linear area (see Appendix M) which is twice as high as in the first test.



**Figure 5-5: Results second test after heating the continuous superconductor. Voltages caused by a resistance of 132 nΩ in 5 cm joint 1, 64 nΩ in 5 cm joint 2 and 239 nΩ have been subtracted. Critical current limit is indicated.**

From Figure 5-5 the critical current can be found to be somewhere approximately 125 A depending on the value of the resistance in the joint itself. From Figure 5-5 it can also be observed that the voltage across the two 2.5 cm joints starts to increase none linear when the current increases. To find the critical current in this area the voltage drop caused by the resistance of 239 nΩ is subtracted. If it is only the superconductor at one of the joints which causes the voltage increase the limit is 2.5 uV, but if it is assumed that the voltage is spread out at both joints the limit is 5 uV The critical current will be somewhere between 137 A and 150 A depending on the voltage deviation. There were no copper wires attached to these joints, but the temperature is reasonably around 32.5 K. It is also worth noticing that these two joints have never been quenched.

### 5.3 Third test

In this test two joints were made with the new soldering tool and compared with a continuous part of the superconductor. First the resistances in the joints were measured at approximately 30.7 K. Then there were made measurements on the critical current.

The resistances were this time 71 nΩ and 58 nΩ. This is a bit higher than expected since the resistances in the 5 cm joints were as low as 60 nΩ. Four of the softest springs were used in the soldering tool. The layer of soldering tin was measured to be between 146 – 135 μm thick see Figure 5-6. In addition were the surfaces not polished and the temperature was 100 °C lower than previous.

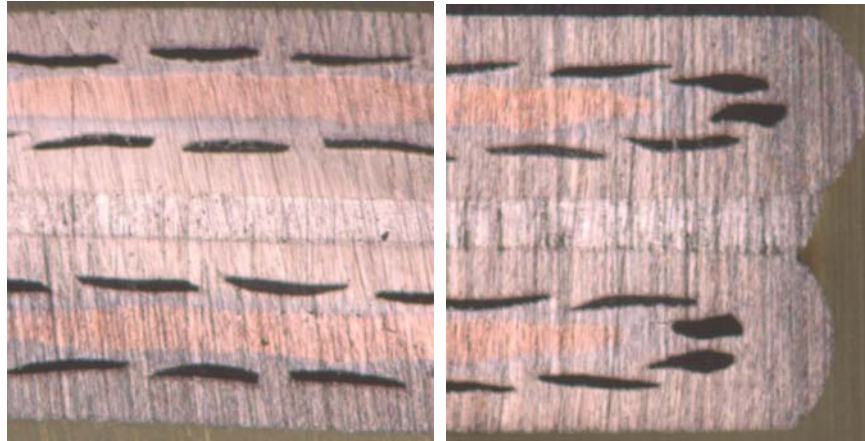

**Figure 5-6: Cross section of an overlap joint. Thick layer of soldering tin when using too weak spring force increases the resistance. The layer of soldering tin was measured to be between 146 – 135  $\mu\text{m}$  thick**

To get the voltage across CS1 or joint 2 to start rising, this side of the sample was heated to approximately 35 K. As expected the joint reaches mixed state first as shown in Figure 5-7 below. This was a problem because it was never experienced any voltage rise across the continuous superconductor and it was therefore difficult to know how much reduced the critical current is due to the joint.

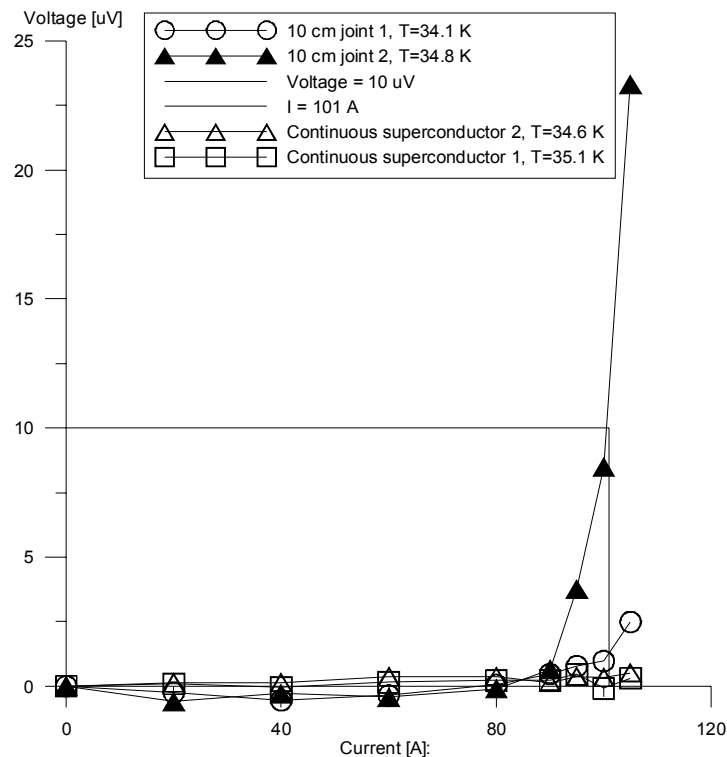

**Figure 5-7: Critical current when resistance in the joints have been subtracted, 101 A at 34.8 K. CS1 and joint 2 side of the sample is heated to approximately 35 K.**

After joint 2 had quenched the other side of the sample was heated to approximately the same temperature as the previously in joint 2. The critical currents are 91 A and 101 A for joint 1 and 2. The results as joint 1 quenches is shown below.

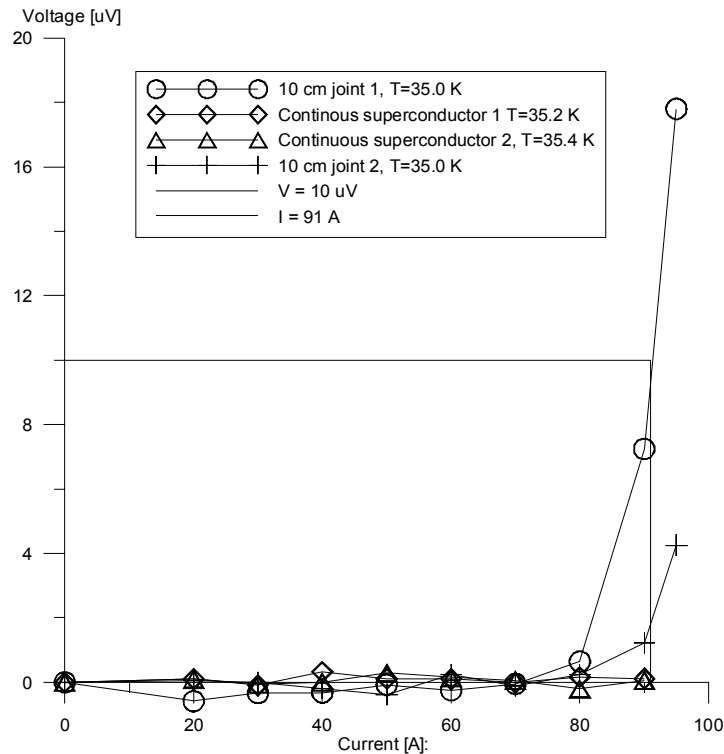

**Figure 5-8: CS2 and joint 1 side of the sample is heated to approximately 35 K. Critical current when resistance in the joints have been subtracted, 91 A at 33.6 K**

### **5.4 Test of continuous superconductor**

This test was performed to get some more values to compare the critical current for the joints with. The problem was first of all that the temperature achieved was not as low as wanted due to poor vacuum quality. The other problem was that the temperature measured with the copper thermometers varied a lot.

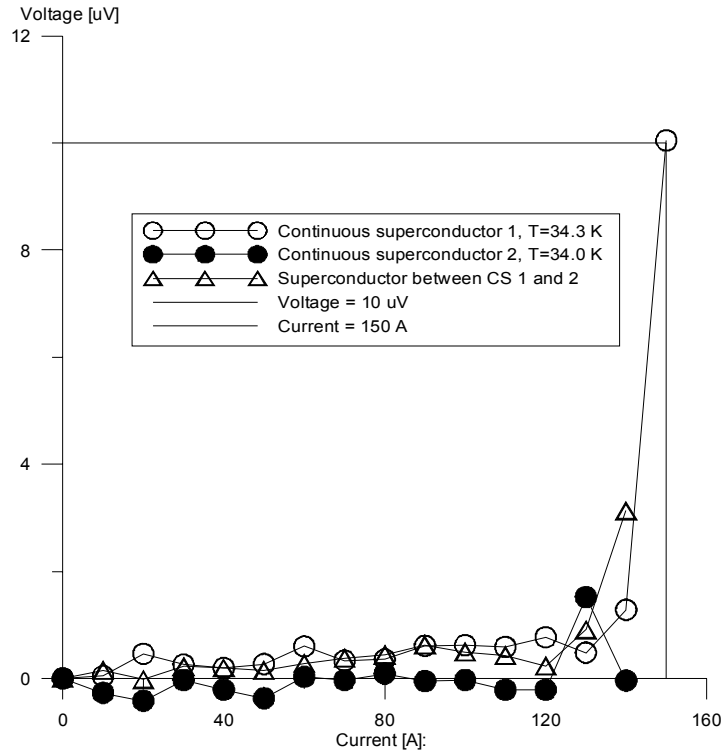

**Figure 5-9: Results after test of continuous superconductor, critical current ca 150 A at 34.3 K**

Table 5-1 contains values from Appendix L. These values show that copper wires only a few millimetres apart from each other measure voltage that varies as much as 0.9 K and 0.8 K across the copper holder. This temperature difference was even higher when using the original copper resistance ratio table. It was decided to purchase a more reliable thermometer to check the copper wires (see Calibration test of copper thermometer). The temperatures listed here are recalculated after this test.

**Table 5-1: Temperature measurements during test of continuous superconductor**

Temperature during critical current test [K]:			
CS1	turn below CS1	CS2	turn below CS2
34.3	35.2	34.0	33.2 K

### 5.5 Calibration test of copper thermometer

Because there had been trouble with unlikely high deviations in the temperature measurements among the copper wires there was a need for a calibration or check of the copper thermometers. This was done with two reference temperatures; one in boiling nitrogen and one in ice water. If the deviation from the reference temperatures was the same as the deviation from one stable temperature in the joint test it could be that the copper wires need a calibration before use. Since the copper thermometers are glued to the samples the whole sample from the third joint test was cooled to check these thermometers. Before lowering the test into liquid nitrogen the sample was cooled slowly by letting it hang a few centimetres above the liquid nitrogen inside a closed box made by polystyrene. In Table 5-2 the reference resistance is measured in room temperature.



**Table 5-2: Summary of calibration test of copper thermometer.**

Temperature in boiling nitrogen [K]:				
Time:	CS2	Joint 1	CS1	Joint 2
2.30 p.m.	77.76	77.62	77.86	77.71
Differance	0.46	0.32	0.56	0.41
3.10 p.m.	77.79	77.66	77.89	77.73
Differance	0.49	0.36	0.59	0.43
Temperature in ice water [K]:				
5.30 p.m.	274.76	274.82	275.01	274.88
Differance	1.6	1.66	1.85	1.72
7.45 p.m.	274.77	274.82	274.59	274.86
Differance	1.61	1.66	1.43	1.7
Comparing with deviations during third joint test:				
	28.64	27.84	28.86	28.34

Because of large incubators and air conditioning in the same room this temperature varies a lot. When recalculating the temperature in liquid nitrogen with the resistance in ice water as reference (R0) the deviation from 77.3 K is reduced as shown in Table 5-3.

**Table 5-3: Recalculating the temperature of liquid nitrogen when the resistance in ice water is the reference.**

Temperature in boiling nitrogen [K]:				
Time:	CS2	Joint 1	CS1	Joint 2
3.10 p.m.	77.54	77.40	77.63	77.46
Differance	0.24	0.10	0.33	0.16

Since the measurements were still were a bit inaccurate and a fixed temperature below 77.3 K were not available it was decided to by a precise calibrated Cernox thermometer to calibrate the copper wires at lower temperatures. This test was performed with a special made copper holder (see Figure 4-8 and Appendix G) to ensure equal conditions for the thermometers. The results can be viewed in Figure 5-10 and Figure 5-11. The temperature on the x-axis in Figure 5-11 is the temperature measured with the Cernox sensor. The data table is given in Appendix O.

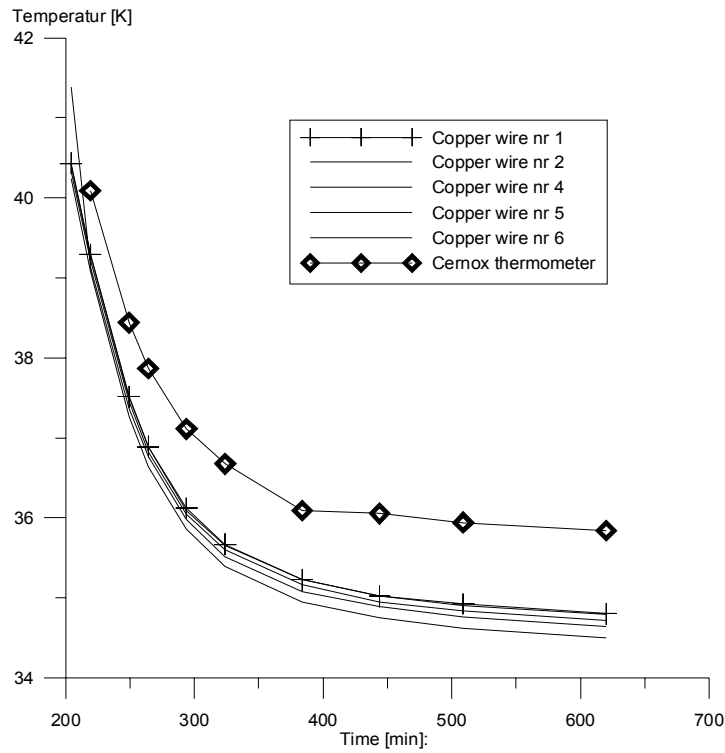

**Figure 5-10: Results from test of copper thermometers.**

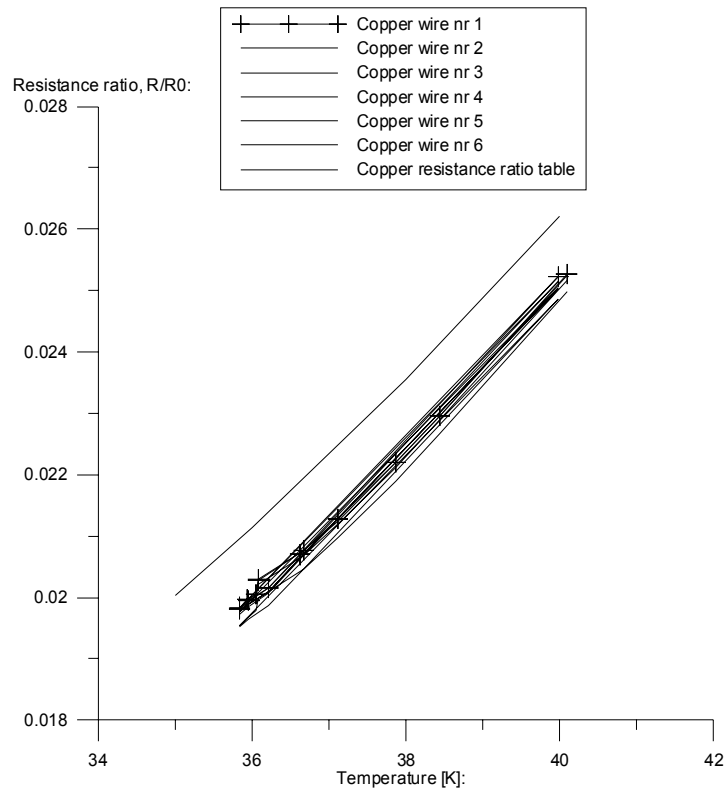
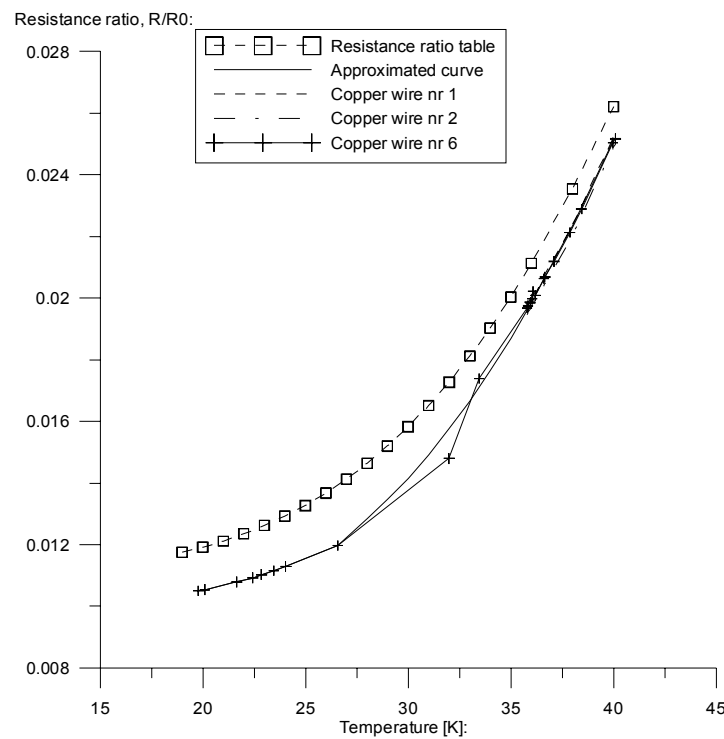

**Figure 5-11: Results from test of copper thermometers. Resistance ratio vs temperature.**

The temperature difference between the Cernox sensor and the copper wires are approximately 1 K and the six copper wires are not varying more than 0.5 K. It is also worth mentioning that if the difference in the R0 value calculated from temperatures in ice water and

room temperature was 0.13 % and it caused a difference of only 0.07 % in the resulting temperature at a temperature of 36 K. The results from the copper thermometer calibration at low temperatures are plotted in Figure 5-12. The values above 35 K are the values from the first calibration test (5.5). The heating element for regulating the temperature was damaged after increasing the temperature to ~24 K. To increase the temperature further the cooling machine had to be turned off and on. This caused the temperature to rise and fall faster which caused more inaccurate readings.

Since the resistance ratio is flattening out for low temperatures the difference in the temperature calculated by use of the two tables increase as the temperature decreases. If the measured resistance ratio is 0.012 the temperature is 21 K according to the original table and 26.5 K according to the new values. If the ratio is 0.018 the temperatures are 33 and 34.5 K. Only copper wire nr 6 was compared with the Cernox sensor, but the previous test showed that the copper wires did not vary very much.



**Figure 5-12: Resistance ratio vs. temperature for copper wires. Approximated curve between 25 and 35 K due to few measured values.**

To be able to use the results for calculating the temperature later an approximated curve had to be made. By using the approximated curve more interpolation points was established. Below 26 K the readings follow a straight line and the values can be used directly for interpolation. The results are given in Appendix N.

## 5.6 Fourth joint test

In Figure 5-13 the voltage current characteristics for the joints are shown. When determining the resistance only the values from the linear region i.e. before the superconductor enters mixed state, can be used. This was done for each of the critical current measurements in addition to one measurement at a lower temperature. The voltages are quite low due to the

low resistance and it is therefore sensitive for disturbance which causes the voltage measurements to vary more than previously.

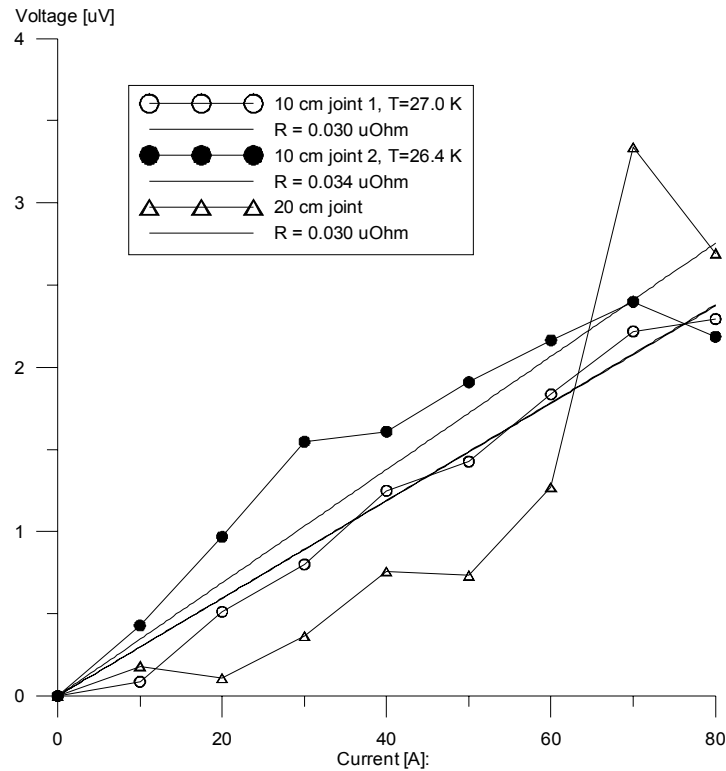
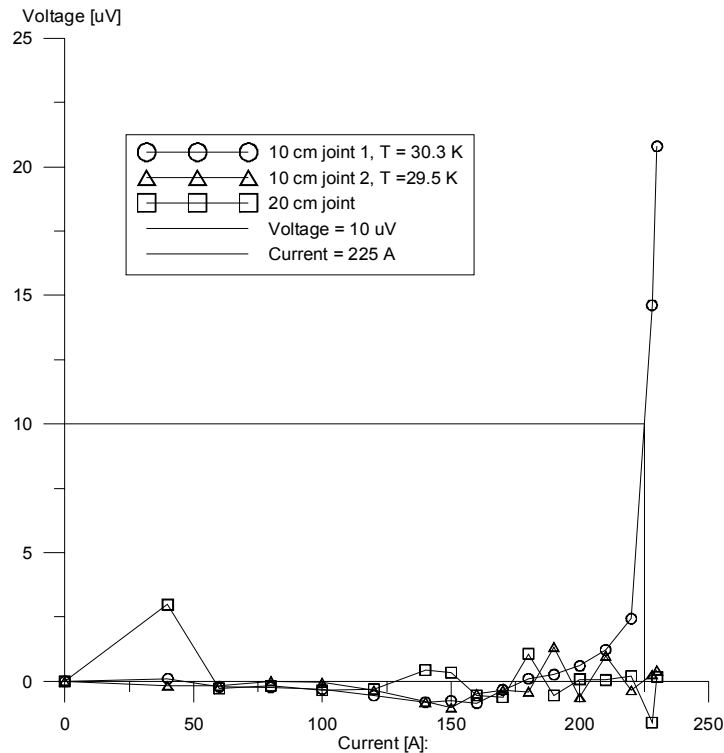

Figure 5-13: Resistance measurement by using best fit in the linear area.

After the resistance in the joints have been determined the voltage across the superconductors in the joint can be plotted and the critical current value can be found. It is assumed that all the voltage is across the joint which defines the critical state to be when the voltage reaches 10  $\mu\text{V}$  across a 10 cm long joint.



**Figure 5-14: Critical current of 225 A at a temperature of 30.3 K. Voltage caused by the resistance in the joints have been subtracted before plotting.**

Plotting of the four other critical current measurements can be viewed in Appendix P and the results are given in Table 5-4 (and Table 5-6).

**Table 5-4: Critical current values after fourth joint test.**

Test nr	Temperature [K]:	Current [A]:
1	34.4	96
2	31.1	205
3	32.0	175
4	32.5	161
5	30.3	225

The critical current vs. temperature has been plotted in Figure 5-15. By extending the line the critical current at 30 K will be 238 A. For comparison the critical current determined by the producer of the superconductor is 298 A at 0 T and 30 K. The joint has therefore reduced the critical current for the superconductor with 60 A which is 20.1 %.

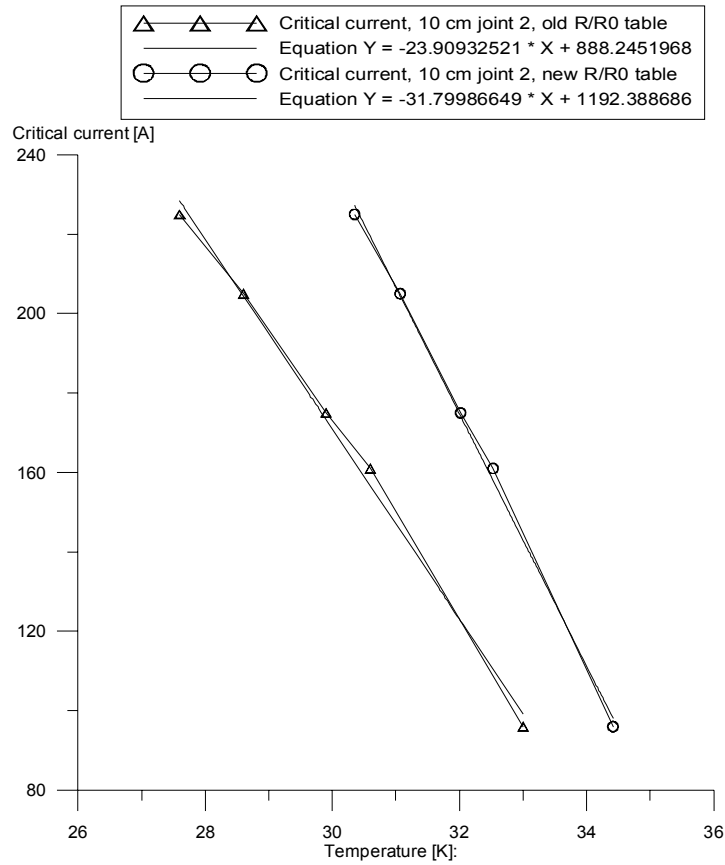

**Figure 5-15: Critical current vs. temperature for 10 cm joint 2. Two different reference tables are used for the resistance ratio of copper.**

The effect of increasing the force pressing the superconductor tapes together is shown in Figure 5-16. The surplus of soldering tin has very effectively been squeezed out. For comparison see Figure 5-6.

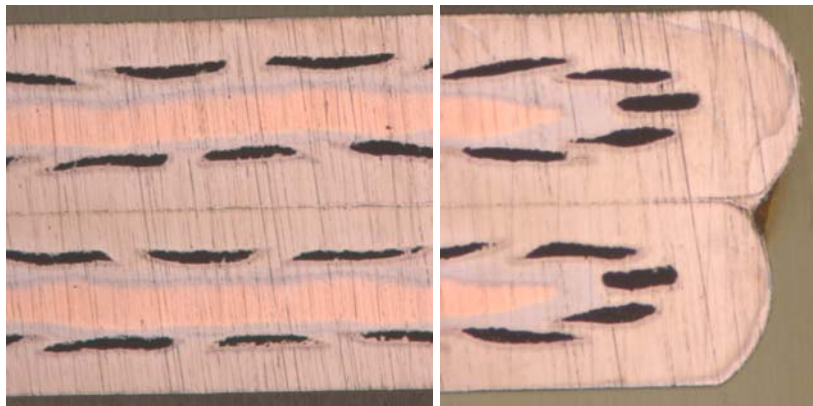

**Figure 5-16: Cross section of a joint. Stiffer springs increase the pressing force which reduces the layer of soldering tin effectively.**

**Table 5-5: Resistance in the joints.**

	10 cm joint 1		10 cm joint 2		20 cm joint
Temperature [K]:	Resistance [nΩ]:	Temperature [K]:	Resistance [nΩ]:	Resistance [nΩ]:	
	34.4	44	33.1	58	40
	32.5	37	31.5	48	32
	32.0	34	31	44	30
	31.1	34	30.1	44	32
	30.3	38	29.5	46	32
Average:	32.1	37.4	31.0	48.0	33.2

The measurements are not accurate enough to determine the temperature dependency of the joints and therefore the average values have been calculated. Since the 20 cm joint is in two parts with one part attached close to each of the two 10 cm joints the temperature will be about the same as at the closest 10 cm joint.

The heat generated from a 10 cm joint with 50 nΩ resistance is  $P = V * I = R * I^2 = 50 \text{ e-9} * 200^2 = 2 \text{ mW}$ . The joints should not exceed a few micro ohms according to /13/ which seems to be no problem with these joints. The current in the induction heater will be 200 A at a temperature of 20-22 K. With approximately zero magnetic field density these joints can conduct 238 A at 30 K and approximately 400A at 25 K if the linear curve from Figure 5-15 do not break. The joints are tested without magnetic field. The magnetic field on the outside of the superconductor is approximately 100 mT /5/. From the producers report 100 mT reduces the critical current with 45 A at 30 K which is 15 %. If the critical current for the joints are reduced by 15 % they can conduct 340 A at 25 K. The reduction is always less at lower temperatures so 15 % reduction is probably a pessimistic estimate.

## **5.7 Result summary**

When recalculating the temperatures for the previous tests the temperature increases and the superconductor performs better than first assumed. In **Figure 5-17** the critical current vs. temperature is plotted. For the continuous superconductor only one value at 34.8 K is from experiments carried out here. The two others are values specified by the superconductor producer. The 5 cm joint has as expected lower critical current than the two 10 cm joints. The joints from third test seem to perform better than the joints in the fourth test, but there are few values to compare. There is also a possibility that the copper wires which were wound around the joints measure a higher temperature than if they are attached on the outside like in the last test.

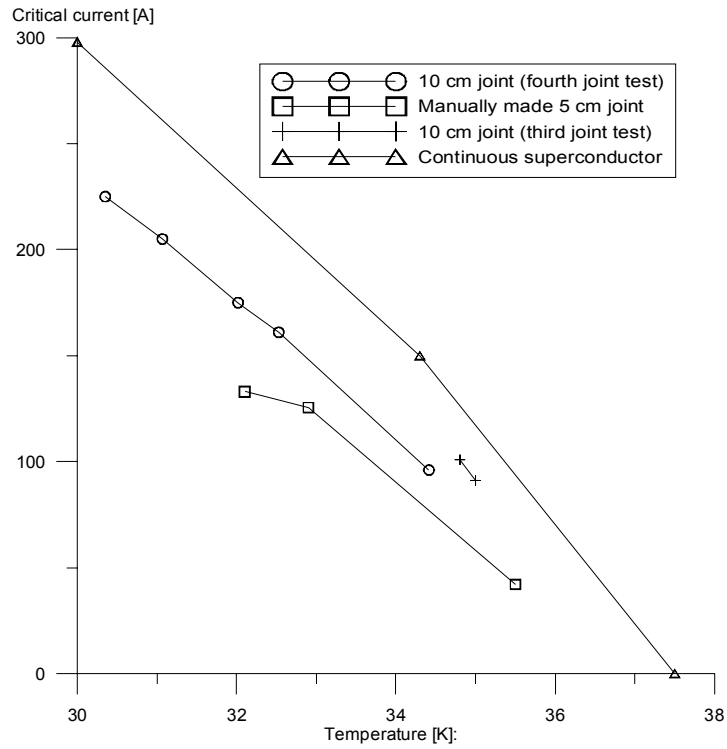

**Figure 5-17: Critical current vs. temperature for some of the tested joints.**

In Table 5-6 the results are summarized. The temperatures in the parenthesis are the temperatures calculated when using the resistance table in Appendix B. The resistance values are listed in the same sequence as the joint lengths in the comment column. If both resistance and critical current measurement is performed at the same time the temperature listed is the temperature at the joint that quenched.



**Table 5-6: Summary of the results**

Test nr:	Temperature [K]:	Resistance [nΩ]:	Critical current [A]:	Comments:
1	30.8 (28.5)	106, 127, 63, 60		2.5 – 2.5 – 5 – 5 cm. 4 manually made joints
	35.5 (34.5)	119, 133, 76, 66	42	5 cm joint 1 heated and reaches mixed state first
	32.1 (30.7)	121, 127, 92, 61	133	5 cm joint 1 heated and reaches mixed state first. Higher resistance at 5 cm joint 1 than before: 92 nΩ
2	32.9 (30.5)	239, 132, 64	125.5	2x2.5 – 5 – 5 cm Same as test nr 1, but with measurement across a piece of continuous superconductor. Both 2.5 cm joints measured in series. Even higher resistance at 5 cm joint 1 than before: 132 nΩ.
	32.5 (30)?		137 -> 150	Critical current depends on voltage deviation between the 2.5 cm joints. No thermometer attached at these joints.
3	30.7 (28.2)	71, 58		10 – 10 cm. Two 10 cm joints made with soldering tool, but without polishing and acetone
	34.8 (33.4)	98, 83	101	10 cm joint 2 heated and reaches mixed state first
	35.0 (33.6)	97, 83	91	10 cm joint 1 heated and reaches mixed state first
4	34.3 (32.8)		150	Test of superconductor without joints
5	40 - 35			Test of copper thermometer. Copper wires and Cernox thermometer do not give the same result with old R/R0 table.
6	34.4		96	10 – 10 – 20 cm. 10 cm joint 1 heated and always reaches mixed state first. See table Table 5-4 for all the resistance measurements.
	32.5		161	
	32.0		175	
	31.1		205	
	30.3		225	
	~31,6	37, 48, 33		

Comparison critical current of a previous made test coil was 96 A at 32.5 K and 0.04 T /13 p.6/.

## 6 Discussion

### The joint soldering tool:

There were some problems with jamming of the springs when using flat washers so these were exchanged with profiled washers. The eight springs are a bit time-consuming to install and therefore it was tried with four, but then the force became too weak. The tool was used with a voltage of 230 V, but then power needs to be turned off to avoid exposing the superconductor to too high temperatures. The difficult part of making the joints is polishing the surfaces and applying soldering tin which covers the entire surface. During polishing it is very easy to unfortunately bend the superconductor. When applying soldering tin the surfaces can suddenly change character which causes the melted tin to glance off. This can be the reason why one of the two 10 cm joints had higher resistance than the other although it is hard to detect any large areas of this type by observing the pictures in Appendix Q. Why the 20 cm joint did not have lower resistance can be of the same reason, but the voltage got more and more difficult to measure as the resistance decreased.

### Testing the joints:

No other joint alternatives than the overlap joints consisting of the superconductors alone were tested. Why exactly ten centimetres long joints were chosen is not precisely argued, but this is more a compromise between the available space, how complicated the manufacturing becomes and what is acceptable resistance. If the resistance had become too high which means that the length of the overlap is too short then a new tool would have to be designed.

The resistance measurements were more accurate for the small joints due to higher resistance and higher measured voltage. When measuring the voltage drop across the 10 cm joints in the fourth test the voltage was fluctuating more than previously. The temperature dependency of the resistance in the joints has therefore not been determined.

In the critical current measurements it is assumed that the voltage rise only occurs across the joint, but the voltage is measured across a longer length. It is always the area with the joint that is heated to decrease the critical current compared with the rest of the sample. In the third test a turn without joints was glued to the holder to compare the voltage across the continuous superconductor with the voltage across the joint. No voltage rise was measured across the superconductor which confirms that the assumption is valid. It is a bit surprising that the 10 cm joints in the third test performed that well although the resistance was that much higher than the joints in the last test. In the third test the copper wires used to measure the temperature was wound around the superconductor joints instead of in a coil on the outside as in the last test, but this should not affect the measured temperatures that much and is hardly worth mentioning. The percentage reduction mentioned at the end of chapter 5.6 might be a bit too low because the superconductor producer has not enlightened us with the quality control test for the last batch of superconductor although the superconductor has been slightly improved. The current values still applies.

The unlikely high temperature differences measured on the samples can be caused by heat sinking in to the measuring wire from the ambient temperature. This might happen if there is poor thermal anchoring or too short heat sinking length which is the length of the area used to cool the leads to the thermometer. In addition might the temperature difference of 2 degrees across the 15 cm sample holder under stationary conditions be caused by a thermal shortcut across the paper layers between the sample holder and the cold head. If several of these errors occur at the same sample it might cause large variations in the measured temperature.

### The copper thermometer:

There are several explanations that can explain the high temperature differences measured with the copper thermometers. The calibration test showed that the copper wires can vary with 0.5 degrees. In addition was proper thermal anchoring of the leads not given much attention in the first tests. In the calibration test of the copper thermometers the heat sinking lengths were the same for all the copper wires and the temperature difference were therefore less ( $< 0.5$  K). At temperatures below 35 K only one copper wire was compared with the Cernox sensor and it is assumed that the copper wires behave homogeneous at lower temperatures. The last test determined that the difference in the temperature measured by the Cernox sensor and the copper thermometer was not caused by too short heat sinking length, but different resistance ratio. A new interpolation table was therefore made and all the temperature measurements in the report have been recalculated according to these values. Due to the flattening of the curve the error caused by the deviation between the copper wires and inaccuracy will increase.

## 7 Conclusion

### The joint soldering tool:

To avoid a thick layer of soldering tin eight stiff springs ought to be used. The force used in the last test was sufficient and did not seem to damage the superconductor. Different types of joints can be made with the soldering tool by using for example copper sheets to increase the cooling. In this thesis overlap joints which consisted of only the superconductor were tested. The layer of tin in the joint can doubtfully be made any thinner. To further reduce the resistance of joints with this length one would have to start slicing of the nickel embedding. One should however be aware of spots where the melted soldering tin glance off the surface of the tape and try to avoid spots like this.

### Results from the joint testing:

The resistances in the two last 10 cm joints were 37 and 48 n $\Omega$ . When made without surface polishing and with a lower force pressing the conductors together the resistances were 71 and 58 n $\Omega$ . If this increase in resistance is caused by the extra layer of soldering tin or because of no polishing is not determined. If polishing of the conductors will imply a high risk of bending the conductors it might be better to make the joints without polishing the surfaces. When not polishing the surfaces it is a bit more difficult to get the soldering tin to cover the whole surface and not just glance off.

If 50 n $\Omega$  is a reasonable resistance to expect each joint will generate 2 mW of heat at an operating current of 200 A. The 16 joints will generate 32 mW of heat in each coil excluded the heat caused by the joints on the current leads in and out of the cryostat. The results from the critical current measurement follow a linear curve from 96 A at 34.4 K to 225 A at 30.3 K. If the curve is extended to 30 K the expected critical current is 238 A and 400 A at 25 K. For comparison the critical current stated by the producer of the superconductor is 298 A at 0 T and 30 K. The joint has therefore reduced the critical current for the superconductor with 60 A at 30 K which is 20.1 %. The magnetic field density is about 100mT on the outside of the coils. From the producers report 100 mT reduces the critical current with 45 A at 30 K which is 15 %. If the critical current for the joints are reduced by 15 % they can conduct 340 A at 25 K. The joints should therefore be able to conduct the operating temperature of 200 A with a large safety margin. Although this result is based on one joint there is no reason to believe that other joints of the same length made in the same way will have other critical current values. The joints in this thesis were cooled from one side only. If further testing is to be done it might be interesting to investigate how much better the joints will perform if they were cooled from both sides.

### The copper thermometer:

It is not recommended to use self made thermometers without calibrating them with a reliable temperature sensor first. In this case the interpolation table which originally was going to be used to calculate the temperature by using copper wires gave as much as 5 degrees error at 21 K and an error of 1.5 degrees at 33 K. This requires that the temperature measured by the Cernox sensor is correct. The copper wires behave quite homogeneously within  $\pm 0.25$  K for temperature between 35 and 40 K. If the required accuracy is not so high then a copper thermometer may be used for these temperatures and above. At lower temperatures the resistance ratio is flattening out which can cause large deviations if small errors in measuring the resistance occurs. The slope  $(d(R/R_0)/dT)$  is only 0.000162 at 20.1 K which is very low compared to for example the Cernox sensor which has  $dR/dT$  equal 55 at 21 K.

Only copper resistors were tested here, but diodes, carbon resistors or wire of other metals can be used. I would suggest to either purchase calibrated sensors or to substitute the copper wire with for example platinum wire and then do the calibration test once again. Thermocouples are can also have good accuracy.

## Part 2: Insulation and wet-winding of MgB<sub>2</sub> tapes

### 1 Introduction

In this part the insulation wet-winding processes will be described. The making of the disc have been divided into four steps. The MgB<sub>2</sub> superconducting tape is delivered without any electrical insulation. Insulation therefore has to be put on before the wet winding of the discs can start. This is done with a semi-automatic machine described in step 1. Step 2 is the removal of half of the superconductor tape length from insulated superconductor reel. Why this is necessary is also explained here. The two last steps describes the wet-winding of first the lower layer and next the upper layer. The whole process is done on one single steel frame which is changed from step to step.

### 2 The process step by step

#### Step 1: Insulating the tape

The MgB<sub>2</sub> superconducting tape has to be electrically insulated before the wet winding can start. The insulating tape is an 8 mm wide and 25 μm thick polyimide film which is delivered in rolls of 500 m. Since 550 m of conductor is required in each double disc the roll of polyimide film has to be replaced with a new one at least once during each insulating process. The insulating process is done with a special designed machine shown in Figure 2-1 and Figure 2-2:

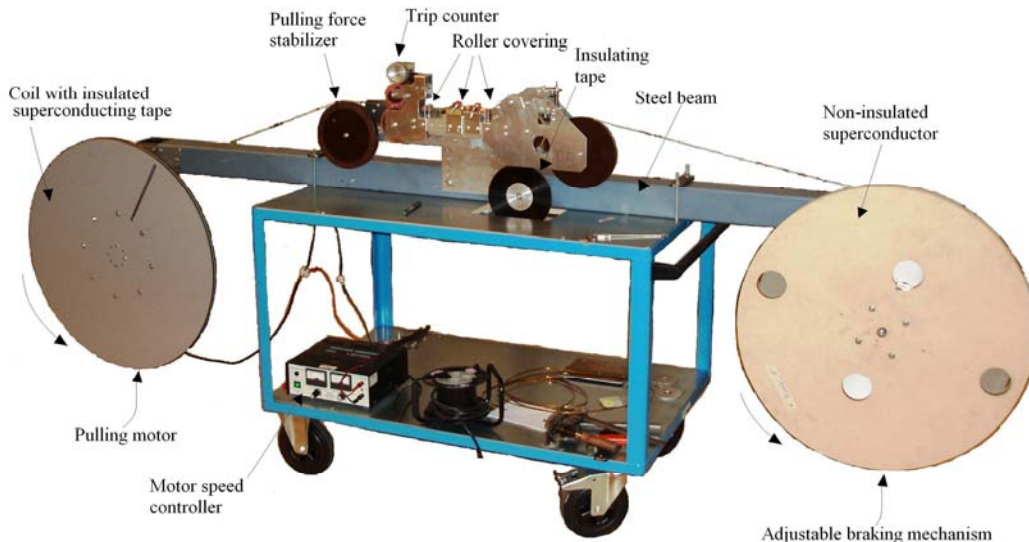

Figure 2-1: Insulating machine set up.

The superconductor can not be bended more than a radius of 15 cm and it can never be bended in the opposite direction. The tape is therefore rolled against wheels with larger radius than the minimum bending radius. The superconductor tape can in addition not be pulled with a force larger than 10 kg. This is controlled with a spinning wheel that measures this force. This wheel also work as a stabilizer for the pulling force any sudden changes in the force will be absorbed in a spring. To avoid the non insulated superconductor reel to keep on spinning after stopping the motor it is installed an adjustable breaking mechanism on the shaft of this reel. In addition to change the roll of insulation the superconductor tape have to be marked in

the beginning, middle and in the end. This is to make sure that the two layers are made equal in size and to know how much is left on the reel during winding. The marking is usually 0, 5, 270, 275, 280, 545, 550 and 555 meters. The speed is usually about 10 m per minute.

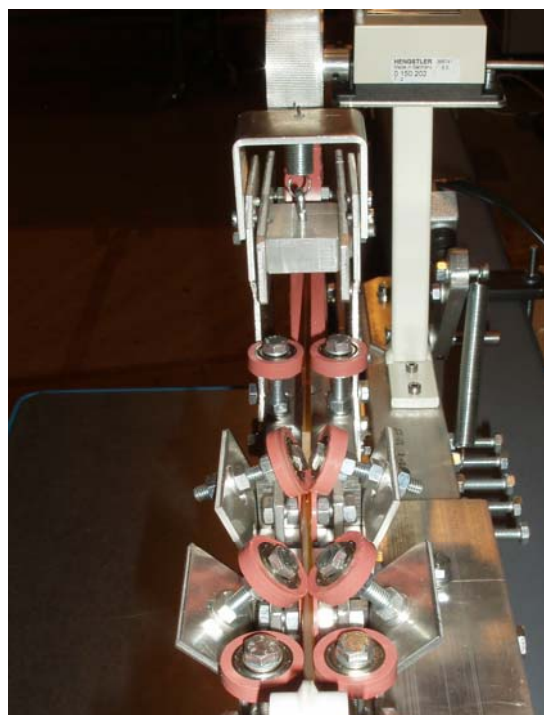
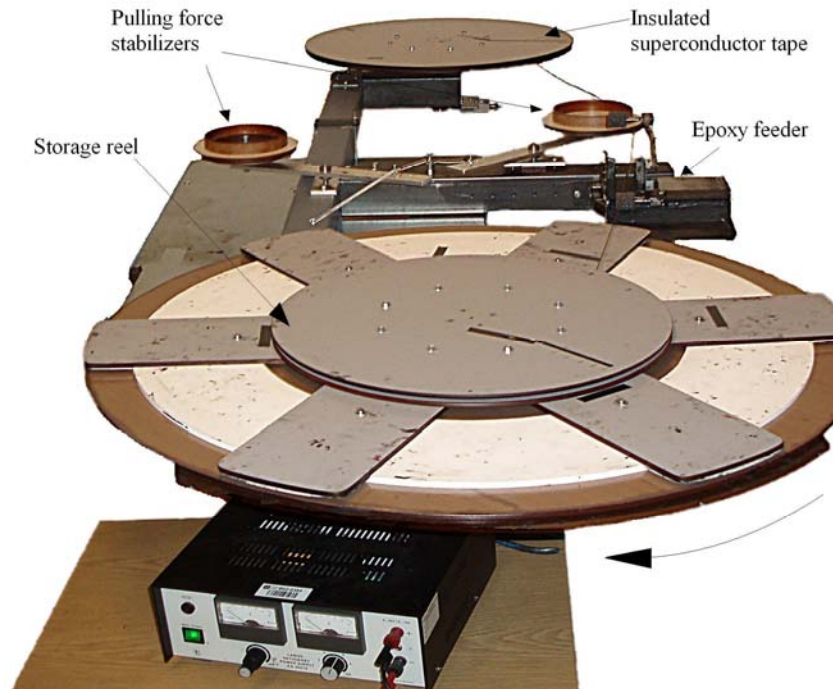

Figure 2-2: The roll covering wheels folds the insulation around the superconducting tape.

## Step 2: Removing half of the insulated superconductor

After the whole length has been insulated the insulating unit and both reels can be removed from the frame. Then the frame is tilted 90 degrees and the winding table is lifted on to the motor shaft. The reel with the insulated superconductor is placed in the other end of the machine and two pulling force stabilizing wheels are mounted on the frame.

To avoid having any joints between the discs inside the coils both start and finish of each disc have to come out on the outside of the disc. This is because the magnetic field density inside the coil is higher than on the outside which would reduce the critical current even more in the joints. The joints therefore have to be on the outside of the coils. This is done by letting the superconductor end on the inside wind its way out, forming a second layer on top of the first layer. Both layers will require the same length of conductor. Since this is a pulling winding process it always has to start with the innermost turns. Inside of the disc there will therefore be a crossing between upper and lower layer. When starting to wind the first layer the winding actually starts in the middle of the whole tape length which means that the first half of the tape length have to be removed from the reel before starting. This is done by winding 275 m on to a storage reel where it is stored temporarily while the first layer is wound as shown in Figure 2-3. The storage reel only need to carry 275 m and is therefore made smaller than the other reels. The epoxy feeder unit is used to ensure that the height of the superconductor is higher than the rotating cover plates.



**Figure 2-3: Removing half of the superconductor length by winding it on to a storage reel.**

The six plate covers are insuring that the superconductor turns are equal in height and that the conductor never slips across the table edge during winding. Before the wet winding can start the superconductor has to be put in place under the first plate. To be able to do this without bending the conductor the storage reel has to be gently moved to the outer edge of the table and a protective screen is attached to prevent the conductor from bending or moving when the pulling begins. The storage reel will rotate along with the table while the first layer is wound.





**Figure 2-4:** After removing 275 m the superconductor storage reel is moved to the edge of the winding table, the continuing part is placed under the first cover plate, the epoxy unit is put in position and the protective screen for the superconductor is assembled.

### **Step 3: Winding the first layer**

After removing half of the superconductor length the first layer of the two layered disc coil can be wound. The epoxy have to be mixed properly and a thin layer of slip agent has to be applied to the table and winding shape to ensure easy removal of the finished disc. To apply epoxy to the superconductor a box made of paper or cardboard (usually made of a milk carton) together with foam rubber is used. There is cut an opening in the box in both ends which is filled with a piece of matching rubber foam. In the piece of rubber foam there is cut a split almost the whole way down which the superconductor is pulled through. When filling the box with epoxy and pulling the conductor through it the rubber foam prevents that a lot of epoxy is leaking out. As long as there is epoxy enough to cover the conductor it will receive a proper layer of epoxy. To control the epoxy-layer-thickness a wiper that wipes of all the superfluous epoxy from both sides of the conductor is used. The epoxy remaining after this process which is mainly on top of and underneath the superconductor tape is scattered over the surface by the two rubber foam rollers. The surplus of epoxy wiped off is reused by pouring it back into the milk carton.

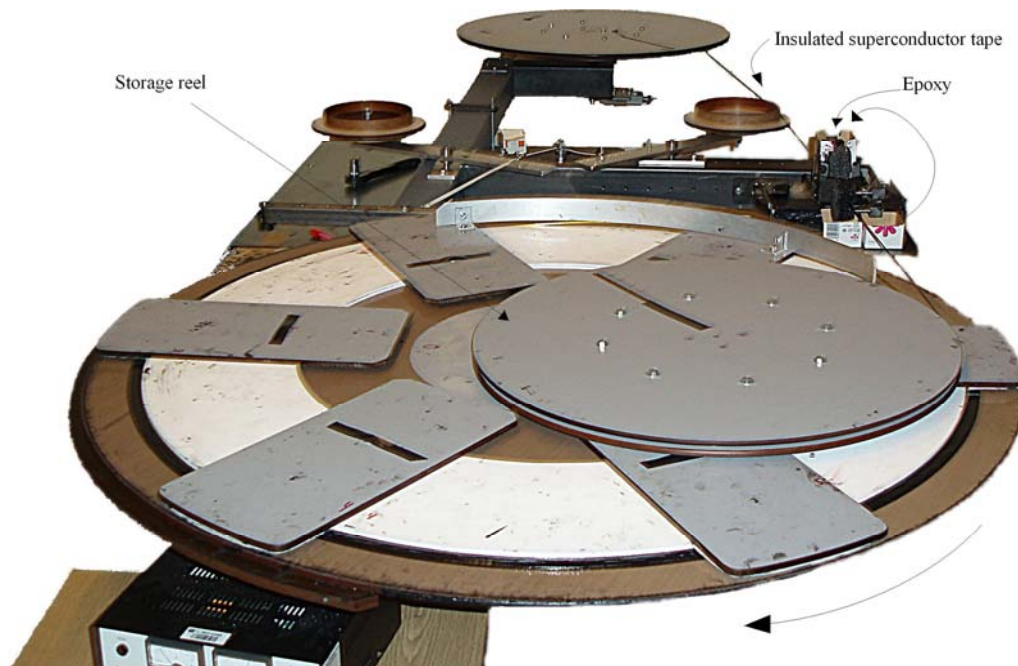

Figure 2-5: Winding the first layer.



Figure 2-6: The epoxy feeder with the wiper and roller mechanism.

When the whole first layer is wound the end has to be secured properly so that it is not bended or damaged in any way during winding of the second layer. This is done by attaching another protective screen that prevents the end of the coil to be hanging loose and being littered with epoxy. Placing and removing the epoxy feeder has to be done with great care not to bend the conductor.

#### **Step 4: Winding the second layer**

Before one can start to wind the second layer the empty reel has to be removed and the storage reel containing the superconductor length for this layer has to be moved to this end of the frame. The process of manually moving the reel containing 275 metres of superconductor

without bending the conductor which is attached to the lower layer is probably the process with the highest risk of failure.

After putting the storage reel in place the six cover plates has to be removed and a distance piece is put in between the plate and table to adjust the height. At the same time the protective screen is removed and the superconductor is put in place ready to start winding from inside and out. To wind the upper layer the table has to turn the other way around. The epoxy feeder arrangement therefore has to be moved to the other side of the table and the polarity of the motor current has to be switched.

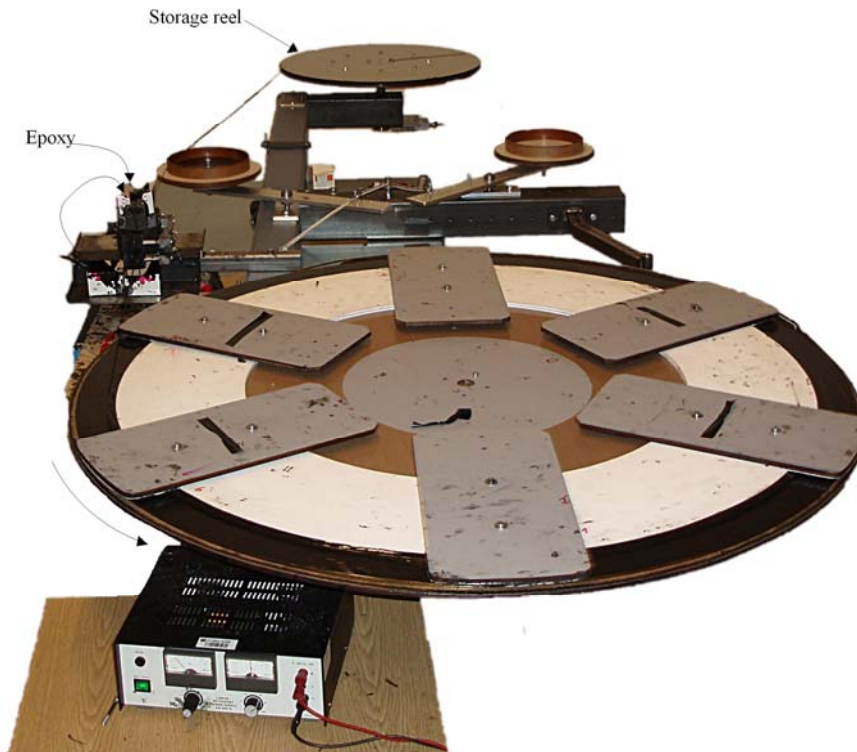

**Figure 2-7: Winding the second layer.**

When finishing both the upper and lower layer the ends of the superconductor were reinforced with two extra layers of superconductor to make the exit end entry area of the disc a bit more mechanical robust. The covering plates and the epoxy feeder have to be removed before hardening which takes one night at ambient temperature. Since the epoxy hardens it is very important to clean all the equipment littered with epoxy. The surfaces covered with slip agent are often easier to clean after hardening by scraping of the hard layer of epoxy. The rubber foam and milk cartons are one time use and can be disposed. It is possible to shorten the hardening time by increasing the temperature.

### **3 Discussion/Conclusion of insulation and wet-winding of MgB<sub>2</sub> tapes**

There was a problem with the polyamide film fluctuating sideways during the insulating process of the superconductor. This was usually caused by a small bend on the roll of the polyamide film. This problem can probably be solved by moving the polyamide film longer down and/or installing another wheel to limit the fluctuations in the tape. This will also reduce the jerkily extraction of the polyimide film.

There are some actions in the wet-winding process that have high risk of bending the superconductor. To move the storage reel from the winding table to the other end of the machine while winding out conductor is very difficult and requires at least two persons. If more time is to be spent on improving the performance of the machine a mechanism to move this reel from the winding table to the other end of the frame is desirable. This can for instance be a large steering arm or a rail mounted on the frame with a carriage on top. Also placing and removing the epoxy feeder unit can easily cause unwanted stress on the superconductor, but this is difficult to avoid. To save time some extra large reels can be made which then makes it possible to insulate several batches of superconductors without having to change to the wet winding set up of the machine. The hardening time can be reduced by applying current through the disc and thereby heating it.

The winding of the coils went flawlessly after the operators got some experience. Little epoxy was wasted and the winding process was performed within the hot time of the epoxy. Some improvements can be performed on the machine which will reduce the risk of damaging the superconductor and decrease the total winding time of the coils.

## References

- [1] *What is a Superconductor?* Available from <http://www.superconductors.org/>
- [2] P. Childs, *Practical Temperature Measurement*, Butterworth-Heinemann, Oxford 2001
- [3] Bureau International des Poids et Mesures, *Techniques for approximating the international temperature scale of 1990*, Pavillon de Breteuil F-92312 Sèvres, 1997
- [4] J.Nagamatsu, N.Nakagawaa, T.Muranaka, Y. Zenitani, J.Akimitsu, *Superconductivity at 39 K in magnesium diboride*, Nature, Vol 410, march 2001
- [5] E-mail from Niklas Magnusson 3.6. 2008
- [6] L. Michalski, K. Eckersdorf, J. Kucharski and J. McGhee, *Temperature Measurement*, John Wiley & Sons Ltd, Chichester 2001
- [7] M. Tinkham, *Introduction to superconductivity*, Dover publications Inc, Mineola, New York, 2004
- [8] C. Enss, S. Hunklinger, *Low temperature physics*, Springer- Verlag Berlin Heidelberg, 2005
- [9] N. Magnusson and M. Runde, *A 200 kW MgB<sub>2</sub> Induction Heater Project*, J. Phys: Conf. Ser., vol. 43, pp. 1019-1022, 2006
- [10] S. Giljarhus, *AC losses in MgB<sub>2</sub> superconductors*, Master`s thesis NTNU 2007
- [11] N. Magnusson, *AC Losses in High-temperature Superconducting Tapes: Calorimetric Measurement System and Semi-empirical Modelling*, doctoral dissertation, Kungl Tekniska Högskolan, Stockholm, 2000
- [12] James D. Doss, *Engineer`s Guide to High-Temperature Superconductivity*, John Wiley & Sons, New York, 1989
- [13] M. Runde, A. Stenvall, N. Magnusson, G. Grasso, R. Mikkonen, MgB<sub>2</sub> coils for a DC superconducting induction heater.
- [14] Superconductivity and details about MgB<sub>2</sub>, Available from Columbus: <http://www.columbussuperconductors.com/>

# Appendices

## Appendix A

### The soldering device

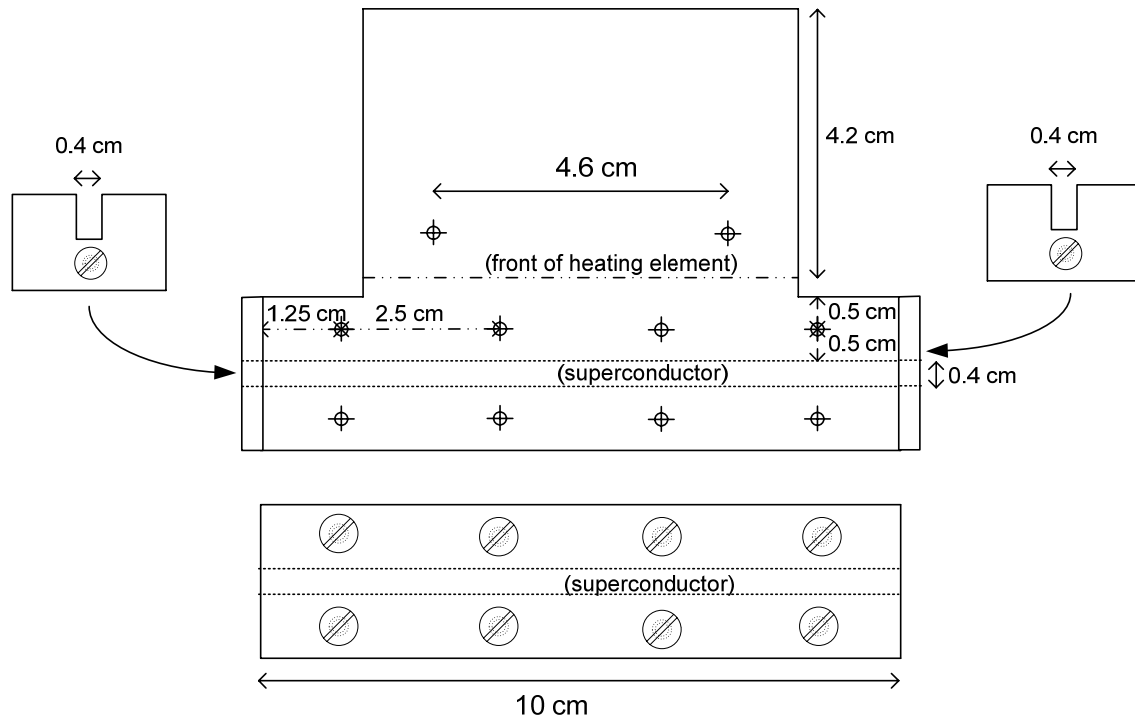

Voltage [V]:	Temperature [° C ]:
230	468
180	350
165	300
150	250
125	200

Temperature was measured between the side plates and the thick copper plate and registered after approximately 3 minutes with stable temperature.

**Tables for temperature calculation**

Cu R/R0 table 1:

T [K]:	R/R0	T [K]:	R/R0
23	0.01262	76	0.13239
24	0.01292	80	0.14854
25	0.01327	85	0.16975
26	0.01368	90	0.19145
27	0.01413	95	0.21348
28	0.01464	100	0.23582
29	0.0152	110	0.28105
30	0.01583	120	0.32649
31	0.01651	130	0.37192
32	0.01727	140	0.41723
33	0.01812	150	0.46233
34	0.01903	160	0.50705
35	0.02004	170	0.55169
36	0.02113	180	0.59603
38	0.02355	190	0.64002
40	0.02621	200	0.68387
42	0.02927	210	0.7275
44	0.03274	220	0.77098
46	0.03671	230	0.81429
48	0.04089	240	0.8575
50	0.04547	250	0.90051
52	0.05039	260	0.94358
54	0.05563	270	0.9865
56	0.0613	273.16	1
58	0.06732	280	1.0293
60	0.07359	290	1.07218
64	0.08686	300	1.11504
68	0.10137	310	1.15785
72	0.11626		

Voltage generated by the thermocouples:

T [K]:	Voltage:
3	-1116
13	-1078
23	-999
33	-885
43	-736
53	-555
63	-344
73	-106
83	158
93	446
103	756
113	1087
123	1440
133	1812
143	2203
153	2612
163	3038
173	3482
183	3942
193	4417
203	4908
213	5413
223	5932
233	6464
243	7010
253	7567
263	8137
273	8719
283	9310
293	9911
303	10520

Both tables are received from Niklas Magnusson

**First joint test**

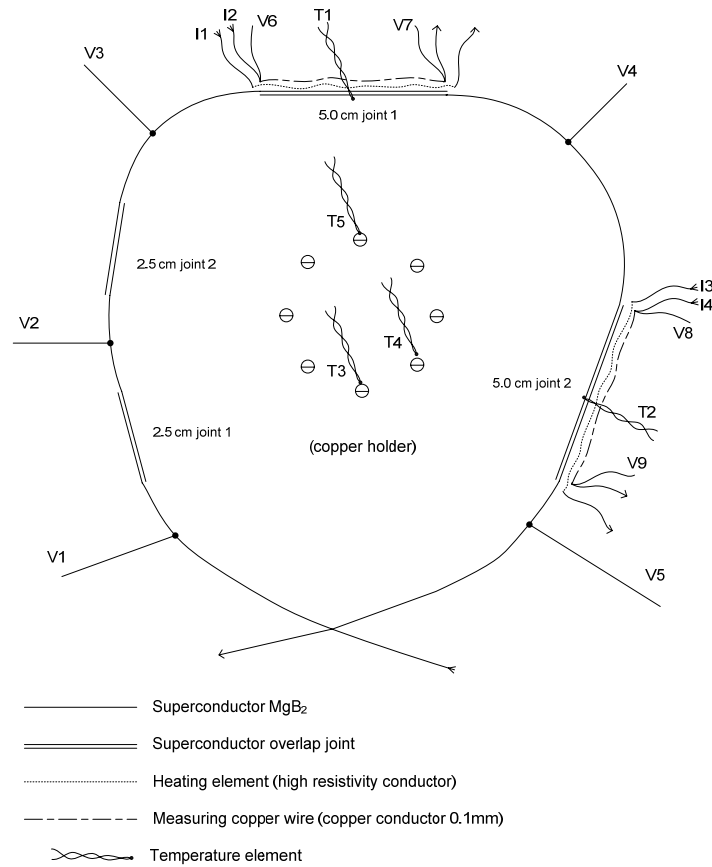

Copper holder: 1 mm thick, 1 cm high bend

Measurement set-up:

- V1-V2 voltage across 2.5 cm joint 1
- V2-V3 voltage across 2.5 cm joint 2
- V3-V4 voltage across 5 cm joint 1
- V4-V5 voltage across 5 cm joint 2
- V6-V7 voltage across copper wire stretched out along 5 cm joint 1
- V8-V9 voltage across copper wire stretched out along 5 cm joint 2
- I1 current for heating element along 5 cm joint 1
- I2 current for excitation of copper wire along 5 cm joint 1
- I3 current for heating element along 5 cm joint 2
- I4 current for excitation of copper wire along 5 cm joint 2
- T1–T5 thermocouples



Second joint test

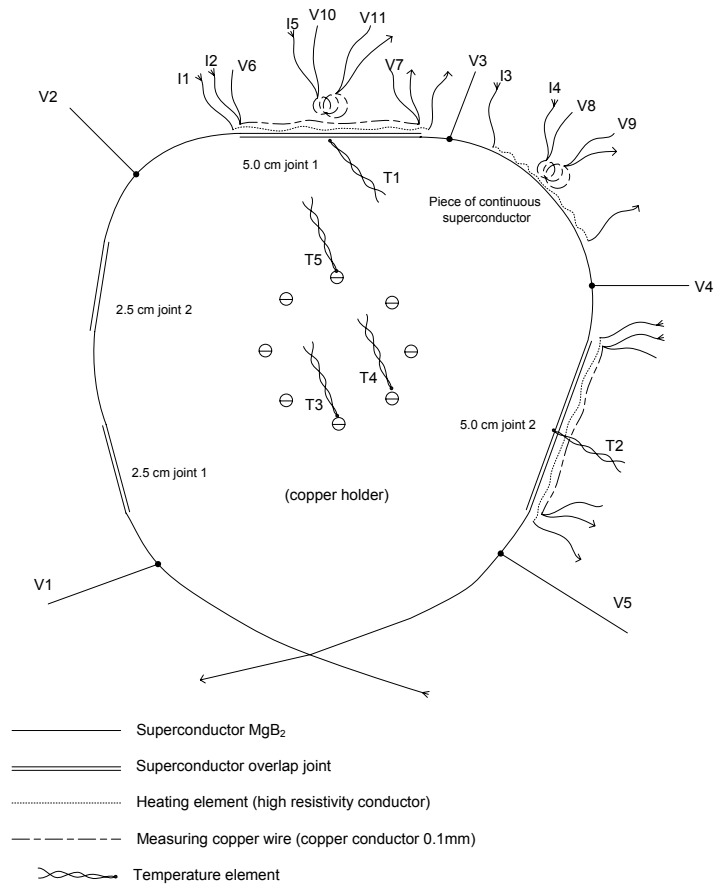

Copper holder: 1 mm thick, 1 cm high bend

Measurement set-up:

- V1-V2 voltage across 2.5 cm joint 1 and 2
- V2-V3 voltage across 5 cm joint 1
- V3-V4 voltage across continuous superconductor
- V4-V5 voltage across 5 cm joint 2
- V6-V7 voltage across copper wire stretched out along 5 cm joint 1
- V8-V9 voltage across copper wire wound in coil on continuous superconductor
- V10-V11 voltage across copper wire wound in coil on 5 cm joint 1
- I1 current for heating element along 5 cm joint 1
- I2 current for excitation of copper wire along 5 cm joint 1
- I3 current for heating element along continuous superconductor
- I4 current for excitation of copper wire wound in coil on continuous superconductor
- T1-T5 thermocouples

Third joint test

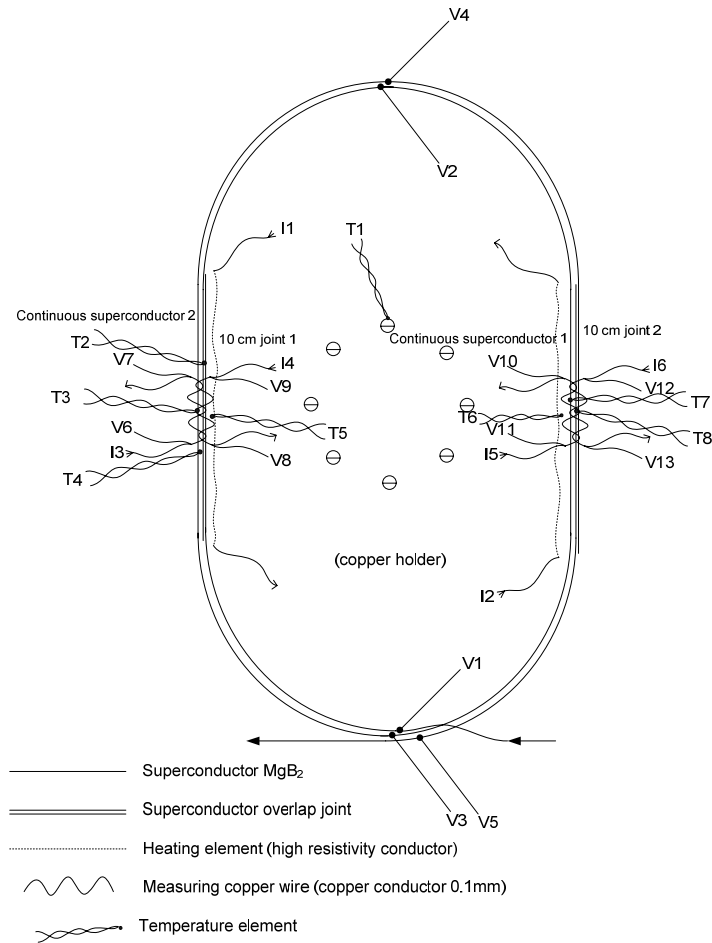

Copper holder: 1.5 mm thick, 1 cm high bend

Measurement set-up:

- V1-V2 voltage across joint 1
- V2-V3 voltage across continuous superconductor 1
- V3- V4 voltage across continuous superconductor 2
- V4- V5 voltage across joint 2
- V6- V7 voltage across copper wire wound around continuous superconductor 2
- V8- V9 voltage across copper wire wound around joint 1
- V10- V11 voltage across copper wire wound around continuous superconductor 1
- V12- V13 voltage across copper wire wound around joint 2
- I1 current for heating element along 10 cm joint 1 (inside of bend)
- I2 current for heating element along 10 cm joint 2 (inside of bend)
- I3 current for excitation of copper wire wound around continuous superconductor 2
- I4 current for excitation of copper wire wound around 10 cm joint 1
- I5 current for excitation of copper wire wound around continuous superconductor 2
- I6 current for excitation of copper wire wound around 10 cm joint 2

**Test of superconductor without joints**

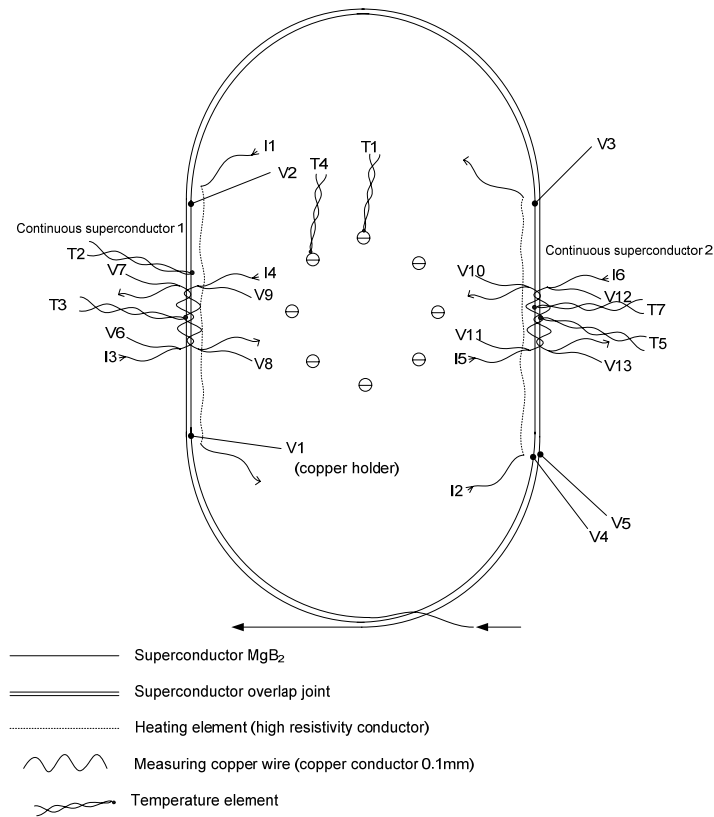

Copper holder: 1.5 mm thick, 1 cm high bend

Measurement set-up:

- V1-V2 voltage across continuous superconductor 1
- V2-V3 voltage across superconductor between continuous superconductor 1 and 2
- V3-V4 voltage across continuous superconductor 1
- V4-V5 voltage across the rest of the superconducting sample.
- V6-V7 voltage across copper wire wound around turn below continuous superconductor 1
- V8-V9 voltage across copper wire wound around continuous superconductor 1
- V10-V11 voltage across copper wire wound around continuous superconductor 2
- V12-V13 voltage across copper wire wound around turn below continuous superconductor 2
- I1 current for heating element along continuous superconductor 1 (inside of bend)
- I2 current for heating element along continuous superconductor 2 (inside of bend)
- I3 current for excitation of copper wire wound around turn below continuous superconductor 1
- I4 current for excitation of copper wire wound continuous superconductor 1
- I5 current for excitation of copper wire wound continuous superconductor 2
- I6 current for excitation of copper wire wound around turn below continuous superconductor 2

**Thermometer calibration holder**

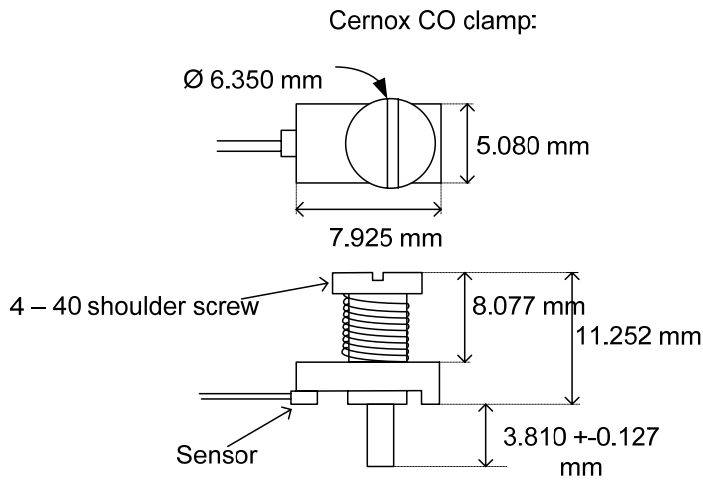
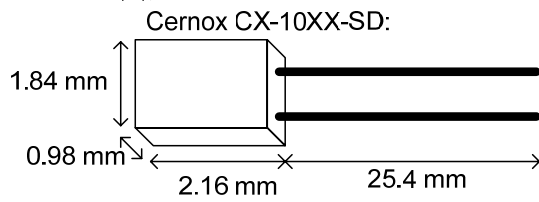
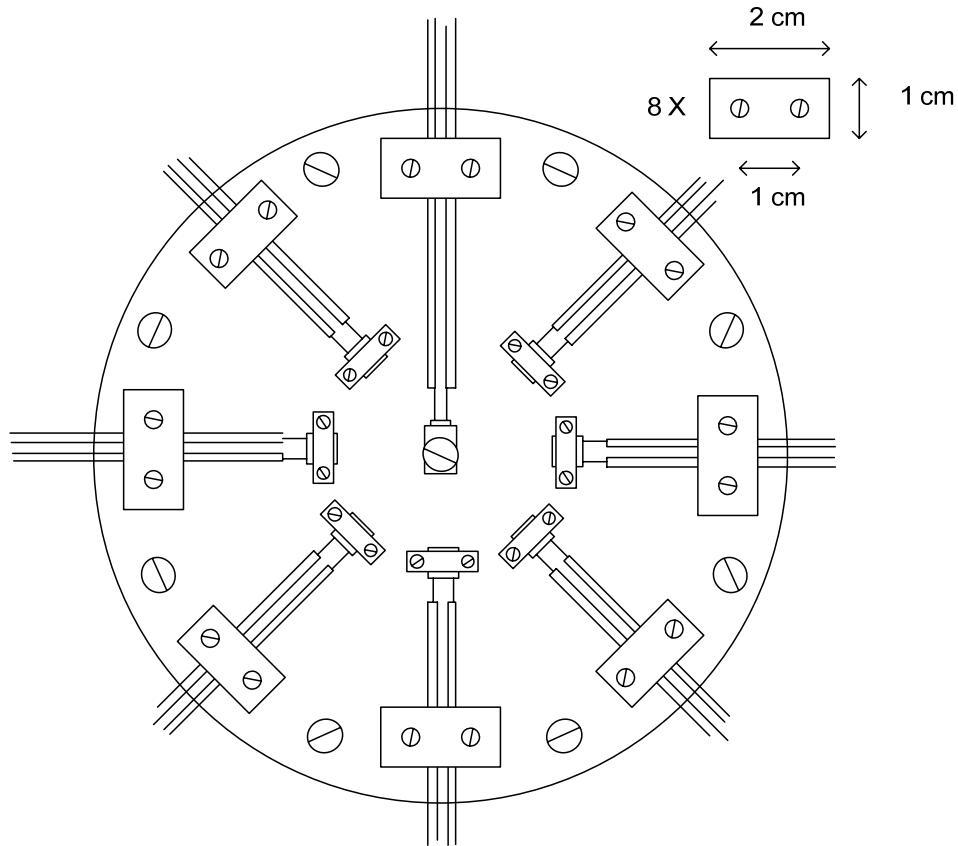

Fourth joint test

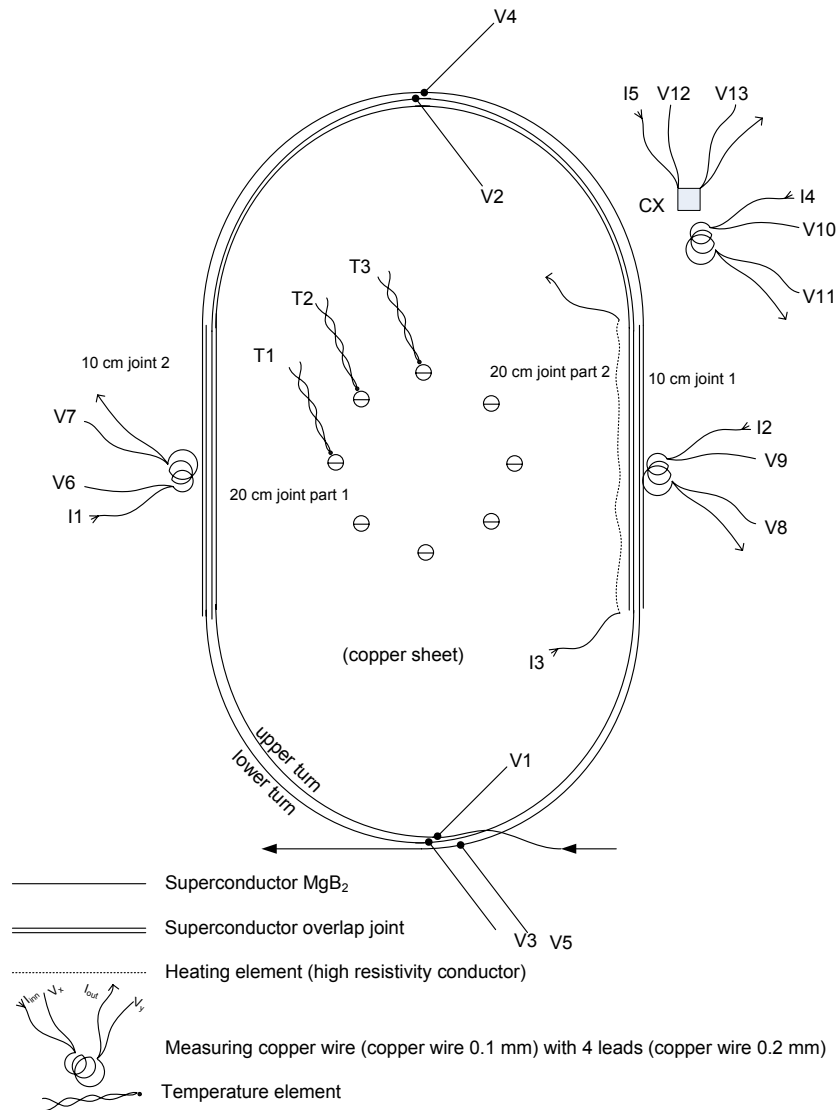

Copper holder: 1.5 mm thick, 1 cm high bend

Measurement set-up:

- V1-V2 voltage across 20 cm joint part 1
- V2-V3 voltage across 20 cm joint part 2
- V3-V4 voltage across 10 joint 2
- V4-V5 voltage across 10 joint 1
- V6-V7 voltage across copper wire attached to 10 cm joint 2
- V8-V9 voltage across copper wire attached to 10 cm joint 1
- V10-V11 voltage across copper wire attached close to Cernox sensor
- V12-V13 voltage across Cernox sensor
- I1 current for excitation of copper wire on 10 cm joint 2
- I2 current for excitation of copper wire on 10 cm joint 1
- I3 current for heating element along 10 cm joint 1 (inside of bend)
- I4 current for excitation of copper wire attached close to Cernox sensor
- I5 current for excitation of Cernox sensor

**Temperature calculations first test**

Calculation of R0 in room temperature:

Excitation current [mA]:	Voltage [mV]:	
	5 cm joint 1: (V6 - V7)	5 cm joint 2: (V7 - V8)
14.45	12.55	12.99
25.79	22.4	23.17
8.9	7.73	7.99
Resistance [ $\Omega$ ]:		
	0.8685	0.899
	0.8686	0.8984
	0.8685	0.8978
R(avg)	0.8685	0.8984
Ro	0.78964	0.81682

$R/R_0 = 1.09987$  when  $T_{room} = 21.3$  C (by interpolation)

Excitation current [mA]:	Voltage [ $\mu$ V]:	
	5 cm joint 1: (V6 - V7)	5 cm joint 2: (V8 - V9)
31.7	358	-394
-31.7	-378	392
3.84	33	-48
-3.89	-55	47
Error to be added:	~10	~1

Temperature during resistance measurements:

Copper resistance thermometer:

Excitation current [mA]:	Voltage [ $\mu$ V]:	
	5 cm joint 1: (V6 - V7)	5 cm joint 2: (V8 - V9)
21.3	232	261
incl.error:	242	262
Resistance [m $\Omega$ ]:		
R	11.3615	12.3005
Ro	0.78964	0.81682
R/Ro	0.01439	0.01506
Temperature [K]:		
Cu R/R0 tab. 1:	27.66	28.85
Cu R/R0 tab. 2:	30.3	31.2

Thermo couples.

	5 cm joint 1: (T1)	5 cm joint 2: (T2)
Voltage [mV]:	-925	-931
Temperature [K]:	29.79	29.29

Temperature during critical current test nr 1:

Copper resistance thermometer:

Excitation current [mA]:	Voltage [ $\mu$ V]:	
	5 cm joint 1:	5 cm joint 2:

Thermo couples:

	5 cm joint 1: (T1)	5 cm joint 2: (T2)

	(V6 - V7)	(V8 - V9)
21.32	314	320
incl.error:	324	321
Resistance [mΩ]:		
R	15.197	15.0563
Ro	0.78964	0.81682
R/Ro	0.01925	0.01843
Temperature [K]:		
Cu R/R0 tab. 1:	34.16	33.29
Cu R/R0 tab. 2:	35.5	34.7

Temperature during critical current test nr 2:  
Copper resistance thermometer

Excitation current [mA]:	Voltage [μV]:	
	5 cm joint 1: (V6 - V7)	5 cm joint 2: (V8 - V9)
21.36	257	279
incl.error:	267	280
Resistance [mΩ]:		
R	12.5	13.1086
Ro	0.78964	0.81682
R/Ro	0.01583	0.01605
Temperature [K]:		
Cu R/R0 tab.1:	30.05	30.36
Cu R/R0 tab. 2:	32.1	32.3

Voltage [mV]:	-859	-875
Temperature [K]:	34.92	33.74

Thermo couples.

	5 cm joint 1: (T1)	5 cm joint 2: (T2)
Voltage [mV]:	-904	-913
Temperature [K]:	31.50	30.78

**Temperature calculations second test**

Calculation of R0 in room temperature:

Excitation current [mA]:	Voltage [mV]:		
	5 cm joint 1: (V6 - V7)	5 cm joint 1: (V10 - V11)	CS (V8 -V9)
4.35	-3.78	12.99	2.51
9.14	-7.91	23.17	5.25
18.24	-15.81	7.99	10.5
Resistance [Ω]:			
	0.869	0.423	0.577
	0.8654	0.4227	0.5744
	0.8668	0.4228	0.5744
R(avg)	0.8671	0.4228	0.5757
Ro	0.78886	0.38465	0.52375

R/R0 = 1.09918 when T<sub>room</sub> = 23.1 C (by interpolation)

Critical current test:

Copper resistance thermometer

Excitation current [mA]:	Voltage [μV]:		
	5 cm joint 1: (V6 - V7)	5 cm joint 1: (V10 - V11)	CS (V8 -V9)
10.75	152.36	69.4	104.9
(-) 10.73	114	67.36	105.6
(avg.+ -) 10.74	133.18	68.38	105.25
Resistance [Ω]:			
R	0.01240037	0.00636685	0.00979981
Ro	0.78886	0.38465	0.52375
R/Ro	0.01571936	0.01655233	0.01871086
Temperature [K]:			
Cu R/R0 tab.1:	29.88	31.04	33.59
Cu R/R0 tab.2:	32.0	32.9	35.0



**Temperature calculations third test**

Calculation of R0 in roomtemperature:

	Voltage [mV]:			
Excitation current [mA]:	CS2: (V6 - V7)	Joint 1: (V8 - V9)	CS1: (V10 - V11)	Joint2: (V12 - V13)
17.65	11.58	10.78	10.91	11.51
(-) 34.33	16.76	15.62	15.72	16.58
(avg.+ -) 25.02	16.42	15.32	15.47	16.32
	Resistance [Ω]:			
	0.6561	0.6108	0.6181	0.6521
	0.656	0.6117	0.6178	0.6519
	0.6563	0.6123	0.6183	0.6523
R(avg)	0.6561	0.6116	0.618	0.6519
Ro	0.59439	0.55448	0.56089	0.59112

R/R0 = 1.09987 when T<sub>room</sub> = 23.3 C (by interpolation)

Calculation of R0 in ice water (part of calibration test):

	Voltage [mV]:			
Excitation current [mA]:	CS2: (V6 - V7)	Joint 1: (V8 - V9)	CS1: (V10 - V11)	Joint2: (V12 - V13)
8.85	5.27	4.919	4.9787	5.249
9.11	5.4273	5.061	5.1225	5.398
Avg: 8.98	5.3494	4.99	5.0506	5.3235
	Resistance [Ω]:			
R(avg) = R0	0.59570156	0.55567929	0.56242762	0.592817372
R <sub>room</sub> - R <sub>icew.</sub>	-0.0013116	-0.0011993	-0.00153762	-0.001697372

R/R0 = 1.0 when T<sub>r</sub> = 0.01 C

Resistance measurement:

	Voltage [μV]:			
Excitation current [mA]:	CS2: (V6 - V7)	Joint 1: (V8 - V9)	CS1: (V10 - V11)	Joint2: (V12 - V13)
23.75	210.2	174.4	200.25	209.43
(-) 23.46	209.2	205.4	199.41	203.99
(avg.+ -) 23.605	209.7	189.9	199.83	206.71
	Resistance [Ω]:			
R	0.00888371	0.00804491	0.00846558	0.008757043
Ro	0.59439	0.55448	0.56089	0.59112
R/Ro	0.01494593	0.01450892	0.01509312	0.014814324
	Temperature [K]:			
By Cu R/R0 table 1:	28.66	27.89	28.91	28.44
By Cu R/R0 table 2:	31.0	30.5	31.2	30.9

	T8	T7	T6	T4	T5	T3	T1	Cold head
--	----	----	----	----	----	----	----	-----------

Voltage [ $\mu$ V]:	-917.78	-936.47	-950.74	-929.2	-932.99	-929.08	-948.4	-1059
Temperature [K]:	30.39	28.82	27.57	29.44	29.12	29.45	27.78	15.85

Critical current test nr 1:

Voltage [ $\mu$ V]:				
Excitation current [mA]:	CS2: (V6 - V7)	Joint 1: (V8 - V9)	CS1: (V10 - V11)	Joint2: (V12 - V13)
16.09	173.47	140.2	168.7	177.8
(-) 15.3	167.35	169.55	163.04	166.08
(avg.+ -) 15.695	170.41	154.875	165.87	171.94
Resistance [ $\Omega$ ]:				
R	0.0108576	0.00986779	0.01056833	0.010955081
Ro	0.59439	0.55448	0.56089	0.59112
R/Ro	0.01826679	0.01779648	0.01884208	0.018532753
Temperature [K]:				
By Cu R/R0 table 1:	33.11	32.58	33.73	33.40
By Cu R/R0 table 2:	34.6	34.1	35.1	34.8

	T8	T7	T6	T4	T5	T3	T1	Cold head
Voltage [ $\mu$ V]:	-856.6	-870.25	-882.7	-869.6	-875.5	-872.9	-893.3	-1058
Temperature [K]:	35.09	34.09	33.16	34.14	33.70	33.89	32.34	15.99

Critical current test nr 2:

Voltage [ $\mu$ V]:				
Excitation current [mA]:	CS2: (V6 - V7)	Joint 1: (V8 - V9)	CS1: (V10 - V11)	Joint2: (V12 - V13)
15.16	174	176.57	162.65	165.9
(-) 15.24	171.97	139.53	160.9	169.6
(avg.+ -) 15.2	172.985	158.05	161.775	167.75
Resistance [ $\Omega$ ]:				
R	0.01138059	0.01039803	0.01064309	0.011036184
Ro	0.59439	0.55448	0.56089	0.59112
R/Ro	0.01914667	0.01875275	0.01897536	0.018669956
Temperature [K]:				
By Cu R/R0 table 1:	34.05	33.64	33.87	33.55
By Cu R/R0 table 2:	35.4	35.0	35.2	35.0

	T8	T7	T6	T4	T5	T3	T1	Cold head
Voltage [ $\mu$ V]:	-855.91	-870.21	-883.99	-857.95	-863.13	-861.03	-888.3	-1057
Temperature [K]:	35.14	34.09	33.06	34.99	34.62	34.77	32.73	16.13

**Temperature calculations test of superconductor**

Calculation of R0 i roomtemperature:

Excitation current [mA]:	Voltage [mV]:			
	Below CS1 (V6 - V7)	CS1 (V8 - V9)	CS2 (V10 - V11)	Below CS2 (V12 - V13)
16.32	10.21	10.08	10.14	9.85
(-) 33.81	21.18	20.93	21.03	20.42
(avg.+ -) 20.88	13.08	12.92	12.98	12.61
Resistance [Ω]:				
16.32	0.62561275	0.61764706	0.62132353	0.603553922
33.81	0.62644188	0.61904762	0.62200532	0.603963324
20.88	0.62643678	0.61877395	0.62164751	0.603927203
R(avg)	0.6261638	0.61848954	0.62165879	0.603814816
Ro	0.56731869	0.56036564	0.56323705	0.547070002

R/R0 = 1.10372496 when T<sub>room</sub> = 24.2 C (by interpolation)

Critical current test:

Excitation current [mA]:	Voltage [μV]:			
	Below CS1 (V6 - V7)	CS1 (V8 - V9)	CS2 (V10 - V11)	Below CS2 (V12 - V13)
29.74	310.48	290.25	296.87	275.4
(-) 30.62	338.1	318.65	304.7	281
(avg.+ -) 30.18	324.29	304.45	300.785	278.2
Resistance [Ω]:				
R	0.0107452	0.01008781	0.00996637	0.009218025
Ro	0.56731869	0.56036564	0.56323705	0.547070002
R/Ro	0.01894032	0.01800219	0.0176948	0.016849809
Temperature [K]:				
By Cu R/R0 table 1:	33.84	32.81	32.46	31.43
By Cu R/R0 table 2:	35.2	34.3	34.0	33.2

**Best fit curves for first, second and third test**

Example of how the resistance were determined in first joint test:

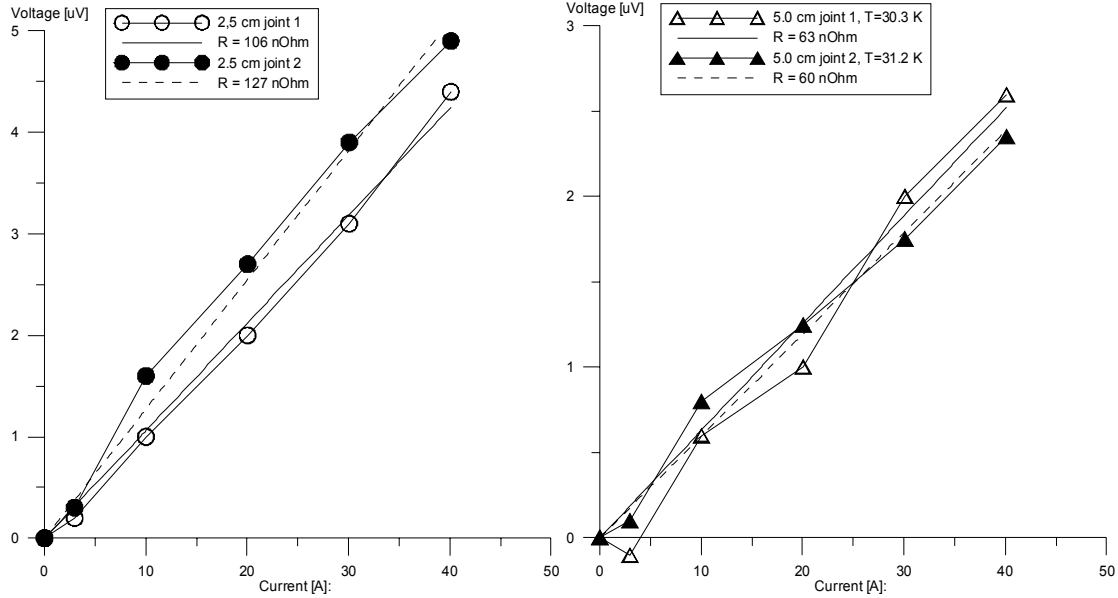

Second test, after heating the continuous superconductor piece by 5 degrees, linear area only

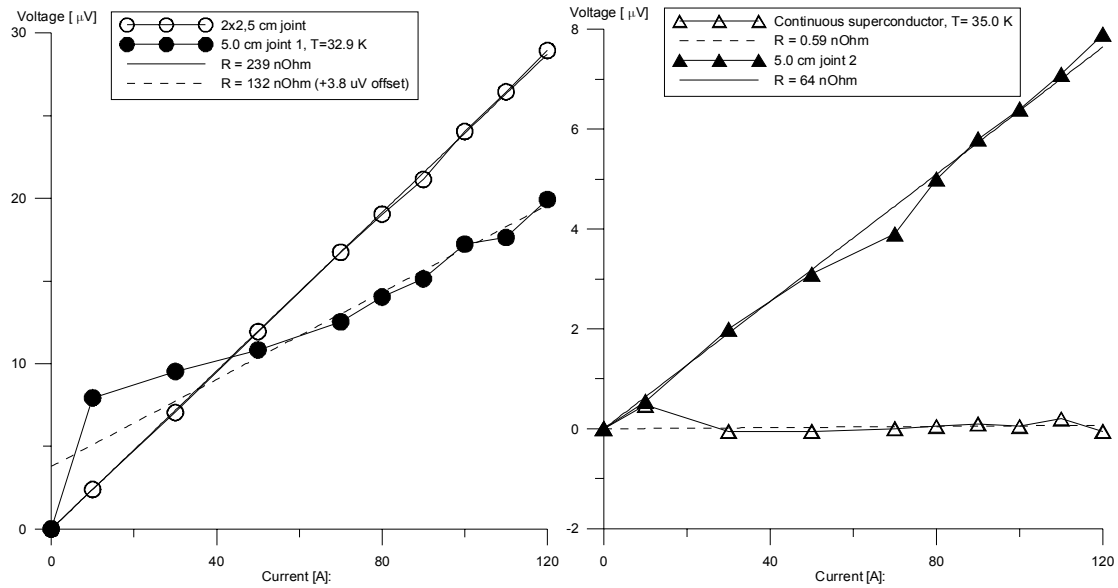

### Third test:

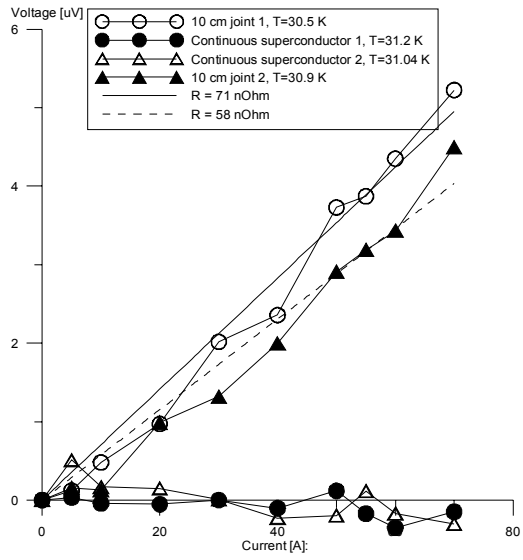

**Resistance ratio for the copper wire**

Cu R/R0 table 2:

T [K]:	R/R0:	d(R/R0)/dT
19.79	0.010496	0.000133
20.11	0.010539	0.000162
21.66	0.010789	0.000173
22.44	0.010925	0.000245
22.86	0.011029	0.000226
23.45	0.011162	0.000232
24.06	0.011301	0.000171
25	0.011463	0.000387
26	0.011849	0.000462
27	0.012311	0.000537
28	0.012848	0.000612
29	0.01346	0.000687
30	0.014148	0.000762
31	0.01491	0.000838
32	0.015747	0.000913
33	0.01666	0.000988
34	0.017648	0.001063
35	0.018711	0.001138
36	0.019849	0.001213
37	0.021062	0.001288
38	0.022351	0.001364
39	0.023714	0.001439
40	0.025153	0.000629

**Results from calibration test**

Temperature (Cernox) [K]:	Resistance ratio copper wires:						Avg
	1	2	3	4	5	6	
40.09	0.025269	0.024983		0.025056	0.025254	0.025165	0.025145
39.98	0.025229	0.024871	0.025031	0.024988	0.025147	0.025037	0.02505
38.44	0.022961	0.022663		0.022781	0.022952	0.022889	0.022849
37.87	0.022207	0.021894		0.022056	0.022197	0.022125	0.022096
37.11	0.021282	0.020969		0.021103	0.021243	0.021191	0.021157
36.67	0.020769	0.020467		0.0206	0.020759	0.020691	0.020657
36.63	0.020701	0.020408	0.020641	0.020538	0.020694	0.020632	0.020602
36.21	0.020151	0.019867	0.020102	0.019993	0.020149	0.020081	0.020057
36.09	0.020287	0.019985		0.020129	0.020288	0.020224	0.020183
36.05	0.02006	0.019785		0.019937	0.02006	0.019985	0.019965
35.96	0.019951	0.019649	0.019889	0.019789	0.019936	0.019853	0.019844
35.94	0.019965	0.01966		0.019803	0.019946	0.019873	0.01985
35.84	0.019838	0.019535		0.019678	0.01983	0.01976	0.019728
35.84	0.019817	0.019522	0.019765	0.019668	0.019813	0.019733	0.01972
35.78	0.019755	0.019466	0.019702	0.019604	0.019758	0.01968	0.019661
33.46						0.017384	
32.00						0.014795	
26.56						0.01197	
24.06						0.011301	
23.45						0.011162	
22.86						0.011029	
22.44						0.010925	
21.66						0.010789	
20.11						0.010539	
19.79						0.010496	

The resistance ratios are calculated the same way as in previous calculation with reference resistance in ice water as reference. The interpolation table in the calibration report is used to calculate the temperature from the resistance in the Cernox sensor.

**Best fit curves last test**

Example of one resistance measurement and the five critical current measurements from the fourth joint test:

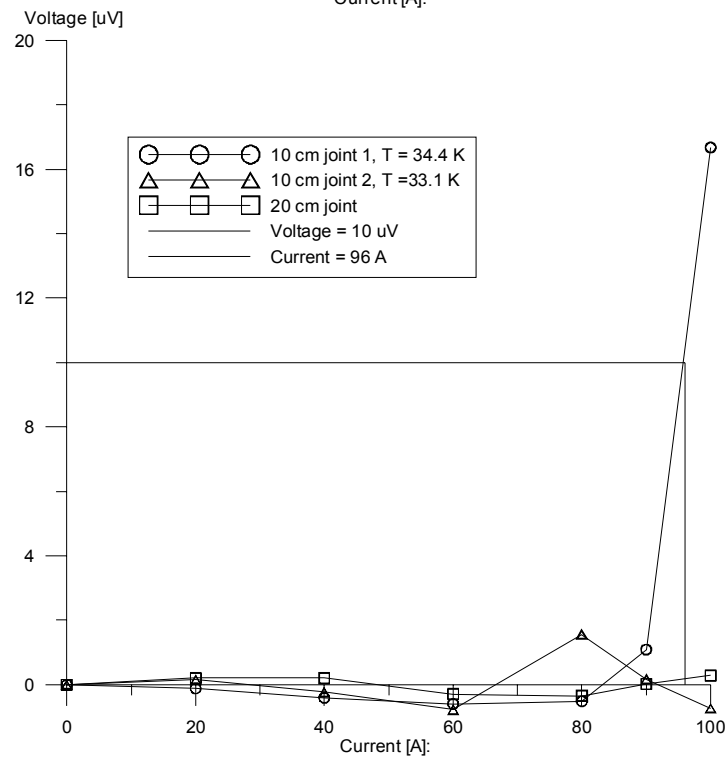
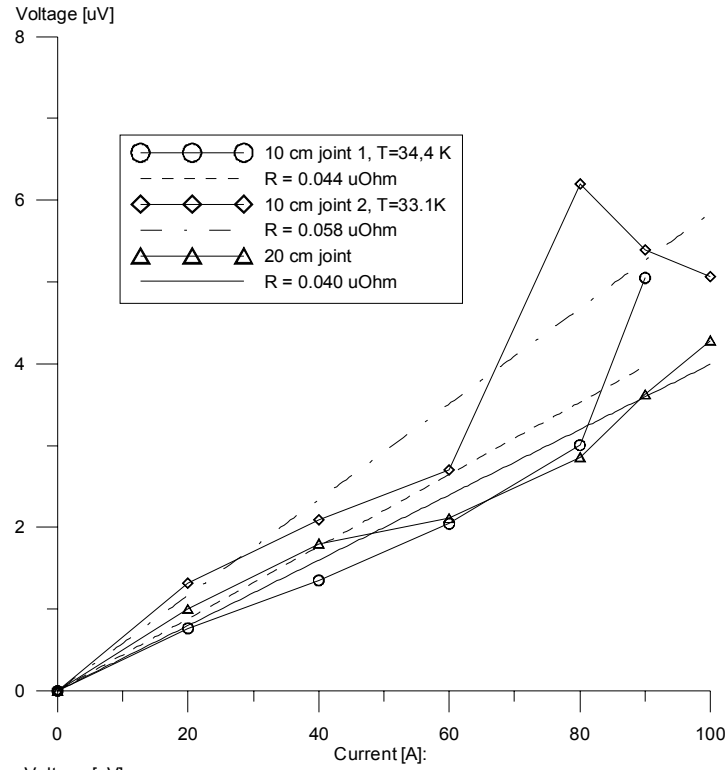



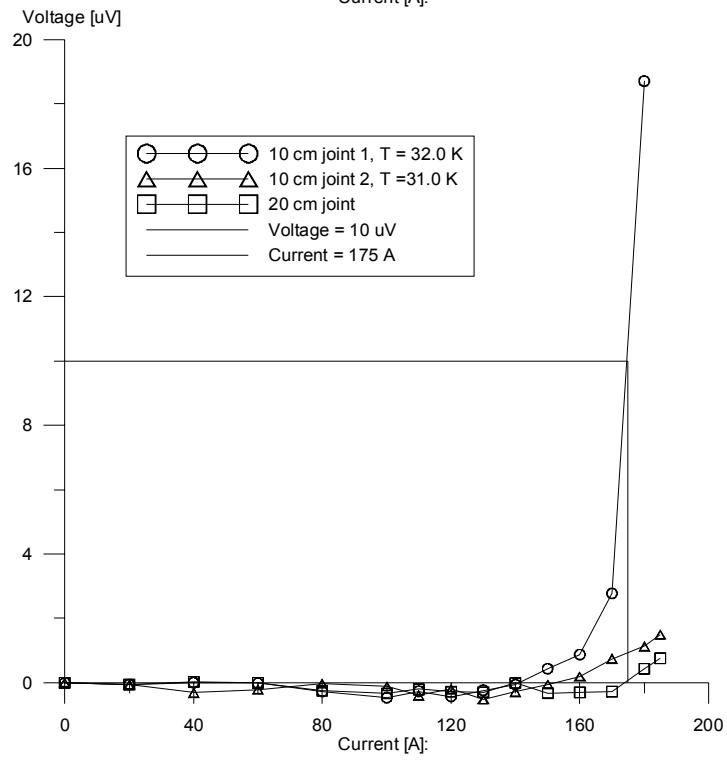
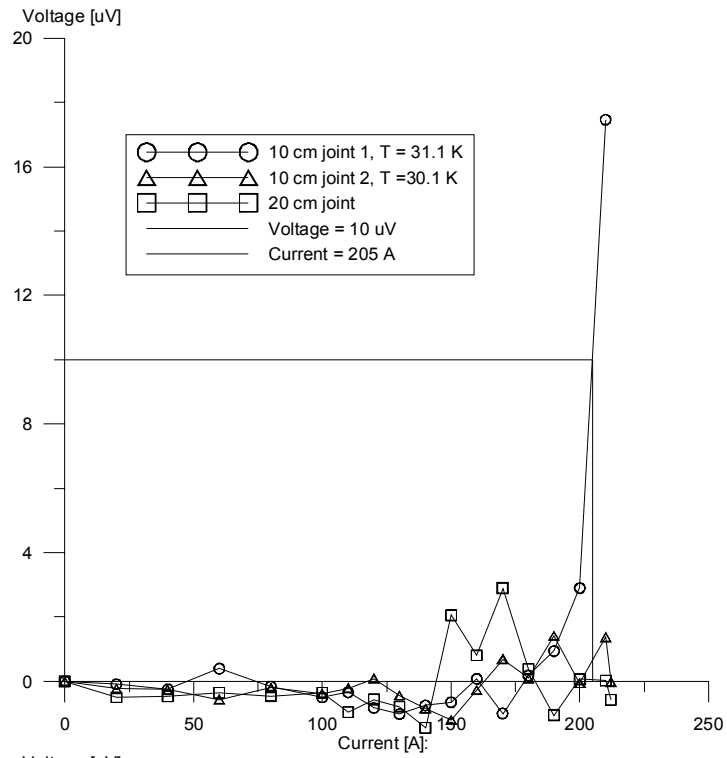

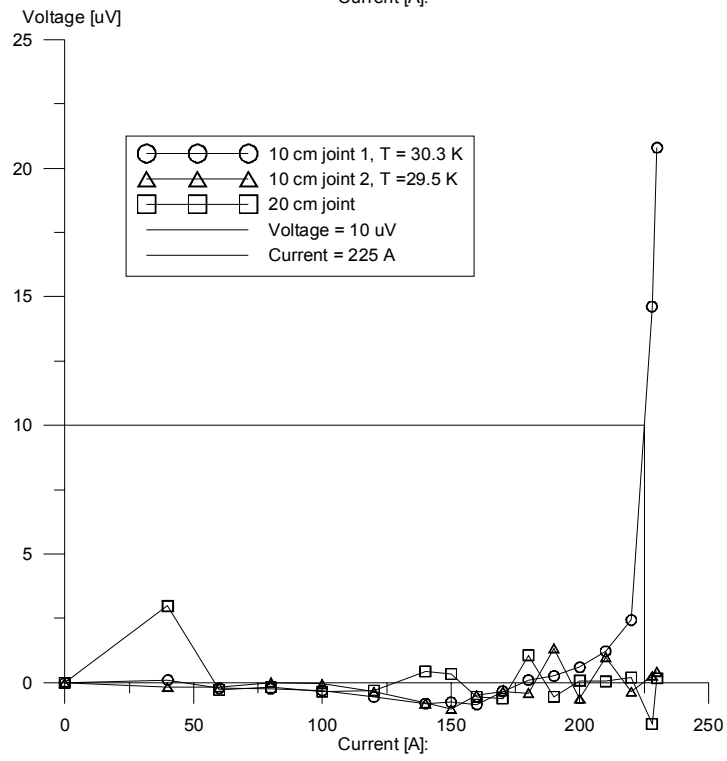
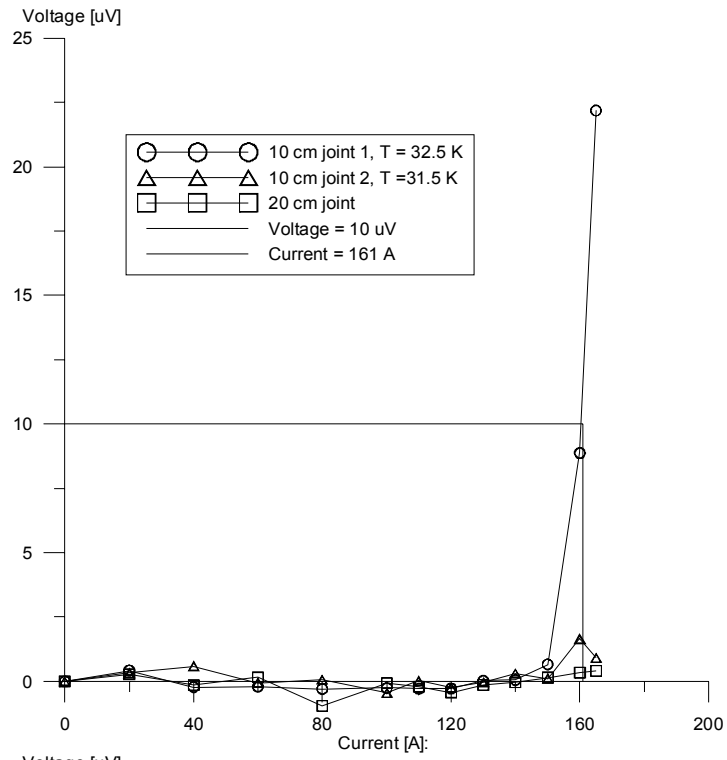

*Picture of the surfaces with soldering tin*



**Equipment list**

Equipment:	Type:	Number	Comment
Cold pump	Leybold Coolpak 6000	P05-0060	
Data acquisition unit	Agilent	G05-0102	
PC		P07-0739	
Power sources	Morgenstierne	B02-0054	cu wires
	Morgenstierne	B02-0026	heating wires
	Agilent DC power supply	B02-0503	superconductor
	Knick Prazisions-spannungsgeber	B02-0212	Cernox
Vacuum pump	Alcatel	P05-0060	
Digital thermometer	Yokogawa	N02-0049	
Multimeters	Fluke 26.3	S03-0327	Current Cu
	Fluke 89.4	S03-0309	Current Cx