



Norwegian University of
Science and Technology

Precipitation of carbonates in the pretreatment process for regeneration of ethylene glycol

Thomas Montazaud

Chemical Engineering and Biotechnology

Submission date: June 2011

Supervisor: Jens-Petter Andreassen, IKP

I declare that this is an independent work according to the exam regulations of the Norwegian University of Science and Technology.

Porsgrunn, 20th June 2011

Thomas Montazaud

A. Abstract

Offshore gas production is a big deal in the oil industry. Ethylene glycol (MEG) is used to prevent blockage in pipes. The cleaning of this substance from ions and water that enter the flow during the production is crucial in order to reuse it. Statoil developed a new way to achieve it and this work's goal is to set the best parameters for it (temperature and residence time). The mixture behaviour is not constant and it was found that it is better to keep increasing the temperature (up to 90°C) but the residence time has to be a certain value to reach the best cleaning. The process implies a Boiler and a pre-heating tank. In this last one, where the temperature should be around 90°C, the residence time should be 45 minutes with the given composition. Indeed, it was also seen that the feed composition has a great impact on the results. But in the end, more than 50% of the ions can be taken away and in parallel to get the purity of the MEG back to 90% when it was 70% in the feed. Some more studies have to be driven to try to increase the amount of ions taken away.

B. Acknowledgments

I would like to thank first my teacher Mr. Jens-Petter Andreassen who took the initiative for this project when I mentioned that I wanted a Master work related to the industry. He took contact with Mr. Bård Kåsa who I thank for finding the project itself on which I had a great time. Mr. Andreassen and Mr. Kåsa were helpful even if they were in Trondheim some hundreds of kilometres away from where I was then down in Porsgrunn. I would also thank Mr. Kåsa for giving me the possibility to use the Lasentech® probe that was a powerful tool to study the particles.

I would like also to thank the team with which I worked in Porsgrunn. Ms. Gry Pedersen Kojen supervised the overall project and gave me some good advices during those 6 months of work. I mainly worked with Ms. Kari Straume Andersen who explained to me in details all the new process and how she studied it so far. She also was very helpful while running the experiments when they took more than 10 hours. Her work on the analysis (SEM, alkalinity, ...) saved me a lot of trouble also. Alf Olav Larsen was so helpful for the determination of the species and polymorphs. He carried out all the XRD analysis and gave all the explanations useful to understand them.

I want to thank also all the people I met in Porsgrunn and who were helpful a way or another. I want to thank the company Statoil itself that provided me an accommodation in Porsgrunn and all the IT I needed for the work and for writing the present report.

C. List of abbreviations

Abbreviation	Meaning	Unit
C _p	Heat capacity	J/K/g
IAP	Ionic Activity Product	none
a _x	Ionic activity	none
K	Solubility	none
SR	Saturation Ratio	none
S	Supersaturation $S = \sqrt{SR}$	none
T _x	Temperature of the entity x	°C
F _x	Flow X	mL/min
n _x	Size density of the species X	#/mL/μm
V _x	Volume of tank X	L
C _z	Concentration of species X	#/mL
L _x	Reference length of particle X	μm
ΔL _x	Reference length interval	μm
t	Time	min
Δt	Time interval	Min
G _x	Growth rate of species X	nm/s
RT _x	Residence time in the tank X	min
N _x	Nucleation rate of species X	#/s/L
Alk	Alkalinity	mmol/L or mmol/kg
[X]	Concentration of species X	mmol/L or mmol/kg
Abbreviation	Meaning	
CSD	Crystas Size Distribution	
ICP	Inductive Coupled Plasma	
FBRM	Focused Beam Reflectance Measurement	
SEM	Scanning Electron Microscope	
XRD	X-Ray Diffraction	
FX	Experiment number X	

This report has 89 pages.

A.	ABSTRACT	1
B.	ACKNOWLEDGMENTS.....	2
C.	LIST OF ABBREVIATIONS	3
D.	INTRODUCTION	8
E.	BACKGROUND AND THEORY	9
E.1)	Presentation of the problem.....	9
a)	The oil journey	9
	Temperature and pressure differences.....	9
	Formation and condensed water – ions and hydrates	10
b)	MEG/water mixture characteristics	11
	MEG to prevent blockage.....	11
	MEG/water.....	12
c)	pH stabilizers	13
d)	The MEG circuit	14
	In the pipes	14
	Regeneration – 3 solutions	15
e)	Example to be studied: Ormen Lange	16
E.2)	Iron and Calcium Carbonate crystals	17
a)	Definition of the Saturation Ratio – SR	17
b)	Crystal characteristics	19
	Calcium carbonate	19
	Iron carbonate	20
c)	Types of Nucleation.....	20
	Primary	20
	Secondary.....	21
d)	Induction time	21
e)	Aggregation.....	22
f)	Solubility of carbonates	22
g)	Multiscale®.....	23
E.3)	Theoretical study of the experimental settings.....	23
a)	CSD & MSMR	23

b)	The flows and the residence times in the experiment	26
c)	Population balances – Growth and nucleation rates	28
	For the Mixing Tank	28
	For the Boiler	29
E.4)	Previous findings in Statoil®	29
F.	EXPERIMENTS	31
F.1)	The settings	31
F.2)	Protocol	33
F.3)	Measurements.....	34
a)	ICP.....	34
b)	Alkalinity.....	34
c)	SEM.....	35
d)	XRD	35
e)	FBRM.....	36
F.4)	The samples	37
a)	Ion concentration and alkalinity analysis	37
b)	SEM pictures.....	37
c)	XRD analysis	38
d)	CSD measurements.....	38
G.	RESULTS	39
G.1)	Types of experiments	39
G.2)	Reproducibility.....	39
a)	Concentration profiles.....	40
b)	XRD results.....	42
c)	SEM picture	43
d)	SEM and XRD results in the Boiler and in the Settler.....	43
e)	Cristal Size population.....	44
G.3)	Temperature effects.....	45
a)	Concentration profiles.....	45
b)	XRD results.....	47
c)	SEM pictures.....	48
d)	Growth and nucleation rates	48

G.4) Residence time effects	49
a) Concentration profiles.....	49
b) XRD results.....	51
c) SEM pictures.....	52
d) Growth and nucleation rates	52
G.5) Iron concentration effects	53
a) Concentration profiles.....	53
b) XRD results	54
c) SEM pictures.....	55
d) Growth and nucleation rates	55
G.6) MEG/water ratio effects	55
a) Concentration profiles.....	56
b) XRD results	57
c) Growth and nucleation rates	57
H. RECOMMENDATION	59
I. CONCLUSION	60
J. APPENDIX	61
Appendix 1: Recirculation effect	61
Appendix 2: MEG/water phase diagram	63
Appendix 3: Ormen Lange composition	65
Appendix 4: Result regression	65
Appendix 5: Concentration results	67
Appendix 6: Lasentech® results	72
Appendix 7: Final Lasentech® results	74
Appendix 8: XRD and SEM results	75
a) Temperature effects in the Boiler and in the Settler	75
b) Residence time effects	76
In the Mixing tank when repeating for a residence time of 60mins.....	76
In the Boiler and in the Settler.....	77
c) Iron concentration effects in the Boiler and in the Settler	78

Master Thesis:
Precipitation of carbonates in the pretreatment process for regeneration of ethylene glycol

K. REFERENCES 81

HAZARDOUS ACTIVITY IDENTIFICATION PROCESS 85

D. Introduction

Offshore gas production is one of the main activities of Statoil, the Norwegian oil company. The company has mastered the art of collecting the natural gas from reservoir for decades however, the technique is perfectible. One of the main problems that can occur in the pipes that lay on the sea floor is their blockage. The best solution found so far to avoid it is to inject ethylene glycol or MEG in the flow. A massive quantity of this substance is used and, as it is quite stable, can be reused several times. The aim of the present work is to define the best settings to clean the MEG from water and ions (iron and calcium) that pollute the flow during the gas transportation. The setting for cleaning the MEG is experimental and has been developed by Statoil researchers. Settings already in use achieve the cleaning but in bad conditions as some scaling can form on their walls and they have to be stopped to remove this scale. The new setting implies a recirculation loop from a Boiler to a Mixing Tank where the feed arrives. This allows the feed to be warmed up before entering the Boiler. The particles that are formed from the precipitations of ions in the Boiler can grow freely in the Mixing Tank and then be removed by settling for example without the process being stopped.

This report will develop some theory that will be useful to get some clues on the behaviours of the studied ions but also it will show on which theories rely the tools that are used to study the process. Then, the process itself will be described as well as the protocol under which it will be studied. Then the work will study the effect of temperature and residence time in the Mixing Tank and try to find the best combination to get the most particles and also the biggest ones. The feed can also be modified depending on what is happening during the gas transportation. This will also be studied.

E. Background and Theory

Statoil® is one of the biggest companies in Norway and is the first actor in the oil industry in the country. This firm is present in 34 countries around the world. Its main production sites as well as its offices are mainly based in Norway. The company is able to deal with processes regarding oil and gas extraction from the reservoirs inside the earth crust to the commercialisation of the products (petrol stations for examples). An important stage is the production itself where the oil or gas is recovered from the reservoir in the earth crust. Norway has a lot of oil and gas resources but all of these are located deep under the sea level along the Norwegian coasts.

The present work is based on the natural gas production and particularly the treatment of the production flow. The gas can be used for several purposes in the industry. It can be used to synthesise other chemical components such as ammonia.

Statoil® developed both ways to detect the presence of natural gas and the capacity of recovering it. This implies, after the gas being extracted from the reservoir through a well, to ship it back to an onshore facility for treatment. There can be two possibilities to achieve the shipment. A boat can handle that but pipelines are also often used. This allows having a continuous production. The pipes can be relatively long and the operators have to be aware of the possibilities that the pipe can be blocked. Several measures are taken in order to limit this from happening. This implies that the onshore facility should have extra units where anti-blockage treatments have to take place.

E.1) Presentation of the problem

a) The oil journey

Temperature and pressure differences

In Norway, the natural gas often comes from offshore production sites. This means that the well from which it is extracted lies on the sea floor. When it comes out of the well, the gas is under high pressure and high temperature (about 100 bars and 100°C). Then a pipeline takes the gas from this site to an onshore facility for

treatment and gas recovery. Given the depth at which the sea floor is (some 1000 meters), the pressure stays high but the temperature falls to 0°C. The pipe between the production site and the treatment site can be 100km long and the gas has time to cool down. When it reaches the onshore facility, the gas is suddenly in presence of a lower pressure (1 bar) and of a higher temperature due to the treatment.

Below is presented a sketch of the journey of the gas from the reservoir to the treatment centre. One can see the different conditions to which the gas is confronted. Moreover, the reservoir does not only contain the gas but also some water charged with minerals (ions). The pipes, especially at the well level, can leak and some sea water can enter the process. Some carbon dioxide can also be present in the gas phase and then dissolve in the water under the form of carbonate. All these, as it will be seen, can lead to the blockage of the pipe or damage the onshore treatment facility.

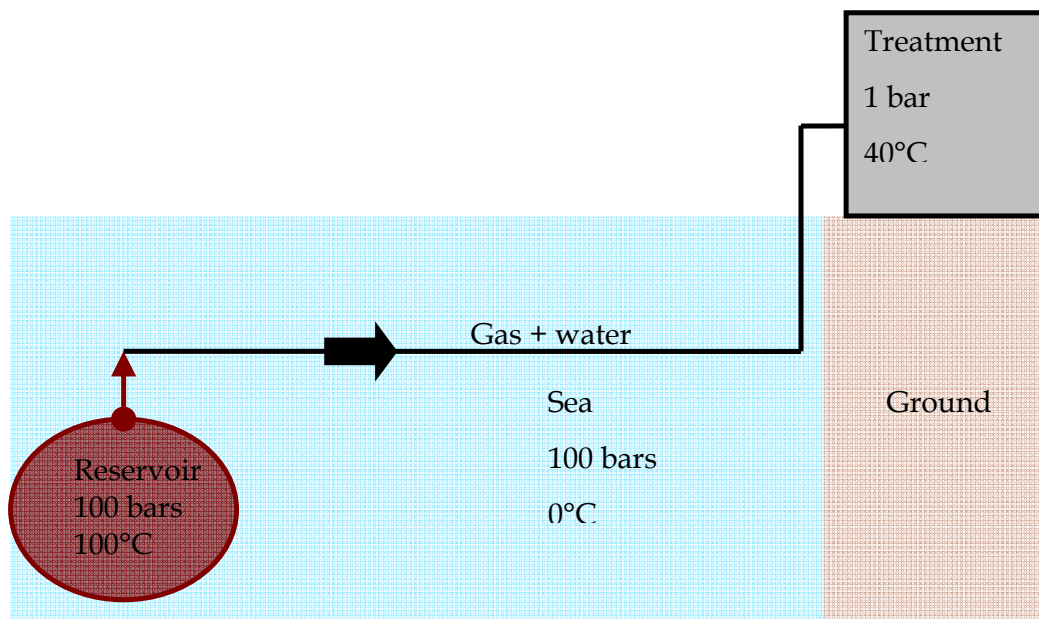

Sketch 1: Gas journey from the offshore production site to the onshore treatment centre

Formation and condensed water – ions and hydrates

Along the journey, some liquid water will appear in the pipes because it will either be created by condensation or it will come along with the gas from the reservoir or from leakages in the well. As the well is placed on the seabed, the water is charged with sodium chloride whereas the formation water from the reservoir contains some

other minerals dissolved. Though, this formation water contains ions and especially some calcium (Ca^{2+}).

Hydrates form in the presence of ions, water and gas at high pressure and low temperature. In the pipe conditions, hydrates can be formed and if they appear in too large quantities, they will block the pipe.

CO_2 can also dissolve in the water and decrease the pH. That will lead to the corrosion of the pipe that is mainly made of steel. Plus, the carbonate ions coming from the dissolution of CO_2 will precipitate with the iron or calcium ions to create solid carbonates that will scale on the pipe walls. They will contribute to the blockage of the pipe.

The dissolution of the CO_2 happens like the following:

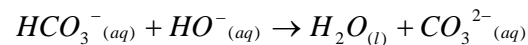
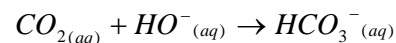
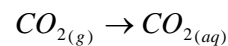

Reac. 1

The consumption of HO^- will indeed lead to an increase of the acidity.

To sum up, the presence of water and ions at high pressure and low temperature can form hydrates. The CO_2 increases the pH and lead to the corrosion of the pipes. The dissolved CO_2 , the iron from the corrosion and the calcium from the formation water can precipitate. All this can lead to the blockage of the pipe. If this happens, it would be difficult to unblock the pipe that is at 1000 meters under the sea level.

b) MEG/water mixture characteristics

An alcohol is mixed to the oil (enriched with unwanted water) directly after the well in order to prevent the blockage. The alcohol that is used is the Ethylene Glycol or MEG.

MEG to prevent blockage

Only adding a substance to the gas/water mixture will prevent the hydrates from forming. This is mainly due to the dilution of the water. Its concentration will go down and below a certain value; the amount of water will be so low that no hydrate

can form. The amount of MEG injected is so that the water concentration is kept as low as possible.

The ethylene glycol has the following formula:



Because it also has a high boiling point, this makes it stable under the liquid form for the pipe conditions. Moreover, having a boiling point at 200°C (1 bar) will also help to separate it from the water after the journey in the pipe.

The MEG cannot prevent the corrosion but it has been found in several studies that it has an effect on the formation of iron and calcium carbonate. According the E. Flaten (2010), calcium carbonate does not form or grow as fast as when no MEG is present. In a report of the "Institute for Energy Technology" (2009), it was found that increasing the content of MEG decreases the growth rate of iron carbonates. However, the MEG does not seem to have an effect on the formation of new iron carbonate crystals.

MEG/water

To describe the characteristics of the MEG/water mixture, the next values are presented.

Table 1: Some physical properties for the MEG and the water

	Density g/L	Cp J/K/g	Boiling point (1 bar)
Water	1,0	4,184	100°C
MEG	1,1	2,200	197°C

First, the densities are relatively close and hence, calculations can be made in terms of mass or volume without any conversion as both products have a density close to 1. So, speaking of the solvent, the value for its mass in kg or for its volume in L will be assumed to be equal. Same for the heat capacities, these are relatively close, plus, the temperatures that will be used do not differ that much (from 40 to 140°C). These capacities can be assumed to be equal to ease the calculations. The mass fraction of MEG (%wtMEG) will be around 50-90%wtMEG and hence the global properties of the MEG/water mixture will not change drastically.

After being used in the pipes, the MEG and the water need to be separated from each other in the MEG/water mixture. This can be achieved by using the differences in

their boiling points. In order to be effective, the MEG purity should be around 90%wtMEG. In *Appendix 2*, the phase diagram of the MEG/water mixture shows that this purity is reached when the boiling point is at 140°C.

This step is crucial given that when the mixture reaches the facility, the MEG concentration can fall to 50-60%wtMEG and the water needs to be extracted to increase the ratio.

During the journey, the MEG can also decay into acetic acid (ethylic acid) whose formula is:



When this happens, some new MEG needs to be added to the flow.

c) pH stabilizers

As it has been said, the MEG does not prevent the corrosion, other chemicals need to be used for this purpose.

Also, in order to diminish the corrosion, the pH needs to be stabilised at a higher value. Corrosion happens in acid environment. The increase of pH means that the acidity will vanish. Some alkaline chemicals will be added in order to achieve this. Those pH stabilizers can be potassium based (KHCO₃/K₂CO₃) or sodium based (NaHCO₃/Na₂CO₃). They act as proton absorbers which is what make the solution acid. Say AB being the pH stabilizers, it will act as follow:



From these chemical compositions, one can see a drawback to this. The more pH stabilizers there are the more CO₃²⁻ there will be in the mixture. This will encourage the formation of solid carbonates.

Theses stabilizers work well but some corrosion remains so in the end, the mixture will be composed of water, MEG and ions. Iron will always be present among the ions due to residual corrosion but the presence of other chemicals depends on the production site itself. Calcium is always present but its concentration will vary depending on the reservoir.

d) The MEG circuit

The MEG, even if in the end it will decay, is stable for a long amount of time and can be used and even reused. In order to save big amount of MEG (around 200m³/day) a recirculation loop was designed to allow the MEG to be used several times. It has been seen that many impurities and water mix with the MEG and hence need to be taken out through a regeneration process. First, it will be described the journey of the MEG in the pipes and then the way it is regenerated.

In the pipes

The next sketch shows the loop circuit followed by the MEG.

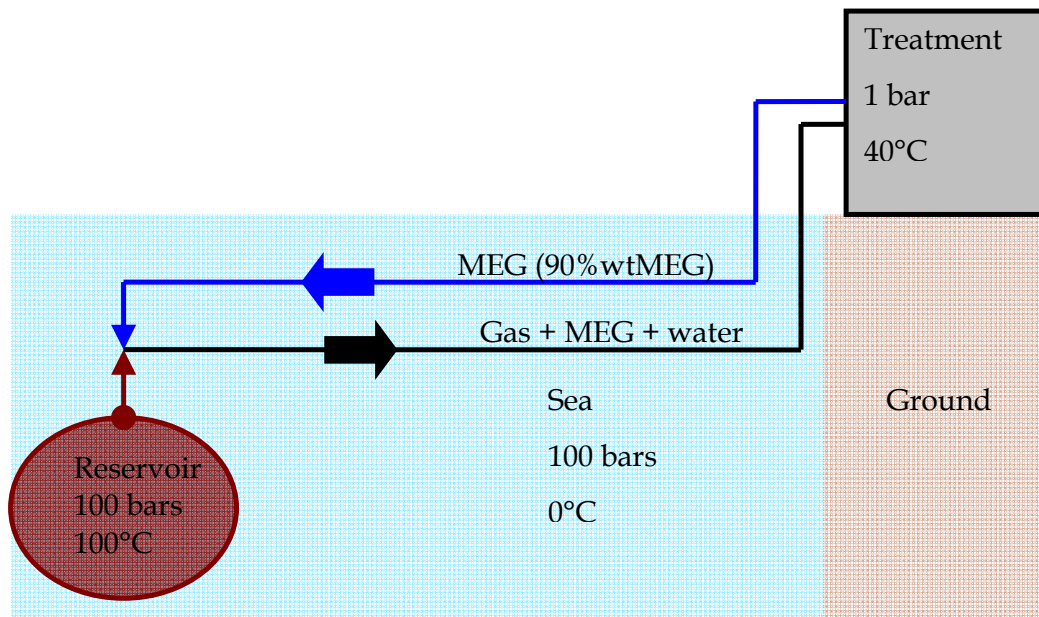

Sketch 2: MEG loop journey in the pipes

For half the journey, the MEG is confronted to the same conditions as the gas. The other half, where the MEG is alone, the same conditions are met but come backwards.

Then the regeneration consists in separating the water from the MEG after the gas has been removed. At 140°C, the MEG can be purified at 90%wtMEG. However, at that temperature, the carbonates will scale on the pipe. It has been observed in treatment installations that the scales appear mostly in the heat exchanger that increases the mixture temperature to around 90°C before entering the separation

room at 140°C. Three solutions were studied in order to diminish the scaling and so the risk for the process to fail.

Regeneration – 3 solutions

The MEG is used several times in the pipeline so it needs to be cleaned before being injected back at the well. Before the MEG/water separation, the gas is first removed through a previous separation process so the mixture that comes into the regeneration process is composed of MEG/water, ions (Fe^{2+} , Ca^{2+} ...) and dissolved CO_2 at 40°C.

Then the regeneration of the MEG begins. There are several steps.

The liquid goes to a flash drum in order to release the pressure. A heating process warms up the mixture up to 80 or 90°C before entering a boiler at 140°C to remove the water. The iron and calcium ions should be precipitating along the process and then be removed by filtration or settling.

Statoil® developed three different ways to warm up the mixture to 80 or 90°C. The two first processes use a heater that is inline for the first case or in a recirculation loop between the inlet and the outlet of the flash drum for the second case. But in both cases, a scale forms on the walls of the heat exchanger that forces the process to stop for a while in order to clean the heating device.

The third solution is to use the heat from the boiler in order to warm up the liquid before it enters the boiler itself. A mixing tank is added to the process in order to get a constant temperature profile in the liquid when the cold and the hot streams meet. Before and after the recirculation loop, two tanks act as buffers in order to store an amount of MEG that can be used in the case the process should be stopped at some points. So if a step of the process stops, the global regeneration process could still go on until the used buffer gets empty.

Downward is a sketch of the industrial process when a heater is used (2 first cases).

A second sketch showing the 3rd solution has also been drawn.

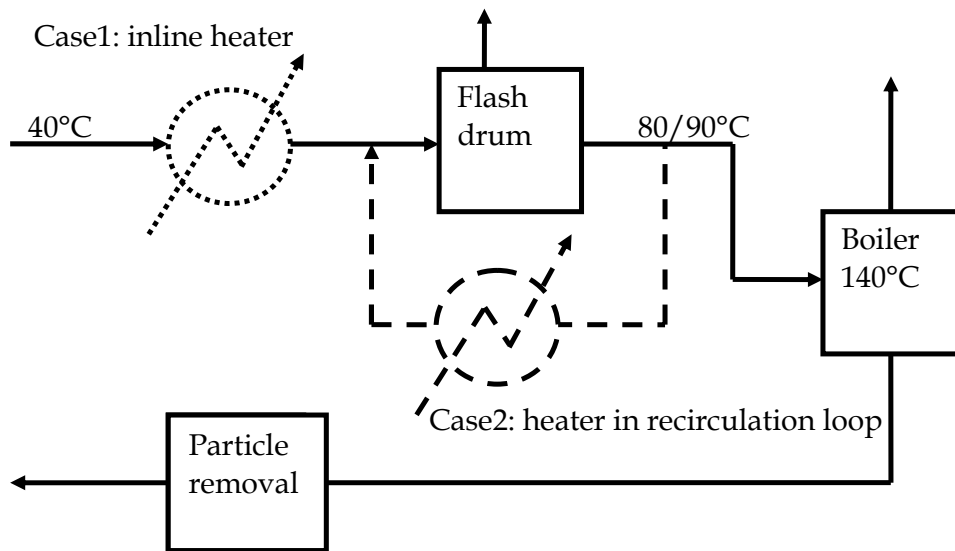

Sketch 3: Regeneration process, two solutions to pre-heat the mixture with a heat exchanger

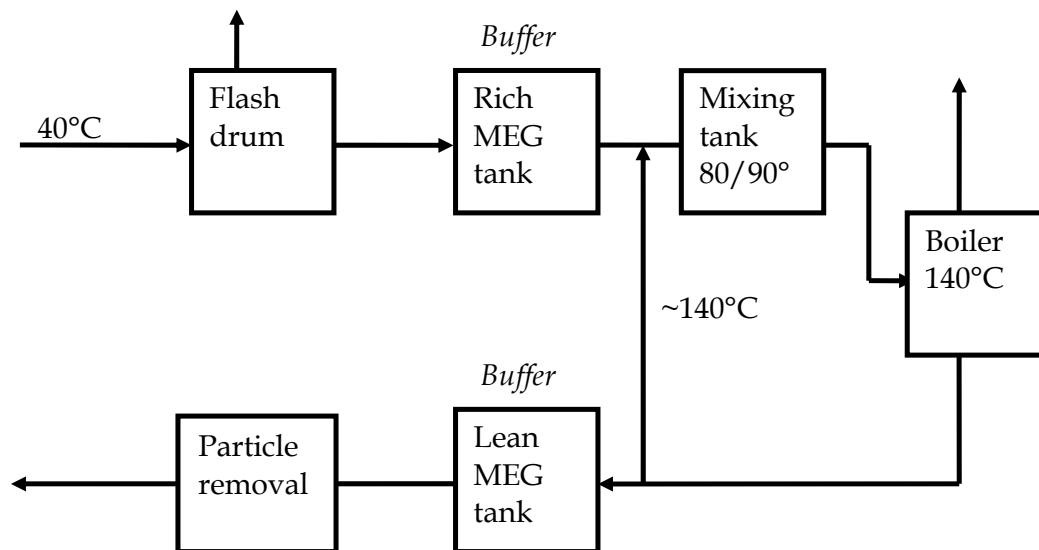

Sketch 4: Regeneration process, pre-heating the mixture with a recirculation loop from the boiler

e) Example to be studied: Ormen Lange

The whole work focused on this MEG regeneration process by using the 3rd preheating system. However the composition of the incoming flow may vary depending on the production site.

In the present work, one specific site will be studied: Ormen Lange. Hence, a definite composition in the formation water will be treated.

Ormen Lange facility is an onshore coastal terminal site in the south part of Norway between Trondheim and Bergen. Here, the pH stabilization is potassium based and

some acetic acid is also present. This comes from the slow decay of MEG. As the pH is kept high, the acetic acid will be found under the form of potassium acetate. The particularity of the oil/MEG mixture that arrives to the treatment facilities is that it is rich in iron but poor in calcium.

E.2) Iron and Calcium Carbonate crystals

Iron and Calcium are the two main ions present in the system and observed to scale with carbonates during the process. If not in the pipe, they precipitate in the heater but if the 3rd solution is used, no scale is observed as there is no heater so to speak. But if those ions/solids are not removed at this point, their concentrations will build up. Some blockages could then happen somewhere in the pipe. The point is to understand how and how much those solids are formed during the regeneration in order to increase their formations without scaling and then be able to remove them by filtration for example.

a) Definition of the Saturation Ratio – SR

The most important condition under which crystals can be or cannot be formed is the ions activity. The activity depends on the ions' concentrations (not only the one whose activity is calculated) and the temperature. To see if a crystal is to be formed, the Ionic Activity Product (IAP) can be calculated with respect to the crystal chemical composition. For example for FeCO₃:

$$IAP_{FeCO_3} = a_{Fe} \times a_{CO_3} \quad (1)$$

Where a_x is the activity of the ion x in the solution. For CaCO₃, the formula is the same; Fe has to be replaced by Ca.

Each polymorph has a define solubility product K at a given temperature. If IAP is higher than K , then the crystal will be formed, if not and if the crystal is present in the solution, it will dissolve. In every cases the equilibrium is when $K=IAP$.

At the equilibrium, the crystals and the ion quantities remain stable. Only a change in the system conditions can break this stability.

To estimate how far the system from the equilibrium is, the Saturation Ratio SR is used. It is defined by:

$$SR = IAP/K \quad (2)$$

Hence, the evolution of the system can be estimated by studying SR:

- $SR < 1$: The crystal, if present, will dissolve
- $SR = 1$: Nothing happens
- $SR > 1$: The crystal will form

Formation of crystals can mean two things:

- Nucleation: new particles are created
- Growth: particles that already exist get bigger

The former is observed at high SR whereas the latter is seen when SR is close but strictly superior to 1. Moreover, SR can be slightly superior to 1 and yet nothing can be observed because the kinetic is so slow that the system seems to be at the equilibrium. When this happens, the system is then metastable. To illustrate all those effects, a figure is drawn next.

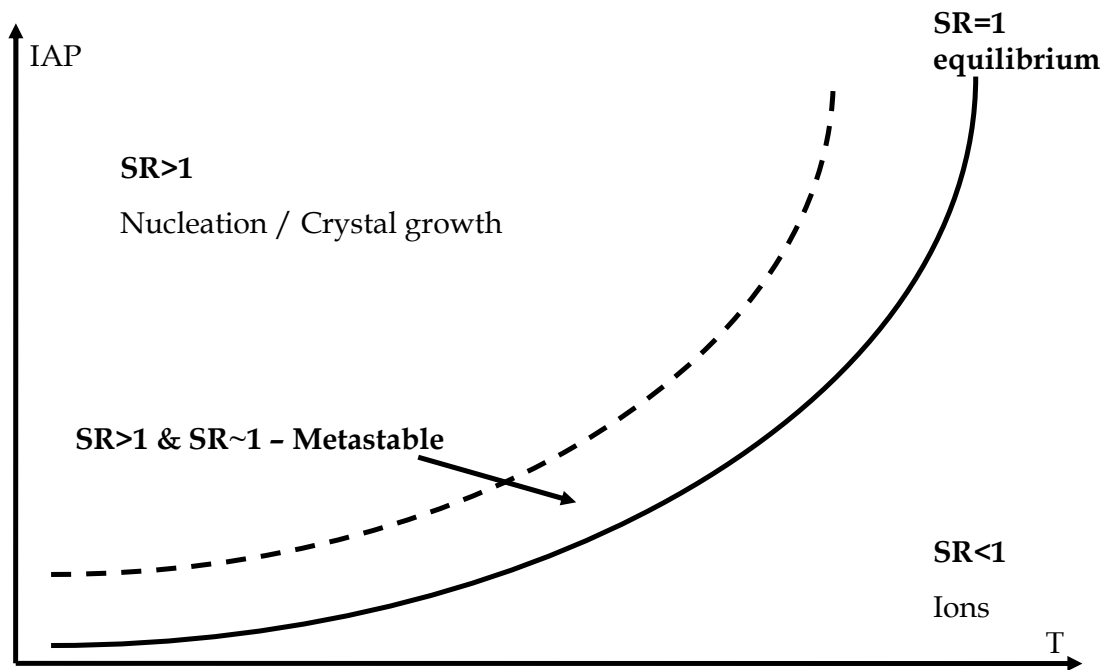

Sketch 5: Crystal existence area the diagram IAP vs. Temperature T

The present work will deal with this Saturation Ratio SR but the Supersaturation S can also be used for the same purpose and is mostly present in the literature. It is defined in this case where solids are formed by the coupling of two ions by:

$$S = \sqrt{SR} = \sqrt{\frac{IAP}{K}} \quad (3)$$

One can see that S and SR are close and that the same information can be given by either of them two. Only the amplitude of the numbers will change (above 1, SR is bigger than S).

b) Crystal characteristics

In aqueous solutions and under certain conditions, solids can be formed by the assembling of ions present in the solution. The present work will focus on carbonates and especially on iron and calcium carbonates. Hence, the ions that intervene in this process are Fe^{2+} , Ca^{2+} and CO_3^{2-} . The solids are formed through the chemical reactions that follow:



A solid with a given composition can have several possible shapes depending on the temperature and on the time. When the solid forms, it is first mainly amorphous. It means that the ions are randomly dispatched in the solid. This shape is not so thermodynamically stable and will evolve to a crystal where the ions will occupy specific locations. This happens for the same chemical composition, several crystal shapes or polymorphs can exist. It is the case for calcium carbonate that possesses 3 stable polymorphs. However one is the most stable but is formed after a certain amount of time. Indeed, the speed of formation of a crystal or kinetic is a predominant factor and depends mainly on the temperature.

In the next paragraphs, the two crystals will be briefly described.

Calcium carbonate

Calcium carbonate has got three polymorphs. From the most stable to the least stable, next is the list of the 3 calcium carbonate polymorphs with an indication of their particle shapes and temperature formations:

1. Calcite - cubic - low temperatures $\sim 10^\circ\text{C}$
2. Aragonite - needle like - higher temperatures $\sim 90^\circ\text{C}$
3. Vaterite - spherical - intermediate temperatures $\sim 30^\circ\text{C}$

Master Thesis:

Precipitation of carbonates in the pretreatment process for regeneration of ethylene glycol

Even if all the polymorphs can be observed (by adapting the temperature) they will all end up in Calcite if they stay in solution. In dry conditions, those solids remain as they are.

According to E. Flaten (2010), the nucleation and the growth of calcium carbonate is slowed down by the presence of iron. Only some traces of iron can have an impact on the formation of this crystal. Some experiments will be designed to study this effect.

Still according to E. Flaten (2010), the growth rate of calcium carbonate should be around 1nm/s. This is a rough figure given that it depends on many factors such as the temperature, the MEG fraction, the iron presence...

Iron carbonate

Iron carbonate has got only one polymorph under casual conditions. The iron carbonate will end up in Siderite particles whose shape is a bit like Vaterite that is spherical. This means that one cannot trust particle pictures to determine if one is in presence of iron or calcium carbonates. Some more analyses have to be done. However iron carbonate particles are much smaller (1 μ m) than calcium carbonate particles (up to 10 μ m). Even if this is far from being precise, this still gives an indication.

According to a study made by the "Institute for Energy Technology" in 2009, it was found that unlike calcium carbonate, the formation of iron carbonate is not impacted by the presence of calcium. This will be verified by some experiments. Still according to this study, the growth rate of iron carbonate should be below 0,1nm/s up to 0,1pm/s but this depends also on many parameters.

c) Types of Nucleation

When new particles are formed, this process is called nucleation. This can happen in different conditions but always when the saturation ratio is high enough.

Primary

The primary nucleation happens when no crystal of the studied compound is present in the solution. The crystals that will form in this condition will be the very first one

to be present in the environment. Once there, the secondary nucleation will be possible.

The primary nucleation can either be homogeneous or heterogeneous. If homogeneous, then there is no compound (impurities) in the solution to catalyse the nucleation. The energy to be used for the formation of crystal is the greatest and SR has to be far bigger than 1.

If heterogeneous, then there are some impurities in the solution that can help the particles to form. They act as catalysers and the energy to be deployed is lower hence SR does not need to be that big.

The heterogeneous nucleation is always encountered at some point as it is impossible to get a 100% pure solution and impurities are always present.

Secondary

As it has been said, the secondary nucleation happens when particles of the studied species are already present in the solution. Usually the ions will “deposit” on the existing particles in order to make it grow. But if the SR is high enough, those particles, like the impurities in the heterogeneous nucleation, can act as catalysers and help a new crystal to be created.

d) Induction time

SR says how far from the equilibrium a compound is. To reach it (if $SR > 1$), the compound can nucleate or grow so that SR decreases to 1. However SR is a thermodynamical value. The induction time is a kinetic value. It can be necessary to wait some amount of time before seeing anything happening (nucleation or growth if $SR > 1$ for example). The time needed to be waited is called induction time.

In this project, only the results for the steady states are in the scope. From previous work, it was seen that the induction time can be of some minutes to some hours. As a general rule one should wait 10 residence times (to be defined in some paragraphs) before stating that steady state is reached. As a check, samples were taken from the start to the end of the runs to check that steady state was reached and that the induction time was passed.

e) Aggregation

It was seen that the particles can either nucleate or grow when ions were consumed. They can also grow without ion consumption if they aggregate. This means that 2 particles can collide in the solution and stick and merge together to form in the end only 1 big particle. A sketch of this process is given below.

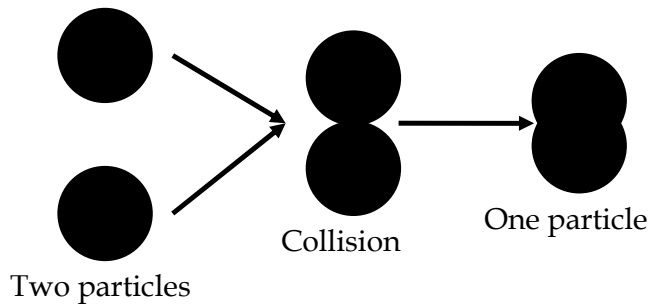

Sketch 6: Aggregation process

From that, it can be deduced that while the particles are growing, the number of them goes down as they are consumed by this process (2 particles end up in 1). This effect can be detected by these results: particles growing but their numbers going down.

f) Solubility of carbonates

The solubility K of a species determines its equilibrium in an aqueous solution. Several studies were made to evaluate those coefficients. For calcium carbonate, Plummer (1982) gives the equations to calculate the solubility for the three calcium carbonate polymorphs.

- Calcite:

$$\log(K_c) = -171,9065 - 0,077993T + \frac{2839,319}{T} + 71,595 \log(T) \quad (4)$$

- Aragonite:

$$\log(K_a) = -171,9773 - 0,077993T + \frac{2903,293}{T} + 71,595 \log(T) \quad (5)$$

- Vaterite:

$$\log(K_v) = -171,1295 - 0,077993T + \frac{3074,688}{T} + 71,595 \log(T) \quad (6)$$

Hence, if there is a given solubility for each polymorph there is also a given SR for each polymorph (SR being calculated for each K). Calcite being the most stable one, only the SR for this species will be given in the next parts of this report. Then Calcite will be the reference for the precipitation of the calcium carbonate. Its SR will always be the largest one (as K is the smallest all the time).

The same for the iron carbonate (Siderite), Sun et al. (2009) developed an equation to calculate the solubility taking into account both the temperature and the ionic strength. The terms dealing with this last parameter were not written as the temperature is considered as the main variable in the present study.

$$\log(K_s) = -59,3498 - 0,041377T - \frac{2,1963}{T} + 24,5724\log(T) \quad (7)$$

From all those equations that give the solubility for all the studied polymorphs, one can see that they go down when the temperature goes up. This means that these species will precipitate more when the temperature gets higher and they will dissolve when the solution cools down. This is an unusual behaviour as it is common for other species (NaCl - common salt for example) to dissolve in a greater extent when the temperature is greater.

g) Multiscale®

SR is then calculated by the use of K, temperature, ion activities, solvent composition... It is a hard work to compile all these data to find the right value. To simplify this work, a program was developed by NTNU and Statoil® members. The user only needs to compute all the data and the program returns many results. The one that were taken from the program were SR and the equilibrium concentrations. The equilibrium concentrations are the quantity of ions that should be found when the system is stable when closed (no feed). These are the minimum achievable ion concentrations; it is not possible to get lower for the given conditions.

E.3) Theoretical study of the experimental settings

a) CSD & MSMR

If all the particles are assumed to have the same shape, a reference length L can be introduced (it can be the diameter for sphere like particles for example). A Crystal

Size Distribution (CSD) gives the number of particles in a population having a certain size L . from this distribution; it is possible to measure the growth rate and the nucleation rate of the population. In Mullin (2001), the Mixed - Suspension Mixed Product Removal model (MSMPR) is used to calculate the rates from a CSD. The reactor based on this model is drawn next.

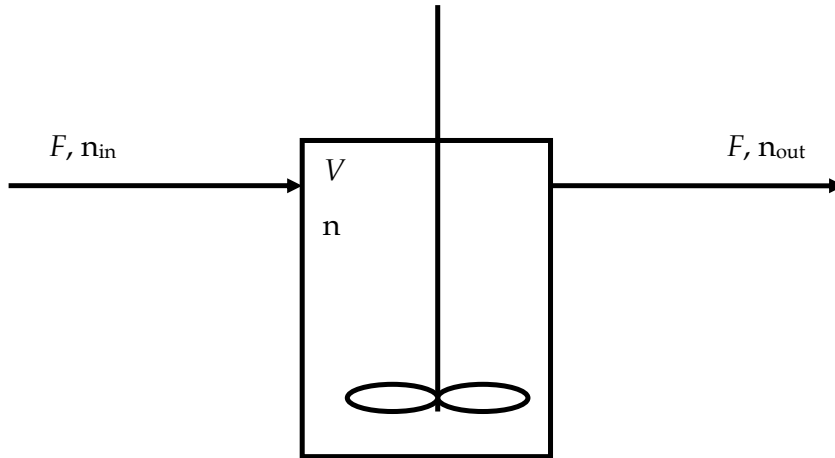

Sketch 7: MSMPR model to calculate the growth and nucleation rates of a CSD

Where F is the flow in mL/min and n_x is the particle concentration per length in #/mL/ μm at different points in the process. Say C_x being the concentration in #/mL of particles whose reference length L is between two values L_1 and L_2 . The n_x is defined to be:

$$n_x = \frac{C_x}{L_2 - L_1} \quad (8)$$

To apply this model, it must be assumed the following:

- Steady state
- No crystals in the feed ($n_{in}=0$)
- The growth is independent of the size
- Well mixed reactor ($n=n_{out}$)

An example of a CSD for this model reactor is given in the following graph. Its coordinates are n (particles concentration in #/mL/ μm) versus L (linear dimension in μm).

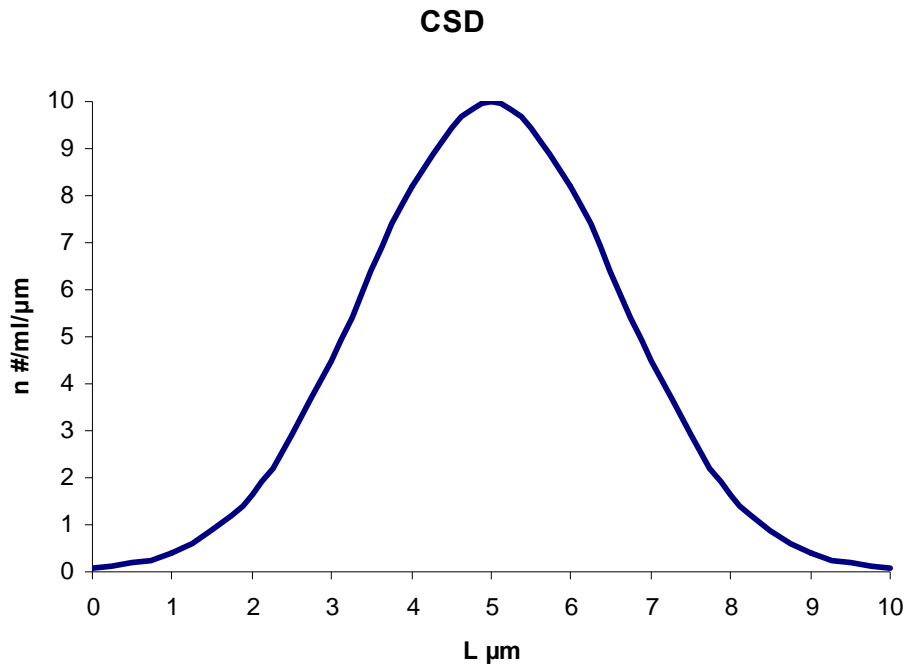

Graph 1: CSD type example following a normal distribution

A population balance is applied to the reference length. From this CSD, it is possible to study the growth by taking a smaller population between two length L_1 and L_2 with $\Delta L=L_2-L_1$. Then the growth G is used to study how much particles coming from the border population with a size slightly below L_1 come to the studied one and how much will leave as their sizes exceed L_2 . The population balance is actually done on the size and not on the particles themselves. The balance is done within a time interval Δt . The next graph illustrates the process.

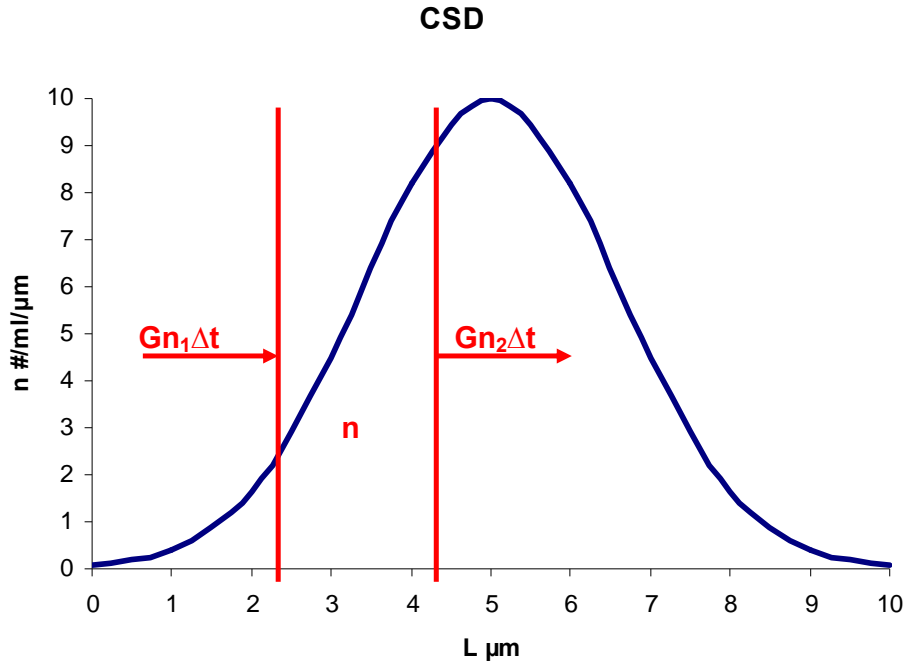

Graph 2: Population balance applied on the CSD

In a reactor with a volume V and a single outflow of particle F , the population balance is written:

$$Gn_1\Delta tV = Gn_2\Delta tV + Fn\Delta t\Delta L \quad (9)$$

This equation gives for a simple reactor (MSMPR type) the variation of length through time if the CSD is known.

b) The flows and the residence times in the experiment

Next is a sketch showing the flows in the separation process. This flow will also be applicable to the experiment.

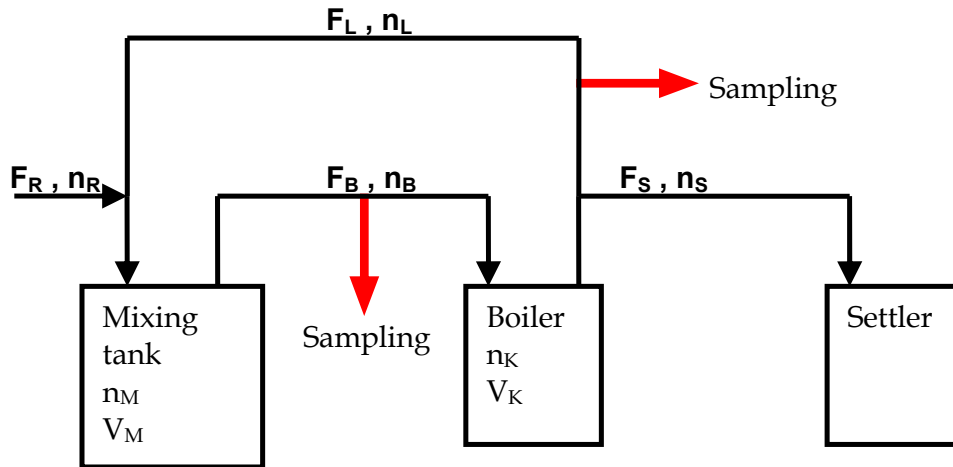

Sketch 8: Sketch of the flows in the experiments and sampling points for the CSD determination

Where F_x are the flows in mL/min and n_x are the particle concentrations in #/mL/ μm . x can be R, B, S or L.

It is assumed that the mixture has the same density through all the process and that the water that is removed at the Boiler is negligible. One can write:

$$\begin{aligned} F_R + F_L &= F_B = F_S + F_L \\ F_R &= F_S \end{aligned} \quad (10)$$

The Mixing Tank and the Boiler are assumed to be operated in a steady state. This way, a simple mass balance can be applied. G_M and G_K are the growth rates respectively in the Mixing Tank and in the Boiler in nm/s/L. The same way, V_M and V_K are the volumes of those tanks in litre. As in the model, the tanks are assumed to have a homogeneous repartition of particles achieved by the stirring. Then it can be written:

$$\begin{aligned} n_M &= n_B \\ n_K &= n_S = n_L \end{aligned} \quad (11)$$

It is also assumed that there is no particles in the incoming flow F_R and hence $n_R=0$.

In the experiments, the feed flow also contains particles, so a new term has to be added to this equation. This term will give the number of particles of a certain size L that will make the studied population (between L_1 and L_2) grow.

Regarding the residence times in the Mixing Tank and in the Boiler, those are given below.

- For the Mixing Tank:

$$RT_M = \frac{V_M}{F_R + F_L} \quad (12)$$

- For the Boiler:

$$RT_B = \frac{V_B}{F_R + F_L} \quad (13)$$

And as the volumes are kept equal, the residence times will always be equal:

$RT_M = RT_B$, hence, only the value of RT being both the residence time for the Mixing Tank and the Boiler will be used.

c) Population balances – Growth and nucleation rates

For the Mixing Tank

Growth rate

For the Mixing Tank, the population balance is:

$$G_M n_{M,1} \Delta t V_M + F_L n_L \Delta t \Delta L = G_M n_{M,2} \Delta t V_M + F_B n_B \Delta t \Delta L \quad (14)$$

Then by assuming that the time and the length intervals are small enough, it can be written the following:

$$G_M V_M \frac{\Delta n_M}{\Delta L} = F_L n_L - F_B n_B \quad (15)$$

With all the assumptions and the equalities found, those equations can be rewritten as:

$$G_M V_M \frac{\Delta n_M}{\Delta L} = F_L n_L - (F_R + F_L) n_B \quad (16)$$

To find the growth rate G_M , it will be calculated and plotted the deltas' ratios versus the right hand side of the equations. Then, if the points seem to be positioned on a straight line, the coefficient $G_M V_M$ will be calculated by a regression. The growth rate will finally be found.

Nucleation rate

For the nucleation rate, a new population balance has to be done on the total number of particles entering and leaving the reactor. Say N_X being the nucleation rate in

Master Thesis:

Precipitation of carbonates in the pretreatment process for regeneration of ethylene glycol

#/s/L. If there were an in and an out coming flow that would be charged of particles, the population balance would be:

$$N_X V_X \Delta t + F_{in} n_{in} \Delta t = F_{out} n_{out} \Delta t \quad (17)$$

And then:

$$N_X = \frac{F_{out} n_{out} - F_{in} n_{in}}{V_X} \quad (18)$$

Applied to the Mixing Tank, that would give:

$$N_M = \frac{F_L n_L^{tot} - (F_R + F_L) n_B^{tot}}{V_M} \quad (19)$$

Where n_X^{tot} is the total concentration of particles in the fluid.

For the Boiler

Growth rate

The same way for the boiler, one can write:

$$G_K n_{K,1} \Delta t V_K + F_B n_B \Delta t \Delta L = G_K n_{K,2} \Delta t V_K + (F_S n_S + F_L n_L) \Delta t \Delta L \quad (20)$$

And:

$$G_K V_K \frac{\Delta n_K}{\Delta L} = F_B n_B - F_S n_S - F_L n_L \quad (21)$$

$$G_K V_K \frac{\Delta n_K}{\Delta L} = (F_R + F_L) (n_B - n_L) \quad (22)$$

As for the Mixing Tank, the growth rate G_K will be found by a regression that will allow finding the value of the coefficient $G_K V_K$ hence G_K .

Nucleation rate

Also, for the nucleation rate,

$$N_K = \frac{(F_R + F_L) (n_B^{tot} - n_L^{tot})}{V_K} \quad (23)$$

E.4) Previous findings in Statoil®

Many experiments were run prior to the present study at Statoil® to discover the effects of parameters such as the temperature.

Master Thesis:

Precipitation of carbonates in the pretreatment process for regeneration of ethylene glycol

First some experiments were run by mixing some synthetic unclean mixture (MEG/water + ions) with some clean MEG. This was done to study how low the iron and calcium concentrations could go when using one of the three pre-heating solutions. It was found, as predicated, that the 3rd solution (recirculation loop) is the best solution and by far. The lowest achievable concentrations were quite met.

Then the 3rd solution was deeply studied by setting the entire recycling loop. There, the effect of iron on the calcium carbonate precipitation was able to be seen. When alone, the calcium concentration sank drastically but with iron, it staid quite high close to the initial concentration (hardly no precipitation). The same way, the temperature in the Mixing Tank was varied and when higher, the concentration went downer also as predicted by the theory.

F. Experiments

F.1) *The settings*

The industrial process presented above needs to be adapted for the experimental work. The incoming stream (Rich MEG) will be created by the mean of chemicals provided by chemical companies such as Merck®. The compositions will be given in accordance with the one measured at the Ormen Lange facility and with the requirements of the experiments. In order to reach faster the wanted conditions, some synthetic Lean MEG (90%wtMEG) will also be put in the Lean MEG tank following the same requirements.

The process will be slightly changed to the one that is presented downwards. The flow chart presented above will still remain valid.

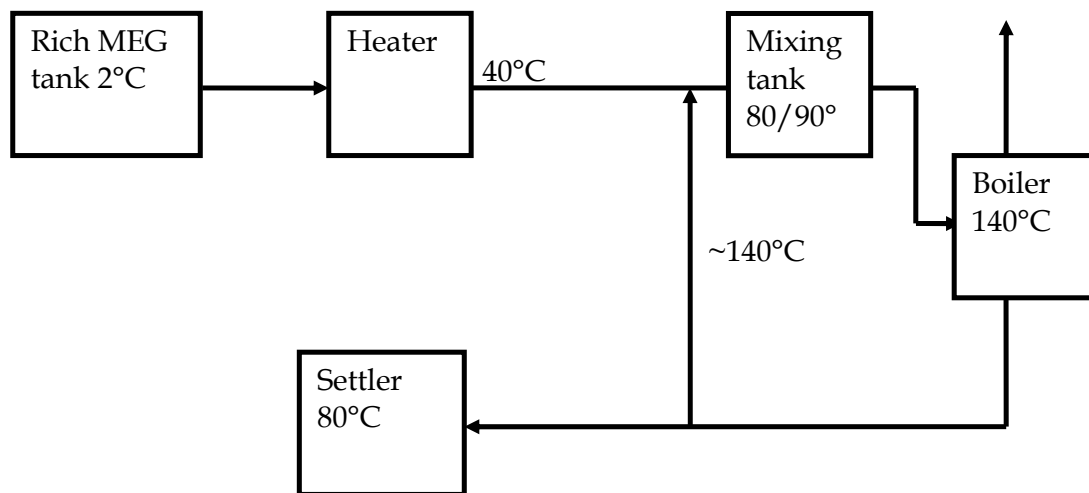

Sketch 9: Flowchart of the experimental process for the MEG regeneration studies

Some synthetic Lean MEG will be put in the boiler at the start of the process so the boiler can be turned on when the process starts which can not be possible if the boiler is empty.

All the process is oxygen free and a flow of carbon dioxide / nitrogen is injected continuously in the tanks that are hermetically closed. The pressure remains at 1bar in all the process.

The rich MEG tank is jacketed and keeps the Rich MEG at a low temperature as if it was coming from the sea floor. The Heater warms up this mixture to model the separation treatment before the regeneration of the MEG. The Mixing Tank is where the “cold” and the “hot” streams meet. The Boiler is where the water evaporates and the mixture gets higher in MEG concentration. Finally the mixture goes to settle in the Settler at 80°C. The settling should allow the MEG to be separated from the particles formed through the process. An alternative to this would be to put a centrifuge to separate the solid particles from the liquid (MEG) phase.

As it has been said, one specific composition will be studied. In the following tables, the composition and the mass fraction of MEG in the mixture are given. The values in bold will be changed in order to study their effects on the process. The composition is given in terms of chemical substances both in the Rich MEG and in the synthetic Lean MEG. The unit used is milligram per kilogram solvent ($\text{mg}/\text{kg}_{\text{solvent}}$). Their molar mass in gram per mole (g/mol) is also given as an indication.

Table 2: Chemical composition of the base case

Chemicals	Ormen Lange composition $\text{mg}/\text{kg}_{\text{solvent}}$		Molar mass g/mol
	Rich MEG	Lean MEG	
$\text{FeCl}_2(4\text{H}_2\text{O})$	748	0	198,8
$\text{CaCl}_2(2\text{H}_2\text{O})$	147	0	147,0
NaCl	13 339	17 150	58,4
KCl	14 008	18 010	74,6
KHCO_3	1 318	0	100,1
K_2CO_3	0	1 170	138,2
NaHCO_3	0	0	25,7
Na_2CO_3	0	0	17,4
CH_3COOK	2 319	2 982	98,1

The chemical composition of the base case in terms of ions is presented in *Appendix 3*.

Table 3: Mass fraction in MEG in the solvent for the base case

Mass fraction	Ormen Lange %wtMEG	
	Rich MEG	Lean MEG
MEG	70	90
Water H ₂ O	30	10

In the experiments, it will mainly be studied the effects of the temperature in the Mixing Tank (from 70 to 90°C) and of the residence time in this same reactor. The iron concentration will be changed in order to see its impact on the calcium carbonate formation. The MEG fraction in the rich MEG is higher than usually encountered. It will be put down to be more generic and applicable to other production sites.

The temperature in the Mixing Tank is changed by simply setting the temperature of the heating plate under it. The residence time is set by adapting the feed and recirculation flow. As shown in the *Appendix 1*, the recirculation is always set to be 68% of the feed to get a temperature of about 80°C in the Mixing Tank according to heat transfer calculations.

F.2) Protocol

Before the start, the Rich MEG is introduced in the Rich MEG tank and cooled down to a few degrees (~2°C) by the mean of a cooling system and a magnetic stirrer. 500mL of Lean MEG is filled in the Boiler. The Mixing Tank and the Settler are then empty. The Heater and the heating systems for the Boiler and the Settler are put on. Then a pump conducting the Rich MEG from the Rich MEG tank to the Mixing Tank through the Heater is activated. A second pump is also put at work and takes the Lean MEG from the Boiler to the Mixing Tank through the recirculation hose. After a certain amount of time, the Mixing Tank is full and overflows back to the Boiler. The level of liquid in the Boiler is then rising. When a designated volume is reached, a third pump is put in service. It takes the exceeding liquid to the Settler. A magnetic stirrer is put in the Mixing Tank and in the Boiler to keep a homogeneous repartition of particles in the mixture.

After all those steps, the process has totally started. It will need some more time to reach the steady state in terms of concentrations. But at that point, the steady state in

terms of flows is established. The length of a run is dependant on the amount of Rich MEG that is initially introduced in the Rich MEG tank.

F.3) Measurements

Few techniques were used during the experiments. They helped to describe what was happening along the process. In this part, the different used technologies are briefly described.

a) ICP

ICP is short for Inductively Coupled Plasma. This technique is used to measure the concentrations of iron and of calcium in the mixture. The plasma is produced by induction and can attain a temperature of several 10 000°C. Varying electromagnetic fields are then produced by the plasma that infects the solution to be studied. The ions reply to this excitation and a captor can then measure the nature and the quantity of a certain ion.

This method allows the measurement of many samples at a relatively high speed. After the machine being programmed the measurements go on automatically. The concentration results are given in milligram per litre of solvent ($\text{mg}/L_{\text{solvent}}$).

According to the ICP operator in Statoil, the accuracy of the results is around 15% and the lower limits of detection for iron and calcium are respectively of $2\text{mg}/L_{\text{solvent}}$ and $1\text{mg}/L_{\text{solvent}}$. This means that lower values cannot be trusted. Moreover, in terms of moles, the lower limits are then respectively $0,04\text{mmol}/L_{\text{solvent}}$ and $0,02\text{mmol}/L_{\text{solvent}}$. When calculating SR in Multiscale® with those values, the results are close to when the ions are said to have completely vanished (concentration of 0).

If smaller values than the lower limits are encountered, the ions will be said to have concentrations such that they are negligible.

b) Alkalinity

The alkalinity of a solution is its ability to absorb protons. A basic solution can become acid only if enough protons (acid component) are introduced. The mixtures are here pH stabilized to a high value. In short, the alkalinity can be calculated by the following formula for the present experiments:

$$Alk = [Na^+] + [K^+] + 2[Ca^{2+}] + 2[Fe^{2+}] - [Cl^-] \quad (24)$$

Where $[X]$ is the concentration of X in mmol/L_{solvent}.

For the base case, in the Rich MEG, the alkalinity is calculated to be around 37mmol/L_{solvent} and 47mmol/L_{solvent} in the synthetic Lean MEG. The synthetic Lean MEG is lower in water hence the concentration is higher.

Measuring the alkalinity will help to see in which extent the CO₂ will dissolve in the mixture.

The measurements are done by a titrator like apparatus. Hydrochloric acid is put drop by drop in the solution and the apparatus measures directly the pH evolution hence the proton absorption capacity. In the end, the alkalinity of the solution is given in mmol/L_{solvent}.

c) SEM

SEM stands for Scanning Electron Microscope. This microscope allows seeing microscopic details of the particles down to some micrometers.

A sample is taken from the experiment then washed and some particles are deposited on a metal support. These are then coated to be able to react to the electron emission in the right way.

The support containing the particles is put in the microscope where void is then made. The coated surface is then bombarded with electrons that are refracted and analysed by a captor so that the surface can be drawn on the computer screen.

Coupling this observation technique with the next one (XRD), one is then able to identify the particles that are formed along the process.

d) XRD

As for the SEM, samples are taken from the experiment but then dried. Quite a big amount needs to be taken as only the powder (many particles, MEG and water free) is used and some grams are needed to undertake the measurements.

XRD stands for X-ray Diffraction analysis. Once the powder is produced, it is place in a chamber and be bombarded by X-rays. The matter will react to it and reemit a beam that will be analysed by some captors. The reemitted beams will have certain properties (wavelength, energy, angle...) that is both dependant on the chemical

composition of the matter and on the crystallography. This means that a particle can be identified to be calcium or iron carbonate and (for calcium carbonate) Vaterite, Aragonite or Calcite.

e) FBRM

With the SEM and XRD analysed, particles can be identified but it is impossible to measure the length of them. The SEM pictures can give an approximation of the size as some particles are observed directly but it cannot give the overall size of the population.

The FBRM or Focused Beam Reflectance Method is a technology developed by Mettler Toledo® to measure particle size. More accurately, it measures chords of particles.

A sample is taken from the experiment and then kept under mixing. The FBRM arm is put into the sample. At the end of it, there is a small window. Inside the arm, there is a laser source and a captor. A laser beam is emitted through the window and focused at some millimetre from the window. The beam circles around the window close to the arm's wall such as displayed in the next sketch.

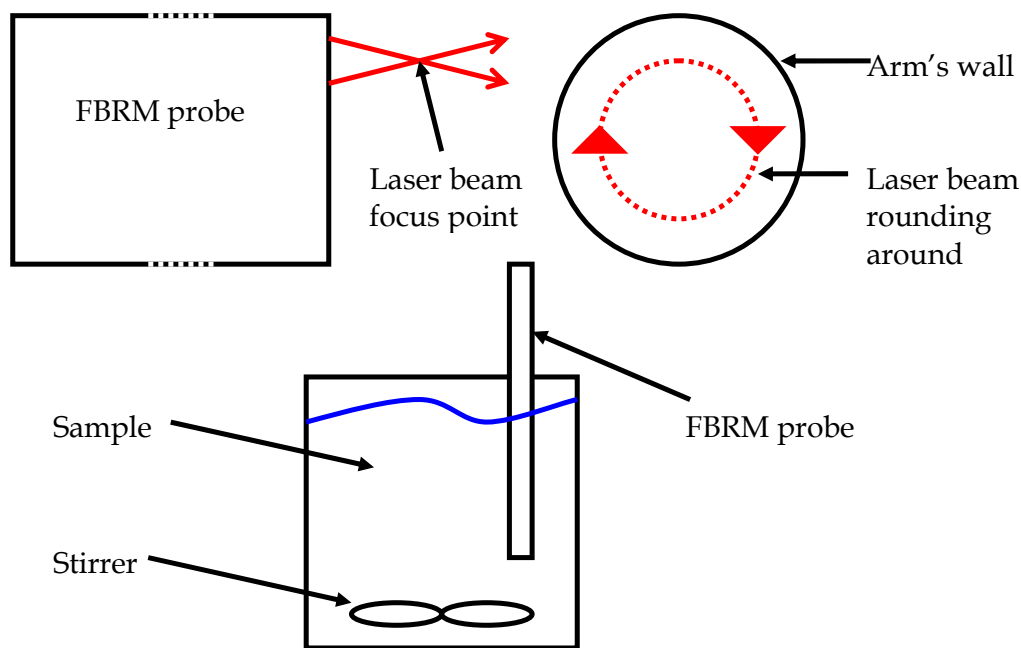

Sketch 10: From left to right and up to down: FBRM probe and focused beam, front of the arm end showing the laser beam circling around and FBRM probe in use in the sample

The measured sizes can or cannot be the biggest size of the particles. Anyway, in average, a CSD can be estimated from the results. From it, the growth and nucleation rates can be calculated as shown in a previous section.

F.4) The samples

In the upper sections, only the technologies were discussed. In practise, the way the samples are taken from the system has to be defined and the operator has to stick to it. Changing the process of taking samples can dramatically change the results.

a) Ion concentration and alkalinity analysis

Through the run, samples to concentrations and alkalinity analysis will be taken every hour (more frequently at the start) from three different points. Those are the Mixing Tank, the Boiler and the Settler. Two kinds of samples will be taken, one to measure the concentrations in terms of iron and calcium and a second to measure the alkalinity of the mixture at those points. Each time, the samples are taken by the mean of a long needle diving in the tanks and a syringe that sucks some liquid from the tanks.

As the first type of sampling aims at measuring concentrations, the sample is first filtrated with Hydrophilic Millipore Millex® 0,22µm in order to remove the particles that could redissolve and distort the results. Then 5mL of filtrate is put in a tube to which 1mL of hydrochloric acid is added. The tube content will be analysed by the Inductively Coupled Plasma method (ICP).

The second type of sampling will require about 15mL of mixture in order to quantify the alkalinity. There, no filtrations are necessary.

b) SEM pictures

Also, in order to picture the particles, some samples are also taken from the tanks and then analysed through a Scanning Electron Microscope (SEM). The samples are taken from each of the tanks at the end of the experiment once the steady state is well established. As for the concentration and alkalinity samples, some liquid is taken by a long needle diving in the mixture and sucked into a syringe.

c) XRD analysis

When the run is over, the tanks as well as the liquid they contain are left without heating and agitation one night long in order for them to cool down. The gas is still on so that no oxygen can access to the system. After one night, the particles have enough time to settle in all the 3 tanks. Some liquid from the upper layer is taken away by pumping. Then what remains in the three tanks goes for X-Ray Diffraction analyse (XRD) in order to identify the crystals that were formed.

d) CSD measurements

The samples to CSD measurement (FBRM) will be taken twice of three times per run. They will be taken between the Mixing Tank and the Boiler from both hoses that connect those two tanks but in which the liquid goes in opposite directions. About 15mL of mixture is taken by the mean of taps that are included in the circuit. A Lasentech® probe is then used. This can estimate a Crystal Size Distribution (CSD) in a solution. Hence it is possible to get an idea of the size of particles that go from the Mixing tank to the Boiler and vice versa. The sampling points were shown in the Sketch 8. However, the Lasentech® probe measures chords and not the real reference length. Hence the measured sizes will only be approximations but will anyway help to give an estimation of the growth and nucleation rates.

G. Results

G.1) Types of experiments

The purpose of this project is to study the effects of the temperature, residence time, iron concentration and MEG/water ratio on the process. The iron concentration and the MEG/water ratio are actually set by the system itself and how much the pipes are corroded or how much water gets formed along the way. Yet varying these allow to see how the process would react if the corrosion rates or water formation change. Prior to the experiments studying those effects, a base case was defined. It gives a reference point to which all the next experiments hence the differences can be compared with. Then, to be sure that the measurements are relevant, the base case was run three times in exactly the same conditions. The results were then compared. The composition of the base case was given in Table 2. The residence time is set to be $RT=20\text{mins}$ and the temperature in the Mixing Tank is 80°C .

Each experiment is named like "Fx" where "x" is a number between 11 and 21. F11, F12 and F13 are the three first runs corresponding to the base case reproducibility verification.

G.2) Reproducibility

Three experiments were run with exactly the same conditions that are gathered in the following list.

- Temperature in the mixing tank: 80°C
- Residence time (Mixing tank and Boiler): 20 minutes
- Initial iron concentration: 210mg/kg
- Initial calcium concentration: 40mg/kg
- MEG mass fraction in the Rich MEG: $70\%\text{wtMEG}$

The initial concentrations are meant to be the one in the Rich MEG tank. Once the flow are mixed in the Mixing Tank with the synthetic Lean MEG (iron and calcium free), the concentrations fall to 125mg/kg and 24mg/kg for respectively the iron and the calcium. From now on, when speaking of initial concentrations, the latest values are referred to.

The purpose of F11, F12 and F13 was to demonstrate the reproducibility of the experiment. The iron and calcium concentrations were measured through time every hour (more measurements at the start). For the three reactors, the results are presented in graphs.

a) Concentration profiles

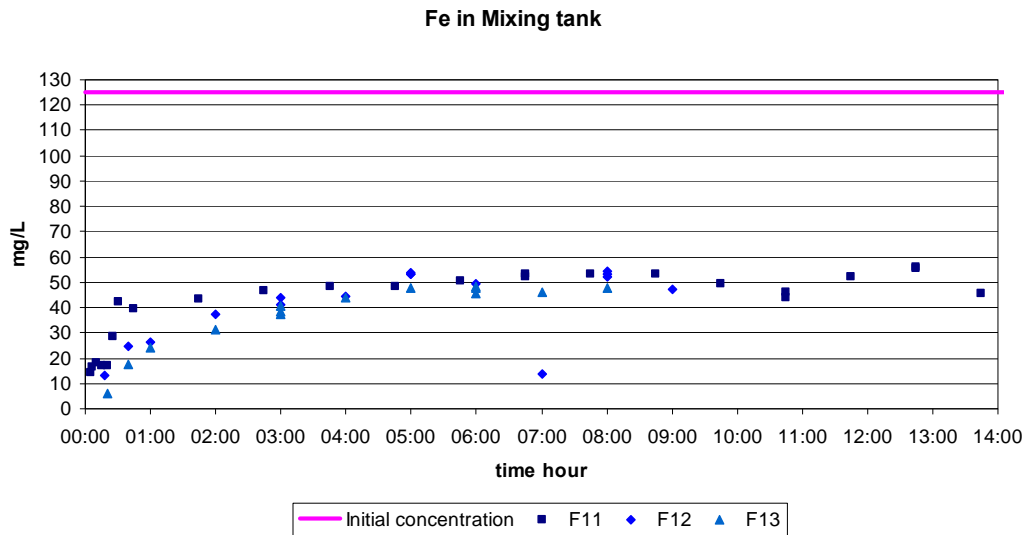

Graph 3: Iron concentration in the Mixing Tank for F11, F12 and F13

The iron concentrations follow the same behaviour whatever the run. One point is totally out of the line but it must be an experimental error. Moreover, it can be seen that the steady state is established after 6 hours that is 18 residence times. For the next experiments, the length of each run will be set to be at least of 18RT.

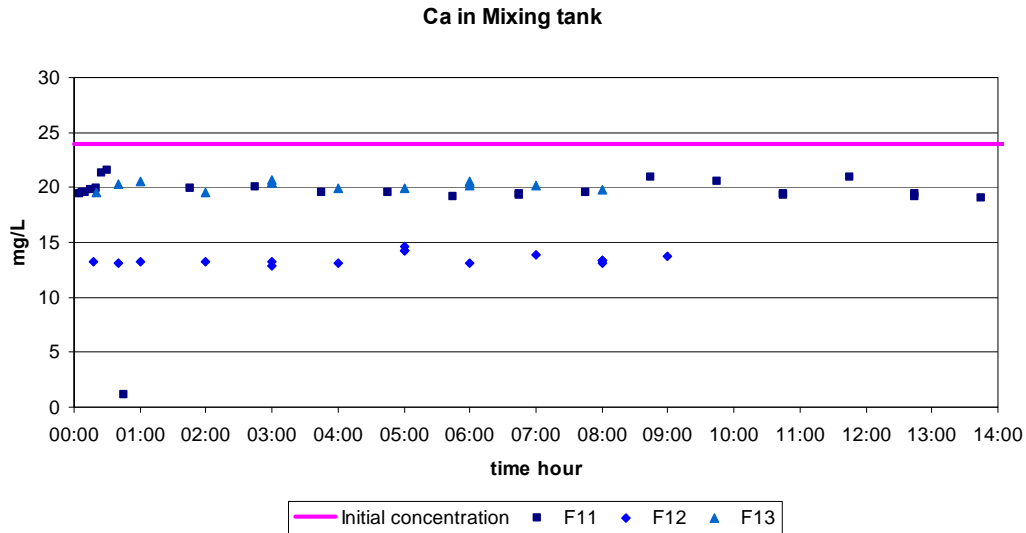

Graph 4: Calcium concentration in the Mixing Tank for F11, F12 and F13

For the calcium concentration, an irregularity is seen. F12 has the same behaviour as the other two experiments except that it is some 6mg/L lower. This may be due to the real initial concentration in calcium that was not accurately 24mg/L.

According to the graphs, the experiments are quite reproducible except for the calcium that seems to be sensitive to initial conditions.

Concentrations in the Boiler and the Settler

No results for the Boiler and the Settler are presented here because the found concentrations are below the detection limits defined in an above section. For this reason, the results cannot be exploited. However, it can be said that, as it is below the detection limits, the iron and calcium ion presence becomes negligible once the Mixing Tank step is passed.

b) XRD results

In the XRD Graph 1, Siderite (S) and Maghemite (M) are detected. The Maghemite is

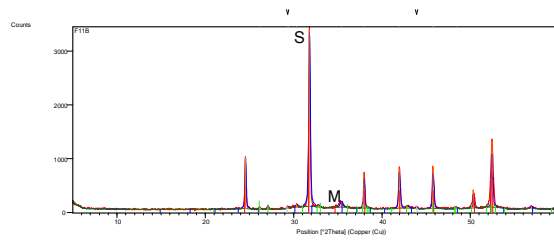

XRD Graph 1: Composition in the Mixing Tank for F11

an iron oxide crystal. This means that there is still some oxygen being introduced in the system. But seeing the height of the peak, it is not that big amount. Also, no calcium carbonate is detected here.

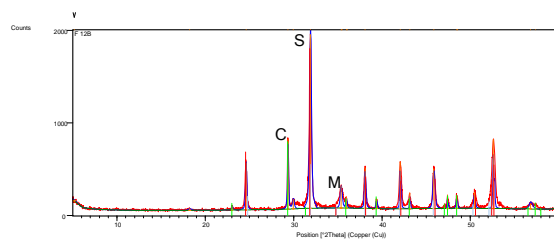

XRD Graph 2: Composition in the Mixing Tank for F12

In the XRD Graph 2, some Calcite (C) is detected. This is consistent with the lower calcium concentration as some calcium carbonate form in the Mixing Tank.

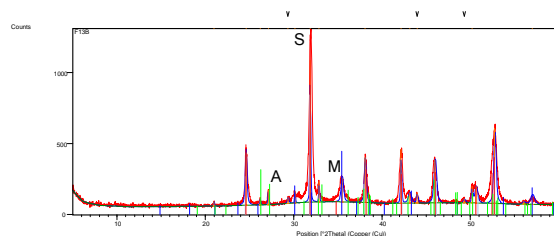

XRD Graph 3: Composition in the Mixing Tank for F13

In the XRD Graph 3, even more iron oxide is seen. The calcium carbonate is here Aragonite (A).

c) SEM picture

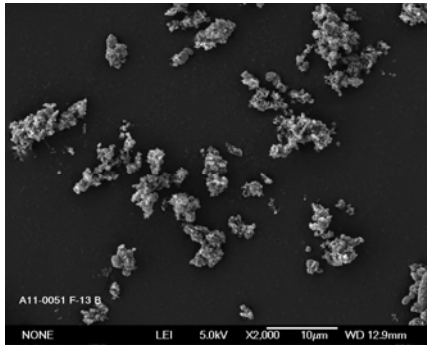

The picture on the left reveals that there are no or few well defined particles. The sizes seem to be around a few micrometers.

SEM Picture 1: In the Mixing Tank for F13

d) SEM and XRD results in the Boiler and in the Settler

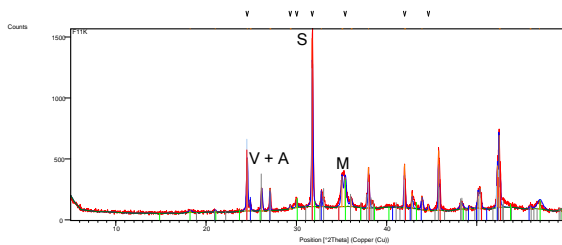

XRD Graph 4: Composition in the Boiler for F11

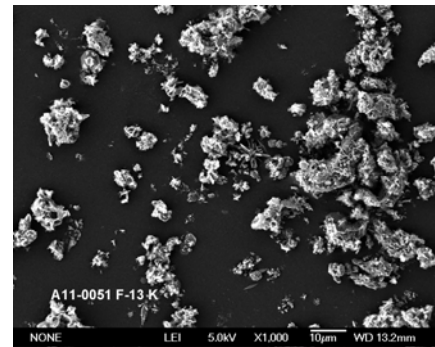

SEM Picture 2: In the Boiler for F13

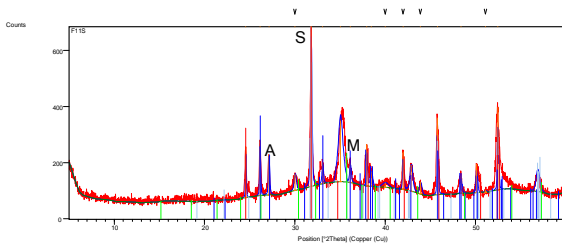

XRD Graph 5: Composition in the Settler for F11

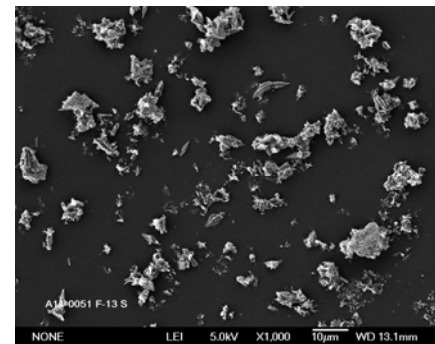

SEM Picture 3: In the Settler for F13

The upper graphs and pictures show the compositions and the shapes of particles in the Boiler and in the Settler. Only one of the 3 experiments results were used as they are redundant. It can be seen that both in the Boiler and in the Settler, there are some Siderite and some Maghemite plus a detectable presence of calcium carbonate being

mainly Aragonite. This polymorph forms at higher temperature. This is a clue to say that the particles nucleate mainly in the Boiler where the higher temperatures are encountered (up to 140°C).

e) Cristal Size population

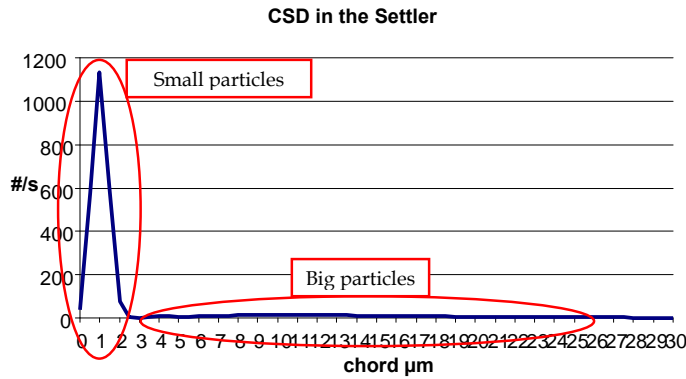

Graph 5: CSD in the Settler for F13; 0 to 30µm

After F13 being run, the CSD in the Settler was measured by the Lasentech® probe. It revealed the results presented on the left. 2 size groups were found. Many small particles and few big particles were detected. Thanks to the SEM

pictures, it was concluded that the small particles detected were actual particles and the bigger ones were actually clusters (agglomeration of particles). However it does not seem to be the agglomeration process that was described upper in the present report. Here, the particles seem to be weakly put together and do not form only one big particle even if a small number of these can be seen when looking at the samples with the SEM.

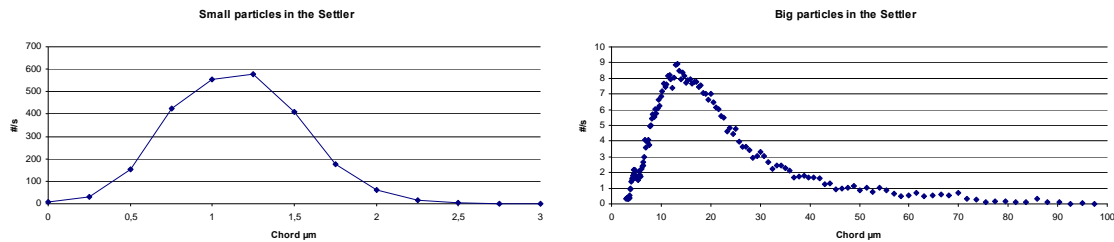

Graph 6: CSD in the Settler for F13; 0 to 3µm (left) and 0 to 100µm (right)

In order to focus on either of the two size populations, two series of results were produced for each sample. One series focuses on the smaller range, up to 3µm while the other focuses on the bigger range, up to 100µm.

The two last graphs show each of those series. Indeed, 2 peaks were detected. After calculation, the averages were found to be 1,1µm and 16,9µm for respectively the small and the big particle populations.

G.3) Temperature effects

Using the base case chemical composition, 3 different experiments were run. The residence time was all the time 20mins but the temperature in the Mixing Tank was changed to 70, 80 and 90°C.

Iron and calcium ion concentrations as well as XRD and SEM analysis were undertaken to study the effect of this change in the results. Also, the CSD was measured.

a) Concentration profiles

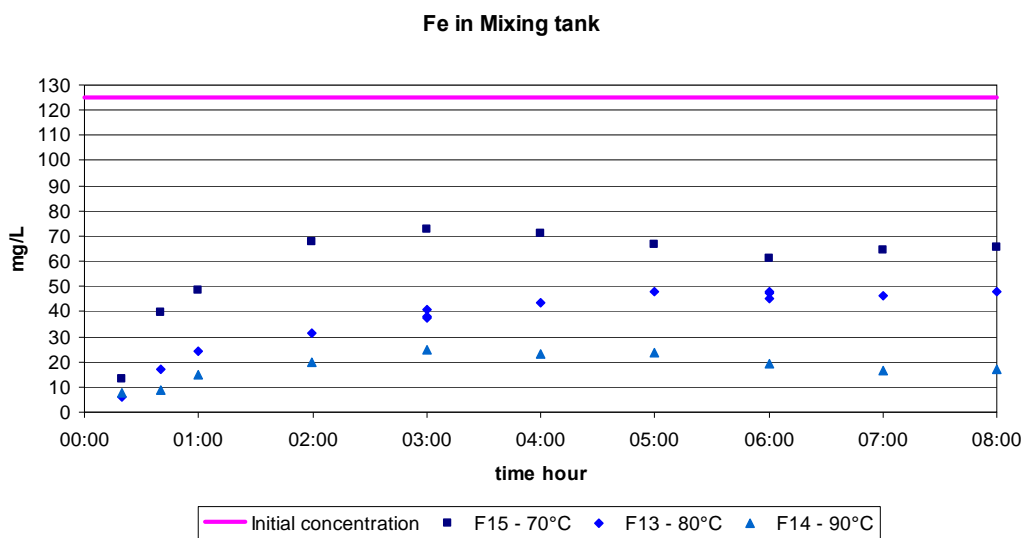

Graph 7: Iron concentration in the Mixing Tank at 3 different temperatures

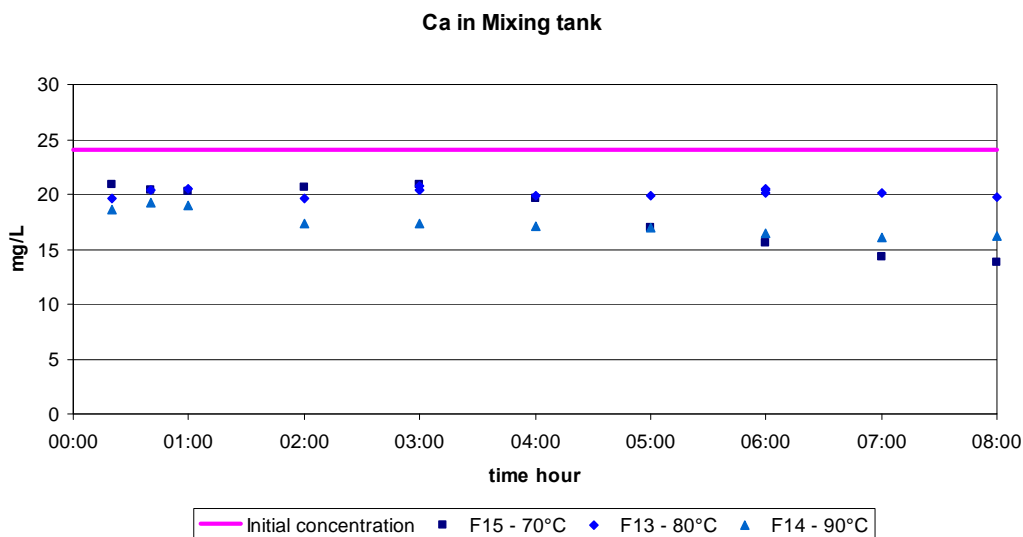

Graph 8: Calcium concentration in the Mixing Tank at 3 different temperatures

Looking at the results for iron, it is obvious that the higher the temperature, the lower the iron concentration at steady state. In the worst case (70°C), the concentration still falls to the half of the initial one.

However, for the calcium, the results do not follow this rule. Unlike the reproducibility experiments, all three concentration profiles start around the same value. From that, it can be said that calcium was introduced in the same quantity in the 3 experiments. Anyway, the best result arises when the temperature is of 70°C. An explanation for this effect is given in the next section with the XRD results.

Looking at the alkalinity, it was calculated to be initially around 37mmol/kg_{solvent} and at steady state; it goes down to 31mmol/kg_{solvent}. The alkalinity consumption is of about 20% of the initial value.

Saturation Ratio study

From the concentrations and the experimental conditions, the SR is calculated at the start end at the end of the experiment. Firstly, for all 3 runs, SR for the iron is above 60 000 and for calcium it is around 50. This means that for both compounds, the system is far from the equilibrium. Multiscale® found that, at the equilibrium, the concentration should be far below the detection limit of the ICP technique.

At the end, iron and calcium are hardly detectable in both the Boiler and the Settler. In the Mixing Tank, those stay quite high and the SR for the iron is still around 3 000 at 90°C, 3 000 at 80°C and even 20 000 at 70°C. For the calcium, it is around 25 for all 3 cases. Here, the thermodynamic equilibrium is not reached but the kinetic is so low that the system does not have the time to reach it. The next series of experiment where the residence time is changed will tell how the time parameter can change the results at the steady state.

b) XRD results

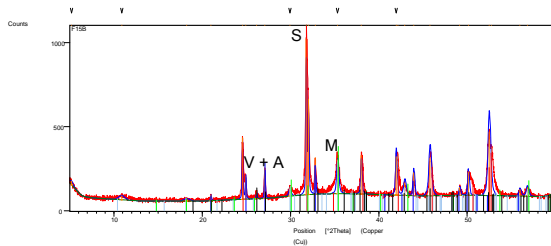

On the graph on the left, Siderite (and iron oxide) and calcium carbonate are detected. Few Aragonites and a quite bigger amount of Vaterite are present.

XRD Graph 6: Composition in the Mixing Tank for F15 - 70°C

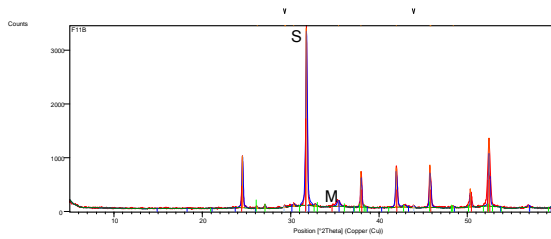

For the base case, the nice results of F11 are used as a reference. Here, no calcium carbonate is detected and the conditions were that good enough not to get to much oxygen and iron oxide in the system.

XRD Graph 7: Composition in the Mixing Tank for F11 - 80°C

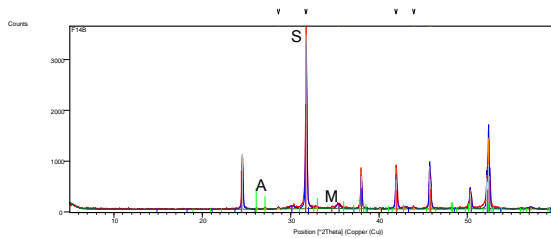

At 90°C, some traces of Aragonite are seen but it is close to nothing. Otherwise, the pattern is the same as in the base case.

XRD Graph 8: Composition in the Mixing Tank for F14 - 90°C

From the upper results, the formation of calcium carbonate happens mainly under the form of Vaterite. The formation of Aragonite is blocked by the presence of iron in the solution. Above 70°C, it is the domain of Aragonite (no or few Vaterite can be formed) but this is blocked. At 70°C, calcium carbonate can form under the form of Vaterite whose formation does not seem to be as blocked as Aragonite. This way, calcium ions can be consumed in the Mixing Tank to form crystals hence the lower concentration.

Although, Aragonite is formed more easily at 90°C, than at 80°C, so the calcium concentration gets lower and some Aragonite can be detected by the XRD analysis.

c) SEM pictures

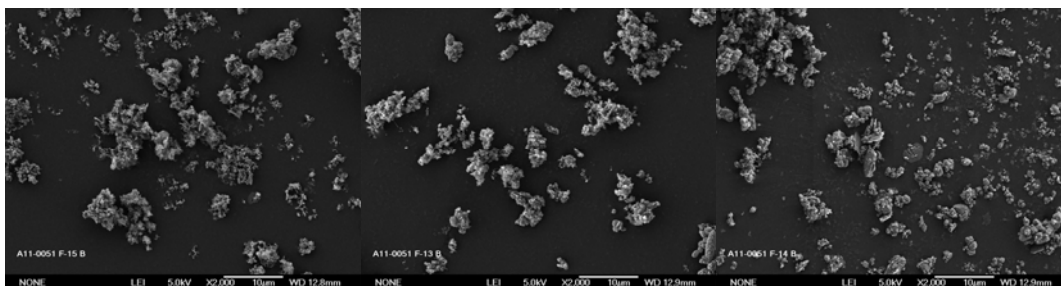

SEM Picture 4: SEM pictures of particles in the Mixing tank at different temperatures:
F15 - 70°C, F13 - 80°C and F14 - 90°C

No or few defined crystals can be seen on the SEM pictures. Still, they seem to be a bit more defined at higher temperature. On the upper pictures, the size of particles is quite constant in all three experiment and be situated around a few micrometers.

In the SEM pictures of the Boiler and the Settler (see *Appendix 8*), at 90°C, some define needle like particles (Aragonite) can be seen whereas at 80°C, it is still this undefined crystal population that is displayed. But in both cases, in those reactors, the particles are quite bigger close to some 10 micrometers even if 1 micrometer big particles can still be present.

d) Growth and nucleation rates

From the Lasentech® results and the population balance whose results are shown in the first part of this report, the growth and nucleation rates in the Mixing Tank and in the Boiler were founded. As well, the average size of the particles in either tank was also found. This was carried out for the extreme temperatures that are 70 and 90°C. The raw results and the calculated rates and sizes are shown in the *Appendix 6* and 7.

For 90°C, growth and nucleation were found only in the Boiler. Those are negative in the Mixing Tank but here the particles are bigger up to 20µm instead of some 18µm in the Boiler. This shows that the particles agglomerate in the Mixing Tank. They do not grow as single particles but are put together to form bigger species hence the population number and the growth seem to go down. But as seen on the SEM pictures, no really big particles (20µm) can be seen. These should actually be clusters where the particles are weakly joined.

For 70°C; the same effects are seen between the Mixing Tank and the Boiler but here some nucleation and growth can be detected in the Mixing Tank and oppositely; the nucleation rate is lower in the Boiler compare to the higher temperature.

For either temperature, the growth rate in the Boiler is around 0.1 to 0.2nm/s and the nucleation rate is between 2 000#/s/L at 70°C and 3 500#/s/L at 90°C.

G.4) Residence time effects

To study the effect of kinetic, the residence time was changed. The residence time tells how long the mixture stays in the reactors hence how much time it has to react. For recall, the residence time is calculated by the formulas (12) and (13) that are the ration of the reactor volume by the flow. The volume being set by the reactor model, one can play with the flow to change the residence time. The flows were modified by changing the pumping regime.

3 different residence times were studied, 20 minutes for the base case and 40 and 60 minutes.

a) Concentration profiles

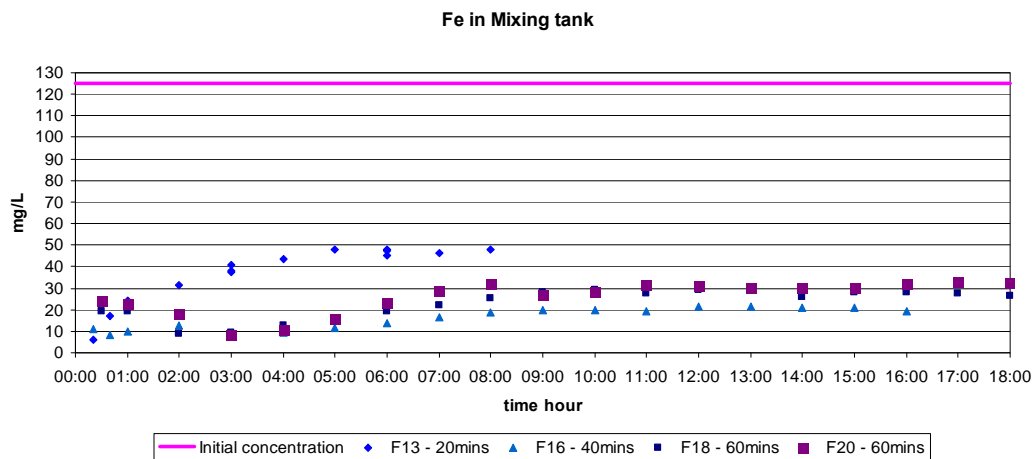

Graph 9: Iron concentration in the Mixing Tank at 3 residence times

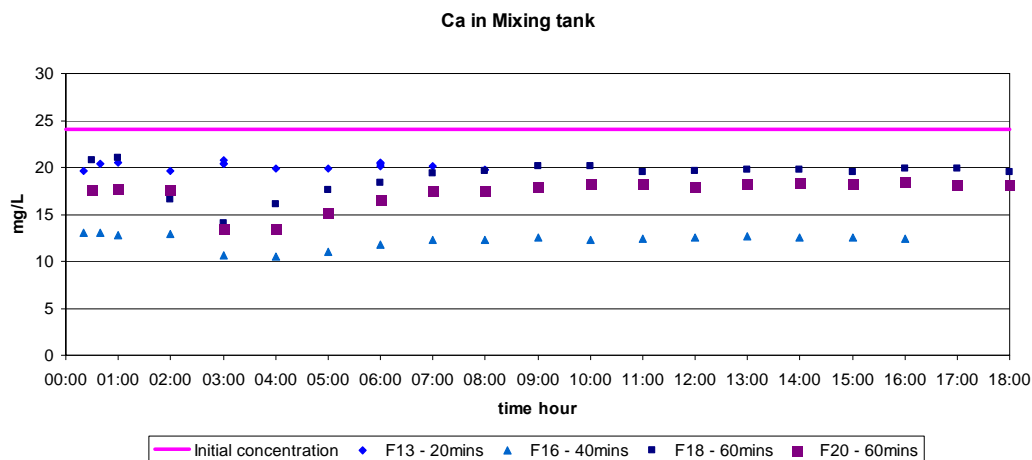

Graph 10: Calcium concentration in the Mixing Tank at 3 residence times

From the concentration profiles presented above; it can be concluded that increasing the residence time is beneficial until a certain point. The concentrations go down from 20 to 40 minutes but go up again when increasing to 60 minutes. As this results was puzzling; two runs were done at 60 minutes and the same tendency was found as it can be seen on the graphs (F18 and F20). For the calcium concentration at steady state, there is hardly a difference between 20 and 60 minutes.

As before, ions are hardly detectable in the other tanks.

It has to be added that the experiment with a residence time of 40 minutes was rerun by Kari Straume Andersen and she found much higher concentration in calcium in the steady state. The final concentration in calcium was actually close to the initial one that is 24mg/L. All the experiments were run with a temperature in the Boiler being 140°C but it was measured a MEG/water ratio of 88-89%wtMEG in the tank. In order to get the 90%wtMEG, Kari run this experiment at 145°C and got 90%wtMEG. This difference in terms of temperature and hence in terms of MEG/water ratio can be the reason of the calcium concentration change.

The alkalinity has the same behaviour in all 3 experiments and goes down to 31mmol/kg_{solvent} compare to the initial value of 37mmol/kg_{solvent}.

Saturation Ratio study

The composition does not change between all those 3 runs so the SR is the same around 60 000 (iron) and 50 (calcium) at the start in the Mixing Tank. As the

concentrations are higher at 90°C at steady state, the SR is also higher. It is at 6 000 instead of 4 000 for the iron and 30 instead of 20 for the calcium. As before, the thermodynamic steady state is not reached but the time does not help here to approach it. The thermodynamic situation at 40 minutes is comparable with the one when the temperature is at 90°C (SR around 3 000 – 4 000 in both cases). Coupling the two effect might help to get better results.

b) XRD results

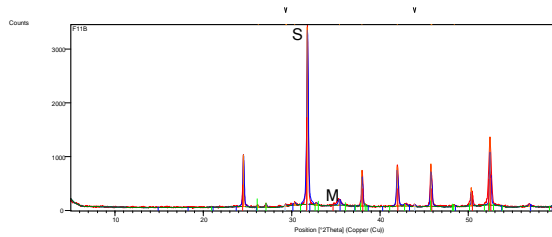

As before, only Siderite and some Maghemite are detected.

XRD Graph 9: Composition in the Mixing Tank for F11 - 20mins

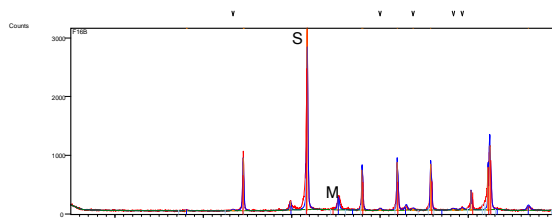

As for the base case; Siderite and Maghemite are present and only those.

XRD Graph 10: Composition in the Mixing Tank for F16 - 40mins

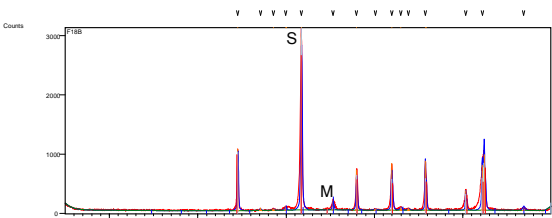

At 60mins, no change is found at least in terms of species.

XRD Graph 11: Composition in the Mixing Tank for F18 - 60mins

From the XRD and concentrations results, changing the residence time is here only a matter of quantity. The system has time to form more or less particles but they still remain the same. Changing the time does not interfere with the nature of the particles and do not help the calcium carbonate particles to form.

c) SEM pictures

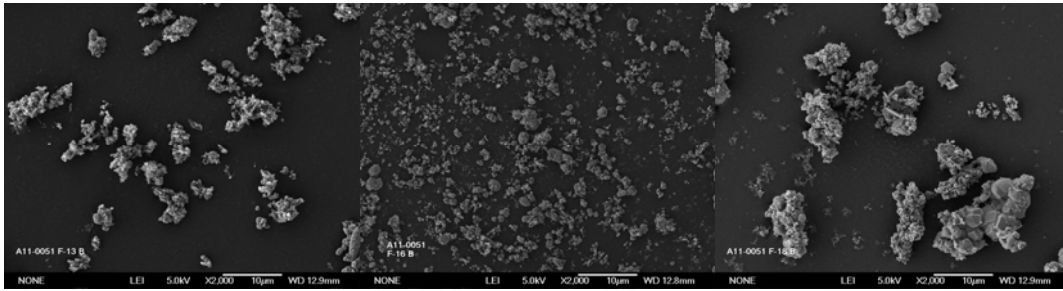

Picture 1: SEM pictures of particles in the Mixing tank at different residence times:

F13 - 20mins, F16- 40mins and F18 - 60mins

The SEM pictures confirm the statement of the upper section, the nature of particles stay the same but the aspect (shape and size) changes. The base case still present mostly undefined particles that are also found at 40 minutes but that are here smaller and much more numerous. From that; it seems that the agglomeration is lower at 40 minutes but the nucleation is far greater in the system. The next results will confirm this hypothesis.

d) Growth and nucleation rates

As seen on the SEM pictures, the size of the particles are around $22\mu\text{m}$ at 60mins instead of $20\mu\text{m}$ at 40mins. Moreover, at 60mins and in contrast with what was seen before, the particles seem here to be strongly attached in the clusters. A real agglomeration is happening at 60mins. At lower residence time, it seems that the particles have only the time to get together but do not form strong links. After 60mins, they have both the time to achieve this plus to create strong links with their neighbours. This has the effect to diminish the particle surface that could consume some ions from the solution. This might explain why the concentration is higher at 60mins than at 40mins.

The growth rates are comparable for both cases and found to be lower than 0.1nm/s in the Boiler. It is found to be negative in the Mixing Tank and this is the cause of the agglomeration which happens also at 40mins but in a smaller extent.

The nucleation rates are also comparable: about $4000\#/\text{s/L}$ in the Boiler and negative in the Mixing Tank due to agglomeration.

Redoing the experiment at 60mins gave exactly the same results and confirms them.

G.5) Iron concentration effects

After studying the parameters on which the operator could act, now, the system will be studied under circumstances where the incoming flow or feed is modified. The main changes that can happen are the iron concentration and the MEG ratio. First, the iron concentration modifications are studied. For recall, 210ppmFe are introduced in the feed for the base case. As this value was considered a bit high, lower concentrations were used as 20 and 0,5ppmFe. 20ppmFe is assumed to be a more realistic number so it had to be tried. As said in a previous section, the calcium carbonate precipitation is blocked by the presence of iron and 0.5ppmFe is a really small amount and hence, the calcium carbonate precipitation can be studied when iron is scarcely present.

a) Concentration profiles

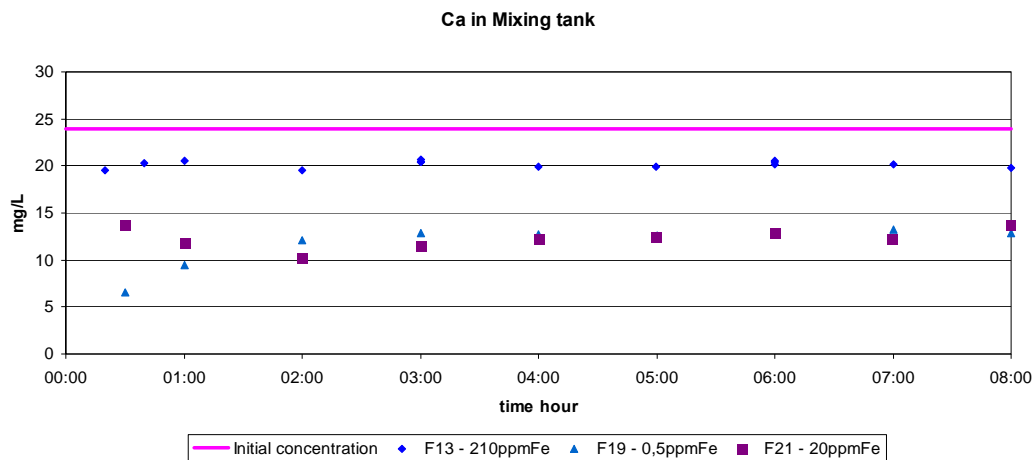

Graph 11: Calcium concentration in the Mixing Tank at 3 different initial iron concentrations

The calcium species being the one studied here, the results for the iron are not shown. From the concentration profile, the precipitation of calcium carbonate is greater when iron is less present in the solution as said by the theory. However, few differences are seen between 20 and 0,5ppmFe. Still the thermodynamic equilibrium is not reached. According to Multiscala®, the concentration should be lower than the ICP detection limit as for what is happening in the Boiler and the Settler.

Saturation Ratio study

At the start, the SR for the calcium is around 50 (as for the base case) and goes down to 30 and 15 for respectively 20 and 0,5ppmFe. These SR are similar to the one of the base case where more iron is present (210ppmFe) even if here the concentrations are lower. For 20ppmFe, the iron has a SR of 6 000 at the start that allows it to anyway precipitate and end up to be close to the equilibrium.

b) XRD results

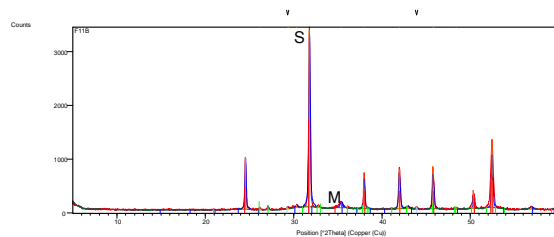

The base case composition is still displayed for comparison.

XRD Graph 12: Composition in the Mixing Tank for F11 - 210ppmFe

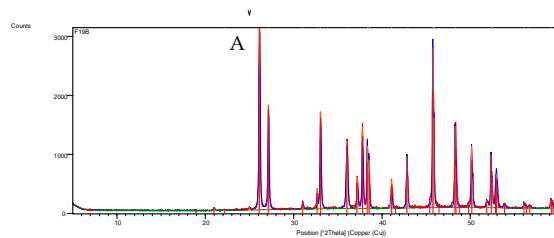

When only traces of iron are detected, Aragonite forms in the larger extent. No iron particles can be detected.

XRD Graph 14: Composition in the Mixing Tank for F19 - 0,5ppmFe

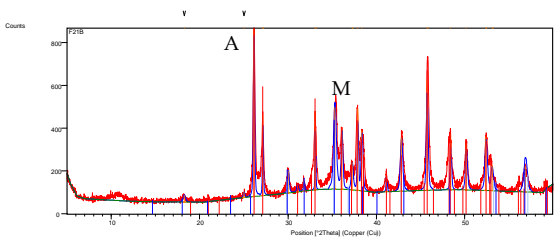

When a bit more iron is introduced, Aragonite is still formed in the same extent but Maghemite (iron oxide) is also produced. Still some oxygen is present in the system and it seems that all present iron reacts with it.

XRD Graph 13: Composition in the Mixing Tank for F21 - 20ppmFe

Obviously, when few iron ions are introduced, few iron particles are detected. However here, lot of Aragonite appears. At 80°C, Aragonite is formed preferably to the other calcium carbonate polymorphs but it was previously blocked by the presence of iron. When the iron concentration is lower than 20ppmFe, the blockage is avoided and Aragonite is freely formed.

c) SEM pictures

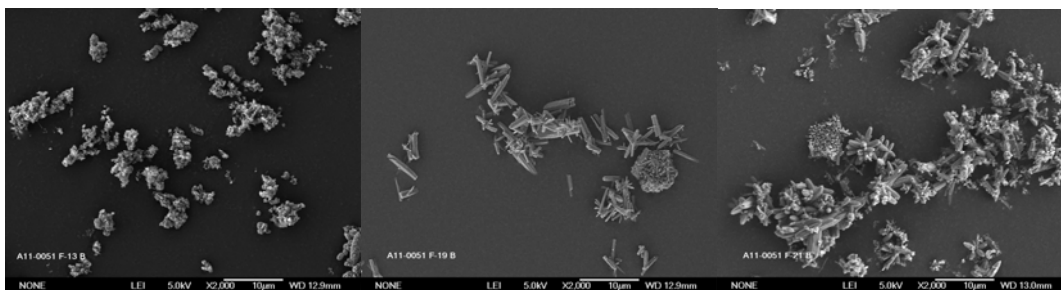

Picture 2: SEM pictures of particles in the Mixing tank at different iron concentrations:

F13 - 210ppmFe, F19 - 0,5ppmFe and F21 - 20ppmFe

The pictures confirm the formation of Aragonite. The long needles can be clearly seen of both pictures for lower iron concentrations. At 20ppmFe, the same fluffy particles can be seen as the one for 210ppmFe. This is the iron oxide that has no visible define structure.

d) Growth and nucleation rates

Even if the concentrations of calcium end up to be the same for both low iron concentration experiments, the causes are different.

At 0,5ppmFe, the calcium is used by growth both in the Mixing Tank (0,5nm/s) and the Boiler (0,4nm/s).

At 20ppmFe, the calcium is consumed by the high nucleation that is around 3 000#/s/L in the Boiler.

This is clearly seen in terms of size. At 0,5ppm, the particles are about 30 to 40µm big compare to the size at 20ppmFe that less that 20µm in both tanks.

Those sizes could be the ones of particles or clusters but the SEM pictures confirm that the Aragonite longer dimension can be around those values.

G.6) MEG/water ratio effects

After changing one property of the feed (iron concentration), one can also change the solvent. The main property of the solvent is the MEG/water ratio. This was set to be 70%wtMEG in the feed but a more realistic value is actually 55%wtMEG.

a) Concentration profiles

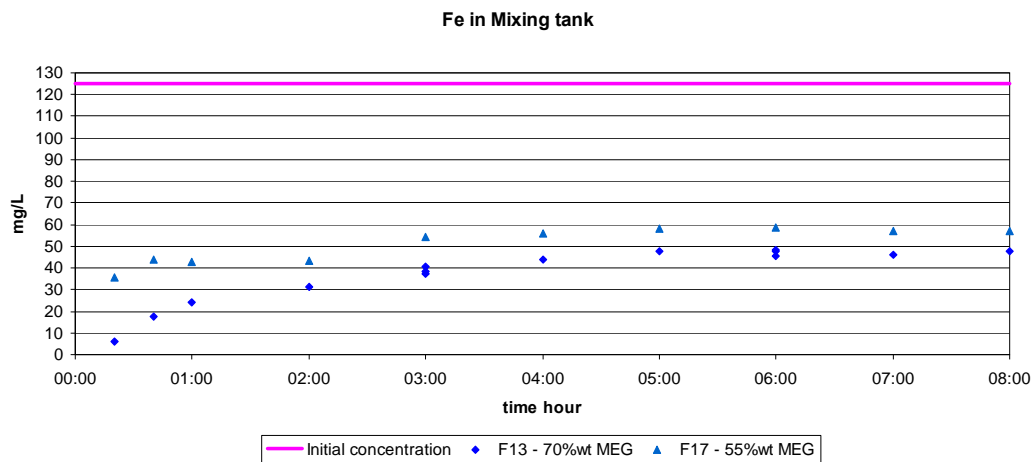

Graph 12: Iron concentration in the Mixing Tank at 3 different MEG ratios

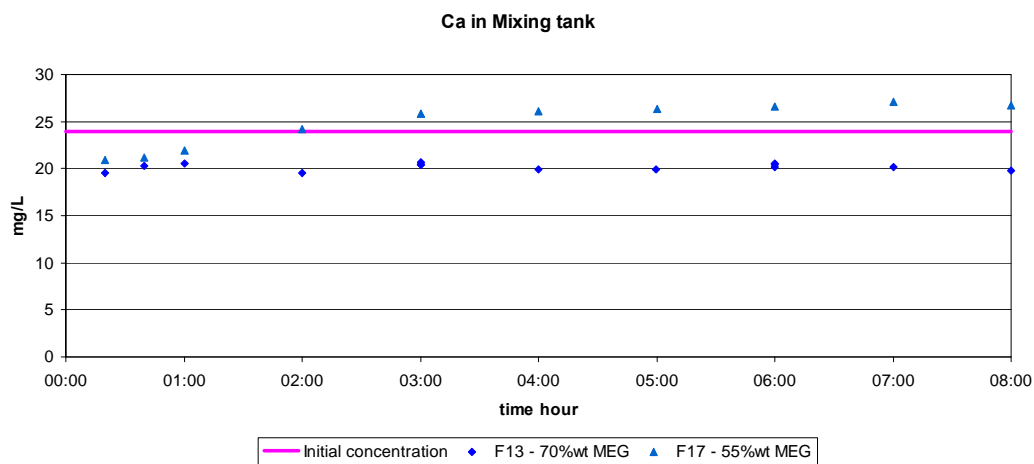

Graph 13: Calcium concentration in the Mixing Tank at 3 different MEG ratios

Firstly, it has to be mentioned that the mixture being higher in water, the energy to provide to the system for evaporation was much higher than in the previous experiment. As a consequence, the temperature of 140°C in the Boiler was not reached. This was because the heating plate was not powerful enough. Anyway, the mixture was higher in water.

The studied ions are more soluble in water than in MEG, it is then no surprise to see them to be more present at steady state when the MEG/water ratio falls to 55%wtMEG. Still for the iron, the concentrations are different of only about 10mg/L.

With the measurement inaccuracy, this result is not that obvious even if the tendency is given. Looking at the calcium concentration profiles, there is a build up in the concentration when the mixture is richer in water because the final value is higher than the initial one.

Saturation Ratio study

When starting the experiment with lower MEG/water ratio, the SR for the iron is some 55 000 compare to the 60 000 of the base case. The difference is not that big and both should converge to the same concentration especially for calcium where both SR are around 50. In the end (Steady State), while SR for the base case is around 4 000, the one for lower MEG/water ratio is still high to 17 000. Even if the calcium concentration is higher in the end than in the beginning, its SR goes lower than 50.

b) XRD results

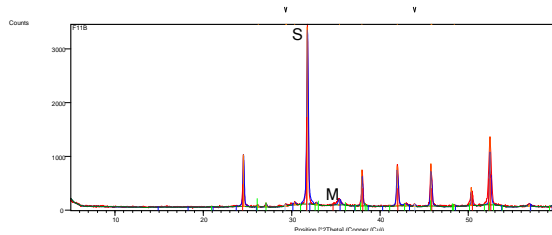

XRD Graph 15: Composition in the Mixing Tank for F11 - 70%wtMEG

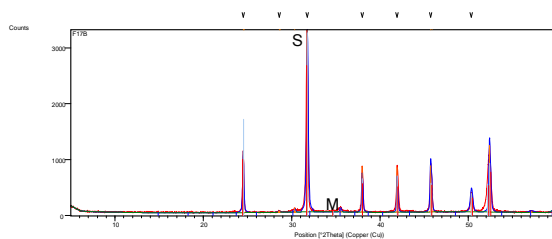

XRD Graph 16: Composition in the Mixing Tank for F17 - 55%wtMEG

There is no difference between the base case and the experiment at higher water.

This confirms that no calcium is consumed in the Mixing Tank.

c) Growth and nucleation rates

When looking at the growth rates, hardly any difference can be found between the two MEG/water ratios, they are both around 0,1nm/s in the Boiler and close to 0 in the Mixing Tank. However, the nucleation rates are much higher, in the Boiler they are around 12 000#/s/L and slightly positive in the Mixing Tank. Cluster formations

Master Thesis:

Precipitation of carbonates in the pretreatment process for regeneration of ethylene glycol

are also detected in the Boiler at 4 000#/s/L. It is clear that agglomeration is happening here. Indeed, the size of cluster is much higher in both reactors with 30 μ m in the Mixing Tank and 27 μ m in the Boiler, compare to 16,9 μ m for the base case. In this experiment, SEM pictures were not taken so it is not possible to say if those clusters were real big particles formed by agglomeration or only weakly joined smaller particles.

H. Recommendation

From the experiments on the temperature and the residence time, it can be concluded that the higher the temperature, the lower the concentration but the residence time needs to be set to an intermediate value.

With 90°C in the Mixing Tank, one can get rid of 80% of the iron ions and 40% of the calcium ions. With a residence time of 40 minutes, also 80% of the iron vanishes (even at 80°C) and about 50% of the calcium is taken away from the mixture. In *Appendix 4*, some regression graphs were plotted to find clearly the tendency with respect to both parameters.

The drawback is that it is for these experiments that the particles sizes are the lowest. Only when the temperature goes to 70°C, one can see big clusters appearing but there, the ions disappearance is not that high.

Also, it was seen that the results can be quite different when the temperature in the Boiler changes. This changes, of course the temperature but also the water concentration in the solvent that are 2 important parameters.

As further work, it should be run an experiment with the best parameters found in this work (90°C and 40 minutes) but with the same Boiler temperature (140°C). Then, the Boiler temperature impact should be also studied for it seems to have big consequences on the overall system.

The impact of iron concentration in the feed was a bit studied and it was seen that with low concentration, the impact on the system was different and even negligible. In order to find the threshold where the iron starts to impact on the calcium precipitation; the base case should be rerun several times while increasing gradually the iron concentration from 20ppmFe. This might be important as the corrosion can change unexpectedly.

Also, the MEG/water concentration was studied but the materials did not allow getting the right temperature in the boiler. The water can be more or less present in the feed, so it should be also run some experiment with different MEG/water ratios.

I. Conclusion

The main goal of this work was to find the best way to get rid of the ions (calcium and iron) in order to clean the MEG before reinjection in the gas production circuit. This was done using the settings developed by Statoil researchers. It was found that the best way to achieve this was to increase the temperature in the Mixing Tank and to have a residence time in it of about $\frac{3}{4}$ of an hour. Then both ion concentrations will sink to less than 50% of their initial concentrations (even reach 20% of the initial value for the iron). Still, some ions will remain; this being due to the continuous flow that wash out the forming particles. Also, it seems to be contradictory to have both big particles and few ions, the big particles being formed under lower temperature and ions being consumed under higher temperature.

Moreover, the feed can be modified depending on what is going on in the pipes on the see bed. The iron, calcium and water concentration can be modified. There effects on the system can be important and the expected results can be largely modified.

J. Appendix

Appendix 1: Recirculation effect

For recall the recirculation ratio is calculated to be the recirculation flow over the feed flow. These two flows mix in the Mixing Tank. Before considering temperature matters, it was first calculated with the help of Multiscale® the higher achievable SR (hence the lowest achievable concentrations in the studied ions). The results are plotted in the two next graphs. The calculations were run using the base case at 90°C.

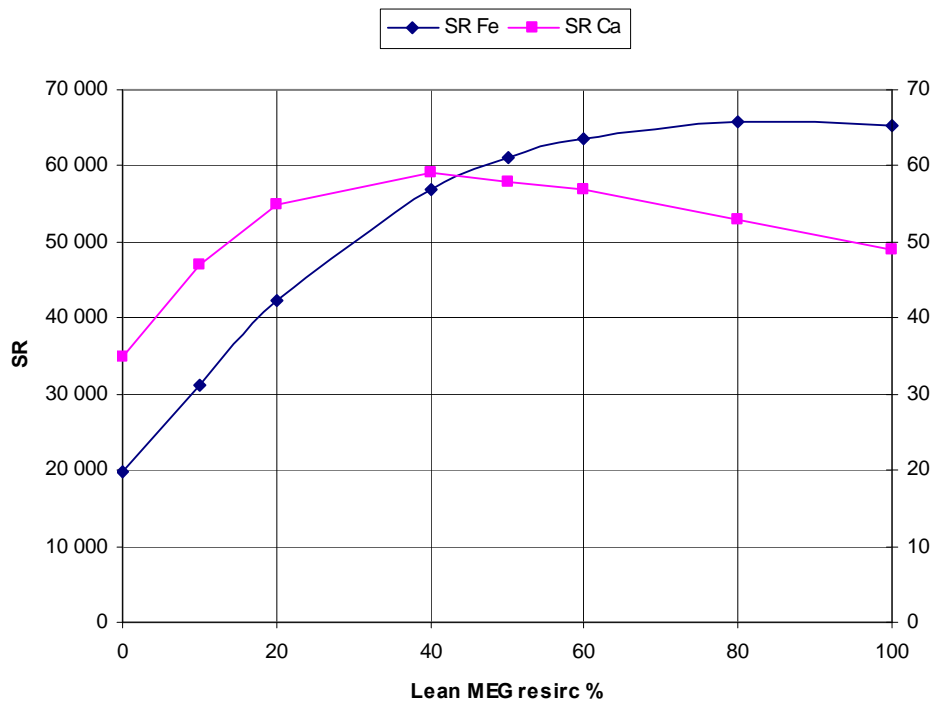

Graph 14: Saturation Ratio for iron and calcium plots for different recirculation flows with the base case at 90°C

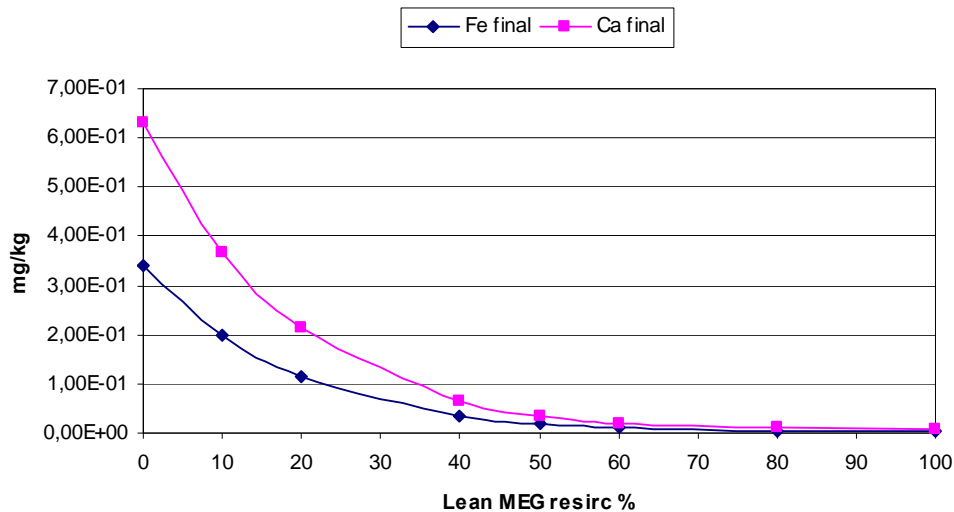

Graph 15: Final concentration for iron and calcium plots for different recirculation flows with the base case at 90°C

As it can be seen on the above graphs, the final concentrations are lower than 0,1mg/kg_{solvent} (or mg/L) and even lower if the recirculation is more than 50%. Moreover on the first graph, it is seen that the SR for the calcium goes down again after this recirculation value so the recirculation should not be too far from 50% but still above it.

As it was assumed in the entire project, the heat capacities and the densities of the solvent are constant. The temperature to be reached in the Mixing Tank has to be around 80°C and the temperature resulting from the mixing of the two flows can be calculated by only using the flow rates (the one of the feed and the one of the recirculation).

For recall, the feed is at 40°C and the recirculation flow (from the Boiler) is at 140°C. Hence the temperature is, with the chosen rates:

$$T_{\text{MixingTank}} = \frac{16,2 \times 40 + 11,0 \times 140}{16,2 + 11,0} \approx 80,5^{\circ}\text{C} \quad (25)$$

The recirculation ratio is hence:

$$\frac{11,0}{16,2} \times 100 \approx 67,9\% \quad (26)$$

Whatever the flows (Residence Time), this recirculation ratio was conserved.

Appendix 2: MEG/water phase diagram

The next table and graph justify why the temperature of 140°C was chosen in the Boiler to reach 90%wtMEG in the outlet. The values were communicated by Bård Kåsa.

Table 4: MEG/water mixture, liquid and gaseous phases while boiling

Temperature °C	Liquid phase %wtMEG	Gas phase %wtMEG
110	57,4	5,2
115	68,3	7,9
120	75,6	10,9
125	80,8	14,1
130	84,7	17,4
135	87,8	21,1
140	90,2	25,0

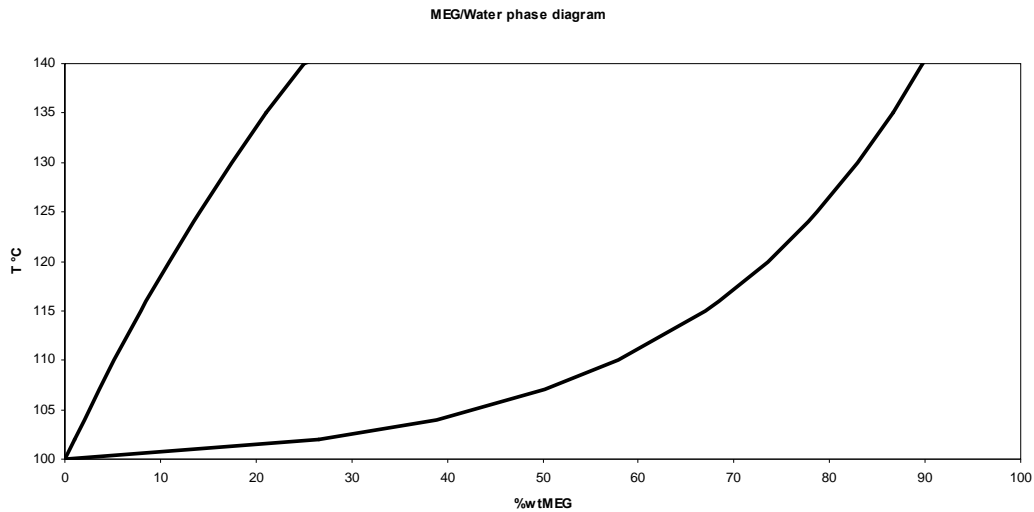

Graph 16: MEG/water phase diagram from 100 to 140°C

From the table and the diagram, one can see that 140°C correspond to a concentration of 90% in MEG. However, further measurements showed that this concentration was actually a bit lower of a few percent in the experiments.

Master Thesis:

Precipitation of carbonates in the pretreatment process for regeneration of ethylene glycol

Plus, at 140°C, about the gaseous phase contain 25% of MEG. This means that a part of the MEG leaves the system with the water.

Appendix 3: Ormen Lange composition

In the report, the composition in term of chemicals was given for the base case. Here, the composition in terms of ions (once the chemicals are dissolved in the solutions) is given.

Table 5: Chemical composition in ions for base case in mmol/kg_{solvent}

Ions	Ormen Lange composition mmol/kg _{solvent}	
	Rich MEG	Lean MEG
Na ⁺	228,25	293,46
K ⁺	224,69	288,90
Ca ²⁺	1,00	0
Fe ²⁺	3,76	0
Cl ⁻	425,67	535,05
CO ₂ _{solved}	13,16	8,47
CH ₃ COO ⁻	23,63	30,39

This table is used to calculate the SR through Multiscale®. Each time the chemical composition is changed the concentrations of Fe²⁺ or Ca²⁺ and Cl⁻ have to be recalculated.

Appendix 4: Result regression

From the few results, some regressions were done. The next graphs were drawn by doing a polynomial regression on the 3 points that were obtain by the experiments on the temperature and on the Residence Time. For the Residence Time, the two results for 60 minutes were used.

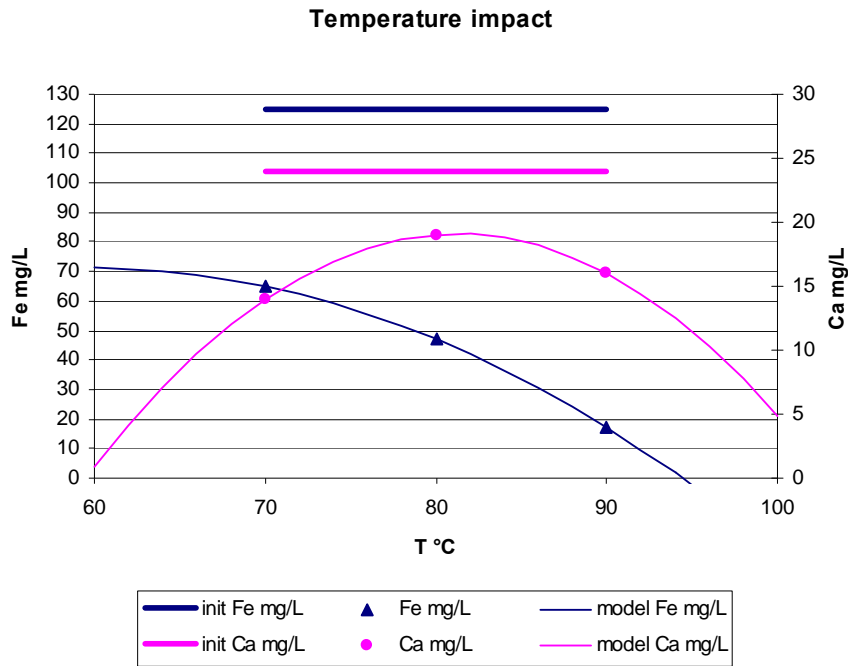

Graph 17: Regression with respect to the temperature results

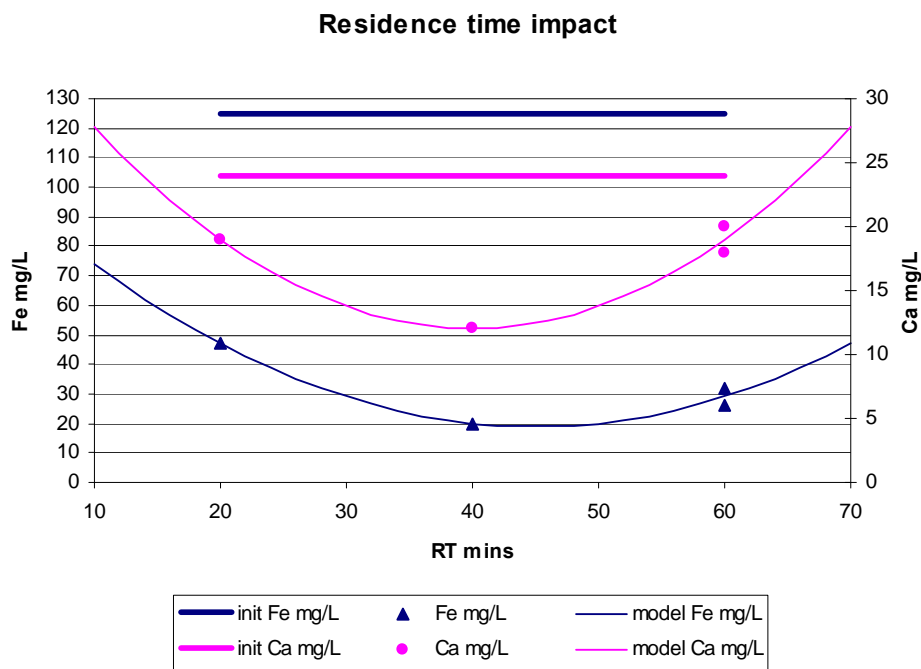

Graph 18: Regression with respect to the Residence Time results

For the two parameters (temperature and Residence Time), a maximum of efficiency is detected. They confirm that the minimum concentrations are obtained at high temperature (90°C) and intermediate Residence Time (about 45 minutes).

Appendix 5: Concentration results

In this appendix are presented all the concentration and alkalinity results.

Table 6: Results for F11 - base case

Time after start hr:min	Fe mg/L	Ca mg/L	Alkalinity mmol/L
00:05	14	19	31
00:07	17	20	
00:10	18	20	
00:15	17	20	35
00:20	17	20	
00:25	29	21	34
00:30	43	22	33
00:45	39	1	33
01:45	43	20	32
02:45	46	20	31
03:45	48	20	31
04:45	48	20	32
05:45	51	19	31
06:45	52	19	
07:45	63	20	31
08:45	53	21	30
09:45	49	21	30
10:45	45	19	30
11:45	52	21	
12:45	56	19	31
13:45	46	19	30
14:05	36	18	31

Table 7: Results for F12 - base case

Time after start hr:min	Fe mg/L	Ca mg/L	Alkalinity mmol/L
00:18	13	13	34
00:40	25	13	33
01:00	27	13	33
02:00	38	13	32
03:00	42	13	31
04:00	44	13	31
05:00	53	14	31
06:00	50	13	31
07:00	14	14	
08:00	53	13	31
09:00	47	14	31

Table 8: Results for F13 - base case

Time after start hr:min	Fe mg/L	Ca mg/L	Alkalinity mmol/L
00:20	6	20	
00:40	17	20	34
01:00	24	31	33
02:00	31	20	32
03:00	38	20	35
04:00	44	20	32
05:00	48	20	32
06:00	47	20	32
07:00	46	20	32
08:00	48	20	32

Table 9: Results for F14 - 90°C

Time after start hr:min	Fe mg/L	Ca mg/L
00:20	8	19
00:40	9	19
01:00	15	19
02:00	20	17
03:00	25	17
04:00	23	17
05:00	24	17
06:00	19	17
07:00	26	16
08:00	17	16

Table 10: Results for F15 - 70°C

Time after start hr:min	Fe mg/L	Ca mg/L	Alkalinity mmol/L
00:20	13	20	
00:40	39	20	34
01:00	49	20	
02:00	68	21	32
03:00	73	21	
04:00	80	22	
05:00	67	17	32
06:00	61	16	
07:00	64	14	32
08:00	65	14	

Table 11: Results for F16 - 40mins

Time after start hr:min	Fe mg/L	Ca mg/L	Alkalinity mmol/L
00:20	11	13	
00:40	8	13	35
01:00	10	13	
02:00	13	13	33
03:00	8	11	
04:00	9	11	31
05:00	11	11	
06:00	14	12	
07:00	16	12	
08:00	19	12	31
09:00	20	13	
10:00	20	12	31
11:00	20	12	
12:00	22	13	30
13:00	22	13	
14:00	21	12	30
15:00	21	13	
16:00	19	12	31

Table 12: Results for F17 - 55%wtMEG

Time after start hr:min	Fe mg/L	Ca mg/L	Alkalinity mmol/L
00:20	35	21	36
00:40	44	21	
01:00	43	22	
02:00	43	24	32
03:00	54	26	
04:00	56	26	32
05:00	58	26	
06:00	59	27	32
07:00	57	27	
08:00	57	27	32

Table 13: Results for F18 - 60mins

Time after start hr:min	Fe mg/L	Ca mg/L	Alkalinity mmol/L
00:30	19	21	36
01:00	19	21	36
02:00	9	17	34
03:00	10	14	32
04:00	13	16	
05:00	16	18	
06:00	19	18	31
07:00	22	19	
08:00	15	20	31
09:00	18	20	
10:00	19	20	31
11:00	28	20	
12:00	29	20	31
13:00	30	20	
14:00	26	20	
15:00	28	20	
16:00	28	20	
17:00	27	20	
18:00	26	20	31

Table 14: Results for F19 - 0,5ppmFe

Time after start hr:min	Ca mg/L
00:30	7
01:00	10
02:00	12
03:00	13
04:00	13
05:00	13
06:00	13
07:00	13
08:00	13

Table 15: Results for F20 - 60mins repetition

Time after start hr:min	Fe mg/L	Ca mg/L	Alkalinity mmol/L
00:30	24	18	36
01:00	23	18	35
02:00	28	18	
03:00	8	13	
04:00	11	13	
05:00	16	15	31
06:00	23	17	
07:00	29	18	
08:00	32	18	
09:00	27	18	31
10:00	28	18	
11:00	31	18	30
12:00	31	18	
13:00	31	18	
14:00	31	18	
15:00	30	18	
16:00	32	19	
17:00	33	18	
18:00	32	18	

Table 16: Results for F21 - 20ppmFe

Time after start hr:min	Ca mg/L	Alkalinity mmol/L
00:30	14	38
01:00	12	38
02:00	10	37
03:00	12	
04:00	12	
05:00	13	
06:00	13	38
07:00	12	
08:00	14	37

Appendix 6: Lasentech® results

The growth and nucleation rates were measured by the CSD from the Lasentech® probe for 2 different ranges. Next are all the drawings of the raw results. They show the number of counts per second (#/s) with respect to the chord in micrometer. On the left is the lower range (0 to 3µm) and on the right is the higher range (0 to 100µm). There are two curves per plot; one is the CSD from the Mixing Tank and the other from the Boiler.

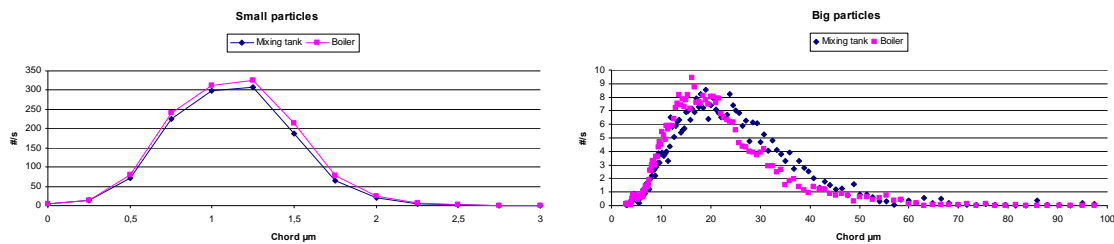

Graph 19: CSD plots for F14

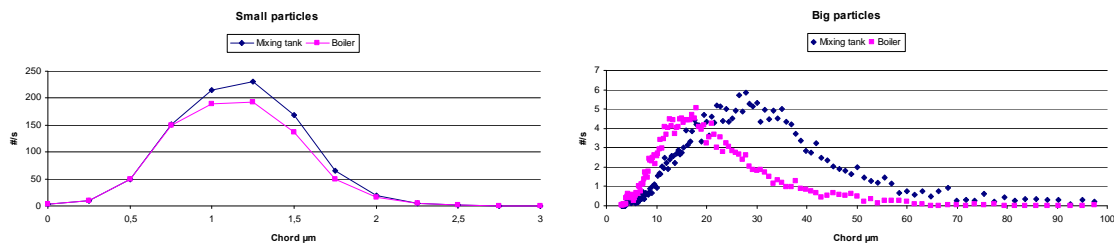

Graph 20: CSD plots for F15

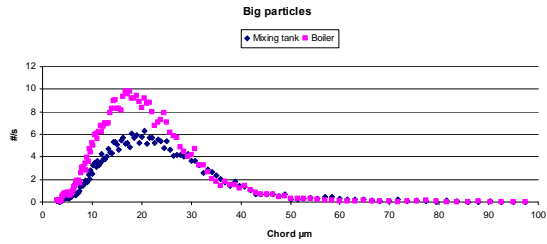
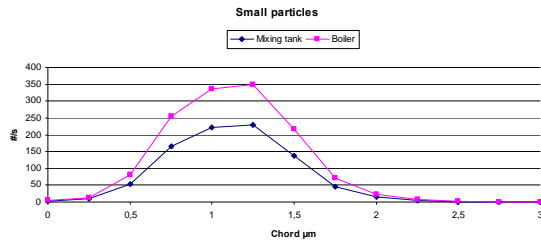

Graph 21: CSD plots for F16

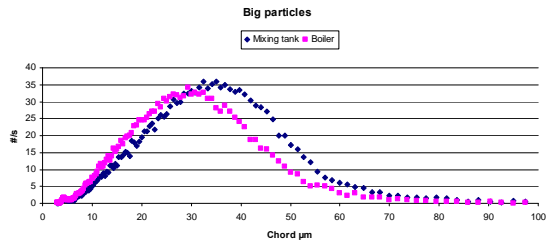
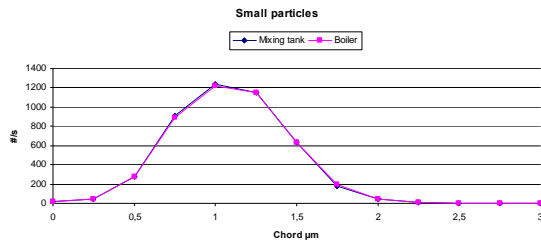

Graph 22: CSD plots for F17

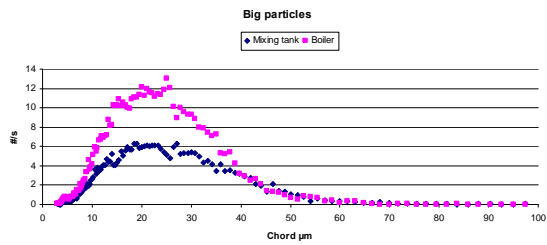
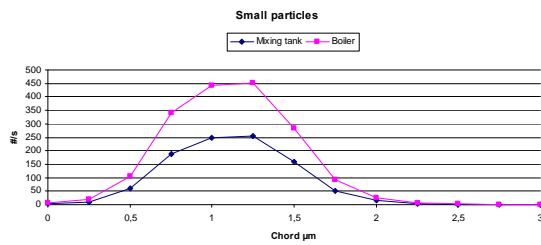

Graph 23: CSD plots for F18

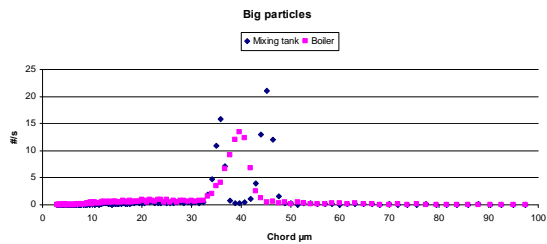
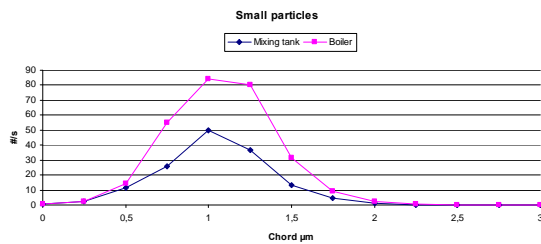

Graph 24: CSD plots for F19

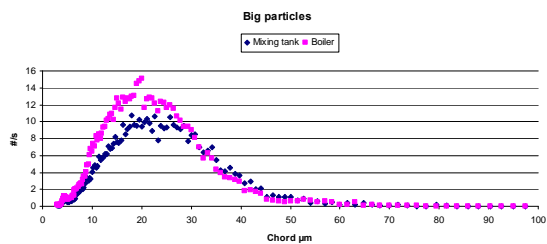
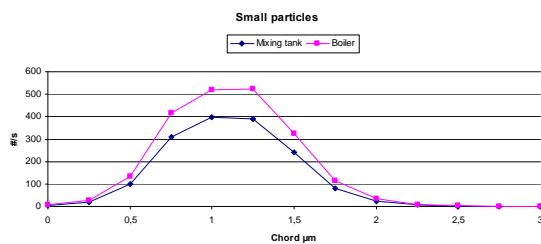

Graph 25: CSD plots for F20

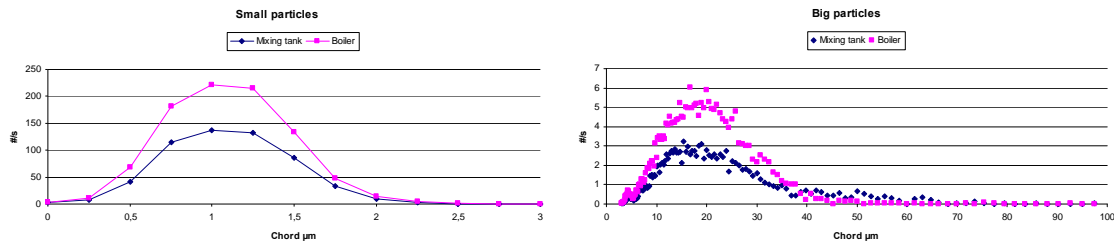

Graph 26: CSD plots for F21

Appendix 7: Final Lasentech® results

After obtaining the CSD, the calculations were done to calculate the growth and nucleation rates. The results are in nm/s and the correlation is also given. If this number is far lower below 1 (less than 0,9), then the model is not respected and this can mean that agglomeration is happening. The average size is also given.

Table 17: Growth rates and the correlations from the CSD and population balance calculations
In the Mixing Tank

nm/s		
Experiment	Fe	Ca
F14	-0,015	-0,032
F15	0,027	-0,105
F16	-0,055	-0,081
F17	0,001	-0,059
F18	-0,054	-0,062
F19	-0,187	0,470
F20	-0,023	-0,037
F21	-0,124	-0,122

Correl		
Experiment	Fe	Ca
F14	0,8158	0,5139
F15	0,8526	0,5347
F16	0,9920	0,8387
F17	0,5298	0,6708
F18	0,9998	0,6287
F19	0,9371	0,6973
F20	0,9967	0,8021
F21	0,9964	0,5516

Table 18: Nucleation rates and particle sizes in the Mixing Tank

#/s/L		
Experiment	Fe	Ca
F14	-192	0
F15	203	71
F16	-862	-259
F17	22	52
F18	-925	-285
F19	-246	-2
F20	-644	-291
F21	-612	-195

µm		
Experiment	Fe	Ca
F14	1,1	20,6
F15	1,2	26,8
F16	1,1	20,1
F17	1,1	30,3
F18	1,1	22,2
F19	1,0	38,8
F20	1,1	21,2
F21	1,1	19,1

Table 19: Growth rates and the correlations from the CSD and population balance calculation In the Boiler

nm/s		
Experiment	Fe	Ca
F14	0,128	0,147
F15	0,111	0,151
F16	0,076	0,085
F17	0,122	0,182
F18	0,053	0,064
F19	0,163	0,372
F20	0,082	0,094
F21	0,170	0,166

Correl		
Experiment	Fe	Ca
F14	0,9997	0,8680
F15	0,9965	0,8890
F16	1,0000	0,8453
F17	0,9999	0,7317
F18	1,0000	0,7874
F19	0,9989	0,7124
F20	1,0000	0,8181
F21	0,9999	0,7566

Table 20: Nucleation rates and particle sizes in the Boiler

#/s/L		
Experiment	Fe	Ca
F14	3684	1012
F15	1946	510
F16	4506	1382
F17	12019	3989
F18	3980	1248
F19	997	306
F20	7337	2157
F21	3336	911

µm		
Experiment	Fe	Ca
F14	1,1	18,3
F15	1,1	17,9
F16	1,1	18,1
F17	1,1	26,5
F18	1,1	21,0
F19	1,1	33,9
F20	1,1	19,4
F21	1,1	17,6

Appendix 8: XRD and SEM results

In this section; the XRD and SEM results are presented. They were commented along the result study in the report but the focus was on the Mixing Tank.

a) Temperature effects in the Boiler and in the Settler

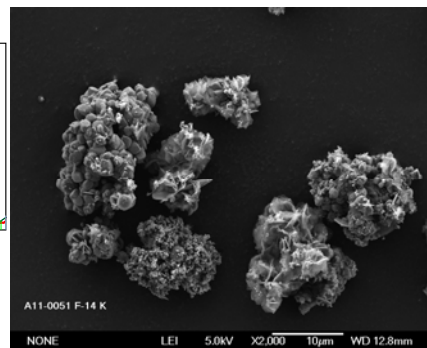
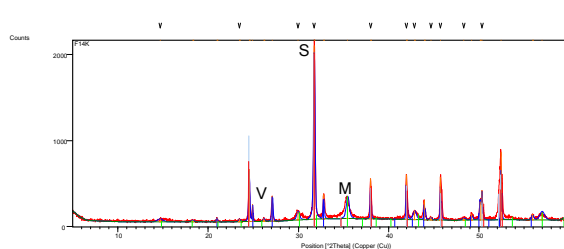

XRD and SEM results 1: F14 - 90°C in the Boiler

Master Thesis:
Precipitation of carbonates in the pretreatment process for regeneration of ethylene glycol

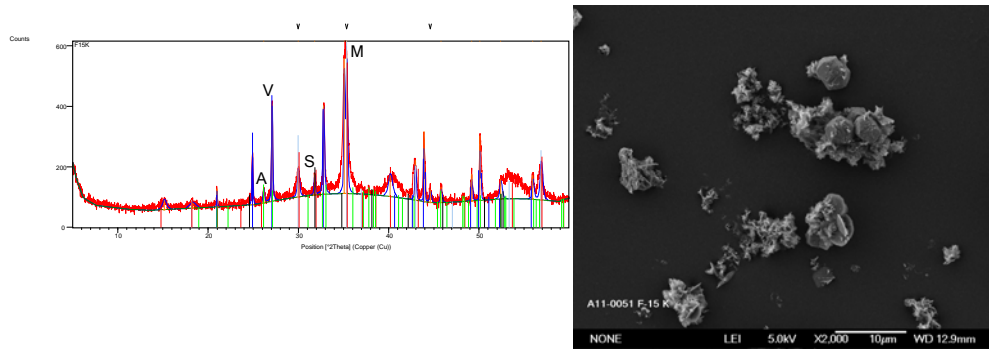

XRD and SEM results 2: F15 - 70°C in the Boiler

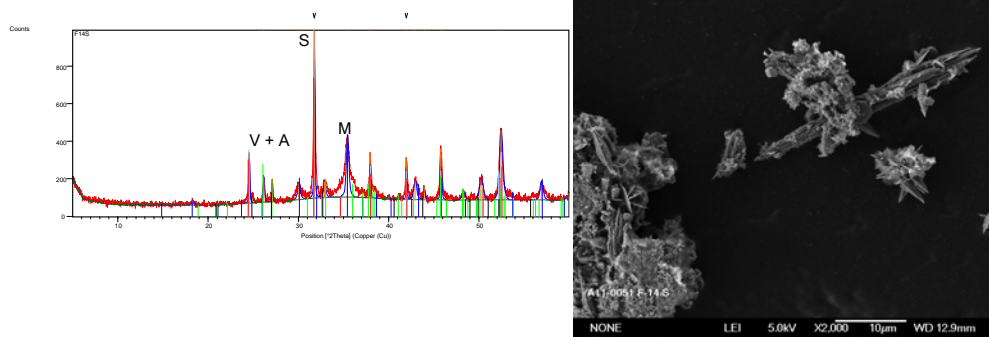

XRD and SEM results 3: F14 - 90°C in the Settler

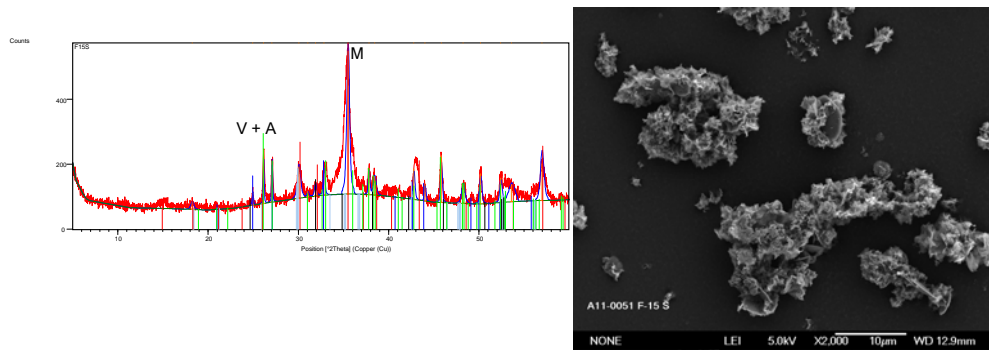

XRD and SEM results 4: F15 - 70°C in the Settler

b) Residence time effects

In the Mixing tank when repeating for a residence time of 60mins

Master Thesis:
Precipitation of carbonates in the pretreatment process for regeneration of ethylene glycol

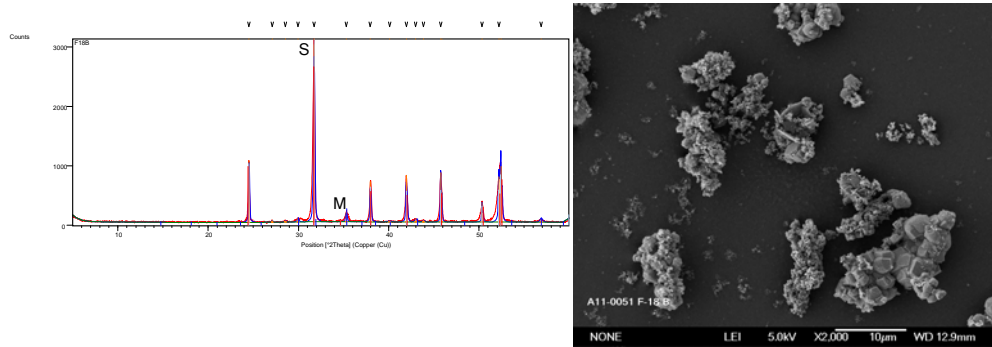

XRD and SEM results 5: F18 - 60mins in the Mixing Tank

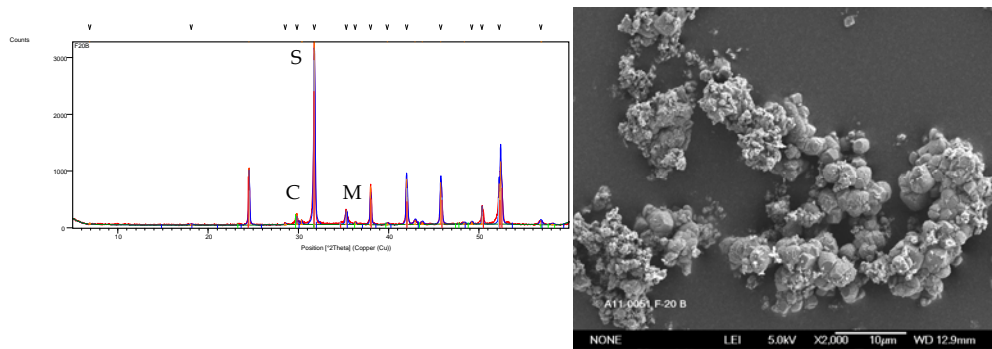

XRD and SEM results 6: F20 - 60mins in the Mixing Tank

In the Boiler and in the Settler

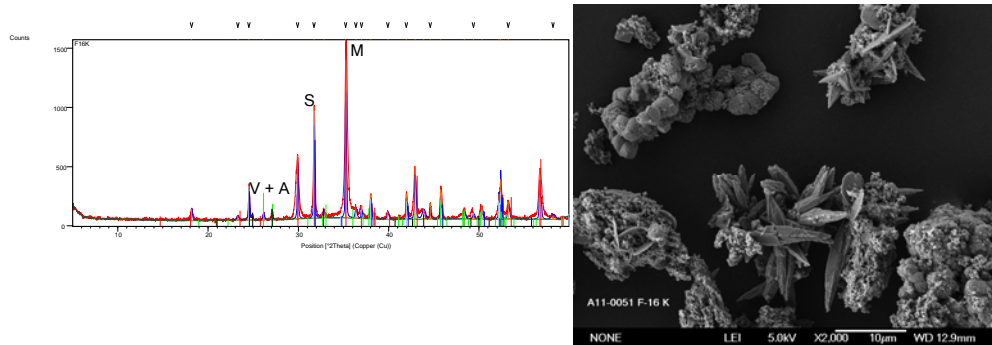

XRD and SEM results 7: F16 - 40mins in the Boiler

Master Thesis:
Precipitation of carbonates in the pretreatment process for regeneration of ethylene glycol

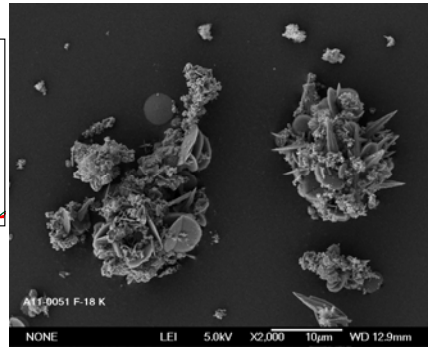
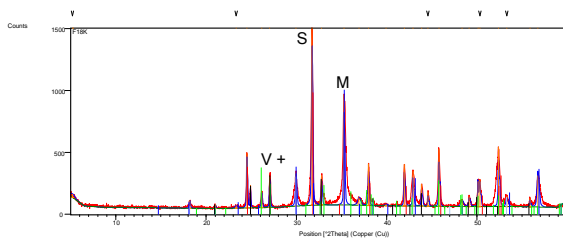

XRD and SEM results 8: F18 - 60mins in the Boiler

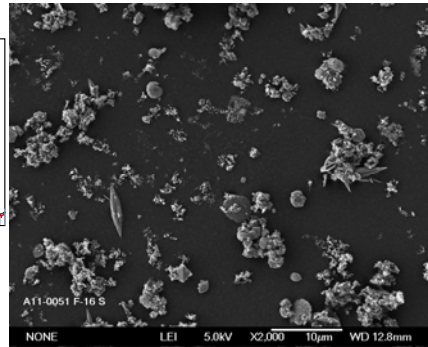
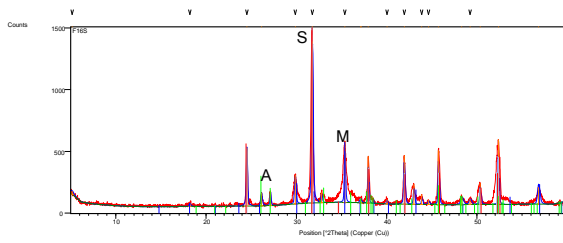

XRD and SEM results 9: F16 - 40mins in the Settler

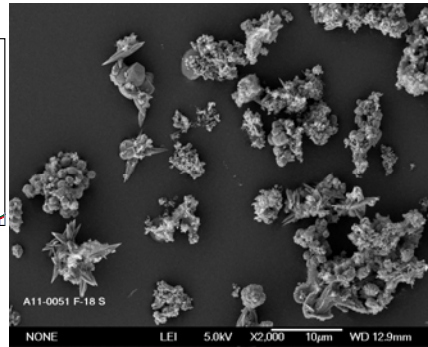
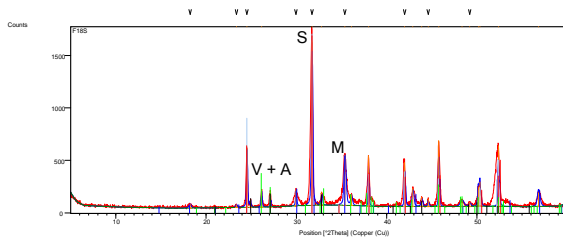

XRD and SEM results 10: F18 - 60mins in the Settler

c) Iron concentration effects in the Boiler and in the Settler

Master Thesis:
Precipitation of carbonates in the pretreatment process for regeneration of ethylene glycol

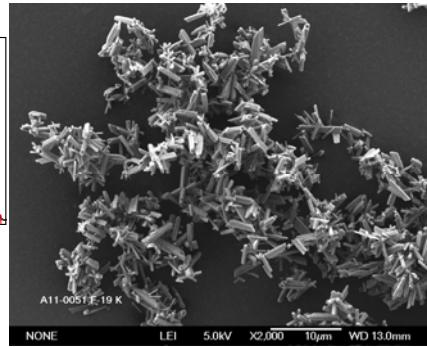
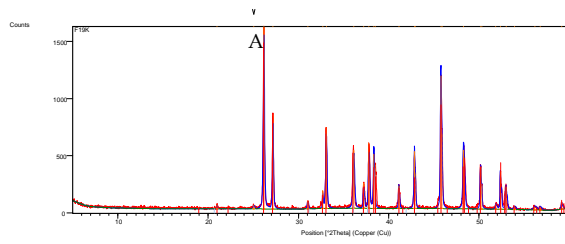

XRD and SEM results 11: F19 - 0,5ppmFe in the Boiler

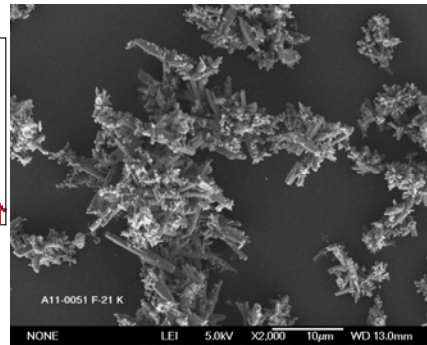
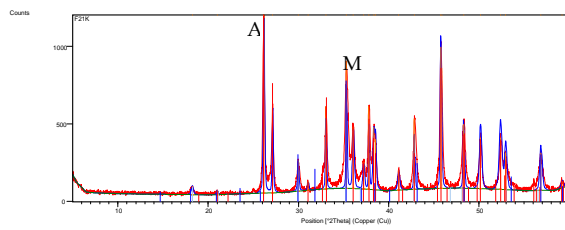

XRD and SEM results 12: F21 - 20ppmFe in the Boiler

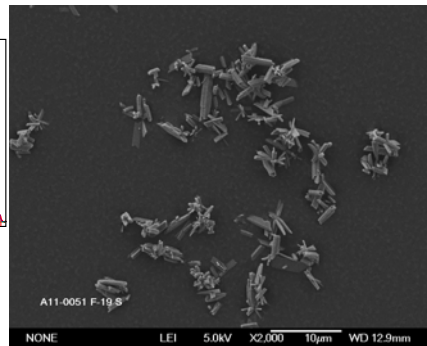
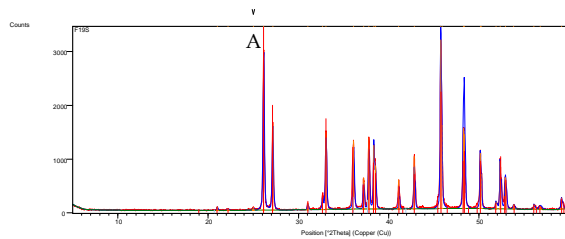

XRD and SEM results 13: F19 - 0,5ppmFe in the Settler

Master Thesis:
Precipitation of carbonates in the pretreatment process for regeneration of ethylene glycol

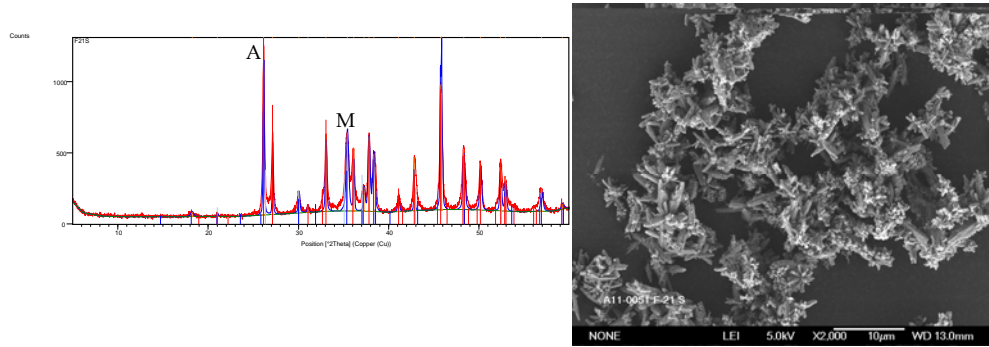

XRD and SEM results 14: F21 - 20ppmFe in the Settler

K. References

Jens-P Andreassen and M.J. Hounslow (2004), Growth and Aggregation of Vaterite in Seeded-Batch Experiments, *American Institute of Chemical Engineers, AIChE Journal*, November 2004 Vol. 41, No 11 (p. 3883-2782)

Ellen Marie Flaten (2010), The effect of MEG (mono ethylene glycol) on the precipitation kinetics of calcium carbonate related to natural gas production from subsea wells, Trondheim 2010, *Thesis for the degree of philosophiae doctor, Norwegian University of Science and Technology, Faculty of Natural Sciences and Technology, Department of Chemical Engineering*, ISBN 978-82-471-2042-2 (electronic version)

Magnus Ø. Olderøy et al. (2009), Growth and Nucleation of Calcium Carbonated Vaterite Crystals in Presence of Alginate, *Crystal Growth and Design article*, 2009 vol. 9 (p. 5176-5183)

J. W. Mullin (2001), Crystallisation, 4th edition, Butterworth Heinemann, 600pp (ch. 8 p. 315-402 and ch. 9 p. 403-477)

Ellen Marie Flaten et al. (2009), Polymorphism and morphology of calcium carbonate precipitated in mixed solvents of ethylene glycol and water, *Journal of Crystal Growth* 311 (2009) (p. 3533-3538)

Geir Watterud et al., Precipitation of FeCO₃ in MEG/Water mixtures. Solubility and kinetic measurements

Ellen Marie Flaten et al., Precipitation of iron and calcium carbonate in pipelines at varying MEG contents, *SPE 114089*

Tonje Berntsen (2009), Iron carbonate precipitation rate and its effect on the CO₂ corrosion rate, *KP8104 Industrial crystallization and precipitation – Doctoral degree level*

Master Thesis:

Precipitation of carbonates in the pretreatment process for regeneration of ethylene glycol

Ellen Marie Flaten et al. (2010), Growth of the calcium carbonate polymorph Vaterite in mixtures of water and ethylene glycol at conditions of gas processing, *Journal of Crystal Growth* 312 (2010) (p. 953-960)

Ellen Marie Flaten et al. (2010), Induction time studies of calcium carbonate in ethylene glycol and water, *Chemical Engineering Research and Design*, doi: 10.1016/j.cherd.2010.01.028

L. Niel Plummer and Eurybiades Busenberg (1982), The solubilities of calcite, aragonite and Vaterite in CO₂-H₂O solutions between 0 and 90°C, and an evaluation of the aqueous model for the system CaCO₃-CO₂-H₂O, *Geochimica et Cosmochimica Acta* Vol. 46 (p. 1011-1040), Pergamon Press Ltd 1982

Amjad Zahid, *Advances in crystals growth inhibition technologies*, ed. Wahid Amjad, Printed NY, Kluwer Academic, Plenum publishers

Controlling FeCO₃ precipitation in a closed loop MEG system adopting theory and experimental work into plant design, 17th international oil field chemistry symposium, Geilo, 19-22 March 2006



How to monitor a closed loop MEG system, 18th international oil field chemistry symposium, Geilo, 25-28 March 2007

Effect of scale and corrosion inhibitors on the precipitation kinetics of iron and calcium carbonate in a closed loop MEG system, 20th international oil field chemistry symposium, Geilo, 22-25 March 2009

Wei Sun, Srdjan Nesic, Richard C Woolam (2009), The effect of temperature and ionic strength on iron carbonate (FeCO₃) solubility limit, *Corrosion science* (2009), Vol. 51, issue 6 (p. 1273-1276)

Master Thesis:
Precipitation of carbonates in the pretreatment process for regeneration of ethylene glycol

Several Statoil internal reports were also used in this work.

NTNU	Elaboration of the points in the form "Identification of Hazardous Activity"	Prepared by	Number	Date	
		HSE section	HMSRV-26/02	01.12.2006	
HSE		Approved by	Page	Replaces	
		The Rector	84 out of 6	New	

What

Activity/process

Identification of activities/processes included in the risk assessment that may entail a risk of human injury or environmental damage, such as machinery, laboratory activities, work in engineering workshops, the use of certain chemicals etc. Break down the whole activity/process into its constituent parts, and give a short description of each of these parts. The participants must come to agreement about the scope of the activities to be risk assessed.

The following aspects must be considered

- "A risk to whom" – employees, the environment, isolated individuals or a group, the enterprise, society?
- "A risk posed by what" – which installation, which activity, what categories of accident?
- "For which time period/duration"- the risk level may vary over time

Risk represents a potential loss, not a loss that has already occurred. Activities/processes that are normally deemed relatively risk-free may involve an increased risk under certain conditions.

Responsible person

Who is responsible for each activity/process? Do other units carry responsibility or carry out tasks in relation to reducing the risks? Organisational maps can be used to clarify responsibility.

Laws, regulations etc.

What laws, regulations and other official requirements apply to the activity/process? See the HSE handbook, [HMSRV-20/01](#), [www.lovddata.no](#), [www.arbeidstilsynet.no](#), [www.hmsetatene.no](#), and municipal regulations ([www.trondheim.kommune.no](#))



Existing documentation

The unit must access existing central and local guidelines, construction drawings, certificates, crane operator licences, forklift operator licences, completed training, service agreements, operation manuals, checklists etc. See also earlier risk assessments and HSE checks, local HSE booklet, lab handbook, [NTNUs stoffkartotek](#) etc.

Safety measures

What safety measures already exist for the area/equipment? (E.g. ventilation, personal protective equipment, emergency stop device,

marking/signposting, partition walls etc.).

NTNU	<u>Hazardous activity identification process</u>	Prepared by	Number	Date	
		HSE section	HMSRV-26/01	01.12.2006	
HSE		Approved by	Page	Replaces	
		The Rector	85 out of 6	15.12.2003	



Unit: MEG Rigg

Date: 13/01/2011

Participants in the identification process (including their function): Thomas Montazaud

Short description of the main activity/main process: Cleaning the MEG by precipitations and evaporation of water

Activity/process	Responsible person	Laws, regulations etc.	Existing documentation	Existing safety measures	Comment
Process study	Thomas Montazaud	Statoil internal regulations	Safety courses, documentation on the intranet	Emergency shower, first aid box, alarms	
Cleaning the materials	Thomas Montazaud	Statoil internal regulation	Safety courses, documentation on the intranet	Emergency shower, first aid box, alarms	

NTNU	HSE action plan	Prepared by	Number	Date	
		The HSE section	HMSRV-12/24	01.12.2006	
HSE		Approved by	Page	Replaces	
		The Rector	86 of 89	20.08.1999	

Unit: MEG Rigg _____

What	Measure	Unit responsible	Priority	Cost	Current status
Process study	Wear gloves, goggles, labcoat and cellphone	Thomas Montazaud			Up and running
Cleaning the materials	Wear gloves, goggles, labcoat and cellphone	Thomas Montazaud			

Date: 13/01/2011 _____ Line manager: Gry Pedersen Kojen _____

NTNU	Risk assessment	Prepared by	Number	Date	
		HSE section	HMSRV-26/03	01.12.2006	
HSE/KS		Approved by	Page	Replaces	
		The Rector	87 out of 6	15.12.2003	

Unit: MEG Rigg

Date: 13/01/2011

Line manager: Thomas Montazaud

Participants in the risk assessment (including their function): Thomas Montazaud (operator, student)

Activity from the identification process form	Potential undesirable incident/strain	LIKELIHOOD:	CONSEQUENCE:			Risk value	Comments/status Suggested measures
		Likelihood (1-4)	Human (1-4)	Environment (1-4)	Economy/materiel (1-4)		
Running the experiments	Hot mixture spilling, MEG spilling, glass tank breakage	1	2	1	2	2	Call at once someone or the emergency department. Breakage can be fixed by the glass department.
Cleaning	MEG spilling, glass tank breakage, acid spilling	1	1	1	2	2	Same as above.

Likelihood, e.g.:

1. Minimal
2. Low
3. High
4. Very high

Consequence, e.g.:

1. Relatively safe
2. Dangerous
3. Critical
4. Very critical

Risk value (each one to be estimated separately):

Human = Likelihood x Human Consequence

Environmental = Likelihood x Environmental consequence

Financial/materiel = Likelihood x Consequence for Economy/materiel

NTNU	Risk assessment	Prepared by	Number	Date	
		HSE section	HMSRV-26/03	01.12.2006	
HSE/KS		Approved by	Page	Replaces	
		The Rector	88 out of 6	15.12.2003	

Potential undesirable incident/strain

Identify possible incidents and conditions that may lead to situations that pose a hazard to people, the environment and any materiel/equipment involved.

Criteria for the assessment of likelihood and consequence in relation to fieldwork

Each activity is assessed according to a worst-case scenario. Likelihood and consequence are to be assessed separately for each potential undesirable incident. Before starting on the quantification, the participants should agree what they understand by the assessment criteria:

The likelihood of something going wrong is to be assessed according to the following criteria:

- 1 Minimal**
Once every 10 years or less
- 2 Low**
Once a year
- 3 High**
Once a month
- 4 Very high**
Once a week or more often

Human consequence is to be assessed according to the following criteria:

- 1 Relatively safe**
Injury that does not involve absence from work; insignificant health risk
- 2 Dangerous**
Injury that involves absence from work; may produce acute sickness
- 3 Critical**
Permanent injury; may produce serious health damage/sickness
- 4 Very critical**
Injury that may produce fatality/ies

Environmental consequences are assessed according to the following criteria:

- 1 Relatively safe**
Insignificant impact on the environment
- 2 Dangerous**
Possibility of undesirable long term effects; some cleanup is to be expected
- 3 Critical**
Undesirable long term effects; cleanup to be expected
- 4 Very critical**
Damaging to living organisms; irreversible impact on the environment; cleanup must be undertaken

NTNU	Risk assessment	Prepared by	Number	Date	
		HSE section	HMSRV-26/03	01.12.2006	
HSE/KS		Approved by	Page	Replaces	
		The Rector	89 out of 6	15.12.2003	

The unit makes its own decision as to whether opting to fill in or not consequences for economy/materiel, for example if the unit is going to use particularly valuable equipment. It is up to the individual unit to choose the assessment criteria for this column.

Risk = Likelihood x Consequence

Please calculate the risk value for “Human”, “Environment” and, if chosen, “Economy/materiel”, separately. For activities with a risk value of 16 or 12, or a single value of 4, safety measures (designed to both reduce the likelihood and to limit the consequences) must be documented with descriptions of measures and allocation of responsibility.

About the column ”Comments/status, suggested preventative and corrective measures”:

Measures can impact on both likelihood and consequences. Prioritise measures that can prevent the incident from occurring; in other words, likelihood-reducing measures are to be prioritised above greater emergency preparedness, i.e. consequence-reducing measures.