

Impact of Power Flow Direction on the Stability of VSC-HVDC seen from the Impedances Nyquist Plot

Mohammad Amin, *Student Member, IEEE*, Marta Molinas, *Member, IEEE*, Jing Lyu, *Student Member, IEEE*, and Xu Cai, *Member, IEEE*

Abstract

The high voltage dc (HVDC) systems are appearing more and more, and it is becoming a requirement that the HVDC voltage source converters (VSCs) operate both as an inverter and a rectifier without changing the controls to provide the flexibility of having power flows in both directions. It is observed that the HVDC system operates stably when the power flow direction is from the power controlled-converter to the dc voltage controlled-converter and it becomes unstable when the power flow direction has been altered. In order to analyze such instability problem and to design the local control, an impedance-based method is proposed. Identifying the source and the load impedance are prerequisite to apply the impedance-based method. Existing method of determining the source and the load impedance cannot predict the stability when the power flow direction is altered; therefore a method based on the power flow direction has been presented to determine the source and the load impedance. The converter which injects power to the dc system is the current source represented with its Norton equivalent parallel impedance while the other converter impedance is considered as the load impedance. The stability of the system is determined by the ratio of the load impedance to the current source impedance. Once the source and the load impedance are analytically obtained, the impedance-based Generalized Nyquist Stability Criteria is applied to determine the stability. The system stability for the two power flow directions is well predicted from the Nyquist plot of impedance ratio. A two-terminal HVDC system has been developed in MATLAB/Simulink to demonstrate the application of this method and the results are compared with the experimental results.

Index Terms

HVDC, Stability Analysis, Impedance analysis, VSC control, Nyquist Stability Criteria.

Mohammad Amin is the corresponding author of this manuscript. Address: Dept. of Engineering Cybernetics, NTNU, Trondheim-7491, Norway. Phone:+47 7359 4439, Email:mohammad.amin@ntnu.no.

Mohammad Amin and Marta Molinas are with the Department of Engineering Cybernetics, Norwegian University of Science and Technology, Trondheim-7491, Norway. Jing Lyu and Xu Cai are with the Wind Power Research Center, Shanghai Jiao Tong University, Shanghai, China.

Note: A part of this work has been presented in IEEE POWERTECH EINDHOVEN 2015 Conference [24]. It has been fully revised, expanded and experimental results included prior to its submission for consideration to the IEEE Transaction on Power Electronics.

I. INTRODUCTION

The Voltage Source Converter (VSC)-based High Voltage dc (HVDC) transmission system has received considerable attention due to development of the power electronics converter [1], [2]. A Large range of modeling and control of the VSC-based HVDC system have been published in the last few years [3]- [11]. From these studies it becomes clear that the control and the system impedance can have the impact on the stability of the system. It is therefore necessary to pre-asses their impact on the system stability before connecting to the main grid. Continuous efforts have been made to investigate the stability of such system by different approaches. Existing approaches for the stability study of the VSC-HVDC system are based on the controller dynamics which do not include the system impedance and the dc line dynamics. Another approach is based on the state-space model and eigenvalue analysis [12]- [18]. The eigenvalue-based approach requires the design of each components of the HVDC system and does not support the local control development at individual terminals. Impedance-based approach is a simple method for stability analysis and supports the local control development [19]- [33].

A common practice when designing the control of an HVDC is: the dc voltage controlled-converter operates as an inverter and the power controlled-converter operates as a rectifier [34]. Thus, the active power flows in one direction from the power control to the dc voltage controlled-converter. If it is necessary to change the power flow direction, the control mode between the converters needs to be changed. However, the HVDC systems are appearing more and more and it is becoming a requirement that the VSCs operate both as an inverter and a rectifier without changing the controls to provide the flexibility of having power flows both directions, as an ac transmission system in which two ac networks support each other. It has been observed that the HVDC system operates stably when the power flow direction is from the power controlled-converter to the dc voltage controlled-converter and it becomes unstable when the power flow direction has been altered. Existing impedance-based stability method cannot determine the stability when the power flow direction has been altered. This paper has proposed a method based on impedances Nyquist plot to investigate such instability problem.

In order to determine the stability based on the impedance-based approach, the impedance model derivation is the prerequisite. In the literature most researcher have so far focused on the ac impedance modeling either in the positive-negative sequence [25], [26] or in the dq-frame [27]- [30] and considered to have an ideal voltage source or a current source in the dc side in which the dc lines/cables impedance are neglected. However in a VSC-based HVDC system the dc side dynamics have a significant impact on the system stability. Therefore, the impact of the dc line impedance must be considered in the stability analysis. A dc impedance-based resonance analysis for the VSC-HVDC system is investigated for different value of the dc link capacitance in [34]; however it doesn't include the detailed stability analysis. Another dc impedance-based stability method has been presented in [22], [24]; however these papers have not discussed the impact of the power flow direction on the stability.

In this study, a dc impedance-based approach is adopted to analyze the stability of the VSC-based HVDC transmission system. An analytical method is derived to calculate the dc impedance, which refers to the impedance of the VSC including the controller dynamics and the dc line impedance. The derived model is validated by comparing the frequency response of the analytical impedance and the impedance measured at the dc terminal from

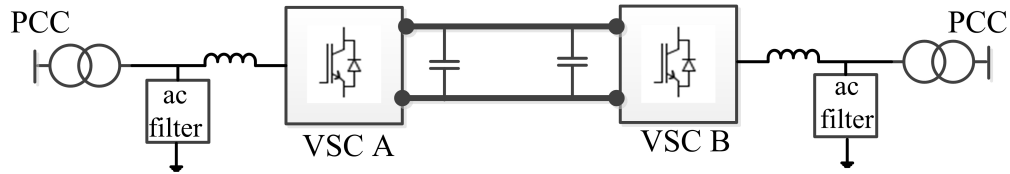

Fig. 1: Point-to-point connection VSC-based HVDC system

a detailed switching model of the VSC-HVDC system. The impedance of the VSCs not only depends on the passive components, but also on the converter control dynamics.

In order to apply the impedance-based stability method, it is necessary to determine the source and the load impedances. A method for determining the current source and the voltage source for the dc system has been presented in [35] in which the subsystem connected in series with an inductor is assumed to be the current source while the converter connected in parallel with a capacitor is assumed to be the voltage source. Moreover, in the literature the subsystem which regulates the voltage is assumed to be the voltage source and other converter is assumed to be the current source regardless of the direction of the current (power flow) [20]. Hence, the system can be represented by an equivalent small-signal impedance model consisting of both the voltage source and the current source, and the stability can be determined from the minor loop gain which is the ratio of the voltage source to the current source impedance [20]. However, the stability of a system consisting of a current source and a voltage source system cannot be determined for both directions of the active power flow. A method based on the Generalized Inverse Nyquist Criteria (GINC) has been presented in [28] which could be useful to analyze such instability problem but it does not have any indication when should be used the Generalized Nyquist Criteria (GNC) or GINC for a case when the power flow direction has been altered.

It is therefore important to design the control which makes the system stable for both directions of power flow. To design the appropriate control, the instability problem needs to be defined analytically. In an attempt to do that, an impedance based method is proposed and the HVDC converter stations are represented by its Norton equivalent current source with parallel connected impedance, and the source and the load impedance are determined based on the power flow direction. The identification of the source and the load impedance is based on the power flow direction which is a new method presented in this paper. The stability analysis has been performed for two different directions of power flow where the method can determine the stability for both directions of power flow and the theoretical analysis has been verified by time domain simulation and by experiments.

The rest of the paper is organized as follows: Section II describes the modeling and control of the HVDC system. The developed HVDC system is tested by time domain simulation and experiment in Section III. Section IV presents the impedance based stability method. Moreover, An impedance model is derived analytically and the derived impedance model is verified with the frequency response of the impedance obtained from simulation. The stability analysis method based on the power flow direction is described in Section V. Finally the results of this study are concluded in section VI.

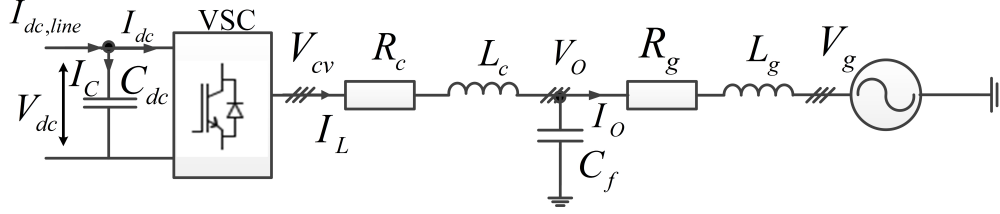

Fig. 2: Overview of VSC-HVDC converter station

II. HVDC SYSTEM MODELING AND CONTROL

The two-terminal VSC-based HVDC system under this study is depicted in Fig. 1. The HVDC system consists of the converter transformers, ac filters, two VSC HVDC converters named VSC-A and VSC-B, and the dc cable. Both the VSC-A and VSC-B are assumed to be identical in structure. The electrical circuit of a VSC-HVDC converter for analytical modeling is shown in Fig. 2 where L_c and R_c are the total series inductance and resistance of the VSC, C_f is the filter capacitance, and L_g and R_g are the inductance and resistance of the grid. The modeling, analysis and control of the system will be presented in a synchronous reference frame (SRF). The transformation of the three phase quantity from stationary reference frame to the SRF is based on the amplitude-invariant Park transformation, with the d-axis aligned with the voltage vector v_o and q-axis leading the d-axis by 90° . The dynamic equations of the converter in per unit (pu) can be given by (1), the filter by (2) and the grid by (3) where ω_b is base angular grid frequency; ω_g is the grid frequency in per unit (pu); voltage and current of these equations are indicated in Fig. 2 [36], [37].

$$\frac{di_L}{dt} = \frac{\omega_b}{L_c} v_{cv} - \frac{\omega_b}{L_c} v_o - \omega_b \left(\frac{R_c}{L_c} + j\omega_g \right) i_L \quad (1)$$

$$\frac{dv_o}{dt} = \frac{\omega_b}{C_f} i_L - \frac{\omega_b}{C_f} i_o - j\omega_b \omega_g v_o \quad (2)$$

$$\frac{di_o}{dt} = \frac{\omega_b}{L_g} v_o - \frac{\omega_b}{L_g} v_g - \omega_b \left(\frac{R_g}{L_g} + j\omega_g \right) i_o \quad (3)$$

A. Current Controller

The inner loop current controller is assumed to be the widely used SRF Proportional-Integral (PI) controller of the VSC with a decoupling term. The output voltage references, $v_{cvdq,ref} = \left(v_{cvd,ref} \quad v_{cvq,ref} \right)^T$ obtained from the current controller including the feed-forward terms can be given by

$$v_{cvdq,ref} = G_{cc} i_{Ldq,ref} - (G_{cc} + G_{del}) i_{L,dq} + v_{o,dq} \quad (4)$$

and defined

$$G_{cc} = \begin{pmatrix} H_{cc}(s) & 0 \\ 0 & H_{cc}(s) \end{pmatrix},$$

$$G_{del} = \begin{pmatrix} 0 & \omega_{PLL} L_c \\ -\omega_{PLL} L_c & 0 \end{pmatrix}$$

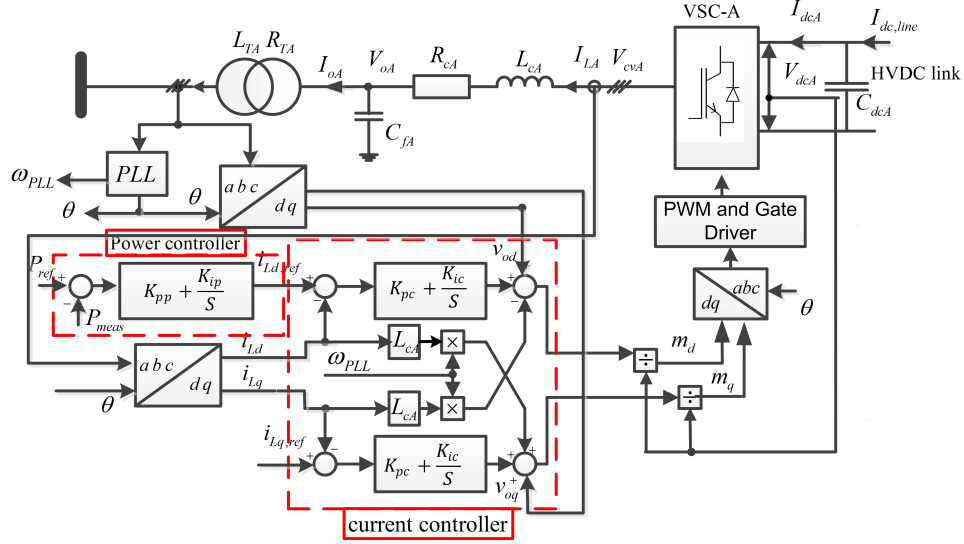

Fig. 3: The control structure of the power control converter, VSC-A.

where $i_{Ldq,ref} = (i_{Ld,ref} \quad i_{Lq,ref})^T$; $i_{Ld,ref}$ and $i_{Lq,ref}$ are the reference active and reactive current components obtained from the outer loop controller of the VSCs; $H_{cc}(s) = k_{pc} + k_{ic}/s$ is the current compensator transfer function where k_{pc} and k_{ic} are the proportional and the integral gain of the current compensator, respectively and ω_{PLL} is the frequency of the PLL in pu. The analytical modeling of the current controller remains the same for both VSC-A and VSC-B.

B. The Power Controlled-converter, VSC-A

VSC-A controls the active power. The outer loop PI controller gives the d-axis current reference and the q-axis current reference is set to a constant value according to the reactive power requirements; in this case it is zero. The control structure of the power controlled-converter is shown in Fig. 3. The current reference for the active power controller can be defined by

$$i_{Ld,ref} = H_p(s)(P_{ref} - P_{meas}) \quad (5)$$

and the measured power

$$P_{meas} = v_{odA}i_{LdA} + v_{oqA}i_{LqA} \quad (6)$$

where $H_p(s) = k_{pp} + k_{ip}/s$ is the power compensator transfer function where k_{pp} and k_{ip} are the proportional and integral gain of the power controller, respectively. The subscript, 'A' denotes VSC-A.

C. The dc voltage controlled-converter, VSC-B

The control structure of VSC-B is shown in Fig. 4. VSC-B regulates the HVDC link voltage. The outer loop PI controller gives the d-axis current reference to the current controller. The q-axis current is set to constant value.

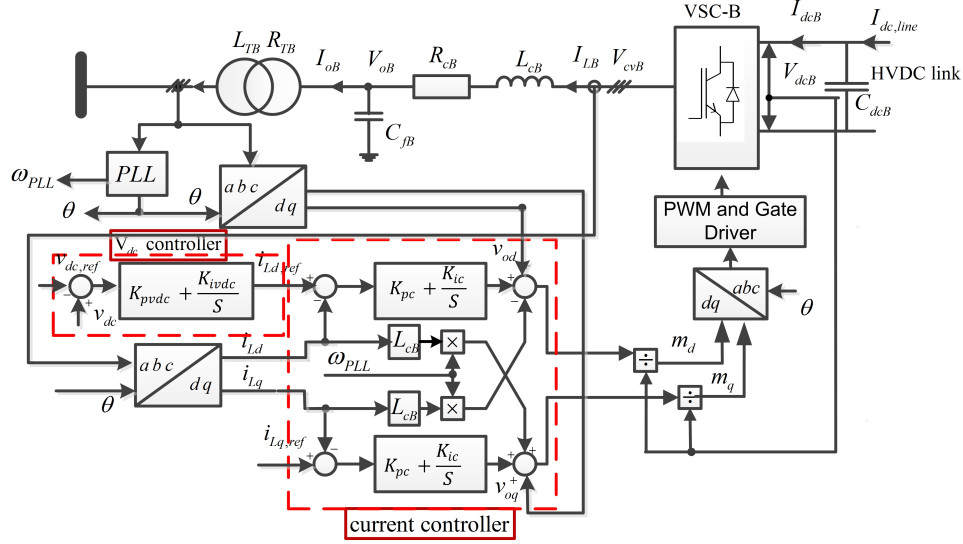

Fig. 4: The control structure of dc voltage control converter, VSC-B.

The d-axis current reference, $i_{Ld,refB}$ can be given by,

$$i_{Ld,refB} = H_{vdc}(s)(v_{dc,refB} - v_{dcB})(-1) \quad (7)$$

where $H_{vdc}(s) = k_{pvdc} + k_{ivdc}/s$ is the dc voltage controller transfer function; k_{pvdc} and k_{ivdc} are the proportional and integral gain of the PI controller, respectively and $v_{dc,refB}$ is the reference dc voltage. The subscript, 'B' denotes VSC-B.

III. SIMULATION AND EXPERIMENTS

The analytical model of a two-terminal VSC-HVDC system discussed in previous section is implemented in MATLAB/Simulink with detailed switching model of the VSCs. In addition, the simulation results are also compared with the set-up of a two-terminal system built in laboratory. The theoretical analysis and simulations have been performed for a low voltage level in order to compare with the same voltage and system parameters in the experiments. The electrical circuit parameters of the system are given in Table I in Appendix. The inner-loop current controller of VSC-A is tuned at $H_{ccA}(s) = 4 + 800/s$ and the close-loop control bandwidth is 160 Hz with 150 degree phase margin. The active power compensator transfer function is $H_P(s) = 0.005 + 1/s$, and the close-loop control bandwidth is 27 Hz with 75 degree phase margin. The current compensator of VSC-B is $H_{ccB}(s) = 5 + 1000/s$ and the close-loop control bandwidth is 157 Hz with 150 degree phase margin, and the dc voltage compensator transfer function is $H_{vdc}(s) = 4.5 + 3/s$ and the control bandwidth 8 Hz with 170 degree phase margin. The control tunings satisfy the standard bandwidth requirements and the system is expected to operate stably.

The dc voltage reference to VSC-B is set to 500 V. The active power reference to VSC-A is set -10 kW. The negative power reference to VSC-A means that VSC-A is exporting active power to the dc system and is operating as a rectifier. Thus, VSC-B is extracting power from the dc system and operates as an inverter. A time domain

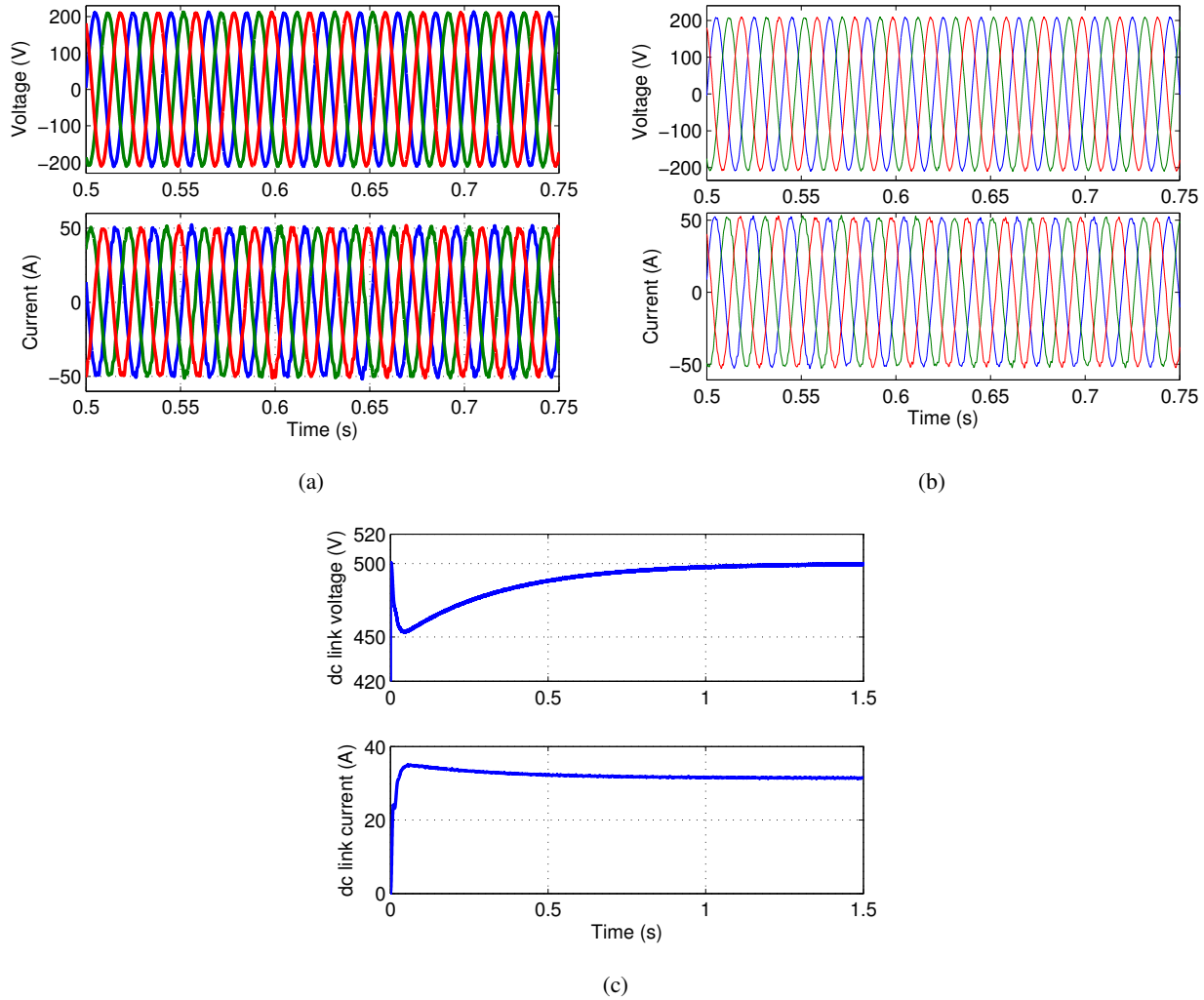

Fig. 5: Simulation results for -10 kW power reference to the VSC-A (Stable case): (a) Three-phase ac voltage and current at PCC of VSC-A, (b) Three-phase ac voltage and current at PCC of VSC-B and (c) dc link voltage and current of VSC HVDC system.

simulation has been carried out for these tuning and setting, and the resulting time domain responses are shown in Fig. 5 which shows that the system operates stably. Fig. 6 shows the experimental results. The system operates stably in both the time domain simulation and the experiment.

The HVDC system is expected to operate stably for both directions of the power flow. Therefore, the opposite direction of the power flow is tested for the same control tuning. The active power reference is now set to +10 kW which is the opposite to the previous direction. For this power reference, VSC-A is extracting the power from the dc system and operates as an inverter and VSC-B is exporting power to the dc system. The power reference has been altered from the negative reference to the positive while the controls of the VSCs remain the same. A time domain simulation has been carried out and the resulting time domain responses are shown in Fig. 7. As

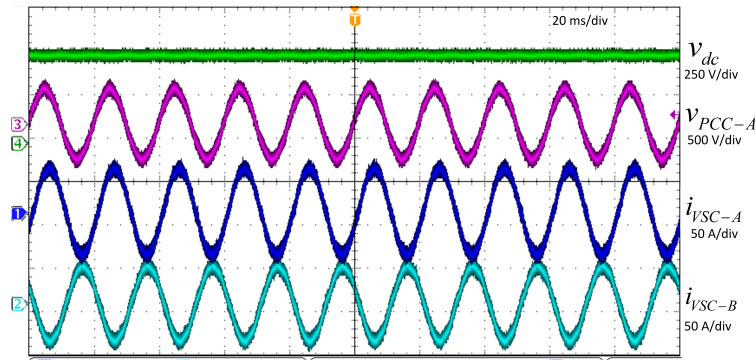

Fig. 6: Experimental results for -10 kW power reference to the VSC-A (Stable case): dc link voltage, voltage at PCC of VSC (phase-a), current of VSC-A (phase-a) and VSC-B (phase-a).

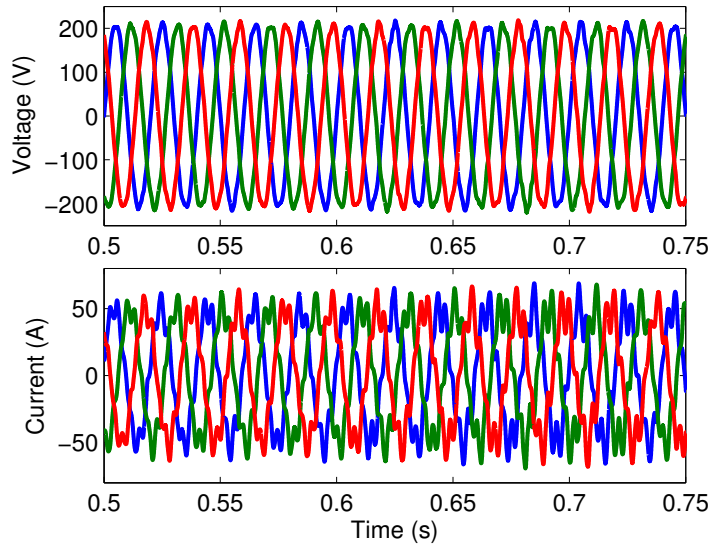

Fig. 7: Simulation results for +10 kW power reference to the VSC-A (Unstable case): The three-phase voltage and current at PCC of VSC-B.

can be seen in Fig. 7, the system has become unstable and the PCC voltage and current are polluted by different harmonic. An experiment has been carried out for the same set up and power reference. Fig. 8 shows the results from the experiment. The experimental result has confirmed that the system is unstable and has polluted by the different harmonic. Moreover, it cannot be continued the operation in the experiment since protection system has been tripped.

The system operates stably when the power flow direction is from the power controlled-converter to the dc voltage controlled-converter and becomes unstable when the power flow direction has been altered. To analyze the stability and find the causes of this instability, an impedance based-stability method is adopted. The next two Sections have presented the stability analysis of the system and the possible solution to overcome this instability.

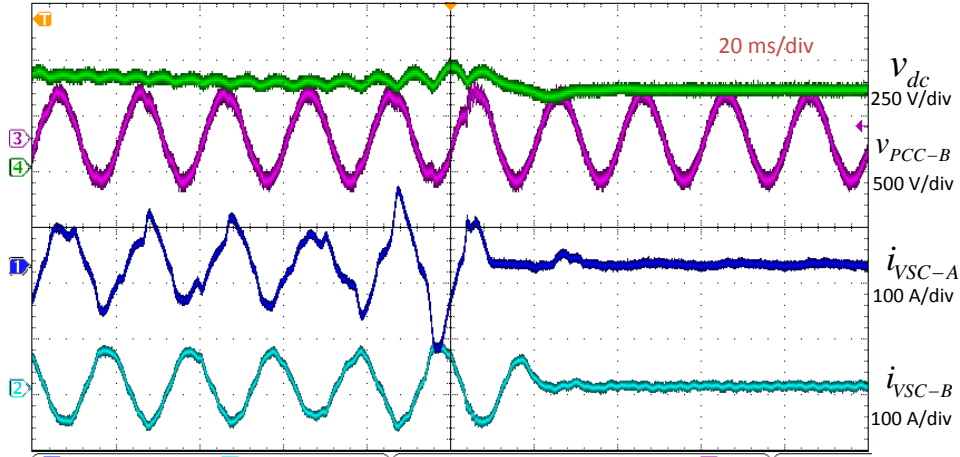

Fig. 8: Experimental results for +10 kW power reference to the VSC-A (Unstable case): dc link voltage, voltage at PCC of VSC (phase-a), current of VSC-A (phase-a) and VSC-B (phase-a).

IV. STABILITY ANALYSIS

A. Impedance Modeling and Verification

In order to apply the impedance-based stability method deriving the impedance model is prerequisite. The stability of the system is analyzed based on the dc impedance. A dc impedance model is derived for a switching model of the VSC including the PWM delay based on the method presented in [24]. The details impedance model derivation is described below.

The impedance model will be derived based on the analytical model of the VSC-HVDC system described in section II. Applying the small-signal deviation and Laplace transformation and let $\Delta v_{cv,dq} = \begin{pmatrix} \Delta v_{cvd} & \Delta v_{cvq} \end{pmatrix}^T$, $\Delta v_{o,dq} = \begin{pmatrix} \Delta v_{od} & \Delta v_{oq} \end{pmatrix}^T$ and $\Delta i_{L,dq} = \begin{pmatrix} \Delta i_{Ld} & \Delta i_{Lq} \end{pmatrix}^T$, Eqn. (1) can be written in matrix form by

$$\Delta v_{cv,dq} = \Delta v_{o,dq} + Z_c \Delta i_{L,dq} \quad (8)$$

where

$$Z_c = \begin{pmatrix} R_c + sL_c/\omega_b & -\omega_g L_c \\ \omega_g L_c & R_c + sL_c/\omega_b \end{pmatrix}.$$

Assume that the grid voltage v_g is stable and $\Delta v_{g,dq}=0$, Eqn. (3) gives the relation between $\Delta i_{o,dq}$ and $\Delta v_{o,dq}$ and can be given by

$$\Delta i_{o,dq} = Y_g \Delta v_{o,dq} \quad (9)$$

where

$$Y_g = \begin{pmatrix} R_g + sL_g/\omega_b & -\omega_g L_g \\ \omega_g L_g & R_g + sL_g/\omega_b \end{pmatrix}^{-1}$$

and $\Delta i_{o,dq} = \begin{pmatrix} \Delta i_{od} & \Delta i_{oq} \end{pmatrix}^T$. The relation between the PCC voltage, $\Delta v_{o,dq}$ and converter current, $\Delta i_{L,dq}$ can be found by applying Laplace transformation, linearization and inserting (9) into (2) and can be written by

$$\Delta v_{o,dq} = \overbrace{(Y_{Cf} + Y_g)^{-1}}^{\Omega_g} \Delta i_{L,dq} \quad (10)$$

where

$$Y_{Cf} = \begin{pmatrix} sC_f/\omega_b & -\omega_g C_f \\ \omega_g C & sC_f/\omega_b \end{pmatrix}.$$

Inserting (10) into (8) gives the relation between converter ac voltage, v_{cvdq} and ac current, i_{Ldq} and can be expressed by (11).

$$\Delta v_{cv,dq} = (\Omega_g + Z_0) \Delta i_{L,dq} \quad (11)$$

Throughout this paper, it is assumed that the PLL is operating satisfactory and we neglect the impacts of the PLL dynamics. Now applying small-signal deviation and neglecting the higher order term, (4) with small perturbations with $v_{cvdq,ref} = V_{dc,0}(v_{cvdq}/v_{dc})$ can be written by

$$G_{PWM} G_{cc} \Delta i_{dq,ref} = (Z_c + G_{PWM}(G_{cc} + G_{del})) \Delta i_{L,dq} - \begin{pmatrix} m_{d0} \\ m_{q0} \end{pmatrix} \Delta v_{dc} \quad (12)$$

where $m_{dq0} = V_{cvdq0}/V_{dc0}$ is the modulation index at a operating point and the PWM delay is modeled as

$$G_{PWM} = \frac{1}{1 + 1.5T_{sw}s}$$

where $T_{sw} = 1/f_{sw}$; f_{sw} is the switching frequency. If the converter is assumed to have only the current controller, $\Delta i_{Ldq,ref}$ will be zero.

By neglecting the losses due to switching, the power balance constraint between the dc and the ac side can be given by (13) and linearized equation of (13) is given by (14).

$$P = v_{dc} i_{dc} = i_{Ld} v_{cvd} + i_{Lq} v_{cvq} \quad (13)$$

$$\begin{pmatrix} I_{dc0} \\ V_{dc0} \end{pmatrix}^T \begin{pmatrix} \Delta v_{dc} \\ \Delta i_{dc} \end{pmatrix} = \begin{pmatrix} I_{Ld0} \\ I_{Lq0} \end{pmatrix}^T \Delta v_{cv,dq} + \begin{pmatrix} V_{cvd0} \\ V_{cvq0} \end{pmatrix}^T \Delta i_{Ldq} \quad (14)$$

The dc impedance of the converters can be calculated as $\Delta v_{dc}/\Delta i_{dc}$. In (14), the variables $\Delta v_{cv,dq}$ and Δi_{Ldq} are ac side quantities which implies that the derivation should involve both ac and dc side [34], therefore the ac side quantities have to be expressed in terms of the dc side quantities in order to get an expression of the dc impedance, $Z_{dc} = \Delta v_{dc}/\Delta i_{dc}$.

Equation (14) can be simplified by inserting (11) as

$$\begin{pmatrix} I_{dc0} \\ V_{dc0} \end{pmatrix}^T \begin{pmatrix} \Delta v_{dc} \\ \Delta i_{dc} \end{pmatrix} = \left(\begin{pmatrix} I_{Ld0} \\ I_{Lq0} \end{pmatrix}^T (\Omega_g + Z_c) + \begin{pmatrix} V_{cvd0} \\ V_{cvq0} \end{pmatrix}^T \right) \Delta i_{Ldq}. \quad (15)$$

To get the expression of the dc impedance, the ac quantity, Δi_{Ldq} of (15) have to be expressed with the dc quantity by the dc voltage or the dc current. The investigated HVDC system has the outer-loop active power control

in VSC-A and outer loop dc voltage control in VSC-B. Hence, it is necessary to find an expression of $\Delta i_{Ldq,ref}$ in terms of either Δi_{Ldq} or Δv_{dc} in (12) to include the impact of the outer-loop on the stability.

1) *Impedance model of the Power Controlled-Converter (VSC-A)*: The analytical modeling of the control of VSC-A is presented in section II and the impedance modeling of the VSC-A including the outer-loop is presented in the following subsection. The reference current, $\Delta i_{dq,refA}$ can be obtained in terms of Δi_{LdqA} by linearizing (5) and (6) and inserting (10) and rearranging (12), and can be given by

$$\Delta i_{Ldq,refA} = \overbrace{(-G_{iA} - G_{vA}\Omega_g)}^{G_A} \Delta i_{Ldq} \quad (16)$$

where

$$G_{vA} = H_P(s) \begin{pmatrix} V_{od0A} & V_{oq0A} \\ 0 & 0 \end{pmatrix}$$

$$G_{iA} = H_P(s) \begin{pmatrix} I_{Ld0A} & I_{Lq0A} \\ 0 & 0 \end{pmatrix}.$$

Inserting (16) into (12) and solving together with (15), the dc impedance of VSC-A is obtained as

$$Z_{dcA}(s) = \frac{\Delta v_{dcA}}{\Delta i_{dcA}} = \frac{-V_{dc0A}}{I_{dc0A} - \begin{pmatrix} I_{Ld0A} \\ I_{Lq0A} \end{pmatrix}^T (\Omega_g + Z_c) + \begin{pmatrix} V_{cvd0A} \\ V_{cvq0A} \end{pmatrix}^T G_{idcA}} \quad (17)$$

where

$$G_{idcA} = (Z_{cA} + G_{PWM}(G_{ccA} + G_{del}) - G_{PWM}G_{ccA}G_A)^{-1} \begin{pmatrix} m_{d0A} \\ m_{q0A} \end{pmatrix}.$$

2) *Impedance model of the dc voltage controlled-converter (VSC-B)*: The impedance model of the dc voltage controlled-converter is described in this subsection. The current reference, $\Delta i_{Ldq,refB}$ can be expressed in terms of the dc voltage by linearizing (7) and can be given by

$$\Delta i_{Ldq,refB} = \begin{pmatrix} H_{vdc}(s) \\ 0 \end{pmatrix} \Delta v_{dcB}. \quad (18)$$

Inserting (18) into (12) gives the relation between the dc voltage, Δv_{dcB} and ac currents Δi_{Ldq} . Now solving (12), (15) and (18) together and rearranging, the dc impedance model of VSC-B can be obtained and is given by

$$Z_{dcB}(s) = \frac{\Delta v_{dcB}}{\Delta i_{dcB}} = \frac{-V_{dc0B}}{I_{dc0B} - \begin{pmatrix} I_{Ld0B} \\ I_{Lq0B} \end{pmatrix}^T (\Omega_g + Z_c) + \begin{pmatrix} V_{cvd0B} \\ V_{cvq0B} \end{pmatrix}^T G_{idcB}} \quad (19)$$

where

$$G_{idcB} = (Z_{cB} + G_{PWM}(G_{ccB} + G_{del}))^{-1} \left(\begin{pmatrix} m_{d0B} \\ m_{q0B} \end{pmatrix} + G_{PWM}G_{ccB} \begin{pmatrix} H_{vdc}(s) \\ 0 \end{pmatrix} \right).$$

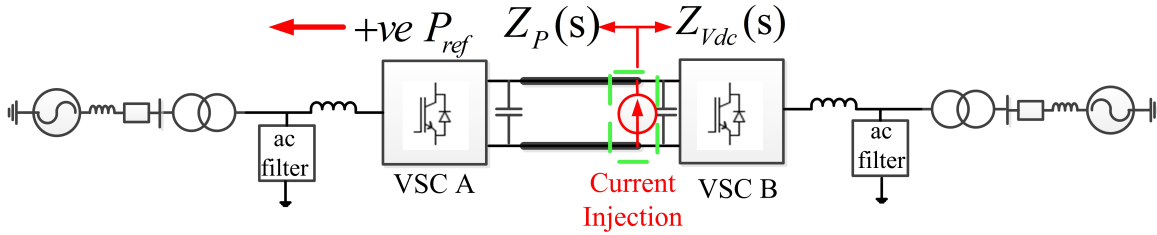

Fig. 9: Investigated point-to-point VSC-based HVDC system including current injection structure for impedance model verification

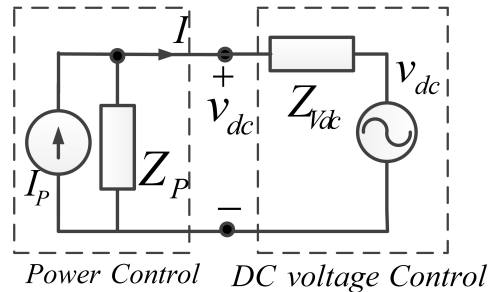

Fig. 10: Equivalent small-signal impedance model of VSC-HVDC system consisting of both the voltage source and the current source.

B. Stability Analysis based on the literature

The investigated two-terminal VSC-HVDC system including the shunt current injection structure for the impedance model verification is depicted in Fig. 9. For stability analysis, the equivalent small-signal impedance model of the VSC-HVDC system is shown in Fig. 10. The power controlled-converter subsystem including the dc-line impedance is modeled by its Norton equivalent circuit consisting of an ideal current source, I_P in parallel with equivalent impedance, $Z_P(s)$ while the dc voltage controlled-converter subsystem is modeled by its Thevenin equivalent circuit consisting of a voltage source with a series equivalent impedance, $Z_{Vdc}(s)$.

The current source impedance can be given by

$$Z_P(s) = \frac{Z_{dcA}(s)}{1 + sC_{dcA}Z_{dcA}(s)} + Z_{dc,cable}(s) \quad (20)$$

and the voltage source impedance is

$$Z_{Vdc}(s) = \frac{Z_{dcB}(s)}{1 + sC_{dcB}Z_{dcB}(s)}. \quad (21)$$

The analytical impedance model developed for the VSCs in (20) and (21) are validated by simulation with detailed switching model of the VSCs. A perturbation current (1% of rated dc steady-state current) at different frequency from 1 Hz to 1 kHz is injected as shown in Fig. 9 and the voltage is measured. The Fast Fourier Transformation (FFT) tool from the SimPower System is used to analyze the different frequency voltage and current, and the impedance is calculated by dividing the voltage by current at each frequency. The analytical and

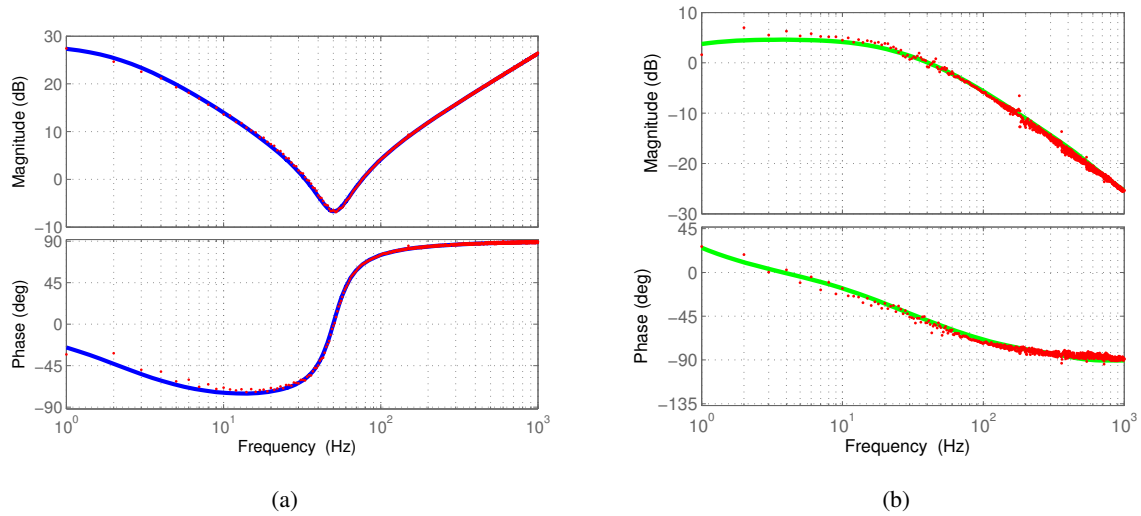

Fig. 11: Frequency response of the impedance: (a) the impedance of the current source subsystem and (b) the impedance of the voltage source subsystem (solid-line is from model prediction and the red-points are from detailed simulation).

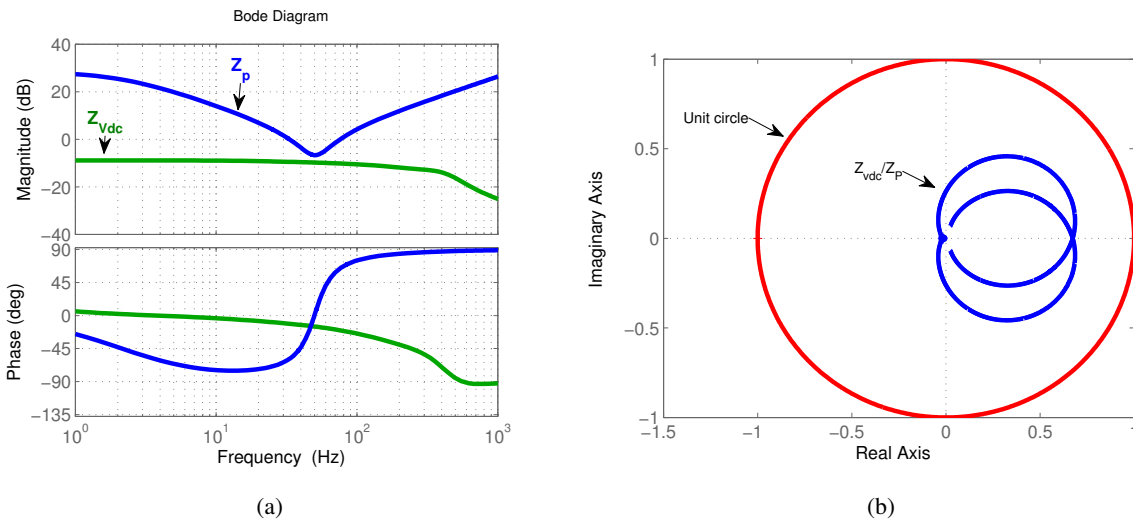

Fig. 12: Negative power reference: (a) Impedance frequency response of the voltage source and current source subsystem and (b) the Nyquist plot of the impedance ratio ($Z_{Vdc}(s)/Z_P(s)$).

simulation impedance is shown in Fig. 11 and the electrical circuit parameters of this system are given in Table I in Appendix. The solid-line is the analytical impedance and the red-points show the results from detailed simulation. Both analytical and simulation impedance magnitude and phase have good agreement which validates correctness of the impedance model derivation.

The equivalent small-signal impedance model of the VSC-HVDC shown in Fig. 10 is a hybrid system consisting

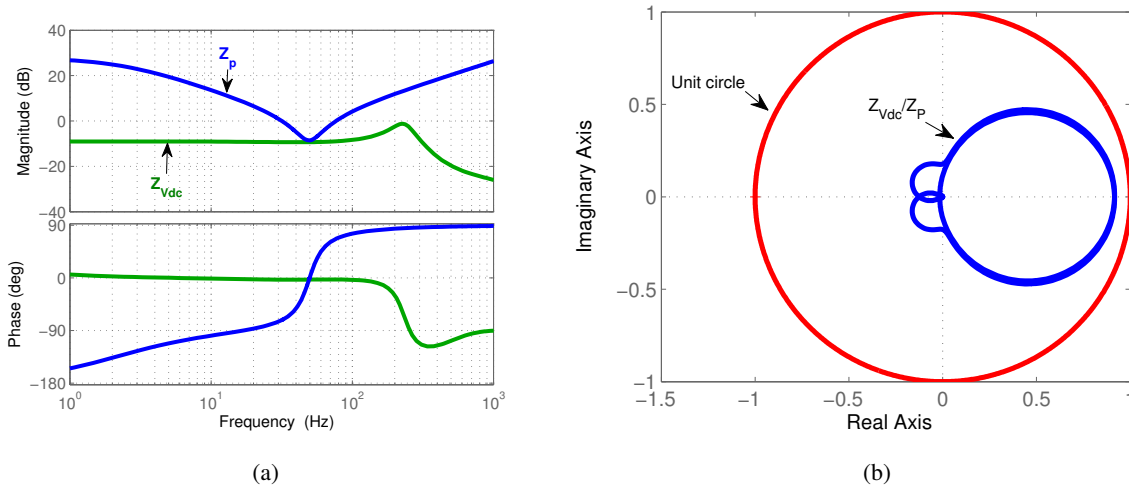

Fig. 13: Positive power reference: (a) Impedance frequency response of the voltage source and current source subsystem and (b) the Nyquist plot of the impedance ratio ($Z_{Vdc}(s)/Z_P(s)$).

of both a voltage source and a current source. Therefore, the dc voltage at interconnection of Fig. 10 can be given by

$$v(s) = (v_{dc}(s) + i_P(s)Z_{vdc}(s)) \frac{1}{1 + \frac{Z_{Vdc}(s)}{Z_P(s)}} \quad (22)$$

where the second part of the equation resembles a closed loop transfer function and the stability of the system can be determined by checking the Nyquist plot of the voltage source to the current source impedance ratio regardless of the current source behaves as a source or a sink. Moreover, this criteria indicates that a point-to-point connection VSC-HVDC system should be designed to have high output impedance as possible in the current source subsystem and low input impedance in the voltage source in order to operate stable under a wide range of frequencies.

Fig. 12 (a) shows the impedance frequency response of the voltage source and the current source subsystem for the negative power reference of the power controlled-converter. As can be seen, the impedance of the current source subsystem, ($Z_P(s)$) is higher than the impedance of the voltage source subsystem, ($Z_{Vdc}(s)$) at all frequencies which is desirable to have the stable system. Fig. 12 (b) shows the Nyquist plot of the impedance ratio. Since the magnitude of the $Z_P(s)$ is higher than the magnitude of the $Z_{Vdc}(s)$ at all frequencies, the Nyquist plot stays inside the unit circle and it never encircles the point $(-1, j0)$; therefore the system is stable for the negative power reference. The system is found to be stable in time domain simulation and in the experiment.

Since the impedance also depends on the steady-state operating point, the impedance is calculated for the +10 kW power reference to VSC-A (which is the new operating point). Fig. 13 (a) shows the impedance frequency response for the positive (+10 kW) power reference. As can be seen in Fig. 13 (a), the impedance of the current source subsystem, ($Z_P(s)$) is higher than the impedance of the voltage source subsystem, ($Z_{Vdc}(s)$) at all frequencies, therefore, the Nyquist plot of the impedance ratio stays inside the unit circle and it never encircles the point $(-1,$

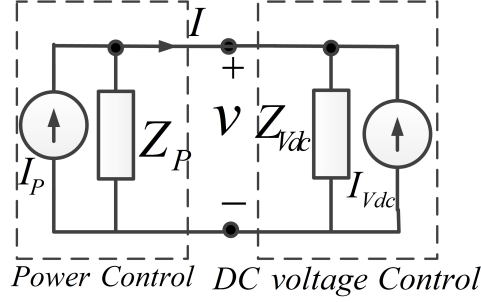

Fig. 14: Equivalent small-signal impedance model of VSC-HVDC system: current source equivalent model.

$j0$) as shown in Fig. 13 (b). Therefore, the system is predicted to be stable from frequency domain analysis by the existing impedance based stability method; however, the system is found to be unstable in the time domain simulation and the experiments. Therefore, existing method can not determine the stability of the system when the power flow direction has been altered.

V. PROPOSED STABILITY ANALYSIS METHOD

In previous section it has been observed that the existing impedance-based method can not determine the stability of the system when the power flow direction has been altered. Therefore, to overcome this limitation in this paper an impedance-based stability method is proposed where the subsystems are represented by only a Norton equivalent current source instead of representing them by a hybrid system consisting of both a voltage source and a current source. This assumption is valid, since the voltage controlled-subsystem can be represented by its Norton equivalent current-source with parallel connected impedance [20]. The modified equivalent small-signal impedance-model of the two-terminal HVDC system is shown in Fig. 14.

Now we assume that the power reference of the power controlled-converter, VSC-A is negative, this means that VSC-A injects power into the dc system and works as a current source and the dc voltage controlled-converter, VSC-B operates as an inverter and extracts active power from the dc system. Therefore, VSC-A is operates as a current source while VSC-B is a current sink or load. For this condition, the current, $I(s)$ at interconnection in Fig. 14 can be given by

$$I(s) = \left(I_P(s) - I_V(s) \frac{Z_{Vdc}(s)}{Z_P(s)} \right) \frac{1}{1 + \frac{Z_{Vdc}(s)}{Z_P(s)}}. \quad (23)$$

Note that the second part of (23) resembles the close-loop transfer function of a negative feedback control system with a forward gain of unity and the feedback gain is $Z_{Vdc}(s)/Z_P(s)$. Hence based on (23), the HVDC system will operate stably if the ratio of the dc voltage controlled-converter impedance to the power controlled-converter impedance, $Z_{Vdc}(s)/Z_P(s)$ satisfies the Nyquist Stability Criteria. Fig. 12 shows the impedance frequency response and the Nyquist plot of the impedance ratio for the negative power reference and the system is predicted to be stable. The system operates stably in the time domain simulation and the experiments as shown in Fig. 5 and 6, respectively.

Now the reference power of VSC-A is set to +10 kW, this means that VSC-A is extracting power from the dc system and working as a current sink or load, while VSC-B is working as a current source. In that case, the current $I(s)$ at interconnection can be given by

$$I(s) = \left(I_V(s) - I_P(s) \frac{Z_P(s)}{Z_{Vdc}(s)} \right) \frac{1}{1 + \frac{Z_P(s)}{Z_{Vdc}(s)}}. \quad (24)$$

Therefore, based on (24) the stability of the HVDC system depends on the impedance ratio of the input impedance of the power controlled-subsystem to the output impedance of the dc voltage controlled-subsystem, $Z_P(s)/Z_{Vdc}(s)$ which is the inverse of the previous assumption of (23). The system operates stably if $Z_P(s)/Z_{Vdc}(s)$ satisfies the Nyquist Stability Criteria.

Fig. 15 shows the Nyquist plot of the impedance ratio, $Z_P(s)/Z_{Vdc}(s)$ for the positive power reference of VSC-A. As can be seen in Fig. 13, the magnitude of the $Z_P(s)$ is higher than the magnitude of the $Z_{Vdc}(s)$ and the Nyquist plot of $Z_P(s)/Z_{Vdc}(s)$ (Fig. 15) does not cross the unit circle; however it encircles the point $(-1, j0)$, hence the system is predicted to be unstable. Therefore, the system has become unstable in the simulation and experiments as shown in Fig. 7 and 8, respectively.

Eqn. (24) indicates that the system stability can be improved by increasing the magnitude of $Z_{Vdc}(s)$ which can be done by modifying the converter passive components and the controller bandwidth. It is not a feasible way to modify the passive components instead it is better to modify the controller gain. Hence, the voltage controller gain is re-tuned at $H_{Vdc}(s) = 1 + 3/s$ and the close-loop crossover frequency is 7.2 Hz with 172 degree phase margin. Fig. 16 shows the impedance frequency response of the subsystems for the negative power reference. The impedance magnitude crosses each other at frequency of 30.6 Hz and 65.8 Hz with a phase margin of 160° and 66.5° , respectively. Fig. 17 depicts the Nyquist plot of impedance ratio, $Z_{Vdc}(s)/Z_P(s)$. As can be seen in Fig. 17 (a), the Nyquist plot does not encircle the point $(-1, j0)$. Therefore, it has been predicted that the system operates

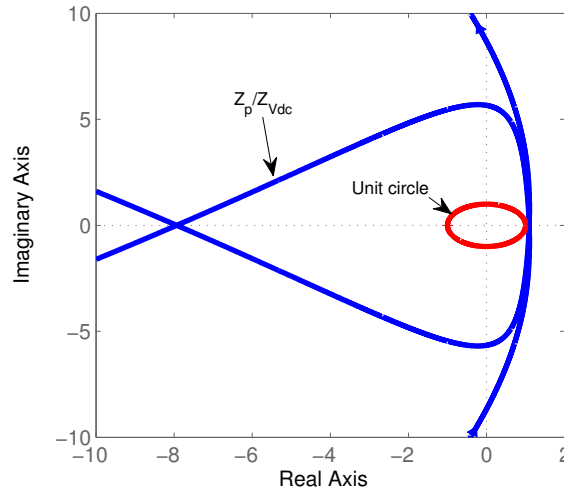

Fig. 15: Nyquist plot of impedance ratio, $Z_P(s)/Z_{Vdc}(s)$.

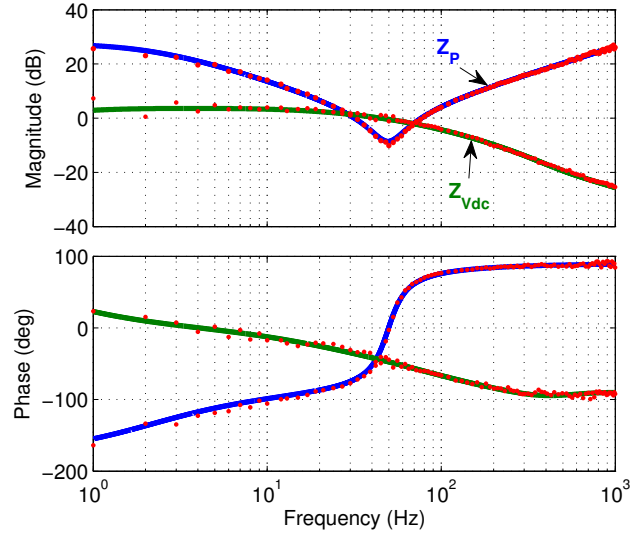

Fig. 16: Frequency response of the impedance model at interfacing point for modified control tuning (the solid-line is from model prediction and the red-points are from detailed simulation).

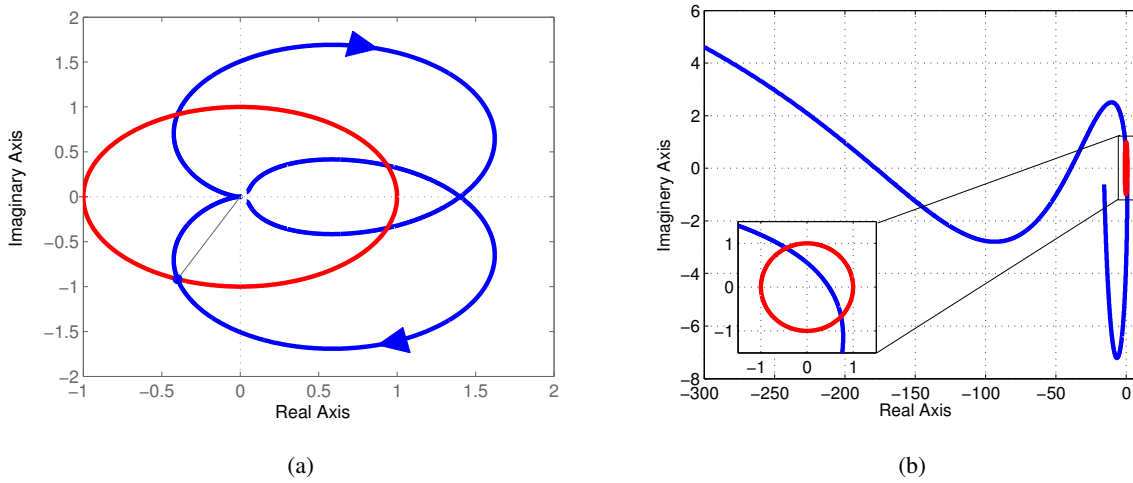

Fig. 17: Nyquist plot of impedance ratio for modified control tuning: (a) Negative power reference: $Z_{Vdc}(s)/Z_P(s)$ and (b) Positive power reference: $Z_P(s)/Z_{Vdc}(s)$.

stably for the negative power reference. Now stability analysis is performed for the positive power reference, and the resulting Nyquist plot of the impedance ratio, $Z_P(s)/Z_{Vdc}(s)$ is shown in Fig. 17 (b) and the Nyquist plot predicts that the system will operate stably. The system is predicted to be stable for both directions of the power flow.

A time domain simulation has been carried out for a step of active power reference from -10 kW to +10 kW and the resulting time domain simulation is shown in Fig. 18. The system operates stably for both direction of power

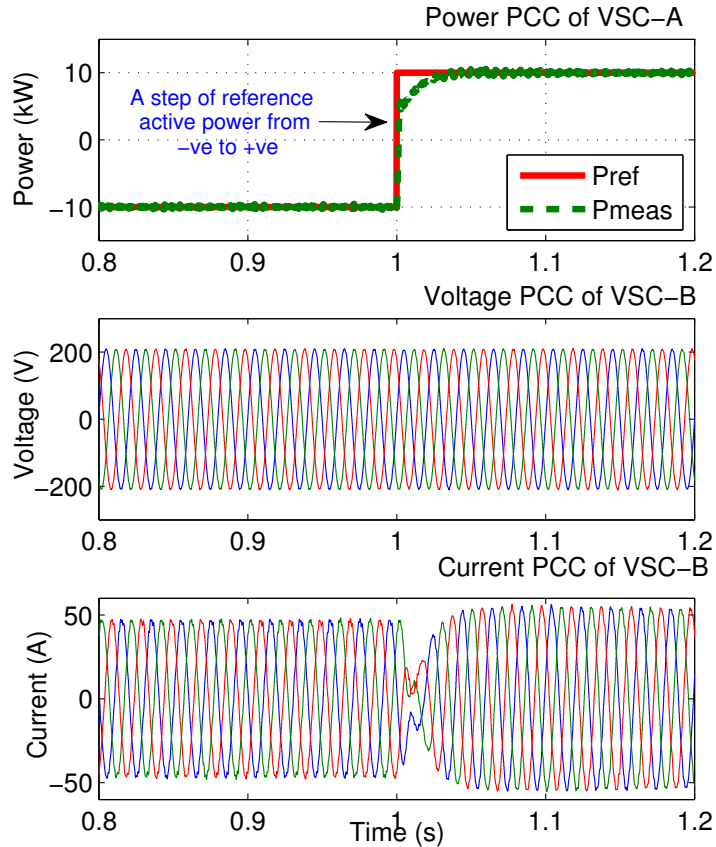

Fig. 18: Simulation results for a step change of power reference from negative to positive 10 kW.

flow which is further confirmed in the experiments. Both the simulation and the experiments have validated the theoretical analysis.

Moreover, the impact of the controller dynamics on the stability has been investigated to further validate the effectiveness of the dc impedance-based method. The proportional gain of the dc voltage controller further reduces to 0.03 with the close-loop crossover frequency of 7.13 Hz and 148 degree phase margin. The impedance frequency response and the Nyquist plot for this tuning is shown in Fig. 19. As can be seen in Fig. 19 (a), the dc voltage controlled-subsystem impedance becomes larger at low frequency for lower value of proportional gain and it crosses the unit circle at frequency of 2.96 Hz with low phase margin (20°) as shown in Fig. 19 (b). Since Nyquist plot does not encircle the point $(-1, j0)$, the system is stable. However, the phase margin is low, the system would have a low frequency oscillation at around 2.96 Hz in transient condition. A time domain simulation has been carried out and the time domain response of the dc voltage and the current and FFT of the dc current are shown in Fig. 20 (a). As can be seen, the system has a stable pole with oscillation frequency around 3 Hz as predicted in the frequency domain analysis by the Nyquist plot in Fig. 19 (b). This oscillation is also observed in the ac side as shown in Fig. 20 (b) which is reflected by 50 Hz fundamental frequency, f_1 as $\pm(f - f_1)$ [26].

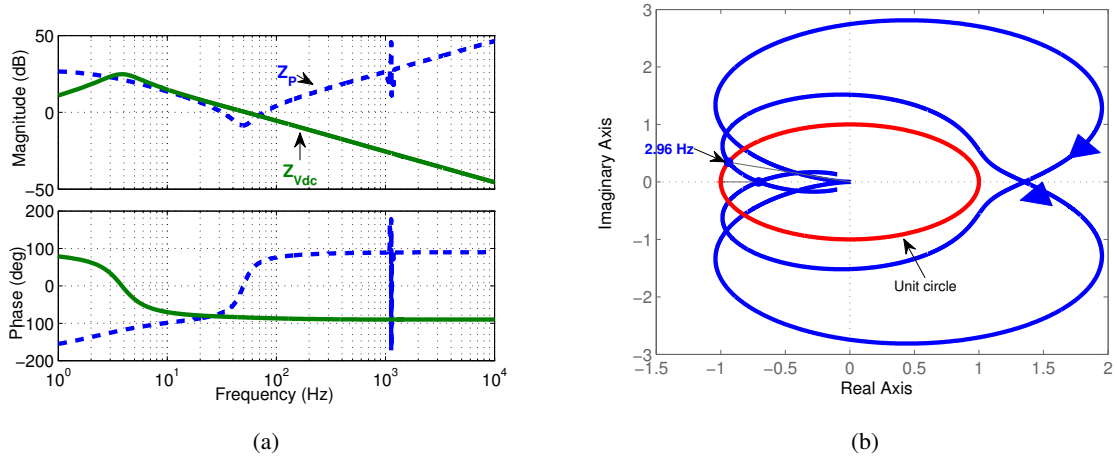

Fig. 19: (a) Impedance of the subsystem for dc voltage control proportional gain of 0.03 and (b) Nyquist plot of impedance ratio, $Z_{Vdc}(s)/Z_P(s)$.

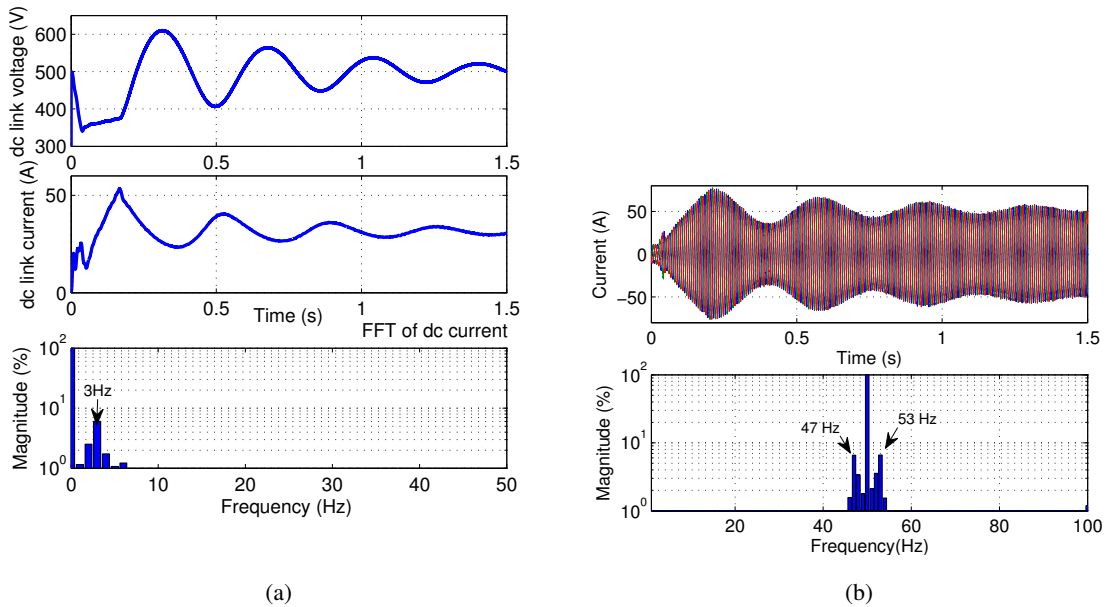

Fig. 20: Simulation results: (a) The dc link voltage and current and FFT of dc current for dc voltage controller proportional gain of 0.03, (b) The three-phase current at PCC of VSC-B for dc voltage controller proportional gain of 0.03.

An example case is also presented to show the impact of the power controller dynamics on the system stability. The power controller proportional gain is purposely increased to 2×0.005 and the close-loop cross-over frequency is 27 Hz and 116 degree phase margin. The corresponding impedance frequency response defined in (20) is shown in Fig. 21. As can be seen, the increased gain does not have significant impact on the impedance frequency response.

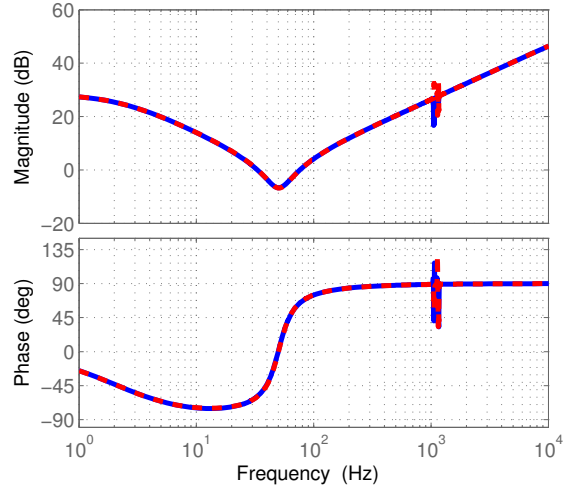

Fig. 21: Impedance frequency response for different value of proportional gain of power controller (Solid-blue line is for $k_{pp} = 0.005$ and red-dash line is for $k_{pp} = 2 \times 0.005$).

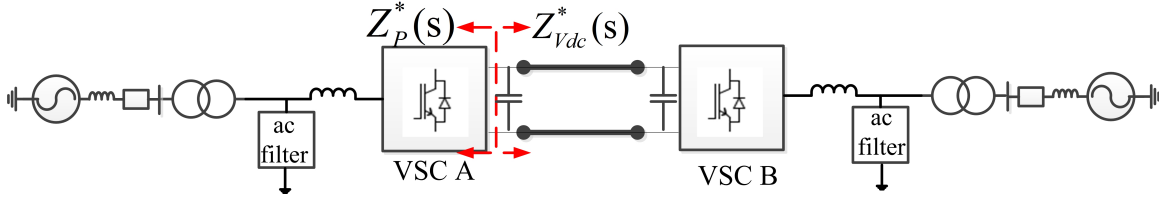

Fig. 22: Point-to-point VSC-based HVDC system to study the impact of power controller dynamics.

It is because the dc link capacitance and the dc line inductance are together behaving as a low pass filter and the high frequency oscillations has been filtered by this low pass filter. Therefore, it cannot predict the instability which results the high frequency oscillation from the source and load impedance defined at the interfacing point of Fig. 9. In order to determine instability caused by the power controller dynamics, the impedance-based analysis needs to be performed at the interfacing point as shown in Fig. 22 where the subsystem impedances are defined as

$$Z_P^*(s) = Z_{dcA}(s) \quad (25)$$

$$Z_{Vdc}^*(s) = \frac{1}{sC_{dcA}} \parallel \left(Z_{dc,cable}(s) + \frac{Z_{dcB}(s)}{1 + sC_{dcB}Z_{dcB}(s)} \right). \quad (26)$$

The system is represented by the small-signal equivalent impedance model as depicted in Fig. 14 and the stability is predicted by the GNC. The Nyquist plot of $Z_{Vdc}^*(s)/Z_P^*(s)$ is shown Fig. 23 for two different values of proportional gain of power controller. As can be seen in Fig. 23, the system is stable for $k_{pp} = 0.005$ and unstable for $k_{pp} = 2 \times 0.005$. A time domain simulation has been carried out to verify the theoretical analysis and the resulting time domain response is shown in Fig. 24. The proportional gain of the power control has been increased at 0.5 s. As can be seen in Fig. 24, the system operates stably for $k_{pp} = 0.005$ and it introduces harmonic instability for

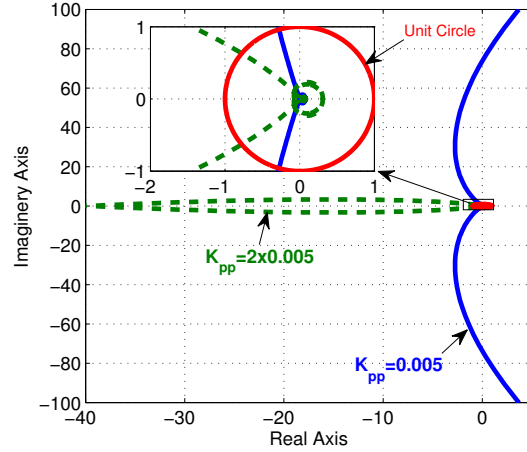

Fig. 23: Nyquist plot of impedance ratio, $Z_{V_{dc}}^*(s)/Z_P^*(s)$ (blue line is for $k_{pp} = 0.005$ and green-dash line is for $k_{pp} = 2x0.005$).

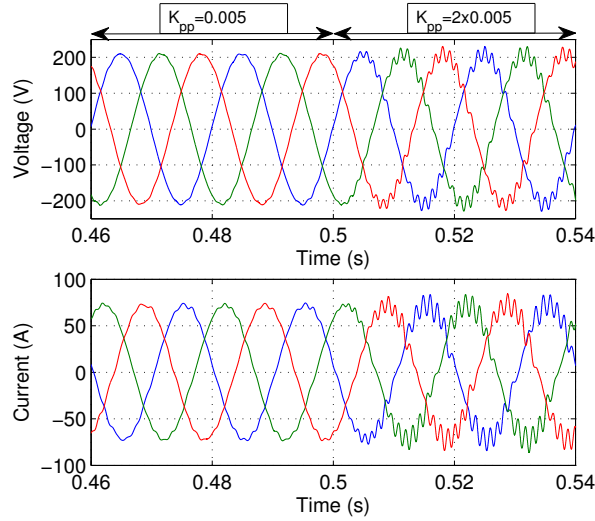

Fig. 24: The three-phase voltage and current at PCC of VSC-A for a change of the power controller proportional gain from 0.005 to $2x0.005$ at 0.5 s.

$k_{pp} = 2x0.005$ at 0.5 s. The simulation result is further verified in the experiment. The experimental results are shown in Fig. 25. As can be seen, the system has been polluted by the harmonic oscillation. Both the simulation and experiment results have the harmonic oscillation which has been predicted from the Nyquist plot of impedance ratio as shown in Fig. 23.

A weakness of the dc impedance based method is that it cannot determine the instability that results for a weak network, because variation of the ac grid impedance does not reflect significantly on the dc impedance [34]. Therefore, the dc impedance-based analysis is used to analyze the stability in the dc side. On the other hand, the ac impedance based analysis cannot determine the instability caused by the dc line dynamics, since we calculate the ac

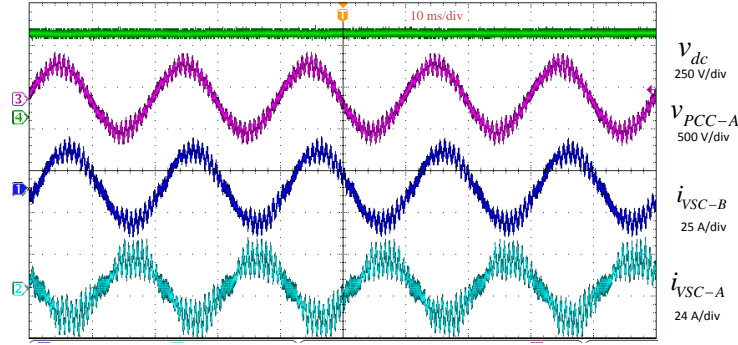

Fig. 25: Experimental results for power controller proportional gain of 2×0.005 : (i) dc link voltage, (ii) voltage at PCC of VSC-A (phase-a), current of (iii) VSC-B (phase-a) and (iv) VSC-A (phase-a).

impedance assuming the dc side a constant voltage source because of large dc link capacitor. Therefore to determine the instability resulting for the weak grid/network, the stability analysis should be performed in the ac side based on the ac impedance either in positive-negative sequence impedance [25], [26] or the d-q frame impedance [27]-[29].

VI. CONCLUSION

This paper has presented the impact of the power flow direction on the stability for a two-terminal VSC-HVDC system. It has been observed that the system operates stably when the power flow direction is from the power controlled-converter to the dc voltage controlled-converter and it becomes unstable when the power flow direction has been altered. To overcome this problem an impedance based method is proposed. Existing method of determining the source and the load impedances cannot predict the stability when the power flow direction has been altered; therefore a method based on the power flow direction has been presented to determine the source and the load impedance. The converter which is injecting power to the dc system is the current source represented with its Norton equivalent parallel impedance while the other converter impedance is considered as the load impedance. The stability of the system has been determined by the ratio of the load impedance to the current source impedance. Once the source and the load impedance are analytically obtained, the impedance-based Generalized Nyquist Stability Criteria has been applied to predict the stability of the interconnected system. The control has been redesigned based on the proposed method such that the power flows both directions without changing the control between the converters. The system stability for the two power flow directions is well predicted from the Nyquist plot of impedance ratio. A two terminal HVDC system has been developed in MATLAB/Simulink to demonstrate the application of this method and the results have been compared with the experimental results.

APPENDIX

TABLE I: The investigated system parameters

Parameter	Value	Parameter	Value
Rated Power, S_b	150 kVA	L_c	2.1 mH
Rated ac voltage	380 V	R_c	0.01 Ω
Rated frequency	50 Hz	C_f	50 μ F
Trans. inductance	0.04 pu	V_{dc}	500 V
Trans. resistance	0.005 pu	L_{dc}	1.66 mH
Grid inductance	0.1 pu	R_{dc}	0.2 Ω
Grid resistance	0.0229 pu	C_{dc}	3 mF

REFERENCES

- [1] Flourentzou, N.; Agelidis, V.G.; Demetriades, G.D., "VSC-Based HVDC Power Transmission Systems: An Overview," in Power Electronics, IEEE Transactions on , vol.24, no.3, pp.592-602, March 2009
- [2] Bahrman, M.P.; Johnson, B.K., "The ABCs of HVDC transmission technologies," Power and Energy Magazine, IEEE , vol.5, no.2, pp.32,44, March-April 2007
- [3] Beerten, J.; Cole, S.; Belmans, R., "Modeling of Multi-Terminal VSC HVDC Systems With Distributed DC Voltage Control," in Power Systems, IEEE Transactions on, vol.29, no.1, pp.34,42, Jan. 2014
- [4] M. Guan and Z. Xu, "Modeling and Control of a Modular Multilevel Converter-Based HVDC System Under Unbalanced Grid Conditions," in IEEE Transactions on Power Electronics, vol. 27, no. 12, pp. 4858-4867, Dec. 2012.
- [5] L. Shen; M. Barnes; R. Preece; j. milanovic; K. Bell; M. Belivanis, "The Effect of VSC HVDC Control and Operating Condition on Dynamic Behavior of Integrated AC/DC System," in IEEE Transactions on Power Delivery , vol.PP, no.99, pp.1-1, 2016
- [6] S. Li, T. A. Haskew and L. Xu, "Control of HVDC Light System Using Conventional and Direct Current Vector Control Approaches," in IEEE Transactions on Power Electronics, vol. 25, no. 12, pp. 3106-3118, Dec. 2010.
- [7] G. Liu; F. Xu; Z. Xu; Z. Zhang; G. Tang, "Assembly HVDC Breaker for HVDC Grids with Modular Multilevel Converters," in IEEE Transactions on Power Electronics , vol.PP, no.99, pp.1-1, 2016
- [8] G. Stamatiou; M. Bongiorno, "Stability Analysis of Two-Terminal VSC-HVDC Systems using the Net-Damping Criterion," in IEEE Transactions on Power Delivery , vol.PP, no.99, pp.1-1, 2016
- [9] Minyuan Guan; Zheng Xu, "Modeling and Control of a Modular Multilevel Converter-Based HVDC System Under Unbalanced Grid Conditions," in Power Electronics, IEEE Transactions on , vol.27, no.12, pp.4858-4867, Dec. 2012
- [10] C. Karawita and U. D. Annakkage, Multi-Infeed HVDC Interaction Studies Using Small-Signal Stability Assessment, in IEEE Transactions on Power Delivery, vol. 24, no. 2, April 2009, pp. 910918, 2009
- [11] S. Cole, J. Beerten, R. Belmans, "Generalized Dynamic VSC MTDC Model for Power System Stability Studies," in IEEE Transactions on Power Systems, vol.25, no.3, August 2010, pp.1655-1662
- [12] M. K. Zadeh, M. Amin, J. A. Suul, M. Molinas, O. B. Fosso, Small-Signal Stability Study of the Cigr DC Grid Test System with Analysis of Participation Factors and Parameter Sensitivity of Oscillatory Modes, PSCC 2014, August 18-22, 2014, Poland
- [13] Kalcon, G.O.; Adam, G.P.; Anaya-Lara, O.; Lo, S.; Uhlen, K., "Small-Signal Stability Analysis of Multi-Terminal VSC-Based DC Transmission Systems," in Power Systems, IEEE Transactions on , vol.27, no.4, pp.1818-1830, Nov. 2012
- [14] M. Amin, J. A. Suul, S. DArco, E. Tedeschi, M. Molinas,"Impact of state-space modelling fidelity on the small-signal dynamics of VSC-HVDC systems" 11th IET ACDC 2015, Birmingham, UK
- [15] Y. Song and C. Breitholtz, "Nyquist Stability Analysis of an AC-Grid Connected VSC-HVDC System Using a Distributed Parameter DC Cable Model," in IEEE Transactions on Power Delivery, vol. 31, no. 2, pp. 898-907, April 2016.

- [16] G. Pinares and M. Bongiorno, "Modeling and Analysis of VSC-Based HVDC Systems for DC Network Stability Studies," in *IEEE Transactions on Power Delivery*, vol. 31, no. 2, pp. 848-856, April 2016.
- [17] J. Beerten, S. D'Arco and J. A. Suul, "Identification and Small-Signal Analysis of Interaction Modes in VSC MTDC Systems," in *IEEE Transactions on Power Delivery*, vol. 31, no. 2, pp. 888-897, April 2016.
- [18] M. Amin, M. K. Zadeh, J. A. Suul, E. Tedeschi, M. Molinas, O. B. Fosso, Stability analysis of interconnected AC power systems with multi-terminal DC grids based on the Cigr DC grid test system, 3rd IET RPG 2014, September 25-25, 2014, Naples, Italy
- [19] R. D. Middlebrook, Input filter considerations in design and application of switching regulators, in *Rec.1976 IEEE Ind. Appl. Soc. Annu. Meeting*, pp. 366382.
- [20] Jian Sun, "Impedance-Based Stability Criterion for Grid-Connected Inverters," *Power Electronics, IEEE Transactions on* , vol.26, no.11, pp.3075,3078, Nov. 2011
- [21] Cespedes, M.; Lei Xing; Jian Sun, "Constant-Power Load System Stabilization by Passive Damping," in *Power Electronics, IEEE Transactions on* , vol.26, no.7, pp.1832-1836, July 2011
- [22] H. Liu, S. Shah and J. Sun, "An impedance-based approach to HVDC system stability analysis and control development," *2014 International Power Electronics Conference (IPEC-Hiroshima 2014 - ECCE ASIA), Hiroshima, 2014*, pp. 967-974.
- [23] J. Lyu, X. Cai and M. Molinas, "Frequency Domain Stability Analysis of MMC-Based HVdc for Wind Farm Integration," in *IEEE Journal of Emerging and Selected Topics in Power Electronics*, vol. 4, no. 1, pp. 141-151, March 2016.
- [24] Amin, M.; Molinas, M., "Impedance based stability analysis of VSC-based HVDC system," in *PowerTech, 2015 IEEE Eindhoven* , vol., no., pp.1-6, June 29 2015-July 2 2015
- [25] Hanchao Liu; Jian Sun, "Voltage Stability and Control of Offshore Wind Farms With AC Collection and HVDC Transmission," in *Emerging and Selected Topics in Power Electronics, IEEE Journal of* , vol.2, no.4, pp.1181-1189, Dec. 2014
- [26] Cespedes, M.; Jian Sun, "Impedance Modeling and Analysis of Grid-Connected Voltage-Source Converters," in *Power Electronics, IEEE Transactions on* , vol.29, no.3, pp.1254-1261, March 2014
- [27] Bo Wen; Dong Dong; Boroyevich, D.; Burgos, R.; Mattavelli, P.; Zhiyu Shen, "Impedance-Based Analysis of Grid-Synchronization Stability for Three-Phase Paralleled Converters," in *Power Electronics, IEEE Transactions on* , vol.31, no.1, pp.26-38, Jan. 2016
- [28] B. Wen; D. Boroyevich; R. Burgos; P. Mattavelli; Z. Shen, "Inverse Nyquist Stability Criterion for Grid-Tied Inverters," in *IEEE Transactions on Power Electronics* , vol. PP, no.99, pp.1-1, 2016
- [29] Bo. Wen, D. Boroyevich, R. Burgos, P. Mattavelli, and Z. Shen, Analysis of D-Q small-signal impedance of grid-tied inverters, *IEEE Trans. Power Electronics*, vol. 31, no. 1, pp. 675-687, January 2016.
- [30] S. Lissandron, L. Dalla Santa, P. Mattavelli and B. Wen, "Experimental Validation for Impedance-Based Small-Signal Stability Analysis of Single-Phase Interconnected Power Systems With Grid-Feeding Inverters," in *IEEE Journal of Emerging and Selected Topics in Power Electronics*, vol. 4, no. 1, pp. 103-115, March 2016.
- [31] Bo Wen; Boroyevich, D.; Burgos, R.; Mattavelli, P.; Shen, Z., "Small-Signal Stability Analysis of Three-Phase AC Systems in the Presence of Constant Power Loads Based on Measured d-q Frame Impedances," in *Power Electronics, IEEE Transactions on* , vol.30, no.10, pp.5952-5963, Oct. 2015
- [32] Ling Xu; Lingling Fan, "Impedance-Based Resonance Analysis in a VSC-HVDC System," *Power Delivery, IEEE Transactions on* , vol.28, no.4, pp.2209,2216, Oct. 2013
- [33] Xiongfei Wang; Blaabjerg, F.; Weimin Wu, "Modeling and Analysis of Harmonic Stability in an AC Power-Electronics-Based Power System," *Power Electronics, IEEE Trans. on* , vol.29, no.12, Dec. 2014
- [34] Ling Xu; Lingling Fan; Zhixin Miao, "DC Impedance-Model-Based Resonance Analysis of a VSCHVDC System," in *Power Delivery, IEEE Transactions on* , vol.30, no.3, pp.1221-1230, June 2015
- [35] J. Sun, "Autonomous Local Control and Stability Analysis of Multiterminal DC Systems," in *IEEE Journal of Emerging and Selected Topics in Power Electronics*, vol. 3, no. 4, pp. 1078-1089, Dec. 2015.
- [36] Blasko, V.; Kaura, V., "A new mathematical model and control of a three-phase AC-DC voltage source converter," *Power Electronics, IEEE Transactions on* , vol.12, no.1, pp.116,123, Jan 1997
- [37] Kroutikova, N.; Hernandez-Aramburo, C.A.; Green, T.C., "State-space model of grid-connected inverters under current control mode," *Electric Power Applications, IET* , vol.1, no.3, pp.329,338, May 2007