

1 Durability evaluation of adhesive tapes for buildings applications

2 Selamawit Mamo Fufa^{a*}, Nathalie Labonnote^b, Susanne Frank^b, Petra R  ther^b and Bj  rn Petter Jelleb^{b,c}

3

4 ^a SINTEF Building and Infrastructure, NO-0373 Oslo, Norway.

5 ^b SINTEF Building and Infrastructure, NO-7465 Trondheim, Norway.

6 ^c Norwegian University of Science and Technology (NTNU), NO-7491 Trondheim, Norway.

7 * Corresponding author: selamawitmamo.fufa@sintef.no (e-mail).

8

9 **Abstract**

10 In the building sector, various adhesive materials are experiencing an increased usage for sealing of
11 overlaps and joints between most commonly used building materials, around penetrations, pipes
12 and windows for increasing the moisture and airtightness of buildings. Among the adhesive materials
13 are adhesive tapes that are used to ensure adequate air tightness of a building and thus must be able to
14 withstand severe environmental conditions without significant long-term deterioration. Durability test
15 methods are needed to evaluate whether the tapes fulfill their performance requirements for the service
16 life of the whole building. However, there is a lack of reliable test methods and evaluation procedures
17 for tapes used for building applications. This study was performed to evaluate tape durability testing
18 and evaluation methods, which hence form a basis for further improvements of the existing methods.

19 **Keywords:** Air tightness; Accelerated ageing; Building; Durability; Digital image correlation; Joint;
20 Adhesive; Tape

21

22 **1. Introduction**

23 Adhesive materials, mainly tapes, and sealants, are becoming increasingly popular for maintaining
24 and/or increasing the moisture and air-tightness of buildings [1]. These products are used to seal joints
25 and overlaps in the wind- and vapour barrier layers, to repair damages, and to tighten ducts (see Figure
26 1). One benefit is the practical application of adhesive joints, which is simple and quick compared to
27 mechanical tightening solutions. Most importantly, the application of adhesive tapes is essential in
28 order to meet increased airtightness requirements. Both the air tightness of the wind barrier layer on
29 the outside and the vapour barrier on the inside of the building play indeed a major role for the energy

30 efficiency of state of the art buildings. For example, in Norway, since January 2017, the requirement
31 in the Norwegian building regulation (TEK 10) for the infiltration rate at 50 Pa is set to 0.6 h^{-1} for
32 residential buildings, and 1.5 h^{-1} for apartment buildings [2]. Compared to the previous regulation, the
33 current required infiltration rate for residential buildings corresponds to about 25% of the original
34 requirement. Hence, adhesive joints have a double role: they ensure both energy efficiency and
35 protection of the building (e.g. avoiding moisture damages).

36

37 Adhesive tapes should adhere satisfactorily to the surfaces of end use materials, they should remain
38 unaffected by temperature extremes and the presence of moisture and they should tolerate surface
39 contaminants. As adhesive tapes are concealed in the building envelope and hence less accessible,
40 they need to maintain their sealing function for the intended service life of the envelope (e.g. 50 years,
41 100 years or longer). The influence of cyclic and climate exposure conditions such as temperature,
42 liquid water and humidity on durability of adhesive tapes used in the building industry is obvious. It is
43 important to identify the adequate properties with their corresponding requirements for specially
44 formulated and targeted adhesive tapes which are able to withstand these exposure conditions and thus
45 are suitable for their intended applications.

46

47

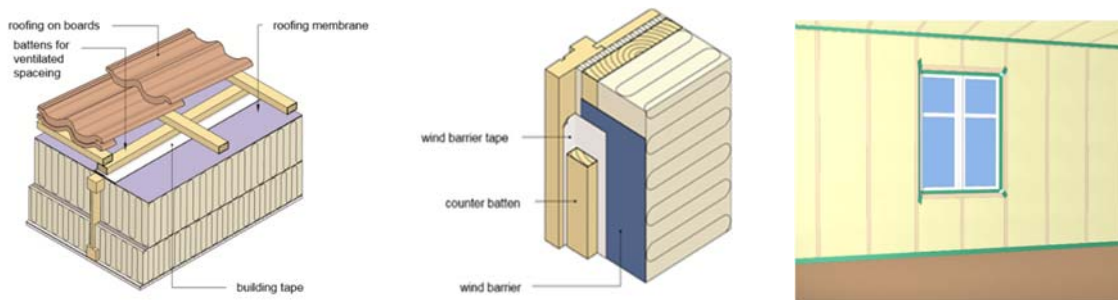

48

49 Figure 1 Examples for the use of tapes to increase air tightness in the building envelope. Left: seal an
50 overlap in the roofing membrane. Middle: Seal between the wind barrier and a window frame. Right:
51 vapour barrier tape for sealing of vapour barrier and a window frame (figure adapted from SINTEF).

52 Durability of joints is therefore important, and accurate and reproducible test methods should evaluate
53 their adhesive properties. Small-scale and large-scale accelerated climate laboratory ageing are widely
54 used as durability evaluation methods. With such methods, main properties of building components or
55 systems and their durability towards climate strains can be investigated within a relatively short period
56 of time. Thus, various accelerated ageing apparatuses are utilized in the laboratory according to
57 different ageing methods and standards. The selection of the apparatuses depends on a number of
58 factors including the type of product or material to be tested, the end-use application, the main
59 degradation modes, and budgetary restrictions. For adhesive tapes, UV resistance, moisture resistance,
60 and thermal resistance properties are important to withstand degradation during the actual construction
61 period and use phase of the building. Thermal resistance is of special importance when adhesive tapes
62 are to be subjected to high temperatures, which may be the case during the construction period or
63 around windows and the roof area [3]. Accelerated ageing experiments may provide information
64 related to the expected service life, the deterioration processes and maintenance schedules of the new
65 systems during their real applications.

66

67 To the authors knowledge, such reliable durability test methods (e.g. accelerated ageing procedures
68 and long-term performance prediction methods) are lacking for adhesive tapes used for outdoor
69 building applications [4], despite the existence of different standards [5-8] relevant to tapes used for
70 other application areas. There is only one standard, DIN 4108-11 [9], recently developed by German
71 Institute for Standardization, which describe the minimum requirements to the durability of adhesive
72 tapes used for buildings. However, this national standard is used only for adhesive tapes applied for
73 sealing of vapour barrier layers.

74

75 SINTEF Building and Infrastructure (SINTEF) evaluates and documents the performances of building
76 materials, components and construction systems used in Norwegian buildings. This is a requirement
77 given by the Norwegian building authorities (Direktoratet for Byggkvalitet) in the building
78 engineering regulation[2], for building materials used in Norwegian buildings. Among others, SINTEF
79 has performed testing and evaluation of the durability of tapes used in buildings according to SINTEF

80 guidelines for tapes used in buildings [10], in order to evaluate the suitability of the tapes for the use in
81 buildings exposed to the harsh Norwegian climate.

82

83 SINTEF guidelines for tapes used in buildings provide test methods for tapes used for sealing both
84 wind barrier and/or vapour barrier building layers. The guideline is based on the standard test methods
85 used for testing roof membranes [11-13], considering the tapes are expected to be exposed to similar
86 climate conditions like the roof membranes. According to the guideline, the durability of the adhesive
87 tape joints is evaluated by exposing the test specimens to main environmental conditions (i.e. water,
88 UV, freeze/thaw and heat) in accelerated laboratory ageing. The durability of the adhesive tapes and
89 adhesive joints is evaluated using two weeks of accelerated ageing in a climate simulator with four
90 repeated cycles, according to NT Build 495 [14], and 24 weeks of heat aging at 70 °C in accordance
91 with NS-EN 1296 [15]. The tensile strength of the tape and the shear and peel resistance of the
92 adhesive joints are evaluated before and after ageing, and for different tape/substrate interfaces.

93 However, the test is time-consuming (e.g. accelerated ageing tests need 24 weeks), and expensive (e.g.
94 testing of one tape with two end-use substrates leads to testing of more than 30 test specimens). In
95 addition, there is uncertainty on the exposure condition of vapour barrier tapes and wind barrier tapes
96 in the accelerated ageing chamber. The objective of this study is twofold, i.e. to evaluate existing tape
97 durability test methods and explore possible future research perspectives. These results from this work
98 are expected to help establishing guidelines for a new testing scheme. Possible future perspectives are
99 also discussed.

100 **2. Methodology**

101 The methodology section of this paper is divided into two parts. The first part outlines the durability
102 test and evaluation methods, designed and performed. It includes the description of materials used for
103 testing, accelerated aging test method used to evaluate the effect of different weathering factors and
104 description of the test methods used to evaluate the performance of the adhesion bonds. This first part
105 also describes the statistical and sensitivity analysis used for the evaluation of the adhesion test results.

106 The second part outlines the test method used to quantify the effect of wind load on the adhesive
107 properties of wind barrier and adhesive tape joints.

108 **2.1 Test methods**

109 **2.1.1 Materials**

110 Adhesive tapes are viscoelastic materials (i.e. have both viscous and elastic properties) that adhere to a
111 surface only by applying a light pressure [16]. Because of their viscous properties, they can flow easily
112 and be able to dissipate energy during the adhesive bonding process to the substrate. They also resist
113 separation under stress due to their elasticity. The degree of wetting is one of the criteria for good
114 adhesion and it mainly depends on the difference between the surface energy of adhesive and
115 substrate. Surface energy is sensitive to the surface chemistry and the morphology of the surface. For
116 example, metals and glass have a high surface energy and are easier to bond; whereas plastics have a
117 lower surface energy and are harder to bond. Wood fiberboards concrete, bricks and certain types of
118 oriented strand boards (OSB) require a high quality primer in order to improve adhesion as the
119 surfaces of these materials may delaminate when the adhesive tape is applied. For adhesive tapes
120 applied to rough and textured surfaces, the ability of the adhesives to flow and fill out different
121 textured surfaces is crucial. When dealing with difficult-to-bond substrates and critical applications,
122 use of primer or special adhesive enhancing formulations may help to ensure predictable adhesion
123 conditions.

124

125 The surface of the substrate where the adhesive tape is glued must be clean, dry, grease- and solvent-
126 free for a good adhesion. Besides the properties of the adhesive and the substrate characteristics, stress
127 conditions (e.g. weathering) and end use environment (e.g. indoor use or outdoor use) are other factors
128 which affect the performance of the adhesive tape.

129

130 Four types of single-sided acrylic tapes and seven types of substrates were selected to evaluate the
131 adhesion and cohesion performance of adhesive tapes. Two of the tapes are designed for indoor
132 applications and the other two are designed for outdoor applications. The seven substrates used

133 represent typical materials in which the tape is applied. The description of the test specimens along
 134 with the notation system used in this study are presented in Table 1.
 135 The four tapes (S, E, I and W) were applied on the selected substrates (WT, WI, VT, S, CS, G, GS)
 136 and preconditioned at a temperature of (23 ± 2) °C and a relative humidity of (50 ± 2) % for 48 h
 137 before the test.

138

139 Table 1 Tapes and substrates used in the experiments.

Description of the acrylic tapes and substrates used in the test			
Tapes	Description		Notation
	Adhesive	Backing	
Tapes for indoor applications	Modified acrylic adhesive	PE coated paper backing	S
	Modified acrylic adhesive	PE film backing	E
Tapes for outdoor applications	Modified acrylic adhesive	Grid fabric of PE film backing	I
	Modified acrylic adhesive	Polyolefine backing	W
Substrates	Description		Notation
Wind barriers	PE based wind barrier		WT
	PP based wind barrier		WI
Vapour barrier	PE based vapour barrier		VT
Uncoated spruce	Planed wood		S
Coated spruce	Wood coated with water based paint		CS
Glass	-		G
Galvanized steel	-		GS

140 2.1.2 Accelerated ageing

141 Accelerated ageing tests are used to predict the long-term performance of joints. Two different
142 accelerated ageing test series were selected:

- 143 • In the first ageing test series, the materials were first exposed to two weeks of climate ageing
144 in a vertical climate simulator, according to NT Build 495 [14]. In the vertical climate
145 simulator, the samples are subjected in turns to four different climate exposure conditions;
146 ultraviolet (UV) and infrared irradiation (black panel temperature of 63 °C), water spray (15
147 $\text{dm}^3/(\text{m}^2 \text{ h})$), freezing (-20 °C) and ambient laboratory conditions. The exposure time is 1 h
148 for each climate condition. The samples are then subjected to 24 weeks of heat ageing at 70 °C
149 in heat chamber, according to NS-EN 1296. The temperature of 70 °C was used since the
150 maximum temperature of 60 °C to 70 °C is the normally accepted upper safe temperature limit
151 for accelerated ageing of polymers [17]. However, also note that higher temperatures may
152 occur for shorter period at extreme conditions, e.g. up to 90 °C under dark coloured roof tiles.
- 153 • In the second ageing test series, the test specimens were directly exposed to 24 weeks of heat
154 ageing at 70 °C in a heat chamber according to NS-EN 1296 [15].

155

156 The two weeks of climate ageing test (in the first ageing test series) are used to simulate the potential
157 maximum outdoor climate exposure of tapes during the construction period, whereas the 24 weeks of
158 heat ageing (in the first and second ageing test series) simulate the potential ageing of the tapes during
159 their intended use.

160

161 Untreated (fresh) test specimens and aged specimens, after 2, 8, 12 and 24 weeks of ageing, were
162 evaluated. Untreated (fresh) test specimens were used as a reference for comparison of the ageing
163 result with aged specimens. The notation system used for the two ageing series and test intervals is
164 summarized in Table 2.

165

166 Table 2 Accelerated ageing and test intervals (with notation system used)

<i>Ageing</i>	<i>Test interval</i>					
Test series 1: Climate and heat ageing	Fresh (f)	After 2 weeks climate ageing (c)	After 2 weeks heat ageing (1)	After 8 weeks heat ageing (2)	After 12 weeks heat ageing (3)	After 24 weeks heat ageing (4)
Test series 2: Heat ageing		After 2 weeks heat ageing (1h)	After 8 weeks heat ageing (2h)	After 12 weeks heat ageing (3h)	After 24 weeks heat ageing (4h)	

167 **2.1.3 Test methods for determination of the performance of adhesive joints**

168 Adhesion to a surface and cohesion or internal strength properties of adhesive tapes determine the
169 sticky nature of adhesive tapes. Adhesion is the binding force between two different materials,
170 whereas cohesion is the binding force between two similar materials. Peel and shear resistance test
171 methods are used to evaluate the adhesion and cohesion performance of adhesive joints.

172 Peel resistance is the force required to peel an adhesive tape from a specified substrate at a specified
173 angle and speed. The peel resistance gives information about the bond strength between the adhesive
174 tape and the substrate. The peel force measured is not an inherent property of the adhesive, but
175 depends on many variables such as the test method, temperature, peel rate, adhesive chemistry,
176 adhesive thickness, ageing, the stiffness and thickness of the adhesive backing and properties of the
177 substrate [18].

178

179 180 degree peel test, 90 degree peel test and T-peel test are the three main types of peel tests. The 90
180 and 180 degree peel tests are commonly used when an adhesive tape is adhered to a more rigid
181 substrate (e.g. wood) while the T-peel test is used for tape applied to thin, flexible substrates (e.g.
182 polyethylene vapour barrier). Even if both 90 degree and 180 degree peel tests are peeled at the same
183 testing rate, the peel rate for 90 degree is greater than for the 180 degree [18].

184

185 The shear resistance is a measure of the internal strength or cohesiveness of an adhesive. For tapes
186 sealing joints, they will be exposed to sustained forces caused by different rates of expansion and

187 contraction of the surfaces on both sides of the joint. High shear resistance of the adhesive tapes used
 188 to cover joints is thus important to create an air and/or moisture seal which absorbs stress and
 189 movement to help structures stay strong and safe [3, 19].

190

191 In this work, the peel and shear resistance of adhesive tapes glued to essential end-use substrates were
 192 evaluated before and after accelerated ageing according to NS-EN 12316-2 [12] and NS-EN 12317-2
 193 [13], respectively (see Figure 2). The tests were carried out using a universal testing machine (Zwick
 194 MT-411).

195

196

197

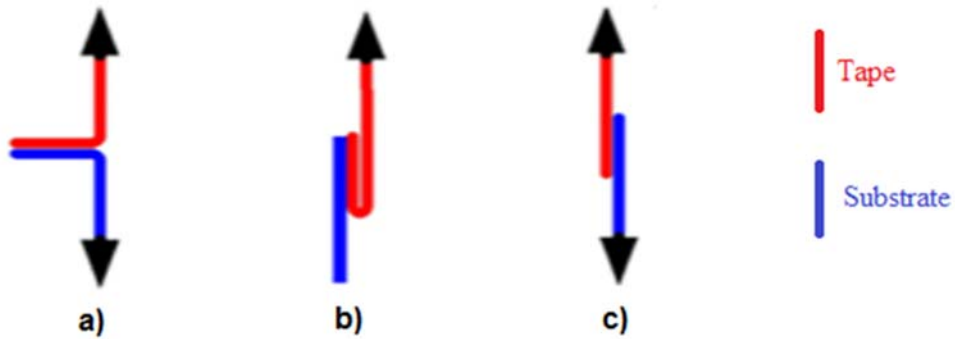

198

199 Figure 2 Schematic diagram of peel resistance tests (T-peel resistance test of tape adhered to flexible
 200 substrate (a) and 180 degree peel resistance test of tape adhered to rigid substrate (b)) and shear
 201 resistance (c) tests, adapted from [4].

202

203 The test methods, test specimen dimensions and the number of test specimen's replicate used are
 204 summarized in Table 3.

205

206 Table 3 Test methods, test specimen sizes and number of test specimen's replicate.

	<i>Peel resistance test</i>	
--	-----------------------------	--

	<i>T-peel (for tapes applied to flexible substrates)</i>	<i>180 degree (for tapes applied to rigid substrates)</i>	<i>Shear resistance test</i>
Standards	NS-EN 12316-2 [12]	NS-EN 12316-2 [12]	NS-EN 12317-2 [13]
Grip distance (mm)	100 ± 2	200 ± 2	120 ± 2
Grip separation speed (mm/min)	100 ± 10	100 ± 10	100 ± 10
Sample size (width x length) mm, for tapes	(50 x 300) ± 0.5	(50 x 300) ± 0.5	(50 x 220) ± 0.5
Sample size (width x length) mm, for substrates	(70 x 220) ± 0.5	(70 x 220) ± 0.5	(70 x 220) ± 0.5
Number of test specimens replicas used for Test series 1	5	5	3
Number of test specimens replicas used for Test series 2	3	3	3
Total number of test specimens tested	990		594

207

208 **2.1.4 Statistical treatment of the results**

209 A total of 1584 evaluations were performed and are classified into different *configurations* and
210 different *evaluations*. A *configuration* is defined by a tape: *t*, a substrate: *s*, and an exposure: *e*. An
211 *evaluation X* can be either peel resistance: *PR* or shear resistance: *SR*. For each evaluation, between
212 three and five replicates were used. The replicate number is referred to as *i*, and the number of
213 replicates is referred to as *n* in the following.

214

215 It is assumed that most of the evaluations *X* collected under a given configuration are representative of
216 a unique population. Evaluations are identified that are collected under a given configuration, but do
217 not belong to the assumed population, e.g. external perturbation during the test.

218

219 The criterion for identifying an evaluation X not belonging to the assumed population for a given
 220 configuration is adapted from Minitab statistical software (2010), and is defined as follows:

221

$$222 \begin{cases} \text{If } X \in [Q_1 - 1.5(Q_3 - Q_1); Q_3 + 1.5(Q_3 - Q_1)], \text{ then } X \text{ belongs to the population} \\ \text{If } X \notin [Q_1 - 1.5(Q_3 - Q_1); Q_3 + 1.5(Q_3 - Q_1)], \text{ then } X \text{ does not belong to the population} \end{cases} \quad (1)$$

223

224 where Q_1 and Q_3 are the lower and upper quartiles [20], respectively. The following statistical
 225 indicators are computed. The mean value \bar{X} is defined as:

$$226 \bar{X} = \sum_{i=1}^n \frac{X_i}{n} \quad (2)$$

227

228 The standard deviation S^2 is defined as:

$$229 S^2 = \sqrt{\sum_{i=1}^n \frac{(X_i - \bar{X})^2}{n-1}} \quad (3)$$

230

231 2.1.5 Sensitivity analysis

232 The statistical design of experiments (DOE) methodology [20] was used for identification and
 233 correlation of the significant factors that affect the mechanical properties of the taped joints. Three
 234 general factors: exposure times, substrates, and tapes, were selected as input variables, and two
 235 adhesive properties: peel resistance and shear resistance, were selected as output variables. The three
 236 factors and their levels are shown in Table 4.

237

238 Table 4 Factors and levels used for the full factorial design.

<i>Factors</i>	<i>Levels</i>
Exposure time e	c, 1, 2, 3, 4, f, h2, h8, h12, h24
Substrate s	GS, G, S, CS, WT, WI, VT

Tape t	I, W, E, S
----------	------------

239

240 Statistical evaluation of the data was performed using Minitab 17 software. The main response value
 241 compares the relative strength of the various factors on a selected response. For example, the main
 242 effect of a given tape t_1 is defined as:

243
$$\bar{\bar{X}}_{t_1} = \bar{X}_{\text{for } t=t_1} \quad (4)$$

244

245 The interaction value quantifies the interaction of two factors at all possible combinations on the mean
 246 response. For example, the interaction of a given tape t_1 and a given substrate s_1 is defined as:

247
$$X_{t_1s_1} = \bar{X}_{\text{for } t=t_1 \text{ and } s=s_1} \quad (5)$$

248 **2.2 Digital image correlation**

249 Digital image correlation (DIC) was employed for measuring full-field displacements of wind-barriers
 250 membrane (WT) joined by adhesive tapes (W) under wind loads. Wind loads were applied according
 251 to the experimental protocol described in standard EN 12211:2000 [21]. Two loading protocols were
 252 followed, according to the wind resistance method given in Annex B of the standard EN 12211:2000:

- 253 • Loading protocol 1: a maximum dynamic pressure equivalent to a strong breeze ($P_1 = 40$
 254 km/h, positive pressure) is progressively applied from the inside of the test specimen. A
 255 negative pressure is then progressively applied to the inside of the test specimen in order to
 256 reach - 40 km/h ($-P_1$) wind speed in the opposite direction (from outside to inside).
- 257 • Loading protocol 2: a maximum dynamic pressure equivalent to a violent storm ($P_1 = 113$
 258 km/h, positive pressure) is progressively applied from the inside of the test specimen.

259

260 The test specimen construction corresponds to a typical Scandinavian timber frame construction with
 261 36 mm × 148 mm solid timber studs at a spacing of 600 mm between timber studs, as recommended
 262 by [22], and shown in Figure 3a). A two-part wind-barrier membrane of type *WT* was fixed to each
 263 studs be means of staples every 20 cm. A 50 cm wide adhesive tape of type *S* was used to join the

264 different parts of the wind-barrier membrane. The overlapping joint was located 20 cm from the
265 nearest timber stud, and 40 cm away from the furthest stud.
266
267 Prior to the test, a surface of approximately 30 cm x 30 cm was spray-painted with an alcohol free
268 acrylic black paint on the outside of the test specimen. A perforated plate with a regular pattern was
269 used to ensure a fine-grained and high contrast speckle pattern, see Figure 3b). During testing, grey-
270 scale images of the speckle-patterned specimen surface were recorded at a framing rate of 1 Hz using
271 two Prosilica GC2450 digital cameras equipped with a 28 – 105 mm Nikon lens, see Figure 3c). The
272 recorded images were post-processed using an in-house three-dimensional DIC software [23] in order
273 to compute displacement and strain fields of the specimen.
274

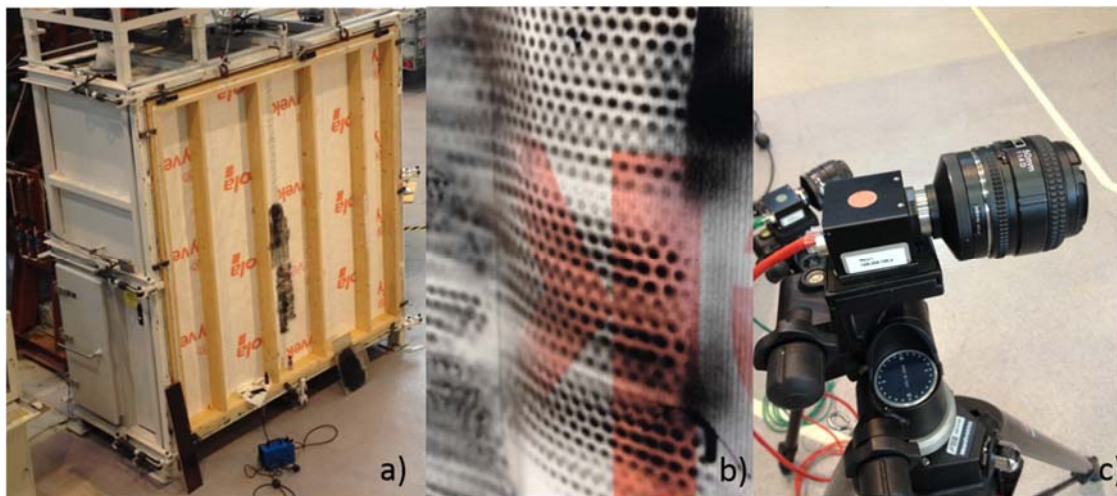

275
276 Figure 3 a) Full scale test specimen, b) Speckle pattern on both the tape (W) and the wind barrier
277 (WT), and c) One of the digital cameras used for recording images.

278 3. Results

279 3.1 Peel and shear resistance

280 3.1.1 Wind barrier tapes

281 The mean peel resistance and shear resistance for wind barrier tapes from test series 1 (2 weeks
282 climate ageing and 24 weeks' heat ageing) are presented in Figure 4.

283 The results show significant reduction in peel resistance with exposure time and relatively higher peel
284 values for rigid substrates (GS, G, S and CS) compared to wind barriers (WT, WI). From rigid
285 substrate, the lowest peel resistance for S (uncoated spruce) can be due to the effect of exposure on the
286 adhesive-substrate interface. However, there was slight reduction in shear resistance with respect to
287 exposure time and type of substrate. There was also significant difference in shear resistance between
288 the two types of wind barrier tapes (I, W) with respect to exposure time and type of substrate, although
289 the peel resistance was almost similar. The difference in the chemical composition of the two tapes can
290 be one reason for the variation of the results. These results may be summarized as follows:

- 291 • In general, W tape is less affected by increase in exposure and type of substrates but has a
292 lower peel and shear resistance compared to I tape.
- 293 • In particular, type of exposure and choice of substrate have a non-significant effect on shear
294 resistance of W tape.
- 295 • The lowest peel and shear resistance of WT with respect to type of exposure and the two tapes
296 can be due to the lower surface energy properties of the polyethylene based substrate, WT. It
297 is also stated by Maassen et al. [24] that polyethylene, polypropylene and other commonly
298 used polyolefines exhibit a low surface energy, and that adhesion of adhesive tape to such
299 substrates is still a challenge.
- 300 • The effect of exposure is more significant for peel resistance: mean reduction of up to 50% of
301 the measured performance, than for shear resistance: mean reduction of up to 30% of the
302 measured performance. These show that the surface properties of the substrate and exposure
303 condition have significant effect on the peel adhesion tests.
- 304 • Exposure has a less significant effect on the shear resistance, and all substrates are observed to
305 experience a sharp reduction of performance during the last period of the aging protocol.
- 306 • The only notable exception to this pattern is the WT substrate, which exhibits a sharp
307 reduction of performance at the very beginning of aging protocol, and then maintains an
308 almost constant performance to the end of the aging protocol. This can be due to the substrate-
309 adhesive interface properties.

310
 311
 312
 313
 314

315

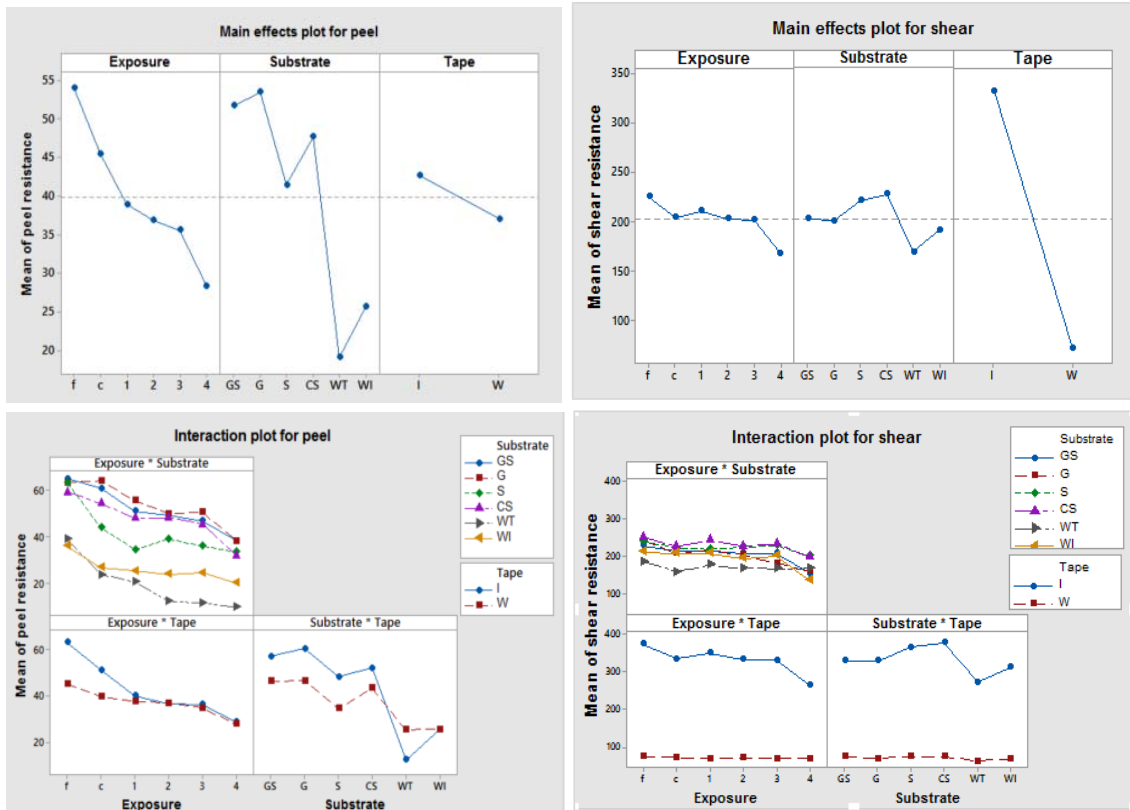

317

318 Figure 4 The main effect and interaction plot of factors on the mean peel and shear resistance for wind
 319 barrier tapes exposed to 2 weeks climate ageing and 24 weeks of heat ageing (test series 1).

320 The mean peel and shear resistance results for wind barrier tapes investigated in test series 2 (24 weeks
 321 heat aging) (Figure 5) were showing almost similar trends as test series 1 (Figure 4). The lack of
 322 climate aging protocol results in the following differences:

- 323
- Slightly general higher performance with respect to both peel resistance (+12%) and shear
 324 resistance (+4%).
 - The effect of exposure onto peel resistance is observed to be "delayed" for tape I, since the
 325 reduction of performance is significant only from the third period of the aging protocol.
 326

327

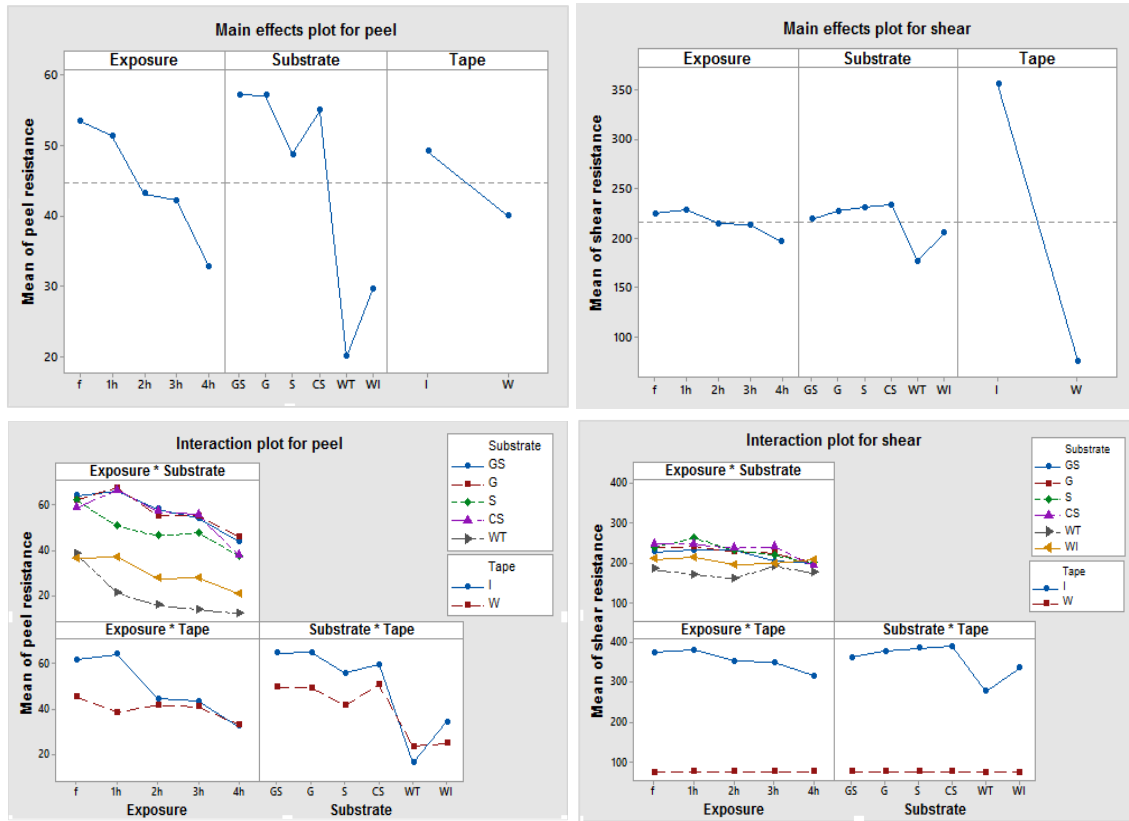

328

330

331 Figure 5 The main effect and interaction plot of factors on the mean peel and shear resistance for wind
 332 barrier tapes exposed to 24 weeks of heat ageing (test series 2).

333 **3.1.2 Vapour barrier tapes**

334 Figure 6 and Figure 7 present the mean peel and shear resistance for the vapour barrier tapes from test
 335 series 1 and test series 2, respectively.

336

337 The results from test series 1 (Figure 6) showed significant reduction in the peel and shear resistance
 338 of S tape after 2 weeks of climate ageing (c). The peel resistance keeps on decreasing with increase in
 339 exposure time while the shear resistance changes very slightly. It was also observed that the peel and
 340 shear resistance for rigid substrates (GS, G, S and CS) were higher than that for the vapour barrier
 341 (VT). However, the peel and shear resistance between the two types of vapour barrier tapes (E, S) with
 342 respect to exposure time and type of substrate (except for CS) were nearly similar. These results may
 343 be summarized as follows:

- 344 • Both peel resistance and shear resistance of S tape are substantially affected by climate ageing
- 345 (c), and are slightly affected by choice of substrate. The response of S to different exposure
- 346 condition can be due to the properties of adhesive and backing composition and adhesive-
- 347 substrate interfaces. The significant reduction in peel and shear resistance of S tape is due to
- 348 the effect of moisture on the paper backing of S tape during climate ageing. This may be due
- 349 to that S tape is exposed to an environment where it was not designed. That means, S tape is
- 350 designed to be used for indoor application where climate exposure is limited.
- 351 • Peel resistance of tape E increases after 2 weeks of climate ageing (c). This can be due to the
- 352 effect of temperature during ageing in the heat chamber. The temperature may soften the
- 353 adhesive and wet the substrate, which leads to increase in the peel resistance.
- 354 • Shear resistance of tape E is not significantly affected by exposure type or by choice of
- 355 substrates. The exposure to heat ageing can reduce the shear resistance of the tape due to the
- 356 softness of adhesive (which reduces the cohesion force). However, the reduction in shear
- 357 resistance is very slow and steady.

358

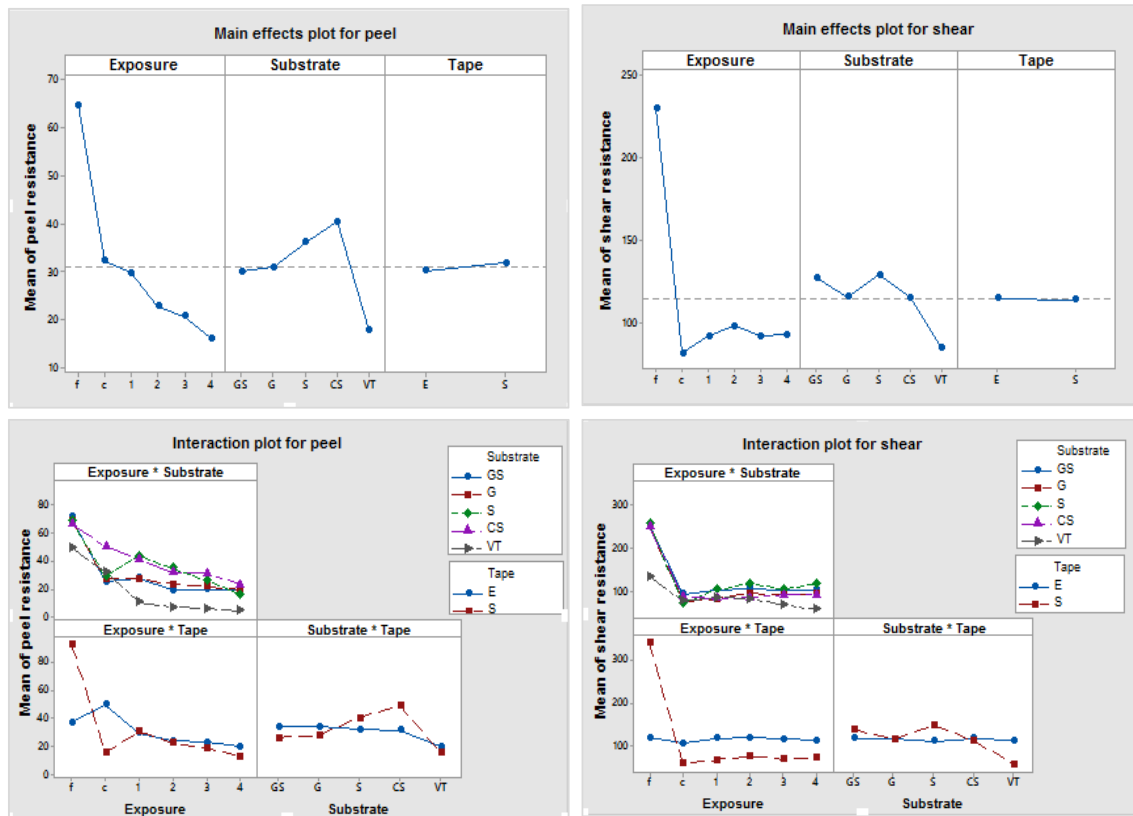

360

361 Figure 6 The main effect and interaction plot of factors on the mean peel and shear resistance for vapour
 362 barrier tapes exposed to 2 weeks climate ageing and 24 weeks of heat ageing (test series 1).

363

364 The results from test series 2 (Figure 7, 24 weeks of heat ageing) indicated that the peel resistance
 365 reduced significantly with exposure time, while the shear resistance remains similar. It was also
 366 observed that the peel and shear resistance of rigid substrates (GS, G, S and CS) were higher than for
 367 the vapour barrier (VT). In addition, the peel and shear resistance of S tape was significantly higher
 368 than E with respect to exposure time and type of substrate (except for VT). Here it should be noted
 369 that, the properties of the different backings used in adhesive tapes can influence the peel and shear
 370 resistance. These results may be summarized as follows:

- 371 • The lower peel and shear resistance of substrate VT compared to all other tested substrates
- 372 may be due to the lower surface energy of VT.
- 373 • Shear resistance of both E and S tapes is not significantly affected by the type of exposure.

374

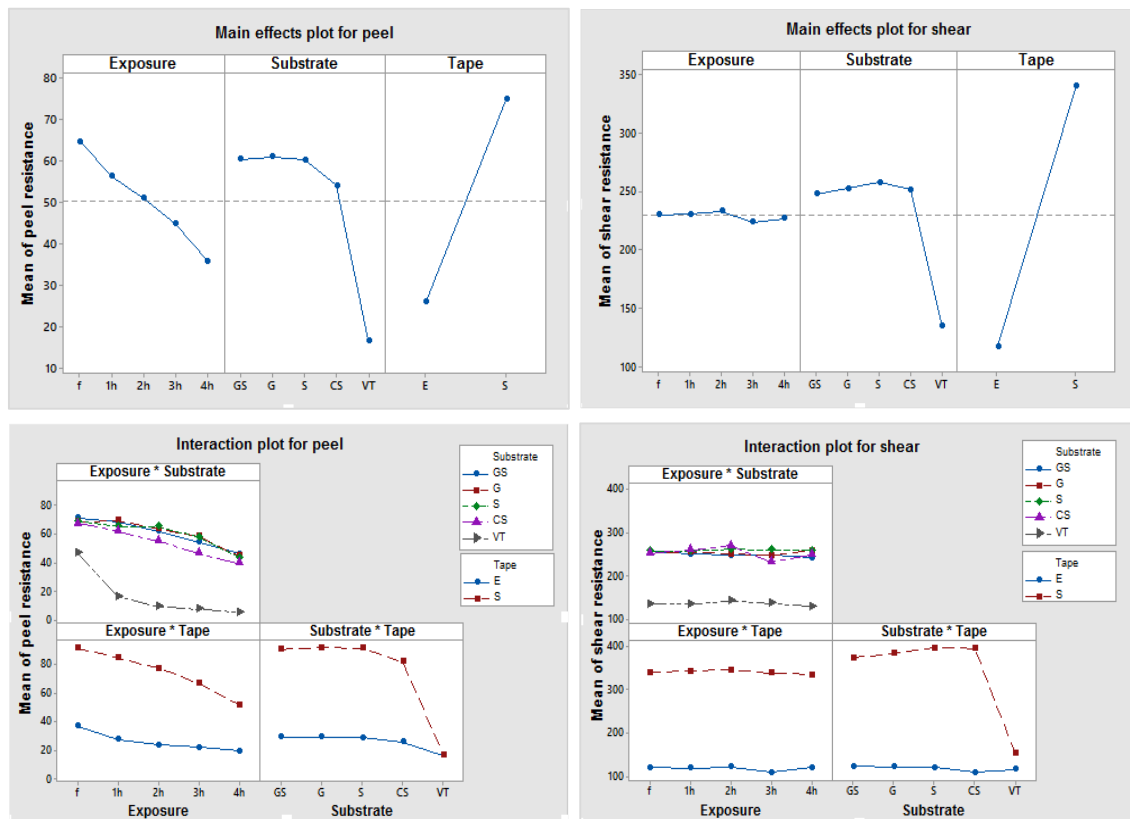

376

377 Figure 7 The main effect and interaction plot of factors on the mean peel and shear resistance for vapour
378 barrier tapes exposed to 24 weeks of heat ageing (test series 2).

379

380 The peel and shear resistance results of vapour barrier tape joints exposed to test series 1 (2 weeks of
381 climate ageing and 24 weeks of heat ageing) were significantly affected by climate ageing.

382 **3.2 Digital image correlation**

383 Results from the digital image correlation (DIC) experiments show limited permanent deformation of
384 the test specimens after the first loading protocol, see Figure 8b, and substantial permanent
385 deformation after the second loading protocol, see Figure 8c. The initial undeformed speckle pattern is
386 given in Figure 8a for easy comparison.

387

388 After the first loading protocol, just a slight change in the speckle pattern is visible compared to the
389 initial speckle pattern. At the right side of the tape the speckle pattern is hardly widened. After the
390 second loading protocol, stronger deformation of the speckle pattern is visible at the edges of the tape.

391 Clear white lines are observed.

392

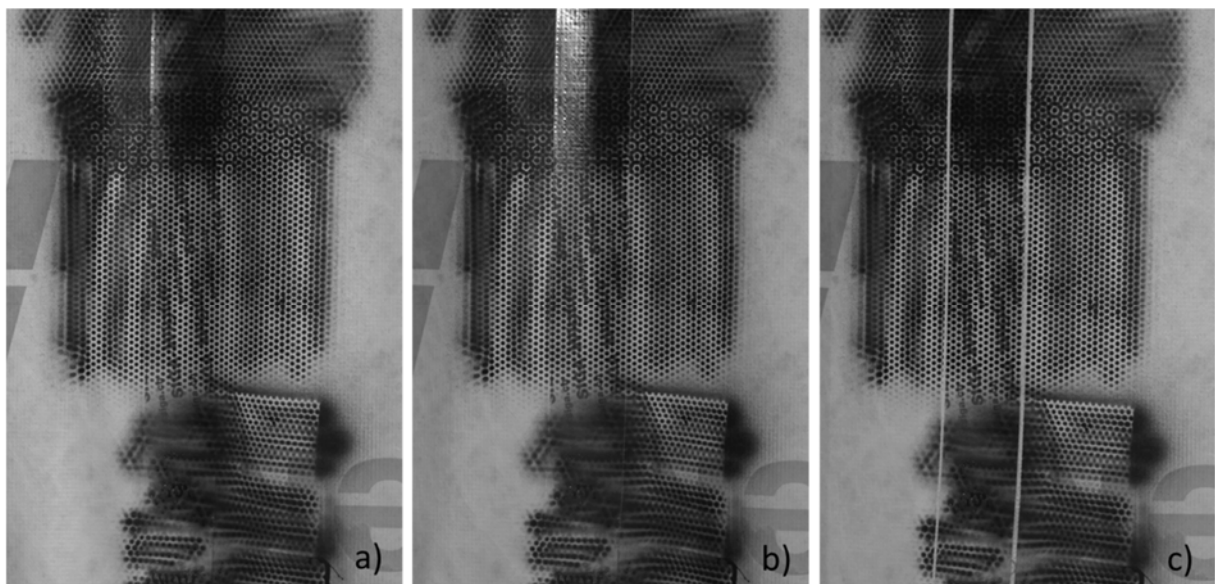

393

394 Figure 8a) Initial speckle pattern, b) deformed speckle pattern after loading protocol 1, and c)
395 deformed speckle pattern after loading protocol 2.

396 Detailed analyses of the evolution of the strain field (Figure 9) suggest adhesive degradation or
397 deformation and a consequent sliding of the tape across the wind barrier. However, the deformation
398 and sliding of the tape is relatively small. Further analysis of the degradation processes as well as
399 better understanding of the mechanical properties of the bonding between tape and substrate are
400 therefore required.

401

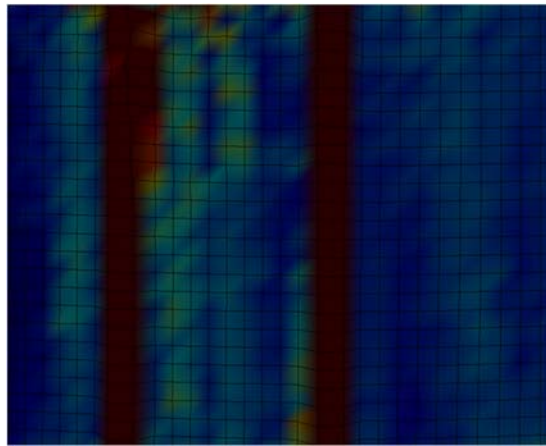

402

403 Figure 9 An example of strain field obtained from post-processing. Blue colour no movement. Green
404 colour little movement. Red colour large movement

405 **4. Discussions and future research perspectives**

406 The scope of this work was limited to evaluation of the durability of adhesive joints based on
407 mechanical tests. The chemical properties of the adhesive joints before, during and after the
408 accelerated ageing test were not evaluated. In further work, detail investigation on the
409 chemical properties of adhesive joints should be incorporated. Fourier transform infrared
410 spectroscopy (FTIR) analysis can be used as a potential surface characterization technique to
411 understand chemical composition of the adhesive tape and the chemical changes in the
412 adhesive joints before, during and after ageing. Scanning electron microscope (SEM) is
413 another possible method, where elemental analysis through energy-dispersive x-ray

414 spectroscopy (EDS) embedded in the SEM can be used for extracting information about
415 chemical changes during ageing processes.

416

417 The peel and shear resistance results of vapour barrier tape joints exposed to test series 1 (2
418 weeks of climate ageing and 24 weeks of heat ageing) were significantly affected by 2 weeks
419 climate ageing. The results from test series 2 (24 weeks of heat ageing) indicated that the peel
420 resistance reduced significantly with exposure time, while the shear resistance remains
421 similar. In real world conditions, the probability of these joints to be exposed to rain and frost
422 might be limited as these tapes are intended for indoor use. It was argued that the vapour
423 barrier tapes should be exposed to only 24 weeks of heat ageing provided the tapes will not be
424 exposed to solar radiation and moisture during the construction period of the building (for
425 example exposure to rain or frost before the roof has been covered). However, the possibility
426 of the vapour barrier tapes exposure to solar radiation during for example transportation,
427 storage, or installation, was also discussed. Thus, to ensure that the vapour barrier tapes
428 withstand any solar radiation exposures, it is recommended to expose vapour barrier tapes for
429 three days in horizontal ageing apparatus followed by 24 weeks of heat ageing. The horizontal
430 ageing apparatus is a non-commercial accelerated ageing apparatus, which is used for
431 exposing materials to a combined horizontal UV, temperature and water spray on a
432 consecutive basis according to EN 1297[17]. Due to the possibility of exposure of the wind
433 barrier tapes to different exterior climate conditions during the construction period (before the
434 building is covered with cladding), it is recommended to expose wind barrier tapes for 2
435 weeks climate ageing before the 24 weeks of heat ageing.

436

437 Accelerated ageing experiments may provide information related to the expected actual
438 service life of a product, the deterioration processes and maintenance schedules of the new
439 systems during their real applications. One of the critical aspects of durability testing is
440 prediction of the equivalent service life of products from accelerated ageing tests. That means,
441 for example an estimation of the equivalent actual service life of adhesive tape after
442 accelerated ageing for 2 weeks in climate simulator and 24 weeks in heat chamber at 70 °C
443 (test series 1). Service life estimations are important for several reasons including for
444 comparison of different products, giving warranties, making life time cost calculation, and
445 establish requirements for maintenance and renovation. The rate of degradation in the
446 accelerated ageing test chamber can be compared with actual outdoor exposure using an
447 acceleration factor, a number correlating the ageing time in the test chamber with actual
448 natural outdoor ageing exposure. A simplified calculation methodology has been used to
449 calculate an acceleration factor [17, 25]. However, this methodology is developed using a
450 number of assumptions. The calculation considered the effect from UV and temperature while
451 the influence from other climate strains such as moisture exposure, has not been included. In
452 addition, the calculation is very dependent on the choice of reference natural temperature. It is
453 also difficult to give a precise comparison between artificial and natural aging. The outdoor
454 exposure can vary a lot depending on the weather conditions where the building is situated
455 and how strongly it is exposed for example solar radiation, rain, heat and frost. In this work,
456 the service life estimation of the adhesive tapes is not included. It is recommended to
457 investigate and elaborate existing service life estimation method and evaluate how accelerated
458 ageing test results of joints simulate the actual service life conditions.

459

460 Although standard test substrates, such as glass and steel, are used as a standard test plates,
461 glass and galvanized steel along with main end-use substrates have been tested in order to

462 evaluate the actual substrate/interface property. The test results of peel and shear resistance of
463 wind barrier and vapour barrier tapes adhered to hard substrates i.e. galvanized steel (GS),
464 glass (G), coated spruce (CS) and planed spruce (S) are almost similar. This might indicate
465 the possibility of using one of the substrate as a standard test substrate, for e.g. galvanized
466 steel (as suggested by AFERA) or glass (as suggested by FINAT) in place of coated and
467 uncoated wood when testing wind barrier and vapour barrier tapes. This standard test
468 substrate can also be used in place of other materials like gypsum board or materials with
469 delaminate surfaces such as concrete, brickwork, OSB and wood fiberboards (after the
470 application of primers on the surface of the materials in order to improve adhesion
471 performance of the surface).

472

473 The peel and shear resistance results of adhesive tapes adhered to flexible membranes, wind
474 barrier membranes (WT and WI) and vapour barrier (VT), were relatively lower compared to
475 adhesive tapes adhered to rigid substrates. This shows the importance of using a standard
476 reference substrate from flexible membrane for testing wind barrier and vapour barrier tapes.
477 Thus, it is suggested to test the wind barrier tapes against a standard hard or rigid substrate
478 (e.g. galvanized steel) and polyethylene (PE) wind barrier membranes (e.g. WT), while
479 vapour barrier tapes can be tested against a standard hard substrate (e.g. galvanized steel) and
480 PE vapour barrier membranes (e.g. VT). Using a standard substrate can minimize the number
481 of end-use substrates used to test the actual substrate/interface properties, which leads to
482 reducing the time and cost of durability testing. Further investigation of the effect of surface
483 energy of different building materials on which the wind barrier and vapour barrier tapes are
484 applied is needed to verify these findings.

485

486 Detailed analyses of the evolution of the strain field from the digital image correlation results
487 suggest adhesive degradation and a consequent sliding of the tape across the wind barrier.
488 However, the deformation and sliding of the tape is relatively small. Further analysis of the
489 degradation processes as well as better understanding of the mechanical properties of the
490 bonding between tape and various substrates is recommended.

491

492 Here it is important to note that the performance of the adhesive tapes is also very dependent
493 on the actual application of the tapes in buildings. First it is important to determine the
494 adequate properties with their corresponding requirements for adhesive tape suitable for the
495 specific application areas, e.g. identify tapes intended for indoor and outdoor applications.

496 The condition of the surface of the substrate is another factor which determines adhesion
497 performance. It is important to know the surface properties of the substrate and evaluate if
498 special surface treatment is required before the application of the adhesive tapes. In order to
499 guarantee good adhesion, the surface should also be dry and free from dust and grease.

500 Adhesive tapes become hard and glassy with decreasing temperature and higher temperatures
501 make the adhesive stickier and reduce their adhesive strength. Thus, tapes should not be
502 stored and/or applied in too cold or too warm temperature. Special adhesive tapes designed
503 for extreme temperature can be used for very high or too low temperature applications.

504 Manufacturers or suppliers of adhesive tapes should provide technical data, instructions and
505 information about the application area and conditions of application of the adhesive tapes, and
506 the end users should follow the given procedures during the application of the tapes to achieve
507 the required adhesion.

508

509 **5. Conclusions**

510 Adhesive tapes are used to maintain and/or increase the moisture and air-tightness of
511 buildings. To the authors knowledge, adequate durability test methods (e.g. accelerated ageing
512 procedures and long-term performance prediction methods) are lacking for tapes used for
513 outdoor building applications. In this study, the long-term degradation mechanisms and
514 mechanical properties of various commercially available adhesive tapes used for buildings
515 applications were evaluated. Two wind barrier tapes and two vapour barrier tapes adhered to
516 seven different types of substrates have been tested in order to evaluate the effect of different
517 properties of the substrates on the durability of the joints. Two accelerated ageing test series
518 have been used applying two different ageing procedures to evaluate the durability of the
519 adhesive tapes used for wind barrier and vapour barrier joints. Peel and shear resistance tests
520 were performed before, during and after accelerated ageing of the test specimens in order to
521 evaluate the adhesion and cohesion performance of adhesive joints. The statistical design of
522 experiments (DOE) technique was used for identification and correlation of the significant
523 factors that affected the mechanical properties of the taped joints. Furthermore, the effects of
524 wind load on the adhesive properties of wind barriers and adhesive tape joints were also
525 investigated.

526 From the accelerated ageing test results, it was suggested to differentiate the accelerated
527 ageing exposure of tapes used for indoor and outdoor during accelerated ageing tests.
528 The possibility of using standard substrates when testing the adhesive tapes instead of
529 applying actual end-use substrates was also suggested. The study also highlights the need for
530 further analysis of better understanding of the chemical and mechanical properties of the
531 adhesive tapes, bonding between adhesive tapes and various substrates, the degradation
532 processes and reliable service life prediction methods. The body of this work is expected to
533 strengthen the further development of durability testing and evaluation methodology for
534 adhesive tapes for building applications.

535 **References**

- 536 1. Hutchinson, A.R., A. Pagliuca, and R. Woolman, *Sealing and resealing of joints in buildings.*
537 Construction and Building Materials, 1995. **9**(6): p. 379-387.
- 538 2. TEK 10, *The Norwegian building regulations (Byggteknisk forskrift, TEK 10).*
539 <https://lovdata.no/dokument/SF/forskrift/2010-03-26-489>. 2016.
- 540 3. Moll, L., *Airtightness in buildings.* Downloaded June 4, 2014 from
541 <http://www.ecologicalbuildingsystems.com/docs/Airtightness2.pdf>.
- 542 4. Fufa, S.M., M. Kvalvik, and P. R  ther. *Adhesive tapes for building purposes: Framework for*
543 *evaluation of performance and durability.* in *XIII International Conference on Durability of*
544 *Building Materials and Components.* 2-5 September 2014,. Sao Paulo, Brazil.
- 545 5. EN 1939, *Self adhesive tapes - Determination of peel adhesion properties.* 2003: European
546 committee for standardization, Brussels.
- 547 6. EN 1943, *Self adhesive tapes - Measurement of static shear adhesion.* 2002: European
548 committee for standardization, Brussels.
- 549 7. EN 12024, *Self adhesive tapes - Measurement of resistance to elevated temperature and*
550 *humidity.* 1996: European committee for standardization, Brussels.
- 551 8. EN 12028, *Self adhesive tapes - Measurement of elongation under static load.* 1996:
552 European committee for standardization, Brussels.
- 553 9. DIN 4108-11, *Thermal insulation and energy economy in buildings — Part 11: Minimum*
554 *requirements to the durability of bond strength with adhesive tapes and adhesive masses for*
555 *the establishment of airtight layers (In German).* 2015: German Institute for Standardization,
556 Berlin.
- 557 10. SINTEF Building and Infrastructure, *SINTEF Teknisk Godkjenning Retningslinjer -Tape til*
558 *bygningformål i damp- og vindsperresjiktet.* 2011.
- 559 11. NS-EN 12311-1, *Flexible sheets for waterproofing Determination of tensile properties-Part 2:*
560 *Plastic and rubber sheets for roof waterproofing.* 2013: Standard Norge, Oslo.
- 561 12. NS-EN 12316-2, *Flexible sheets for waterproofing Determination of peel resistance of joints*
562 *Part 2: Plastic and rubber sheets for roof waterproofing* 2013: Standard Norge, Oslo.
- 563 13. NS-EN 12317-2, *Flexible sheets for waterproofing Determination of shear resistance of joints*
564 *Part 2: Plastic and rubber sheets for roof waterproofing.* 2010: Standard Norge, Oslo.
- 565 14. NT BUILD 495, *Building materials and components in the vertical position:Exposure to*
566 *accelerated climatic strains.* 2000, Nordtest, Espoo, Finland.
- 567 15. NS-EN 1296, *Flexible sheets for waterproofing-Bitumen, plastic and rubber sheets for roofing*
568 *- Method of artificial ageing by long-term exposure to elevated temperature* 2001: Standard
569 Norge, Oslo.
- 570 16. Benedek, I., *Pressure-sensitive adhesives and applications. Second edition, Revised and*
571 *Expanded.* 1997, Marcel Dekker Inc, New York
- 572 17. Jelle, B., *Accelerated climate ageing of building materials, components and structures in the*
573 *laboratory.* Journal of Materials Science, 2012. **47**(18): p. 6475-6496.
- 574 18. McGuiggan, P.M., et al., *Peel of an adhesive tape from a temperature-gradient surface.*
575 International Journal of Adhesion and Adhesives, 2008. **28**(4-5): p. 185-191.
- 576 19. 475 (2014). *Adhesive Bonds and Failures: What's Going On?.* Downloaded June 4, 2014 from
577 <https://foursevenfive.com/adhesive-bonds-and-failures-whats-going-on/>.
- 578 20. Ronald E. Walpole, et al., *Probability & statistics for Engineers & Scientists,* ed. U.S.R. 8th
579 Edition. Pearson Education International. 2007.
- 580 21. EN 12211, *Windows and doors - Resistance to wind load - Test method* 2000: European
581 committee for standardization, Brussels.
- 582 22. BKS 523.251, *Bindingsverk av tre i sm  hus. Dimensjonering og utf  relse.* 2014: SINTEF
583 Building and Infrastructure, Oslo.

- 584 23. Fagerholt, E., *Field Measurements in Mechanical Testing Using Close-Range Photogrammetry*
585 *and Digital Image Analysis*. , in *Doctoral thesis at NTNU, Department of Structural*
586 *Engineering*. 2012.
- 587 24. Maassen, W., M.A.R. Meier, and N. Willenbacher, *Unique adhesive properties of pressure*
588 *sensitive adhesives from plant oils*. *International Journal of Adhesion and Adhesives*, 2016.
589 **64**: p. 65-71.
- 590 25. Jelle, B.P. *Evaluation of Building Products by Conducting Accelerated Climate Ageing in the*
591 *Laboratory*. in *XII International Conference on Durability of Building Materials and*
592 *Components*. 12-15 April 2011,. Porto, Portugal.

593

594