

Faculty of Natural Science and Technology
Department of Physics



MASTER'S THESIS FOR

STUD. TECHN. EMIL NYGAARD NILSEN

Thesis started: 19.01.2009
Thesis submitted: 15.06.2009

DISCIPLINE: PHYSICS

Norsk tittel: *“Prøvecelle med kontrollert temperatur og luftfuktighet for røntgenspredning på tekstilprøver.”*

English title: *“Controlled humidity and temperature sample cell for x-ray scattering on textile samples.”*

This work has been carried out at NTNU, under the supervision of Dag Werner Breiby.

Trondheim, 15.06.2009

Dag Werner Breiby

Responsible supervisor

Associate Professor at Department of Physics

Abstract

A test cell for x-ray scattering on textile samples under controlled humidity and temperature has been built. The system contains three independent parts, a sample cell, a humidifying system and a sample holder. The sample cell has been built with connections for measuring instruments, a copper tube for cooling/heating fluid, nipples for gas in and outlet, two K-type thermocouples and with a $\frac{17\pi}{9} = 340^\circ$ azimuth angle and $\approx \frac{10\pi}{23} \approx 78.2^\circ$ zenith angle geometry. The humidifying system has been built using two bubble bottles and the ability to control the relative humidity between 0 and 97 % RH at room temperature has been demonstrated. A peltier element equipped sample holder has been built and has been shown to operate from room temperature to 70 °C.

Sammendrag

En testcelle for røntgenspredning på tekstilprøver med kontrollert temperatur og luftfuktighet har blitt bygd. Systemet består av tre uavhengige deler, en prøvecelle, et luftfuktningssystem og en prøveholder. Prøvecelle har blitt bygd med kontakter for instrumenter, et kobberrør for kjøle/varmevæske, nippler for inn og utførsel av gass, to termoelementgivere av K-typen og med en geometri med $\frac{17\pi}{9} = 340^\circ$ asimutvinkel og $\approx \frac{10\pi}{23} \approx 78.2^\circ$ senitvinkel. Luftfuktningssystem har blitt bygd av to bobleflasker og det har blitt vist at systemet er i stand til å regulere luftfuktigheten mellom 0 og 97 % RH ved romtemperatur. En prøveholder med påmontert peltierelement har blitt bygd og det har blitt vist at denne kan operere mellom romtemperatur og 70 °C.

Preface

"Was wir mathematisch festlegen, ist nur zum kleinen Teil ein objektives Faktum, zum größeren Teil eine Übersicht über Möglichkeiten."
(Werner Heisenberg)

This report has been written as the master thesis for the Master of Science in engineering program at The Norwegian University of Science and Technology (NTNU). The project is written as the subject TFY4900 - Physics, Master Thesis in the 10th semester of the curriculum and is given 30 ECTS-credits.

I would like to thank everyone who have helped me during this project. I specially have to thank my supervisor, associate professor Dag W. Breiby at the NTNU for all the help given during this thesis. I would also like to thank professor emeritus Frode Mo for sharing his experience in building a temperatur and humidity controlled test cell. I also have to thank my father, Stein E. Nilsen for helpful discussions and aid regarding turning, drilling, milling and other machining related topics. A warm thank goes to the electronics workshop at the department of physics, NTNU, for all the help, guiding, good ideas and problem solving spirit. Last I have to thank the crew of D5-175 at NTNU for all the help and the useful discussions during the project.

Emil Nygaard Nilsen

Trondheim, June 2009

Contents

1	Introduction	1
1.1	Material science	1
1.2	The research council of Norway, NFR	1
1.3	ColdWear	2
1.4	The assignment given	2
2	Theory	5
2.1	Materials	5
2.1.1	Kapton	5
2.1.2	PEEK	5
2.2	Humidity	6
2.3	Thermal properties	6
2.3.1	Thermal conduction	6
2.3.2	Thermoelectricity	7
3	Design Concepts	9
3.1	System geometry design	9
3.1.1	Related cell design	9
3.1.2	The chosen cell design	10
3.1.3	Gas cooler/heater	13
3.2	Sample hotplate	13
3.3	Humidifying system	13
4	The test cell	17
4.1	The sample cell	17
4.2	Gas humidifier	20
4.3	The sample holder	23
4.4	Data acquisition card	23
5	Testing the cell	25
5.1	Relative humidity	25
5.2	The sample holder	32
5.3	Pump	35

6	Discussion	37
6.1	The finished test cell system	37
6.2	The tests and measurements made	37
6.2.1	Humidity	37
6.2.2	Sample holder	38
6.3	Improvements	39
6.3.1	Thermocouples	39
6.3.2	Humidifying system	40
6.3.3	Sample holder	40
6.3.4	Control system	41
6.3.5	Gas cooler/heater	41
7	Experiences	43
7.1	Mechanical workshop	43
7.2	Electronics workshop	44
7.3	Curriculum	44
8	Conclusion	45
A	Drawings	47
B	Data sheets	57
B.1	8P8C socket	57
B.2	Humidity sensor	59
B.3	Peltier element	66
B.4	DAQ	79
B.5	K element preamplifier	85
B.6	Cellkraft P-Series	89
C	Cell geometry	95

Chapter 1

Introduction

1.1 Material science

Material science is one of the oldest forms of science, as engineering and applied science. As human science evolved, so did material science. During the 20th century material science slowly changed. In the beginning of the century metallurgy was given almost all the attention in the discipline of material science due to the importance of metals. As the focus broadened, crystal solid states were still the most important. But in the middle of the 20th century other fields of what is now called condensed matter physics was explored. Polymers, ceramics and liquid crystals are examples of fields receiving increased attention during this period. The last couple of years the possibility to tailor materials to specific needs have become more and more evident. Therefore fields of material science such as nano-structured and functional materials are receiving a lot of attention. This has led to new technological advances such as displays made of organic light emitting diodes (OLED) and the use of silver nano-particles against bacteria due to its bacteriostatic/bactericidal property.

1.2 The research council of Norway, NFR

The research council of Norway is an organisation with the goal of advising the Norwegian government in matters regarding research. It is also receiving funding through the government budgeted to fund research projects. Its choices in funding projects are based upon the research strategy of the Norwegian government. The Norwegian government has shown an increased interest in new materials. In a report from 1998 [1] some main areas of focus for Norwegian research were mentioned, but material science was not among those. But in 2002 research on new materials got dedicated funding and in 2005 the Norwegian government decided that new materials and nanotechnology should be one of three main focus areas for technological development [2].

NFR also establishes interdisciplinary research programs in areas it thinks deserve attention. In 2006 NFR decided to start such a research program focusing on the high north [3].

1.3 ColdWear

Sintef has an ongoing research program concerning textiles and clothing for arctic environments. The name of the project is ColdWear and the goal is to expand knowledge on smart materials and instrumentation to develop clothing improving safety, performance and comfort for workers exposed to the environment in the high north. Being in the intersection of material science and applications in the high north it has been awarded funding from NFR. Industrial partners in the project are Wenaas AS, Swix Sport AS, Janusfabrikken AS, and StatoilHydro. Non-industrial partners are The Norwegian Defence Logistics Organisation, The Norwegian Oil Industry Association and The Norwegian Police Logistics Organisation. The total budget for the 2008-2011 ColdWear project is NOK 17.1 million. Part of the research is carried out at NTNU.

According to literature [4] temperature and humidity were suggested as important factors for human comforts at the end of the 19th century. Experimental evidence supporting this was published in the beginning of the 20th century. Later on temperature and humidity "comfort zones" were established relating certain temperature and humidity levels to human comfort. Today air temperature and humidity are well accepted as the two most important factors concerning clothing and human comfort. It is desirable to get a better understanding of how different materials for clothing respond to changes in humidity and temperature. Therefore a test cell for x-ray scattering on textile samples under controlled climatic conditions was sought.

1.4 The assignment given

The task is to design and test a sample cell for organic samples under controlled climatic conditions.

The system should have temperature and humidity control. The gases involved should mainly be water vapour and air or nitrogen. It must be possible to seal the cell tight.

It should have a practical design, the size should permit to transport the cell, e.g. to synchrotron x-ray sources, the geometry should allow the x-ray beam to enter and exit the cell with an acceptable scattering angle.

It should be stable, mechanically and also regarding the chosen climatic conditions.

The mounting of samples should be simple, reproducible and done with high mechanic accuracy.

It should be possible to visually observe the sample without opening the cell.

It must have the necessary electronics, pc-connection and gas supply.

The most interesting samples for the ColdWear project are textile samples and are of sizes less than 20 by 20 mm². They can be filaments, fibre, patches of woven material, or other textile samples on a substrate. The most interesting temperature range is from

10 °C to around body temperature.

The main part of this project is the drawing, construction and testing of this test cell.

Chapter 2

Theory

Some of the materials used in this project will be presented here along with some theory and definitions useful for the understanding of this report.

2.1 Materials

2.1.1 Kapton

Kapton is a DuPont brand name for poly(4,4'-oxydiphenylene-pyromellitimide). The kapton monomer is shown in fig. 2.1. Kapton is produced as transparent polymer films with an orange colour. According to C. E. Sroog [5] the glass transition temperature and the melting point are $T_g = 385$ °C and $T_m = 595$ °C, respectively. The polymer film has an high x-ray transmittance and shows close to no radiation degradation. Therefore the material is often used for x-ray windows in beam paths and detectors.

2.1.2 PEEK

PEEK is short for polyetheretherketone, a polymer with a monomer as shown in fig. 2.2. The polymer is semi-crystalline with a glass transition temperature and a melting point of $T_g = 145$ °C and $T_m = 334$ °C, respectively [6]. PEEK is a polymer often used in

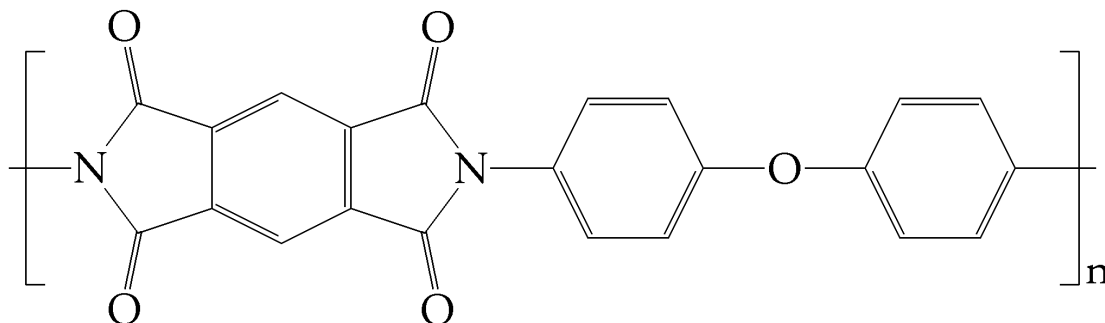

Figure 2.1: The kapton monomer [6].

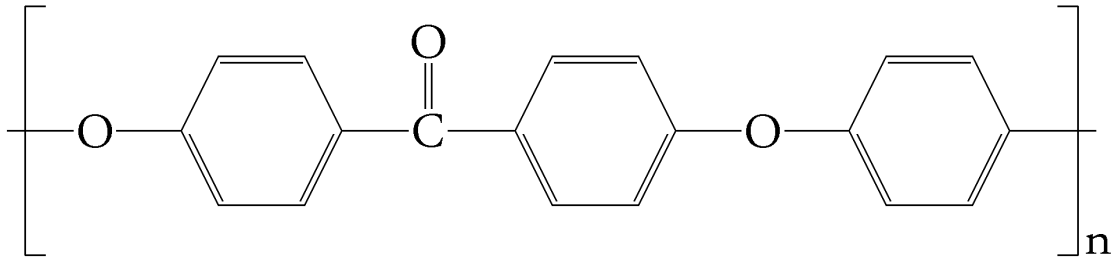

Figure 2.2: The PEEK monomer [6].

engineering applications due to its high melting point, low thermal degradation and also due to a low thermal conductivity.

2.2 Humidity

The measure for humidity used in this text is the relative humidity, RH, is defined as

$$RH = \frac{p_{H_2O}}{p_{H_2O}^{sat}} \cdot 100 \% \quad (2.1)$$

where p_{H_2O} is the partial pressure of water vapour and $p_{H_2O}^{sat}$ the saturation vapour pressure.

2.3 Thermal properties

2.3.1 Thermal conduction

When two points in a material are having different temperatures there is normally a flow of heat between those points and the heat flow rate, Φ , and the heat flow rate density, \mathbf{q} , are defined as:

$$\Phi = \frac{dQ}{dt} \quad (2.2)$$

$$\mathbf{q} = \frac{d\Phi}{d\mathbf{A}} \quad (2.3)$$

where Q is heat, t time and $d\mathbf{A}$ a surface element [7]. As different materials have different heat conducting properties one can introduce the thermal conductivity, $\boldsymbol{\kappa}$:

$$\mathbf{q} = -\boldsymbol{\kappa} \cdot \nabla T \quad (2.4)$$

where T is the temperature [8]. $\boldsymbol{\kappa}$ is a second rank tensor, but for isotropic materials this can be reduced to a scalar. The thermal conductance, G , between two points A and B, is defined as:

$$G = \frac{\Phi}{\Delta T} \quad (2.5)$$

where ΔT is the temperature difference between the two points [9]. The thermal conductance between two ends the distance L apart of an isotropic, homogeneous conductor of constant cross section, A , can be rewritten using equ. 2.3 and equ. 2.4 as:

$$G = \frac{\Phi}{\Delta T} = \frac{\int \mathbf{q} d\mathbf{A}}{\Delta T} = \frac{-\int \kappa \cdot \nabla T d\mathbf{A}}{\Delta T} = \frac{\kappa \cdot A}{L} \quad (2.6)$$

2.3.2 Thermoelectricity

Some definitions of thermal conduction have already been stated analogue to electric conduction. These two effects can be treated separately if only one occur at the time. But when both occur simultaneously they are coupled and a more thorough treatment is necessary. For isotropic materials thermoelectricity can be divided into three effects, the Seebeck effect, the Peltier effect and the Thomson effect.

The Seebeck effect relates a voltage to a temperature gradient. When an electrically conducting material is subjected to a temperature gradient an e.m.f. occurs. A coefficient called the Seebeck coefficient, S , relating the e.m.f. and the temperature difference is defined as:

$$S = \frac{dE}{dT} \quad (2.7)$$

where E is the e.m.f. and T the temperature [10]. If the junctions of a conducting circuit of 2 homogeneous conductors A and B are subjected to a temperature difference the resulting e.m.f. is derived by integration of equ. 2.7:

$$E = \int_{T_1}^{T_2} (S_A(T) - S_B(T)) dT \quad (2.8)$$

where T_1 and T_2 are the temperatures at the junctions and S_A and S_B the Seebeck coefficients of material A and B. As S_A and S_B are functions of temperature, the output e.m.f. is non-linear with respect to temperature. The output e.m.f. is exploited in measuring-devices called *thermocouples*. A circuit of two conductors is placed with each junction where a temperature difference measurement is desired. The voltage across one of the junctions is measured and the temperature difference deducted. If one of the junctions is placed at a known temperature the temperature of the other junction can be deducted. To compensate for temperature fluctuations at room temperature, mostly used as the known temperature, a cold junction device is often used. This device compensates for fluctuations, giving a stable reference voltage. There are many different thermocouples commercially available, the most used one is named "K-type". A K-type thermocouple is made out of nickel chromium and nickel aluminium alloys and has a typical output of approximately 40 $\mu\text{V}/\text{K}$ [11].

The Peltier effect occurs when an electric current, I , is allowed to flow across a junction of two different materials A and B. To maintain a constant temperature at the junction there must be a flow of heat:

$$\Phi = \Pi_{AB} \cdot I \quad (2.9)$$

where Π_{AB} is a temperature and material dependent coefficient [12]. This flow of heat can be used for cooling or heating. Commercially available devices called peltier elements are used to this end. As this is a reversible effect a temperature difference can be used to produce a current. This is to a small extent used for energy production, often to harvest waste heat where the temperature differences usually are small, much in the same way sterling engines are used for high temperature differences.

The Thomson effect occurs when a current flows in a conductor with a temperature distribution. If a current flows in a homogeneous conductor of constant cross section a heat flow must exist to keep the temperature distribution:

$$d\Phi = \tau \cdot I \cdot dT \quad (2.10)$$

where τ is a temperature dependent material coefficient called the Thomson coefficient [13].

With the introduction of tensors this formalism can be extended to also describe those effects in anisotropic materials.

Chapter 3

Design Concepts

The design and conception part of this project have been quite challenging. It has been multidisciplinary work, using knowledge spanning from x-ray scattering to control and feedback systems. All disciplines had to come together and take the others into account. While one technical solution might seem superior from one point of view, it might be discarded due to the lack of compatibility with other demands. An example was the idea to use salt solutions to control the humidity. This would give a stable humidity level, but difficult to change within desired time frames. During the entire project the possibility to incorporate all solutions into a control system was very important. Other areas that were given attention were the measurements of environment inside the cell, the mechanical stability, the usability of the finished cell and adaptability to other areas of use than x-ray scattering, e.g. experiments using visible light or measurements of electrical properties of the samples.

3.1 System geometry design

The first part of the conception work was to decide the geometry of the test cell. Several ideas were brought forward, and of those a rectangular cuboid shaped and a cylindrical test cell seemed the most promising. Those concepts were considered in greater detail and the pros and cons of those concepts were compared. Regarding the design criteria both seemed fairly equal, except that the cylindrical geometry seemed to offer a larger solid angle for the scattered beam and it also offered the possibility to rotate the cylinder around its axis. Exploiting the latter could offer an easy way of rotating the sample in situ. Therefore the cylindrical geometry was chosen.

3.1.1 Related cell design

The first suggestion for a cylindrical cell was to construct a cell very similar to the one used by F. Mo and K. Ramsøskar [14] and make minor changes to adapt it to the present needs. The main advantage of this approach was that this cell had already been used and several technical problems already solved. This system was, in summary, a base plate built around a goniometer. The goniometer was used for sample mounting while the base plate contained a gas cooling system based on peltier elements. The gas was

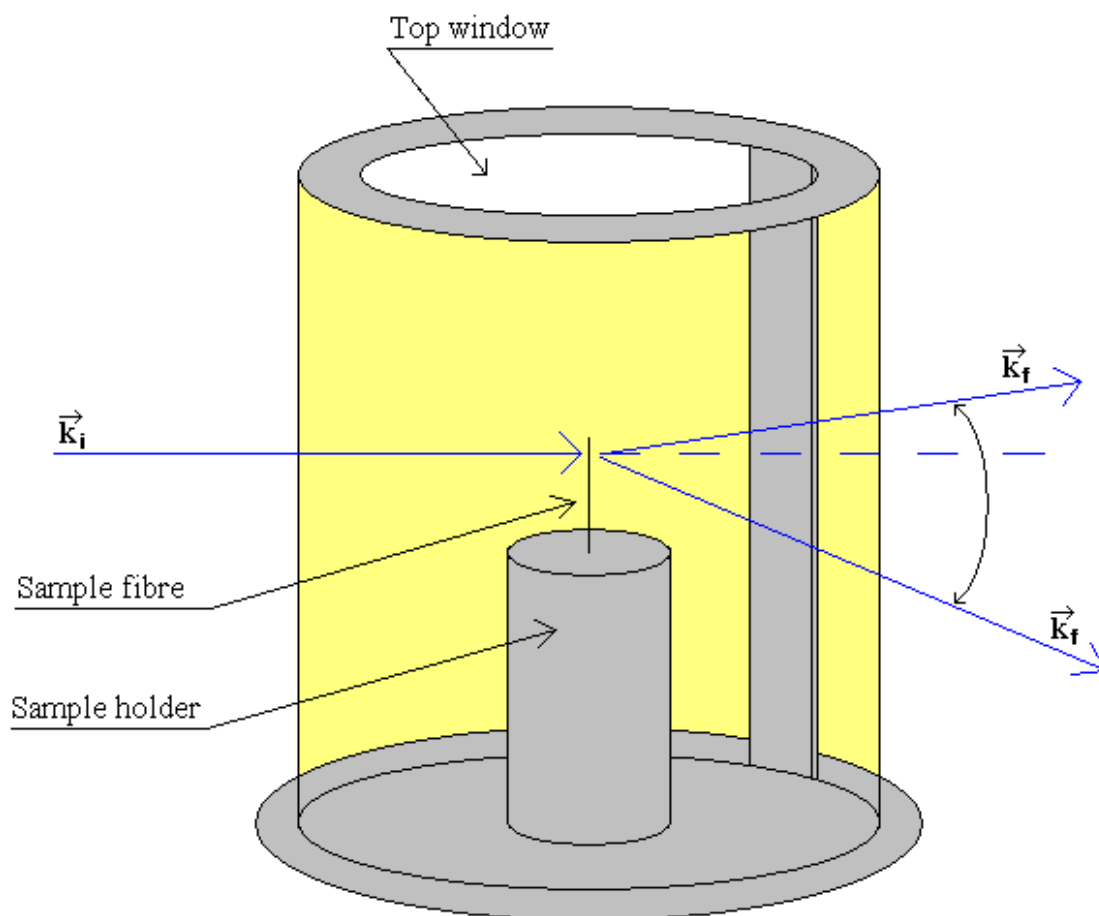

Figure 3.1: The planed test cell geometry. A cylindrical cell with metal base plate and metal top. In between the cylinder wall was planned to be made out of kapton. At the top a window was planned for observation of the samples in situ.

led from this cooling system to the sample in-between two truncated cones made out of copper. Both cones were thermally insulated from the exterior. The idea behind this design was to create a laminar gas flow with low thermal gradients. This cell was covered with a kapton cone. This suggestion was *not* chosen due to the needs to adapt the cell to different experiments. A solution having more space for sample mounting and different sensors was sought.

3.1.2 The chosen cell design

A suggestion of a more versatile cell was made to meet those requirements. This was a cell with metal top and bottom and with kapton in between. It was also planned to fit a window at the top to enable observations of the sample in situ, as seen in fig. 3.1

Due to the humidification requirements, it was considered to construct the test cell in three independent parts. This idea is shown in fig. 3.2. This design consisted of a system with a sample cell containing the sample and the necessary sensors, a gas humidifier for

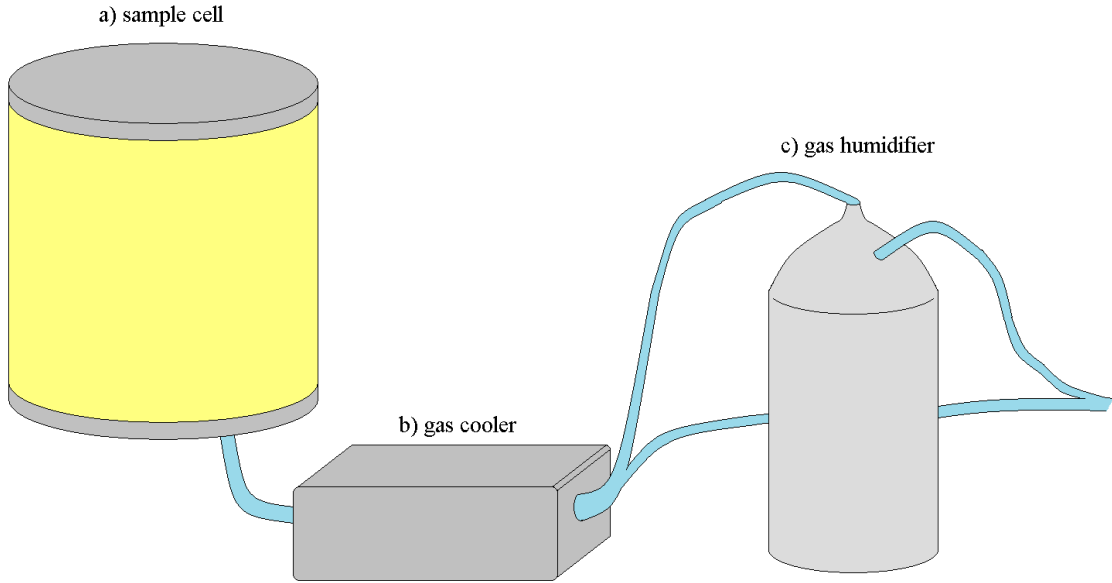

Figure 3.2: The concept of a three piece system with three independent parts: a) a sample cell, b) a gas cooler/heater and c) a gas humidifier.

controlling the humidity entering the sample cell and a gas cooler/heater to control the gas temperature.

The sample chamber was suggested to be cylindrical with a baseplate and an interchangeable cap. As materials with a high x-ray transmittance do not necessarily have an high visible light transmittance a change of material for the beam windows might be needed when changing between x-ray and visible light experiments. The reason for an interchangeable cap was to ensure the possibility of easy changing of such experimental methods. The plan was to make the sides of the cap out of kapton and the top and bottom in aluminium with a glass window in the centre of the top, as mentioned above. This idea can be seen in fig. 3.3

The base plate was to be made out of stainless steel and containing a centrepiece to install a goniometer as a sample holder. Plans for the necessary vias for gas inlet and outlet and for cooling/heating fluid inlet and outlet was also made as seen in fig. 3.4. The cooling/heating fluid inlet was planned to contain nipples on the inside for mounting and changing of different copper pipes depending on the experimental needs. This design suggestion was later changed to a fitting for changing the entire copper pipes. One other plan was to connect a thermal conductor to the copper pipes to easily control the temperature in close proximity to the sample. It was planned to equip the base plate with electrical connectors to mount different sensors inside the sample cell. The first technical drawings contained a 50 mm long, 25 mm diameter extension on the underside. This was thought to be used to fasten the cell during testing of the cell and also during later experiments. This was changed to only a small threaded extension (8 mm M6) to enable fastening to specialized mounting systems for different experimental set-ups, e.g. holders in fixed x-ray beam paths.

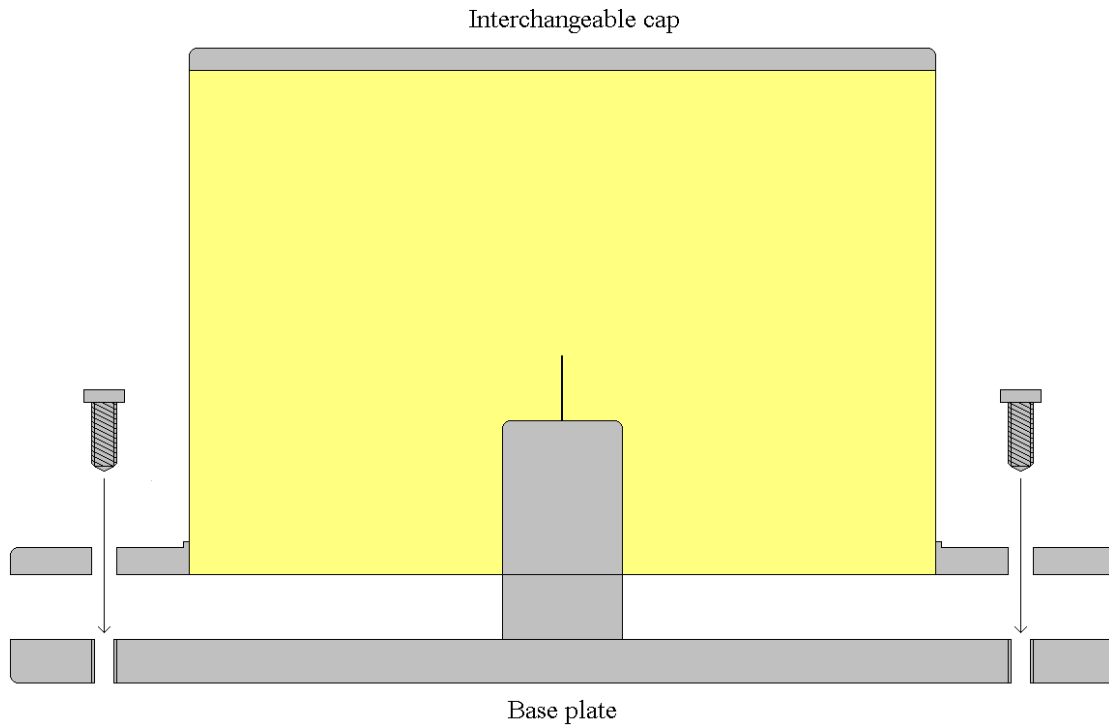

Figure 3.3: Conceptual design of a sample cell with interchangeable cap.

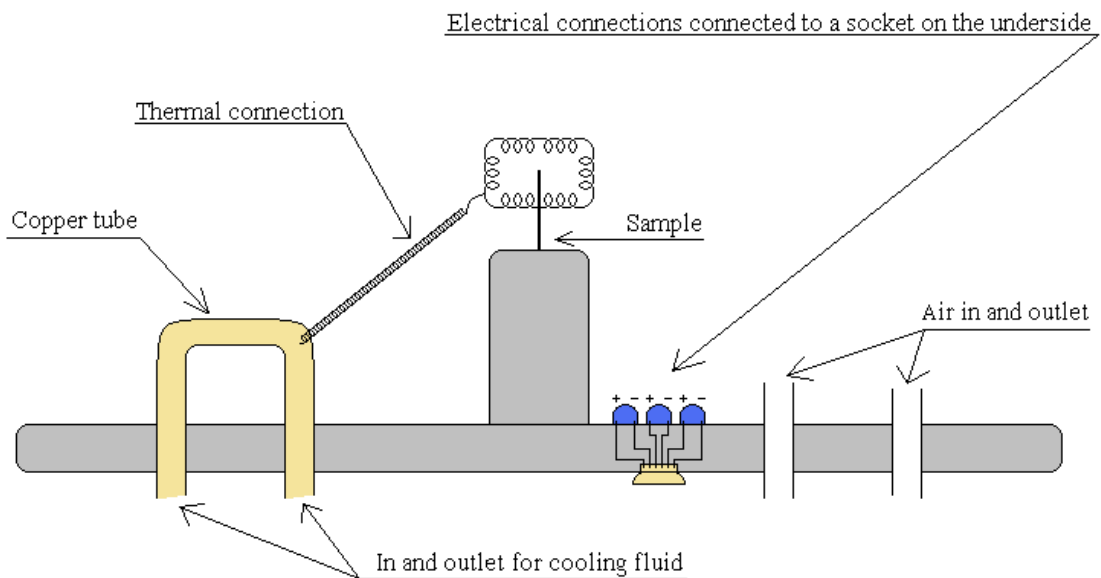

Figure 3.4: The base plate of the sample chamber.

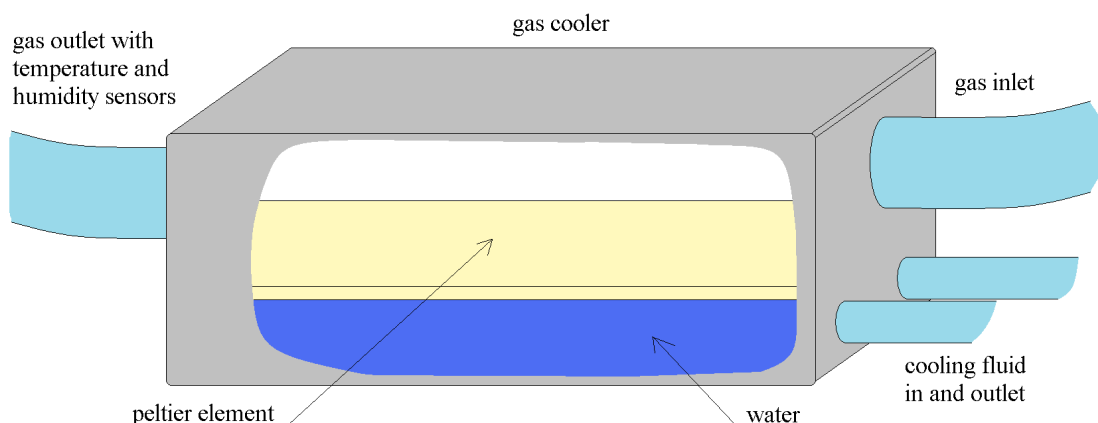

Figure 3.5: Heat exchanger design for cooling/heating the gas.

3.1.3 Gas cooler/heater

Plans for a gas cooling/heating system were also made. This system was planned to be made using a peltier element to either cool or heat the gas. The plan was to place this in the very proximity of the sample cell gas inlet to minimize temperature gradients caused by the low specific heat capacity of air. The system should be equipped with a liquid system to either cool or heat the side of the peltier element not in contact with the gas, as shown in fig. 3.5.

3.2 Sample hotplate

A cooled/heated sample holder was designed. The samples were planned to be mounted on a copper piece fastened to a copper disk. Underneath this disk a peltier element should be fitted to control the sample holder temperature. The idea was to fasten another copper disk on the underside of the peltier element and thermally connect this disk to the cooling/heating fluid copper tubes inside the sample cell. This sample holder was designed to be thermally insulated from and mounted on a goniometer. The mounting system was designed to be fastened on the upper side of the upper copper disk. This was to ensure minimal displacement of the upper side of the upper copper disk due to thermal expansion, i.e. to minimize the displacement of the samples. The heated sample holder can be seen in fig. 3.6 and the thermal expansion concept is shown in fig. 3.7.

3.3 Humidifying system

Another important step was to decide on the control system for the humidity. A closed cell with no gas exchange is of course an easy way to obtain a steady and well known humidity, using for example salt solutions. But this offers no evident way of changing the humidity in situ. Therefore, and also due to the need of incorporating the necessary equipment for heating, humidification and measuring, led to the concept of humidifying the gas outside the sample cell and then introducing this gas into the cell. For the

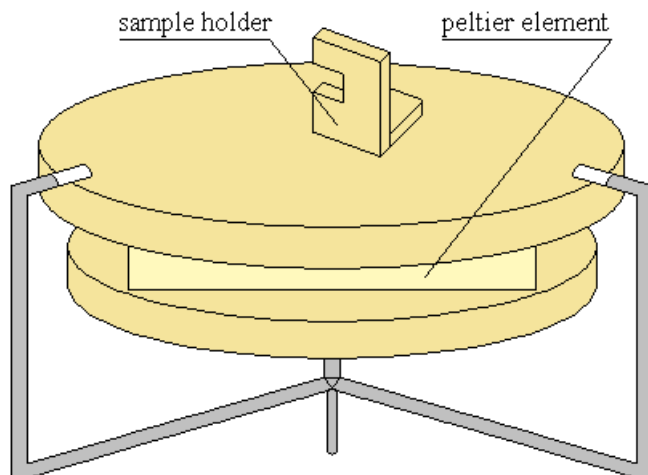

Figure 3.6: The conceptual idea for a heated sample holder.

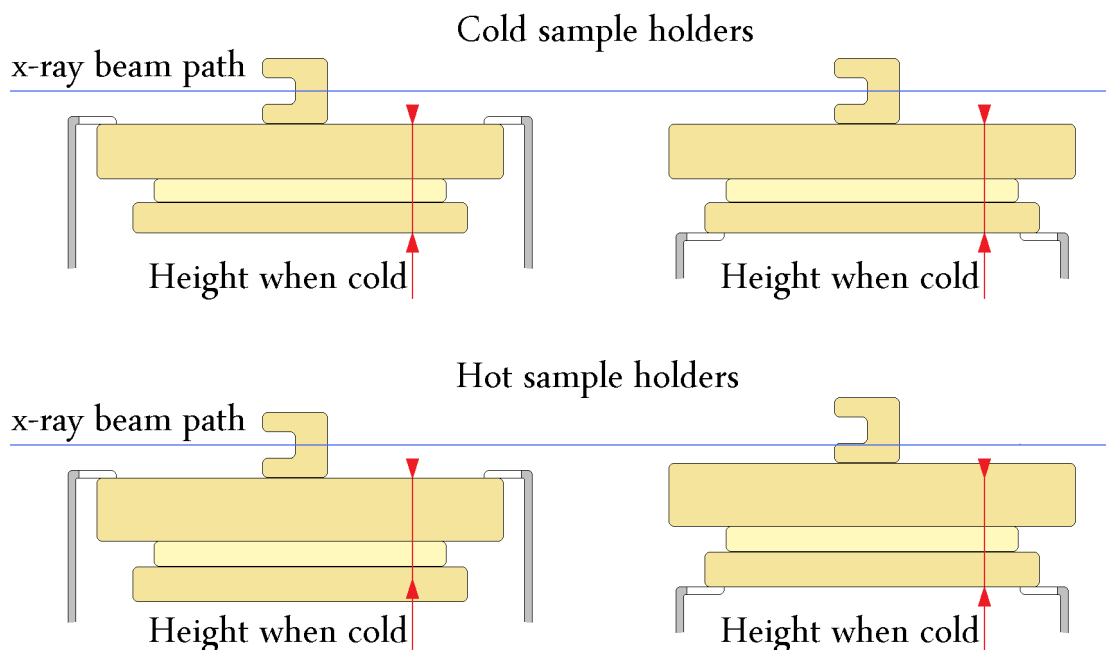

Figure 3.7: The concept of minimizing the sample displacement due to thermal expansion. At the top cold sample holders are shown, to the left with the holder mounted on the upper side of the top copper disk and to the right with the holder mounted on the underside of the lower copper disk. At the bottom the corresponding hot holders are shown. For the top mounted sample holder, the sample is still in the beam path when heated, while for the bottom mounted holder the sample displacement might cause inconvenient displacements. The sample holder height when cold, indicated in red, is the same in every figure.

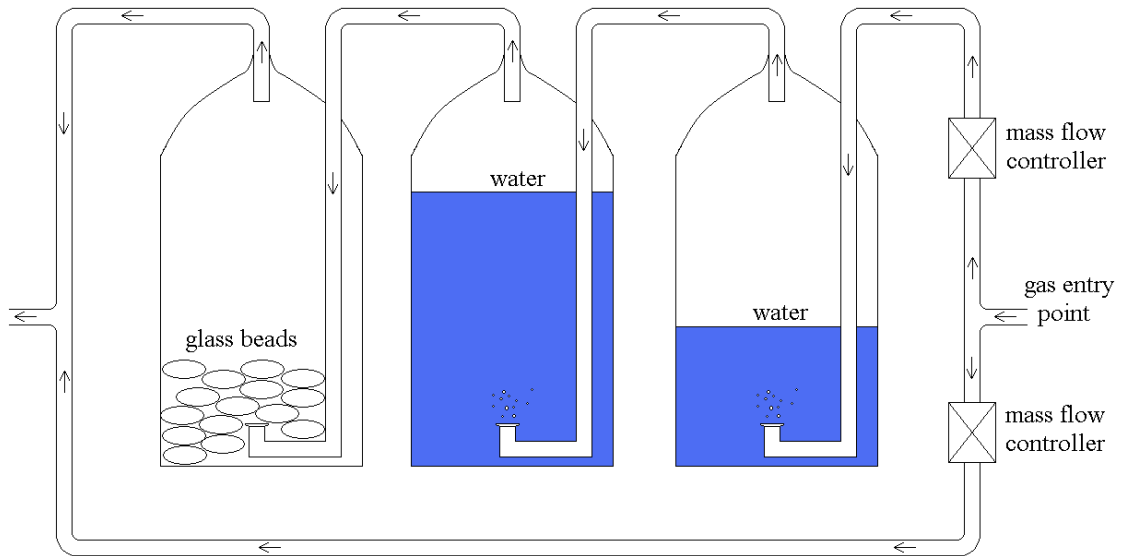

Figure 3.8: The gas humidifying system. A gas stream is split into two partial streams. One is left untreated while the other is led through a series of bubble bottles. Controlling the mass flow of each stream enables the control of the humidity at the exit point.

humidifying both options of buying a humidifying system possibly with temperature control or building one was considered. Of the commercial available systems the Cellkraft P 10 seemed like a reasonable choice due to its ability to deliver a sufficient amount of gas with the option of built in temperature control. The data sheet of the Cellkraft P 10 is shown in Appendix B.

External humidification systems have been built and used, by both M. Kim et. al. [15] and K. Linnow et. al. [16]. It was decided to build a simplified version of such systems and test it and expand the system later on if needed. The gas humidifier was therefore suggested to be made by splitting a dry gas stream into two partial streams. Then one of the partial streams should be led through bubble bottles while the other partial stream should be left untreated as seen in fig. 3.8. It was planned to lead the treated stream through a bottle with glass beads if problems with supersaturated gas occurred. The two partial streams should be mixed together and by controlling the mass flow of each stream one should be able to regulate the gas humidity.

Chapter 4

The test cell

In the following the finished test cell system will be presented. The test cell system consists of three different parts: a sample cell, a gas humidifier and a sample holder. Together they constitute the test cell system. But each of the three parts can also be used independently of the others. The entire system is shown in fig. 4.1. In this picture the sample holder is mounted on the sample cell base plate.

4.1 The sample cell

The finished sample cell consists of a base plate and an interchangeable cap. These parts have been manufactured at the NTNU mechanical workshop. Technical drawings can be seen in Appendix A.

The upper side of the base plate is shown in fig. 4.2 (a). Close to the outer rim there are 8 M6 screw holes for tight fastening of the top cap. Inside the holes an 112 x 3 mm O-ring is placed to secure sealing of the sample cell when closed. There are two Rexroth-Mecman 2121-0-0818-0 G 1/8 nipples for 8 mm outer diameter tubes. Those are for gas in and outlet and enable the fastening of tubes to define the gas inlet and outlet point anywhere inside the cell. The threaded part of those were cut slightly to have enough space to fasten from both sides. This can be seen in fig. 4.3 (a). A 10 mm copper tube is also present. It is for cooling/heating fluid. There are also 3 AMP 0-0555052-1 8P8C sockets for connection of electrical equipment inside the cell. A technical drawing is shown in Appendix B. Two APPA 50BK K-type thermocouples for temperature measurements are permanently fastened to vias in the base plate. The reason they are permanently fastened is to secure sealing of the sample cell. Aquarium-type silicone was used to seal the thermocouples and the 8P8C sockets. In the centre of the base plate there is a 25 mm diameter centrepiece. This contains two screw holes for mounting of a goniometer fastening piece. This piece can be seen in fig. 4.3 (b)

The underside of the sample cell is shown in fig. 4.2 (b). It contains the corresponding items to the upper side; nipples for gas in and outlet, 8P8C sockets, the thermocouple wires and both ends of the copper tube. In the centre there is a 8 mm M6 for fastening of the cell to experimental holders, e.g. a holder in a x-ray beam path.

A cap for the sample cell has also been made. This cap is shown in fig 4.4. The top



Figure 4.1: Picture of the entire test cell system. The sample cell can be seen to the left with the cap in front of the baseplate. The sample holder is mounted on the baseplate. In the middle the cooling/heating fluid pump can be seen with its 12 V power supply visible behind. To the right the bobble bottles of the gas humidifier is seen.

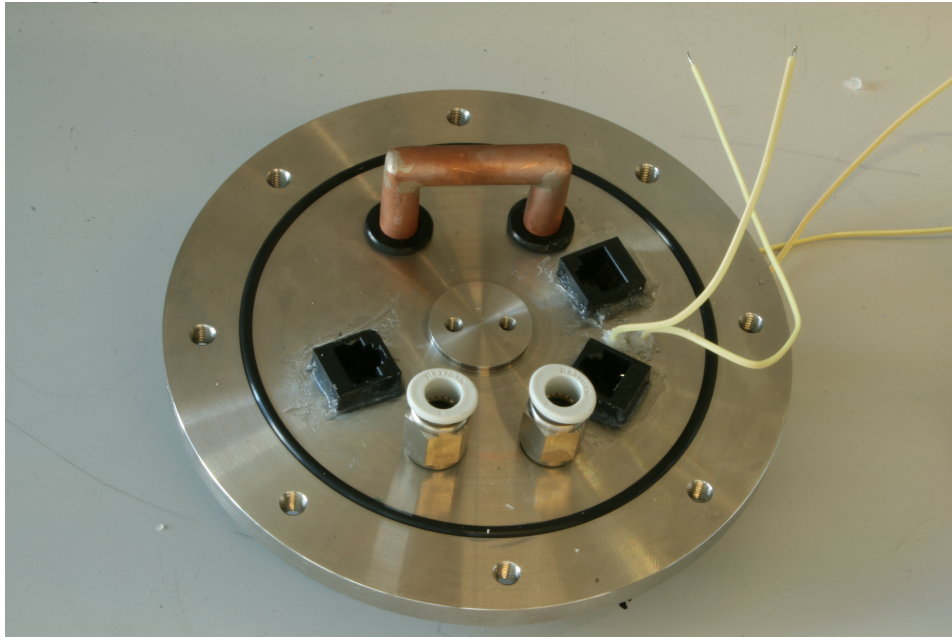

(a) Picture of the upper side of the baseplate. A black O-ring can be seen inside the 8 screw holes. Inside the O-ring and at the bottom there are 2 G 1/8 nipples. To the right two K-type thermocouples with yellow cables can be seen. There are three 8P8C sockets, two to the right and one to the left. At the top there is a copper tube for cooling/heating fluid, meant to work as a thermal sink. The centrepiece is for mounting of a goniometer.

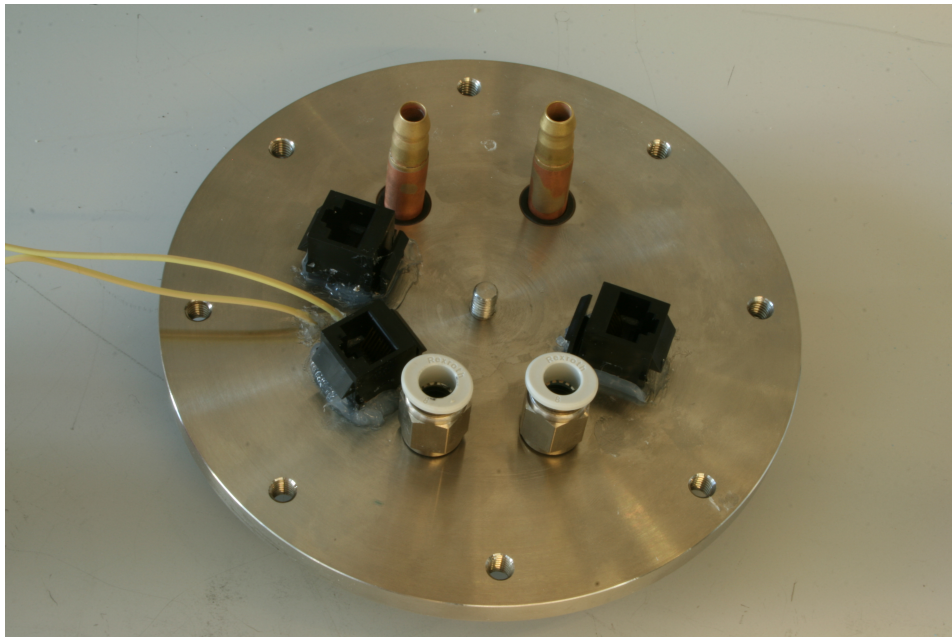

(b) Picture of the underside of the baseplate. One can see the same connections as on the upper side, the 3 8P8C sockets, the 2 nipples and the 2 yellow thermocouple cables. Both ends of the copper tube are also visible at the top. In the centre there is a M6 pin.

Figure 4.2: The sample cell baseplate.



(a) G 1/8 nipples.

(b) Goniometer fastening piece.

Figure 4.3: In (a) an uncut nipple to the left and a cut one made to fit the sample cell base plate to the right. (b) shows the goniometer fastening piece to be fastened to the centrepiece of the baseplate.

and bottom of the cap are made out of aluminium while the cylinder wall is made out of kapton. At the bottom of the cap there are 8 holes for fastening of the cap to the base plate and in the centre of the top a glass window is fitted.

For the cooling/heating fluid a pump is shown in fig. 4.5 (a). 8 mm outer diameter, 5 mm inner diameter silicone tubes are used together with a 12 V pump and a power supply.

An Honeywell HIH-4000-002 RH sensor with the wires attached to a 8P8C plug has been prepared. The data sheet of this sensor is found in Appendix B. The contacts of 8P8C plug not used by the humidity sensor have been attached to wires for the option of attaching more sensors at a later stage.

4.2 Gas humidifier

The gas humidifier is made out of two bubble bottles connected in series as seen in fig. 4.6. They are made out of 1.5 l bottles with aquarium-type air diffusers to produce small bubbles and thus increase the gas-fluid interface. The tubes are the above-mentioned silicone tubes. There is a light press fit for the tubes in the bottle caps and the holes are placed to facilitate easy drilling of a new hole for water refilling as seen in fig 4.5 (b). At the gas entry point of the humidifier there is a y-bend splitting the gas stream in two. One is lead trough the bubble bottles, the other is left untreated. Close to the y-bend there is fitted a manual valve on each of the partial streams to control the individual flows. At the gas exit point of the humidifier there is another y-bend to combine the two partial streams.

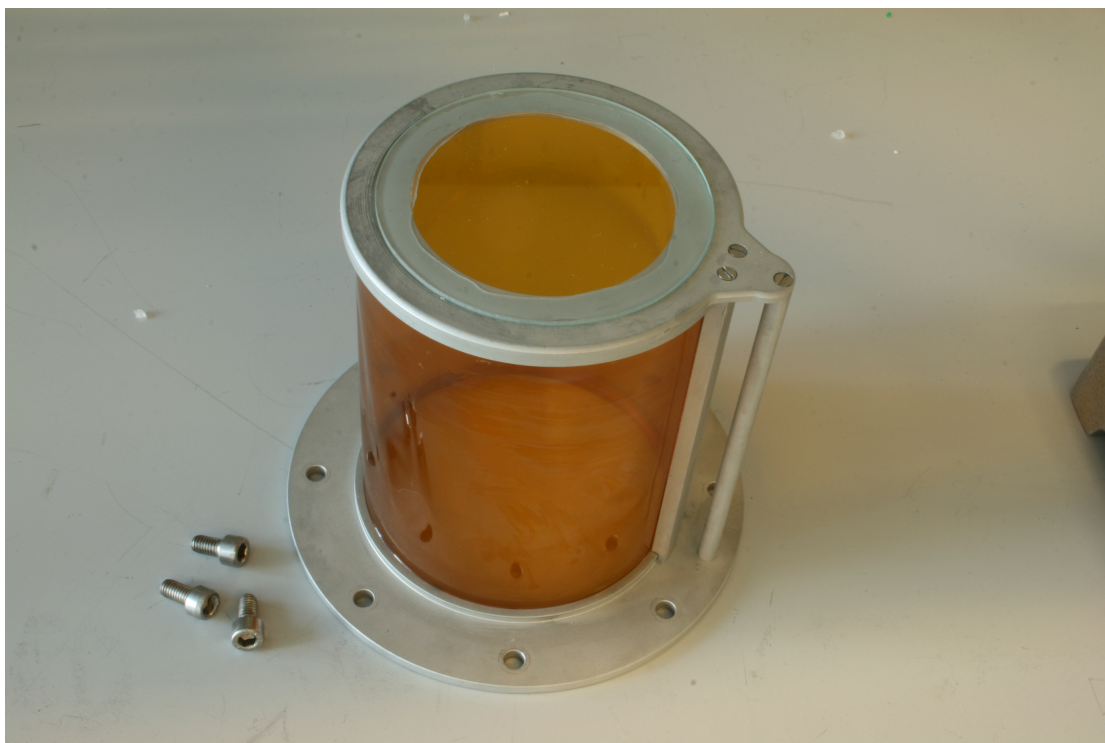
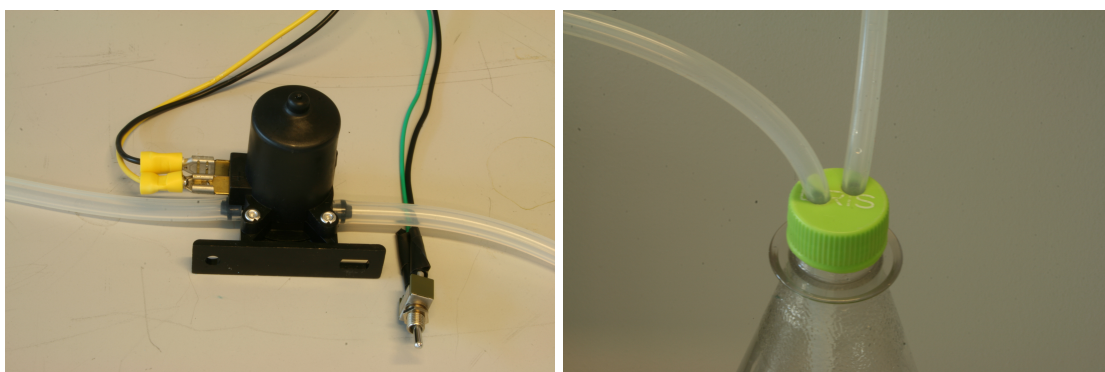

Figure 4.4: Picture of the sample cell cap. The walls are of kapton, while the top and bottom are made out of aluminium. In the centre of the top a glass window is fitted.



(a) Pump.

(b) Cap.

Figure 4.5: In (a) the cooling/heating fluid pump is shown. A bubble bottle cap is seen in (b). The inlet and outlet are placed to leave enough space for a third hole for refilling of fluid.

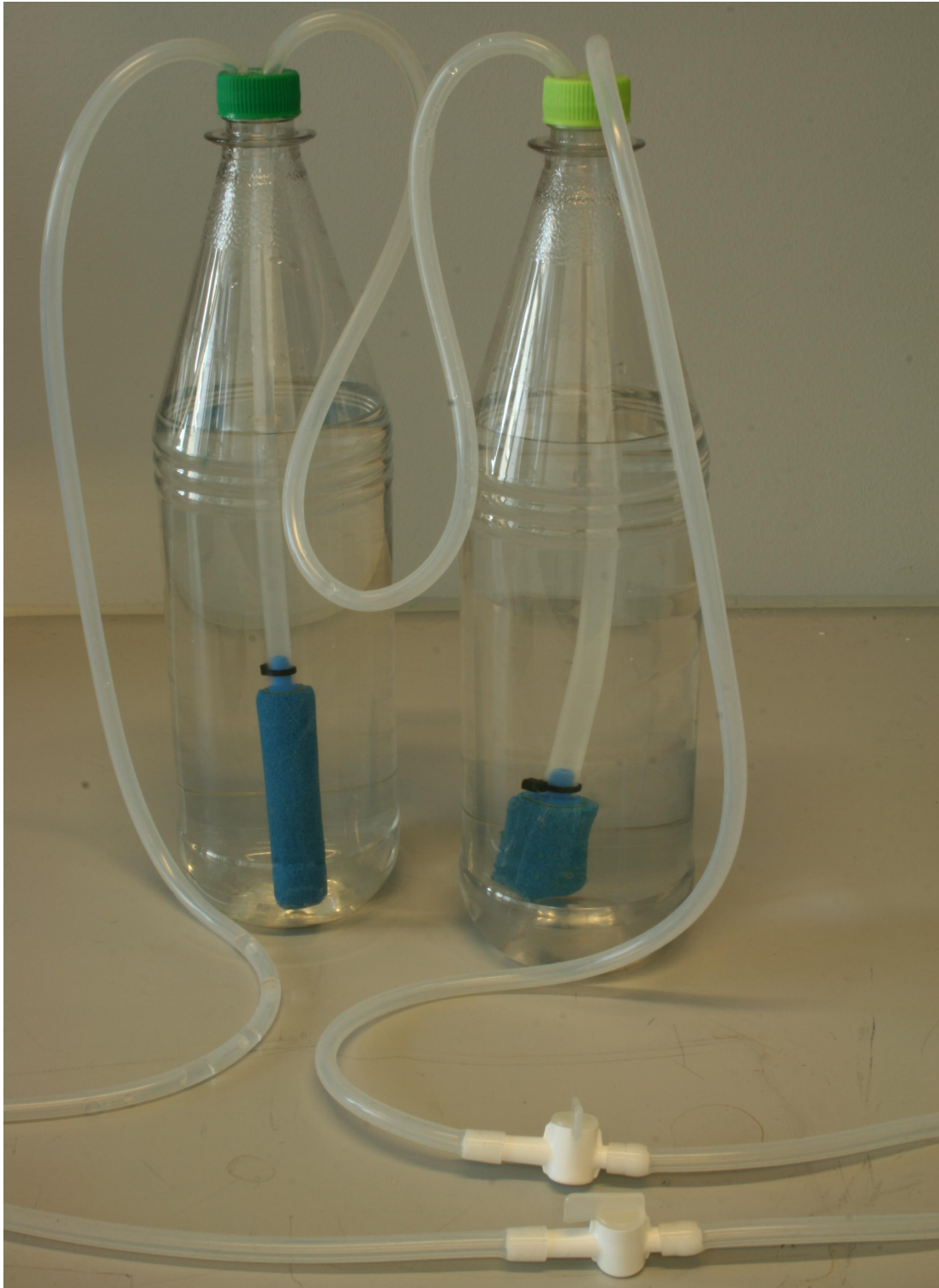

Figure 4.6: Picture of the gas humidifier. There are two 1.5 l bottles in series equipped with aquarium-type air diffusers. The silicone tubes and the manual valves can also be seen.

4.3 The sample holder

A sample holder to cool or heat the sample has been made. The parts for this sample holder have also been made at the NTNU mechanical workshop and the technical drawings can be seen in appendix A. This holder is shown in fig. 4.7. It is made out of one copper disk with a slightly larger copper disk mounted above, and with a Supercool PE-071-10-13-S peltier element in-between the two disks. Data sheet for the peltier element can be found in Appendix B. On the underside of the lower disk a tubular braided copper wire measured to approximately 1 by 6 mm² when flattened has been attached for thermal connection to a cooling/heating system. This was done by silver soldering of the wire to a shallow groove on the underside of the lower copper disk in such a way that there is enough room for a second wire to be attached next to the existing one and not overlap the screw holes. The distance from the lower copper disk to the copper tube for cooling/heating fluid is approximately 40 mm when the sample holder is mounted on a goniometer inside the sample cell. The two discs are fastened together by 4 nylon screws. The choice of nylon is to ensure low thermal conductance between the two disks. A brass holder of three arms is attached to the *upper* copper disk with small pieces of PEEK for thermal insulation. The arms are attached to the top surface of the copper disk to ensure minimal thermal expansion upwards, i.e. minimal displacement at the sample position. Below the lower copper disk the three arms come together and there is a 3 mm pin for fastening to a goniometer. On top of the upper copper disk a copper bracket is fastened. This is primary for mounting of fibre samples. This piece has been designed in such a way that the vertical centreline of the gap in the front face is coaxial with the axes of the copper disks and the goniometer fastening pin. Silver based thermal paste has been used between the peltier element and both copper disks, and also between the copper bracket and the upper copper disk to ensure good thermal connections. A 8P8C plug has been attached to the thermocouple wires.

4.4 Data acquisition card

A National Instrument USB 6008 card has been bought to use with the test cell. The data sheet is shown in Appendix B.

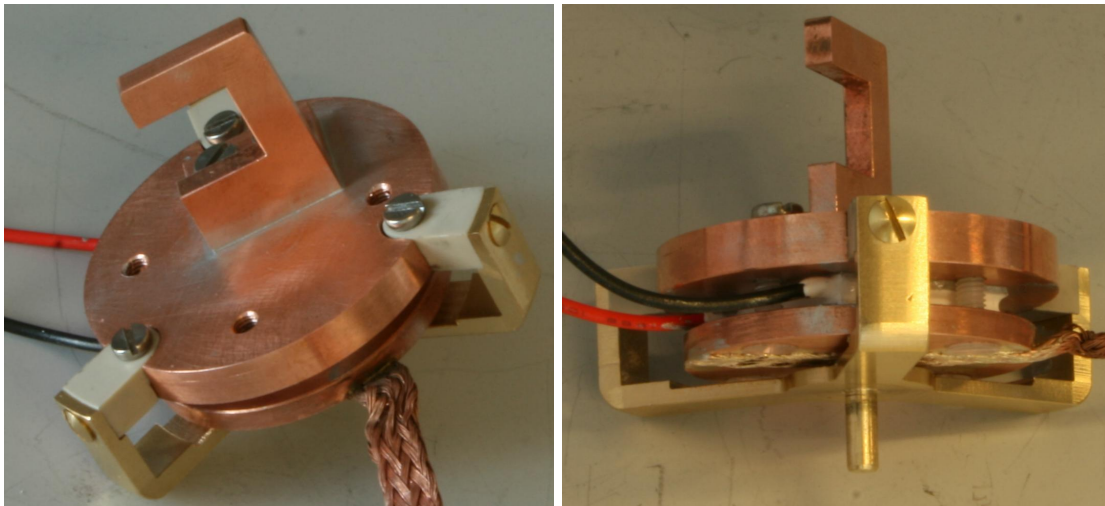

(a) Top of sample holder.

(b) Side of sample holder.

Figure 4.7: Top (a) and side view (b) of the sample holder.

Testing the cell

Some measurements of testing the test cell system are presented. A National Instrument USB 6008 card was used for sampling of the measurements. This card was connected to a computer running LabView for saving of the data to file. A picture of the LabView loop used is shown in fig. 5.1.

5.1 Relative humidity

Measurements of relative humidity inside the sample cell have been conducted. The sensor used was a Honeywell HIH-4000-002 RH sensor. This was powered by the 5 V supply of the National Instrument USB 6008 card. Nitrogen from a gas bottle equipped with a reduction valve was used as gas for the tests. The gas flow was estimated using a water seal system. In the following "wet gas" corresponds to gas that has been lead trough the bubble bottles of the gas humidifier while "dry gas" means gas that has not been lead trough the bubble bottles. The voltage output fit suggested by the RH sensor manufacturer is

$$V_o = V_s (K_1 (H_{rel}) + K_2) \quad (5.1)$$

where V_o is the sensor output voltage, V_s the supply voltage used to power the sensor, H_{rel} the relative humidity at the sensor and K_1 and K_2 constants used for the linear fit. The values suggested by the manufacturer were $K_1 = 0.0062$ and $K_2 = 0.16$. Using this fit yielded negative RH readings for the lowest values. To have RH readings between 0% and 100% this fit was changed to $K_1 = 0.00635$ and $K_2 = 0.155$

As reference fig. 5.2 shows measurements of dry N_2 gas. The sensor was put inside the opening of the gas tubes outside the sample cell. This shows the lowest humidity to be close to 0 % RH. Measurements conducted with compressed air instead of nitrogen gave a lowest reading of 3.3 % RH.

In the plots of the measurements a single exponential fit is also plotted. The fits of the RH are of the form

$$H_{rel} = H_0 \cdot \left(1 - e^{\frac{-t}{\tau}}\right) + H_{min} \quad (5.2)$$

$$H_{rel} = H_0 \cdot e^{\frac{-t}{\tau}} + H_{min} \quad (5.3)$$

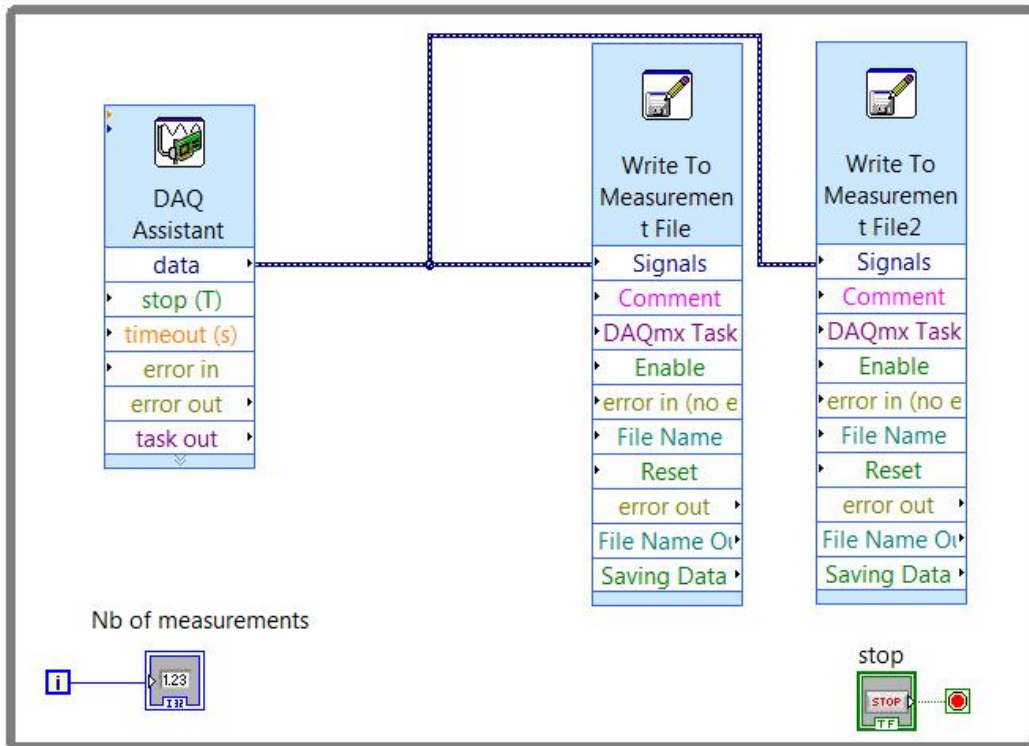

Figure 5.1: The LabView loop used for saving of the data to file. To the left the DAQ Assistant, receiving the data from the National Instrument USB 6008, is shown. To the right two units saving the data to file is shown. The reason for two such units is for having one file with a header and another with pure data, simplifying the post-experiment data treatment using other computer programs.

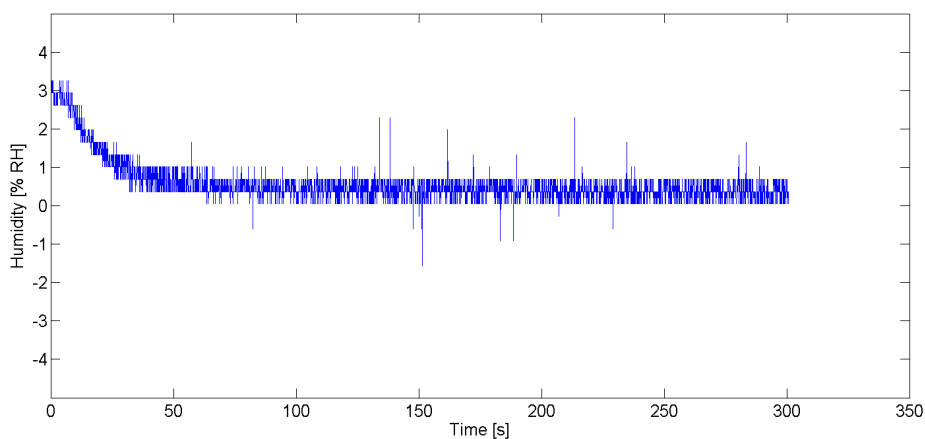

Figure 5.2: The measurements of the humidity sensor put inside the dry gas tube, calibrated to give a zero reading.

Fig	Flow	H_0	H_{min}	τ	Comment
5.3	100 ml/s	83	2	48 s	Wet gas
5.4	100 ml/s	66	2	60 s	Dry gas
5.5	200 ml/s	85	5	12 s	Wet gas
5.6	200 ml/s	87	3	12 s	Dry gas
5.7	200 ml/s	38	2	12 s	Mixture of dry and wet gas
5.8	200 ml/s	97	2	12 s	Wet gas and with bubble bottles in hot water

Table 5.1: Table of the measurements performed.

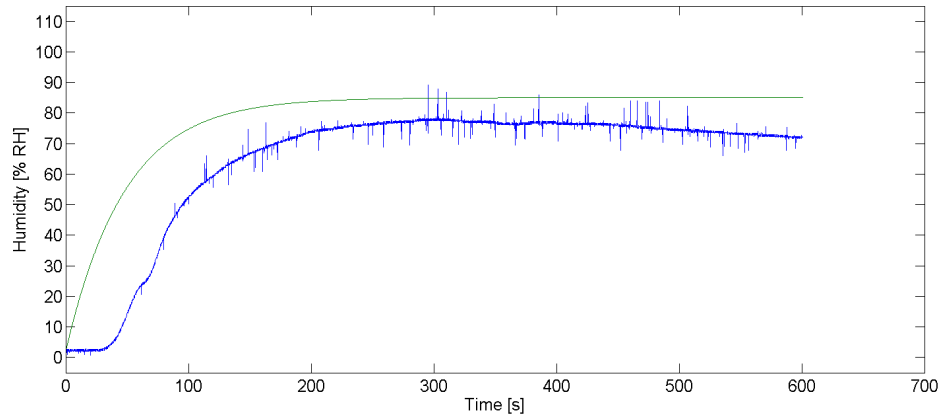

Figure 5.3: The blue curve is the measurements made with the use of wet gas in a cell with dry gas and a gas flow of 100 ml/s. The green curve is a single exponential fit with $H_0 = 83$, $H_{min} = 2$ and $\tau = 48$ s.

for increasing and decreasing RH, respectively. H_0 is a scaling factor, H_{min} the minimum RH of the fit and τ is the time constant. The results are summarized in table 5.1.

Fig. 5.3 and fig. 5.4 show measurements made with an estimated gas flow of 100 ml/s. Fig. 5.3 shows the development with the use of wet gas in a cell filled with dry gas. In fig. 5.4 dry gas is used in a cell starting out filled with wet gas.

The same as fig. 5.3 and fig 5.4 is shown in fig. 5.5 and fig. 5.6, but this time the gas flow was increased to about 200 ml/s. In fig. 5.7 a mixture of dry and wet gas is used.

At no time during the above mentioned experiments was condensation seen inside the cell, at the kapton wall nor the top window. Fig. 5.8 shows the measurements made using wet gas in a cell filled with dry gas. The flow rate was again about 200 ml/s, but this time the bubble bottles were immersed in a hot water reservoir. This time condensation was clearly visible on the inside of the kapton wall, on the inside of the top window and on the sample holder.

Fig. 5.9 shows the development of the humidity inside a cell filled with wet gas when the cell was sealed with blinded tubes. Fig. 5.10 shows the equivalent using dry gas. The latter was measured after a series of tests using both wet and dry gas. Fig. 5.11 shows the same but this time the sample cell has been dried in room temperature.

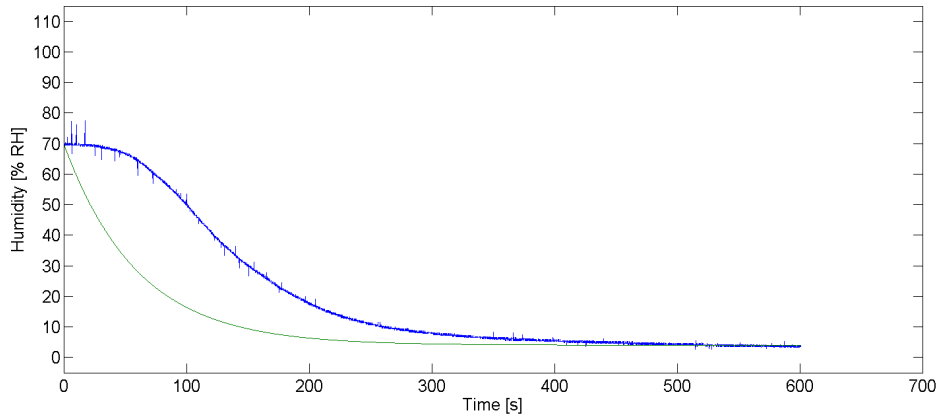

Figure 5.4: The blue curve is the measurements made with the use of dry gas in a cell with wet gas and a gas flow of 100 ml/s. The green curve is a single exponential fit with $H_0 = 66$, $H_{min} = 2$ and $\tau = 60$ s.

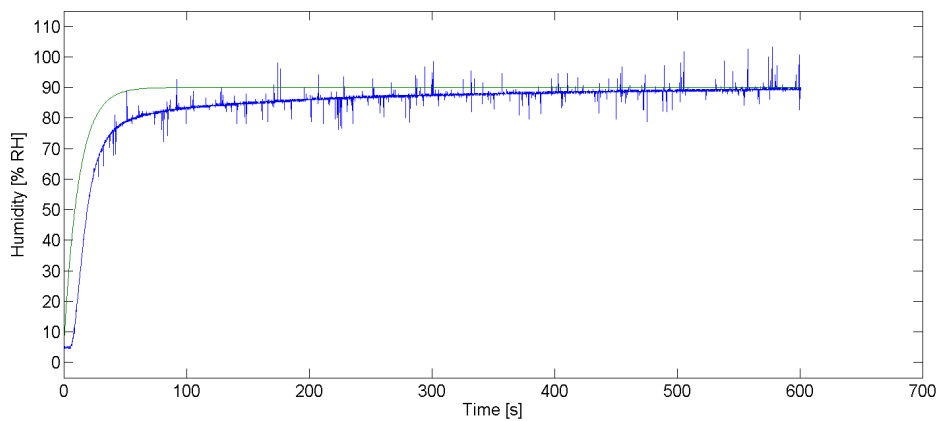

Figure 5.5: The blue curve is the measurements made with the use of wet gas in a cell with dry gas and a gas flow of 200 ml/s. The green curve is a single exponential fit with $H_0 = 85$, $H_{min} = 5$ and $\tau = 12$ s.

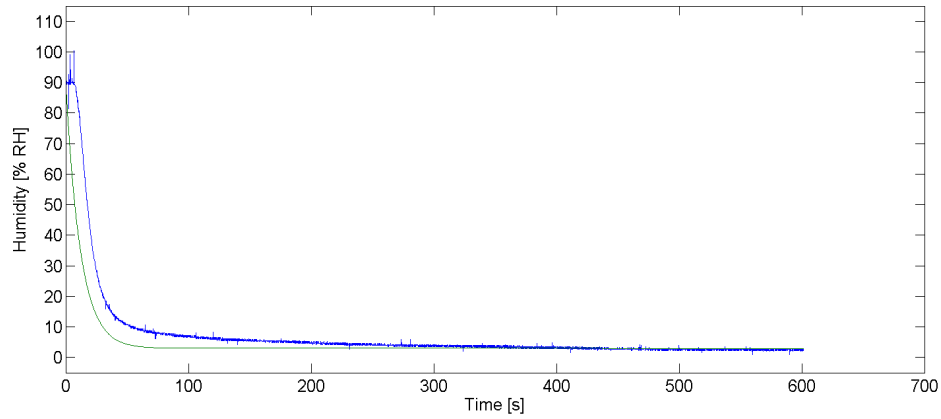

Figure 5.6: The blue curve is the measurements made with the use of dry gas in a cell with wet gas and a gas flow of 200 ml/s. The green curve is a single exponential fit with $H_0 = 87$, $H_{min} = 3$ and $\tau = 12$ s.

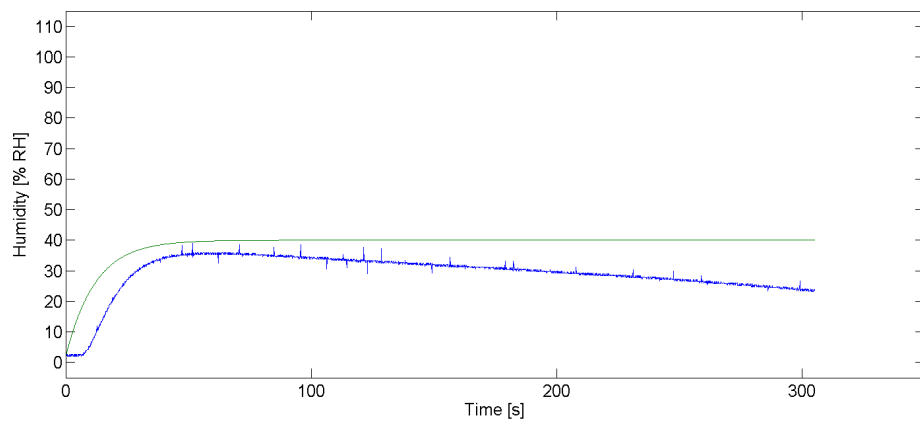

Figure 5.7: The blue curve is the measurements made with the use of mixture of dry and wet gas in a cell with dry gas and a gas flow of 200 ml/s. The green curve is a single exponential fit with $H_0 = 38$, $H_{min} = 2$ and $\tau = 12$ s.

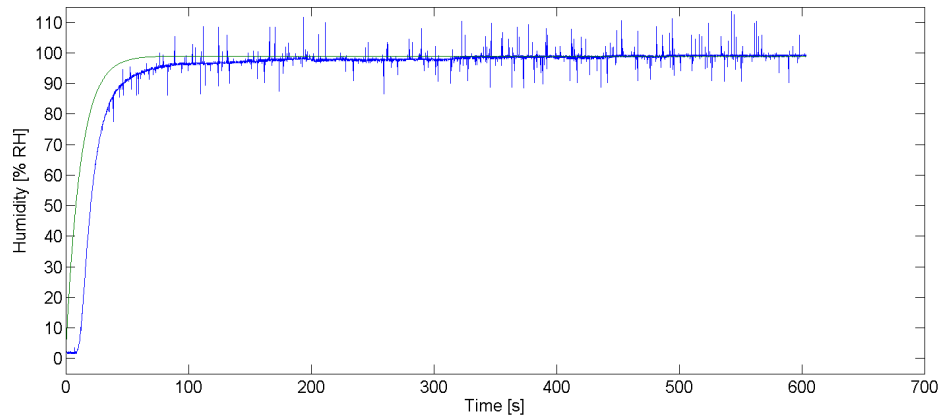

Figure 5.8: The blue curve is the measurements made with the use of wet gas in a cell with dry gas and a gas flow of 200 ml/s. The bubble bottles were immersed in hot water. The green curve is a single exponential fit with $H_0 = 97$, $H_{min} = 2$ and $\tau = 12$ s.

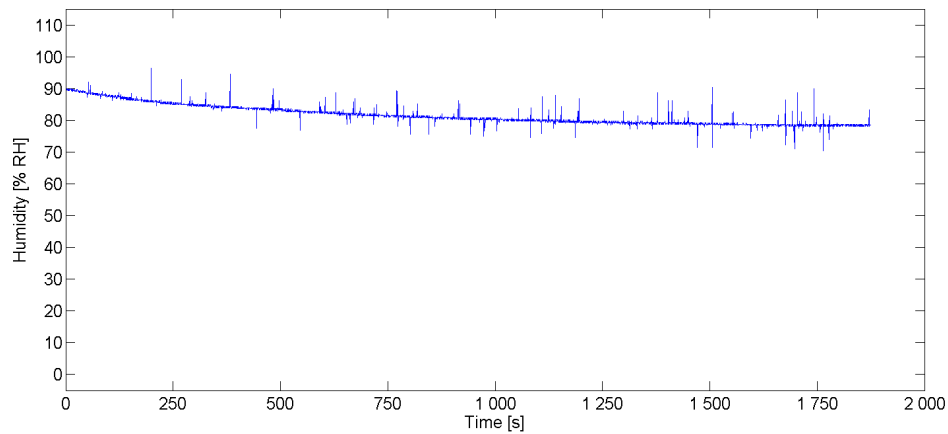

Figure 5.9: The cell is filled with wet gas and sealed at time $t=0$.

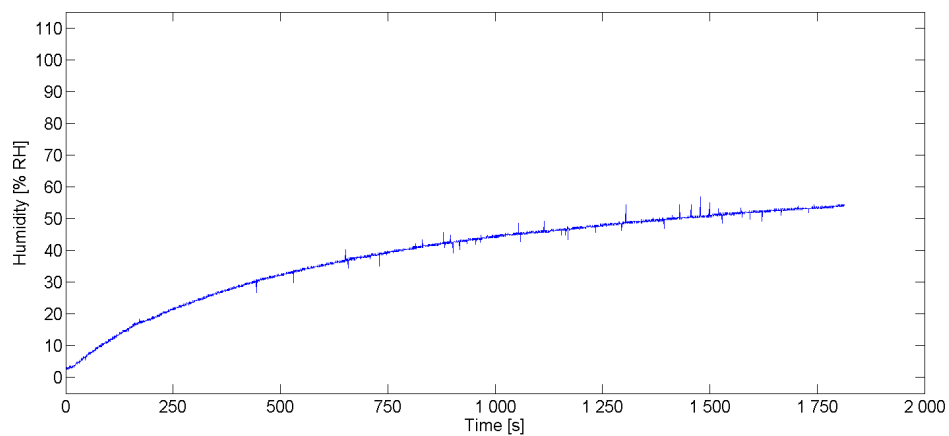

Figure 5.10: The cell is filled with dry gas and sealed at time $t=0$.

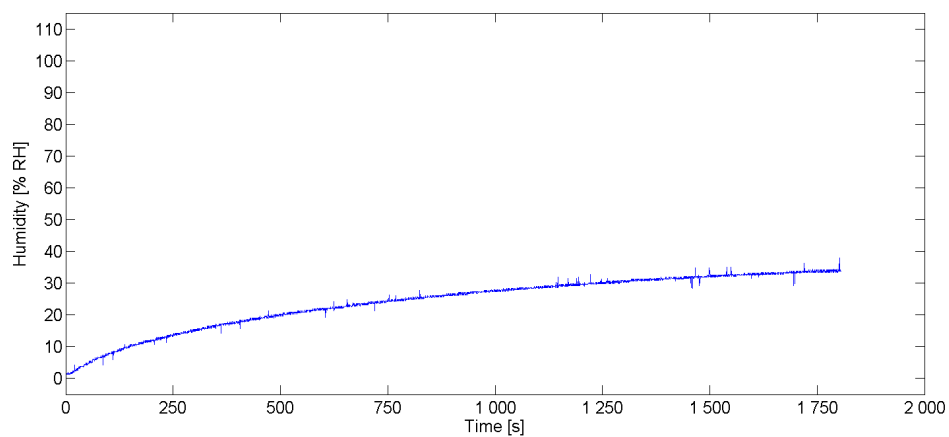

Figure 5.11: The cell is filled with dry gas and sealed at time $t=0$. The cell has been dried in room temperature.

5.2 The sample holder

The peltier element of the sample holder has been tested. Two set of tests were performed, one initial pretest and a second test with temperature measurements.

At the pretest the peltier element was powered with 8 V. The current started off at 2.5 A and after a short while dropped to 1.8 A over a period of about 20 s. Both copper disks became too hot to touch after a short while. When the voltage was applied to cool the upper copper disk the temperature dropped for a short while. But the current dropped as the temperature rose to the untouchable. During the tests the copper wire attached to the lower copper disk was immersed in a cold water reservoir approximately 100 mm from the copper disk. Close to the disk the wire became hot as the disk became hot, while close to the water it stayed cooled at all times.

During the second test session the sample holder was immersed in a water reservoir in such a way that the lower surface of the lower copper disk was under water. For temperature measurements the K elements of the sample cell were used. Due to the small voltages typically delivered by K-type thermocouples, pre-amplifier and cold junction circuits were borrowed and used with each of the K-type thermocouples. The data sheet of the pre-amplifier circuit is shown in Appendix B. The amplification of this circuit was set to 1000 during the measurements. The following conversion function from current to °C was used ¹

$$\begin{aligned}
 T_{\circ C} = & 2.508355 \cdot 10^4 \cdot V_K + 7.860106 \cdot 10^4 \cdot V_K^2 - 2.503131 \cdot 10^8 \cdot V_K^3 \\
 & + 8.315270 \cdot 10^{10} \cdot V_K^4 - 1.228034 \cdot 10^{13} \cdot V_K^5 + 9.804036 \cdot 10^{14} \cdot V_K^6 \\
 & - 4.413030 \cdot 10^{16} \cdot V_K^7 + 1.057734 \cdot 10^{18} \cdot V_K^8 - 1.052755 \cdot 10^{19} \cdot V_K^9
 \end{aligned}
 \tag{5.4}$$

where $T_{\circ C}$ is the temperature in degree Celsius and V_K is the K element cold junction compensated output voltage. Fig. 5.12 shows the temperature of the sample holder copper bracket when 8 V is applied to the peltier element for bracket cooling. The current started off at 3.2 A and dropped to 2.8 A after 60 s. Condensation was observed on the upper copper disk and copper bracket of the sample holder.

5 V is applied to the peltier element in fig. 5.13, but this time to heat the upper copper disk and copper bracket. The current started off at 2.4 A and dropped to 1.85 A after 60 s.

Fig. 5.14 shows the temperature when 2 V is applied to the peltier element to heat the upper copper disk and copper bracket.

In fig. 5.15 and fig. 5.16 step changes of the voltage are applied. In fig. 5.15 the voltages applied to heat the upper copper disk and copper bracket were 5 V for 120 s, 2 V for 180 s and 0 V for 120 s. 8 V for 120 s, 5 V for 180 s and 0 V for 120 was applied to cool the upper copper disk and copper bracket in fig. 5.16.

¹Taken from the National Instrument LabView 8.6, Volt to temperature sub VI from the Convert thermocouple reading VI.

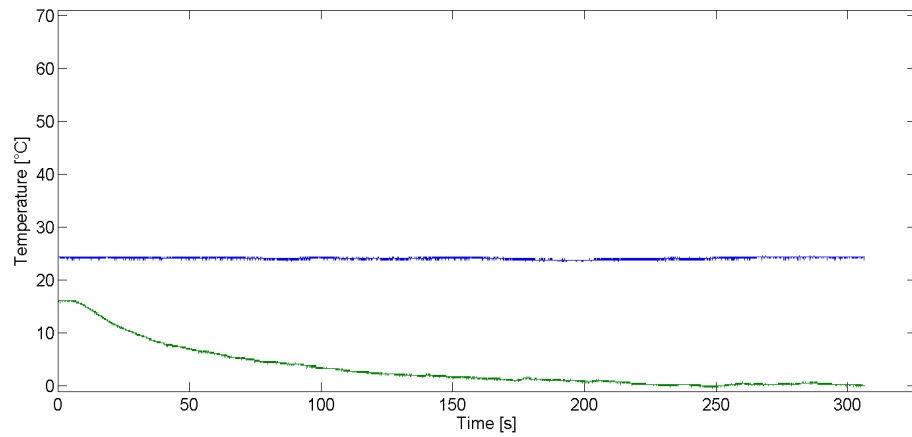

Figure 5.12: The green curve shows the copper bracket temperature when 8 V is applied in cooling mode. The blue curve shows the air temperature.

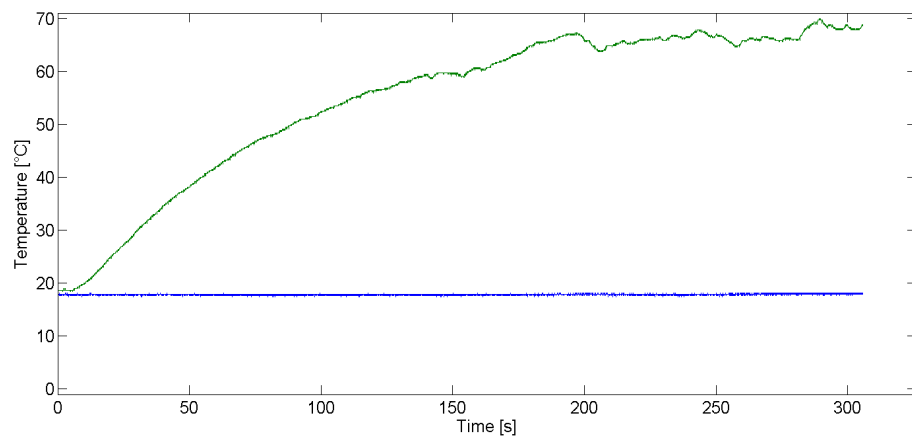

Figure 5.13: The green curve shows the copper bracket temperature when 5 V is applied in heating mode. The blue curve shows the water temperature.

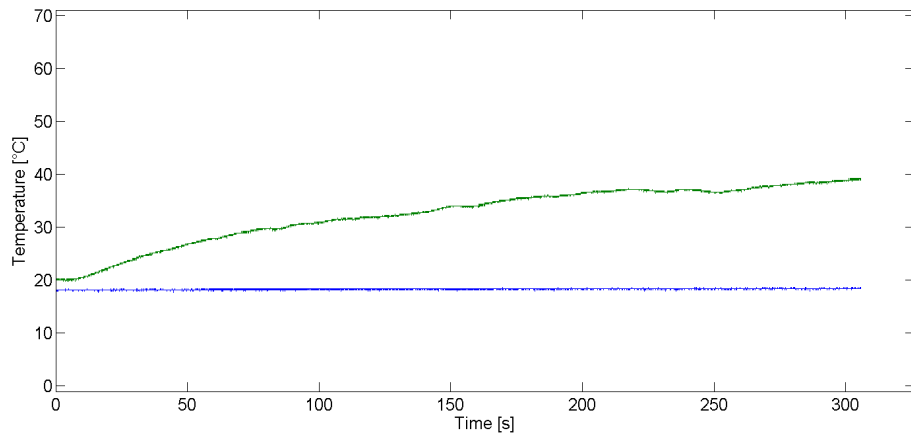

Figure 5.14: The green curve shows the copper bracket temperature when 2 V is applied in heating mode. The blue curve shows the water temperature.

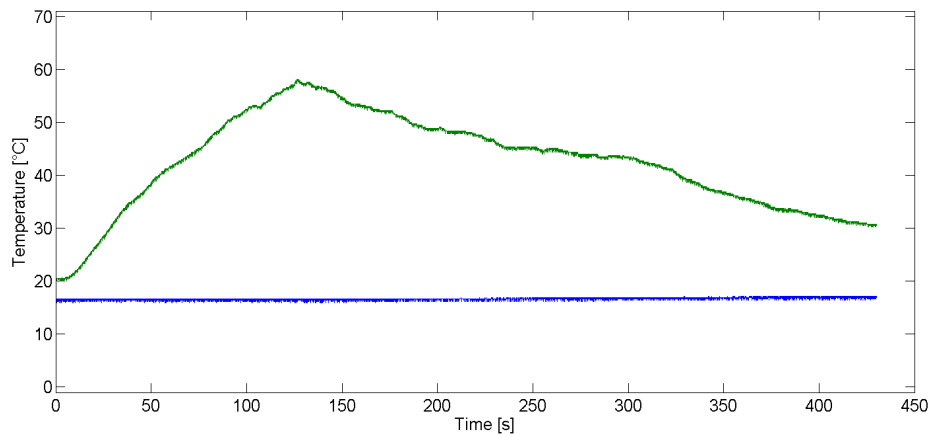

Figure 5.15: The green curve shows the copper bracket temperature when 5 V for 120 s, 2 V for 180 s and 0 V for 120 s is applied in heating mode. The blue curve shows the water temperature.

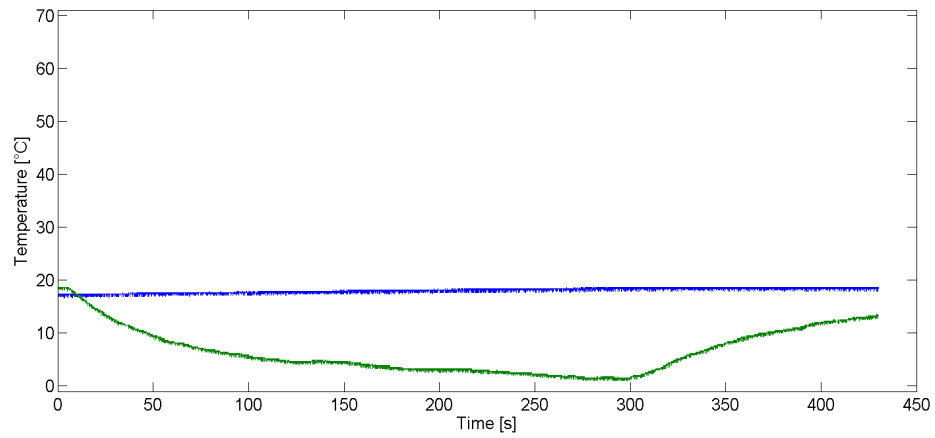

Figure 5.16: The green curve shows the copper bracket temperature when 8 V for 120 s, 5 V for 180 s and 0 V for 120 s is applied in cooling mode. The blue curve shows the water temperature.

5.3 Pump

The cooling/heating fluid pump and its power supply have been tested. Both worked, but the flow rate seemed a bit low.

Chapter 6

Discussion

Some of the test results already presented will be discussed in the following. The finished test cell system is ready to use. It still has potential for a lot of improvements and some of the possible improvements are discussed below.

6.1 The finished test cell system

A test cell system for x-ray scattering on textile samples under controlled humidity has been built. The finished system is mechanically stable, has the possibility of further upgrades and has a sample holder with a peltier element for heating. All the parts planned have been made, except for the external gas cooler/heater. With the chosen sockets standard, modification or installation of new sensors can easily be made. The cell has a $\frac{17\pi}{9} = 340^\circ$ azimuth angle and $\approx \frac{10\pi}{23} \approx 78.2^\circ$ zenith angle geometry. Calculation of the sample cell geometry has been made in Appendix C. Both azimuth and zenith angles are the total available angles, the corresponding available scattering angles for experiments are smaller.

6.2 The tests and measurements made

The results of the measurements made will be discussed here. It should be kept in mind that the tests performed are preliminary to get an idea of the possible performance of the test cell system.

6.2.1 Humidity

The measurements done with the test cell system show that it is ready for use. Fig. 5.6 and fig. 5.5 show that it is possible to attain minimum and maximum humidity of 3 and 90 % RH within acceptable time frames at room temperature. Fig. 5.8 shows that a humidity of 99 % RH is attainable when the bubble bottles are heated. The condensation observed using heated bubble bottles indicates a humidity probably as close to saturation as achievable. Problems of achieving humidities of more than 99 % RH in test cells have

been reported [17]. Fig. 5.7 demonstrates that stable intermediate values of RH are also achievable.

In fig. 5.3 and fig. 5.7 there is a drop in RH. This is most likely due to the experimental set-up. The gas used was nitrogen from a gas bottle and the flow was controlled using a reduction valve. This valve was unstable, at times there was a 50 % difference in the flow estimated before and after a series of tests.

The development of RH with no circulation of gas is shown in fig. 5.9 to fig. 5.11. When wet gas is used the RH drops from 90 to just below 80 % in 30 minutes. The development of RH using dry gas was tried twice. The first time was after a series of other tests, the second was after the sample cell had been dried at room temperature. The second test gave smallest change, the RH rose from about 0 to about 35 %. It is thus difficult to maintain a low and stable humidity without circulation of gas inside the cell.

The measurements made at low RH show a more stable behaviour than the measurements performed at high RH. All the measurements performed at high RH show this instability. The source of this instability is unknown.

6.2.2 Sample holder

The preliminary test of the sample holder showed low capability of cooling the upper copper disk. But when the lower copper disk was immersed in a water bath the system showed good cooling capabilities. This shows that the braided copper wire used for thermal conduction from the lower copper disk has an insufficient thermal conductance for the cooling of the copper bracket. Depending on the purity, copper has a thermal conductivity of close to $400 \text{ W} \cdot \text{m}^{-1} \cdot \text{K}^{-1}$ [18][19] at room temperature. If the braided copper wire is assumed to be compact when flattened the conductance would according to equ. 2.6 be:

$$G = \frac{400 \cdot 1 \cdot 10^{-3} \cdot 6 \cdot 10^{-3}}{4 \cdot 10^{-2}} \text{ W} \cdot \text{K}^{-1} = 6 \cdot 10^{-2} \text{ W} \cdot \text{K}^{-1} \quad (6.1)$$

The maximum cooling power of the peltier element used is according to the manufacturer 21.2 W. To achieve a heat flow rate of 21 W through the braided copper wire according to equ. 2.5 a temperature difference of

$$\Delta T = \frac{21}{6 \cdot 10^{-2}} \text{ K} \approx 350 \text{ K} \quad (6.2)$$

is needed. The assumption of a compact wire when flattened is optimistic, and the heat flow rate needed to run the peltier element on full cooling power would certainly be higher than 21 W. The maximum temperature difference between the hot and the cold side of the peltier element is 74 K. It is therefore impossible to use the maximum cooling power of the peltier element with the present cooling system. The heating of samples with the current system is on the other hand achievable.

With the use of a water reservoir for cooling, the sample holder with the peltier element showed good cooling capabilities. The peltier element was able to cool the copper bracket to around 0 °C as seen in fig. 5.12. The two plots in this figure appear to contain a lot of noise with a high frequency compared to the thermocouple signal.

This is most probably 50 Hz interference. Due to this the sampling frequency for the temperature measurements was kept high, e.g. the sampling frequency used for the measurements shown in fig. 5.15 and fig. 5.16 is 200 Hz. The idea behind this is to fulfil the Nyquist criterion:

$$f_s > 2 \cdot f_{max} \quad (6.3)$$

where f_s is the sampling frequency and f_{max} the maximum frequency present in the signal to be sampled. In this way one is sure to also sample the 50 Hz interference. The idea behind this is to be able to condition and treat the signal to filter out this interference. One could average the signal over a certain number of samples or one could employ a low pass filter. The same interference is seen in all the plots done with the thermocouples.

Temperatures close to 70 °C were achieved as shown in fig. 5.13. No more than 5 V was used so a higher temperature can be achieved if a higher voltage is applied. But as the recommended maximum hot side temperature of the peltier element is 80 °C and due to the lack of an adequate control system for the temperature, caution is necessary when more than 5 V is used. Fig. 5.13 also shows some instability when the temperature is elevated. The origin of this behaviour is unknown.

6.3 Improvements

There is a lot of possible improvements that can be made to the test cell system. All are questions of whether its worth the time, effort and money needed to do such upgrades. Some further tests should also be performed.

The RH sensor can be calibrated using known humidities, e.g. using salt solutions. This would lead to a better RH to voltage fit and more reliable data. A second RH sensor can be used to cross check the humidity against the one present, both for stability and calibration reasons. It might be that the instability shown is just caused by the RH sensor design itself and cannot be helped with this type of sensor. A second sensor would also enable the measurements of the RH difference between the sample position and the sensor position.

Some humidity tests should be redone under controlled flow conditions. As the reduction valve used was unstable, some of the results were clearly influenced by this. The reduction valve controls the output pressure. As there will be a pressure difference between untreated gas and gas lead through the bubble bottles, there will most probably also be a flow difference between experiments conducted with dry and wet gas as the same water seal method was used to estimate the flow in both cases.

The sample holder should also be tested further. Both to investigate the instability shown at high temperatures and to determine the final temperature achieved at certain voltages.

6.3.1 Thermocouples

A pre-amplification, cold junction and signal conditioning circuit for the thermocouples could be built. Circuits similar to the one used for the measurements could be built and adding a low pass filter could filter out most of the common 50 Hz interference. Due to the low voltage of the signal delivered by the K-type thermocouples it would be quite

difficult to obtain useful data without any pre-amplification circuit using the already acquired National Instrument USB 6008 card.

6.3.2 Humidifying system

There are many options for improving the humidifying system. The most rewarding of those would in my opinion be to install mass flow controllers. This would easily give a stable gas flow together with the possibility of a feedback control system using the RH sensor inside the sample chamber.

The system could in any way be improved towards the standards of the system described by K. Linnow et. al. [16]. Two things worth noting is the heater for the bubble bottle and the adsorption dryer. A temperature regulator could limit condensation problems for low temperatures and enable the possibility of high RH for high temperatures. This could be realised if the bubble bottles were immersed in a temperature regulated water bath. If the thermal conductivity of the existing bottles were to be too low the bottles could easily be changed with ones made out of metal, e.g. aluminium. Installing an adsorption dryer would enable the use of air rather than N₂

6.3.3 Sample holder

It is evident that the braided copper wire attached to the lower copper disk of the sample holder is insufficient for conducting the required amount of heat when the peltier element runs at full cooling power. There are several ways to improve the thermal conduction. One that easily comes to mind is to increase the total copper wire cross section. Additional wires could be soldered to the copper disk like the existing one. If a temperature difference of 50 K is assumed the required cross section of a copper wire would according to equ. 2.6 be:

$$A = \frac{21 \cdot 4 \cdot 10^{-2}}{400 \cdot 50} \text{ m}^2 = 4.2 \cdot 10^{-5} \text{ m}^2 = 42 \text{ mm}^2 \quad (6.4)$$

This is a low value estimate, no thermal resistance is assumed at the junctions and a temperature difference of 50 K is also quite high. A copper wire with a 42 mm² cross section would probably result in a rigid and impractical system. So an expansion of the current copper wire concept of thermal conduction does not seem rewarding.

A more promising option is to change the sample holder and extend the space between the lower copper disk and the holder of three arms to make space for a water cooling system. Changing the copper pipe already present to a new one directly connected to a water driven heat exchanger mounted on the under side of the lower copper disk would probably yield far better cooling capacity than already present.

For the measurements of the temperature a power supply was borrowed to power the peltier element. Such a power supply should be acquired both for the sample holder and also for an eventual gas cooler/heater. This power supply should be electronically controllable and should supply at least 3.9 A at 8.5 V to enable the use of a control system together with the K-type thermocouples and the use of maximum cooling power of the peltier element.

6.3.4 Control system

The reason for acquiring a data acquisition card was to sample the output from the sensors. But an equally important reason for buying the National Instrument USB 6008 card was the option of using it together with a control system. The card has 8 analogue inputs, 2 analogue outputs and 12 digital I/O lines. Using this card together with LabView enables a complete control system to be made. Using LabView as a the basis for a control system enables the making of an user friendly control system for every parameter of the test cell system collected together in one user interface.

6.3.5 Gas cooler/heater

A gas cooler/heater as described in the Plan chapter could be made. It seems like the best option for adding temperature control of the sample chamber. To maintain a low and stable RH a constant circulation of gas is needed. Therefore it might be difficult to maintain high or low temperatures in samples with the use of only the sample holder.

Chapter 7

Experiences

The design and manufacturing of the test cell system has been a challenging and time consuming task. As suggestions have been made I had to be sure all parts were available and every design compatible with the other systems. With no responsibility for the economy of this project, the decisions of which design to actually manufacture and which parts to order were ultimately not mine. The first suggestion for the base plate of the sample cell contained 4 mm outer diameter plastic pneumatic tubes and corresponding M5 nipples. As it was decided to change the tubes to silicone tubes, a vendor had to be found. The tubes that matched available manual valves were 8 mm outer diameter. This led to the need to change the nipples and the one I came across was G 1/8. Due to the increase of major diameter, from 5 mm to 9.728 mm [20], more space was needed on the base plate to fit those nipples and a redrawing of the base plate was necessary.

7.1 Mechanical workshop

During this project I have been quite dependent of the manufacturing of the parts. All the parts described in Appendix A have been manufactured at the NTNU mechanical workshop. The delivery time at this workshop has in my opinion been far longer than optimal for a project like this. Some of the parts with a production time of one day have had a delivery time of three weeks. As the drawings for the sample holder were delivered to the workshop a production time of approximately two weeks was promised. After an inquiry three weeks later, the production of the parts had not yet started, and the parts were delivered four weeks after delivery of drawings. The communication and information flow at the mentioned workshop was also not satisfactory. Important additional information was given by me when drawings were delivered, but apparently not given in the correct way to the craftsmen. An example is the distance from the top of the upper copper disk to the upper plane of where the three arms of the three arm holder of the sample holder come together. This is marked in the sketch delivered to the workshop as seen in Appendix A and was specifically explained when the drawings were delivered. But the distance of the finished sample holder was from top of upper copper disk to top of goniometer. As a consequence of the service given at this workshop, when a temporary base for the base plate was needed to facilitate the preliminary tests of the

cell, I made one myself at an external workshop. This required three hours of fabricating, but I suspect it would have required at least two weeks delivery time at the mentioned workshop.

7.2 Electronics workshop

The electronics workshop at NTNU aided me a lot during this project, e.g. with the ordering and preparations of the sensors and the peltier element. The crew at this workshop have given advise on concepts and designs and have given important help in problem solving and in the realization of several technical solutions. All the help have been given on short notice and parts and work have had short delivery times.

7.3 Curriculum

This report has been written as the master thesis of the engineering curriculum at the NTNU. This has been the final part of this curriculum, and as such, a preparation for the engineering profession. The project has involved a broad range of the knowledge acquired during the curriculum and I feel it has been a good preparation for the challenges to come.

Chapter 8

Conclusion

A complete test cell system has been made. A humidifying system has been built capable of delivering RH at least in the range from 3 to 97 %. Blinded tubes have been made to enable sealing of the cell, but due to the thin kapton film covering the cell, the pressure has to be close to atmospheric. The system has a $\frac{17\pi}{9} = 340^\circ$ azimuth angle and $\frac{10\pi}{23} \approx 78.2^\circ$ zenith angle geometry. The main component of the test cell is the actual sample cell with a solid base plate of stainless steel that ensures mechanical stability. The sample cell is cylindrical and is constructed in such a way that a rotation of the entire sample cell would enable the rotation of samples in situ. To obtain stable humidity levels a constant flow of gas through the cell is needed. A heatable sample holder has been made. With this, fibre samples can easily be mounted accurately and reproducibly. The NI data acquisition card ensures connection to computer for sampling. The system is made in such a way that it can easily be expanded or modified to new needs.

Appendix **A**

Drawings

In the following scans of the original technical drawings are presented. They are as returned after production at the NTNU mechanical workshop. Some of them contain notes to the craftsmen, some contain further sketches made by the craftsmen. The originals are in scale 1:1 but due to some scaling in the scanning process the drawings presented might be off scale.

Fig. A.1 to A.3 are of the sample cell base plate, fig. A.4 to A.7 are of the sample cell cap and fig. A.8 and A.9 are of the sample holder.

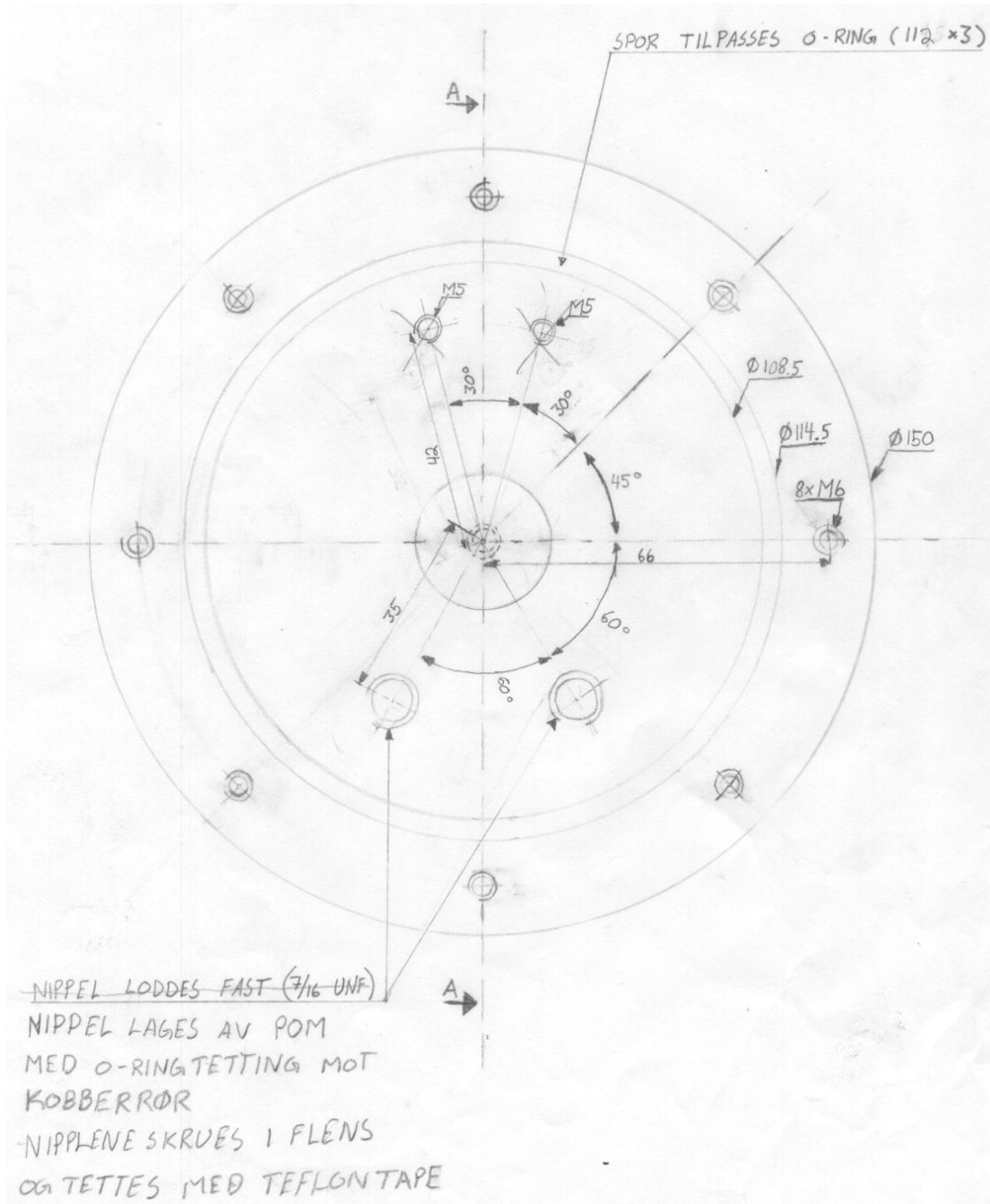

Figure A.1: The sample cell base plate, from above.

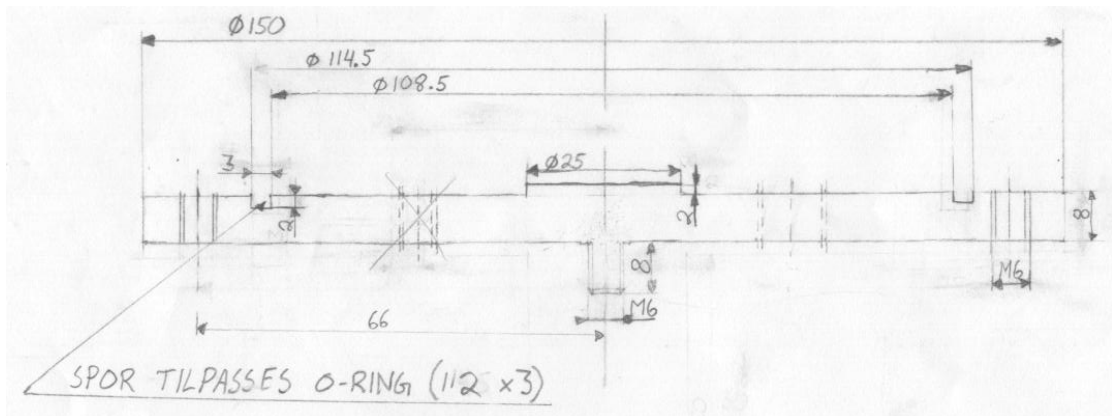

Figure A.2: The sample cell base plate, AA.

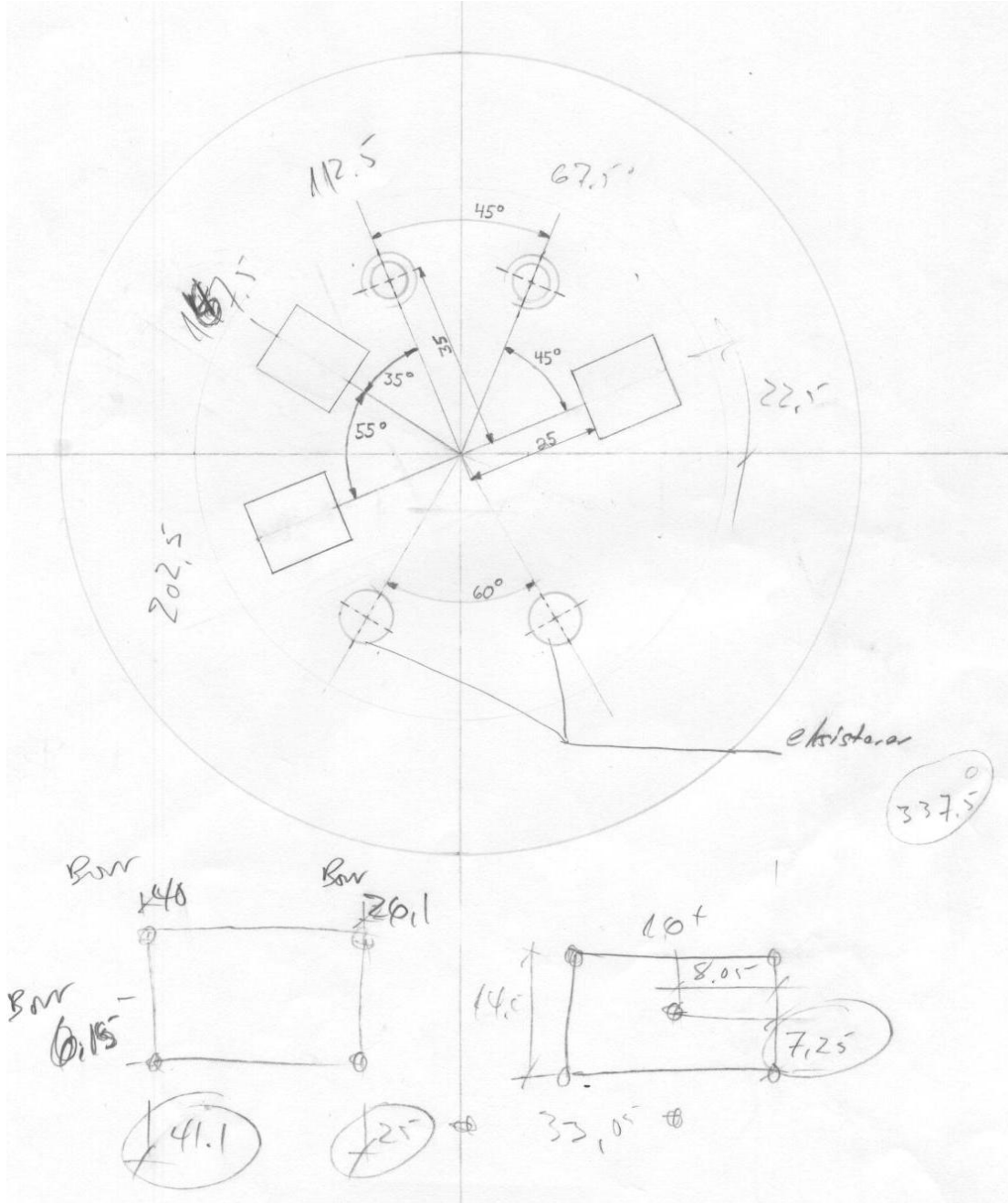

Figure A.3: The sample cell base plate, indicating the positions of the 8P8C sockets.

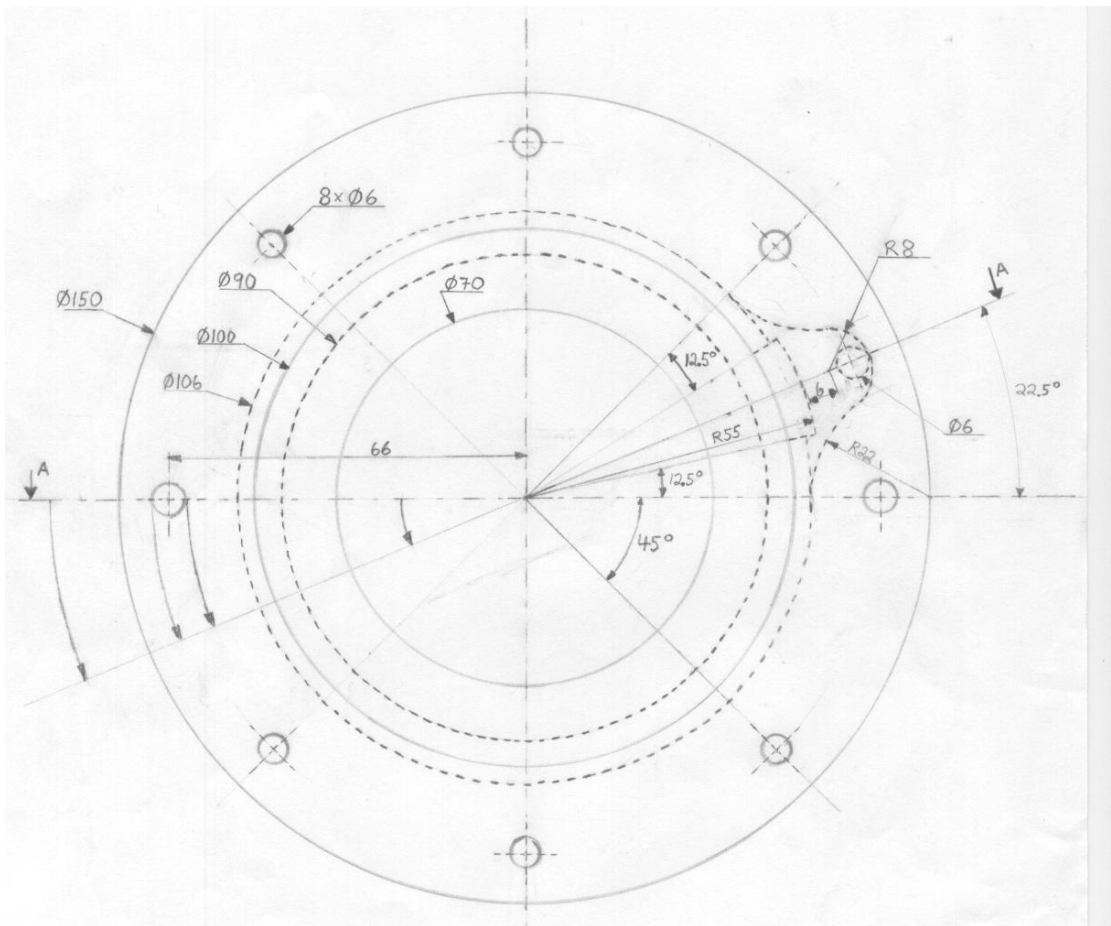

Figure A.4: The sample cell cap, from below.

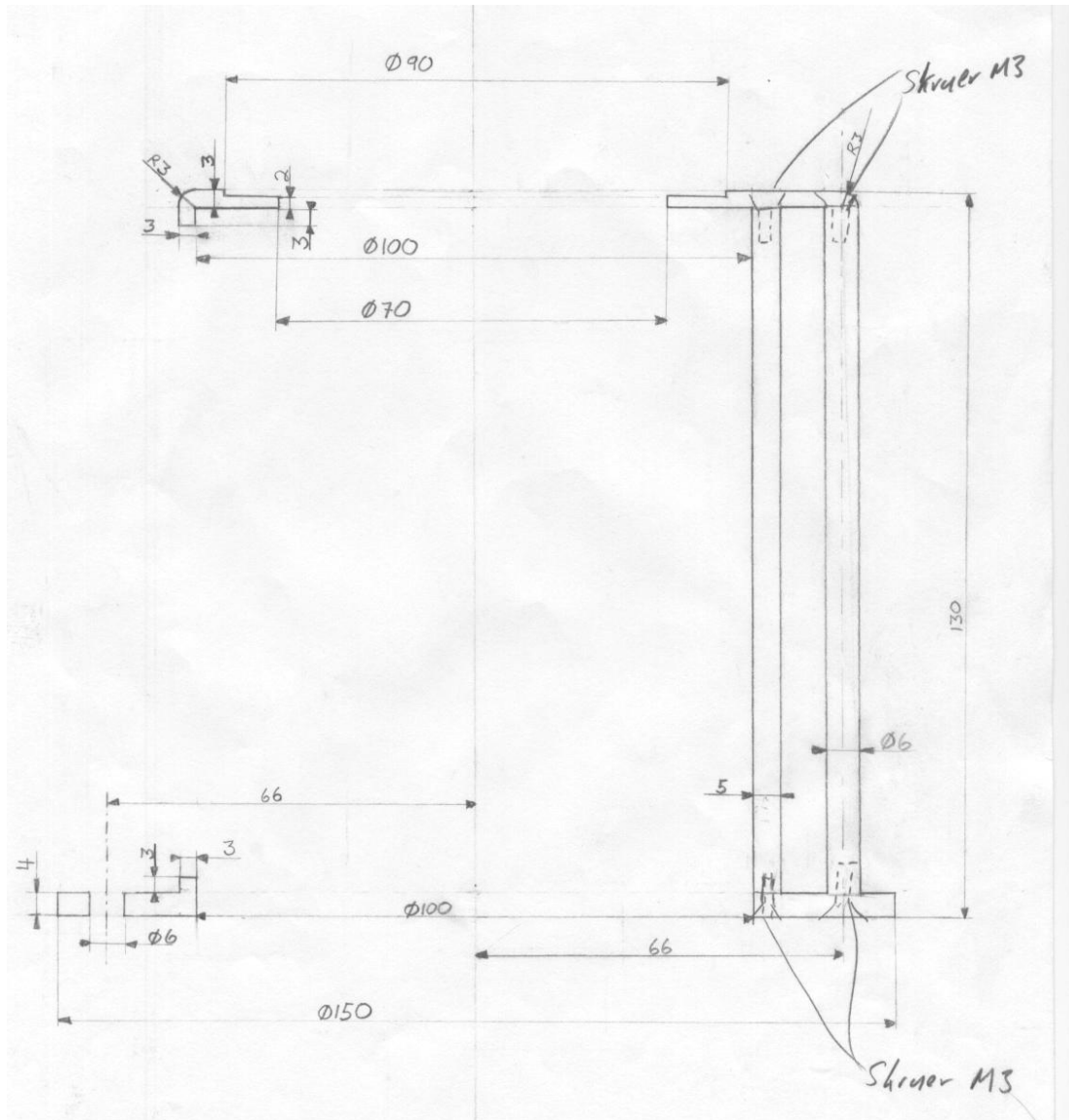

Figure A.5: The sample cell cap, AA.

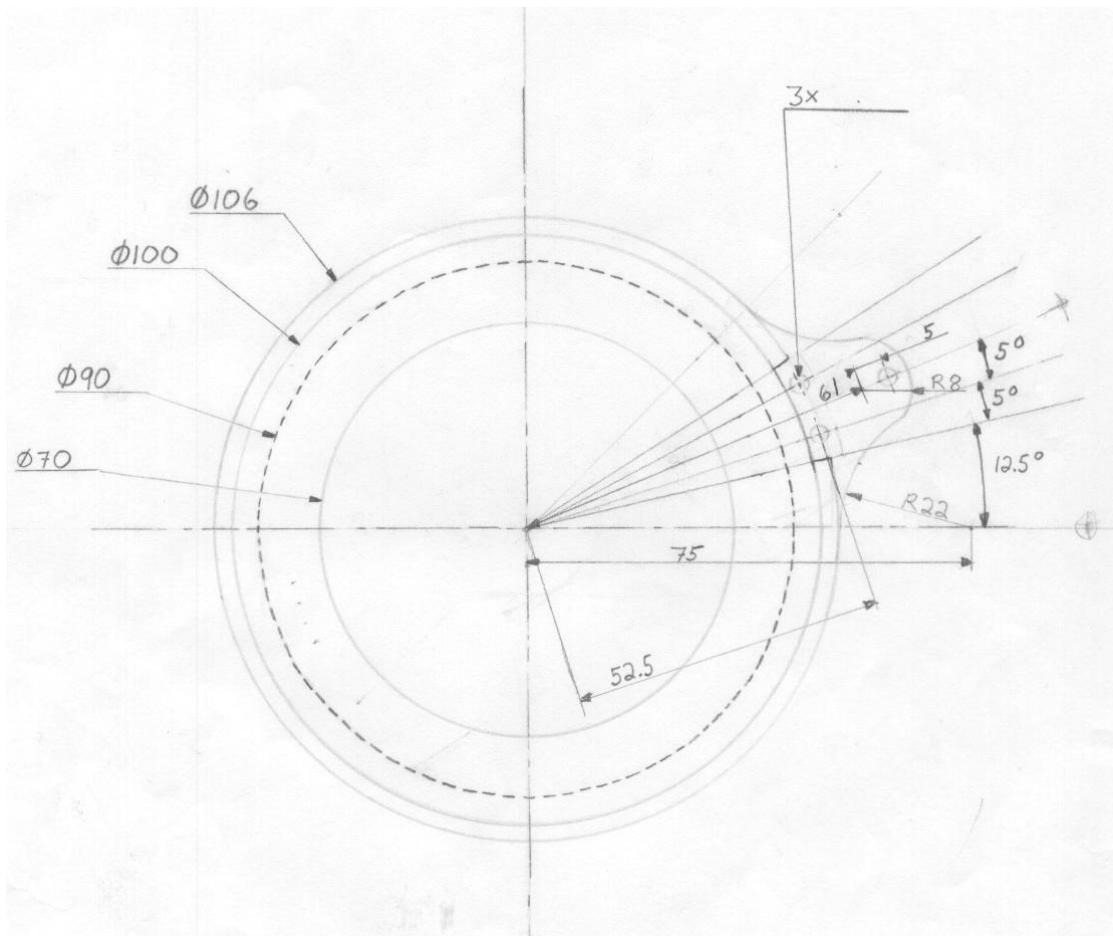

Figure A.6: Top of the sample cell cap, from below

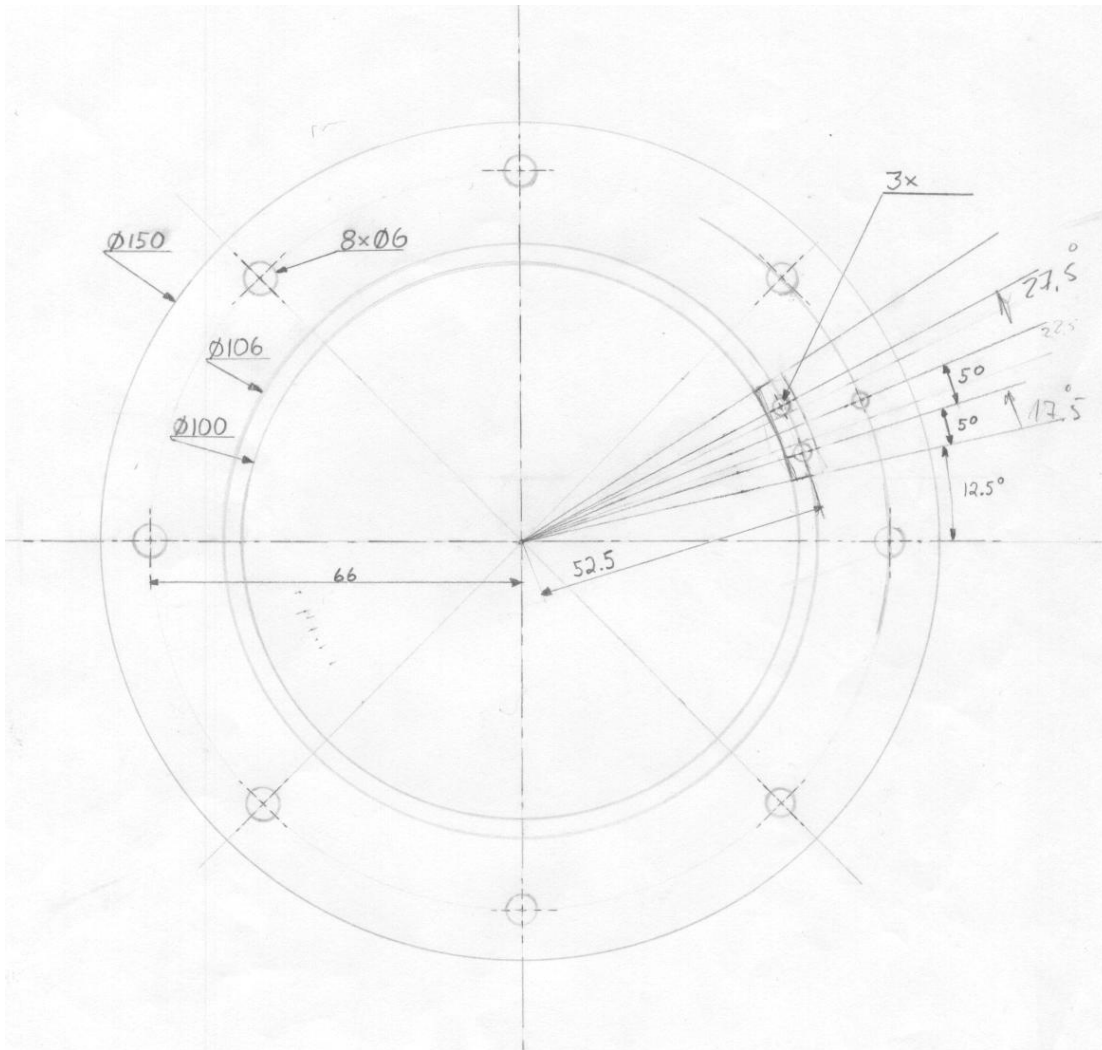

Figure A.7: Bottom of the sample cell cap, from above

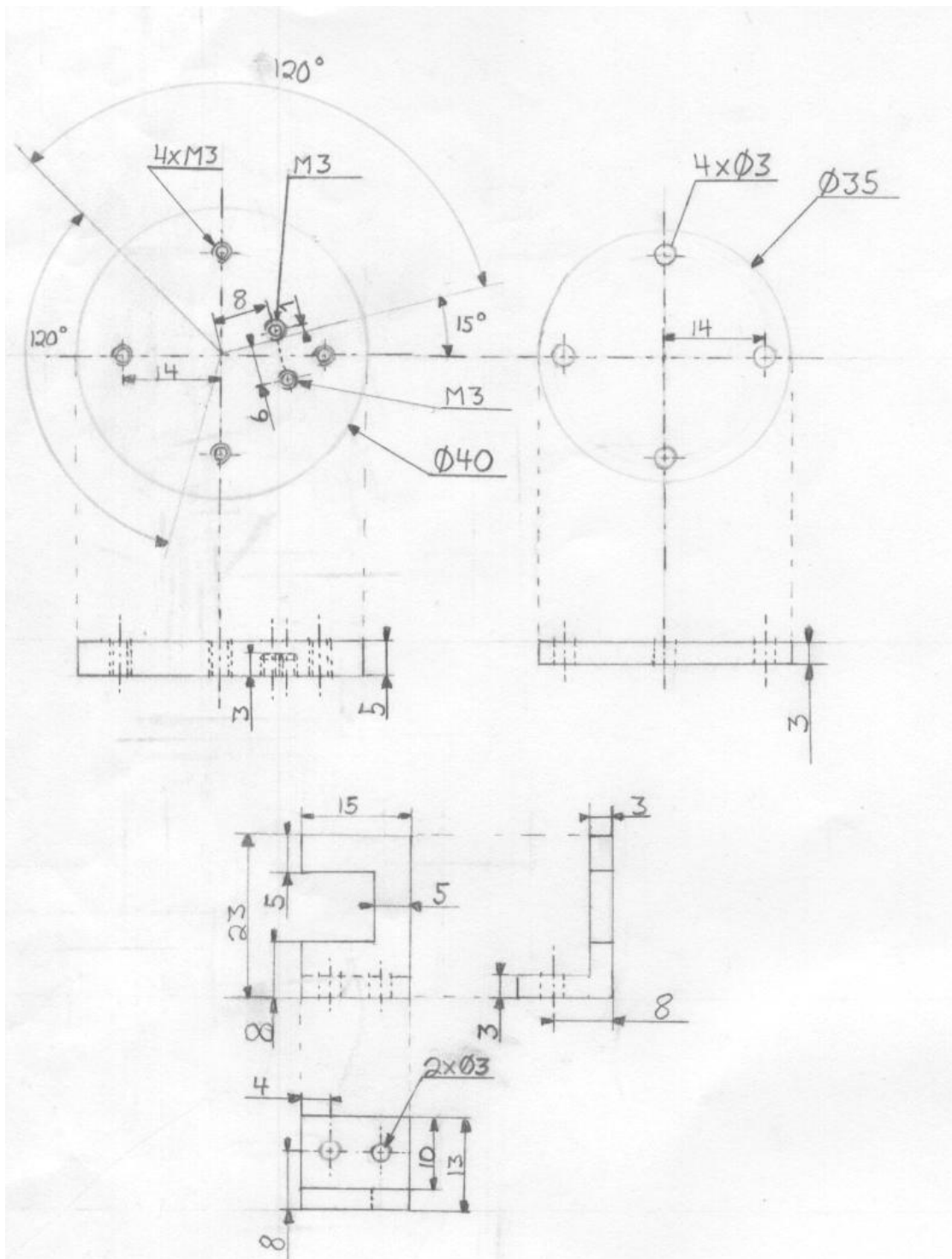

Figure A.8: The most important parts for the sample holder.

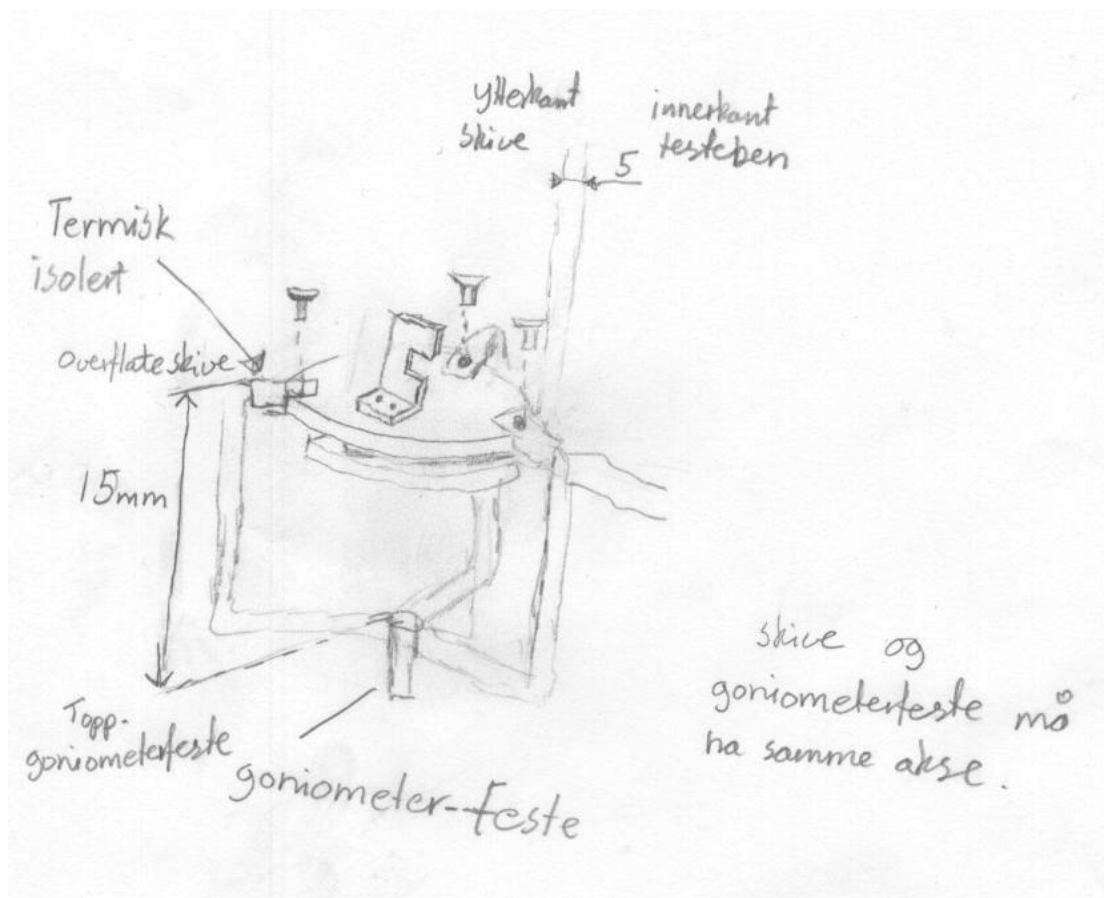

Figure A.9: Rough sketch of the sample holder.

Appendix **B**

Data sheets

B.1 8P8C socket

The technical drawing of the 8P8C socket used. It should be noted that the unit used is inches.

REV	DATE	REVISIONS	DATE	BY
AA	28	REVISION	22JUN03	SWI/SHT
F		REVISED PER ECR-05-004344		

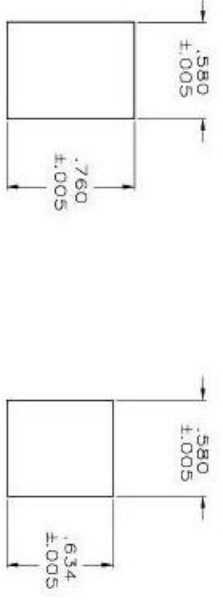
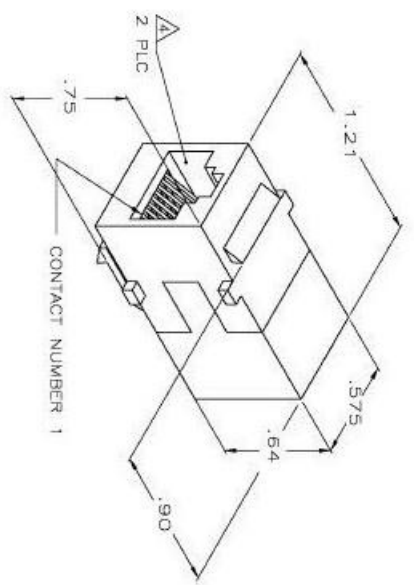

RECOMMENDED PANEL CUTOUT
 FOR SINGLE WALL PLATE
 AND BACK PANEL FOR
 DOUBLE WALL PLATE

RECOMMENDED FRONT PANEL
 CUTOUT FOR DOUBLE
 WALL PLATE

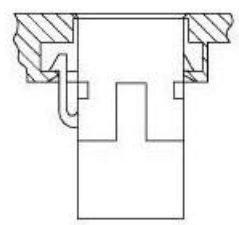

DOUBLE WALL PLATE
 NOT TO SCALE

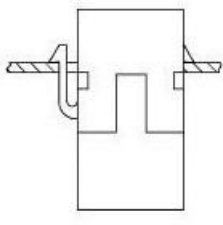

SINGLE WALL PLATE

- ALL DIMENSIONS SHOWN ARE MAXIMUM UNLESS OTHERWISE SPECIFIED.
- MATERIAL:
 HOUSING - POLYPHENYLENE OXIDE, BLACK.
 TERMINAL - .018 DIA PHOSPHOR BRONZE PLATED WITH .000050 MINIMUM THICK GOLD OVER .000050 MINIMUM THICK NICKEL.
- MOUNTING PANEL THICKNESS .062 NOMINAL.
 CAVITIES SHALL CONFORM TO FCC RULES AND REGULATIONS, PART 68, SUBPART F.
 BULK P/N = 2-555052-1. BULK PACK IN QUANTITIES OF 100 PCS.

THIS DRAWING IS A CONTROLLED DOCUMENT.

DATE	REVISED	BY	DATE	BY
28	AA	SWI/SHT	22JUN03	SWI/SHT

DATE: 2.1

555052

2-555052-1

555052-1

PART NO

555052

DATE: 2.1

REV: 1

BY: F

DATE: 2.1

REV: 1

BY: F

B.2 Humidity sensor

The data sheet of the Honeywell HIH-4000-002 humidity sensor

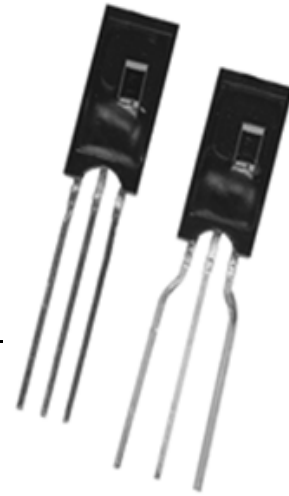

HIH-4000 Series

Humidity Sensors

The HIH-4000 Series Humidity Sensors are designed specifically for high volume OEM (Original Equipment Manufacturer) users. Direct input to a controller or other device is made possible by this sensor's linear voltage output. With a typical current draw of only 200 μ A, the HIH-4000 Series is often ideally suited for low drain, battery operated systems. Tight sensor interchangeability reduces or eliminates OEM production calibration costs. Individual sensor calibration data is available.

FEATURES

- Molded thermoset plastic housing
- Linear voltage output vs %RH
- Laser trimmed interchangeability
- Low power design
- High accuracy
- Fast response time
- Stable, low drift performance
- Chemically resistant

The HIH-4000 Series delivers instrumentation-quality RH (Relative Humidity) sensing performance in a competitively priced, solderable SIP (Single In-line Package). Available in two lead spacing configurations, the RH sensor is a laser trimmed, thermoset polymer capacitive sensing element with on-chip integrated signal conditioning. The sensing element's multilayer construction provides excellent resistance to most application hazards such as wetting, dust, dirt, oils and common environmental chemicals.

TYPICAL APPLICATIONS

- Refrigeration equipment
- HVAC equipment
- Medical equipment
- Drying
- Metrology
- Battery-powered systems
- OEM assemblies

HIH-4000 Series

TABLE 1. PERFORMANCE SPECIFICATIONS (At 5 Vdc supply and 25 °C [77 °F] unless otherwise noted.)
 (%RH performance specifications include test system measurement errors (±0.5 % typical.)

Parameter	Minimum	Typical	Maximum	Unit
Interchangeability (best fit straight line)	–	–	–	–
0 % to 60 %	-5	–	5	%RH
60 % to 100 %	-8	–	8	%RH
Interchangeability (2nd order curve)	–	±3.5	–	%RH
Accuracy ¹ (best fit straight line)	–	±3.5	–	%RH
Accuracy (2nd order curve)	–	±2.5	–	%RH
Hysteresis	–	3	–	%RH
Repeatability	–	±0.5	–	%RH
Settling time	–	–	70	ms
Response time (1/e in slow moving air)	–	15	–	s
Stability ² (@ 50 %RH)	–	±1.2 (per year)	–	%RH
Stability ³ (@ 50 %RH)	–	±0.5 (per year)	–	%RH
Voltage supply	4	–	5.8	Vdc
Current supply	–	–	500	µA
Voltage output (1 st order fit)	$V_{out} = V_{supply} (0.0062(\text{sensor RH}) + 0.16)$			
Voltage output (2nd order curve fit)	$V_{out} = 0.00003(\text{sensor RH})^2 + 0.0281(\text{sensor RH}) + 0.820$, typical @ 25 °C			
Temperature compensation	$V_{out} = (0.0305 + 0.000044T - 0.0000011T^2)(\text{Sensor RH}) + (0.9237 - 0.0041T + 0.000040T^2)$, T=Temperature in °C			
Operating temperature	-40[-40]	See Figure 1.	85[185]	°C[°F]
Operating humidity	0	See Figure 2.	100	%RH
Storage temperature	-40[-40]	–	125[257]	°C[°F]
Storage humidity	See Figure 2.			%RH

Notes:

1. For HIH-4000-003 and -004 only.
2. Specification includes testing outside of recommended operating zone.
3. Specification includes testing for recommended operating zone only.

NOTICE

- Do not expose sensor to condensing environments. Exposure to condensing environments will cause sensor output to indicate 0 %RH.
 - Sensor is light sensitive. For best performance, shield sensor from bright light.
 - Sensor is static sensitive. Sensor connection protected to 15 kV maximum.
 - Sensor output is ratiometric to supply voltage.
- Failure to comply with these instructions could result in death or serious injury.**

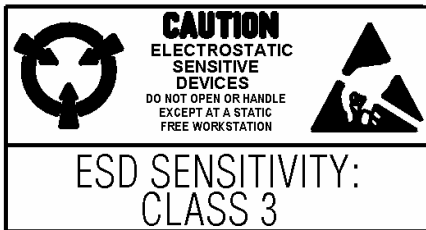

FACTORY CALIBRATION DATA

HIH-4000 Sensors may be ordered with a calibration and data printout (Table 2). See order guide on back page.

TABLE 2. EXAMPLE DATA PRINTOUT

Model	HIH-4000-001
Channel	92
Wafer	030996M
MRP	337313
Calculated values at 5 V	
V _{out} @ 0 %RH	0.958 V
V _{out} @ 75.3 %RH	3.268 V
Linear output for 2 %RH accuracy @ 25 °C	
Zero offset	0.958 V
Slope	30.680 mV/%RH
RH	(V _{out} -zero offset)/slope (V _{out} -0.958)/0.0307
Ratiometric response for 0 % to 100 %RH	
V _{out}	V _{supply} (0.1915 to 0.8130)

Humidity Sensors

FIGURE 1. RECOMMENDED OPERATING CONDITIONS

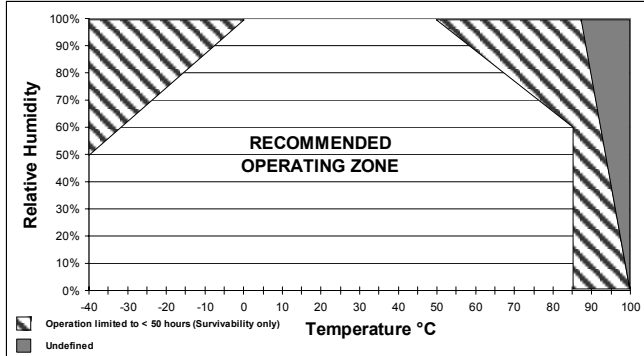

FIGURE 2. STORAGE ENVIRONMENT

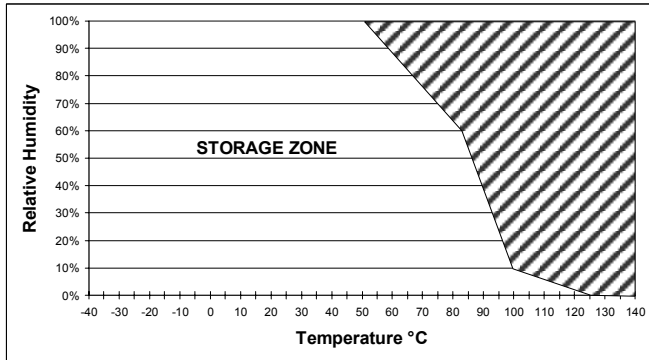

FIGURE 3. MOUNTING DIMENSIONS for reference only mm/[in]

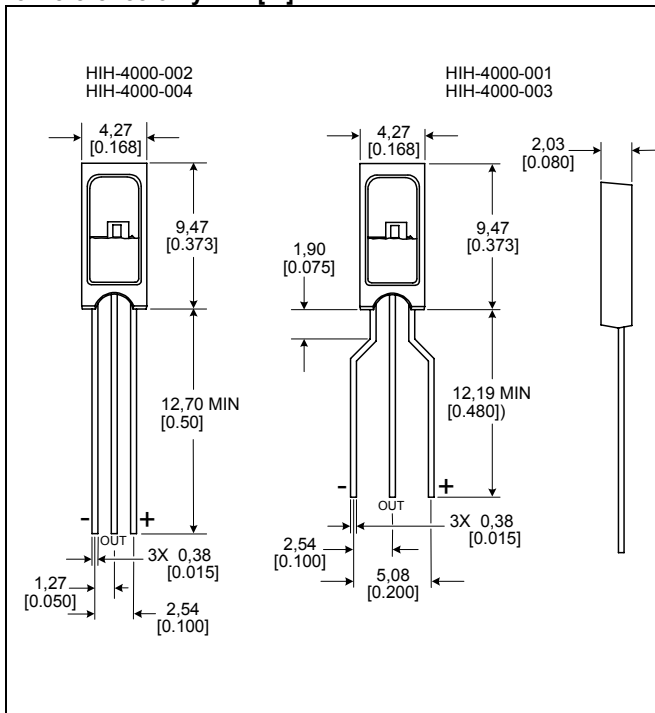

FIGURE 4. TYPICAL BEST FIT STRAIGHT LINE

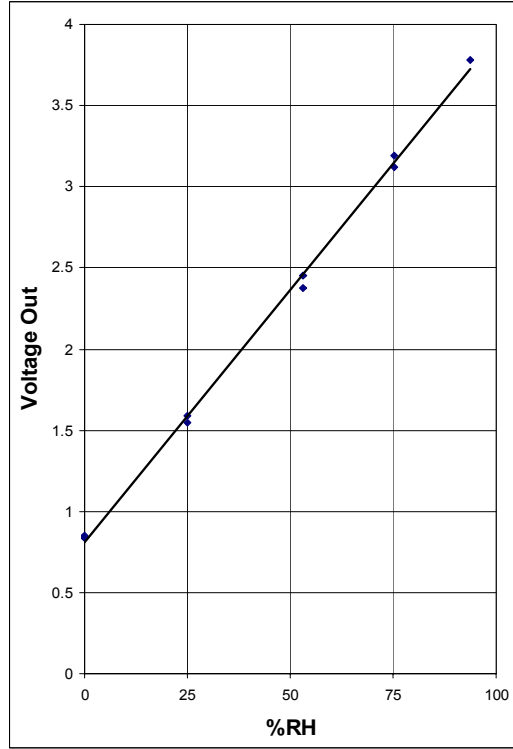
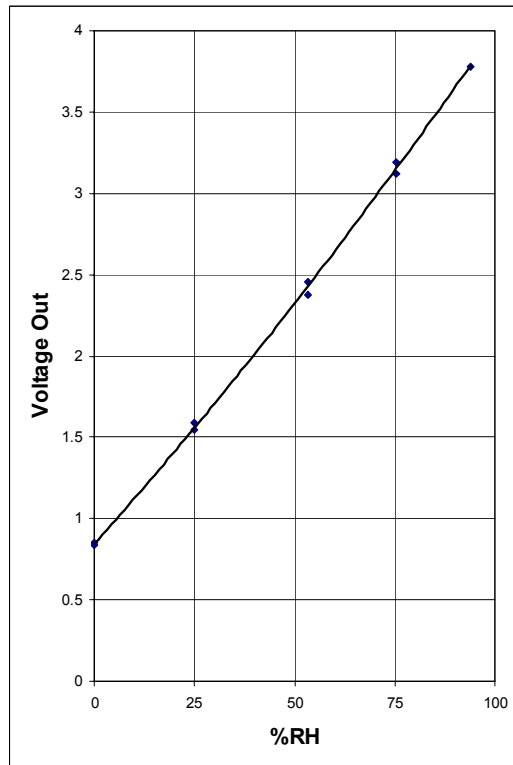

FIGURE 5. TYPICAL 2nd ORDER CURVE FIT



ORDER GUIDE

Catalog Listing	Description
HIH-4000-001	Integrated circuitry humidity sensor, 0.100 in lead pitch SIP
HIH-4000-002	Integrated circuitry humidity sensor, 0.050 in lead pitch SIP
HIH-4000-003	Integrated circuitry humidity sensor, 0.100 in lead pitch SIP with calibration and data printout
HIH-4000-004	Integrated circuitry humidity sensor, 0.050 in lead pitch SIP with calibration and data printout

WARNING

MISUSE OF DOCUMENTATION

- The information presented in this product sheet is for reference only. Do not use this document as a product installation guide.
- Complete installation, operation, and maintenance information is provided in the instructions supplied with each product.

Failure to comply with these instructions could result in death or serious injury.

WARNING

PERSONAL INJURY

DO NOT USE these products as safety or emergency stop devices or in any other application where failure of the product could result in personal injury.

Failure to comply with these instructions could result in death or serious injury.

WARRANTY/REMEDY

Honeywell warrants goods of its manufacture as being free of defective materials and faulty workmanship. Honeywell's standard product warranty applies unless agreed to otherwise by Honeywell in writing; please refer to your order acknowledgement or consult your local sales office for specific warranty details. If warranted goods are returned to Honeywell during the period of coverage, Honeywell will repair or replace, at its option, without charge those items it finds defective. **The foregoing is buyer's sole remedy and is in lieu of all other warranties, expressed or implied, including those of merchantability and fitness for a particular purpose. In no event shall Honeywell be liable for consequential, special, or indirect damages.**

While we provide application assistance personally, through our literature and the Honeywell web site, it is up to the customer to determine the suitability of the product in the application.

Specifications may change without notice. The information we supply is believed to be accurate and reliable as of this printing. However, we assume no responsibility for its use.

Automation and Control Solutions

Sensing and Control

Honeywell

11 West Spring Street

Freeport, Illinois 61032

www.honeywell.com/sensing

SALES AND SERVICE

Honeywell serves its customers through a worldwide network of sales offices, representatives and distributors. For application assistance, current specifications, pricing or name of the nearest Authorized Distributor, contact your local sales office or:

E-mail: info.sc@honeywell.com

Internet: www.honeywell.com/sensing

Phone and Fax:

Asia Pacific +65 6355-2828

+65 6445-3033 Fax

Europe +44 (0) 1698 481481

+44 (0) 1698 481676 Fax

Latin America +1-305-805-8188

+1-305-883-8257 Fax

USA/Canada +1-800-537-6945

+1-815-235-6847

+1-815-235-6545 Fax

Honeywell

Installation Instructions for the HIH-4000 Humidity Sensor

ISSUE 1
50009357

CAUTION

IMPROPER HANDLING

- Do not remove the sensor from its original protective packaging until it is ready to be installed.
- Do not touch the sensor surface. Use latex finger cots. Handle the sensor by its package edges or leads.
- Do not allow objects to enter the cavity of the sensor element.

Failure to comply with these instructions may result in product damage.

NOTICE

- Under condensing conditions where enough liquid water forms on the sensor to create a parasitic leakage path, the HIH-4000 Series Humidity Sensor produces an erroneous reading of 0 % humidity. If this erroneous reading is assumed to be correct by your control function, excess humidity is likely to be introduced into the system. Once the liquid water evaporates from the sensor and the environment returns to a non-condensing state, the device returns to normal functionality.
- Shade the sensor from direct light. Intense direct light can flood junctions in the CMOS (Complementary Metal Oxide Semiconductor) device and drive the output signal to the minimum. This does not harm the sensor or affect calibration. Proper operation resumes shortly after the direct light is removed. Ambient scattered light normally does not affect performance.

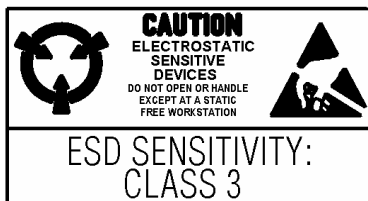

RECOMMENDED PCB MOUNTING

Catalog Listing	Mill-Max Socket Number
HIH-4000-001 HIH-4000-003	310-93-132-41-001 or similar
HIH-4000-002 HIH-4000-004	851-93-032-10-001 or similar

SOLDERING/ASSEMBLY

CAUTION

IMPROPER CLEANING

- Insert and solder the sensor after the PCB cleaning process.
- Clean sensor with isopropyl alcohol after soldering.

Failure to comply with these instructions may result in product damage.

Hand soldering is recommended; however, if wave soldering is required, use a no-clean flux. Limit the contact of the flux to the leads only.

Recommended PC board wave soldering temperature is 250 °C to 260 °C [482 °F to 500 °F].

MOISTURE SEALING THE LEADS

If, in the presence of intermittent moisture or other contaminants, there is the possibility of galvanic paths between the leads, moisture seal the leads.

MOUNTING DIMENSIONS

(for reference only mm/[in])

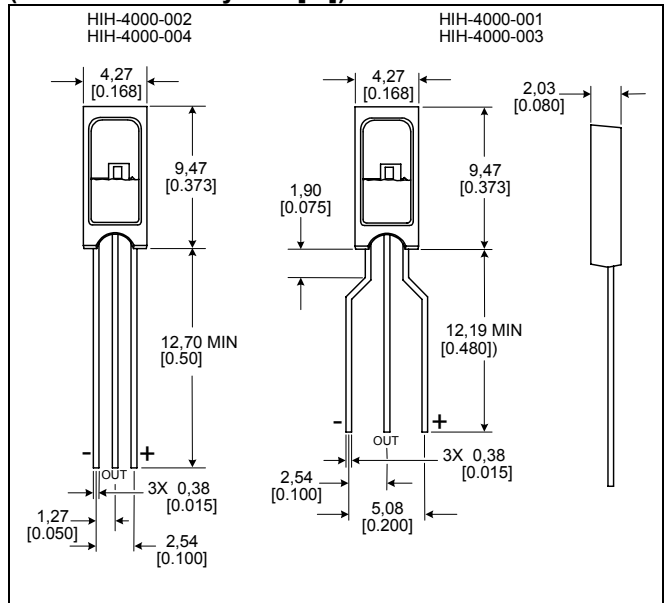

WARNING

PERSONAL INJURY

DO NOT USE these products as safety or emergency stop devices or in any other application where failure of the product could result in personal injury.

Failure to comply with these instructions could result in death or serious injury.

WARRANTY/REMEDY

Honeywell warrants goods of its manufacture as being free of defective materials and faulty workmanship. Honeywell's standard product warranty applies unless agreed to otherwise by Honeywell in writing; please refer to your order acknowledgement or consult your local sales office for specific warranty details. If warranted goods are returned to Honeywell during the period of coverage, Honeywell will repair or replace, at its option, without charge those items it finds defective. **The foregoing is buyer's sole remedy and is in lieu of all other warranties, expressed or implied, including those of merchantability and fitness for a particular purpose. In no event shall Honeywell be liable for consequential, special, or indirect damages.**

While we provide application assistance personally, through our literature and the Honeywell web site, it is up to the customer to determine the suitability of the product in the application.

Specifications may change without notice. The information we supply is believed to be accurate and reliable as of this printing. However, we assume no responsibility for its use.

SALES AND SERVICE

Honeywell serves its customers through a worldwide network of sales offices, representatives and distributors. For application assistance, current specifications, pricing or name of the nearest Authorized Distributor, contact your local sales office or:

E-mail: info.sc@honeywell.com

Internet: www.honeywell.com/sensing

Phone and Fax:

Asia Pacific	+65 6355-2828
	+65 6445-3033 Fax
Europe	+44 (0) 1698 481481
	+44 (0) 1698 481676 Fax
Latin America	+1-305-805-8188
	+1-305-883-8257 Fax
USA/Canada	+1-800-537-6945
	+1-815-235-6847
	+1-815-235-6545 Fax

Automation and Control Solutions

Sensing and Control

Honeywell

11 West Spring Street

Freeport, Illinois 61032

www.honeywell.com/sensing

50009357-1-EN IL50 GLO Printed in USA
March 2005
© 2005 Honeywell International Inc.

Honeywell

B.3 Peltier element

The data sheet of the Supercool PE-071-10-13-S2 peltier element

Thermoelectric modules

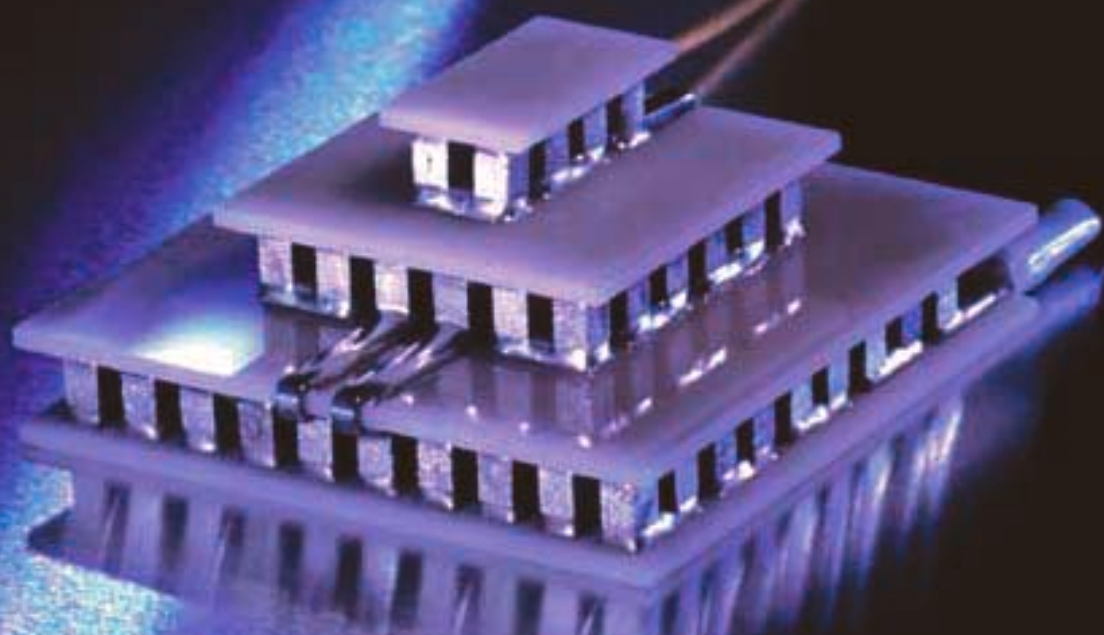

Supercool®

**There are 120 reasons to choose a
standard thermoelectric module from Supercool.
But one is enough**

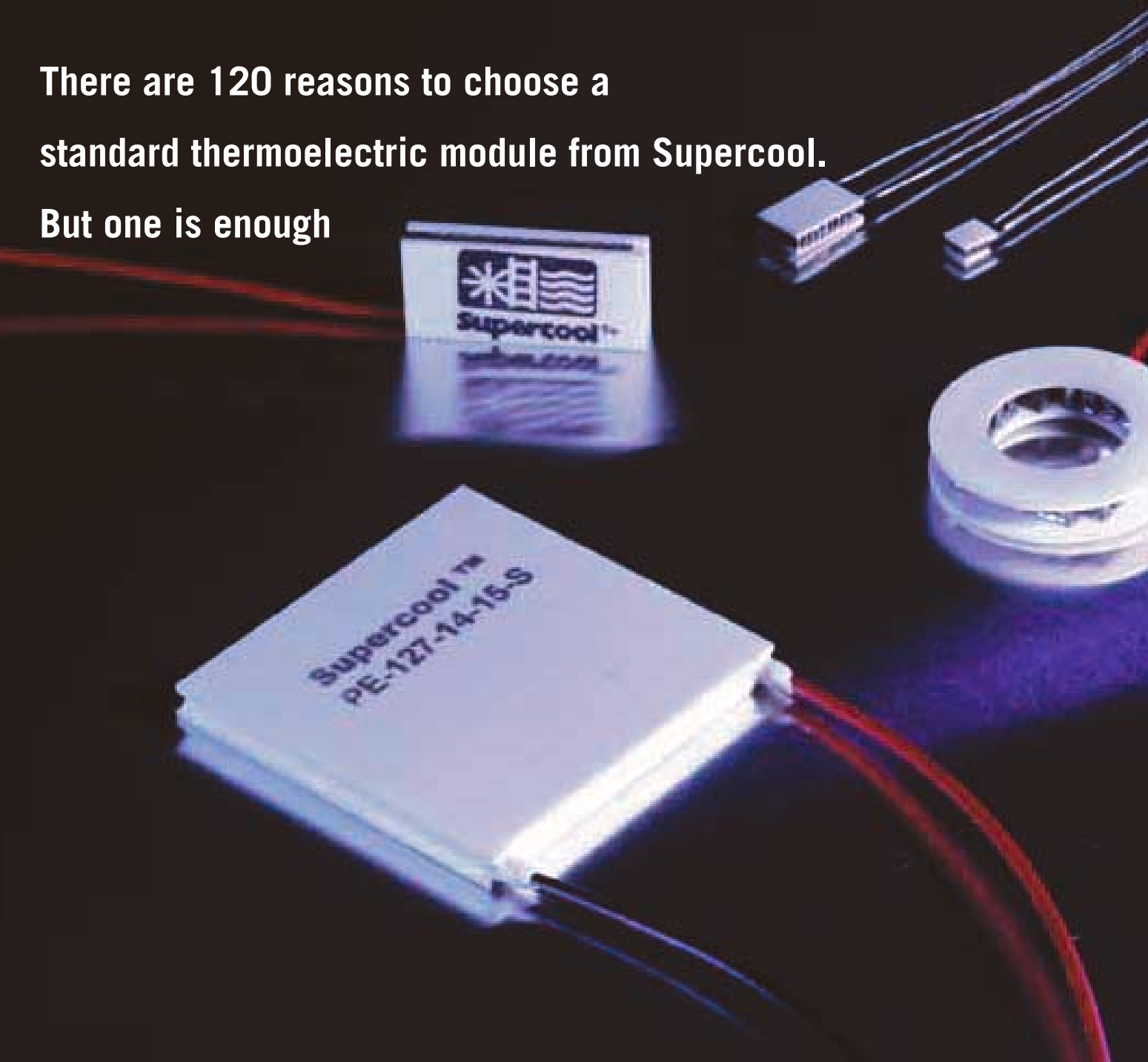

We Scandinavians don't tend to sing our own praises. So when we say we supply the best thermoelectric modules on the market, it's no idle boast.

Thanks to unrivaled material characteristics, our modules deliver truly outstanding performance (max. ΔT up to 75°C). To illustrate our point, we'd like you to consider the following. If power consumption is constant, then a standard

refrigerator running on our TE-modules will be about 3-4°C cooler than if you use the vast majority of competing products.

Whatever your application, we have the modules

With over 120 standard TEMs available off-the-shelf, Supercool supplies one of the market's widest selections. Our

Custom design	4-5	High performance modules	Multistage modules	8
Supercool worldwide	5	Standard modules	High temperature modules	9
		Miniature modules	Power modules	9
		Center hole modules		8

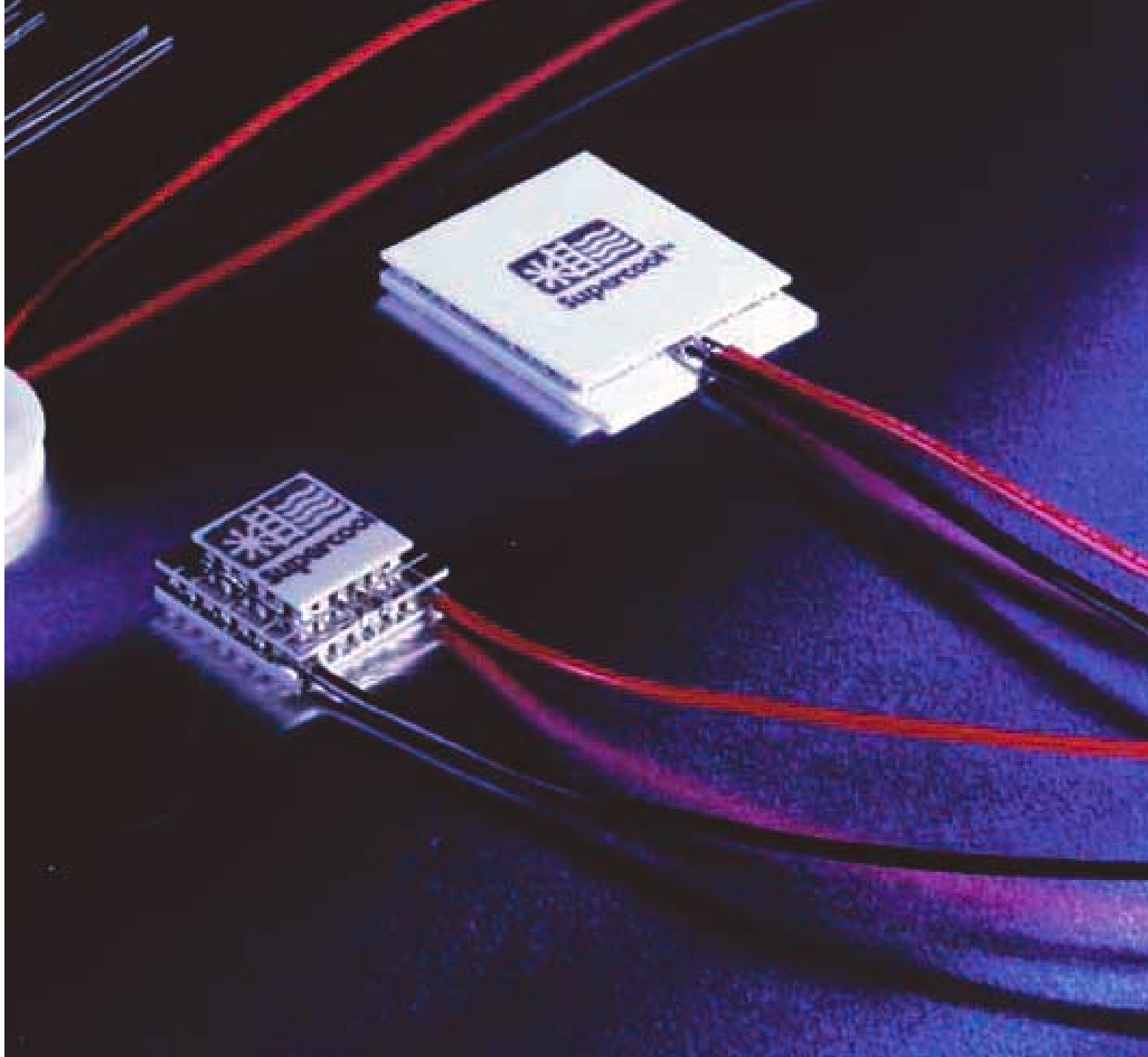

range includes modules of every conceivable size – from the tiniest miniature modules to high-power density TEMs delivering cooling power up to 340 W. In addition, silicon and epoxy sealing, metallization as well as other options are all available on request.

Temperature controllers to ensure top performance

Specially designed for thermoelectric applications, our temperature controllers guarantee not only reliable performance but also the temperature stability of your system. For more information, order our 'Thermoelectric solutions' catalog.

Medium performance modules 10
Technical information 10-11

For more information on the market's leading thermoelectric assemblies, order our TE solutions catalog.



Examples of custom-designed TE modules:
a gold metallized micro-TEM, a kit of 3 sealed TEMs with wire
harness, and a 5-stage module optimized for best ΔT .

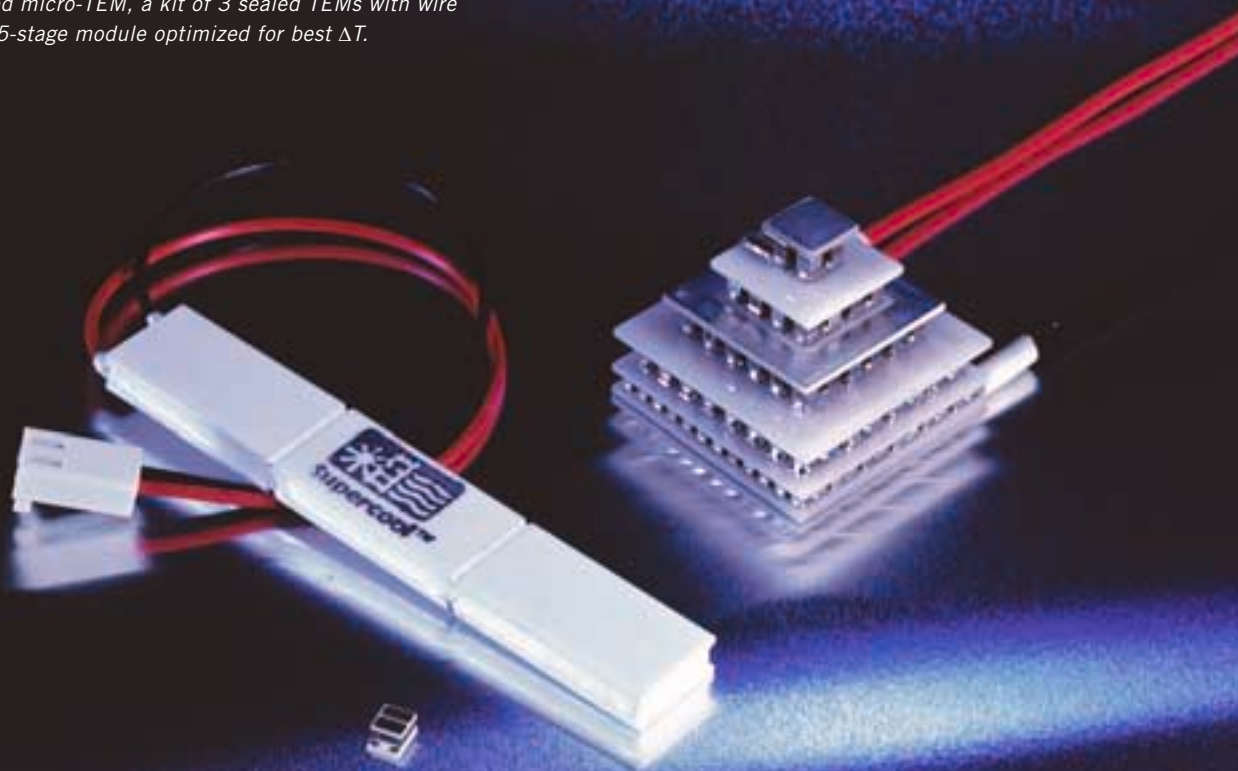

This 2-stage TE module, epoxy
bonded to a machined heat sink,
cools a CCD in a vacuum.

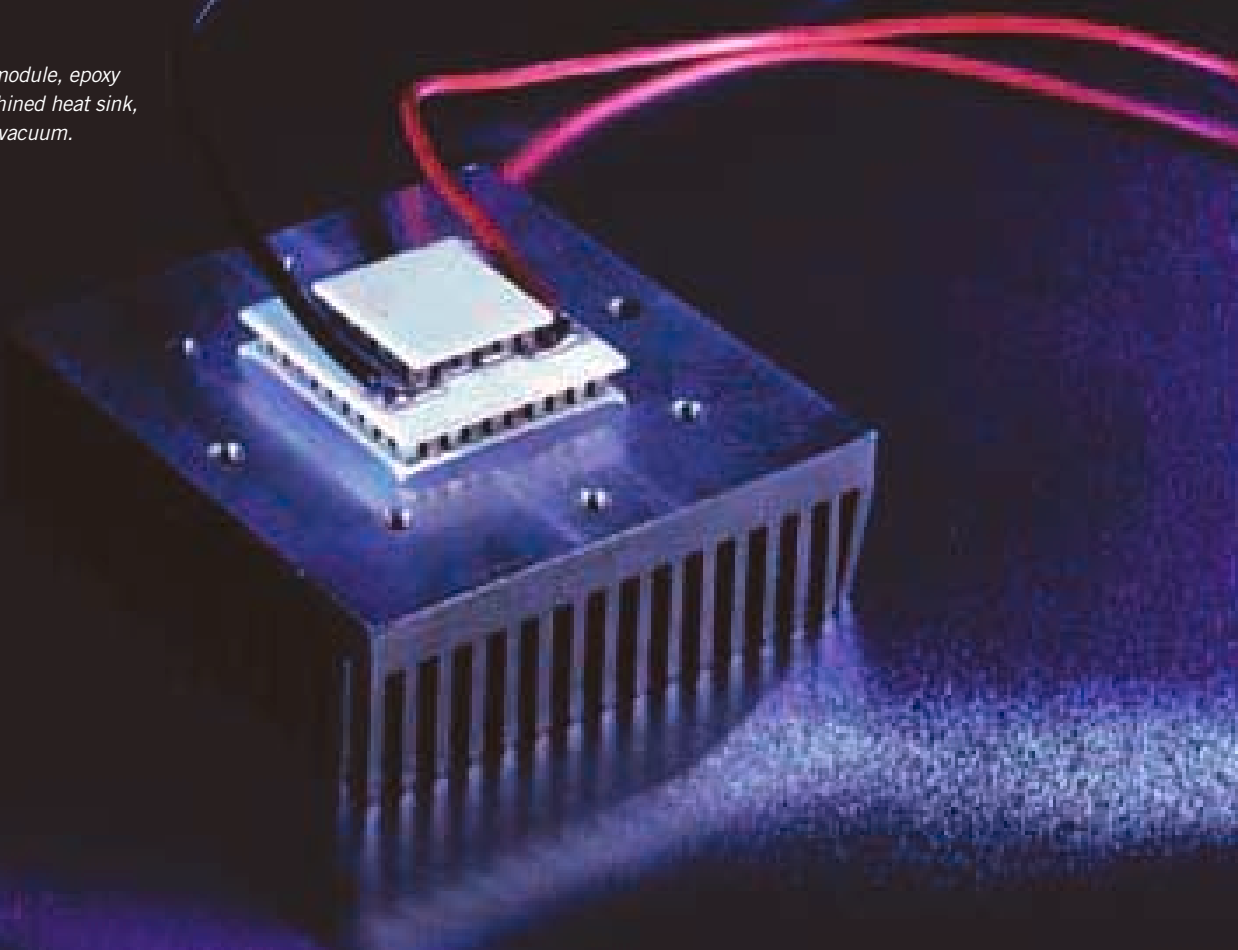

Custom design – finding a solution quickly

Although we provide more than 120 standard modules, we're fully aware that a standard product will not always meet your needs. That's why we pride ourselves on being able to customize solutions quickly and cost-efficiently. All you have to do is ask.

Making sure you get the best

We'll help you conduct thermal studies to define your demands. Supercool's design engineers will then work closely with your personnel to implement the solution. Our flexible production process enables us to meet your requirements – without you having to invest a fortune in either prototypes or large-volume production.

Modules alone won't do the job

We provide not only modules, but also wire harnesses, packaging such as epoxy bonding to heat sinks and much more.

To make the most of the market's finest TEMs, be sure to challenge our designers. And if your project calls for it, we can test-run systems in our climatic chamber.

Naturally, we also offer complete thermoelectric solutions, including assemblies, temperature controllers and power supplies.

A Supercool product has to work all over the world

Today it's widely accepted that thermoelectrics enjoy virtually limitless potential. That's why our solutions see action all over the world. They withstand shocks and vibrations. They manage thermal cycling and provide absolute accuracy. Yet they never lose their cool.

Typical applications:

- CCDs
- Lasers
- Sensors
- Analytical instruments
- Liquid chillers
- Thermal cycling
- Point-of-sale refrigerators
- Automotive applications.

Supercool in reality...

Though we have operations in Sweden and the United States, it's only through our international network of partners and representatives that we can offer you a global service. Their

commitment to quality, service and integrity has established Supercool as a global supplier of thermoelectric solutions. You're never far from Supercool – wherever you are.

...and in virtual reality

www.supercool.com is much more than simply a shopwindow for us. This is where you go for the latest news as well as tips and advice on how to best manage your thermal challenges.

Cool by nature

Environmental legislation is getting ever tougher. But once you opt for thermoelectrics you need never worry that you've chosen a cooling system that has a negative impact on the environment. That's because electricity triggers the cooling process; there are no CFCs and no need for refills.

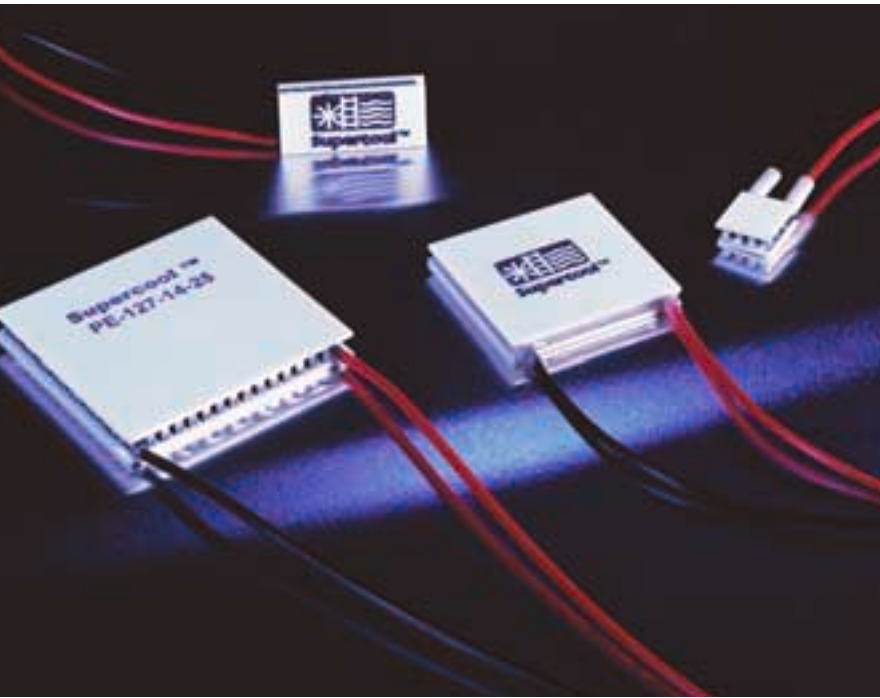

Standard modules

Supercool's thermoelectric modules for industrial and commercial applications deliver the market's best cooling performance.

By using one or more TEMs, you can design a cooling system with effects ranging from just a few Watts all the way up to several hundred Watts. With max. voltage from 0.9 V up to 30 V DC and an array of pellet geometries, there's every chance of finding just the right module for your application. In the event that our standard range doesn't meet all your requirements, we offer a choice of other dimensions and pellet geometries. Max. ΔT up to 75°C (at $T_{hot} = 25^\circ C$).

To optimize service life, maximum warm side temperature is 80°C.

Sealed versions

We also provide a selection of off-the-shelf standard TEMs with perimeter sealing.

Silicon moisture sealing: A cost-effective moisture sealing method suitable for most applications. Add -S after product code (PE-071-14-15-S)

Epoxy moisture sealing: Moisture and vapor sealing using special epoxy resin with low thermal conductivity. Add -E after product code (PE-127-10-13-E)

Sealed modules (-S or -E) available from stock are given in the table below.

All high performance modules are available in a sealed version on request.

Product No.	I _{max} (A)	U _{max} (V)	P _{cmax} (W)	ΔT _{max} (°C)	R _{AC} (ohm)	(mm)				S	Available Sealing ¹
						A	B	H	L		
Standard modules											
PE-007-14-15	6.0	0.9	3.3	74	0.12	10	10	3.9	200	22	
PE-017-10-15	3.4	2.1	4.5	74	0.49	10	10	3.8	200	24	
PE-017-14-15	6	2.1	7.6	74	0.29	15	15	3.9	200	22	
PE-031-08-15	2.2	3.8	5.1	74	1.57	13	13	3.8	200	24	
PE-031-10-08	6	3.8	13.8	72	0.52	15	15	3.1	200	22	
PE-031-10-13	3.9	3.8	9.3	74	0.93	15	15	3.6	200	24	S
PE-031-10-15	3.4	3.8	8.1	74	1.03	15	15	3.8	200	24	S
PE-031-14-15	6	3.8	14.5	74	0.48	20	20	3.9	200	22	
PE-063-08-15	2.2	7.8	10.4	74	3.20	25	12	3.8	150	24	
PE-063-10-15	3.4	7.8	16.5	74	2.03	30	15	3.8	200	24	
PE-071-10-08	6	8.8	31.6	72	1.17	20	20	3.1	200	22	
PE-071-10-13	3.9	8.8	21.2	74	1.98	20	20	3.6	200	24	S
PE-071-10-15	3.4	8.8	18.5	74	2.18	20	20	3.8	200	24	
PE-071-14-11	8.5	8.8	45.8	72	0.83	30	30	3.8	200	20	
PE-071-14-15	6	8.8	33.2	74	1.27	30	30	3.9	200	22	S
PE-071-14-25	3.9	8.8	21.6	75	1.88	30	30	4.8	200	22	
PE-071-20-15	13.1	8.8	71.9	74	0.55	47	47	4.6	200	20	
PE-127-08-15	2.2	15.7	20.9	74	6.2	25	25	3.8	200	24	
PE-127-08-25	1.3	15.7	12.6	75	11.0	25	25	4.8	200	24	S
PE-127-10-08	6	15.7	57.1	72	2.23	30	30	3.1	200	22	S
PE-127-10-13	3.9	15.7	37.9	74	3.46	30	30	3.6	200	24	S, E
PE-127-10-15	3.4	15.7	33.2	74	4.02	30	30	3.8	200	24	
PE-127-10-25	2	15.7	19.7	75	6.7	30	30	4.8	200	24	
PE-127-14-11	8.5	15.7	82.1	72	1.54	40	40	3.8	300	20	S, E
PE-127-14-15	6	15.7	59.4	74	2.23	40	40	3.9	300	22	S, E
PE-127-14-25	3.9	15.7	38.6	75	3.36	40	40	4.8	350	22	S, E
PE-127-20-15	13.1	15.7	128.7	74	1.08	62	62	4.6	200	20	
PE-127-20-25	8	15.7	78.7	75	1.68	62	62	5.6	200	20	
PE-131-10-13	3.9	16.2	39.1	74	3.65	40	23	3.6	200	24	S
PE-161-12-10	6.7	20.0	83.9	72	2.44	40	40	3.3	350	22	S
PE-161-12-13	5	20.0	62.3	74	3.34	40	40	3.7	350	22	S
PE-161-12-15	4.4	20.0	54.6	74	3.87	40	40	3.9	350	22	S
PE-241-10-13	3.9	30.0	71.8	74	6.6	40	40	3.6	200	24	
PE-241-10-25	2	30.0	37.3	75	12.7	40	40	4.8	300	24	S
PE-241-14-15	6	30.0	112.7	74	4.21	55	55	3.9	200	22	

¹) S = Silicon sealed version available. E = Epoxy sealed version available. Note! Max ΔT is reduced by 2-3°C for S-type and 1-2°C for E-type.

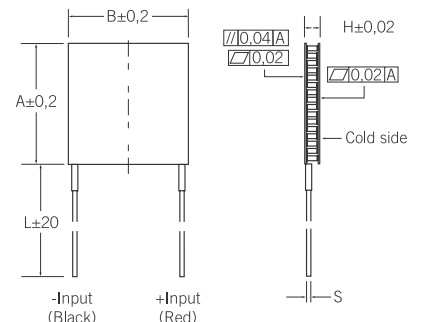

- Lead wires are approved acc. to UL 1569.
- R_{AC} tolerance = ±10%
- Tolerance of I_{max}, U_{max}, Q_{max} = ± 5%



Miniature modules

This range has been specially developed for low-effect applications where space is limited, such as optical components, sensors and lasers typically found in the opto-electronics and telecom industries. Our superior TE-material makes it possible to achieve ΔT up to 74°C (at $T_{hot} = 25^\circ C$). Standard sizes range from 2.5 x 2.5 mm up to 13.2 x 13.2 mm.

Standard internal solder temperature is 138°C ($T_{h\ max} = 80^\circ C$). Optionally we can offer 183°C and 232°C internal solder – both with an operating temperature of up to 150°C. Gold metallization and pretinning (95, 138 or 183°C) are other options.

We also provide miniature TEMs on request.

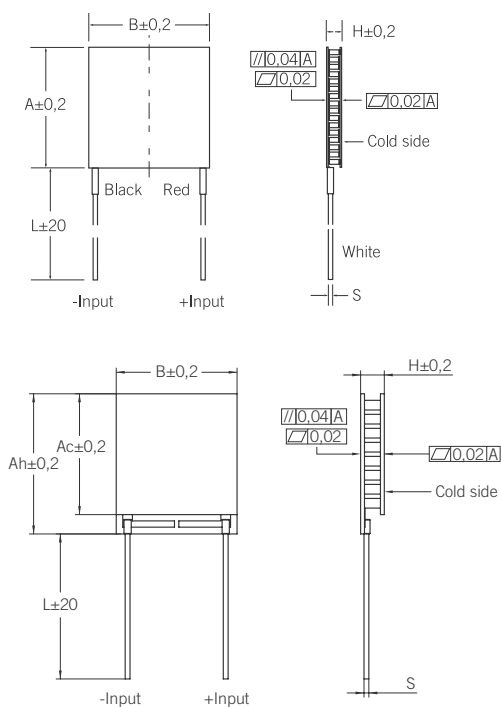

- R_{AC} tolerance = $\pm 10\%$
- Tolerance of I_{max} , U_{max} , Q_{max} = $\pm 5\%$

Product No.	I_{max} (A)	U_{max} (V)	$P_{c\ max}$ (W)	ΔT_{max} (°C)	R_{AC} (ohm)	(mm)					S mm/mm ²
						A / Ac	Ah	B	H	L	
Miniature modules											
PE-008-03-09	0.5	1.0	0.3	71	1.82	2.5	3,5	2.5	2.05	50	0.25 ¹
PE-018-03-09	0.5	2.2	0.6	71	4.29	3.5	4,5	3.5	2.05	50	0.25 ¹
PE-032-03-09	0.5	3.9	1.1	71	7.62	5.0	6.0	5.0	2.05	50	0.25 ¹
PE-007-06-11	1.5	0.9	0.8	72	0.42	4.0	4.0	2.7	50	0.25 ¹	
PE-017-06-11	1.5	2.1	2.0	72	1.12	6.0	6.0	2.7	50	0.25 ¹	
PE-018-06-11	1.5	2.2	2.1	72	1.22	6.0	7.2	6.0	2.7	50	0.25 ¹
PE-023-06-11	1.5	2.8	2.6	72	1.53	8.2	6.0	1.95	50	0.25 ¹	
PE-029-06-11	1.5	3.6	3.3	72	1.87	10.2	6.0	2.7	50	0.25 ¹	
PE-031-06-11	1.5	3.8	3.6	72	2.03	8.0	8.0	2.7	50	0.25 ¹	
PE-068-06-11	1.5	8.3	7.8	72	4.35	13.2	13.2	2.7	50	0.25 ¹	
PE-007-05-15	0.8	0.9	0.4	74	0.88	4.0	4.0	3.0	50	0.07 ²	
PE-011-05-15	0.8	1.4	0.7	74	1.45	4.0	6.0	3.0	50	0.07 ²	
PE-017-05-15	0.8	2.1	1.1	74	2.15	6.0	6.0	3.0	50	0.07 ²	
PE-031-05-15	0.8	3.8	2.0	74	4.11	8.0	8.0	3.0	50	0.07 ²	
PE-065-05-15	0.8	8.1	4.2	74	8.2	11.0	12.0	3.0	100	0.07 ²	
PE-007-07-10	2.4	0.9	1.3	72	0.34	6.0	6.0	2.5	50	0.14 ²	
PE-011-07-10	2.4	1.4	1.9	72	0.53	6.0	8.0	2.5	50	0.14 ²	
PE-017-07-10	2.4	2.1	2.9	72	0.82	8.0	8.0	2.5	50	0.14 ²	
PE-031-07-10	2.4	3.8	5.3	72	1.49	10.0	10.0	2.5	50	0.14 ²	
PE-065-07-10	2.4	8.1	11.1	72	3.12	14.0	15.0	2.5	50	0.14 ²	

1) Bare wire, Ni over Cu, diameter in mm
 2) Teflon insulated wire. Cross section in mm²

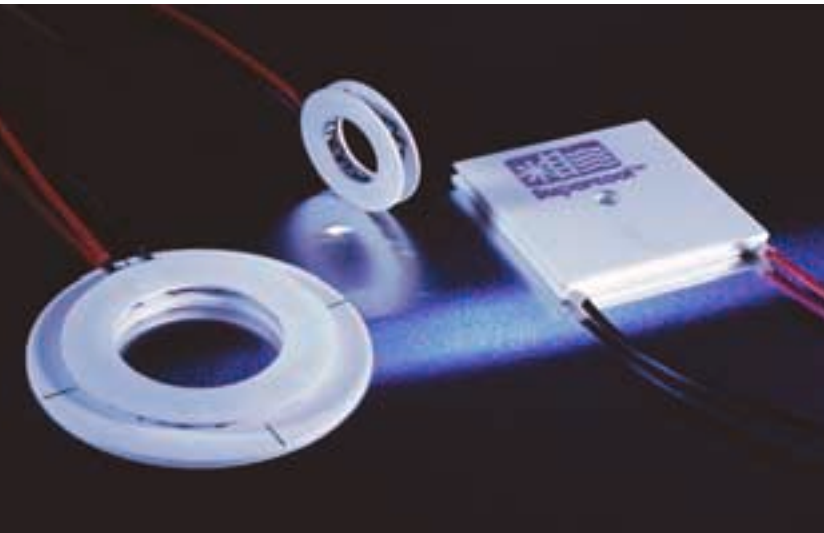

Center hole modules

Center hole modules are used when light, wires or other hardware need to be transferred through the module.

We only stock a limited number of modules of this type. Let us know about the challenges of your application, and we'll make sure you get just the right module. In principle, all modules can be supplied with a center hole.

Operating temperature is max. 80°C.

Product No.	I _{max} (A)	U _{max} (V)	P _{c max} (W)	ΔT _{max} (°C)	R _{AC} (ohm)	(mm)				S AWG #
						A, B, D	d	H	L	
Center hole modules										
PE-119-10-13HS ¹⁾	3.9	14.7	35.5	71	3.37	30	4.7	3.6	200	24
PE-125-14-11HS ¹⁾	8.5	15.6	81.5	70	1.46	40	4.7	3.8	300	20
PE-125-14-15HS ¹⁾	6	15.5	58.5	72	2.16	40	4.7	3.9	300	22
PE-014-14-25RH ²⁾	3.9	1.7	4.3	75	0.37	26	14	4.7	200	22
PE-032-14-15RH ²⁾	6	4.0	15	74	0.54	55 ³⁾	27	3.9	200	22
PE-038-10-13RH ²⁾	3.9	4.7	11.4	74	1.05	24	10	3.6	200	24

¹⁾ S = Silicon sealed versions.

²⁾ Round design. D = outer diameter and d = inner diameter.

³⁾ Outer diameter on warm side = 55 mm. Outer diameter on cold side = 44 mm.

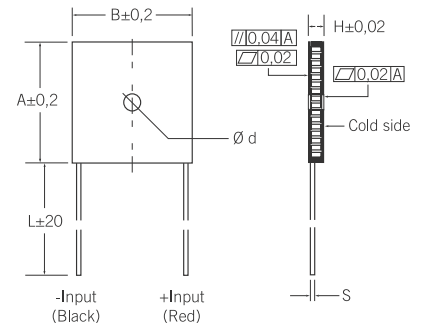

- Lead wires are approved acc. to UL 1569..
- R_{AC} tolerance = ±10%
- Tolerance of I_{max}, U_{max}, Q_{max} = ±5%

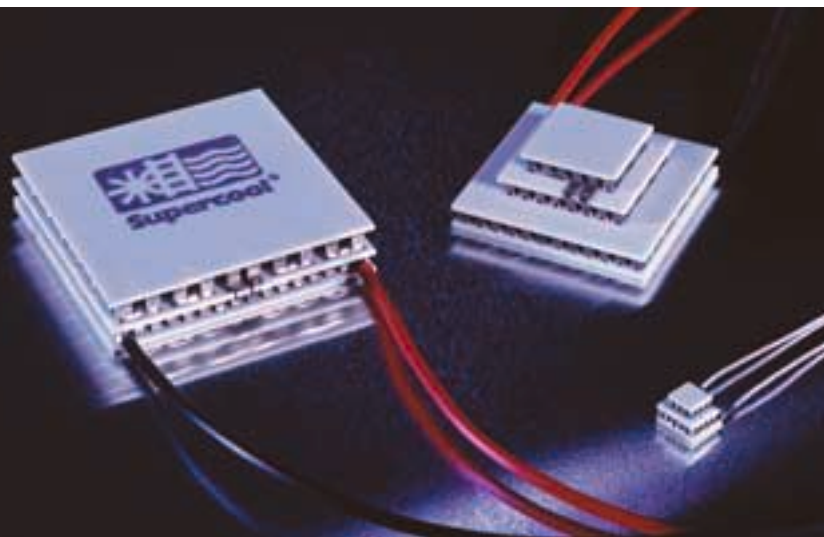

Multistage modules

Thanks to superior material characteristics we can offer a range of truly outstanding multistage TEMs. If your system has to generate a ΔT above 50°C, you normally need a multistage module. Typical applications include CCD arrays, IR detectors and analytical instruments.

If you can't find the right TEM for your application, feel free to put our designers to the test.

Operating temperature is max. 80°C.

Product No.	I _{max} (A)	U _{max} (V)	P _{c max} (W)	ΔT _{max} (°C)	R _{AC} (ohm)	(mm)						S AWG #
						Ac	Bc	A	B	H	L	
Multistage modules												
PE-010-0606-1111	1.1	0.9	0.35	92	0.64	3.2	3.2	3.9	3.9	4.2	50	0.07 ¹⁾
PE-024-0606-1111	1.1	2.2	0.81	92	1.47	4.1	4.1	6.1	6.1	4.6	50	0.07 ¹⁾
PE-049-1010-1515	2.1	3.8	3.4	87	1.53	11.5	11.5	15	15	6.6	200	24
PE-049-1414-1515	4	3.8	3.7	87	0.83	15	15	20	20	7.2	200	22
PE-107-1010-1212	3	9.2	9.2	89	2.72	22.6	22.6	22.6	22.6	6.25	200	24
PE-190-1010-1212	2.8	15.7	16.4	87	4.78	30	30	30	30	6.5	200	24
PE-192-1420-1118	6.7	15.6	39.9	87	2.15	40	40	40	40	8.1	300	20
PE-192-1420-1525	4.4	16.0	27.3	88	3.03	40	40	40	40	8.1	300	22
PE3-070-20-25	6.5	6.5	3.0	118	0.93	14	8	36	36	16	200	22
PE3-119-14-15	3.9	8.0	7.5	100	2.09	15	15	30	30	10.4	200	22
PE3-119-20-15	8	8.2	14.9	100	0.97	22	22	44	44	12.9	200	20
PE3-231-10-15	1.9	15.5	6.9	104	7.22	15	15	30	30	9.5	200	24
PE4-115-14-15	3.5	7.6	2.6	122	1.95	14.5	4.5	33	24	13.8	200	22
PE4-129-10-15	1.8	8.2	1.9	115	3.83	8	8	23	23	12.5	200	24
PE5-257-10-15	1.5	14.5	2.0	123	7.9	8	8	30	30	15.4	200	24

¹⁾ Teflon insulated wire. Cross section in mm²

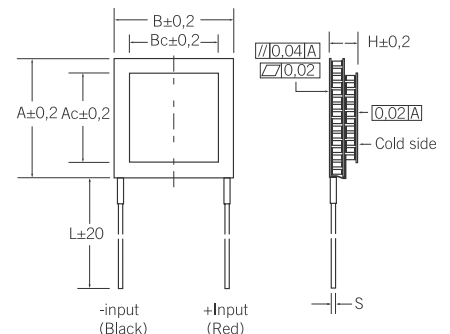

- Lead wires are approved acc. to UL 1569.
- R_{AC} tolerance = ±10%
- Tolerance of I_{max}, U_{max}, Q_{max} = ± 5%

High temperature modules

Supercool's high temperature modules deliver not only long-term operation up to 150°C, but also outstanding cooling performance (Max. $\Delta T = 73^\circ\text{C}$ at $T_{\text{hot}} = 25^\circ\text{C}$).

Although we boast a modest standard range, we can, in principle, supply all modules as high temperature modules should your application call for high volumes.

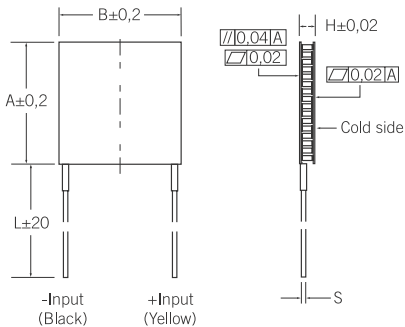
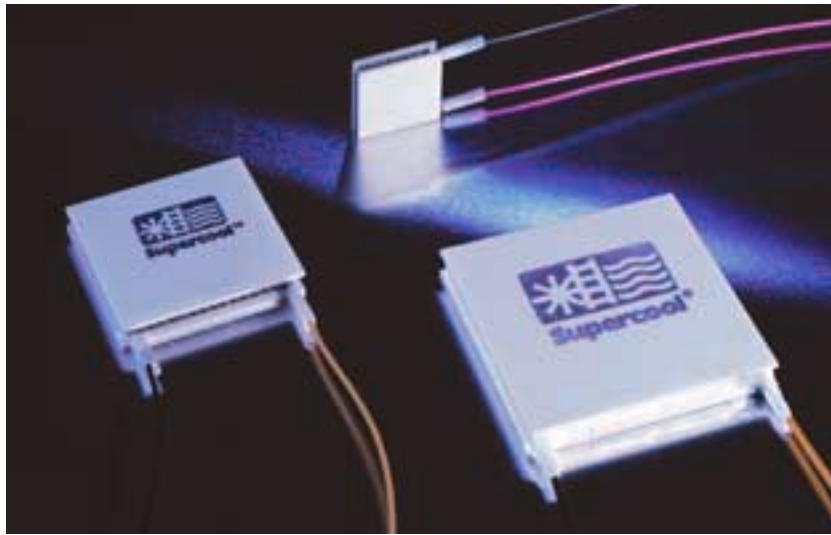

- High temperature modules feature Teflon (PTFE) insulated lead wires.
- R_{AC} tolerance = $\pm 10\%$
- Tolerance of $I_{\text{max}}, U_{\text{max}}, Q_{\text{max}} = \pm 5\%$

Product No.	I_{max} (A)	U_{max} (V)	$P_{\text{c max}}$ (W)	ΔT_{max} ($^\circ\text{C}$)	R_{AC} (ohm)	(mm)				S mm ²
						A	B	H	L	
High temperature modules										
PF-031-10-13	3.9	3.8	8.0	73	0.91	15	15	3.6	200	0.20
PF-071-10-13	3.9	8.8	20.9	73	1.97	20	20	3.6	200	0.20
PF-071-14-15	6	8.8	32.8	73	1.32	30	30	3.9	200	0.35
PF-127-10-13	3.9	15.7	37.4	73	3.47	30	30	3.6	200	0.20
PF-127-10-20	2.6	15.7	24.9	74	5.7	30	30	4.3	200	0.20
PF-127-14-11	8.5	15.7	81.0	71	1.52	40	40	3.8	300	0.50
PF-127-14-15	6	15.7	58.6	73	2.19	40	40	3.9	300	0.35
PF-127-14-25	3.9	15.7	38.1	74	3.42	40	40	4.8	350	0.35
PF-127-14-11-S ¹⁾	8.5	15.7	77.6	69	1.52	40	40	3.8	300	0.50
PF-127-14-15-S ¹⁾	6	15.7	56.1	71	2.19	40	40	3.9	300	0.35
PF-127-14-25-S ¹⁾	3.9	15.7	36.6	72	3.42	40	40	4.8	350	0.35

¹⁾ S = Silicon sealed versions.

Power modules

Power modules are for applications where you need to pump a great amount of heat onto a small surface. We offer power density of up to 14 W/cm². These TEMs also provide outstanding thermal cycling properties and can be used for applications such as lasers, PCR cycling and thermal testing of micro-processors.

By powering the TEMs to around half of U_{max} you can use these modules to achieve exceptionally high efficiency (COP). The porch style offers a strong lead attachment. Operating temperature is max. 120°C.

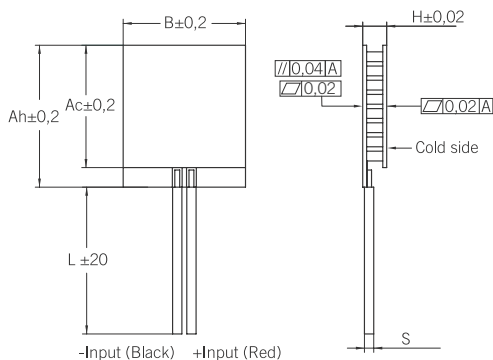
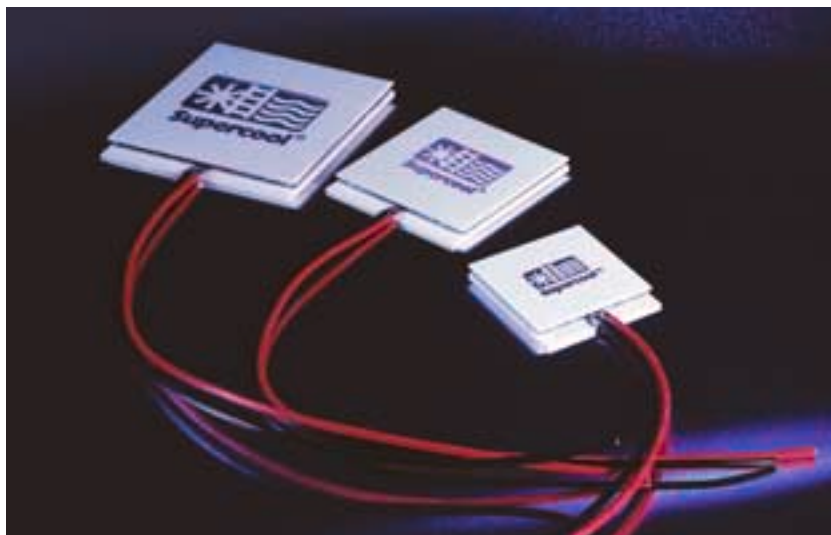

- Power modules feature Teflon (PTFE) insulated lead wires.
- R_{AC} tolerance = $\pm 10\%$
- Tolerance of $I_{\text{max}}, U_{\text{max}}, Q_{\text{max}} = \pm 5\%$

Product No.	I_{max} (A)	U_{max} (V)	$P_{\text{c max}}$ (W)	ΔT_{max} ($^\circ\text{C}$)	R_{AC} (ohm)	(mm)					S mm ²
						Ac	Ah	B	H	L	
Power modules											
PC-128-10-05	9	15.8	88.2	68	1.38	30	34	30	2.5	200	0.50
PC-072-14-06	15.4	8.9	85.1	68	0.45	30	34	30	3.3	200	0.75
PC-128-14-06	15.4	15.8	151.4	68	0.82	40	44	40	3.3	300	0.75
PC-128-20-08	24	15.8	235.5	70	0.55	55	59	55	4.0	200	0.75
PC-200-14-06	15.4	25.0	236.5	68	1.28	40	44	40	3.3	200	0.75
PC-200-14-11	8.5	24.9	127.5	71	2.36	40	44	40	3.8	200	0.50
PC-288-10-05	9	35.8	198.4	68	3.11	40	44	40	2.5	200	0.50
PC-288-10-08	6	35.8	127.6	71	4.83	40	44	40	3.1	200	0.50
PC-288-14-06	15.4	35.8	340.5	68	1.84	52	56	52	3.3	200	0.75
PC-288-14-11	8.5	35.8	182.6	71	3.39	52	56	52	3.8	200	0.5

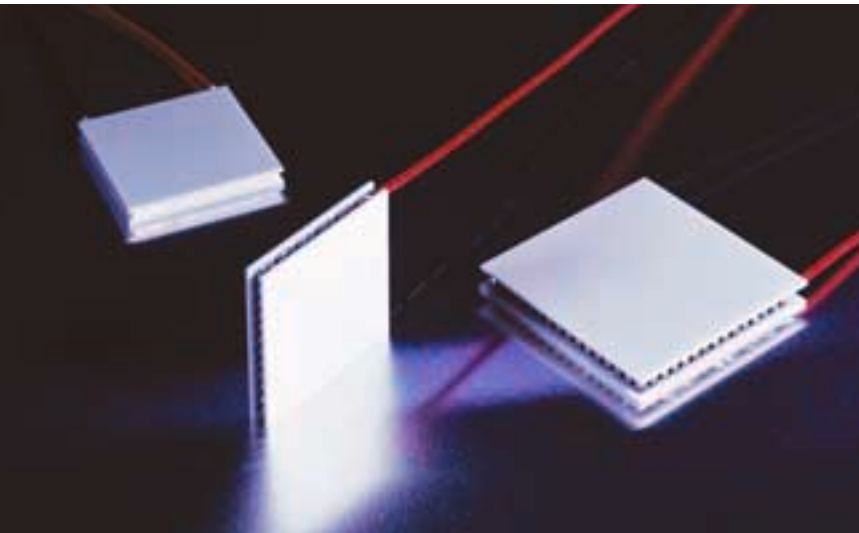

Medium performance modules

Kristall, our new range of medium performance thermoelectric modules, is specially designed for high volume applications. A novel manufacturing technique allows us to offer dependable performance – at an attractive price. Max. ΔT of up to 72°C at $T_h = 25^\circ\text{C}$.

The Kristall range is based on a patented method for growing thermoelectric material that delivers not only competitive cooling properties but also cost-effective production. Thanks to an advanced nickel diffusion barrier process, these modules can be used long-term at temperatures up to 90°C. Options are silicon or epoxy sealing and lapping.

Typical application areas include commercial refrigeration, electronics, industrial automation and automotive.

We stock a limited range of standard products. However, most specifications can be met for high volumes.



Plate and bar ingots – special materials technology

- Lead wires are PVC insulated.
- Max temperature = 105°C
- R_{AC} tolerance = $\pm 10\%$
- Tolerance of I_{max} , U_{max} , Q_{max} = $\pm 5\%$

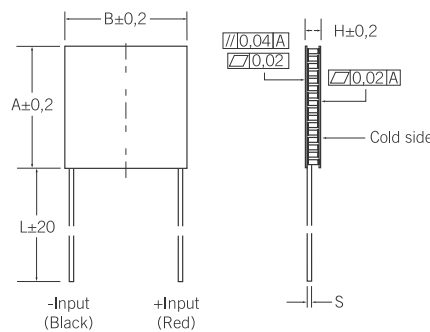

Product No.	I_{max} (A)	U_{max} (V)	P_{cmax} (W)	ΔT_{max} (°C)	R_{AC} (ohm)	(mm)				S AWG #
						A	B	H	L	
Medium performance modules										
PM-071-10-13	3.9	8.8	18.2	71	2.0	20	20	3.6	200	24
PM-071-14-15	6.0	8.6	29	71	1.30	30	30	3.9	200	22
PM-127-10-13	3.9	15.4	32.5	71	3.50	30	30	3.6	200	24
PM-127-14-11	8.5	15.4	73	69	1.50	40	40	3.8	200	20
PM-127-14-15	6.0	15.4	51.6	71	2.20	40	40	3.9	200	22
PM-127-14-25	3.9	15.4	32.5	72	3.4	40	40	4.8	200	22

Silicon sealed and Epoxy sealed version are available. Note ! Max ΔT is reduced by 2-3°C for S-type and 1-2°C for E-type

Thermoelectrics and how it works

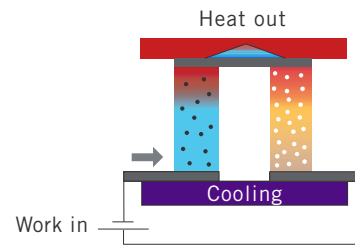

Heat Pump (Refrigerator) Peltier (1834)

The Thermoelectric Peltier effect is the most direct way to utilize electricity to pump heat. Electrical current (work input) forces the matter to approach a higher energy state (black dots) and heat is absorbed (cooling).

The energy is released (heating) as the matter approaches a lower energy state (white dots). The net cooling or heating effect is proportional to the electric current and Peltier coefficient.

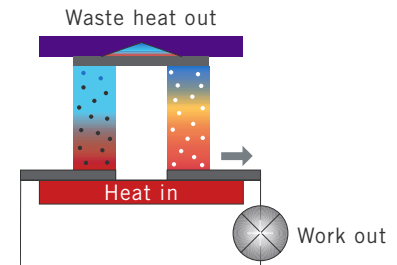

Power Generator Seebeck (1822)

Thermoelectric material can also be used for electric power generation. Some of the heat input is converted to electric current (work), as the higher energy matter (black dots) releases energy and cools to a lower energy state (white dots). The net work is proportional to the temperature difference and Seebeck coefficient.

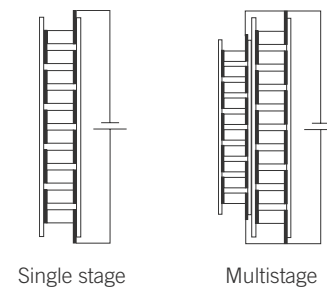

Thermoelectric modules

The material used at working temperatures up to 150°C is normally bismuth telluride, doped to obtain p (positive) and n (negative) semi-conducting properties.

A number of pn-couples, thermally parallel and electrically in series, are sandwiched between ceramic plates.

The maximum temperature differential (ΔT_{max}) between the cold and the warm side of a Supercool single stage module is up to 75°C at warm side temperatures of 25°C or $\Delta T = 85^\circ\text{C}$ at a warm side temperature of 50°C. By increasing the number of stages in a multistage arrangement, you also increase maximum ΔT .

Installation

- Recommended mounting methods are clamping using thermal grease, bonding with thermal epoxy, or soldering with metallized ceramics (option).
- TE modules should not be subjected to significant shear forces.
- Surface flatness of heat sinks should be 0.05 mm/100 mm or better.
- Soldering is not recommended for TE modules whose size is 18 x 18 mm or larger.
- Maximum clamping pressure is 1000 kPa for miniatures and 1500 kPa for other modules.

Operation

- Storage and operation in a condensing environment is only recommended if you use sealed modules.
- Generally TE modules are operated at 40-80% of U_{max} .
- Be sure to handle TE modules carefully during transportation and in production.
- When regulating in ON/OFF mode, make sure cycle time is 60 sec. or more.
- If you use your own PWM-controller, make sure switching frequency is 5 kHz or more.

For more information, please contact Supercool.

Cooling power (P_c) versus Temperature difference (ΔT) for single stage modules.

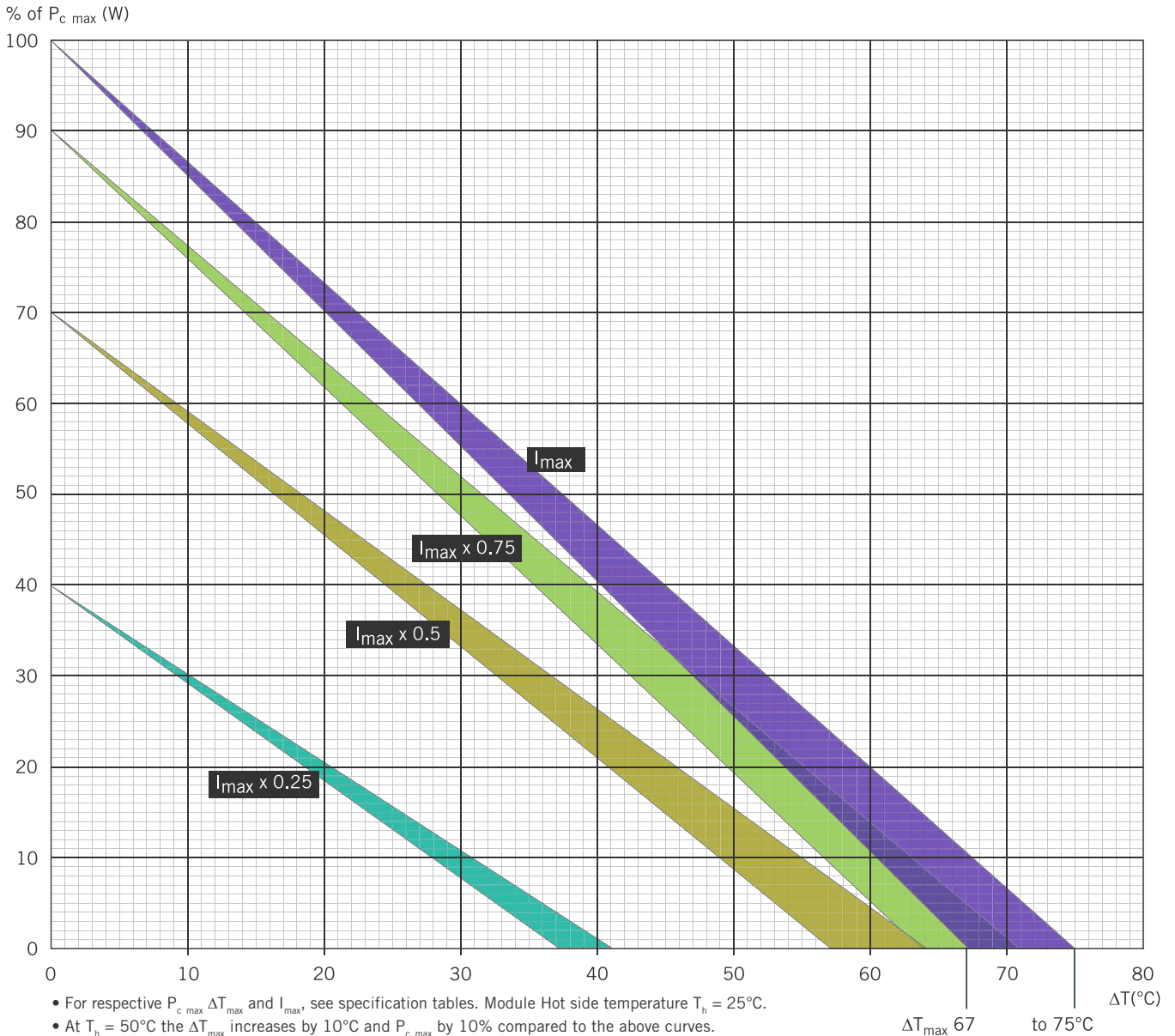

- For respective $P_{c,max}$, ΔT_{max} and I_{max} , see specification tables. Module Hot side temperature $T_h = 25^\circ\text{C}$.
- At $T_h = 50^\circ\text{C}$ the ΔT_{max} increases by 10°C and $P_{c,max}$ by 10% compared to the above curves.
- For multistage modules, as well as for more detailed specifications for any module, please call for individual performance graphs.
- U_{max} and I_{max} are specified at $\Delta T = \Delta T_{max}$
- ΔT = Hot side temperature (T_h) less Cold side temperature (T_c).

Supercool on the Internet

To find out more about Supercool, our products and solutions, visit us at www.supercool.com.

We've also posted a complete list of representatives on our website, including contact details.



The widest range of standard solutions

Robust, efficient and compact, our thermoelectric solutions have been put to the test in scores of applications. Our experience and know-how create the foundations for an unrivaled selection of standard products.

We provide everything you need to get your thermoelectric system up and running, including assemblies, temperature controllers and power supplies.

For more information, order our 'Thermoelectric solutions' catalog.



www.supercool.com

SUPERCOOL AB, Box 27, 401 20 Göteborg, Sweden, Tel. +46 31-42 05 30, Fax. +46 31-24 79 09 E-mail: info@supercool.se

• Copyright 2004, Supercool AB © • Supercool reserves the right to alter the design and specifications of products without prior notice.

B.4 DAQ

The data sheet of the National Instruments USB 6008 card.

Low-Cost, Bus-Powered Multifunction DAQ for USB – 12- or 14-Bit, up to 48 kS/s, 8 Analog Inputs

NI USB-6008, NI USB-6009

- 8 analog inputs at 12 or 14 bits, up to 48 kS/s
- 2 analog outputs at 12 bits, software-timed
- 12 TTL/CMOS digital I/O lines
- 32-bit, 5 MHz counter
- Digital triggering
- Bus-powered
- 1-year warranty

Operating Systems

- Windows Vista (32- and 64-bit)/XP/2000
- Mac OS X¹
- Linux^{®1}
- Windows Mobile¹
- Windows CE¹

Recommended Software

- LabVIEW
- LabVIEW SignalExpress
- LabWindows™/CVI
- Measurement Studio

Other Compatible Software

- C#, Visual Basic .NET
- ANSI C/C++

Measurement Services Software (included)

- NI-DAQmx driver software
- Measurement & Automation Explorer configuration utility
- LabVIEW SignalExpress LE

¹You need to download NI-DAQmx Base for these operating systems.



Product	Bus	Analog Inputs ¹	Input Resolution (bits)	Max Sampling Rate (kS/s)	Input Range (V)	Analog Outputs	Output Resolution (bits)	Output Rate (Hz)	Output Range (V)	Digital I/O Lines	32-Bit Counter	Trigger
USB-6009	USB	8 SE/4 DI	14	48	±1 to ±20	2	12	150	0 to 5	12	1	Digital
USB-6008	USB	8 SE/4 DI	12	10	±1 to ±20	2	12	150	0 to 5	12	1	Digital

¹SE = single ended, DI = differential ²Software-timed

Overview and Applications

With recent bandwidth improvements and new innovations from National Instruments, USB has evolved into a core bus of choice for measurement applications. The NI USB-6008 and USB-6009 are low-cost entry points to NI flagship data acquisition (DAQ) devices. With plug-and-play USB connectivity, these modules are simple enough for quick measurements but versatile enough for more complex measurement applications.

The USB-6008 and USB-6009 are ideal for a number of applications where low cost, small form factor, and simplicity are essential.

Examples include:

- Data logging – quick and easy environmental or voltage data logging
- Academic lab use – student ownership of DAQ hardware for completely interactive lab-based courses (Academic pricing available. Visit ni.com/academic for details.)
- OEM applications as I/O for embedded systems

Recommended Software

National Instruments measurement services software, built around NI-DAQmx driver software, includes intuitive application programming interfaces, configuration tools, I/O assistants, and other tools designed to reduce system setup, configuration, and development time.

National Instruments recommends using the latest version of NI-DAQmx

driver software for application development in NI LabVIEW, LabVIEW SignalExpress, LabWindows/CVI, and Measurement Studio software.

To obtain the latest version of NI-DAQmx, visit

ni.com/support/daq/versions.

NI measurement services software speeds up your development with features including:

- A guide to create fast and accurate measurements with no programming using the DAQ Assistant.
- Automatic code generation to create your application in LabVIEW.
- LabWindows/CVI; LabVIEW SignalExpress; and C#, Visual Studio .NET, ANSI C/C++, or Visual Basic using Measurement Studio.
- Multithreaded streaming technology for 1,000 times performance improvements.
- Automatic timing, triggering, and synchronization routing to make advanced applications easy.
- More than 3,000 free software downloads available at ni.com/zone to jump-start your project.
- Software configuration of all digital I/O features without hardware switches/jumpers.
- Single programming interface for analog input, analog output, digital I/O, and counters on hundreds of multifunction DAQ hardware devices. M Series devices are compatible with the following versions (or later) of NI application software – LabVIEW, LabWindows/CVI, or Measurement Studio versions 7.x; and LabVIEW SignalExpress 2.x.



Low-Cost, Bus-Powered Multifunction DAQ for USB – 12- or 14-Bit, up to 48 kS/s, 8 Analog Inputs

Every M Series data acquisition device also includes a copy of LabVIEW SignalExpress LE data-logging software, so you can quickly acquire, analyze, and present data without programming. The NI-DAQmx Base driver software is provided for use with Linux, Mac OS X, Windows Mobile, and Windows CE operating systems.

Recommended Accessories

The USB-6008 and USB-6009 have removable screw terminals for easy signal connectivity. For extra flexibility when handling multiple wiring configurations, NI offers the USB-600x Connectivity Kit, which includes two extra sets of screw terminals, extra labels, and a screwdriver.

In addition, the USB-600x Prototyping Kit provides space for adding more circuitry to the inputs of the USB-6008 or USB-6009.

NI USB DAQ for OEMs

Shorten your time to market by integrating world-class National Instruments OEM measurement products into your embedded system design. Board-only versions of NI USB DAQ devices are available for OEM applications, with competitive quantity pricing and available software customization. The NI OEM Elite Program offers free 30-day trial kits for qualified customers. Visit ni.com/oem for more information.

Information for Student Ownership

To supplement simulation, measurement, and automation theory courses with practical experiments, NI has developed the USB-6008 and USB-6009 student kits, which include the LabVIEW Student Edition and a ready-to-run data logger application. These kits are exclusively for students, giving them a powerful, low-cost, hands-on learning tool. Visit ni.com/academic for more details.

Information for OEM Customers

For information on special configurations and pricing, call (800) 813 3693 (U.S. only) or visit ni.com/oem. Go to the Ordering Information section for part numbers.

Ordering Information

NI USB-6008 ¹	779051-01
NI USB-6009 ¹	779026-01
NI USB-6008 OEM	193132-02
NI USB-6009 OEM	193132-01
NI USB-6008 Student Kit ^{1,2}	779320-22
NI USB-6009 Student Kit ^{1,2}	779321-22
NI USB-600x Connectivity Kit	779371-01
NI USB-600x Prototyping Kit	779511-01

¹ Includes NI-DAQmx software, LabVIEW SignalExpress LE, and a USB cable.

² Includes LabVIEW Student Edition.

BUY NOW!

For complete product specifications, pricing, and accessory information, call 800 813 3693 (U.S. only) or go to ni.com/usb.

BUY ONLINE at ni.com or CALL 800 813 3693 (U.S.)

Low-Cost, Bus-Powered Multifunction DAQ for USB – 12- or 14-Bit, up to 48 kS/s, 8 Analog Inputs

Specifications

Typical at 25 °C unless otherwise noted.

Analog Input

Absolute accuracy, single-ended

Range	Typical at 25 °C (mV)	Maximum (0 to 55 °C) (mV)
±10	14.7	138

Absolute accuracy at full scale, differential¹

Range	Typical at 25 °C (mV)	Maximum (0 to 55 °C) (mV)
±20	14.7	138
±10	7.73	84.8
±5	4.28	58.4
±4	3.59	53.1
±2.5	2.56	45.1
±2	2.21	42.5
±1.25	1.70	38.9
±1	1.53	37.5

Number of channels..... 8 single-ended/4 differential
 Type of ADC Successive approximation

ADC resolution (bits)

Module	Differential	Single-Ended
USB-6008	12	11
USB-6009	14	13

Maximum sampling rate (system dependent)

Module	Maximum Sampling Rate (kS/s)
USB-6008	10
USB-6009	48

Input range, single-ended..... ±10 V
 Input range, differential..... ±20, ±10, ±5, ±4, ±2.5, ±2, ±1.25, ±1 V
 Maximum working voltage ±10 V
 Overvoltage protection ±35 V
 FIFO buffer size 512 B
 Timing resolution 41.67 ns (24 MHz timebase)
 Timing accuracy 100 ppm of actual sample rate
 Input impedance 144 kΩ
 Trigger source..... Software or external digital trigger
 System noise..... 5 mV_{rms} (±10 V range)

Analog Output

Absolute accuracy (no load) 7 mV typical, 36.4 mV maximum at full scale
 Number of channels..... 2
 Type of DAC Successive approximation
 DAC resolution..... 12 bits
 Maximum update rate 150 Hz, software-timed

Output range 0 to +5 V
 Output impedance..... 50 Ω
 Output current drive..... 5 mA
 Power-on state 0 V
 Slew rate..... 1 V/μs
 Short-circuit current..... 50 mA

Digital I/O

Number of channels..... 12 total
 8 (P0.<0..7>)
 4 (P1.<0..3>)
 Direction control Each channel individually programmable as input or output
 Output driver type
 USB-6008 Open-drain
 USB-6009 Each channel individually programmable as push-pull or open-drain
 Compatibility CMOS, TTL, LVTTTL
 Internal pull-up resistor 4.7 kΩ to +5 V
 Power-on state Input (high impedance)
 Absolute maximum voltage range..... -0.5 to +5.8 V

Digital logic levels

Level	Min	Max	Units
Input low voltage	-0.3	0.8	V
Input high voltage	2.0	5.8	V
Input leakage current	–	50	μA
Output low voltage (I = 8.5 mA)	–	0.8	V
Output high voltage (push-pull, I = -8.5 mA)	2.0	3.5	V
Output high voltage (open-drain, I = -0.6 mA, nominal)	2.0	5.0	V
Output high voltage (open-drain, I = -8.5 mA, with external pull-up resistor)	2.0	–	V

Counter

Number of counters 1
 Resolution 32 bits
 Counter measurements..... Edge counting (falling edge)
 Pull-up resistor 4.7 kΩ to 5 V
 Maximum input frequency..... 5 MHz
 Minimum high pulse width..... 100 ns
 Minimum low pulse width..... 100 ns
 Input high voltage 2.0 V
 Input low voltage 0.8 V

Power available at I/O connector

+5 V output (200 mA maximum) +5 V typical
 +4.85 V minimum
 +2.5 V output (1 mA maximum) +2.5 V typical
 +2.5 V output accuracy 0.25% max
 Voltage reference temperature drift... 50 ppm/°C max

¹Input voltages may not exceed the working voltage range.

Low-Cost, Bus-Powered Multifunction DAQ for USB – 12- or 14-Bit, up to 48 kS/s, 8 Analog Inputs

Physical Characteristics

If you need to clean the module, wipe it with a dry towel.

Dimensions (without connectors)	6.35 by 8.51 by 2.31 cm (2.50 by 3.35 by 0.91 in.)
Dimensions (with connectors)	8.18 by 8.51 by 2.31 cm (3.22 by 3.35 by 0.91 in.)
Weight (without connectors)	59 g (2.1 oz)
Weight (with connectors)	84 g (3 oz)
I/O connectors	USB series B receptacle (2) 16-position (screw-terminal) plug headers
Screw-terminal wiring	16 to 28 AWG
Screw-terminal torque	0.22 to 0.25 N•m (2.0 to 2.2 lb•in.)

Power Requirement

USB (4.10 to 5.25 VDC)	80 mA typical 500 mA maximum
USB suspend	300 µA typical 500 µA maximum

Environmental

The USB-6008 and USB-6009 are intended for indoor use only.

Operating environment	
Ambient temperature range	0 to 55 °C (tested in accordance with IEC-60068-2-1 and IEC-60068-2-2)
Relative humidity range	10 to 90%, noncondensing (tested in accordance with IEC-60068-2-56)
Storage environment	
Ambient temperature range	-40 to 85 °C (tested in accordance with IEC-60068-2-1 and IEC-60068-2-2)
Relative humidity range	5 to 90%, noncondensing (tested in accordance with IEC-60068-2-56)
Maximum altitude	2,000 m (at 25 °C ambient temperature)
Pollution degree	2

Safety and Compliance

Safety

This product is designed to meet the requirements of the following standards of safety for electrical equipment for measurement, control, and laboratory use:

- IEC 61010-1, EN 61010-1
- UL 61010-1, CSA 61010-1

Note: For UL and other safety certifications, refer to the product label or visit ni.com/certification, search by model number or product line, and click the appropriate link in the Certification column.

Electromagnetic Compatibility

This product is designed to meet the requirements of the following standards of EMC for electrical equipment for measurement, control, and laboratory use:

- EN 61326 EMC requirements; Minimum Immunity
- EN 55011 Emissions; Group 1, Class A
- CE, C-Tick, ICES, and FCC Part 15 Emissions; Class A

Note: For EMC compliance, operate this device according to product documentation.

CE Compliance

This product meets the essential requirements of applicable European Directives, as amended for CE marking, as follows:

- 2006/95/EC; Low-Voltage Directive (safety)
- 2004/108/EC; Electromagnetic Compatibility Directive (EMC)

Note: Refer to the Declaration of Conformity (DoC) for this product for any additional regulatory compliance information. To obtain the DoC for this product, visit ni.com/certification, search by model number or product line, and click the appropriate link in the Certification column.

Waste Electrical and Electronic Equipment (WEEE)

EU Customers: At the end of their life cycle, all products must be sent to a WEEE recycling center. For more information about WEEE recycling centers and National Instruments WEEE initiatives, visit ni.com/environment/weee.htm.

电子信息产品污染控制管理办法 (中国 RoHS)

中国客户 National Instruments 符合中国电子信息产品中限制使用某些有害物质指令 (RoHS)。关于 National Instruments 中国 RoHS 合规性信息，请联系 ni_ece@ni.com 或 ni.com/rohs (for information about China RoHS compliance, go to ni.com/environment/rohs_china.)

NI Services and Support



NI has the services and support to meet your needs around the globe and through the application life cycle – from planning and development through deployment and ongoing maintenance. We offer services and service levels to meet customer requirements in research, design, validation, and manufacturing. Visit ni.com/services.

Training and Certification

NI training is the fastest, most certain route to productivity with our products. NI training can shorten your learning curve, save development time, and reduce maintenance costs over the application life cycle. We schedule instructor-led courses in cities worldwide, or we can hold a course at your facility. We also offer a professional certification program that identifies individuals who have high levels of skill and knowledge on using NI products. Visit ni.com/training.

Professional Services

Our Professional Services Team is comprised of NI applications engineers, NI Consulting Services, and a worldwide National Instruments Alliance Partner program of more than 600 independent consultants and integrators. Services range from start-up assistance to turnkey system integration. Visit ni.com/alliance.



OEM Support

We offer design-in consulting and product integration assistance if you want to use our products for OEM applications. For information about special pricing and services for OEM customers, visit ni.com/oem.

Local Sales and Technical Support

In offices worldwide, our staff is local to the country, giving you access to engineers who speak your language. NI delivers industry-leading technical support through online knowledge bases, our applications engineers, and access to 14,000 measurement and automation professionals within NI Developer Exchange forums. Find immediate answers to your questions at ni.com/support.

We also offer service programs that provide automatic upgrades to your application development environment and higher levels of technical support. Visit ni.com/ssp.

Hardware Services

NI Factory Installation Services

NI Factory Installation Services (FIS) is the fastest and easiest way to use your PXI or PXI/SCXI combination systems right out of the box. Trained NI technicians install the software and hardware and configure the system to your specifications. NI extends the standard warranty by one year on hardware components (controllers, chassis, modules) purchased with FIS. To use FIS, simply configure your system online with ni.com/pxiadvisor.

Calibration Services

NI recognizes the need to maintain properly calibrated devices for high-accuracy measurements. We provide manual calibration procedures, services to recalibrate your products, and automated calibration software specifically designed for use by metrology laboratories. Visit ni.com/calibration.

Repair and Extended Warranty

NI provides complete repair services for our products. Express repair and advance replacement services are also available. We offer extended warranties to help you meet project life-cycle requirements. Visit ni.com/services.



ni.com • (800) 813 3693

National Instruments • info@ni.com



351378C-01

2008-9621-301-101-D

B.5 K element preamplifier

The data sheet of the K element preamplification circuit.

Appendix: IAKtemp instrument amplifier type PGA204 from Burr Brown

Description:

Power:

J4-1 +15V through diode bridge D1, to prevent reverse voltage.

J4-3 0V

J4-2 -15V through diode bridge D2

Gain settings:

J2-1 A0 bit0

J2-2 A1 bit1

J2-3 Digital GND

A1	A0	Gain
0	0	X1
0	1	X10
1	0	X100
1	1	X1000

Note that you change the gain with "A0" and "A1" only. "T/E" and "GND" should be kept closed (value 0).

Signal in:

J1-1 + Amplifier input (BNC center).

J1-2 - Amplifier input (BNC jacket)

DIP switch S1.3 and S.4 open.

Signal out:

J5-1 Amplifier output (BNC center).

J5-2 Analogue GND (BNC jacket)

Thermoelement

Input type K:

J3-1 - input. Serial connection with U2, **which generates cold junction** (see datasheet LT1025) compensation voltage. It's been

subtracted from the thermoelement voltage.

J3-2 + input. Filter over C1, fed through the amplifier + input.

Through DIP switch S1.3 (closed). S1.4 (closed) adding the - input to the analogue GND.

VR1 generate +5V from +15V power, used as "pullup" resistor at A0 and A1.

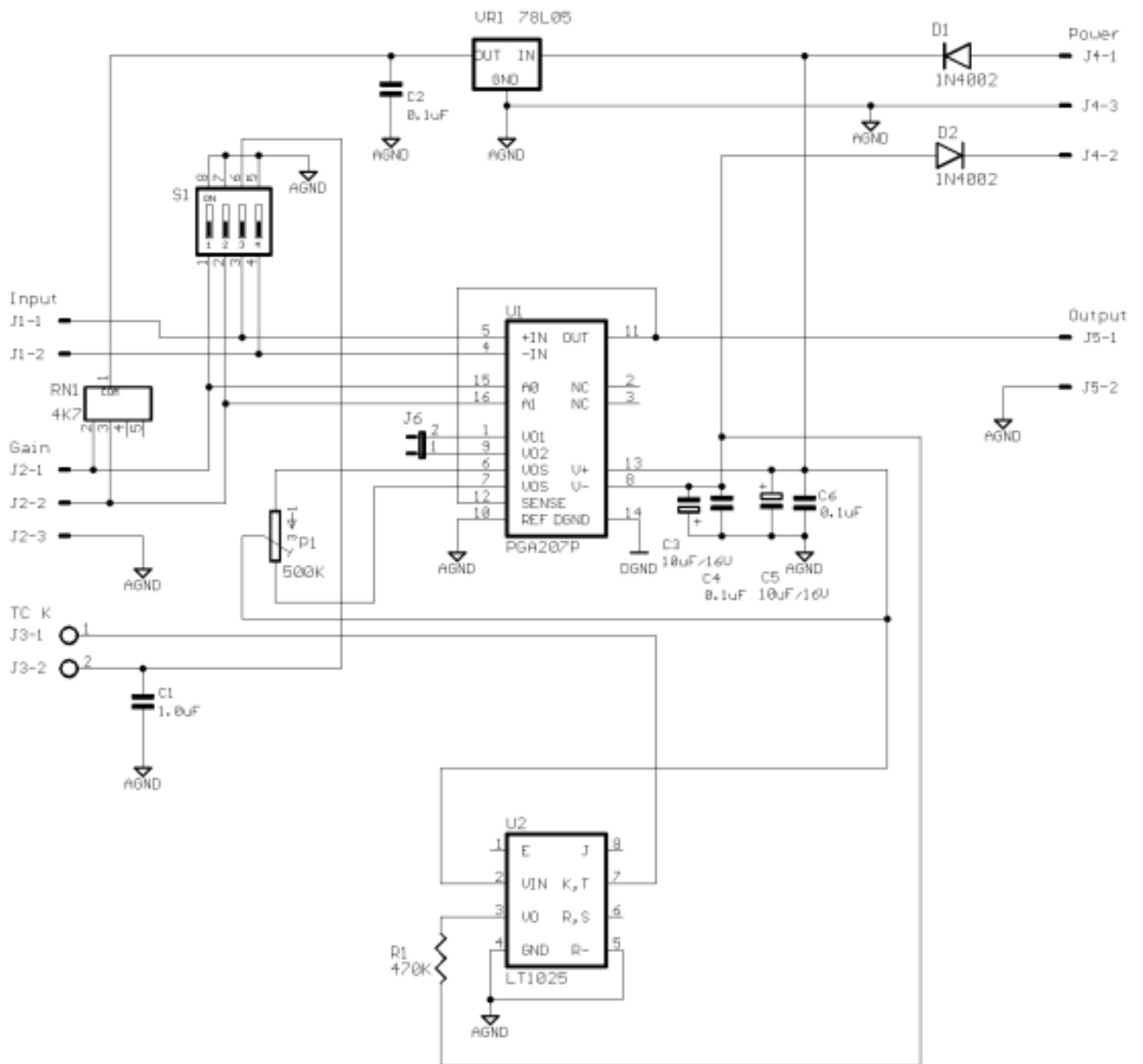

Above: Instrumentation Amplifier schematic diagram

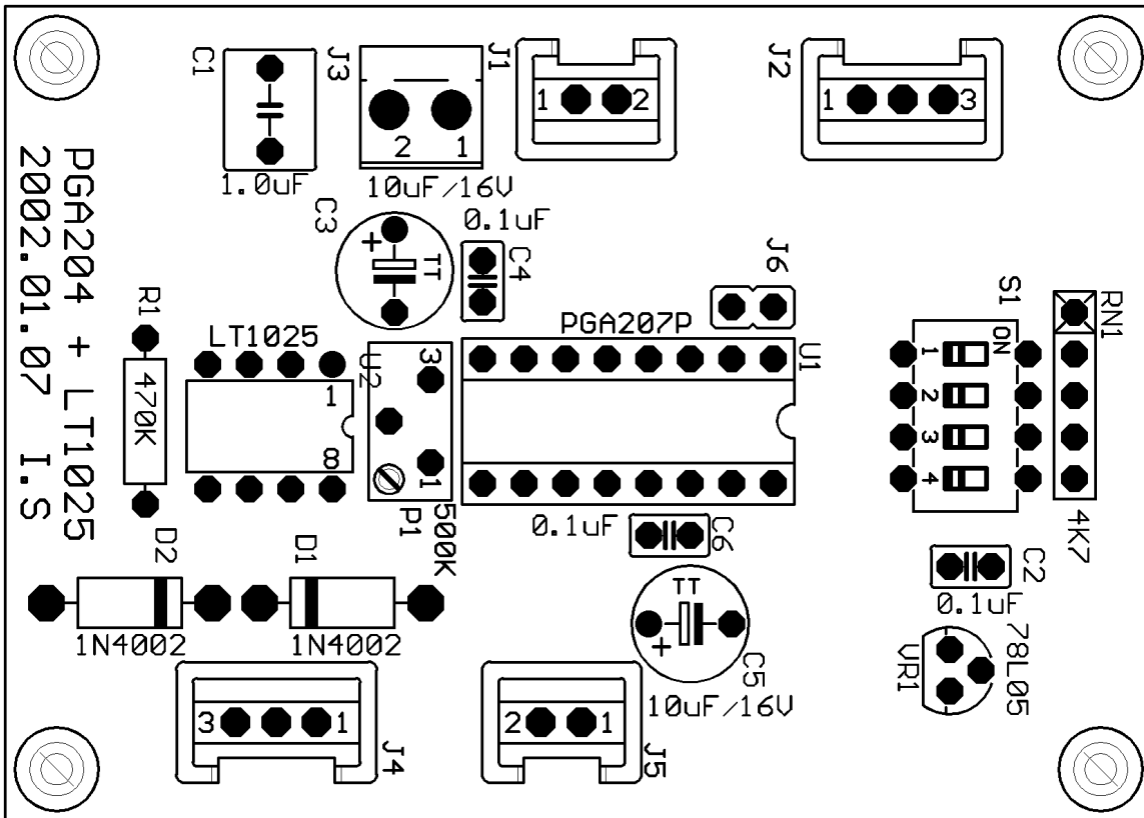

Above: Instrumentation Amplifier print layout

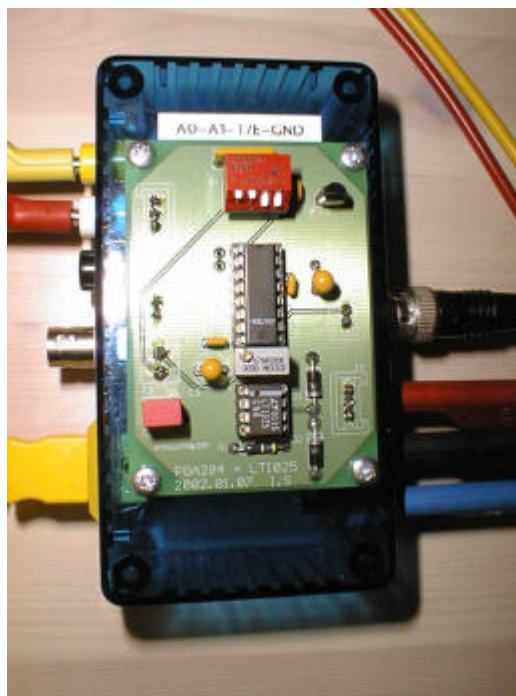

Above: Instrumentation amplifier circuit: A0-A1-T/E-GND refer to dip switches from left to right. Open (1 value) when it is up and Close (0 value) when it is down.

B.6 Cellkraft P-Series

The data sheet of the Cellkraft P-Series humidifiers.

P-Series

The Cellkraft P-series humidifier is a reliable and stable tool to humidify air/gas flows. The P-Series is suitable for flow rates up to 200 standard litres per minute (slpm) and pressures up to 10 bar (g). The technical principle is membrane humidification. The humidifiers are available in basic versions that can be equipped with additional features.



Advantages

- 100% guarantee of performance in the entire flow range.
- No condensation at low flow rate, down to 0 NI/min
- No droplets at full flow
- Automatic water supply by pump
- Compact
- Corrosion resistant components
- Suitable for air, oxygen, hydrogen and other gases.

Applications

- Climate chambers
- Environmental simulation
- Fuel Cell testing
- Semiconductor industry
- Tube furnaces
- Chamber furnaces
- Testing laboratories
- Pharmaceutical industry

Technology

- Membrane humidifier for accurate humidity control without droplets
- Individual control of humidity, temperature (optional) and flowrate (optional).
- Stainless steel and teflon components
- CE-compliance

Capacity

Model	P-10	P-50	P-100	P-200
Flow (l/min)	0...10	0...50	0...100	0...200
Humidity (Tdew)	20...85 °C (-20...+150 °C on request)			
Temperature	20...100 °C (up to 180 °C on request)			

Stable operation

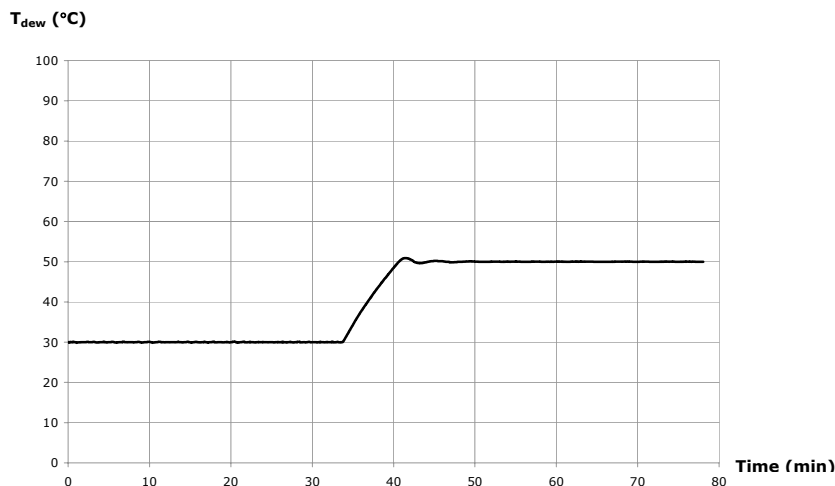

Technical data

Performance	P-10	P-50	P-100	P-200
Flow (l/min)	0...10	0...50	0...100	0...200
Humidity (Tdew)	20...85 °C (-20...+150 °C on request)			
Temperature	20...100 °C (20...180 °C on request)			
Accuracy	± 1 °C T _{dew} (following calibration curve)			
Repeatability	± 1 %			
Max pressure	4 bar (g) (20 bar (g) on request)			
Pressure drop at max flow, 85 °C Tdew	300 mbar	500 mbar	500 mbar	500 mbar
Liquid supply				
Water quality	Deionised or distilled (max 10µS / cm)			
General				
Power	500 W	1600 W	1600 W	2400 W
Ambient temperature in use	+5... +45 °C			
Ambient temperature storage	-40... +60 °C			
Suction capacity of inlet water	1 m			
Start-up time to Tdew 50 °C	5 min			
Wetted materials ²	PP, FFPM, PTFE, Stainless steel			
Certification	CE certified			
Mechanical				
WxHxD	190x363x363 mm	471x281x413 mm	471x281x413 mm	471x281x413 mm
Weight	10.5 kg	20.5 kg	23 kg	23 kg
Water tank volume	1.5 liter	-		
Interface				
Voltage	110 V or 230 V / 50-60 Hz AC			
Remote control digital	RS 232 (optional)			
Remote control analogue	0...10 V, 0...5 V, 0...20 mA or 4...20 mA. (optional)			
Liquid inlet	6 mm or 1/4" compression fitting Swagelok®			
Air inlet/outlet	6 mm or 1/4" compression fitting Swagelok®	12 mm or 1/2" compression fitting Swagelok®		

Capacity

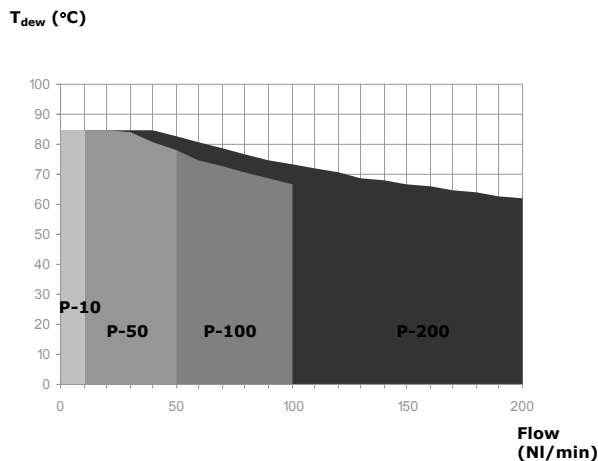

Technical principle

The P-Series humidifier creates a humidified air flow by transfer of water vapour through a membrane to the air/gas flow. The humidity is in the basic version controlled by setting the temperature of the water surrounding the membrane tubes where the gas is flowing. Optionally a humidity sensor monitors and controls the humidity. The technology gives extremely stable performance in the full flow range. No droplets at high flow rate and full precision at low flow rate. The units can be operated in the range from zero to full flow.

Optional features

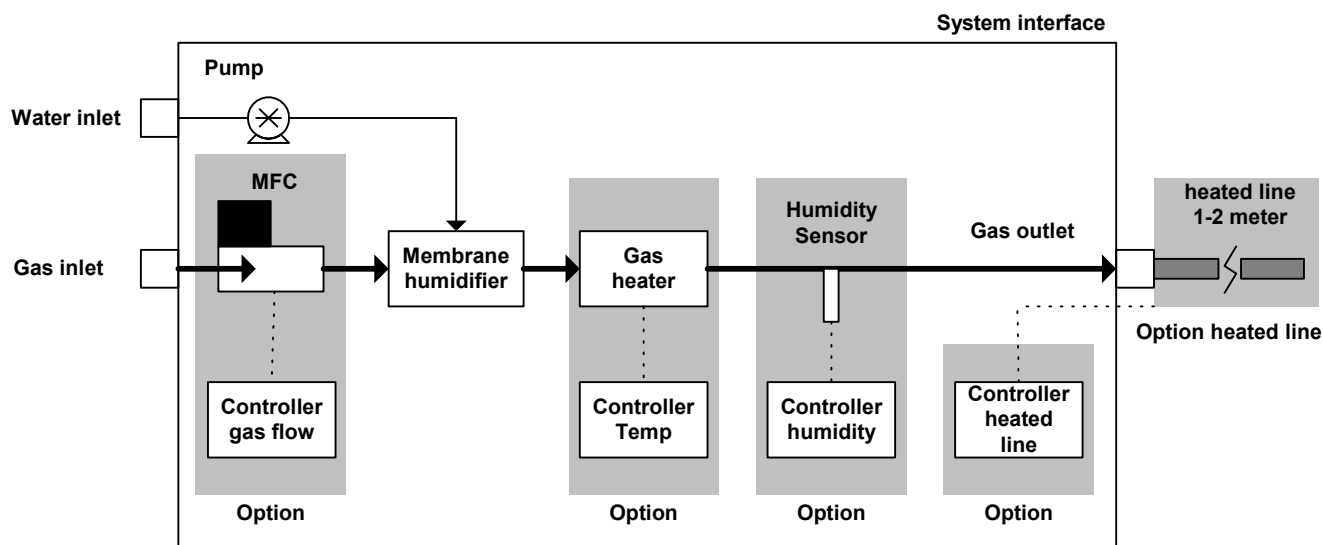

Flowrate control

The humidifier can be equipped with an internal mass flow controller. This allows the user to control the flowrate from the front panel. This option requires that gas supply with some overpressure is available.

Flow control	P-10	P-50	P-100	P-200
Control range (l/min)	0...10	0...50	0...100	0...200
Accuracy	± 1 %			
Repeatability	± 1 %			
Supply pressure	2 bar higher than humidifier operating pressure			

Temperature control

The humidifier can be equipped with an internal heater. This allows the user to set the temperature of the humidified gas. In this way the humidity and temperature can be set independently.

Temperature control	P-10	P-50	P-100	P-200
Control range	20-100 °C (20-180 °C on request)			
Accuracy	± 1 °C			
Repeatability	± 1 %			

Humidity closed loop control by humidity sensor

Closed loop control of humidity based on a signal from a humidity sensor replaces the need for calibration curve. The humidifier will give the correct humidity at any flowrate. The setpoint and the actual value of humidity are presented on the front panel. Humidity can be expressed as relative humidity (% RH) or dewpoint (°C).

Humidity sensor	P-10	P-50	P-100	P-200
Control range	20-85 °C T _{dew} (-20...150 °C on request)			
Accuracy	± 1 °C			
Repeatability	± 1 %			

Line heater

Line heater controlled and powered from the front panel eliminates the risk of condensation in the tubing from the humidifier.

Line heater	P-10	P-50	P-100	P-200
Control range	20-100 °C			

Easy installation and operation

Connect the dry gas to the inlet. Connect supply of deionised water to the water inlet or fill the internal water tank. The unit has suction capacity and can be connected to a water tank or a pipe network. Connect the unit to AC power. The unit can be delivered in 110 or 230 VAC version. Humidity is in basic version controlled by setting the temperature of the internal humidifier. Based on the flowrate and the desired dewpoint, a calibration chart gives the correct temperature to set. A PID controller on the front panel will maintain this temperature stable. The humidified gas is delivered at the outlet connector on the front panel. The basic version can be upgraded by several optional features.



Picture:
P-100 rear panel. Connectors for inlet water, inlet gas, outlet gas and power and signals.

Contact

Anders Ocklind
+46 8 673 19 14
anders.ocklind@cellkraft.se

Joakim Nordlund
+46 8 673 19 15
joakim.nordlund@cellkraft.se

Cellkraft AB
Björnnäsv. 21
SE-113 47 Stockholm
Sweden

www.cellkraft.se

Cellkraft reserves the right to change data in this document.
Data is binding only after contractual agreement with Cellkraft.

Aug-08 ver: Eng. P.15

Ordering key and price

P - I - II III IV V

Order key	Price (SEK)
-----------	-------------

I Basic model - Max flow rate

10 = 10 l/min	75 000 SEK
50 = 50	109 600 SEK
100 = 100	154 300 SEK
200 = 200	195 000 SEK

II Flow control

0 = no	P-10, 50, 100	P-200
1 = yes	40 000 SEK	53 300 SEK

III Temperature control

0 = no	-
1 = yes	27 000 SEK

IV Closed loop humidity control

0 = no	-
1 = yes	53 300 SEK

V Line heater

0 = no	-
1 = yes	25 000 SEK

1 SEK≈0,11 Euro≈0,14 USD

An example:

P - 50 - 1 1 1 0

This is the key for a humidifier with a capacity of 50 l/min, with integrated mass flow controller and temperature control. The unit has a humidity sensor for readout of actual dewpoint. The price of this unit is 229 900 SEK.

Appendix C

Cell geometry

The sample cell geometry can be calculated using the following formulae:

$$\Omega = \frac{2\pi \cdot R \cdot h \cdot \frac{2\pi - \alpha}{2\pi}}{4\pi \cdot R^2} \cdot 4\pi = (2\pi - \alpha) \cdot \frac{h}{R} \quad (\text{C.1})$$

where Ω is the solid angle, α the angle covered by the cap top plate support pillar as seen from the centre axis of the sample cell, R the radius of a sphere with the sample cell cylinder inscribed and h the height of the sample cell cylinder. As $\alpha = 20^\circ = \frac{2\pi}{18}$ the formulae becomes:

$$\Omega = 2\pi \cdot \frac{17}{18} \cdot \frac{h}{R} \quad (\text{C.2})$$

If the sample is assumed placed in the centre of the sample chamber and the outer rim of the cap bottom plate is used to calculate R with the assumption of symmetric upper and lower cylinder halves the values are

$$h = 122$$

$$R = \frac{61}{\sin(\tan^{-1}(\frac{61}{75}))} \quad (\text{C.3})$$

which leads to a solid angle of

$$\begin{aligned} \Omega &= 2\pi \cdot \frac{17}{18} \cdot \frac{122}{\frac{61}{\sin(\tan^{-1}(\frac{61}{75}))}} \\ &= 2\pi \cdot \frac{17}{18} \cdot 2 \cdot \sin\left(\tan^{-1}\left(\frac{61}{75}\right)\right) \approx 7.49 \text{ steradians} \end{aligned} \quad (\text{C.4})$$

Using the same assumptions for the sample position and the cell as above, the azimuth and zenith angles become

$$\text{azimuth} = 2\pi - \frac{2\pi}{18} = 340^\circ \quad (\text{C.5})$$

$$\text{zenith} = \tan^{-1}\left(\frac{61}{75}\right) \approx \frac{10\pi}{23} \approx 78.2^\circ \quad (\text{C.6})$$

Bibliography

- [1] Report No. 39 (1997-1998) to the Storting
- [2] Report No. 20 (2004-2005) to the Storting
- [3] Account of The Research Council of Norway governing board meeting 15. jun 2006
- [4] A. Wexler, Humidity and moisture (Reinhold, USA, 1965)
- [5] C. E. Sroog, Progress in Polymer Science 16, 561, (1991)
- [6] J. E. Mark, Physical properties of polymers handbook (Springer, USA, 2007)
- [7] H. Stöcker, Taschenbuch der Physik (Harri Deutsch, Germany, 2007)
- [8] P.C. Hemmer, Termisk fysikk (Tapir Akademisk Forlag, Norway, 2002)
- [9] C. Angell and B. E. Lian, Fysiske størrelse og enheter (Universitetsforlaget, Norway, 2004)
- [10] R. E. Hummel, Electronic Properties of Materials (Springer, U.S.A, 2001)
- [11] J. A. Blackburn, Modern Instrumentation for Scientists and Engineers (Springer, U.S.A, 2001)
- [12] S. R. Elliott, The Physics and Chemistry of Solids (John Wiley & Sons, England, 2005)
- [13] J. F. Nye, Physical Properties of Crystals (Oxford University Press, England, 1985)
- [14] F. Mo and K. Ramsøskar, Journal of Applied Crystallography 42, 531, (2009)
- [15] M. Kim, C. J. Glinka and R. N. Carter, Review of Scientific Instruments 76, 113904, (2005)
- [16] K. Linnow, A. Zeunert and M. Steiger, Analytical Chemistry 78, 4683, (2006)
- [17] J. Katsaras and M. J. Watson, Review of Scientific Instruments 71, 1737, (2000)
- [18] VDI-Wärmeatlas (VDI-Verlag, Germany, 1984)

- [19] C. J. Smithells, W.F. Gale and T.C. Totemeier, Smithells metals reference book (Elsevier, Netherlands, 2004)
- [20] H. Hartvigsen, R. Lorentsen, K. Michelsen and S. Seljevoll, Verkstedhåndboka (Yrkesopplæringsans, Norway, 1994)