



Norwegian University of  
Science and Technology

# Hydrogen Production from Wind and Solar Power in Weak Grids in Norway

**Dimitri Quentin Alexis Pinel**

Master of Science in Electric Power Engineering

Submission date: June 2017

Supervisor: Magnus Korpås, IEL

Norwegian University of Science and Technology  
Department of Electric Power Engineering



## Abstract

In this thesis, the possibility of implementing an hydrogen factory in the north of Norway was studied through the simulation of the system and an optimization of the needed investment with the exclusion of the grid and in the first scenario of 10% of the production coming from electrolysis. The same study was then repeated multiple times to study how the previous results changes if the proportion of hydrogen produced by electrolysis is increased. The necessary grid upgrade to avoid rationing was also found out. The main results were that the investment in wind power was mainly at bus 9 and 8 and that even if the electrolyzer size increased approximately linearly, the storage size on the other hand does not and increase greatly after the case 40%.

The possibility of investing in solar was then added to the model at a price of 3,8\$/Wp and it turned out to not be profitable at this price before the case 50%. It was however found that the addition of solar power yields a positive impacts on the size of the storage needed due to advantageous seasonal effects.

The next step was to study different prices in order to find when solar becomes profitable. The resulting value for the case 10% was around 0.4\$/Wp much lower than the current price of 1,6\$/Wp but also reasonable in a longer term as suggested by some other studies. The next study was to account for the cost of the grid expansion in different cases to see if only limiting rationing is a good criteria. The simulation was used again with different grids and it appears that limiting the rationing was often giving the cheapest result even though upgrading the grid further do not result in a big increase in cost due to a trade off between operation cost and investment cost.

The last study was focused on the behaviour of the hydro system during the previous simulation cases and it highlighted some interesting seasonal effect of the different technology.

As of now, solar power does not appear to be a good solution for the case of 10% of the total hydrogen coming from electrolysis due to its cost. Wind power appears to be a preferable solution even if the investment is not large and thus does no take fully advantage of the resources of the north of Norway.

# Acknowledgment

I would like to thank Magnus Korpås for supervising the thesis and providing insights and guidelines in the work. I would also like to thank particularly Espen Flo Bødal for providing the optimization tool with the grid model and the data for wind, taking the time to answer my questions and helping me out when needed.

# Nomenclature

## Indices

$i, j$	Bus
$t$	Time stage

## Parameters

$\alpha_i^{sol}$	Area coefficient of solar power [ $m^2/MW$ ]
$\alpha^{temp}$	Temperature coefficient of solar panel [%/K]
$\delta$	Price addition import [€/MW]
$\eta^d, \eta^s$	Conversion factor from hydrogen to power directly from electrolyzer or from storage tanks [ $MW/Nm^3$ ]
$\eta^{dc/ac}$	DC to AC conversion efficiency [%]
$\eta^{sol}$	Efficiency of solar panel [%]
$\gamma_i$	Conversion factor capacity to production [ $MWh/MW$ ]
$\lambda_t^s$	Spot price [€/MWh]
$A^{max}$	Area maximum for the solar panels
$C^r, C^i$	Cost of rationing [€/MWh] and cost of importing hydrogen [€/Nm <sup>3</sup> ]
$C^{v+}, C^{v-}$	Cost of violating end reservoir level [€/MWh]
$C^w, C^e, C^s$	Annualized cost of wind power [€/MW], electrolyzer [€/MW], and hydrogen storage [€/Nm <sup>3</sup> ]
$C_i^{sol}$	Annualized cost of solar power [€/MW]
$D_i$	Electricity demand
$E_i^{pot}$	Potential for electrolyzers [MW]
$H_t^D$	Hydrogen demand [Nm <sup>3</sup> ]
$H_i^{pot}$	Potential for hydrogen storage [Nm <sup>3</sup> ]
$I_{t,i}$	Inflow in hydro reservoir [MWh]
$K_{t,i}$	Temperature
$P_t^w$	Wind power production profile
$Q_i^{max}$	Max hydro power production [MW]
$Q_{t,i}^{min}$	Min hydro power production due to unregulated inflow [MW]
$S^{ref}$	Reference power for the system [MW]

$S_{t,i}$	Insolation [ $W/m^2$ ]
$T_{t,i,j}^{max}$	Max transmission capacity from bus i to j [ $MW$ ]
$V_i^0$	Initial hydro reservoir volume [ $MWh$ ]
$V_i^{max}$	Reservoir capacity [ $MWh$ ]
$W_i^{init}$	Initially installed wind power [ $MW$ ]
$W_i^{pot}$	Potential for wind power expansion [ $MW$ ]
$X_{i,j}$	Reactance on line between bus i and j [ $p.u.$ ]

### Sets

$\mathcal{B}$	All buses
$\mathcal{C}_i$	Buses connected to bus i by transmission lines
$\mathcal{H}, \mathcal{W}, \mathcal{H}_2$	Buses with hydro power, wind power or hydrogen plants
$\mathcal{N}$	All normal buses (market bus excluded)
$\mathcal{T}$	Time stages

### Variables

$\delta_{t,i}$	Voltage phase angle at bus
$c_t$	Energy curtailment [ $MW$ ]
$e_i^{max}$	Installed electrolyzer capacity [ $MW$ ]
$f_{t,i,j}$	Power flow from bus i to j [ $p.u.$ ]
$h_{t,i}^d$	Hydrogen supplied to load directly from electrolyzer [ $Nm^3$ ]
$h_{t,i}^{imp}$	Hydrogen imported to supply load [ $Nm^3$ ]
$h_i^{max}$	Installed hydrogen storage capacity [ $Nm^3$ ]
$h_{t,i}^p$	Hydrogen production from electrolysis to storage [ $Nm^3$ ]
$h_{t,i}^s$	Hydrogen supplied to the load from the storage [ $Nm^3$ ]
$h_{t,i}$	Level of hydrogen in storage tank [ $Nm^3$ ]
$p_{t,i}^{exp}$	Power export [ $MW$ ]
$p_{t,i}^{imp}$	Power import [ $MW$ ]
$q_{t,i}$	Hydro power production [ $MW$ ]
$q_{t,i}^{spil}$	Spillage [ $MWh$ ]
$r_{t,i}$	Rationing of power [ $MW$ ]

$s_i^{exp}$	Solar power expansion [MW]
$s_{t,i}$	Solar power production [MW]
$s_{t,i}^{curt}$	Solar power curtailment [MW]
$v^+, v^-$	Violation of end reservoir level [MWh]
$v_{t,i}$	Reservoir level [MWh]
$w_i^{exp}$	Wind power expansion [MW]
$w_i^{max}$	Installed wind power capacity [MW]
$w_{t,i}$	Wind power production [MW]
<b>Others</b>	
$Wp$	Watt peak

# Contents

Nomenclature	iii
List of Figures	viii
List of Tables	x
<b>1 Introduction</b>	<b>1</b>
<b>2 Theory and Technology</b>	<b>4</b>
2.1 Hydrogen . . . . .	4
2.1.1 Hydrogen Production Technologies . . . . .	5
2.1.2 Hydrogen Storage Technologies . . . . .	7
2.2 Wind Power . . . . .	8
2.3 Solar Power . . . . .	12
2.4 Area Modelled: Northern Norway . . . . .	14
2.4.1 Buses and Lines . . . . .	15
2.4.2 Hydro Power . . . . .	16
2.4.3 Wind Power . . . . .	16
2.4.4 Load . . . . .	16
2.5 Optimization Formulation . . . . .	16
2.6 Review of Older Studies on Hydrogen Production from Renewable . . . . .	18
<b>3 Hydrogen Reference Case: 10% of the Total Hydrogen Production from Electrolysis</b>	<b>20</b>
<b>4 Increasing the Proportion of Hydrogen from Electrolysis</b>	<b>23</b>
<b>5 Introduction of Solar Power in the System</b>	<b>27</b>
<b>6 Study of Different Price Scenario</b>	<b>35</b>
<b>7 Finding out the Ideal Grid Size</b>	<b>45</b>
7.1 Grid Study in the Case 10% . . . . .	45
7.2 Grid Study in the Case 50% . . . . .	49
7.3 Grid Study in the Case 10% and a Low Solar Cost . . . . .	51
<b>8 Evolution of Hydro System in the Different Studies</b>	<b>54</b>
<b>9 Conclusion</b>	<b>60</b>
<b>10 References</b>	<b>62</b>
<b>11 Appendix</b>	<b>65</b>
11.1 Raw Results Base Case . . . . .	65
11.2 Raw Results Studies Case 10% . . . . .	70
11.3 Raw Results Increasing Proportion from Electrolysis . . . . .	74
11.4 Raw Results Study Weak Grid 10% Solar at 1,6\$/Wp . . . . .	77
11.5 Raw Results Study Weak Grid 10% Solar at 0,3\$/Wp . . . . .	80
11.6 Raw Results Studies Case 50% . . . . .	84



11.7 Utilization Factor of Lines for the Increased Production Case . . . . .	89
11.8 Curtailment of wind and solar for the different hydrogen case and the different prices . . . . .	90
11.9 Evolution of the Costs for Each Grid Case Without Zoom . . . . .	91

# List of Figures

1	Wind potential in Norway, source: NVE, 2005[15]	2
3	Basic graphic of a water electrolysis device	6
4	Wind turbines common features ©2011, IEEE	8
5	Power curve of a 3MW Wind turbines from Vestas	9
6	Heat map of the normalized wind resource at one of the bus in the year	11
7	Map over Norway of the yearly average wind speed at 80m	11
8	Silicon crystalline solar cells	13
9	Silicon crystalline solar cells	13
10	An example of the distribution of radiation in the world (credit: GHI Solar Map © 2017 Solargis)	14
11	Area modeled with the actual transmission grid from NVE Atlas	15
12	The system that was studied in "Hydrogen production in weak grids"[28]	19
13	Utilization of the lines 6 and 7, case 10%	20
14	Production from wind power, case 10%	21
15	Curtailement of wind power, case 10%	21
16	Evolution of the lines capacity in the different hydrogen production cases	25
17	Storage size and electrolyzer size in the different hydrogen production cases	25
18	Heat map of the insolation in the year	28
19	Storage size in the cases with and without solar investment possibility	30
20	Wind power production at bus 8, case 60%	31
21	Curtailement at bus 9 with and without solar, case 60%	31
22	Hydrogen production to storage with and without solar, case 60%	32
23	Solar power production at bus 6, case 60%	32
24	Hydrogen storage evolution with and without solar, case 60%	33
25	Hydrogen cost as a function of the investment cost of solar power for the case 10%	36
26	Evolution of the resulting cost of hydrogen in the different scenarios	39
27	Evolution of the wind and solar curtailement in the different hydrogen cases	39
28	Wind power curtailement at bus 1, case 30%	40
29	Wind power curtailement at bus 1, case 30%	41
30	Utilization of the lines between bus 8 and 9, cases 30% and cheapest solar	42
31	Utilization of line 1, case 30%	42
32	Utilization of line 0, case 30%	43
33	Duration curves of the utilization of lines 1 and 0, case 10% and 30% with and without solar	43
34	Wind power and curtailement at bus 8 and 9 for the different grid case and the case 10%	47
35	Evolution of the costs for each grid case, case 10%	48
36	Duration curve of the wind power production at bus 9 for the different grid cases, case 50%	50
37	Evolution of the costs for each grid case, case 50%	51
38	Evolution of the costs for each grid case, case 10% with low solar investment cost	53
39	Hydro reservoir 1 for the different studies	54
40	Hydro reservoir 2 for the different studies	55
41	Hydro reservoir 3 for the different studies	55

42	Hydro reservoir 4 for the different studies . . . . .	56
43	Hydro reservoir 5 for the different studies . . . . .	57
44	Hydro reservoir 7 for the different studies . . . . .	57
45	Hydro reservoir 8 for the different studies . . . . .	58
46	Hydro reservoir 9 for the different studies . . . . .	58
47	Spillage for reservoir 4 for case 10%, different studies . . . . .	59
48	Spillage for reservoir 7 for case 10%, different studies . . . . .	59
137	Evolution of the costs for each grid case, case 10% . . . . .	91
138	Evolution of the costs for each grid case, case 50% . . . . .	91
139	Evolution of the costs for each grid case, case 10% with low solar investment cost . . . . .	91

# List of Tables

1	Overview of the wind power in the system . . . . .	16
2	Total installed wind power at each bus (MW) . . . . .	23
3	Curtailed wind power at each bus in percentage of the actual production (%) . . . . .	24
4	Hydrogen cost ( $\text{€}/Nm^3$ ) . . . . .	26
5	Total installed wind power at each bus for the solar case (MW) . . . . .	29
6	Total installed solar power at each bus for the solar case (MW) . . . . .	29
7	Hydrogen price for the different cases ( $\text{€}/Nm^3$ ) . . . . .	30
8	Curtailed wind power at each bus in percentage of the actual production for the solar case (%) . . . . .	34
9	Total installed wind power at each bus for the study of solar investment price (MW) . . . . .	35
10	Total installed solar power at each bus for the study of solar investment price (MW) . . . . .	35
11	Total installed wind power at each bus for different investment prices and hydrogen cases (MW) . . . . .	37
12	Total installed solar power at each bus for different investment prices and hydrogen cases (MW) . . . . .	37
13	Electrolyzer and storage size for each price and hydrogen case . . . . .	38
14	Wind and solar power (MW) and rationing (MWh) at each bus for the different grid cases in the case 10% . . . . .	46
15	Electrolyzer and storage size and hydrogen cost for the different grid cases and the case 10% . . . . .	47
16	Wind and solar power (MW) and rationing (MWh) at each bus for the different grid cases in the case 50% . . . . .	49
17	Electrolyzer and storage size and hydrogen cost for the different grid cases and the case 50% . . . . .	50
18	Installed wind and solar power, and rationing at different bus for different grid cases, case 10% with low solar investment cost . . . . .	52
19	Electrolyzer and storage size and hydrogen cost for the different grid cases and the case 10% with low solar investment cost . . . . .	52
20	Wind power at each bus base case (MW) . . . . .	65
21	Utilization factor of the lines base case . . . . .	65
22	Utilization factors of the lines for the different studies in the case 10% . . . . .	70
23	Utilization factors of the lines for the different studies in the case 50% . . . . .	84
24	Utilization factor of lines . . . . .	89
25	Wind and solar curtailment in the study of the different price scenario . . . . .	90

# 1 Introduction

Hydrogen is the most abundant component of the universe. It represents 75% in mass of all the chemical elements. It is for example in stars where it fuels them or in gaseous planets. On earth, hydrogen is found in water molecules for example but is not present in a directly exploitable form. As a consequence it requires energy to produce hydrogen, whether in a gaseous or liquid form. The hydrogen then obtained can be stored and used later in chemical processes or to produce electricity through fuel cells, be it in vehicles or for grid balancing operations. Hydrogen is thus an energy carrier, as opposed to crude oil or coal which are pre-existing energy sources.

Hydrogen is one of the solution proposed to the problem of green house gases and a more sustainable future.[10] Indeed, using hydrogen in a fuel cell, emits only water and is thus not polluting during the production of the energy. Even though the most common way to produce it uses fossil fuel and emits carbon dioxide, it is also possible to produce it with electricity through electrolysis and especially with electricity from renewable sources. It also offers the advantage of controlling where the emission happens and perhaps also to use carbon capture and storage processes. Controlling where the emissions happen would also be a tool to control air pollution in big cities where the air pollution problem has become more and more important those past years.

One of the factors limiting the development of the hydrogen is the problematic of switching from a gas economy to a hydrogen economy; no one wanting to take the first step on either side: developing vehicles or developing infrastructures for fuelling; both side arguing on the need of the other to come first. In spite of some advantages that were presented previously, some argue nonetheless on the interest of hydrogen for a renewable energy system due to the use of fossil fuel and the emissions of green house gases in the most common hydrogen production method. The other method for production of hydrogen, electrolysis, is less common due to the low efficiency of the process. Researches are conducted in order to find new designs and to improve existing ones, for example by crafting new materials <sup>1</sup>. [23]

Renewable energies have a major role to play in the current shift towards a cleaner and more sustainable future. The use and development of these technologies is one of the main alternatives to fossil fuels. The other alternative would be nuclear power, but after the Fukushima incident, the lower public acceptance of this technology combined with the yet to resolve nuclear waste problematic, make this path less attractive. The growth of the renewable market is fast and steady. In 2005 only 43 countries had renewable energy targets, but by mid-2015 it was 164 countries. [19] In addition to targets on renewable energies, limits of emission levels are also adopted. At the end of 2015, the COP21 agreement was agreed upon by 196 countries and set goals in order to limit the human impact on global warming and to try to limit to between 1,5 and 2°C the global rise in temperature by the year 2100. Even if the United States recently announced their withdrawal from the agreement, one can expect the rest of the world to keep their goals and be a favourable ground for the development and integration of renewable energy. Moreover the US will still be part of the shift through its companies and cities that

---

<sup>1</sup><https://phys.org/news/2017-06-scalable-fuels-future-hydrogen-economy.html>

embrace the problematic and take part in the global action.

Norway is a specific case for renewable energy with around 98% of its electricity production coming from hydro power. This specificity makes it so that other renewable energy forms such as solar and wind power are hardly developed despite strong potential for wind power. The wind potential for Norway is strong, both onshore and offshore; in 2005 the potential for wind energy was estimated by NVE at 245 500 GWh (for wind higher than 7m/s).[15] The distribution of this potential can be seen on figure 1.

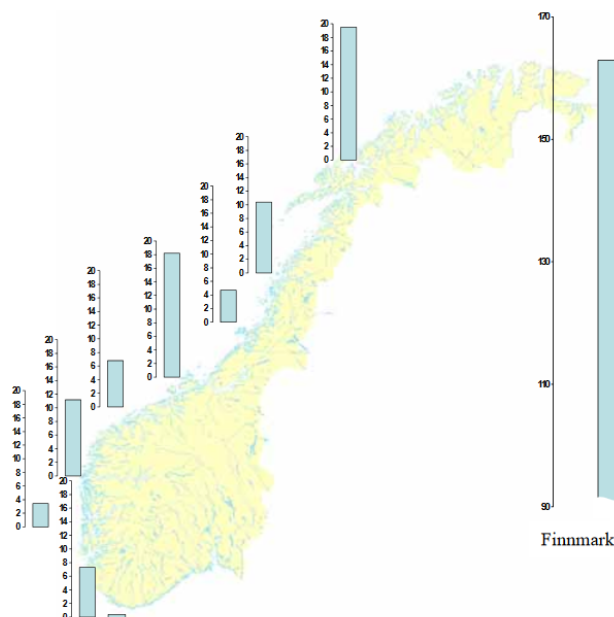

Figure 1: Wind potential in Norway, source: NVE, 2005[15]

The way the potential is divided on the Norwegian territory shows the importance of the Finnmark region, in the north of Norway. It represents most of the potential for wind power. However, the grid is not developed as much in this area because it is less densely populated. A bottleneck starting around Nord-Trøndelag limits the transmission capacity in north of Norway. This limits the possible development in wind power as well, due to the inability to transfer the production to the rest of the country or to other countries. Different options are available in order to counter that. The different options are: increasing the capacity of the lines or increasing the local use of energy (with power hungry industries). Increasing the local use of energy could be done by implementing aluminum production or hydrogen production. The production of hydrogen in the traditional way, through reforming would need the energy in order to liquefy the hydrogen and electrolysis could also be used as a mean of production.

The HYPER project lead by SINTEF in collaboration with major Norwegian actors aims to study the viability of large scale hydrogen production through both reforming and electrolysis with excess renewable energy. It also considers the possibility of using carbon capture and storage as a way to reduce the emissions of green house gases.<sup>2</sup> This

<sup>2</sup><https://www.sintef.no/en/projects/hyper/>

thesis is set in the context of this project and aims to understand better the impact on the grid, the market and the electrical system in general of different scenarios for the production of hydrogen with electrolysis. The base scenario consider a production of 10% of the total hydrogen goal (total goal: 500 tons/day or  $232\ 000m^3/h$ ) to be from electrolysis. An optimization procedure is used to find the best investment in electrolyzer size, storage size and additional renewable power over 1 year with hourly time-steps.

The study will first study the base scenario of 10% production from electrolysis and then increase the share of electrolysis in the total production. The focus will then be turned on studying the possibility of using solar power in addition to wind power. The price needed in order to invest in solar and the economically best grid design will finally be discussed before analyzing the changes in the operation of the hydro system.

## 2 Theory and Technology

### 2.1 Hydrogen

Hydrogen is a chemical element that is abundantly present in the universe. Actually it is by far the most abundant. However it is also most of the time contained inside other molecules (such as water  $H_2O$  or with carbon hydrogen bonds in organic compounds such as polymers) rather than as a stand alone dihydrogen ( $H_2$ ). Some researches suggest that hydrogen could be extracted from deep inside earth's crust in specific rocks where 1 cubic meter of rocks would produce 5 liters of hydrogen.[32] However this potentially large source of hydrogen would face the challenge of extraction with current drilling technology far from being able to reach such depths and even less with a process consuming less than it extracts.

The recent interest for hydrogen comes from the possibility we have to use it as a way to produce energy, it is an energy carrier. The main demand for hydrogen currently comes from the chemical industry where it is needed for some processes for the production of fertilizer for example or in the petroleum industry where it is used in the refining process.<sup>3</sup> In the future other uses are possible. The 2 main are the use of hydrogen in fuel cells for the grid and the use for vehicles.

In the grid it could be a tool that helps reduce the grid constraints due to a high integration of renewable energy. By producing during the peaks of renewable production it would help keep the power balance of the network while producing fuel that can be used in a fuel cell to produce electricity again during period of low renewable energy production. Several such projects already exist.[8] For example in Grapzow, Germany, a combination of wind turbines for a total of a 140 MW wind farms features a 1MW hydrogen production facility.<sup>4</sup>

It can also be used as a fuel for vehicles such as cars, bus, trucks, or ferries. It is currently already in use for some ferries and some cars but the amount is still marginal. However it is developing slowly due to the low efficiency of the hydrogen fuel cell and to the need of hydrogen fueling stations. Some hydrogen vehicles already exist, such as the Toyota Mirai in Japan (2014). The use of hydrogen in cars is currently limited due to the small number of refueling stations but some car makers want to push the technology to the market.<sup>5</sup> Even if the main processes of producing hydrogen produces carbon dioxide as well, one advantage of hydrogen cars on conventional ones would be to limit the emission and air pollution in cities and the possibility of storing the produced  $CO_2$ .

---

<sup>3</sup>Part of these explanations are copied from my specialization project. [28]

<sup>4</sup><http://www.hydrogenics.com/about-the-company/news-updates/2013/10/01/140-mw-wind-park-officially-opens-in-germany-with-energy-storage-facility-using-1-mw-power-to-gas-system-from-hydrogenics>

<sup>5</sup><https://www.wired.com/2017/04/honda-will-nearly-everything-get-hydrogen-car/>





(a) Wind hydrogen solution



(b) Toyota Mirai, a hydrogen car

A study published in 2014 has aggregated estimations of the number of fuel cell cars running in different parts of the world at different times. In Europe by 2020 they estimated the amount of fuel cell cars to be around 350 000, in the US 20 000, in Korea 50 000 and in Japan 100 000. They also estimated this number to be above 1 million cars for Germany, Denmark and the UK and around 800 000 in France by 2050. [6] [36]

The global demand for hydrogen has also been estimated for the european commission, and reaches 1 000 *Mtoe* (toe: ton oil equivalent). [4, p.107] It is equivalent to 42 *EJ*, that we can compare to the 8 *EJ* of 2005. Most of the hydrogen would be used in the transport sector.

### 2.1.1 Hydrogen Production Technologies

The most common way of producing hydrogen currently is reforming of natural gas. Other ways are coal gasification, thermal water splitting, production from biomass, photo electrolysis and other technologies that still need research to become viable. In 2007, 48% of the hydrogen was produced from reforming, 30% from gas, 18% from coal and only 4% from electrolysis. The annual production was at the same date  $65 \cdot 10^6$  tons of hydrogen.[5]

In the gas reforming method the methane inside the gas reacts with steam at high temperature to produce hydrogen and carbon monoxide that is then reused to produce hydrogen and carbon dioxide in a process called water gas shift. The 2 equations of these reactions are :

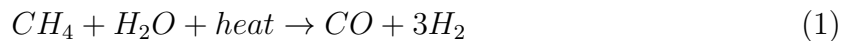

Coal gasification consists of having coal, steam and oxygen at high pressure and temperature; it produces hydrogen, carbon monoxide and dioxide and other gases. A water gas shift reaction can be performed as well to use the carbon monoxide left and to produce additional hydrogen.

Different new methods are investigated as ways to produce hydrogen. These methods rely on heat or on light in different ways; for example to split water or to grow micro-organism.

Electrolysis of water is one of the methods that can be used to produce hydrogen. It is a classic electrolysis where a direct current forces oxidation and reduction to happen at

the anode and the cathode. The basic system is represented figure 3. It is for example a method used in the production of aluminium. In an electrolysis, the electricity forces (or facilitate) the combination of ions (in this case  $H^+$ ) at the cathode by making electrons available ( $2H^+ + 2e^- \rightarrow H_2$ ) and on the anode side electrons are released ( $4H_2O \rightarrow O_2 + 2H_2O + 4e^-$ ).

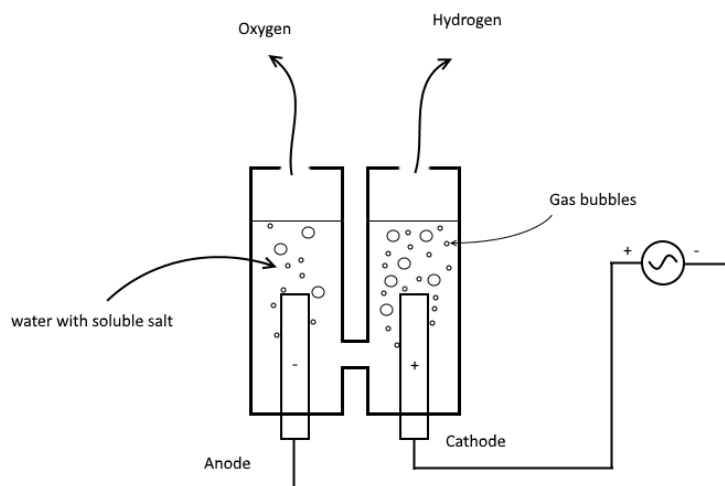

Figure 3: Basic graphic of a water electrolysis device

The overall equation of the reaction in the case of hydrogen production is:



The efficiency of electrolyzers are usually between 55 and 75%. [5] The efficiency of the process is affected by several factors. The ohmic resistance of the electrodes, bubbles on the electrodes limiting the actual surface and ionic transfer limitations affect the efficiency and cause the production of heat. Another factor limiting the efficiency is due to the activation energy of the reactions (to go from a state A to a state C it is need to go through a state B that has a quite higher potential). [38] Different kinds of electrolyzer exists: alkaline, PEM, Solid Oxide,... But they are not all at the same stage of development, the most mature being the alkaline technology. Alkaline electrolysis is the closest to the simplified figure 3. A difference being that a membrane is used to separate both sides while allowing proton to go through. This membrane is a cause of loss in this kind of electrolyzers. PEM (proton exchange or polymer electrolyte membrane) is a technology that will reach markets in a close future for large sizes. It uses a material that has a high proton conductivity, directly in between the electrodes. [29] One advantage, in addition to being more efficient than alkaline electrolyzers, is that it operates at higher temperature and higher pressure. The higher temperature gives a better efficiency while the higher pressure reduce the needs of compressor that are necessary for many hydrogen applications. Another advantage of this technology is the ability to adapt to rapidly varying electrical input. [34] Solid oxide cells are further from reaching the markets but would offer even higher efficiency by operating at higher temperature. [34] Researches try to optimize the efficiency by considering different electrodes material and architecture or by finding efficient catalysts. [38]

Electrolyzers can be expensive; one of the reason for that being the use of platinum electrodes. Commercial electrolyzer units are up to 2 – 3 MW. Their specific power consumption is about 4.3 kWh/Nm<sup>3</sup>.

### 2.1.2 Hydrogen Storage Technologies

Different methods of storage of hydrogen exist. Some are physical based:

- Compressed gas
- Cold/Cryo Compressed
- Liquid hydrogen

Those physical based storage are the most mature ones. The usual compression pressure are 350 and 700 bars. The compressed systems have a good density but can take a lot of space. In the cold/cryo case they are also cooled to temperatures up to below 150 K in the cryo case. The atmosphere temperature compressed are considered to be best suited for fuel cell vehicles but could also be fitted for larger scale applications.[18] Liquid hydrogen is a safe option but requires a lot of energy to perform the liquefaction.

Other technologies are being developed, they are called material based:

- Metal hybrids materials storage
- Chemical storage
- Sorbent storage

The metal hybrid technology is based on the fact that a lot of metal hybrids (for example  $MgH_2$  or  $NaAlH_4$ ) binds strongly to hydrogen. To release the hydrogen you then have to heat the metal at temperatures between 120°C and 200°C. The technology offers a good density by volume but not by weight.

The chemical storage is a storage where the hydrogen has covalent bindings to a molecule. It is more suited for single-use storage because the re-hydrogenation can be complex. It is the technology with the highest density.

The Sorbent storage uses the adsorption capability of materials to store hydrogen.

An other type of possible storage are underground caverns. It can be man made caverns or natural ones. The man made caverns are built in rock salt and are gas-tight. Those caverns are used to store hydrogen at 200 bar or more and can contain up to 1 000 000 m<sup>3</sup> of hydrogen.[22, p.13] In Norway man made caverns are already being used for the storage of crude oil in multiple locations. There are underground crude oil storage facilities in Sture and in Mongstad that represents more than 1 million cubic meters.[11] Salt caverns have been used to store hydrogen in Texas Clemens (1983), Moss Bluff (2007) and in Teesside,UK (1972). The ones in Texas can store up to 580 000 m<sup>3</sup> at a pressure of between 50 and 150 bar while the one in the UK is made of 3 caverns of 70 000 m<sup>3</sup> capacity each, with a pressure of 45 bar.[22, p.17] Underground caverns are a good solution for large scale storage.

## 2.2 Wind Power

Wind has its origin in the uneven amount of solar energy received by the different part of earth due to its inclination as well as earth's rotation. This indirect form of solar energy can be converted to electricity through the use of wind turbines. Wind turbines are generators (that can be of different types for example induction generator or permanent magnet synchronous generator) with or without gearbox and with different power electronics designs. Figure 4 from IEEE[24] summarize wind turbine designs. The most common type of wind turbine used is vertical with 3 blades for efficiency and stability reasons.

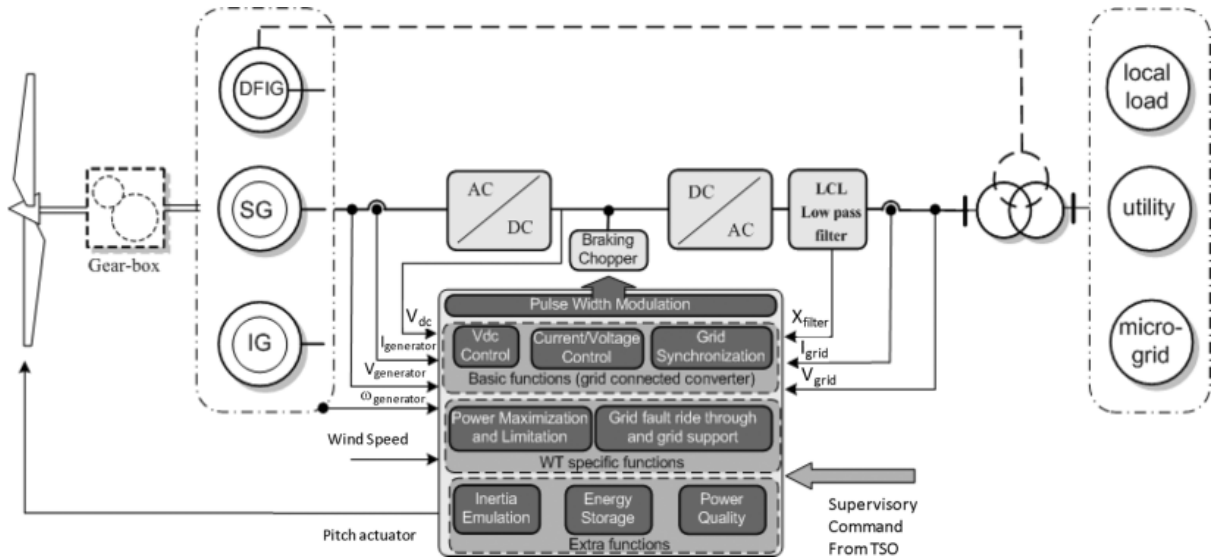

Figure 4: Wind turbines common features ©2011, IEEE

The power output of a wind turbine can be modelled by this formula:

$$P_{el} = \frac{1}{2} C_p(\lambda) \rho A \nu^3 \quad (4)$$

$C_p$  is called the power coefficient and it is a function of the tip speed ratio  $\lambda$ . The tip speed ratio is calculated with :

$$\lambda = \frac{\omega R}{\nu} \quad (5)$$

In equation 4,  $\rho$  is the air density,  $A$  is the rotor area and  $\nu$  is the wind speed. The formula tells us that increasing the area of the rotor will increase the power output linearly, i.e. increasing the diameter of the blades will increase the power output quadratically. That is however without taking into account the power coefficient dependence on  $\lambda$ . Moreover too high diameter can lead to problem related to the tip speed and to vibrations and noise. The air density influences also the production, it decreases with increasing altitude but it increases with decreasing temperature. Humidity also influences it, the more humidity in the air, the lower the air density. Those variations due to altitude (location of the turbine) and in time through temperature and humidity can modify from tens of percent the actual production. The most important parameter in the power output is the wind speed though, as it is a cubic variation. Doubling the wind speed results in a 8 times

higher power output. In equation 5,  $R$  is the radius of the blade and  $\omega$  is the rotational speed of the blades and the rotor.

The power coefficient has a theoretical maximal value of  $16/27$ . This value is called the Betz limit. The  $C_p - \lambda$  curve allow you to determine the optimal power coefficient (and the optimal pitch angle for the blades in case of pitch control) and then the power curve. An example of a power curve can be seen figure 5. The documentation on this wind turbine can be found on Vestas' website.

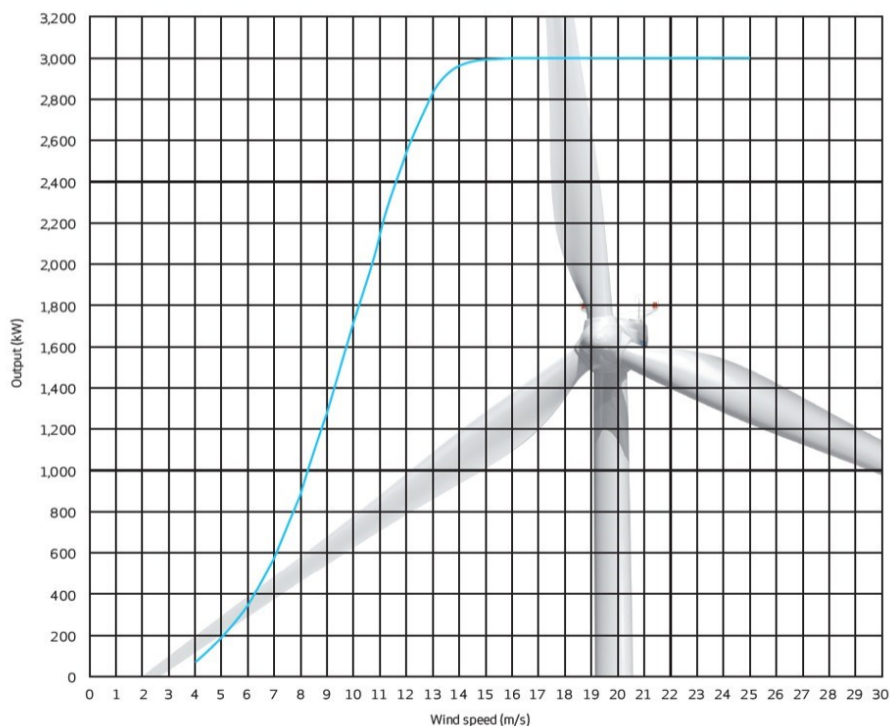

Figure 5: Power curve of a 3MW Wind turbines from Vestas

Having several buses with wind farms in the system allows to reduce a problem that can be met with wind turbines. The problem is that with only one site, the production will be really dependent on that one site. Having wind farms at different buses allows to smooth the wind production due to the different wind conditions at different instant. By having three wind farms separated by more than 100km each, it has been shown that the probability of a zero power output was reduced from 20% to only 5%. [21]

Good wind conditions are necessary for obtaining a good power output from a wind farm. It is then necessary to prospect in order to find a location that offer those good wind conditions but also a favorable terrain.

Different methods are available in order to assess the wind conditions at a site. A commonly used method is to set up a mast along with several measurement instruments such as cup-anemometers. The measurements can be performed at different altitude on the mast in order to get a better picture. This mast then needs to stay there for at least a year in order to have sufficient data. Other ways of getting those measurements are starting to be used. They are for example SODAR (sonic detection and ranging) and

LIDAR (light detection and ranging). They use respectively sound and light in order to measure wind speed and direction with Doppler effect.

When it is not possible to measure the wind speed at the correct height with a mast, it is possible to extrapolate the wind speeds obtained at another height. The first method is the power law (6) and the second method is the logarithmic law (7).[25]

- Power law profile:

$$\frac{U(z)}{U(z_r)} = \left(\frac{z}{z_r}\right)^\alpha \quad (6)$$

- Logarithmic profile:

$$\frac{U(z)}{U(z_r)} = \frac{\ln\left(\frac{z}{z_0}\right)}{\ln\left(\frac{z_r}{z_0}\right)} \quad (7)$$

The terrain also has an important role; a urban terrain with a lot of construction will result in lower wind speed for low altitude compared to the sea for example. The exact position of the turbine is also important as it can affect the wind received, for example a wind turbine located behind a hill will not get the optimal wind speed it could get in that area in the direction blocked by the hill.

In 2016, the world total installed wind power was 486,7GW with 54,6GW newly installed that year. About a third of this total is located in Europe with a total of 161,3GW and 13,9GW newly installed.[2] In Norway, 2 515GWh was produced in 2015<sup>6</sup>. In 2014 it was 2 214GWh that had been produced. At the end of 2014, 856 MW of wind was installed in Norway of which 45MW was newly installed and their capacity factor was around 30%<sup>7</sup>.

Norway offers many locations with favorable wind and the fact that this energy is not as developed as it could be is due to the low price of electricity. Most of the electricity comes from hydropower. A lot of wind farms sites could be developed. Figure 7 shows a map of the yearly average wind speed at 80m in all of Norway. More detailed maps are also available on the NVE website<sup>8</sup>.

The input data for the system is presented as a heatmap on figure 6. It allows to see the variations during the year and especially that the production is higher on average at the beginning and the end of the year for this site and this particular year.

---

<sup>6</sup><https://www.ssb.no/energi-og-industri/statistikker/elektrisitet/aar>

<sup>7</sup><https://www.ieawind.org/countries/norway.html>

<sup>8</sup><https://www.nve.no/energiforsyning-og-konsesjon/vindkraft/vindressurser/>

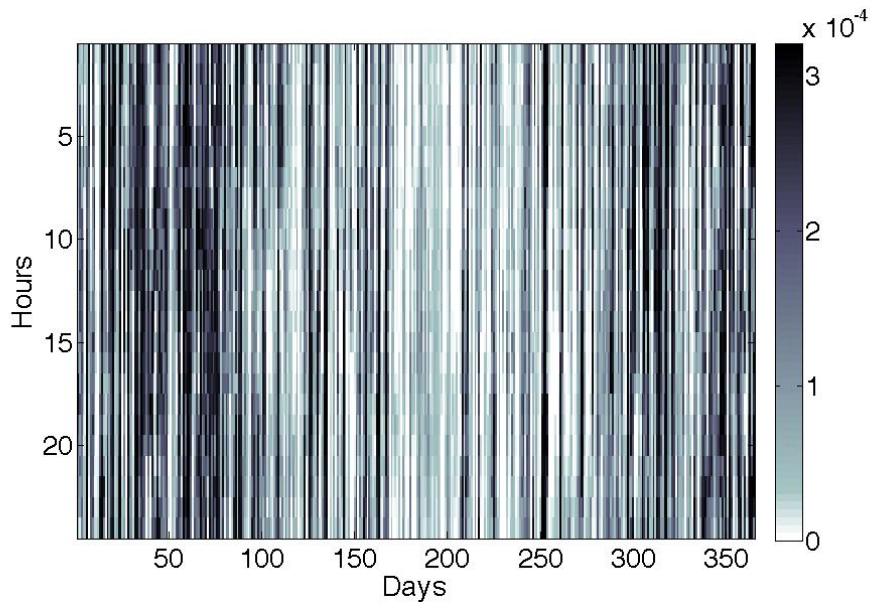

Figure 6: Heat map of the normalized wind resource at one of the bus in the year

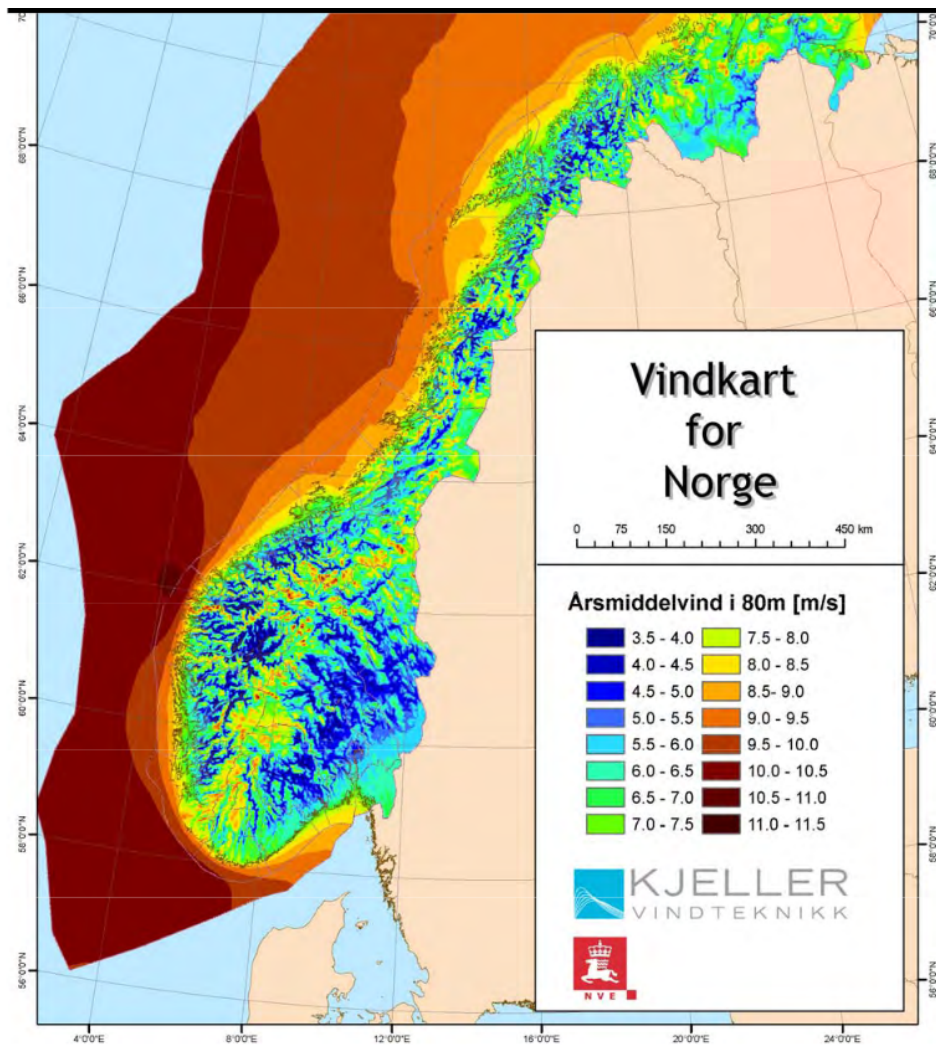

Figure 7: Map over Norway of the yearly average wind speed at 80m

There doesn't appear to be a pattern, day/night or other, for the wind intensity inside a day; there is only variations between months.

## 2.3 Solar Power

Photovoltaic cells can be used to produce electricity from solar radiation. The first modern solar cell was built by Bell Telephone laboratories after discovering that silicon had photoelectric properties.[1] Its efficiency was then only 4%. However, the photoelectric effect was known for many years before that. It was discovered by Becquerel in 1839 through the electrical effect of solar radiation on batteries. Einstein discovered in 1905 that this energy was proportional to the electromagnetic wave frequency.[37]

Solar panels are made of several solar cells that use the photovoltaic effect to create an electrical current. Solar cells are made by combining several layers of semi-conductive materials that forms a p-n junction. This junction is made of a layer of negatively doped semi-conductive material and a layer of positively doped semi conductive material. Doping the semi-conductor negatively means introducing impurity: replacing some atoms of, for example, silicon by another one that will have a free electron. The material has now many free electrons. Doping positively means the opposite, you replace some of the silicon by an atom that will have an incomplete covalent link with another silicon atom in the crystal, thus creating a material that has a lot of gaps for electrons to fill. When creating the p-n junction (putting together the two materials), electron from the negatively doped material will migrate and recombine in the positively doped material. This will create a transition zone; the zone were electrons recombined prevents the other electrons from recombining with the gaps on the other side. Photon arriving on the solar cell can give energy to an electron that will leave it's atom and migrate to the negatively doped zone, creating an electrical current. Gathering several solar cells in solar panels and in solar plant allows to have a good power production means in areas with good insolation.

In the "Renewable 2016 Global status report", the REN21 association reported that in 2015, 50 GW of solar power (representing around 185 millions solar panels) have been installed worldwide, increasing the global solar capacity to 227GW.[31] In Europe it is 7.5GW that has been constructed for a total of around 95GW.[31] In Norway solar power is barely present and the production from solar power is not even mentioned on the national statistics<sup>9</sup>. However the website fornybar.no<sup>10</sup> reports that around 13 MW of solar power was built in Norway in around 150 000 installations, mainly in order to have electricity in cabins and for coastal navigation lights, which are not connected to the grid.

Several solar cell technologies are now available in the market or are being developed. The commercially available technologies are the crystalline silicon and the thin film technology (both still have research going on for improving their efficiency) and the one that still require development are concentrated photovoltaic and organic material cells. The crystalline silicon technology efficiency ranges from 14 to 19% and it is the technology that

---

<sup>9</sup><https://www.ssb.no/energi-og-industri/statistikker/elektrisitet>

<sup>10</sup><http://www.fornybar.no/solenergi/produksjon-og-marked>



is the most present in installed solar panels.[16] It is divided between mono-crystalline and poly-crystalline. The differences between those two comes from the way they are produced. While offering higher efficiency the mono-crystalline technology is also more expensive due to the fabrication process. Those technology can be seen on figure 8<sup>11</sup>.

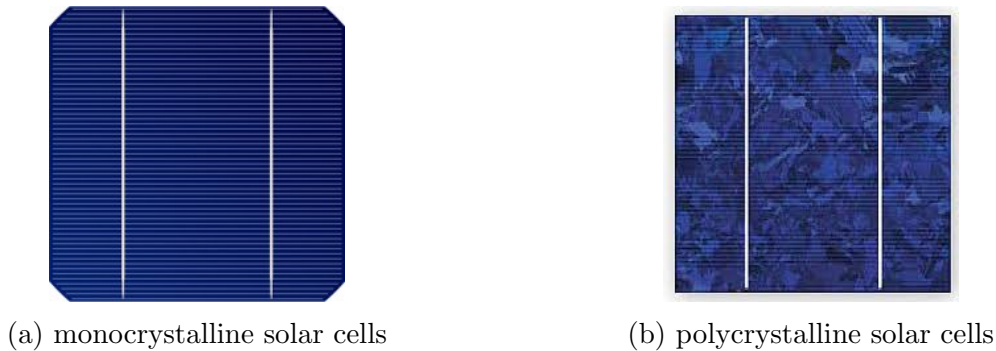

Figure 8: Silicon crystalline solar cells

The thin film technology (figure 9a<sup>12</sup>) uses many thin layers of silicon on a substrate. The technology while being available for purchase is also investigated due to the potential high cost reduction. This potential comes from the fact that this technology uses a lot less semiconductor materials and uses inexpensive substrate. It is believed to be able to reach prices under 1€/Wp (Wp: watt peak).[3] In addition, they also offer the possibility of using them in flexible and lightweight structures.[16]

The concentrating photovoltaics technology use optical devices such as lenses and mirrors in order to concentrate the light on small solar panels. The reduction in panel size makes it possible to use high-end solar cells technology with good efficiency. Drawbacks of this technology are the impossibility of using the diffuse light and the need for cooling. Organic cells (figure 9b<sup>13</sup>) are solar cells made of organic materials, such as polymers. It makes them more affordable than the other technologies even though their efficiency is low, between 4 and 5%.[16] They also offer many possibilities due to the fact they are printed on plastic. They could then be used on flexible material or coated on all kind of items that are used outside. The cost for this technology are expected to be reduced to 0.50 USD/Wp by 2020.[33]



Figure 9: Silicon crystalline solar cells

<sup>11</sup>(fr) <http://www.photovoltaique.info/Techniques-de-fabrication-des.html>

<sup>12</sup><https://www.sciencedaily.com/releases/2008/02/080206154631.htm>

<sup>13</sup><http://topdiysolarpanels.com/3rd-generation-of-solar-panels-thin-film/>

The IRENA (International Renewable Energy Agency) published a report tackling solar technology and its cost, both the cost at the time of publication and the expected cost in the future. They gathered price estimates for the horizon 2020 and 2030 and found that the projections for crystalline silicon solar panels at utility scales would cost around 1,8 USD/W<sub>p</sub> in 2020 and 1,2 USD/W<sub>p</sub> in 2030 with prices for 2010 being around 3,8 USD/W<sub>p</sub>. For residential use the cost would be slightly higher at 2,5 USD/W<sub>p</sub> in 2020 and 1,65 USD/W<sub>p</sub>. For residential thin-film use, their price estimate for 2015 was around 2 USD/W<sub>p</sub>. [1]

The opportunity of building solar plants is highly dependent on the solar radiation received at the desired location. Indeed the power output from the plant will depend on how much solar radiation arrives on the solar panels. The radiation received depends highly on the location, the highest radiation being around the equator as can be seen on figure 10.

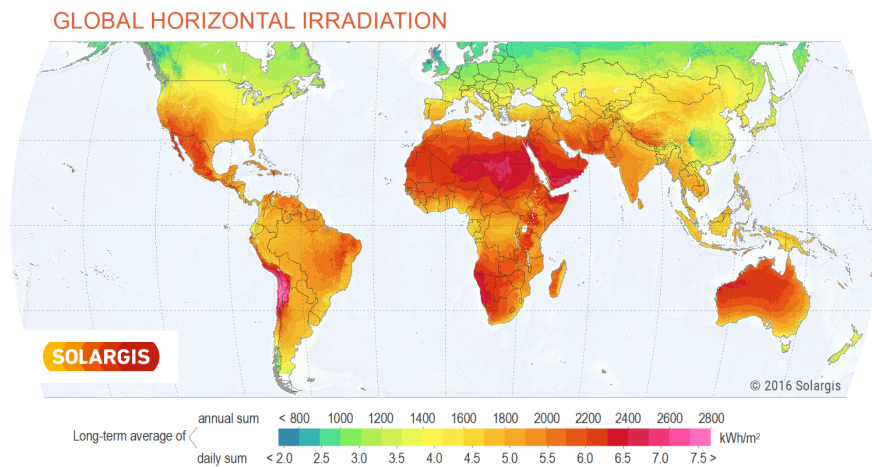

Figure 10: An example of the distribution of radiation in the world (credit: GHI Solar Map © 2017 Solargis)

In order to get the maximal radiation at all times, systems are available to motorize the solar panels in order to make them able to follow the sun.

According to the map above, it seems quite unprofitable to install solar panels in Norway especially up in the north. There the winter nights offer little radiation for long periods. On the other hands the radiation during the summer can be taken advantage of at almost all hours. In addition to the fact that the efficiency of solar panel is increased with lower temperature (and decreased with temperature higher than 25°C) [9], the opportunity to install solar panel in addition to the wind power can still be studied.

## 2.4 Area Modelled: Northern Norway

The area that is modelled in the simulation tool is large, it covers the Troms and Finnmark region in Norway. The grid in this area is often referred to as a weak grid. This is due to the structure of the network there. The lines are mostly old and of limited capacity and the security of supply is hard to maintain due to the few parallel paths. In the rest

of the paper we will refer to those problem when mentioning north-Norway as having a weak grid.

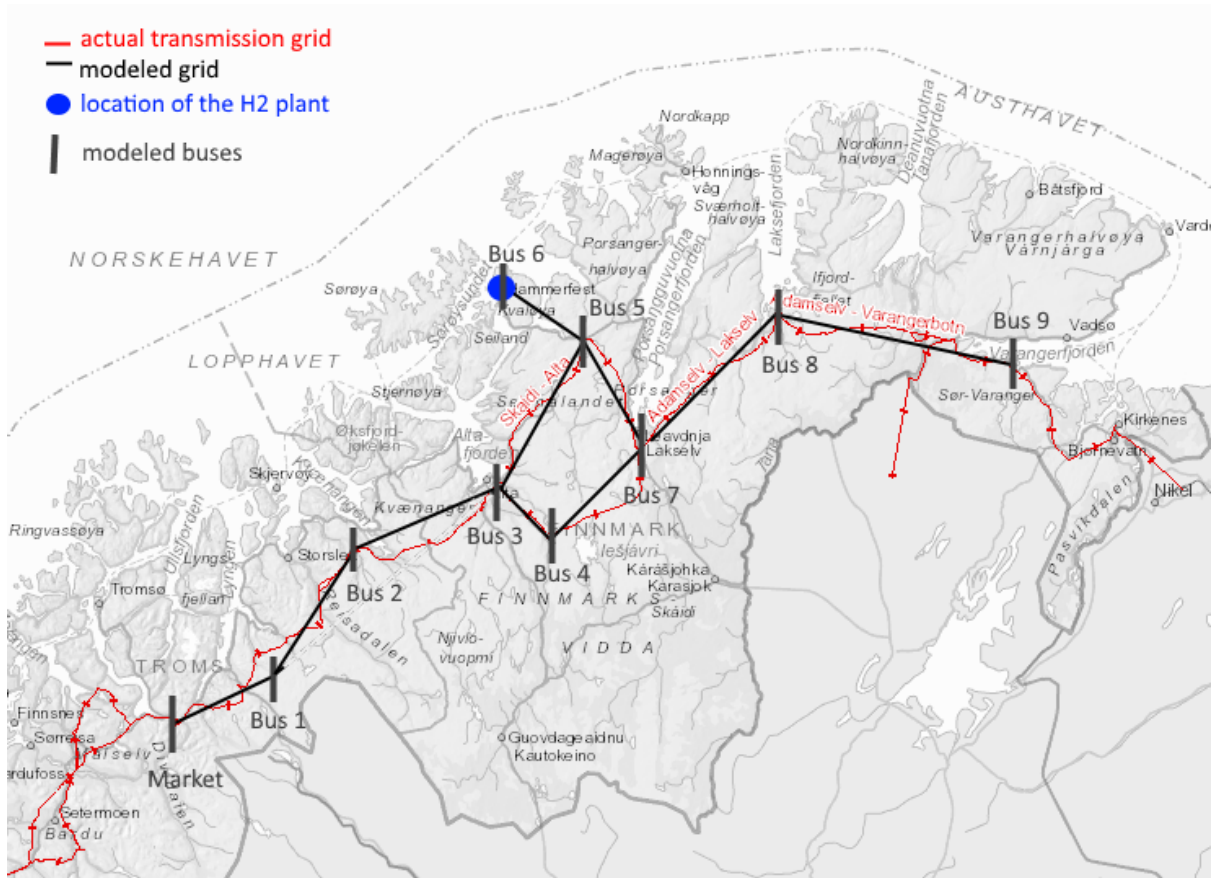

Figure 11: Area modeled with the actual transmission grid from NVE Atlas

On figure 11, one can see the Norwegian transmission system and the way it was reduced to a model that could be handled more easily. Some things are worth mentioning. The rest of the Norwegian system is simply modeled by a market. The market is modeled based on electricity prices from Nordpool that allow us to sell or buy power. The connections with Finland and Russia are ignored. Those connections are really limited. They represent for 2015 and 2016 less than 20 MW in average.[27] Only the transmission system is considered, the distribution network is not. There is one exception to this for the line from Bus 5 to Hammerfest due to the fact that this line has a major role in the supply of the factory needs in energy.

In order to run the model, a lot of different values are needed; from the grid data to the potential wind development for each bus there was a need to set those values. In this section we will explain how the values were obtained and the choices that were made.

### 2.4.1 Buses and Lines

The buses of the power system are represented by their longitude and latitude. The lines that connect these buses are modelled with their reactance and the line capacity. The resistance is not included because we chose to model the lines with dc flow. The

localization and capacity of buses and lines is available on NVE (Norges vassdrags og energidirektorat) atlas<sup>14</sup>.

### 2.4.2 Hydro Power

The hydro power system is modelled by an aggregated reservoir at each bus. The reservoir capacity, power capacity and inflows each year are obtained from NVE atlas and aggregated for each bus. The inflow were obtained from the EMPS<sup>15</sup> developed by SINTEF.

### 2.4.3 Wind Power

The wind power plant initial capacity is obtained and aggregated at each bus thanks to NVE atlas as well. The tool also allows to know of former and current project in wind development and this is what was used for defining the potential for wind power at each bus. The wind series come from NVE. The NVE atlas is again used in order to compile the potential for wind power for each bus using the data for ongoing project or abandoned project.

bus	1	5	6	8	9
initial capacity (MW)	0	40.5	0	30	95
potential capacity (MW)	10	160	10	1550	453

Table 1: Overview of the wind power in the system

### 2.4.4 Load

The loads are aggregated for each bus based on data of electricity consumption from SSB (Statistisk sentralbyrå). On the website, one can get the energy use for each city and for different years. It is also possible to differentiate between the different kinds of use, for example the use of the industry. Some modifications are applied. Indeed the mining industry in hammerfest increases a lot the energy use for this city. However they produce their own electricity through gas turbines, thus we can substract this from the load. We then have yearly energy use per city. The next step is to gather them approximately at each bus. Then we use the data from Nordpool<sup>16</sup> on electricity consumption to get the hourly time series. On this website we can also get the time series for the spot price of electricity that we use in the model.

## 2.5 Optimization Formulation

In order to simulate the grid, we use a simulation tool created by Espen Flo Bødal.[7] The grid is represented by its different buses and lines, and at each bus is aggregated

<sup>14</sup><https://atlas.nve.no>

<sup>15</sup><https://www.sintef.no/en/software/emps-multi-area-power-market-simulator/>

<sup>16</sup><http://nordpoolspot.com/historical-market-data/>

the production from hydro power, the production from wind power and the hydrogen plant in the appropriate bus and of course the loads. The grid is connected to a market, representing the rest of the national grid, where the prices is fixed for each time step based on data from previous years from Nordpool. The simulation is solved with hourly steps by linear programming with the following objective function :

$$\begin{aligned} \max \left\{ -\frac{T}{8760} \left[ \sum_{i \in \mathcal{W}} C_i^w w_i^{exp} + \sum_{i \in \mathcal{H}_2} C_i^e e_i^{max} + \sum_{i \in \mathcal{H}_2} C_i^s h_i^{exp} \right] + \sum_{t \in \mathcal{T}} \left[ \lambda^s p_{t,0}^{imp} - (\lambda^s + \delta) p_{t,0}^{exp} \right. \right. \\ \left. \left. - \sum_{i \in \mathcal{N}} C^r r_{t,i} - \sum_{i \in \mathcal{H}_2} C^i h_{t,i}^i \right] - \sum_{i \in \mathcal{H}} (C^{v+} v_i^+ + C^{v-} v_i^-) \right\} \quad (8) \end{aligned}$$

It maximizes the profit from energy sale to the market while minimizing the investment costs in hydrogen storage, the electrolyzer and wind power. There is also penalties for having a different end reservoir than planned and the possibility to use rationing or to import hydrogen at a high cost.

The constraints are the following:

**Energy balance:**  $w_{t,i} + q_{t,i} - \eta^d h_{t,i}^d - \eta^s h_{t,i}^p - p_{t,i}^{exp} + p_{t,i}^{imp} + r_{t,i} = D_{t,i} \quad (9)$   
 $\forall i \in \mathcal{N}, \forall t \in \mathcal{T}$

**Flow balance:**  $p_{t,i}^{exp} - p_{t,i}^{imp} = S^{ref} \sum_{j \in \mathcal{C}_i} f_{t,i,j} \quad \forall i \in \mathcal{B}, \forall t \in \mathcal{T} \quad (10)$

**DC load flow:**  $f_{t,i,j} = \frac{\delta_{t,i} - \delta_{t,j}}{X_{i,j}} \quad \forall i \in \mathcal{B}, \forall j \in \mathcal{C}_i, \forall t \in \mathcal{T} \quad (11)$

**Transmission limit:**  $f_{t,i,j} \leq \frac{T_{i,j}^{max}}{S^{ref}} \quad \forall i \in \mathcal{B}, \forall j \in \mathcal{C}_i, \forall t \in \mathcal{T} \quad (12)$

**Rationing limit:**  $r_{t,i} \leq D_{t,i} \quad \forall i \in \mathcal{N}, \forall t \in \mathcal{T} \quad (13)$

**Wind production:**  $w_{t,i} + c_{t,i} = \gamma_i w_i^{max} P_{t,i}^w \quad \forall i \in \mathcal{W}, \forall t \in \mathcal{T} \quad (14)$

**Wind capacity composition:**  $w_i^{max} = W_i^{init} + w_i^{exp} \quad \forall i \in \mathcal{W} \quad (15)$

**Wind expansion limit:**  $w_i^{exp} \leq W_i^{pot} \quad \forall i \in \mathcal{W} \quad (16)$

**Hydro reservoir balance:**  $v_{t,i} = v_{t-1,i} - q_{t,i} - q_{t,i}^{spil} + I_{t,i} \quad \forall i \in \mathcal{H}, \forall t \in \mathcal{T} \quad (17)$

**Initial reservoir level:**  $v_{0,i} = V_i^0 \quad \forall i \in \mathcal{H} \quad (18)$

**End reservoir level:**  $v_{T,i} - v_i^+ + v_i^- = V_i^0 \quad \forall i \in \mathcal{H} \quad (19)$

**Reservoir level constraint:**  $v_{t,i} \leq V_i^{max} \quad \forall i \in \mathcal{H}, \forall t \in \mathcal{T} \quad (20)$

**Hydro production constraint:**  $Q_{t,i}^{min} \leq q_{t,i} \leq Q_{t,i}^{max} \quad \forall i \in \mathcal{H}, \forall t \in \mathcal{T} \quad (21)$

**Hydrogen reservoir balance:**  $h_{t,i} = h_{t-1,i} + h_{t,i}^p - h_{t,i}^s \quad \forall i \in \mathcal{H}_2, \forall t \in \mathcal{T} \quad (22)$

**Hydrogen production balance:**  $h_{t,i}^d + h_{t,i}^s + h_{t,i}^{imp} = H_{t,i}^D \quad \forall i \in \mathcal{H}_2, \forall t \in \mathcal{T} \quad (23)$

**Electrolyzer expansion limit:**  $e_i^{max} \leq E_i^{pot} \quad \forall i \in \mathcal{H}_2 \quad (24)$

**Electrolyzer power limit:**  $\eta^d h_{t,i}^d + \eta^s h_{t,i}^p \leq e_i^{max} \quad \forall i \in \mathcal{H}_2, \forall t \in \mathcal{T} \quad (25)$

$$\text{Hydrogen reservoir limit:} \quad h_{t,i} \leq h_i^{max} \quad \forall i \in \mathcal{H}_2, \forall t \in \mathcal{T} \quad (26)$$

$$\text{Storage expansion limit:} \quad h_i^{max} \leq H_i^{pot} \quad \forall i \in \mathcal{H}_2, \forall t \in \mathcal{T} \quad (27)$$

The transmission grid is modelled by DC load flow (equation 11) and is thus neglecting the transmission losses. In order to behave correctly, the system is subject to the energy and flow balance (equation 9 and 10). The wind production is the sum of the already existing wind power and the optimized investment in wind power (equation 15). The hydro power behaviour is modelled by the reservoir balance (equation 17) and we aim at the end reservoir level to be the same as at the beginning of the year and penalize variation from this objective as seen in equation 19 and 28. The constraints that limits the operation of the system are represented with equations 12, 13, 16, 20, 21, 24, 25, 26 and 27.

## 2.6 Review of Older Studies on Hydrogen Production from Renewable

A study conducted by Genevieve Saur and Todd Ramsden in 2011 for the American National renewable energy laboratory (NREL) studied the cost of hydrogen from wind power in different scenarios. Different sites with different wind conditions were studied in a simulation tool with an hourly resolution. Not surprisingly the study found a dominating effect of the wind turbine cost and the electrolyzer cost in the final hydrogen price, highlighting the important effect of uncertainty on the results and estimated viability of such projects. The study also found a price of hydrogen ranging from 4 to 12\$/kg of hydrogen[30] depending on the wind conditions with the lowest price for the best wind conditions. We can compare those numbers with another study which found hydrogen prices of 2.8€/kg in a case study of an island with weak connection to the land in Norway[14] and a higher price of 6.2€/kg in the case of an isolated system. The results are a bit different. It can be explained by the wind conditions but mostly because the latter study considered taking advantage of seasonal variations to bring down the cost of hydrogen which was purposely excluded from the first study.

The use of wind power in cooperation with hydrogen specifically in weak grids was studied in 2008 by Magnus Korpås and Christopher Greiner. This study includes storage as well, unlike the previous one and considers a constant hydrogen load. The results from this study are multiple. It was found that operating the electrolyzer at constant power was reducing the size of the needed storage and electrolyzer but had the disadvantage of requiring more imports from and exports to the grid.[20]

The cost of hydrogen electrolyzer is expected to reach between 600 and 800€/kW by 2030 in a study from Element energy on electrolysis in the EU.[12]

In the specialisation project "Hydrogen production from wind power in weak grids"[28], Dimitri Pinel studied the same case of an hydrogen factory in Hammerfest but with a different simulation tool. The simulation tool used was able to simulate the factory on a more local perspective with only 3 wind farms and only one bus. A representation of this system can be seen on figure 12. The simulation tools used in this paper is thus a big improvement with the whole north of Norway being modeled. Another main differences

is that the tool was used with wind farms size as an input and not a result from an optimization process. On the other hand it was possible to study how the local system and the exchange with the grid were for up to 30 years. Three controlled strategies were studied and compared.

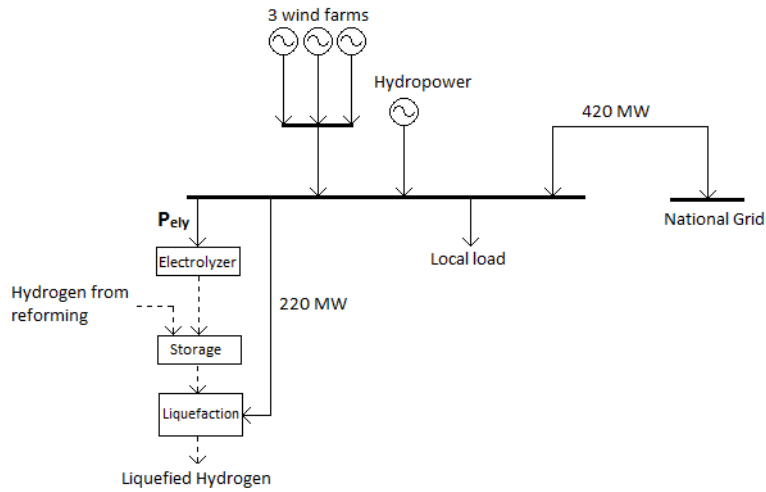

Figure 12: The system that was studied in "Hydrogen production in weak grids" [28]

The main results from this study are that meeting the hydrogen demand of the factory was possible with the various control strategies but with different amount of wind power. Some control strategies ended up with some hydrogen not being delivered to the hydrogen load even with a really big storage due to days with insufficient wind. Some rationing at the local load also happened for some hours. Another result was that the size of the storage could be greatly reduced by simply relaxing the constraint on the hydrogen production.

### 3 Hydrogen Reference Case: 10% of the Total Hydrogen Production from Electrolysis

In this reference case, the plan is to have a hydrogen factory at Hammerfest that would produce hydrogen at 90% from gas reforming and at 10% from electrolysis. This represents  $23173,9Nm^3/h$  from the electrolysis and  $208565 Nm^3/h$  from reforming. In all the report, the different hydrogen case will be referred to as "case X%", meaning case with X% of the total hydrogen coming from electrolysis. In this part, the main results of simulating this system with the optimization tools will be presented.

In this case the system that result of the optimization is the following. The amount of wind power in the whole system is 519,8MW. It represents an increase from the pre-existing wind power of 341,4MW. The biggest wind farms are located at bus 5 (200,5 MW) and at bus 9 (269,34MW). There is also 40 MW at bus 8 and 10 at bus 1. In order to not have rationing, the size of the lines have been increased, as will be described in the next section. It result in a grid with lines with a slightly higher capacity compared to the existing lines.

The optimization also resulted in having no storage and an electrolyzer of 108MW that produces constantly directly to the hydrogen load.

The resulting hydrogen cost is  $0,1417 \text{ €/Nm}^3$  in the spot calculation and  $0,152 \text{ €/Nm}^3$  in the nodal calculation; both calculations exclude the cost of upgrading the lines.

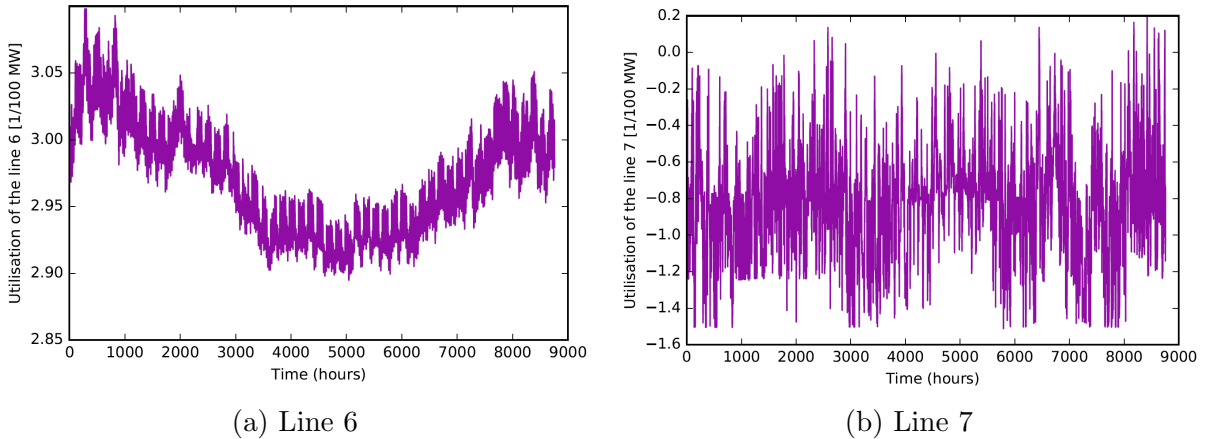
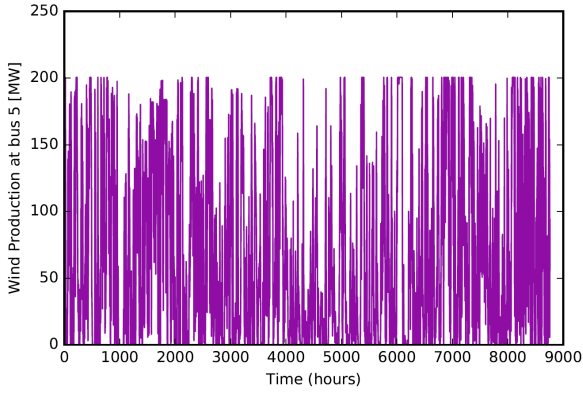
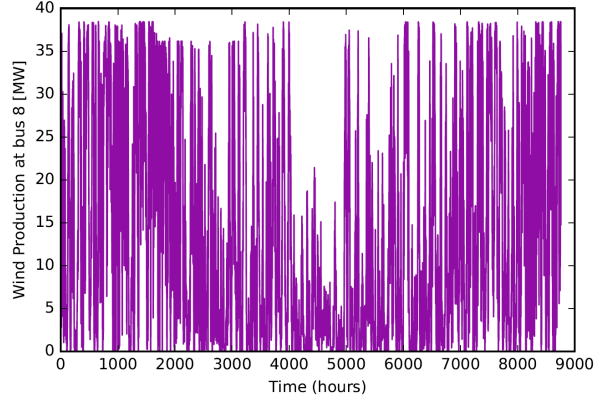

Figure 13: Utilization of the lines 6 and 7, case 10%





(a) At bus 5



(b) At bus 8

Figure 14: Production from wind power, case 10%

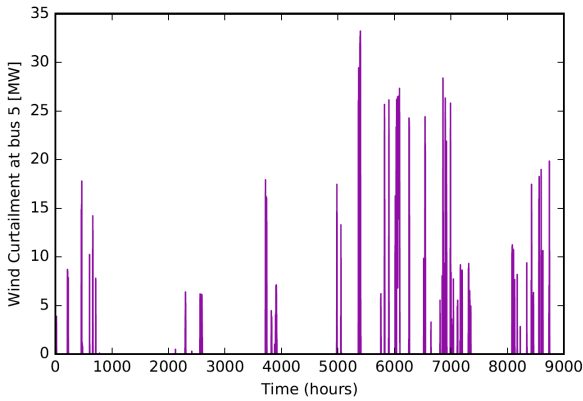

(a) At bus 5

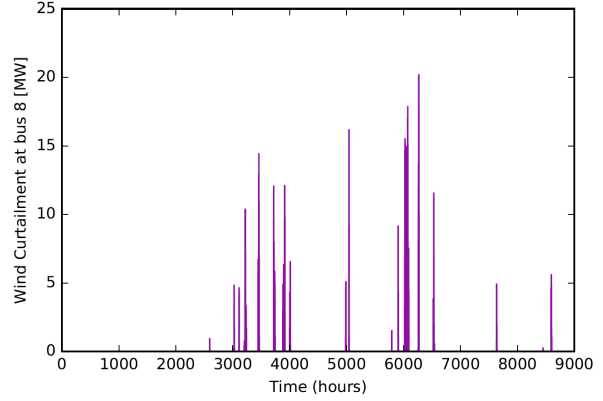

(b) At bus 8

Figure 15: Curtailment of wind power, case 10%

The figures above show some examples of the behaviour of the system resulting of the optimization. The utilization factor of the line 6 and 7 can be seen on figure 13. For line 7, which is the line between the bus 5 and 7, one can see that the exchanges are mainly from bus 7 to bus 5, but with big variations and some exchanges from bus 5 to 7. On the contrary for line 6 which is the one between bus 5 and 6, the line that feeds the hydrogen factory, the exchanges are always in the direction from bus 5 to bus 6 and with much less variations due to the needs of the electrolyzer. Figure 14 shows the wind production at bus 5 and 8. In both cases, the production pattern is similar. However at bus 8, the gap between 4000 and 5000 hours seems less prominent, but there is still seasonal variations in the productions. The patterns of those seasonal variations are not exactly the same but overall the production is higher in the winter, autumn and spring months than in the summer months. The curtailment of the wind production for the same buses is shown on figure 15. The curtailment is limited, especially for bus 5. Those curtailment could be avoided by upgrading even more the grid than just upgrading the grid in order to avoid rationing but this would probably not be economically optimal.

The curtailment are limited overall, with 569MWh at bus 1, 4854MWh at bus 5, 846MWh at bus 8 and 707MWh at bus 9 for a total of 6975MWh. They represent less than 1% of

the production except for bus 1 where it represents around 2%. The overall percentage of the production is 0.5% which is a good result.

This short part, described the system in the configuration that would currently be preferred if the factory was to be built now,i.e. with 10% of the hydrogen coming from electrolysis. The next part are going to focus on different aspect diverging from this solution by looking at other options.

## 4 Increasing the Proportion of Hydrogen from Electrolysis

The hydrogen production facilities has two means of producing hydrogen. The first one is to use the gas reforming and the second one is from the electrolyzer. In the reference case, the electrolysis only accounts for 10% of the global hydrogen production from the production plant. This case was studied by Espen Bødal in an article[7]. In this part we will study the impact of increasing the share of the hydrogen production coming from the electrolyzer on the electrical grid and on the optimal investment in wind, and on the electrolyzer and hydrogen storage.

For each case, simulations were run in an iterative process. For example for the case of 10 % of the hydrogen coming from the electrolyzer, we started the optimization with the existing grid. We then obtained a result optimization that was constrained and had a lot of rationing due to the grid. These rationing were impossible to reduce by themselves in the model, they were found as the most economic solution even though really expansive. We then "upgraded" the lines by increasing their capacity and reducing their reactance accordingly. It was done by analyzing the results of the previous optimization; looking at the buses where rationing occurred and the utilization of the lines it was possible to assess the need for upgrades. We then repeated this process until there was no more rationing. Once done, it was possible to go on to the next case using the final grid of the previous case as a start.

While performing the iterative process, something that was recurrent is the pattern that was needed to upgrade the grid. The first need for upgrade was in the area of the plant and in the area with high wind potential. And in the next run, it would then be necessary to upgrade the connection with the national grid.

The cost of the grid upgrade is not included in this part of the study.

Case	Bus 0	Bus 1	Bus 2	Bus 3	Bus 4	Bus 5	Bus 6	Bus 7	Bus 8	Bus 9
initial	0	0	0	0	0	40.5	0	0	40	95
0%	0	7.11	0	0	0	200.5	0	0	40	171.69
10%	0	10	0	0	0	200.5	10	0	40	229.82
20%	0	10	0	0	0	200.5	10	0	40	319.69
30%	0	10	0	0	0	200.5	10	0	40	418.92
40%	0	10	0	0	0	200.5	10	0	68.23	517.97
50%	0	10	0	0	0	200.5	10	0	424.35	548
60%	0	10	0	0	0	200.5	10	0	765.01	548
70%	0	10	0	0	0	200.5	10	0	1590.0	548
potential	0	30	0	0	0	480	30	0	4650	1359

Table 2: Total installed wind power at each bus (MW)

Table 2 shows the investment that was found optimal by the program in each hydrogen production case. Between the initial case and the case 0% some investment was made by the program. It is interesting to notice it because the grid is exactly the same in those cases. It means that even right now it would be profitable to invest at least this

much in wind power. For the other results it can be difficult to assess that because the grid was also modified. After this first investment, the investment in wind power was limited at bus 9 until the case 40% when it starts back at bus 8. After that the investment is focused at that bus and stops at bus 9. At bus 1, 5 and 6, the investment happens in the first case and does not change for the cases with a higher load and bigger grids. It suggest that those investment are profitable for exchanging power through the market. The investments at bus 8 and 9 represent investments that feed the bus 6, its own potential for wind power being limited. In none of the buses is the limit for investment reached but all buses where investment was possible got at least a little investment.

The curtailment can also be analyzed. It is presented by a percentage. This percentage represents how much the curtailment is compared to the actual production. For example if the actual production from wind at one bus is 100MWh for the year that is optimized and the percentage is 10%. It means that there is 100MWh of energy produced from the wind plus 10MWh that could have been produced but have been curtailed.

Case	Bus 1	Bus 5	Bus 6	Bus 8	Bus 9	Total
0%	1,93	0,813	0	0	0	0,419
10%	1,93	0,813	0	0,71	0,1	0,486
20%	1,93	0,813	0,813	2,71	0,29	0,67
30%	1,93	0,813	0,813	10,15	0,92	1,4
40%	1,93	0,813	0,813	11,3	3,43	3,33
50%	1,93	0,813	0,813	17	12,57	11,7
60%	1,93	0,813	0,813	22	28	20,4
70%	1,93	0,813	0,813	92	57,5	69,2

Table 3: Curtailed wind power at each bus in percentage of the actual production (%)

Until the case 60%, the curtailments are alright. Having to curtail 10% is a loss of energy but still ok. However for the case 60 and 70% the curtailment starts to skyrocket. This is true especially for bus 8 and 9, which concentrate most of the investment in wind power, and thus lead to a lot of curtailment in overall. The production could be increased by 70% in the last case.

This curtailment is due to the lines. They are upgraded manually in order to not have any rationing, but in this case they are not big enough to be able to transfer the production in extreme cases.

The line were upgraded, as mentioned before, in order to have zero rationing. The evolution of the lines between the different cases can be seen on figure 16. The lines are named after the buses they connect, for instance the line connected the bus 3 and 4 is called line 3-4.

On figure 16, one can notice several things. Lines 3-4 and 4-7 are almost not changed whatever the case. That can be understood by taking another look at figure 11, there we can see that those lines are a parallel path to lines 3-5 and 5-7. Moreover the latter lines are the one that are more stressed due to the fact that they give access to the line serving bus 6 where the major load is located. In this situation, line 3-4 and 4-7 are just needed to feed the local load at theses buses.

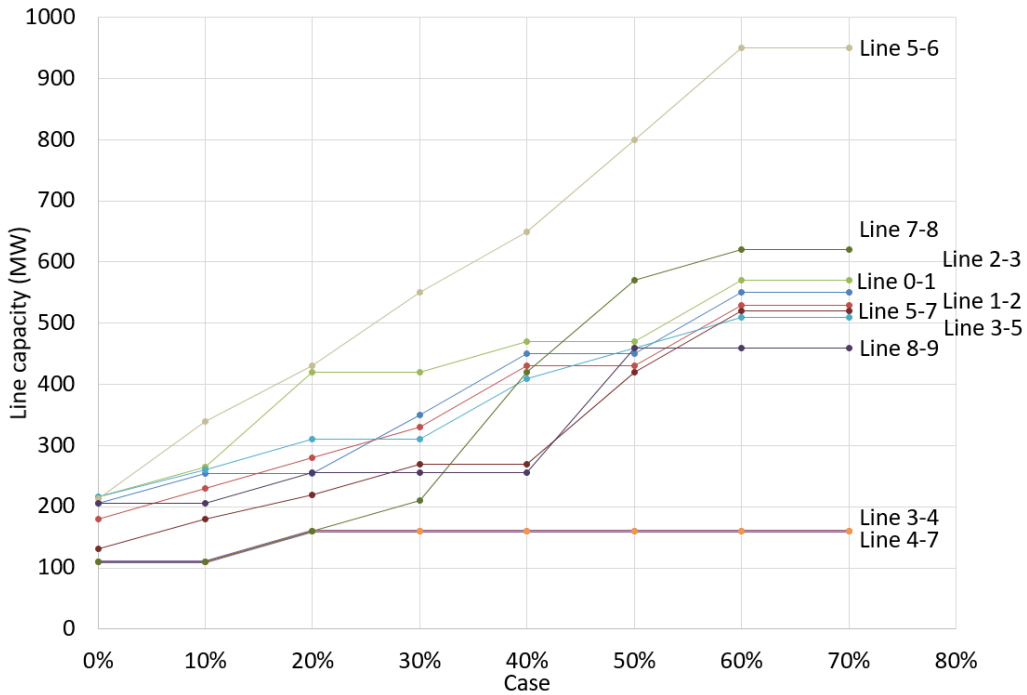

Figure 16: Evolution of the lines capacity in the different hydrogen production cases

Line 5-6 is upgraded in an almost linear way; this line feeds the electrolyzer so it is normal that with the increasing hydrogen production asked, the size of the electrolyzer needed increases and the lines needs to be increased as well. Line 0-1, 2-3, 1-2, 5-7, 3-5 and 8-9 often are around the same size but their evolution is not the same throughout. Lines 0-1, 1-2 and 2-3 have a close evolution except for the case 20% when line 2-3 is developed more; it is caught up in the following cases. Line 3-5 also follows this evolution. However, line 5-7, 7-8 and 8-9 have a slightly different evolution. After the case 30% the size of those lines starts to increase faster, it corresponds to the investment in wind power at bus 8.

A table (table 24) with the different utilization factors of each line can be found in the appendix (11.7).

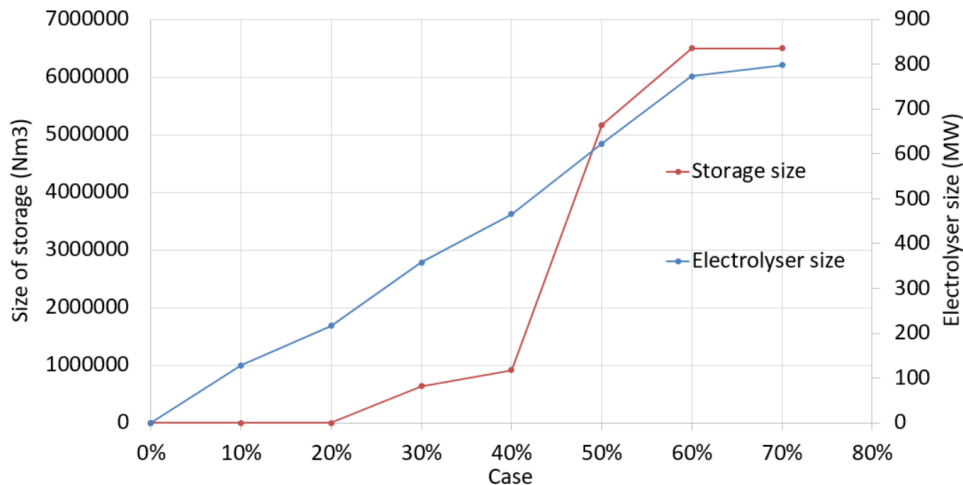

Figure 17: Storage size and electrolyser size in the different hydrogen production cases

On figure 17, the electrolyzer size and the storage size that was invested in by the optimization program can be seen. The electrolyzer size is quite linear. With the need of more hydrogen production from electrolysis, the size of the electrolyzer is increased as well. The storage size evolution is different, it stays zero for the first cases before having a small storage for the cases 30% and 40%. The storage size then increases greatly in the case 50% and above.

The cost of hydrogen is calculated as well in order to compare the different cases. To calculate it, the investment cost in the hydrogen unit and in the storage is added to the cost of electricity used in the electrolysis process. The cost related to electricity is calculated in two ways, a spot calculation and a nodal calculation. The spot method use the spot price from nordpool spot (same value as for the market) as a price for electricity while the nodal method use the dual value of the energy balance constraint as a price for electricity. The latter method takes into account the production of wind power and, in general, the modifications to the system that are not taken into account simply by prices data from previous years.

Method	Case 10%	Case 20%	Case 30%	Case 40%	Case 50%	Case 60%	Case 70%
Spot	0.1417	0.1417	0.1482	0.1475	0.1608	0.1624	0.1566
Nodal	0.152	0.1634	0.2338	0.413	0.7614	0.8883	3051.3782

Table 4: Hydrogen cost ( $\text{€}/Nm^3$ )

The first comment that can be made is that in the case of the price being independent to the load and the changes in the system, the spot case, the price is much lower than in the other case as we could expect. Indeed, the load addition, even though it is compensated by the wind investment, still creates tension in the grid, as can be seen on the increased utilization factors. The price being dependent on the electrolyzer investment and the electrolyzer size varying almost linearly it is normal to find an evolution that is quite linear. There is an exception to this between cases 40% and 50% because the cost depends also on the storage size and a big investment happens for this case.

The case 70% is particular. It is done with the same grid as the case 60% and therefore has electrical rationing that explains the gigantic cost.

The different aspects of increasing the production have been seen and additional figures regarding this part can also be found in the appendix. To increase the share of electrolysis in the hydrogen production requires to expand the grid and can lead to major investment in storage in the extreme cases but is also the way of really increasing the investment in wind power.

## 5 Introduction of Solar Power in the System

While it may seem strange to study the inclusion of solar power in north Norway due to the low insolation overall. The fact that the insolation in the summer months is all day long makes it an interesting topic to look into. Indeed solar in addition to wind could have beneficial effects on the overall system and that is what we are interested in in this section.

In order to study this, the optimization formulation needs to be reformulated. We now consider the same system but with the possibility of investing in solar power at the different buses (except the market bus). The new objective function is the following:

$$\begin{aligned} \max \left\{ -\frac{T}{8760} \left[ \sum_{i \in \mathcal{W}} C_i^w w_i^{exp} + \sum_{i \in \mathcal{H}_2} C_i^e e_i^{max} + \sum_{i \in \mathcal{H}_2} C_i^s h_i^{exp} + \sum_{i \in \mathcal{N}} C_i^{sol} s_i^{exp} \right] + \right. \\ \left. \sum_{t \in \mathcal{T}} \left[ \lambda^s p_{t,0}^{imp} - (\lambda^s + \delta) p_{t,0}^{exp} - \sum_{i \in \mathcal{N}} C^r r_{t,i} - \sum_{i \in \mathcal{H}_2} C^i h_{t,i}^i \right] - \sum_{i \in \mathcal{H}} (C^{v+} v_i^+ + C^{v-} v_i^-) \right\} \quad (28) \end{aligned}$$

The energy balance constraint (equation 9) is modified and becomes:

$$w_{t,i} + q_{t,i} + s_{t,i} - \eta^d h_{t,i}^d - \eta^s h_{t,i}^p - p_{t,i}^{exp} + p_{t,i}^{imp} + r_{t,i} = D_{t,i} \quad (29)$$

New constraints related to the solar are included:

$$\begin{aligned} \text{Solar production equation: } s_{t,i} + s_{t,i}^{curt} = S_{t,i} s_i^{exp} \alpha_i^{sol} (\eta_i^{sol} + \alpha^{temp} K_{t,i}) \eta^{dc/ac} \\ \forall i \in \mathcal{N}, \forall t \in \mathcal{T} \quad (30) \end{aligned}$$

$$\text{Solar production limit: } s_{t,i} \leq s_i^{exp} \quad \forall i \in \mathcal{N}, \forall t \in \mathcal{T} \quad (31)$$

$$\text{Solar area limit: } s_i^{exp} \leq \frac{A^{max}}{\alpha_i^{sol}} \quad \forall i \in \mathcal{N} \quad (32)$$

For the value of the different parameters of the solar panel we use the value of commercially available solar panels from SunPower<sup>17</sup>. We choose an efficiency of 16.5% and a temperature coefficient of -0,37%/K. The area factor is chosen to 7,5 m<sup>2</sup>/kW according to a report by IRENA.[17] This value is a bit higher than what we can find on the data sheet from SunPower. The area limit is set arbitrarily to 100km<sup>2</sup>, as an upper boundary for investment.

The production from solar is modelled as follows; the sum of the solar production and curtailment is equal to the insolation received in the area for the time step multiplied by the amount of installed solar power and by the efficiency of the solar panel (depending on the temperature at the time step) and also including a factor for the conversion from dc to ac. The area that the solar pane takes is limited in order to not have too high surfaces covered in solar.

The initial investment cost for solar power used is 3,8\$/W converted to euro, it corresponds to a value for utility scale crystalline silicon panel for 2010 given in the IRENA

<sup>17</sup><https://us.sunpower.com/sites/sunpower/files/media-library/data-sheets/ds-sunpower-p17-355-commercial-solar-panels.pdf>

report on photovoltaic from 2012.[17] To use this value in the optimization procedure we need to annualize it. We do it via a 4% discount rate and 25 years of lifetime. The lifetime chosen corresponds to the warranty duration offered by SunPower, the actual duration of solar panel might be higher.

Several ways of obtaining insolation data have been tried. In order to have values corresponding exactly to the location and thus taking into account potential smoothing effects, satellite data have been considered. The satellite data were obtained from a NASA service online and gave daily average insolation for around 30 years. These daily averages were averaged in order to have daily insolation for an average year for each buses. These values were then correlated to the day length at each bus during the year and coupled with a simplified model of the evolution of the sun insolation during a day to have hourly values for an average year. However after comparing these values with values from measuring stations, this solution was assessed to not be precise enough. The problem might be errors while handling the values or could also come from the climate effect that is not taken into account in the satellite data. The simulation consequently uses directly values coming from one measuring station, no matter which bus. This solution has both advantages and disadvantages. On the one hand, the smoothing that could have occurred due to the different location can not be assessed and the differences in insolation due to latitude are neglected. But on the other hand, the data is more precise and takes into account the variations due to weather. The data also comes from multiple years and have been aggregated to be insolation data of an average year. The measured data can be found on this website<sup>18</sup>. The insolation data used can be seen on the heat map on the figure below. It allows to visualize the seasonality of the solar resource. It shows in particular, the winter months without any insolation and the summer time with insolation all day long as well as the transition period. It's not perfectly linear due to the day to day variations due to the weather.

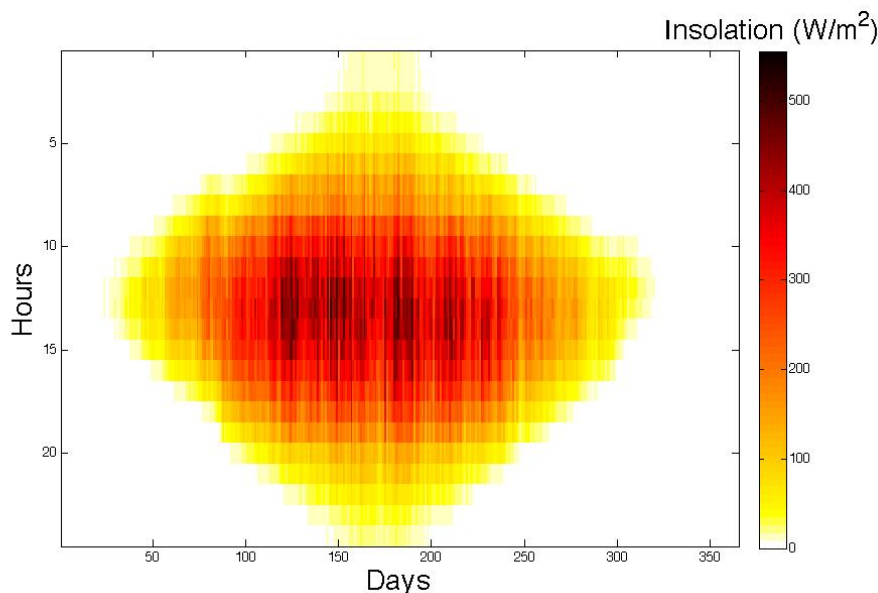

Figure 18: Heat map of the insolation in the year

We run this optimization for the different hydrogen production cases from electrolysis

<sup>18</sup><http://lmt.bioforsk.no/>



with the same grid expansion as for the previous part.

Case	Bus 0	Bus 1	Bus 2	Bus 3	Bus 4	Bus 5	Bus 6	Bus 7	Bus 8	Bus 9
0%	0	7.11	0	0	0	200.5	0	0	40	171.69
10%	0	10	0	0	0	200.5	10	0	40	229.82
20%	0	10	0	0	0	200.5	10	0	40	319.69
30%	0	10	0	0	0	200.5	10	0	40	418.92
40%	0	10	0	0	0	200.5	10	0	68.23	517.97
50%	0	10	0	0	0	200.5	10	0	407.8	548
60%	0	10	0	0	0	200.5	10	0	534.61	548

Table 5: Total installed wind power at each bus for the solar case (MW)

Case	Bus 0	Bus 1	Bus 2	Bus 3	Bus 4	Bus 5	Bus 6	Bus 7	Bus 8	Bus 9
0%	0	0	0	0	0	0	0	0	0	0
10%	0	0	0	0	0	0	0	0	0	0
20%	0	0	0	0	0	0	0	0	0	0
30%	0	0	0	0	0	0	0	0	0	0
40%	0	0	0	0	0	0	0	0	0	0
50%	0	0	0	0	0	0	28.22	0	0	0
60%	0	0	0	0	0	0	62.64	0	0	0

Table 6: Total installed solar power at each bus for the solar case (MW)

Tables 5 and 6 show us that the optimization resulted in the solar power configuration and cost given to turn out unprofitable in most cases. It did however appear in the cases that have the highest demand for hydrogen: cases 50% and 60%. In those cases the investment in wind power was reduced and it was replaced by an investment in solar power. In the case without any solar investment, the system is the same as for the case seen in the previous part with only wind. For the case 50% the investment in wind was reduced by 15.5MW at bus 8 and replaced by 28.22MW of solar at bus 6; for the case 60% the investment was reduced by 230,4MW and was replaced by 62,64MW of solar at bus 6.

The electrolyzer size for those cases are practically the same as before, with an increase of less than 10MW in the solar 50 and 60% cases. The storage size behaved differently and benefited from the introduction of solar as can be seen on figure 19.

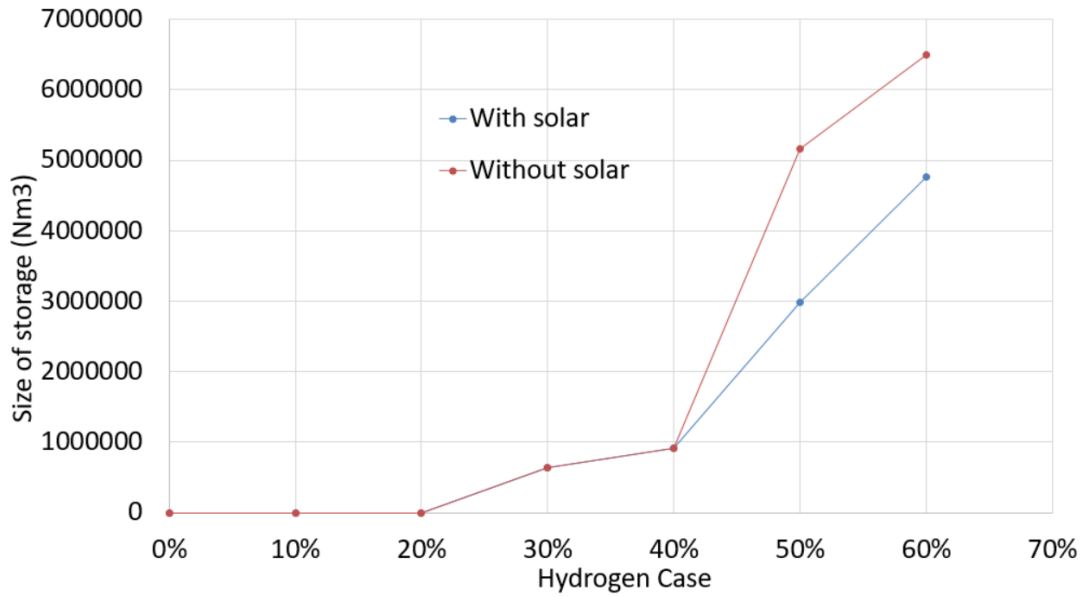

Figure 19: Storage size in the cases with and without solar investment possibility

This limited investment in solar in those cases reduced greatly the size of the storage. This also directly impacts the resulting cost of hydrogen (table 7).

Case	Without solar possibility	With solar possibility
50% spot	0.1608	0.1557
50% nodal	0.7614	0.6963
60% spot	0.1624	0.1596
60% nodal	0.8883	0.6336

Table 7: Hydrogen price for the different cases ( $\text{€}/Nm^3$ )

The price difference is particularly evident in the nodal calculation (table 7), highlighting the decrease in the price of energy in the area of the system after the introduction of solar.

Let's take a look at what results in a reduction of the needed storage size. The wind power production and curtailment at bus 8 and 9 can first be analyzed before and after the introduction of solar power in the case of 50 and 60% of hydrogen production from electrolysis.

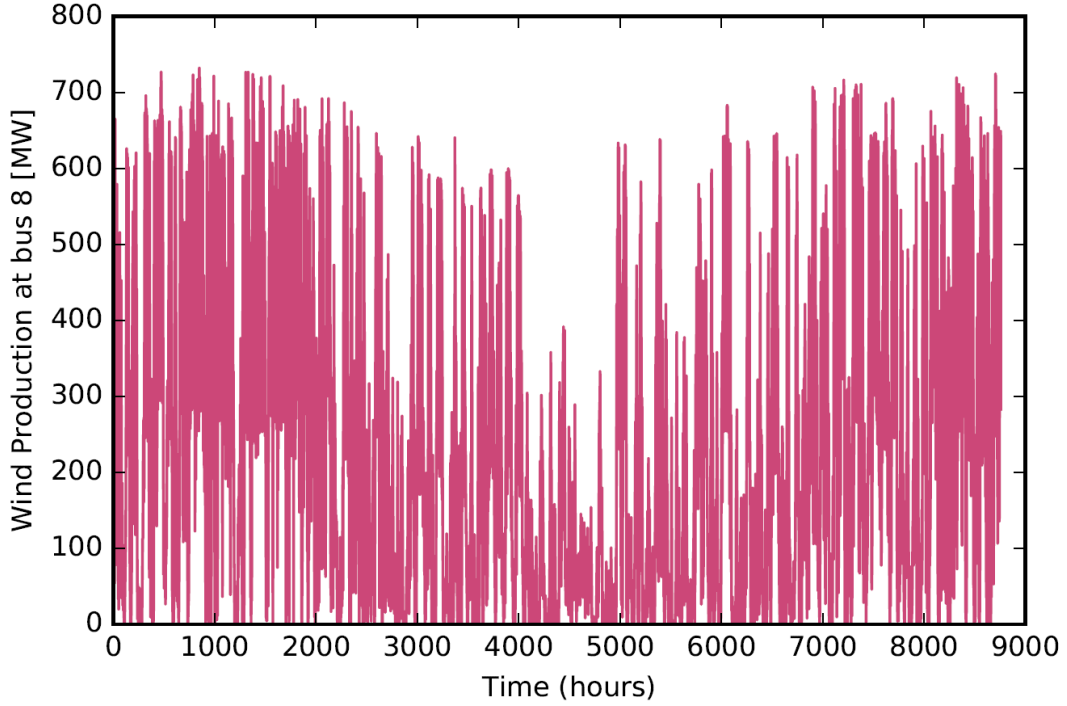

Figure 20: Wind power production at bus 8, case 60%

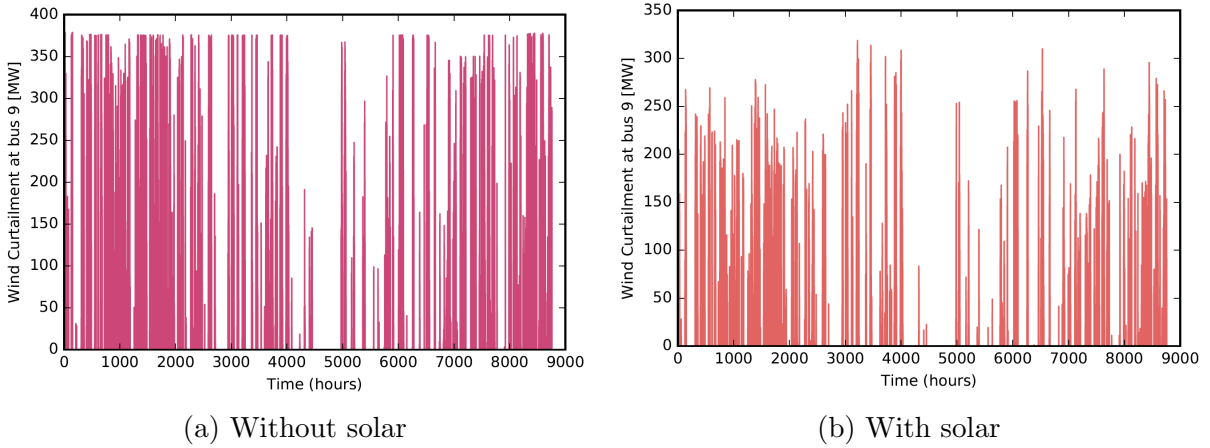

Figure 21: Curtailment at bus 9 with and without solar, case 60%

From figure 20 one can notice that the production is varying during the year and in a particular way. The variations are seasonal, in the winter months, the production is higher and decreases during the summer months, both in the average value and peak value. One can clearly see for example between hours 4000 and 5000, the gap in production compared with other time in the year. This can also be seen on the curtailment (figure 21), where the gap is also clearly defined. From these figures, one can also notice that the introduction of solar in the system reduced the wind curtailment and not only due to the reduction in the wind farm size.

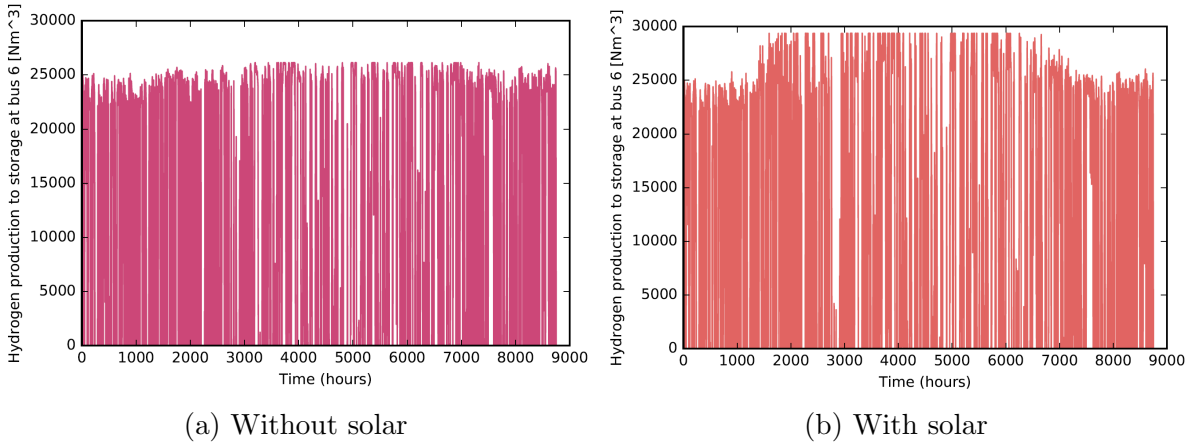

Figure 22: Hydrogen production to storage with and without solar, case 60%

Figure 22 shows the production from hydrogen that goes in the storage. The difference between the case with and without solar is clear. In the summer months, more hydrogen is sent to the storage in the case of solar productions. This can be understood by looking at figure 23, where the production from solar is shown.

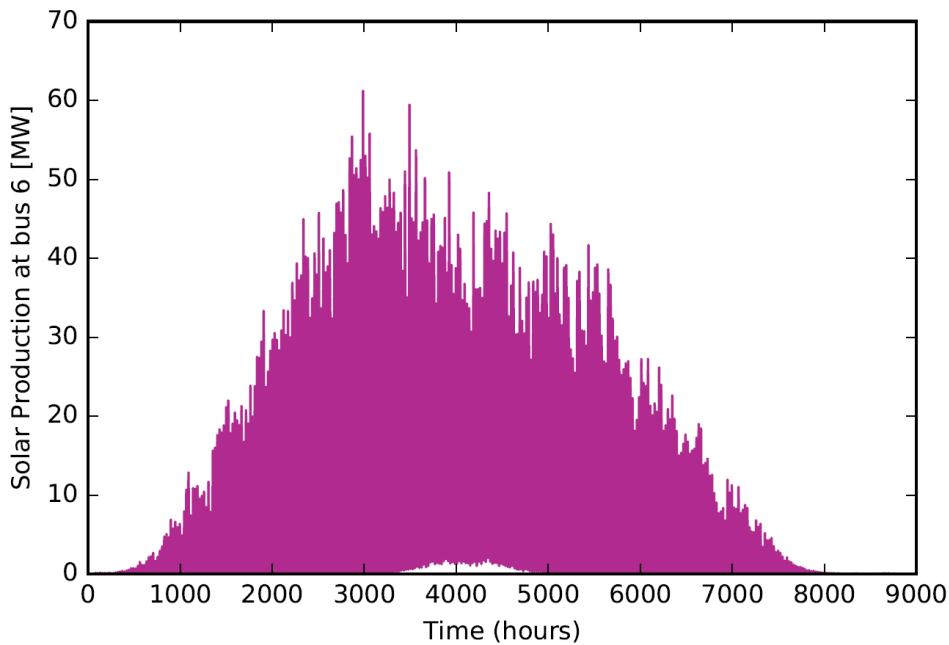

Figure 23: Solar power production at bus 6, case 60%

It can be seen that the production is very seasonal due to the specific solar conditions of high latitude like in the north of Norway. During the winter months, no production happens at all while it increases at the end of winter and in spring to reach the peak production at the end of spring, it then decreases in summer and autumns. This seasonal evolution can be compared to the wind production seasonal evolution. For the wind, the summer months are characterized by lower winds than in the rest of the year; while in winter spring and autumn, the production is still quite substantial. Those seasonal variations while not being perfectly inverted, still allows for the solar to compensate a little for the lack of wind in summer months.

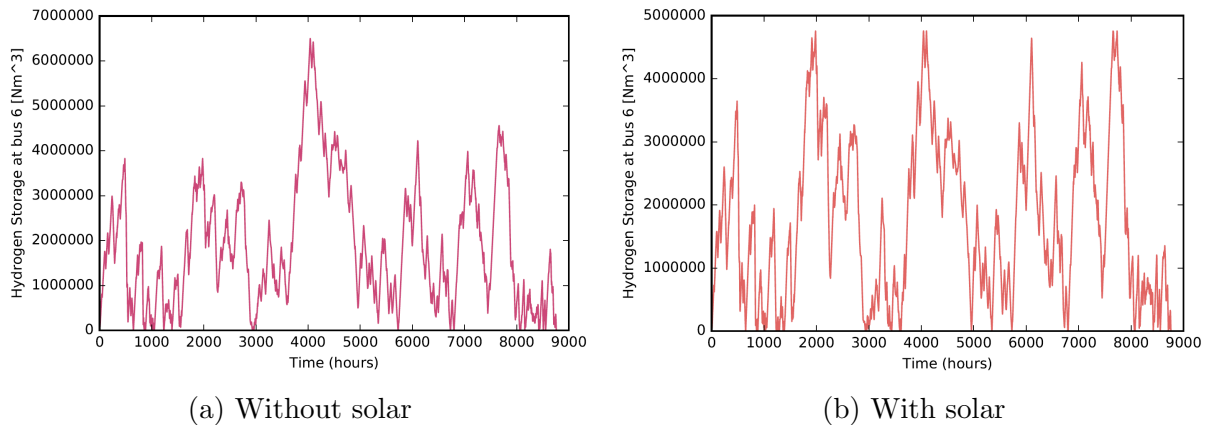

Figure 24: Hydrogen storage evolution with and without solar, case 60%

This result in what can be seen on figure 24. The additional power from solar in spring and summer, results in more available power to produce and feed the storage. In return it is possible to reduce the peak that happened in the case without solar and that was there to anticipate the consequence of the low wind. It results in a system and a hydrogen storage without a major peak and with quite higher utilization factor of the storage. The peak at around hour 400 that was at  $6,5 \cdot 10^6$  is now only below  $5 \cdot 10^6$ .

To summarize, in the case without solar, the system is facing summer months with low wind production; to counterbalance that, it invests more in wind so that in the months before it can store hydrogen. By adding solar, this anticipation is not needed anymore, the wind power needed is reduced and partly replaced by solar power that makes up for the production in the summer months and thus also reduce the storage needed.

We can then wonder why this solution is not adopted for the cases with less hydrogen production needed such as the case with 10% hydrogen production from electrolysis. Indeed those effect and consequences of introducing solar in the system should also exist in the other hydrogen cases. For the case 10%, no storage was present in the system so this effect can't take place, the grid can provide the energy missing in the summer time. For the case 30% however the difference might be visible since there is a storage. However, there is still no difference, this is probably due to the cost. While the solar solution could be used to reduce the storage size, the optimization finds it a more economically profitable solution to invest more in wind. The difference in outcome to the optimization between the cases 30 and 40% and 50 and 60% might be because of the difference in the size of the storage, making the gain you would have for reducing the already limited storage size not important enough to cover the cost of the introduction of solar.

Let's also take a look at the curtailment.

Case	Bus 1	Bus 5	Bus 6	Bus 8	Bus 9	Total
0%	1,93	0,813	0	0	0	0,419
10%	1,93	0,813	0	0,61	0,12	0,48
20%	1,93	0,813	0,813	2,62	0,30	0,67
30%	1,93	0,813	0,813	10,79	0,87	1,4
40%	1,93	0,813	0,813	10,7	3,507	3,33
50%	1,93	0,813	0,813	15,73	10,93	10,45
60%	1,93	0,813	0,813	10,86	10,05	8,7

Table 8: Curtailed wind power at each bus in percentage of the actual production for the solar case (%)

As seen above, the wind power that was chosen in this case by the optimization is lower than in the case without solar at bus 8 and 9. The line being the same, it is normal to see that the curtailment are now lower. In the case without solar for 50 and 60% hydrogen from electrolysis, the curtailment from wind power were really high, but with solar they are normal. This effect is, as the reduction of storage size, positive for the system.

In this part, the addition of the possibility to have investment in solar was added and the results shows that the investment cost is too high considering the insolation to have investment for most cases. However when there is solar investment it reduces the size of the storage as a bonus effect. The investment cost necessary to have more solar is studied in the next part.

## 6 Study of Different Price Scenario

After that the case of introducing solar in the system was studied, it is interesting to study how these results change in the case of different prices for the solar panels. In the previous section, the price for solar panel was set at 3,8\$/W corresponding to a 2010 price cited in an IRENA report from 2012 [1]. The annualized price converted to euro is then 0,223231€/W with a 4% discount rate a 25 years lifetime and a euro-dollar conversion of 0.91772 €/\$. The case scenario of 10% hydrogen production from electrolysis is used. The prices was decreased with steps of different size until an unrealistic price of zero was reached. Other studies regarding the price have also been performed: at a given investment cost for the different hydrogen loading case. The price will be presented in US dollars to have more convenient values.

In the dummy case of an investment price of 0, the investment is done as expected. The solar power is invested at a maximum everywhere and the wind power has no investment.

Investment Cost	Bus 1	Bus 5	Bus 6	Bus 8	Bus 9
0.225 ( \$/W.yr)	10	200.5	0	40	229.82
⋮	⋮	⋮	⋮	⋮	⋮
0.03 (\$/W.yr)	10	200.5	0	40	229.82
0.025 (\$/W.yr)	10	200.5	0	40	217.65
0.02 (\$/W.yr)	0	200.5	0	40	183.91
0.015 (\$/W.yr)	0	200.5	0	40	127.68
0.01 (\$/W.yr)	0	200.5	0	40	95
0.005 (\$/W.yr)	0	138.2	0	40	95

Table 9: Total installed wind power at each bus for the study of solar investment price (MW)

Investment Cost	Bus 1	Bus 3	Bus 5	Bus 6	Bus 7
0.225 (\$/W.yr)	0	0	0	0	0
⋮	⋮	⋮	⋮	⋮	⋮
0.03 (\$/W.yr)	0	0	0	0	0
0.025 (\$/W.yr)	0	188.7	106.5	0	0
0.02 (\$/W.yr)	118.3	400.3	251.0	0	0
0.015 (\$/W.yr)	153.5	496.7	416.07	0	0
0.01 (\$/W.yr)	194.6	613.9	266.1	277.25	70.73
0.005 (\$/W.yr)	276.7	1093.6	113.7	569.11	259.62

Table 10: Total installed solar power at each bus for the study of solar investment price (MW)

In tables 9 and 10, the result of the optimization in terms of investment for solar and wind is shown. The wind power stays globally the same except for the case of bus 9 where it decreases significantly for low prices. The investment in solar is however much higher than the decrease of solar for those same prices. Another important aspect is the

way the investment happens. With solar and the way we modeled it, all buses have the same capacity and solar resources. It allows the optimization to balance the amount of solar power at each bus according to the grid constraints in a more efficient way than the limited capacities of wind does. It is however done without taking into account the differences in solar radiation at the different bus because of the data we used. In the case of 10% hydrogen production from electrolysis, the solar becomes viable only for really low investment costs. We can compare these investment costs with different studies on the expected evolution of the price of photovoltaics. The first study has been cited before and was produced by IRENA [17], it highlights investment cost of 5,59\$/Wp in 2010, 3,85\$/Wp in 2015 and 2,65\$/Wp in 2020 (which gives respectively annualized in our case: 0,358\$/Wp.yr, 0,2464\$/Wp.yr and 0,1696\$/Wp.yr). With those prices and even in 2020 the investment in solar would still be unviable by almost a factor 10. In "Current and future cost of photovoltaics", a study done by the Fraunhofer institute[26], the evolution of investment cost over the years is presented on figure 19 page 29. The investment costs presented there are overall inferior to the ones from the IRENA study, with for example 1,9€/Wp in 2010 and 0.7€/Wp in 2014. Those price while still being too high for solar investment are closer to the break even cost of solar. They are too high by a factor 2 "only". In addition, this study looks into the expected cost of photovoltaics in 2050 as well. The price range is then between 0,61 and 0,28€/Wp (which gives 0,0368 and 0,0169€/Wp.yr). If the costs reduction turns out to be as expected in this study, the use of solar in the system in 2050 could be viable. Another important point is that the investment cost of solar panel for 2015 (not an expected one, but the one they found at the time of the Fraunhofer report) is around 1,6€/Wp (around 0.11\$/W.yr converted in dollar and annualized), this price is also considered in the e-Highway European project.[35] The price is more than half the price we used in the previous studies. The results obtained before still stands and this price is still too high for solar investment but it would happen for a lower hydrogen case than previously.

The price of hydrogen resulting of the different solar investment cost scenarios in the case of 10% hydrogen coming from electrolysis is shown on figure 25.

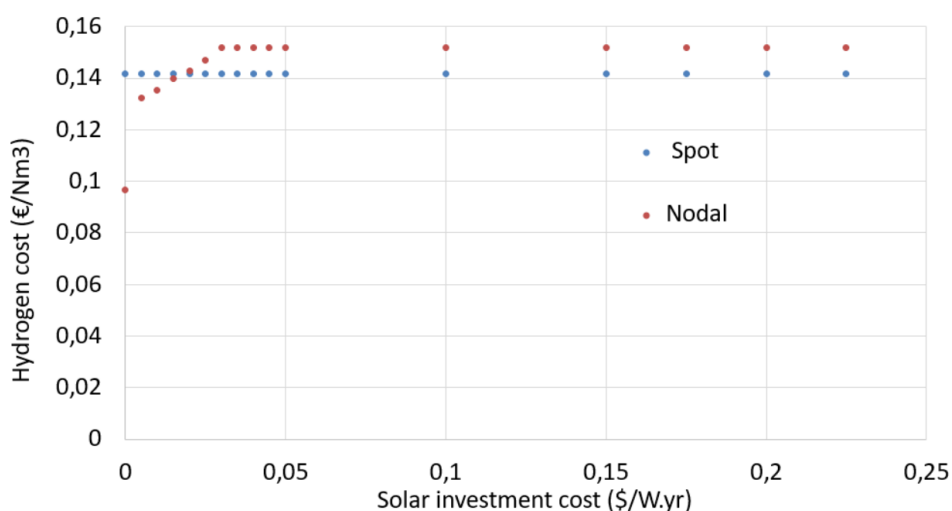

Figure 25: Hydrogen cost as a function of the investment cost of solar power for the case 10%

Those prices consider the investment cost for the electrolyzer and storage as well as the



cost of electricity used by the electrolyzer; in the spot calculation, the electricity price used is the cost at the market while in the nodal method the price is the one from the dual value from the production constraint. The cost for hydrogen stays the same in the spot cost calculation because the investment in the electrical system is not accounted for in this calculation and here the size of both the electrolyzer and storage doesn't change and the spot price for electricity is an input to the simulation. In the nodal method the cost is decreasing when the cost of solar power is reduced, because the nodal cost of electricity is a result of the optimization problem and reflects the dual value of the constraints for each bus.

Another study was then performed to analyze different price scenario for each hydrogen loading case. The prices that were studied were 0,1\$/Wp.yr, 0,05\$/Wp.yr and 0,02\$/Wp.yr. It covers different costs that have been studied in the case of 10% production from electrolysis; with both costs that were not resulting in any hydrogen investment and costs that gave some investments.

	Bus 6			Bus 8			Bus 9		
price case (\$/W.yr)	0,1	0,05	0,02	0,1	0,05	0,02	0,1	0,05	0,02
Case 0%	0	0	0	40	40	40	172	172	95
Case 10%	0	0	0	40	40	40	230	230	184
Case 20%	10	10	0	40	40	40	320	320	284
Case 30%	10	10	10	40	40	40	419	417	385
Case 40%	10	10	10	68	51	40	518	502	480
Case 50%	10	10	10	406	273	225	548	548	548
Case 60%	10	10	10	368	341	318	548	548	548

Table 11: Total installed wind power at each bus for different investment prices and hydrogen cases (MW)

	0,1(\$/W.yr)		0,05(\$/W.yr)		0,02(\$/W.yr)				
	Bus 6	Bus 7	Bus 6	Bus 7	Bus 1	Bus 2	Bus 3	Bus 5	Bus 6
Case 0%	0	0	0	40	155	0	335	51	0
Case 10%	0	0	0	40	118	0	400	251	0
Case 20%	0	0	0	40	6	322	174	61	349
Case 30%	0	0	7,3	40	90	0	205	0	939
Case 40%	0	0	63	68	92	0	384	0	1058
Case 50%	53	0	280	406	92	0	522	0	1056
Case 60%	122	68	193	368	98	0	464	295	1146

Table 12: Total installed solar power at each bus for different investment prices and hydrogen cases (MW)

In the tables above, only the buses that experiences changes are included.

price case (\$/W.yr)	Electrolyzer size			Storage size		
	0,1	0,05	0,02	0,1	0,05	0,02
Case 0%	0	0	0	0	0	0
Case 10%	108	108	108	0	0	0
Case 20%	216	216	216	0	0	0
Case 30%	357	356	350	633035	620814	475283
Case 40%	465	462	459	913483	738430	511124
Case 50%	621	614	609	2373864	1501548	1668515
Case 60%	773	762	745	2059113	1858156	1854218

Table 13: Electrolyzer and storage size for each price and hydrogen case

The reduction in the wind investment with the different price scenario are limited to the most demanding cases for bus 8 and doesn't represent a big reduction. The investment in solar, on the contrary, is happening in bus 7 even for the intermediary investment cost; the overall solar investment remains however limited and begins to be important only for the extreme hydrogen cases. In the low price scenario, a non-negligible investment is done in solar from the beginning that doesn't only replace some wind. It appears that in this cost case it is viable directly as is for the market. When the demand at bus 6 increases (higher hydrogen demand case) the solar investment appears at bus 6 and changes between the other buses to be relocated where it is needed according to the grid constraints specific to each case. For example, one can see that at bus 2 some solar appears in quite large amount but only in the case 20%. Looking at the grid expansion on figure 16, it can be seen that in the case 20% the line between bus 2 and 3 got a big upgrade, while the other lines in this area were upgraded in a less important way. This new transmission capacity allowed the investment in bus 2 to feed partially bus 1 and 3, reducing the investment there. The electrolyzer size is globally staying the same throughout the different costs cases, with little reduction in the most favorable case. The storage size is also decreasing as explained before. It is however important to notice that even small inclusion of solar allows to have significant reductions. In the case 40%, a 130MW solar investment result in a 19% reduction in storage size while an investment of 1534MW of solar results in a 44% reduction in storage size. The investment price going from 0,05 to 0,02\$/W.yr results in 12 times higher investment in solar and a 20 percentage point additional storage size reduction.

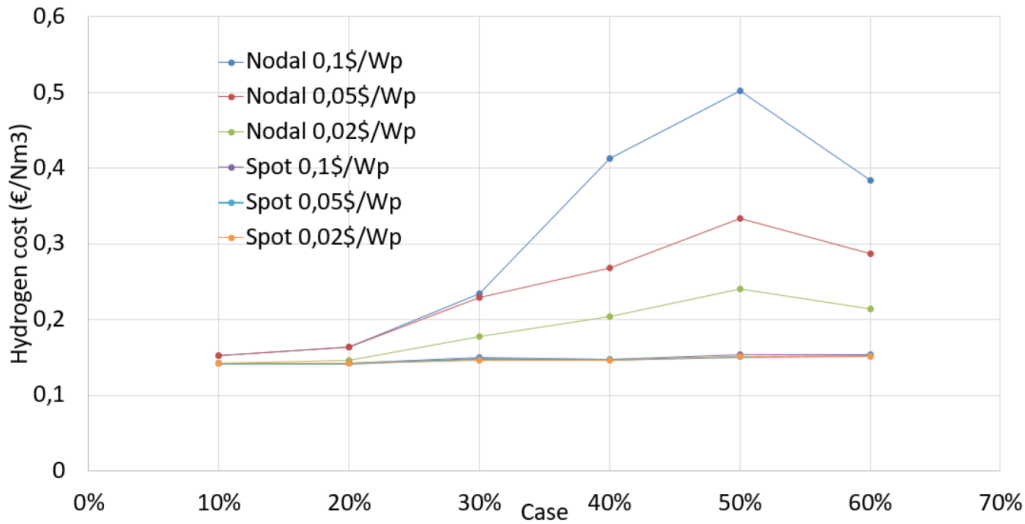

Figure 26: Evolution of the resulting cost of hydrogen in the different scenarios

On figure 26, the evolution of the resulting cost of hydrogen in the different cases is shown. When the investment cost for solar is reduced, the amount of solar in the system and the local price of electricity decreases, leading to a reduction in the hydrogen cost. The reduction in the storage size and the reduction in electricity cost brought by solar power leads to the decrease in hydrogen cost that happens for the case 60%. Overall the cost is increasing because of the constraints on the grid that appears while increasing the demand at bus 6 and are not compensated enough by upgrading the grid solely to have no rationing. The cost from the spot calculation isn't changing much due to the unchanged electricity cost in this method. It shows that the variations in electrolyzer size and storage size seems to be much less important in the hydrogen cost than the electricity.

One can also take a look at the changes in the curtailment of wind power and look at the curtailment of solar power in the different cases. The figure below shows the total curtailment for wind and solar for each cases. The detail can be found in the appendix (table 25).

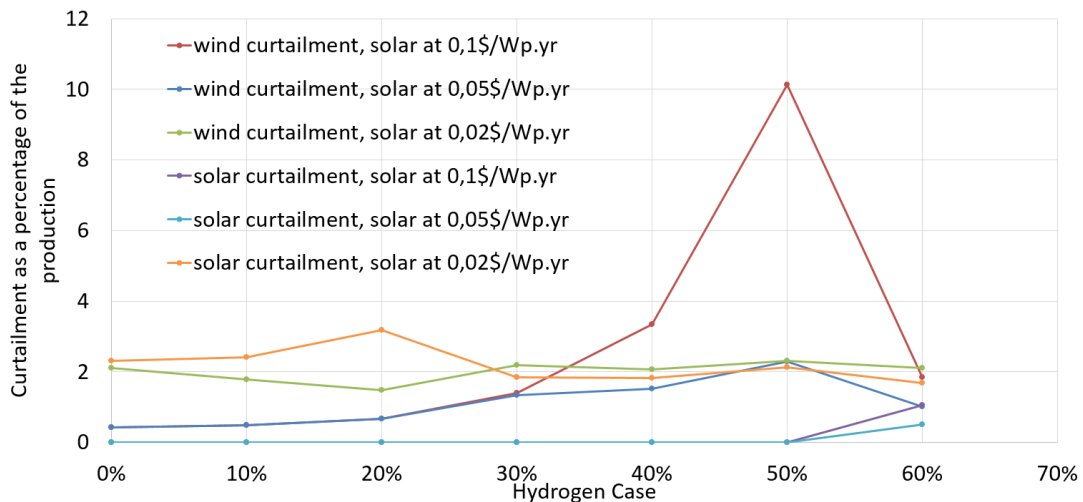

Figure 27: Evolution of the wind and solar curtailment in the different hydrogen cases

The curtailment for wind and solar are shown in table 25. The curtailment are expressed in percentage of the production in the same way as they were presented in section 4 and 5 (tables 3 and 8). The curtailments are of course the same when the solar costs is too high in order to add solar power in the system. Small differences appears in the table but are just artifacts; the case 20% for the first and second cost illustrates that. No solar has been added in this case but the curtailment is slightly different at bus 8 and 9. It is because the grid is not a limiting factors at certain moment when the rationing happen so curtailing at bus 8 or 9 is the same; the total curtailed mount remains unchanged.

When some solar is added, in the case of the first solar cost and 50-60% of hydrogen from electrolysis, the evolution of curtailment is not the same. When the first solar is added in the case 50% (introduction of 52MW of solar, no reduction of wind power), the curtailment amount is almost the same. When the solar is increased more (190MW in the case 60%) the curtailment is in that case greatly reduced, going from 20,4% to only 2%. The addition of solar makes the system more efficient. The solar curtailment is limited as well.

In the cases with lower solar cost, the wind curtailment remains lowered, due to the decrease of the amount of wind power installed, and the amount of solar energy curtailed stays low in spite of the increase in solar capacity. The lower curtailment from solar can partly be explained by the distribution in the grid of the solar power, balancing grid constraints.

Despite being currently too expensive in those scenario, introducing solar power in the system proves to be beneficial in terms of size of storage, "spillage" of renewable resources through curtailment and grid balancing. In the future, if the price scenarios for the costs of photovoltaics turn out to be correct and if the wish is to increase the share of hydrogen produced by electrolysis, including solar would become both an economically viable and technically better solution.

In the case 30% with the lowest solar investment cost, there is both wind and solar power at bus 1. It can then be interesting to look at some more detailed results there.

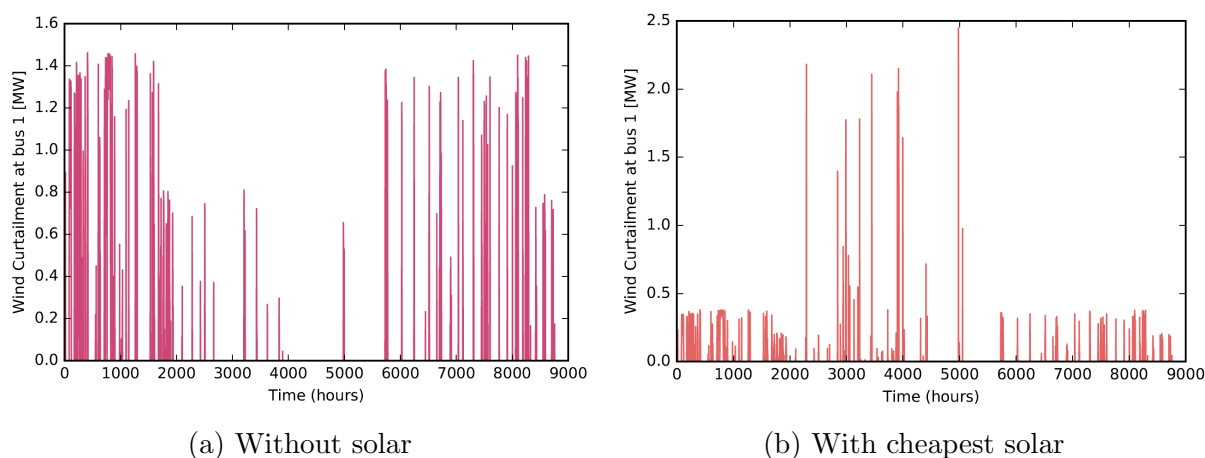

Figure 28: Wind power curtailment at bus 1, case 30%

The curtailment profile changes radically between the case without solar and the case

where the price allows a lot of investment. Let's repeat the state of the system for both cases here. The case without solar has 10MW of wind power at bus 1 and a total of around 700MW wind power in the system. In the case with solar at a low price, there is only 2,6MW of solar at bus 1 and 640MW total; there is also 90 MW of solar at bus 1 and 1200MW total.

In the case without solar, the curtailment peaks at around 1,4MW out of 10 whereas in the case with, some peaks reaches 2,5 out of 2,6MW. The peaks are relatively more important in the case with solar, but they are also fewer large peaks. The large peaks are only located during some hours in spring and summer. The curtailment outside summer in both case are of the relatively same importance (around 20%) compared with the amount of wind power at the bus. It means that the solar, even though it looks like the situation improved with lower curtailment most of the time, is not making the situation better, the improvement is only due to the reduction in the amount of wind power.

Looking at a bus without solar installed to see how the curtailment profile is affected is also interesting. Bus 9 is a good candidate for this because it has a lot of wind power and has no solar power with the closest solar installation being at bus 6, where a large amount of solar is located.

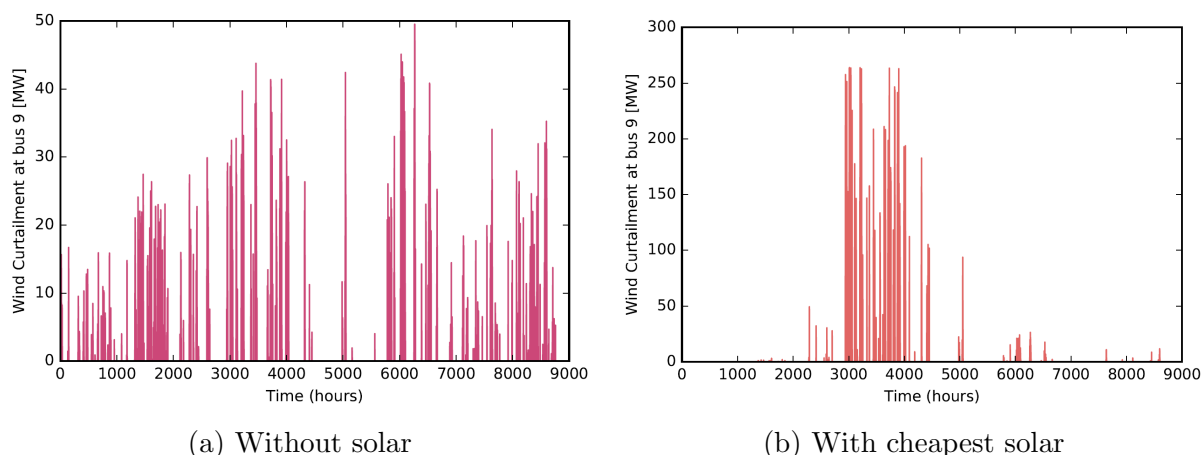

Figure 29: Wind power curtailment at bus 1, case 30%

The profile is different at this bus, the curtailment without solar is less dominant in the winter and with higher peaks in the summer. With solar power, the peaks are much higher than before at more than 250MW when they were hardly at 50MW before, and this without having any solar power installed at the bus. However outside of the summer peaks, the situation is better than before with lower curtailments even when considering the reduction in installed wind power.

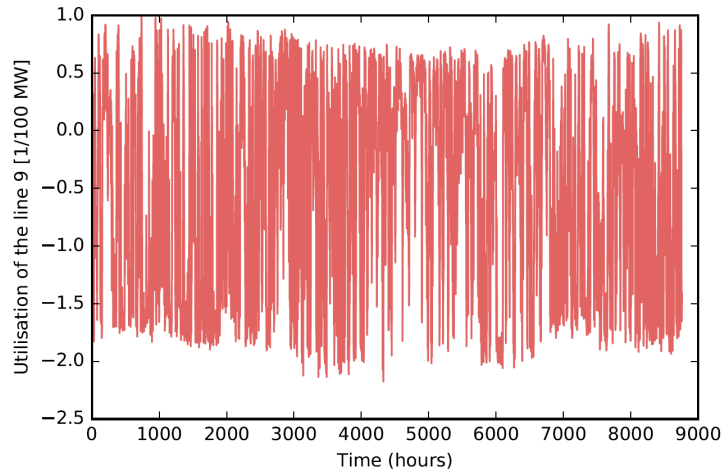
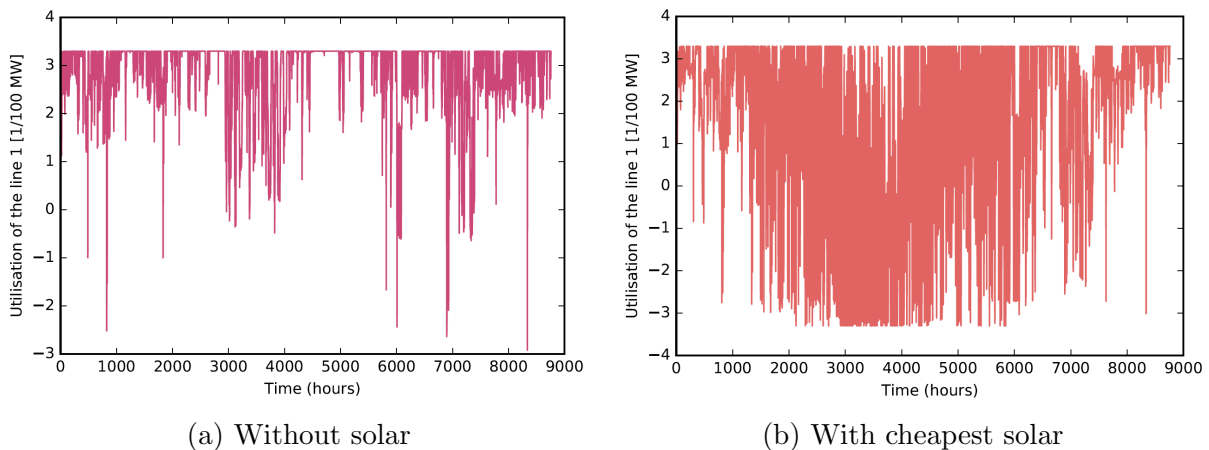

Figure 30: Utilization of the lines between bus 8 and 9, cases 30% and cheapest solar

As can be seen on figure 30, the line is far from limiting the ability to export energy. In the case with solar, there is so much solar installed that in some critical hours, the production is sent to the other buses to feed the load there and the local wind power is curtailed. Why is the power not exported elsewhere? The power can not be exported elsewhere because of some lines that creates a bottleneck in the critical hours. The lines 9 (bus8-9) and 8 (bus 7-8) are never saturated but the lines 7 (bus 5-7) and 5 (bus 4-7) are saturated when the solar production is high and floods the lines. This leads to a lot of curtailment during some hours in the summer. In order to reduce this curtailment the lines could be upgraded in order to allow for a transfer of this energy to the market or to the other buses but it is questionable whether or not such an upgrade for such a limited number of hours would be economically coherent.

Looking at the utilization of the lines is also interesting to see how the system changed. The utilization of lines 0 and 1 are shown under (respectively on figures 32 and 31) and the duration curves for those same lines are shown on figure 33. On the duration curve figures, 4 lines are drawn, the two at the top represent the case 30% of hydrogen from electrolysis while the two at the bottom represents the the case 10%; both times without solar and with the cheapest solar.



(a) Without solar

(b) With cheapest solar

Figure 31: Utilization of line 1, case 30%

What strikes directly when looking at the two figures is the much higher variability in the transfer through the line in the case with solar. While without solar, the line was used primarily in one direction, with solar the two directions are used. Once again, the pattern specific to the solar production is distinguishable even though there is no solar at bus 2. It is the solar from buses 3 and maybe 6 that is in excess and that transits from bus 2 to bus 1 through the line. Looking at the utilization of line 0 (between buses 0 and 1) (figure 32) one can see this pattern again. Without solar the market was mainly used as a source of extra balancing energy but the addition of solar results in export to the market in summer time.

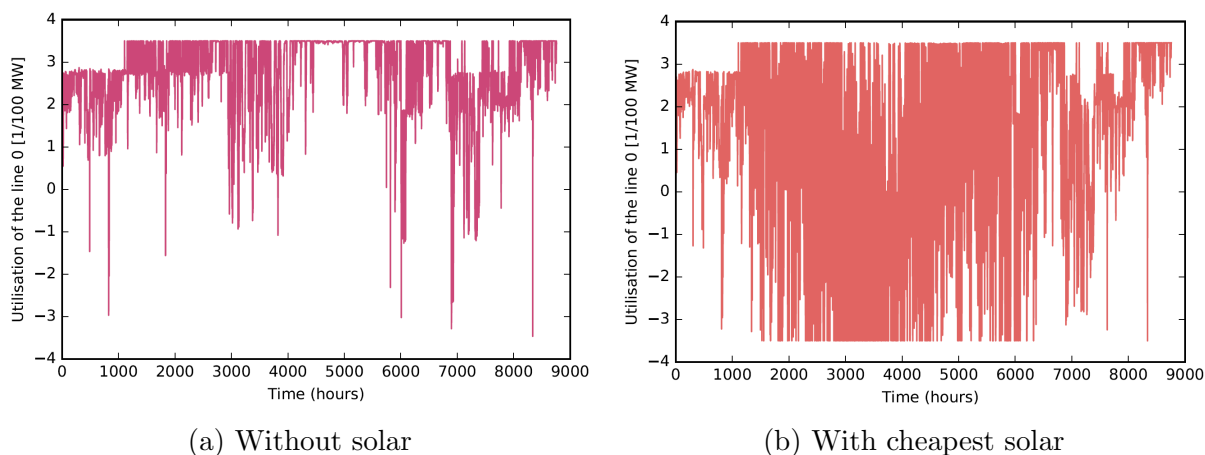

Figure 32: Utilization of line 0, case 30%

In the case without solar, the line 1 was used at its maximum for around two-thirds of the time due to import from the market to feed the production at bus 6. This shows that the energy from the market in that case is cheaper than additional wind power. By including solar, the saturation is limited to only a third of the time and some exchange are happening in the other direction while it was almost nonexistent beforehand.

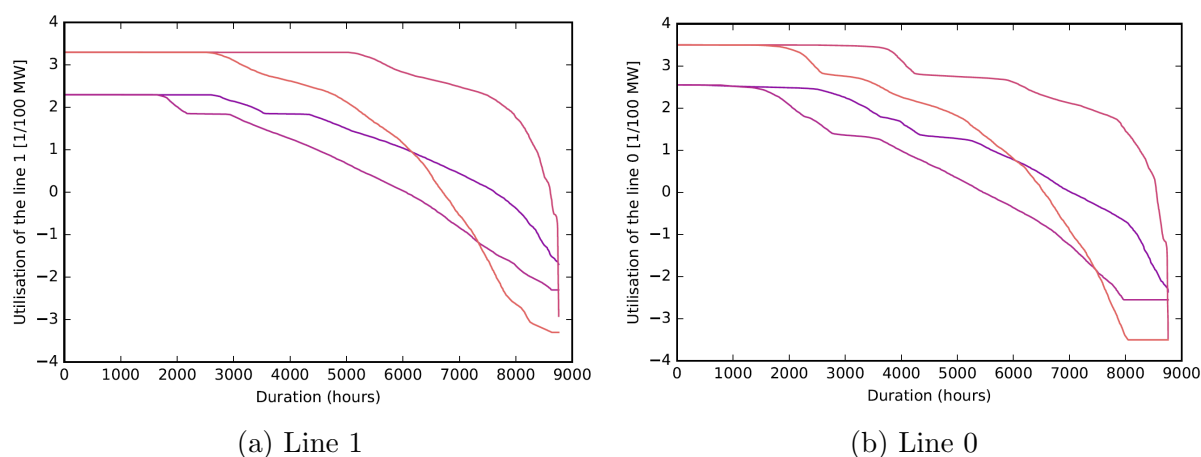

Figure 33: Duration curves of the utilization of lines 1 and 0, case 10% and 30% with and without solar

The duration curve of line 0 is affected in a similar manner than the one of line 1, with a reduction of the saturation periods and a global shift towards more exchange from the

system to the market. However for line 0 there is also saturation in the direction from the system to the market that appears. The duration curves for the case 10% hydrogen from electrolysis is also shown on the same graphs and one can see that the behaviour is the same with the introduction of solar. What can be noticed is the difference between the curves without solar for the same line, the amount of time saturated is much higher which characterize the fact that the upgrade of the line, which was made in order to have no rationing, is not enough to have the same behaviour of the system.

In this part we have seen in details the impact of different investment costs on the different hydrogen from electrolysis cases. The state of the system as well as the curtailment and utilization of lines were discussed. However since the beginning of the report, the cost of the line was never included so it is what is analyzed in the next part.



## 7 Finding out the Ideal Grid Size

It was seen in the previous sections that the grid, even though upgraded until no rationing, was still a limiting factor in some hours for the system. Whether it is with solar or barely wind there is some hours when the lines are saturated. Including the dimensioning of the lines in the optimization is excluded since it would lead to a quadratic problem that cannot be solved with this kind of optimization process. Moreover it would also increase greatly the computation time that is already high. Instead, the optimization is going to be performed for several grid cases and the results will be compared. Both weaker and stronger grids are going to be used to see how it influences the different outputs.

The cost of the line upgrade is going to be added afterwards to allow for an overall comparison of each scenario. The annualized cost for investment in the grid is set at 5424€/MW.yr on average based on a SINTEF report on the nordic power system [13] and a European project.[35] This annualized cost is calculated for lines of 80km on average, and it fit quite well here where the lines are around this length. A more detailed computation taking into account the length of the lines would give a more precise result but the method used here will give good enough results to have a better idea of the grid upgrades cost.

The simulation is done first with the same price as in the base scenario of 3,8\$/Wp even if this price was seen to be too high even for today, in order to keep the same reference point. The result will still be meaningful for the current price because we have seen that the investment in solar were quite close between the reference price and the current price. The optimization is performed for two cases, the case 10% hydrogen from electrolysis and the case 50%, so that it is done for both with and without solar investment.

The grid case used are referred to by a number which corresponds to which upgrade it is: for instance grid 0 is the grid as it is now without upgrade, grid 1 is the grid after the first upgrade (the grid that was used in the previous section for the case 10%), and grid 4 is the grid after the fourth upgrade (as it was used in the previous section for the case 40%). Cases with decimals are intermediary cases with a proportional grid: for example grid 1,3 is grid 1 plus 30% of the upgrade of grid 2.

The results show that the grid is undersized at first, which leads to costly rationing and imports of hydrogen as well as massive investment in solar at bus 6 to produce as much as possible and limit rationing to a minimum. When the grid size increases those effects are reduced until no more solar investment happens. After even more upgrades, investment happens in wind power at bus 9 to take advantage of the new transmission capacities.

Let's look at those effect with more details.

### 7.1 Grid Study in the Case 10%

The first study case is with the hydrogen load from electrolysis of 10%. In this case no solar investment was previously found by the optimization. The simulation is done with

the solar investment cost of 3,8\$/Wp.

Grid Case	Wind					Solar	Rationing
	Bus 1	Bus 5	Bus 6	Bus 8	Bus 9	Bus 6	Bus 6
0	2,29	40,5	10	40	95	13333	59299
0,1	2,8	40,5	10	40	95	13333	56399
0,3	2,34	40,5	10	40	95	13333	27747
0,5	10	200,5	10	40	209,78	365	26498
0,7	10	200,5	10	40	234,49	0	0
0,9	10	200,5	0	40	231,53	0	0
1	10	200,5	0	40	229,82	0	0
1,3	10	200,5	0	40	245,08	0	0
1,6	10	200,5	0	40	267	0	0
2	10	200,5	0	40	296,4	0	0
2,3	10	200,5	0	40	311,71	0	0
2,6	10	200,5	0	40	328,29	0	0
3	10	200,5	0	40	352,62	0	0

Table 14: Wind and solar power (MW) and rationing (MWh) at each bus for the different grid cases in the case 10%

What was described previously can be seen here. The solar power is maxed out in order to limit the rationing. What is interesting however is that no investment happen for wind power in the same way. One could expect that investing in the wind which is more profitable due to the solar price would happen first but it is not the case because the potential for wind at bus 6 is low and the line are too small to be able to transfer wind power from other lines.

Rationing in the system happens for each case until the case 0,7. Before that, it decreases continuously. This tells us that the grid that we had for the previous study of the case 10% is a bit bigger than needed in regard of the criterion that was "to have no rationing". And this is also because the grid was dimensioned in a iterative process where the steps might have been to big to be exactly on the no rationing size.

When the grid is further increased, the solar power disappears and is replaced by wind power at bus 9, the lines connecting the bus 9 and 6 now being strong enough to allow for the transmission of the power when it is needed. The wind power is further increased at this bus to take advantage of the lines size and the curtailment is reduced at bus 8 and 9 even though the power increases. This is shown on figure 34.

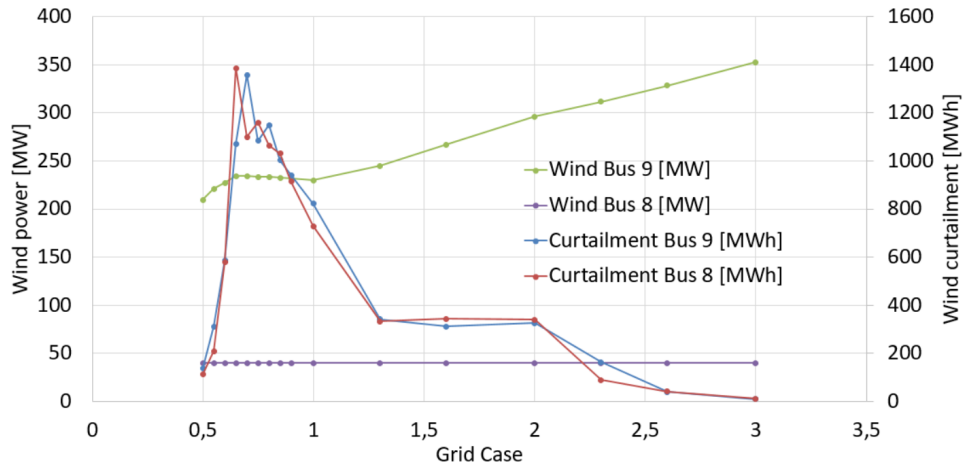

Figure 34: Wind power and curtailment at bus 8 and 9 for the different grid case and the case 10%

Table 15 shows additional results. The storage size is at its maximum for the first case as one could expect. It tries to reduce rationing and import of hydrogen by storing as much as possible in order to only take from the storage in critical hours. For bigger grids (above 0.7) the grid make it possible to always have enough power to run the electrolyzer and thus the storage disappears. The electrolyzer size evolves in the same way and for the same reasons. It is huge compared to the hydrogen demand for the small grids so that it can fill the storage when energy is available. For bigger grids, it falls back to the exact size needed to provide the load by producing continuously.

The hydrogen prices evolves in the same way as in the previous sections. It is however possible to see how much of an influence the rationing and import of hydrogen have on this price in the case nodal where the price is local and more representative of the real situation.

Grid Case	Storage Size ( $Nm^3$ )	Electrolyzer size (MW)	Hydrogen Price Spot ( $\text{€}/Nm^3$ )	Hydrogen Price Nodal( $\text{€}/Nm^3$ )
0	6500000	537,07	0,3886	1331,5384
0,1	6500000	488,59	0,3651	1485,5932
0,3	6500000	340,37	0,3097	465,0369
0,5	6500000	160,44	0,2414	10,2895
0,7	57656,46	110,93	0,1432	0,2359
0,9	0	107,99	0,1417	0,1527
1	0	107,99	0,1417	0,152
1,3	0	107,99	0,1417	0,149
1,6	0	107,99	0,1417	0,1485
2	0	107,99	0,1417	0,1479
2,3	0	107,99	0,1417	0,1445
2,6	0	107,99	0,1417	0,143
3	0	107,99	0,1417	0,1422

Table 15: Electrolyzer and storage size and hydrogen cost for the different grid cases and the case 10%

From the results above it is hard to conclude on which grid is the best from a techno-economic point of view. Is grid 0,7 , with some storage, less wind power and more curtailment and a smaller grid, more viable than for example grid 2 that while being bigger, allows for more wind power with less curtailment and no storage at all. That's why we compute the global cost of the system, in order to be able to compare. It includes the cost of wind investment, solar investment, storage and electrolyzer cost as well as the cost of the grid (based on the price discussed at the beginning of this section) in the investment costs as well as the operating cost including cost related to spillage and hydro reservoir constraints, rationing and import of hydrogen and the cost and revenue of import and export of energy from the system. This gives a value that is equal to the result of the objective function from the optimization at the difference of the cost of the grid that is now included; it allows for a better comparison. The results for each case are shown on figure 35. The cost is divided between the investment cost and operation cost in order to see how they change and their influence on the total cost. The figure only shows the results for grid higher than 0.7 to be easier to read; the complete results can be found in the appendix (figure 137). The costs can seem high but it is important to remember that in this global cost, the revenue from selling the hydrogen are not included.

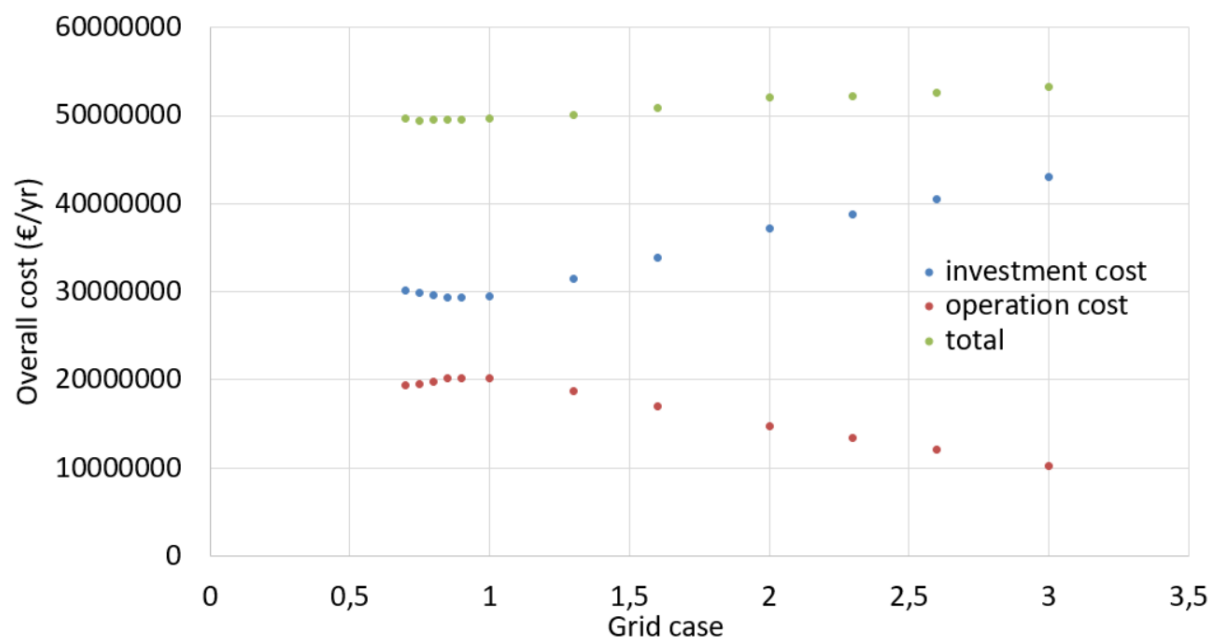

Figure 35: Evolution of the costs for each grid case, case 10%

On figure 137, the investment cost is high due to the storage and solar but the operation cost are much more expansive due to rationing and import of hydrogen and energy. The grid cases from 0 to 0.6 are thus excluded. On figure 35, one can see that the investment and operation cost for grid cases from 0,7 are almost opposite, when one increases at a certain rate, the other changes in an opposite manner. This results in a trade-off as the grid is increased and makes the overall cost almost constant. For grids between 0,7 and 1, the investment cost is reduced slightly despite the grid increase due to the reduction in the wind power and in storage size; the operations cost increase probably due to higher imports and lower exports to the market. In the case 0,7, the difference between imports in the system and exports is 1 040 144MWh while its 1 077 040 MWh in the grid case 0.9. It tends to show that the increase is due to this, even if it can't be said for sure because

the price are varying as well and the moment for import and export is important as well. For grids higher than grid case 1, the investment cost increases due to the effect of the cost of the grid and the cost of the wind power at bus 9. The operation cost decreases because of more exports to the market.

It is now possible to chose the grid that is the best solution. By comparing the total costs, the best solution appears to be the grid case 0,75. It is however important to note that from grid case 0,7 to 1, the difference in total cost compared to the grid case 0,75 is inferior to 0,5%; and the difference with the grid case 1,3 is inferior to 1,5%. This means that even if 0,7 is the best economically speaking, one could still prefer one of the other grid in order to reduce the curtailment of wind or for example to increase the amount of wind power installed. Moreover, the trade-off between the cost of upgrading the grid and installing more wind power and the gains from the sales of wind power only results in a limited increase in the total cost, so this could also be a reasonable solution if there is a will to include more wind power.

## 7.2 Grid Study in the Case 50%

The second study case is with the hydrogen load from electrolysis of 50%. In this case only a little solar investment of 28MW was previously found by the optimization at bus 6. The simulation is done with the solar investment cost of 3,8\$/Wp.

Grid Case	Bus 1	Bus 5	Wind			Solar	Rationing
			Bus 6	Bus 8	Bus 9	Bus 6	Total
4,2	3,43	200,5	10	1182	548	13333	50548
4,4	10	200,5	10	1590	548	761	45534
4,6	10	200,5	10	1590	548	144	12407
4,8	10	200,5	10	708	548	46,6	0
5	10	200,5	10	408	548	28,2	0
5,3	10	200,5	10	283	548	0	0
5,6	10	200,5	10	282	548	0	0
6	10	200,5	10	295	548	0	0

Table 16: Wind and solar power (MW) and rationing (MWh) at each bus for the different grid cases in the case 50%

In the table above (table 16), the rationing is not only located at bus 6. Unlike the previous case, the rationing is divided between buses 4, 5, 6, 7, 8 and 9 with most of it at bus 6. In this case as well, the grid could have been reduced a bit considering the criterion on rationing because the case 4,8 already doesn't have any rationing. The investment in solar is following the same pattern as before, starting with the maximum amount to reduce the impact of the under-dimension of the grid. The wind power stays the same throughout at bus 1, 5, 6 and 9, but it changes significantly at bus 8. When the size of the grid increases, the wind power at bus 8 is reduced and stabilizes around 290MW for grid higher than grid case 5. If the grid was further increased, wind power might increase again at bus 8 to take advantage of it.

The curtailments are reduced as expected when the grid size increases and this can be

seen well on figure 36 that shows the duration curve of the wind production at bus 9 where the amount of wind power stays the same throughout.

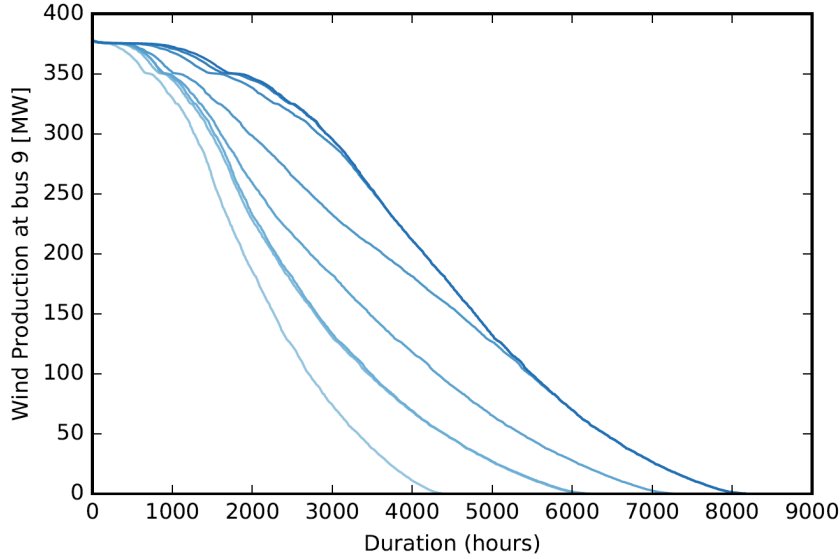

Figure 36: Duration curve of the wind power production at bus 9 for the different grid cases, case 50%

On the figure above, the lighter shade of blue represents the weakest grid and the darker it gets, the higher transmission capacity the lines have. The figure highlights the reduction of wind curtailment and its amount. In the lighter shade curve (weakest grid), the production can be estimated approximately to be half of the case with the strongest grid, showing how large curtailment there was. The amount of curtailment for the grid case 4,2 to 4,8 is still important and at grid case 5 it is still possible to reduce it. For grid case 5,3 and above the variations is almost zero, the curves are almost superposed.

Grid Case	Storage Size ( $Nm^3$ )	Electrolyzer size (MW)	Hydrogen Price Spot ( $\text{€}/Nm^3$ )	Hydrogen Price Nodal( $\text{€}/Nm^3$ )
4,2	6500000	897,4	0,1846	526,9091
4,4	6500000	650,84	0,1657	16,2503
4,6	2026372,6	607,63	0,1515	7,4384
4,8	3204672,18	609,98	0,1548	1,7472
5	2988464,99	629,77	0,1557	0,6962
5,3	1054400,52	625,97	0,1501	0,245
5,6	788400,17	588,11	0,1469	0,213
6	598904,98	563,29	0,1447	0,1843

Table 17: Electrolyzer and storage size and hydrogen cost for the different grid cases and the case 50%

The electrolyzer size starts really high with almost 900MW and is smaller when the constraints in the grid are less extreme. When the grid is increased again after grid case 5 the electrolyzer size decreases. The storage size also evolves in the same way but this time the reduction is more important. The storage size is almost divided by 3 between

the grid case 5 and 5,3. It still decreases after that but at a slower rate, although the reduction is still of a factor 2 between grid case 5,3 and 6.

Grid case 4,8 seems like a good candidate to replace the grid 5. Indeed, it has more solar and wind power and this without rationing. However the curtailment of the installed wind power is higher and the price of hydrogen produced seems to be much higher than with grid 5. In order to get a more precise answer, the costs have to be calculated and compared.

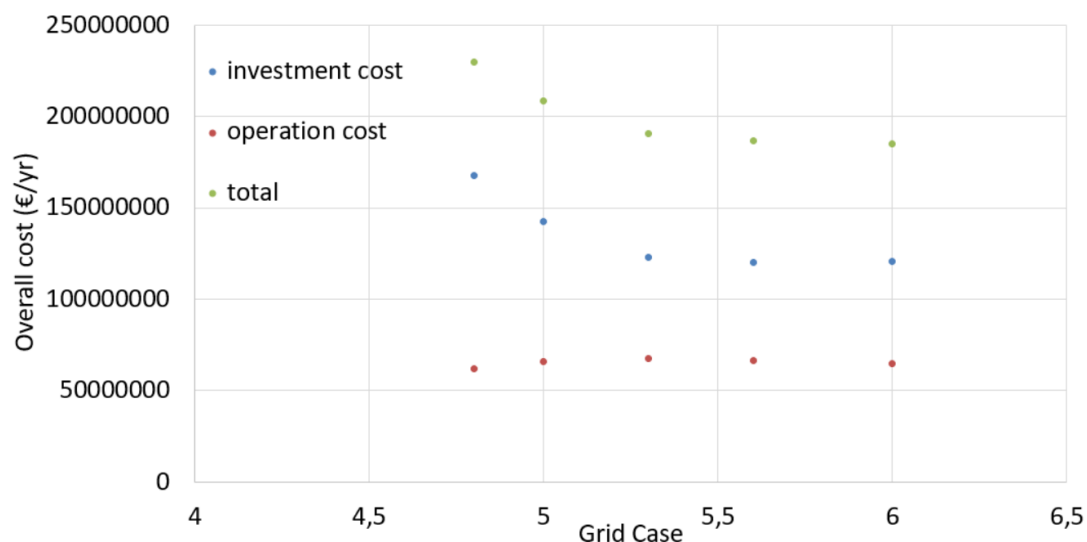

Figure 37: Evolution of the costs for each grid case, case 50%

The complete figure can be seen in the appendix (figure 139). The figure here is zoomed to better show the differences between relevant grid cases. For grid cases before 4,8 there is rationing so they are not discussed further. Even though in case of a limited rationing strategies could be developed, such as having contracts with some industries to reduce their load for some hours in the year, it is out of the scope of the study. Grid 4,8 has the cheapest operation costs from the grids studied but the high investment cost due to the storage and the wind and solar power prevent from making it the most profitable grid. The most profitable grid appears to be grid 6 even if grid 5,6 comes quite close. Higher grid cases have not been studied because the case 70% has not been studied so there is no grid 7. However, it is expected that grid 6 would remain the cheapest by assuming the investment cost and operation cost evolves in the same way as for the study of case 10%, which is not a big assumptions considering that the grid expansion cost will end up taking over the reduction in storage size and electrolyzer size and the operation cost will be reduced to some point by the increase in renewable power, the reduction of curtailment and the sales of energy. In addition the local maximum of operation cost is reached for grid case 5,3 and the local minimum for the investment cost is reached for the grid case 5,6. The best solution is then again in this case one without solar power.

### 7.3 Grid Study in the Case 10% and a Low Solar Cost

To see if a low solar cost influences the best grid solution we simulate again the case of 10% hydrogen from electrolysis with an annualized solar investment cost of 0,02\$/W.yr.

Grid	Wind					Solar					Rationing
	Bus 5	Bus 6	Bus 8	Bus 9	Bus 1	Bus 2	Bus 3	Bus 5	Bus 6	Bus 7	Bus 6
0	40,5	10	40	95	80,4	0	0	0	13333	0	59299
0,1	40,5	10	40	95	79,5	0	0	0	13333	0	56398
0,3	40,5	10	40	95	78,9	0	0	0	13333	0	27747
0,5	113,2	10	40	95	79,4	0	0	0	3225,5	0	14223
0,7	200,5	10	40	188,8	115,4	0	309,8	0	322	0	0
0,9	200,5	0	40	186,3	117,6	0	390,7	0	254	0	0
1	200,5	0	40	183,9	118,3	0	400,3	251	0	0	0
1,3	200,5	0	40	186,1	101,3	0	517,1	64,5	60	25,3	0
1,6	200,5	0	40	201	87,3	217	409,5	44,5	0	0	0
2	200,5	0	40	210,5	7,4	359,3	384,4	0	0	0	0
2,3	200,5	0	40	202	83,3	461,3	256	0	0	0	0
2,6	200,5	0	40	203,3	131,1	220	490,5	0	0	0	0
3	200,5	0	40	191,1	139,2	455,9	314,2	0	0	0	0

Table 18: Installed wind and solar power, and rationing at different bus for different grid cases, case 10% with low solar investment cost

Table 18 can be compared with the other study with the higher investment cost of solar. At bus 1 there is no investment in wind power, at bus 5,6 and 8 it does not change much, and at bus 9 there is surprisingly more investment in the case with the low investment cost. The rationing is still only located at bus 6. It starts at the same value but then decreases faster; however in both case the rationing is at zero for grid case 0,7. As seen before, this solar investment cost enables to invest largely in solar. Between the grid case 0,7 and 2 the amount of solar power is almost constant around 750MW and it only increases for the higher grid cases up to 910MW for grid case 3.

Grid Case	Storage Size ( $Nm^3$ )	Electrolyzer size (MW)	Hydrogen Price Spot ( $\text{€}/Nm^3$ )	Hydrogen Price Nodal( $\text{€}/Nm^3$ )
0	6500000	537,07	0,3886	1331,5
0,1	6500000	488,59	0,3651	1485,6
0,3	6500000	340,37	0,3103	465,0
0,5	4379205	226,14	0,2407	4,931
0,7	55485	109,96	0,1428	0,1944
0,9	0	107,99	0,1417	0,143
1	0	107,99	0,1417	0,1428
1,3	0	107,99	0,1417	0,1413
1,6	0	107,99	0,1417	0,1408
2	0	107,99	0,1417	0,1406
2,3	0	107,99	0,1417	0,1399
2,6	0	107,99	0,1417	0,1393
3	0	107,99	0,1417	0,1389

Table 19: Electrolyzer and storage size and hydrogen cost for the different grid cases and the case 10% with low solar investment cost

The storage size and electrolyzer size evolves in a similar way as before. The hydrogen cost evolves also in the same way, but in the nodal calculation it reaches value that are even lower than the spot price.



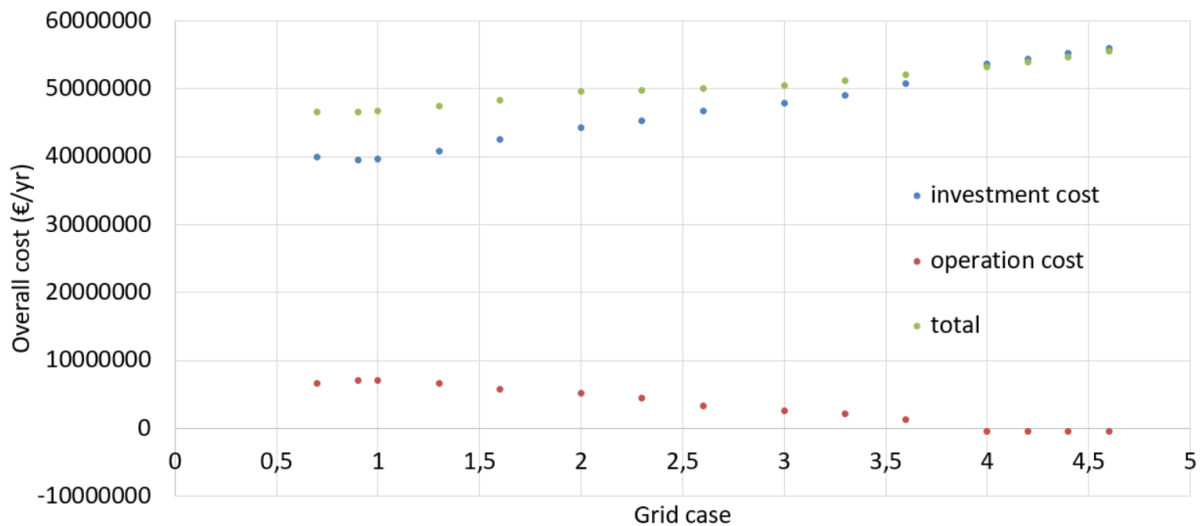

Figure 38: Evolution of the costs for each grid case, case 10% with low solar investment cost

The total cost for the case with cheap solar is only slightly lower for the first cases but with a distribution between investment and operation that is quite different. In the case with cheap solar, the investment cost is about 33% higher but with half the operation cost. The overall shape of the curve is kept but with a predominant investment cost. Another interesting fact is that the sells from solar production allows the overall operation cost to become negative from grid case 4 even if it stabilizes and the profit doesn't increase a lot.

It is important to add few things regarding what has been done. First, the numbers in the overall costs seems really high and are annualized but one should remember that the revenues from the sells of hydrogen are not included and the amount of hydrogen produced in the case 10% is around 202,5 millions of cubic meter each year. Even if the hydrogen was sold around  $0.25\text{€}/Nm^3$ , would the system be viable. Speaking of the hydrogen cost, it can be compared with prices for the reforming method. A publication from the gas company Total gives a price of  $1,5\text{€}/kg$  for hydrogen production from reforming without including distribution costs<sup>19</sup>, if we convert this price using the hydrogen density at the correct conditions gives around  $0,125\text{€}/Nm^3$ . This prices shows that the cost found in the different studies that has been around 0,143 is just slightly higher (10 to 15% higher depending on the case) which makes it a serious contender for reforming. If we consider the complete cost of hydrogen from electrolysis including the grid expansion and the wind and solar investment and revenues, then it is still "only" twice as much as with reforming. This values is about the same as the lower values for hydrogen cost that were presented earlier in the introduction. The cost of grid expansion and investment in production capacity could be taken all or partly by other actors such as the states, the transmission system operator and electricity producer for example or be subsidize, which would make the cost of hydrogen closer to the lower value.

<sup>19</sup>(fr) <http://www.planete-energies.com/fr/medias/decryptages/une-revolution-de-l-hydrogene-est-elle-possible>

## 8 Evolution of Hydro System in the Different Studies

In the previous study, the influence of different parameters have been studied, and the modifications in the grid behaviour and the resulting system has been seen. However, the influence of introducing wind and solar power on the hydro system has not been discussed. Hydro power being the major source of electricity in Norway, it is important to assess the changes introduced by new production means. It is in particular interesting to see if the spillage is increased and how the reservoir are managed and if there is a big difference with the current operations.

To make it easier to compare results, only the case 10% and 50% is going to be shown as they represent both with and without solar in the system. The different cases and their associated color on the figures below are:

- base case; red
- wind expansion only; blue
- wind and solar expansion with solar cost of 3,8\$/Wp (2010 cost); green
- wind and solar expansion with solar cost of 1,6\$/Wp (around current cost); pink
- wind and solar expansion with solar cost of 0,3\$/Wp (low cost, optimistic expectation for around 2050[26]); yellow

The base case to which we refer here is the case without any production of hydrogen from electrolysis in the system and it acts as a comparison case.

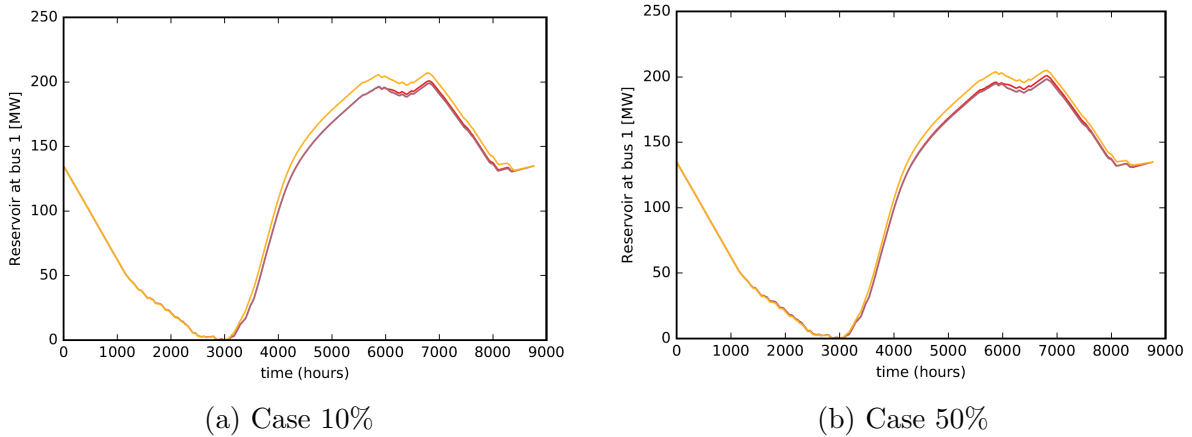

Figure 39: Hydro reservoir 1 for the different studies

The first reservoir has a quite large capacity and its evolution during a year is quite typical for a hydro reservoir. In the winter, the electricity demand is high due to heating and the reservoir are used a lot, the inflow are quite low because it snows instead of raining and it doesn't make up for the used water. The water value is then quite high in the winter. In the spring, the ice and snow melt from the mountains and the lakes and the inflows are really high, which allows the reservoirs to be replenished. The water value at this time is usually really low, and can even reach zero if the inflow are so high that it is

not possible to use it fast enough. This kind of pattern is common to almost all reservoir in Norway. Here the different case scenario don't affect the way the first reservoir is used. Barely slightly less of water is used in the summer in the case with solar in the system due to the solar production in the summer. It is going to be interesting to see in the other reservoirs whether the fact that both the large inflows and the solar production happens simultaneously has a negative impact on the system or not.

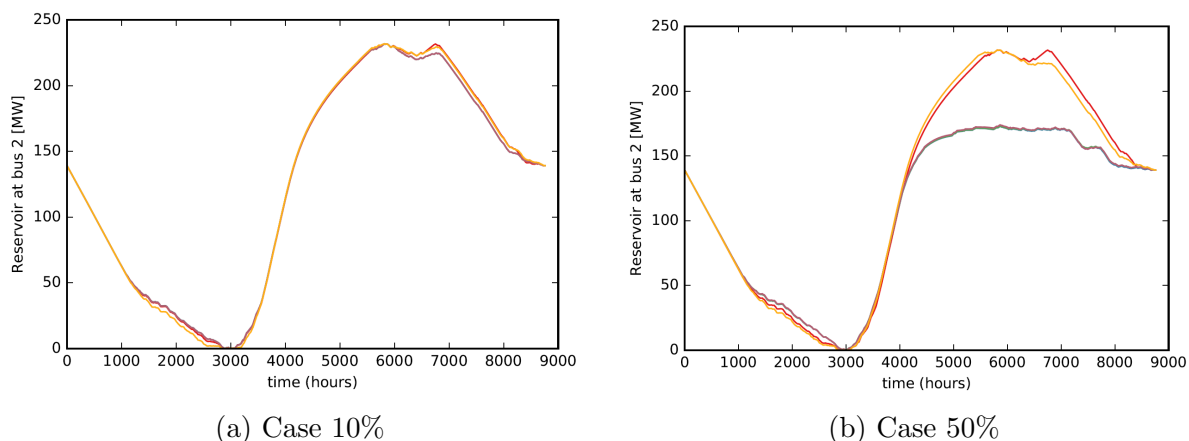

Figure 40: Hydro reservoir 2 for the different studies

The reservoir 2 above (figure 40) is really similar to the first one, in terms of size or behaviour. The only difference is the behaviour of the system for the case 50% and the pink, green and blue lines, representing the system with only wind power (as there is no investment in solar for this case and this price). For those cases, the reservoirs do not refill to the maximum in the spring as opposed to the case without wind and the case with wind and solar.

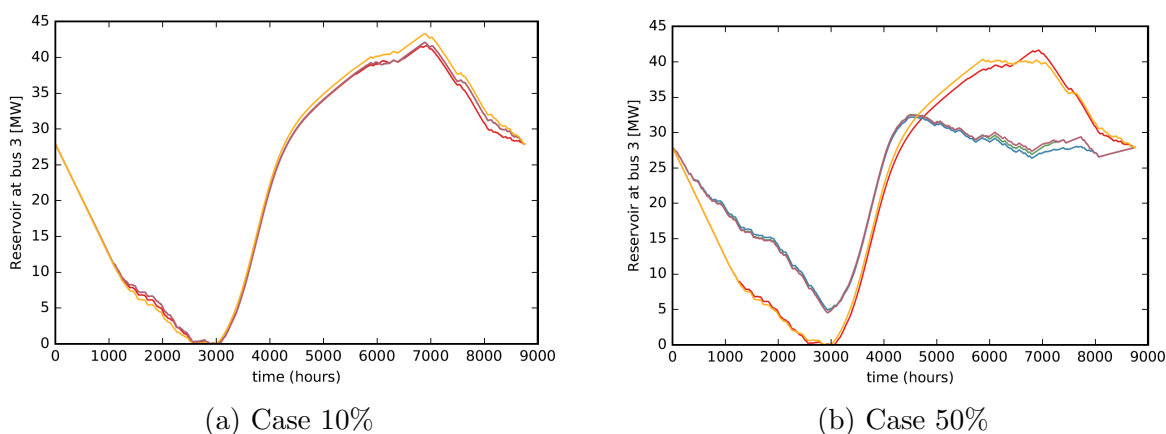

Figure 41: Hydro reservoir 3 for the different studies

For reservoir 3, the behaviour in the summer for the same case as before is also similar but in the winter there is also less water used. This would allow the water value to be less high in the winter and higher in the summer in this area. A possible explanation for the behaviour in the summer is the following. It was seen before that the summer was a period with a deficit of wind production compared to the rest of the year. In the case with a high load and only wind investment to feed that load, this leads to this wind

investment to not be enough to feed the load and so the water is used and transferred to bus 6, creating this difference in behaviour whereas in the case with solar, it is the high solar production of the summer that feed the load. In the case 10% we can suppose that the load increases due to the electrolysis is not enough to require more hydro production.

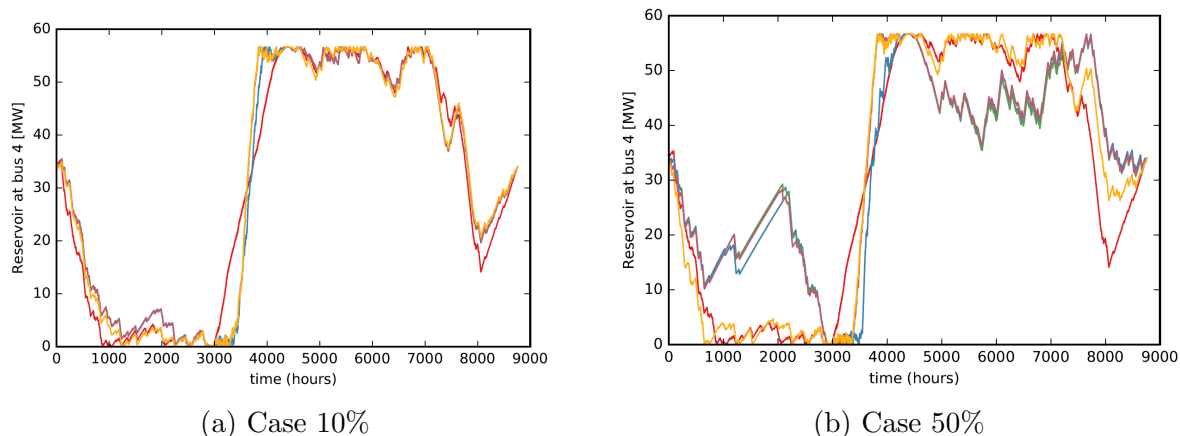
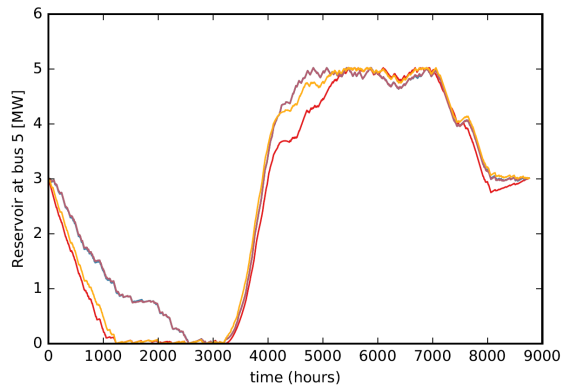
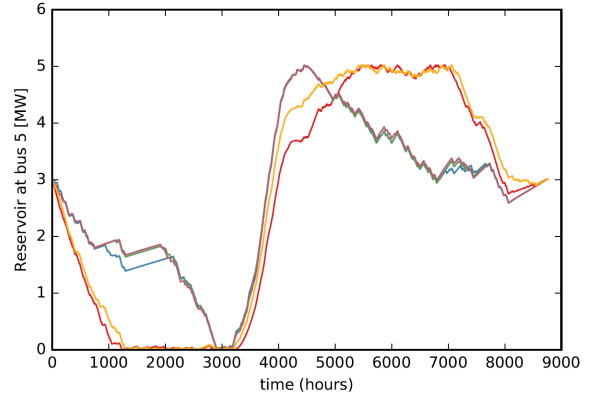

Figure 42: Hydro reservoir 4 for the different studies

For reservoir 4, the utilization of the reservoir is the same in the case 10%, with only a small difference in the operation at the transition between winter and summer. The case 50% is quite different in terms of operation; there is again the increased use of water in the summer for the case without installed solar and the reduced use of water in the winter. By looking at the production curve (not shown here), it appears that the production stops between around hour 700 and 2000 except for a short window at the middle. At bus 4 where this reservoir is, the load is quite low compared to the production and so it mainly is exported to the other surrounding buses (3 and 7) and probably eventually to the load at bus 6. When there is only investment in wind power, the time between hour 1000 and 2000 is a time with a high wind production as was seen before, so we can assume that the need for the production at bus 4 to feed the loads is decreased and thus the production at bus 4 is decreased, leaving more water in the reservoir. In the case with solar investment (yellow line), the solar production at the time is low and there is less wind power installed at bus 8 than in the case of only wind investment. This lower wind power at bus 8 probably means that the reservoir 4 is still solicited in that time to feed the load as in the base case.



(a) Case 10%



(b) Case 50%

Figure 43: Hydro reservoir 5 for the different studies

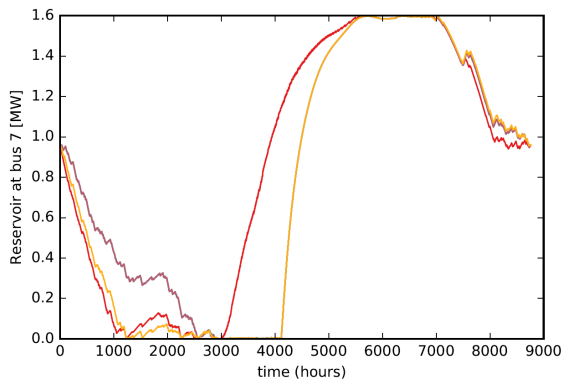

(a) Case 10%

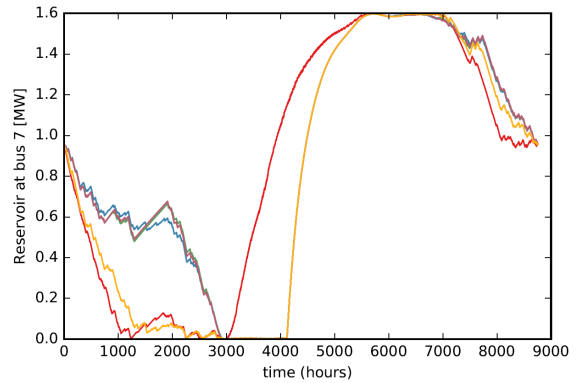

(b) Case 50%

Figure 44: Hydro reservoir 7 for the different studies

The reduction in use of water is also happening for the case 10% in reservoir 5 and 7. The reservoirs in this case are quite small so the impact is limited. In the case of reservoir 7, the behaviour of the base case is different from the others, with the replenishment of the reservoir happening sooner than in the other cases, probably due to the lower load. The spillage in this case is also different in the base case than in the other cases as can be seen on figure 48.

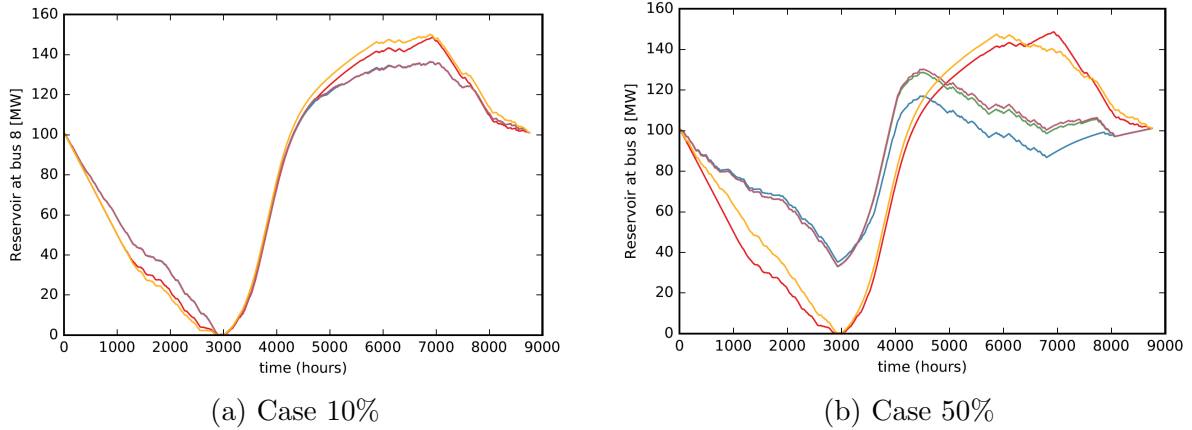

Figure 45: Hydro reservoir 8 for the different studies

Reservoir 8 is a quite large one and the profile remains similar for the case 10%. For the case 50%, the seasonal effect due to wind power explained before happens as well, in the summer and the winter, and reduces the yearly amplitude of variations in the reservoir level. This would have the effect to limit the variations of the water value throughout the year.

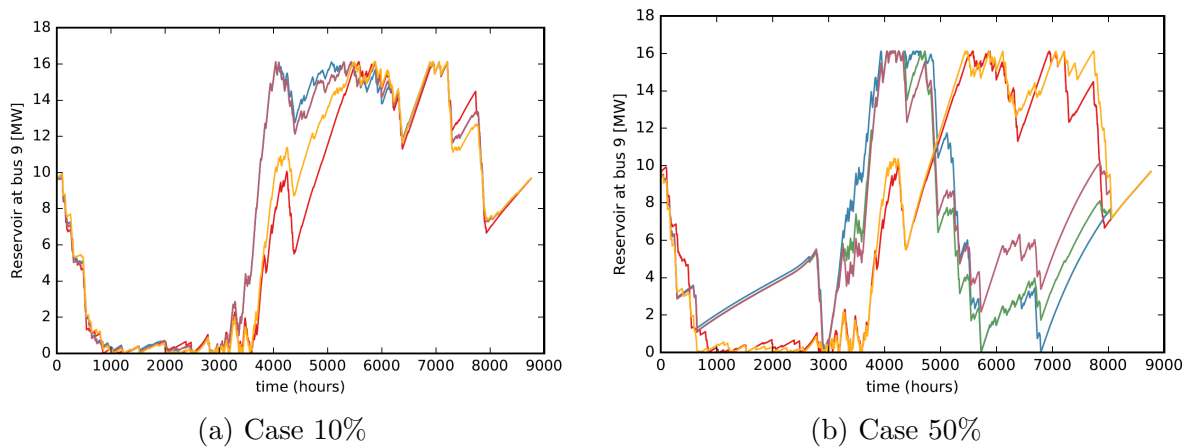

Figure 46: Hydro reservoir 9 for the different studies

This reservoir (figure 46a) is quite small, so the variations in the level of the reservoir can seem abrupt. The curves are of the same kind as explained before, but with the difference in this case that the water value gets really high in the summer due to a low reservoir level with the wind power seasonal effect.

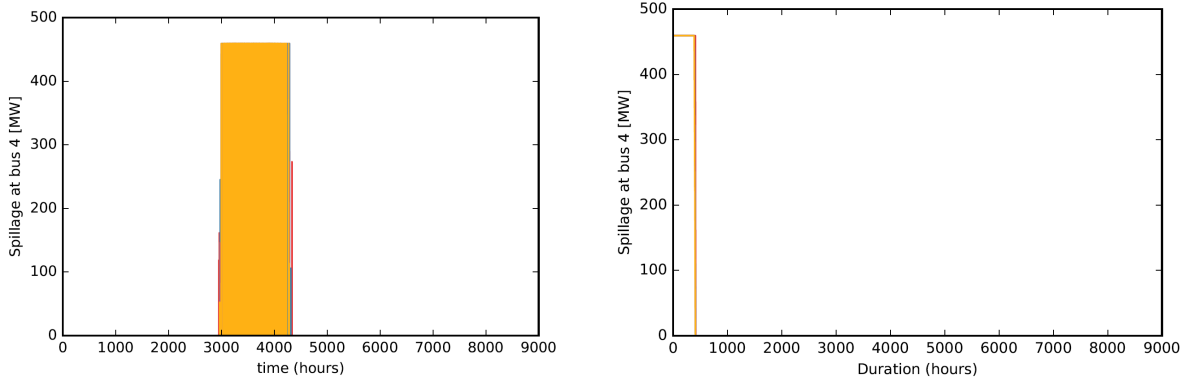

Figure 47: Spillage for reservoir 4 for case 10%, different studies

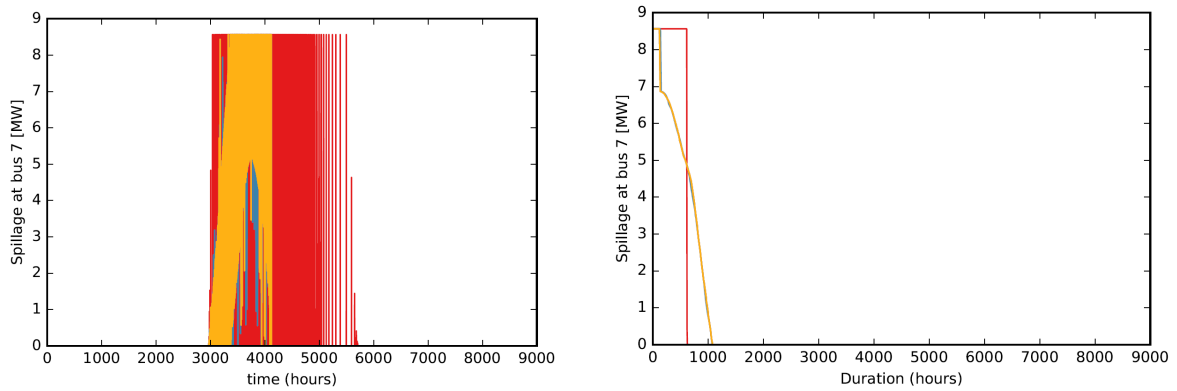

Figure 48: Spillage for reservoir 7 for case 10%, different studies

As seen above, during spring the inflow at some buses is much higher than the reservoir and production capacity, leading to a lot of spillage. The expansion of the system smooths the spillage profile in the case of reservoir 7.

From the results above, one can say that the hydro system is operated in the same way in the case 10% and that in the case 50% with solar it remains the same while with only wind power investment a seasonal effect leads to a reduction of the variations of the reservoir level throughout the year and thus a reduction in the variations of the water value. Overall the impact of expanding the grid and the production capacity with new means of production while increasing the load does not bring a completely new pattern of operation for the hydro system.

## 9 Conclusion

In this thesis, the possibility of implementing an hydrogen factory in the north of Norway was studied through the simulation of the system and an optimization of the needed investment with the exclusion of the grid and in the first scenario of 10% of the production coming from electrolysis. The same study was then repeated multiple times to study how the previous results changes if the proportion of hydrogen produced by electrolysis is increased. The necessary grid upgrade to avoid rationing was also found out. The main results were that the investment in wind power was mainly at bus 9 and 8 and that even if the electrolyzer size increased approximately linearly, the storage size on the other hand does not and increase greatly after the case 40%.

The possibility of investing in solar was then added to the model at a price of 3,8\$/Wp and it turned out to not be profitable at this price before the case 50%. It was however found that the addition of solar power yields a positive impact on the size of the storage needed due to advantageous seasonal effects.

The next step was to study different prices in order to find when solar becomes profitable. The resulting value for the case 10% was around 0.4\$/Wp much lower than the current price of 1,6\$/Wp but also reasonable in a longer term as suggested by some other studies.

The next study was to account for the cost of the grid expansion in different cases to see if only limiting rationing is a good criteria. The simulation was used again with different grids and it appears that limiting the rationing was often giving the cheapest result even though upgrading the grid further do not result in a big increase in cost due to a trade off between operation cost and investment cost.

The last study was focused on the behaviour of the hydro system during the previous simulation cases and it highlighted some interesting seasonal effect of the different technology.

As of now, solar power does not appear to be a good solution for the case of 10% of the total hydrogen coming from electrolysis due to its cost. Wind power appears to be a preferable solution even if the investment is not large and thus does not take full advantage of the resources of the north of Norway. In the end it seems that even by having a bigger load and solar, upgrading the lines is necessary for not having rationing in the system.

The study could be further developed by refining the data of insolation in north of Norway or even only with data for the location of the factory. It could also be wise to improve the grid model with resistances. Another location was considered for the project and it would also be insightful to perform a similar study there and compare the results. Expanding the simulation on a longer time period could help to tackle critical years in terms of wind, solar insolation or water inflow. Finally, a last aspect that could be tackled, as suggested by a previous work, is how interesting economically it would be to allow for variations in the constant production instead of requiring it to be every hour the same. It was seen in a previous work that it would reduce the size of the storage but studying the impact on the investment as well as the impact on the final user would be valuable. It might also



reduce the size of the lines needed in order to not have rationing.

## 10 References

- [1] Renewable power generations costs in 2014. Technical report, IRENA, 2015.
- [2] Global wind statistics 2016. Technical report, Global Wind Energy Council, 2017.
- [3] Armin Aberle. Thin-film solar cells. *Thin solid films*, 517(17), July 2009.
- [4] Unknown Author. *WETO-H2 (World Energy Technology Outlook - 2050)*. European Commission, 2006.
- [5] Unknown Author. Iea energy technology essentials, hydrogen production and distribution. Technical report, IEA, 2007.
- [6] Unknown Author. Iea technology roadmap, hydrogen and fuel cells. Technical report, IEA, 2015.
- [7] Espen Bødal and Magnus Korpås. Sizing and regional effects of hydrogen production plants in congested transmission grids. *European Energy Market Conference*, 2017.
- [8] Fuel cell and Hydrogen energy association. Fuel cells and wind. <https://static1.squarespace.com/static/53ab1feee4b0bef0179a1563/t/55897cbce4b05d31342ece54/1435073724814/Wind.pdf>.
- [9] Swapnil Dubey, Jatin Narotam Sarvaiya, and Bharath Seshadri. Temperature dependent photovoltaic (pv) efficiency and its effect on pv production in the world – a review. *Energy Procedia*, 33:311 – 321, 2013.
- [10] P.P. Edwards, V.L. Kuznetsov, W.I.F. David, and N.P. Brandon. Hydrogen and fuel cells: Towards a sustainable energy future. *Energy Policy*, 36(12):4356 – 4362, 2008. Foresight Sustainable Energy Management and the Built Environment Project.
- [11] Arnulf Hansen et al. Underground constructions for the oil and gas industry. Technical Report 16, Norwegian Tunneling Society, 2007.
- [12] Lucas Bertuccioli et al. Study on development of water electrolysis in the eu. Technical report, ElementEnergy, 2014.
- [13] Ingeborg Graabak and Leif Warland. A carbon neutral power system in the nordic region in 2050. Technical report, SINTEF, 2014.
- [14] Christopher Greiner, Magnus Korpås, and Arne Holen. A norwegian case study on the production of hydrogen from wind power. *International Journal of Hydrogen Energy*, 37(10), July 2007.
- [15] Knut Hofstad, Kjersti Mølman, and Lars Tallhaug. Vindkraftpotensialet i norge (en: The wind power potential in norway). Technical report, NVE, 2005.
- [16] Ahmed Hossam Eldin, Mostafa Rifaey, and Abdelrahman Farghly. A review on photovoltaic solar energy technology and its efficiency. 2015. 17th International Middle-East Power System Conference.
- [17] IRENA. Solar photovoltaics. Technical report, IRENA, 2012.

- [18] Brian D James. Overview of Hydrogen Storage Technologies. In *Prepr. Symp., Div. Fuel Chem., Am. Chem. Soc.*, pages 568–569, 2008.
- [19] Ghislaine Kiefferr and Toby D. Couture. Renewable energy target setting. Technical report, IRENA, June 2015.
- [20] Magnus Korpås and Christopher Greiner. Opportunities for hydrogen production in connection with wind power in weak grids. *Renewable Energy*, 33(6), June 2008.
- [21] Magnus Korpås, John Olav Giæver Tande, Kjetil Uhlen, Einar Ståle Huse, and Terje Gjendegal. Planning and operation of large wind farms in areas with limited power transfer capacity. Technical report, Dept. of Electrical Power Engineering, Norwegian University of Science and Technology and SINTEF Energy Research, 2012.
- [22] Olaf Kruck, Fritz Crotofino, Ruth Prelicz, and Tobias Rudolph. Overview of all known underground storage technologies for hydrogen. Technical report, European Project HyUnder, 2013.
- [23] Yu Lei, Srimanta Pakhira, Kazunori Fujisawa, Xuyang Wang, Oluwagbenga Oare Iyiola, Néstor Perea López, Ana Laura Elías, Lakshmy Pulickal Rajukumar, Chanjing Zhou, Bernd Kabius, Nasim Alem, Morinobu Endo, Ruitao Lv, Jose L. Mendoza-Cortes, and Mauricio Terrones. Low-temperature synthesis of heterostructures of transition metal dichalcogenide alloys (wxmo1–xs2) and graphene with superior catalytic performance for hydrogen evolution. *ACS Nano*, 11(5):5103–5112, 2017. PMID: 28471652.
- [24] M. Liserre, R. Cardenas, M. Molinas, and J. Rodriguez. Overview of multi-mw wind turbines and wind parks. *IEEE Transactions on Industrial Electronics*, 58(4):1081–1095, April 2011.
- [25] J. F. Manwell, J. G. McGowan, and A. L. Rogers. *Wind Energy Explained*, pages 23–89. John Wiley and Sons, Ltd, 2009.
- [26] Johannes N. Mayer. Current and future cost of photovoltaics. long-term scenarios for market development, system prices and lcoe of utility-scale pv systems. Technical report, 2015. Study on behalf of Agora energiewende.
- [27] Nordpool. Exchange between norway, finland and russia. <http://www.nordpoolspot.com/Market-data1/Power-system-data/Exchange1/NO/Hourly211/?view=table>.
- [28] Dimitri Pinel. Hydrogen production from wind power in weak grids, 2016. Specialisation project.
- [29] Mamoon Rashid, Mohammed Al Mesfer, Hamid Naseem, and Mohd Danish. Hydrogen production by water electrolysis: A review of alkaline water electrolysis, pem water electrolysis and high temperature water electrolysis. *International Journal of Engineering and Advanced Technology*, 4(3), February 2015.
- [30] Genevieve Saur and Todd Ramsden. Wind electrolysis: hydrogen cost optimization. Technical report, NREL, 2011.

- [31] Janet Sawin, Kristin Seyboth, Freyr Sverrisson, and al. Renewables 2016 global status report. Technical report, REN21, 2016.
- [32] David Tenenbaum. Deep hydrogen. Technical report, NASA, 2008. <https://astrobiology.nasa.gov/news/deep-hydrogen/>.
- [33] Sven Teske, Gaetan Masson, and al. Solar generation 6: Solar photovoltaic electricity empowering the world. Technical report, European Photovoltaic Industry Association and Greenpeace, 2011.
- [34] Fuel Cell Today. Water electrolysis and renewable energy systems. Technical report, Fuel Cell Today, 2013.
- [35] A Vafeas, T Pagano, and E Peirano. Modular development plan of the pan-european transmission system 2050: Technology assessment from 2030 to 2050. Technical report, e-Highway2050 and Europe, 2014.
- [36] Marcel Weeda, Reinhold Wurster, Geert Schaap, and Floris Mulder. Towards a comprehensive hydrogen infrastructure for fuel cells electric cars in view of eu ghg reduction targets. Technical report, Hydrogen Infrastructure for Transport, 2014.
- [37] Stuart R Wenham. *Applied photovoltaics*. Routledge, 2012.
- [38] Kai Zeng and Dongke Zhang. Recent progress in alkaline water electrolysis for hydrogen production and applications. *Progress in Energy and Combustion Science*, 36:307–326, June 2010.

# 11 Appendix

The appendix are going to include raw results from some of the studies done in a way that is readable. For some of the graphs, only a duration curve is going to be shown to keep it readable while superposing cases in order to reduce the space taken in the appendix. The results are also going to be shown primarily for the case 10% and 50% to again reduce the size.

## 11.1 Raw Results Base Case

This case is before the factory implementation, no hydrogen is produced so there is no electrolyzer and no storage. No solar is in the system either and the wind power is the one already there. There is no rationing at any bus. Hydro spillage only happens for the bus shown below, if it is not shown there is no spillage.

Bus 0	Bus 1	Bus 2	Bus 3	Bus 4	Bus 5	Bus 6	Bus 7	Bus 8	Bus 9
0	7.11	0	0	0	200.5	0	0	40	171.69

Table 20: Wind power at each bus base case (MW)

Line 0	Line 1	Line 2	Line 3	Line 4	Line 5	Line 6	Line 7	Line 8	Line 9
0.62	0.61	0.51	0.47	0.42	0.45	0.89	0.37	0.45	0.18

Table 21: Utilization factor of the lines base case

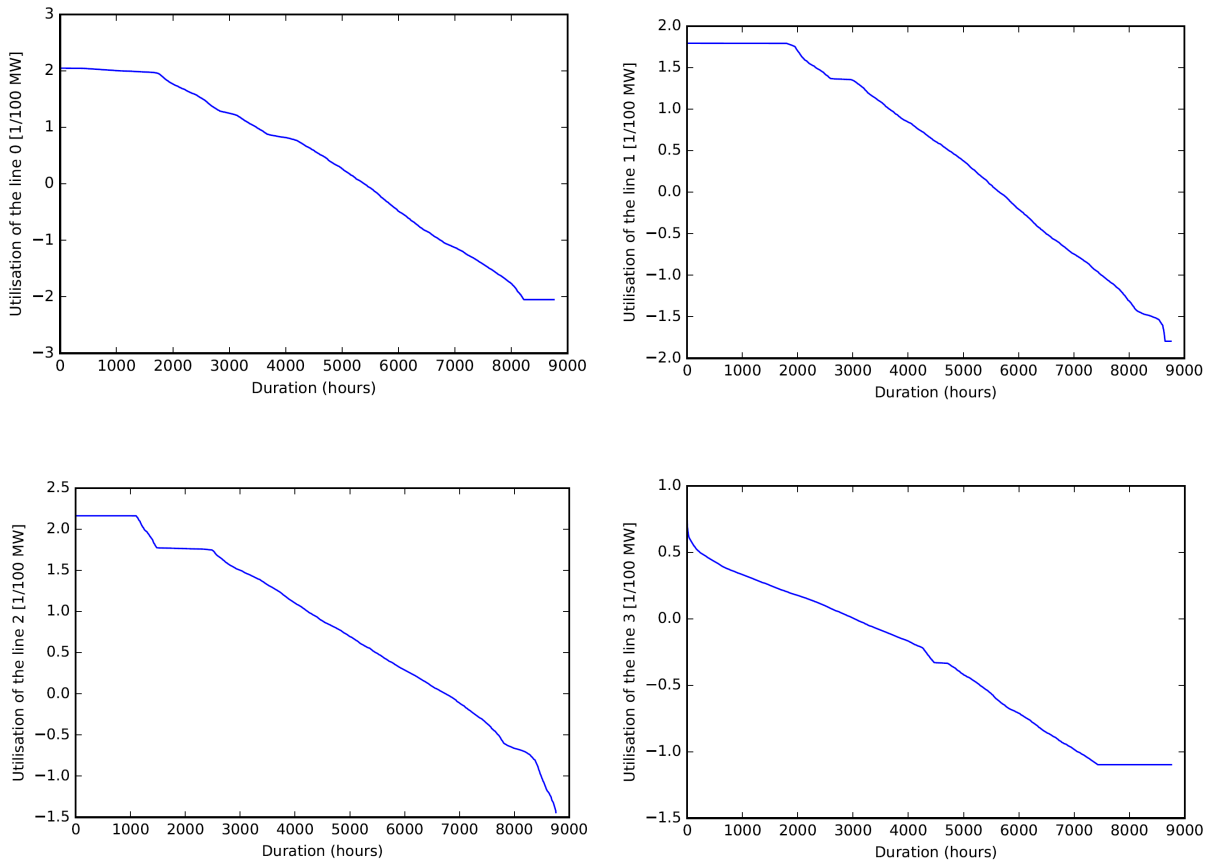

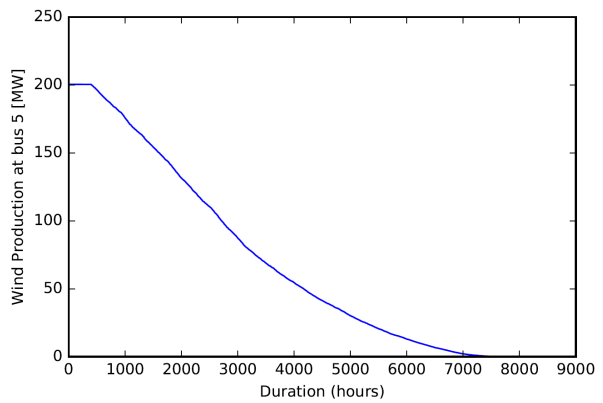
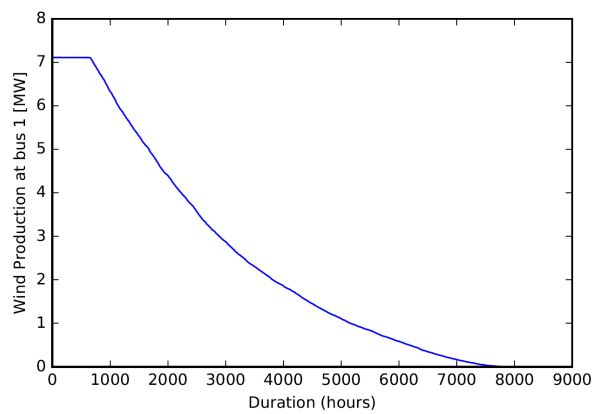
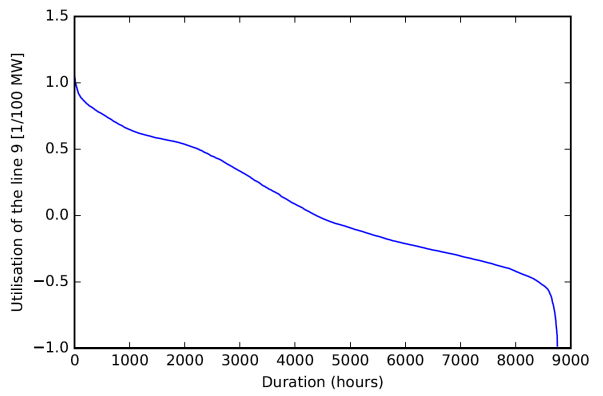
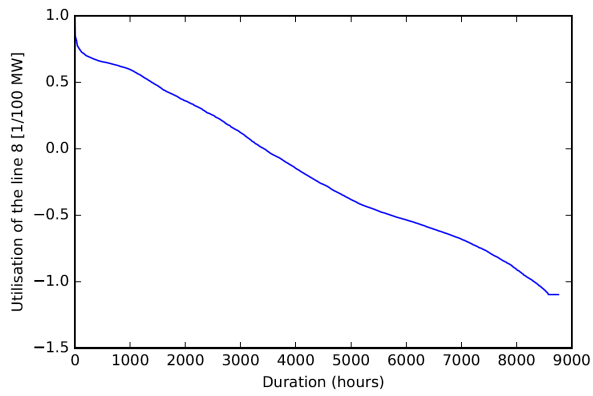
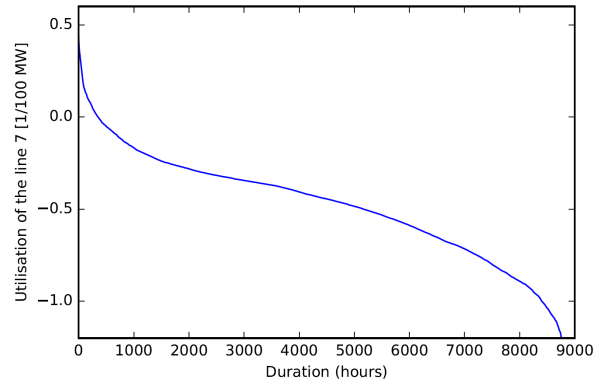
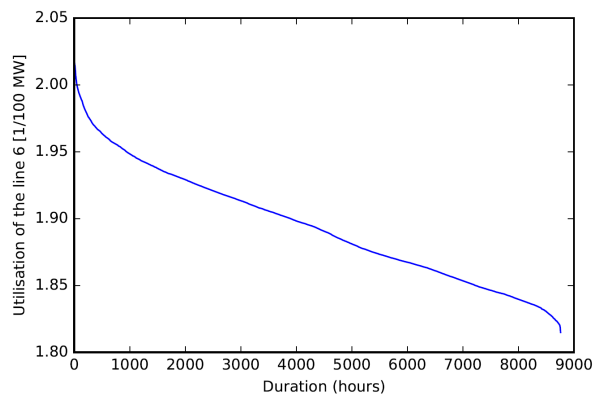
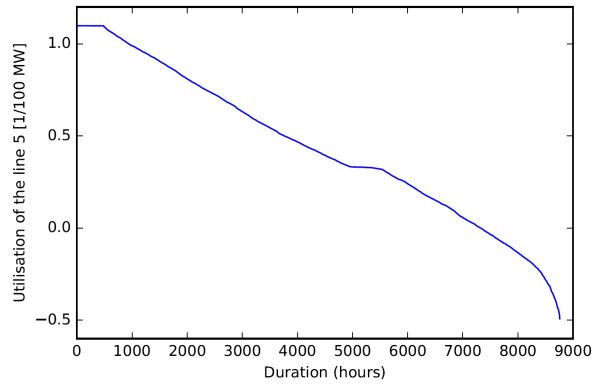
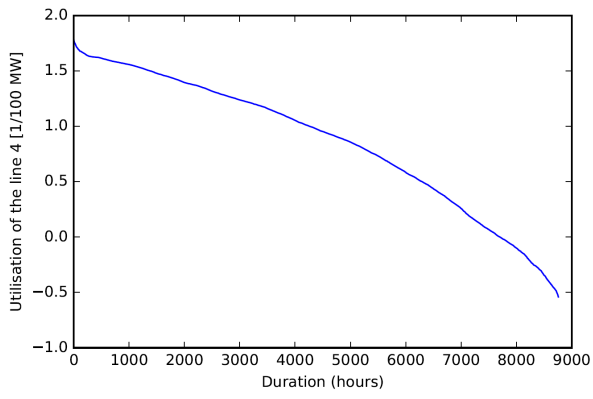

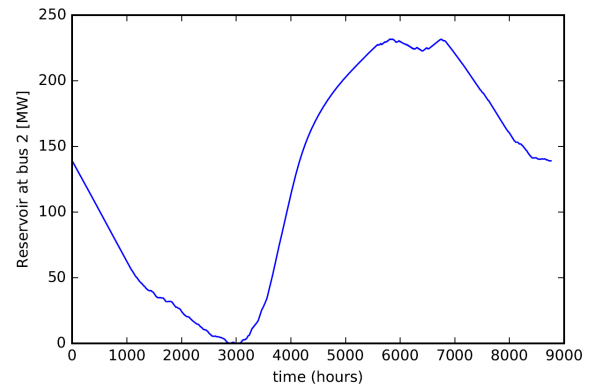
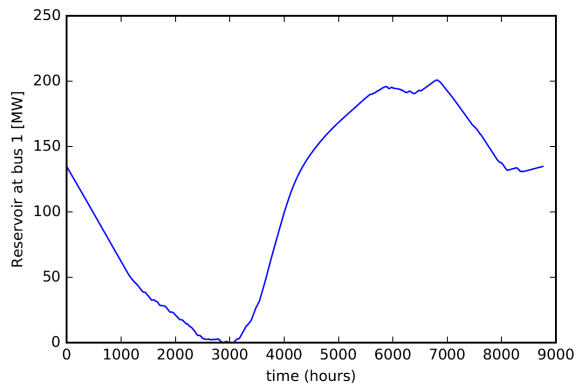
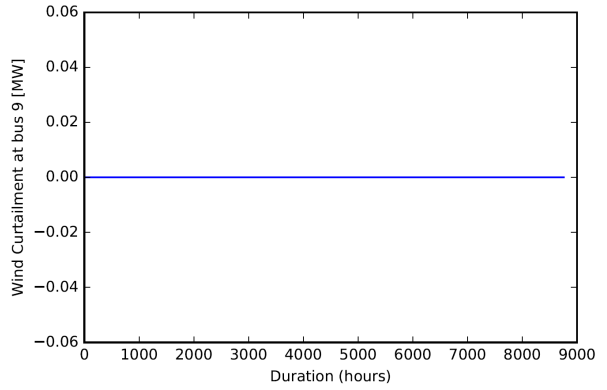
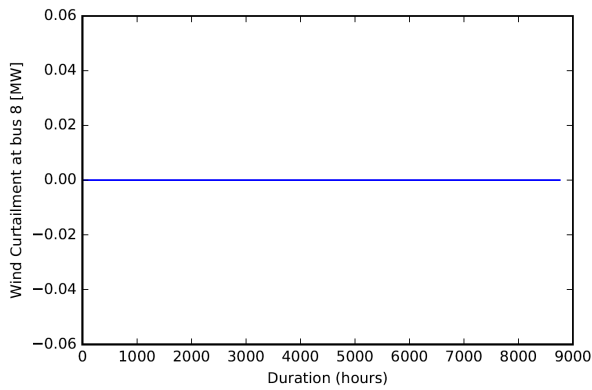
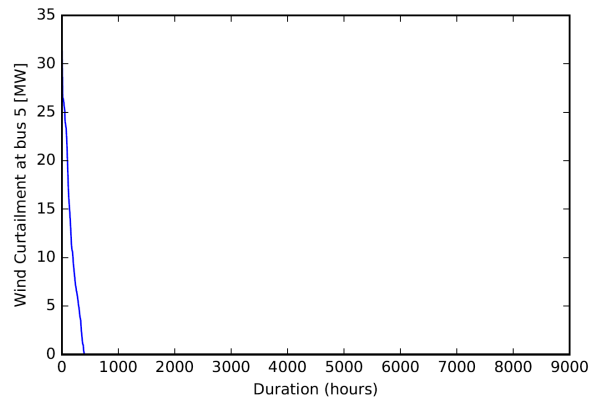
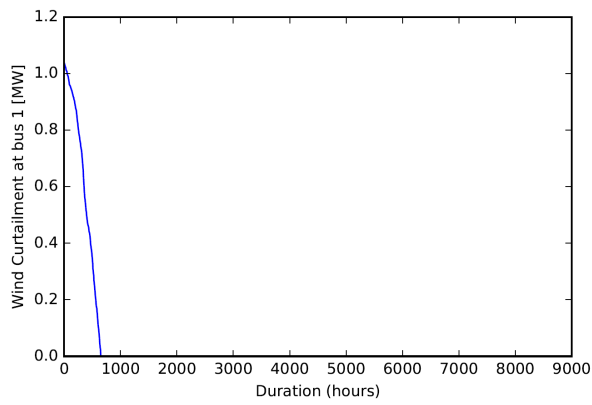
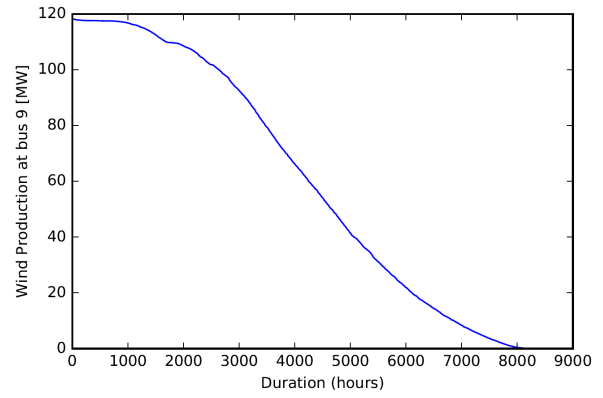
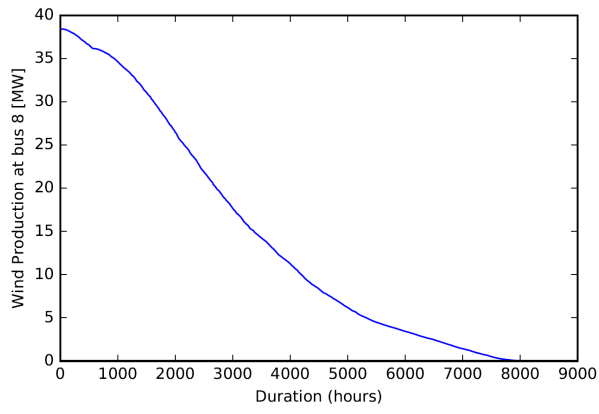

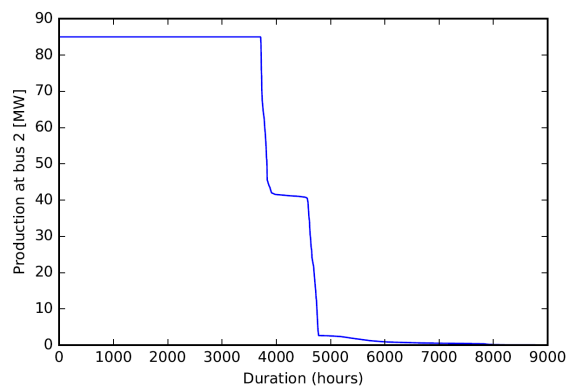
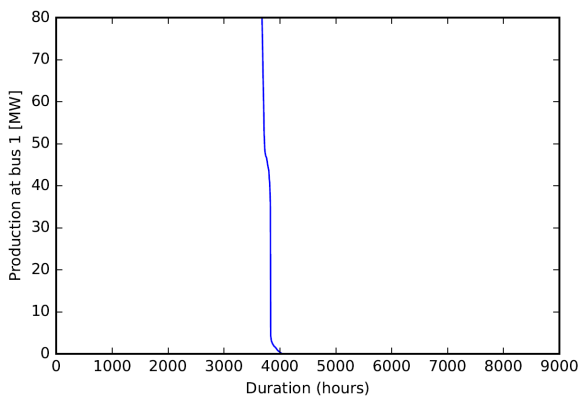
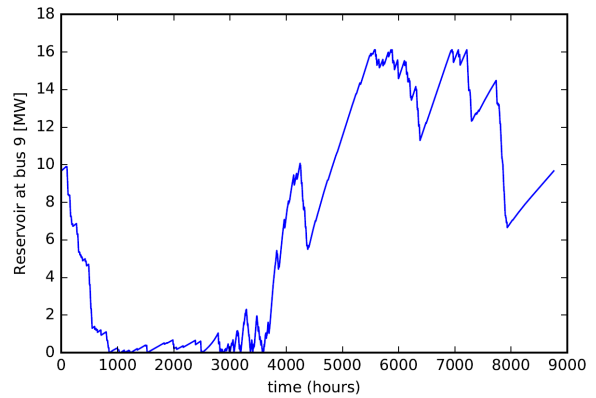
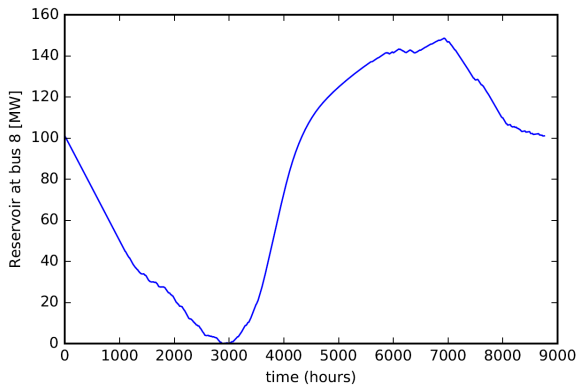
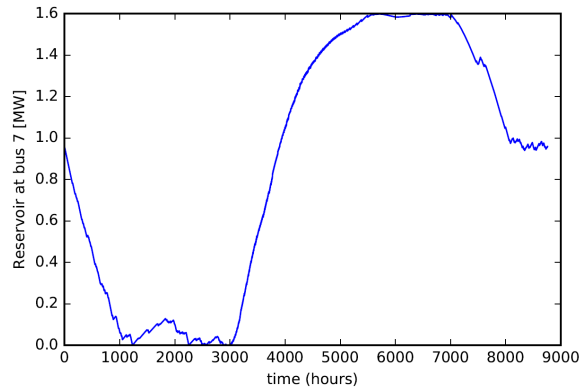
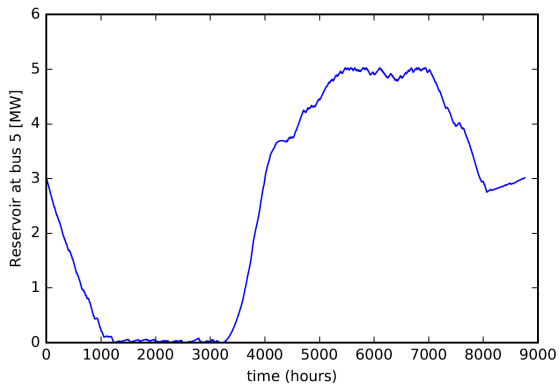
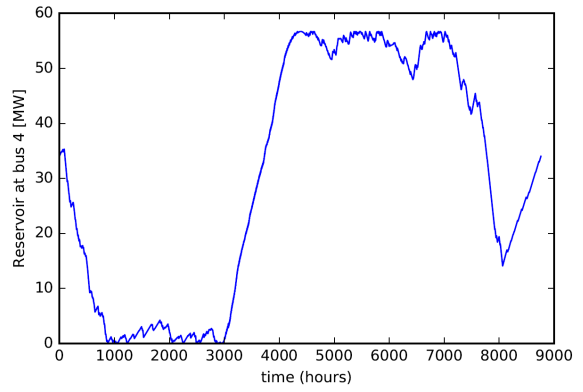
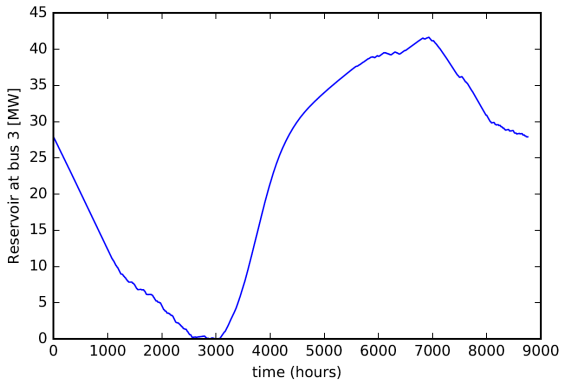



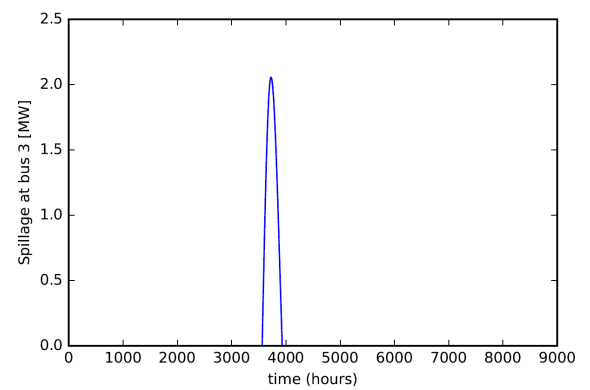
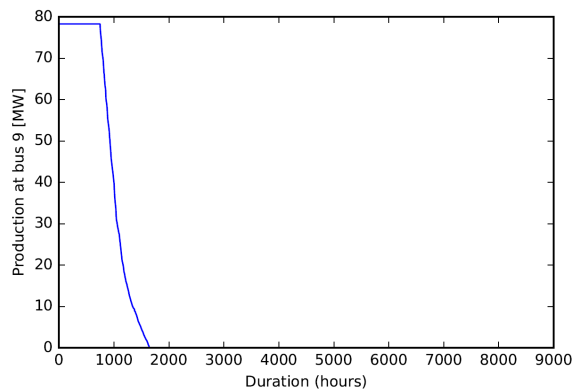
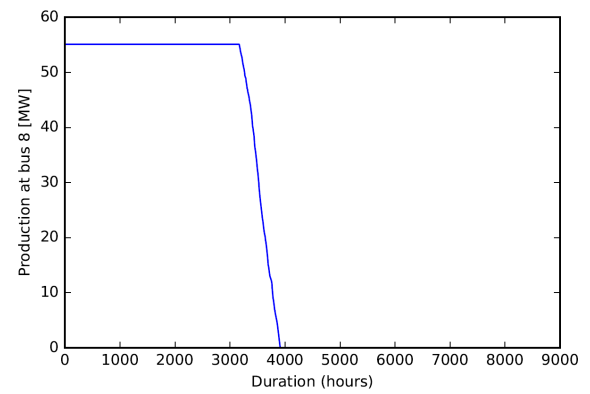
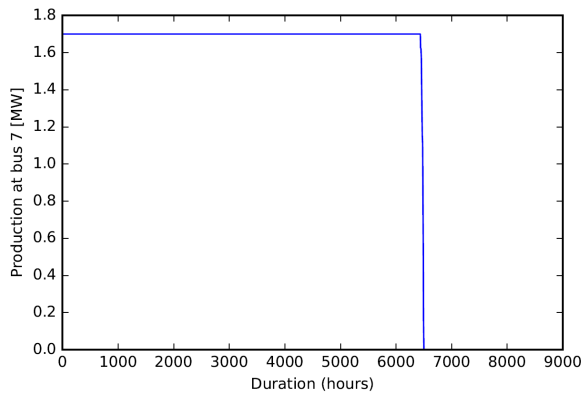
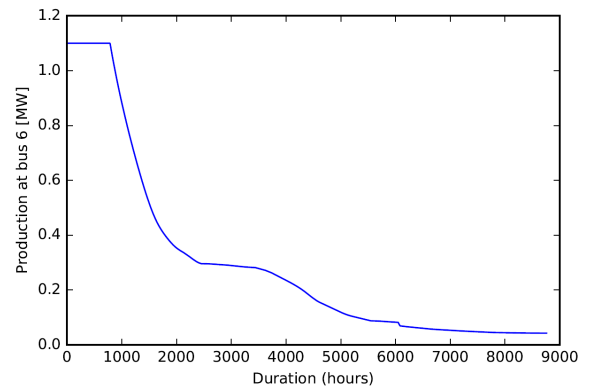
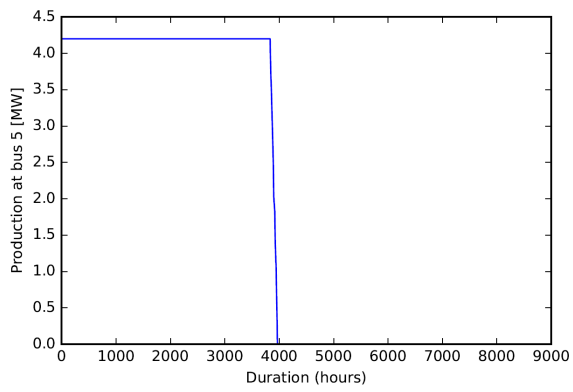
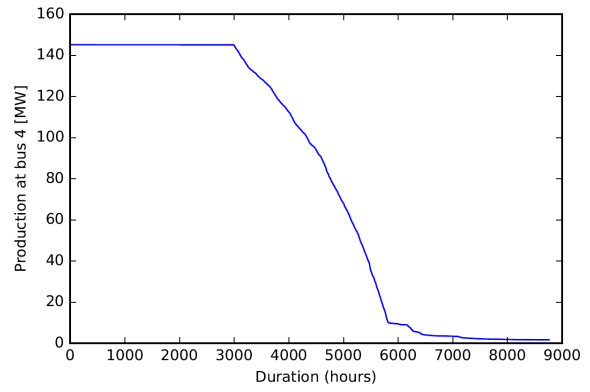
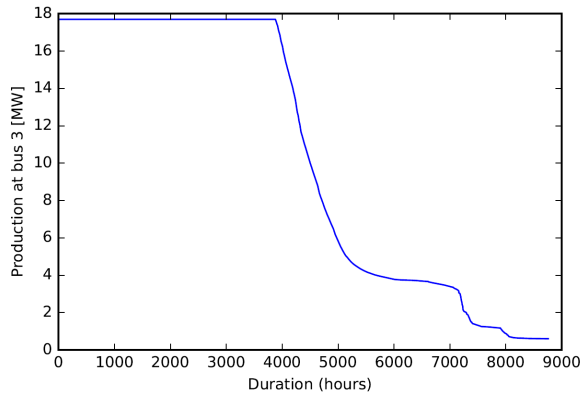

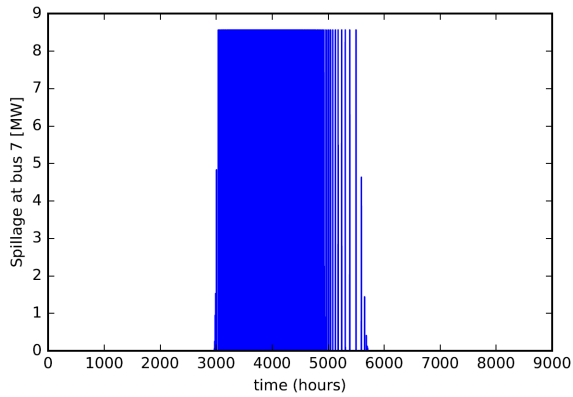
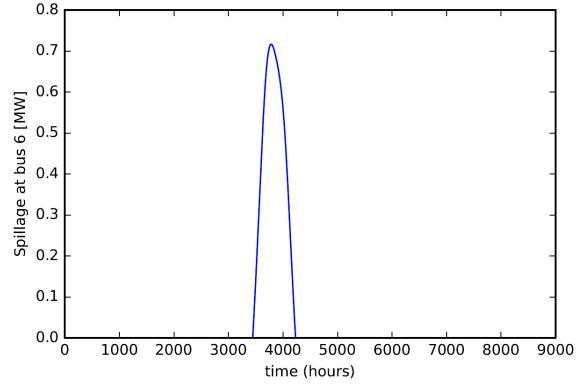
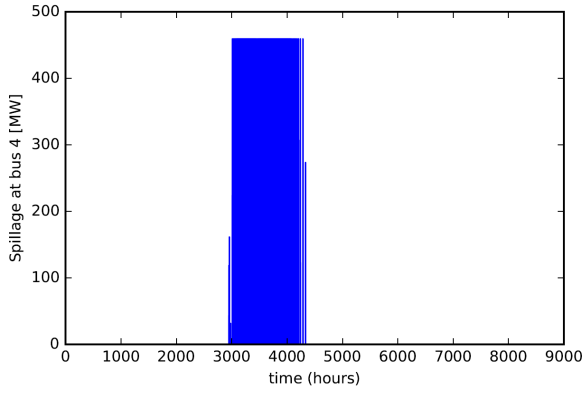

## 11.2 Raw Results Studies Case 10%

The results for the state of the system and the investments are already included in the thesis and discussed, so they will not be repeated here. Only the graphs are going to be presented instead. The figures for the hydro system are not shown either because they are presented in the last section of the thesis. On the figures below, the red line is the case with only wind expansion, the green line is wind+solar at 3,8\$/Wp, the yellow line 1,6\$/Wp and the pink line 0,3\$/Wp. The dual values associated with the constraints are not shown here.

	Line 0	Line 1	Line 2	Line 3	Line 4	Line 5	Line 6	Line 7	Line 8	Line 9
Case Wind Expansion	0.61	0.67	0.68	0.35	0.61	0.56	0.87	0.46	0.51	0.22
Case Solar 3,8\$/Wp	0.61	0.67	0.68	0.35	0.61	0.56	0.87	0.46	0.51	0.22
Case Solar 1,6\$/Wp	0.61	0.67	0.68	0.35	0.61	0.56	0.87	0.46	0.51	0.22
Case Solar 0,3\$/Wp	0.59	0.62	0.61	0.42	0.55	0.56	0.87	0.38	0.46	0.19

Table 22: Utilization factors of the lines for the different studies in the case 10%

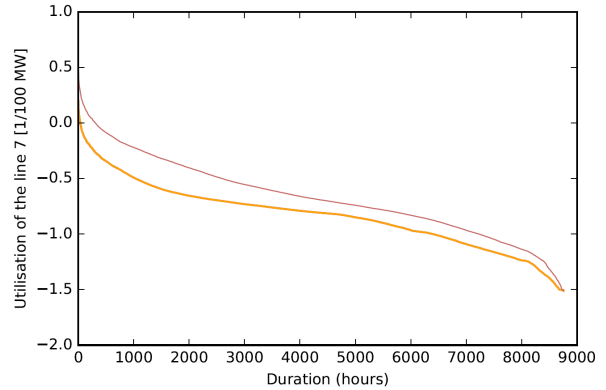
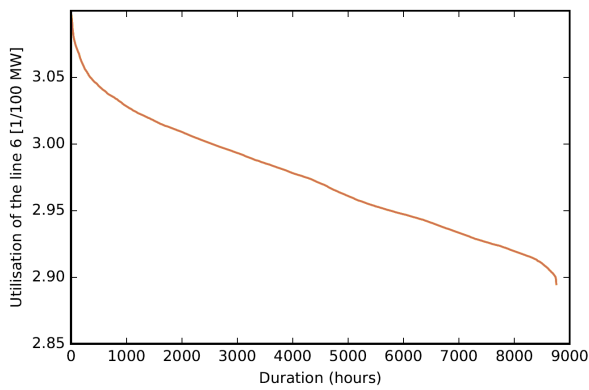
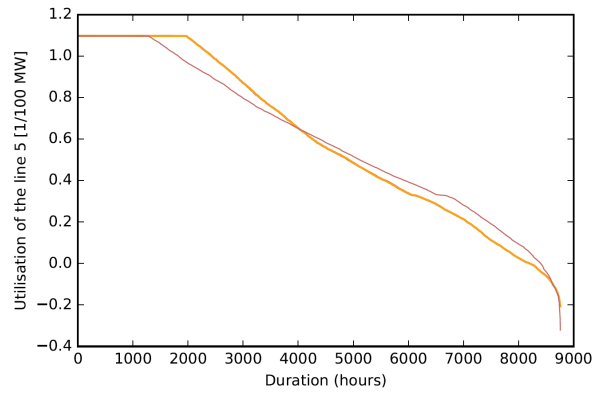
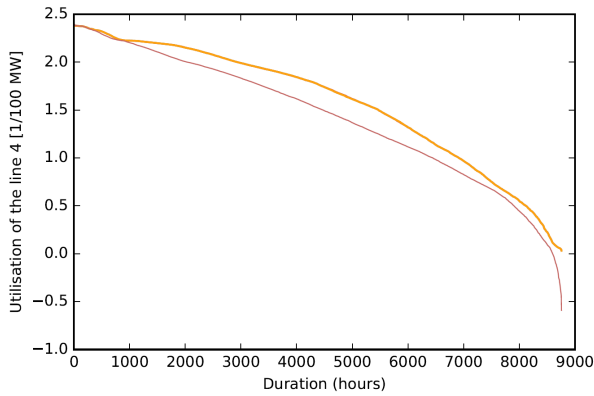
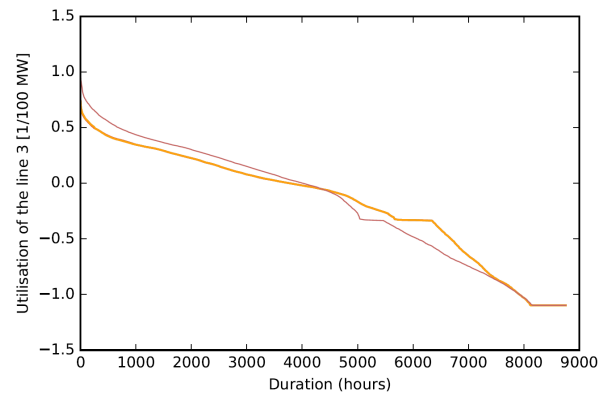
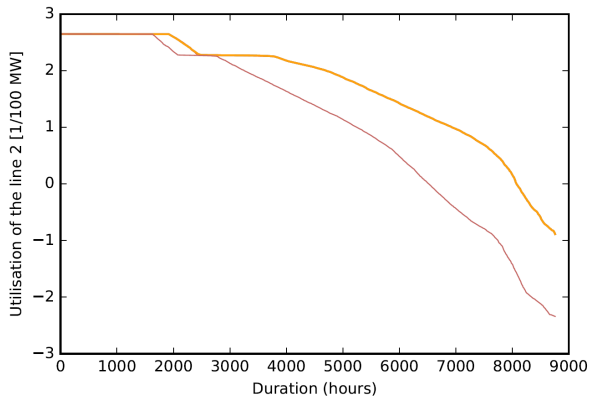
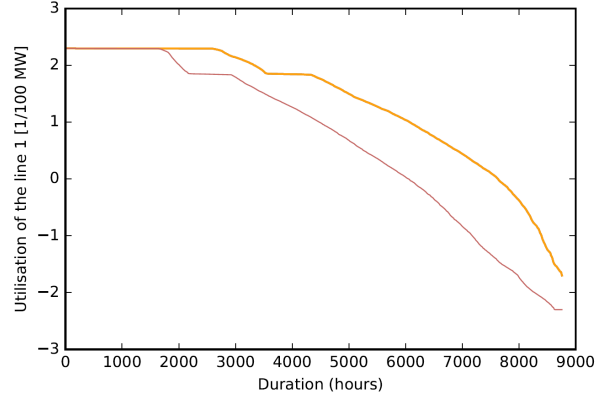
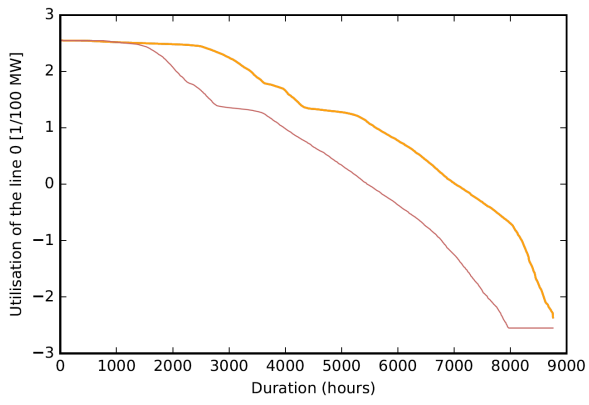

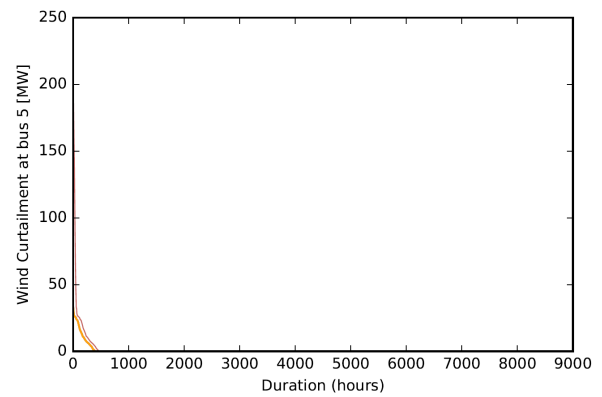
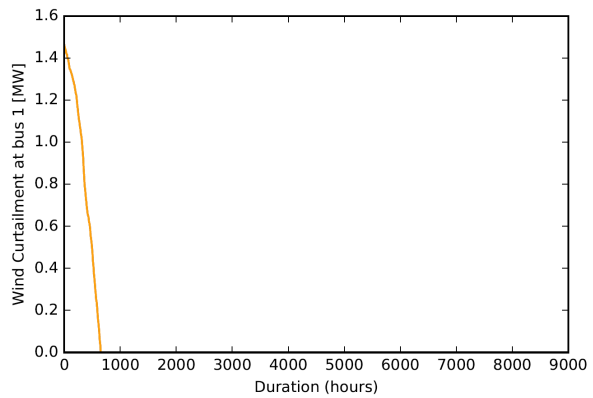
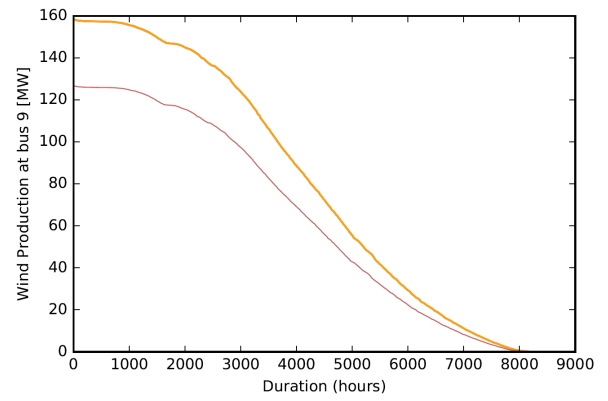
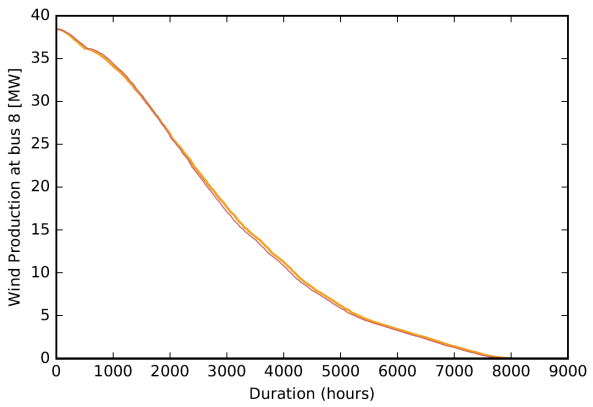
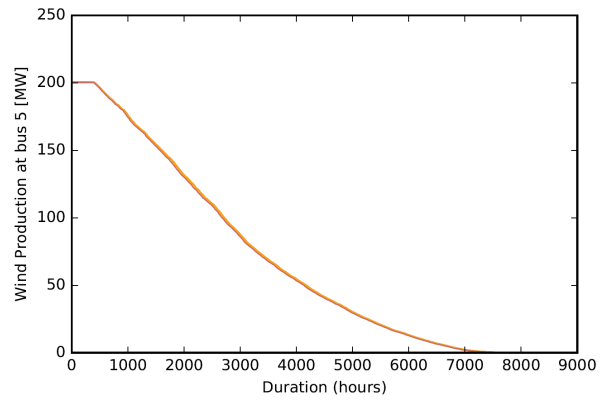
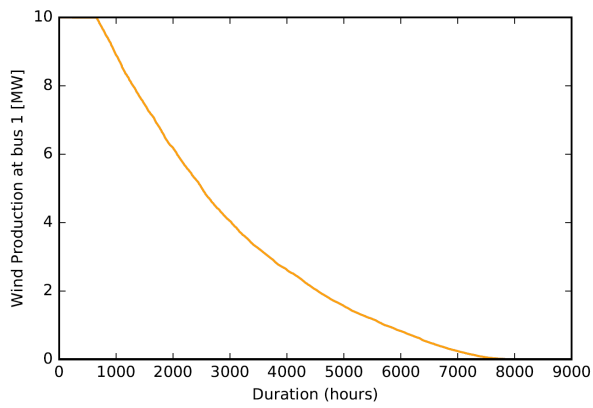
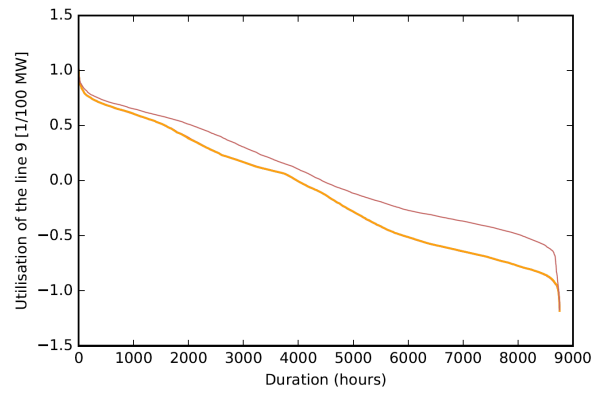
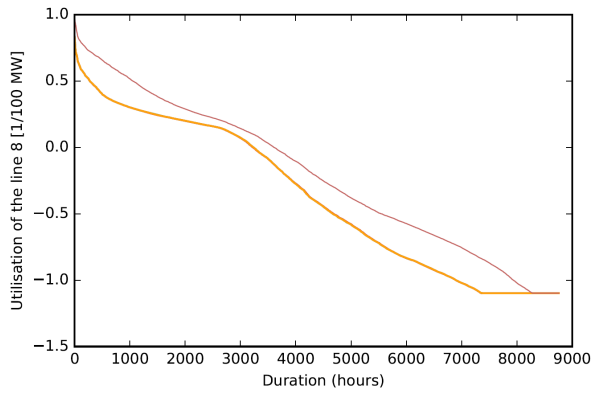

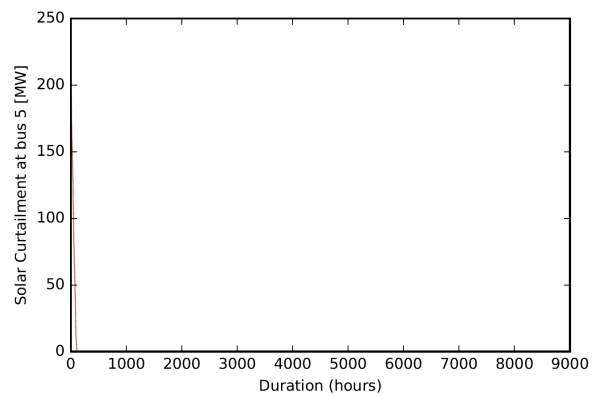
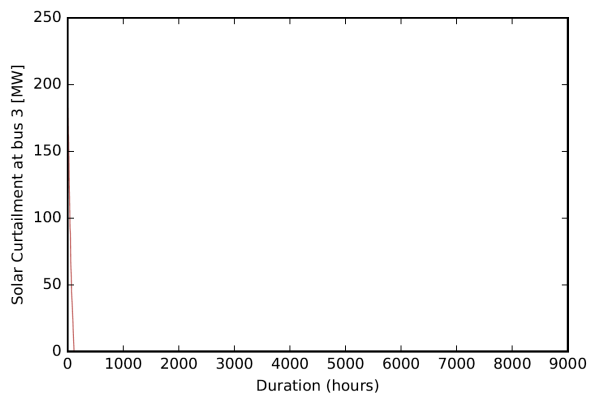
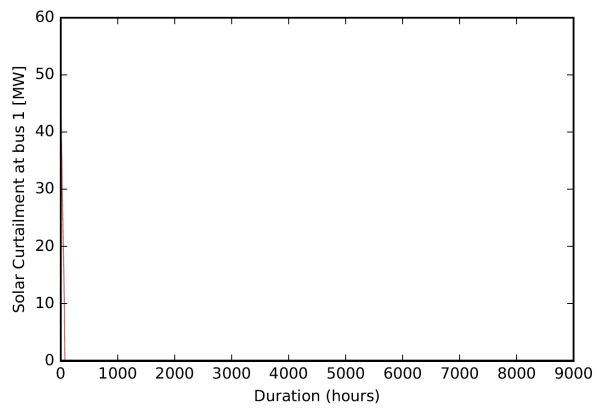
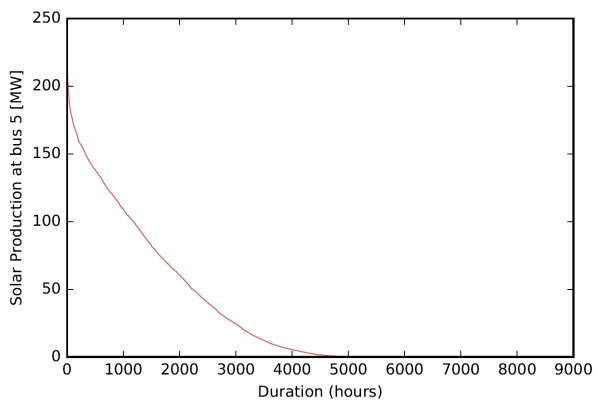
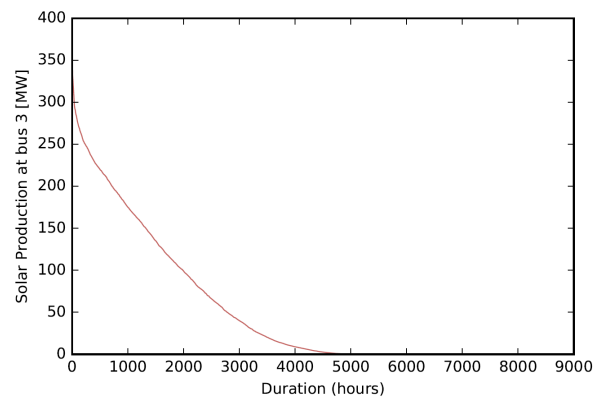
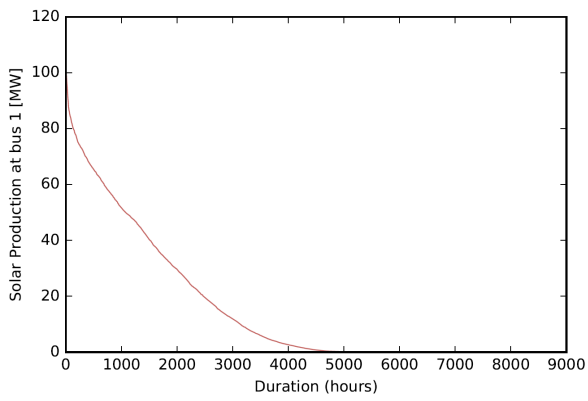
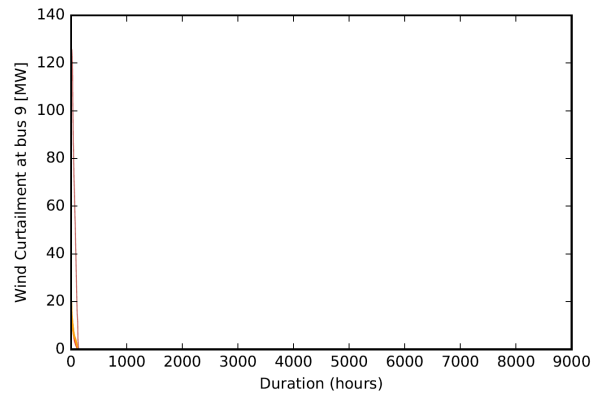
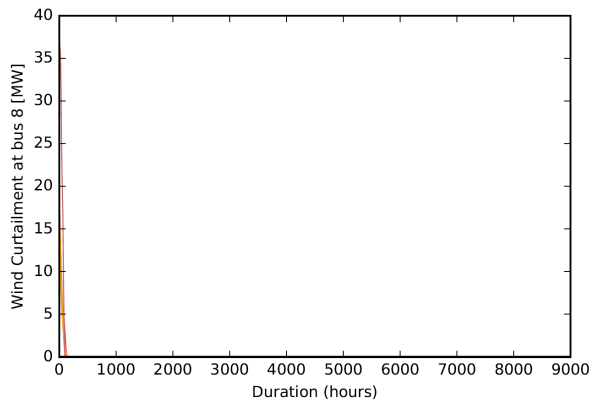

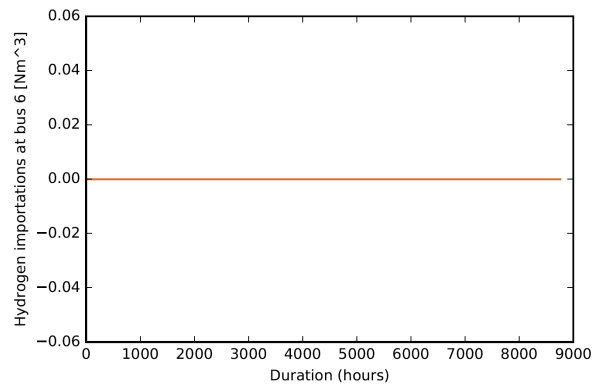
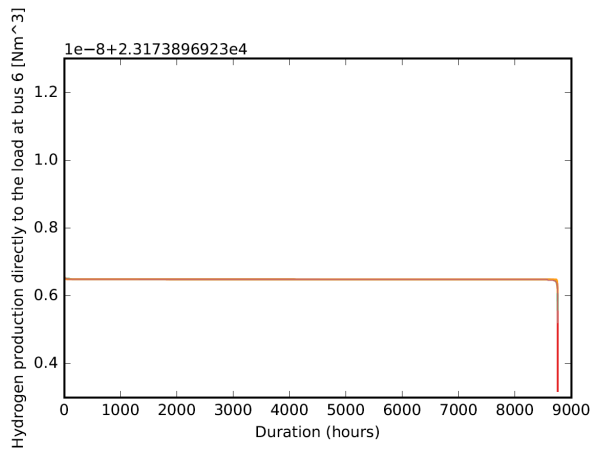

### 11.3 Raw Results Increasing Proportion from Electrolysis

The figure in this part are shown from the lowest proportion from electrolysis (lightest line) to the highest (darkest line).

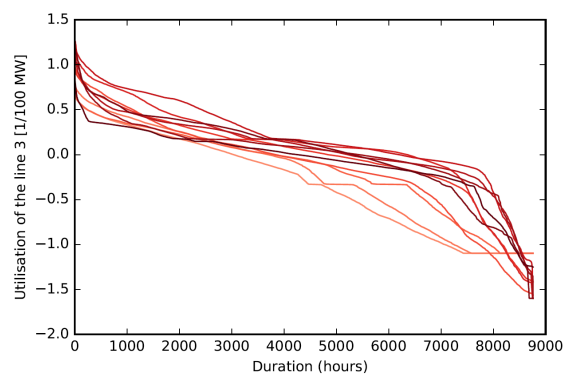
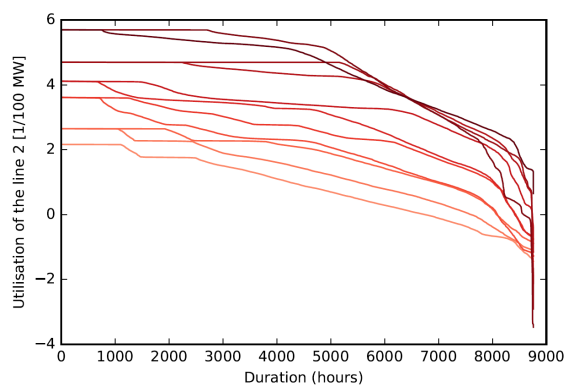
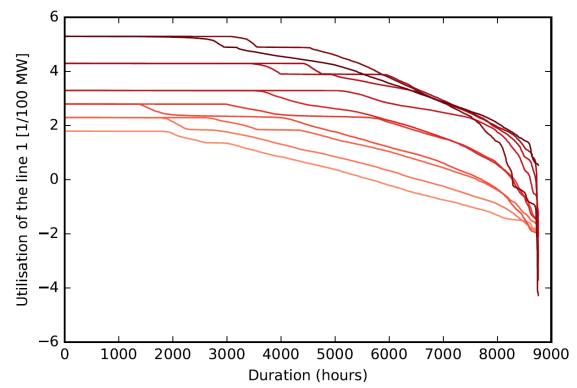
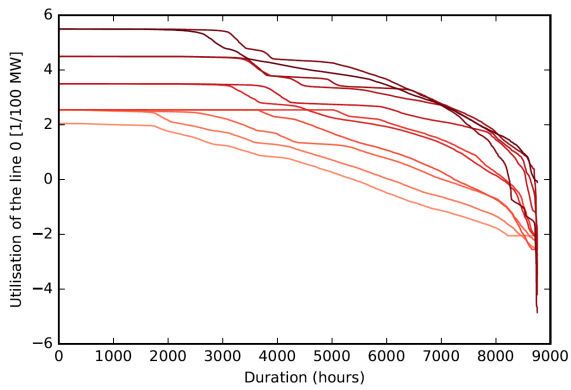

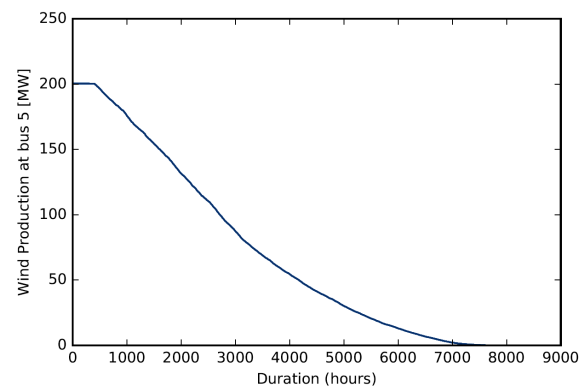
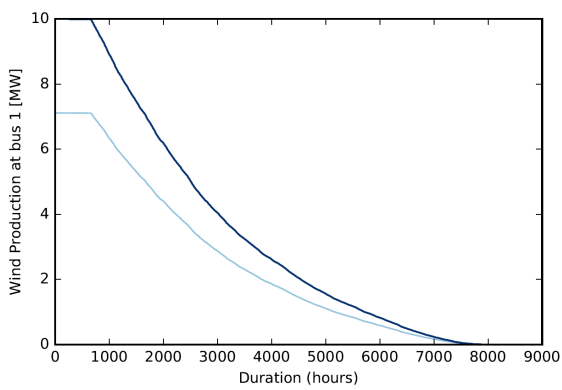
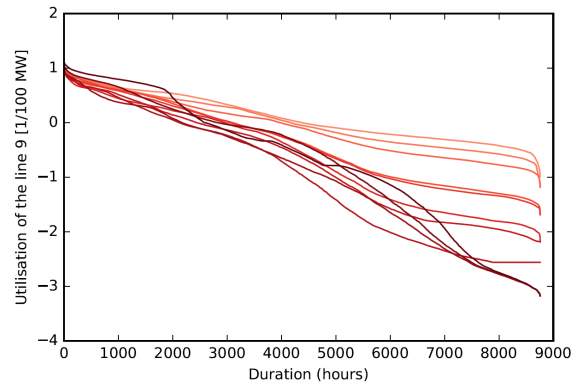
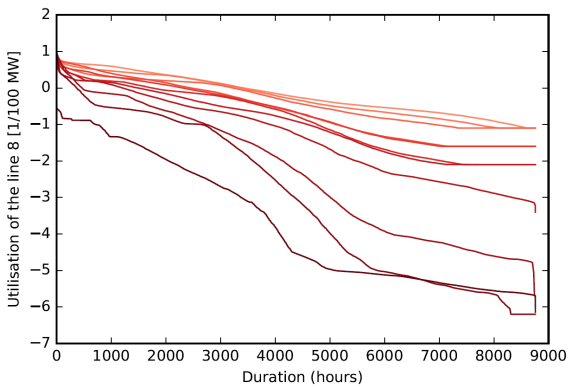
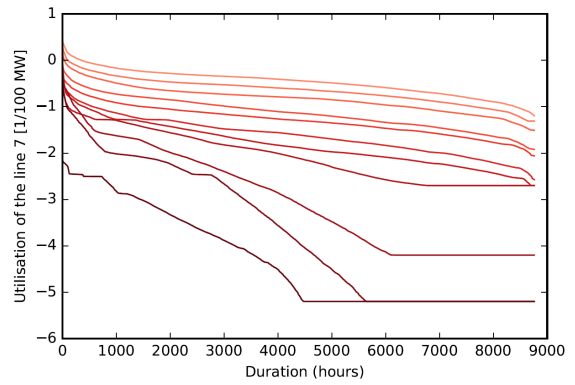
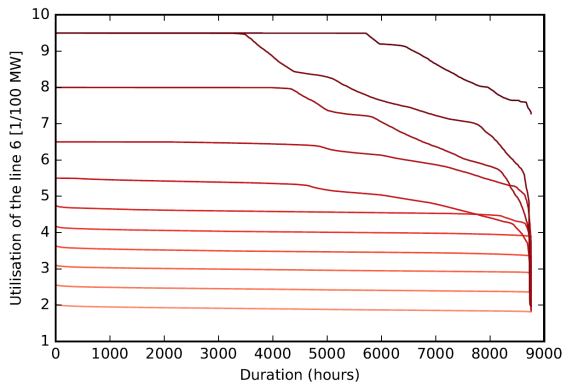
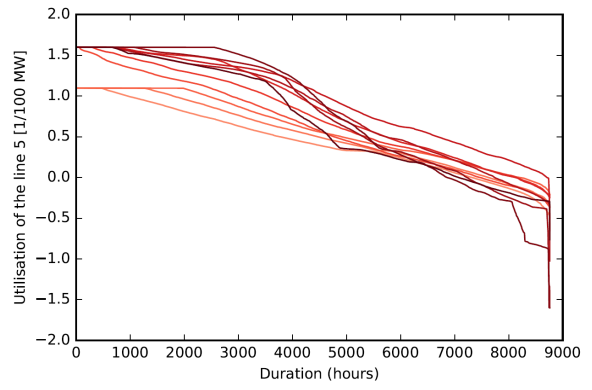
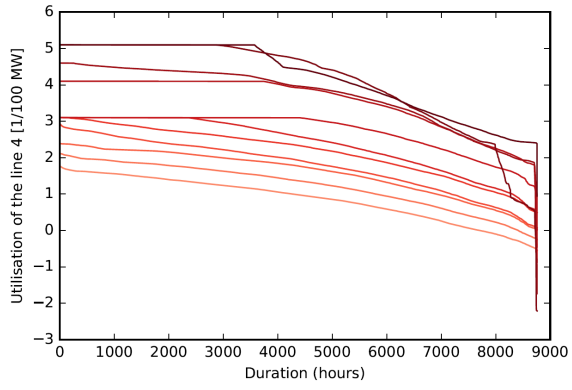

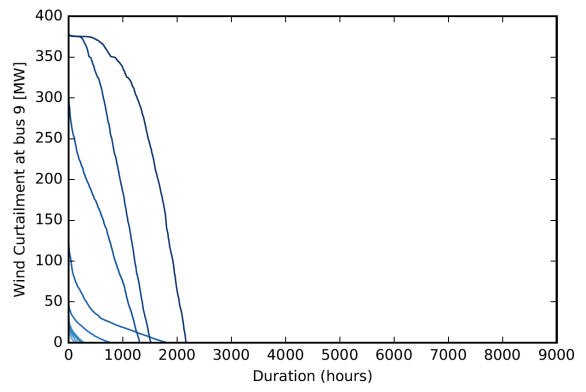
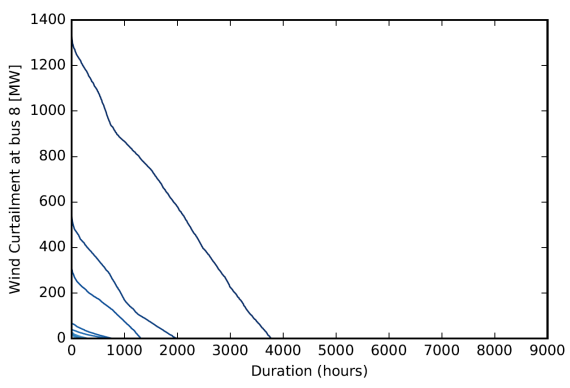
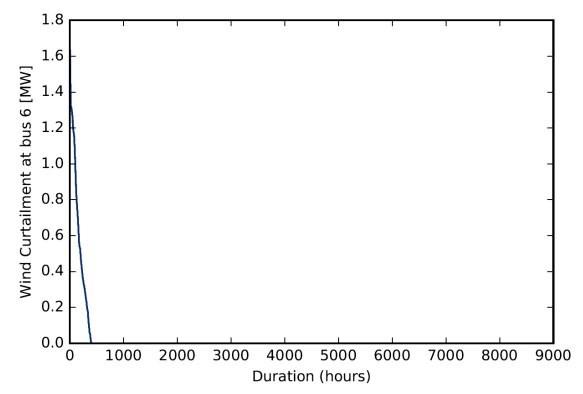
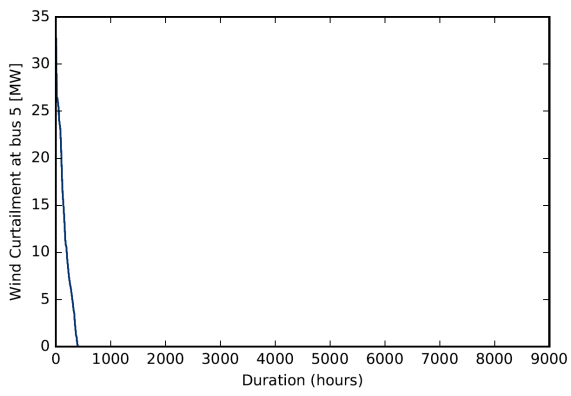
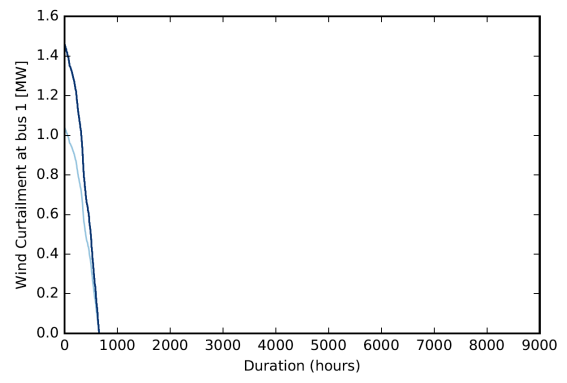
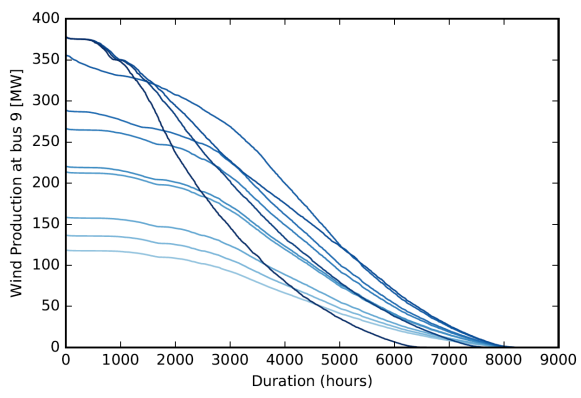
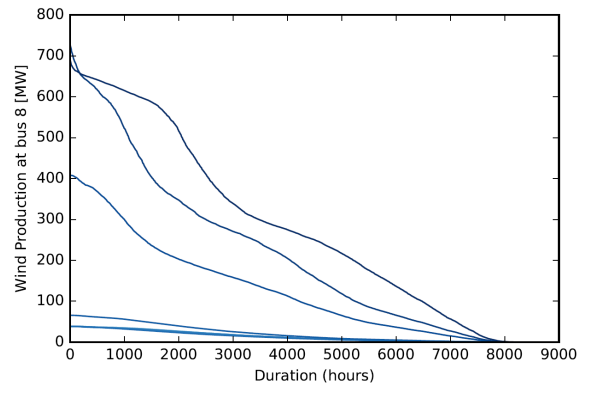
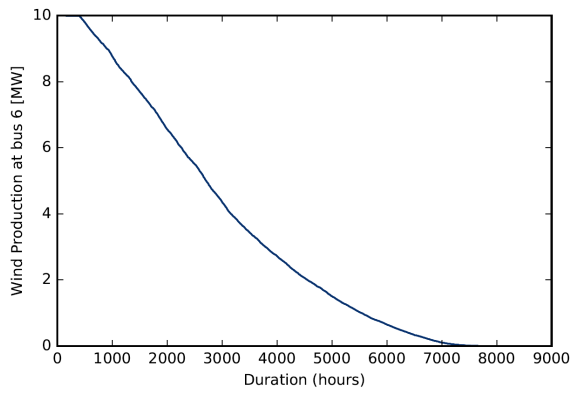



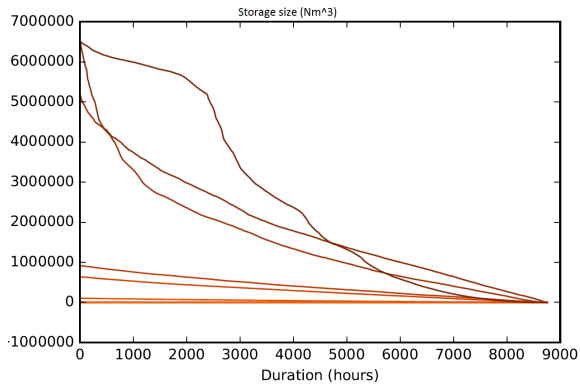

### 11.4 Raw Results Study Weak Grid 10% Solar at 1,6\$/Wp

The results are presented from the smallest grid (lightest line on the graph) to the biggest grid (darkest line on the graph).

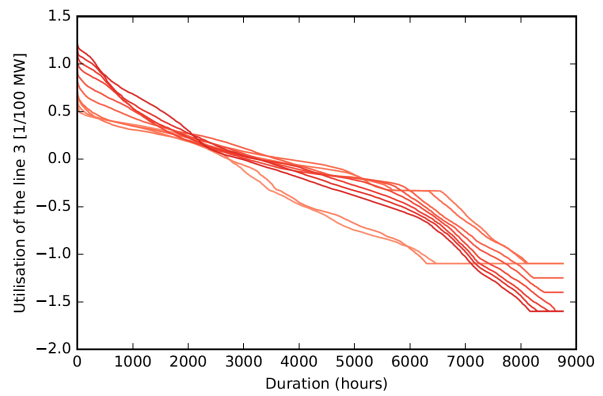
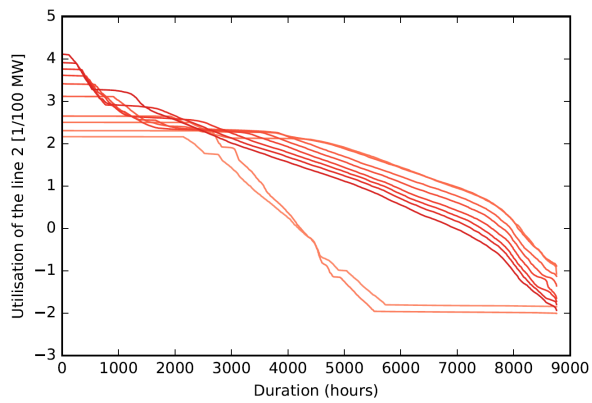
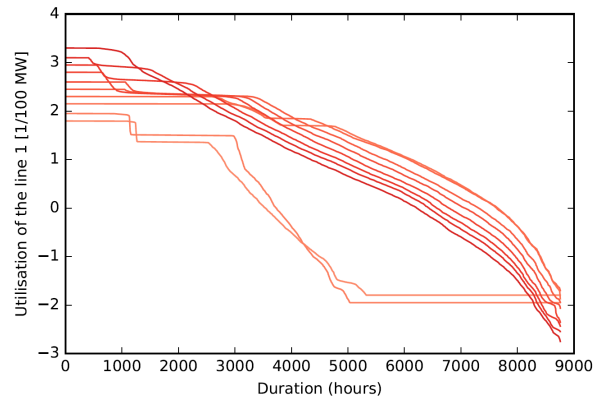
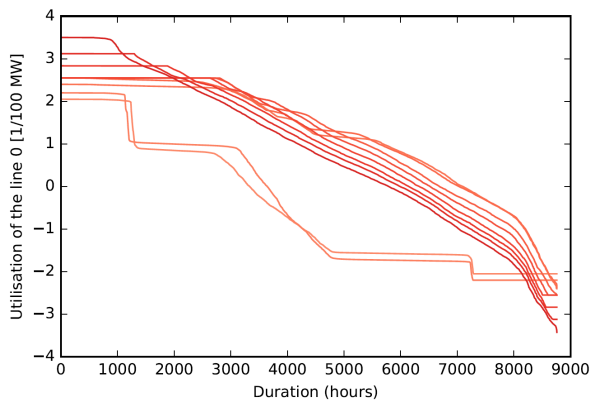

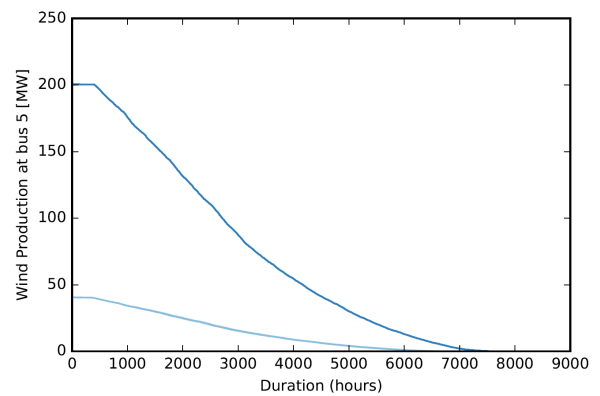
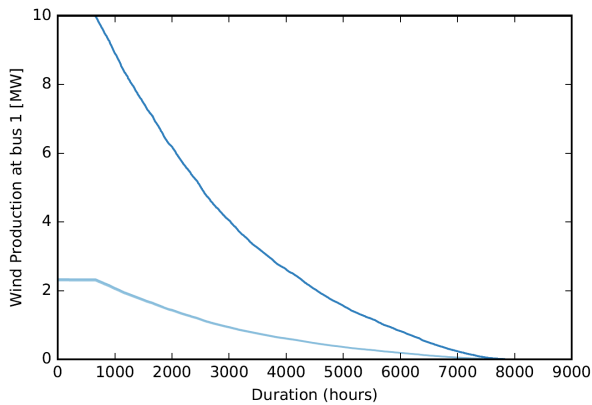
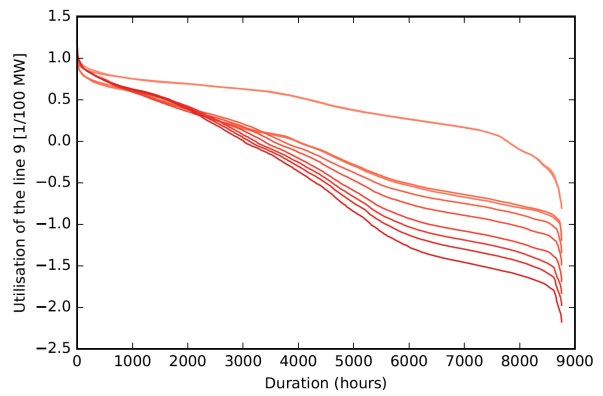
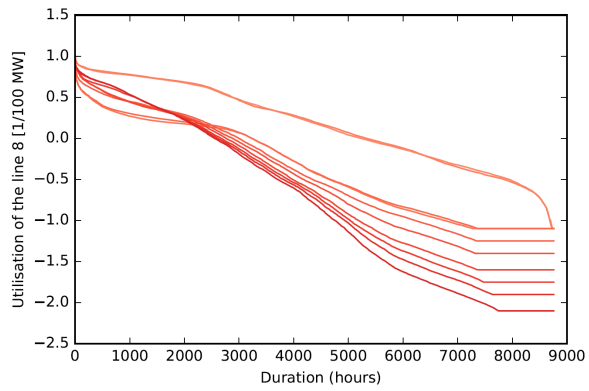
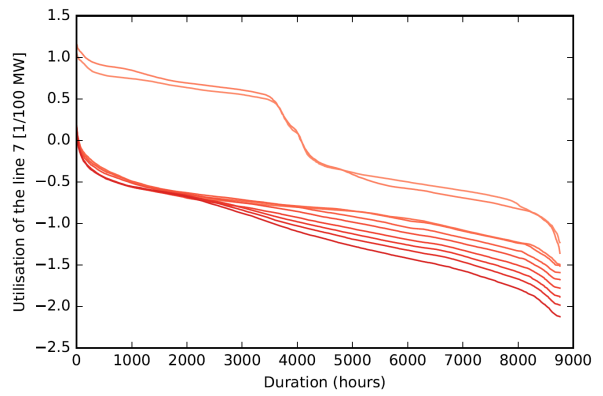
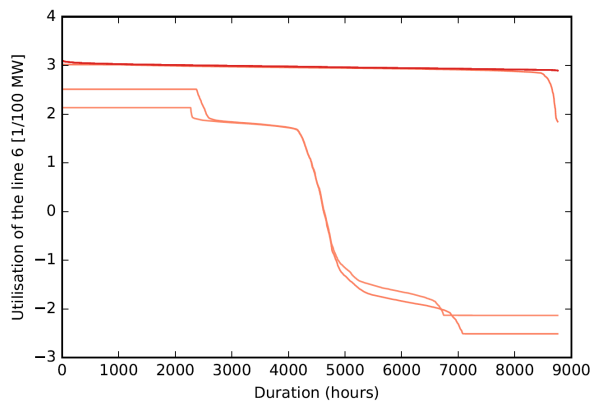
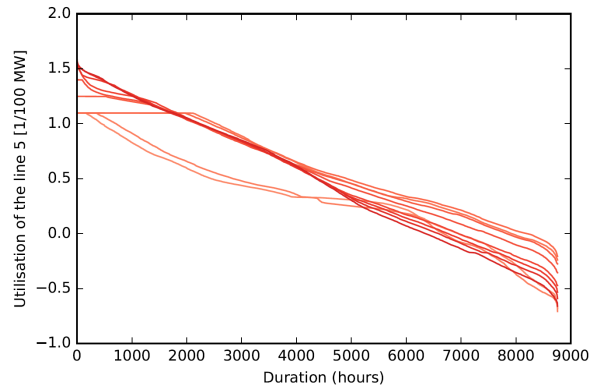
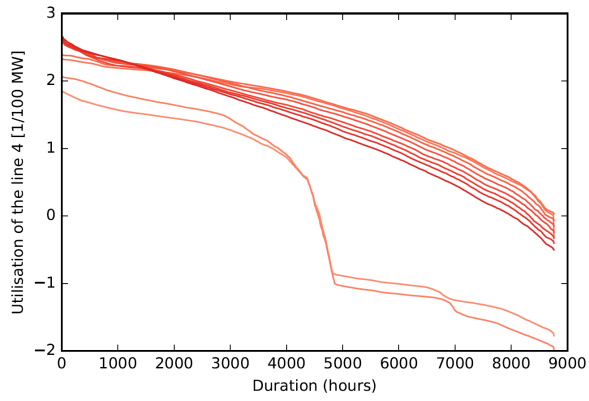

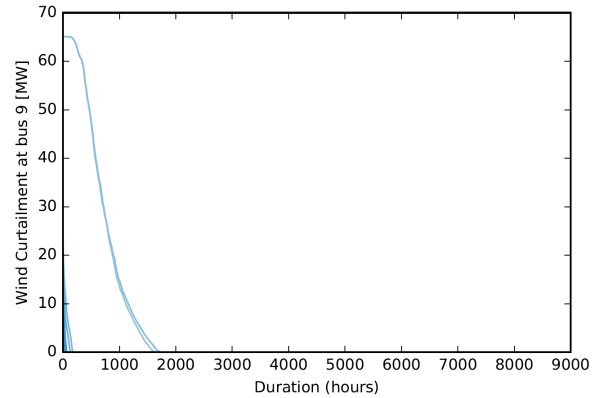
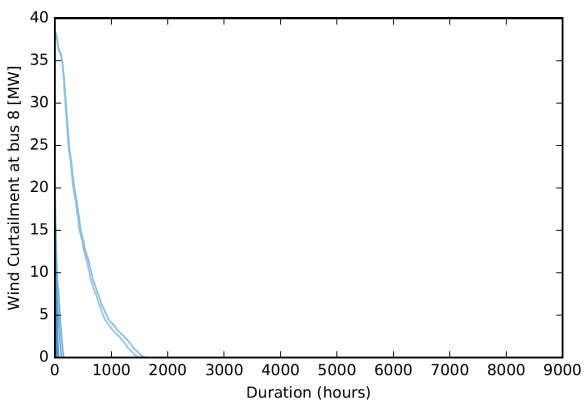
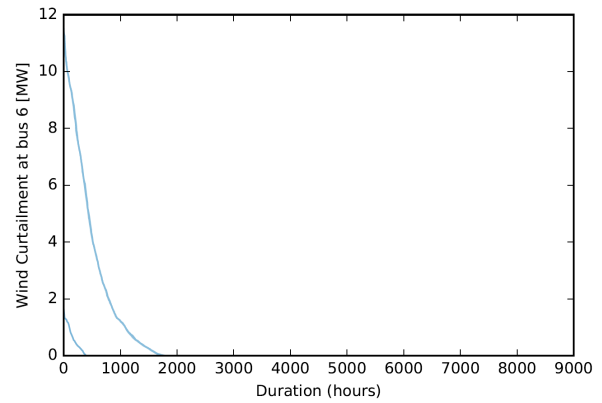
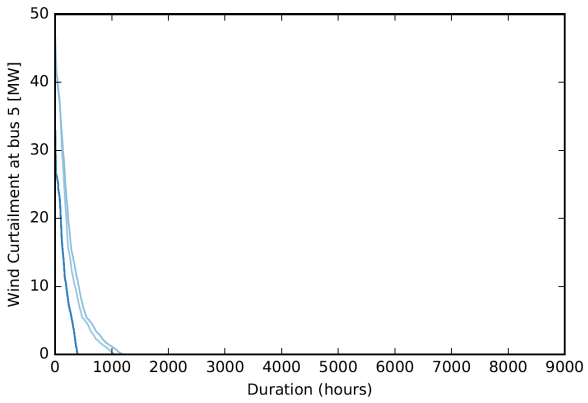
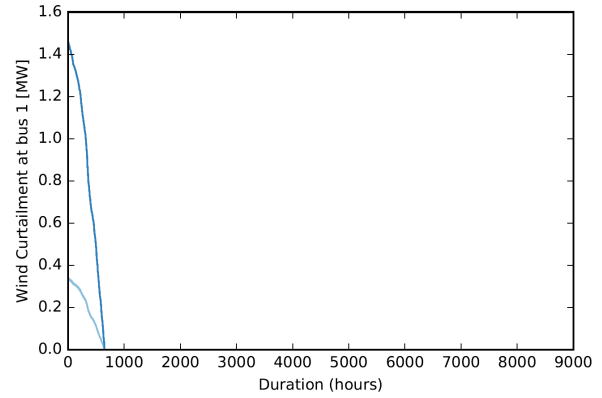
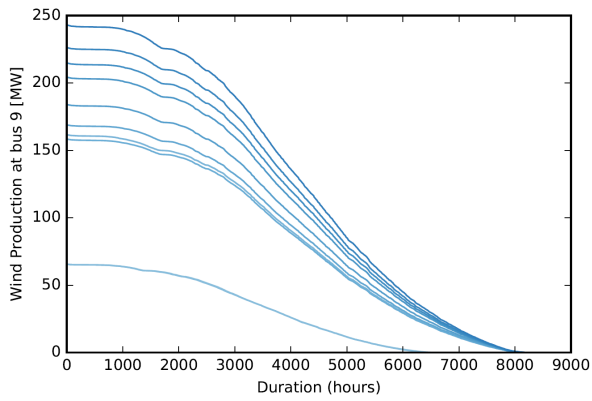
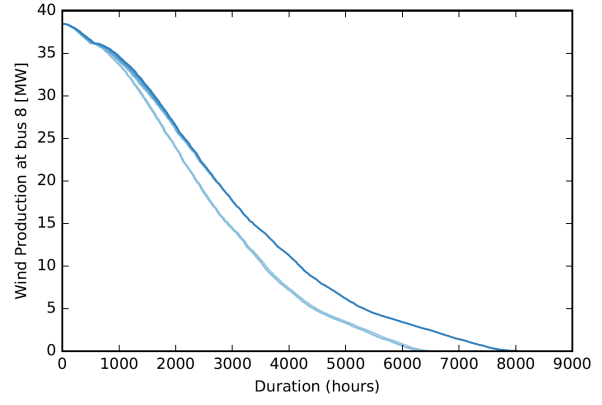
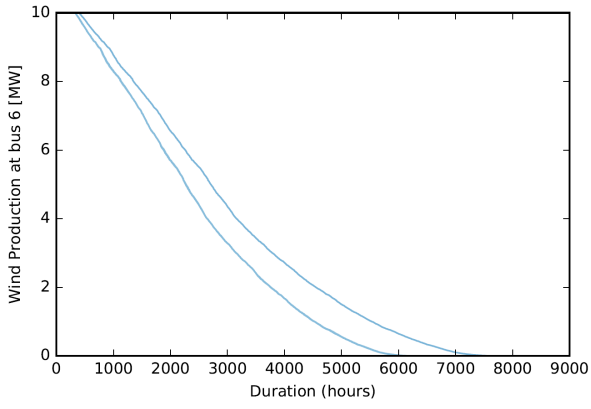

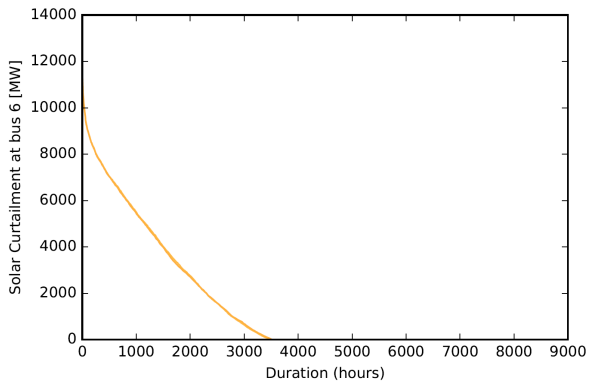
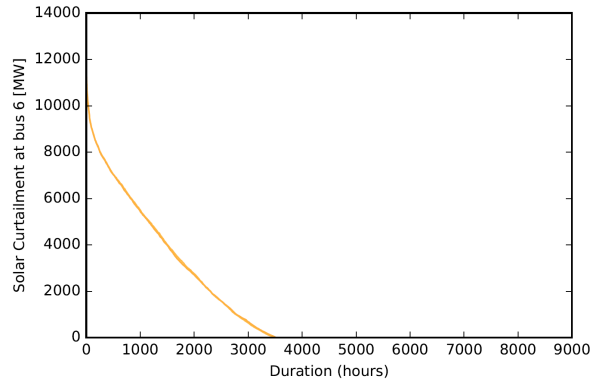
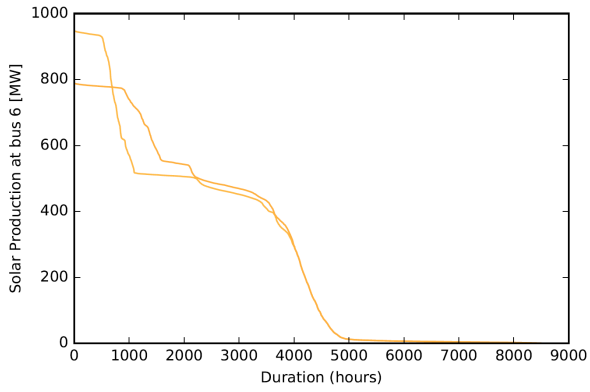

## 11.5 Raw Results Study Weak Grid 10% Solar at 0,3\$/Wp

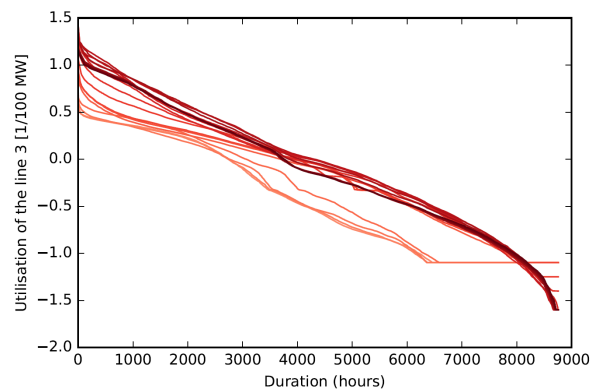
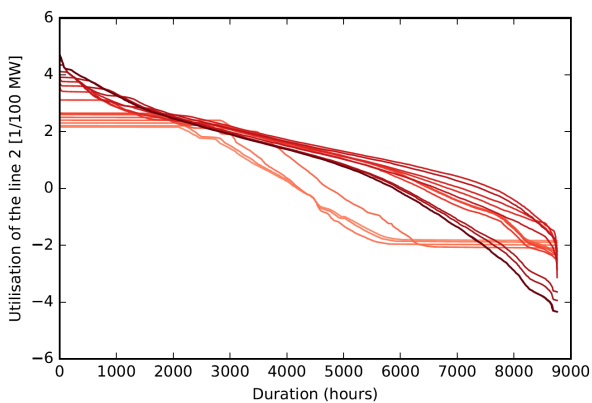
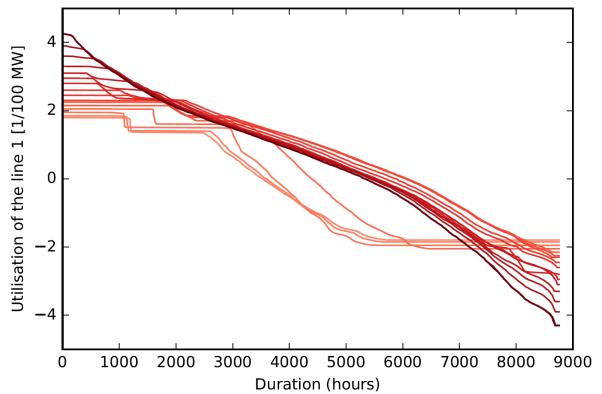
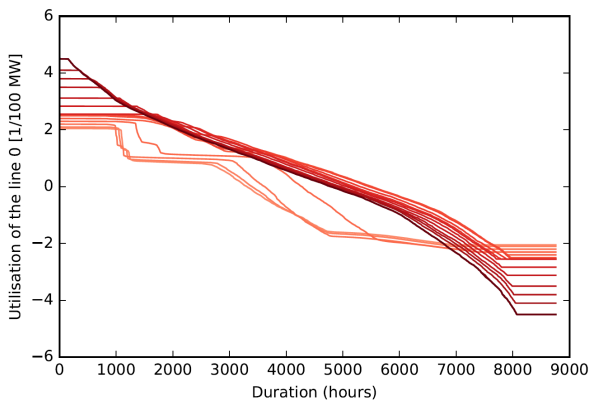

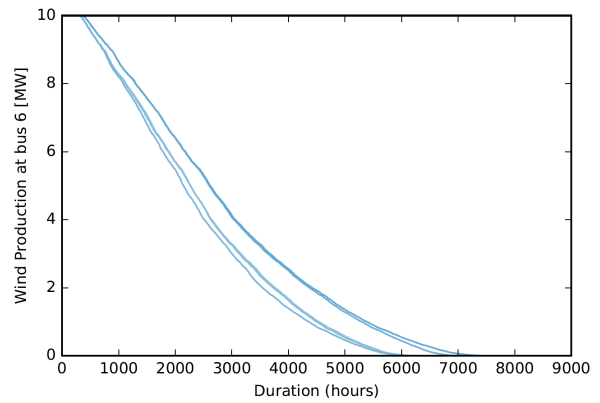
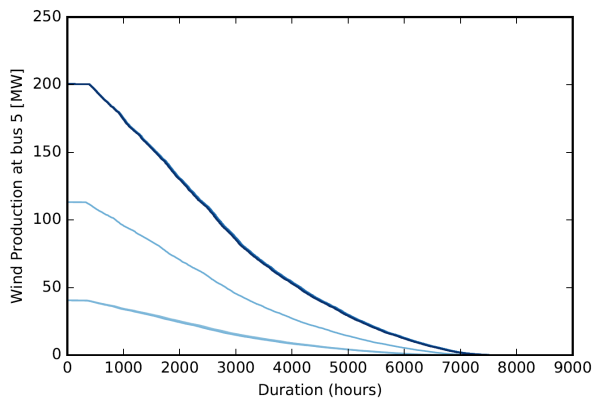
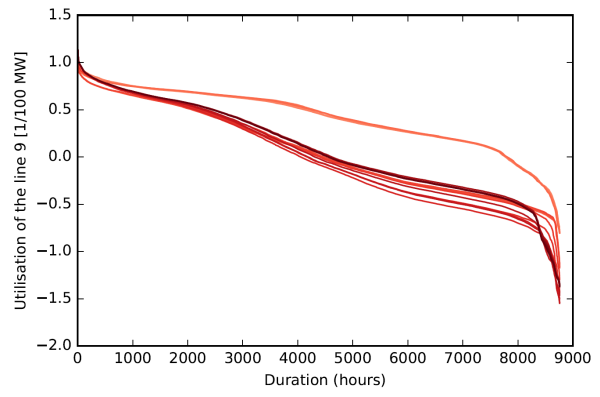
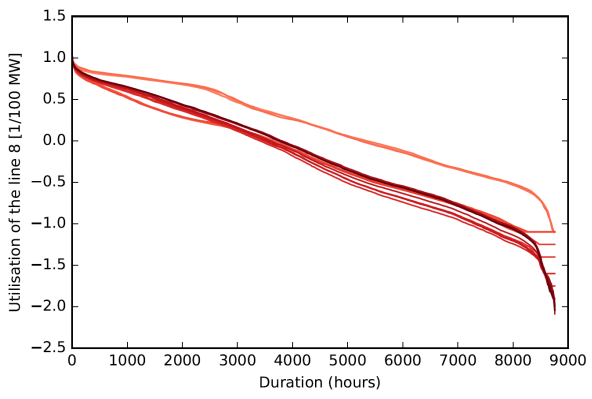
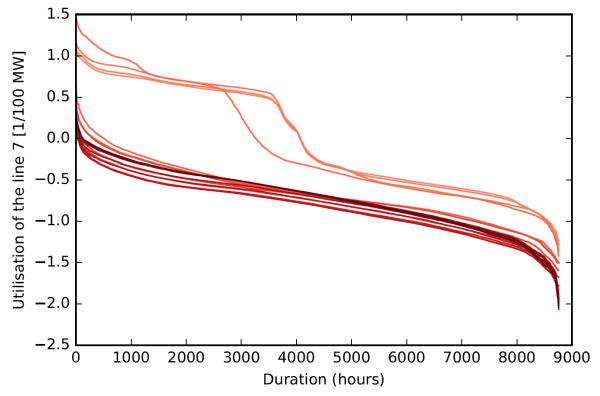
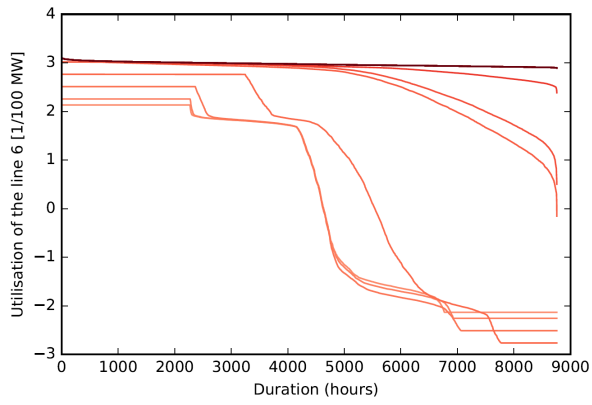
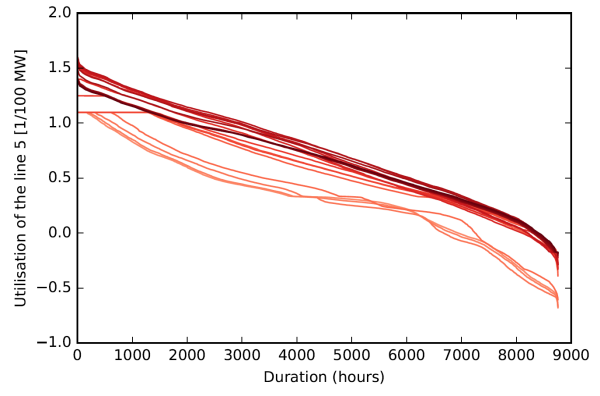
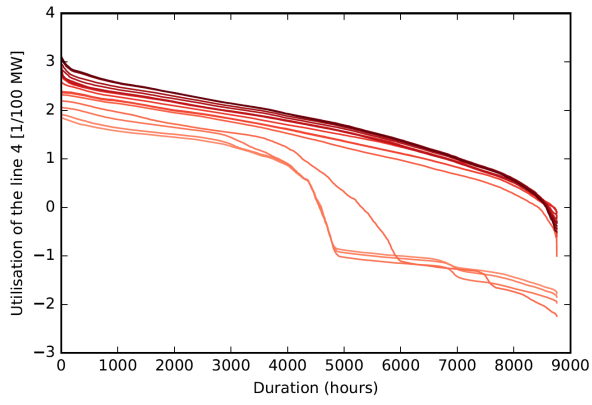

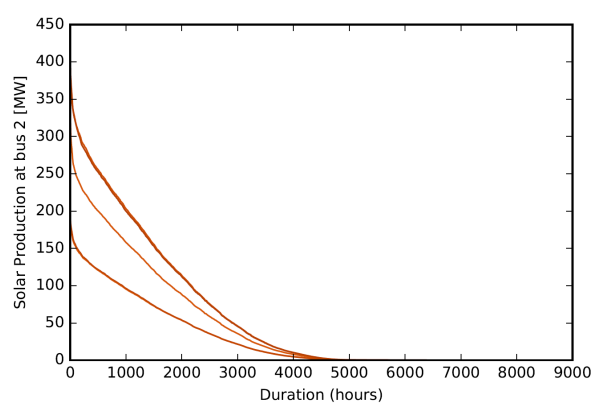
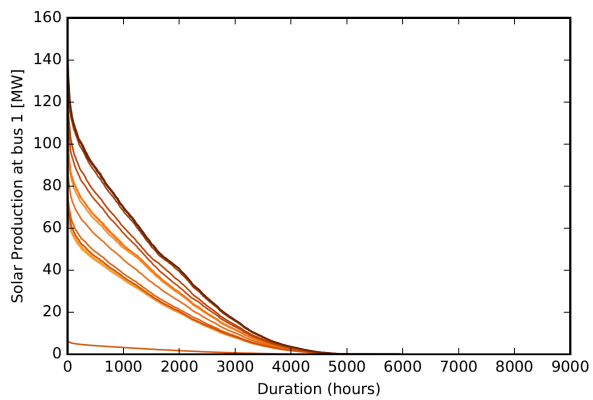
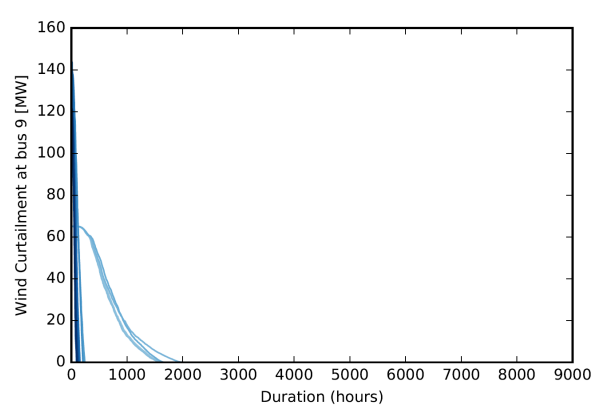
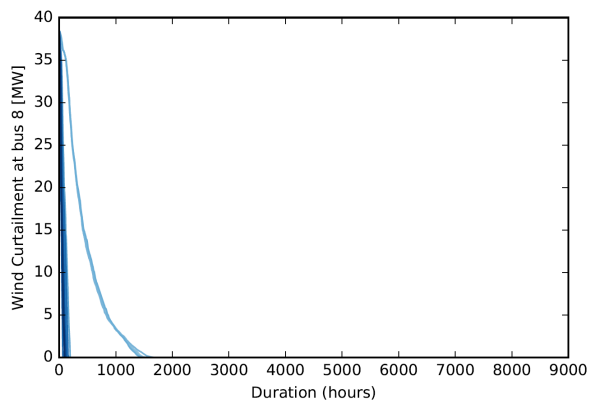
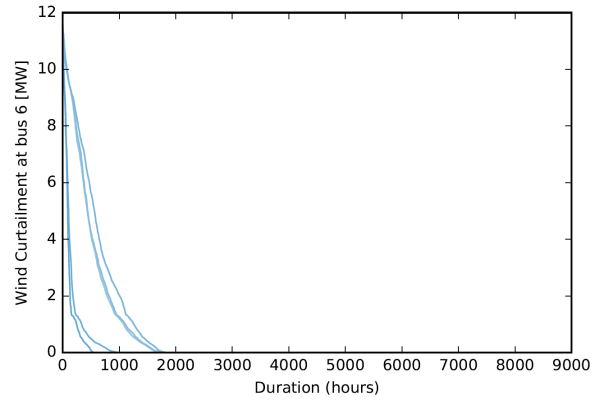
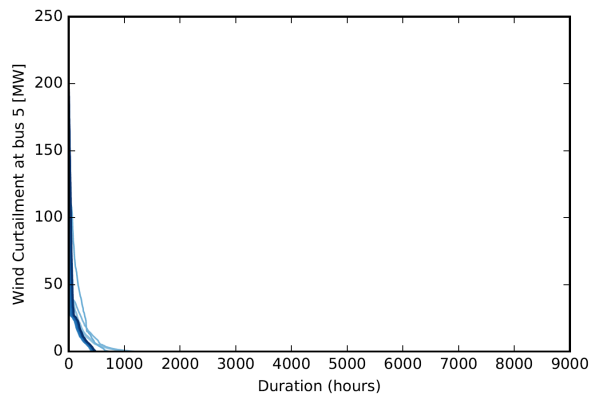
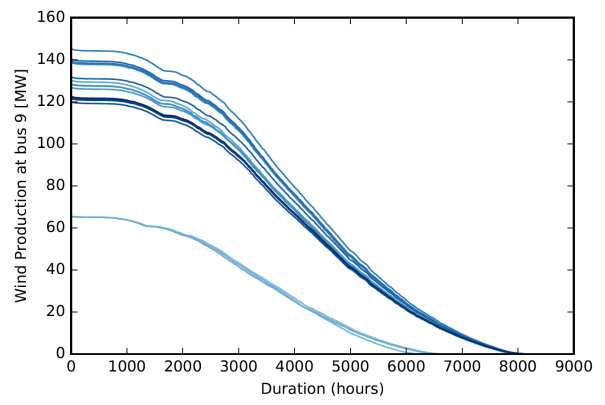
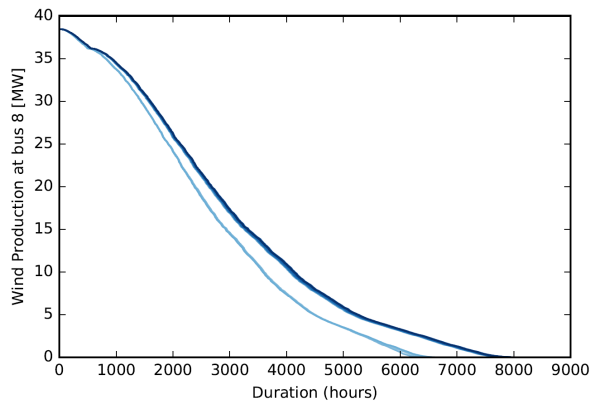

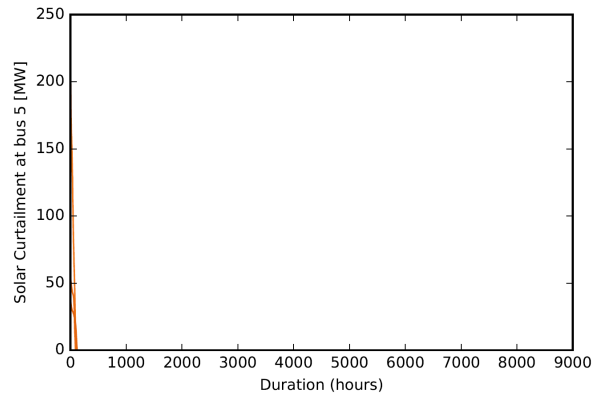
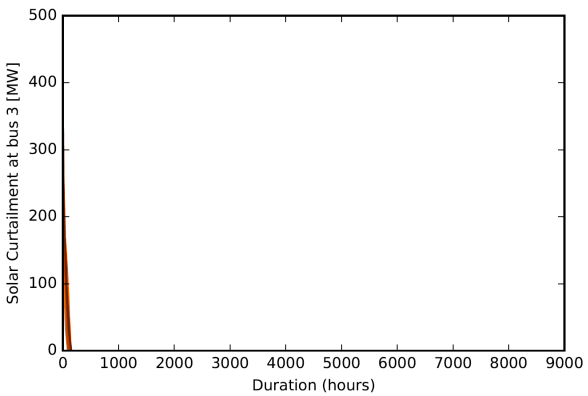
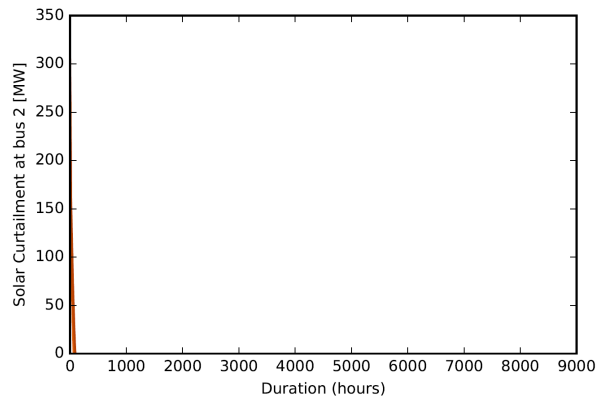
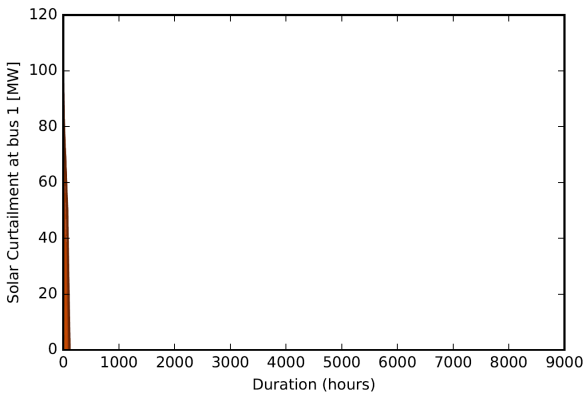
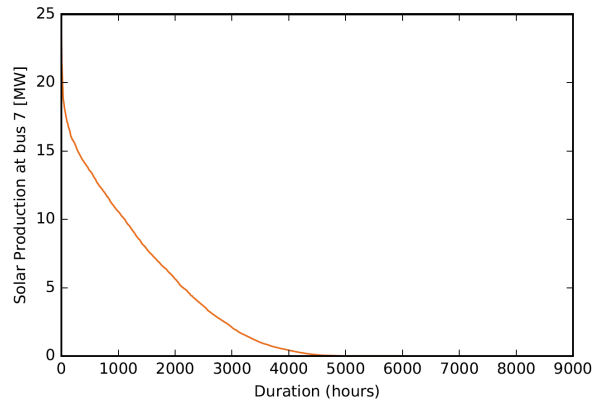
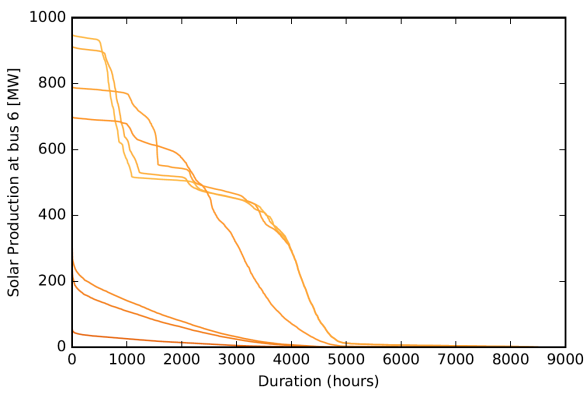
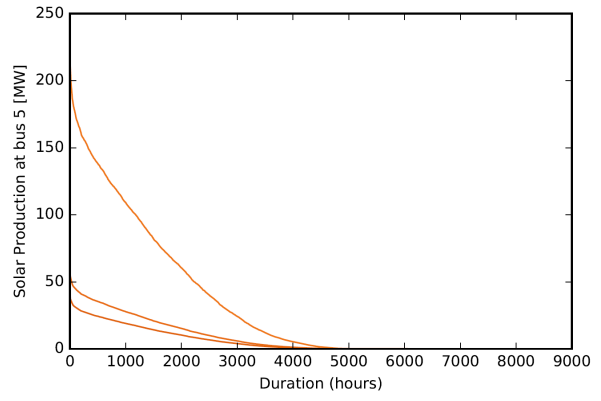
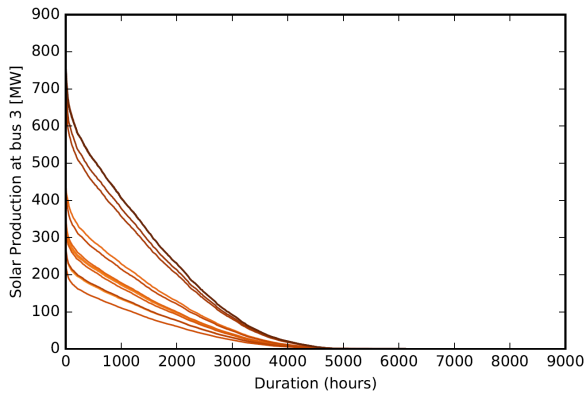

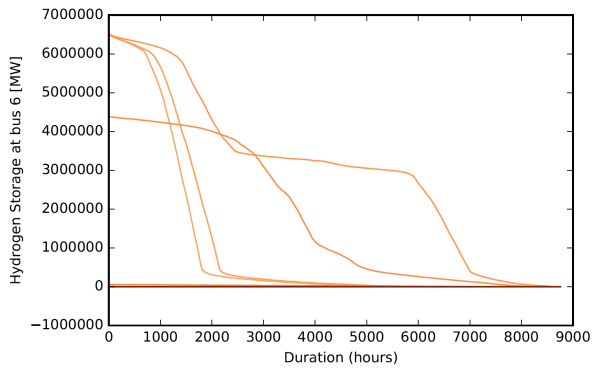
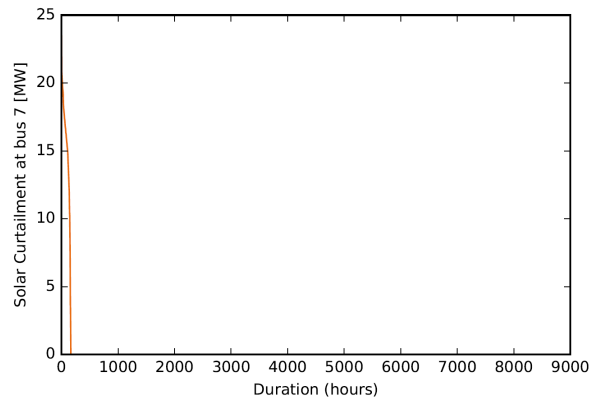
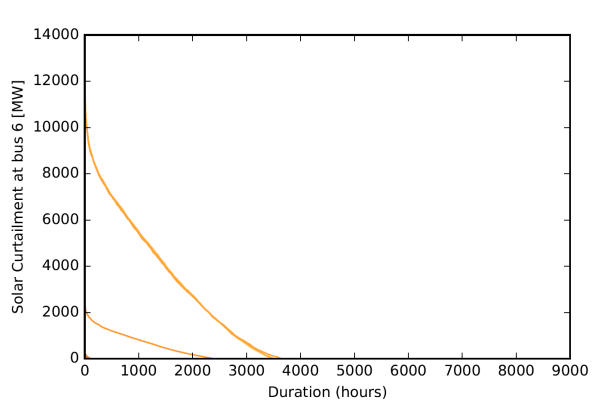

## 11.6 Raw Results Studies Case 50%

	Line 0	Line 1	Line 2	Line 3	Line 4	Line 5	Line 6	Line 7	Line 8	Line 9
Case Wind Expansion	0.79	0.85	0.86	0.17	0.8	0.56	0.91	0.72	0.42	0.26
Case Solar 3,8\$/Wp	0.79	0.85	0.86	0.17	0.8	0.56	0.9	0.71	0.42	0.26
Case Solar 1,6\$/Wp	0.79	0.85	0.85	0.18	0.79	0.56	0.9	0.71	0.42	0.26
Case Solar 0,3\$/Wp	0.7	0.73	0.73	0.31	0.64	0.51	0.74	0.6	0.38	0.3

Table 23: Utilization factors of the lines for the different studies in the case 50%

The rationing is at 0 for all buses during all year for every studies.

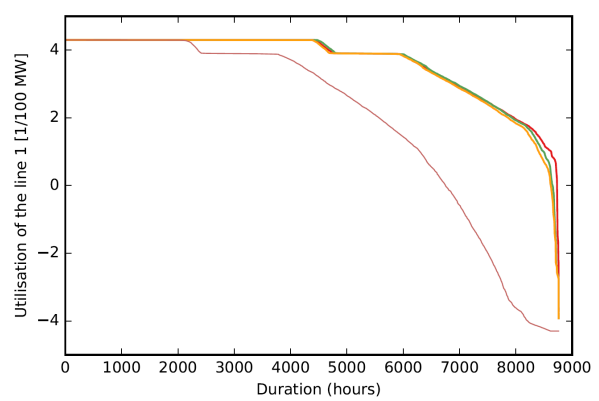
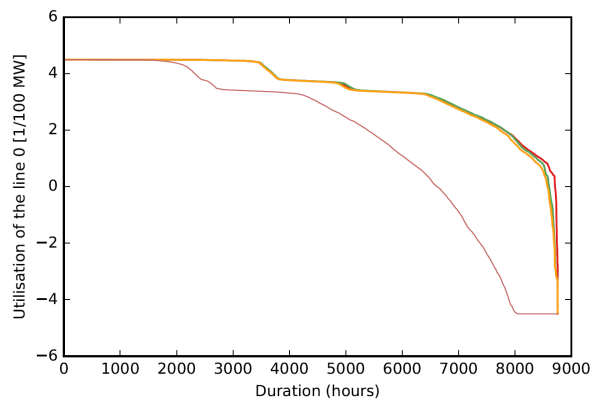



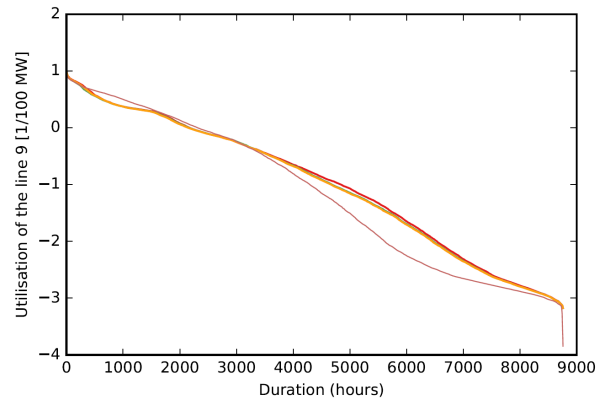
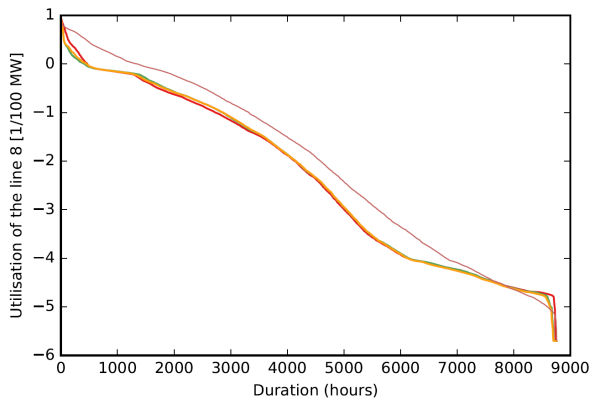
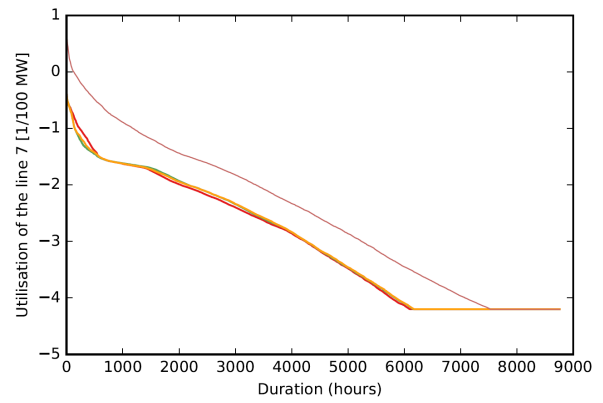
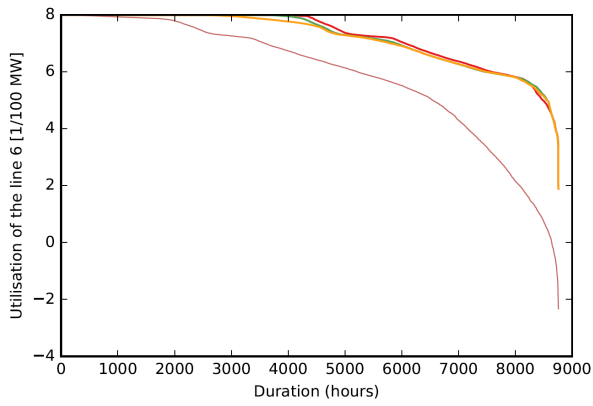
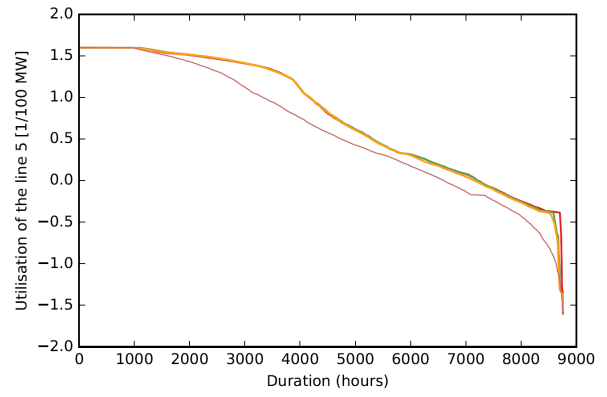
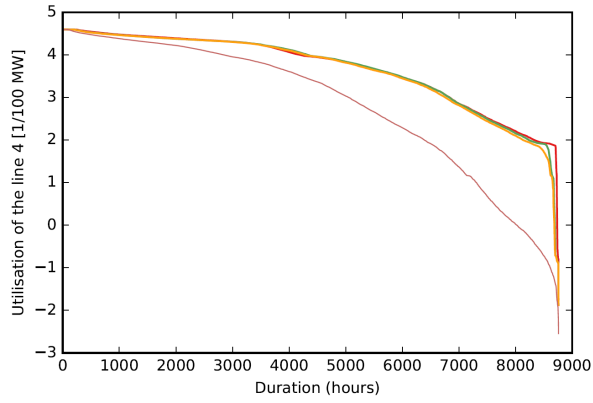
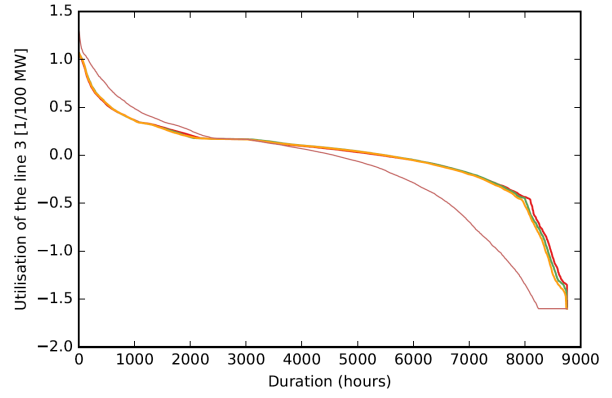
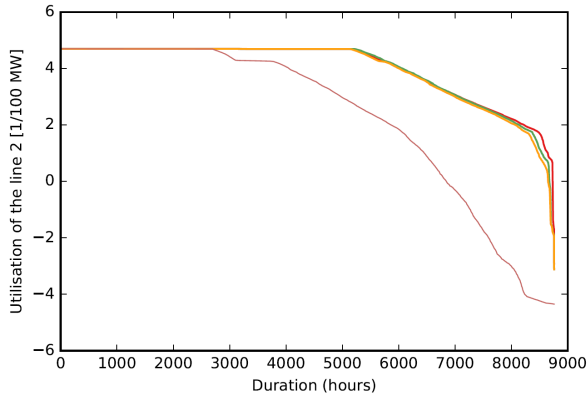

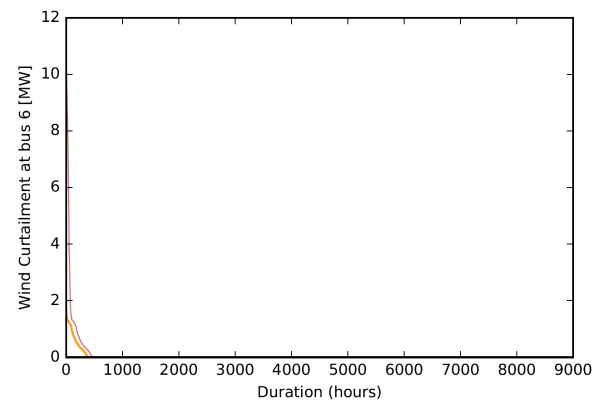
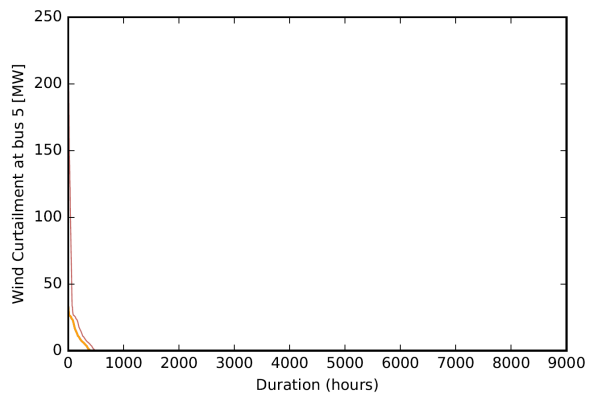
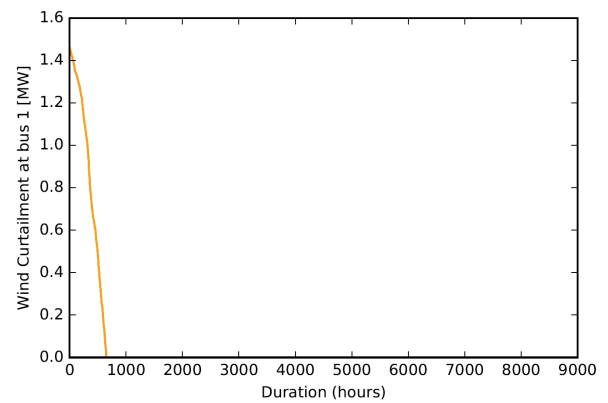
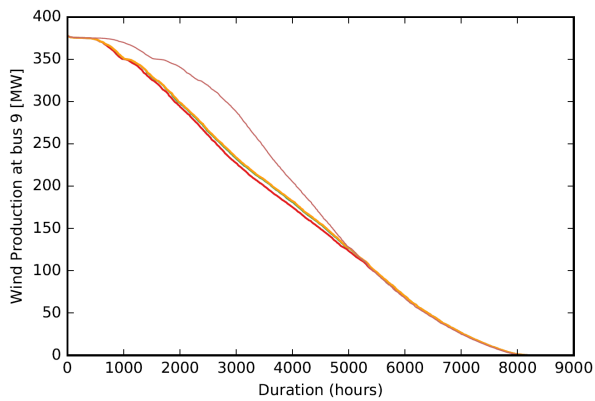
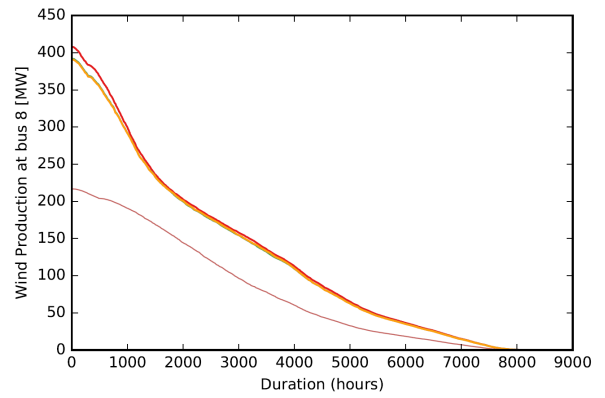
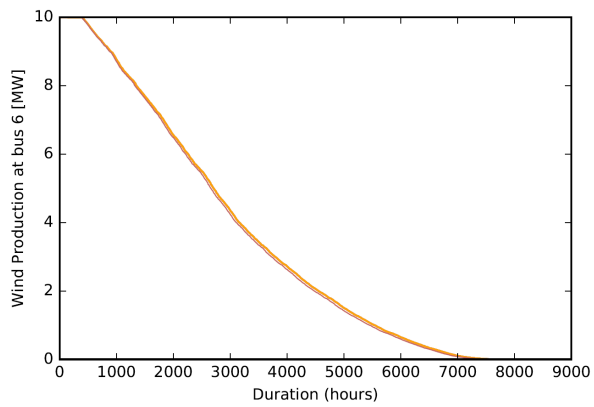
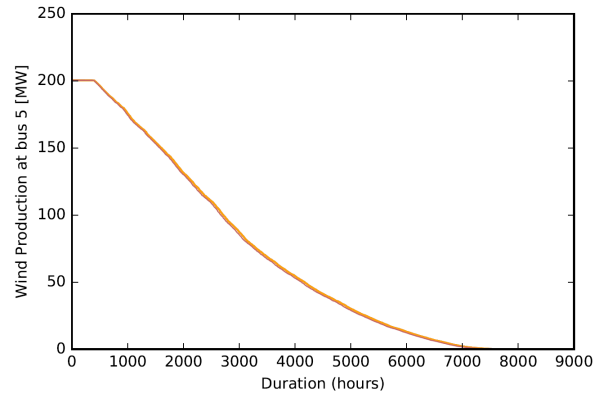
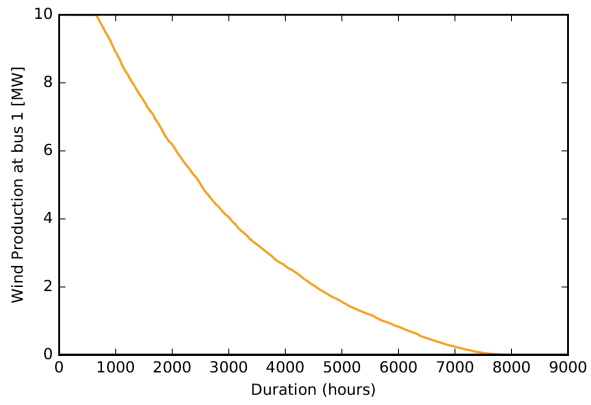

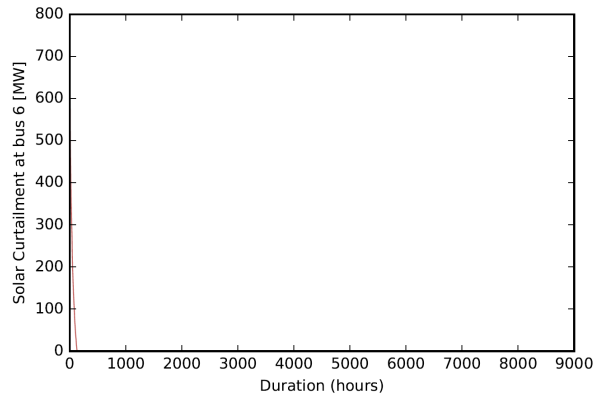
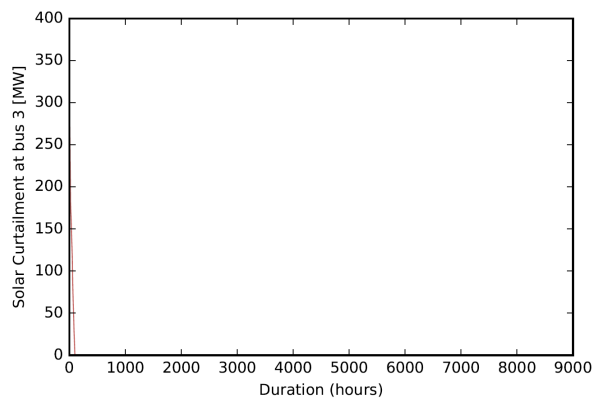
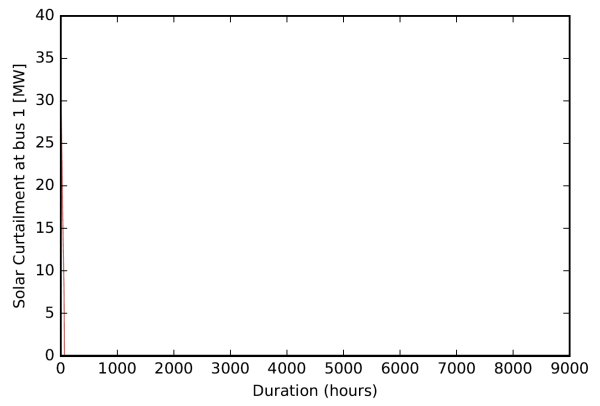
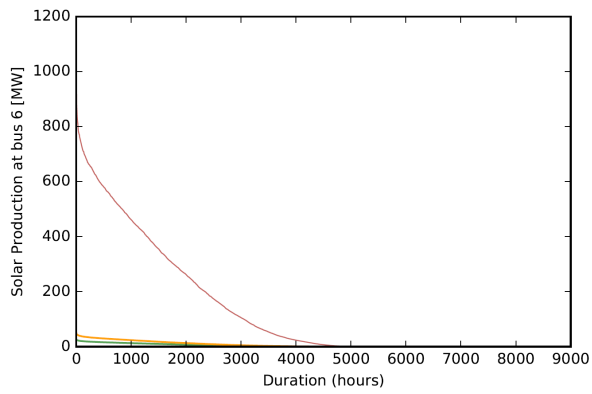
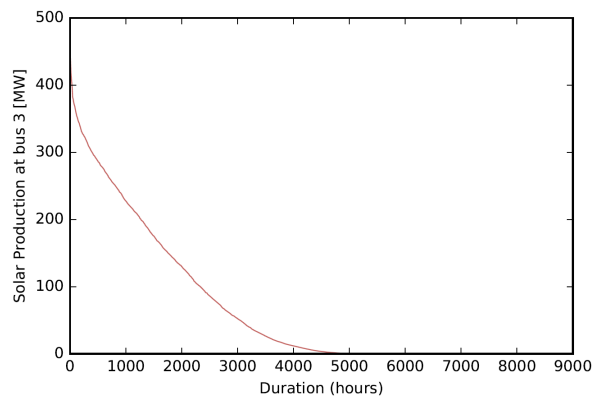
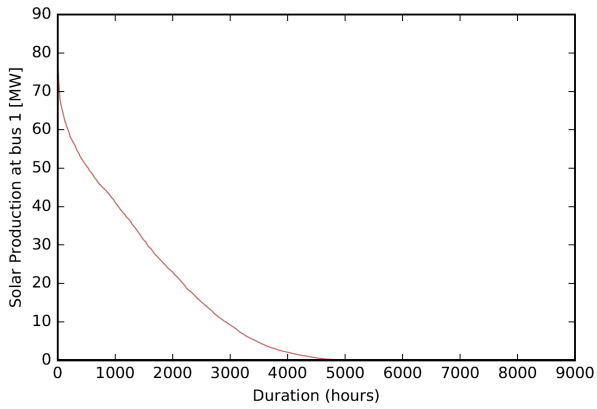
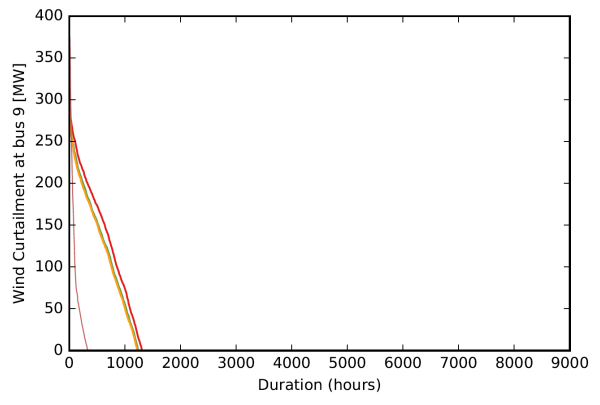
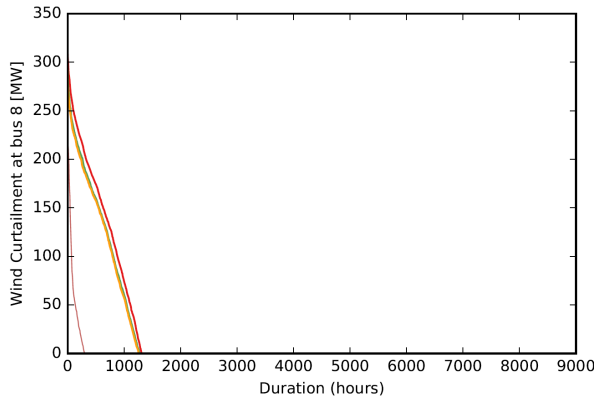

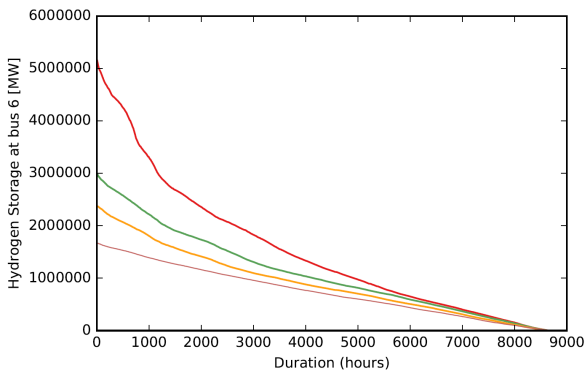
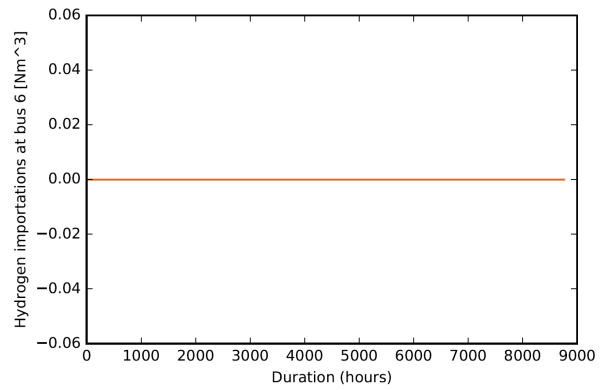
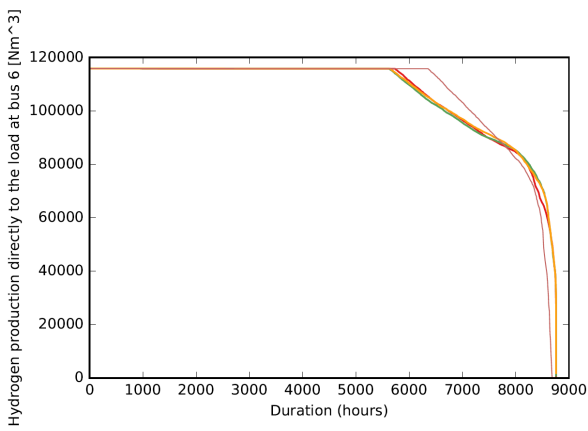
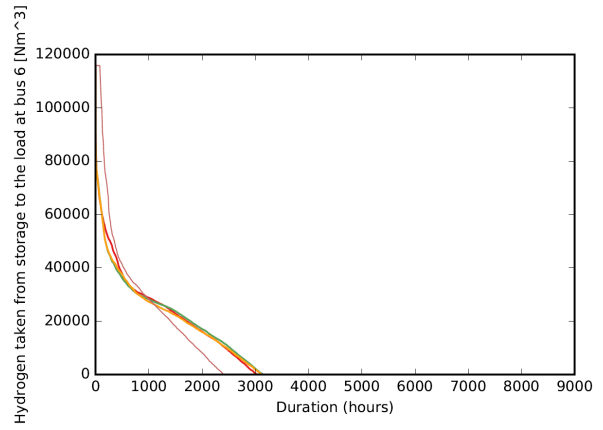
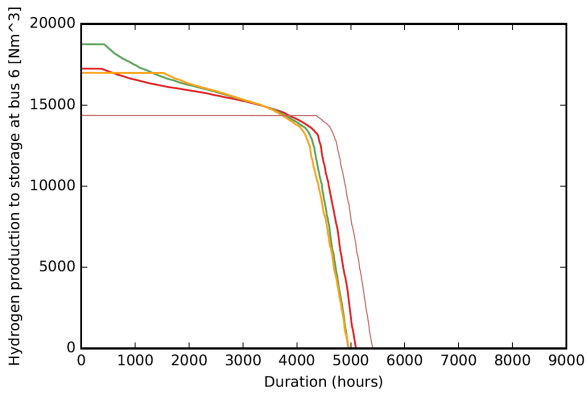

## 11.7 Utilization Factor of Lines for the Increased Production Case

Case	Line 0	Line 1	Line 2	Line 3	Line 4	Line 5	Line 6	Line 7	Line 8	Line 9
0%	0.62	0.61	0.51	0.47	0.42	0.45	0.89	0.37	0.45	0.18
10%	0.61	0.67	0.68	0.35	0.61	0.56	0.87	0.46	0.51	0.22
20%	0.82	0.78	0.6	0.23	0.7	0.49	0.93	0.59	0.52	0.28
30%	0.79	0.87	0.77	0.24	0.88	0.61	0.93	0.67	0.51	0.38
40%	0.77	0.83	0.84	0.19	0.86	0.55	0.95	0.77	0.34	0.48
50%	0.79	0.85	0.86	0.17	0.8	0.56	0.91	0.72	0.42	0.26
60%	0.74	0.78	0.78	0.24	0.8	0.6	0.88	0.71	0.5	0.24
70%	0.72	0.77	0.78	0.17	0.82	0.49	0.96	0.83	0.6	0.24

Table 24: Utilization factor of lines

## 11.8 Curtailment of wind and solar for the different hydrogen case and the different prices

<b>0,1\$/Wp</b>		<b>Bus 1</b>	<b>Bus 2</b>	<b>Bus 3</b>	<b>Bus 5</b>	<b>Bus 6</b>	<b>Bus 7</b>	<b>Bus 8</b>	<b>Bus 9</b>	<b>Total</b>
<b>Wind</b>	0%	1,932	-	-	0,813	0	-	0	0	0,420
	10%	1,932	-	-	0,813	0	-	0,611	0,120	0,486
	20%	1,932	-	-	0,813	0,813	-	2,625	0,302	0,672
	30%	1,932	-	-	0,813	0,813	-	10,814	0,870	1,404
	40%	1,932	-	-	0,813	0,813	-	11,386	3,430	3,336
	50%	1,932	-	-	0,813	0,813	-	15,282	10,557	10,133
	60%	1,932	-	-	0,813	0,813	-	2,596	1,750	1,848
<b>Solar</b>	0%	-	-	-	-	-	-	-	-	-
	10%	-	-	-	-	-	-	-	-	-
	20%	-	-	-	-	-	-	-	-	-
	30%	-	-	-	-	-	-	-	-	-
	40%	-	-	-	-	-	-	-	-	-
	50%	-	-	-	-	0	-	-	-	0
	60%	-	-	-	-	0	2,961	-	-	1,046
<b>0,05\$/Wp</b>										
<b>Wind</b>	0%	1,932	-	-	0,813	0	-	0	0	0,420
	10%	1,932	-	-	0,813	0	-	0,611	0,120	0,486
	20%	1,932	-	-	0,813	0,813	-	2,558	0,310	0,672
	30%	1,932	-	-	0,813	0,813	-	10,170	0,816	1,339
	40%	1,932	-	-	0,813	0,813	-	4,863	1,488	1,525
	50%	1,932	-	-	0,813	0,813	-	4,174	1,947	2,287
	60%	1,932	-	-	0,813	0,813	-	1,413	0,826	1,013
<b>Solar</b>	0%	-	-	-	-	-	-	-	-	-
	10%	-	-	-	-	-	-	-	-	-
	20%	-	-	-	-	-	-	-	-	-
	30%	-	-	-	-	-	0	-	-	0
	40%	-	-	-	-	-	0	-	-	0
	50%	-	-	-	-	-	0	-	-	0
	60%	-	-	-	-	-	2,427	0	-	0,508
<b>0,02\$/Wp</b>										
<b>Wind</b>	0%	-	-	-	2,177	-	-	1,649	2,176	2,113
	10%	-	-	-	1,987	-	-	1,834	1,540	1,779
	20%	2,533	-	-	1,727	-	-	1,548	1,244	1,471
	30%	2,490	-	-	2,236	2,272	-	3,863	1,977	2,181
	40%	-	-	-	2,008	2,159	-	2,903	2,026	2,070
	50%	-	-	-	2,313	2,559	-	2,986	2,014	2,302
	60%	-	-	-	1,524	1,735	-	2,566	2,080	2,116
<b>Solar</b>	0%	2,032	-	2,096	4,664	-	-	-	-	2,316
	10%	1,424	-	2,040	3,515	-	-	-	-	2,420
	20%	4,442	2,263	3,075	4,586	3,812	-	-	-	3,175
	30%	1,357	-	2,907	-	1,649	-	-	-	1,835
	40%	1,183	-	2,446	-	1,645	-	-	-	1,817
	50%	1,185	-	2,117	-	2,207	-	-	-	2,123
	60%	1,069	-	1,389	3,238	1,456	-	-	-	1,680

Table 25: Wind and solar curtailment in the study of the different price scenario

## 11.9 Evolution of the Costs for Each Grid Case Without Zoom

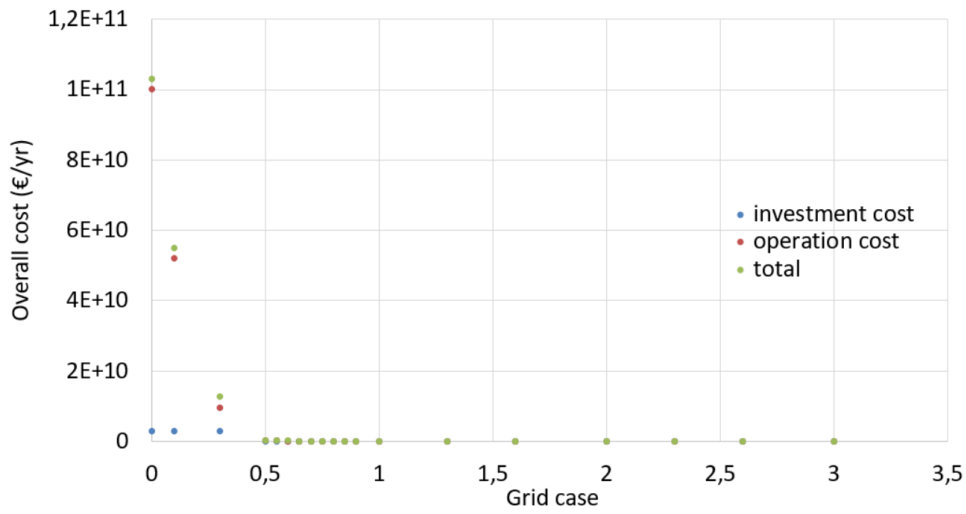

Figure 137: Evolution of the costs for each grid case, case 10%

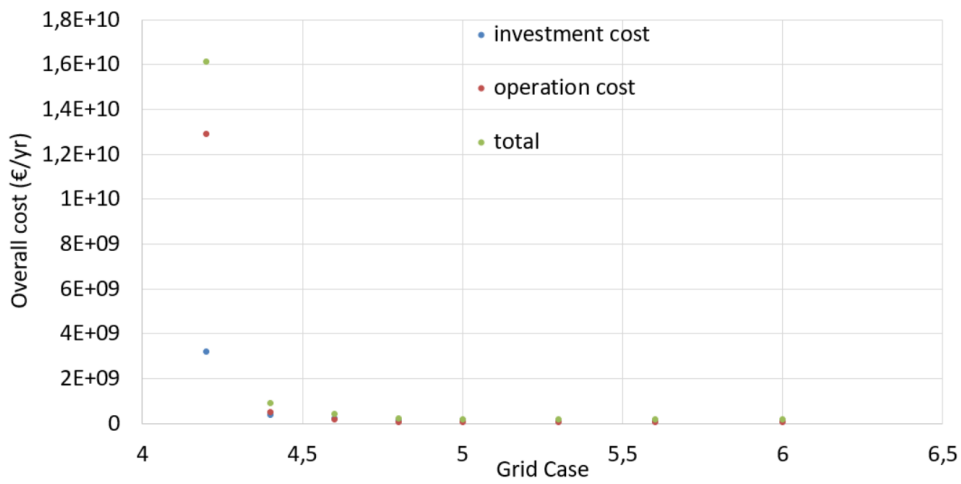

Figure 138: Evolution of the costs for each grid case, case 50%

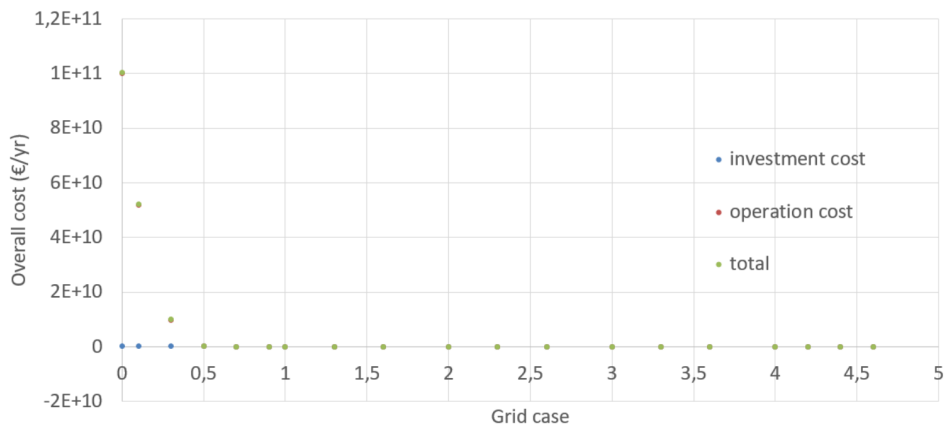

Figure 139: Evolution of the costs for each grid case, case 10% with low solar investment cost