

ISBN 978-82-326-2298-6 (printed ver.)
ISBN 978-82-326-2299-3 (electronic ver.)
ISSN 1503-8181

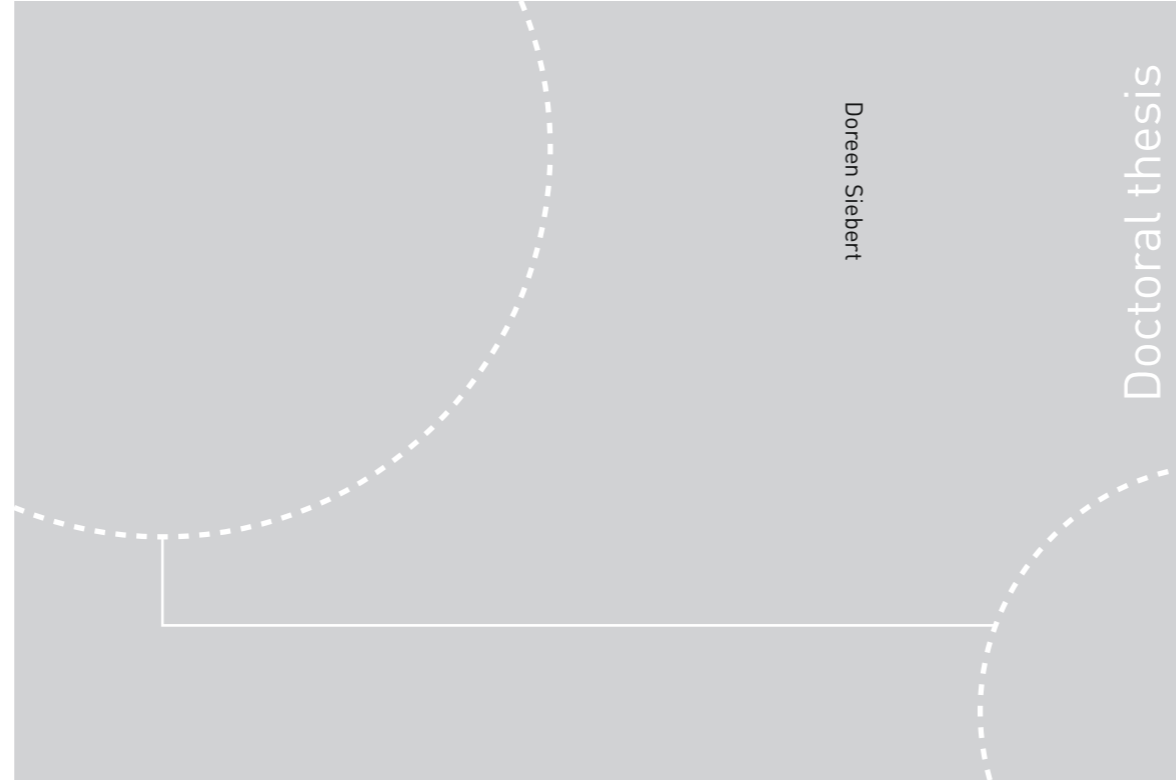

Doctoral theses at NTNU, 2017:113

Doreen Siebert

How wear affects road surface texture and its impact on tire/road noise

 **NTNU**
Norwegian University of
Science and Technology

Doctoral theses at NTNU, 2017:113

NTNU
Norwegian University of Science and Technology
Thesis for the Degree of
Philosophiae Doctor
Faculty of Engineering
Department of Civil and Environmental
Engineering

 NTNU

 **NTNU**
Norwegian University of
Science and Technology

Doreen Siebert

How wear affects road surface texture and its impact on tire/road noise

Thesis for the Degree of Philosophiae Doctor

Trondheim, May 2017

Norwegian University of Science and Technology
Faculty of Engineering
Department of Civil and Environmental Engineering



Norwegian University of
Science and Technology

NTNU

Norwegian University of Science and Technology

Thesis for the Degree of Philosophiae Doctor

Faculty of Engineering

Department of Civil and Environmental Engineering

© Doreen Siebert

ISBN 978-82-326-2298-6 (printed ver.)

ISBN 978-82-326-2299-3 (electronic ver.)

ISSN 1503-8181

Doctoral theses at NTNU, 2017:113

Printed by NTNU Grafisk senter

Preface

This thesis is submitted to the Norwegian University of Science and Technology (NTNU) for partial fulfillment of the requirements for the degree of philosophiae doctor. The work was carried out at the Norwegian Public Roads Administrations (NPRA) Road directorate and the Department of Civil and Transport Engineering at NTNU. The funding for the study was given by the NPRA.

The study started in 2008 as a part of a research and development project called “Environmentally Friendly Pavements”. The projects aim was to develop low noise, wear resistant and durable pavements adapted to Norwegian climatic and traffic conditions. The focus in this thesis was to investigate the changes in road surface texture caused by wear and its effect on the pavements acoustical characteristics.

The main supervisor for the work was Associate Professor Helge Mork at the Department of Civil and Transport Engineering at NTNU. Co-supervisors were Professor Inge Hoff from the same Department and PhD Jostein Aksnes from the NPRAs Road directorate.

Within this study, four research papers were written/elaborated. These papers present the main work of the study. Three papers have been published in the proceedings of international conferences; one paper will be submitted as a conference article. Each paper presents an individual study, which can be read separately.

The committee for the appraisal of this thesis was comprised of the following members:

Professor Björn Birgisson (first opponent),
Texas A&M University, USA

Chief Engineer Geir Berntsen (second opponent),
The Norwegian Public Roads Administration, Norway

Associate Professor Kelly Pitera (administrator),
Norwegian University of Science and Technology, Norway

Advisors during this study have been:

Associate Professor Helge Mork,
Norwegian University of Science and Technology, Norway

Professor Inge Hoff,
Norwegian University of Science and Technology, Norway

Chief Engineer PhD Jostein Aksnes,
The Norwegian Public Roads Administration, Norway

Acknowledgements

This thesis is a result of many years of work, where many people have been crucial for the results. First of all, my gratitude goes to my main supervisor Helge Mork and my co-supervisors Inge Hoff and Jostein Aksnes for their support and guidance through the study. Thank you for spending so many hours correcting my drafts and always encouraging me to finish the study.

I also would like to thank the NPRA for funding this work and all my colleagues at the NPRAs Road directorate for their support. I am very thankful for getting the opportunity to work with this study and to perform the required testing. A special thanks goes to Brynhild Snilsberg and Nils Uthus for helpful discussions and their encouragement. I also want to mention Svein Å. Storeheier, and thank him for his professional help and interest on the topic.

Within this study, numerous experimental work has been accomplished at different laboratories. I want to thank all the people that helped me to prepare and carry out the tests, both at the NPRA, NTNU and VTI. I would like to acknowledge especially Odd Durban Hansen for helping out whenever it was needed.

The last two years of this study, I was so lucky to share my workplace with three very special girls. Sara, Kine and Elena, I am so grateful for your friendship. Thank you for always being there for me! I also want to thank Lisbeth Johansen and everybody who join the lunch and coffee breaks for the moral support.

Of course, there is a world outside this PhD-bubble. In this world, I have an amazing family with two wonderful children and the most loving husband. Mads and Mea, thank you for your patience. Tino, what would we have done without you? Without your patience and belief in me, this would not have been possible. Thank you for being the most caring, supportive and encouraging person in my life!

Finally, a deep gratitude goes to my family “back home” that supports me every day in my life and always encourages me to go one step further.

Trondheim, December 1, 2016

Doreen

Summary

Mechanical pavement wear in the Nordic countries is essentially influenced by the use of studded tires during long winter seasons. The abrasive effect of the studded tires is the cause of significant damage on the pavement and a contributor to rutting. In addition, the mechanical aggregate removal due to the studded tires is the reason for significant changes in the road surface texture. At traditional dense asphalt pavements, the mechanical wear is initiated by the abrasion of the mortar, which leads to a protrusion of coarse aggregates. Regarding the noise characteristics of asphalt pavements, those texture alterations will have a negative impact.

Several methods to reduce the noise emission have been investigated. However, in the Nordic countries, the reduction of maximum aggregate size in the mix design of asphalt pavements is considered the most efficient way to develop satisfactory pavement noise characteristics. The challenge is to find the right balance between the wear of the mortar and the wear of the coarse aggregates to produce a limited worn surface with positive acoustical characteristics.

Within this study, common Norwegian asphalt mixture types, including different rock materials and binder types were investigated to study the effect on pavement wear, the resulting changes in surface texture and the road's noise properties. Laboratory tests were carried out to simulate the wear by studded tires. The texture characteristics were measured on the test specimens, both initially, during and after testing. In addition, pavement wear, surface texture and tire/road noise was measured on several full-scale test sections.

A reduction of the maximum aggregate size causes an increase in mechanical wear by studded tires. However, by reducing the maximum aggregate size, both the initial surface texture and the surface texture of the worn pavement have a positive effect on the acoustical characteristics of the asphalt pavement. The characteristics of the rock material used for the aggregates in the asphalt mixture is crucial for the pavement service life and the development of the surface texture. By using a rock material in the fine fraction that is more resistant against the wear by studded tires than the rock material used for the aggregates in the coarse fraction, the wear of the pavement surface will be balanced and result in a surface texture that is favorable for little noise generation. To reduce the wear and keep positive acoustical characteristics, a gap graded asphalt mixture type is preferable.

List of contents

Preface	I
Acknowledgements	III
Summary	V
List of contents	VII
List of abbreviations and definitions	XI
1 Introduction	1
1.1 Project background and funding	1
1.2 Motivation	1
1.3 Problem statement	2
1.4 Objectives	4
1.5 Scope	4
1.6 Thesis structure	5
1.7 Publications	6
Paper I	6
Paper II	6
Paper III	6
Paper IV	7
2 Traffic noise, road surface texture and pavement wear	9
2.1 Noise	9
2.1.1 Health effects related to noise	9
2.1.2 Noise sources	10
2.1.3 Noise generation mechanisms	11
2.2 Pavement surface texture	13
2.3 Texture parameters and their correlation to noise	14
2.3.1 Texture spectrum	14
2.3.2 Mean Profile Depth	16
2.3.3 Estimated Road Noisiness Level	17
2.3.4 Shape factor g	18
2.4 Pavement wear	18
3 Tests and measurement methods	21

3.1	Tire/road noise measurements	21
3.1.1	Wayside noise measurements.....	21
3.1.2	Source Noise Measurements	22
3.2	Texture measurements	26
3.2.1	Sand Patch Method.....	26
3.2.2	Pendulum Test.....	27
3.2.3	Outflow method.....	27
3.2.4	Profilometry	27
3.3	Pavement wear testing	28
3.3.1	Prall Test	28
3.3.2	Road Simulator test.....	31
3.4	Testing of aggregates.....	33
3.4.1	Los Angeles.....	33
3.4.2	micro-Deval.....	33
3.4.3	Nordic abrasion value.....	34
3.4.4	Norwegian wearing index	35
4	Summary of the papers	37
4.1Paper I: The effect of asphalt mixture materials on changes of the road surface texture	37
4.2	Paper II: Prall tests to study the effect of mortar on the wear of Norwegian asphalt mixtures	38
4.3	Paper III: Road Simulator Tests to study the Effect of Asphalt Mixture Components on the Development of Surface Texture and Noise Characteristics.....	39
4.4	Paper IV: Surface texture and noise development on SMA 8 pavements in Norway	40
5	Discussion	43
5.1	Wear of asphalt mixtures	43
5.2	Comparison of the results from Prall Test (Method A) and Road Simulator test	45
5.3	Surface texture development	46
5.3.1	Changes in texture spectra.....	47
5.3.2	Balancing the wear of mortar and coarse aggregates	47
5.3.3	Influence of the NWI.....	47

5.4	Additional factors to affect wear and surface texture development of asphalt pavements	48
5.4.1	Performance and workmanship.....	48
5.4.2	Design and layout of the road	49
6	Conclusions and recommendations.....	51
6.1	Conclusions	51
6.2	Recommendations	53
7	References.....	55

List of abbreviations and definitions

AC	Asphalt concrete
A _N	Nordic abrasion value
CPX	Close-Proximity method (Noise measurement method)
D _{max}	Maximum aggregate size
ERNL	Estimated Road Noisiness Level
LA	Los Angeles coefficient
M _{DE}	micro-Deval coefficient
MPD	Mean Profile Depth
MTD	Mean Texture Depth
NWI	Norwegian Wearing Index
NPRA	Norwegian Public Roads Administration
OBSI	On-Board Sound Intensity
OT	Outflow Time
PTV	Pendulum Test Value
SMA	Stone mastic asphalt
SRTT	Standard Reference Test Tire

1 Introduction

The following introduction gives some general information about the motivation for this PhD-study. It also explains the problem statement and describes the scope and the objectives of the thesis. An overview of the papers that are included in this thesis is given at the end of this chapter.

1.1 Project background and funding

This PhD study started as a part of a research and development program, called Environmentally Friendly Pavements, conducted by the Norwegian Public Roads Administration (NPRA). The focus of the program was to reduce the environmental impact from road surfaces by optimizing their properties regarding noise and dust emission. The programs aim was to contribute to reduce the levels of noise and dust in Norway. The research, including extensive large scale testing, has been funded by the NPRA.

1.2 Motivation

Noise is an environmental issue that hits many people and contributes to discontentment and impairment of health. Road traffic noise is the main source for outdoor noise. 2011, 1.2 million people in Norway were exposed to noise levels above 55 dB(A) outside their dwellings

(StatisticsNorway, 2013). The World Health Organization approved in 1994 a European action plan for health and environment. As a result, a national Norwegian action plan was developed, based on the European action plan and the Helsinki Declaration. This action plan encompasses the national government's goals and actions in the area of environment and health; noise has been selected as one of the themes (Regjeringen.no, 2001). The national Norwegian goal is to reduce noise nuisance with 10 % by 2020 from the 1999 level (calculated without population growth) and to reduce the number of people who are exposed to noise >38 dB(A) inside their homes with 30 % by 2020 from the 2005 level (Regjeringen.no, 2007).

To reach these goals it is important to reduce the noise by the main source. There are several possibilities to reduce road traffic noise. Noise barriers, noise protection walls and noise insulation of facades are effective ways to reduce noise in densely built-up areas. A noise reduction at the car engine and noise reducing car tires can contribute to reach the goals as well. However, when a car is driving on the road with speeds between 30-45 and 120 km/h, the interaction between tire and road surface dominates the traffic noise generation (Sandberg and Ejsmont, 2002). By focusing on one of the factors, the road surface, this study will consider another important contributor to reduce road traffic noise – low-noise road pavements.

1.3 Problem statement

The surface design of road pavements is the decisive factor that decides whether the pavement contributes to a reduction or an amplification of the noise that is generated by the interaction between a car tire and the road pavement. (Sandberg, 1999) gives some guidelines on how to design a road surface to reach low noise characteristics for the pavement and reduce the tire/road noise. Currently, the most common types of low-noise asphalt road pavements are thin layer surfaces and porous asphalt. The noise reduction from thin surface layers is mainly based upon a small maximum aggregate size (D_{max}) of 6 or 8 mm. Porous asphalt pavements reduce noise generation and propagation due to a high percentage of air void (Kloth et al., 2008). Especially double layer porous pavements reduce the noise due to high absorption (Iwase, 2000). However, in Norway neither thin layer surfaces nor porous asphalt pavements are very efficient regarding noise reduction over a long period of time. During the research and development project

“Environmentally Friendly Pavements”, both thin layer surfaces and porous asphalt pavements were tested. Thin layer surfaces were worn very quickly and had a very short pavement life (Evensen, 2009). Porous asphalt pavements tended to lose their noise reducing characteristics after two to three years, assumed to be caused by clogging (Berge et al., 2009).

Another type of low-noise road pavements are poroelastic surfaces. They consist of granulated rubber or fiber that is combined with the binder. The air void content is usually between 30 and 40 %. Hence, on poroelastic surfaces the noise absorption as well as the noise reduction is very high. However, the performance of such pavements has not been successful in Norway so far (Saba, 2006). Saba (2006) mentioned the following problems that arose under testing:

- Missing adhesion between surface and sub layer
- Low durability
- Low friction on wet surface
- High costs
- Fire hazard (Saba, 2006).

Texture optimization on dense asphalt mixtures has been the most reasonable solution to create low-noise pavements in Norway. While a rough texture on road surfaces increase vibratory mechanisms of noise generation, a totally smooth pavement will cause a lot of noise due to air pumping. A smooth surface with high porosity has a high noise reduction. Even if these facts are well known, it is challenging to find an asphalt mixture that delivers these characteristics over long term. Due to cold winters with high precipitation rates, a high percentage of studded winter tires is used on Norwegian roads. The steel studs in tires have a highly abrasive effect on the road pavement and cause mechanical wear during the winter season. High concentrations of minerals in the dust in the air produced in the winter (70-80 %) (Låg et al., 2004) verify this assumption. To avoid the abrasion, dense asphalt mixtures with D_{max} of 16 mm are commonly used in Norway. However, noise measurements have shown that noise levels increase with increasing D_{max} . To achieve a noise reduction on dense asphalt pavements, the D_{max} should be reduced (Berge et al., 2009). There is a limitation as to how much the D_{max} could be reduced, though, because the pavement wear is increasing with a decreasing D_{max} (Snilsberg, 2008). A

reduction of wear results in higher durability of the pavement and less health issues caused by the dust production due to abrasion.

1.4 Objectives

This study aims to investigate the surface texture changes of asphalt pavements, which are exposed to studded tires during the winter period. Since the changes of surface texture mainly depend on the wear of the pavement caused by the studded tires, different parameters that affect the abrasion of the material at the pavement surface have been considered. The main goal was to investigate how the composition of the materials of an asphalt mixture influences the texture development over time. The specific objectives of the study were to:

- Analyze the correlation between asphalt mixture characteristics and the changes in surface texture at some of the test sections from the research and development project “Environmentally Friendly Pavements”.
- Study the effect of different mortar characteristics on the wear of asphalt pavements by varying the rock material of the fine and the coarse fraction of the stone skeleton.
- Develop a method to study the texture of Prall test specimens after testing.
- Study the effect of the asphalt mixture components on the surface texture development due to changes in the rock material of the coarse fraction and by changing the binder from unmodified to polymer-modified binder.
- Study the development of the wear, the surface texture and the noise levels at test sections paved with SMA 8.

1.5 Scope

Noise from road traffic is generated from a stream of vehicles travelling along the road. As the focus of this study is on wear and the texture changes of the road surface, only the noise generated by the interaction between a passenger car tire and the road surface is considered. The reason for this limitation is twofold:

- In urban areas, where many people are affected by noise, this is the dominant source of noise (see chapter 2.1.2).
- From the viewpoint of a pavement engineer, the tire/road noise could be minimized by changing asphalt properties.

The study was started due to a lack of knowledge on the durability and the pavement life of low noise road surfaces in Norway. The climatic conditions, the use of heavy winter maintenance equipment and especially the use of studded tires give unique challenges to keep the texture durable regarding characteristics that favor low noise generation from the tire/road interaction. As described in chapter 1.3, there are several types of asphalt pavements with different potential for reducing tire/road noise. However, this study was limited to the two most commonly used dense asphalt pavements in Norway, stone mastic asphalt (SMA) and asphalt concrete (AC). A reduction of D_{\max} in the mix design, results in a surface texture that generates less noise. However, asphalt mixtures with smaller D_{\max} produce more dust due to abrasion by the studded tires. The study investigated the development of the wear over time after being exposed to studded tires. This wear on the pavement surface causes changes in the surface texture, which again lead to increasing noise levels. The challenge of the study was to find an asphalt mixture that generates less noise and at the same time is resistant to the abrasive action of the studded tires.

1.6 Thesis structure

This thesis is divided into two parts.

Part I consists of six chapters. Chapter 1 provides a brief introduction to the topic with the problem statement. The scope and the objectives are mentioned in chapter 1 as well. Chapter 2 describes the background theory for the study, and reviews road traffic noise and its generation mechanisms as well as the pavement surface texture and its characteristics that are important for tire/road noise generation. Test and measurement methods are explained in chapter 3. In chapter 4, summaries of all papers concerning this study are given, and chapter 5 discusses the findings. In chapter 6, conclusions are drawn and recommendations are given.

The scientific work of the study is presented in part 2 of this thesis. It includes four research papers. The author of the thesis has been the main author of all the papers. Three of the papers are published in proceedings of different conferences. The last paper will be submitted to an international conference.

1.7 Publications

Within this study, four papers have been elaborated. All papers are listed below. The full papers are included in part 2 of the thesis.

Paper I

Fritzsche, Doreen; Storeheier, Svein Å.; Mork, Helge

The effect of asphalt mixture materials on changes of the road surface texture

Proceedings of 41st International Congress and Exposition on Noise Control Engineering 2012 (INTER-NOISE 2012). Institute of Noise Control Engineering (INCE). ISBN 978-1-62748-560-9

Paper II

Siebert, Doreen; Mork, Helge

Prall tests to study the effect of mortar on the wear of Norwegian asphalt mixtures

Proceedings of 6th Euroasphalt & Eurobitume Congress, 1st – 3rd June 2016. Czech Technical University in Prague. ISBN 978-80-01-05962-3. [dx.doi.org/10.14311/EE.2016.225](https://doi.org/10.14311/EE.2016.225)

Paper III

Siebert, Doreen; Mork, Helge

Road simulator tests to study the effect of asphalt mixture components on the development of surface texture and noise characteristics

Proceedings of 2016 ISAP Symposium and 53rd Petersen Asphalt Research Conference

Paper IV

Siebert, Doreen; Aksnes, Jostein; Berge, Truls S.; Hoff, Inge; Mork, Helge

Surface texture and noise development on SMA 8 pavements in Norway

Submitted to SURF 2018 – 8th Symposium on Pavement Surface Characteristics

Introduction

2 Traffic noise, road surface texture and pavement wear

In this chapter, the background theory of the study is presented. It gives an overview of the topics, which are analyzed and discussed within the thesis, and provides details for a better understanding of the problem statement.

2.1 Noise

Noise is defined as sound that is unwanted by the receiver. Sound does not become noise until someone is annoyed by it. For this reason, noise is a subjective term depending on the annoyance threshold of the receiver. However, as sound from traffic generally is regarded as unwanted, the term noise is used rather than sound (Sandberg and Ejsmont, 2002).

2.1.1 Health effects related to noise

In addition to annoyance, noise has severe negative health effects. Some of the health problems related to noise above 55 dB(A) are:

- Cardiovascular diseases
- Cognitive impairment
- Sleep disturbance
- Tinnitus (WHO, 2011).

Even if the risk of early death caused by noise is relatively small for each individual, the large number of people affected by noise makes this to one of the major environmental problems.

2.1.2 Noise sources

Several sources cause noise. In Norway, road traffic, railways, aviation, manufacturing and other industries are considered to be the main sources of environmental noise (Miljødepartementet, 2014). Figure 1 emphasizes road traffic as the dominant source of noise. About 1.4 million people in Norway are exposed to noise above 55 dB(A). For 88 % of them, road traffic has been figured out as the source of the noise (Miljødirektoratet, 2016). In Europe, research indicates that 17 percent of the population is exposed to environmental noise above 65 dB(A) (Gibbs et al., 2005) .

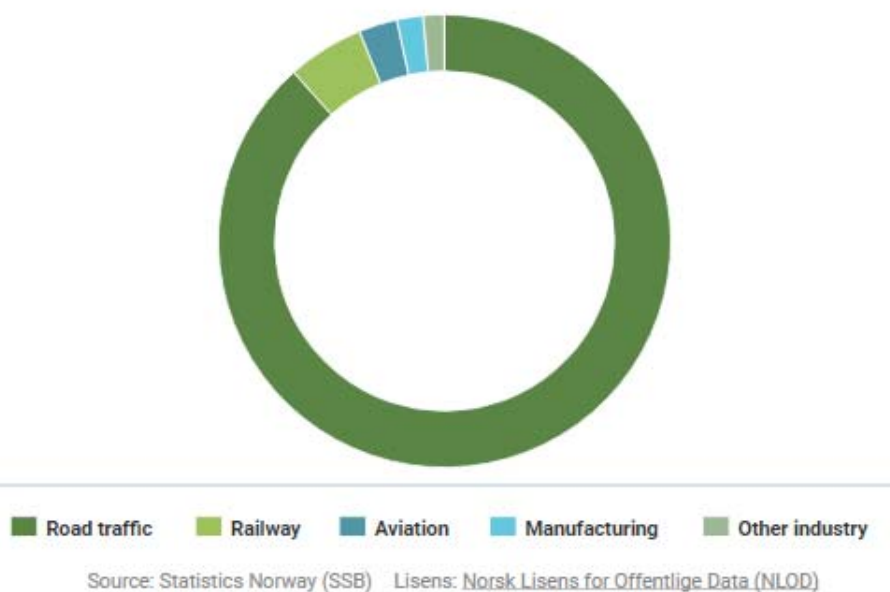

Figure 1: Percentage of people exposed to noise above 55 dB(A) by source in Norway in 2011 (Miljødirektoratet, 2016)

Road traffic noise is the sum of the noise emission produced by a stream of vehicles on the road.

2.1.3 Noise generation mechanisms

Noise from one passenger car is mainly generated by three sources, wind turbulence, the power unit of the car and the interaction between the car tires and the pavement surface. Wind turbulence noise is related to the airflow around and partly through the vehicle. This aerodynamic noise source dominates for speeds above around 120 km/h (Sandberg and Ejsmont, 2002). Noise from the power unit is produced by the engine, exhaust, fan and the intake system of the car. Commonly, the power unit is considered the main source of vehicle noise. However, for a cruising car, the tire/road noise starts to dominate for speeds above 15-25 km/h (Sandberg and Ejsmont, 2002). Therefore, tire/road noise is an important cause of noise from road traffic (Morgan et al., 2006).

During the interaction between the rolling car tire and the road pavement, numerous mechanisms happen simultaneously, resulting in noise. Figure 2 summarizes the main mechanisms, and visualizes and explains the generation and the propagation of tire/road noise.

Morgan et al. (2006) divide the mechanisms described in Figure 2 into three groups; impacts and shocks, adhesion and micro-movement effects, and aero-dynamical processes. The impact and adhesion mechanisms are related to the excitation of the tire treads to vibrate when the car tire is interacting with the road surface. Radial and tangential vibrations of the tire treads and the tire belt spread to the tire sidewalls and generate noise. The aero-dynamical processes include all movements of air in the area between the tire treads and the contact patch of the tire on the road surface.

Several factors affect the generation of tire/road noise. However, the road surface, driving conditions, vehicle related factors and climatic conditions are known to have major influence on tire/road noise emission (Descornet and Sandberg, 1980a, Iwao and Yamazaki, 1996, Bueno et al., 2011).

As the tyre rotates there are no forces acting upon the tread block under observation.

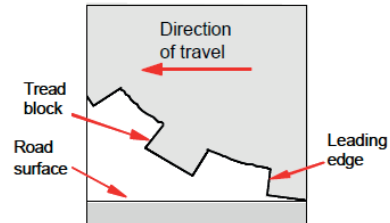

As the tread block impacts with the road surface, shocks are sent through the block which generates vibrations. Air caught between individual tread blocks is compressed

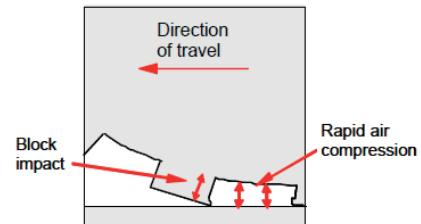

The air trapped between the tread blocks is compressed and decompressed as the tyre passes over the road surface. This is known as "air pumping". Organ pipe resonance occurs in the longitudinal tyre grooves. Friction forces acting on the tread blocks in contact with the road surface cause the "slip-stick" effect.

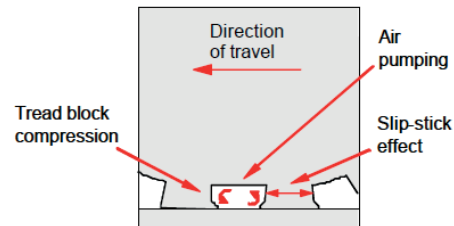

As the tread block leaves the contact patch, compressed air in the tread cavity is expelled rapidly, resulting in the "air pumping" effect. The tread block itself is returned to its undeflected rolling radius position by "snapping out" from the compressed state in the contact patch.

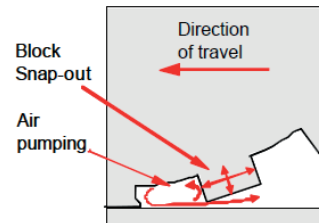

Noise generated at the contact patch is amplified by the geometry of the tyre and road surface (the "horn effect"). The tread block returns to its steady state as the tyre rotates.

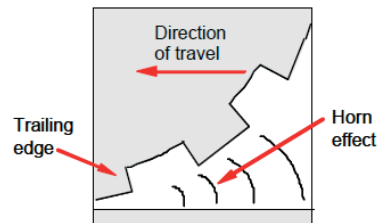

Figure 2: The mechanisms of tire/road noise generation (Morgan et al., 2006)

2.2 Pavement surface texture

The texture of road pavement surfaces is defined by the vertical deviations of their surface from a planar surface, linked to wavelengths varying from zero to 500 mm (CEN, 1997, CEN, 2002a). In 1987, the World Road Association established standard categories of texture, classified by wavelengths (Rasmussen et al., 2011b). The texture ranges of these categories were defined as microtexture (wavelengths up to 0.5 mm), macrotexture (wavelengths 0.5 to 50 mm) and megatexture (wavelengths 50 to 500 mm). Wavelengths above 500 mm were categorized as roughness or in (CEN, 1997, CEN, 2002a) as unevenness. Figure 3 illustrates the texture wavelength ranges and their positive and negative influence on different performance indicators of road pavements. Noise generated by the interaction between tire and pavement is positively influenced by the macrotexture, and deleteriously influenced by the megatexture.

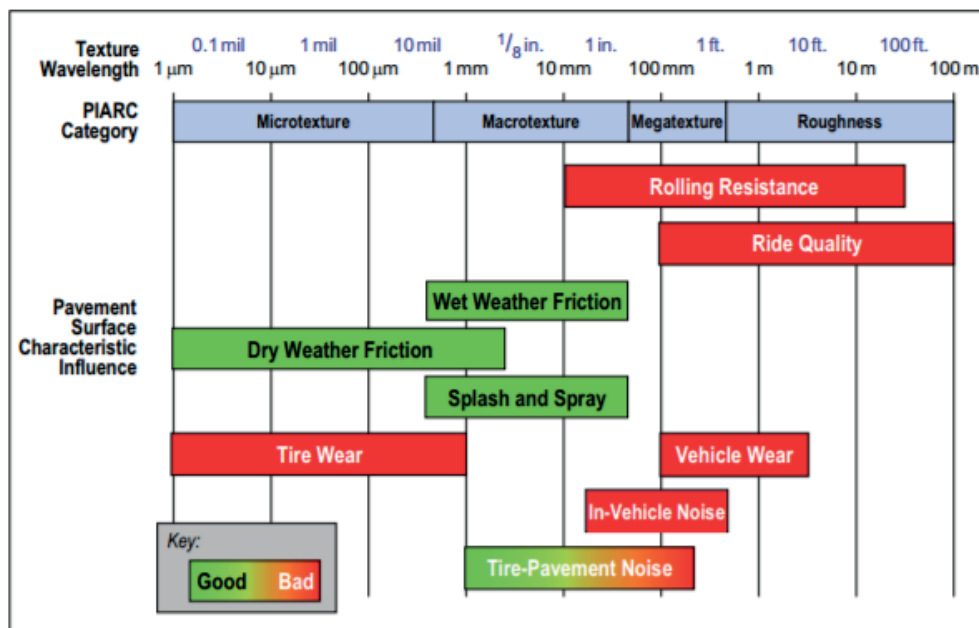

Figure 3: World Road Association texture definitions and their influence on pavement surface characteristics (Rasmussen et al., 2011b)

2.3 Texture parameters and their correlation to noise

The pavement surface texture can be described by several parameters, depending on how the measurements are analyzed. Commonly used parameters are:

- Texture spectrum
- Mean Profile Depth
- Estimated Road Noisiness Level
- Shape factor

2.3.1 Texture spectrum

The texture spectrum is the result of the signal processed texture profile. The texture profile is expressed as a function of spatial wavelength by applying a Fourier transformation to the measured data. The following equation is used to express the texture profile level $L_{tx,\lambda}$ (CEN, 2002a):

$$L_{tx,\lambda} = 20 \lg \left(\frac{a_\lambda}{a_{ref}} \right) \quad (1)$$

where:

$L_{tx,\lambda}$ is the texture profile level (ref. 10^{-6} m), in dB;

a_λ is the root mean square value, in m;

a_{ref} is the reference root mean square value ($= 10^{-6}$ m);

λ is a subscript indicating a value obtained with a one-third-octave-band filter having center wavelength λ .

It is common to consider one-third-octave wavelength bands when generating a texture spectrum. The relationship between noise levels and texture profile levels were analyzed in Descornet and Sandberg (1980a) and Descornet and Sandberg (1980b) and confirmed by Anfosso-Lédée and Do (2002) and (Kragh et al., 2013). The analyses showed that the sound pressure levels at low frequencies increase with texture amplitude for texture wavelengths larger than around 10 mm. For wavelengths smaller than 10 mm, the sound pressure level at

high frequencies decreases with texture amplitude. Figure 4 shows the contours of the correlation coefficient R from the linear regression analysis of the third-octave-bands of acoustic frequency (y-axis) on third-octave bands texture wavelength (x-axis). The maximum and minimum values are denoted by white ovals.

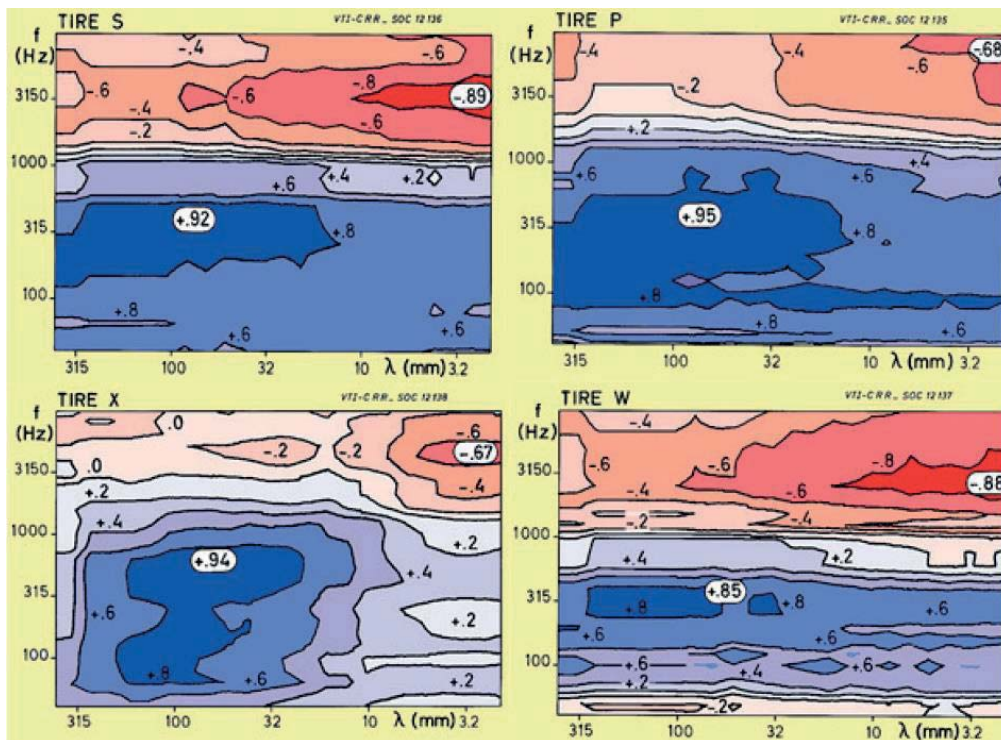

Figure 4: Contour lines of the correlation coefficient R between noise level (at 80km/h) and texture level (Sandberg and Ejsmont, 2002)

Regarding noise generation, the lower frequencies (<1 kHz) can be linked to the tread block impact mechanisms while the air displacement mechanisms cause high frequency (>1 kHz) noise. Based on this, a texture spectrum that is favorable for less noise generation caused by tire/road interaction should look like the spectrum shown in Figure 5. A spectrum, which reflects low noise road surfaces, should show higher amplitudes in the texture level for the smaller wavelengths and lower amplitudes in texture level for the higher wavelengths. The peak

in the spectrum is created by the D_{\max} in the mix design. A smaller D_{\max} generates less noise. Hence, the peak in a texture spectrum for low noise surfaces should preferably be moved to the right. The arrows in Figure 5 indicate the attempt to modify the spectrum to obtain noise reduction.

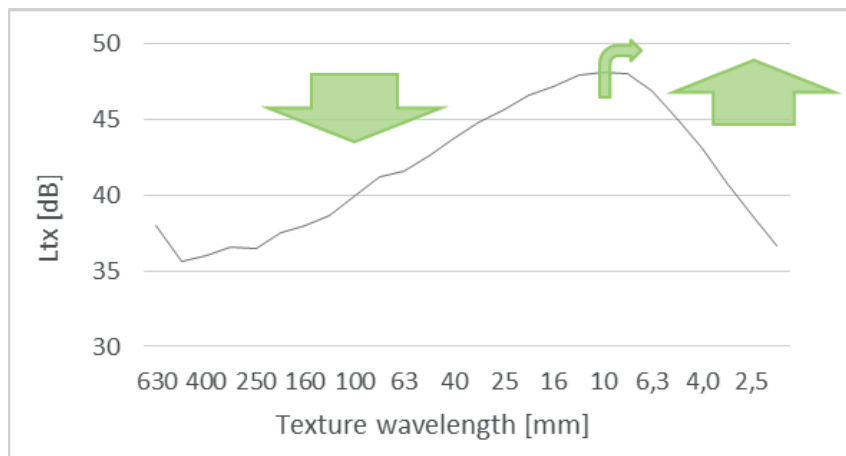

Figure 5: Favorable texture spectrum to achieve a low noise road surface
 [adapted from (Sandberg and Ejsmont, 2002)]

2.3.2 Mean Profile Depth

The Mean Profile Depth (MDP) is defined by ISO 13473-1 and 2 (CEN, 1997, CEN, 2002a) as the average value of the profile depth over a 100 mm long baseline (visualized in Figure 6). For most asphalt pavements, MPD varies between 0.4 and 2.0 mm (Evensen, 2009). However, MPD seems not to be directly correlated to noise levels measured by the Close proximity (CPX) method (described in chapter 3.1.2). On the other hand, texture profile level in the octave band with center at 80 mm texture wavelength ($L_{tx,80}$) and MPD are highly correlated, and $L_{tx,80}$ has a good correlation with CPX noise levels. The higher the values for $L_{tx,80}$, the higher the A-weighted noise levels from the CPX measurements (Kragh et al., 2013).

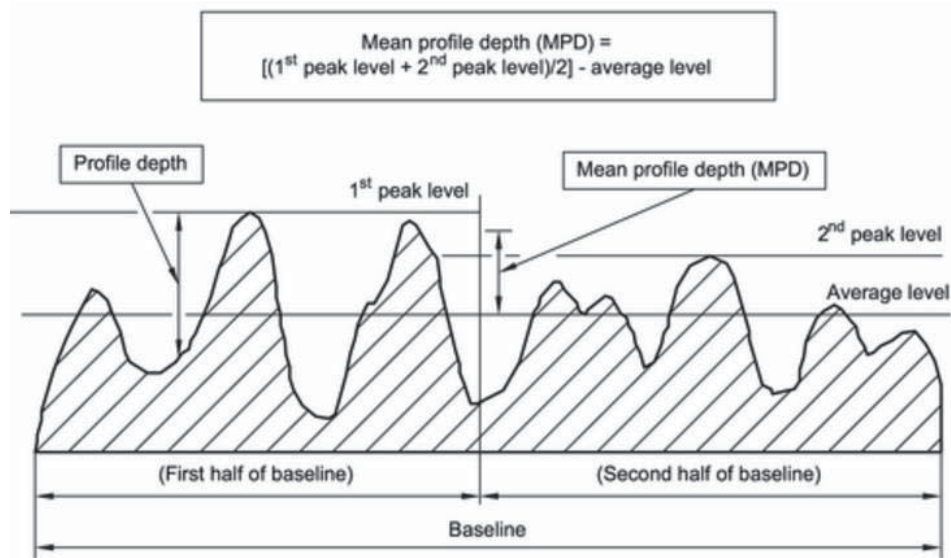

Figure 6: Illustration of the terms baseline, average level, peak level, profile depth, MPD (CEN, 1997)

2.3.3 Estimated Road Noisiness Level

The Estimated Road Noisiness Level (ERNL) is a parameter that reflects the relationship between A-weighted noise level and the texture levels. It was developed in the early 80ies to predict the changes of tire/road noise resulting from a change of texture (Sandberg, 2010). The following equation is used to express ERNL:

$$\text{ERNL} = a \cdot L_{\text{tx},80} - b \cdot L_{\text{tx},5} + c \quad (2)$$

where:

ERNL is the Estimated Road Noisiness Level, in dB(A);

$L_{\text{tx},80}$ is the texture level in the octave band with center at 80 mm texture wavelength, in dB(A);

$L_{\text{tx},5}$ as above, but for the wavelength 5 mm, in dB(A);

constants suggested: $a = 0.50$; $b = 0.25$; $c = 60$ (Sandberg, 2010).

2.3.4 Shape factor g

The shape factor, denoted g , is determined by a statistical analysis of the frequencies of the profile depths. A concave texture, that reflects a surface formed as plateaus and gaps, obtains low noise levels. Less vibration is generated and in addition, the air between the tire and the pavement is able to escape. Factor $g > 60\%$ displays a concave texture. Pavement surfaces formed by tops and valleys result in a convex texture with factor $g < 60\%$ (Angst et al., 2010). Those pavements are considered to generate high noise levels (Beckenbauer, 2007). Figure 7 shows a concave and a convex texture profile including their corresponding shape factor g .

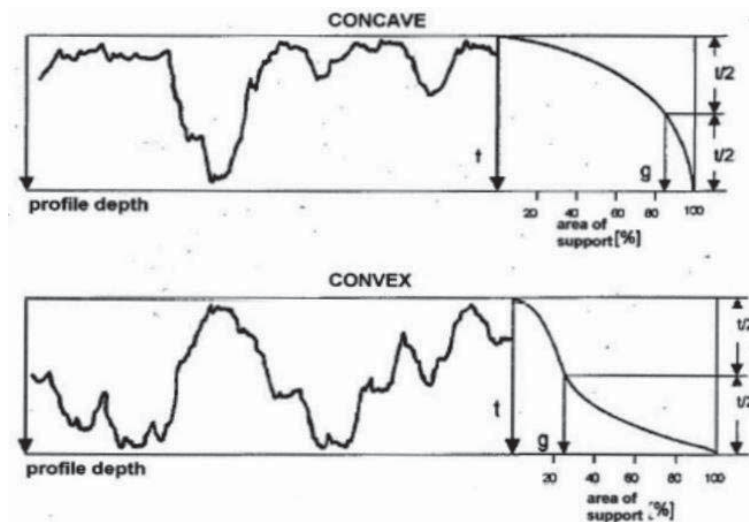

Figure 7: Concave and convex texture profiles and their shape factor g (Kuijpers, 2001)

2.4 Pavement wear

Pavement wear was defined in 1968 as the progressive loss of material from the operating surface of a body occurring as a result of relative motion at its surface (Landsdown and Price, 1986). On asphalt road pavements, a moving car tire is causing the loss of material. Thus, mechanical wear occurs due to the abrasion of particles of the asphalt surface. In the Nordic countries, accelerated mechanical wear takes place mainly during wintertime caused by the abrasive action of studded tires. Each stud cause a small amount of pavement material to

dislodge from the surface. The consequence of pavement wear is the production of airborne particulate matter. Snilsberg (2008) collected several factors on which the production of dust regarding pavement wear depends:

- Type of stud (metal/plastic/weight)
- Amount of traffic
- Design/shape of streets/roads
- Cleaning of the pavement
- Vehicle type
- Driving speed
- Weather
- Driving conditions
- Maintenance measures
- Quality of pavement
- Type of aggregate in the pavement

Traction sand has been figured out by Kupiainen et al. (2003) as another contributor to asphalt pavement wear. The use of traction sand is an anti-skid method to enhance traction on snowy or icy road surfaces. When both, traction sand and studded tires are used together, the use of traction sand is increasing the pavement wear due to the grinding impact of sand under the tires (Kupiainen et al., 2003).

The abrasion of pavement material due to wear results in changes in the surface texture. In Norway, strong aggregates are used in the asphalt mix design and a larger D_{\max} (16 mm) is recommended to minimize pavement wear. However, this leads to a wear initiated by the abrasion of the mortar and a following protrusion of the coarse aggregates over time. In this study, the mortar is defined as a mixture of aggregates from the fine fraction with a size up to 2 mm, the binder and additives.

3 Tests and measurement methods

This chapter describes the test methods needed to accomplish the analyses included in this study. Measurement methods for noise and texture characteristics and test methods to investigate pavement wear and material properties are specified.

3.1 Tire/road noise measurements

Several standardized methods exist to measure noise that is generated by the tire/road interaction. These methods can be divided in two groups:

1. Wayside noise measurements
2. Source noise measurements

3.1.1 Wayside noise measurements

Three techniques of recording traffic noise fit into the category of wayside noise measurements:

- Statistical Pass-By (ISO, 1997)
- Controlled Pass-By (NFS, 2001)
- Coast-By (ISO, 2003)

The three methods are specified in Table 1. Wayside noise measurements is a relatively realistic listening situation for the complete noise output from road vehicles. However, they are only valid for road segments with a maximum length of 100 m and have to be repeated at least every 100 meters for longer sections. The methods work very well for specially designed test sections, but for longer sections it is more efficient with source measurements. It can get challenging to carry out wayside measurements because of reflecting objects and acoustical background noise that may interfere the noise to be measured (Haider and Descournet, 2006). Wayside measurements are more useful to study how variations in traffic affect noise levels over time. They can be used to document noise levels at objects close to the road.

Table 1: Conditions for wayside noise measurements

Measuring method	Measurement set-up	Driving conditions		Vehicle conditions
Statistical Pass-By	One or two microphone(s) each positioned 7.5 m from the center of the test track	Cruising-by	No control with vehicle speed or the technical characteristics of the vehicle	Normal traffic
Controlled Pass-By	Microphone located 1.2 m above the test area surface Devices to measure air temperature, road surface temperature, wind speed, vehicle speed		Constant speed with the engine running at normal conditions for the test speed	Two or more different vehicle types, all being equipped with different tire sets
Coast-By		Coasting-by at constant speed with engine switched off and the transmission put in neutral		

3.1.2 Source Noise Measurements

Using source noise measurements, the noise is measured close to the tire of the test vehicle. The microphones are positioned close to the contact patch between the tire and the road

pavement. The data are collected as the vehicle is in motion at a defined speed. Two methods are considered as source noise measurements:

- On-Board Sound Intensity (OBSI) (N/A, 2009)
- Close Proximity (CPX) method (ISO, 2013)

The OBSI- method uses two microphone probes mounted on the right rear wheel of a vehicle, near the contact points between the tire and the pavement. One microphone is placed in the edge of the tire where it first interacts with the pavement (leading edge), the other microphone at the edge where the tire patch comes off the road surface (trailing edge). A more specifically description of the OBSI set-up is illustrated in Figure 8.

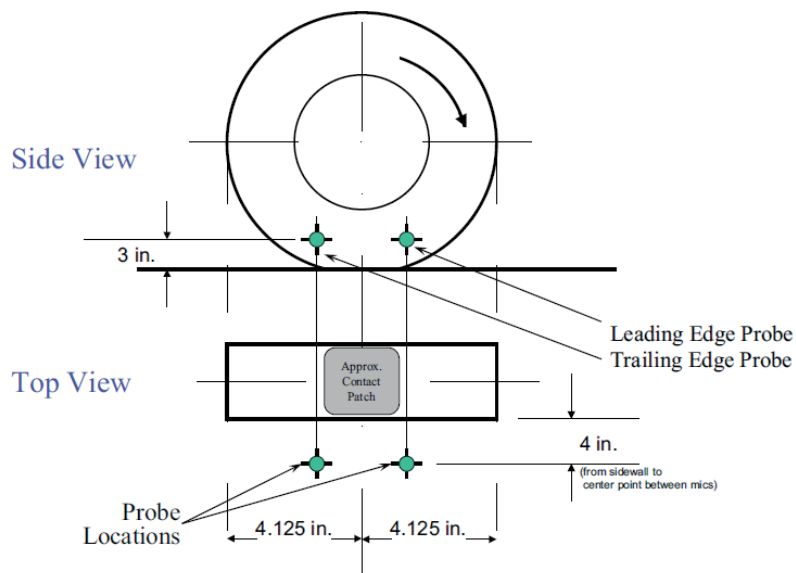

*Figure 8: Sound intensity probe positions with respect to the tire-pavement interface
(Rasmussen et al., 2011a)*

The CPX method uses an enclosed and sound insulated trailer that is towed by a normal vehicle. Inside the trailer, two tires are mounted according to ISO FDIS 11819-2 (ISO, 2013). Microphones are placed at each side of the trailer at an angle of 45° to the perpendicular axis of the center of the tire. The distance from the sidewall of the tire to the microphones is 0.2 m; the

height is 0.1 m above the surface. Figure 9 displays the microphone positions in the CPX-trailer according to (ISO, 2013). Only the mandatory microphones are installed in the CPX-trailer used for the noise measurements within the study. According to ASTM F2493 – 14 (ASTM, 2014), standard reference test tires (SRTT), type Uniroyal Tigerpaw 225/60 R16 97S, with a tire pressure of 200 kPa were used. The load on each tire was adjusted to 3200 N.

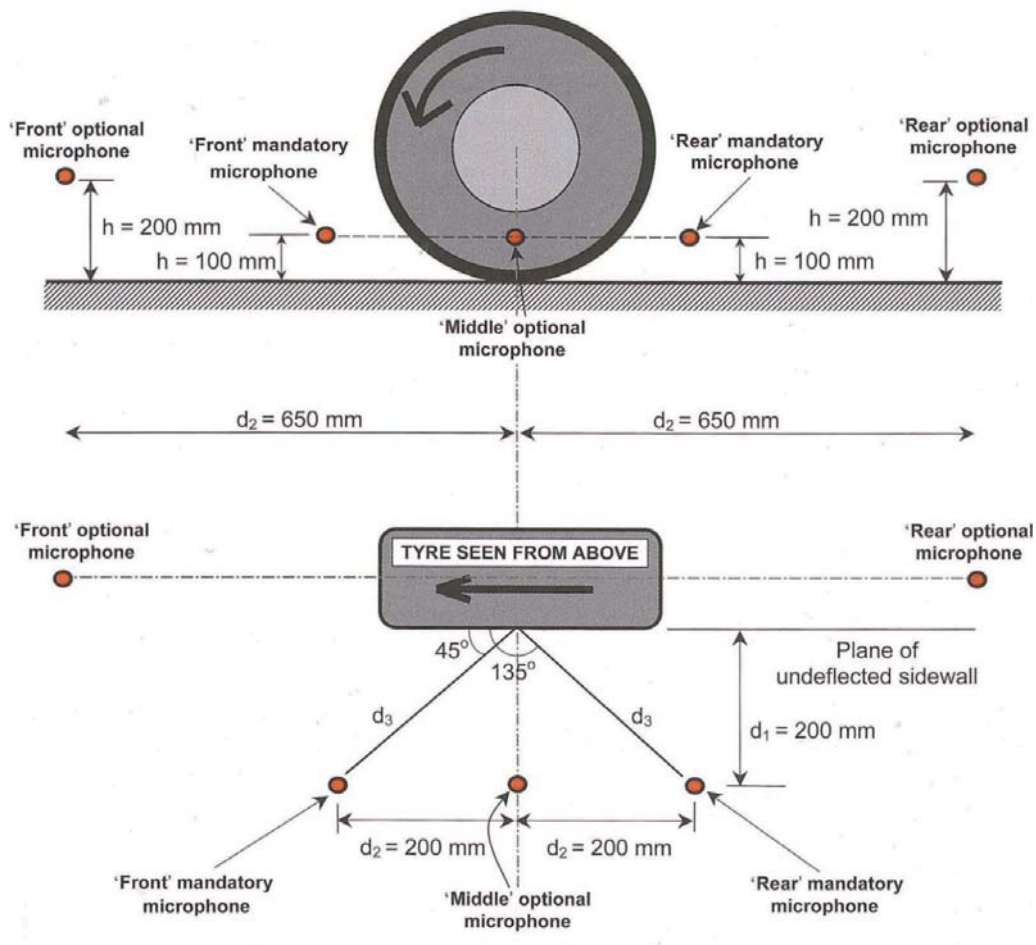

Figure 9: Microphone positions in the CPX-method according to (ISO, 2013)

The noise levels were recorded for several driving speeds. The result is an A-weighted noise level (L_{CPX}) that is produced for test sections of 20 m length by the determination of the average

level from the two microphones at each side of the trailer in one-third-octave band. The levels from several 20 m long sub sections are arithmetically averaged over the total length of the respective test section. The noise level from one test run is found by an arithmetical average of the levels from both tires of the trailer.

The following equation is applied to correct the noise levels L_{CPX} to the reference speed (v_{ref}) of 50 km/h (ISO, 2013):

$$L_{corr} = B \cdot \log\left(\frac{v}{v_{ref}}\right) \quad (3)$$

where

- L_{corr} is the correction of the noise level measured by the CPX-method, in dB(A);
- B is the speed coefficient, dimensionless, depending on the type of road surface, ($B = 30$ for a clogged porous, semi-porous or dense asphalt pavement);
- v is the speed of the CPX-trailer while measuring the noise, in km/h;
- v_{ref} is the reference speed, in km/h.

As noise was measured on dense asphalt pavements only within this study, the speed coefficient B was set to 30 according to ISO FDIS 11819-2 (ISO, 2013). The L_{CPX} values were so corrected as following: $L_{CPX, 50} = L_{CPX} - L_{corr}$. In addition, all noise levels were corrected to a reference temperature of 20 °C by an adjustment factor -0.05 dB/°C.

Based on the following advantages, compared to wayside measurements, the CPX-method was used to carry out all noise measurements within this study:

- Good control with the vehicle
- Controlled speed, driving and surface conditions
- Practicability and cost-effectiveness (Haider and Descournet, 2006)

3.2 Texture measurements

Several methods for the characterization of pavement surface texture have been listed and commented by Sandberg (1998). The following methods are specified in ISO or EN standards:

- Sand Patch method (CEN, 2010b)
- Pendulum test (CEN, 2011b)
- Outflow method (CEN, 2003a)
- Profilometry (CEN, 1997, CEN, 2002a, CEN, 2002b, CEN, 2008)

3.2.1 Sand Patch Method

The Sand Patch method is a manual and stationary method used to measure the mean texture depth (MTD). The area to be tested has to be dry and clean. Sand is measured to an exact volume in a cylinder and poured into a conical heap in the center of the area to be tested. A straightedge is used to spread the sand into a circular patch. The sand fills the surface cavities up to the tips of the surrounding aggregates. The result of this method is the sand circle diameter D . D is the average of at least four measurements where each records the diameter twice. The diameter D is used to calculate MTD by the following equation (CEN, 2010b):

$$MTD = \frac{4 \cdot V}{\pi \cdot D^2} \quad (4)$$

where:

MTD is the mean texture depth, in mm

V is the sample volume (i.e. internal cylinder volume), in mm³

D is the average diameter of the area covered by the material, in mm.

To carry out measurements using this method, a closure of the traffic lane is necessary. However, the Sand Patch method is not very precise on smooth pavements (Sandberg, 1998).

3.2.2 Pendulum Test

The Pendulum Test includes a portable test device to determine the slip/skid resistance of road surfaces. Prior testing, the surface temperature has to be checked. The surface is tested by a pendulum swinging over the particular area that is required for testing. The test provides indirect and approximate measurements of the microtexture by measuring the Pendulum Test Value (PTV). The PTV is the arithmetic mean of five individual values, collected from five swings. The PTV for a location is the mean of three individual PTV determinations. When the test is carried out at other temperatures than 20 °C, the PTV has to be corrected for that after given correction factors in EN 13036-4 (CEN, 2011b). This test method measures the slip/skid of a small area of a surface (approximately 0.01 m²). Hence, its applicability to non-homogenous surfaces should be considered (CEN, 2011b).

3.2.3 Outflow method

The outflow method can be used as a supplement to the Pendulum test. It is used to determine the horizontal drainage of the road surface and to evaluate its macrotexture. The horizontal drainability is defined as “the capacity of the road surface to provide interconnecting voids through which water can be squeezed out by a moving tire” (CEN, 2003a). The method is based on recording the time water filled in a cylinder needs to drain into the road surface. The test shall be carried out in the wheel track. At least 10 measurements are required on a test panel with a length of 25 m. The result of the outflow method is the Outflow Time (OT) as an arithmetical mean of the results of the 10 test points. The OT is not corrected for temperature.

3.2.4 Profilometry

Out of the mentioned texture measurement methods, the Profilometry is the most detailed and reliable test method to detect the characteristics of the pavement surface texture. In Norway, all texture measurements are carried out by the use of Profilometry. A Norwegian laser based measuring system used for the measurement of rutting and unevenness was used for all texture measurements within this study. The system uses a Selcom OptocatorTM laser, type 2008-180/390-A. The operating range of the laser is up to 180 mm with a sampling frequency of 32

kHz. The longitudinal sampling interval is 0.35 mm for a driving speed of 40 km/h. The system provides values that represent profile levels of the pavement surface. The resulting texture levels are calculated from the measured profile, and analyzed as described in chapter 0. The texture measurements and the subsequent analyses have been accomplished in accordance with ISO 13473-1 to 4 (CEN, 1997, CEN, 2002a, CEN, 2002b, CEN, 2008). Results of texture measurements are presented in Paper I, III and IV.

3.3 Pavement wear testing

To measure the wear on asphalt pavements that is caused by the use of studded tires, the following test methods can be used:

- Prall Test
- Road Simulator tests

In addition, several tests for aggregates are discussed in chapter 3.4.

3.3.1 Prall Test

The Prall Test is divided into Methods A and B (CEN, 2004). Within this study, Method A was used to test several asphalt mixtures regarding their wear resistance against studded tires.

Results from the analysis of testing asphalt specimens with the Prall Test (Method A) are presented in Paper II. The test was performed in accordance with EN 12697-16 (CEN, 2004). Figure 10 shows the setup of the Prall abrasion apparatus.

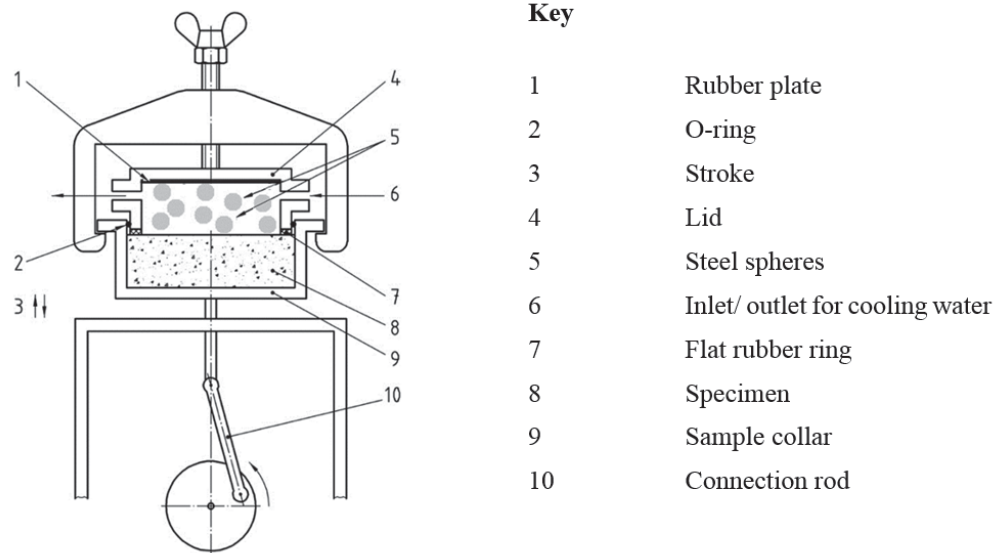

Figure 10: Abrasion apparatus Prall Test (Method A) (CEN, 2004)

A cylindrical specimen with a diameter of 100 ± 2 mm and a height of 30 ± 2 mm is placed in the test chamber of the Prall abrasion apparatus together with 40 steel spheres. Prior to testing, the specimen is cooled down to 5°C . During the test, water flows through the test chamber with a temperature of 5°C at a rate of 0.2 liter per minute. The standard duration of the test is 15 minutes, during which the steel balls are forced to bounce up and down on the surface. The purpose of the Prall Test (Method A) is to simulate the abrasive action of studded tires on asphalt mixtures at winter road conditions. Figure 11 shows Prall Test specimens after testing, with some of the steel spheres.



*Figure 11: Prall Test specimens after the test with some of the steel spheres
(Photo by Knut Opeide)*

The result of the test is presented as the abrasion value according to the following equation (CEN, 2004):

$$\text{Abr}_A = \frac{(M_1 - M_2)}{\rho_{\text{bssd}}} \quad (5)$$

where:

Abr_A is the abrasion value, in ml, reported to the nearest single decimal place;

M_1 is the mass in air of a water stored specimen, surface dry, before abrasion, in grams, rounded to one decimal;

M_2 is the mass in air of a water stored specimen, surface dry, after abrasion, in grams, rounded to one decimal;

ρ_{bssd} is the bulk density of the specimen according to chapter 4.3.4 in NS-EN 12697-16, in Mg/m^3 , rounded to three decimals.

The Prall Test has been used for many years, especially in Sweden, and good correlations between the test and measured wear from studded tires on real roads have been found (Snilsberg et al., 2008). The Prall Test seems to be a better method for testing resistance to wear than to just test the aggregates by the Nordic ball mill test according to EN 1097-9 (CEN, 2014).

The Prall Test (Method B) tests a cylindrical specimen with a diameter of 100 ± 1 mm and a height of 45 mm. The specimen is cooled down to 5°C and worn wet by studded tires during 2

hours. The abrasion apparatus (Figure 12) is a rotation unit with three studded rubber tires placed in circle 120 ° apart and a magnetic plate to hold the specimen. The result is the abrasion value recorded as the loss of material in ml.

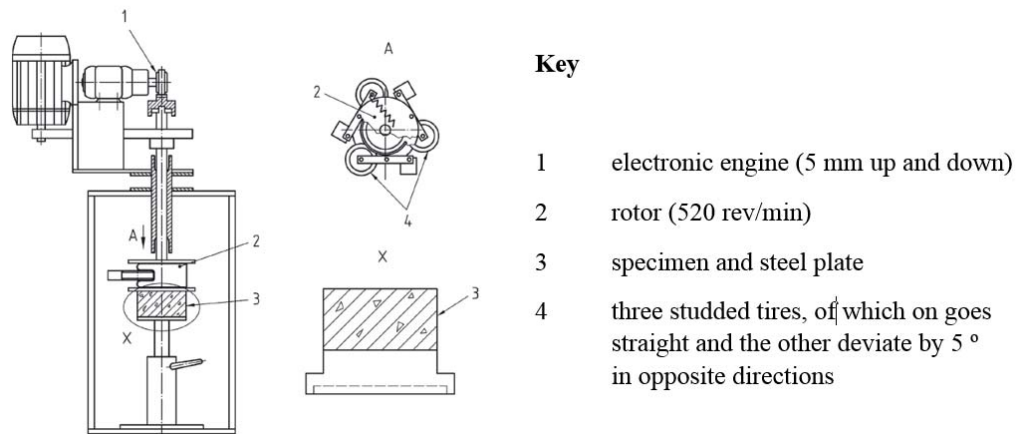

Figure 12: Abrasion apparatus Prall (Test Method B) (CEN, 2004)

3.3.2 Road Simulator test

In Paper III of this study, the wear of 14 asphalt mixtures tested in the Road Simulator at the Swedish National Road and Transport Institute (VTI) is analyzed. The simulator is a carousel-like test machine where six arms rotate on a circular track as shown in Figure 13.



Figure 13: Road Simulator (Photo by VTI)

During the tests, four of the arms were equipped with normal size car tires each applying the impact generated on the road pavement by one passenger car tire. The laser described in chapter 3.2.4 was installed at one of the two remaining arms. 28 asphalt pavement plates, two from each asphalt mixture, are prepared in a mold. The plates with the same asphalt mixture are placed at opposite sides of the circular track. Figure 14 sketches the Road Simulator including the laser equipment and the pavement plates.

Temperature and air humidity can be adjusted in the test chamber, so that the pavement wear can be studied close to realistic conditions. The normal rotational speed of the Road Simulator is 70 km/h for pavement wear tests. However, the machine was slowed down to 40 km/h to perform the texture measurements included in the tests for Paper III.

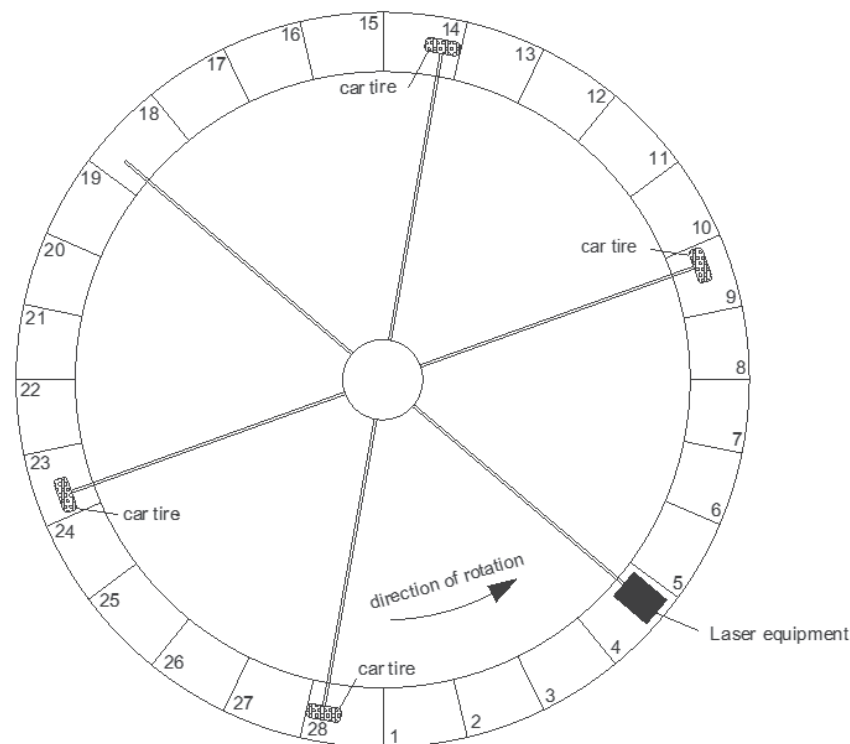

Figure 14: Sketch of the Road Simulator including laser equipment

3.4 Testing of aggregates

Several tests are used to define the strength of rock materials that are used as aggregates in the skeleton of asphalt mixtures. Strong aggregates usually ensure less wear on asphalt pavements caused by studded tires. Within this study, the following tests were used to characterize the rock materials used in the tested and analyzed asphalt mixtures. However, of these, just the Nordic abrasion value is used to assess wear resistance to studded tires.

3.4.1 Los Angeles

The Los Angeles method described in EN 1097-2 (CEN, 2010a) is used to determine the resistance to fragmentation of coarse aggregates. The test simulates the strains the aggregates are exposed to in a road pavement by rotating the material together with steel balls in a drum. The percentage of the crushed aggregate size fraction 10-14 mm that passes the 1.6 mm sieve after testing is used to calculate the Los Angeles coefficient (LA) from the following equation (CEN, 2010a):

$$LA = \frac{5000 - m}{50} \quad (6)$$

where:

LA is the Los Angeles coefficient, reported to the nearest integer, in %;

m is the mass retained on the 1.6 mm sieve, in grams.

A lower LA value reflects a higher resistance of the aggregates to fragmentation.

3.4.2 micro-Deval

The micro-Deval coefficient is defined in EN 1097-1 (CEN, 2011a) as the percentage of the original sample reduced to a size smaller than 1.6 mm due to rolling. During the test, 500 g aggregates with a size fraction 10-14 mm are placed together with steel balls and water in a rotating drum for two hours. The resulting weight loss of the aggregates is used to determine

their resistance against abrasive wear. The micro-Deval coefficient is calculated from the following equation (CEN, 2011a):

$$M_{DE} = \frac{500-m}{5} \quad (7)$$

where:

M_{DE} is the micro-Deval coefficient (in wet conditions), reported to the nearest integer, in %;
 m is the mass of the oversize fraction retained on a 1.6 mm sieve, in grams.

The lower the micro-Deval coefficient, the better the resistance to wear.

3.4.3 Nordic abrasion value

The Nordic abrasion value is described in EN 1097-9 (CEN, 2014) as the resistance of coarse aggregates to wear by abrasion from studded tires. Single-sized aggregates with size fraction 11.2-16 mm are rotated one hour in a steel drum together with steel balls and water. The test is meant to simulate the wear of the aggregates used in asphalt pavements that are exposed to studded tires. After the test, the aggregate portion is sieved on the 2 mm sieve to measure the wear as percentage loss. The Nordic abrasion value can then be calculated from the following equation (CEN, 2014):

$$A_N = \frac{100(M_1-M_2)}{M_1} \quad (8)$$

where:

A_N is the Nordic abrasion value, reported to the nearest single decimal, in %;
 M_1 is the initial dry mass of the test specimen, in grams;
 M_2 is the dry mass of aggregate particles greater than 2 mm, obtained after abrasion, in grams.

The initial dry mass of the specimen, M_1 , is defined in EN1097-9 as following (CEN, 2014):

$$M_1 = \frac{1000\rho_p}{2,65} \pm 5 \quad (9)$$

where:

M_I is the initial dry mass of the test specimen, in grams;

ρ_p is the pre-dried particle density determined in accordance with EN 1097-6, Annex A (CEN, 2013), in mega grams.

A low A_N value ensures good resistance to wear by abrasion from studded tires.

The micro-Deval test and the A_N value test are very similar and the results correlate very well.

3.4.4 Norwegian wearing index

The Norwegian Wearing Index (NWI) was developed within the research and development project “Environmentally Friendly Pavements”. For dense asphalt mixtures, the NWI includes the quality of the rock material used for the aggregates and the quantity of aggregates larger than 2 mm. The NWI is expressed by using the following equation (Uthus and Snilsberg, 2009):

$$NWI = \frac{A_N}{\text{percentage of aggregates } > 2 \text{ mm}} \cdot 100 \quad (10)$$

where:

NWI is the Norwegian wearing index, reported to the nearest single decimal place, in %

A_N is the Nordic abrasion value, in %.

Higher NWI value will cause more abrasion by studded tires.

4 Summary of the papers

To get a better insight into the results and analyses, this chapter gives a short summary of each paper that is included in the thesis. This acts as a background for the discussion following in chapter 5.

4.1 Paper I: The effect of asphalt mixture materials on changes of the road surface texture

Paper I presents an analysis of results that have been achieved during the research and development project “Environmentally Friendly Pavements”, accomplished by the NPRA. Nine test sections were chosen regarding their similarities in either location or surface type. Six of them were located at Trolle close to Trondheim, where three sections were paved with AC and the other three with SMA. The remaining three test sections were located at Mastemyr south of Oslo and paved with SMA. The D_{\max} of the SMA surfacing included both 6, 8 and 11 mm.

The paper analyzes and discusses the results of texture measurements that have been carried out at all test sections over five years, and presents correlations to the asphalt mixture properties of each test pavement. The texture measurements are presented as texture spectra, ERNL values and factor g . The properties of the asphalt mixtures were considered as the grading curves, the D_{\max} value and the NWI for aggregates larger than 2 mm.

As the result of the analysis, the following conclusions are drawn:

- The more gap-graded the grading curve of the aggregates, the more pronounced is the peak of the texture spectrum. (grammar)
- The road surface texture differs among the asphalt mixtures, especially regarding the aggregate properties.
- No correlation is found between ERNL and NWI_{2mm} . However, factor g and NWI_{2mm} correlate quite well with each other. An exponential regression model gives a correlation coefficient $R^2 = 0.935$. A decreasing NWI_{2mm} results in an increasing g factor.

4.2 Paper II: Prall tests to study the effect of mortar on the wear of Norwegian asphalt mixtures

Paper II describes a study to reveal the effect of aggregate choice on the wear of Norwegian asphalt mixtures. 19 asphalt mixtures were produced including AC and SMA mixtures with D_{max} 6, 8 or 11 mm and an unmodified binder. The mixtures were tested with the Prall Test (Method A) and the texture surface of the tested specimens was analyzed. Three rock types (A, B and C), differing amongst other things in their Nordic abrasion value, LA coefficient and micro-Deval value, were used differently in the stone skeleton of the asphalt mixtures. Rock material A was most resistant against abrasion; C was the less resistant material according to the micro-Deval and LA coefficient and the Nordic abrasion value.

The purpose of the study was to investigate how the surface of the asphalt specimens changes after being exposed to the Prall Test, and how these changes vary with the choice of different rock types in the fine and coarse fraction of the aggregate in the asphalt mixture. To evaluate the surface texture of the tested specimens, a new method was developed. The Prall Test specimens were cut into two half-moon shaped pieces and the texture profile was analyzed by measuring the Texture Area by means of AutoCAD.

The main conclusions of the study are as following:

- Size and percentage of coarse aggregates in the asphalt mixture are crucial for the Prall Test abrasion value and the Texture Area.

- The correlations for the Prall Test abrasion value and the Texture Area regarding the Nordic abrasion value show opposite trends
- i.e., it is difficult to find an asphalt mixture that is wear resistant and at the same time can obtain a low noise road surface after being exposed to studded tires.
- The texture surface of the specimens should be further investigated regarding their texture characteristics to find more correlations between texture surfaces to the noise characteristics.
- The placement of the cutting edge affects the results of the Texture Area.
- i.e., more specimens are needed to have more reliable results.

4.3 Paper III: Road Simulator Tests to study the Effect of Asphalt Mixture Components on the Development of Surface Texture and Noise Characteristics

Paper III is a following-up of Paper II. Road Simulator tests were carried out to simulate the wear of different asphalt pavements during the period from surfacing until the end of the first winter after paving. Eight asphalt mixtures from Paper II, tested by the Prall Test, were also tested in the Road Simulator. In addition, for six of these mixtures the binder was changed to a modified binder. Altogether, 14 asphalt mixtures were then tested in the Road Simulator. However, the aggregates of the asphalt mixtures included only rock material A in the fine fraction and varied between A and B in the coarse fraction.

The aim of the study was to analyze the wear development and the texture changes under changing performance conditions. To measure the wear and the texture of the pavements, a laser was installed on the Road Simulator. The test was divided into three parts, simulating different conditions regarding summer and winter tires, temperature and humidity. When winter tires were used, there was a 50/50 distribution between studded and studless tires.

The tests resulted in the following conclusions:

- The wear from summer tires is not surprisingly very small and can be neglected.
- Pavement wear increases continuously when winter tires are installed.

- Significant texture changes can be correlated to the initial pavement wear that is caused by the studded tires. However, changes in texture do not increase significantly after the initial wear.
- The study verifies the previous finding that asphalt mixtures with smaller D_{max} are worn faster. However, the pavement wear is minimized by using a more wear resistant rock material in the mix. In addition, a polymer modified binder can result in less wear of the asphalt pavement. Thus, the choice of wear resistant aggregate and a modified binder may repeat the effect of a smaller D_{max} on the wear.
- Texture changes are very similar, independent of the asphalt mix design. The texture spectra for all asphalt mixtures show the same tendency in their development.

The study reveals choosing the right materials for an asphalt mixture is crucial to avoid pavement wear that leads to a negative development for the noise characteristics of a pavement surface.

4.4 Paper IV: Surface texture and noise development on SMA 8 pavements in Norway

In Paper IV, The results from three Norwegian test sections that were paved with SMA 8 are analyzed regarding their development in wear, texture and noise characteristics. The mix designs of the asphalt mixtures were quite similar; the only obvious difference for one of the sections was the type of binder used. In the attempt to reduce the wear caused by the choice of the small D_{max} , special requirements were set to the quality of the rock material used for the aggregates in the asphalt mixtures on the test sections.

The focus of the study was to look at the performance of the pavements and to analyze the development of their surface characteristics. Both, pavement wear, noise levels and surface texture were measured over several years. The paper presents the analyses of these measurements. The results show that the pavements on three test sections developed differently despite similar preconditions. The progression in the surface characteristics was considered regarding pavement wear related to both material characteristics and environmental conditions of the test sections.

The study arrived at the following main conclusions:

- The performance of asphalt pavements can vary a lot, even if the mix design and the environmental conditions are similar.
- The materials chosen for the mix design of the asphalt mixtures affect the pavement wear to a certain degree. However, other factors contribute to the destruction of the road surface.
 - The workmanship during paving is crucial for the surface characteristics and the long-term performance of the pavement.
 - The distribution of traffic loadings on road sections with more than one lane can cause different performance on a road section depending on which lane is analyzed.
- The more the pavement is worn, the bigger are the changes in surface texture. As the noise characteristics are related to the texture, these changes are reflected in the development of the noise characteristics too.

Summary of the papers

5 Discussion

In this chapter, the results of the papers that are published within this study are discussed. The discussion is divided into three main parts. Part 1 discusses the effect on the pavement wear of different materials used in asphalt mixtures. The influence the strength of the mortar and the coarse aggregates has on the surface texture is discussed in part 2. In part 3, additional factors that might affect wear and surface texture development are considered.

5.1 Wear of asphalt mixtures

The use of studded tires causes a lot of wear on Norwegian roads. However, different asphalt pavements are worn differently. Several parameters that effect the wear are investigated in this study:

- D_{max}
- Type of rock material used for the aggregates
- NWI
- Asphalt mixture type
- Binder type

It is well known that the wear by studded tires decreases with an increasing D_{\max} (Snilsberg, 2008). This effect was verified by the results shown in paper II and III in this study. The asphalt mixtures with $D_{\max} = 8$ mm gave higher values for both the Prall abrasion value and the pavement wear measured in the Road Simulator, compared to the mixtures including the same materials but having a D_{\max} of 11 or 16 mm.

The results also reveal that the type of rock material used in the asphalt mixture affects the wear. For the asphalt mixtures that were analyzed within the study, different rock materials were used for the aggregates in the stone skeletons. The rock materials differed amongst other things in their resistance to the wear by abrasion from studded tires, which is reflected in the characteristics of the aggregates. The results show that the use of strong aggregates (rock material with low values for LA, M_{DE} and A_N) in the asphalt mixtures will result in less wear compared to a similar asphalt mixture that includes weaker aggregates (rock material with higher LA, M_{DE} and A_N).

The NWI is a parameter, which combines the strength and aggregate distribution effects. The results show that asphalt mixtures with lower NWI values gave less wear and a positive surface texture development regarding pavement noise characteristics than the use of asphalt mixtures with higher NWI values.

Taking the type of the asphalt mixture into account, gap-graded asphalt mixtures (SMA) result in less wear compared to asphalt mixtures with more evenly distributed aggregates in the stone skeleton (AC).

Regarding the influence of the binder type, the results from the Road Simulator show a slight wear improvement for some of the mixtures including polymer modified binder, while the results from the test section that were analyzed in Paper IV show the opposite. Hence, the results of this study do not show any clear effect of a polymer modified binder on the wear by studded tires.

5.2 Comparison of the results from Prall Test (Method A) and Road Simulator test

Some of the tested asphalt mixtures were tested against wear from studded tires both by the Prall Test (Method A) and the Road Simulator. Figure 15 compares the results of both test methods. It shows the final pavement wear of the asphalt specimens after 325 000 rotations in the Road Simulator and the Prall abrasion value of the asphalt mixtures. The graph shows a good correlation between the results from both test methods. Only the results for the AC 8 A diverge. The specimens of this asphalt mixture showed a distinctive cavity after testing with Prall Test (Method A), differently from specimens of the other mixtures. This might be caused by a failure of the mixture during the Prall test (Siebert and Mork, 2016). However, Figure 15 shows the same tendency regarding the wear from studded tires, tested with both Prall Test (Method A) and Road Simultaor.

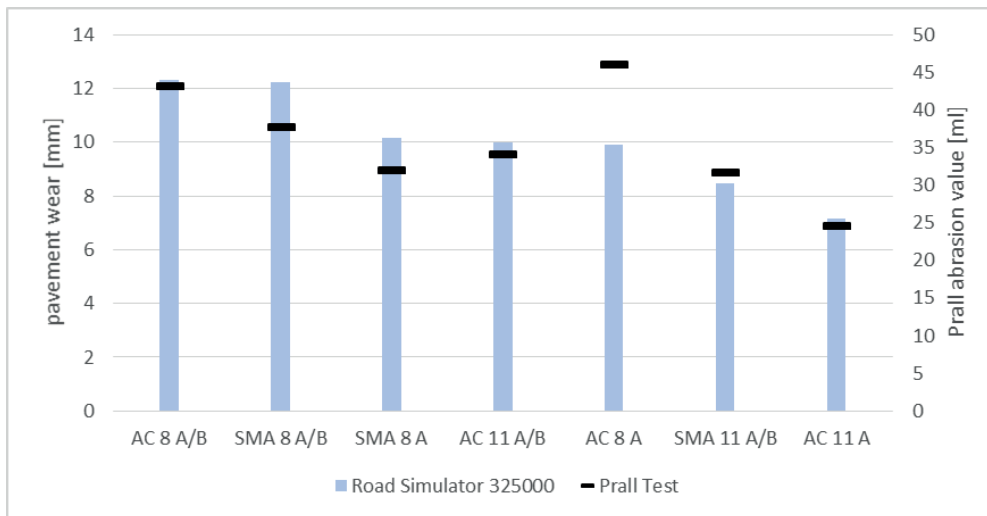

Figure 15: Comparison of the results from Prall Test and Road Simulator

Figure 16 shows the correlation between the both test methods. The results from testing AC 8 A were not considered to calculate the R^2 value. Since the results from the tests are well correlated ($R^2 = 0.8749$), both tests seem to be suitable to get an indication for the wear of asphalt pavement that are exposed to studded tires.

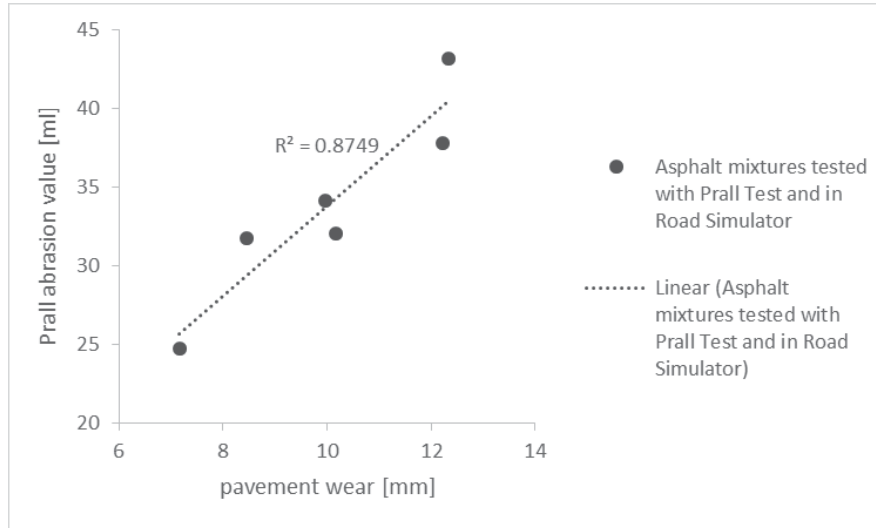

Figure 16: Correlation between the results from Prall Test and Road Simulator

5.3 Surface texture development

The pavement wear changes the surface texture over time. However, how the texture is changing depends on how the wear of the surface is progressing. Considering the surface texture development, the wear of asphalt pavements should be distinguished between the amount of wear and that part of the asphalt mixture that is worn (coarse aggregates or mortar). If the asphalt surface is worn evenly, it signifies that the mortar (fine aggregates < 2 mm, binder and additives) and the coarse aggregates are worn to the same amount at the same time. That indicates similar or same resistance to abrasive wear by studded tires for the mortar and the coarse aggregates. On the other hand, if the mortar is worn first and the coarse aggregates protrude from the surface, the mortar is less resistant to wear than the coarse aggregates. Hence, the development of surface texture is dependent on the wear resistance of both the mortar and the coarse aggregates. If the coarse aggregates have the same wear resistance as the mortar, the wear will be more balanced and the protrusion of the coarse aggregates is reduced. This can be achieved by using less strong coarse aggregates (with lower LA, M_{DE} and A_N) and stronger fine aggregates (with higher LA, M_{DE} and A_N).

5.3.1 Changes in texture spectra

The results from the analyses of texture spectrum development reveal that the changes in the texture spectra are similar, independent of composition of the asphalt mixture. The texture levels for the smaller wavelengths decrease while the levels for the bigger wavelengths increase. However, for asphalt mixtures with small D_{\max} (6 or 8 mm), the shape of the texture spectra was more favorable regarding noise generation, also after a couple of years with exposure to studded tires. This reveals that the initial texture spectrum, or the initial surface texture, is decisive for the noise characteristics of the road surface, both, just after paving and after a couple of years.

5.3.2 Balancing the wear of mortar and coarse aggregates

The results of the analyses of the Texture Area show that a smooth surface texture can be reached by using a weaker rock material for the aggregates in the coarse fraction and a strong rock material for aggregates in the fine fraction. Especially, the asphalt mixtures with material A in the fine fraction and material B in the coarse fraction provided little Texture Area. The asphalt mixtures with the strongest rock material (A) in the coarse fraction provided the highest Texture area values. Hence, the right choice of rock materials in the fine and coarse fraction can optimize the pavement wear regarding texture development. However, a small Texture Area implies a smooth surface, which does not necessarily result in less noise generation (Heckl, 1986). In addition, the total wear should always be considered as well.

5.3.3 Influence of the NWI

When the NWI was considered, the analyses point out a correlation between the NWI and the shape factor g . The results show that lower NWI values are followed by higher values for the factor g . Thus, an asphalt mixture with a high amount of strong aggregates larger than 2 mm will deliver higher values for factor g . The same tendency for the values of NWI and factor g is found on the analyzed test sections, but two test sections were included.

The results show the importance of the choice of rock material for the aggregates in the asphalt mixture. Especially the characteristics of the aggregates larger than 2 mm are important to

provide low noise characteristics in the long term. However, as discussed in chapter 5.3.2, the coarse aggregates should not be much stronger than the mortar to avoid a protrusion of those at the worn pavement surface.

5.4 Additional factors to affect wear and surface texture development of asphalt pavements

The reasons for differences in asphalt pavement performance are not easily found. Some asphalt pavements can be very similar in mix design and environmental conditions, but their development over time can be very different. One example is given in Paper IV. Two of the analyzed test sections in this paper are based on a very similar mix design. The rock material used in the asphalt mixtures is even from the same quarry. The only obvious difference is the binder type. However, these two test sections show a very different development. While one of them performs very well over long term, the other one had to be repaved after two years due to a lot of wear. Hence, additional factors that are not analyzed within the study might affect the wear and the surface texture development of asphalt pavements as well.

5.4.1 Performance and workmanship

The choice of materials often seems not to be the only reason why asphalt pavements do not perform as expected. Sometimes, asphalt mixtures with the same mix design show different initial texture characteristics. Even if a strong rock material, an adapted binder and a proper mix design establish a good foundation for a durable pavement surface, the execution and workmanship on the construction site is a crucial factor to achieve the required performance indicators over a long term. Aurstad et al. (2016) analyzed the influence of asphalt workmanship on pavement service life. They found out that one of the consequences of poor execution and workmanship is asphalt pavement inhomogeneity. An asphalt mix segregation can take place during loading, unloading, transport and construction, and will cause a variation between open and dense areas of the surface layer (Aurstad et al., 2016). Besides durability and poor friction problems, this cause different surface texture characteristics within the macrotexture range for one asphalt mixture. Thus, the noise characteristics may vary for inhomogeneous asphalt pavements. Other effects of poor execution and workmanship might be a lack of bonding

between asphalt layers and poor longitudinal and transverse joints (Aurstad et al., 2016). However, these effects mostly affect the wear in the megatexture range and are not decisive for the noise characteristics of road surfaces.

5.4.2 Design and layout of the road

Changes in surface texture might also be caused by the road design and layout. The curvature, slopes or acceleration/deceleration zones expose the asphalt pavement surface to shear forces that cause deformation. This deformation, which over time might lead to cracks in the pavement, can affect the surface texture in the macro- and megatexture range. Thus, the texture development might be different on sections that are more exposed to a challenging design and layout than straight road sections that are exposed to vehicles driving at constant speed. However, no research has been done on that within this study.

Discussion

6 Conclusions and recommendations

This chapter presents a compilation of the conclusions drawn in the research papers included in this study and the discussion in the previous chapter. The closing remarks give some recommendations on further research and future work.

6.1 Conclusions

Changes in surface texture of Norwegian asphalt pavements are often caused by the use of studded tires during the winter season. The studded tires cause wear of the asphalt material at the pavement surface. Usually, the wear starts by an abrasion of the mortar, which causes a protrusion of the coarse aggregates. This protrusion changes the surface texture and has a negative effect on the acoustical characteristics of the road pavement by causing noise generation due to vibration mechanisms in the tire/road interaction. This study considered the use of different materials in the asphalt mixtures to investigate the changes in surface texture over time caused by pavement wear. Particular interest was given to the mix design of typical Norwegian asphalt mixture types as AC and SMA. Especially, the type and amount of aggregates used in the fine and coarse fraction of the stone skeleton in the asphalt mixtures were factors that were closely examined.

In order to estimate the effect of different characteristics of the particular components of an asphalt mixture, several laboratory tests were carried out to simulate the abrasive action from studded tires, both on the aggregates and on asphalt pavements. To investigate the development of wear and surface texture, numerous field and laboratory measurements were analyzed. The acoustic characteristics of the road pavements were also taken into account.

The following conclusions can be drawn from the analyses and test carried out to evaluate asphalt mixtures and their development in pavement wear and surface texture:

- The D_{max} affects both the pavement wear and the surface texture. However, the wear is increasing with a decreasing D_{max} , but the texture spectra are more favorable regarding low noise pavement characteristics for asphalt mixtures with a smaller D_{max} .
- The analyses of the texture spectra development show, that the changes in texture appear similarly, independent of the mix design.
- The rock material that is used for the aggregates in an asphalt mixture is important for both the amount of pavement wear and the texture development. However, it should be distinguished between the fine and coarse fractions within the stone skeleton. The use of strong rock materials with low LA, M_{DE} and A_N will usually result in less wear. However, to balance the wear between the mortar and the coarse aggregates, the rock material in the coarse fraction should be as closely resistant to abrasion as the mortar as possible. By balancing the wear, the protrusion of the coarse aggregates can be avoided. Thus, the surface texture of the worn pavement is smoother and lower noise levels might be generated.
- The distribution of the aggregates in the asphalt mixture affects the wear and the surface texture development. Gap-graded asphalt mixture types (SMA) result in less wear than asphalt mixtures with evenly distributed aggregates (AC). In addition, the acoustic characteristics of SMA surfaces are more favorable regarding noise reduction.
- The NWI combines the strength and the distribution of the aggregates. Within this study, a correlation between the calculated values of NWI and shape factor g has been found. The lower the values for NWI, the more favorable are the values for factor g regarding the acoustic characteristics of the pavement.

- The use of polymer modified binder in asphalt mixtures shows no clear reduction in pavement wear caused by the exposure to studded tires, compared to the wear of asphalt mixtures including unmodified binder.
- A comparison of the results of tests carried out by the Prall Test and the Road Simulator shows a good correlation between the wear parameters. This reveals that both tests are adequate for ranking asphalt pavements regarding wear caused by studded tires.

6.2 Recommendations

The conclusions proof the importance of the awareness of the aggregate choice in mix design for maintaining the good surface noise characteristics. To provide low noise characteristics of an asphalt pavement in the long term, the characteristics of the aggregates larger than 2 mm are crucial, but should also be adjusted to the characteristics of the mortar. However, the study is limited to asphalt mixture types that are currently commonly used in Norway. Nevertheless, the possibility to reduce noise that is caused by the interaction between a car tire and a road pavement is limited, as long as the mix design for road pavements is limited to dense asphalt pavements. International research on low noise road pavements shows that there are new promising concepts. Traditionally, there exist a slight skepticism towards new products in the road sector in Norway due to failure of untraditional products in the past. However, new materials and surface treatments should be tested to achieve better results for noise reduction even after exposure to studded tires.

Conclusions and recommendations

7 References

- ANFOSSO-LÉDÉE, F. & DO, M.-T. 2002. Geometric descriptors of road surface texture in relation to tire-road noise. *Transportation Research Record: Journal of the Transportation Research Board*, 160-167.
- ANGST, C., BELTZUNG, F., BOSSHARDT, D., ZIEGLER, T. & BÜHLMANN, E. 2010. Lärmarme Strassenbeläge innerorts Jahresbericht 2010. Swiss: Bundesamt für Strassen (ASTRA), Bundesamt für Umwelt (BAFU).
- AURSTAD, J., UTHUS, N. S., TELLE, R. & BAKLØKK, L. J. 2016. The influence of workmanship on pavement service life. *6th Euroasphalt & Eurobitume Congress*. Prague, Czech Republic.
- BECKENBAUER, T. 2007. SPERON model and AOT project. *Presentation at Texture Workshop organized by NPRA*. Oslo, Norway.
- BERGE, T. S., HAUKLAND, F. & USTAD, A. 2009. Environmentally friendly pavements: Results from noise measurements 2005-2008.
- BUENO, M., LUONG, J., VIÑUELA, U., TERÁN, F. & PAJE, S. 2011. Pavement temperature influence on close proximity tire/road noise. *Applied Acoustics*.
- CEN 1997. ISO 13473-1 Characterization of pavement texture by use of surface profiles - Part 1: Determination of Mean Profile Depth. Geneva, Switzerland: International Organization for Standardization.

References

- CEN 2002a. ISO 13473-2 Characterization of pavement texture by use of surface profiles - Part 2: Terminology and basic requirements related to pavement texture profile analysis. Geneva, Switzerland: International Organization for Standardization.
- CEN 2002b. ISO 13473-3 Characterization of pavement texture by use of surface profiles - Part 3: Specification and classification of profilometers. Geneva, Switzerland: International Organization for Standardization.
- CEN 2003. EN 13036-3 Road and airfield surface characteristics - Test methods - Part 3: Measurement of pavement surface horizontal drainability. Brussels, Belgium: European Committee for Standardization.
- CEN 2004. EN 12697-16 Bituminous mixtures - Test methods for hot mix asphalt - Part 16: Abrasion by studded tyres. Brussels, Belgium: European Committee for Standardization.
- CEN 2008. ISO/TS 13473-4 Characterization of pavement texture by use of surface profiles - Part 4: Spectral analysis of surface profiles. Geneva, Switzerland: International Organization for Standardization.
- CEN 2010a. EN 1097-2 Tests for mechanical and physical properties of aggregates - Part 2: Methods for the determination of resistance to fragmentation. Brussels, Belgium: European Committee for Standardization.
- CEN 2010b. EN 13036-1 Road and airfield surface characteristics - Test methods - Part 1: Measurement of pavement surface macrotexture depth using a volumetric patch technique. Brussels, Belgium: European Committee for Standardization.
- CEN 2011a. EN 1097-1 Tests for mechanical and physical properties of aggregates - Part 1: Determination of the resistance to wear (micro-Deval). Brussels, Belgium: European Committee for Standardization.
- CEN 2011b. EN 13036-4 Road and airfield surface characteristics - Test methods - Part 4: Method for measurement of slip/skid resistance of a surface: The pendulum test. Brussels, Belgium: European Committee for Standardization.
- CEN 2013. EN 1097-6 Tests for mechanical and physical properties of aggregates - Part 6: Determination of particle density and water absorption. Brussels, Belgium: European Committee for Standardization.
- CEN 2014. EN 1097-9 Tests for mechanical and physical properties of aggregates - Part 9: Determination of the resistance to wear by abrasion from studded tyres - Nordic test. Brussels, Belgium: European Committee for Standardization.
- DESCORNET, G. & SANDBERG, U. Road surface influence on tire/road noise-Part I. Inter-Noise 80, 1980a Miami, USA. 259-266.

References

- DESCORNET, G. & SANDBERG, U. Road surface influence on tire/road noise-Part II. Inter-Noise 80, 1980b Miami, USA. 267-272.
- EVENSEN, R. 2009. Environmentally Friendly Pavements - Final Report. Oslo, Norway: Norwegian Public Roads Administration - Road Directorate.
- GIBBS, D., IWASAKI, R., BERNHARD, R., BLEDSOE, J., CARLSON, D., CORBISIER, C., FULTS, K., HEARNE JR, T., MCMULLEN, K. & ROBERTS, J. 2005. Quiet pavement systems in Europe. Washington DC, United States.
- HAIDER, M. & DESCOURNET, G. 2006. Noise classification methods for urban road surfaces - Classification Methodology.
- HECKL, M. 1986. Tyre noise generation. *Wear*.
- ISO 1997. 11819-1 Acoustics - Measurement of influence of road surfaces on traffic noise - Part1: Statistical Pass-By method. Genève, Switzerland: International Organization of Standardization.
- ISO 2003. 13325 Tyres - Coast-by methods for measurement of tyre-to-road sound emission. Geneva, Switzerland: International Organization for Standardization.
- ISO 2013. FDIS 11819-2 Acoustics - Method for measuring the influence of road surfaces on traffic noise - Part 2: Close-proximity method. Online: International Organization for Standardization.
- IWAO, K. & YAMAZAKI, I. 1996. A study on the mechanism of tire/road noise. *JSAE review*.
- IWASE, T. Acoustic properties of porous pavement with double layers and its reduction effects for road traffic noise. Proceedings of Inter Noise, 2000.
- KLOTH, M., VANCLUYSEN, K., CLEMENT, F. & ELLEBJERG, L. 2008. Local Noise Action Plans - Recommendations from the SILENCE project. Bergisch Gladbach, Germany.
- KRAGH, J., IVERSEN, L. M. & SANDBERG, U. 2013. Road surface texture for low noise and low rolling resistance, Nordtex final report. Copenhagen, Denmark.
- KUIJPERS, A. 2001. Further analysis of the Sperenberg data, Towards a better understanding of processes influencing tyre/road noise, Technical Report M+P.MVM.99.3.1. Vught, The Netherlands.
- KUPIAINEN, K., TERVAHATTU, H. & RÄISÄNEN, M. 2003. Experimental studies about the impact of traction sand on urban road dust composition. *Science of the Total Environment*.

References

- LANDSDOWN, A. R. & PRICE, A. L. 1986. Materials to resist wear: A guide to their selection and use. *Pergamon materials engineering practice series*. Oxford, New York, United States.
- LÅG, M., MYRAN, T., REFSNES, M., SCHWARZE, P. E. & ØVREVIK, J. 2004. Veidekker: Svevestøv og helse. Oslo, Norway: Nasjonalt folkehelseinstitutt.
- MILJØDEPARTEMENTET 2014. Handlingsplan mot støy 2007-2011, med oppdatering ut 2015. Oslo, Norway: Ministry of climate and Environment, Norwegian Government.
- MILJØDIREKTORATET. 2016. *Noise* [Online]. Norwegian Environment Agency. Available: <http://www.environment.no/topics/noise/> [Accessed 04.10.2016].
- MORGAN, P., ABBOTT, P., ANDERSEN, B., ANFOSSO-LEDEE, F., BARTOLOMAEUS, W., BENDTSEN, H., VAN BLOKLAND, G., DESCORNET, G., EIJBENSEN, M., EJSMONT, J. A., HABERL, J., HAMET, J.-F., MIODUSZEWSKI, P., NILSSON, R., PADMOS, C., PUCHER, E., ROOVERS, C., SANDBERG, U., SLIWA, N., VEISTEN, K., VAN VLIET, W. J. & WATTS, G. 2006. FEHRL REPORT, Guidance manual for the implementation of low-noise road surfaces. Brussels, Belgium.
- N/A 2009. *AASHTO Provisional Standards, 2009 Edition*, American Association of State Highway and Transportation Officials (AASHTO).
- NFS 2001. 31-1193-2 Acoustics: In-situ characterization of the acoustic qualities of road surfaces - Pass by acoustic measurement - Part 2: Controlled pass-by method. Paris, France: National French Standard, AFNOR.
- RASMUSSEN, R., SOHANEY, R. & WIEGAND, P. 2011a. Measuring and Reporting Tire-Pavement Noise Using On-Board Sound Intensity (OBSI). *National Concrete Pavement Technology Center, Iowa State University, Ames, Iowa*.
- RASMUSSEN, R. O., SOHANEY, R., WIEGAND, P. & HARRINGTON, D. 2011b. Measuring and analyzing pavement texture. *National Concrete Pavement Technology Center, Tech Brief January*.
- REGJERINGEN.NO. 2001. *The Norwegian National Environmental and Health Action Plan* [Online]. Ministry of Environment and Ministry of Health and Social Affairs. Available: <https://www.regjeringen.no/no/dokumenter/the-norwegian-national-environment-and-h/id105635/> [Accessed 04.10.2016].
- REGJERINGEN.NO. 2007. *St.meld.nr 26 (2006-2007) - Regjeringens miljøpolitikk og rikets miljøtilstand* [Online]. Available: <https://www.regjeringen.no/no/dokumenter/Stmeld-nr-26-2006-2007-/id465279/?ch=1&q=> [Accessed 05.10.2016].
- SABA, R. G. 2006. Miljøvennlige vegdekker - Spesialdekker - Poroelastiske dekker. Oslo, Norway.
-

References

- SANDBERG, U. 1998. Influence of road surface texture on traffic characteristics related to environment, economy and safety: A state-of-the-art study regarding measures and measuring methods. *VTI notat 53A-1997*. Linköping, Sweden: Statens väg- och transportforskningsinstitut, VTI.
- SANDBERG, U. 1999. Low noise road surfaces. A state-of-the-art review. *Journal of the Acoustical Society of Japan (E)*, 20, 1-17.
- SANDBERG, U. 2010. Road surface texture influence on tyre/road noise. VTI.
- SANDBERG, U. & EJSMONT, J. A. 2002. Tyre/road noise reference book. Kisa, Sweden.
- SIEBERT, D. & MORK, H. 2016. Prall Tests to study the effect of mortar on the wear of Norwegian asphalt mixtures. *6th Euroasphalt & Eurobitumen Congress*. Praha, Czechia.
- SNILSBERG, B. 2008. *Pavement wear and airborne dust pollution in Norway - Characterization of the physical and chemical properties of dust particles*. Norwegian University of Science and Technology.
- SNILSBERG, B., MYRAN, T., UTHUS, N. & AURSTAD, J. 2008. Evaluation of different laboratory methods for simulation of pavement wear and road dust generation. *Road Materials and Pavement Design*.
- STATISTICS NORWAY. 2013. *Støyeksponering og støyplage i Norge. 1999 – 2011. Flere støyutsatte* [Online]. Available: <http://www.ssb.no/natur-og-miljo/artikler-og-publikasjoner/flere-stoyutsatte> [Accessed 04.10.2016].
- UTHUS, N. & SNILSBERG, B. 2009. Miljøvennlige vegdekker - Sluttrapport for arbeidspakke 3: Støv. Oslo, Norway: Norwegian Public Roads Administration.
- WHO 2011. Burden of disease from environmental noise _Quantification of healthy life years lost in Europe. Copenhagen, Denmark.

References

Paper I

Proceedings of 41st International Congress and Exposition on Noise Control Engineering 2012
(INTER-NOISE 2012). Institute of Noise Control Engineering (INCE).

ISBN 978-1-62748-560-9

The effect of asphalt mixture materials on changes of the road surface texture

Doreen Fritzsche

Department of Road Technology, Norwegian Public Roads Administration, Postboks 8142, Dep, 0033 Oslo, Norway, doreen.fritzsche@vegvesen.no

Svein Å. Storeheier

Department of Acoustics, SINTEF ICT, Stiftelsen SINTEF, box 4760 Sluppen, 7465, Trondheim, Norway, Svein.A.Storeheier@sintef.no

Helge Mork

Department of Civil and Transport Engineering, NTNU-Trondheim, Norwegian University of Science and Technology, 7491 Trondheim, Norway, helge.mork@ntnu.no

In the period 2004-2008, the Norwegian Public Roads Administration conducted a research and development project called “Environmentally Friendly Pavements”. In this project, different road surfaces were tested regarding their texture and noise characteristics. Follow-up measurements, including texture and noise measurements, were performed on a number of dense surfaces in 2009 and 2010. The results show that the biggest changes in texture and noise levels occur after the first winter season with exposure to studded tires. These changes are correlated to the asphalt mixture. The aggregates used in the asphalt mixtures on the different road sections vary in rock type, maximum aggregate size and grading. In addition, the used binders differ in content and type. About 1/3 of the tested asphalt mixtures contain a polymer modified binder. The data for all dense asphalt mixtures tested have been analyzed to find correlations between the specific material characteristics and the texture properties. This paper reports the results of these analyses of the material characteristics and their effect on the changes of the road surface texture. The strong correlation between road surface texture and tire/road noise allows additional assumptions regarding noise performance.

1 Introduction

A well-known effect of noise is a reduction of well-being and a negative impact on people's behavior and state of health. In 2007, the Norwegian Ministry of Environment set a national target, which aims to reduce noise annoyance, and the number of people exposed to noise. In Norway, road traffic is the source for almost 80 % of noise nuisance.¹ There are generally three physical measures to reduce the noise caused by road traffic: noise barriers, building insulation and low noise surfaces.

A development project, called "Environmentally Friendly Pavements", was launched by the Norwegian Public Roads Administration in 2004 and completed in spring 2009. Within this project, the focus was given to low noise asphalt surfaces. Noise and texture measurements were carried out over a couple of years. One objective was to test different asphalt mixes regarding their surface texture and noise characteristics to find a relationship between the different types of road surfaces and the measured noise values. In addition, it has been the aim of the project to optimize the environmental properties of road surfaces and to contribute to achieve the national target set for noise levels.²

The paper includes data collected under the project "Environmentally Friendly Pavements" and followed up in 2009 and 2010. The aggregates of the asphalt mixes used for the test sections that were included in the project differ in grading, maximum aggregate size and mineralogy. Information about the asphalt mixes used for the test sections and texture data will be presented and analyzed. The aim is to describe the effects different types, sizes and amounts of aggregates used in asphalt mixes have on the changes of the road surface texture over time. No data of noise measurements will be presented or discussed.

2 Background

The noise generation mechanisms of the tire/road interface are related to the road surface texture characteristics, among other factors.³ Changes in surface texture are correlated to the changes in noise levels.⁴ The road surface texture is expected to differ according to the asphalt mixes, and the different properties of asphalt surfaces should affect the progression of surface texture.

A general method to visualize the surface texture is to use a texture spectrum, which is obtained by analyzing the measured texture profile curve using the discrete fast Fourier transform (FFT) analysis.

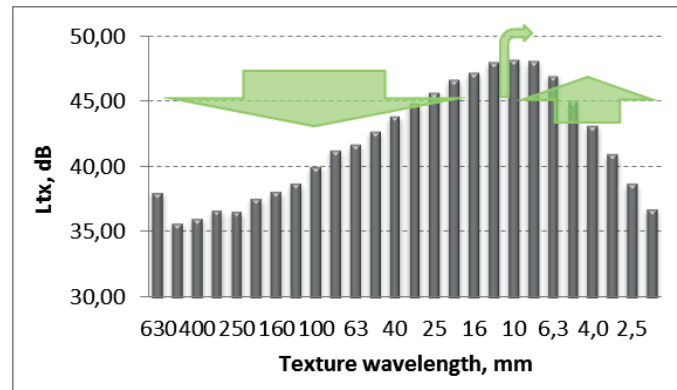

Fig. 17 - Desirable texture spectrum for achieving a low noise road surface *adapted from 3*

By using specific values from a texture spectrum, it is possible to draw conclusions regarding the noise characteristics of a surface layer. A texture spectrum that represents a low noise road surface should display low values within texture wavelength range 20-500 mm and high values within texture wavelength range 0,5-10 mm. The peak should occur as far as possible to the right in the spectrum.³ This is illustrated by figure 1.

3 Materials and methods

A total of 37 test sections have been established on normally trafficked roads as part of the project “Environmentally Friendly Pavements”. Surface layers on those test sections include dense surfaces, thin layers and porous surfaces. Due to the special climate in Norway and the use of studded tires, dense surfaces have been considered as most durable. This paper will therefore focus on dense surfaces only.

On all test sections, texture measurements have been carried out annually using a laser profilometer mounted on a driving vehicle.

4 Selection of test sections to be analyzed

The wide variety of 37 test sections makes it difficult to find common properties to compare the characteristics of the different surface types properly. By focusing on a selection of test sections, an attempt is made to find test sections with basic similarities in either location or surface type. Table 1 presents the main traffic and road information for the nine test sections selected to be analyzed in this paper.

Table 1 - Road and traffic information for test sections analyzed in the paper

Location	Surface type	Maximum aggregate size [mm]	Annual average daily traffic per lane (AADT)	Percentage heavy vehicles	Speed limit [km/h]	Percentage studded tires
Trolla (Trondheim)	AC	6	1 350	10	80	59
	AC	8				
	AC	11				
	SMA	6				
	SMA	8				
	SMA	11				
Mastemyr (Oslo)	SMA	6	2 300	10	90	20
	SMA	8				
	SMA	11				

Six of the selected sections are located at Trolla, close to Trondheim. Three of them are asphalt concrete (AC), the other three are stone mastic asphalt (SMA). The maximum aggregate sizes were 6, 8 and 11 mm for each surface type. The remaining three test sections are located at Mastemyr, close to Oslo and are SMA. The maximum aggregate sizes were again 6, 8 and 11 mm.

4.1 Texture measurements

The company ViaTech has developed a new laser system capable of performing texture measurements. With this system, texture can be recorded continuously over a road section of at least some 100 meters length. Texture measurements have been performed annually on all test sections all through the project period. Texture data were recorded with a Selcom 32 kHz laser that is also used to measure rutting and unevenness. The system delivers point values for the

pavement's height profile (2D measurements). Using a recording speed of 40 km/h, this corresponds to a sampling interval of 0,35 mm along the road. Only the inner (left) wheel track was used as measuring line.

5 Texture analysis

The Texture analysis was conducted in accordance to ISO 13473 parts 1, 2 and ISO/TS 13473-4. Calculations of texture levels are based on a discrete FFT analysis for each test section to deliver the texture profile level $L_{tx,\lambda}$, where L_{tx} is the texture profile level (dB, ref. 1 μm), and λ describes the center wave length (mm) in the one-third-octave band. The texture spectrum visualizes the texture profile levels over the measured test section.⁸

Two texture parameters can be correlated with noise characteristics of the road surface: the Estimated Road Noisiness Level (ERNL) and the G factor.

The ERNL is expressed in dB(A) and is used to predict the contribution of a road surface to the perceived noise at the A-weighted noise level. ERNL is calculated by the following equation:³

$$\text{ERNL} = 0,50 \cdot L_{tx,80} - 0,25 \cdot L_{tx,5} + 60 \quad (1)$$

$L_{tx,80}$ and $L_{tx,5}$ are 1/1-octave band levels. Values obtained are based on values of the texture spectrum and correspond to typical peak noise level for coast-by of a passenger car at 70 km/h at a distance of 7,5 m.³

The G factor is a shape factor of the road surface in % that is based on cumulative amplitude distribution of the profile heights. It is used to consider the orientation of the texture. A higher value indicates a negative skew; a lower value indicates a positive skew. The negative skew (concave distribution) indicates certain flatness in the surface texture. The positive skew (convex distribution) indicates certain "peakyness" in the surface texture. To obtain low noise values, a negative skew, i.e. a high value of the G factor, is desired.⁹

6 Analysis

The analysis considered both the characteristics of the selected asphalt surfaces and the texture progression. The asphalt surfaces have been analyzed regarding their aggregates considering the grading curve, maximum aggregate size and different characteristics of the mineralogy. Results representing the texture progression are assembled in graphs visualizing texture spectra, ERNL and G factor.

6.1 Characteristics of the selected asphalt surfaces

The selected asphalt surfaces differ mainly in grading and rock type. The maximum aggregate sizes were 6, 8 and 11 mm. Dense surface types such as asphalt concrete and stone mastics asphalt form the basis for the analysis in this paper. For all chosen test sections the same binder type pen 70/100 was used.

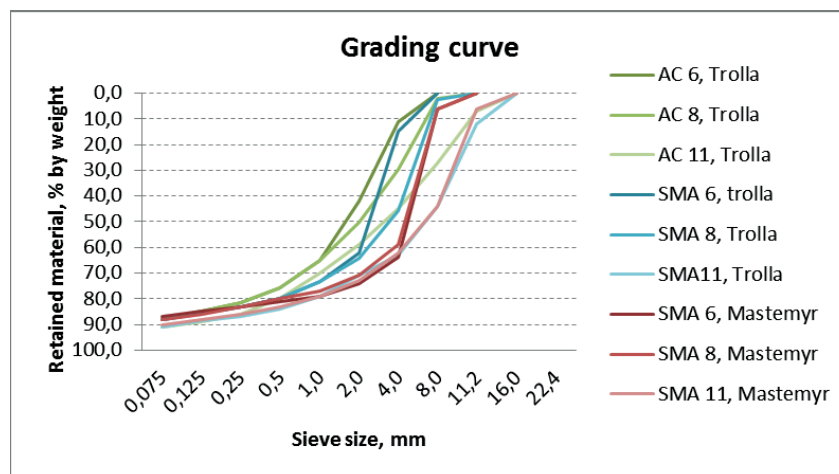

Fig. 2 - Grading curves for the selected asphalt materials

Figure 2 presents the grading curves taken from the recipe of the asphalt materials of the nine sections. The curves demonstrate clearly the difference between the gap-graded distribution of aggregates in SMA and the evenly distributed aggregate sizes in AC. Comparing the grading curves for the SMAs, it turns out that especially the materials used for the SMA 6 and SMA 8 at Trolla contain less aggregates in fraction 2-4 mm than the corresponding materials used for

the test sections at Mastemyr. The distribution of the aggregates of the SMA surfaces at Trolle tends to be a blend of the distribution of the aggregates for traditional AC and SMA asphalt mixes. This means that the distribution of aggregates in SMA surfaces at Trolle is less gap-graded than that at Mastemyr. Furthermore, it can be seen that the grading curves for SMA 6 and SMA 8 at Mastemyr overlap to a large degree and are almost the same. However, both grading curves for SMA with maximum aggregate size of 11 mm correspond very well to each other.

The progression of the texture is supposed to depend on the wearing resistance of the surface material. Earlier studies have demonstrated that the quality of aggregates is important for the wearing resistance of the asphalt surface. However, the amount of coarse aggregates is significant as well.^{10, 11} The Norwegian wearing index (NWI) includes the Nordic abrasion value (A_N) and the amount of aggregates larger than 2 mm.¹⁰ Since three of the selected test sections have a maximum aggregate size of 6 mm it seems to be appropriate to analyze the rock material larger than 2 mm. Uthus and Snilsberg [2009] correlated the NWI for aggregates larger than 2 mm to the Tröger value and found a linear correlation coefficient R^2 close to 1. This is shown in figure 3. The Tröger value is the result of a test described by EN 1871, Annex K [2000] and Statens vegvesen [2005]. Tröger is a simple laboratory test which is used to simulate the wear of studded tires on asphalt surfaces.¹⁴

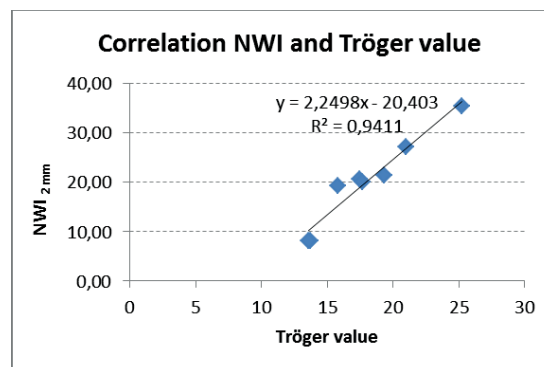

Fig. 3 - Correlation between NWI for aggregates > 2 mm and Tröger value *adapted from 10*

To calculate NWI for aggregates larger than 2 mm, the following equation has been applied:¹⁰

$$NWI_{2\text{ mm}} = \frac{A_{N,\text{compound}}}{\text{percentage of aggregates } > 2\text{ mm}} \cdot 100 \quad (2)$$

In this equation, the A_N is the result of a test procedure for the simulation of the abrasive action of studded tires on coarse aggregates used in a surfacing layer.¹⁵ For the test sections at Trolla, the aggregates larger than 2 mm are composed of different rock types. A compound Nordic abrasion value ($A_{N,\text{compound}}$) was calculated considering the amount of the different rock types. Table 2 presents wear resistance values for aggregates larger than 2 mm. Figure 4 shows the results of NWI for aggregates larger than 2 mm for the selected test sections.

Table 2 – Wear resistance values for aggregates larger than 2 mm

Location	Surface type	Maximum aggregate size [mm]	Compound Nordic abrasion value, $A_{N,\text{compound}}$	Percentage of aggregates > 2 mm [%]	NWI for aggregates > 2 mm
Trolla (Trondheim)	AC	6	13,06	37	35,30
	AC	8	13,06	48	27,21
	AC	11	13,16	64	20,56
	SMA	6	12,85	60	21,42
	SMA	8	12,85	64	20,08
	SMA	11	12,78	66	19,36
Mastemyr (Oslo)	SMA	6	6,10	77	7,92
	SMA	8	6,10	74	8,24
	SMA	11	6,10	75	8,13

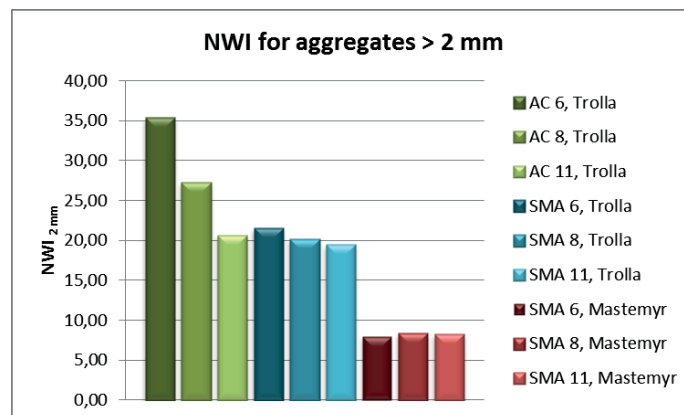

Fig. 4 - NWI for aggregates larger than 2 mm

Table 2 and figure 4 outline the different characteristics of the test sections regarding the used aggregates. The same rock material has been used for all asphalt surfaces at Trolla. It is composed of two different rock types. In addition, test sections at Trolla are AC and SMA which results in different distributions of the aggregates. These are the reasons why the $A_{N, \text{compound}}$ differs for each test section. The aggregates used for test sections at Mastemyr consists of only one rock type. The A_N is therefore the same for these test sections. The percentage of aggregates larger than 2 mm differ for each asphalt material and so does the $NWI_{2 \text{ mm}}$. However, figure 4 emphasizes that there is a clear difference of the quality of the aggregates used for surfaces laid at Trolla and those at Mastemyr. Caused by a much lower A_N and a higher percentages of aggregates larger than 2 mm, test sections at Mastemyr have a much lower $NWI_{2 \text{ mm}}$ than those at Trolla. Since AC 6 and AC 8 include a lower amount of aggregates larger than 2 mm compared to AC 11, the $NWI_{2 \text{ mm}}$ for these test sections are the highest, which should indicate less resistance to wear.

6.2 Texture progression

Figure 5 presents the texture progression of the asphalt surfaces arranged by their maximum aggregate sizes. Each graph visualizes the progression of the texture spectra from 2006 until 2010. All asphalt surfaces were laid in 2005. The assembly drawings of the texture spectra demonstrate both the different characteristics and the progression for each surface texture.

At this point it has to be mentioned that there are some uncertainties regarding the progression of the texture data for AC 6 located at Trolla. The surfacing layer was applied very thin. After 2-3 years, it was partly worn, probably due to the high percentage of studded tires and a lot of moisture on the road surface. As a consequence of this, some results of the texture measurements on AC 6 may represent the layer underneath. The results for AC 6 are therefore considered to be uncertain, at least after 2008.

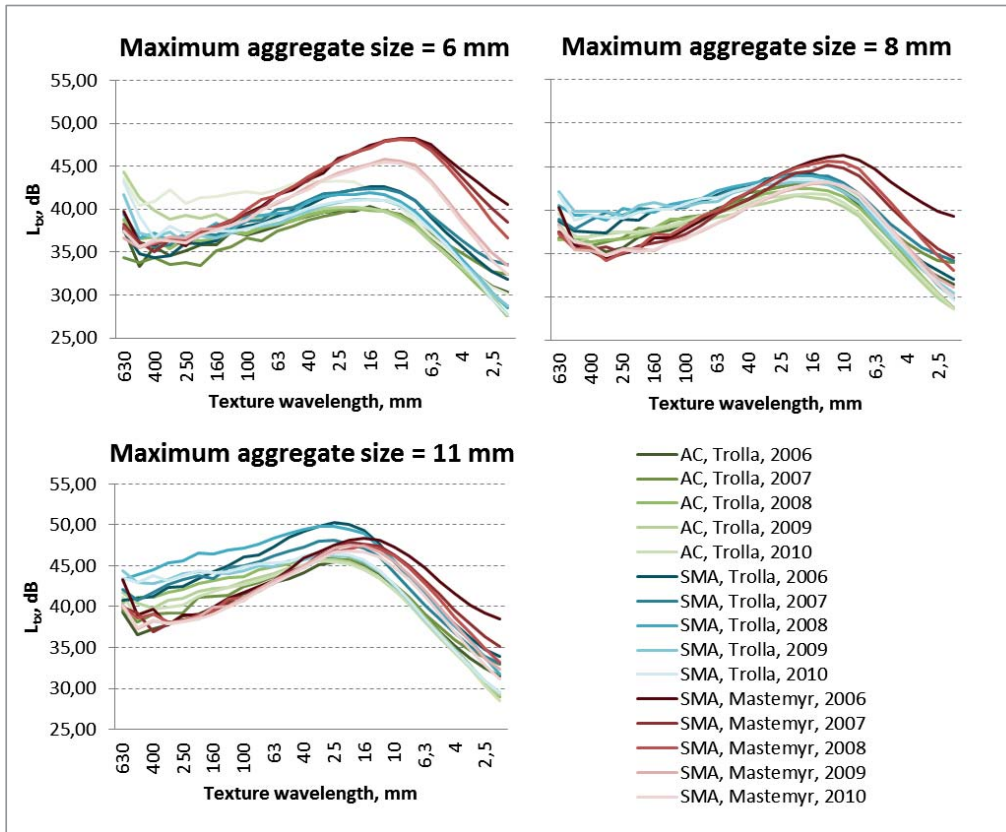

Fig. 5 - Texture progression of the asphalt surfaces arranged by their maximum aggregate sizes

The spectra for all asphalt surfaces do not exhibit large differences. However, according to figure 1 the texture spectra in figure 5 outline the SMA surfaces located at Mastemyr as the surfaces with the most favorable texture regarding noise reduction. All spectra for the SMA at Mastemyr display the lowest values within texture wavelength range 20-500 mm and the highest values within texture wavelength range 2,5-12,5 mm. The peak of the texture spectra occurs for all SMA at Mastemyr the furthest to the right. In addition, it can be seen that the spectra for SMA surfaces at Trolla are more similar to the AC surfaces at Trolla than to the SMA surfaces at Mastemyr, which is unexpected. This implies that even if the surface type is the same, the texture spectra can turn out to be different.

The progression of ERNL(80/5) and G factor is presented in figure 6. The results for ERNL(80/5) are spread over the diagram for the different surfaces. Anyway, it is possible to see that the results for the SMA located at Mastemyr have the lowest values. However, the progression of the G factor for the different surfaces appears assembled and arranged in three groups. While the results for AC located at Trolla are in the lower part of the diagram, are the results for SMA at Mastemyr in the upper part. A significant gap can be seen between the values of the G factor for the surfaces at Mastemyr and Trolla.

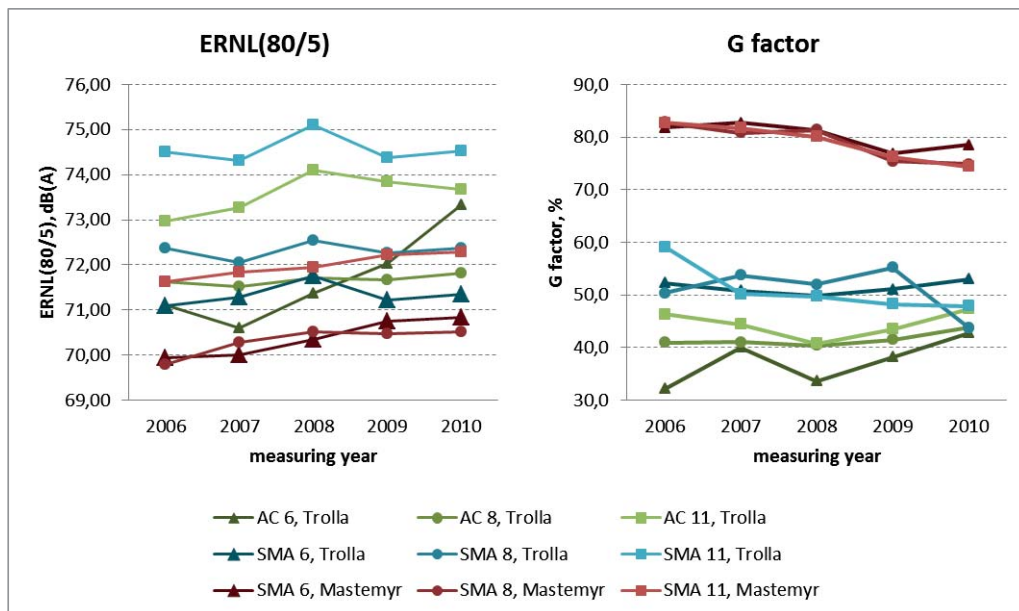

Fig. 6 - Progression of ERNL(80/5) and G factor for the selected asphalt surfaces

7 Discussion and conclusions

The aim of the paper was to describe the effects of aggregates used in asphalt mixes on the changes of the surface texture over time. Nine asphalt mixes have been analyzed regarding their different types, sizes and amounts of aggregates. In addition, the progression of the surface texture of the nine asphalt surfaces has been described.

7.1 Correlation between texture progression and aggregate properties

The grading of the aggregates seems to affect the shape of the texture spectra. The more gap-graded the aggregate grading is the more pronounced will be the peak of a texture spectrum.¹⁶ This fact is ascertained by linking the grading curves in figure 2 to the texture spectra in figure 5. SMA surfaces at Mastemyr have been found to be more open-graded than the others. Especially in the texture spectra for SMA 6 and SMA 8 at Mastemyr, the peaks are more pronounced. However, the texture spectra for asphalt surfaces with maximum aggregate size 11 mm do not reflect this evidence. It can be seen that the grading curve for SMA 11 at Mastemyr is less open-graded than those of SMA 6 and SMA 8 at Mastemyr.

As mentioned in 3.3, ERNL(80/5) and the G factor are texture parameters that are correlated to the noise characteristics of the road surfaces. The results presented in the paper demonstrate that the road surface texture differ according to the asphalt mixtures, especially according to the properties of the aggregates. In figure 7, ERNL(80/5) is correlated to NWI_{2mm} in the graph to the left, and the G factor is correlated to the NWI_{2mm} in the graph to the right. Both graphs visualize the collocation for all asphalt mixes selected for analysis in the paper.

The left graph does not outline any significant relationship between ERNL(80/5) and NWI_{2mm} . This means that there is no significant correlation between the surface related noise characteristics of an asphalt surface and the quality and amount of aggregates larger than 2 mm.

However, looking at the right graph in figure 7, there seems to exist a correlation between the values of the G factor and NWI_{2mm} . The quality and the amount of aggregates larger than 2 mm appear to affect the shaping of the surface. This correlation is visualized more in detail in figure 8.

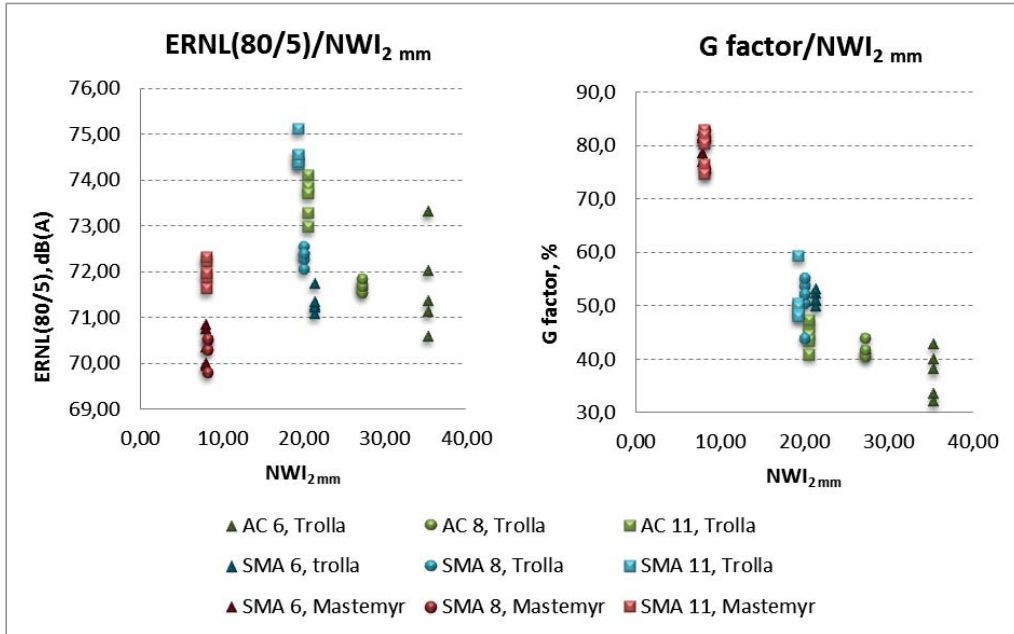

Fig. 7 - Relationship for ERNL(80/5) and the G factor against NWI_{2mm}

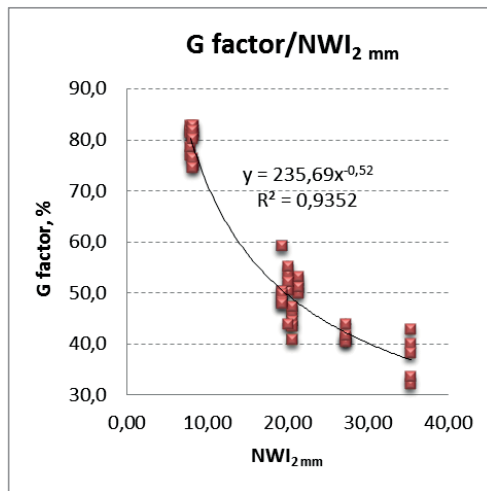

Fig. 8 - Correlation between the G factor and NWI_{2mm}

Correlating the values of the G factor to NWI_{2mm} for all asphalt mixes, it is possible to draw an exponential regression line with the correlation coefficient $R^2 = 0,9352$. Based on this

correlation coefficient it can be concluded that the values of the G factor increase when NWI_{2mm} decreases. In other words, the values of the G factor increase and stay at high levels with an asphalt material that includes a lot of aggregates larger than 2 mm that have a high ability to resist the abrasive action of studded tires.

The results in this paper are based on a small selection of different asphalt mixes. To confirm the results that have been presented and the conclusions that have been drawn, more research is needed. More data are necessary and it is therefore of importance to analyze a larger group of asphalt mixes. Hereby it is fundamental to choose asphalt mixes with the same surface type, e.g. SMA and AC to obtain the possibility to compare the data to the results of the paper. It will also be of interest to analyze other asphalt mixes additionally.

7.2 Texture measurement uncertainties

Special texture measurements carried out with a stationary measuring van (simulated runs above a perfectly smooth grey aluminum surface) showed some inherent electronic noise at small texture wavelengths. The 1/3-octave band texture levels at wavelengths 5 mm and below may be affected. The texture levels were therefore corrected for this "background" noise on an energy basis.

The raw height profile signal may also contain some unrealistic peak values (positive or negative), i.e. "dropouts" or "spikes". These are most likely generated in the laser system, and are unwanted signals. This effect seems to be greatest when texture measurements are made on newly laid asphalt. Only road surfaces with at least one winter season in service were considered in this investigation. Some simple procedures were applied in order to suppress these signals. Although the agreement with results from more elaborate systems was very good, one should consider the possibility of less accurate results in some cases, especially in the shorter texture wavelength range.

8 Acknowledgements

This research was supported by the Norwegian Public Roads Administration and SINTEF ICT.

9 REFERENCES

- [1] Det kongelige Miljødepartementet, *Handlingsplan mot støy 2007-2011*, (2007)
- [2] Lurfald, B.O., *Miljøvennlige vegdekker, Sluttrapport forsøksstrekninger*, Teknologirapport nr. 2546, Statens vegvesen Vegdirektoratet, Oslo, Norway, (2009)
- [3] Sandberg, U. & Ejsmont, J.A., *Tyre/road noise reference book*, INFORMEX Ejsmont & Sandberg Handelsbolag, Kisa, Sweden, (2002)
- [4] Storeheier, S.Å., *Investigation on road surface texture levels in tyre/road noise mitigation*, Inter Noise 2004, Prague, Czech Republic, (2004)
- [5] ISO 13473-1:1997(E), *Characterization of pavement texture by use of surface profiles – Part 1: Determination of Mean Profile Depth*, Genève, Switzerland, (1997)
- [6] ISO 13473-2:2002(E), *Characterization of pavement texture by use of surface profiles – Part 2: Terminology and basic requirements related to pavement texture profile analysis*, Genève, Switzerland, (2002)
- [7] ISO/TS 13473-4:2008(E), *Characterization of pavement texture by use of surface profiles – Part 4: Spectral analysis of surface profiles*, Genève, Switzerland, (2008)
- [8] Storeheier, S.Å., *Miljøvennlige vegdekker: Resultater fra teksturmålinger 2006-2008*, Rapport A10917, SINTEF IKT, Trondheim, Norway, (2009)
- [9] Beckenbauer, T. et al., *Einfluss der Fahrbahntextur auf das Reifen-Fahrbahn-Geräusch*. Forschungsbericht FE-Nr. 03.293/1995/MRB, Bergisch Gladbach, Germany, (2001)
- [10] Uthus, N./Snilsberg, B., *Miljøvennlige vegdekker – Sluttrapport for arbeidspakke 3:Støv*, Teknologirapport nr. 2544, Statens vegvesen Vegdirektoratet, Oslo, Norway, (2009)

- [11] Horvli, I./Værnes, E., *SIV – Steinkvalitet og sporutvikling i vegdekker. Oppsummeringsrapport*, SBF53 A06013, SINTEF Byggforsk AS, Veg- og jernbaneteknikk, Trondheim, Norway, (2006)
- [12] CEN, EN 1871:2000(E), *Road marking materials – Physical properties, Annex K: Thermoplastic and cold plastic – Test method for determining the Tröger wear*, European Committee of Standardization, Brussels, (2000)
- [13] Statens vegvesen, *Håndbok 014 Laboratorieundersøkelser – 14455 Møllemetoden*, Statens vegvesen Vegdirektoratet, Oslo, Norway, (2005)
- [14] Snilsberg, B., *Pavement wear and airborne dust pollution in Norway – Characterization of the physical and chemical properties of dust particles*, Doctoral Theses at NTNU, Trondheim, Norway, (2008)
- [15] CEN, EN 1097-9:1998(E), *Test of mechanical and physical properties of aggregates – Part 9: Determination of the resistance to wear by abrasion from studded tires – Nordic test*, European Committee for Standardization, Brussels, (1998)
- [16] Sandberg, U., *Road surface texture influence on tyre/road noise*, Project NordFoU, VV dnr BY20A2008:12388, Swedish National Road and Transport Research Institute (VTI), Sweden, (2010)

Paper II

Proceedings of 6th Euroasphalt & Eurobitume Congress, 1st – 3rd June 2016. Czech Technical University in Prague.

ISBN 978-80-01-05962-3. [dx.doi.org/10.14311/EE.2016.225](https://doi.org/10.14311/EE.2016.225)

Prall Tests to study the effect of mortar on the wear of Norwegian asphalt mixtures

Doreen Siebert

NTNU, Department of Civil and Transport Engineering; Høgskoleringen 7, 7491 Trondheim;
Norway; doreen.siebert@ntnu.no

Helge Mork

NTNU, Department of Civil and Transport Engineering; Høgskoleringen 7, 7491 Trondheim;
Norway; helge.mork@ntnu.no

With the use of studded tires, the mineralogy of the aggregates used in asphalt mixtures is considered crucial for the wear resistance of the road surface. High strength of the coarse aggregates and adequate binder content are usually considered good requirements. However, field observations indicate that the mortar is the least wear resistant portion of the asphalt mixture. Being exposed to studded tires, the binder coating the coarse aggregates will be grinded off, and a significant part of the further wear takes place between the coarse particles. As the wear is caused by the studded tires, the Prall Test (Method A) is used to check the effect of the mortar. The purpose was to study how to improve the mortar to achieve both as little and as even as possible wear on the asphalt surface. In addition, the evenness of the worn asphalt surface was evaluated by calculating the area which is formed between the peak and the minimum of the surface texture. Three rock materials with different Nordic abrasion values were used for the stone skeletons of 19 asphalt mixtures. The mixtures varied thereby in their combination of rock materials in the fine and coarse aggregates. The paper shows the results of the Prall Test and the evaluation of the surface texture on the Prall tested specimens. The correlations of the results to the Nordic abrasion values are opposite of one another, indicating further research is needed to improve the wear characteristics of the asphalt mixture and keeping a low noise surface texture at the same time.

1 Introduction

The wear on asphalt pavements can be reduced by increasing the amount and the maximum aggregate size (D_{\max}) of the coarse aggregates [1]. However, on dense asphalt pavements, a reduction in maximum aggregate size gives a reduction in noise generation [2]. Thus, it is challenging to develop an asphalt mixture which is resistant against abrasion at the same time as it has noise reducing effect.

In the Nordic countries, most of the wear is caused by the use of studded tires during the wintertime. The surface texture is changing rapidly, and it is observed that the mortar is usually worn away first. As a consequence, the coarse aggregates protrude from the pavement surface and form high amplitudes in the macro texture range (0.5-50 mm), which generates tire/road noise [3]. The bigger the maximum aggregate size, the more protrusion of the coarse aggregates, and the more tire/road noise is generated. Figure 1 illustrates the wear on a pavement surface before and after it is exposed to studded tires.



Figure 1: Pavement surface before and after exposure to studded tires

Since the mortar seems to be the weakest part of the asphalt mixture, the challenge is to find a rock material for the fine aggregates which strengthens the mortar. To avoid the coarse aggregates protruding, the abrasion characteristics of their rock material should be adjusted to those of the mortar. This is supposed to equalize the wear of the mortar and the coarse aggregates and to result in a more evenly worn asphalt surface. At the same time, the overall wear of the asphalt surface is required to be as low as possible after being exposed to studded tires.

In this study, 19 asphalt mixtures were developed using different combinations of three rock materials in their stone skeleton. The purpose was to balance the wear of the asphalt pavement and the evenness of the pavement surface texture. The quality of the aggregates is supposed to

be crucial regarding the effect on the abrasion characteristics of the mortar and the coarse material. Therefore, the three rock materials differed amongst other things in their Nordic abrasion value, which reflects the resistance of the rock material against the abrasive action of studded tires [4]. To analyze the wear on the asphalt pavement caused by studded tires, all 19 asphalt mixtures were tested with the Prall Test (Method A). Afterwards, the Prall specimens were cut in two halves and the surface texture was analyzed on the cut surface of the specimen. Therefore, an area was calculated, which is formed between a 50 mm long horizontal line touching the peak of the surface texture and a line retracing the surface texture.

The study was carried out to investigate whether the wear characteristics of an asphalt mixture can be improved by mixing rock materials with different characteristics in the fine and coarse fraction of the stone skeleton. The objective was to develop an asphalt mixture, which provides a more even surface texture after the asphalt pavement has been exposed to studded tires. Thus, the surface texture can provide noise reducing characteristics over a long term.

2 Chosen materials

19 asphalt mixtures were developed. The most common asphalt mixture types in Norway are stone mastic asphalt (SMA) and asphalt concrete (AC). To get usable results, only these two mixture types were investigated during this study. The D_{\max} ranged from 8 to 16 mm. Since a reduction in maximum aggregate size results in noise reduction, D_{\max} of 8 and 11 mm were dominating. Three types of rock material (A,B and C) were used differently in the stone skeletons to compose the mixtures. As bitumen, an unmodified 70/100 was used. The stone skeletons of the asphalt mixtures were accomplished by combining either one or two of the rock materials. When two rock materials were used in one asphalt mixture, one of them was used for the fine aggregates with aggregate size up to 4 mm and the other one was used for the coarse material with aggregate size above 4 mm.

Table 1 gives an overview of the tested asphalt mixtures with their D_{\max} and the rock materials used for the fine and coarse aggregates.

Table 1: Asphalt mixtures with their D_{max} and the rock materials used for fine and coarse aggregates

Asphalt mixture types	D _{max}	Rock material		Notation
		fine aggregates	coarse aggregates	
AC	8		A	AC8A
		A	B	AC8A/B
			B	AC8B
	11		A	AC11A
		A	C	AC11A/C
		A	B	AC11A/B
			C	AC11C
		C	A	AC11C/A
			B	AC11B
	16		A	AC16A
SMA	8		A	SMA8A
		A	B	SMA8A/B
			B	SMA8B
	11		A	SMA11A
		A	B	SMA11A/B
			C	SMA11C
			B	SMA11B
	16		A	SMA16A

Table 2 presents the different characteristics of the rock materials. The rock materials A and B were tested at Veidekke Industri. The results for the rock material C are taken from the homepage of the Geological survey of Norway (NGU).

Table 2: Characteristics of the rock materials

Test method	Rock material		
	A (porphyry)	B (gabbro)	C* (monzonite)
Specific density [5]	2,614 g/cm ³	3,011 g/cm ³	2,72 g/cm ³
Flakiness index 4-8 mm [6]	26	9	-**
Flakiness index 8-11 mm [6]	13	3	-**
Micro-Deval value [7]	2	10	4,3
LA coefficient [8]	12 %	13,5 %	30,1 %
Nordic abrasion value [4]	3,9 %	11 %	13,7 %

* Values provided by [9]

** no values available

As Table shows, the rock material A is most resistant against abrasion by studded tires; C is the least resistant one.

3 Measurement of abrasion due to studded tires

The 19 asphalt mixtures were tested with the Prall Test (Method A) at the central laboratory of the Norwegian Public Roads Administration (NPRA). The purpose of this test is to simulate the abrasive action of studded tires on the asphalt mixture. As the result, the loss of volume [ml] is recorded and reported as the Prall abrasion value (Abr_A). This value indicates the wear resistance of an asphalt pavement which is exposed to studded tires; the lower the value, the more resistant the pavement. The method is only used in the Nordic countries and is described in [10]. Figure 2 shows the setup of the Prall abrasion apparatus.

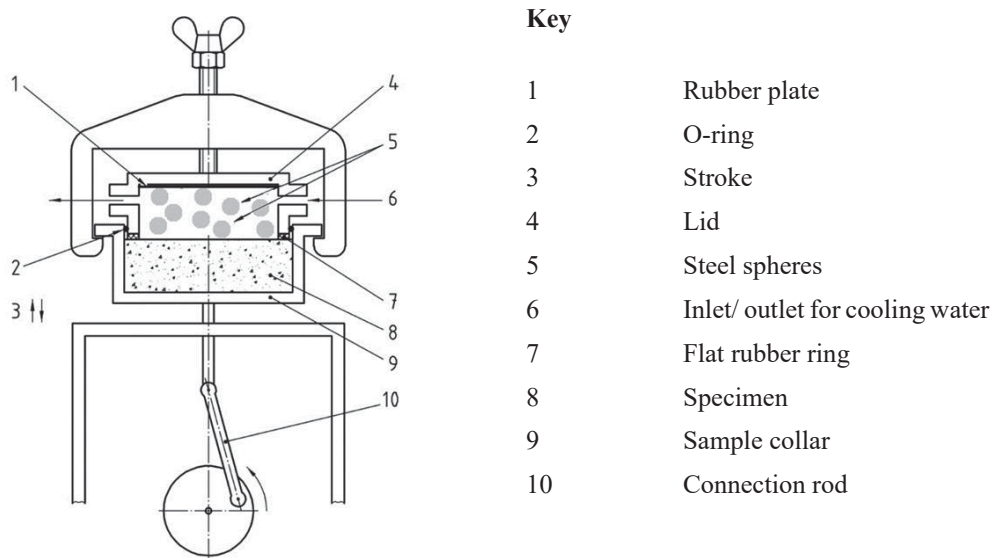

Figure 2: Prall abrasion apparatus, in general [10]

The test requires cylindrical asphalt specimens with a diameter of 100 mm and a height of 30 mm. At least three specimens of each asphalt mixture were prepared by the Marshal Mix

Design, compacted by 50 blows on either side. Each Marshall Test specimen was cut in two halves, where each half made one Prall Test specimen. Prior to testing the specimens are cooled down to a temperature of 5 degree Celsius. Placed in the Prall Test chamber with 40 stainless steel spheres, the specimen is worn by abrasive action over the standard time period of 15 minutes. During testing the specimen is flowed with 0,2 liters of water per minute, at a temperature of 5 degree Celsius. 6 to 8 specimens were tested for all 19 asphalt mixtures. The Prall abrasion value for each asphalt mixture is calculated as the average value from all specimens of the respective asphalt mixture.

3.1 Changes in test equipment

The Prall Test was performed in two sets. The first set was tested in 2010, the second one in 2013. In 2012, the Prall abrasion apparatus was further developed and the requirements for the Prall Test were tightened. This resulted in a change of equipment at the laboratory. The most important development with the new test equipment was an automatic system to control temperature and quantity of the water, which flows the specimen during testing. While the tests accomplished in 2010 were performed with the old equipment, the new revised equipment was used for the tests in 2013.

4 Surface texture evaluation

To achieve information on the worn surface, all specimens had to be analyzed regarding their surface texture after being tested by the Prall Test. However, in Norway, no standardized equipment exists to measure the texture of the asphalt surface on small specimens. The challenge was to find a simple method to evaluate the surface texture on the Prall Test specimens. In order to do that, at least three Prall Test specimens of each asphalt mixture were cut vertically into two half-moon shaped pieces of the same size (see Figure 3). The specimens were placed in the saw with no special consideration. Thus, the cutting edges are positioned randomly.



Figure 3: Cut Prall Test specimens

All cutting edges were photographed. The pictures were plotted in AutoCAD. The upper part of the cutting edge provides the surface texture of the specimen in form of a rugged line. This line was retraced in AutoCAD. In addition to this texture line, a horizontal line touching the peak of the surface line was drawn. Between the texture line and the horizontal line an area is generated, which is easily found in AutoCAD. The size of the area reflects the condition of the surface texture. The higher the value, the rougher the surface texture. A big area above the texture line reflects that the mortar is worn away and the coarse aggregates protrude. The smaller the area, the smoother the surface texture. Small values reveal a balanced wear of both, the fine and the coarse aggregates. In the following, the generated area will be named “Texture area”.

4.1 Adjustments related to the test equipment

When the specimen is tested in the Prall Test chamber, the specimen is trapped in the test chamber by an O-ring with a flat rubber ring underneath (see Figure 2) [10]. These rings cause an edge around the specimen, which does not get in contact with the steel spheres under testing, and like that stays unworn. In addition, the part of the worn surface is rounded into these edges caused by the geometry of the steel spheres, which have a diameter of 11.50-12.01 mm (see Figure 4). Only 50 mm in the middle of the specimen were considered to properly reflect the abrasion by studded tires on the surface. The horizontal line was therefore drawn through the

highest peak in this 50 mm section. Figure 4 visualizes the cut surface of the Prall Test specimen with both edges and roundings including their dimensions and the Texture area calculated.

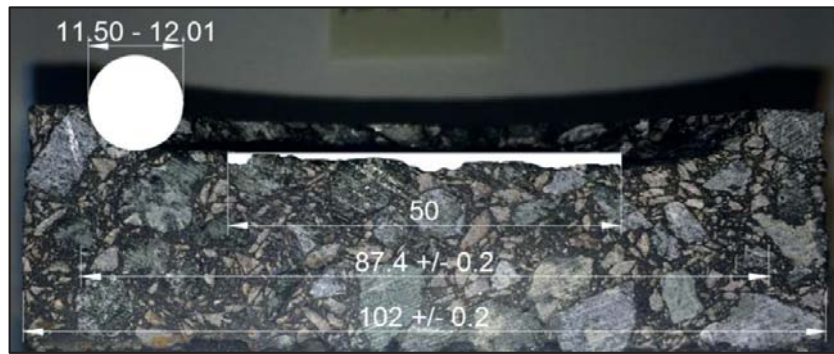

Figure 4: Cut Prall Test specimen as it is edited in AutoCAD to calculate the Texture area

5 Prall Test results

The results of the Prall Test are reflected by the Prall abrasion value (Abr_A), which is calculated by the following equation:

$$Abr_A = \frac{(M_1 - M_2)}{\rho_{bssd}} \quad (1)$$

where

Abr_A is the Prall abrasion value, [ml];

M_1 is the mass of the specimen with air dried surface, stored in water before testing, [g];

M_2 is the mass of the specimen with air dried surface, stored in water after testing, [g];

ρ_{bssd} is the bulk density of specimen according to 4.3.3 in NS-EN 12697-16:2004, [g/ml] [10].

Figure 5 gives an overview of the Abr_A value for the 19 tested asphalt mixtures. The lighter bars emphasize the results for the asphalt mixtures tested with the new Prall Test equipment in 2013.

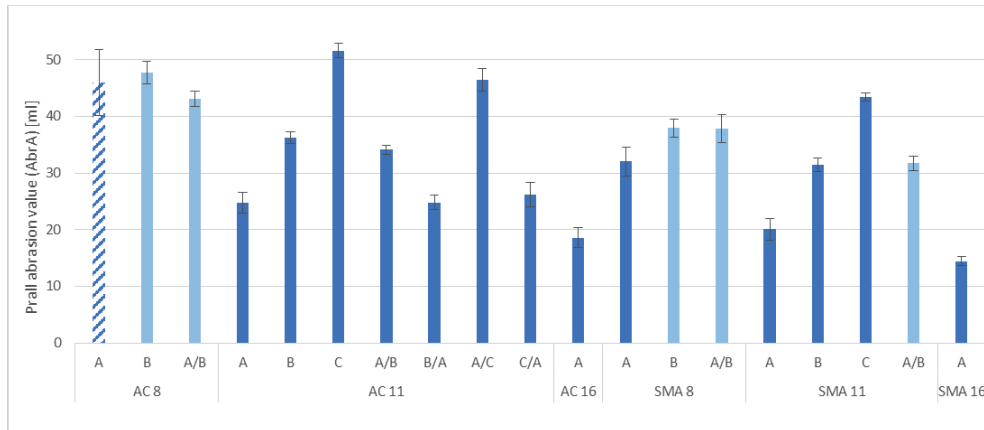

Figure 5: Prall abrasion value - overview

The graph illustrates that asphalt mixtures, which include the strongest rock material A in the coarse fraction, give the results with the lowest Abr_A . The highest values occur for the mixtures, which include the rock material C.

However, the value for the AC8 with rock material A in both the fine and coarse aggregates is questionable as it is higher than the value for the AC8 with A in the fine and B in the coarse fraction. Both the LA coefficient and the Nordic abrasion value in Table reflect that the rock material B is weaker than the material A. Therefore, the Abr_A for AC8A should be lower than the Abr_A for the AC8A/B. Looking closer at the tested specimens for AC8A, it seems like the mixture failed during the Prall Test. Figure 6 shows a representative example for the specimens of the AC8A mixture after testing. Differently from specimens of the other mixtures, these specimens have a distinctive cavity, which results in a high Abr_A . Caused by that, the results for the AC8A are not considered in the following discussions.



Figure 6: Cut specimen of AC8A after testing with the Prall Test

Looking closer at the asphalt mixtures with the same rock material in their stone skeleton, the results show the influence of the mixture type (AC or SMA) and D_{max} on the Abr_A . The graph clearly shows that the Abr_A decreases with an increase of D_{max} . It also shows that the values for AC mixtures are higher than the values for the respective SMA mixtures. The graph also shows that mixtures including only one rock material have a clear increase in Abr_A the higher the LA coefficient and the Nordic abrasion value of the rock material. For the mixtures including two rock materials, we get some improvement for the abrasion characteristics when using rock material in the fine fraction with a low LA coefficient and a low Nordic abrasion value. However, it is still the rock material used in the coarse fraction that primarily affects the results of the Prall Test.

6 Results from surface texture evaluation

The surface texture was evaluated for three specimens of each of the 19 asphalt mixtures, as described in chapter 4. The results reflect the average of the three calculated areas of each mixture. Figure 7 gives an overview of the results. As explained in chapter 5, the results for AC8A are not subject to the following discussions. Also here, the lighter bars emphasize the results for the asphalt mixtures tested with the new Prall Test equipment in 2013.

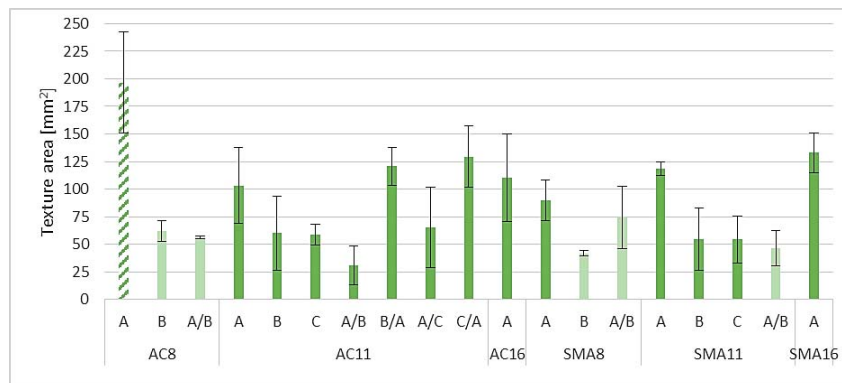

Figure 7: Texture area - overview

The results for the Texture area are generally widespread. The lowest values for the Texture area occur when the asphalt mixture includes rock material B in the coarse fraction. For

mixtures with material A in the fine and coarse or only the coarse fraction, the area gets the highest values. The graph in Figure 7 also indicates an increase of the Texture area with an increase in D_{max} for the asphalt mixtures, which include only one rock material in their stone skeleton. However, for mixtures with the rock material combination A/B, the Texture area decreases with an increasing D_{max} . This rock material combination also gives the lowest values for each asphalt mixture, irrespective of D_{max} .

Figure 7 includes the error bars, which reflect the standard deviation for each asphalt mixture. The error bars show that the Texture areas for one asphalt mixture vary a lot, while the results are close to each other for another one.

7 Discussion

By assembling the results for the Texture area and the Prall abrasion value in Figure 8, no obvious correlation can be found. The results differ a lot from each other for every asphalt mixture and from one to another.

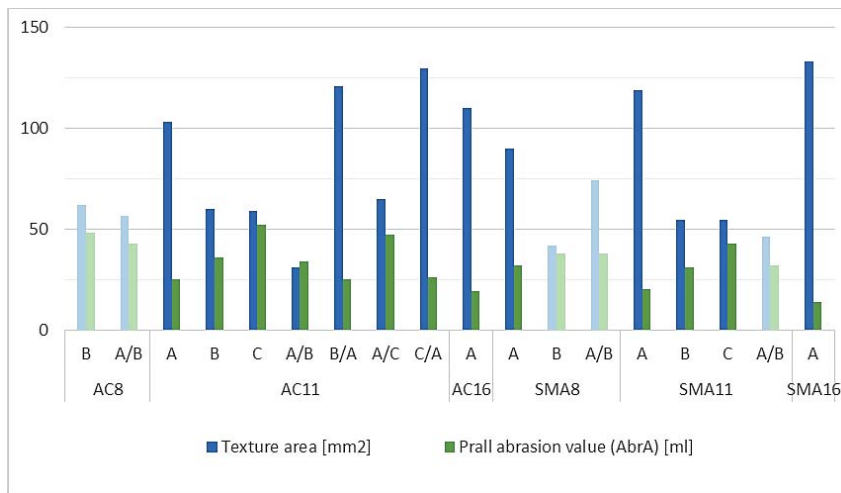

Figure 8: Assembling Prall abrasion value and Texture area

To obtain the best results relating to a sustainable low noise road surface, both the Abr_A and the Texture area should be as low as possible. The asphalt mixture that delivers relatively low

values in both categories is AC11A/B. However, the mixtures that have lower values for Abr_A turn out to form a big Texture area in general.

Figure 9 and Figure 10 show the correlation for the Nordic abrasion values to the Abr_A and the Texture area for aggregates > 4 mm and < 4 mm, respectively. While Figure 9 visualizes a good correlation for the aggregates > 4 mm to both Abr_A and the Texture area, Figure 10 indicates that there is no correlation for the aggregates < 4 mm.

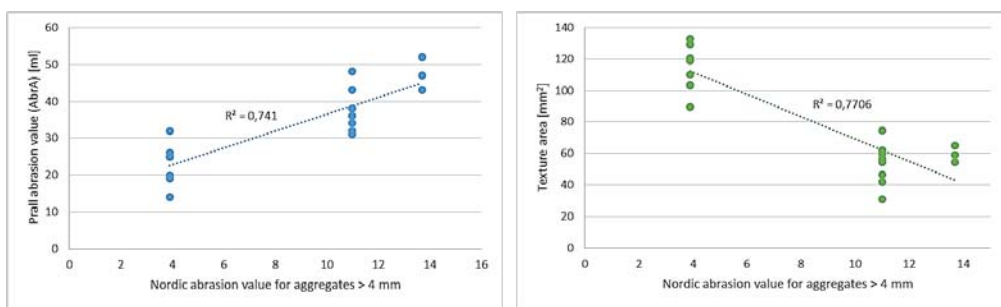

Figure 9: Correlations regarding the Nordic abrasion value for aggregates > 4 mm

The Nordic abrasion value for the aggregates > 4 mm seems to be decisive for both, the Prall abrasion value and the Texture area. However, the correlations are contrary for the Abr_A and the Texture area. The wear caused by studded tires is increasing for an increasing Nordic abrasion value. On the other hand, the surface gets smoother for the asphalt mixtures, which includes the weaker material in the coarse fraction.

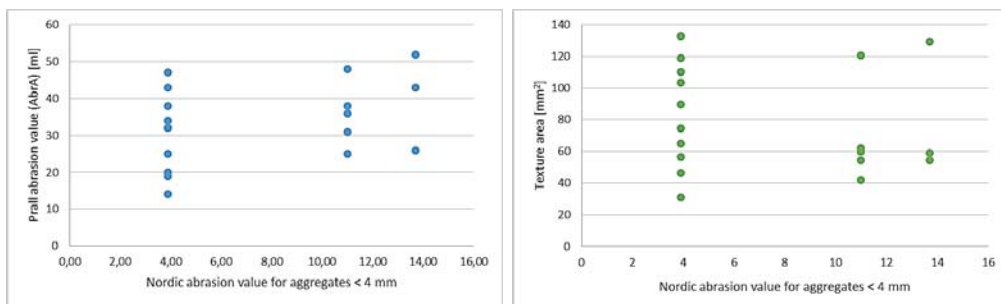

Figure 10: Correlations regarding the Nordic abrasion value for aggregates < 4 mm

Figure 10 visualizes that there is no correlation found for the abrasion characteristics of the aggregates < 4 mm neither to the Prall abrasion value, nor to the Texture area. The results are widespread and no trend is indicated.

The rock materials for the asphalt mixtures that have been used for the study were chosen with the intention to get as big variations in the abrasion characteristics as possible. However, considering the requirements for the Prall abrasion value it is obvious that most of the asphalt mixtures are not usable in real road conditions.

Figure 11 shows the results of the Abr_A together with the requirements for low and high traffic roads, according to [11]. Only a few asphalt mixtures meet the requirements for the Prall abrasion value according to [11] for roads with an AADT >10000.

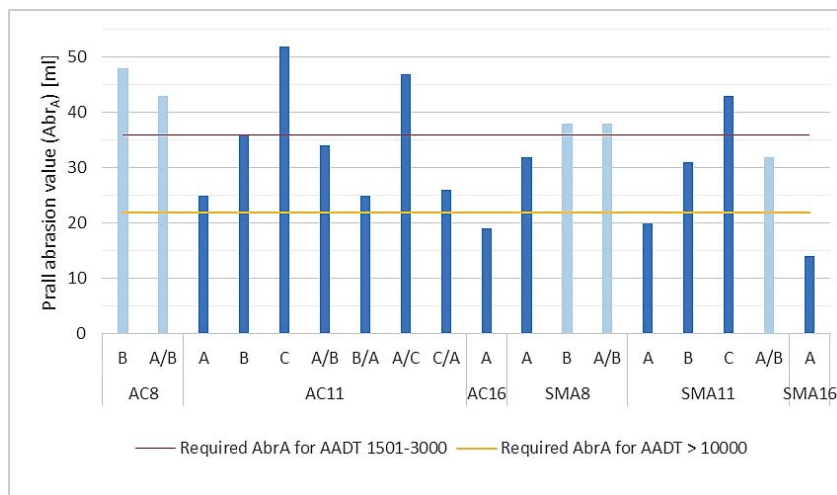

Figure 11: Results of Abr_A together with the requirements stated in NPRA's handbook N200

8 Conclusions

The results of the study verify that both the size and the quality mainly of the coarse aggregates in the asphalt mixture affect the Prall abrasion value. But also surface texture characteristics are essentially controlled by the characteristics of the rock material used in the fractions > 4 mm. Since the correlations for the Abr_A and the Texture area show opposite trends, it is difficult to

find an asphalt mixture that is wear resistant and can obtain a low noise road surface at the same time after being exposed to studded tires. Achieving a balanced wear on the mortar and the coarse aggregates results in high total abrasion for the chosen rock material combinations in this study.

Further, it should be investigated how the Texture area reflects the texture characteristics of an asphalt mixture. The area above the surface only gives information about the smoothness of the surface texture. However, the surface texture should not only be smooth in order to reduce noise generating mechanisms. The Mean Profile Depth (MPD) is one of the texture characteristics that can be correlated to the noise characteristics of the surface texture [2]. One opportunity might be to calculate the MPD on the 50 mm section of the Prall Test specimens to find out more details about the texture characteristics. At the same time, it should be investigated whether a section of 50 mm is sufficient to evaluate the surface texture regarding their noise characteristics.

Figure 7 shows that the Texture area can vary a lot from one specimen to another for some of the asphalt mixtures. These variations might be caused by the placement of the cutting edge on the specimen. On the cylindrical Prall Test specimen, the surface texture varies in all directions. Thus, placing the cutting edge in another angle can change the results of the Texture area. More samples might be needed to get more reliable results.

Acknowledgements

This research was sponsored by the NPRA. The authors thank the technical staff at the “Kompetansesenter for Asfalt” of Veidekke Industri.

9 References

- [1] *Asphalt pavement wear and road dust generation – Effects of different aggregate grading, vehicle tires and driving speed*, Snilsberg B., Myran T., Uthus N., p. 4, 2008
- [2] *Road surface texture for low noise and low rolling resistance – NORDTEX final report*, J. Kragh, L. Møller Iversen, U. Sandberg, Vejdirektoratet, rapport 506, 2013

- [3] *Tyre/road noise reference book*, U. Sandberg, J.A. Ejsmont, Informex, 2002
- [4] *NS-EN 1097-9:2014, Tests for mechanical and physical properties of aggregates - Part 9: Determination of the resistance to wear by abrasion from studded tyres - Nordic Test*, CEN, 2014
- [5] *Håndbok R210 – Laboratorieundersøkelser* (in Norwegian), Statens vegvesen Vegdirektoratet, 2014
- [6] *NS-EN 933-3:2012, Tests for geometrical properties of aggregates - Part 3: Determination of particle shape - Flakiness index*, CEN, 2012
- [7] *NS-EN 1097-1:2011, Tests for mechanical and physical properties of aggregates - Part 1: Determination of the resistance to wear (micro-Deval)*, CEN, 2011
- [8] *NS-EN 1097-2:2010, Tests for mechanical and physical properties of aggregates - Part 2: Methods for the determination of resistance to fragmentation*, CEN, 2010
- [9] Homepage of the Geological Survey of Norway, <http://www.ngu.no/en/topic/datasets>
- [10] *NS-EN 12697-16:2004, Bituminous mixtures - Test methods for hot mix asphalt - Part 16: Abrasion by studded tyres*, CEN, 2004
- [11] *Håndbok N200 – Vegbygging* (in Norwegian), Statens vegvesen Vegdirektoratet, p. 314, Norway, 2014

Paper III

Proceeding of 2016 ISAP Symposium and 53rd Petersen Asphalt Research Conference

Road simulator tests to study the effect of asphalt mixture components on the development of surface texture and noise characteristics

Doreen Siebert

NTNU, Department of Civil and Transport Engineering; Høgskoleringen 7, 7491 Trondheim;
Norway; doreen.siebert@ntnu.no

Helge Mork

NTNU, Department of Civil and Transport Engineering; Høgskoleringen 7, 7491 Trondheim;
Norway; helge.mork@ntnu.no

The road surface texture has a major impact on the noise characteristics of roads in the Nordic countries. Due to wear by studded tires, the texture roughness increases with time. Consequently, the road surface generates more noise, mainly caused by the protrusion of the coarse aggregates of the asphalt mixture. Field measurements in Norway show that the most significant texture changes occur during the first winter season after surfacing. To better understand this process, 14 common Norwegian asphalt mixtures were tested in a Road Simulator. The main purposes of the test were to achieve better insight to the process of texture changes during the first months after surfacing, and to find a correlation between texture development and the chosen components in the asphalt mixture. The test was carried out in three steps to simulate different climatic conditions and the impact of studded tires. Pavement wear and surface texture were measured at regular intervals. The results show that the use of highly wear resistant aggregates or the use of a modified binder can result in less pavement wear. However, it is difficult to obtain satisfactory surface texture development so that low noise surface characteristics could be maintained.

Keywords: Surface texture development, noise, material characteristics, asphalt mixture, Road Simulator

1 Introduction

In the Nordic countries, the wear of asphalt pavements is mainly caused by the use of studded tires during the winter season. The fine aggregates and the binder, also defined as mortar, are worn away first and the coarse aggregates protrude from the pavement surface. The wear on the pavement surface can be visualized by texture measurements. References [1] and [2] define pavement texture as the deviation of a pavement surface from a true planar surface. A texture profile is generated by a laser spot reflected from the pavement while moving along the surface. The profile is a two-dimensional sample of the surface texture [3]. The profile curves are further analyzed by digital or analogue filtering techniques in order to determine the magnitude of its spectral components at different wavelengths [4].

On Norwegian roads, the surface texture is measured annually with the laser equipment ViaPPS mounted on a measuring vehicle. These measurements revealed big changes in the texture properties after the first winter after surfacing. The texture spectra show a decrease in the texture levels for smaller wavelengths (less than 10-16 mm) and an increase for the texture levels for wavelengths bigger than 16-20 mm [5]. The measured texture changes reflect the protrusion of the coarse aggregates and the wear of the mortar. The abrasive action of studded tires is the assumed reason for the changes on the surface texture. Thus, the aim of the study was to simulate the wear on the asphalt pavement for the period from the day of surfacing until the end of the winter season. This simulation took place at the Road Simulator of the Swedish National Road and Transport Research Institute (VTI). The surface texture was measured at regular intervals. The idea was to detect when exactly the changes in the surface texture occur, and to find out if it is possible to minimize the texture changes by adjusting the characteristics of the materials used in the asphalt mixture, e.g. by using a stronger mortar and weaker coarse aggregates in the asphalt mixture.

In Norway, noise measurements are performed together with the annual texture measurements. Based on the results from these measurements, it is known that Norwegian asphalt road surfaces get much noisier during the first winter after surfacing, coincident with the biggest changes in the surface texture. Hence, the rapidly changing noise characteristics of the road surface can be connected to the changes in the surface texture [5, 6]. The rapid deterioration of the noise

characteristics is significant. Road surfaces that were defined as low noise road surfaces (see definition in [3]) at the time of their construction lose this property after the first winter. Therefore, the challenge in the Nordic countries is to find an asphalt mixture that keeps its noise reducing surface texture over several winter periods while the pavement is exposed to studded tires.

14 common Norwegian dense asphalt mixture types were composed by using two rock types in their stone skeletons. Both polymer modified binder and unmodified binder 70/100 were used. The purpose was to get variations in the wear resistance of the mortar and the coarse aggregates. Hence, the surface texture of the 14 asphalt mixtures was expected to change differently over time. Using a stronger rock type for the fine aggregates and a polymer modified binder was expected to improve the wear resistance of the mortar. Using a rock type with a lower abrasion value for the coarse aggregates was intended to result in less protrusion of the stones. The aim was to find an asphalt mixture that provides a balanced wear of the mortar and the coarse aggregates at the same time as the total wear on the pavement is not exceeding the requirements. The balanced wear was supposed to result in less change in the surface texture.

2 Texture Measurements at the Road Simulator

Texture measurements are usually performed at real road conditions. However, this is expensive, takes a long time and to be able to perform the measurements, the road surface has to be dry. Thus, there was a wish to perform these measurements in the laboratory.

2.1 Road Simulator

In Norway, no equipment exists to measure road surface texture in the laboratory. To accomplish the study, the Road Simulator at the Swedish National Road and Transport Research Institute was therefore used. The simulator is a carousel-like equipment with six “arms” rotating on a circular track [7]. Four of these “arms” were equipped with car tires. The load on one tire at the Road Simulator simulated the load generated on the road by one tire on a passenger car. On one arm, the laser equipment was installed to measure the surface texture of the pavement. The rotation speed of the Road Simulator was 70 km/h. To perform the texture measurements

the speed was slowed down to 40 km/h. The Road Simulator made it possible to measure the texture on different asphalt mixtures at the same time and thus, to record the development in the surface texture over time. The specimens were prepared in a mold that fits in the circular track at the Road Simulator and compacted by rolling.

2.2 Tested Materials

14 asphalts pavements were tested simultaneously for wear at the Road Simulator. The mixture types used for the pavements are two commonly used types of dense asphalt mixtures in Norway, stone mastic asphalt (SMA) and asphalt concrete (AC). All asphalt mixtures were compound, using two rock types (A and B) in the stone skeleton and with either of the two binder types 70/100 and polymer-modified binder (Pmb). Table presents the properties of the rock materials used for the aggregates. The tests to determine the properties were accomplished at Veidekke Industri, Norway. The values in table 1 show that rock material A is more resistant against abrasion by studded tires as rock material B.

Table 1. Properties of the aggregates

Test method	Rock material	
	A (porphyry)	B (gabbro)
Micro-Deval value (NS-EN 1097-1)	2	10
LA coefficient (NS-EN 1097-2)	12 %	13,5 %
Nordic abrasion value (NS-EN 1097-9)	3,9 %	11 %

The rock types and the binders were composed differently in the mixtures to obtain variations in the wear of the coarse aggregates and the mortar. The maximum aggregate sizes (D_{max}) was either 8 or 11 mm. Table gives an overview of the used asphalt mixture types including D_{max} , the combination of the rock types in the fine and coarse aggregates and the binder used.

Table 2. Overview of the tested asphalt mixture

Asphalt mixture type	D _{max}	Rock material		Binder	Notation	Plate number
		Fine aggregates	Coarse aggregates			
SMA	11	A	B	Pmb	SMA 11 Pmb A/B	1 + 15
AC	11	A	A	Pmb	AC 11 Pmb A	2 + 16
AC	11	A	B	Pmb	AC 11 Pmb A/B	3 + 17
SMA	8	A	B	Pmb	SMA 8 Pmb A/B	4 + 18
AC	8	A	A	Pmb	AC 8 Pmb A	5 + 19
AC	8	A	B	Pmb	AC 8 Pmb A/B	6 + 20
AC	8	A	B	70/100	AC 8 A/B	7 + 21
AC	8	A	A	70/100	AC 8 A	8 + 22
SMA	8	A	B	70/100	SMA 8 A/B	9 + 23
SMA	8	A	A	70/100	SMA 8 A	10 + 24
AC	11	A	B	70/100	AC 11 A/B	11 + 25
AC	11	A	A	70/100	AC 11 A	12 + 26
SMA	11	A	B	70/100	SMA 11 A/B	13 + 27
SMA	11	A	A	70/100	SMA 11 A*	14 + 28

* reference pavement

The placement of the pavement plates in the Road Simulator was arranged according to the Norwegian Wearing Index of the aggregates (definition in [8]), then the plates were sorted by D_{max} and binder type. The intention was to arrange the plates according to their expected total wear, and thus, to avoid jumps between the plates caused by different pavement wear. Pavements with similar expected wear characteristics were placed side by side. Two plates of each asphalt mixture were prepared and placed at opposite sides of the track in the Road Simulator, see figure 1.

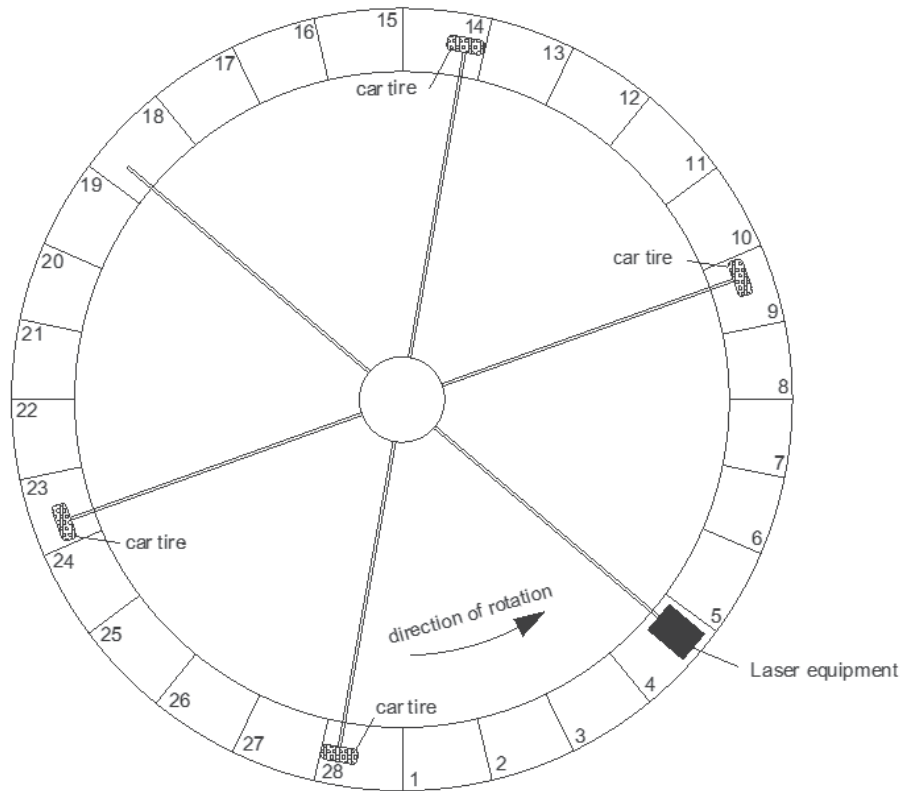

Figure 1. Sketch of the Road Simulator including plate numbers and laser equipment

2.3 Measurement conditions

The Road Simulator is placed in an air temperature and humidity controlled room. This is crucial for studying pavement wear in the right conditions. The aim of the study was to reveal the texture changes from the moment of surfacing until the first winter season has passed. Thus, the test was divided into three main parts. The first part simulated the period from surfacing until the start of the winter season. Four common summer tires were installed, and the temperature in the test chamber was set to 10 °C. After 105 000 rotations of the simulator, the tires were changed to a set of winter tires. This included two studded winter tires and two

studdless winter tires. At the same time, the test chamber was cooled down to a temperature of -5 °C. The temperature at the pavement surface was -2 °C. After 215 000 rotations in total, the test surface was sprinkled with water (6-8 l/min) to simulate precipitation during the last part of the test. The final measurements were carried out after 325 000 rotations.

The purpose of the study was to measure the texture development over time while the pavement is exposed to different car tires and varying climatic conditions. To accomplish the texture measurement, the speed of the Road Simulator was decelerated to 40 km/h after a certain number of rotations. Texture measurements were performed after each 20 000 - 40 000 rotations, in total 13 times. To measure the wear on the pavement, the simulator was stopped at the same intervals as the texture measurements were performed. The quantity of measurements resulted in a huge amount of data. To make the analysis feasible, the results of the four decisive changes in the measurement conditions were chosen. Those are listed in table 3.

Table 3. Decisive changes in measurement conditions

Number of Stop	Total number of rotations	Measuring subject	Comment
0	0	<ul style="list-style-type: none"> ▪ Profile ▪ Texture 	<ul style="list-style-type: none"> ▪ 4 summer tires ▪ Initial measurement
4	105 000	<ul style="list-style-type: none"> ▪ Profile ▪ Texture 	<ul style="list-style-type: none"> ▪ Tire change <ul style="list-style-type: none"> ○ 2 winter tires ○ 2 studded winter tires ▪ Cooling down the test site
8	215 000	<ul style="list-style-type: none"> ▪ Profile ▪ Texture ▪ Stud size 	<ul style="list-style-type: none"> ▪ Change of climatic conditions <ul style="list-style-type: none"> ○ Wet surface ○ Temperature increase to ca. 0°C
12	325 000	<ul style="list-style-type: none"> ▪ Profile ▪ Texture ▪ Stud size 	<ul style="list-style-type: none"> ▪ Final measurement

2.4 Laser

The ViaPPS laser used for the study is a Selcom Optocator™ type 2008-180/390-A, the same equipment as used for the annual texture measurements on Norwegian roads. The Optocator system is an optoelectronic device equipped with a laser diode light source. The operating range of the laser is up to 180 mm with a sampling frequency of 32 kHz. With a measuring speed of 40 km/h the sampling distance is around 0,35 mm. The laser was installed at one of the arms of the Road Simulator. While rotating in the same track as the car tires, the laser measured the pavement surface texture.

2.4.1 Limitations by the Measurement Setup

Since the texture was measured by a laser, the Nyquist-Shannon sampling theorem has to be applied to the recorded data. The Nyquist-Shannon sampling theorem states: If a signal is limited to a bandwidth B , a given sample rate f_s is guaranteed possible to be perfectly reconstructed for a band limit $B < f_s/2$ [9]. The bandwidth for the sampling of the texture in the Road Simulator is given by the geometry of the plates that are placed in the circular track. As the laser rotates circularly, the length measured for one plate is defined as an arc length. The maximum measured arc length for one plate is around 600 mm. To distinguish the measured results for the different asphalt materials at the plates, an edge was milled into the plates. Thus, the arc length that can be considered for the measurements on one plate is shortened to around 300 mm. Applying the Nyquist-Shannon sampling theorem, the maximum arc length that gives reliable results will be 150 mm per plate. In addition, the data show big inaccuracy and scattering for wavelengths bigger than 70 mm. Consequently, only texture measurements for wavelengths up to 70 mm have been considered in the analysis. Thus, the study is limited to the texture wavelengths that reflect the characteristics of the asphalt surface linked to materials smaller than 70 mm. The D_{max} for the chosen asphalt mixtures was 8 and 11 mm.

3 Results

Each asphalt mixture type was mounted on two plates in the Road Simulator, placed diametrically opposite. The results for the pavement wear and the surface texture are both represented as averages of the results from the two plates.

3.1 Pavement Wear

The graph in figure 2 illustrates the pavement wear sorted by declining values. The wear of each asphalt pavement is visualized by three bars that reflect the two major changes in the measurement setup.

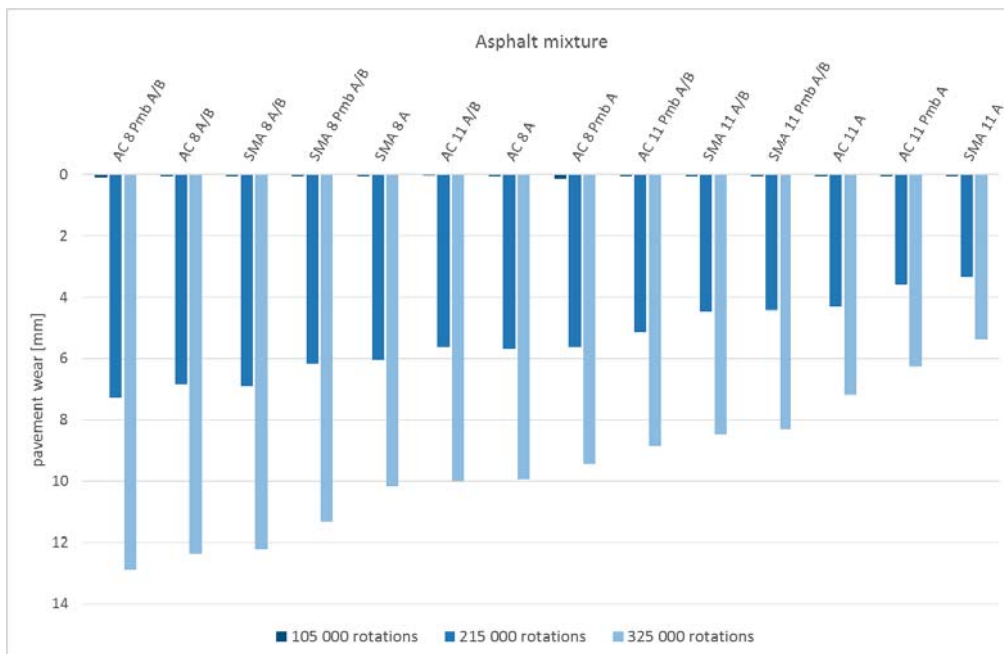

Figure 2. Pavement wear for the two major changes in the measurement setup

The first bar for each asphalt mixture shows the pavement wear after 105 000 rotations caused by the summer tires operating at 10 °C. After 105 000 rotations, the tires of the Road Simulator were changed to winter tires, and the room temperature was reduced to -5 °C. The temperature at the pavement surface was measured -2 °C. The second bar shows the wear after 215 000

rotations. The graph shows a significant increase for the wear for all asphalt pavements after inducing studded tires. The wear after 215 000 rotations is almost exclusively caused by the winter tires on dry, cold surface. The third bar reflects the total wear after the final measurements. Between 215 000 and 325 000 rotations, the surface was additionally sprinkled with water. The values for the final measurements are almost twice as high as after 215 000 rotations. Thus, the wear from the winter tires on wet surface is almost the same as the wear from winter tires on dry surface.

3.2 Surface Texture Development

To characterize a road surface texture, usually a texture spectrum is used. The spectrum shows the texture profile level in dB versus the texture wavelength in mm. The profile level is defined in [2] as the logarithmic transformation of an amplitude representation of a curve $Z(x)$, the latter expressed as a root mean square value, in accordance with the following equation:

$$L_{tx,\lambda} = 20 \lg \left(\frac{a_\lambda}{a_{ref}} \right) \quad (1)$$

where

$L_{tx,\lambda}$ is the texture profile level (refe. 10-6 m), in decibels;

a_λ is the root mean square value, in meters

a_{ref} is the reference root mean square value (= 10-6 m);

λ is a subscript indicating a value obtained with a one-third-octave-band filter having center wavelength λ [2].

Figure 3 shows a texture spectrum (solid line), and the arrows its preferred development to reflect a surface texture that generates as little noise as possible.

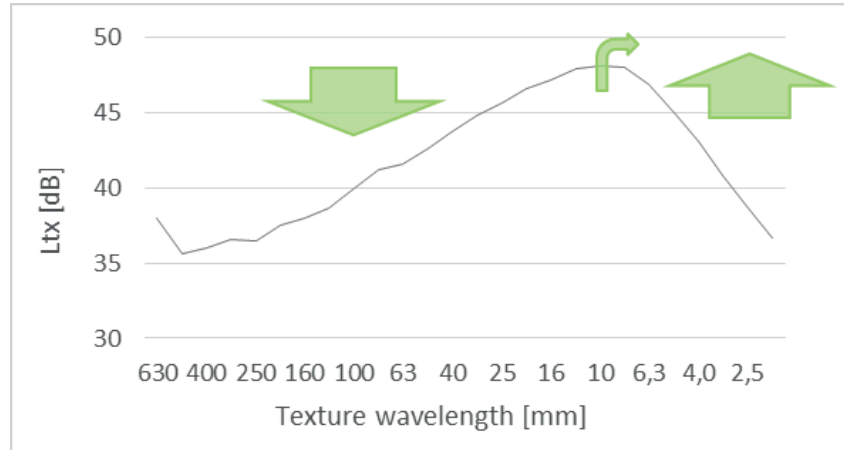

Figure 3. Texture spectrum visualizing a low noise pavement surface

The texture profile level values (L_{tx}) for smaller texture wavelengths (12.5-16 mm) have a clear negative correlation to high-frequency noise. Thus, the noise will decrease with increasing texture [5]. This high-frequency noise can be attributed to aero-dynamical phenomena like air pumping or several acoustic amplifying or reducing effects [3]. The bigger the L_{tx} values in this part of the spectrum, the better is the sound absorption and the less aero-dynamical phenomena occur. The L_{tx} -values for wavelengths above 25 mm reflect the properties of the parts of the asphalt surface that are responsible for low-frequency noise [5]. Mechanical vibrations that occur in the interaction between the car tire and the road surface generate low-frequency noise [3]. The mechanical vibrations are amplified by the protrusion of the coarse aggregates. To avoid low-frequency noise the L_{tx} -values for wavelengths above 25 mm should be as low as possible.

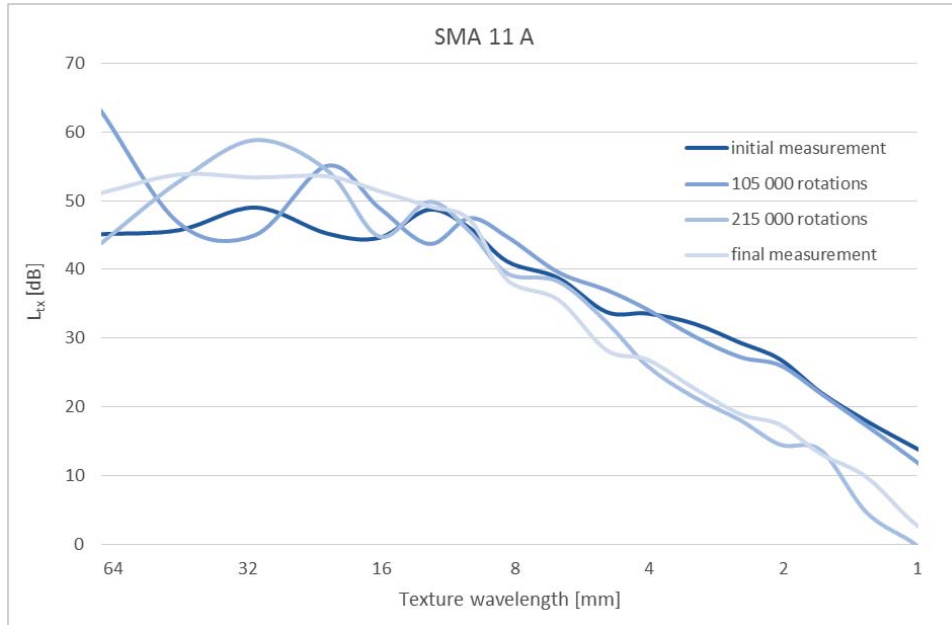

Figure 4. Development of the texture spectrum for SMA 11 A

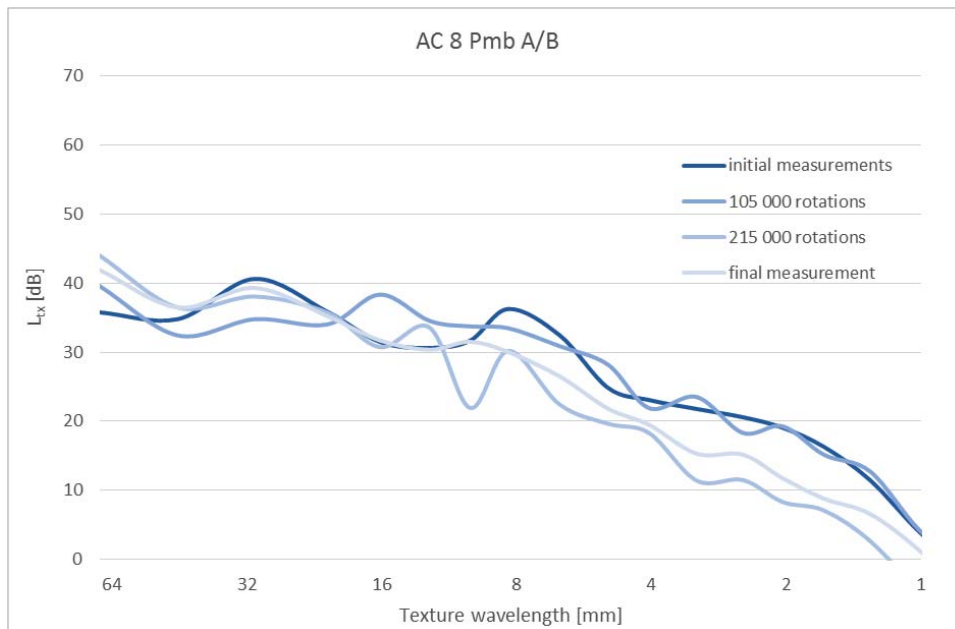

Figure 5. Development of the texture spectrum for AC 8 Pmb A/B

Figures 4 and 5 illustrate the development of the two pavements with the least and the most wear after the test was finished. SMA 11 A has the least wear, AC 8 Pmb A/B is the asphalt mixture that is worn the most. As described in chapter 2.4.1, caused by the size of the plates it was not possible to properly measure the texture levels for wavelengths bigger than 65 mm. Thus, the texture spectra in figures 4 and 5 only include wavelengths between 1 and 65 mm. This reflects only the characteristics of the pavements that can be attributed to the properties of the mortar, since the D_{max} of the tested asphalt mixtures was 8 or 11 mm.

The graphs clearly show the decrease of the texture levels after driving with studded tires on the pavement. There is almost no change in the texture levels after the first 105 000 rotations. The wear of the asphalt after 105 000 rotations is only caused by the summer tires. However, at 215 000 rotations a clear change is visible. On the other hand, after 325 000 the changes in the texture spectrum are not significant anymore. This suggests that the changes in texture happens almost immediately after the first contact of the surface pavement with the studded tires. The changes are in the same range for all mixtures. However, the starting point is different. For pavements with $D_{max} = 11$ mm, the initial values are already higher than those for pavements with $D_{max} = 8$ mm. For texture levels for the wavelengths less than D_{max} , this gives a positive effect, since high values are requested here. However, the levels for wavelengths bigger than D_{max} should be as low as possible. The texture levels for pavements with $D_{max} = 8$ mm are significantly lower than those for pavements with $D_{max} = 11$ mm, which results in less noise generation.

4 Discussion and Conclusions

Since the wear from the summer tires is very small compared to the wear caused by the winter tires, it will be neglected in the discussion.

The graph in chapter 3.1 shows that the pavement wear increases continuously after installing the studded tires in the Road Simulator. However, the texture is not changing significantly after 215 000 rotations. Thus, the significant changes in surface texture are mainly correlated to the initial pavement wear that is caused by the studded tires on dry cold asphalt surface.

Figure 2 verifies the effect of the maximum aggregate size on the pavement wear. All the asphalt mixtures with $D_{\max} = 8$ mm are worn more than those with $D_{\max} = 11$ mm. However, smaller D_{\max} generates less noise [6]. The graph in figure 2 also illustrates that the wear can be improved by using a wear resistant rock material. For example are the results for the AC 11 A/B almost the same as the results for the AC 8 A. The results for the AC 8 Pmb A are even better than those for the AC 11 A/B. Thus, the choice of strong aggregates and a modified binder may counteract the choice of a smaller D_{\max} . The use of rock material A in the mortar and B for the coarse aggregates results in more wear. Mixtures only using rock material A in their stone skeleton get significantly better results for the pavement wear than those using both rock materials. However, the effect of the Pmb is not that clear looking at the results of the pavement wear of all asphalt mixtures.

The described effects can not be transferred to the development of the texture spectrum. The texture spectra for all asphalt mixtures show the same tendency in their development. Significant changes occur initially after installing the studded tires. However, the final measurements show a slight increase in texture levels for the wavelengths up to 4-8 mm, especially for the AC mixtures including Pmb. Nevertheless, this should be confirmed by further testing.

One of the purposes of the study was to point out the protrusion of the coarse aggregates caused by the abrasion due to the studded tires. Unfortunately, the size of the plates in the Road Simulator are not big enough to give reliable texture measurements with the given measurement setup. Further research is needed to explore the development of the surface texture for wavelengths above 60 mm.

Summing up, the changes in texture are more or less similar independent of the asphalt mixture. However, a good starting point by using an asphalt mixture that provides a low noise surface initially will probably result in lower noise values also after wear by studded tires than an asphalt mixture that provides high noise values already after surfacing. Choosing the right materials for the asphalt mixture can result in less pavement wear and a satisfactory surface texture over time regarding noise generation.

5 Acknowledgement

This research was supported by the Norwegian Public Roads Administration. The authors are grateful to VTI and ViaTech for assistance with the measurements at the Road Simulator. We thank Tomas Halldin and Erik Espe who provided expertise that greatly assisted the research.

6 References

- [1] ISO 13473-1:1997(E), Characterization of pavement texture by use of surface profiles – Part 1: Determination of Mean Profile Depth, Genève, Switzerland, (1997)
- [2] ISO 13473-2:2002(E), Characterization of pavement texture by use of surface profiles – Part 2: Terminology and basic requirements related to pavement texture profile analysis, Genève, Switzerland, (2002)
- [3] Sandberg, U. & Ejsmont, J.A., Tyre/Road Noise Reference Book, INFORMEX Ejsmont & Sandberg Handelsbolag, Kisa, Sweden, (2002)
- [4] ISO/TS 13473-4:2008(E), Characterization of pavement texture by use of surface profiles – Part 4: Spectral analysis of surface profiles, Genève, Switzerland
- [5] Storeheier, S.Å., Miljøvennlige vegdekker: Resultater fra teksturmålinger 2006-2008, report A10917, SINTEF IKT, Trondheim, Norway, (2009)
- [6] Kragh, J., Møller Iversen, L., Sandberg, U., Road Surface Texture for Low Noise and Low Rolling Resistance, NordTex final report, Danish Road Directorate, report 506, Copenhagen, Denmark, (2013)
- [7] Homepage of the Swedish National Road and Transport Research Institute <http://www.vti.se/en/research-areas/environment/air-pollution-and-quality/vti-road-simulator/>
- [8] Uthus, N.S., Snilsberg, B., Miljøvennlige vegdekker – Sluttrapport for arbeidspakke 3: Støv, Technology report 2544, Norwegian Public Roads Administration – Road Directorate, Oslo, Norway, (2009)

- [9] Shannon, C.E., Communication in the presence of noise, Proc. Institute of Radio Engineers, vol. 37, no. 1, pp. 10–21, Jan. 1949. Reprint as classic paper in: Proc. IEEE, vol. 86, no. 2, (1998)

Paper IV

Submitted to Surf 2018 – 8th Symposium on Pavement Surface Characteristics

Pavement wear and its effect on surface texture and noise development on SMA 8 pavements in Norway

Doreen Siebert

NTNU, Department of Civil and Transport Engineering; Høgskoleringen 7, 7491 Trondheim; Norway; doreen.siebert@ntnu.no

Jostein Aksnes

Department of Road Technology, Norwegian Public Roads Administration, Postboks 8142, Dep, 0033 Oslo, Norway; jostein.aksnes@vegvesen.no

Truls Berge

Department of Acoustics, SINTEF ICT, Stiftelsen SINTEF, box 4760 Sluppen, 7465, Trondheim, Norway; Truls.Berge@sintef.no

Inge Hoff

NTNU, Department of Civil and Transport Engineering; Høgskoleringen 7, 7491 Trondheim; Norway; inge.hoff@ntnu.no

Helge Mork

NTNU, Department of Civil and Transport Engineering; Høgskoleringen 7, 7491 Trondheim; Norway; helge.mork@ntnu.no

Pavement wear is among the reasons for deterioration of asphalt pavements. Surface depression and abrasion caused by heavy traffic loadings and studded tires respectively, result both in ruts on the road surface. The abrasive action of the studded tires is considered to change the surface texture. Those texture alterations are expected to give changes in the acoustic characteristics of the road surface. Within this study, three test sections paved with stone mastic asphalt with a maximum aggregate size of 8 mm were analyzed regarding their development in wear, texture and noise characteristics. By including special requirements to the quality of the rock material in the asphalt mixtures,

the aim was to achieve satisfactory pavement life on the test sections and to maintain the low noise characteristics of the road surfaces. The results of the study show the effect of the material choice in the mix design on the pavement wear and the resulting texture and noise development.

Introduction

It is difficult to reduce noise emission from pavements in Nordic countries. The abrasive wear from studded tires reduces the effectiveness for porous asphalt pavements, which perform very well as low noise pavements in other countries. The pavements tend to clog very quickly, and their noise reducing characteristics are limited to just two or three years (Berge et al., 2009). By using traditional Norwegian asphalt pavements, a reduction of maximum grain size in asphalt mixtures from 16 to 8 mm can reduce noise by 3-4 dB(A) from newly paved surfaces (Evensen, 2009). However, the abrasive action of studded tires requires that coarse aggregates are used in the asphalt mixture design.

A maximum aggregate size (D_{max}) of 16 mm is often used in Norwegian mix design to ensure durable asphalt pavements. However, a D_{max} of 16 mm is not preferable considering low noise road surfaces. A reduction of the D_{max} to 8 mm results in less noise generation from the tire-road interaction (Evensen, 2009). Unfortunately, asphalt pavements with $D_{max} = 8$ mm are worn more quickly than asphalt pavements with $D_{max} = 16$ mm (Snilsberg, 2008). Thus, the anticipated lifetime of pavements with $D_{max} = 8$ mm is expected to be shorter, depending on the percentage of studded tires and speed limit of the respective road section.

In this study, three test sections were analyzed regarding their development in wear, texture and noise characteristics. The test sections were paved with Stone Mastic Asphalt (SMA) using a D_{max} of 8 mm. Special requirements were set to the mix design, in an attempt to reduce the wear caused by the choice of the D_{max} , and to extend the time period with low noise characteristics of the road surfaces. Test sections 1 and 2 were paved in 2012, test section 3 in 2005.

Even if the mix designs for the test sections were similar, the pavement characteristics developed differently with time, and substantial variation was observed in the pavement performance from one test section to another. In this study, a closer look at the materials used in the asphalt receipts and the properties of the asphalt surfaces in the field is performed. The aim was to find a possible reason for the different development of the test pavements. Annual

measurements give an overview of the development for wear, noise and texture characteristics, starting the year the sections were paved.

Overview of the road sections

The traffic data for the analyzed test sections are similar. The roads are defined as high volume roads with an Annual Average Daily Traffic (AADT) of more than 10 000 cars. The percentage of vehicles longer than 5.5 m is around 10 % for all test sections. The percentage of cars driving with studded tires is only measured for one test section. The traffic data are summarized in Table 1. Test sections 1 and 2 are placed on two-lane roads, one in each direction. Test section 3 is placed on a four-lane road, two in each direction.

Table 1: Traffic data for the analyzed test sections

Test section no.	1	2	3
Location	Nittedal	Halden	Mastemyr
AADT	13 300	14 400	11 800
Traffic per lane	6 650*	7 200*	1 800*
Percentage of vehicles longer than 5.5 m	10	9	12
Speed limit	70/50	70	90
% studded tires	25*	20*	20

* Estimated value

To ensure a satisfactory pavement life on the test sections and to extend the durability of the low noise characteristics, special requirements were set to the quality of the rock material used for the aggregates in the stone skeleton of the asphalt mixture. The used materials consist of 100 % crushed rock, and requirements for the Los Angeles value ($LA \leq 15$) and the Nordic abrasion value ($A_N \leq 7$) were set. Table 2 gives an overview of the material characteristics of the aggregates used for the mix design. The asphalt mixtures of test sections 1 and 3 included rock material from the same quarry.

Table 2: Characteristics of the materials used for the road sections

Test section no.	1	2	3
Quarry	Bjønndalen	Hadeland	Bjønndalen
Aggregate type	Rhombus porphyr	Porphyr	Rhombus porphyr
LA (CEN, 2010a)	15	13	15
Nordic abrasion value (CEN, 2014)	7	4.6	7

Table 3 gives an overview of the properties of the asphalt mixtures. The data reflect the results from the material testing at the laboratory.

Table 3: Intended asphalt mixture properties according to receipt

Test section no.	1	2	3
Asphalt mixture type	SMA		
D_{max}	8		
Binder type	65/105-80	65/105-80	70/100
Modification of the binder	Polymer modified		unmodified
Binder content (receipt)	6.5 ± 0.4	6.9 ± 0.4	6.5 ± 0.4
Air voids (receipt)	4.0 ± 2	3.5 ± 1.5	3.5 ± 1.5

The volumetric properties of the asphalt mixtures according to the mix design are very similar. However, some field samples showed large deviation from the intended values (see Table 4).

Table 4: Asphalt mixture properties of field samples

Test section no.	1	2	3
Binder content (average of two field samples)	6.2	6.7	6.5
Air voids (average of four field samples)	11.0	3.5	3.0

Pavement wear

The pavement wear is expressed by the rut depth at the pavement surface. Data from transverse profile analyses are collected annually, and give information on the development of the rut depth development. Figure 1 shows the results of the rut depth measurements for the three test sections. The data reflect the median values from the rut depth measurements for 20 m long sections. The maximum allowed value for rut depth is 20 mm for roads with AADT > 5 000 (NPRA, 2012). The normalized expected pavement life for SMA with an AADT in the range 10 001 – 20 000 is 7 years (NPRA, 2014). In the Nordic countries, the rut depth is the combined result of the abrasion caused by studded tires and the deformation from surface depression in the wheel path. On high volume roads, including a structure with little deformation in the unbound granular materials in the sub-layers and a stiff high quality asphalt in the top layer, wear generated by the abrasion of studded tires is considered to dominate.

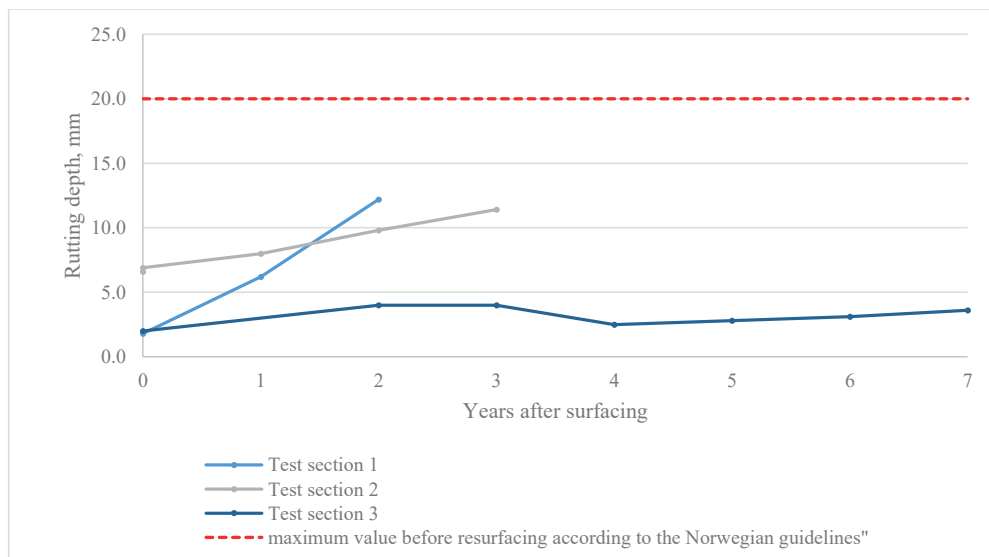

Figure 1: Development of rutting depth with time

Figure 1 shows that the wear on test section 1 increased a lot during the first two years after paving, giving less than 30 % of the expected pavement life. As there was a lot of damage at this test section, the pavement was renewed after three years in service. The graph for test section 2 shows a higher initial rut depth than the graphs for the other two test sections. Three years after paving, the rut depth was almost as high as test section 1 after two years in service.

Test section 2 was repaved after 4 years in service. Test section 3 performed very well, and shows no big changes in rut depth over time.

Asphalt mixture analyses

For further analyses, core specimens from test sections 1 and 2 were tested in the laboratory. The following tests and measurements were carried out:

- Maximum density (Rice density), No. 363 in NPRA (2016)
- Air voids content, No. 364 in NPRA (2016)
- Prall Test (method A) (CEN, 2004)
- Wheel track (CEN, 2003b).

Core specimens from test section 3 were analyzed 2005 within a research and development project conducted by the Norwegian Public Roads Administration. However, results for maximum density and air voids content only were available. The results for all three test sections are compiled in Figure 2, including their standard deviations.

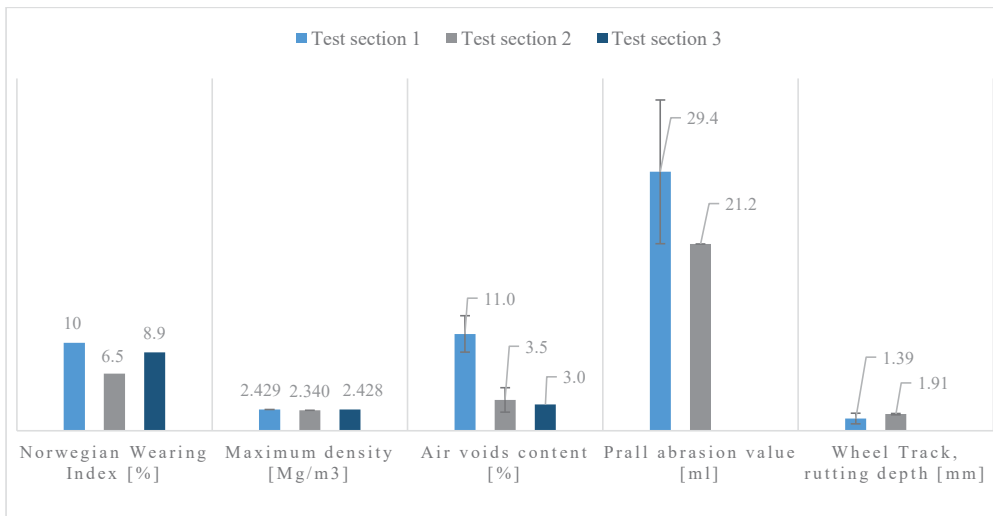

Figure 2: Results of laboratory testing

Analyzing asphalt pavement wear on Norwegian roads, the Norwegian Wearing Index (NWI) is considered as well. The NWI includes the Nordic abrasion value (A_N) and the amount of aggregates larger than 2 mm. The A_N reflects the rock material's resistance against abrasive action by studded tires. The larger the NWI values, the more abrasion is caused by the use of

studded tires (Uthus and Snilsberg, 2009, Snilsberg, 2008). NWI is calculated by the following equation:

$$NWI = \frac{A_N}{\text{percentage of aggregates } > 2 \text{ mm}} \cdot 100 \quad (1)$$

where

A_N is the Nordic abrasion value for the aggregates smaller than 2 mm.

The test results for field samples revealed a very high air voids content for the core specimens from test section 1. Instead of 4.0 ± 2 % as required in the receipt, the measured mean air voids content was 11 %. Also, the results from the Prall Test show very high values for test section 1. However, the maximum density and the results from Wheel Track testing are very similar for the test sections. Figure 2 also shows a very high standard deviation for the Prall abrasion value for the specimens from test section 1. One of the samples shows a much higher Prall abrasion value compared to the others. However, none of the samples from test section 1 meet the requirements according to NPRA (2014); a maximum Prall abrasion value of 22 cm^3 for roads with AADT greater than 10 000.

Noise

Noise measurements

Noise measurements were performed with the CPX-trailer in accordance with the ISO standard ISO/DIS 11819-2 (ISO, 2013). Standard reference tires (SRTT), type Uniroyal Tigerpaw 225/60 R16 97S were used for all noise measurements. The trailer is designed to give a load of 3200 N on each of the tires. The tire pressure is specified to 200 kPa.

New SRTT tires were used for the measurements 2012 at the then newly paved test sections 1 and 2. Following an increase in hardness, the tires were replaced by a new set 2015 (3 years after paving of test sections 1 and 2). The hardness was tested in accordance with the TS draft for 11819-3, as prepared by ISO WG33. The noise levels two years after paving (2014) for test sections 1 and 2 were adjusted in accordance with the increase in hardness compared to 2012. However, test section 3 was paved 2005 and no adjustments of noise levels have been made for the tires used on this section.

For each test section, an A-weighted frequency specter (1/3 octave) is measured in the range 315-5000 Hz. The mean A-weighted L_{CPX} value is produced by the determination of the average of the noise levels recorded by the two microphones at each side of the CPX-trailer for each 20 m measurement section and in each 1/3 octave band. Afterwards, the levels from each of the 20 m sections are arithmetically averaged over the total length of the test section. Then, the levels from each wheel track (from each SRTT-tire) are arithmetically averaged again. The following equation is applied to correct the noise levels to the reference speed of 50 km/h:

$$L_{corr} = B \cdot \log\left(\frac{v}{v_{ref}}\right) \quad (2)$$

where

- B is the speed coefficient, dimensionless, depending on the type of road surface,
- v is the speed of the CPX-trailer while measuring the noise,
- v_{ref} is the reference speed of 50 km/h (chosen for this study).

The measured L_{CPX} values are finally corrected as follows: $L_{CPX, 50} = L_{CPX} - L_{corr}$. The results are presented as $L_{CPX, 50}$ values in dB(A). All results are also corrected for temperature to the reference value of 20 °C by an adjustment factor -0.05 dB/°C according to the proposal from ISO WG27 for dense asphalt surfaces.

Noise development

Figure 3 gives an overview of the $L_{CPX, 50}$ values at the three test sections, the A-weighted noise levels corrected to 50 km/h.. The results represent the development of the noise levels for the years after surfacing, including the standard deviation. For test section 1, no L_{CPX} values are available later than one year after surfacing.

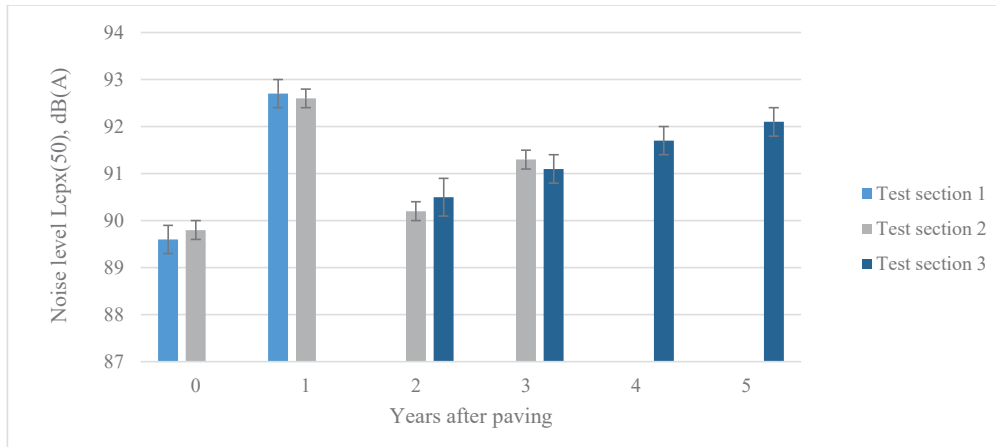

Figure 3: Noise development with time measured at 50 km/h

The figure shows very high L_{CPX} values at test sections 1 and 2 one year after paving. Two years after paving, the measured noise levels for test section 2 is again down to a more normal level. The high levels one year after paving are assumed be related to the temperature during the noise measurements. The measurements one year after paving were performed at 8-13 °C, while the temperature one year later was 17-22 °C. For the analysis, the standard temperature correction to +20 °C by -0.05 dB/°C was used. However, recent research suggests a mean correction by -0.10 dB/°C for dense surfaces (Bühlmann et al., 2013). The new correction factor would result in lower L_{CPX} values for the first year after paving. In addition, the correction factor for the hardness of the test tire for test section 2 may contribute to an explanation of the measured noise level variations. The correction is based on a study in Switzerland (Bühlmann et al., 2013), and it is not fully clarified whether this factor is valid for the specific tires used in these measurements. For example, if the noise influence of the hardness of the tire is lower than expected, the L_{CPX} values for the second year after surfacing would be higher.

Surface texture

Texture measurements

The texture measurements were performed with a Selcom OptocatorTM laser, type 2008-180/390-A. The operating range of the laser is up to 180 mm with a sampling frequency of 32

kHz. At a driving speed of 40 km/h, the sampling distance is around 0,35 mm. The collected data are sampled values of height profiles of the pavement surface. The results of the texture measurements are calculated from the measured profile and are presented as texture spectra, MPD values and factor g . The presented result are average values from texture measurements in the right wheel track. The texture measurements and the subsequent analyses have been accomplished in accordance with ISO 13473-1 to 4 (CEN, 1997, CEN, 2002a, CEN, 2002b, CEN, 2008).

Texture development

Texture data were collected annually for test sections 2 and 3. The development of the texture spectra is shown in Figure 4. The spectra for test section 2 show that the texture changes rapidly during the first year after paving and stays nearly the same the following years. For test section 3, the texture spectrum from the initial measurement is missing. However, the development of the texture spectra shows the typical characteristics for Norwegian surfaces; the older the pavements are, the lower the texture levels (L_{tx}) for the smaller wavelength. Text section 2 also shows an increase of L_{tx} with time for the longer texture wavelengths.

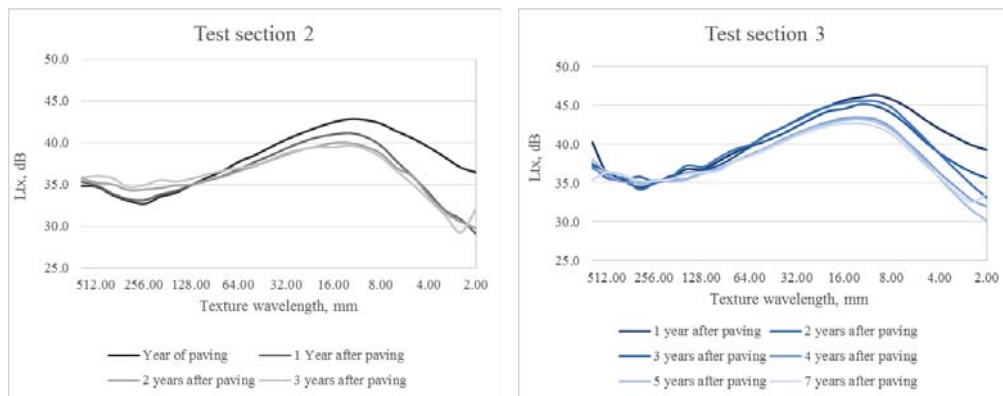

Figure 4: Development of texture spectrum with time

Figure 5 shows the development of the Mean Profile Depth (MPD) over time for test sections 2 and 3. The initial measurement for test section 3 is missing, but the development of the MPD seems to be similar for both sections. There is an increase in MPD one year after paving, afterward the changes for the average values are not that large. However, the standard deviation

for the average values gets larger over time for both sections, which means that there are increasing variations in the measured MPD values at the test sections.

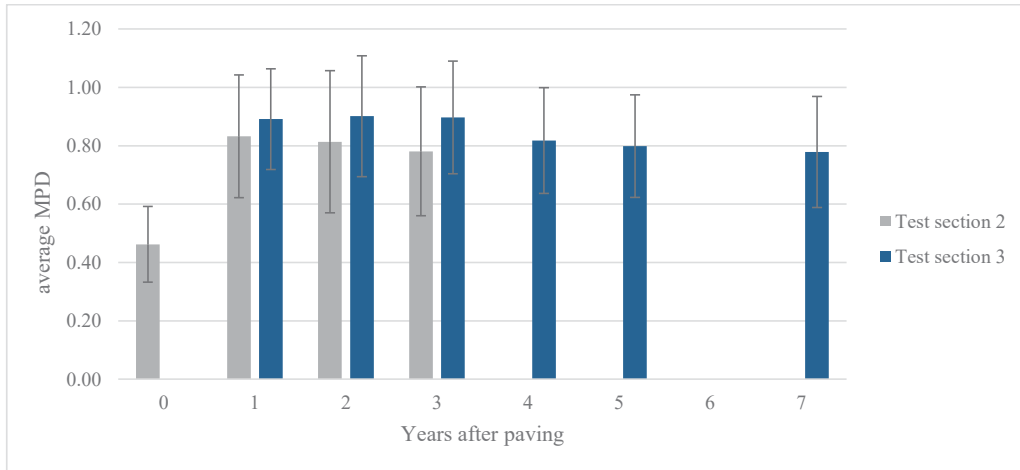

Figure 5: Development of MPD with time

Generally, there is a poor correlation between tire/road noise and MPD values (Kragh et al., 2013). However, the MPD can be related to surface texture levels at third-octave band with center wavelength 80 mm (L_{tx80}). L_{tx80} on the other hand is related to L_{CPX} (Kragh et al., 2013). Due to the statistical analyses of the frequencies of the profile depths, it is possible to determine a parameter to identify the shape of the texture. This parameter is called shape factor g , visualized in Figure 6.

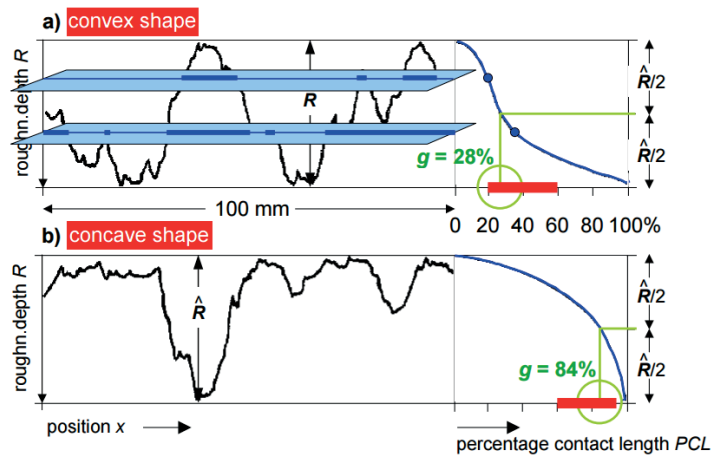

Figure 6: Illustration of shape factor g (Beckenbauer, 2007)

A high factor g reflects a concave texture (plateau with valleys) which results in low noise generation from the tire/road interaction. The factor g should be higher than 60 % to ensure a low noise road surface (Angst et al., 2010).

The development of the shape factor g with time is shown in Figure 7. Again, the initial measurement for test section 3 is missing. However, the factor g for test section 3 one year after paving is still high (> 80 %), which suggests a similar initial factor g for test sections 2 and 3. The development of the factor g differs substantially from test section 2 to test section 3, though. Already one year after paving the factor g for test section 2 decreases considerably. The factor g for test section 3 stays rather high over time. As for the MPD-values, the standard deviation for the average values of the factor g increases with time, and the variations for the measured values increase for both test sections.

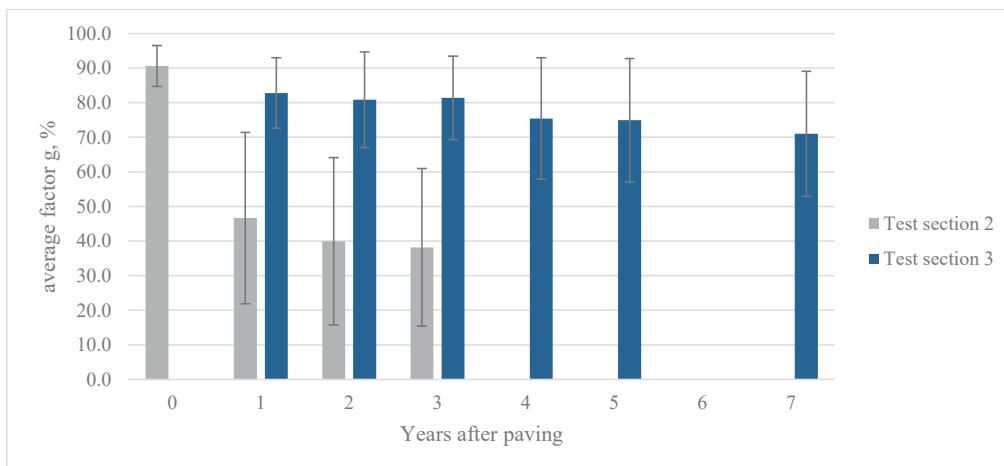

Figure 7: Development of factor g with time

A factor g below 50 % indicates a “peaky” profile, while a factor g larger than 50 % indicates a “plateau like” profile with slits in it (Kragh et al., 2013). Hence, a factor g larger than 50 % reflects a surface texture that provides less tire/road noise than a surface with a factor g below 50 %. Based on this observation, the noise characteristics for test section 3 should be better than those for test section 2. However, the results from the noise measurements shown in Figure do not confirm this assumption.

Discussion

The results from the laboratory testing indicate that the rut depth at test sections 1 and 2 (shown in Figure 1) are caused by abrasion and not by deformation. Even if the air voids content at test section 1 was very high, the Wheel Track did not show higher deformation. As the Prall Test reflects the abrasion of studded tires and the Wheel Track reflects the deformation by passenger cars at high temperatures, it is clearly the abrasion which causes the most wear for test sections 1 and 2. The abrasion is supposed to depend on the quality of the stone and the amount of aggregates larger than 2 mm (Uthus and Snilsberg, 2009). Considering the NWI, the higher values for test section 1 can explain the rapid wear on this pavement. However, a similar high NWI for test section 3 does not seem to have the same effect on the pavement wear.

Visual assessment of test section 1 showed parts with a high aggregate loss at the pavement surface, which was the main reason for repaving this section after three years in service. The aggregate loss is caused by either raveling or stripping. The analyses of the asphalt mixture revealed a high air voids content. It is therefore reasonable that aggregate segregation occurred at the test section. Also, inadequate compaction might be the reason for the high air voids content. Another likely consequence of the high air voids content is moisture damage. Water penetrates into the surface, and in combination with freeze and thaw cycles, the aggregate loss occurs.

Comparing test section 1 and test section 3, there is no obvious difference between the asphalt materials used for the pavement surface. The asphalt receipts are quite similar and the rock material used originate from the same quarry. This quarry is well-established and often used for paving materials. A possible explanation for the large variations in performance for these two test sections, might be the quality of the workmanship. The test results from the laboratory testing revealed a very high air voids content for test section 1, which affects the pavement life. The reason for the high air voids content can be a low temperature during compaction. Low compaction of the asphalt mixture during surfacing can lead to high air voids content. The workmanship is crucial. It is important that the work is done properly and that the road is paved according to the requirements. Otherwise, the characteristics of the pavement will usually not fulfill the requirements, and the pavement life can be reduced.

Test section 3 is very interesting as it shows that it is possible to achieve a longer pavement life than expected, even with a smaller D_{max} and an unmodified binder. To find reliable

explanations, different aspects have been considered. One of them is the location of the test section. Test section 3 is located in the left traffic lane at a road with two lanes in each direction. The road has a slope of ca. 3-3,5 % in the direction of the traffic flow. Most of the heavy vehicles are assumed to stay in the right traffic lane. The wear of test section 3 is consequently considered to be generated mainly by passenger cars. The other two test sections are located at single carriageway roads with one lane in each direction. At these sections, the traffic is composed of both heavy vehicles and passenger cars.

The results of the texture analyses reflect the development of the tests section's pavement wear. Test section 3 shows good results with time for the analyzed texture parameters. Especially the factor g is staying high over time, which also indicates relatively stable noise characteristics of the pavement. However, test section 3 shows an increase in noise levels with time. A slight decrease in the high values for factor g at this section reflects the development of the noise characteristics. The results for factor g at section 2 decrease remarkably after one year in service. The noise levels of this section show an accordingly increase one year after paving. However, the high noise level one year after paving is connected to some uncertainties related to the climatic conditions during the noise measurements.

Conclusions

Within this study, pavement wear and its effect on the surface texture and noise development of SMA road surfaces has been analyzed. The following conclusions can be summarized from the results of the analyses.

The wear of road pavements depends on a lot of parameters. Even for pavements with similar mix design, traffic- and environmental stress, the performance can vary considerably. The chosen materials for the mix design affect the pavement wear to a certain degree. However, the workmanship during paving is crucial for the characteristics and the performance of the road pavement. In addition, the distribution of the traffic loading affects the pavement wear.

The observed surface texture development corresponds with the pavement wear. Higher pavement wear results in larger changes in the texture spectra, the MPD and the factor g . As noise can be connected to the texture parameters, a reflection of the pavement wear is also shown in the development of the noise levels over time.

Acknowledgements

This research was funded by the Norwegian Public Roads Administration. The authors are grateful to SINTEF IKT and the laboratory of the Norwegian University of Science and Technology (NTNU) for carrying out the tests and measurements required for the analyses in this study.

References

- ANFOSSO-LÉDÉE, F. & DO, M.-T. 2002. Geometric descriptors of road surface texture in relation to tire-road noise. *Transportation Research Record: Journal of the Transportation Research Board*, 160-167.
- ANGST, C., BELTZUNG, F., BOSSHARDT, D., ZIEGLER, T. & BÜHLMANN, E. 2010. Lärmarme Strassenbeläge innerorts Jahresbericht 2010. Swiss: Bundesamt für Strassen (ASTRA), Bundesamt für Umwelt (BAFU).
- ASTM 2014. F2493 - 14 Standard Specification for P225/60R16 97S Radial Standard Reference Test Tire. West Conshohocken, United States: ASTM International.
- AURSTAD, J., UTHUS, N. S., TELLE, R. & BAKLØKK, L. J. 2016. The influence of workmanship on pavement service life. *6th Euroasphalt & Eurobitume Congress*. Prague, Czech Republic.
- BECKENBAUER, T. 2007. SPERON model and AOT project. *Presentation at Texture Workshop organized by NPRA*. Oslo, Norway.
- BERGE, T. S., HAUKLAND, F. & USTAD, A. 2009. Environmentally friendly pavements: Results from noise measurements 2005-2008.
- BUENO, M., LUONG, J., VIÑUELA, U., TERÁN, F. & PAJE, S. 2011. Pavement temperature influence on close proximity tire/road noise. *Applied Acoustics*.
- BÜHLMANN, E., SCHULZE, S. & ZIEGLER, T. 2013. Aging of the new CPX reference tyres during a measurement season. *Inter Noise*. Innsbruck, Austria.
- CEN 1997. ISO 13473-1 Characterization of pavement texture by use of surface profiles - Part 1: Determination of Mean Profile Depth. Geneva, Switzerland: International Organization for Standardization.
- CEN 2002a. ISO 13473-2 Characterization of pavement texture by use of surface profiles - Part 2: Terminology and basic requirements related to pavement texture profile analysis. Geneva, Switzerland: International Organization for Standardization.

- CEN 2002b. ISO 13473-3 Characterization of pavement texture by use of surface profiles - Part 3: Specification and classification of profilometers. Geneva, Switzerland: International Organization for Standardization.
- CEN 2003a. EN 13036-3 Road and airfield surface characteristics - Test methods - Part 3: Measurement of pavement surface horizontal drainability. Brussels, Belgium: European Committee for Standardization.
- CEN 2003b. NS-EN 12697-22 Bituminous mixtures - Test methods for hot mix asphalt - Part 22: Wheel tracking. Brussels, Belgium: European Committee for Standardization.
- CEN 2004. EN 12697-16 Bituminous mixtures - Test methods for hot mix asphalt - Part 16: Abrasion by studded tyres. Brussels, Belgium: European Committee for Standardization.
- CEN 2008. ISO/TS 13473-4 Characterization of pavement texture by use of surface profiles - Part 4: Spectral analysis of surface profiles. Geneva, Switzerland: International Organization for Standardization.
- CEN 2010a. EN 1097-2 Tests for mechanical and physical properties of aggregates - Part 2: Methods for the determination of resistance to fragmentation. Brussels, Belgium: European Committee for Standardization.
- CEN 2010b. EN 13036-1 Road and airfield surface characteristics - Test methods - Part 1: Measurement of pavement surface macrotexture depth using a volumetric patch technique. Brussels, Belgium: European Committee for Standardization.
- CEN 2011a. EN 1097-1 Tests for mechanical and physical properties of aggregates - Part 1: Determination of the resistance to wear (micro-Deval). Brussels, Belgium: European Committee for Standardization.
- CEN 2011b. EN 13036-4 Road and airfield surface characteristics - Test methods - Part 4: Method for measurement of slip/skid resistance of a surface: The pendulum test. Brussels, Belgium: European Committee for Standardization.
- CEN 2013. EN 1097-6 Tests for mechanical and physical properties of aggregates - Part 6: Determination of particle density and water absorption. Brussels, Belgium: European Committee for Standardization.
- CEN 2014. EN 1097-9 Tests for mechanical and physical properties of aggregates - Part 9: Determination of the resistance to wear by abrasion from studded tyres - Nordic test. Brussels, Belgium: European Committee for Standardization.
- DESCORNET, G. & SANDBERG, U. Road surface influence on tire/road noise-Part I. Inter-Noise 80, 1980a Miami, USA. 259-266.

- DESCORNET, G. & SANDBERG, U. Road surface influence on tire/road noise-Part II. Inter-Noise 80, 1980b Miami, USA. 267-272.
- EVENSEN, R. 2009. Environmentally Friendly Pavements - Final Report. Oslo, Norway: Norwegian Public Roads Administration - Road Directorate.
- GIBBS, D., IWASAKI, R., BERNHARD, R., BLEDSOE, J., CARLSON, D., CORBISIER, C., FULTS, K., HEARNE JR, T., MCMULLEN, K. & ROBERTS, J. 2005. Quiet pavement systems in Europe. Washington DC, United States.
- HAIDER, M. & DESCOURNET, G. 2006. Noise classification methods for urban road surfaces - Classification Methodology.
- HECKL, M. 1986. Tyre noise generation. *Wear*.
- ISO 1997. 11819-1 Acoustics - Measurement of influence of road surfaces on traffic noise - Part1: Statistical Pass-By method. Genève, Switzerland: International Organization of Standardization.
- ISO 2003. 13325 Tyres - Coast-by methods for measurement of tyre-to-road sound emission. Geneva, Switzerland: International Organization for Standardization.
- ISO 2013. FDIS 11819-2 Acoustics - Method for measuring the influence of road surfaces on traffic noise - Part 2: Close-proximity method. Online: International Organization for Standardization.
- IWAO, K. & YAMAZAKI, I. 1996. A study on the mechanism of tire/road noise. *JSAE review*.
- IWASE, T. Acoustic properties of porous pavement with double layers and its reduction effects for road traffic noise. Proceedings of Inter Noise, 2000.
- KLOTH, M., VANCLUYSEN, K., CLEMENT, F. & ELLEBJERG, L. 2008. Local Noise Action Plans - Recommendations from the SILENCE project. Bergisch Gladbach, Germany.
- KRAGH, J., IVERSEN, L. M. & SANDBERG, U. 2013. Road surface texture for low noise and low rolling resistance, Nordtex final report. Copenhagen, Denmark.
- KUIJPERS, A. 2001. Further analysis of the Sperenberg data, Towards a better understanding of processes influencing tyre/road noise, Technical Report M+P.MVM.99.3.1. Vught, The Netherlands.
- KUPIAINEN, K., TERVAHATTU, H. & RÄISÄNEN, M. 2003. Experimental studies about the impact of traction sand on urban road dust composition. *Science of the Total Environment*.

- LANDSDOWN, A. R. & PRICE, A. L. 1986. Materials to resist wear: A guide to their selection and use. *Pergamon materials engineering practice series*. Oxford, New York, United States.
- LÅG, M., MYRAN, T., REFSNES, M., SCHWARZE, P. E. & ØVREVIK, J. 2004. Veidekker: Svevestøv og helse. Oslo, Norway: Nasjonalt folkehelseinstitutt.
- MILJØDEPARTEMENTET 2014. Handlingsplan mot støy 2007-2011, med oppdatering ut 2015. Oslo, Norway: Ministry of climate and Environment, Norwegian Government.
- MILJØDIREKTORATET. 2016. *Noise* [Online]. Norwegian Environment Agency. Available: <http://www.environment.no/topics/noise/> [Accessed 04.10.2016].
- MORGAN, P., ABBOTT, P., ANDERSEN, B., ANFOSSO-LEDEE, F., BARTOLOMAEUS, W., BENDTSEN, H., VAN BLOKLAND, G., DESCORNET, G., EIJBENSEN, M., EJSMONT, J. A., HABERL, J., HAMET, J.-F., MIODUSZEWSKI, P., NILSSON, R., PADMOS, C., PUCHER, E., ROOVERS, C., SANDBERG, U., SLIWA, N., VEISTEN, K., VAN VLIET, W. J. & WATTS, G. 2006. FEHRL REPORT, Guidance manual for the implementation of low-noise road surfaces. Brussels, Belgium.
- N/A 2009. *AASHTO Provisional Standards, 2009 Edition*, American Association of State Highway and Transportation Officials (AASHTO).
- NFS 2001. 31-1193-2 Acoustics: In-situ characterization of the acoustic qualities of road surfaces - Pass by acoustic measurement - Part 2: Controlled pass-by method. Paris, France: National French Standard, AFNOR.
- NPRA 2012. Standard for drift og vedlikehold av riksveger - Håndbok R610. www.vegvesen.no/Fag/Publikasjoner/Handboker: Norwegian Public Roads Administration - Road Directorate.
- NPRA 2014. Vegbygging - Håndbok N200. www.vegvesen.no/Fag/Publikasjoner/Handboker: Norwegian Public Roads Administration - Road Directorate.
- NPRA 2016. Laboratorieundersøkelser - Håndbok R210. www.vegvesen.no/Fag/Publikasjoner/Handboker: Norwegian Public Roads Administration - Road Directorate.
- RASMUSSEN, R., SOHANEY, R. & WIEGAND, P. 2011a. Measuring and Reporting Tire-Pavement Noise Using On-Board Sound Intensity (OBSI). *National Concrete Pavement Technology Center, Iowa State University, Ames, Iowa*.
- RASMUSSEN, R. O., SOHANEY, R., WIEGAND, P. & HARRINGTON, D. 2011b. Measuring and analyzing pavement texture. *National Concrete Pavement Technology Center, Tech Brief January*.

- REGJERINGEN.NO. 2001. *The Norwegian National Environmental and Health Action Plan* [Online]. Ministry of Environment and Ministry of Health and Social Affairs. Available: <https://www.regjeringen.no/no/dokumenter/the-norwegian-national-environment-and-h/id105635/> [Accessed 04.10.2016].
- REGJERINGEN.NO. 2007. *St.meld.nr 26 (2006-2007) - Regjeringens miljøpolitikk og rikets miljøtilstand* [Online]. Available: <https://www.regjeringen.no/no/dokumenter/Stmeld-nr-26-2006-2007-/id465279/?ch=1&q=> [Accessed 05.10.2016].
- SABA, R. G. 2006. Miljøvennlige vegdekker - Spesialdekker - Poroelastiske dekker. Oslo, Norway.
- SANDBERG, U. 1998. Influence of road surface texture on traffic characteristics related to environment, economy and safety: A state-of-the-art study regarding measures and measuring methods. *VTI notat 53A-1997*. Linköping, Sweden: Statens väg- och transportforskningsinstitut, VTI.
- SANDBERG, U. 1999. Low noise road surfaces. A state-of-the-art review. *Journal of the Acoustical Society of Japan (E)*, 20, 1-17.
- SANDBERG, U. 2010. Road surface texture influence on tyre/road noise. VTI.
- SANDBERG, U. & EJSMONT, J. A. 2002. Tyre/road noise reference book. Kisa, Sweden.
- SIEBERT, D. & MORK, H. 2016. Prall Tests to study the effect of mortar on the wear of Norwegian asphalt mixtures. *6th Euroasphalt & Eurobitumen Congress*. Praha, Czechia.
- SNILSBERG, B. 2008. *Pavement wear and airborne dust pollution in Norway - Characterization of the physical and chemical properties of dust particles*. Norwegian University of Science and Technology.
- SNILSBERG, B., MYRAN, T., UTHUS, N. & AURSTAD, J. 2008. Evaluation of different laboratory methods for simulation of pavement wear and road dust generation. *Road Materials and Pavement Design*.
- STATISTICS NORWAY. 2013. *Støyeksponering og støyplage i Norge. 1999 – 2011. Flere støyutsatte* [Online]. Available: <http://www.ssb.no/natur-og-miljo/artikler-og-publikasjoner/flere-stoyutsatte> [Accessed 04.10.2016].
- UTHUS, N. & SNILSBERG, B. 2009. Miljøvennlige vegdekker - Sluttrapport for arbeidspakke 3: Støv. Oslo, Norway: Norwegian Public Roads Administration.
- WHO 2011. Burden of disease from environmental noise _Quantification of healthy life years lost in Europe. Copenhagen, Denmark.