



Your ref.: MS/N14T22/IGB/LSKKP

Date: 18.02.2016

**GEOL Master Thesis for  
Natural Resource Management student Lena Selen**

**STUDY ON MATERIAL PROPERTIES TESTING OF VARIOUS ROCK TYPES,  
DEVELOPMENT OF INVESTIGATION PROCEDURE AND TEST METHODOLOGY FOR  
FUTURE PROJECTS**

**Background**

Statkraft, and its subsidiaries SN Power and Aqua Imara, have experienced challenging rock behaviour during development of several projects in South America; East Asia and Africa. Many of these challenges were related to a variation of rock properties during construction and operation, compared to the estimated behaviour during planning. Such behaviour included swelling, disintegration, loss of strength and deformability properties, which is less familiar in the Norwegian environment.

**MSc Project Task**

Therefore, this master thesis shall study material properties of various rock types from the actual project site, to develop a database of parameters and give input to a methodology for rock testing of various rocks in future projects. The thesis will include:

- Theoretical review on swelling potentials of the volcanic rocks
- Brief review of the geological conditions of the case project(s)
- Review and discuss existing test methodologies for rock properties such as mineralogical, swelling and strength tests of intact rock and crushed rock powder.
- Discuss testing facilities at NTNU and KiT.
- Sample the rock, prepare test specimens of the rock samples collected from the case project and carry out tests for mineralogical composition, swelling potential and standard test suits such as UCS.
- Analyse the test results and compare the results obtained from NTNU and KiT
- Discuss the strength and weaknesses of the swelling test carried out in different two laboratories and give recommendations.

**Relevant computer software packages**

As per the need

### **Background information for the study**

- Relevant information about the project such as reports, maps, information received from Statkraft and data collected by the candidate from field work.
- The information provided by the supervisors.
- Scientific papers, reports and books related to the subject.

### **Cooperating partner**

Statkraft is the co-operating partner. **Dr. Siri Stokseth & MSc Thomas Shonborn** from Statkraft will be the co-supervisors for this project.

MSc thesis work starts on February 15<sup>th</sup> 2016 and it should be completed by May 15<sup>th</sup> 2017.

The Norwegian University of Science and Technology (NTNU) Department  
of Geology and Mineral Resources Engineering

February 18<sup>th</sup>, 2016



Krishna K. Panthi

Associate Professor of geological engineering, main supervisor

# ABSTRACT

This master thesis aims to provide insight and qualitative information about swelling mechanisms in volcanic rocks, in particular the swelling of rocks related to hydropower water tunnels. Additionally, traditional laboratory methods for determining the main rock material properties controlling swelling behavior are investigated. The rock samples tested are obtained from the Alimit area in Philippines, where The Alimit HEPP is in its feasibility phase. The hope is to provide an enhanced understanding of the swelling potential of the volcanic rocks, and introduce a suggestion on a proper investigation procedure to detect potential challenges at an early stage.

The first step in this investigation, was to get an overview of “the status quo” in swelling rock sciences. The further work was based on the leading hypothesis on swelling clay minerals (i.e. smectites or similar groups of swelling clay minerals) to be the main cause of tunnel collapses in previous projects. Other explanations, as the swelling of chlorites and zeolites, and moisture swelling, were also kept in mind during the investigations.

The next step was to survey the project case site, located in the Ifugao province of the Philippines, to get an overview of the geological and topographical features of the area. Sampling of the assumed most dominating rock types, with focus on regions in which major constructions are planned, was performed. The samples were obtained from the borehole core storage of SN Aboitiz (cooperating partner of SN Power/Statkraft) in Lagawe, Philippines.

The main part of the investigation procedure was to obtain information on rock material key properties of the collected samples, by different laboratory test methods. The samples underwent mineralogical analyses, UCS-tests, and different types of swelling tests. Oedometer swelling tests were performed at two different institutes (NTNU and KiT), for comparison of methodology and output.

The study has uncovered an unexpected swelling potential of strong, andesitic rock types, despite the lack of swelling clay minerals in the samples tested. The swelling pressure magnitudes are confirmed by repeated tests, and apply on the results obtained at both institutes. The swelling potential is assumed closely linked to the high content of laumontite (zeolite). Content of swelling clay minerals, in particular montmorillonite,

is detected in other rock types tested. The rock material of these samples are weak and disintegrated, and thus not up to standards for UCS testing. However, the swelling pressure magnitudes are lower in the weak material, compared to the strong andesitic rock.

The comparison of the oedometer methodology in operation at NTNU and KiT, uncovered important differences between the two institutes. The deviations apply on both the apparatus used, and the procedures of swelling tests. The differences include the version of the ISRM suggested methods, intern modifications on apparatus and procedures, and intern traditions in how specific points in the ISRM standard is translated in practice.

Based on the work performed throughout the investigation, a suggestion on an improved investigation procedure is presented at the end of this thesis.

## SAMMENDRAG

Denne masteroppgaven har som målsetting å bidra til innsikt og kvalitativ informasjon om svellemekanismer i vulkanske bergarter, spesielt svelling i bergarter tilknyttet vannkrafttunneler. I tillegg er tradisjonelle laboratoriemetoder for bestemmelse av de viktigste materialeegenskapene til bergartene undersøkt. Bergartsprøvene som er testet er hentet fra Alimit området i Filippinene, hvor Alimit HEPP er i undersøkelsesfasen. Håpet er å bidra til en økt forståelse av svellepotensialet til disse vulkanske bergartene, samt introdusere en kurant undersøkelsesmetodikk som kan avdekke potensielle utfordringer i en tidlig fase.

Det første steget i undersøkelsene har vært å skaffe en oversikt over «status quo» i vitenskapen innen svellende bergarter. Det videre arbeidet har basert seg på ledende hypoteser om svellende leirmineraler (m.a.o. smektitter og lignende grupper av svellemineraler), som hovedforklaring på tunnelkollapser i tidligere prosjekter. Andre forklaringsmodeller, som svelling av kloritter og zeolitter, og fysisk svelling, har også vært med i betraktningene i undersøkelsene som er gjort.

Det neste steget i prosessen var å undersøke lokasjonen for prosjektet, som befinner seg i Ifugao provinsen i Filippinene, for å få en oversikt over topografien og geologien i området. Innhenting av bergartsprøver fra aktuelle områder hvor viktige konstruksjoner er planlagt, ble gjennomført. Bergartsprøvene ble hentet fra lageret av borekjerner til SN Aboitiz, i Lagawe, Filippinene.

Hoveddelen av arbeidet har dreid seg om å skaffe informasjon om de innsamlede bergartsprøvene sine materielle nøkkelegenskaper, ved å gjennomføre ulike laboratorietester. Prøvene har gjennomgått mineralogiske analyser, UCS-tester, og ulike former for svelletester. Ødometertester har blitt gjennomført på to ulike institusjoner (NTNU og KiT), for å sammenligne metodologi og resultater.

Studien har avdekket et uforventet svellepotensial hos sterke, andesittiske bergartstyper, til tross for at de ikke inneholder svellende leirmineraler. Kaliberet på svelletrykkene som er målt er bekreftet ved gjentatt testing, og er målt på begge institusjonene. Det antas at svellepotensialet er tett knyttet til et høyt innhold av laumontitt (zeolitt). Det er målt innhold av svellende leirmineraler i andre bergartstyper, da spesielt

montmorillonitt. Bergartsmaterialet i disse prøvene er svakt og oppløst, derfor har det ikke vært mulig å gjennomføre UCS-tester på disse. Størrelsen på svelletrykkene til det svake materialet er lavere enn for den sterke, andesittiske bergartstypen.

Sammenligningen av den operative metodologien i ødometer testene på NTNU og KiT, avdekket viktige forskjeller mellom institusjonene. Forskjellene gjelder både apparaturen som brukes, og prosedyren i svelletestene. Avvikene inkluderer ISRM-versjonen metodene baserer seg på, interne modifikasjoner på apparatur og prosedyrer, og interne tradisjoner i tolkningen av spesifikke punkter i ISRM-standarden.

Basert på arbeidet som er gjort i undersøkelsene, er det foreslått en forbedret undersøkelsesmetodikk som avslutning på denne oppgaven.

## ACKNOWLEDGEMENTS

The master thesis has been carried out during the period of February 2016 to February 2017, at the Department of Geology and Mineral Resources Engineering, Norwegian University of Science and Technology (NTNU), Trondheim, Norway. The cooperating partner has been Statkraft, Oslo, Norway.

Associate professor Krishna K. Panthi, at the Department of Geology and Mineralogical Resources Engineering (NTNU), has been my supervisor in this work. I thank him for making the very interesting project task, and for his guidance during the period. I will also like to thank Associate professor Bjørn Nilsen (NTNU) for his advisements.

R & D Manager and Dam Safety Coordinator Siri Stokseth, at Statkraft, has been my co-supervisor. I am grateful for her patience and priceless support throughout the entire period, and for her company during the unforgettable fieldtrip to the Philippines. I will also thank MSc. Thomas Schoborn, (Statkraft), for his valuable input during the work, and for contributing to the project task.

Senior engineer, Gunnar Vistnes, has assisted me during the laboratory work at NTNU. His guidance and calmness has been essential for the performance of the laboratory work.

MSc. Maximilliano R. Vergara, at Karlsruhe Institute of Technology, Institute of Soil Mechanics and Rock Mechanics (KiT), Karlsruhe, Germany, has assisted me during the laboratory work at KiT. His patience during the tasks at laboratory, and when answering my questions by mail in the period thereafter, has been crucial. I am very grateful for him shearing his knowledge, and for making the stay in Karlsruhe pleasant and safe.

Special thanks to Marceliano Cruz and his staff at SN Aboitiz, Philippines, for the charity and guidance during the stay in the Philippines.

I will also like to thank Senior Engineer, Laurentius Tijhuis (NTNU), for performing the XRD analyses. A thank also to Torill Sørløkk (NTNU), for shearing her knowledge on the DTA analyses.

To all who have given advices and showed interest on my work during this year; thank you for sharing of your time to answer my questions. None mentioned, none forgotten.

To all my sweet friends; thank you for always standing next to me, no matter what. And to my coach and fellow athletes in Strindheim IL; thank you for pushing me through remorseless (but extremely therapeutic) running intervals every week, and keeping me healthy and strong.

Lastly, a grateful hug to my precious dog, for always sharing her love and company after stressful days.



## ABBREVIATIONS

<b>DTA</b>	Differential Thermal Analysis
<b>HEPP</b>	Hydroelectric Power Plant
<b>KiT</b>	Karlsruhe Institute of Technology
<b>NTNU</b>	Norwegian University of Science and Technology
<b>UCS</b>	Uniaxial Compressive Strength
<b>XRD</b>	X-Ray Diffraction



# Table of Contents

<b>ABSTRACT</b> .....	i
<b>SAMMENDRAG</b> .....	iii
<b>ACKNOWLEDGEMENTS</b> .....	v
<b>ABBREVIATIONS</b> .....	vii
<b>1 Introduction</b> .....	1
1.1 Background .....	1
1.2 The objectives of this study .....	2
1.3 Project case: The Alimit HEPP .....	3
1.4 Definition of swelling.....	4
1.5 Investigation procedure introduction: Swelling rocks in underground engineering ...	5
1.6 Laboratory methodology introduction .....	8
1.7 Available design tools for tunneling in swelling rocks .....	10
1.8 The structure of this thesis .....	11
<b>2 Theories and status quo on swelling rocks</b> .....	13
2.1 The rock material key properties affecting swelling behavior .....	13
2.2 Alteration and degradation of volcanic rocks .....	16
2.3 Swelling mechanism in volcanic rocks .....	21
2.4 The effects of moisture content and swelling on the strength properties of rocks....	27
2.5 Three case examples: The consequences of swelling and rock degradation on the stability of hydropower tunnels.....	29
2.6 The importance of standardized testing procedures .....	34
<b>3 Methods to assess the swelling potential of rocks</b> .....	36
3.1 Preliminary investigations.....	36
3.2 Traditional laboratory methods to assess the swelling rock properties.....	38

<b>4</b>	<b>Geology of the project area and field work</b> .....	46
4.1	The geological history of the Phillipines and project area .....	46
4.2	Geological description of important sites of the project area.....	52
4.2	Review of the fieldtrip to Alimit, Phillipines (19.-31.May 2016).....	57
<b>5</b>	<b>Oedometer swelling tests</b> .....	64
5.1	The background and standardization of the oedometer swelling tests .....	64
5.2	Different traditions of oedometric set-up and procedure in swelling tests .....	67
5.3	Overview of principles and variations of the oedometer swelling tests.....	69
<b>6</b>	<b>The investigation procedure and material of this study</b> .....	73
6.1	The planning process.....	73
6.2	The theoretical background of the selected methods .....	74
6.3	Tried and rejected methods .....	75
6.4	The investigation procedure .....	77
6.5	Material .....	78
6.6	The final test suite included the samples tested .....	81
<b>7</b>	<b>Laboratory test results</b> .....	86
7.1	Mineralogical analyses .....	86
7.2	Strength (UCS) tests.....	87
7.3	Swelling tests.....	89
<b>8</b>	<b>Analysis of the results</b> .....	93
8.1	Analysis of the mineralogy .....	93
8.2	Analysis of the UCS-test results.....	95
8.3	Analysis of the swelling results.....	101
8.4	Linkage between mineralogy, strength and swelling potential: Comparison of two chosen samples .....	107
<b>9</b>	<b>Comparison of the oedometer swelling tests</b> .....	110

9.1	Comparison of the differences in methodology .....	110
9.2	Comparison of the differences in results .....	113
<b>10</b>	<b>Main findings</b> .....	<b>118</b>
10.1	Overview of main findings in the laboratory work .....	118
10.2	Characterization and determination of the swelling potential of the rocks at project site.....	122
10.3	Evaluation of the investigation procedure of this study .....	125
<b>11</b>	<b>Uncertainties and error sources in the work of this study</b> .....	<b>129</b>
11.1	General uncertainties due to the material and investigation procedure .....	130
11.2	Specific error sources in the tests performed.....	136
<b>12</b>	<b>Conclusions and recommendations</b> .....	<b>141</b>
12.1	Conclusions on methodology and the rock material properties/swelling potential... ..	141
12.2	Conclusions on the potential swelling behavior of the rocks at Alimit Dam Site	143
12.3	Suggested improvement on the investigation procedure and test suite .....	144
	<b>REFERENCE LIST</b> .....	<b>147</b>

<b>Appendix 5.A</b>	<b>Set-up and procedures in oedometric swelling tests at NTNU</b>
<b>Appendix 5.B</b>	<b>Set-up and procedure in oedometric swelling tests at KiT</b>
<b>Appendix 6.A</b>	<b>Material data and pictures</b>
<b>Appendix 6.B</b>	<b>Procedure of powder preparation, mineralogical analyses, UCS-tests and free swelling test</b>
<b>Appendix 6.C</b>	<b>Frisvelling</b>
<b>Appendix 6.D</b>	<b>DTA procedure</b>
<b>Appendix 7.A</b>	<b>All results X-Ray Diffraction (XRD) analysis</b>
<b>Appendix 7.B</b>	<b>UCS-results and failure modes</b>
<b>Appendix 7.C</b>	<b>DTA graphs</b>

<b>Appendix 7.D</b>	<b>Powder data and graphs in oedometer tests</b>
<b>Appendix 7.E</b>	<b>Intact rock structure data and graphs in oedometer tests and swelling characterization.</b>
<b>Appendix 8.A</b>	<b>Failure modes and classification in the UCS-test</b>
<b>Appendix 9</b>	<b>Comparison of apparatus set-up, procedures and results (NTNU and KiT)</b>
<b>Appendix 10</b>	<b>Sample of special interest: Andesitic rock with a high laumontite content</b>
<b>Appendix 11.A</b>	<b>Uncertainties in laboratory work for in-situ considerations</b>

# 1 Introduction

## 1.1 Background

There are no clearly defined rules for the investigation procedures of swelling rocks. Difficulties are generally met for characterization and testing of swelling rocks and for prediction of the response to excavation (Barla 1999). In regard of hydropower projects and related water tunnels, these issues are reinforced by the periodically exposure to abounding moisture changes. Case histories have been reported where tunnels are shown to have experienced severe problems caused by swelling during and long after construction.

Statkraft and its subsidiaries SN Power and Aqua Imara, have experienced challenging rock behaviour during development of several projects in South America, East Asia and Africa. Many of these challenges were related to a variation of rock properties during construction and operation, compared to the estimated behaviour during planning. Such behaviour included swelling, disintegration, loss of strength and deformability properties, which is less familiar in the Norwegian environment. A highly relevant case example is the La Higuera Power Plant in Chile, which experienced a tunnel collapse in 2010 due to degradation of the rock mass, assumed caused by high contents of swelling minerals in the rocks.

Considered the current need of understanding the mechanisms causing the above mentioned challenges, this study aims to confront the causes of swelling behavior. Additionally, laboratory methodologies to determine the swelling potential will be assessed.

## 1.2 The objectives of this study

This study is an exploratory research, where the intention is to provide insight and qualitative information about swelling mechanisms in volcanic rocks, based on leading hypotheses. In addition, an evaluation of traditional methods of detecting potential challenges in an early stage of a hydropower project is carried out.

### **The main objectives of this study can be defined as follows:**

- To *investigate* the most important mechanisms inducing swelling behavior in volcanic rocks related to hydropower projects, in particular the swelling of rocks surrounding water tunnels which are periodically exposed to abundant moisture changes during the lifetime of the hydropower plant.
- To *assess and perform* traditional laboratory methods of determining rock material key properties which influence the swelling behavior of volcanic rocks, and review the appropriation of those to different rock types at project case.
- To *compare* the methodology of oedometer swelling tests in operation at two different institutes; i. e. NTNU and KiT.

The work is performed based on the hypothesis of swelling mechanisms in volcanic rocks to be well understood, whereby the swelling of clay minerals is assumed the main cause of tunnel failure in previous projects. One goal is to determine if the assumed explanations of swelling behaviour and degradation of the rocks are confirmed or disconfirmed by qualitative testing of some selected rock samples.

### **The hope is to address the following concerns:**

- What are the *main rock material characteristics* in the project area?
- Which *main mechanisms* control the swelling behavior of the rocks at project site?
- Which laboratory test methods are appropriate to detect the swelling potential and rock material properties of the rock types at project site?



- Do the findings *correspond to the hypothesis* of swelling clay minerals to be the main cause of potential swelling issues?
- Are there any *differences* in apparatus set-up and procedures in oedometer swelling tests between NTNU and KiT? If so, which differences exist, and how do they affect the results?
- Which issues remains *unsolved* after the investigation procedure of this study?
- Is the *investigation procedure* performed in a strategical manner due to the objectives?

Based on the findings and results, the hope is to better understand the controlling swelling mechanisms at the project site, and to contribute to an enhanced basis for further research on testing methodology for coming projects.

#### **Theoretical basement for the work performed:**

- Scientific papers, books and reports
- Field survey, including informative discussions with partners in SN Aboitiz
- Relevant information obtained from SN Aboitiz, including reports, maps and other background information of the project
- Relevant information obtained from Gunnar Vistnes (NTNU) and Maximilliano Vergara (KiT) related to the laboratory work
- Spoken discussions with professors at NTNU and KiT related to the subject

### **1.3 Project case: The Alimit HEPP**

The project area of this study is sited in Ifugao, North Central Luzon in the Philippines. The Alimit hydropower generation project, with an installed capacity of 120 MW is located immediately downstream of the Alimit dam, is in its feasibility stage. The rocks in the area are primarily volcanic rocks of basaltic and andesitic origin, included rocks undergone hydrothermal alteration or metamorphic transformation processes and

different stages of weathering. The project will be constructed entirely in volcanic terrain (SN Aboitiz/Stache 2015).



*Figure 1.1 The Alimit River (Ashganonline 2016)*

The challenges due to swelling of volcanic rocks recognized in similar projects makes the basement for this thesis, where the swelling potential of the rocks in which water tunnels and other constructions will be placed, are the main focus.

#### **1.4 Definition of swelling**

Swelling is associated with volume expansion and has been defined in slightly different ways in the literature. According to the definition given by ISRM (1983), the swelling mechanism is defined as follows:

*“The swelling mechanism is a combination of physico-chemical reaction involving water and stress relief. The physico-chemical reaction with water is usually the major contribution but it can only take place simultaneously with, or following, stress relief” (Barla 1999).*

When volume increase of the rock is hindered, swelling will express itself by an increase of pressure executed on the surroundings and/or support. In this study, the definition of

swelling comprises both volume increase and the development of swelling pressures when the volume increase is obstructed.

## **1.5 Investigation procedure introduction: Swelling rocks in underground engineering**

In general, swelling behavior of rocks depends on complex internal and external factors, such as material properties, hydraulics, fracturing, pore pressure conditions, water availability (including water vapor), stress distribution and other boundary conditions of the rock mass surrounding for example a tunnel (Hudson 1993). In addition will the geological history and degree of weathering and/or other degrading processes after formation influence how the rock reacts to swelling provocations.

### **SPATIAL AND TEMPORAL VARIATION**

The type of swelling minerals present and the rock material strength will influence the swelling process, both the rate at which swelling occurs and the resistance of the rock to disintegration and secondary permeability. In addition, the texture of the rock material, grain size, primary porosity and the amount and chemical composition of the water acting on the rock are of importance (Einstein 1996, Hudson 1993). However, these characteristics may vary within short distances of the rock mass.

At a given time, a rock mass underwent several stages of formation processes, alterations and lithological re-distributions. The spatial variability of rock properties is anisotropic and occurs at multiple scales, ranging from the size of grains to the geological scale of several hundreds of meters (Huber 2013). This variability influences the material behavior in mechanical and hydraulic sense, including the swelling behavior of a rock mass due to geotechnical structures. An example of the processes which may contribute to the rock mass variations are shown in Figure 1.2.

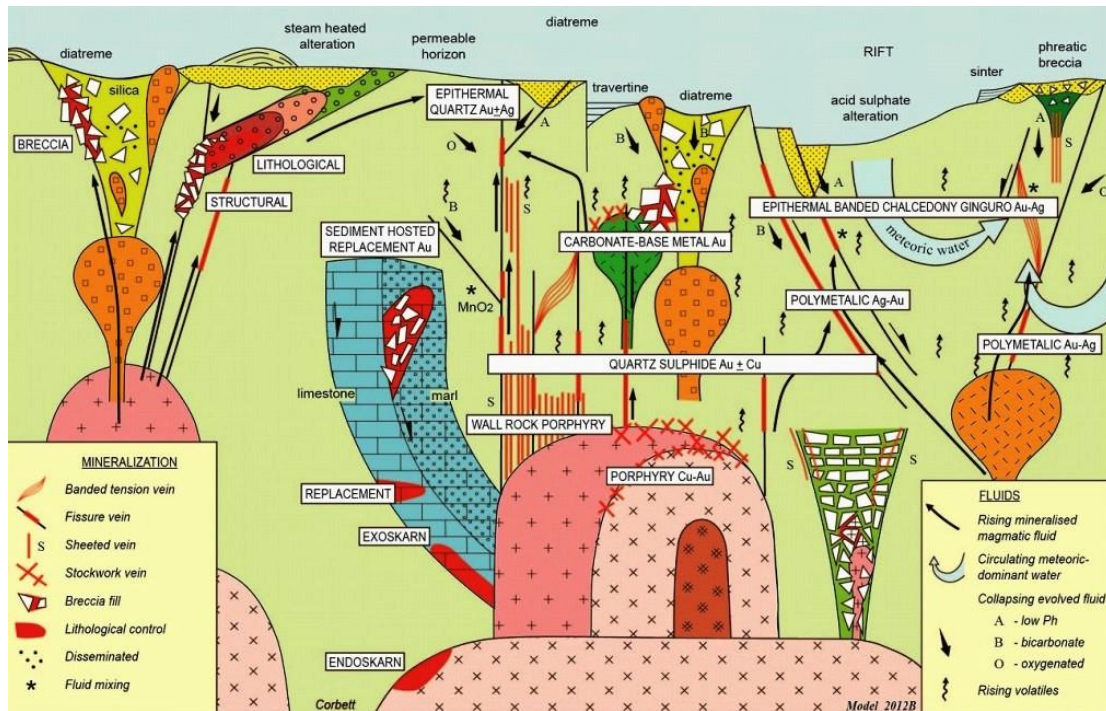

Figure 1.2 Complex geological processes in a rock mass (Corbett 2013)

The rate at which swelling occur is of absolute interest in underground constructions. However, predicting the swelling behavior of an actual geotechnical project is extremely difficult because the mechanisms involved are diverse, with an intricate interacting not decent understood. These aspects are important to consider in the investigation of the rocks at Alimit HEPP.

### TUNNELS IN SWELLING ROCKS – CHALLENGES

The knowledge of the swelling potential of rocks is necessary to make adequate choices on the structural design concept for the tunnel, and for dimensioning of the support system (Pimentel 2015). However, preliminary estimation of the overpressure to be exercised in the contour is difficult to carry out in the design phase of a project (Galera et al. 2014). The difficulties include the distribution of additional stresses in the tunnel support system over an extended period of time, which may lead to failure even when no short term problems have been detected. Swelling in tunnels usually expresses itself by invert heave and associated abutment movements (Figure 1.3), which may happen sudden or be long lasting (Einstein 1996).

As an example, short term heave rates up to 1 m during construction has been reported in the Hauenstein Base tunnel in Switzerland (Einstein 1996). Similarly, long lasting heave rates from 4 to 10 mm/per year is recorded in the Bözberg tunnel. In several other cases swelling zones or rocks containing swelling minerals have caused tunnel collapse which has resulted in considerable additional costs and delays for the project (Selmer-Olsen & Palmstrøm 1989). Further financial loss arises if the problems caused by swelling rocks result in closure and/or cessation of production, e.g. a hydroelectric plant.

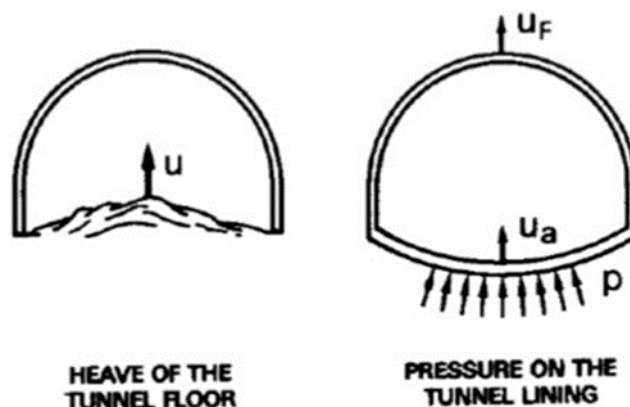

*Figure 1.3 Swelling heave/pressure in tunnels (Michalis 2015)*

Moisture changes is an important factor causing the floor heave of tunnel because of the water adsorption by the structure of the clay minerals and volume expansion of the rock material (Tang & Tang 2012). In-situ observations worldwide show that considerable pressures have been developed considering prevention of the swelling strains, which often is the case in a stiff tunnel lining. In the case of hydropower tunnels, the surrounding rock will be exposed for several disturbances which may change both its state of equilibrium and its mechanical properties, including cyclic wetting and drying processes during the life-time of the hydropower-project.

## ECONOMICAL ASPECTS

It is generally accepted that the cost and time are of main concern in any tunneling project, and the accuracy of the predicted geological conditions during the planning phase plays an important role (Panthi & Nilsen 2007). The problems that have arisen in swelling rocks are often caused by an underestimation of the effort needed in the preliminary studies of a project. In order to obtain a safe and economical structure of a tunnel there must be taken decisions both prior to, during and after construction. The sources of information may include geological explorations, field measurements, laboratory tests, statistical computations, and obtained experience (Hudson 1993).

In the design phase of an underground project it is hard to carry out preliminary estimation of to which extent the swelling potential of the rock mass will cause problems within the life-time of the construction (Zurawski 2014). The nature of the problems, which arise during field investigation and construction, will be leading for to which extent the different investigation methods should be used, and decisions should be taken based on a systematic use of all sources available in a balanced manner in order to obtain the needed knowledge (Fairhurst 2014).

Characterization of swelling rock can be based on mineralogical analyses, different index tests and swelling tests (ISRM 1994). Mineralogical tests are useful to identify the occurrence of minerals that have a swelling potential, while swelling tests may be used to determine swelling parameters or to derive constitutive relations for analytical/numerical models. To capture the economical aspect in this process, the site-specific swelling rock potential must be investigated with effective diagnostic methods, which provide reliable data for the considerations and decisions to be made.

### **1.6 Laboratory methodology introduction**

One of the major task for a geotechnical engineer is to select proper methods for determining the challenges to be faced in the actual project. The output of the chosen tests should lead to adequate information on the conditions in-situ. In addition, the costs and effort invested in the investigation should correspond with the risks in the case

project, and lead to appropriate advices for further work. The goal of the laboratory tests on rock samples from a project case is to determine their characteristics under simple experimental set-ups, and these simplifications must be kept in mind to avoid unsound modeling of the rock mass behavior (McPherson 2013).

Despite the growing effort in originating systematized procedures to gain sufficient knowledge about swelling rocks, a blameless investigation methodology is still not accomplished. Since early in the 1970-ties many models have been proposed to describe the swelling behavior of rocks in order to provide a rational basis for investigation and method procedures (Serafeimidis 2014). Several methods for determining the swelling behaviour of rocks exist, and the methodologies differ between institutes.

The main categories of laboratory testing methodologies include:

- mineralogical analyses
- strength tests
- free swelling index tests, and
- different configurations of oedometric swelling tests

The oedometric swelling tests may be performed on compacted bulk powder samples or on intact rock structure specimen. In Norway there was no tradition of the latter until the beginning of this century, since the main swelling problems in Norwegian environment occur in weakness zones containing swelling gauge material and testing the gauge powder is considered more relevant. The equipment and procedures at NTNU is thus not sharpened yet to assess swelling problems of intact rock. At the university of Karlsruhe, there exist more research on intact rock swelling and the methodology is modified to better detect the swelling potential in intact rock structures.

Besides the assessment of the rock properties at project site, this thesis will compare the oedometer swelling tests used by each labs and find out if there exist any remarkable differences.

Based on the objectives, the following work is performed:

- Field survey of the project case area, including sampling of rock specimens
- Laboratory tests to assess the assumed most important rock properties which affect the swelling behaviour of volcanic rocks
- Testing of strength, free swelling index measurements and mineralogical analyses of the collected rock samples at NTNU
- Oedometer swelling tests according to the current tradition of operation at NTNU and KiT
- Analyses of the laboratory test results, including a comparison of methodology in the oedometer tests at the two institutes

## **1.7 Available design tools for tunneling in swelling rocks**

Traditional analyses based on single rock property values produce valuable indications on coming challenges to be faced, but the probability of failure of a construction requires more comprehensive methods not covered in this thesis. Design solutions can be used to counter the undesired effects of the swelling rock in tunnels, especially floor heave, which is the major challenge in most cases. Computational methods and numeric modeling as a design aid in tunneling are discussed elsewhere, such as by Tang and Tang (2012), Barla (2008) and Hudson (2014). The aspects of design and modelling support are not the scope of this thesis.



## 1.8 The structure of this thesis

This thesis falls naturally into four main parts:

- The theoretical basement for the performed investigations (Chapter 2, 3 and 5)
- Description of the work performed, including the laboratory tests (Chapter 4 and 6)
- Presentation and analyses of the results, including a comparison of the differences between the two institutes (Chapter 7, 8 and 9)
- The main findings, uncertainties and conclusions (Chapter 10, 11 and 12)

In **Chapter 2**, the theoretical basement on swelling mechanisms is presented. In **Chapter 3**, the theoretical basement on investigation procedure to assess the swelling potential of rocks is presented, including the planning phase, field work and laboratory methods.

**Chapter 4** presents the geological history of the Philippines and project case area, including a summary of the field survey at project case area.

A focused review on oedometer swelling tests is assigned in **Chapter 5**, including the theoretical basement and description of different approaches to test configurations. Additionally, the background of the operative methodology and procedures at NTNU and KiT are described, as well as the standardizations and traditions at each of the institutes.

**Chapter 6** review the investigation procedure of this study, and the reasons behind the chosen methods are explained. Finally, an overview of the final test-suite and the tested material is presented. In **Chapter 7**, the test results are presented, while the analyses are given in **Chapter 8**.

In **Chapter 9**, a comparison of both methods and results in the oedometer swelling tests performed at NTNU and KiT is presented. This chapter is linked to the theoretical basement in Chapter 5.

The main findings in this study is presented in **Chapter 10**, including an evaluation of the investigation procedure. **Chapter 11** underlines the uncertainties in this study, including error sources in the tests performed.

**Chapter 12** summarize the main findings linked to the objectives of the study. A suggestion on an investigation procedure for coming projects is given.

Additionally, relevant information is given in the appendices.

## 2 Theories and status quo on swelling rocks

### 2.1 The rock material key properties affecting swelling behavior

The term “rock material” refers to the intact rock within the framework of discontinuities, namely the smallest element of the rock block not cut by any fracture (Goel & Singh 2011). There will always exist some micro-fractures in the rock material, and the extent will affect the mechanical strength properties of the rock, but also the swelling capacity due to increased permeability. To fully understand the relative importance of different factors affecting the swelling behavior, is impossible without exceeding the outline in a limited research. Anyhow, an examination of the key-properties of the rock in case will accomplish the required information to make appropriate decisions in the coming phases of a project.

To determine the swelling potential of a rock, knowledge of the mineralogy is critical. To determine the swelling behavior and response to exposure of water, additional knowledge of the strength properties is required. The awareness of the interaction between rock composition, the mechanical strength, and the swelling of the rock at a project site when exposed to water, should be reflected in the investigation procedure.

#### MINERALOGY

The expansive character of intact rock is in many cases closely linked to the mineralogy, especially the content of clay minerals. However, also other groups of minerals have proved to hold a swelling potential. Galera et al. (2014) list the main minerals and aggregates which are known to produce swelling in volcanic sedimentary formations, as follows:

- Esmectite (Montmorillonite):  $(\text{Na,Ca})_{0,3}(\text{Al,Mg})_2\text{Si}_4\text{O}_{10}(\text{OH})_2$
- Esmectite (Nontronite):  $\text{Na}_{0,3}(\text{Fe}^{3+})_2(\text{Si,Al})_4\text{O}_{10}(\text{OH})_2 \cdot n\text{H}_2\text{O}$
- Illite:  $(\text{K,H}_3\text{O})(\text{Al, Mg, Fe})_2(\text{Si, Al})_4\text{O}_{10}[(\text{OH})_2,(\text{H}_2\text{O})]$
- Zeolite (Laumontite):  $\text{Ca Al}_2\text{Si}_4\text{O}_{12} \cdot 4\text{H}_2\text{O}$

- Chlorite (Clinochlore):  $(\text{Mg,Fe}^{2+})_5\text{Al}((\text{OH})_8/\text{AlSi}_3\text{O}_{10})$

A combination of different types of swelling may occur simultaneous or follow each other, and often different types of swelling minerals are present in the same rock.

## STRENGTH

In engineering terms, rock strength is often defined as the inherent strength of an isotropic rock under specific conditions, notably wet and dry (Hawkins 1998). The strength or weakness of a specific rock material can be related to mineralogy, but is equally likely to be related to material properties as density, porosity, grain/clast size, fabric, texture, small-scale structures and anisotropy (Bieniawski 1989). In underground engineering projects, the most controlling factors in terms of stability are not directly linked to the rock type itself, but rather the discontinuities in the rock mass present on a micro- or macroscale together with the water content of the rock. The discontinuities may be planes of weakness, bedding planes, foliation and cracks.

In laboratory, the strength of the *rock material* is tested. When considering the strength of the *rock mass* in the interest of underground engineering projects, the rock strength and existing discontinuities at larger scales should always be evaluated as a whole (Farmer 2012). Weak rock material will disintegrate more easily and/or crack when exposed to stress, with consecutive increased permeability and thus increased ability of water to react swelling minerals. If the rock mass is already intersected by cracks, water is more free to move and the potential for further fracturing is increased. The linkage between rock expansion and the rock material strength is therefore worth noticing.

By compression tests, the brittleness of the rock may be evaluated (Bieniawski 1989). Figure 2.1 illustrate the brittle fracture mechanism for hard rocks in uniaxial compression.

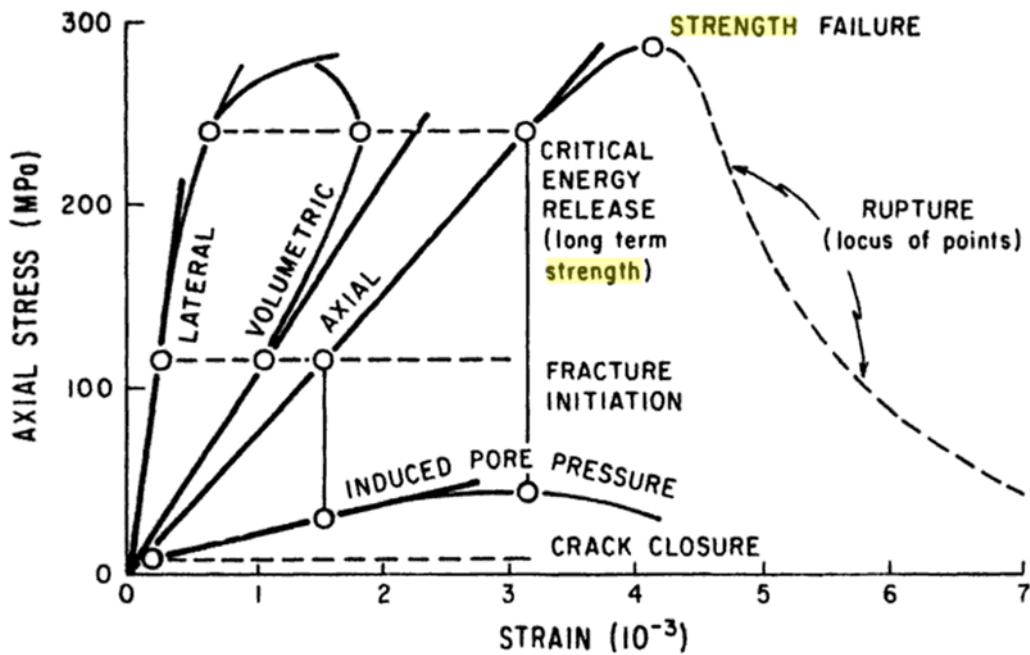
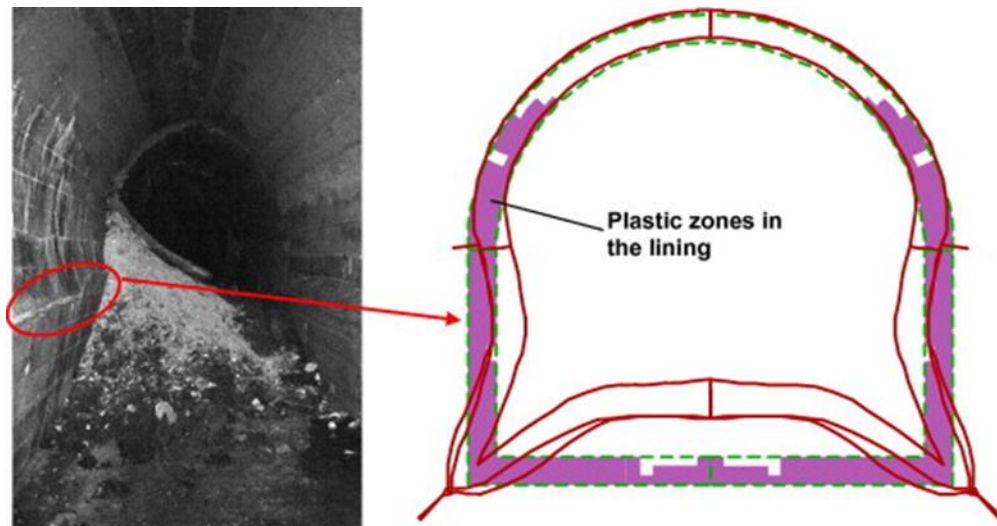

Figure 2.1 Representation of brittle fracture mechanism for hard rock in uniaxial compression (Bieniawski 1989)

#### MAXIMUM SWELLING PRESSURE POTENTIAL

Swelling of rock express itself either by a volume expansion or by inducing pressure on the surroundings (Di Maio 2001). Thus, the maximum swelling pressure potential is a very important parameter for the design of structures interacting with swelling rocks, and should be evaluated in order to prevent damage to tunnels and support of excavations. When volume expansion is prohibited by surrounding rock and/or support, the stress will increase until a maximum value is reached. This maximum swelling pressure induced by the rock on its surroundings imitate the “worst case scenario” of stress conditions in a tunnel if a volume increase is completely prohibited (Vergara 2016). Figure 2.2 illustrates how swelling in tunnels may be expressed when the support is not dimensioned for the induced pressure.



*Figure 2.2 Swelling in tunnels (Barla 2008)*

Some rocks have the potential of increased swelling pressures when volume expansion is not fully restricted. Small increments in deformation may in some cases lead to a remarkable change of the swelling potential (Vergara 2016). In most cases an opportunity of volume expansion will decrease the maximum swelling pressure induced by the rock on its surroundings. An example is when the support in a tunnel allows an expansion of the rock without totally restrict deformation, as suggested in Figure 2.2. However, some rock types behave in the opposite way depending on the composition, structure and strength of the rock material, and may cause unexpected challenges if not examined prior to construction.

## **2.2 Alteration and degradation of volcanic rocks**

From an engineering point of view, some of the most serious problems in underground rock excavation are directly related to alteration of previously competent rocks so as to reduce their sturdiness, durability and strength, with consequences as disintegration and swelling (Wahlstrøm 2012). Knowledge of the interaction between rock and humidity, and the vulnerability to alteration, is thus crucial to prevent construction failure or other unwanted incidents.

Different rocks have different capacity of water adsorption due to factors such as initial stress-state, porosity, permeability, strength, mineralogy, and initial grade of saturation (Terzaghi et al. 1996). Rocks and minerals are subjected to a variety of physical and chemical changes during their lifetimes, and the properties of a rock in a certain case is a consequence of combinations of physio-chemical forces acting together over time. Some minerals are stable through a wide range of environments, while others are more vulnerable to changes in moisture content, stress and temperature. Figure 2.3 illustrates “the rock cycle” and different states of a rock during its lifetime.

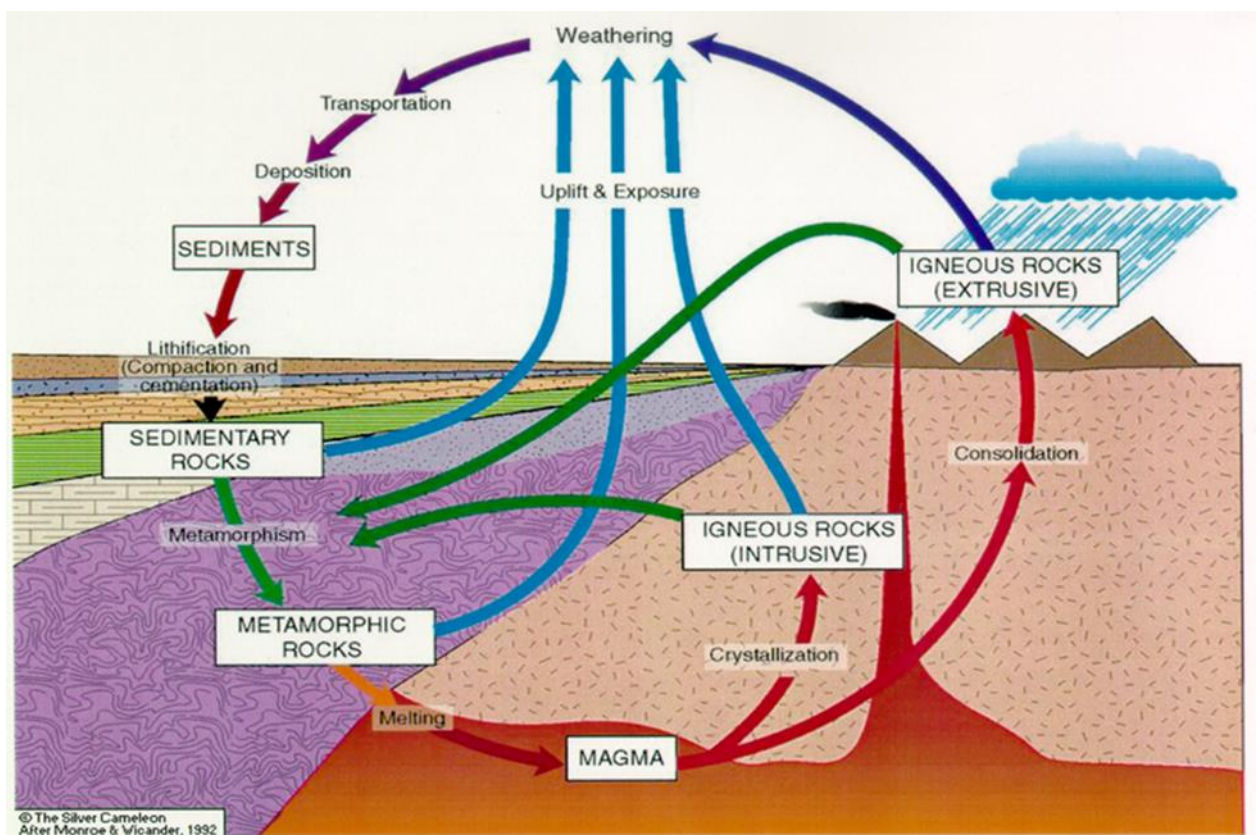

Figure 2.3 The rock cycle showing some phases where rock alteration processes may occur (Manitoba Rocks 2017)

An increase in humidity may cause a remarkable degradation of rock mechanical properties, especially if the rock contains swelling minerals. It is documented that the factors which are responsible for rapid disintegration of basalts and dolerites include hydration and de-hydration of smectitic clay minerals (Bell 2004) and certain zeolites. These mechanisms are assumed to apply also on volcanic rocks of andestitic composition.

## WEATHERING

In general, rocks are stable under their formation conditions, in equilibrium with the temperature, pressure, water and air-conditions at the time of formation and lithification (Wahlstrøm 2012). When the conditions changes, as when a tunnel is constructed, the rock are prone to weathering to adapt the new conditions. The minerals most susceptible to weathering contain abundant magnesium, calcium and iron, and the residual is often clay minerals. Weathering is frequently recognized on surface rocks (Figure 2.4).

The most important weathering reaction is hydrolysis, where the reaction between water and especially silicates cause a chemically breakdown of the crystal structure with clay minerals as byproduct (GeologyIn 2015). However, the processes and products of weathering is dependent on which combination of pre-existing minerals, composition of water and stress changes that interplays in the rock of project case.

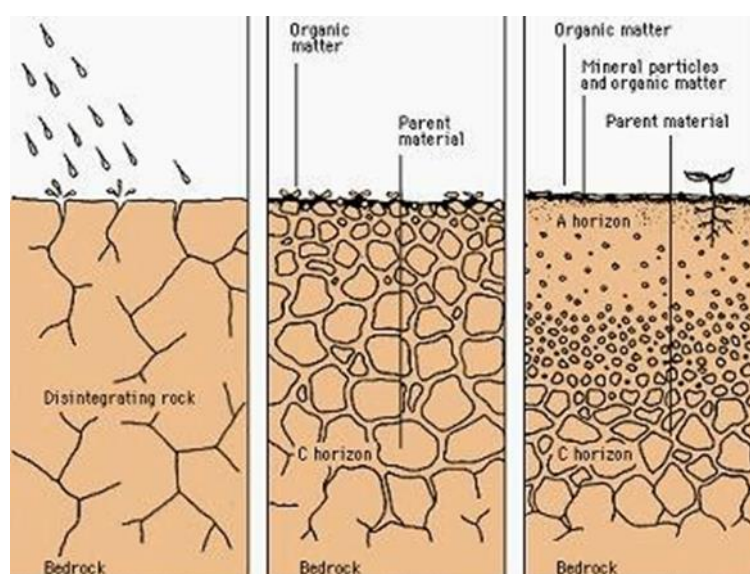

*Figure 2.4 Weathering of surface rocks (GeologyIn 2015)*

Alteration processes and weathering are in many cases closely related. Weathering is most known as a process causing changes in rocks near the earth`s surface because of exposure to chemically active components, principally water, carbon dioxide and oxygen (Wahlstrøm 2012). Smectite, which is one main mineral of attention in swelling rock engineering, commonly result from the weathering of basaltic rocks (Marosvölgy 2010). However, the depth of weathering is largely controlled by topography and the



existence of channels of flow for surface water and ground water (Wahlstrøm 2012). Zones of weathered igneous rocks from the geologic past may be stripped away by erosion, hidden by unconformities and preserved under overlying younger rocks of different origin. Thus, sections of weathered rocks may also occur at depths beyond the expected limits of surface rock weathering, and is difficult to differentiate from hydrothermally altered rocks.

## HYDROTHERMAL ALTERATION

Volcanic/igneous rocks are commonly hydrothermally altered, a process controlled by major or minor channel-ways of circulation localized by faults or joints, as shown in Figure 2.5, or by movement of solutions along grain boundaries of minerals in aggregates (Wahlstrøm 2012). These processes happen within a temperature range of about 100-500 °C and at varying depths. The alterations range from weak, where only some of the minerals or matrix in the host rock is altered, to high, where virtually all primary phases in the rock are altered to new hydrothermal minerals (Shanks III 2012).

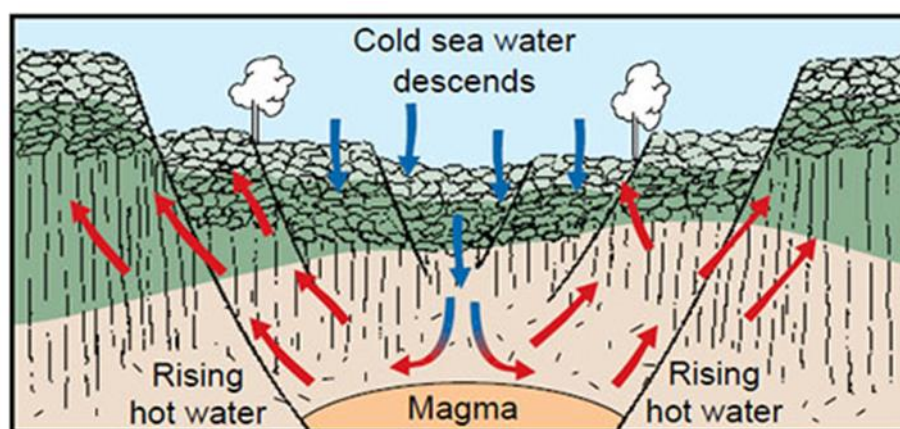

*Figure 2.5 Illustration of rising hot fluids causing hydrothermal alteration  
(Strekeisen 2017)*

Argillization is one type of hydrothermal alteration, a process whereby rocks are converted to clay mineral aggregates (Wahlstrøm 2012). Chlorite and montmorillonite may replace silicate minerals and reduce a previously competent rock to an incoherent and swelling aggregate. Igneous rocks with aluminous ferromagnesian minerals such as pyroxene, hornblende and biotite may be converted by chloritization to fine-grained

chlorite, a process which commonly is accompanied by argillic alteration. Additionally, laumontite and albite are common replacements of feldspar in volcanic rocks where hydrothermal alteration mechanisms find place (Zussman et al. 2004).

## DEURETIC ALTERATION

Deuretic alteration of primary minerals by hot gases and fluids from a magmatic source migrating through the rock, gives rise to the formation of secondary clay minerals (Bell 2004). The primary rock minerals that tend to undergo the most deuretic alteration is olivine, plagioclase, pyroxene and biotite when present in basalt. This type of alteration of igneous rocks may also, especially if they are deficient in silica, form zeolithes (Wahlstrøm 2012). Microfracturing induce this process, creating channels in the rock mass whereby water circulate by driving forces as temperature and changes in stress. Altered pyroclastic rocks tend to disintegrate and swell in contact with water or water, vapor and presents a very difficult challenge in tunneling operations (Wahlstrøm 2012). Figure 2.6 exemplify a mineral alteration-temperature diagram of rocks rich in silicates.

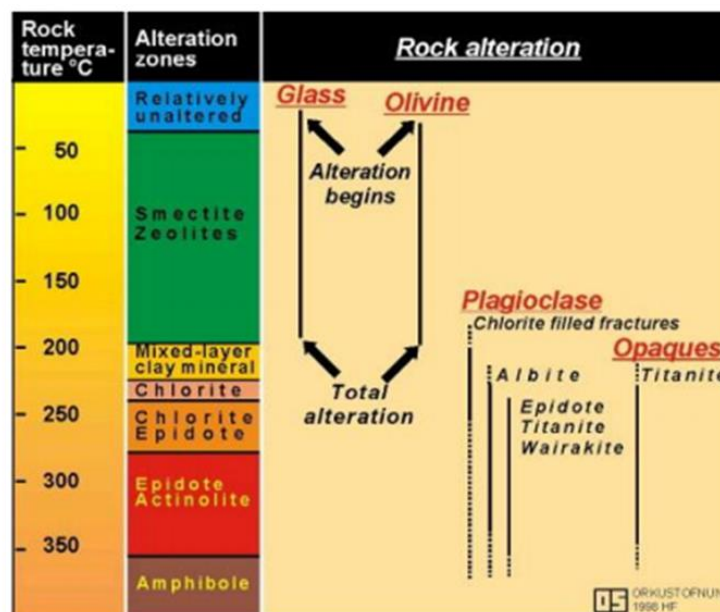

Figure 2.6 Mineral alteration-temperature diagram (Marosvölgyi 2009)

## 2.3 Swelling mechanism in volcanic rocks

Swelling of rocks are often diagnosed by the content of swelling clay minerals or anhydrite. However, intensity of the expansion and the related swell pressure cannot be attributed only to the swelling of clay minerals (Ruedrich et al. 2010). Volcanic rocks show a wide range of grain sizes, porosities and rock fabrics. The fact that swelling may occur in absence of clay minerals and/or anhydrite should not be suppressed when considering the swelling potential of a rock in engineering projects.

The different mechanisms causing swelling behavior interact and results in a complex picture, which makes it difficult to predict the actual volume increase or stress induced. It is possible to calculate theoretical numbers on the potential volume and/or stress increase caused by a specific mechanism, but in reality where several mechanisms interact, no general rule apply and rigorously controlled experiments to determine the increase is necessary (Galera et al. 2014). Thus, the importance of an intelligent investigation procedure should never be underestimated.

### SWELLING OF CLAY MINERAL

The leading explanation in swelling rock sciences is the hydration of swelling clays. Clay minerals are composed of only two types of structural units, and different types of clay minerals can articulate and result mixed-layer clays (Marosvölgy 2009). Smectite is a group of clay minerals where montmorillonites, vermiculites and mixed-layer swelling minerals are most common, formed from the alteration either of if in-situ rock forming minerals or solution deposits (Selmer-Olsen & Palmstrøm 1989). They differ from other silica sheet minerals, like mica and chlorite, in their ability to adsorb and release water in accordance with the external pressure to which they are subjected. For montmorillonite, the volume increase may be up to 100%, depending on the nature of the cations involved and in situ boundary conditions (Schädlich 2014).

Two major types of swelling take place in rocks containing clay; osmotic swelling and intracrystalline swelling. The swelling mechanisms in anhydrite are not well understood and assumed different than what is experienced with clay-bearing rock and soil, and will not be further reviewed in this thesis.

**Osmotic swelling** occurs in clays and argillaceous rocks, and is related to the double layer effect, i.e. the large difference in concentration between ions which are electrostatically held close to the clay particle surfaces and the ions in the pore water further away (Einstein 1996). The positively charged cations surrounded by water molecules align at the surface of the clay particles, while the negatively charged alumino-silicate layers are arranged at the center of positively charged cation-clouds causing an electric double layer (Schädlich 2014). The hydration of the cations results in an increase of the layer distance, in other words; swelling occur (Figure 2.7 b)).

Einstein (1996) states that the theoretical maximum swell pressure for osmotic swelling is approximately 2 MPa. The main controlling factors are the interaction of repulsive forces related to the double layer effect and the externally applied stress, but salinity, pH-level, cations in the pore water and the stress field also affect the osmotic processes (Einstein 1996). Osmotic swelling is initiated by an unloading of the rock, as in an excavation process, which produces negative pore pressures and hence is the driving force for capillary water uptake (Wittke 2014). This type of swelling is reversible by increasing external stresses or temperature (Galera et al. 2014).

**Intracrystalline swelling** occurs in smectite and mixed layer clays, anhydrite, pyrite and marcasite (Einstein 1996). The clay minerals consist of negatively charged layers of aluminosilicate-anions which are bounded by intermediate layers of cations and, in the presence of water, the cations hydrate and water molecules are integrated into the clay mineral crystal, increasing the distance between the aluminosilicate layers (Schädlich 2014). Intracrystalline swelling is illustrated in Figure 2.7.a).

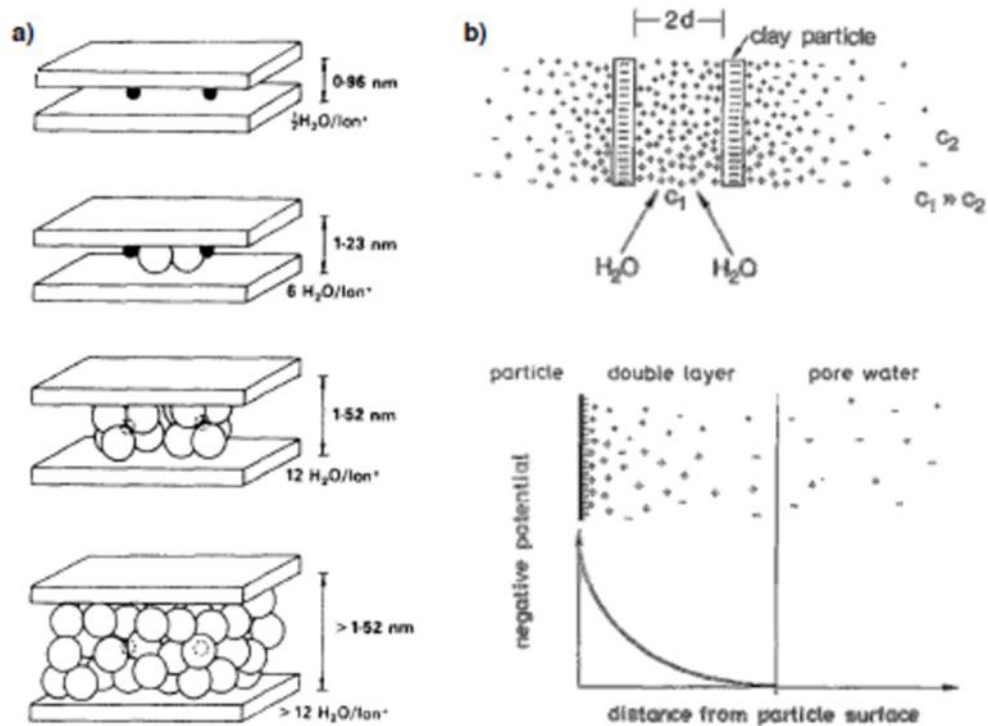

Figure 2.7 a) intracrystalline swelling b) osmotic swelling (Schädlich 2014)

According to Einstein (1996), the theoretically maximum swell pressure between two layers in intracrystalline clay swelling is about 100 MPa. Important controlling factors are the overall stress state, the bulk material properties (e.g. porosity and permeability) and to some extent, temperature (Einstein 1996). It is assumed that intracrystalline swelling does not contribute to swelling deformations after tunnel excavation, since the process already has taken place in most natural clays (Schädlich et al. 2013).

## SWELLING OF CHLORITES

Chlorite is a group of sheet silicate minerals found in igneous, metamorphic and sedimentary rocks which are altered during weathering, deep burial, plate collisions, hydrothermal activity or contact metamorphism (Geology.com 2016). Members of the chlorite-group are severe, and are difficult to distinguish from each other. The behavior of these minerals depend on which form they occur, and if they are interstratified with other mineral layers.

Many chlorite minerals in low-grade metamorphic or hydrothermally altered mafic rocks exhibit abnormal optical properties, and expand slightly when treated with ethylene glycol (Shau et al. 1990). The type of chlorite minerals with these properties may fill or rim vesicles and interstitial void spaces or occur as replacements of forming minerals, and can be detected by methods as XRD, TEM and optical microscopy (Shau et al. 1990). The structural differences between swelling chlorite and “normal” chlorite are relatively easy detectable by optical techniques. The swelling chlorite minerals of most interest are (Shau et al. 1990):

- Corrensite, an ordered 1:1 mixed layer chlorite/smectite
- “Expandable chlorite”, a mixed layer chlorite/corrensite, or chlorite/corrensite/smectite
- Mixed layer chlorite/vermiculite

Smectite and chlorite are products of the diagenesis and low-temperature metamorphism of intermediate to mafic volcanic rocks and volcanogenic sediments, but the range in proportion of expandable layers varies for different occurrences of these mixed-layered phyllosilicates (Bettison-Varga & Mackinnon 1997). Corrensite has a cation exchange capacity approximately half that of smectite, indicating that it is a reactive mineral (Wilson et al. 2014). The different versions of swelling chlorites may co-exist and follow each other in alteration processes, so to differentiate between them, complementary methods should be applied.

## MOISTURE SWELLING

To detect a rocks swelling potential, complex processes of mineralogical aspects and rock fabrics have to be thorough considered in addition to the leading hypotheses of intercrystalline or osmotic swelling (Wedekind et al. 2013). A study by Ruedrich et al. (2011), where sandstones absent of clay are investigated, suggest that micropores with a decreasing average radius lead to an increase in moisture expansion, and that the porosity plays an important role for the swelling (and shrinking) potential of the rock. One of the main suggestions is a correlation between the pore size, the degree of water saturation, the intensity of moisture swelling, and the softening of sandstones which show swelling behavior. This substantiates an alternative cause of swelling also in

volcanic rocks. Figure 2.8 show different types of porosity which may lead to moisture swelling.

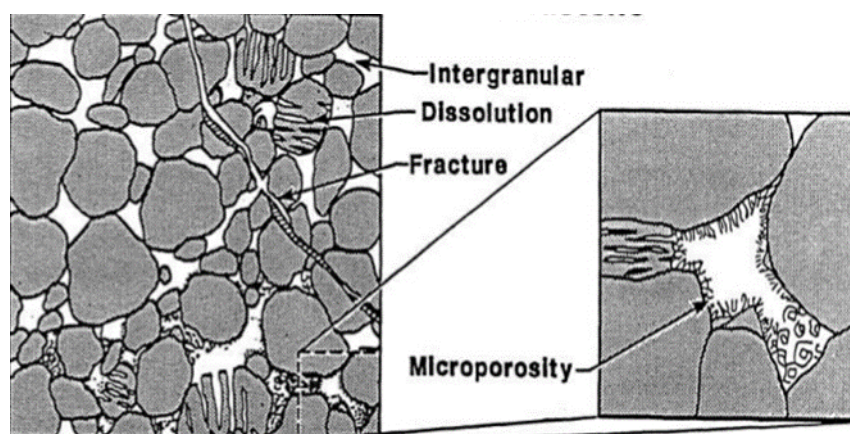

Figure 2.8 Types of porosity which may lead to moisture swelling (Geotravelogist 2017)

A study of Wedekind et al. (2013) confirms this hypothesis; a correlation between the average pore radius and the swelling and moisture expansion values in volcanic tuff was found by testing 14 volcanic tuff building stones almost free from clay minerals. The interaction between existing clay minerals and porosity also was discussed. They underline the undoubtedly fact that clay minerals significantly contribute to swelling and moisture expansion, but also address their findings which clearly shows that not all of the moisture-related expansion can be attributed to the presence and amount of the minerals of swelling clays in the rock.

## SWELLING OF ZEOLITES

One type of alteration which may occur in basalt and andesitic rocks as a result of percolation of fluids, is zeolites replacing primary constituents, especially plagioclase (Sumner et al. 2009). Zeolites are hydrated aluminosilicates with a high swell and shrink potential, and are very often associated with clay minerals. Unlike most other tectosilicates, zeolites have large vacant spaces or cages in their structure which allow incorporation of large cations and molecules (Marosvölgy 2010). Where gas cavities are prominent, the alteration may be pronounced (Sumner et al. 2009).

Many zeolites, similar as for clay minerals, have an affinity of water which is incorporated into their structures (Kranz et al. 1989). These minerals are characterized

by their ability to expand and contract due to hydration or dehydration without damaging their crystal structures (Marosvölgy 2010). Rock composed largely of zeolites may swell or shrink significantly as the rock becomes saturated or dries out, and if such rock is constrained, large stresses may develop (Kranz et al. 1989).

The presence in the basalt of active zeolites, like laumontite, may account for the degradation and lack of durability of the rock mass. A study of basaltic rocks surrounding the transfer tunnel of Lesotho Highlands Water Project, showed that if the laumontite-leonhardite content was higher than 6%, the rock was prone to disintegration (Boniface 1997). The changes in porosity and permeability due to alteration and swelling processes of the rock mass are likely among the causes.



*Figure 2.9 A laumontite crystal (Association 2008)*

The mechanical effects on rocks containing high amounts of zeolites has not been adequately addressed, but a study by Kranz et al. (1989) on zeolitic tuff from the Yucca Mountain showed that samples which were exposed to water under different confining conditions, swelled rapidly to high stresses (up to 2.2 MPa) when axially constrained, followed by a much slower expansion with time (the time elapsed until maximum stress was depending on the confining conditions). This implies a swelling mechanism of importance in the assessments of swelling potential of volcanic rocks. A zeolite mineral is shown in Figure 2.9.



## **2.4 The effects of moisture content and swelling on the strength properties of rocks**

In most underground projects, water play an important role in the challenges which occur during construction in different ways. One of the main concerns is the effect of water on the strength properties of the rock in which construction is performed, and it is crucial to determine to which extent a potential loss of strength will produce safety problems and need for support during construction. The actual mechanisms and effect on different rock types appears to lack well-proven explanations that are universally acceptable to account for the influence of water on rock strengths, probably due to the great variety of rock types (Wong et al. 2016). If the rock additionally has a swelling potential, a reinforcement of the challenges during construction may appear.

### **STRENGTH PROPERTIES AND MOISTURE CONTENT**

It is accepted that the strength of many rock types varies significantly with the moisture content (Hawkins 1998); already in 1960 researchers took note of the impact water have on the effective stresses and reduction in rock strength, and the coming years they were followed by others (Tang & Tang 2012). A large number of experimental investigations on sandstone and mudstone show that the uniaxial compressive strength and elastic modulus behave a linear degradation with water content (Lu et al. 2016). Small increments in moisture content may cause a remarkable strength reduction, depending on several interacting factors and properties of the rock tested. Figure 2.10 shows the effect of moisture content on the compressive strength of rocks.

Goodman & Ohnishi (1973) suggest the strength reduction to be caused by an increase of pore pressures in the rock, but other mechanisms as alteration of the rock mineralogy and changes in structure due to weathering are also possible explanations reviewed by researchers. For engineering purposes, Hawkins (1986) argued that testing of rock cores always should be appropriate to the ground conditions and the specific project (Hawkins 1998). Unrealistically high values of rock strength may be obtained from dry samples, thus testing should always comprehend both dry and wet samples.

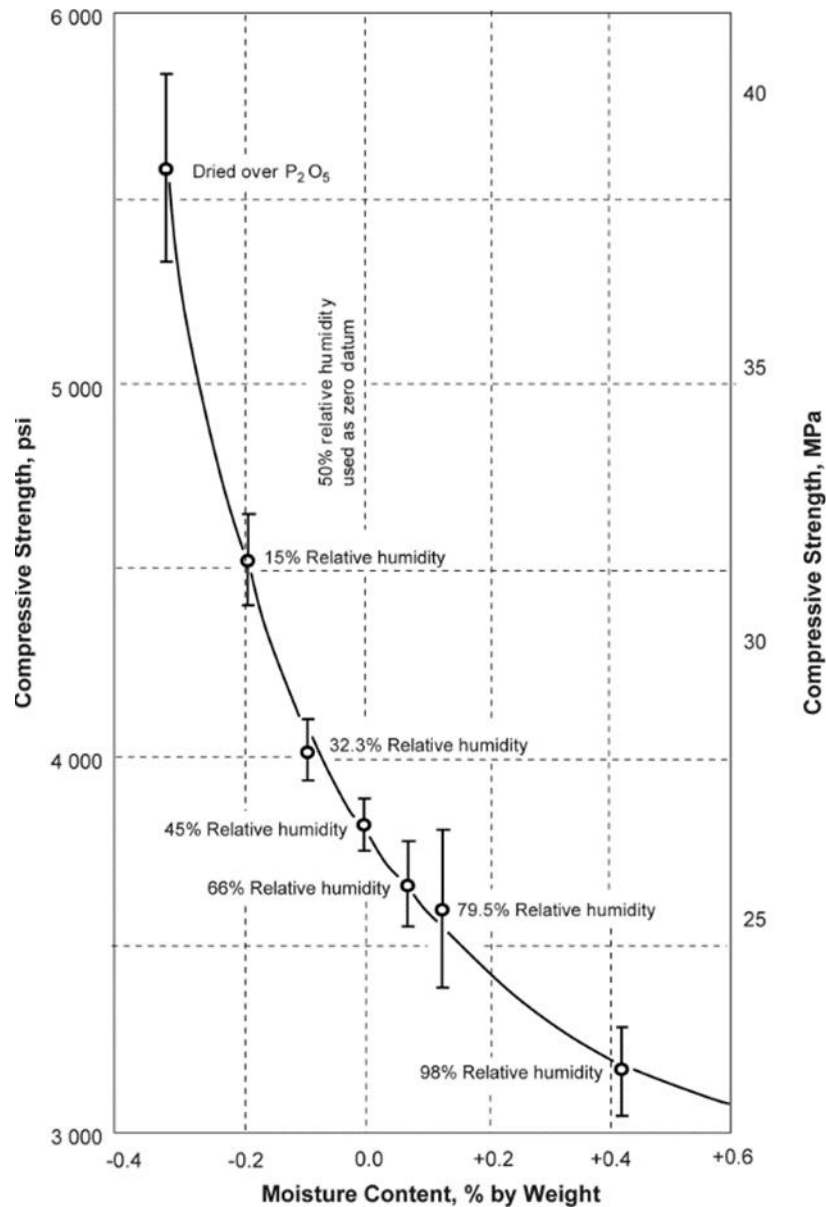

Figure 2.10 Influence of moisture content on the compressive strength of rocks  
(Colback & Wiid 1900)

## STRENGTH PROPERTIES AND SWELLING

Saturation under zero stress condition can cause hydraulic damage resulting from hydration and swelling, and may be evidenced by the appearance of cracks with optical techniques (Mohajerani et al. 2011). The expansion of rocks containing swelling minerals may lead to disintegration and/or fractures in the rock mass, which induces further swelling due to increased secondary permeability. Rock swelling which occurs simultaneously with reduction of the strength properties, may increase the deformations

and downgrade the stability of excavations, also for small increments in the water content (Vergara & Triantafyllidis 2016).

The relationship between strength and swelling capacity have been studied by several authors, including Vergara and Triantafyllidis (2015) where a link between strength loss and swelling potential due to changes in the rock structure as a result of cyclic moistening was found. Morales et al. (2007) found a similar interrelation between the compressive strength and the magnitude of hygric expansion in sandstones (Siegesmund & Snethlage 2014). This may be explained by the destruction of the structure of the rock after swelling and/or the alteration of the rock due to chemical reactions when exposed to water.

## **2.5 Three case examples: The consequences of swelling and rock degradation on the stability of hydropower tunnels**

As mentioned, the swelling of volcanic rocks may cause problems due to decreased strength and durability of the rocks, and may result in tunnel destructions and/or collapses. This is especially critical in hydropower tunnels which are filled with water and in periods emptied, since cycles of wetting and drying expose the rock for substantial moisture changes during the life time of the hydropower plant. Volcanic rocks are prone to weathering and alterations of minerals when exposed to changes in stress and moisture content, and these processes also happen deep within the rock mass not detectable on surface.

In the following, three cases where these topics have been studied are presented.

### **PROJECT CASE: THE LESOTHO HIGHLANDS WATER PROJECT**

A case study by Sumner et al. (2009) reviews the weathering of rocks in the Lesotho Highlands Water Project (LHWP) in South Africa, where parts of the water tunnels run through basaltic rocks. The initial assumption was that the tunnels through basalt would not need to be lined as required in the sedimentary sequences; first during a visual

inspection of the transfer tunnel it was found that large sections of the tunnel length showed severe weathering (Sumner et al. 2009). The explanation for the unexpected low quality of these rocks are the swelling of minerals within the rock mass, which may cause crazing, i.e. micro-fracturing of the rock structure. This phenomenon is not genetically related to swelling clays although the fractures may exploit similar patches when clay minerals are present.



*Figure 2.11 Lesotho Highland Water Project (Boniface 1997)*

In this case the fracture systems originated in amygdales filled mainly by zeolites, which are known to easily hold and release water due to changes in moisture and temperature. The swelling and shrinkage of these minerals may cause structural changes, crazing and failure of the rock when the amounts are sufficient high. The combination of rock types that respond to changes in moisture content, the changes in stress regime on excavation, and the intrinsic geotechnical characteristics of each rock type, was later ascribed as the cause of rapid deterioration of the basalts (Sumner et al. 2009). However, the texture of the parent rock is also of great importance. If the texture results in low permeability of the rock material, the mineralogy may not be sufficient alone to cause deterioration of the rock within the life time of engineering structures. This fact underlines the importance of considering other mechanisms than the clay content of the rocks, in determinations of the swelling potential.

## PROJECT CASE: THE LA HIGUERA HYDRO POWER PLANT (CHILE)

The La Higuera Power Plant (Figure 2.12) is located in the Coquimbo region of Chile, and has a capacity of 155 MW (Clark & Fletcher 2016). The project is managed by Tinguiririca Energia, which is co-owned by Pacific Hydro and SN Power, and the construction was completed in 2009. The headrace tunnel traverses granodioritic intrusives and volcanic/volcanoclastic rocks affected by hydrothermal alterations, where the appearance of smectite clay and zeolite (mainly laumontite) is of particular significance (Riemer 2009). The lithology along the tunnel is shown in Table 2.1.

*Table 2.1 Lithological domains along the La Higuera headrace tunnel (Riemer 2009)*

Domaine	Chainage [m]	Lithology
1	0 - 4600	Granodiorite (diorite, monzonite)
2	- 8100	Tuffs, mainly lithic, andesite
3	- 10020	Andesite
4	- 13660	Andesite tuff, volcanic sandstone, breccia
5	- 16280	Andesite, lithic tuff and volcanic sandstone with much laumontite, hematite and smectite, four wide shear zones
6	- 17526	Andesite, tuffs, breccia

The entire assembly of rocks is affected to various degrees by deuteric effects, thermal metamorphism and hydrothermal alteration (Riemer 2009). Of special interest is the alteration of feldspars, formation of smectite clays, and introduction of laumontite as alteration product of other rock components.

A 20 m-long section section of the headrace tunnel collapsed in August 2010, forcing a repair outage of 20 months (Clark & Fletcher 2016). The collapsed area was sealed off and a bypass (260 m long) was constructed to reinstate water flow. The complete inspection of the tunnel resulted in a reinforcement with a combination of Norwegian girders, cast in place concrete, bolting and shotcrete in areas that showed distress or a high swelling potential, as required. However, the comprehensive support system installed was general and not streamlined to the actual cause of swelling.

Both laumontite and clay minerals were assumed as contributors to the spectacular degrading of the rocks in the project area. The mechanical properties of the rocks, which

later were tested at KiT, changed drastically in response to variations in the saturation (Riemer 2009). Mineralogical analyses found up to 75% of potentially swelling clay minerals in the selected rock samples, and oedometer swelling tests (on *pulverized* samples) determined swelling pressures of up to 5 MPa. In addition, the use of GeoIntegral detected a possibility of a deleterious reaction between shotcrete and laumontite, with the laumontite absorbing water from the shotcrete.



*Figure 2.12 La Higuera Hydropower Plant (Statkraft)*

#### STUDY CASE: CYCLIC SWELLING OF VOLCANIC ROCKS FROM ANDES

The Chacabuquito Hydropower Plant Project is located in the valley of the Aconcagua River, in the Andes Mountains of Central Chile. Several zones with expansive rocks were encountered during construction of two tunnels of the water conduction system for the hydropower plant, causing huge problems with the tunnel invert (Castro et al. 2003). Systematic collection of rock samples was performed for laboratory testing, and mineralogical analysis, strength tests and swelling tests were carried out. Because the rock mass was heavily decomposed and strongly fractured at the most problematic zones, it was impossible to perform reliable uniaxial compression or point load tests.

Among the rock types showing swelling behavior were volcanic breccia, andesite and andesitic tuff, with content of both swelling clay minerals and laumontite. Swelling tests revealed an expansion pressure ranging from less than 0.03 MPa to a maximum of 0.2

MPa (Castro et al. 2003), but the exact mechanism behind the swelling was not concluded.

The cyclic moisture changes and swelling of rocks surrounding hydropower tunnels may be simulated in the laboratory, to detect some main patterns of rock behavior under such conditions. Vergara and Triantafyllidis (2015) studied volcanic rocks, also from the Central Andes of Chile, by performing oedometric cyclic swelling tests on samples with intact rock structure (discs). An example of the development of axial stress in a cyclic test is given in Figure 2.13.

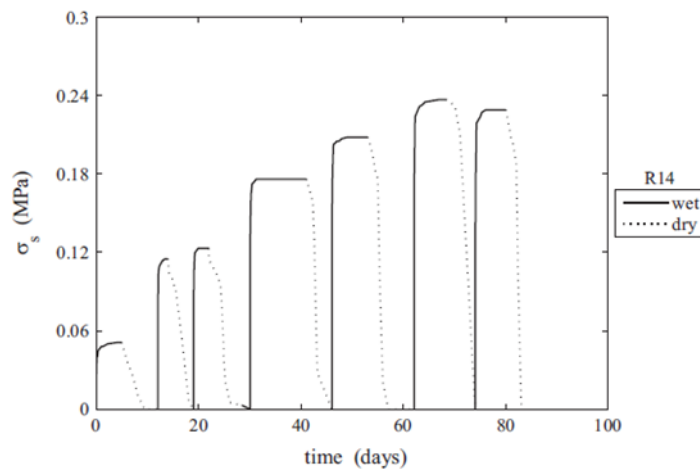

Figure 2.13 Axial swelling stress vs time (Vergara & Triantafyllidis 2015)

Under conditions of zero volume change, i.e. not allowing the samples to deform, the axial stress increased in the second cycle but stabilized during the next cycles. When volume change of the samples was allowed in small increments, the axial swelling stress increased with the number of cycles (up to 30 cycles was performed) before converging to a certain value. The results of both types of cyclic tests indicate that the cyclic wetting and drying influences the swelling behavior only when a volume increase takes place during the swelling phase, presumably because the volume expansion damage the rock structure (Vergara & Triantafyllidis 2015). The resulting increase in permeability and porosity is assumed to allow more water to react with minerals which respond to moisture changes. Measures of the rock strength before and after the cyclic tests by the needle penetrometer test were also performed, which revealed a loss of strength and stiffness of the specimen after testing.

Both the above findings correspond well to the conclusions made by Sumner et al. (2009) regarding the rocks in Lesotho Highlands Water Project. The criteria of allowing volume change of the rock suggested by Vergara and Triantafyllidis are most often fulfilled in tunneling, since excavation change the in-situ stress conditions of the rocks and the support needed to counteract this are critical. Awareness of the combination of increased swelling potential due to cyclic changes in moisture and the simultaneously loss of strength of the rock, is therefore of importance when considering the long term performance of underground engineering projects.

## **2.6 The importance of standardized testing procedures**

Rock problems are inherently complex and it is a mistake to try to oversimplify them. Thus, the exploration and testing of rock samples can't be considered a routine matter, not even for a well experienced geologist or engineer. Consideration must be given to location, position, geology, physical conditions, hydrology, lithology and structural features, and the results must be applied only in the light of all the factors relating to the site from which the samples were obtained (Handy 1971). In addition, the way in which the samples have been handled and their storage history before testing was performed must be taken into account, since several disturbances during extracting and storage may influence the behavior during testing.

Often test results arrive in an office in the form of numerical values for certain rock properties with no explanation as to how they were determined. The fact that it is usually more than one method of testing for a given property followed by different numerical results for the property tested, leads to the need for information on how the test results were obtained (Handy 1971). Several standards are developed by different institutes, including the ISRM standard which is the basis for methods used at NTNU and KiT. These technical specifications describe the methodology for the various laboratory test methods and are frequently updated as a result of ongoing research. Frequently modifications are necessary to capture the difficulties involved in the techniques, imperfections in testing equipment, and the fact that no two of these materials can or should be treated exactly alike in all respects. Regardless of the fact that most results



only describe the index properties of the rocks tested, they are valuable in the purpose of characterize and categorize the rock, and to an extent simulate coming challenges during a project. To compare results with other projects, the methods and equipment used should be according to the same standard.

### 3 Methods to assess the swelling potential of rocks

#### 3.1 Preliminary investigations

In the preliminary stages of a project, it is of interest to obtain index information about the rock which in turn may point out the direction for further investigations. Figure 3.1 exemplify parameters which may contribute the swelling or shrinking processes. To obtain the needed information, the preliminary stages should include a planning phase where the theoretical basement is reviewed. In addition, a field survey should be implemented to get an overview of the project area.

#### PLANNING

In general, planning requires a list of all rock parameters and understanding of the rock properties, including how they interact (Handy 1971). Further, the investigation should reflect the objectives of the investigation and capture the risks in the project. To obtain the relevant information within the economical outlines, selected engineering techniques must fit the scope of the study, which requires experience and knowledge.

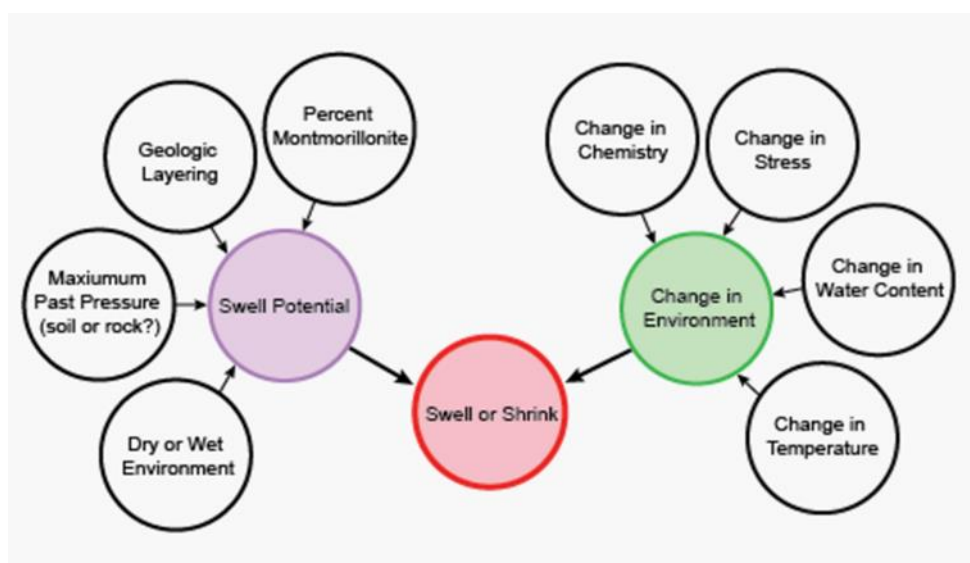

Figure 3.1 Parameters which influence the swelling potential of rocks  
(Wyoming State Geological Survey 2017)

Some parameters have a greater effect on the rock structure system than others, and to quantify the intensity and dominance of parameters, is important to keep the right focus throughout the investigation. When possible, a proper desk study of available maps, feasibility investigations and other background material should be performed prior to the field work and before laboratory methods are selected.

## FIELD WORK

For a geologist or rock engineer, it is of great value to personally survey the project case area to get an overview of the geology and other in-situ conditions of importance. Sampling of proper specimens is critical to meet the criteria for the tests to be performed, and it is therefore of great importance to thoroughly plan the field work and keep the objectives of the investigation in mind in advance of the trip. In many cases, if sampling is not carefully executed, needed information may be lost due to lack of appropriate material to test. When possible, testing of the material in-situ should be performed to the permitted extent, because in-situ tests will in principle reflect more accurately the influence of macro fabric and other factors which is not captured by laboratory tests on the measured rock characteristics, in addition to be less expensive (Ameratunga et al. 2016).

When in-situ tests are not performable, it is still beneficial to get a visual impression of the project location and incorporate the information in the interpretations of the laboratory work. In each project case, the field work and chosen laboratory tests must be adjusted continuously due to experiences made during the work, and to the phase in which the investigations find place.

## 3.2 Traditional laboratory methods to assess the swelling rock properties

### MINERALOGICAL ANALYSES

Information on the mineralogical composition is crucial when investigating swelling rocks. Different methods and techniques are available, where the application favor particular aids, depending on which type of information and details that are preferred. The primary techniques include X-Ray Diffraction (XRD), Scanning Electron Microscopy (SEM), Differential Thermic Analysis (DTA), optical microscopy and other petrographic analyses. In this case, the most interesting information is the overall composition of the rock, and in special the content of swelling clay minerals. Two methods were chosen to meet the criteria of both relevance and availability of time and resources.

#### **X-Ray Diffraction (XRD) analysis**

X-ray diffraction analysis is a method of identifying and determining the mineralogical composition of rock samples. Every mineral or compound has a characteristic X-ray diffraction pattern, call it “fingerprint”, which can be matched against a database of over thousands of recorded phases (Dutrow & Clark 2016).



*Figure 3.2 The XRD-apparatus used at NTNU*

The diffraction of monochromatic X-rays on the surface of a crystal lattice produces varying reflection intensities at varying angles, and the interaction of the incident rays with the sample produces constructive interference when conditions satisfy Bragg's law ( $n\lambda=2d \sin \theta$ ). The apparatus used at NTNU is shown in Figure 3.2.

XRD analysis is performed on pulverized samples which is prepared by standardized methods. Identification and classification of abundance in percentage are found by comparing relative peak heights and mineral crystalline structure (Dutrow & Clark 2016). Modern computer software and an extensive database is used to identify the diffraction patterns, and needs qualified expertise to be handled properly.

### **Differential Thermal Analysis (DTA)**

Differential thermal analysis (DTA) was developed to meet a need for a method of determining the nature and character of certain minerals and mineral mixtures not revealed by either chemical analysis or X-ray patterns (Speil 1944). The method is based upon the fact that the application of heat to many minerals causes certain physical and chemical changes that are reflected in endothermic and exothermic reactions, which is characteristic of the particular mineral under examination. The method may be used in addition to mineralogical analyses to detect clay minerals or other impurities, which by different reasons are not captured by other traditional methods.

The essential step of the analysis is determination of the temperature at which any thermal reactions take place in the sample, and the magnitude of these thermal effects (Speil 1944). By comparing the change in temperature of a mineral heated at definite rate with that of a thermally inert substance (in this case  $\text{Al}_2\text{O}_3$ ), a curve or pattern is obtained showing the thermal reactions (Speil 1944). The diagram must then be compared with the diagnostic patterns of known minerals to identify the minerals.

An example of a reference diagram used at NTNU is shown in Figure 3.3.

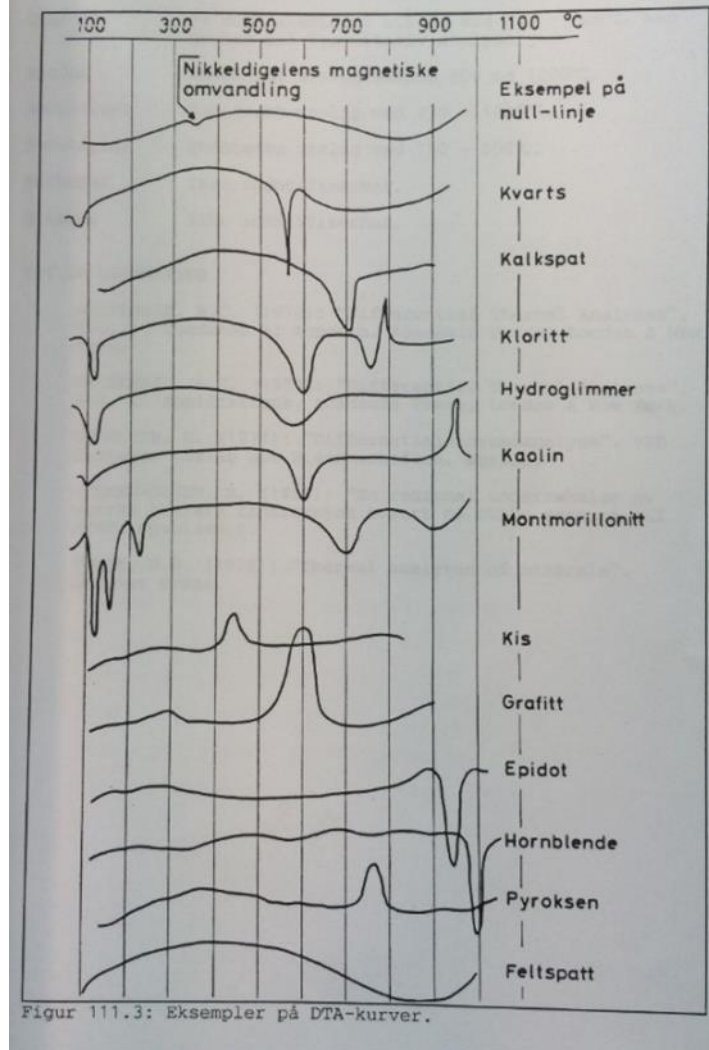

Figure 3.3 Reference diagram of thermal peaks in DTA (NTNU 2016).

### STRENGTH TESTS

Several methods and models have been developed to determine the strength and hardness of rocks, including the uniaxial compressive strength test, tri-axial strength test, point load test and different versions of rebound tests as the Schmidt Hammer test (Palmström & Singh 2001). The purpose of the testing, the phase in which testing is carried out, the quality of the rock of concern, and the availability of rock material and equipment are main controlling factors when choosing the methods to use in each case.

### **The Uniaxial Compressive Strength (UCS) test**

The uniaxial compressive strength of rocks is considered a key property when characterizing rock material strength in engineering practice. The test produce parameters widely used in several methods and models for determining the strength of rocks, for example the Hoek-Brown failure criterion (Hoek et al. 2002). The main values of interest are the Poisson`s Ratio, the E-module and the Uniaxial Compressive Strength (UCS).

The Poisson`s ratio can be defined as the negative of the ratio of transverse strain to the axial strain in an elastic material subjected to a uniaxial stress, and express the tendency of a material to expand or shrink in a direction perpendicular to a loading direction (Gercek 2007). Typical ranges for andesite is 0.2-0.35 and 0.1-0.35 for basalt where values over 0.3 are considered as high (Gercek 2007).

Young`s Modulus (E-module) may be defined as the ratio of stress to the corresponding strain below the proportionality limit of a material, and express the material`s stiffness or resistance to being compressed or extended (Palmström & Singh 2001). Typical values for andesite is ranging from 25-35, and between 45-55 for basalts.

The complete force-displacement curve of an intact rock specimen is useful in understanding the process of specimen deformation and cracking, and can provide insight into potential in situ rock mass behavior (Fairhurst & Hudson 1999). The stress-strain curve show the displacement of the specimen ends from initial loading, through the linear elastic pre-peak region, through the onset of significant cracking, through the compressive strength, into the post-peak failure locus, and through to the residual strength (Okubo & Nishimatsu 1985). Measured values of the compressive strength depend to a great extent on the test conditions, especially the moisture content, the rate of the loading, and the size and shape of the specimen.

A typical stress-strain curve in the UCS-test is shown in Figure 3.4.

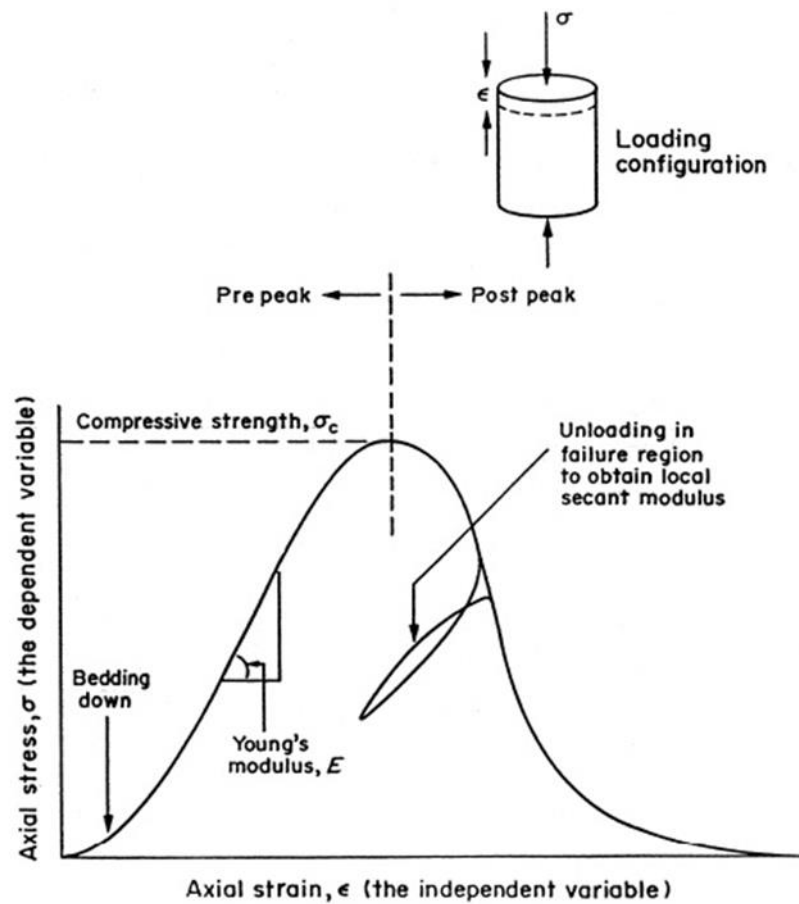

Figure 3.4 The complete stress-strain curve for a rock specimen showing the pre peak Young's modulus, compressive strength and post peak Young's modulus  
(Fairhurst & Hudson 1999)

The uniaxial compressive strength of rock samples is a function of the mechanical properties of the intact rock and of the mechanical properties of mesoscopic discontinuities, and hence related to the mode of failure (Szwedzicki & Shamu 1999). The results should also be considered together with other characteristics of the rock, such as mineralogy, porosity, discontinuities and moisture content, since not all modes of failure produce strength values that can be regarded as the peak strength values for the intact rock material.



## SWELLING TESTS

In general, the two main swelling characteristics that can be determined by laboratory testing are the swelling strain and the swelling pressure. The following two main testing configurations are thus possible (Rauh et al. 2006):

- Swelling strain tests (“zero pressure change”), where only the displacement is measured, with no axial or radial restraint and
- Swelling pressure tests (“zero volume change”), where only pressure is measured with rigid radial and axial restraint.

These testing principles are very often mixed, where the most common is a testing procedure with radial restraint and axial measuring; the latter can be analyzed with or without axial load (Rauh et al. 2006). In addition, the volumetric change of swelling gauge or of pulverized rock material, is common index tests.

### Free Swelling Index tests (powder samples)

The free swelling tests on powder samples are index tests normally used to examine the swelling potential of swelling gouge in weakness-zones (Nilsen 2016), but may also provide useful data regarding the volumetric expansion potential of pulverized and compacted samples of intact rocks. The testing principle is illustrated in Figure 3.5.

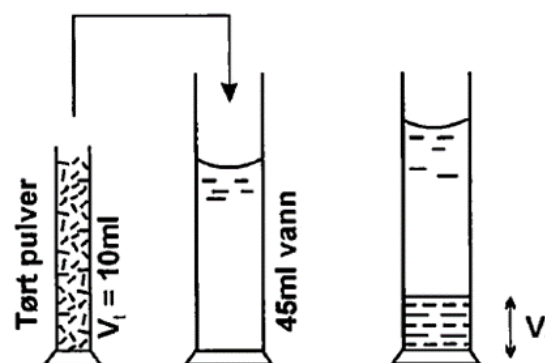
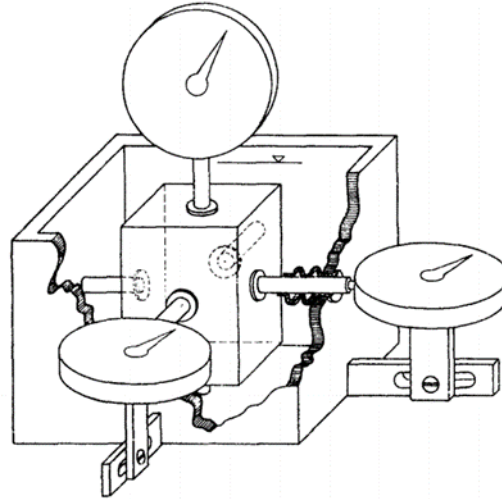

Figure 3.5 Principal sketch of the Free Swelling Index test (NTNU, received pdf)

### Swelling strain tests

The ISRM suggested method for determination of swelling strain include testing of unconfined samples prepared as rectangular prisms or as cylinders (Pettersen Skippervik 2015), as shown in Figure 3.6.



*Figure 3.6 Sketch of cell and rectangular specimen assembly in unconfined swelling strain test (ISRM 1979 (1977)).*

Swelling strain parameters may also be obtained by oedometric tests where the specimen is radially confined and the axial strain (deformation) due to swelling is measured.

Tri-axial tests and models based on three dimensional swelling laws, will not be further reviewed in this thesis.

### Swelling pressure tests

When volume expansion of swelling rocks is prohibited, the pressure will increase until a maximum value is reached (Barla 2008). In order to determine the stress acting on the support in a tunnel, swelling pressure tests are often carried out. The most common methods are performed in oedometers where the samples are radially constrained and the axial pressure is measured. “Zero volume change”-tests are performed by totally hinder axial deformation of the specimens and the maximum swelling pressure potential is measured.

Regarding on the material to be tested and the objective of the investigation, the tests may be performed on compacted powder samples or intact rock structure specimens, and as single or cyclic tests.

Pictures of typical oedometers are given in Appendix 5.A and Appendix 5.B.

### **Combined swelling pressure and swelling strain tests**

By performing oedometric tests under different axial loads, the swelling strain as a function of the axial stress can be determined (Pimentel 2015). Different approaches to obtain the swelling pressure – swelling strain relationship is possible, where the most known versions are the Huder-Amberg test and the ISRM modified Huder-Amberg test.

The swelling pressure and swelling strain tests performed by use of oedometers will be further reviewed in chapter 5 of this thesis.

## 4 Geology of the project area and field work

In this study, there was limited access to geological maps of the area before arrival, and the available rock samples were mainly borehole cores. Since the project is in a preliminary phase, no tunnels were under construction, and in-situ tests thus not performable.

### 4.1 The geological history of the Philippines and project area

The Philippine Sea Plate is the world's largest marginal basin plate, whose motion through time is poorly understood (Zheng et al. 2013). The plate is almost entirely surrounded by subduction zones which separate it from the oceanic ridge system, and consequently, even its present motion with respect to other major plates is difficult to determine (Hall et al. 1995). Previous studies have relied on palaeomagnetic analysis to constrain its rotation, and geophysical data have been collected and analyzed (Lallemand 2016). Still, the origin remains controversial, and this thesis will only include a brief overview of the geological and tectonic history of the Philippines.

#### THE PHILIPPINE SEA PLATE AND “RING OF FIRE”

The Philippine Sea Plate belongs to “The Ring of Fire” (Figure 4.1). It is located in the West Pacific Region at the joint of the India-Australia plate, Eurasia Plate and Pacific Plate, i.e. between the Tethys tectonic zone on the west and the Pacific tectonic zone on the east (Fang et al. 2011). The visible part has a diamond shape, with a maximum north-south length of ~3400 km and a maximum east-west width of ~2600 km (Lallemand 2016). It is mainly composed of oceanic crust, and is surrounded by convergent plate boundaries, which result in subduction zones and huge tectonic activity even today. The area has the most concentrated and active volcanic activities and earthquakes on the earth, including complex evolution processes, which are reflected in the geological features experienced today.

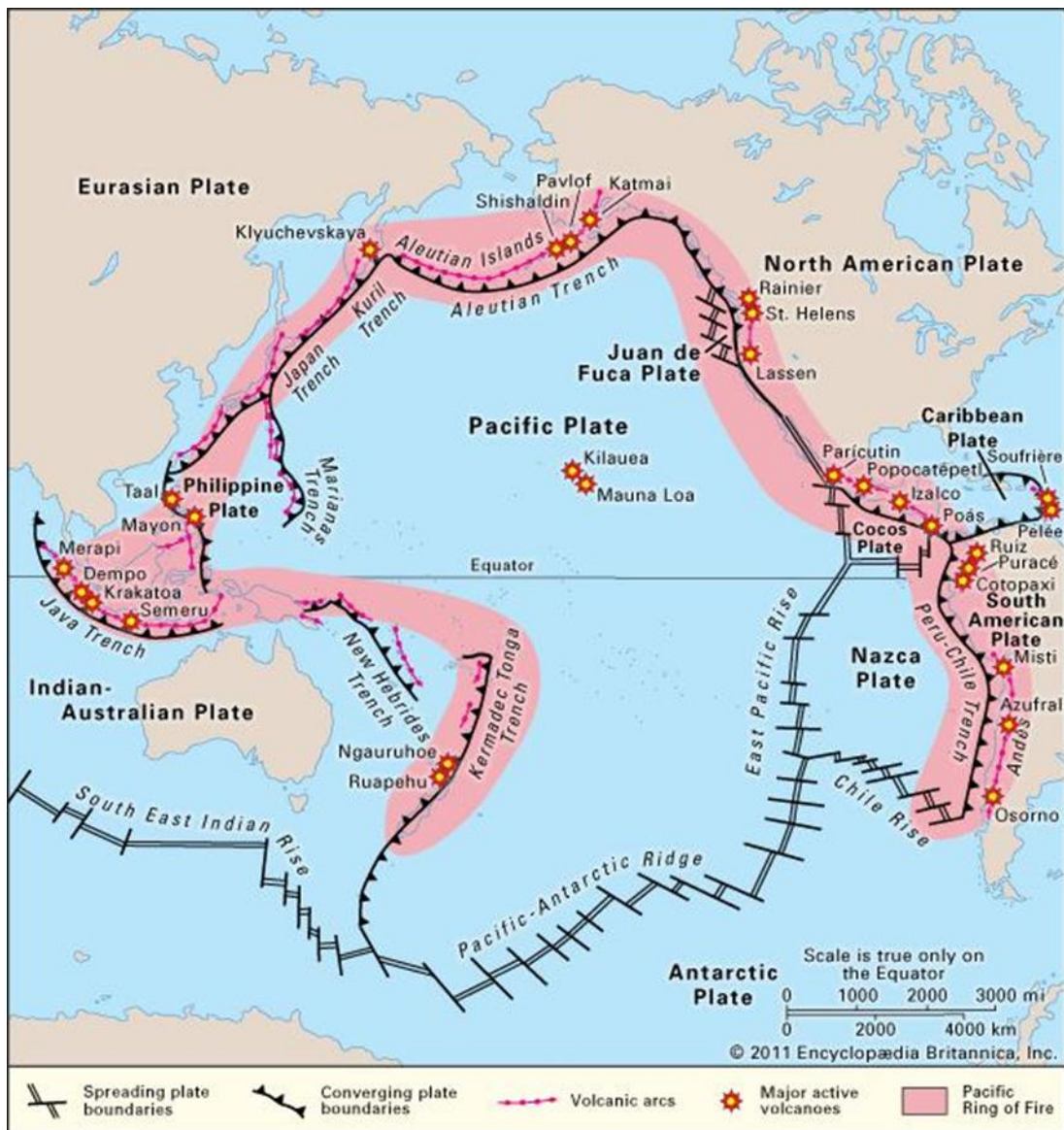

Figure 4.1 Map of “The ring of fire” (The Editors of Encyclopædia Britannica 2015)

The exact geological evolution of the Philippines is not known, but the formation is expected to have a complex history with several stages of back-arc spreading, formation of island arcs, and tectonic transformation (Zheng et al. 2013, Lallemand 2016, Sdrolias et al. 2004). Since approximately late Mesozoic, a global reconstruction happened with northward movement of the India-Australia Plate and collision/subduction with the Eurasia Plate thereafter, as well as the westward subduction of the Pacific Plate under the Eurasia Plate (Fang et al. 2011). This has resulted in the formation of a series of volcanic activity zones and the opening of marginal seas with young oceanic

lithosphere. During Cenozoic times, The Philippine Sea Plate was the fastest-moving plate (Zahirovic et al. 2015). The plate itself appears as a mosaic of oceanic basins, aseismic ridges, plateaus, fracture zones, volcanic arcs and fore-arcs, fossil, and active spreading centers, where the oceanic basins are younger from west to east (Lallemand 2016).

## THE REGIONAL GEOLOGY OF THE PROJECT AREA

The project area is sited in Ifugao, North Central Luzon in the Philippines. The regional geology comprises Miocene age to present-day volcanic materials, which overly a basement complex of pre-Tertiary rocks which are not exposed in the project area (SN Aboitiz/Stache 2015).

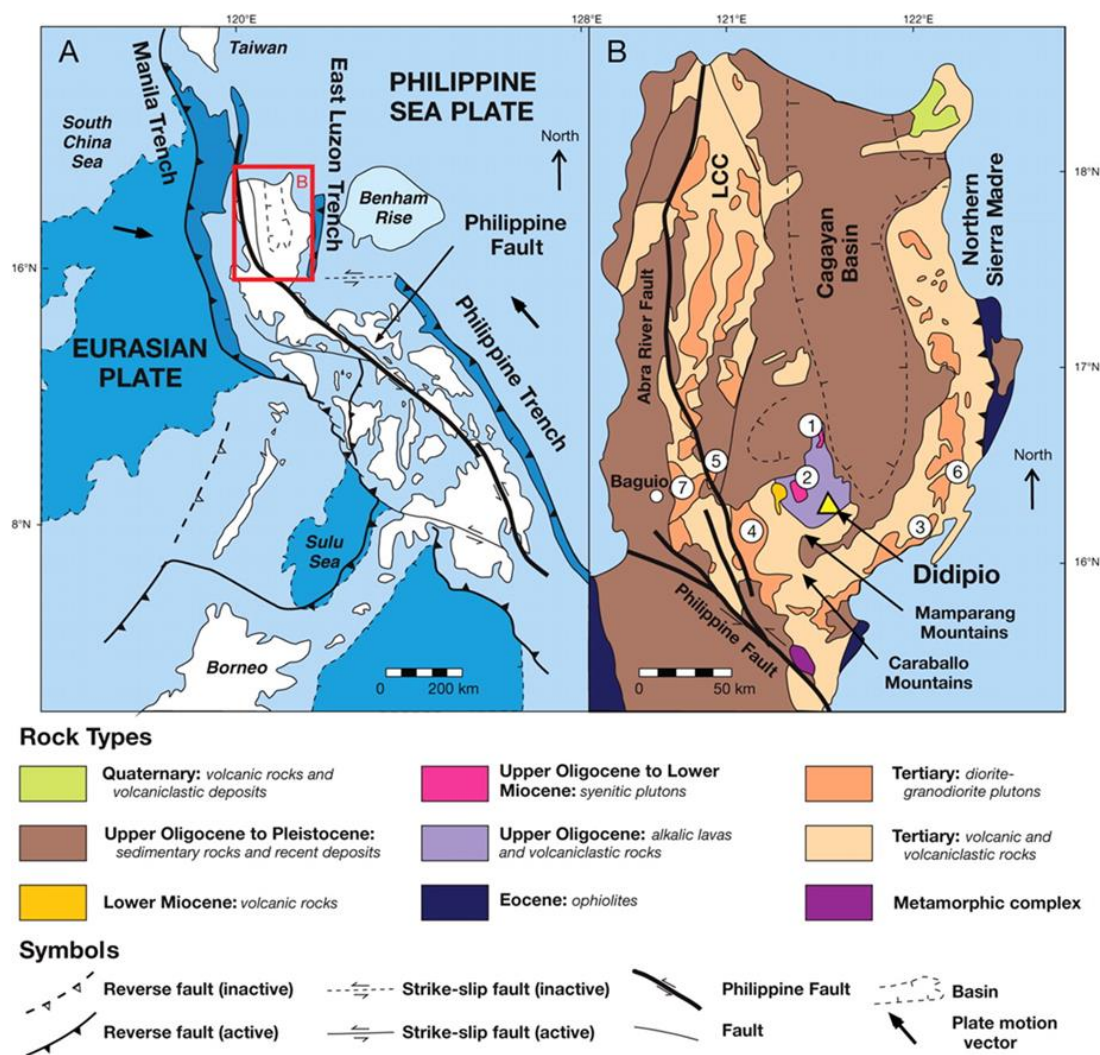

Figure 4.2 Tectonic setting of the Philippines (Economic Geology 2011)

The volcanic lithologies have been interpreted to represent an island arc depositional and tectonic setting related to the collision of two converging plates. There are very minor sedimentary layers within the volcanic series. The lithologies were deposited in a deep marine basin environment and may belong to the Caraballo Formation of Eocene age. The tectonic development of the Luzon Central Cordillera is related to two North-South subduction zones located at the East and West of the Philippines (Figure 4.2). The project area itself belongs to the Cordon Syenite Complex (SN Aboitiz/Stache 2015).

The regional geology of the project area is illustrated in Figure 4.3.

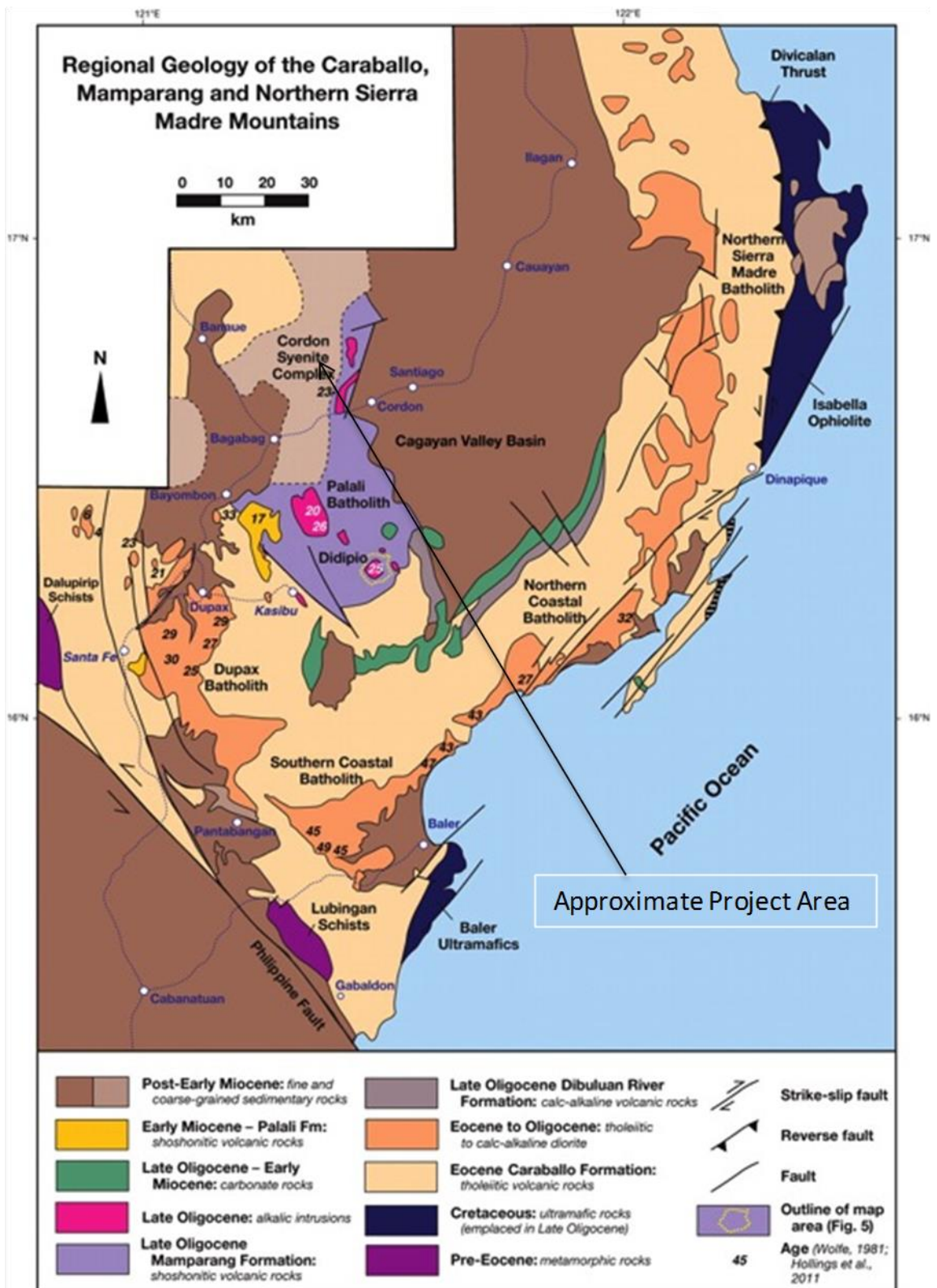

Figure 4.3 Map showing the regional geology of project case area (SN Aboitiz/Stache 2015)



## THE IFUGAO/ALIMIT AREA AND THE ROCKS OF STUDY

Ifugao is a landlocked watershed province, with the Magat River as a south-eastern border that separates this hilly region from the lowland provinces (Unesco Bangkok 2008). The region is bounded by a mountain range to the north and west, with a highest elevation of 2523 meters above sea level. The mountains tempers into undulating hills towards south and the east, with no clear systemic orientation of its ridges.



*Figure 4.4 The landscape surrounding the Magat River*

The rocks in the area are primarily volcanic of basaltic and andesitic origin, included rocks undergone hydrothermal alteration or metamorphic transformation processes, and different stages of weathering (SN Aboitiz/Stache 2015). The project will be constructed entirely in volcanic terrain. Three main volcanic rock units, and at least three sub-units composed of magmatic dykes, sills and intrusions along tectonic

structures, are confirmed by field investigations. The geological sequences in which constructions are planned consist of basalts, tuffs, volcanic agglomerates, igneous intrusions and andesitic rocks. The surface rocks are of alluvial and colluvial origin covered with soil and vegetation, thus not available for mapping without using invasive methods as drilling.

## 4.2 Geological description of important sites of the project area

The main sites of the project area investigated in this study, are the Ibulao intake area, the Alimit Dam Site, the Alimit Powerstation/Olilicon HEPP, and the Ibulao-Olilicon Headrace Tunnel. An overview of the area included the locations are shown in Figure 4.5.

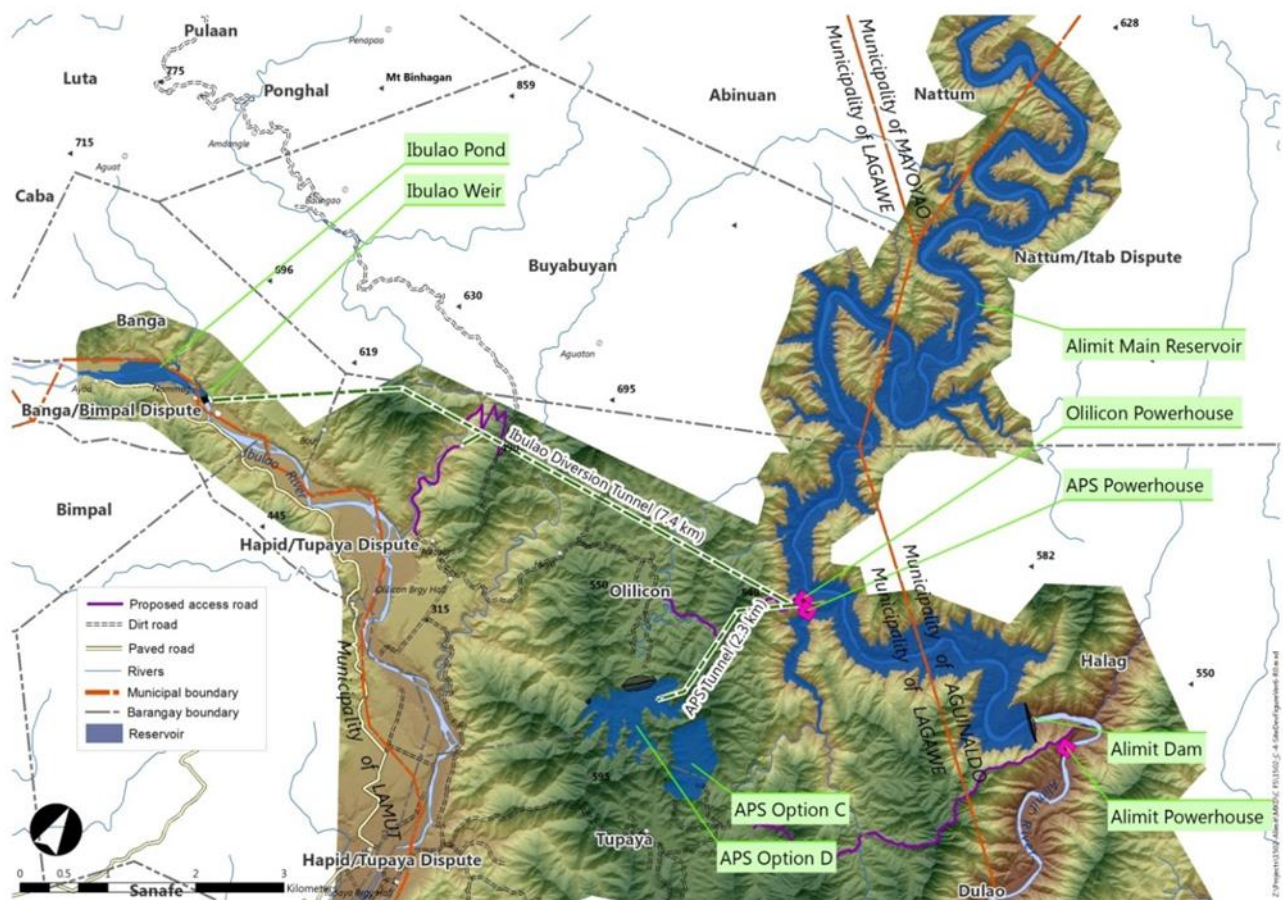

Figure 4.5 Map of the project case area (SN Aboitiz 2015 (received PPP))

## THE IBULAO INTAKE

The Ibulao Intake will be located on the Ibulao river (Figure 4.6), and conduct the water to the Alimit reservoir through a 6-8 km tunnel (SN Aboitiz/Stache 2015). The turbinated water will be released to the Alimit reservoir. The selected site is assumed a geological stable section, composed of massive volcanic andesitic and pillow lava outcrops, with shallow alluvial overburden.



*Figure 4.6 Downstream view of the Ibulao weir location (SN Aboitiz/Stache 2015)*

## THE ALIMIT DAM SITE AND THE ALIMIT POWER STATION/OLILICON HEPP

Alimit hydroelectric scheme consists of an 80 m high dam sited on the Alimit River (SN Aboitiz/Stache 2015). The Alimit HEPP, with an installed capacity of 120 MW, is located immediately downstream of the Alimit dam. The Alimit dam emplacement (Figure 4.7) is characterized by a narrow U-shaped section with steep dipping slopes on both abutments. The overall geology is composed of volcanic flow lithologies consisting of well jointed and sound andesitic volcanic flow layers, as well as of highly fractured intercalated pillow lavas. The powerhouse will be located in a shaft, constructed on a platform set into the ridge on the right bank of the Alimit River.

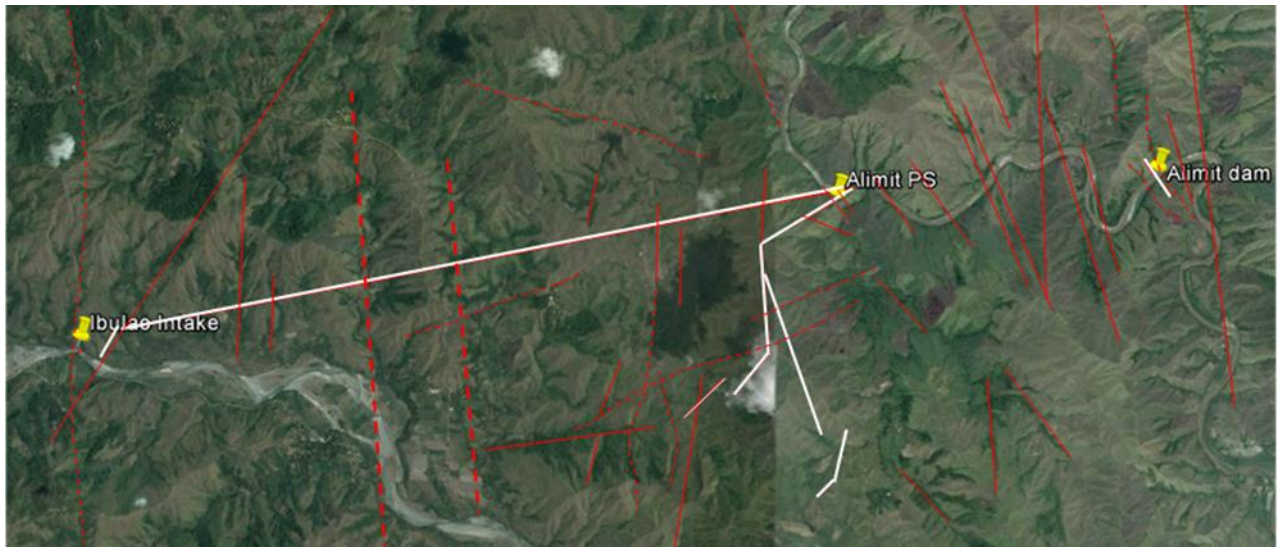

*Figure 4.7 The Alimit dam site, looking along the dam axis to the left abutment (SN Aboitiz/Stache 2015)*

The Alimit dam site and the Alimit Power Station/Olilicon HEPP are located within massive volcanic agglomerates. The drainage pattern, fault system and the morphology in the eastern part of the project also supports a major volcanic block controlled by the local tectonics (SN Aboitiz/Stache 2015).

#### THE IBULAO-OLILICON HEADRACE TUNNEL

Based on the additional field surveys of SN Aboitiz, the overall tunnel alignment from West to East is assumed to cross cut volcanic series of andesitic composition. Towards East approaching the Power House and shaft location, massive volcanic agglomerates will occur more frequently (SN Aboitiz/Stache 2015). Major parts of the tunnel lining will pass through tectonic regimes with large N-S sinking faults zones and several sub-parallel trending zones (Figure 4.8).



*Figure 4.8 Preliminary fault tectonic setting of the overall project area  
(SN Aboitiz/Stache 2015)*

Massive volcanic agglomerates will occur more frequently towards the east, approaching the Power House (PS) and shaft location. The remaining part till the Power House the tunnel will go through massive andesitic flows and agglomerates with high overburden rock mass (SN Aboitiz/Stache 2015).

The cross-sections of the Ibulao-Olilicon Headrace Tunnel are shown in Figure 4.9.

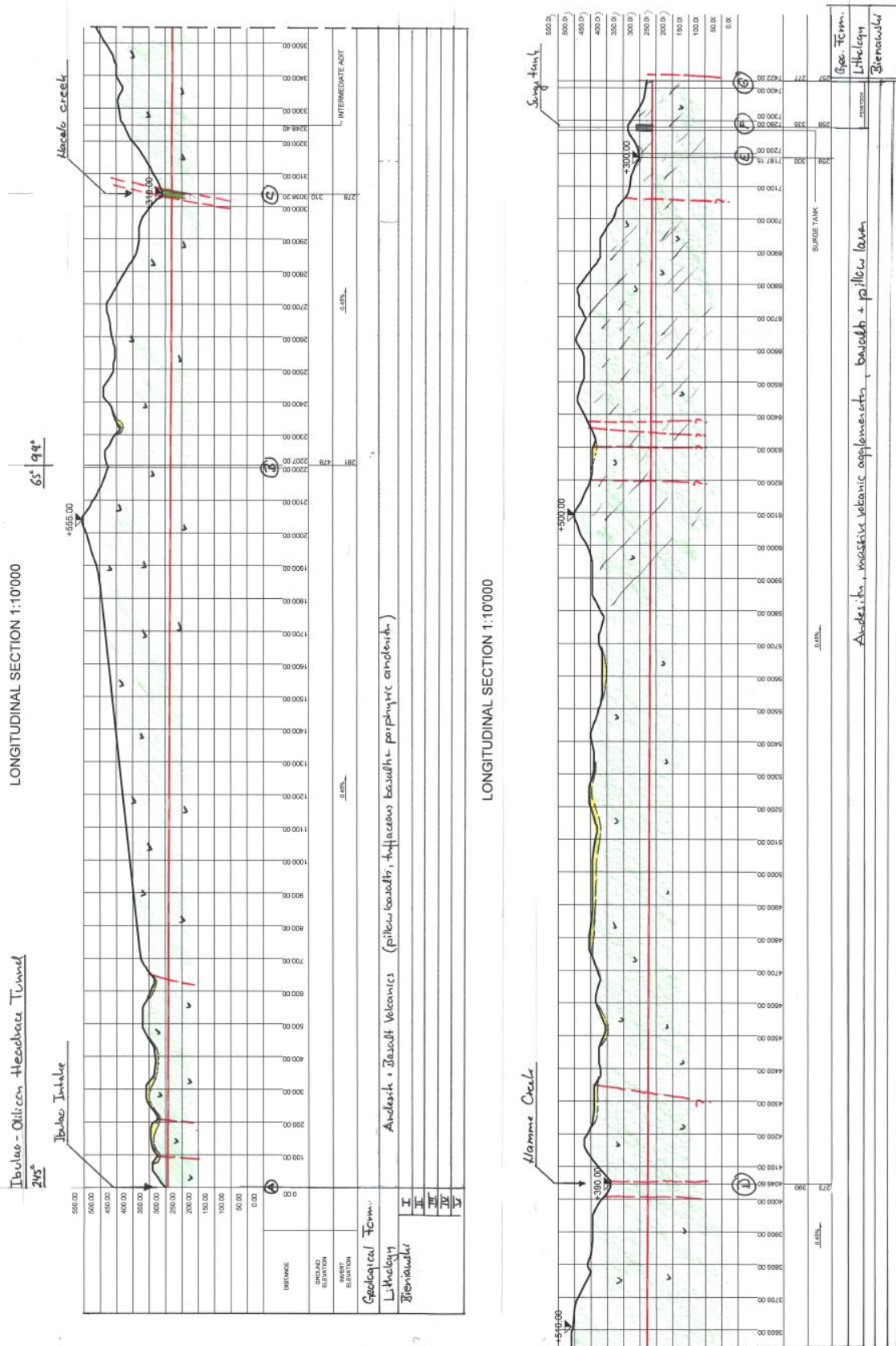

Figure 4.9 Cross-sections of the Ibulao-Olilon Headrace Tunnel  
 ( SN Aboitiz 2015, received report)

## 4.2 Review of the fieldtrip to Alimit, Phillipines (19.-31.May 2016)

### SUMMARY OF THE FIELDTRIP

After a period of detailed planning of practical importances and the work to do, me and my co-supervisor Siri Stokseth arrived the Phillipines the 20. May. We first stayed one night in Manila, before we went to our hotel located in Solano, about one hour by car from Lagawe where SN Aboitiz have an office where the borehole-cores are stored. SN Aboitiz arranged transport and a little crew of native people to bring us safely around. The work performed during our stay are summarized in Table 4.1 below.

*Table 4.1 Overview of the field-work*

	<b>Location</b>	<b>Object/purpose</b>
<b>Day 1</b> (field)	1) Ibulao intake 2) Headrace Tunnel – area 3) Tributary river	1) Exposed rocks near the river 2) Landscape/topography 3) Landscape/geology
<b>Day 2</b> (field)	Headrace Tunnel – area	Landscape
<b>Day 3</b> (field)	Alimit dam site	Borehole-locations/geology
<b>Day 4-8</b>	The Lagawe office of SN Aboitiz where the samples are stored	Visual inspection of samples and borehole cores
<b>Day 9</b>	The Manila office of SN Aboitiz	Meetings with SN Aboitiz employees

#### **Day 1 (field)**

The first day in the field, we first went to the Ibulao intake where we looked at some exposed rocks near the river, to get an image of the rock-types in the area.

We went further by car to the mountain-area near the site of the planned head-race tunnel, where we got a nice overview of the landscape and the meandering river.

The next stop was along the tributary river to Ibulao. The terrain was very challenging in this area, with abundant vegetation and steep slopes.

### **Day 2 (field)**

The second day in field was spent in the mountains further south for the hydro headrace tunnel, but neither here any rocks to study due to the vegetation. However, we had an enjoyable walk in the beautiful mountains and got a nice overview of the landscape surrounding the Alimit river.

### **Day 3 (field)**

The third day we had a long drive and a heavy trip by boat to the Alimit dam site. We got a nice overview of the area from which the borehole samples are collected.

Pictures of the location of AD-05 are shown in Figure 4.10 and Figure 4.11.



*Figure 4.10 Location of borehole AD-05*





*Figure 4.11 Borehole AD-05 at distance*

**Day 4-8 (Lagawe office)**

The next five days, my co-supervisor went to Baguio to follow up another project, and I was left to study the rocks stored in the Lagawe office of SN Aboitiz. All samples were studied and described based on visual impression before made the decision on which samples to include in the laboratory testing.

**Day 9 (Manila office)**

The last day of work was spent at the office of SN Aboitiz in Manila, where we had some interesting discussions with partners in SN Aboitiz.

## AREA OF SAMPLE COLLECTION

The samples obtained from borehole AD-02, AD-05, AD-06, AD-07 and APH-02 are located near the dam-site. The locations are shown in Figure 4.12.

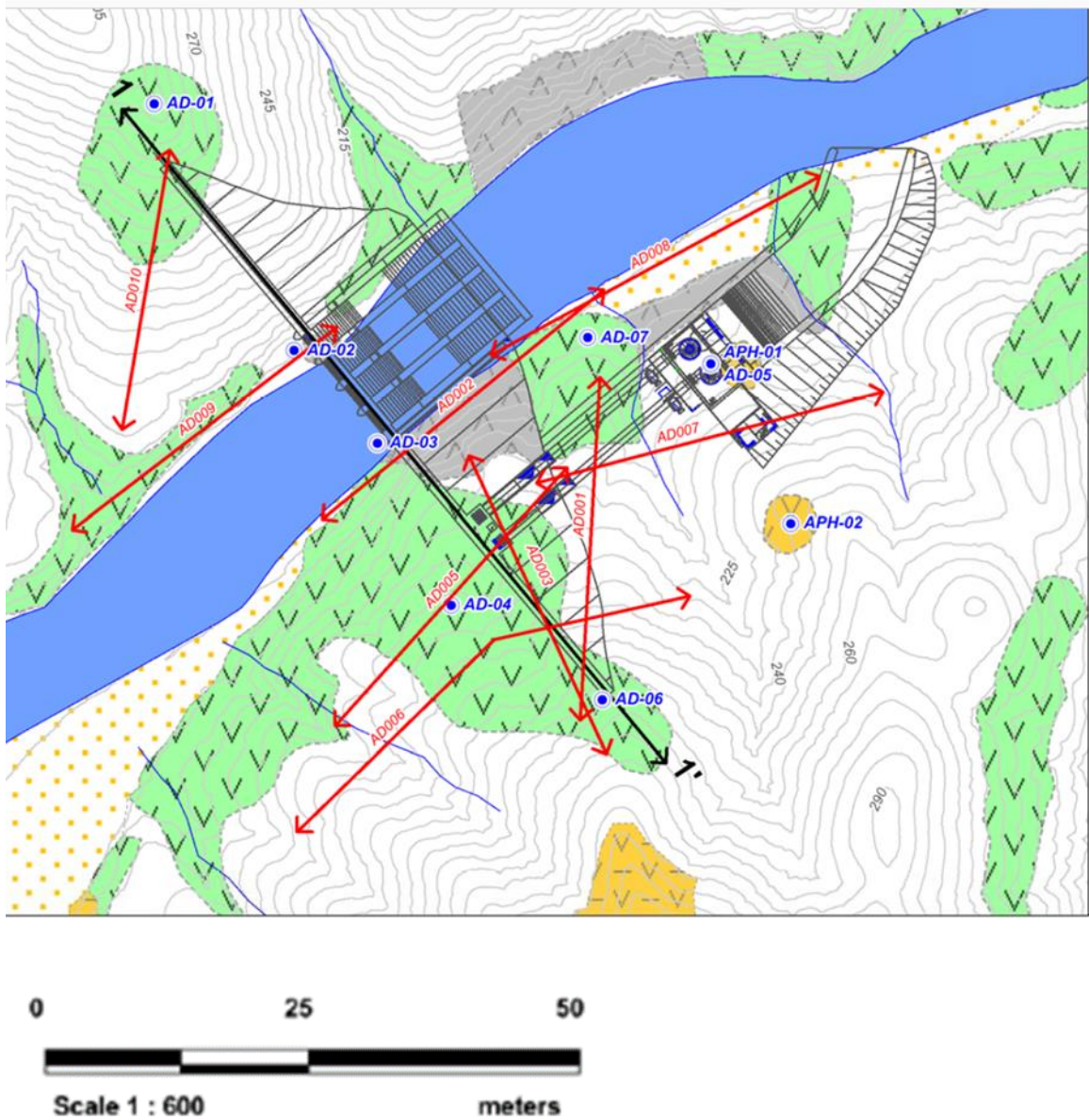

*Figure 4.12 Map of the location of some of the collected samples near the dam-site (SN Aboitiz 2015, received report)*

The samples collected from borehole AQD-02 is from another part of the area, at the opposite side of the river of the additional quarry deposit. The location is shown in Figure 4.13.

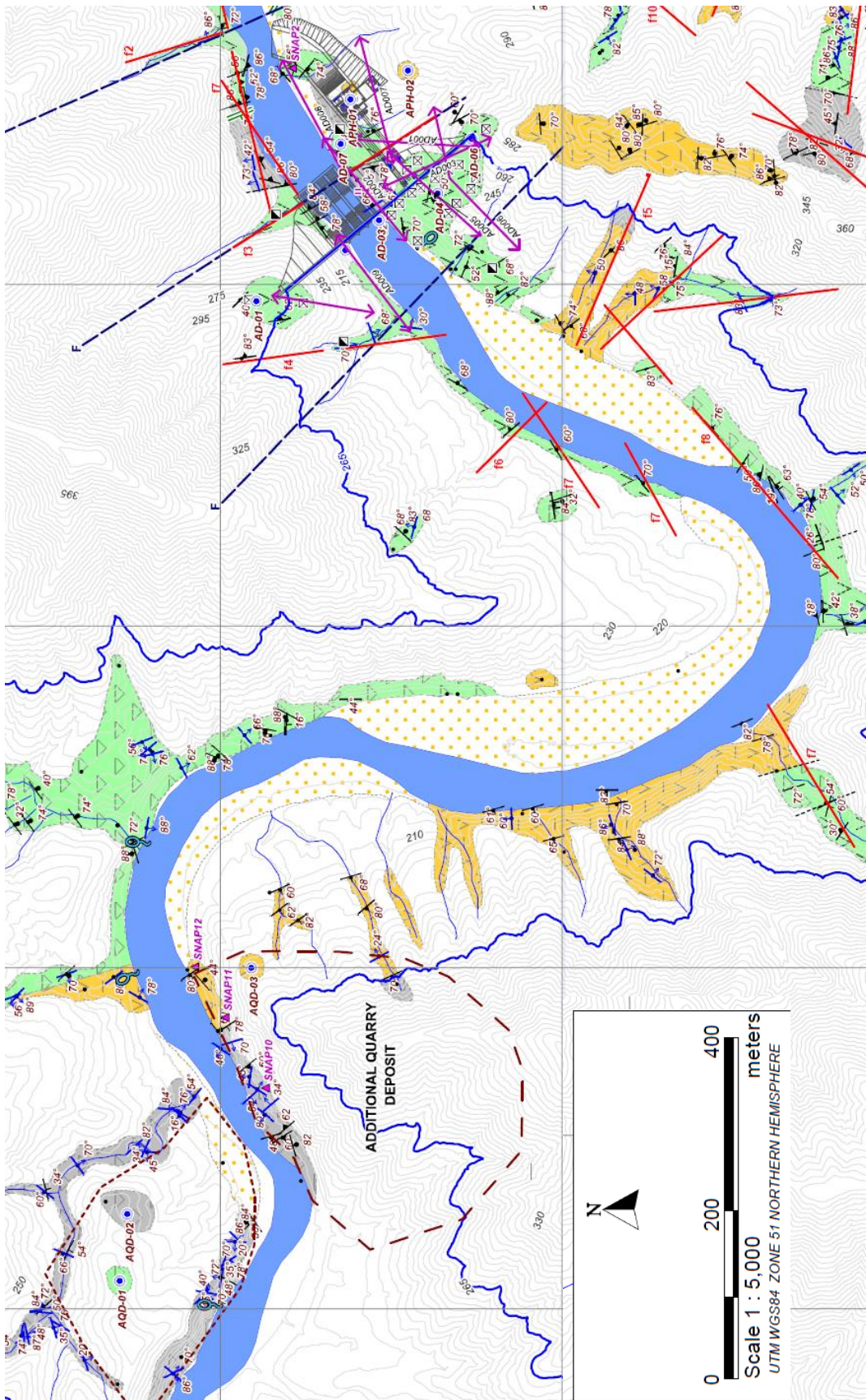

Figure 4.13 Map showing the borehole locations (AQD-02 in the upper left corner) (SN Aboitiz 2015, received report).

## THE VISUAL INSPECTION OF THE BOREHOLE CORE SAMPLES

The visual inspection during the stay at the Lagawe Office of SN Aboitiz, resulted in a decision of which samples to bring to Norway/NTNU for laboratory testing. The samples showed a wide variation of color, structure, minerals, and consistency. Approximately RQD values of the cores was also estimated. The following division of the samples was performed:

- *Rock type "strong"*, apparently strong and intact rocks, with light grey to dark grey or green color, and fine to medium grained matrix.
- *Rock type "weak"*, apparently weak rocks with or without clastic structure of varying color.

Samples which were heavily disintegrated were considered less interesting and thus excluded from the sampling procedure. An overview of the boreholes and depth from which the samples belong to is shown in Table 4.2 and Table 4.3, included the origin (area). The samples are named after the borehole + box number from which they were collected.

*Table 4.2 Overview of the selected (strong) samples*

<b>Rock type «strong»</b>	<b>Depth</b>	<b>Area</b>
<b>AD-02, box 12</b>	~ 40.35 – 44.05 m	Alimit Dam Site
<b>AD-06, box 25</b>	~ 86.30 – 87.30 m	Alimit Dam Site
<b>AD-07, box 12</b>	~ 38.35 – 41.00 m	Alimit Dam Site
<b>AQD-02, box 12</b>	~ 42.25 – 45.60 m	Near the additional quarry deposit

*Table 4.3 Overview of the selected (weak) samples*

<b>Rock type «weak»</b>	<b>Depth</b>	<b>Area</b>
<b>AQD-02, box 5</b>	~ 16.70 – 20.60 m	Near the additional quarry deposit
<b>AQD-02, box 6</b>	~ 20.60 – 24.60 m	Near the additional quarry deposit
<b>APH-02, box 18</b>	~ 59.80 – 63.40 m	Near Alimit Dam Site

## 5 Oedometer swelling tests

The swelling behavior of rocks is normally determined by laboratory tests, because in-situ tests are normally only possible in investigation adits or during construction. Different variations of oedometer-tests are frequently used, whereas many of them are based on the work performed by Huder and Amberg (1970) and Grob (1972) (Wittke-Gattermann & Wittke 2004). The maximum swelling pressure test suggested by ISRM is a modification of the swelling test according to Huder and Amberg, and may be performed on both pulverized samples and intact rock structure specimen.

In this chapter, the basement for the standardization of oedometer swelling tests will be reviewed. Further, the apparatus-set-up and procedures in operation at NTNU and KiT will be presented, including the modifications of each institute.

### 5.1 The background and standardization of the oedometer swelling tests

#### HUDER AND AMBERG

Huder and Amberg (1970) proposed a standard oedometer test to quantify the expansive deformation caused by swelling, which have been widely accepted and often used for geotechnical applications in swelling rocks (Wittke-Gattermann & Wittke 2004). It is a combined swelling pressure and swelling strain test. The procedure, performed on initially dry samples, is in short described as follows (Geotechdata.info 2014; Romana & Serón 2005):

- A) Loading until settlement - in order to compensate for the distressing relief caused by the sample extraction.
- B) Unloading until settlement
- C) Reloading to the maximum applied vertical stress
- D) Repeating a), b) and c) until the maximum possible pressure is reached

- E) Soaking of samples in distilled water and maintaining the maximum vertical stress, allowing vertical expansion of the sample
- F) Stepwise unloading. At each step, the time necessary in order to end the successive expansion that occurs after each decrement of load is allowed, and the immediate strain due to unloading and the final strain due to swelling after equilibrium is recorded.

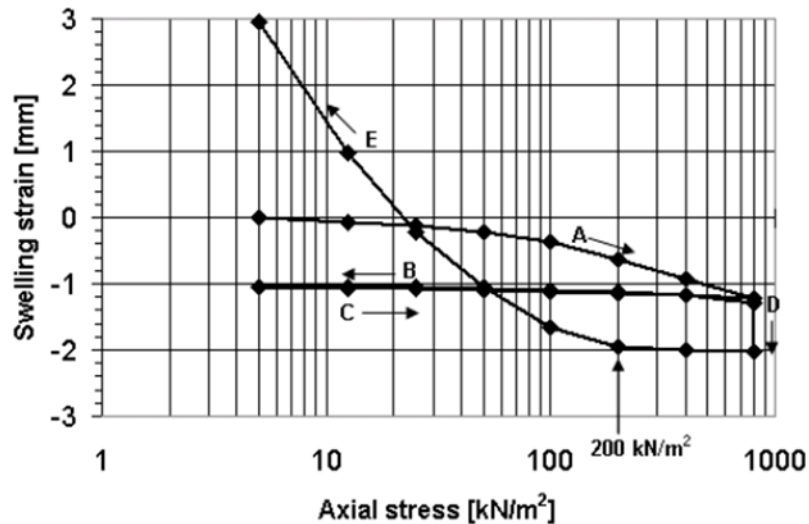

*Fig 5.1 Testing procedure and interpretation of a swelling test according to Huder and Amberg (1970) (Rauh et al. 2006)*

The testing procedure is illustrated in Figure 5.1. The test results are represented by plotting the swelling strain versus time for each stress level (Wittke 2014). The loads used in the pre-loadings are often relatively high. The ISRM (ISRM 1999) have suggested a modified variant of this test without the massive pre-loading procedure.

### GROB'S LAW

Grob (1972) approximated the swelling of the tunnel invert based on the Huder-Amberg oedometer test, and found a clear relation between axial strain and the axial stress (ISRM 1994). This is a one-dimensional model which assumes linearly elastic rock behaviour, and may be viewed as a simple simulation of the situation by the invert of a tunnel after excavation. The model, also called “the semi-logarithmic swelling law” or “Grob’s line”, show that swelling deformations reduce with the logarithm of stress, and

that swelling deformations can be completely suppressed by a sufficiently high pressure (Schädlich et al. 2013). The swelling law is limited due to its one-dimensional character, but is useful provided that the analysis is appropriately structured.

The swelling law can be directly obtained from the one-dimensional swelling tests (ISRM 1994). To obtain the characteristic swelling strain-pressure relationship, measurements on both strain (deformation in axial direction) and swelling pressure are needed. Figure 5.2 illustrates the swelling stress-strain relationship, as detected by Grob. It is important to note that the swelling laws deal with stress-strain and not strain-time-relations.

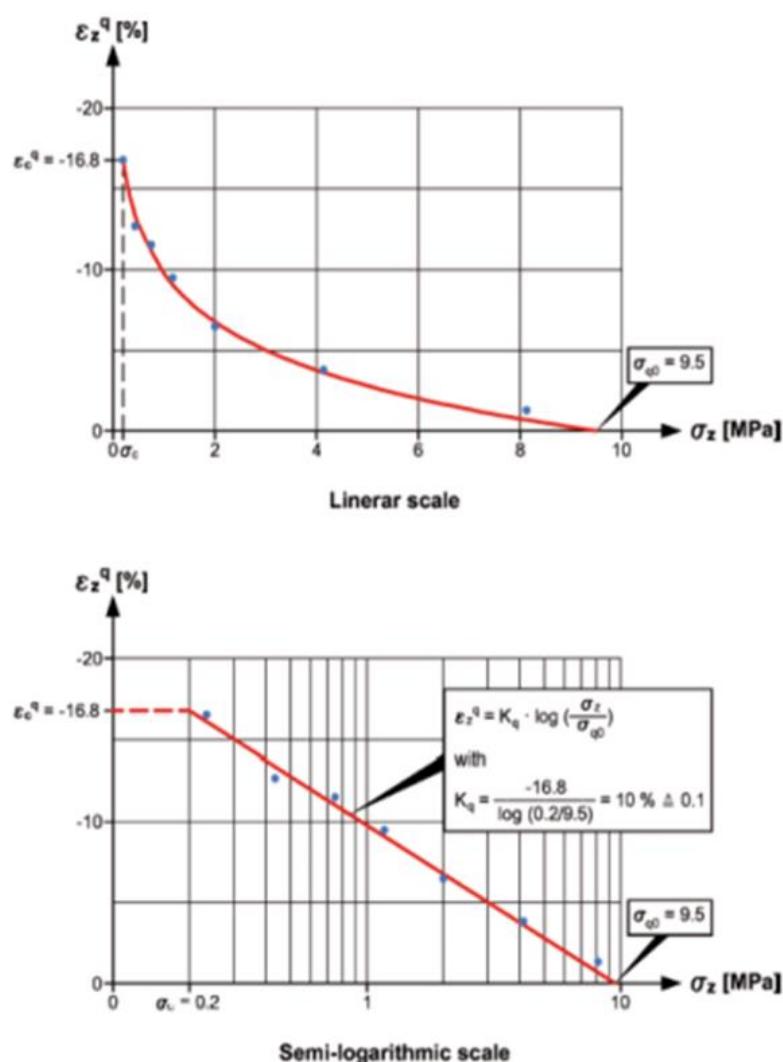

Figure 5.2 Linear scale (normal plot) and semi-logarithmic scale (logarithmic plot) showing the characteristic swelling stress-strain relationship

(Wittke 2014).



## THE ISRM STANDARD

The International Society for Rock Mechanics (ISRM) was founded in Salzburg in 1962 (Einstein 1989). The field of Rock Mechanics is taken to include all studies relative to the physical and mechanical behavior of rocks and rock masses. The ISRM Commission on Swelling Rock was formed in 1980, to provide a systematic treatment of the swelling rock problem in special. The problem was defined in the document “Characterization of Swelling Rock”, followed by an integrated approach to testing, analysis and design. The ISRM Commission is developing a number of suggested testing methods and a survey of analysis/design methods of which the testing procedures are an integral part (ISRM 2016).

The swelling tests described in the recommendations as of ISRM, which have its fundament from the work of Huder and Amberg (1970), can be grouped in tests under unconfined conditions (free swelling tests) and tests under oedometric conditions (Pimentel 2015). The suggestions on preparation, apparatus configuration, procedures and reporting of results are updated several times.

### **5.2 Different traditions of oedometric set-up and procedure in swelling tests**

The traditions at laboratory at NTNU and KiT are both based on the ISRM-standard. However, the institutes rely on two different versions which differ slightly from each other. In addition, minor modifications of the method suggestions on preparation of specimen, apparatus configuration and procedures may happen from project to project, which make a direct comparison of the results problematical. A detailed review of the differences is found in Appendix 9.

## NTNU

There exists a long tradition of testing the swelling potential of rock material at NTNU, due to the well documented problems with swelling gouge in weakness zones in different types of engineering projects (Nilsen 2016). The established practice in oedometric swelling pressure tests are under conditions of zero volume change, where the majority of tests have examined the swelling potential of swelling gouge, and to some extent pulverized and compacted mixed soil/rock samples. In some cases, intact rock structure specimen has also been assessed, as in the study of Pettersen Skippervik (2014).

NTNU have operated with the same oedometer apparatus in decades, except some minor modifications (Vistnes 2016). According to Nilsen (2016), the principle of the swelling pressure test is almost equivalent to the method for determining maximum axial swelling stress for swelling rocks as suggested by ISRM (1979 (1977)): *Part 2: Suggested methods for determining swelling and slake-durability index properties*, SM for *Determining of the swelling pressure index under conditions of zero volume change*.

During the recent years, the focus on swelling of intact rock has increased and new methods have been developed, including the 3D-swelling strain tests on rock cubes (Pettersen Skippervik 2014). However, these methods are most suitable for high-quality rocks which withstand the needed preparation, and will not be further reviewed in this thesis.

## KiT

At the university of Karlsruhe, the ISRM suggested methods (1989) sets the standard for the practice at laboratory. The methodology in oedometer swelling tests has been thoroughly assessed by researchers, and have resulted in modifications on both apparatus and the procedures.

E. Pimentel investigated the existing methods for swelling tests, presented in the paper *“Existing methods for swelling tests - a critical view”* (2015). He introduced a critical view of the existing laboratory testing methods for tunneling and foundations engineering purposes. At almost the same time, M. Vergara together with K. Balthasar and T. Triantafyllidis, studied the boundary conditions imposed on the rock samples in

swelling tests, included the set-up and configurations of oedometers. In the paper “*Comparison of experimental results in a testing device for swelling rocks*” (2014) they presents advantages and disadvantages with the traditional oedometric methodology suggested by ISRM and by Huder-Amberg.

The oedometer apparatus configuration and procedures are based on the work by Pimentel, Vergara, Balthasar and Triantafyllidis. The study of Vergara et al. (2014) highlights some specific factors which contribute to the understanding of the relationship between under which conditions the testing of swelling rocks are performed and the results of these tests. The performance of swelling tests at KiT is later modified due to these findings.

The methods reviewed in this thesis include the mentioned modifications, and the basement for the methodology relies on the following parts of the ISRM (1989) suggested methods: *Part 2: Determining the Maximum Axial Swelling Stress*, and *Part 4: Determining Axial Swelling Stress as a Function of Axial Swelling Strain*.

### **5.3 Overview of principles and variations of the oedometer swelling tests**

In oedometric swelling tests, the samples are radially constrained and the axial swelling pressure and/or axial deformation (strain) is measured. The maximum swelling pressure tests are meant to provide a rapid assessment of the swelling potential, and allow one to check if swelling may become a problem (Thakur & Singh 2005). They also provide a clue on the time it takes for the swelling pressure to develop. However, the boundary conditions in-situ are neither completely constrained or unconstrained and thus the time-aspect is controversial.

To get a more comprehensive picture of the swelling behavior of the rock, the tests producing the characteristic swelling pressure-swelling strain relationship (i.e. swelling tests including loading decrements) are preferred, allowing the time needed for the specimen to reach its potential. If a sufficient number of tests is performed, Grob`s line may be computed.

Table 5.1 shows the principal differences between different approaches to methods in *radially constrained* oedometer tests.

*Table 5.1 Overview of conditions under which radially constrained swelling pressure tests may be performed in oedometers*

<b>Method variations</b>	<b>Test configuration</b>	<b>Output</b>
<b>1) Zero volume change/zero deformation.</b> (maximum swelling pressure tests)	a) Single test (one wetting phase) or b) Multiple tests in cycles (several wetting and drying phases).	Maximum swelling pressure in axial direction, without data on swelling strain (deformation).  If cyclic tests are performed, eventual changes in swelling capacity between cycles may be evaluated.
<b>2) Cyclic tests with controlled axial deformation</b> (cyclic swelling tests)	Multiple tests in cycles, often starting with one or more wetting and drying cycles allowing zero deformation (as for 1b)).  The deformation allowed is fixed in each cycle.	Swelling stress-strain-relationship is obtained (due to Grob's "swelling law").  Changes in swelling capacity between cycles may be evaluated.
<b>3) Constant load</b> (maximum swelling strain test)	Test where the load acting on the specimen is kept constant during the wetting phase.  The test is intended to measure the axial swelling strain developed against a constant axial surcharge.  The load is often low or according to the supposed in-situ stress situation.	Maximum swelling strain/axial expansion.
<b>4) Tests under different axial loads</b> ( i.e. Huder -Amberg test)	Single test where a stepwise unloading is performed during the wetting phase.  The strains due to swelling are measured together with the load acting on the specimen.	Swelling stress-strain-relationship is obtained (due to Grob's "swelling law").

## APPROPRIATENESS OF THE OEDOMETER SWELLING TESTS

In the following, the appropriateness of the different variations of oedometer swelling tests to the assessment of hydropower tunnels in swelling rocks, will be reviewed.

### **Method 1 a/b: Zero volume change (zero deformation of specimen)**

The method is due to the ISRM suggested version of maximum swelling pressure tests, and is intended to measure the pressure necessary to constrain an undisturbed rock specimen at constant volume when immersed in water (Einstein 1996). The maximum swelling pressure is determined by totally prohibiting axial deformation and thus achieving complete volume constraint. It is quick, but sensitive to load increment and rate of loading (Nagaraj et al. 2009).

According to M. R. Vergara, the tests performed under “zero volume change” assumes the porous plates placed at the end faces of the sample to not deform. In fact, the deformation of the specimen is greater than zero because the measured deformation also includes the deformation of the porous plates. If the stiffness of the sample is low, as the case for most argillaceous rocks, this will not induce a big error. The greater the stiffness of the rock, the greater the resulting error in these tests (little deformation leads to high stress difference). The ISRM standard do not include this aspect, but at KiT, modifications are implemented to avoid uncorrect swelling pressure measurements.

The test principle of “zero volume change” can be argued the best way of simulating the worst case swelling pressure induced by a piece of rock of immediate vicinity from the floor of a cavity when exposed to water (Vergara 2016). The rock is naturally radially constrained by its rock surroundings and the axial swelling pressure is the main concern regarding the dimensioning of support. However, the validation of the arguments is dependent on several factors where each case project must be considered as a whole.

The test may be used to estimate the swell pressure in situ by comparison to documented experience for the rock stratum. By performing the test in cycles, an evaluation of changes in swelling potential between wetting and drying phases is possible (Vergara 2016).

### **Method 2: Cyclic swelling tests under conditions of controlled deformation**

This variant is developed by, and often used at KiT. The principle may be considered as a conjunction of the ISRM standard and the Huder-Amberg test. The cyclic

configuration of the test produces information on whether or not periodical exposure to humidity have effects on the swelling potential and behavior of the rock.

The test principle may be combined with tests performed as described in “Method 1”.

### **Method 3: Swelling under conditions of constant load**

Depending on the applied axial load, the test provides background for the evaluation of the vertical heave of a rock structure interface. If measurements on the in-situ stresses are available, the load may be chosen to simulate the actual stress situation in field. To obtain the maximum strain potential of a rock, is in most cases very time consuming (Vergara 2016).

### **Method 4: Tests under conditions of different axial loads**

The main purpose of this method configuration is to obtain the swelling pressure – swelling strain relationship, where the swelling pressure due to different loads are measured during a single test (no drying phases between the load decrements). The maximum strain potential of the rock may be reached, but is often very time consuming.

The extensive pre-loading procedure of the Huder-Amberg test may cause remarkable structural changes in the sample. ISRM have suggested a modified version of this test without the pre-loading to avoid the extent of damages to the specimens (ISRM 1994).

The oedometer swelling tests in this study are performed according to “Method 1” and “Method 2”, according to the tradition at NTNU and KiT.

## 6 The investigation procedure and material of this study

The investigation includes the planning and performance of both the field survey and the laboratory work. Some parameters have a greater effect on the rock structure system than others, and to quantify the intensity and dominance of each parameter is important to keep the right focus throughout the investigation (Handy 1971). Thus, the selection of methods to assess the rock material properties should be carefully considered in this phase.

The main concern of the laboratory work was to uncover the most important mechanisms inducing swelling behavior of the rocks at project site, with special attention on the response to moisture changes. This involves an assessment of the key material properties by well documented laboratory methods, and a comparison of the methodology of oedometer swelling tests in operation at NTNU and KiT.

Of main interest is the probable swelling pressure to be executed on the support of the planned water tunnels. Strength characteristics and mineralogical composition of the samples are two main factors which are assumed to control the swelling behavior of the rocks, and are thus considered as the most important focus along with the swelling pressure potential.

### 6.1 The planning process

The first step in the investigation was, from a theoretical view, to get an overview of the main swelling mechanisms of the rocks at the project area, and to assume which material key properties to be critical in terms of swelling behavior. Based on this, the methods which define the final test suite of this study, were selected according the obtained knowledge on principal parameters affecting swelling behavior of volcanic rocks. The equipment available at the laboratory, and the time frame for the work with the thesis, were also incorporated in the decisions.

The rock properties assumed as most important are the swelling potential, strength and mineralogy. However, other rock characteristics, as mineralogical variations, states of stress, effective porosity, permeability and pore water chemistry, will influence the response to excavation and the swelling behavior, but are not further reviewed in this thesis.

## **6.2 The theoretical background of the selected methods**

### **MINERALOGICAL ANALYSES**

As earlier described, the expansive character of intact rock is in many cases closely linked to the mineralogical composition. Of special interest is the content of swelling clay minerals, but other groups of minerals may also execute swelling behavior, such as zeolites. To assess the composition of the rocks and in special detect swelling minerals, two methods were chosen: X-ray diffraction (XRD) analysis on both bulk material and fine-fraction powder, and differential thermal analysis (DTA) on bulk material powder.

The XRD-analysis was considered as the most suitable for determining the mineralogical composition of the samples. Since some clay minerals may be obscured by more dominant d-spacing patterns in the analysis, DTA was chosen as a complementary test to detect eventual swelling clays overlooked by the XRD.

### **STRENGTH TESTS**

The idea behind the testing of strength was to produce comparable data for distinction of the samples regarding strength properties, and to see if any correlation could be drawn between the swelling behavior and strength of the different rock types. Assuming that the rock of apparently highest quality is the most likely rock for placing the tunnels, the most intact samples were prioritized. The main method scheduled was therefore the uniaxial compressive strength (UCS) test, which is considered as prominent for testing the samples of appropriate coherency and quality. The samples with abundant degradation and which were not up to standards for an UCS-test, were annotated as “weak” without any measurements.



To investigate the influence of water on the mechanical strength of the rocks, UCS-tests were decided performed on both laboratory-dry and saturated samples.

## SWELLING TESTS

Swelling behavior may appear as volume expansion and/or as development of pressure induced by the rock material on its surroundings (Kovari et al. 1998). Free swelling tests are assigned as index tests on volume expansion of bulk powder material prepared from the samples. Further, swelling tests under oedometric conditions were chosen to determine the potential swelling pressure initiated by the rocks when exposed to water. The swelling pressure tests were decided performed at two different institutes (NTNU and KiT) for comparison of methods and results, and to detect eventual differences which may influence the interpretation of the swelling potential of similar rocks.

### **6.3 Tried and rejected methods**

There exist several well documented methods for testing the mentioned rock material properties. However, since the samples were of extremely varying quality, not all preferred methods proved to be implementable in the test suite. The methods discussed and evaluated, but which were not implemented in the program of testing, are described in the following.

#### MINERALOGICAL ANALYSES

Scanning Electron Microscopy (SEM) was discussed as a possible method to determine the texture and crystalline structure of the rock samples in addition to their mineralogical composition. Due to considerations on the available resources, and since the test requires solid samples, the method was decided not implemented in the test suite.

Thin section analysis was also discussed as a possible method with similar intentions as for the SEM-method. The method was considered as performable but not to be

prioritized, due to the assumption of XRD to be satisfactory in terms of determining the main mineralogical constituents contributing to swelling behavior.

### STRENGTH TESTS

The point load test was considered, but there was not enough material of high quality to prepare samples for performing tests on all types of specimen. In addition, the Schmidt Hammer test and the Sklerometer test were evaluated and demonstrated (at NTNU), but failed due to widespread results on identical samples, and uncertainties regarding the frame conditions for the test procedure. The Needle Penetrometer test was also tried (at KiT), but failed because the needle broke when used on the strong/hard samples, and thus a comparison of the rock types was not obtainable.

### SWELLING TESTS

Swelling parameters may be obtained by measurements on swelling strain, swelling stress/pressure or a combination of both. The ISRM suggested methods (1979 (1977)) include determination of swelling strain, where NTNU/SINTEF (Dahl et al. 2013) has developed an apparatus where rock cubes can be tested to obtain 3D data on swelling characteristics. This method was considered, but rejected due to the varying quality of the samples.

### OTHER TESTS

The resistance of a rock sample to weakening and disintegration, may be measured by the slake-durability test (Franklin 1979). Since proper type and amount of material is scarce, this test was not prioritized in this study.

## 6.4 The investigation procedure

Based on the available background information at the time of preparing the test suite, the following investigation procedure was decided:

### Field work

- a) Get a visual overview of the topography and geology in the project area.
- b) Collect samples with characteristics representing the geology in the project case area, both the apparently weak and strong types of rock.
- c) Categorize the samples based on assumed main characteristics and swelling potential.

### Laboratory work

- d) Divide the collected and categorized samples in two groups (where each group contain exemplars of each sample) and perform oedometric swelling tests at the labs of both NTNU and KiT for comparison of methods and results.
- e) Obtain data on swelling potential, mineralogy and strength parameters on all collected samples by selected laboratory tests.

### Analyzes and comparisons

- f) Analyzing the results by:
  - Performing a qualitative description and comparison of mineralogy, swelling data and strength parameters for each rock type in the sample collection, and determine possible correlations between the different parameters.
  - Investigate methodology differences between NTNU and KiT, including the potential consequences of those for further calculations on the swelling pressure potential in situ.
  - Evaluate the swelling behavior in view of known mechanisms controlling swelling in volcanic rock types, based on the performed laboratory tests and field work.

During the laboratory work, the demand for adding samples to the strength tests appeared. These were picked from the stored sample assemblage. Because the swelling tests and mineralogical analyses were already finished at this stage, these additional samples were not included in the original plan of testing. Thus, both mineralogical data and swelling parameters on these samples lacked, but were later carried out with assistance of a fellow student.

## 6.5 Material

The material is collected from the borehole core samples stored at the office of SN Aboitiz in the Philippines. Since the sampling and categorization were made prior to any property investigations, and before achieving the documents from the feasibility study of SN Aboitiz, the samples are evaluated based on visual characteristics. The main cautions were homogeneity, coherency and grain size. In addition, color and appearance of any possible weakness planes was considered. Based on this, the categorizations *Rock type “strong”* and *Rock type “weak”* were obtained. Subsequently, the strong samples were further divided in basaltic and andesitic rock types based on assumptions of origin, where extra attention was given to the sub-category *Andesitic rock*.

In the following, the samples which are tested according to the original investigation procedure (i.e. excluded the additional samples which were tested later), are presented. A complete overview of the material (both original and additional samples) is given in Appendix 6.A.







The samples are named according to the borehole they are extracted from and the box number in which they were stored.

### ROCK TYPE “STRONG”

The main characteristic for the group categorized as “strong”, is the presence of core-lengths of >15 cm, and low degree of visible disintegration. The majority of the intact cores show appearance similar to the assumed andesitic rock type, as of AD-02 (box 12). The distribution of grain sizes and minerals appear as uniform throughout the

samples, and the color is medium grey with shades of green. In most of the samples, white minerals are visible by eye. These “white spots” are evenly distributed in the rock material, or allocated in small stripes. The white minerals are assumed to be laumontite filling the pore cavities and microfractures, and/or to be an alteration product of plagioclase. Table 6.1 show the tested samples in pictures.

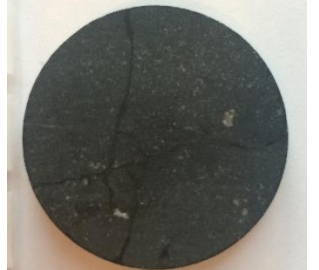
*Table 6.1 Samples of the category “strong”*





	AD-02, box 12 ~ 40.35–44.05 m	AD-06, box 25 ~ 86.30–87.30 m	AD-07, box 12 ~ 38.3 –41.00 m	AQD-02, box 12 ~ 42.25–45.60 m
<b>Rock type strong</b>				
				
<b>Assumed rock type</b>	Andesite	Andesite/basalt	Altered andesite	Altered basalt

## ROCK TYPE “WEAK”

The main characteristics of the “weak” group of samples are the heterogeneity regarding grain sizes and color. The samples break easily by hand force, and are thus considered to not withstand the requested preparation procedure of UCS-tests.

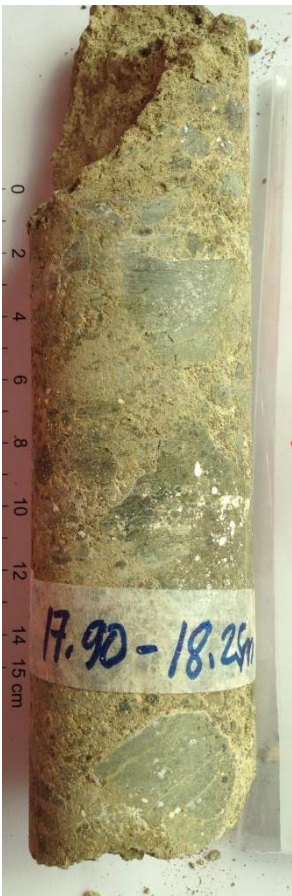
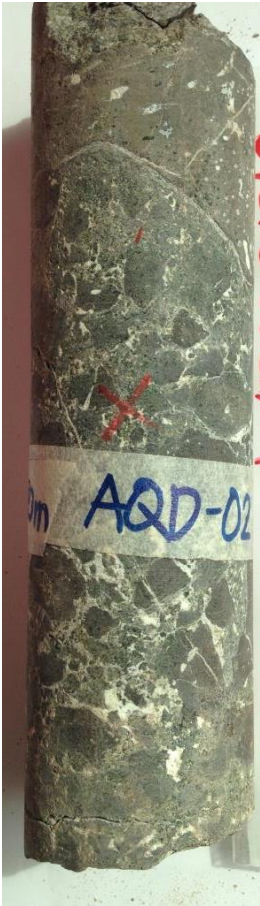
Table 6.2 below show the tested samples in pictures.

*Table 6.2 Samples of the category “weak”*

	AQD-02, box 5 ~ 16.70 – 20.60 m	AQD-02, box 6 ~ 20.60 – 24.60 m	APH-02, box 18 ~ 59.80 – 63.40 m
Rock type <i>weak</i>			
			
Assumed rock type	Volcanic agglomerate/breccia	Volcanic agglomerate/breccia	Altered andesite/basalt

## 6.6 The final test suite included the samples tested

The laboratory test suite consists of methods to determine the earlier described key properties of the selected rock material. Since some samples were added later in the investigation period, not all tests were performed on all samples. Figure 6.1 visualize both the samples in the “original” plan and the added samples, including which tests they underwent.

First, all samples in the original test suite were prepared and tested to obtain the wanted data. After the strength tests on “dry” samples were completed, a fellow student (Silje Elin Skrede) performed XRD-analyses, free swelling index tests, and maximum swelling pressure tests (on pulverized material), where these data lacked. The UCS-tests on wet (“saturated”) samples were the last to be performed, and there was not enough time to perform additional analyses/tests on those. At the end of the testing period, some of the samples were further analyzed by XRD due to some uncertainties detected at this stage.

The procedures of the laboratory tests are described in Appendix 6.B (free swelling tests, UCS-tests and mineralogical analyses), Appendix 5.A (oedometer tests at NTNU) and Appendix 5.B (oedometer tests at KiT). A summary of the tests performed is given in the following.

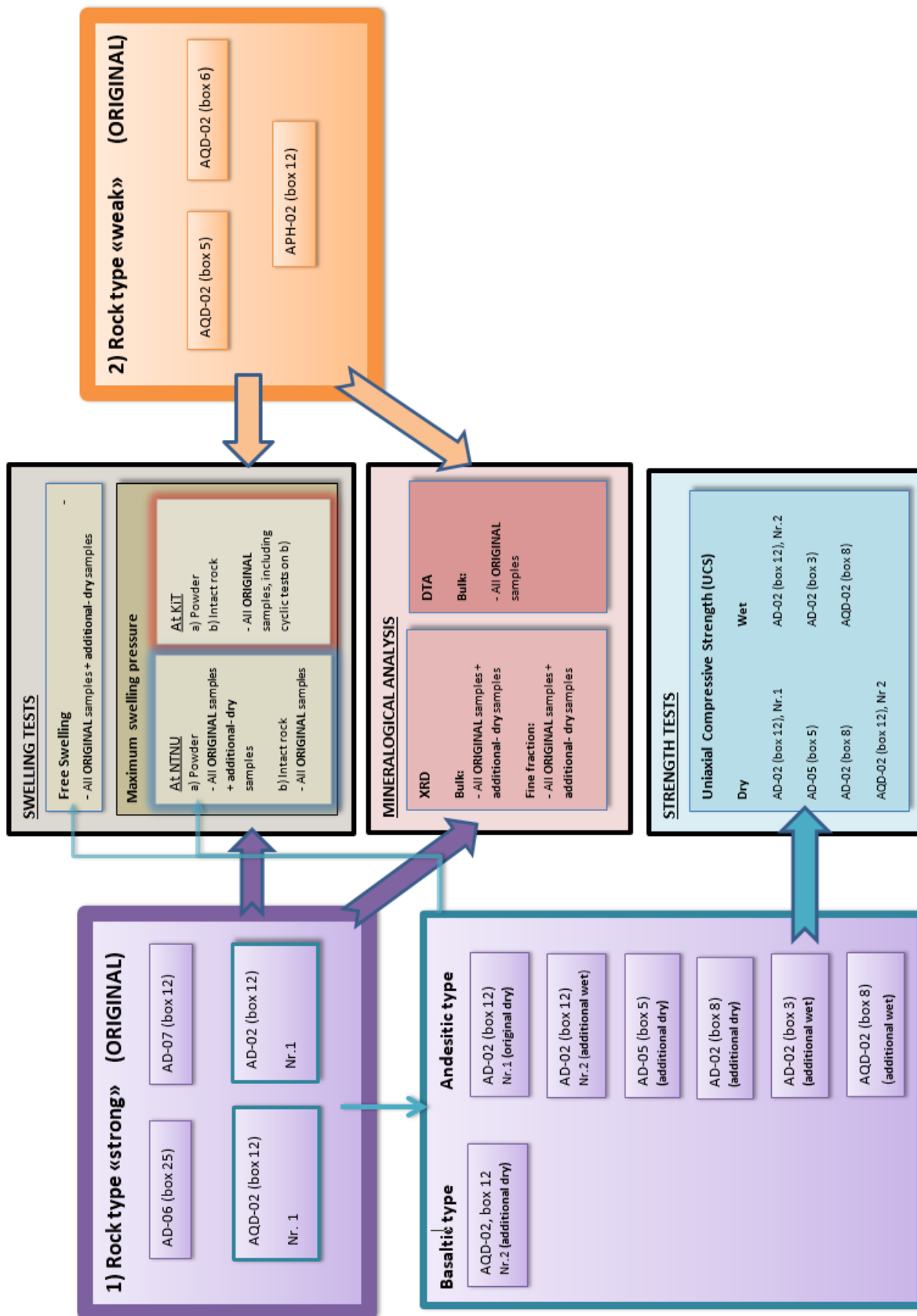

Figure 6.1 Overview of the test suite, including the samples tested



### **The mineralogical analyses: XRD and DTA**

X-ray diffraction analyses were performed on bulk powder to get an overview of the composition of the chosen samples. In addition, the fine fraction of all samples was carried out from gravel of each sample from the powder-preparation process, and treated with ethylene glycol to detect swelling minerals. Sample AD-02 (box 12), APH-02 (box 18) and AD-07 (box 12) underwent supplementary XRD-analyses on fine-fraction material extracted from intact rock pieces.

As a complementary test, differential thermal analyses, where the samples are heated up to 700 °C, were carried out on all samples belonging to the original plan of testing. The principle of the DTA is described in Appendix 6.D (in Norwegian).

### **The strength tests: UCS**

The aspect of strength properties of the different rock types is interpreted by UCS-tests, performed on samples of high enough quality in terms of core-lengths and the resiliency to preparation. Two samples categorized as “strong” from the original plan of testing fulfilled the criteria of the test, where extra attention was given to the samples categorized as “andesitic” and visual alike AD-02 (box 12). Because the UCS-tests demands severe amounts of material, additional cores with assumed similar origin and characteristics as AD-02 (box 12) were used for complementation, annotated as “andesitic rock”. The samples within this group differ slightly in characteristics as color, grain-size, and occurrence of “white spots” (laumontite).

Since water is known to have a considerable effect on the material properties, directly or indirectly, the strength tests were performed on both dry and saturated samples. The porosity and permeability of the samples are not known, but are assumed to be dynamic due to content of sensitive minerals and changes in stress, temperature and water content. Since absorption measurements not are carried out in this study, a verification of the degree of saturation cannot be established. However, the values obtained permits an awareness of the effect of water on the strength properties.

### **The swelling tests: Free Swelling Index tests and oedometer swelling tests**

Samples of the original plan of testing underwent different swelling tests, including oedometric tests and free swelling index tests. The samples which underwent oedometric testing at both NTNU and KiT, are obtained from similar cores.

#### ***Free swelling index tests:***

The free swelling tests are performed according to the tradition at NTNU, and are considered as supplementary index tests. The principle of the test is described in Appendix 6.C (in Norwegian).

#### ***Oedometer tests:***

At NTNU, single swelling pressure tests are performed on both powder and intact rock specimen (Table 5.1, Method 1a). At KiT, single swelling pressure tests are performed on powder, while the intact rock specimen underwent cyclic tests where a deformation of about 0.5 % was allowed in some of the cycles (Table 5.1, Method 1b and 2). The sample AQD-02 (box 5) did not survive the preparation of disc at NTNU, but is tested at KiT.

The configuration of the tests is described in chapter 5. The procedures are described in detail in Appendix 5.A and Appendix 5.B.

Table 6.3 Overview of the number of performed tests

			SWELLING TESTS			MINERALOGICAL ANALYSIS				STRENGTH TESTS	
			Free swelling	Maximum swelling pressure tests (NTNU + KIT)		XRD			DTA	UCS	
				Bulk powder	Bulk powder	Intact rock	Bulk powder	Fine fraction (from gravel)	Fine fraction (from intact rock)	Bulk powder	Dry
Rock type strong	ORIGINAL	AD-06 (box 25)	1	2	2	1	1	0	1	0	0
		AD-07 (box 12)	1	2	2	1	1	1**	1	0	0
		AD-02 (box 12) (1)	1	2	2	2	2	1**	1	1	0
		AQD-02 (box 12) (1)	1	2	2	1	1	0	1	1	0
	Additional (andesitic rocks)	AQD-02 (box 12) (2)	0	0	0	1	1	0	0	0	0
		AD-02 (box 12) (2)	1	1	0	1	1	0	0	0	1
		AD-05 (box 5)	1	1	0	1	1	0	0	1	0
		AD-02 (box 8)	1	1	0	1	1	0	0	1	0
		AD-02 (box 3)	0	0	0	0	0	0	0	0	1
		AQD-02 (box 8)	0	0	0	0	0	0	0	0	1
Rock type weak	ORIGINAL	AQD-02 (box 5)	1	1*	2	1	1	0	1	0	0
		AQD-02 (box 6)	1	2	2	1	1	0	1	0	0
		APH-02 (box 12)	1	2	2	1	1	1**	1	0	0

\* The sample could not be prepared at NTNU due to poor quality

\*\* Additional analyses on fine fraction powder extracted from intact rock structure material

## 7 Laboratory test results

### 7.1 Mineralogical analyses

#### X-RAY DIFFRACTION ANALYSIS (XRD)

The samples are tested as bulk material powder and fine fraction powder. The results presented in Table 7.1 are obtained from the samples belonging to the *original test suite*. For a complete overview of the XRD results, see Appendix 7.A.

The detected swelling minerals are marked with pink (swelling clay) and blue (laumontite). The minerals are listed alphabetical and given in bulk percentage.

*Table 7.1 Overview of the XRD-results obtained from samples of the original test suite*

Sample name	AD-02	AD-06	AD-07	AQD-02	AQD-02	AQD-02	APH-02
Minerals	(box 12)	(box 25)	(box 12)	(box 12)	(box 5)	(box 6)	(box 18)
(%)	(1)			(1)			
Analcime	0	0	12	0	0	0	0
Calcite	0	0	0	5	15	<1	6
Chalcopyrite	0	0	<1	0	0	0	0
Chlorite	4	9	22	12	0	0	9
Clinopyroxene/diopside	15	19	10	18	14	13	22
Corrensite/mixed layer	0	0	Yes*	0	Yes*	Yes*	Yes*
Enstatite	0	0	0	0	14	0	0
Epidote	0	0	0	0	0	0	6
Hematite	0	1	0	4	0	9	7
Hornblende	0	0	4	0	0	0	0
Laumontite	56	3	15	2	6	0	7
Magnesite	<1	<1	0	1	0	0	1
Magnetite	3	3	0	0	0	0	0
Microcline	0	12	22	0	0	0	0
Montmorillonite	0	0	0	0	9	8	0
Muscovite	0	0	0	0	0	0	0
Phrenite	0	0	0	16	0	0	0
Plagioclase/albite	10	38	13	42	35	49	41
Pyrotite 3T	0	<1	0	0	0	0	<1
Quartz	11	13	<1	0	7	0	0
Yugawaralite	0	0	0	0	0	18	0

\* Not quantified amount

## DIFFERENTIAL THERMAL ANALYSIS (DTA)

All samples are tested as bulk material powder and heated up to 700°C. The results presented in Table 7.2 are obtained from the samples belonging to the *original test suite*. The diagrams are found in appendix 7.C.

*Table 7.2 Results of the DTA*

<b>Sample</b>	<b>Result</b>
AD-02, box 12 (1)	No clear thermal peaks in the swelling clay interval. Several undefined thermal reactions are detected.
AD-06, box 25	No thermal peaks in the swelling clay interval. A clear endothermic peak in the quartz-interval is detected.
AD-07, box 12	Thermal peak in the swelling clay interval is detected. A clear endothermic peak in the quartz-interval is detected.
AQD-02, box 12 (1)	No thermal peaks in the swelling clay interval. A clear but undefined endothermic peak around 625 °C.
AQD-02, box 5	Clear endothermic peak in the swelling clay interval. A clear but undefined endothermic peak around 550 °C.
AQD-02, box 6	Clear endothermic peaks in the swelling clay interval. A clear but undefined endothermic peak around 570 °C.
APH-02, box 18	An endothermic peak is detected in the swelling clay interval. A clear endothermic peak in the quartz-interval is detected.

## 7.2 Strength (UCS) tests

The UCS tests are performed on both dry and wet samples. Different samples of assumed andesitic origin are chosen for the tests, except one sample (AQD-02 (box 12), dry test) which is assumed of basaltic origin.

A complete overview, including pictures of the failure modes, is given in Appendix 7.B. In the following, the most central data are presented.

## CENTRAL DATA AND FAILURE MODES OF DRY SAMPLE TESTS

Table 7.3 show central data including the failure modes of the samples tested in dry condition.

*Table 7.3 Test results and central data of the specimen in dry UCS tests*

Sample (dry)	Rock type	Height/diameter (mm)	Weak zones	Mode of failure	Poissons Ratio, $\nu$	E-module (GPa)	UCS $\sigma_{cf}$ (MPa)	Loading control
<b>AD-02, box 12</b>	Medium coarse-grained andesitic rock	161.10 / 60.60	No	Axial splitting with complex failure	0.43	17.32	112.5	30 $\mu\epsilon$ /sek
<b>AD-02, box 8</b>	Fine-grained andesitic rock	161,85 / 60.70	No	Axial splitting with complex failure	0.42	51.81	259.3	15 $\mu\epsilon$ /sek
<b>AD-05, box 5</b>	Fine-grained andesitic rock	139.75 / 60.25	No	Axial splitting	0.30	22.41	27.6	-300 $\mu\epsilon$ /min
<b>AQD-02, box 12</b>	Fine-grained basaltic rock	161,90 / 60.61	Yes	Shear failure along weak zone	0.22	42.57	103.6	-250 $\mu\epsilon$ /min

## CENTRAL DATA AND FAILURE MODES OF WET SAMPLE TESTS

Table 7.4 show central data including the failure modes of the samples tested in wet condition.

*Table 7.4 Test results and central data of the specimen in wet UCS tests.*

Sample (wet)	Rock type	Height/diameter (mm)	Weak zones	Mode of failure	Poissons Ratio, $\nu$	E-module (GPa)	UCS $\sigma_{cf}$ (MPa)	Loading control
<b>AD-02, box 12</b>	Medium coarse-grained andesitic rock	138.79/ 61.10	No	Simple shear failure, probably along an invisible weak zone	0.18	3.4	21.9	3600 $\mu\text{Ea}/\text{min}$
<b>AQD-02, box 8</b>	Fine-grained andesitic rock	162.00/ 60.80	No	Complex shear failure/fracturing due to minor pre-existing cracks	0.49	34.56	205.5	-400 $\mu\text{Er}/\text{min}$
<b>AD-02, box 3</b>	Fine grained andesitic/ basaltic rock	161.5/ 60.60	Yes	Complex shear failure with multiple fracturing	0.41	18.71	58.7	1800 $\mu\text{Ea}/\text{min}$

### 7.3 Swelling tests

Free swelling index tests and oedometer tests are performed on all samples. The oedometer tests are performed on both powder samples and intact rock structure specimens. Cyclic swelling tests were implemented at KiT, where some of the cycles were under condition of controlled deformation.

## FREE SWELLING INDEX TESTS

Four of the samples in the free swelling index tests are active, i.e. expand when water is added. Free swelling of < 100 % is characterized as “low”, 100-140 % as moderate, 140-200% as “high” and >200 % as “very high” (Nilsen & Palmstrøm 2000). Table 7.5 show an overview of the results, including two frequently used systems of classification/characterization.

*Table 7.5 Classification and characterization of the performed free swelling index tests (Rokoengen 1973, Nilsen & Palmstrøm 2000)*

<b>Sample</b>	<b>Classification due to Rokoengen (1973)</b>	<b>Swelling characterization due to Nilsen &amp; Palmstrøm (2000)</b>
<b>AD-02, box 12</b>	FS = 82, slightly active	Low
<b>AD-06, box 25</b>	FS = 70, inactive	Low
<b>AD-07, box 12</b>	FS = 110, active	Moderate
<b>AQD-02, box 12</b>	FS = 75, inactive	Low
<b>AQD-02, box 5</b>	FS = 182, active	High
<b>AQD-02, box 6</b>	FS = 145, active	High
<b>APH-02, box 18</b>	FS = 145, active	High

The samples with the highest Free Swelling Index (FS), is AQD-02 (box 5 and 6), while the sample showing the lowest number is AD-06 (box 25).

## OEDOMETER (POWDER) RESULTS

The powder used in the tests is prepared at NTNU, as described in Appendix 6.B. The test configuration is “zero volume change”, where the maximum swelling pressure is



measured. The values given in Table 7.6 show the maximum swelling pressures obtained during the time of the test (24 hours).

*Table 7.6 Maximum swelling pressures in oedometer powder tests.*

Samples		Maximum swelling pressure (powder) MPa	
		NTNU	KiT
Rock type «strong»	AD-02, box 12 (1)	0.33	4.88
	AD-06, box 25	0.06	0.38
	AD-07, box 12	0.10	2.42
	AQD-02, box 12 (1)	0.10	0.41
Rock type «weak»	AQD-02, box 5	0.43	3.03
	AQD-02, box 6	0.35	2.87
	APH-02, box 18	0.12	0.82

A complete overview of the results is given in Appendix 7.D.

#### OEDOMETER (INTACT ROCK STRUCTURE) RESULTS

An overview of the intact rock structure results is given in Table 7.7. The results from NTNU are obtained by single “zero volume change” tests. The results from KiT are obtained by cyclic tests, where some samples underwent cycles under conditions of “controlled deformation”, marked with “\*”. The maximum swelling pressure obtained in each cycle is presented. The highest values obtained by the cyclic tests is in marked with bold text.

Table 7.7 Overview of all tests performed on intact rock structure discs. All values are given in MPa.

Disc	NTNU	KARLSRUHE							
	Only cycle	1.cycle	2. cycle	3. cycle	4. cycle	5. cycle	6.cycle	7. cycle	8. cycle
<b>AD-02, box 12</b>	1.33	<b>2.08</b>	1.68	1.58	1.74	1.91	1.85	0.61*	-
<b>AD-06, box 25</b>	0.01	<b>0.05</b>	0.04	<b>0.05</b>	-	-	-	-	-
<b>AD-07, box 12</b>	0.22	0.13	0.14	0.15	0.17	<b>0.18</b>	-	-	-
<b>AQD-02, box 12</b>	0.09	0.04	0.04	0.04	-	-	-	-	-
<b>AQD-02, box 5</b>	-	<b>0.38</b>	0.26	0.25	0.13*	0.20*	-	-	-
<b>AQD-02, box 6</b>	0.08	0.17	0.17	0.18	0.09*	0.14*	<b>0.19*</b>	0.18*	0.05*
<b>APH-02, box 18</b>	0.04	0.49	0.48	0.52	0.17*	0.52*	0.48*	0.57*	<b>0.74*</b>

\* = Controlled deformation allowed by reducing the load acting on the specimens.

The results with all data and graphs are found in Appendix 7.E.

## 8 Analysis of the results

One objective in this study is to assess the rock material key properties, with focus on the swelling potential of the rock at case project site. The short and especially long term evolution of swelling, weakening and/or disintegration due to wetting and drying processes, may only be partly reflected by the laboratory results, even for similar conditions of loading and water content (Foged et al. 2006). The external factors characterizing the environment from which the samples are obtained will influence the behavior of the rock, and thus the laboratory results should be reviewed in the light of these features of each case area.

In the following, an analysis of the laboratory method results will be presented, based on a *qualitative* evaluation of the tests performed.

### 8.1 Analysis of the mineralogy

To determine the swelling potential of a rock, and to interpret the response to water, knowledge of its mineralogical composition is critical. A combination of different types of swelling may occur simultaneous or follow each other, and often different groups of swelling minerals are present in the same rock.

In the following, the findings of the XRD-analysis and DTA are presented.

#### SUMMARY OF THE MINERALOGICAL ANALYSES

Table 8.1 show an overview of the main constituents of the samples belonging to the original test suite, based on the XRD-analyses and DTA. In addition, the detection of eventual swelling minerals is specified.

*Table 8.1 Overview of the mineralogical composition and detected swelling minerals of the samples belonging to the original test-suite*

<b>Sample</b>	<b>Main constituents</b>	<b>Detected swelling minerals</b>	<b>Thermal reactions in swelling clay interval</b>	<b>Comments</b>
<b>AD-02, box 12 (1)</b>	Laumontite, clinopyroxene, quartz and plagioclase	Laumontite	Yes (undefined)	No swelling clay confirmed by the DTA analysis, but several undefined thermal reactions find place during the entire heating process. May be due to dehydration of laumontite.
<b>AD-06, box 25</b>	Plagioclase, clinopyroxene, quartz and microcline.	None (small amounts of laumontite)	No	Clear thermal peak (DTA) in the quartz interval.
<b>AD-07, box 12</b>	Microcline, chlorite, laumontite, plagioclase and analcime.	Corrensite, laumontite	Yes	Thermal peak (DTA) in the chlorite-interval indicate swelling of corrensite.
<b>AQD-02, box 12 (1)</b>	Plagioclase, clinopyroxene, phrenite and chlorite.	None (small amounts of laumontite)	No	A clear but undefined thermal peak (DTA) around 625 °C.
<b>AQD-02, box 5</b>	Plagioclase, calcite, clinopyroxene and enstatite.	Montmorillonite, montmorillonite-chlorite (mixed layer), laumontite	Yes	Classic thermal peaks in the smectite-interval (DTA).
<b>AQD-02, box 6</b>	Plagioclase, yugawaralite, clinopyroxene, hematite and montmorillonite.	Corrensite, montmorillonite	Yes	Classic thermal peaks in the smectite-interval (DTA).
<b>APH-02, box 18</b>	Plagioclase, clinopyroxene, chlorite, hematite and laumontite.	Corrensite, laumontite	Yes	Thermal peak (DTA) in the chlorite-interval indicate swelling of corrensite.

## COMMENTS ON THE MINERALOGICAL ANALYSES

All samples hold high contents of silica minerals, mainly plagioclase, pyroxenes and quartz, which are typical forming minerals of igneous rocks. Some samples show alteration- and weathering products, such as laumontite, clay-minerals and chlorites. In special, a correlation between the amount of plagioclase and laumontite is detected. The amount of plagioclase versus the amount of laumontite is assumed to reflect the degree of weathering and/or alteration processes in the region/depth of rock mass from which the samples are extracted.

The analyses were mainly performed to detect swelling clay minerals, whereby four out of seven samples contain either smectites or mixed-layer smectites. The DTA confirms the detection of swelling clay minerals from the XRD-analysis. In addition, some unexplained thermal reactions find place in several samples, included those where swelling clay minerals are not detected by XRD. These reactions may be due to a dehydration of laumontite.

## 8.2 Analysis of the UCS-test results

The rock type of focus in the UCS tests is the “andesitic” rock type visual alike sample AD-02 (box 12). After the tests were performed, some mineralogical differences between the samples within the andesitic group were detected. The differences are given in Table 11.1 (chapter 11).

The UCS tests were performed on both dry and saturated samples, to see how the strength-properties are influenced by water. To analyze eventual changes in the strength as a cause of saturation, the Poisson`s Ratio, E-module and failure modes are briefly evaluated in addition to the UCS-value obtained. A summary of the main findings in the UCS tests is given in Table 8.2 and Table 8.3.

## EVALUATION OF THE FAILURE MODES

An overview of the failure modes together with the central data from the tests, is presented in the following. In addition, the classification of the rock strength based on the suggestion from ISRM (1978) is given. The basement for the evaluation and classification is given in Appendix 8.A.

### **Dry tests**

In the dry tests of the andesitic rock types, all samples show axial splitting with or without complex failure. Brittle rocks may contain numerous randomly distributed micro-flaws such as cracks, pores or weak inclusions, and when they are loaded in compression, cracks may nucleate from these flaws and continue to grow with increasing axial compression (Tang et al. 2005). The axial splitting of the samples indicates such a mechanism, since the cracks tend to become parallel to the direction of the load under these conditions, but the lack of complementary tests prevents a final statement of this assumption. The axial splitting of sample AD-02 (box 8) is shown in Figure 8.1.



*Figure 8.1 Axial splitting of AD-02 (box 8)*

When studying the loading curve of sample AD-02 (box 12), the slope is slowly increasing which indicate a slow stress response due to loading (Figure 8.2). One explanation may be high porosity and/or numerous micro-fissures in the rock material which “collapse” and adsorb the stresses during loading. When all pores and fissures are closed, the rock material itself becomes stressed until the maximum compression strength is reached. A detailed description of the sample AD-02 (box 12) is given in Appendix 10.

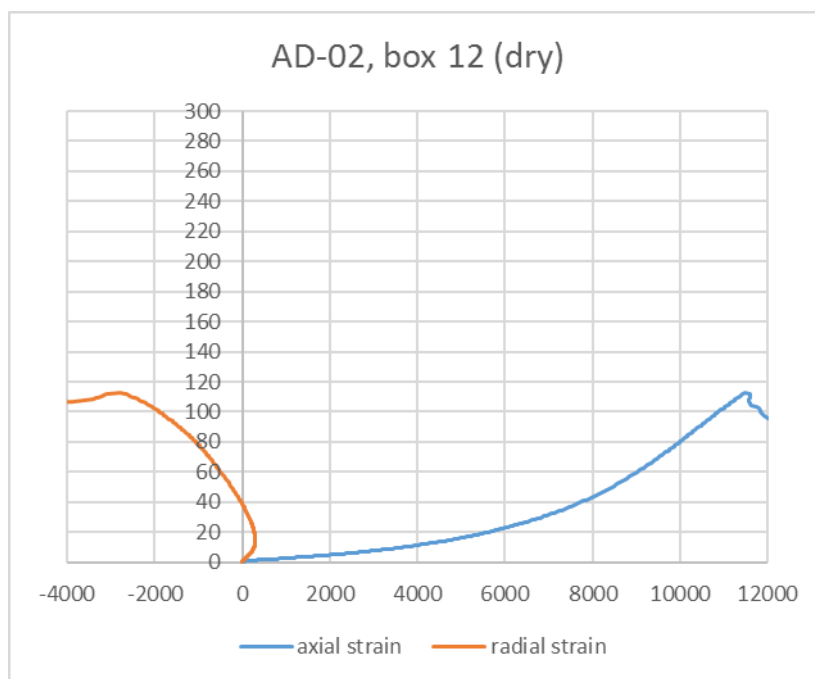

*Figure 8.2 Loading curve of sample AD-02 (box 12), where the vertical axis shows the stresses in MPa and the horizontal axis shows the strain*

The average UCS-result for the andesitic rock type is 133.13 MPa, but due to the earlier mentioned variabilities within the sample group and the extraordinary variability of the results, the average strength value is not considered as informative.

The sample AQD-02 (box 12) is the only sample assumed to be of basaltic origin, and show shear failure along a visible weak zone. Thus, the strength result does not reflect the strength of the rock material, since the failure occur as a consequence of discontinuities cutting through the sample.

The results of the UCS tests on dry samples are given in Table 8.2. AQD-02 (box 12) (grey text) is assumed of basaltic origin, and is thus not counted for in the average value calculation.

Table 8.2 UCS results of the tests in dry condition.

<b>Dry tests</b>					
<b>Sample</b>	<b>Poissons Ratio, <math>\nu</math></b>	<b>E-module (GPa)</b>	<b>UCS <math>\sigma_c</math> (MPa)</b>	<b>Classification UCS (ISRM 1978)</b>	<b>Failure mode</b>
<b>AD-02, box 12 (1)</b>	0, 43	17, 32	112, 50	Strong	Axial splitting with complex failure
<b>AD-02, box 8</b>	0, 42	51, 81	259, 30	> Very strong	Axial splitting with complex failure
<b>AD-05, box 5</b>	0, 30	22, 41	27, 60	Medium strong	Axial splitting
<b>AQD-02, box 12</b>	0, 22	42, 57	103, 6	Very strong	Shear failure along a visible weak zone
<b>Average</b>	<b>0.38</b>	<b>30.51</b>	<b>133.13</b>	<b>Very strong</b>	

### **Wet tests**

The failure modes of the wet samples show a greater variance than for the dry samples, ranging from modes of simple shear to multiple fracturing (Figure 8.3). The results are given in Table 8.3.





*Figure 8.3 Complex fracturing of sample AQD-02 (box 8)*

The samples AQD-02 (box 12) and AQD-02 (box 8) have visible discontinuities prior to the tests, which may explain the modes of failure for those specimen. However, pre-existing weaknesses may also exist in the other samples, but a detection requires the use of optical methods. Thus, any clear explanations on the response to compressive stress and accompanied failure modes cannot be made.

Table 8.3 UCS-results of the tests in wet condition

Wet tests					
Sample	Poissons Ratio, $\nu$	E-module (GPa)	UCS $\sigma_{cf}$ (MPa)	Classification UCS (ISRM 1978)	Failure mode
AD-02, box 12 (2)	0.18	3.40	21.90	Weak	Simple shear failure, probably along an invisible weak zone
AQD-02, box 8	0.49	34.56	205.50	Very strong	Complex shear failure/fracturing due to minor pre-existing cracks
AD-02, box 3	0.41	18.71	58.70	Strong	Complex shear failure with multiple fracturing
<b>Average</b>	<b>0.36</b>	<b>18.89</b>	<b>95.36</b>	<b>Strong</b>	

#### COMMENTS ON THE UCS TEST RESULTS

In terms of rock mechanical behavior, it is reasonable to group the samples AD-02 (box 3, wet), AD-02 (box 12, dry) and AD-02 (box 12, wet) together. A corresponding grouping may be applied on the samples AQD-02 (box 8, wet) and AD-02 (box 8, dry). These assumptions are made mainly based on the development of stresses and strains during loading, and are reflected in the shape of the loading curves (found in Appendix 7.B). However, it is not possible to verify that the samples truly belong together as suggested, due to the low number of tests and the lack of other comparable measurements performed on the samples.

Another trend which is detected, is the lowering of E-modulus and UCS, and the simultaneous increase of Poisson`s ratio when comparing wet contra dry test results. However, this finding is not investigated further.

It is an overall trend that the UCS-value decreases as the samples are saturated. Reasonable theories may be drawn based on the known degrading effect of water on different rock types. For example, an assumption of an induced micro-fracturing of the rock samples as a result of expansion of swelling minerals may be reasonable, for the samples containing laumontite or swelling clay/chlorite. Changes in the rock structure

and mineralogy are known effects for rock types prone to swelling, especially if deformation of the rock is possible (Vergara & Triantafyllidis 2016). An increased permeability may lead to further degradation of the strength properties due to increased water absorption. The degree of degradation is assumed to be time-dependent.

A direct comparison of strength and failure modes should not be accomplished without considering the differences between the samples tested, in terms of mineralogy and the presence of flaws and discontinuities (Vistnes 2016). When considering the strength of the rock in the interest of underground engineering projects, the rock strength and existing discontinuities at larger scales should always be evaluated as a whole, and supplementary tests should be carried out during construction to verify the findings of importance.

### **8.3 Analysis of the swelling results**

When swelling occurs in igneous rocks as basalt and andesite, the expansion of swelling clay minerals is the most frequent explanation. In addition, some studies have proved a link between the presence of active zeolites and swelling behavior of rocks (Boniface 1997, Kranz et al. 1989). As previously mentioned, moisture expansion due to a high porosity may also be a possible explanation for the swelling of rocks, especially in cases where no swelling clay is detected (Ruedrich et al. 2011, Wedekind et al. 2013). Both laumontite swelling and moisture swelling may happen within the rock mass, where spatial and temporal variations makes the swelling zones difficult to detect. In contrast, the swelling gouge fillings in faults and weakness zones, as typical for the Norwegian geological environment, mainly causes swelling enclosed in these zones.

The oedometer swelling tests under zero volume change intend to measure the pressure necessary to constrain an undisturbed rock specimen at constant volume when immersed in water, and should be used as an upper limit of swell pressure under the specified laboratory conditions (Foged et al. 2006). The tests performed as cycles intend to simulate the conditions in situ, as in cases where a water tunnel is periodically filled and emptied during its lifetime.

## SUMMARY OF THE SWELLING TEST RESULTS

Table 8.4 shows an overview of the results obtained from the free swelling index tests and oedometer tests at both NTNU and KiT, and include the detected swelling minerals from the XRD-analyses. For the results obtained from KiT, the maximum swelling pressures obtained from the cyclic tests under conditions of *zero volume change*, are given.

*Table 8.4 Overview of the swelling test results*

Sample		Swelling minerals	Maximum swelling pressure (powder) MPa		Maximum swelling pressure (intact structure) MPa		Free swelling
			NTNU	KiT	NTNU	KiT	
<b>Rock type strong</b>	<b>AD-02, box 12 (1)</b>	Laumontite (56 %)	0.33	4.88	1.33	2.08	82
	<b>AD-06, box 25</b>	Laumontite (3 %)	0.06	0.38	0.01	0.05	70
	<b>AD-07, box 12</b>	Laumontite (15 %) Corrensite (?)	0,10	2.42	0.22	0.18	110
	<b>AQD-02, box 12 (1)</b>	Laumontite (2 %)	0.10	0.41	0.09	0.04	75

Table 8.4 continuing

Rock type «weak»	<b>AQD-02, box 5</b>	Montmorillonite (9%)	0.43	3.03	-	0.38	182
		Laumontite (6 %)					
		Mixed-layer smectite (?)					
	<b>AQD-02, box 6</b>	Montmorillonite (8%)	0.35	2.87	0.08	0.18	145
		Corrensite (?)					
	<b>APH-02, box 18</b>	Corrensite (?)	0.12	0.82	0.04	0.52	145
Laumontite (7 %)							

(?) = amount not quantified

#### COMMENTS ON THE RESULTS FOR TESTS UNDER CONDITIONS OF “ZERO VOLUME CHANGE”

Swelling of rocks express itself either by a volume expansion, or by inducing pressure on the surroundings. When volume expansion is prohibited by surrounding rock and/or support, the stress will increase until a maximum value is reached (Barla 2008). This maximum swelling pressure induced by the rock on its surroundings imitate the “worst case scenario” of stress conditions in a tunnel if a volume increase is completely prohibited (Vergara 2016). By testing under conditions of “zero volume change”, the maximum swelling pressure potential of the rock may be evaluated.

The evaluation of the swelling characteristics is made on the strong and weak group of rocks, respectively.

#### Rock type “strong”

None of the samples contains smectite minerals according to the mineralogical analysis, except AD-07 (box 12), which contain some corrensite (mixed-layer smectite-chlorite). All samples contain the zeolite *laumontite*, which is assumed to hold a swelling potential.

Three out of four samples show low to medium swelling pressures for both powder samples and intact rock structure samples, according to the NTNU-characterization system. Sample AD-02 (box 12) stands out with a pressure characterized as high/very high. The intact rock structure sample show a higher maximum pressure than the powder sample, at the test performed at NTNU. The same trend, with higher values for intact structure, also applies for AD-07 (box 12). This finding is somehow irrational due to the theory of swelling clay minerals to be the main cause of swelling behavior of rocks, since it is likely to believe that more water will be available to react with the swelling minerals in the powder samples. However, the same trend is not seen in the tests performed at KiT, where all samples show a higher degree of swelling for pulverized samples.

The high maximum swelling pressure for sample AD-02 (box 12) is correlated to its high content (56%) of laumontite. This finding is especially interesting, since the rock type is of high rock quality and do not contain any swelling clay minerals. A detailed review of sample AD-02 (box 12) is given in Appendix 10.

### **Rock type “weak”**

All three samples tested contain swelling clay minerals, and show medium/high swelling pressures in the tests performed on powder samples. For the NTNU tests on intact rock structure, only two out of three samples did withstand the preparation. The measured values are characterized as low due to the NTNU characterization system, and it is a clear tendency of higher swelling pressures for powder than intact structure samples.

### **COMMENTS ON THE RESULTS OF CYCLIC TESTS UNDER CONDITIONS OF «CONTROLLED DEFORMATION»**

At KiT, cyclic tests were performed on intact rock structure specimens. Some of the cycles were under conditions of “controlled deformation”, as earlier described. The results are given in chapter 7 and Appendix 7.E.

For intact rock structures, especially where deformation is allowed as is the case in most tunnels, the quantity of active minerals together with sufficient low strength of the rock,

may cause fissuring and/or crazing (Vergara & Triantafyllidis 2016). The increase of secondary rock porosity may result in further swelling and/or disintegration. The eventual increase in porosity may also permit moisture expansion to contribute to a lower durability and strength of the rock after swelling has occurred (Ruedrich et al. 2011).

When deformation is allowed, the maximum swelling pressure normally decrease compared to the previous cycles (Vergara & Triantafyllidis 2015). In cycles where deformation is allowed, the maximum swelling pressure normally increase gradually after some cycles under these conditions. The interesting part is to see if the swelling pressure exceed the maximum value of tests where no deformation is allowed.

Table 8.5 show a comparison of the maximum swelling pressures obtained by the oedometric swelling tests under different test configurations (*zero volume change* and *controlled deformation*) at KiT. In cases where the swelling pressure reach a higher value when deformation of the specimen is allowed, the cycle number is specified behind the result. In cases where the swelling pressure decrease when deformation of the specimen is allowed, this is specified with “decreasing” only. Not all samples have undergone cycles where deformation was allowed, marked with “-“.

*Table 8.5 Comparison of the maximum obtained swelling pressures by tests on intact rock structure specimen (discs)*

KiT		
Test config. Sample	Zero volume change	Controlled deformation
AD-02, box 12	2,08	Decreasing
AD-06, box 25	0,05	-
AD-07, box 12	0,18	-
AQD-02, box 12	0,04	-
AQD-02, box 5	0,38	Decreasing
AQD-02, box 6	0,18	0,19 (6)
APH-02, box 18	0,52	0,74 (8)

As can be seen from Table 8.5, two samples have an increased swelling capacity when deformation is allowed, whereby sample APH-02 (box 18) shows the highest increase.

The increase in swelling potential corresponds to the findings of Vergara and Triantafyllidis (2015), in the study of volcanic rocks from Andes (Chile). The suggested cause of this increase is due to a destruction of the rock structure when the rock material is exposed to cyclic wetting and drying phases where the rock is allowed to expand (Vergara & Triantafyllidis 2015). Small increments in deformation is assumed enough for the permeability to increase and thus more water is consumed by swelling minerals.

The final conclusion on the evolution of swelling pressures due to cyclic tests under conditions of controlled deformation is not drawn, due to limited number of tests performed. To do so, more tests should be performed for a longer time period.

A comparison of the differences between NTNU and KiT in the oedometer tests, will be further reviewed in chapter 9.

#### CLASSIFICATION OF THE SWELLING RESULTS

There is no tradition at KiT to categorize the swelling pressures. The classification of swelling pressures according to the NTNU tradition, is based on swelling gouge (Vistnes 2016). A corresponding characterization system for intact rock structure samples is not developed or in use (Vistnes 2016). The classification system used for the swelling pressure tests at NTNU is given in Appendix 7.E.

The classification of the samples of the original test suite is summarized in Table 8.6. The results used for the classification are those obtained at NTNU, since the methodology behind the KiT results differ. The classification system in the free swelling tests is due to Nilsen & Palmstrøm (2000), as earlier described.



Table 8.6 Classification of swelling potential based on performed swelling tests at  
NTNU

Sample	Swelling potential (free swelling tests)	Swelling potential (swelling pressure tests)
AD-02, box 12 (1)	<i>Low</i>	Powder: <i>High</i> Intact rock: <i>Very high</i>
AD-06, box 25	<i>Low</i>	Powder: <i>Low</i> Intact rock: <i>Low</i>
AD-07, box 12	<i>Moderate</i>	Powder: <i>Low/Moderate</i> Intact rock: <i>Moderate</i>
AQD-02, box 12 (1)	<i>Low</i>	Powder: <i>Low/Moderate</i> Intact rock: <i>Low</i>
AQD-02, box 5	<i>High</i>	Powder: <i>High</i> Intact rock: -
AQD-02, box 6	<i>High</i>	Powder: <i>High</i> Intact rock: <i>Low</i>
APH-02, box 18	<i>High</i>	Powder: <i>Medium</i> Intact rock: <i>Low</i>

#### 8.4 Linkage between mineralogy, strength and swelling potential: Comparison of two chosen samples

As earlier discussed, some samples show a mineralogical composition indicating that the forming processes and origin are similar, but that a difference in the degree of alteration and/or weathering are reflected in the material properties. A comparison of the samples AD-02 (box 12) and AD-02 (box 8) is used as an example in the following. AD-02 (box 12) belongs to the original test suite, while AD-02 (box 8) is used as a complementary sample in the UCS tests. Both samples have undergone mineralogical analysis, UCS-tests in dry condition, and oedometer swelling tests of powder specimens. Table 8.7 show an overview of the main sample characteristics of the two samples.

Table 8.7 Main characteristics of AD-02 (box 12) and AD-02 (box 8)

	AD-02 box 12	AD-02 box 8
<b>Depth</b>	~ 40.35 – 44.05 m	~ 29,7-30,15 m
<b>Rock type /category</b>	Medium to coarse grained andesitic rock/ “Rock type strong”	Fine grained andesitic rock/ “Rock type strong” (complementary sample)
<b>Main minerals</b>	Laumontite (56 %) Clinopyroxene (15 %) Quartz (11 %) Plagioclase (10.%)	Plagioclase (60%) Quartz (10%) Amphibole (7%) Laumontite (7%)
<b>Content of swelling clay</b>	0 %	0 %
<b>Swelling pressure potential of powder samples (measured at NTNU)</b>	Very high 0.33 MPa	Very low 0.08 MPa
<b>UCS-strength</b> <b><u>Dry condition</u></b>	Strong 112.5 (dry)	Very strong 259.3 (dry)

As can be seen from Table 8.7, the main mineralogical difference is the content of laumontite VS. plagioclase. AD-02 (box 8) show a high content of plagioclase and relatively low content of laumontite. The opposite distribution applies for AD-02 (box 12). During alteration processes, plagioclase is often replaced by secondary minerals as zeolites, which may change the properties of the rock. In this case, the main difference is the swelling potential, whereby AD-02 (box 12) hold a very high maximum swelling pressure in the oedometer powder test under conditions of zero volume change. AD-02 (box 8) hold a correspondingly very low swelling potential. This finding indicate that the rock changes its swelling potential during alteration/weathering processes, and that the replacement by laumontite cause the extremely high swelling potential after the alteration.

Since the porosity is unknown, it should be counted for that moisture swelling also may contribute to the swelling of these samples. This type of swelling may happen within the rock mass, in contrast to the swelling gouge fillings in faults and cracks as typical

for Norwegian geological environments. As soon as the rock are exposed to a moisture change, the swelling potential will be activated, and swelling pressure develops if volume change is constrained.

Laumontite hydrates in contact with water and expands without damaging the crystal structure (Marosvolgyi 2010). This permits the rock to adapt both drying and wetting cycles without losing the swelling potential. However, if the quantity of active minerals is high, and the material strength is degraded during the wetting-swelling phase, fissuring and/or crazing may occur and an increase of the rock porosity may result in further swelling and/or disintegration (Sumner et al. 2009, Vergara & Triantafyllidis 2015). The eventual increase in porosity may also permit moisture expansion to contribute to a lower durability and strength of the rock after swelling has occurred, especially if the rock is allowed to deform, as is the case in many tunnels.

## 9 Comparison of the oedometer swelling tests

In chapter 5, different configurations of oedometer tests were reviewed. In addition, the traditional apparatus configuration and procedures at NTNU and KiT were presented. In this chapter, a comparison of the methodologies included the differences in results will be discussed.

### 9.1 Comparison of the differences in methodology

In general, the different oedometer test configurations presented in chapter 5 provide results not automatically comparable, since the deviations also affect the results. The swelling pressures obtained are dependent on the apparatus, frame-conditions under which the tests are performed, and major or minor deviations in procedures, when performed on similar samples. In the following, the main differences in methodology will be discussed.

#### DIFFERENT VERSIONS OF THE ISRM SUGGESTED METHODS– NTNU VS. KiT

There exist some important differences in methodology between the labs at NTNU and KiT. Despite the fact that both methodologies are grounded in the ISRM standard, the institutes have different traditions in how the preparation and testing procedures (including preferred test configuration, see Table 5.1) are performed. Some of the differences can be explained by the recently introduced modifications of apparatus configuration at KiT, encouraged by the research of M. R. Vergara and his associates. However, some basic parts of the standard as sample size, preparation of rock specimen, pre-loading of samples before testing, and conditions under which the tests are performed, exemplify some deviating traditions at the institutes.

After a study of the suggested methods by ISRM, it became clear that the institutes operate with different versions of the ISRM standard as basement for the swelling pressure tests. At NTNU, the suggested method from 1979 (1977) is still in use, while

at KiT, the version from 1989 forms the methodology. Thus, the detected differences are a combination of intern modifications, different versions of the ISRM standard, and different traditions in how some specific points in the suggested methods are translated in operation.

A complete list of the detected differences is summarized in Appendix 9. The differences considered as most influencing for the results, are summarized in Table 9.1.

Table 9.1 Main differences in methodology between NTNU and KiT

	<b>NTNU</b>	<b>KiT</b>
<b>Preparation of rock specimen</b>	<ul style="list-style-type: none"> <li>- Overcoring (drilling)</li> <li>- Use of trimming ring to fit specimen to oedometer ring</li> </ul>	<ul style="list-style-type: none"> <li>- Keep the core diameter if possible and remove the external surface by a lathe</li> <li>- Use of lathe to fit ring to specimen</li> </ul>
<b>Preferred test configuration</b> (cf. Table 5.1)	Method 1a)	Method 1b) and 2).
<b>Placement of dial gauges</b>	<ul style="list-style-type: none"> <li>- One dial gauge placed about 20 cm above the specimen.</li> <li>- Limited correction of the deformation of apparatus components between the dial gauge and specimen during the tests.</li> </ul>	<ul style="list-style-type: none"> <li>- Two dial gauges placed at opposite diameter ends of the loading plate.</li> <li>- Deformation of apparatus is avoided by the abutting of dial gauges and sample, and by manually corrections during the tests.</li> </ul>
<b>Correction due to deformation of the porous plates</b>	No.	Yes.
<b>Administration during tests</b>	<ul style="list-style-type: none"> <li>- Automatic volume control.</li> <li>- Automatic recording of swelling displacement and pressure.</li> </ul>	<ul style="list-style-type: none"> <li>- Manual volume control by reading the dial gauges and manually increase/decrease the load.</li> <li>- Manual recording of swelling displacement and pressure.</li> </ul>
<b>Sample size/mass (dry condition)</b>	Powder <ul style="list-style-type: none"> <li>- Mass: 20 g</li> <li>- Height: not measured</li> <li>- Diameter: 20 mm</li> </ul> Disc <ul style="list-style-type: none"> <li>- Mass: not measured</li> <li>- Height: ~5 mm</li> <li>- Diameter: 35,7 mm</li> </ul>	Powder <ul style="list-style-type: none"> <li>- Mass: 100 g</li> <li>- Height: ~18 mm</li> <li>- Diameter: ~60 mm</li> </ul> Disc <ul style="list-style-type: none"> <li>- Mass: ~135 g</li> <li>- Height: ~18.5 mm</li> <li>- Diameter: ~60.5 mm</li> </ul>
<b>Pre-loading before tests</b>	Yes, on both powder and intact rock structure samples (2 MPa).	No (except 0.1 kN in order to ensure contact).
<b>Climatic control (temperature/humidity)</b>	No.	Yes (20 degrees, 45% air-humidity).
<b>Number of wetting (and drying) cycles</b>	Normally one.	Normally three or more.
<b>Swelling stress and strain relationship</b>	No.	Yes, by allowing deformation (volume expansion in axial direction) in a stepwise manner in the cyclic tests.

## 9.2 Comparison of the differences in results

The mentioned differences in methodology, impede a direct comparison of the results. This fact applies even when the results are obtained from identical rock types and samples, since the swelling parameters are influenced by the conditions under which they are recorded. Confusion may arise when it in the literature on swelling tests sometimes is referred to a ISRM suggested method, without clear specifications on which version. For those who are not familiar with the differences in preparation, apparatus and procedures following the updates, the use of data obtained by different researchers and/or institutes leads to difficulties when comparing the results, since small deviations in methodology may result in incomparable data for similar rocks.

The main differences between the results obtained at NTNU and KiT in this study, will be reviewed in the following.

### DISCUSSION ON THE MAIN DIFFERENCES

The main differences in results between the labs, can summarized as follows:

- **Swelling pressure magnitudes:** The KiT-method induce higher swelling pressure than corresponding tests at NTNU (2-4 times higher values)
- **The contrast in magnitude between powder tests and intact rock structure tests:** Generally higher contrast in swelling pressures between powder samples and intact rock structure samples at KiT compared to NTNU
- **The consistency of the results:** Better agreement in swelling pressures between powder samples and intact rock structure samples at KiT compared to NTNU (higher swelling pressures for powder samples than for intact rock structure samples)

In addition, parameters on the swelling stress- and strain relationship is obtainable at KiT, but not at NTNU.

Figure 9.1 show a comparison of the swelling pressures under conditions of zero volume change, measured at NTNU and KiT. The highest swelling pressure from the cyclic tests under conditions of *zero volume change*, are representing the values obtained at KiT.

Powder sample results are coloured light blue (NTNU) and light orange (KiT), while intact rock structure results have corresponding darker colors.

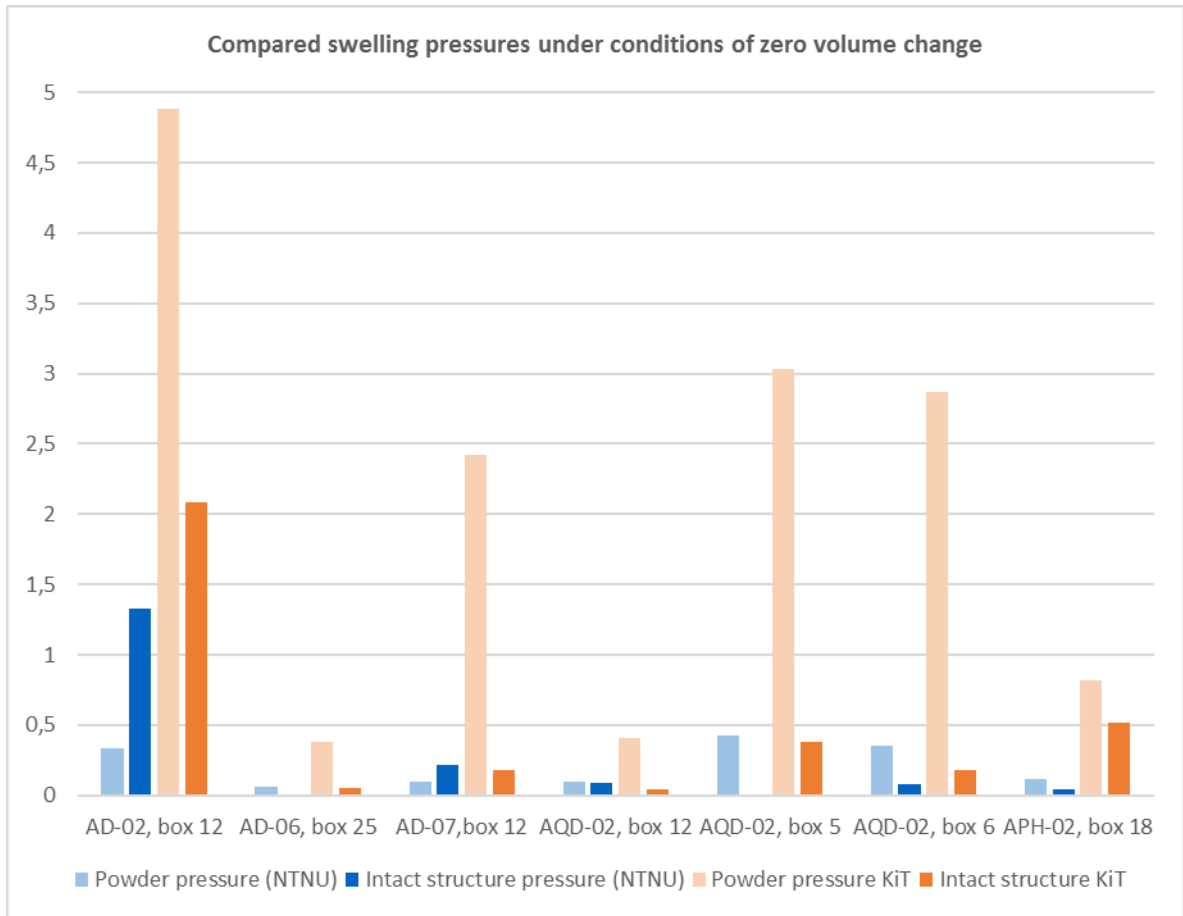

*Figure 9.1 Compared swelling pressures of powder samples and intact rock structure samples*

The following explanations of the differences are considered:

- Swelling pressure magnitudes:** As shown in the above figure, the swelling pressures obtained at KiT are clearly higher than the corresponding results at NTNU. One explanation may be the difference in sample size, where the volume of tested specimens tested at KiT are 2-4 times the volume of specimen tested at NTNU. Another possibility is that the control of apparatus deformation including the placement of the dial gauges, is more suitable in detecting induced swelling pressure by the specimen at KiT due to the recent modification purposed to avoid such error sources. As an additional option, small dissimilarities between the samples representing the same rock type should be



mentioned, since the two versions of each sample may have microscopic internal differences. It is worth noticing that if the characterization system used at NTNU is transferred to the KiT-results, nearly all samples will be characterized with medium to extremely high swelling potential.

- **The contrast in magnitude between powder tests and intact rock structure tests:** The above argumentation may also be valid for the higher contrast in results between powder samples and intact rock structure samples at KiT. For some of the samples, as AD-06 (box 25) and AQD-12 (box 12), the difference is nearly unrecognizable by viewing the results from NTNU. Small increments in swelling pressures may not be detected by the dial gauge if the apparatus configuration allow absorption of the induced swelling pressure.
- **The consistency of the results:** The values from KiT show a better agreement with the assumption of powder samples to be more prone to swelling when exposed to water than intact rock structure. However, the mechanisms controlling swelling of intact rock are known to be complicated, and the factors which favor swelling to occur in a singular rock type and/or specimen may be disturbed when the rock is pulverized and compacted. In samples where swelling clay is absent, the swelling mechanism may be significantly reduced if the rock structure is damaged.

#### THE INCONSISTENCY IN SOME OF THE RESULTS

The results in the oedometer tests of AD-02 (box 12) and AD-07 (box 12) show confusing tendencies when it comes to the correlation between swelling pressure of powder samples and intact rock structure, when comparing the different results between the labs at NTNU and KiT. The values are given in Table 9.2.

*Table 9.2 Inconsistency in results of samples AD-02 and AD-07*

Sample	Maximum swelling pressure (powder) MPa		Maximum swelling pressure (intact structure) MPa	
	NTNU	KiT	NTNU	KiT
<b>AD-02, box 12</b>	0.33	4.88	1.33	2.08
<b>AD-07, box 12</b>	0,10	2.42	0.22	0.18

At NTNU, the related results of swelling pressures of AD-02 are 0,33 MPa (powder) and 1,33 MPa (intact rock structure), indicating a more intense swelling of intact rock compared to pulverized samples. At KiT, the corresponding results are 4,88 MPa (powder) and 2,08 (intact rock structure), indicating higher swelling capacity for powder, which are more logical due to the fact that pulverized samples normally allow more water to react with the swelling minerals. The same tendency applies for sample AD-07, where the samples tested at NTNU show swelling pressures of 0,10 MPa (powder) and 0,22 MPa (intact rock structure), while the corresponding values measured at KiT are 2,42 MPa (powder) and 0,15 (intact rock structure).

Higher pressures in powder samples can be expected, since more material gets in contact with water. On the other hand, the density of the natural (hard) rock is higher than for the powder. According to M.R. Vergara, it could be possible that the rock reaches a higher stress even if it swells less (less material reacting) because it needs less deformation for reaching the same stress (pressure magnitude). The stiffness together with the content of swelling minerals, are assumed to play a role. To exemplify: At high contents of swelling minerals, the rock could swell more than the powder, and at low content of swelling minerals the powder could reach higher swelling pressures than the rock.

Another possible cause may be the relatively high pre-loading of the sample at NTNU (2 MPa), which can cause damage to the rock structure and thus increased secondary permeability. There is no pre-loading of the samples in the KiT procedure, thus the nature of swelling mechanisms and the resistance of the intact rock structure is more likely to be preserved.

For the rest of the samples, the swelling pressures measured at NTNU show similar higher values for pulverized samples than for the intact rock structure specimen, as is the overall trend for samples tested at KiT.

The above findings introduce some aspects regarding the comparability of swelling rock projects, which may be subjects for further discussion and research.

## 10 Main findings

### 10.1 Overview of main findings in the laboratory work

#### OVERVIEW OF THE MAIN FINDINGS ON PREPARATION, APPARATUS AND PROCEDURES

During the laboratory work, several issues were detected in all the types of tests performed. The uncertainties in this study will be further reviewed in chapter 12, while the main findings are summarized in Table 10.1.

*Table 10.1 Overview of main findings related to the methods of this study*

	<b>Mineralogical analyses</b>	<b>Strength-tests</b>	<b>Swelling tests</b>
<b>Preparation</b>	Both XRD and DTA: Fine-fraction material should be prepared directly from intact rock (not gravel).  XRD: The analysis tends to fail in the differentiation of chlorite and corrensite.	Only the high-quality samples could withstand comprehensive preparation, thus few of the chosen samples in the test suite were tested.  Chosen test: UCS	Intact rock structure tests: The weakest samples did not withstand the NTNU-method of preparation.  Disturbances in some of the samples had to be corrected with epoxy.
<b>Apparatus</b>	The DTA apparatus at NTNU do not allow temperature >700 °C.	UCS: OK  Needle penetrometer: Needle broke when tried performed on strong samples.	NTNU: Uncertainties regarding absorption of swelling pressures in apparatus due to the apparatus configuration (placement of the dial gauge).  KiT: Manual recording during tests cause intervals where corrections in load are not performed (nighttime).
<b>Procedure</b>	OK	UCS: OK  Rebound-tests (Schmidt-Hammer, Sklerometer) were difficult to perform under equal conditions from test to test.	NTNU: Climatic control during tests lack.

Table 10.1 continued

<p><b>Other comments</b></p>		<p>Methods which are performable on both strong and weak rock types lack.</p>	<p>Different versions of the ISRM-standard + individual modifications cause differences which impede comparison of results obtained at the different institutes, even when the test-configuration is similar.</p>
<p><b>Suggested improvements for future work</b></p>	<p>SEM/TEM-analysis and thin-section analysis should be performed.</p> <p>DTA-apparatus should be improved to allow temperatures up to 1000 °C, to detect important thermal reactions in the interval 700-1000 °C.</p>	<p>In-situ-tests should be implemented during construction of the tunnels.</p> <p>Gentler methods of preparation of weak rock types should be investigated.</p> <p>Optical methods should be implemented to detect pre-existing weaknesses in the samples prior to the UCS tests.</p>	<p>NTNU: Preparation of intact rock structure specimen should be improved. Climatic control should be implemented. Apparatus and software should be updated to fulfill the latest ISRM-standard, and to allow decrements in load during tests.</p> <p>KiT: Automatic recording during tests should be implemented.</p> <p>General: Operation should be regulated in terms of equal standards of apparatus configuration and methodology to make comparison of test-results obtainable, and to improve the basement for collaboration between institutes.</p>

OVERVIEW OF MAIN FINDINGS DUE TO LABORATORY TEST RESULTS

The results obtained in this study are obtained by a low number of tests, and must therefore be considered as a *qualitative index description* of the samples tested. An overview of the main findings due to results, is presented in Table 10.2.

Table 10.2 Main findings of laboratory test results

	<b>Rock type strong</b> - <b>Grey andesitic type</b>	<b>Rock type weak</b> - <b>Agglomeratic rock type</b>
<b>General description</b>	Apparantly strong, homogeneous and intact rock. Grey with shades of green. White "spots"/grains evenly distributed in the rock matrix.  Do not disintegrate by hand force.	Apparantly weak due to poor coherency and the heterogeneity. Fine-grained matrix with clasts of different shapes, size and color.  Disintegrate easily.
<b>Strength</b>	Strong to very strong, according to the UCS results.	Not up to standards for testing. Assumed very weak.
<b>Swelling potential</b>	Low according to the free swelling tests.  High to extremely high according to oedometer tests.	High, according to both the free swelling tests and the oedometer tests.
<b>Swelling mechanism</b>	Hydration of laumontite.	Swelling of montmorillonite and mixed-layer smectite.
<b>Overall evaluation of the consistency of test-results</b>	The results are of contradictory nature:  1) Free swelling tests and swelling pressure tests indicate different swelling potentials of the rock type.  2) The strongest rock type (both visual and by tests) has the highest swelling potential.  3) Intact rock structure specimens hold higher swelling potentials than the powder samples (NTNU)	The results make sense:  1) Free swelling tests and swelling pressure tests corresponds in terms of expected behavior.  2) The swelling potential is in agreement with visual impression of strength.  3) Intact rock structure specimens hold lower swelling potentials than the powder samples (both NTNU and KiT)

## SWELLING TESTS: DIFFERENT ISRM STANDARDS AS BASEMENT FOR OEDOEMETER TESTS

When comparing the methodology in oedometer tests between NTNU and KiT (Chapter 9), several differences in preparation, apparatus, and procedures were detected. The main differences which may distort the further analysis and calculations can be listed as follows:

- **The preparation method of intact rock specimen** → the degree of disturbances to the rock material and allowance of weak rock types to be tested

- **The fitting of the ring and specimen** → the poor fit between ring and specimen at NTNU allow the specimen to swell in the ring, not detected by the dial gauge
- **The placement of the dial gauge(s) in apparatus** → affect the degree of sensitivity in detecting swelling parameters
- **The error source related to deformation of porous plates during swelling** → the deformation of rock specimen is underestimated when not corrected
- **Sample size** → affect the amount of swelling minerals in the tested sample, the degree of saturation of the samples during the wetting phase, and the time needed to reach maximum swelling potential
- **Pre-loading prior to the swelling phase of test** → affect the degree of disturbances to the rock material, and produces uncertainties due to the effect of pre-loading on the swelling measurements
- **Climatic control during tests** → the effects of humidity and temperature remains uncertain

The fact that different institutes have their own traditions in the operation at laboratory, leads to different results for similar rock types, even when the tests performed belong to the same category and standard. To compare the results with other projects, the methods and equipment used must be aligned and according to the exactly same standard. In addition, the configuration of apparatus and the methodologies should be according to the recent research, to ensure high quality values for the further analyses and calculations. To achieve this, communication between institutes on improvements of methodology and important results, should be shared in detail.

## **10.2 Characterization and determination of the swelling potential of the rocks at project site**

The complexity of the samples proved to be much more challenging than first assumed. The main issues are described in the following.

### **CATEGORIZATION ISSUES**

The categorization was made prior to any property investigations, and was thus based on visual characteristics observed during the field survey. After mineralogical analysis and swelling tests were performed, samples within each category showed differences indicating that the samples correspond to different stages of formation processes, and/or have undergone various degree of weathering or alteration after formation. The sample properties within each of the categories are therefore not uniform, but differ in mineralogical composition, swelling potential and strength. The uncovered complexity of the samples made clear that the categorization is too simplified and not proper in statistical manners, since the tests performed do not interpret the properties of a rock type but rather the singular sample tested.

### **UNESPECTED SWELLING BEHAVIOR OF APPARANTLY STRONG ROCKS**

The hypothesis of swelling clay minerals to be the main mechanism controlling the swelling behavior of the volcanic rocks at project site, was the basement for the work in this study. Additionally, it was assumed that the rocks with a high swelling potential also exhibit heavy degradation in terms of poor quality and disintegration.

During the laboratory work, it became clear that the assumed most proper rock for tunneling exhibits confusing behavior. The pre-assumed correlation between swelling behavior, content of smectites, and strength, is counteracted by the laboratory tests performed. Instead, the study indicates that very strong rock types may hold an unexpected high swelling potential.



## THE SWELLING POTENTIAL OF LAUMONTITE

The high maximum swelling pressure for sample AD-02 (box 12) is correlated to its high content (56%) of laumontite. This finding is especially interesting since the rock type is of high rock quality, and do not contain any swelling clay minerals.

A review of the literature on swelling rocks, and discussions with several professors at the Department of Geology and Mineral Resources Engineering at NTNU, indicate some disagreements on the potential of zeolites to cause swelling problems compared to the more known mechanism of swelling clays. However, this study shows a clear connection between the content of laumontite and the swelling potential of the grey, andesitic rock type tested. The assumption of hydration of laumontite to be the main swelling mechanism in these samples, is reinforced by repeated tests on the actual samples. No swelling clay minerals are detected in this grey andesitic rock type, and the high swelling pressure by the duplicate tests performed at both NTNU and KiT.

The samples rich in laumontite show the highest swelling pressure values in the tests performed under conditions of *zero volume change*, at both NTNU and KiT. The values obtained at KiT together with the content of laumontite and montmorillonite are illustrated in Figure 10.1.

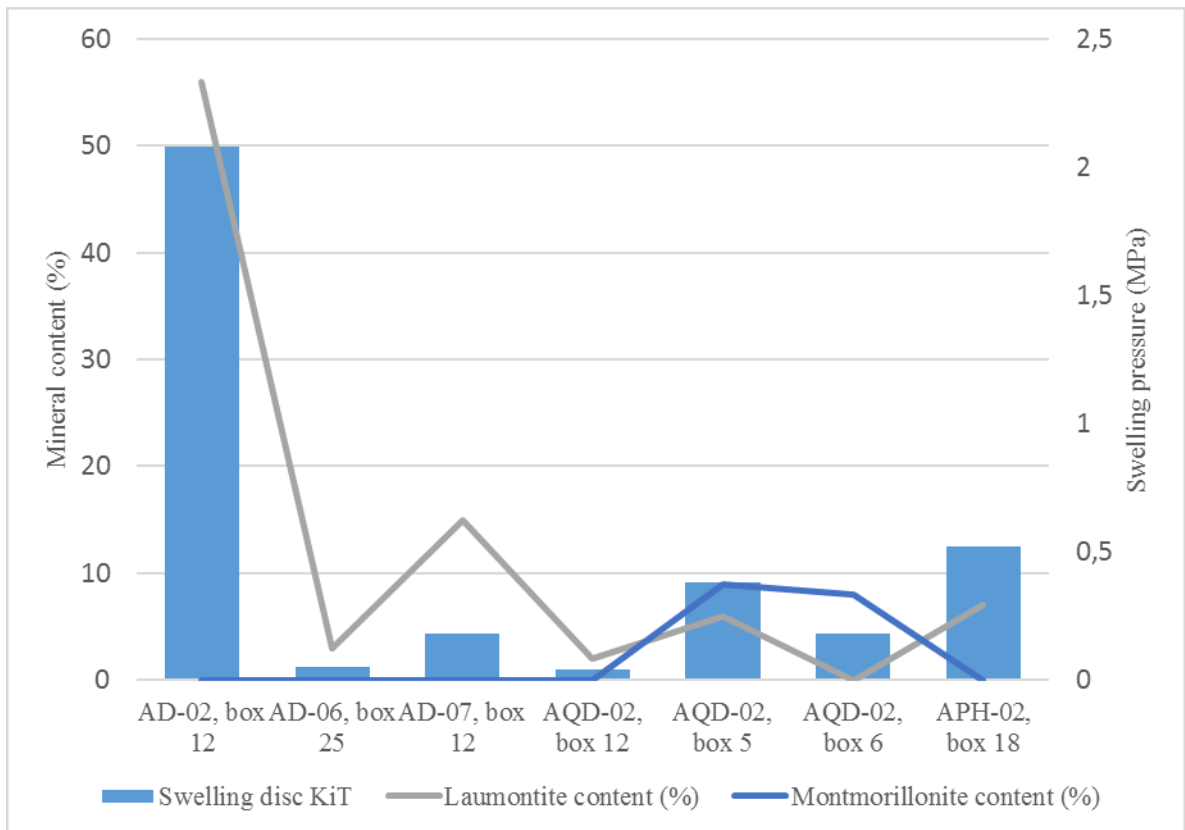

Figure 10.1 Swelling pressure VS. swelling minerals

NB: The swelling caused by corrensite and mixed-layer clays are not counted for, since the content is not quantified. Mixed-layer smectites and corrensite are assumed to contribute to the swelling of AD-07 (box 12), AQD (box 5 and 6) and APH-02 (box 18). However, the swelling potential magnitude executed by these mixed clay minerals are limited, compared to montmorillonites.

#### INCREASED SWELLING POTENTIAL WITH ALLOWED DEFORMATION

Two samples show increased swelling capacity under conditions of *controlled deformation*. The assumed cause is an increased permeability due to destruction of the rock structure, during the volume expansion induced by swelling of smectites and mixed-layer smectites. This characteristic is important to consider in stability calculations of underground engineering projects, especially in hydropower-tunnels where the rock is exposed to abundant moisture changes during the lifetime of the construction.

The UCS tests on wet samples indicate a lowering of the strength properties after saturation, which corresponds well to the assumptions on the effects of swelling on the strength properties, as suggested in the study of Vergara and Triantafyllidis (2016).

A continuation of the cyclic tests will allow to see if each new deformation result in further increase in the swelling pressure. If a sufficient number of measurements is obtained, the Grob`s line may be computed. By performing in situ swelling tests during construction, a comparison of Grob`s line and the actual swelling behavior may produce valuable information on the accuracy of the laboratory tests.

### **10.3 Evaluation of the investigation procedure of this study**

During the work in this study, some weaknesses of the performed investigation methodology became clear. The appropriation of the methods, included the order of the laboratory tests performed, is evaluated. In addition, possible improvements on the overall investigation procedure are presented.

#### **UNSOLVED ISSUES**

In the end-phase of this investigation, some questions remain unsolved. The main issues can be summarized as follows:

- Strength parameters on the weak rock types lack, thus a comparison of the strength properties of the different rock types is not obtained.
- Absorption characteristics, including parameters on porosity and permeability, are not obtained. The degree of saturation of the samples tested in both UCS-tests and oedometer swelling tests is therefore uncertain.
- The individual deviating factors in oedometer apparatus set-up and procedures between NTNU and KiT, are not quantified in terms of the contribution to the differences in results.
- The results of the performed laboratory tests are not evaluated or compared to actual in situ conditions, due to the lack of corresponding measurements in field.

## REVIEW OF THE INVESTIGATION PROCEDURE AND TEST SUITE, WITH SUGGESTED IMPROVEMENTS

The investigation procedure presented in chapter 6.4 is evaluated in terms of appropriation and strategical view. In the following, comments on each step of the investigation procedure are presented.

### **Field work**

- In-situ tests during the field-work should be implemented.
- The collection of samples should be according to the findings of highest interest due the results of these tests.
- Proper amounts of the most interesting rock types should be collected, to allow repeated tests and additional analyses.
- The categorization performed should be based on index properties and not the visual characteristics only.

### **Laboratory work**

- Laboratory tests on absorption characteristics, porosity and texture of the rock material should be implemented.
- The differences in the methodology between the institutes challenged a direct comparison of the results, including the comparison of the results with previous similar projects.

### **Analyzes and comparisons**

- The problems which appeared at this point of the investigation is related to the above mentioned issues.

## **Other comments**

→ Some samples did not withstand the preparation needed, especially in regard of the evaluation of strength parameters. This problem would have been partly solved by knowing the index properties of the rocks before computing the test suite.

→ The number of oedometer swelling tests is not sufficient to compute Grob's line. By performing more tests, the swelling stress-strain relationship may be compared by in situ tests during construction.

## **THE DEMAND FOR PROPER PRELIMINARY TESTING METHODS**

Valid and realistic prediction of rock mass properties is a challenging task. The in-situ conditions are difficult to predict by laboratory tests, where all values are down-scaled to apply on small pieces of rocks. This leaves an open issue in the process of evaluation of the results and planning of design. To best solve this problem, the performance of in-situ tests is suggested in the literature (Palmstrøm & Singh 2001). However, to execute existing in-situ tests in a wise and strategical way, is difficult prior to excavation and construction. The planning phase and field-work is therefore in many cases based on assumptions, where available data are puzzled together to best reflect the geological challenges in the project area.

The planning of the work in this study was accomplished before the geological maps and feasibility study was available. It would clearly have been advantageous to study these documents prior to the field-work and collection of samples. In addition, the need for proper preliminary testing methods became obvious, especially the types of tests which may be executed in-situ. The main points in this regard is to avoid the scale-effects of results obtained by small specimens compared to the reality, and to obtain index properties quickly to continuously adjust the investigation procedure. With such methods, the process of later analyzing the laboratory results would be less challenging, in terms of transformation of laboratory data to calculations on needed support. Since the project was still in the preliminary phase and no tunnels were under constructions when the field-work was performed, the most evident approaches (as repeated in-situ Schmidt-Hammer tests) were not in reach.

The existing in-situ methods which are frequently used are mainly tests intending to predicate density, strength/deformability properties and the nature of detected discontinuities (Palmstrøm & Singh 2001). However, index information on other rock properties as mineralogical composition and swelling potential are in many cases even more interesting and needed. In situ methods, as borehole extensometers and sliding micrometers to measure the deformation in the rocks surrounding a tunnel, are suggested by Kovari et al. 1988). However, these methods are most useful during or after construction.

Hopefully, quick and reliable methods to obtain valuable index properties prior to comprehensive laboratory investigations, will be developed in the future.

## 11 Uncertainties and error sources in the work of this study

Knowledge and understanding of the complexity of the rocks at project site are essential to obtain a good geotechnical design of underground constructions (Stille & Palmström 2008). The geology forms the basis for all rock engineering works, including field investigations and the following rock engineering evaluations. Wrong geological interpretation will affect the further analyses and calculations based on the geological model. However, it can hardly be avoided to end up with some degree of discrepancy between the predicted and actual rock mass conditions (Panthi & Nilsen 2007). Laboratory testing itself is only one way out of many to determine the rock mass behavior, and should always be complemented with other investigations. Figure 11.1 show an example of the components in the understanding of a rock mass behavior.

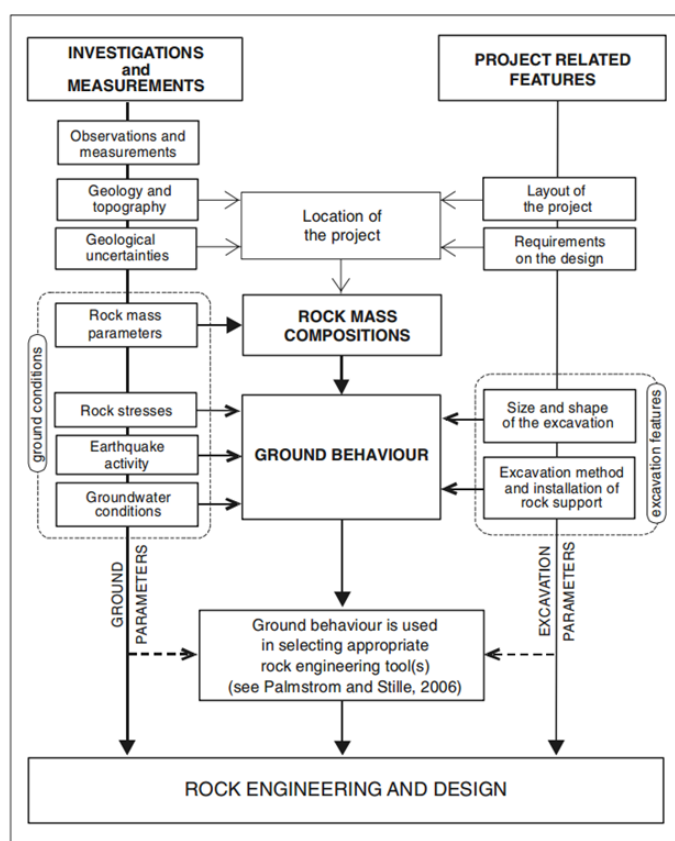

Figure 11.1 Illustration of the different components in the understanding of rock mass behavior (Stille & Palmström 2008)

The investigation procedure of this study rely on different laboratory testing methods, which never perfectly reflect the in-situ conditions. Several factors should be considered and kept in mind when analyzing results from laboratory tests in geotechnical projects, before concluding on the design of constructions and needed support.

An overview of general uncertainties in laboratory work is given in Appendix 11.A. The main uncertainties in this study will be reviewed in the following.

### **11.1 General uncertainties due to the material and investigation procedure**

There exist several uncertainties to the material and investigation procedure of this study, which in general terms applies to all the samples and tests performed.

#### **LIMITED KNOWLEDGE ON THE ORIGIN AND SPATIAL VARIATION**

It is known that the rocks at project case, primarily are of volcanic origin. Based on the knowledge of basic formation processes in the area, it was assumed that hydrothermal alteration is frequently occurring. However, the effects of alteration are not easily distinguished from those brought about by weathering, and several mechanisms may have interplayed.

As earlier described, the samples in this study show a great variance, both visually and by properties. The samples show a complexity which challenged the categorization prior to the tests, and also the analyses of the results after the tests were performed. The distribution of the various weathering grades and alteration products of the rock material, may be related to the porosity of the rock material and the presence of open discontinuities. Several unknown factors are likely to interplay, but the properties investigated are limited. Thus, the issue of correct characterization of the different rock types remains unsolved.



## THE REPRESENTATIVENESS OF THE SELECTED SAMPLES

As the content of minerals in the rock can vary within a small distance, visually similar rocks may have variations only detectable by comprehensive tests and analyses. The same issue applies for fissures and small discontinuities. Further, the storage history and exposure for air, temperature and humidity after extraction are factors which may influence the characteristics of the specimen compared to its origin. Thus, there exist an uncertainty of the representativeness of the samples tested and to which extent the uncovered characteristics applies to the rock mass at project site as a whole, as illustrated in Figure 11.2.

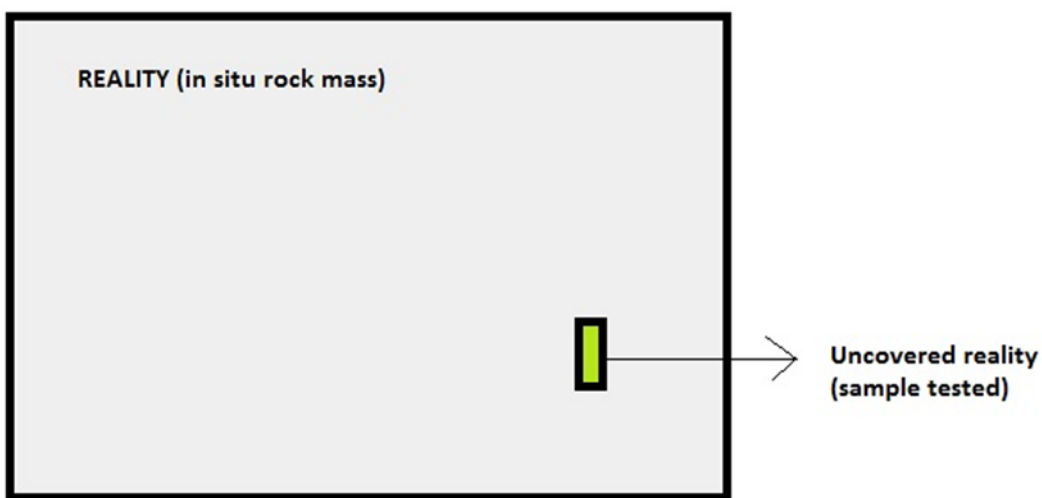

*Figure 11.2 Illustration on the limitations of laboratory tests on small specimen when considering the in situ rock mass*

## SAMPLE DISTURBANCES

The specimen used in the laboratory tests are prepared from borehole cores, and are thus already disturbed by the drilling and extraction process. The main disturbances include damage to the microstructure, changes in effective stress compared to geostatic conditions, and changes in moisture content. Further, the preparation of specimen from the samples will contribute to the additional disturbances by temperature changes, exposure to air, humidity and loads, decomposition processes, and more.

Figure 11.3 show the preparation of sample AQD-02 (box 12), where the drilling and further preparation are examples of phases where sample disturbances are unavoidable.

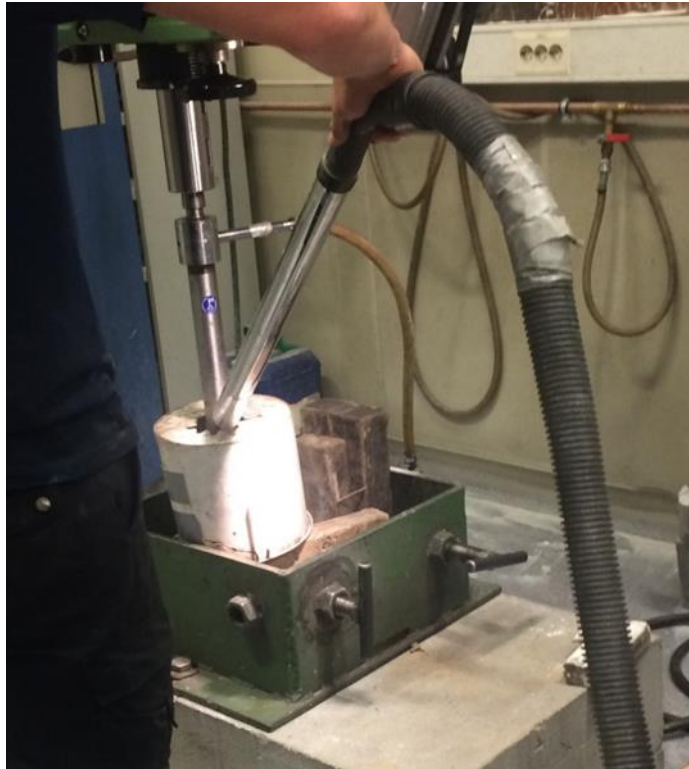

Figure 11.3 a) Sample AQD-02 (box 12) ready to be prepared b) Preparation completed.

#### THE ROCK QUALITY OF THE SAMPLES VS. THE TESTING CRITERIA

To obtain data on the swelling potential of the most frequent appearing rock types at project site, it was crucial to examine the rocks with poor quality as well as the apparently stronger types. However, the testing criteria for certain properties requires a minimum of quality, which made it impossible to obtain the wanted data on some of the samples. The “Rock type *weak*”-category of the samples was therefore excluded from the UCS-tests, since the samples were too small and disintegrated to fulfill the criteria regarding size and smoothness.

The preparation of intact rock structure specimen for swelling tests was challenging, even for the assumed high quality samples. This issue was especially challenging at NTNU, since the laboratory equipment available is custom-built for harder rock types. Because of a lack of procedure regarding dry drilling, and thus no dust-extractor (Figure 11.4), the formation of dust caused problems due to the extracting of samples from the cores.



*Figure 11.4 The use of a vacuum cleaner was necessary due to dust formation during drilling*

There were also challenges with friction in the drilling process, thus it was hard to get perfectly intact samples to meet the demands for intact rock structure swelling tests. Some of the specimens needed treatment with epoxy to compensate for some imperfections of the surfaces before grinding. These corrections may have influenced the results, mainly because the percentage of epoxy compared to rock material in the specimen is unknown.

#### UNKNOWN STORAGE HISTORY

According to the ISRM-standard (1989), the storage of samples should be performed as follows:

- a) Storage time should be minimized.
- b) Storage in a constant temperature (20°C) room is preferred.
- c) The samples must not be exposed to direct sunlight.

d) If long-term storage is necessary, humidity in the storage room should be such as to minimize any moisture gain or loss of the samples.

The samples from the boreholes have been stored in the office of Aboitiz, and later at the laboratory of NTNU, with poor attention to the above criteria. They are therefore exposed to a variety of temperature, humidity and sunlight within an unknown span of time. Prior to the tests, some degree of swelling and shrinking may already have occurred due to the exposure of water and humidity changes during storage. This may have changed the swelling potential of the specimen compared to the situation of undisturbed conditions in-situ.

#### THE NUMBER OF TESTS

The number of swelling tests on each sample-type is ranging from 1-3 (for each variation of test), which do not allow any statistical evaluation of the swelling potential. Thus, there exist an uncertainty regarding the average swelling potential for each type of rock from the sample area, and the data obtained must be considered as index-values.

The number of performed UCS-tests is 3 for the andesitic rock type, and 1 for the basaltic rock type. The ISRM standard recommend a minimum of 5 specimens per set of testing conditions (Fairhurst & Hudson 1999). The characteristics within the “andesitic” type varies in terms of grain size and mineralogy, and other parameters such as porosity and degree of weathering. Additionally, other degrading processes may also contribute to different properties to an unknown extent.

The scarce number of samples tested in combination with the fore-mentioned uncertainties regarding internal differences within the rock-categories, make the comparability controversial. Thus, the results do not allow any clear conclusions about the strength of the rock types and should be considered as qualitative indications on the strength of each sample. To improve the applicability of the results, a statistically significant number of samples should have been tested, and anomalously high or low values considered disregarded (Szwedzicki & Shamu 1999).

## DISCONTINUITIES

The tests performed do not account for discontinuities in the rock mass unit in which they are taken from. The strength tests therefore only describe the strength of the rock material, considering the effect of material properties under laboratory conditions. However, mesoscopic discontinuities (i.e. the scale of rock samples used in a laboratory), such as micro-fractures, may also influence the values of mechanical properties, especially in the uniaxial compressive strength test (Szwedzicki & Shamu 1999). The location, orientation, size, density and extent of these minor discontinuities contribute to the modes of failure, and samples of identical lithological composition may show a large variation in values. The failure modes of the uniaxial compressive strength tests should therefore be evaluated together with information revealed by for example optical techniques.

## HYDRAULICS AND MOISTURE CONTENT

The moisture content plays an important role in both swelling tests and strength tests of rocks, and several uncertainties in this regard are actualized in this study. After bringing the core samples to Norway from the Philippines, they have been stored in the NTNU laboratory for 8-10 weeks. After this period, they were assumed dry, but the natural moisture content is disturbed and unknown. The lack of moisture measurements in combination with an unknown porosity, result in no values on the absorption characteristics. These possible improvements of the investigation program were unfortunately detected too late in the process to be incorporated in the investigation procedure.

The hydraulics of a rock mass is of great importance when considering the percentage of the swelling minerals which is exposed to water (Einstein 1989). However, the difference in size of a specimen versus the original rock mass will challenge a comparison even if the hydraulics of the in-situ rock mass is known. In addition, a specimen in an oedometer cell filled with water are exposed to humidity in a very different manner than a corresponding piece of rock in-situ, due to volume versus surface area (Vistnes 2016). The swelling pressure induced by the specimen under laboratory conditions will therefore not directly reflect the in-situ swelling potential.

## 11.2 Specific error sources in the tests performed

The above described uncertainties result in error sources in the tests performed. The *main* error sources in each test-category are summarized in the following.

### ERROR SOURCES IN THE MINERALOGICAL ANALYSES

The uncertainties in the mineralogical analyses are mainly linked to the preparation method. The rock material used in the mineralogical analyses was prepared by first using a geological hammer to obtain desirable sizes pieces for the jaw crusher, producing gravel material exposed to further milling, to particle sizes of  $<2\ \mu\text{m}$ . For the fine-fraction test in the XRD-analyses, the gravel was rubbed in water by hand to separate the smallest particles from the bigger particles, and to detect eventual swelling clay minerals in a separate analysis with particle sizes of  $<6\ \mu\text{m}$ . However, this procedure should have been performed prior to any crushing of the rock, since inordinately small particles from other mineral groups are mixed with the naturally fine-fractionated clay particles in the water solution. This may have caused a disturbance of the XRD-analyses, by the agency of d-spacing-peaks from other minerals to obscure eventual peaks of smectites or other swelling clay minerals.

The same disturbance is believed to apply in the DTA-analysis, where the powder used is bulk material and not natural fine-fraction powder from the intact rock samples. However, in most cases the reactions induced by swelling clay minerals, in both performed mineralogical analyses, are detectable despite the fore-mentioned weaknesses in preparation, yet harder to detect and justify.

The DTA apparatus at NTNU do not allow heating above  $700\ ^\circ\text{C}$ . Several diagnostic thermal peaks may occur in the temperature interval between  $700\ ^\circ\text{C}$  and  $1000\ ^\circ\text{C}$ . Thus, the analyses performed are not optimal.

## THE UCS-TESTS

The uncertainties and error sources in the UCS tests can be summarized as follows:

- The orientation of bedding planes and discontinuities within the samples are not considered.
- As described earlier, the premature categorization of the samples resulted in an uncorrect grouping of the rocks in the UCS-tests. For each type of rock the mechanical properties vary considerably, and petrological data should be obtained to predict the mechanical performance (Stille & Palmström 2008). The samples representing the andesitic rock type proved to have a different composition than assumed, but this was detected after the UCS-tests were performed. Some of the tested samples have not undergone mineralogical analyses and it is therefore uncertain if they all belong in the “andesitic” category. The average strength values on andesitic rock type are not valid due to the internal variation of the samples within the “andesitic” categorization of the rocks tested.

The detected mineralogical main differences between the tested samples are summarized in Table 11.1.

*Table 11.1 Comparison of the mineralogy of “andesitic rock” samples in the UCS-tests*

	<i>Laumontite</i>	<i>Clinopyroxene</i>	<i>Quartz</i>	<i>Plagioclase</i>
<b>AD-02, box 12</b> (dry test)	56 %	15 %	13 %	11 %
<b>AD-02, box 12</b> (wet test)	43 %	13 %	11 %	5 %
<b>AD-05, box 5</b> (dry test)	12 %	16 %	1 %	54 %
<b>AD-02, box 8</b> (dry test)	7 %	6 %	10 %	60 %
<b>AD-02, box 3</b> (wet test)	Unknown	Unknown	Unknown	Unknown
<b>AQD-02, box 8</b> (wet test)	Unknown	Unknown	Unknown	Unknown

As can be seen from the table, the samples differ in composition mainly by the content of laumontite and plagioclase, assumed to be due to alteration processes occurring after formation. This distinction in mineralogy may contribute significantly to the strength of the rock, and a different division of the samples prior to the tests may have been preferable.

- Only two states of saturation are included in the testing; “*laboratory-dry*” and “*assumed saturated by wetting for 50 days*”, but the exact moisture content prior to and after tests are not known. To which extent the exposure to water have caused degradation of the samples tested, compared to a complete saturation, is therefore not certain.

## THE OEDOMETER SWELLING TESTS

The uncertainties and error sources in the oedometer swelling tests, can be summarized as follows:

- No procedure of measuring the moisture content prior to or after tests are implemented at NTNU. At KiT, the samples were weighted before and after testing to get an approximately value of the water absorption during swelling. It therefore exists a general uncertainty regarding to which extent all the swelling minerals are exposed to water during the tests. In the tests under conditions of zero volume change, the degree of wetting of the samples are additionally uncertain, due to limited duration of the test and unknown absorption characteristics of the rocks tested.
- Irregularities (Figure 11.5) in prepared specimen (intact rock structure tests) and the treatment with epoxy as compensation lead to an uncertainty due to percent epoxy VS. percent rock material. The amount of rock material minerals reacting with water compared to the total mass of specimen is therefore not certain.





*Figure 11.5: Specimen AD-02 (box 12) with irregularities corrected with epoxy (dark regions on the specimen edges).*

- The ISRM suggested method (1989) points out the importance of the sample to fit perfectly in the oedometer ring, to avoid undetected radial swelling of the specimen. This issue is connected to the preparation of the intact rock structure discs, where the smoothness of all surfaces of the specimen is critical. Due to the preparation method at NTNU, which is performed by overcoring (dry drilling) to the desired diameter, irregularities of the samples occur because of friction. The rings itself also vary in size and smoothness, but no correction procedures are incorporated in the methodology. Thus, the specimen visibly did not fit perfectly into the rings used. This allow the specimen to swell in radial direction, not measured by the dial gauge.

At KiT, the preparation procedure includes the use of a lathe, and the original diameter of the cores was kept. In addition, the ring was fitted to the specimen and not vice versa, and this method gently avoid the issues mentioned. However, some minor spacing between the sample and ring must be expected also with this method of preparing.

- It is not known if the results may correspond to the theoretical Grob`s line. To compute this characteristic swelling stress-strain relationship of the rock, more test results is needed. It would have been interesting to compute Grob`s line by the methods at each of the institutes, to see if the values show a correlating pattern in terms of swelling magnitudes. However, the NTNU method do not allow swelling stress-strain relationship to be obtained by the method used

today, but it should be possible to modify the methodology and software to allow this.

All uncertainties should be kept in mind in the dimensioning of rock support, and evaluated together with the test results.

## 12 Conclusions and recommendations

### 12.1 Conclusions on methodology and the rock material properties/swelling potential

#### METHODOLOGY

The following issues are detected during the investigation process:

- **There exist essential differences in the methodology of oedometer swelling tests at NTNU and KiT:** The investigation uncovered that different versions of the ISRM suggested methods in oedometer swelling tests are in operation at NTNU and KiT. In addition, individual modifications and traditions contribute to a widening of the gap in both methodology and results. This point may not be a problem when comparing results internally, but can be confusing when similar projects are investigated by different institutes, especially if a certain standard is referred to in general manners.
  
- **The appropriateness of the different oedometer methods in detecting swelling pressure changes:** The swelling pressure executed from swelling rocks is more easily detected by the KiT-method than the NTNU-method. The reason may be due to several factors as:
  - apparatus configuration (the position of the dial gauge(s))
  - corrections due deformation of the porous plates during swelling
  - preparation (degree of disturbance on samples)
  - sample sizes (volume of rock material exposed to water)
  - testing procedure (especially the pre-loading)
  - climate control during the tests

The individual factors which contribute to the differences in results, are not quantified and thus uncertain.

- **The Free Swelling Index Test do not detect the swelling potential of laumontite:** The widely used Free Swelling Index Test do not reflect the swelling potential of swelling rocks with high content of laumontite. The cause is unknown.
- **The lack of appropriate strength tests impedes important rock material parameters:** There exists no single strength-test which applies to both weak and strong rock material for comparison of results. Only high quality samples which withstand comprehensive preparation are possible to test by well-documented methods.
- **There is a demand for appropriate pre-tests prior to the laboratory investigations:** The need for proper and reliable in-situ methods, including index measurements on mineralogical composition, absorption characteristics, swelling potential and strength properties of the rock material prior to construction, became obvious during the work in this study. In general, preliminary tests prior to detailed planning of the work is critical to make proper decisions on testing strategy.

## ROCK MATERIAL PROPERTIES AND SWELLING POTENTIAL

Based on the test results, the following conclusions are drawn:

- **The rocks at project site are complex with varying material properties:** The rock quality range from very poor (mixed soil-rock aggregates) to very high (intact, coherence and strong rocks). The different rock types fluctuate spatially, without any obvious structural zoning patterns. In addition, rocks with similar visual characteristics may hold different minerals and properties due to alteration processes. Thus, assumed similar rock types may be compositionally deviant.
- **Strong rocks may hold very high swelling potentials:** Apparently strong rocks with high quality may hold a high swelling potential despite the lack of clay

minerals. The cause may be due to the partial alteration of a strong (and not swelling) parent rock, where plagioclase is replaced by laumontite, but where the original rock structure remains intact.

- **Clay minerals are not alone the main cause of the swelling behavior of the rocks at project site:** The laboratory test results indicate that swelling of laumontite is the main cause of swelling behavior of the rocks at project site. The rocks investigated show that intact rock structure material with high laumontite content, have the potential to reach higher swelling pressures than the rock containing smectites. These findings are confirmed by repeated analyses and tests.
- **Increased swelling potential of rocks containing smectites when allowed to deform during cyclic wetting and drying phases:** Rock types of poor quality which contain swelling clay minerals (smectites and mixed-layer clays) show an increase in maximum swelling pressure potential when exposed to cyclic wetting and drying where deformation is allowed. On the other hand, high quality samples containing laumontite show a reduction in swelling pressure followed by a slow regain of the swelling pressure by repeated cycles. The long term evolution of swelling behavior due to cyclic moisture changes in both cases are not concluded due to limited number of cycles performed.

## **12.2 Conclusions on the potential swelling behavior of the rocks at Alimit Dam Site**

The results are mainly obtained from rocks at the Alimit Dam Site, the same area where the powerhouse will be constructed. The rock of focus has been the grey andesitic rock type rich in laumontite (AD-02 box 12), which have proved to hold a high swelling potential. Based on the geological report from SN Aboitiz, it is assumed that this rock type is present to a large extent also in other locations in the project area. However,

different variations with deviations in mineralogical composition, strength and swelling potential have been uncovered. It is therefore not satisfactory with a visual inspection of the rock in considerations of the swelling potential and durability, even if a visually similar rock is tested.

This investigation did not detect swelling clay minerals in the grey andesitic rock type. This fact may cause misleading assumptions on the rock not to hold a swelling potential worth noticing, especially since the rock in addition show a high quality.

This investigation indicates that strong rocks with a high content of laumontite hold a swelling potential higher than poor rocks containing smectites. Laumontite may expand and shrink without losing its swelling potential, and this issue is important in underground engineering structures which are periodically exposed to humidity changes, as water tunnels. The planned headrace tunnel should therefore be constructed with an awareness of these findings.

### **12.3 Suggested improvement on the investigation procedure and test suite**

After the evaluation of the investigation procedure and test suite, and taken into account that all information and maps are available from the beginning of the work, an alternative approach is suggested for future researches:

#### **Preliminary studies**

- a) Desk study of maps, geological cross-sections and other informative documents which may influence which rock-types to focus on, should be obtained. The location relative to the planned constructions should be evaluated.
- b) Computing a tentative test suite based on the desk-study with focus on the mineralogy, texture, strength, swelling properties and absorption characteristics (included porosity measurements) of the samples is preferred. The test suite should include both in-situ tests (if performable) and laboratory tests.

### **Field work**

- c) Field work, including the collection of samples based on the desk study, is critical. Samples with characteristics representing the rock mass in which the constructions are planned, should be selected in sufficient amounts to perform the planned laboratory tests. In-situ tests should be performed during the field-work where possible.

### **Laboratory work**

- d) Divide the collected samples in two groups (where each group contain exemplars of each sample) and perform oedometric swelling tests at two different labs (NTNU and KiT).
- e) Obtain data on mineralogy, texture, strength, swelling properties and absorption characteristics (included porosity measurements) for all collected samples by laboratory tests. Optical methods should be implemented to obtain complementary information on texture, fabric details, microfractures before and after tests, and porosity.

### **Analyzes, comparisons and in situ tests during construction**

- f) Analyze and compare the results by:
  1. Performing a qualitative comparison of mineralogy, texture, absorption characteristics, swelling data and strength parameters for each rock type in the sample collection. Determine possible correlations between the different parameters (especially regarding samples containing swelling clay) and the values obtained by in-situ tests.
  2. Compare the swelling data obtained by similar methods but where the tests are performed at the two different labs with different methodology traditions (NTNU and KiT).
  3. Compare the results with other similar projects, where the laboratory methods are of exactly the same standard and tradition.

4. Evaluate the swelling behavior in view of known mechanisms controlling swelling in volcanic rock types, with awareness of alternative explanations as moisture swelling, swelling chlorites, and the hydration of laumontite.
5. Evaluate the actual swelling potential by comparing laboratory results with the in-situ test results and/or tests/experience during construction. The effects of swelling on the surrounding rocks may be measured by means of leveling and convergence measurements during constructions. Suggested in situ test procedures may be:
  - Borehole extensometers
  - Sliding micrometers
6. Compare the in situ measurements with the Grob`s line, computed by proper numbers of oedometer swelling tests of the rock in case.

When comparing methodologies between institutes, an awareness of the standardization used as basement for the tradition at laboratory, is crucial. Different versions of a certain suggested method may include deviations of importance, and additional modifications may be implemented on the operational basis. It is important to make an effort in obtaining all details of apparatus configuration, preparation, procedure and conditions under which the work is performed. Do not be afraid of showing curiosity; one question too much is better than one answer lacking!



## REFERENCE LIST

- AMERATUNGA, J., SIVAKUGAN, N. & DAS, B. M. 2016. Laboratory Rock Tests. *Correlations of Soil and Rock Properties in Geotechnical Engineering*. Springer.
- ANAGNOSTOU, G. 1993. A model for swelling rock in tunnelling. *Rock mechanics and rock engineering*, 26, 307-331.
- ASHGANONLINE. 2016. *Power talks: A farmers take on the Alimit Hydro Project*.  
URL: <https://agshan.wordpress.com/2016/04/27/power-talks-a-farmers-take-on-the-alimit-hydro-project/>
- ASLAM Z. 2015. *World of mining engineers, Physical Properties of Rock Material*,  
URL: <http://miningworldgenises.blogspot.no/2015/05/groung-control-part-2.html>  
[Retrieved 16. december 2016]
- ASSOCIATION, I. Z. 2008. Database of zeolite structures. *Library and Museum in Yorba Linda, California. The mission of the Festival is to educate students about water-related and conservation issues that correspond to California Science Standards. This year's Festival will reach about*, 6.
- BARLA, M. 2008. Numerical simulation of the swelling behaviour around tunnels based on special triaxial tests. *Tunnelling and Underground Space Technology*, 23, 508-521.
- BARLA, M. 1999. *Tunnels in swelling ground*. Doctoral thesis, Politecnico di Torino.
- BARTON, N. 1978. Suggested methods for the quantitative description of discontinuities in rock masses. *ISRM, International Journal of Rock Mechanics and Mining Sciences & Geomechanics Abstracts*, 15.
- BELL, F. G. 2004. *Engineering geology and construction*, CRC Press.
- BERDUGO DE MOYA, I. R., ALONSO PÉREZ DE AGREDA, E., ROMERO MORALES, E. E., GENS SOLÉ, A. & ALBIS, M. 2009. A review of expansive phenomena in Wagenburg North Tunnel. *Revista de la Academia Colombiana de Ciencias Exactas, Físicas y Naturales*.

- BETTISON-VARGA, L. & MACKINNON, I. D. 1997. The role of randomly mixed-layered chlorite/smectite in the transformation of smectite to chlorite. *Clays and Clay Minerals*, 45, 506-516.
- BIENIAWSKI, Z. T. 1989. *Engineering rock mass classifications: a complete manual for engineers and geologists in mining, civil, and petroleum engineering*, John Wiley & Sons.
- BONIFACE, A. 1997. Lesotho Highlands water project - design and construction of the transfer tunnel. *Proc. Inst. Civil Eng.-Civil Eng.*, 120, 30-42.
- BRIGATTI, M. F. & POPPI, L. 1985. Interlayer water and swelling properties of natural and homoionic corrensite. *Clays and Clay Minerals*, 33, 128-134.
- CASTRO, S., VAN SINT JAN, M., GONZALEZ, R., LOIS, P. & VELASCO, L. 2003. Dealing With Expansive Rocks In the Los Quilos And Chacabuquito Water Tunnels- Andes Mountains of Central Chile. 10th ISRM Congress, 2003. International Society for Rock Mechanics.
- CLARK B. & FLETCHER R. 2016. *Surveying a Tunnel Using an ROV*  
 URL:<http://www.hydraworld.com/articles/print/volume-24/issue-2/features/surveying-a-tunnel-using-an-rov.html>
- COLBACK, P. & WIID, B. 1900. The influence of moisture content on the compressive strength of rocks. *Geophysics*.
- CORBETT G. 2013. *Epithermal and Porphyry Ore deposits - Field Aspects for Exploration Geologists*. URL: <http://klsgeo.com/SC09.htm> [Retrieved 11. January 2017]
- DI MAIO, C. 2001. Swelling pressure of clayey soils: the influence of stress state and pore liquid composition.
- DUTROW B. L. & CLARK C. M. 2016: *X-ray Powder Diffraction (XRD)*  
 URL:  
[http://serc.carleton.edu/research\\_education/geochemsheets/techniques/XRD.html](http://serc.carleton.edu/research_education/geochemsheets/techniques/XRD.html)  
 [Retrieved September 2016]
- EINSTEIN, H. 1989. Suggested methods for laboratory testing of argillaceous swelling rocks. *Intl J of Rock Mech & Mining Sci & Geomechanic Abs*, 26.

EINSTEIN, H. 1994 Comments and recommendations on design and analysis procedures for structures in argillaceous swelling rock. *International Journal of Rock Mechanics and Mining Sciences and Geomechanics Abstracts*, 1994. Oxford; New York: Pergamon Press, 1974-c1996., 535-546.

EINSTEIN, H. 1996. Tunnelling in difficult ground—swelling behaviour and identification of swelling rocks. *Rock mechanics and rock engineering*, 29, 113-124.

FAIRHURST, C. 2014. *Analysis and design methods: comprehensive rock engineering: principles, practice and projects*, Elsevier.

FAIRHURST, C. & HUDSON, J. 1999. Draft ISRM suggested method for the complete stress-strain curve for intact rock in uniaxial compression. *International Journal of Rock Mechanics and Mining Sciences*, 36, 279-289.

FANG, Y., LI, J., LI, M., DING, W. & ZHANG, J. 2011. The formation and tectonic evolution of Philippine Sea Plate and KPR. *Acta Oceanologica Sinica*, 30, 75-88.

FARMER, I. W. 2012. *Engineering behaviour of rocks*, Springer Science & Business Media.

FOGED, N. N., SCHUPPENER, B., POWELL, J., URBARRI, V. E., FRANK, R., SMITS, M., MELZER, K., MAGNAN, J. P. & BOHAC, J. 2006. Eurocode 7 Geotechnical design-Part 2: Ground investigation and testing.

FRANKLIN, J. 1979. Suggested methods for determining water-content, porosity, density, absorption and related properties and swelling and slake- durability index properties. 2. Suggested methods for determining swelling and slake-durability index properties. *International Journal of Rock Mechanics and Mining Sciences*, 16, 151-156.

GALERA, J., PAREDES, M., MENCHERO, C. & POZO, V. 2014 Risk Associated with Swelling Rocks in Volcanic Formations in the Design of Hydro-Tunnels. ISRM Regional Symposium-EUROCK 2014. International Society for Rock Mechanics.

GEOLOGY.COM 2016. *Chlorite*

URL: <http://geology.com/minerals/chlorite.shtml> [Retrieved 03.12.2016]

GEOLOGYIN (2015) *Weathering and soil*

URL:<http://www.geologyin.com/2015/01/weathering-and-soil.html> [Retrieved 27. January 2017]

GEOTRAVELOGIST 2017. *Siliclastic Reservoir Quality*

URL:<http://geotravelogist.blogspot.no/2016/02/siliclastic-reservoir-quality.html>

[Retrieved October 2016]

GEOTECHDATA.INFO 2014 *Huder-Amber swelling test*

URL:<http://www.geotechdata.info/geotest/Huder-Amberg-swelling-test.html>

[Retrieved December 2016](#)

[Retrieved 20. October 2016]

GERCEK, H. 2007. Poisson's ratio values for rocks. *International Journal of Rock Mechanics and Mining Sciences*, 44, 1-13.

GOEL, R. K. & SINGH, B. 2011. *Engineering Rock Mass Classification: Tunnelling, Foundations and Landslides*, Elsevier Science.

GOODMAN, R. E. & OHNISHI, Y. 1973. Undrained shear testing of jointed rock. *Rock Mechanics*, 5, 129-149.

HALL, R., ALI, JR. & ANDERSON, C. 1995. Cenozoic motion of the Philippine Sea Plate: palaeomagnetic evidence from eastern Indonesia. 14, 1117-1132.

HANDY, R. L. 1971. Special Procedures for testing soil and rock for Engineering purposes: 5th ed. 1970. Spons. by ASTM Comm. D-18. ASTM Spec. Tech. Publ. 470. American Society for Testing and Materials, 1916 Race Street, Philadelphia, Pa. 19103. 630 pp. (Book Review).

HAWKINS, A. B. 1998. Aspects of rock strength. *Bulletin of Engineering Geology and the Environment*, 57, 17-30.

HOEK, E. & BROWN, E. T. 1997. Practical estimates of rock mass strength. *International Journal of Rock Mechanics and Mining Sciences*, 34, 1165-1186.

HOEK, E., CARRANZA-TORRES, C. & CORKUM, B. 2002. Hoek-Brown failure criterion-2002 edition. *Proceedings of NARMS-Tac*, 1, 267-273.

HUBER, M. 2013. *Soil variability and its consequences in geotechnical engineering*, Inst. f. Geotechnik.

HUDSON, J. A. 1993. *Comprehensive rock engineering: principles, practice & projects: 4: Excavation, support and monitoring*, Oxford, Pergamon Press.

ISRM 2016 *Introduction to ISRM* (webpage)

URL: <https://www.isrm.net/>

[Retrieved 20. December 2016]

ISRM 1999. Suggested method for laboratory testing of swelling rock. *Int. J. Rock Mech. Min. Sci. & Geomech. Abstr.* 36, 291 – 306.

ISRM 1994. Comments and recommendations on design and analysis procedures for structures in argillaceous swelling rock. *International Journal of Rock Mechanics and Mining Sciences and Geomechanics Abstracts*, 31, 535-546.

ISRM 1989. *Suggested methods for laboratory testing of argillaceous swelling rocks*. *Int. J. Rock Mech. Min. Sci. & Geomech. Abstr.* Vol. 26, No. 5, pp. 415-426.

ISRM 1978 *Suggested methods for determining tensile strength of rock materials*. *Int J Rock Mech Min Sci Geomech Abst* 15:101–103

KOVARI, K., CH AMSTAD, and G. ANAGNOSTOU 1988. "Design/construction methods-Tunnelling in swelling rocks." *The 29th US Symposium on Rock Mechanics (USRMS)*. American Rock Mechanics Association.

KRANZ, R., BISH, D. & BLACIC, J. 1989. Hydration and dehydration of zeolitic tuff from Yucca Mountain, Nevada. *Geophysical Research Letters*, 16, 1113-1116.

KUO, M.-C., TIEN, Y. M. & CHU, C. A. 2004. Study of failure process and failure modes of interstratified rock mass with an emphasis on specimen preparation and image scanning. Gulf Rocks 2004, the 6th North America Rock Mechanics Symposium (NARMS), 2004. American Rock Mechanics Association.

LALLEMAND, S. 2016. Philippine Sea Plate inception, evolution, and consumption with special emphasis on the early stages of Izu-Bonin-Mariana subduction. *Progress in Earth and Planetary Science*, 3.

LIKAR, J., LIKAR, A., ŽARN, J. & ČEBAŠEK, T. M. 2015. Analysis of shallow tunnels construction in swelling grounds. *RMZ–M&G*, 62, 175-191.

LU, Y., WANG, L., SUN, X. & WANG, J. 2016. Experimental study of the influence of water and temperature on the mechanical behavior of mudstone and sandstone. *Bulletin of Engineering Geology and the Environment*, 1-16.

MANITOBA ROCKS 2017. *Origins of rocks*

URL: <http://www.manitoba.ca/iem/min-ed/kidsrock/origins/index.html>

[Retrieved 10. January 2017]

MAROSVOLGYI, K. 2010. Retrograde Alteration of Basaltic Rocks in the Þeistareykir High-Temperature Geothermal Field, North-Iceland.

MCPHERSON, G. 2013. *Statistics in scientific investigation: its basis, application, and interpretation*, Springer Science & Business Media.

MICHALIS I. K. 2015. *Challenges of tunnel design and construction in the GCC region*, Power Point Presentation

URL: <http://www.slideshare.net/ILIASMICHALIS/michalis-presentation2015>

[Retrieved 28. January 2017]

MOHAJERANI, M., DELAGE, P., MONFARED, M., TANG, A. M., SULEM, J. & GATMIRI, B. 2011. Oedometric compression and swelling behaviour of the Callovo-Oxfordian argillite. *International Journal of Rock Mechanics and Mining Sciences*, 48, 606-615.

MOORE, D. E. & LOCKNER D. A. 1995. The role of microcracking in shear-fracture propagation in granite: D. E. Moore & D. A. Lockner, *Journal of Structural Geology* , 17(1), 1995, pp 95–114.

NAGARAJ, H. B., MUNNAS, M. M. & SRIDHARAN, A. 2009. Critical evaluation of determining swelling pressure by swell-load method and constant volume method. *Geotechnical Testing Journal*, 32, 305-314.

NILSEN, B. 2007 *Reliability of Swelling Pressure Testing for Tunnel Support Evaluation*

NILSEN, B., MAO, D. & DAHL, F. 2011 Laboratory Testing of Swelling Gouge From Weakness Zone - Principle And Recent Update. American Rock Mechanics Association.

NILSEN & PALMSTRØM 2000 Engineering Geology and Rock Engineering, NFF/NBG Handbook No. 2.

OKUBO, S. & NISHIMATSU, Y. 1985. Uniaxial compression testing using a linear combination of stress and strain as the control variable. *International Journal of Rock Mechanics and Mining Sciences & Geomechanics Abstracts*, 1985. Elsevier, 323-330.

PALMSTRÖM, A. & SINGH, R. 2001. The deformation modulus of rock masses—comparisons between in situ tests and indirect estimates. *Tunnelling and Underground Space Technology*, 16, 115-131.

PANTHI, K. K. & NILSEN, B. 2007. Predicted versus actual rock mass conditions: A review of four tunnel projects in Nepal Himalaya. *Tunnelling and underground space technology*, 22, 173-184.

PETTERSEN SKIPPERVIK, C. 2014. Study on the Swelling Potential of some Selected Rocks. Institutt for geologi og bergteknikk.

PETROWIKI 2016 *Compressive strength of rocks*

URL: [http://petrowiki.org/Compressive\\_strength\\_of\\_rocks](http://petrowiki.org/Compressive_strength_of_rocks)

[Retrieved 6. November 2016]

PIMENTEL, E. 2015. Existing Methods for Swelling Tests—A Critical Review. *Energy Procedia*, 76, 96-105.

RAUH, F., THURO, K. & SPAUN, G. 2006. The powder swelling test-advantages and limitations. *Engineering Geology for Tomorrow's cities Geological Society London, Engineering Geology Special Publication*, 22.

RIEMER, W. 2009. La Higuera Hydroelectric Power Plant. Tunnel Headrace. Geological Aspects (Report received by Statkraft)

ROCCHI, G., VACIAGO, G., FONTANA, M. & DA PRAT, M. 2013. Understanding sampling disturbance and behaviour of structured clays through constitutive modelling. *Soils and foundations*, 53, 315-334.

ROKOENGEN, K. 1974. Classification of rock gouge materials: In Proc. Rock Mechanics Meeting, Oslo, Nov. 1973. FJELLSPRENGNINGSTEKNIKK-BERGMECHANIKK, TAPIR, OSLO, 1974. *International Journal of Rock Mechanics and Mining Sciences & Geomechanics Abstracts*, 1975. Pergamon, 58.

- ROMANA, M. & SERON, J. 2005. Characterization of swelling materials by Huder-Amberg oedometric test. Proceedings of the international conference on soil mechanics and geotechnical engineering. Aa Balkema publishers, 591.
- RUEDRICH, J., BARTELTSEN, T., DOHRMANN, R. & SIEGESMUND, S. 2011. Moisture expansion as a deterioration factor for sandstone used in buildings. *Environmental Earth Sciences*, 63, 1545-1564.
- SCHÄDLICH 2014. *UDSM – Swelling Rock Model*
- URL: <https://www.plaxis.com/support/models/udsm-swelling-rock-model/>
- [Retrieved 4. August 2016]
- SCHÄDLICH, B., MARCHER, T. & SCHWEIGER, H. 2013. Application of a constitutive model for swelling rock to tunneling. *Geotech Eng*, 44, 47-54.
- SZWEDZICKI, T. 2007. A Hypothesis on Modes of Failure of Rock Samples Tested in Uniaxial Compression. *Rock Mechanics and Rock Engineering*, 40, 97-104.
- SDROLIAS, M., ROEST, W. R. & MÜLLER, R. D. 2004. An expression of Philippine Sea plate rotation: the Parece Vela and Shikoku Basins. *Tectonophysics*, 394, 69-86.
- SELMER, R. & PALMSTROM, A. 1989. Tunnel collapses in swelling clay zones. *Tunnels & tunnelling*.
- SERAFEIMIDIS, K. 2014. *On the dissolution, precipitation and transport processes in sulphatic swelling rocks*, vdf Hochschulverlag AG.
- SHANKS III, W. P., KOSKI, R. A., MOSIER, D. L., SCHULZ, K. J., MORGAN, L. A., SLACK, J. F., RIDLEY, W. I., DUSEL-BACON, C., ROBERT, R. & SEAL, I. 2012. Volcanogenic massive sulfide occurrence model: Chapter C in Mineral deposit models for resource assessment. US Geological Survey.
- SHAU, Y.-H., PEACOR, D. R. & ESSENE, E. J. 1990. Corrensite and mixed-layer chlorite/corrensite in metabasalt from northern Taiwan: TEM/AEM, EMPA, XRD, and optical studies. *Contributions to Mineralogy and Petrology*, 105, 123-142.
- SIEGESMUND, S., SNETHLAGE, R. & SPRINGERLINK 2014. *Stone in Architecture: Properties, Durability*, Berlin, Springer Berlin Heidelberg.
- SN ABOITIZ 2015. *Geotechnical Investigations, Alimit HEPP DAM, Geological sections*. (Unpublished)



SN ABOITIZ/STACHE M. 2015. *Geological Report, Olilicon and Alimit HPP's and Alimit pump storage schemes, Feasibility phase.* (Unpublished)

SPEIL, S. 1944. *Applications of thermal analysis to clays and aluminous minerals*, US Dept. of the Interior, Bureau of Mines.

STATKRAFT 2016. La Higuera.

URL:<http://www.statkraft.com/energy-sources/Power-plants/Chile/La-Higuera/>

[Received 1. February 2017]

STILLE, H. & PALMSTRÖM, A. 2008. Ground behaviour and rock mass composition in underground excavations. *Tunnelling and Underground Space Technology*, 23, 46-64.

STREKEISEN A. 2017 *Seafloor basalt*

URL: <http://www.alexstrekeisen.it/english/meta/metabasalt.php>

[Retrieved 10. January 2017]

SUMNER, P., HALL, K., VAN ROOY, J. & MEIKLEJOHN, K. 2009. Rock weathering on the eastern mountains of southern Africa: Review and insights from case studies. *Journal of African Earth Sciences*, 55, 236-244.

SVERIGES TEKNISKA FORSKNING SINSTITUT AB 2016, *Uniaxial compression tests*

URL:

<https://www.sp.se/en/index/services/rockmechanicaltesting/uniaxial/Sidor/default.aspx>

[Retrieved 17. September 2016]

SZWEDZICKI, T. & SHAMU, W. 1999 The effect of discontinuities on strength of rock samples. *Proceedings of the Australasian Institute of Mining and Metallurgy*. Citeseer, 23-28.

TANG, C., WONG, R., CHAU, K. & LIN, P. 2005. Modeling of compression-induced splitting failure in heterogeneous brittle porous solids. *Engineering fracture mechanics*, 72, 597-615.

TANG, S. & TANG, C. 2012. Numerical studies on tunnel floor heave in swelling ground under humid conditions. *International Journal of Rock Mechanics and Mining Sciences*, 55, 139-150.

TERZAGHI, K., PECK, R. B. & MESRI, G. 1996. *Soil mechanics in engineering practice*, John Wiley & Sons.

THAKUR, V. K. & SINGH, D. N. 2005. Rapid determination of swelling pressure of clay minerals. *Journal of Testing and Evaluation*, 33, 1-7.

THE EDITORS OF ENCYCLOPÆDIA BRITANNICA 2015: Aleutian Island, Archipelago, Pacific Ocean

URL: <https://global.britannica.com/place/Aleutian-Islands> [Retrieved January 2017]

UNESCO BANGKOK, 2008. *The Effects of Tourism on Culture and the Environment in Asia and the Pacific, IMPACT, Sustainable Tourism and the Preservation of the World Heritage Site of the Ifugao Rice Terraces*, Philippines viii + 90 p.

URL:[http://www.unescobkk.org/fileadmin/user\\_upload/culture/Impact/IMPACT\\_Cover/First\\_Chapter\\_IMPACT\\_Ifugao.pdf](http://www.unescobkk.org/fileadmin/user_upload/culture/Impact/IMPACT_Cover/First_Chapter_IMPACT_Ifugao.pdf)

[Retrieved 30.July 2016]

VERGARA, M. R., BALTHASAR, K. & TRIANTAFYLLIDIS, T. 2014. Comparison of experimental results in a testing device for swelling rocks. *International Journal of Rock Mechanics and Mining Sciences*, 177-180.

VERGARA, M. R. & TRIANTAFYLLIDIS, T. 2015. Swelling behavior of volcanic rocks under cyclic wetting and drying. *International Journal of Rock Mechanics and Mining Sciences*, 80, 231-240.

VERGARA, M. R. & TRIANTAFYLLIDIS, T. 2016. Influence of water content on the mechanical properties of an argillaceous swelling rock. *Rock Mechanics and Rock Engineering*, 49, 2555-2568.

WAHLSTROM, E. 2012. *Tunneling in rock*, Elsevier.

WEDEKIND, W., LÓPEZ-DONCEL, R., DOHRMANN, R., KOCHER, M. & SIEGISMUND, S. 2013. Weathering of volcanic tuff rocks caused by moisture expansion. *Environmental earth sciences*, 69, 1203-1224.

WILSON, M., WILSON, L. & PATEY, I. 2014. The influence of individual clay minerals on formation damage of reservoir sandstones: a critical review with some new insights. *Clay Minerals*, 49, 147-164.

WITTKE, W. 2014. *Rock mechanics based on an anisotropic jointed rock model (AJRM)*, John Wiley & Sons.

WITTKE-GATTERMANN, P. 2003. Dimensioning of tunnels in swelling rock. 10th ISRM Congress, 2003. International Society for Rock Mechanics.

WITTKE-GATTERMANN, P. & WITTKE, M. 2004. Computation of strains and pressures for tunnels in swelling rocks. *Tunnelling and Underground Space Technology*, 19, 422-423.

WOLFE, R. C. & COOKE, D. R. 2011. Geology of the Didipio region and genesis of the Dinkidi alkalic porphyry Cu-Au deposit and related pegmatites, northern Luzon, Philippines. *Economic Geology*, 106, 1279-1315.

WONG, L. N. Y., MARUVANCHERY, V. & LIU, G. 2016. Water effects on rock strength and stiffness degradation. *Acta Geotechnica*, 11, 713-737.

WYOMING STATE GEOLOGICAL SURVEY. 2017. *Other Geological Hazards*  
URL: <http://www.wsgs.wyo.gov/hazards/other-hazards>

[Retrieved 5. January 2017]

ZAHIROVIC, S., MÜLLER, R. D., SETON, M. & FLAMENT, N. 2015. Tectonic speed limits from plate kinematic reconstructions. *Earth and Planetary Science Letters*, 418, 40-52.

ZHENG, H.-W., GAO, R., LI, T.-D., LI, Q.-S. & HE, R.-Z. 2013. Collisional tectonics between the Eurasian and Philippine Sea plates from tomography evidences in Southeast China. *Tectonophysics*, 606, 14-23.

ZURAWSKI, R. 2014. *Industrial communication technology handbook*, CRC Press.

ZUSSMAN, J., DEER, W. A. & HOWIE, R. A. 2004. Rock-forming Minerals: Silica Minerals, Volume 4B. 2004. Geological Society of London.

Other material used:

- Received pdf. from Gunnar Vistnes, NTNU: *Frisvelling og ødometer* and *Differentialtermisk analyse (DTA)*, 2016
- Received Power Point Presentation (*PPP*), SN Aboitiz, 2016

- Oral discussions with M.R. Vergara (sited as “Vergara 2016”) and Gunnar Vistnes (sited as “Vistnes 2016”), 2016

## Appendix 5.A Set-up and procedures in oedometric swelling tests at NTNU

The apparatus and procedures are updated several times, mainly based on experience with gauge material. The oedometers do not allow decrements in load during the tests (as according to the Huder-Amberg test) due to the software used. The swelling pressure - swelling strain relationship (Grob's law) is thus not obtainable by use of these oedometers today.

### **OEDOMETER APPARATUS**

The following description of the apparatus for tests under conditions of zero volume change is obtained from "*Suggested method for determining swelling and slake-durability index properties*" by ISRM (1979 (1977)).

An illustration of the apparatus is given in Figure 5.A.1, and is shown by pictures in Figure 5.A.2.

The apparatus may be adapted from that used for soil consolidation testing, and consists essentially of the following:

- (a) A metal ring for rigid radial restraint of the specimen, polished and lubricated to reduce side friction and of depth at least sufficient to accommodate the specimen.
- (b) Porous plates to allow water access at top and bottom of the specimen, the top plate of such a diameter to slide freely in the ring. Filter papers may be inserted between specimen and plates.
- (c) A cell to contain the specimen assembly, capable of being filled with water to a level above the top porous plate.
- (d) A micrometer dial gauge or other device reading to 0.0025mm, mounted to measure the swelling displacement at the central axis of the specimen.

(e) A load measuring device capable of measuring to an accuracy of 1%, the force required to resist swelling.

(f) A loading device such as a screw jack, capable of continuous adjustment to maintain the specimen at constant volume as swelling pressure develops. The force should be applied through rigid members to ensure that the porous plates remain flat, a spherical seat allowing rotation of the top porous plate.”

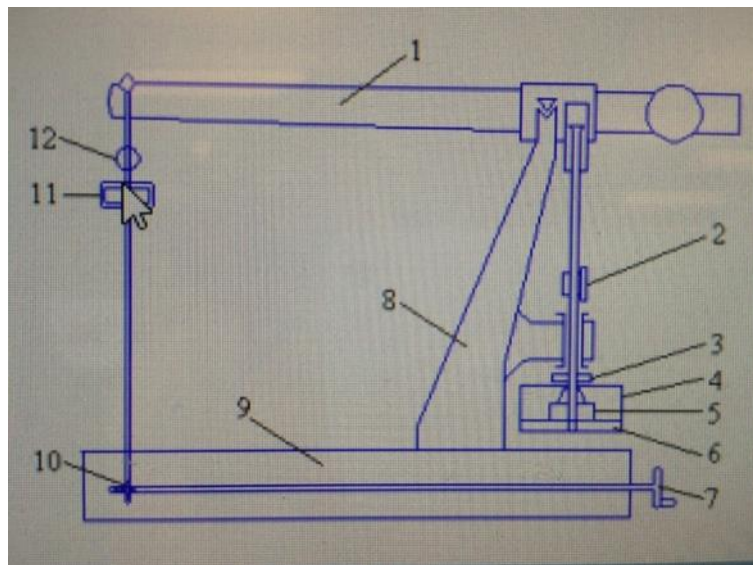

*Figure 5.A.1: 1) Balance lever, with the ratio of 1:10. 2) Dial gauge with a sensitivity of 0.001 mm to measure the height (volume) of the specimen. 3) Adjustment screw. 4) Container. 5) Cylindrical test cell. 6) Steel base plate of the container. 7) Wheel. 8) Frame. 9) Base. 10) Worm gear. 11) Pressure ring . 12) Dial gauge with a sensitivity equivalent to 0.05tons/m<sup>2</sup> to measure the pressure.*

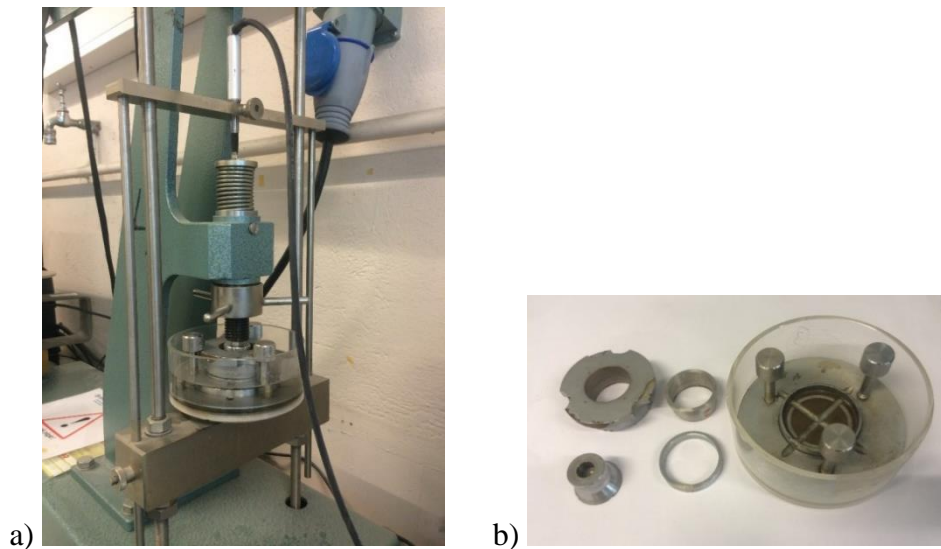

*Figure 5.A.2 Apparatus configuration (a), and sample-cell elements (b).*

## **PREPARATION**

### **Powder tests:**

For each test, 20 g of the prepared powder was packed in a 20 cm<sup>2</sup> cylindrical test cell with a brass filter at the top and a porous glass filter at the bottom before installed into the test apparatus.

### **Intact rock structure specimen:**

The intact rock structure discs were prepared by drilling (over-coring) the cores (without using water) to a diameter of 35, 7 mm. All samples were then cut straight within the indicated tolerances in terms of flatness of the ends and smoothness of the surfaces as suggested by ISRM methods, and to a thickness/height of 5mm. Due to friction issues the smoothness of the surfaces were not perfectly according the standard, and some of the samples were treated with epoxy because of irregularities. The specimens were then placed in the ring and installed in the 10 cm<sup>2</sup> oedometer test cell as for the powder samples. Sample AQD-02 (box 5) had too poor quality to survive the preparation and is thus not tested. The prepared specimen of AD-02 (box 12) is shown in Figure 5.A.3.

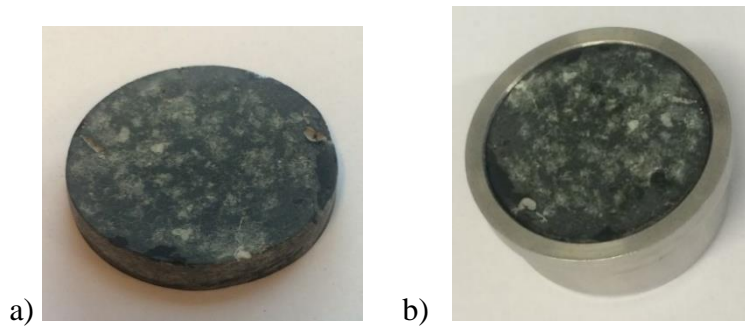

*Figure 5.A.3 (a and b): Prepared intact rock structure specimen (AD-02 box 12) for swelling pressure tests*

Common for all tests, the adjustment screw was used to align the balance lever to the ideal position slightly above the horizontal line followed by the installation of the height transducer. Thereafter both the pressure ring and the pressure dial gauge are installed, and steel disc weights applied to the balance lever compressed the specimen at 2 MPa for 24 hours, followed by an unloading of 2 hours.

### **SWELLING PROCEDURE**

The same procedure is performed on both powder- and intact rock structure specimen, and is based on the ISRM-standard (1979 (1977)).

The swelling procedure was initiated by adding distilled water to the container. The automatized motor of apparatus ensured the volume of samples to stay constant during the tests. The apparatus deformation was also compensated with continuous adjustment of the worm gear connected to the pressure ring and balance lever as the swelling pressure was mobilized and recorded. The specimen was left to swell for 24 hours, which is standard time frame of swelling tests at NTNU.

The testing principle is illustrated in Figure 5.A.4.



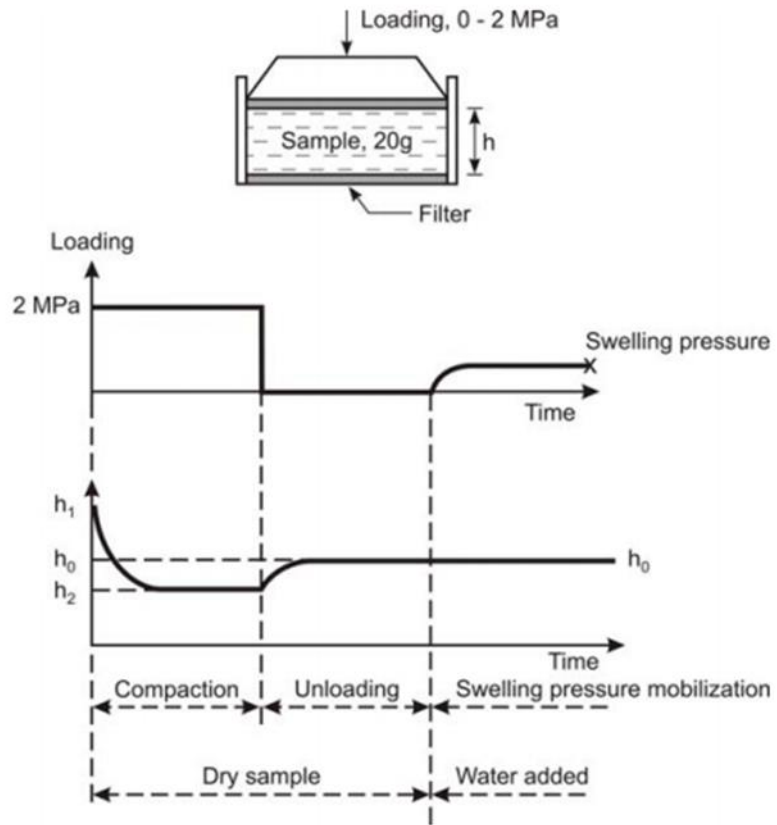

Figure 5.A.4: Principle for testing swelling pressure at constant volume (Nilsen 2007)

## Appendix 5.B Set-up and procedure in oedometric swelling tests at KiT

### **OEDOMETER APPARATUS**

Two types of oedometers have been in operation at KiT the last years, where the last version is a modified type of the ISRM suggested apparatus (1989) and is used in this study. The oedeometers allows control over the deformation or the load on the specimen in order to perform stress or strain controlled swelling tests, and have undergone some recent modifications due to avoid influence of the device stiffness in measuring the deformation of the specimen under constant strain conditions (Vergara et al. 2014). The swelling pressure – swelling strain relationship (Grob`s law) is obtainable with these oedometers.

The following description of the oedometric set-up and methodology is obtained from the articles “Comparison of experimental results in a testing device for swelling rocks” (Vergara et al. 2014) and “Swelling behavior of volcanic rocks under cyclic wetting and drying” (Vergara & Triantafyllidis 2015). The apparatus configuration and swelling procedures are based on the ISRM suggested methods (1989).

#### **Apparatus set-up prior to the updates in 2015:**

The original apparatus consists of a rigid frame formed by two plates and four columns, where the rocks specimen is inserted into a ring and installed in the watering cell between two 5 mm thick porous metal sincereds disks. The load and deformation on the specimen are applied from the top and controlled manually with a spindle, where the load acting on the specimen is measured by a load cell mounted on the bottom plate of the apparatus. The deformation on the specimen is measured by one digital dial gauge placed on the top of the spindle.

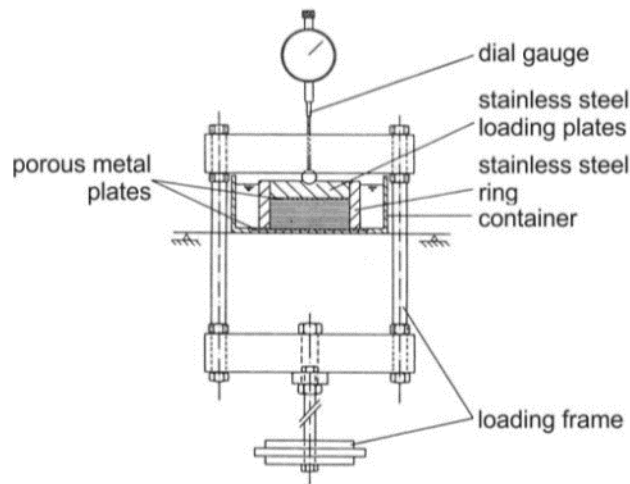
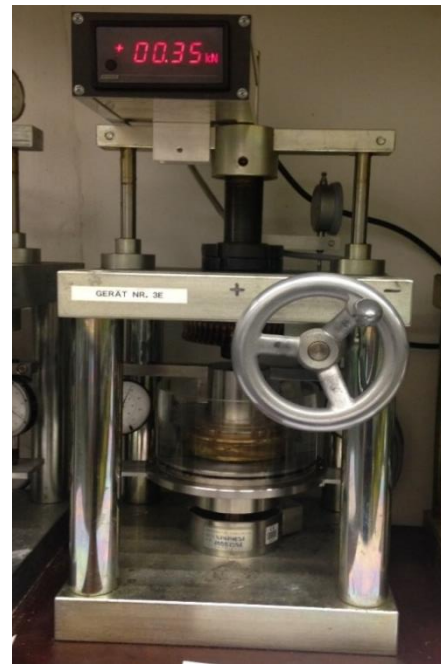
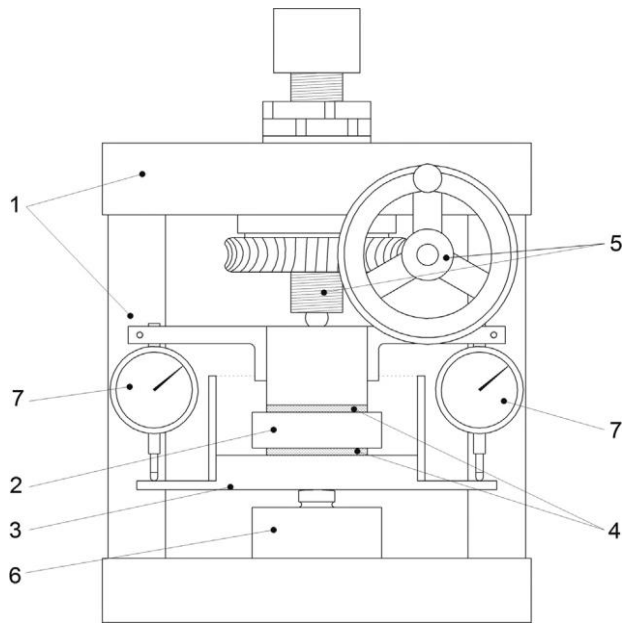

*Figure 5.B.1: Apparatus set-up prior to 2015 (Pimentel 2015)*

**Modified apparatus (used in this study):**

The modified apparatus is improved by two dial gauges attached at opposite diameter ends of the loading plate, which measure the distance between the loading plate and the bottom of the container where the specimen is installed. This allows keeping the axial deformation of the specimen in the desired amount, avoiding the influence of the vertical deformation of the load cell, spindle and the frame due to the swelling pressure induced by the specimen on the apparatus components. The apparatus stiffness is critical to obtain this, and is measured (by investigations done by Vergara et al. 2014 and 2015) to be approximately 100 kN/mm. In addition, corrections are made due to the deformation of the porous plates. In tests performed under constant strain, the vertical deformation of the specimen has to be corrected manually with the spindle during the course of the test.

The apparatus configuration is shown in Figure 5.B.2.



*Figure 5.B.2: Modified oedometric apparatus (Vergara et al. 2014 and 2015) 1) rigid frame, 2) ring with rock specimen, 3) watering cell, 4) porous metal plates, 5) spindle, 6) load cell and 7) dial gauges*

## **PREPARATION**

### **Powder tests:**

The powder used in the tests was prepared at NTNU before arrival at Karlsruhe. For each test, about 100 g of the powder was weighed out for compaction into the ring, producing samples with diameters of about 60-61 mm and thicknesses of 17-19 mm. To obtain the desired density of the powder samples, a standard load frame was used to load the powder with about 200-300 kN (obs: not standard load). The density of the powder should reach the density of the rock in the undisturbed original structure, however, the rock densities are unknown due to lack of measurements and desired densities after preparation are based on assumptions. The densities of the powder specimens ended up in an appropriate range of 1,87- 2,00 g/cm<sup>3</sup>, and were weighed for later calculation of the water absorbed.

The apparatus used for compaction is shown in figure 5.B.3, and the compaction is illustrated in Figure 5.B.4. Figure 5.B.5 show a ready sample.

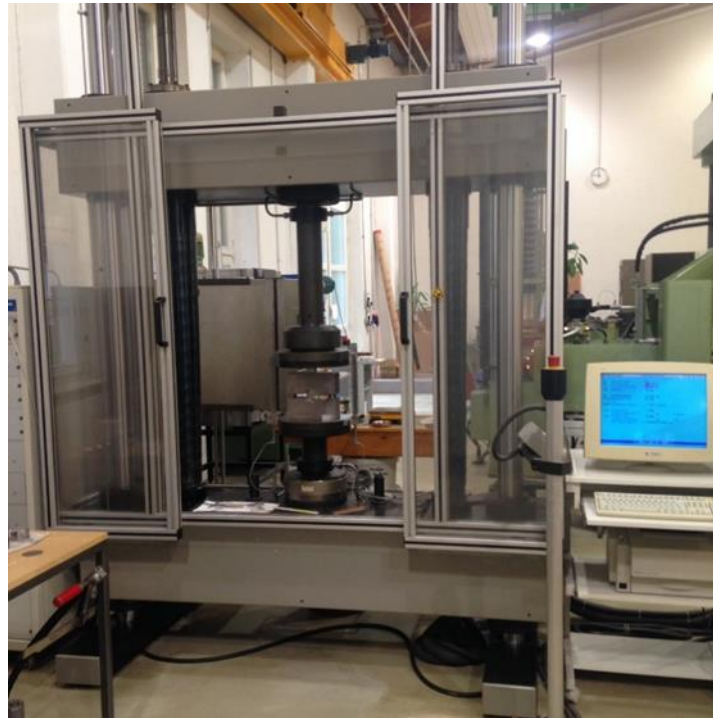

*Figure 5.B.3: The apparatus used for compaction of powder samples at KiT.*

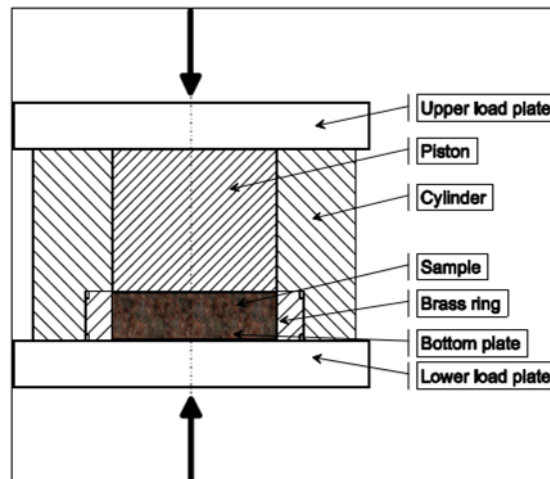

*Figure 5.B.4: Illustration on the compaction of powder samples at KiT (from received report, KiT 2016)*



*Figure 5.B.5: Ready powder sample (APH-02 box 18).*

**Intact rock structure specimen:**

Preparation was performed by the laboratory technician. Because the diameter of the core samples was very close to the diameter of the available rings, the rings were adapted to sample by using a lathe. The cores were cut longer than the ring heights of 20 mm, and pressed into their respective rings. Then the samples were cut at both ends close to the ring, leaving 2-3 mm at both sides, before mounted on a lathe and grinded flat and parallel to each other. The end faces were grinded about 0.5-1 mm into the ring, leaving place at each side for the filters before mounted in the apparatus. The lathe is shown in Figure 5.B.6.

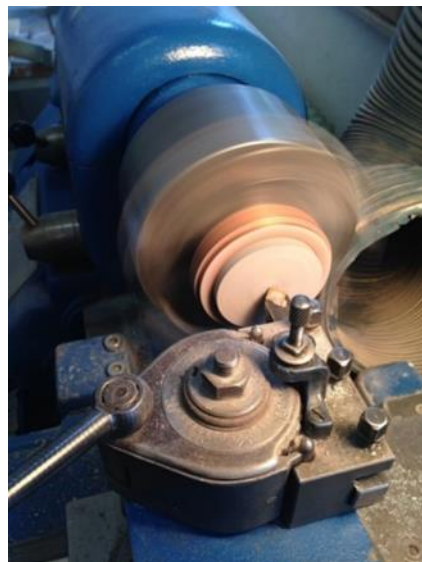

*Figure 5.B.6 Grinding of intact structure specimen by use of a lathe at KiT.*

Common for all tests, the specimens were vertically loaded with 0.1 kN in order to achieve contact between all elements in the oedometer, no other pre-loading nor unloading procedure was performed.

## **SWELLING PROCEDURE**

The same procedure is performed on both powder- and intact rock specimens, and the tests were performed in an acclimatized room in order to minimize the effect of temperature or humidity changes. In the first cycles the tests are performed under conditions of zero volume change, according to the ISRM standard of 1989. Depending on the evolution of swelling pressure during the first cycles, additional cycles allowing about 0.5 % deformation were performed (controlled deformation), keeping this value until the samples were fully swelled.

### **Zero volume change:**

For the powder samples, it was considered satisfactory with one cycle and the water was removed from the vessel and the samples were weighed. For the intact rock structure specimen there were performed cyclic wetting and drying to simulate conditions in a hydropower water tunnel.

Immediately after achieving contact between all elements, demineralized water was added to the watering cell submerging the specimens completely. The axial swelling pressure developed by the specimen was recorded over time, and after no noticeable change in the pressure was observed, the first cycle was assumed completed. The water was removed from the watering vessel and the specimens were left to dry under a controlled temperature of 20 °C and relative air humidity of 45%, still mounted in the testing apparatus. As an effect of drying, the axial pressure produced by swelling decreased until a constant value was reached, marking the “finish-point” of the drying process. The same water used in the previous wetting phase was poured again in the vessel, and the same water was reused in all cycles to avoid the influence of adding new demineralized water to react with the specimens. However, due to evaporation the vessel had to be periodically refilled with demineralized water to keep the volume of water constant during the tests.

**Controlled deformation:**

The procedure is very similar as for single swelling pressure tests in the first cycles (zero volume change-tests). In the cases where the swelling pressure do not increase after about 3 cycles, further cycles were performed where a controlled deformation was allowed to see if it has an effect on the swelling behavior. The degree of deformation was kept constant during each cycle. For the samples which underwent cycles with controlled deformation, the degree of deformation was similar in the next cycles until the pressure was stabilized.

The adjustments to keep the desired volumes during the tests and the recording of swelling pressures were performed manually.



## Appendix 6.A Material data and pictures

The material used in the test-suite consist of samples belonging to the original plan of testing and additional samples for the UCS-tests.

### Overview of samples tested

In the Table 6.A.1 all samples are listed, including description of the depth at which they are taken from, lithology, which tests they underwent during the laboratory work and which category they were placed in.

*Table 6.A.1: The complete overview of material.*

Sample	Depth	Lithology	Tests	Category in swelling tests	Category in UCS-tests
<b>AD-02, box 12 (1), (2)</b>	~ 40.35 – 44.05 m	Grey-green-coloured rock with white spots. Medium to coarse grained homogenous matrix. Apparently strong	* UCS-test (1) dry, (2) wet * Swelling pressure (NTNU and KiT) * Free swelling * XRD * DTA	Rock type “strong”	“Andesitic rock”
<b>AD-06, box 25</b>	~ 86.30 – 87.30 m	Dark grey-coloured rock with some white stripes and spots. Fine-grained homogenous matrix. Apparently strong	* Swelling pressure (NTNU and KiT) * Free swelling * XRD * DTA	Rock type “strong”	-

Table 6.A.1 continued

<b>AD-07, box 12</b>	~ 38.35 – 41.00 m	Different shades of green and some areas/stripes of white colour. Fine-medium-grained heterogeneous matrix. Apparently medium strong.	* Swelling pressure (NTNU and KiT) * Free swelling * XRD * DTA	Rock type “strong”	-
<b>AQD-02, box 12</b>	~ 42.25 – 45.60 m	Grey-purple with some areas/stripes of white colour. Fine-grained heterogeneous matrix. Apparently strong.	* UCS-test (dry) * Swelling pressure (powder and disc, NTNU and KiT) * Free swelling * XRD * DTA	Rock type “strong”	“Basaltic rock”
<b>AQD-02, box 5</b>	~ 16.70 – 20.60 m	Brown matrix with clasts of different colours. Apparently weak.	* Swelling pressure (powder and disc, NTNU and KiT) * Free swelling * XRD * DTA	Rock type “weak”	-
<b>AQD-02, box 6</b>	~ 20.60 – 24.60 m	Green-white matrix with purple clasts. Apparently weak.	* Swelling pressure (powder and disc, NTNU and KiT) * Free swelling * XRD * DTA	Rock type “weak”	-
<b>APH-02, box 18</b>	~ 59.80 – 63.40 m	Melange of brown-red, green and white colour. Fine grained and heterogeneous matrix. Apparently medium weak.	* Swelling pressure (powder and disc, NTNU and KiT) * Free swelling * XRD * DTA	Rock type “weak”	-

Table 6.A.1 continued

<b>AD-05, box 5</b>	~ 15.75- 19.15 m	Grey-coloured rock with some white spots. Medium to coarse-grained matrix. Apparently strong.	* UCS (dry) * Swelling pressure (powder, NTNU) * Free swelling * XRD	-	“Andesitic rock”
<b>AD-02, box 8</b>	~26.05 – 29.75 m		* UCS (dry) * Swelling pressure (powder, NTNU) * Free swelling * XRD		“Andesitic rock”
<b>AD-02, box 3</b>	~8.10 – 11.55 m		* UCS (wet)		“Andesitic rock”
<b>AQD- 02, box 8</b>	~29 m		* UCS (wet)		“Andesitic rock”

Complete overview of the samples in pictures

AD-02, box 12



Medium grey with some green minerals, intact and homogeneous, with small white spots. High RQD.

AD-06, box 25



Dark grey with a green shade, some white stripes which probably are crack-fillings.  
Medium to high RQD.

AD-07, box 12



The color is a mixture of different shades of green with some sporadic stripes of white. Medium to high RQD.

AQD-02, box 12



The color is a mixture of grey, purple and green, with some white spots and stripes.  
Medium to high RQD.

AQD-02, box 5



Agglomeratic rock type with brown matrix and clasts of different colors. The matrix looks like consolidated soil. The intact samples easily break and/or disintegrate by touching them. Low RQD.



AQD-02, box 6



Agglomeratic rock with green-white matrix and purple-brown fragments. Low RQD.

APH-02, box 18



The rock has a strong red-brown color with some white spots and stripes. The fracture surfaces are muddy/pulverized. Low to medium RQD.

AD-05, box 5



Visual alike AD-02 (box 12).

AQD-02, box 8

(picture of box lack)

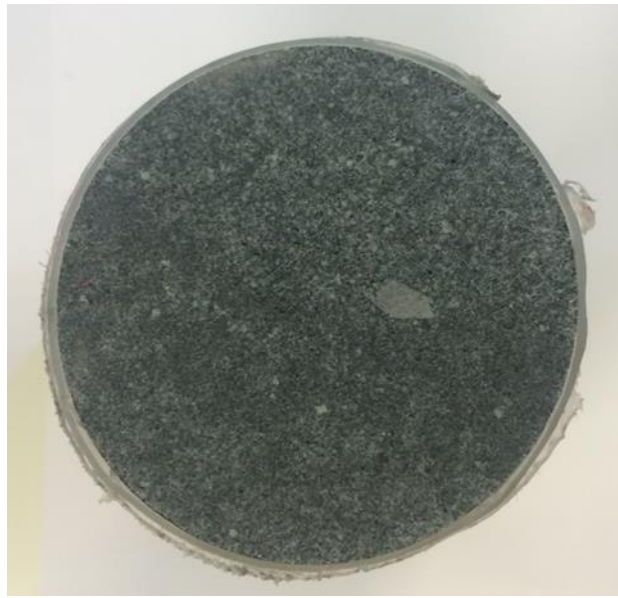

Visual alike AD-02 (box 12), but more fine-grained.

AD-02, box 3



Dark grey fine grained rock with small white grains.

AD-02, box 8



Visual alike AD-02 (box 12).

## Appendix 6.B Procedure of powder preparation, mineralogical analyses, UCS-tests and free swelling test

### **Preparation of bulk-powder for mineralogical analyses and swelling tests**

All powder samples used in the test-suite are prepared the same way due to the ISRM standard (1979). The exception from the standard is the oven-drying of the material prior to tests. The procedure is summarized as follows:

The cores are previously dried in room temperature in >8 weeks before prepared and tested. The powder was prepared by first crushing a piece of the core-samples by hand with a geological hammer followed by further fragmentation in the jaw crusher, giving a rock piece size of about 10-15 mm. The crushed bulk material sample were then placed in a coil mill for 2 minutes, resulting in a milled powder with particles of <2  $\mu\text{m}$ . Powder of each sample was weighed out in two copies for the swelling tests according to the traditional volume used at the different labs. The rest was saved for use in the XRD-analysis, DTA and free swelling tests.

### **Procedure of the mineralogical analyses**

The following description of procedure is general and apply for all the performed tests.

#### **XRD**

Two types of tests were performed at the NTNU chemical/mineralogical laboratory, for each of the pulverized rock samples: One bulk-powder test and one fine fraction (<6  $\mu\text{m}$ ) test. For the first type, the bulk powder obtained from milled sample material as earlier described was used. A few tenths of a gram of the material is smeared uniformly onto the sample container, assuring a flat upper surface.

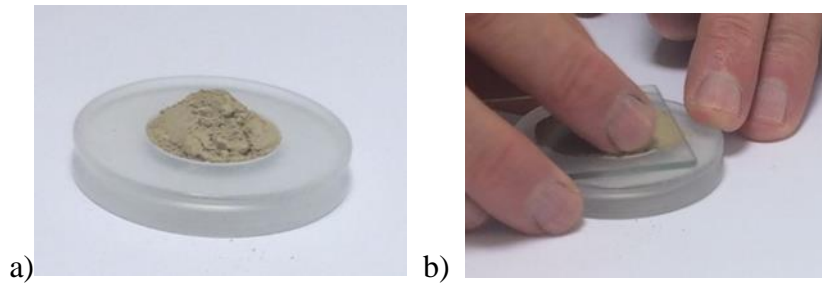

*Figure 6.B.1 (a and b): Preparation of bulk-powder-test*

For the second type of test, the fine fraction powder was separated from gravel by rubbing the material (by hand) in a holder with distilled water. The samples (AD-02 box 12), AD-07 (box 12) and APH-02 (box 18) underwent additional analyzes by preparing the fine-fraction-samples from an intact piece of rock. The fine fraction dissolved in water was then put into a measuring cylinder, and more distilled water was added. The dissolution rested for 1 hour, 45 minutes and 50 seconds due to Stoke`s law, and the first 20 cm of the dissolution was pumped into a flask, containing particles of  $>60 \mu\text{m}$ .



*Figure 6.B.2: Measuring cylinders with fine-fraction material dissolved in water*

A filter with pore sizes of  $0.4 \mu\text{m}$  was used to filtrate the solution (removing the water), and the filter with the particles was pushed against a plate of glass, ready for XRD.



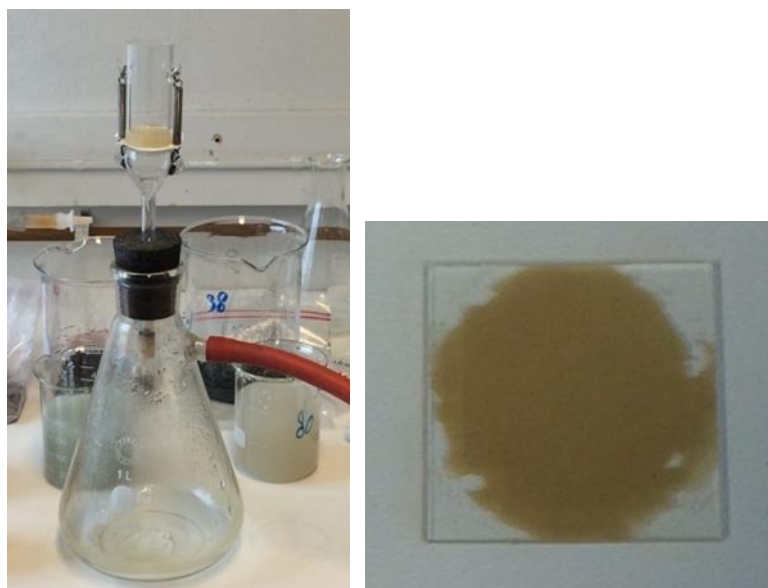
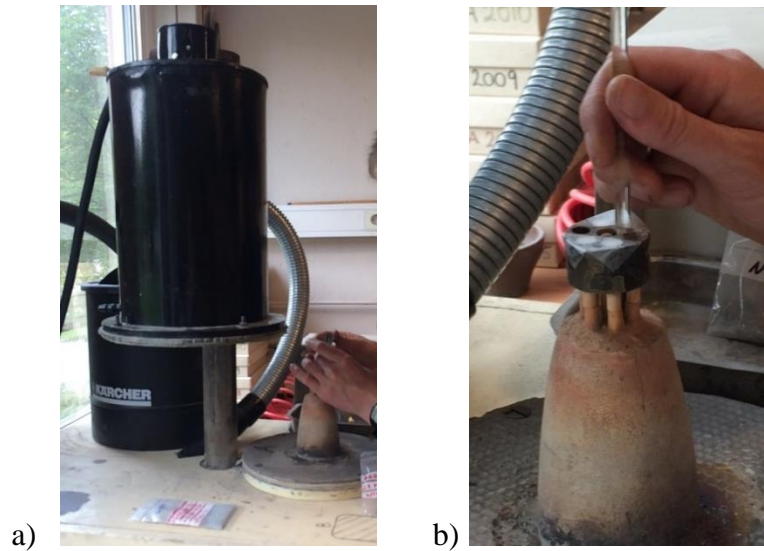

*Figure 6.B.3: Filtration of solution onto filter and plate of glass with the fine-fraction particles*

Two exemplars of each sample were prepared, whereby one of them is treated with ethylene-glycol vapor in an oven for 20 hours and a temperature of 60 °C. For the performance of the XRD analysis a *Bruker D8 ADVANCE with a DIFFRACplus SEARCH* software in combination with *PDF-2* database is used, followed by a quantification of the minerals in the crystalline phases using the *Bruker Rietveld (Topas 4)* software (Pettersen Skippervik 2014).

## **DTA**

All samples in the original test-suite was analyzed. 1-2 grams of bulk-powder from each sample was in four put in the DTA-apparatus, heated up to 700 °C and analyzed by procedures due to the traditions at NTNU. Figure 6.B.4 shows the DTA apparatus and the preparing procedure.



*Figure 6.B.4 (a and b): The DTA-apparatus (a) and the preparing of powder into the apparatus (b).*

### **Procedure of UCS-tests**

Uniaxial compression tests were performed on apparently strong specimens to understand the strength properties of this rock-type, based on the assumption of the strongest rock to be chosen for the excavation of tunnels. Table 6.B.1 below show the samples tested.

*Table 6.B.1: Overview of the samples in UCS-tests*

<b>Samples</b>	<b>Assumed rock type</b>	<b>State of saturation</b>
<b>AD-02,box 12 (1)</b>	Andesitic	Dry
<b>AD-02,box 12 (2)</b>	Andesitic	Wet
<b>AD-05, box 5</b>	Andesitic	Dry
<b>AD-02, box 8</b>	Andesitic	Dry
<b>AD-02, box 3</b>	Andesitic	Wet
<b>AQD-02, box 8</b>	Andesitic	Wet
<b>AQD-02, box 12</b>	Basaltic	Dry

Specimens from drill-/borehole cores were prepared by cutting them to the specified length of about 160 mm, and prepared within the indicated tolerances in terms of flatness of the ends and smoothness of the surfaces as suggested by ISRM methods. Some of the samples were difficult to cleave without damaging the sample and ended up approximately 20 cm shorter than the other ones. The original diameter of approximately 60,5 mm is kept during preparation and tests. Three andesitic rock specimen and one basaltic specimen were left to dry in laboratory environment. Three andesitic specimen were wetted for 50 days before testing.

During the tests the specimens were loaded axially up to failure, and the axial and the radial deformation was measured by the testing machine.

A principal drawing of the UCS test is shown in Figure 6.B.5.

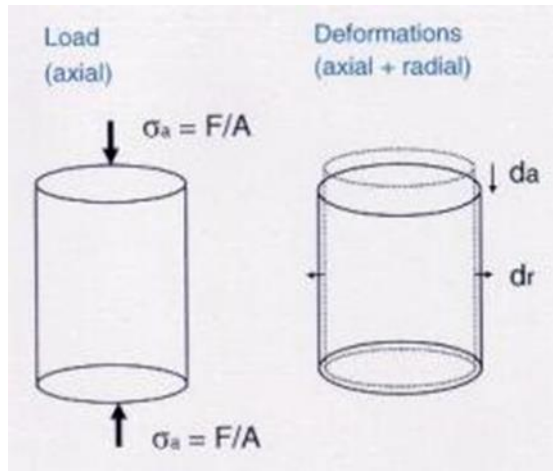

Figure 6.B.5: Principal drawing (Sveriges Tekniska Forskningsinstitut 2016)

The testing device used at NTNU is shown in Figure 6.B.6.

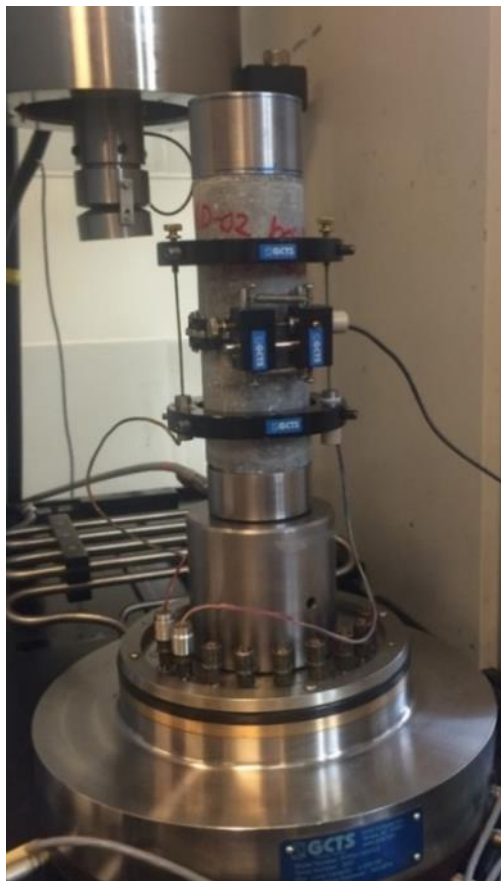

Figure 6.B.6: AD-02, box 12 installed in the testing device

## Swelling tests

### Free Swelling Index (FSI) test

All samples in the original test-suite and those used in the UCS-tests are tested. The procedure was performed by pouring 10 ml of dry loosely packed clay powder into a 50 ml measuring cylinder filled with 45 ml distilled water. The volume occupied by the clay powder after sedimentation was recorded, and the free swelling was calculated as the percentage of the original powder volume. The principal sketch is shown in Figure 6.B.7.

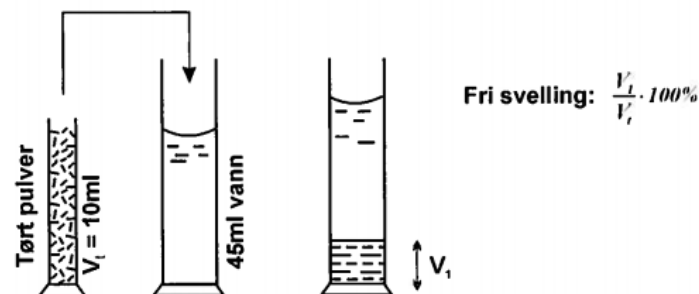

Figure 6.B.7: Principal sketch of the free swelling test (NTNU 2016)

The free swelling index number (FS) is calculated as follows (NTNU 2016):

$$F_s = V_1/V_0 \cdot 100\%$$

where

$V_1$  = Volume of powder after swelling,

$V_0$  = Original volume of dry powder, 10 ml

Figure 6.B.8 (a and b) shows the measuring cylinders with swelled powder from each of the tested samples.

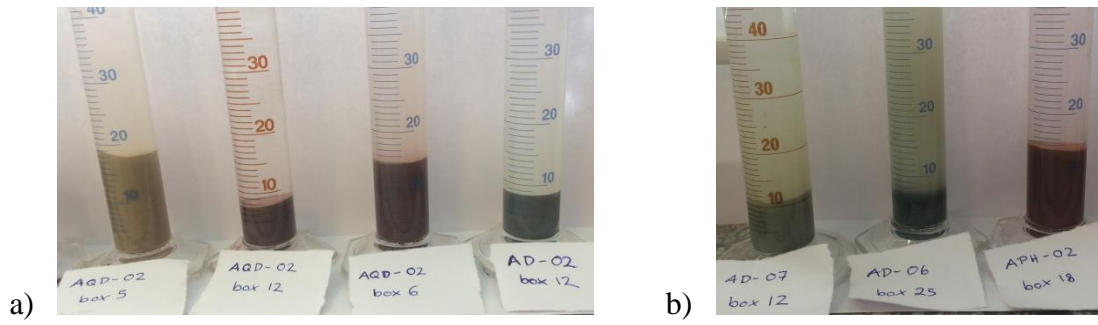

Figure 6.B.8 (a and b): Measuring cylinders with swelled powder from each sample.

Free swelling of < 100 % is characterized as “low”, 100-140 % as moderate, 140-200% as “high” and >200 % as “very high” (Nilsen & Palmstrøm 2000).

## Appendix 6.C Frisvelling

Hentet fra kompendium «Geologiske laboratorieundersøkelser – Laboratoriehefte for emne TGB4195, Ingeniørgeologisk prosjektering». Forfattere: Torill Sørløkk, Kåre Rokoengen, Bjørn Nilsen. År: 2007. Utgiver: NTNU

### **FRI SVELLING**

#### Prinsipp

Fri svelling for et leirmineral er det volum materialet inntar etter at det har fått svelle fritt i vann ved en sedimentasjon, uttrykt i prosent av det opprinnelige volum på 10 ml tørt løst pakket materialpulver.

#### Anvendelsesområde

Ved vurdering av stabiliteten og nødvendige sikringstiltak i forbindelse med leirslepper og leirholdige knusningssoner i fjellanlegg, er svelleegenskapene til sleppematerialet blant de faktorer som tas i betraktning. Metoden benyttes til en orienterende vurdering av et sleppemateriales svelleevne og gir et mål for hvor meget vann det kan binde i suspensjon.

#### Utstyr

- .. Avslemmingssylinder.
- Hevert.
- Glasskål.
- 50 ml målesylinder. - 10 ml målesylinder.
- Destillert vann.
- Spatel.
- Tørkeskap.
- Porselensmølle.

## Preparering

Sleppematerialet oppløses i en glasskål med destillert vann. Alle klumper brytes ned slik at alt finstoffet får løst seg opp. Vannet tømmes over i en avslemningsylinder og ristes godt for homogenisering. Ved avslemming separeres finstoffet som er mindre enn 20 µm fra prøven. For å få til dette må partiklene i væsken sedimenteres i 1 min. og 55 sek., da vil alt finstoffet befinne seg over 25 cm merket. En hevert blir brukt til å suge væsken over til en glasskål. Sylinderen fylles opp med destillert vann, og operasjonen gjentas inntil en klarning av væskefasen over 25 cm merket.

Prøvematerialet tørkes i varmeskapet i minst 24 t ved 105°C. Deretter mortres materialet i en porselensmølle til det blir så fint at man ikke kan kjenne enkeltpartiklene.

## Fremgangsmåte

1. Prøvematerialet drysses løst i en 10 ml målesylinder til 10 ml-streken ved hjelp av en hul spatel.
2. Det tas 45 ml vann i en 50 ml målesylinder.
3. Det tørre pulveret fra 10 ml målesylinderen drysses forsiktig opp i vannet slik at det ikke samles opp på overflaten i store klumper.
4. Når alt materialet er tilført 50 ml målesylinderen, utjevnes eventuelle klumper i det sedimentære materialet ved en forsiktig rotasjon av målesylinderen.
5. Når materialet har sedimentert, avleses det volum det inntar (VI).
6. Fri svelling beregnes som  $FS = \frac{VI - V_t}{V_t} \cdot 100\%$

der VI = volum av materialet etter sedimentasjon. V<sub>t</sub> = volum av tørt pulver = 10 ml.

Se figur 7.1.



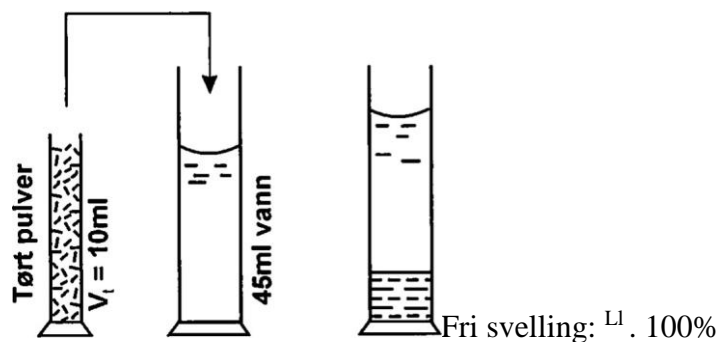

Fig. 7.1. Fri svelling-forsøk.

### Vurdering

For materiale med samme preparering må en regne med en viss spredning i resultatene for parallellprøver pga. forskjellig pakning under påfyllingen i 10 ml sylindere, samt vanskelig avlesning på menisken. Denne spredningen kan være av størrelsesorden  $\pm 5\%$  relativt.

Dessuten kan forskjellig nedmalingsgrad i porselensmølla gi ulik korngradering og pakning og derved spredning i resultatene.

Fri svelling anvendes nå mest alene i vurderingen etter følgende erfaringer: -

Inaktive leirer har vanligvis en fri svelling på 40 - 70% . Norske svelleleirer har gjerne fri svelling på ca. 100 - 170%, i ekstreme tilfeller over 250%.

En anvender derfor gjerne følgende gradering:

Inaktive

Lite aktive 80-120%

Aktive > 120%

En slik enkel vurdering av et materiale bør imidlertid være knyttet til et kjennskap til den mineralogiske sammensetningen av materialet.

### Litteratur

BREKKE, T.L. (1963): "Om montmorillonittførende leirslepper og ras i fjellanlegg. "

Avhandling for den tekniske licentiatgrad i Ingeniørgeologi, Geologisk Institutt, NTH.

BREKKE, T.L. (1965): "On the measurement of the relative potential swellability of hydrothermal montmorillonite clay from joints and faults in precambrian and paleozoic

rock in Norway". International Journal of Rock Mechanics and Mining Sciences, Vol. 2.

ROKOENGEN, K. (1973): "Svelleegenskaper hos leirsoner i ýell. " Avhandling for den tekniske licentiatgrad i Ingeniørgeologi, Geologisk Institutt, NTH.

ROKOENGEN, K. (1973): "Måling av svelletrykk og fri svelling hos jordarter. " Rapport nr. 10, Ingeniørgeologi, Geologisk Institutt, NTH.

## Appendix 6.D DTA procedure

Hentet fra kompendium «Geologiske laboratorieundersøkelser – Laboratoriehefte for emne TGB4195, Ingeniørgeologisk prosjektering». Forfattere: Torill Sørøkk, Kåre Rokoengen, Bjørn Nilsen. År: 2007. Utgiver: NTNU

### **MINERALOGISKE ANALYSER**

#### 9. DIFFERENTIALTERMISK ANALYSE (DTA)

##### Prinsipp

En rekke mineraler har den egenskap at når de oppvarmes eller avkjøles, vil de ved bestemte temperaturer forandre sin krystallstruktur. Slike forandringer vil føre til at mineralene enten opptar eller avgir varme, henholdsvis endoterm eller eksoterm reaksjon. Disse varmetoningene kan registreres i en egnet apparatur.

##### Anvendelsesområde

Metoden egner seg til kvalitativ bestemmelse av en rekke mineraler. Prøvematerialet må være i pulverform enten som avslemmete leirpartikler eller nedknust mineral- eller bergartspulver. Det er imidlertid en del mineraler som ikke har klare varmetoninger i det aktuelle temperaturområde, og som derfor ikke kan påvises.

Kvantitativ bestemmelse av et mineral er mulig, men krever en omhyggelig prøvepreparering og innpakking. En må ha god kontroll med temperaturstigningen og apparaturens følsomhet. Dessuten trengs en prøve av 100% rent mineral slik at en mengdeskurve kan etableres.

##### Utstyr

En DTA-apparatur består av en ovn der prøvematerialet varmes opp, en temperaturkontrollenhet og en datalogger. Ved Kjem/Min og Ingeniørgeologisk Laboratorium finnes to apparater.

Det ene er bygd av professor Rolf Selmer-Olsen, har vært i bruk ved laboratoriet siden 1957 og er modernisert flere ganger. Apparatet har bare styring for oppvarming, men med ulike hastigheter. Det kan gjøres to analyser samtidig.

Vanlig oppvarmingshastighet er  $10^{\circ}\text{C}/\text{min}$ .

Det andre er av merket METTLER TOLEDO TGA/SDTA851 <sup>e</sup>. Det er en teknikk for termogravimetrisk analyse (TGA), og samtidig differentialtermisk analyse (DTA).

#### Utstyrets virkemåte (Prof. R. Selmer-Olsens)

Prøvematerialet befinner seg i en nikkeldigel som er godt varmeledende og formfast (fig.9.2). Det er pakket rundt et termoelement (Pt - Pt 10% Rh). Dette termoelement er differentialkoblet til et likt element plassert i Al<sub>2</sub>O<sub>3</sub>-pulver. Al<sub>2</sub>O<sub>3</sub>-pulveret har ingen varmetoninger i det aktuelle temperaturintervall. Dersom prøvematerialet under oppvarmingen ikke undergår noen endoterme eller eksoterme reaksjoner, vil det ikke gå noen strøm mellom elementene, idet de strømpotensialer som utvikles ved temperaturstigningen vil motvirke hverandre. Om varmetoninger inntreffer ved noen temperatur, vil den strøm som da oppstår mellom termoelementene kunne registreres, se prinsippskisse, fig. 9.1 .

Analysen foretas vanligvis til temperatur opp til ca.  $1050^{\circ}\text{C}$ . Over denne temperatur vil prøvematerialet ofte sintre i digelen og skape vanskeligheter.

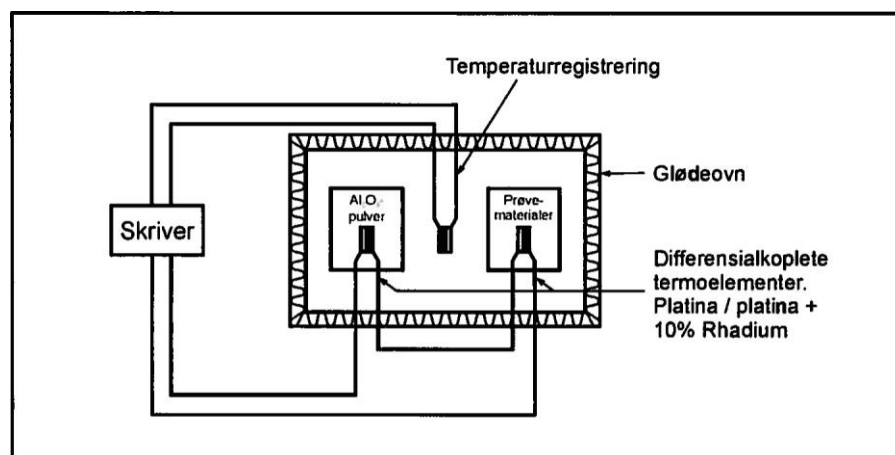

*Fig. 9.1. Prinsippskisse for DTA-apparatur.*

## Utstyr til prøvepreparering.

### Leirmateriale:

- Kar, passende for avslemming, begerglass e.l.
- Avdampningskar. Bruk glasskåler.
- Tørkeskap.
- Porselensmølle eller handmorter.
- Destillert vann.

### Bergartsmateriale, sand, grus:

- Kjeftetygger e.l.
- Slagmølle.

## Preparering

Til analysen må prøvematerialet være i pulverform.

Mineral- og bergartsmateriale, sand og grus knuses. 40 g materiale < ca 5 mm (grovknust) kjøres i slagmølle [SCEBTECHNIK TS 250 i knuserommet] i 2 min. Det knuste materialet vil da få en middelkornstørrelse på 8 — 10  $\mu\text{m}$ , og materiale < 2  $\mu\text{m}$  ligger på ca. 15%. Ved nøyaktige kvantitative prøver kan det være nødvendig å kontrollere korngraderingen.

Leire og sleppemateriale kjøres tørket og pulverisert eller avslemmet i besternte fraksjoner. Pulveriseringen skjer ved handmorter eller porselensmølle til enkeltkorn ikke kjennes mellom fingrene.

Sleppeleirer kan ofte inneholde mye grovt materiale. Dette kan fjernes ved våtsikting. Det er vanlig å kjøre DTA på sleppemateriale avslemmet < 20  $\mu\text{m}$ .

### Fremgangsmåte

Betjening av DTA-apparaturen må bare foretas av personell som har fått spesiell instruksjon.

Materialet pakkes i nikkeldigelen med en glasstav. Forholdsvis hard pakking gir jevnest pakningsgrad som er viktig ved kvantitative analyser. Med prøveholderen i ovnen startes apparaturen, og analysen er ferdig etter maks. 2 timer.

### Tyding og vurdering

For tyding av DTA-kurver trengs kjennskap til de forskjellige mineralers karakteristiske reaksjoner. Man må videre kjenne "null-linjens" forløp, dvs. DTA-kurvens form dersom det overhodet ikke foregår noen varmetoninger. For prøver som inneholder flere mineraler kan en få overlapping av utslagene og vansker med tydingen. Dette gjør også kvantitative bestemmelser vanskeligere. For å kunne bestemme et mineralinnhold kvantitativt, må mineralet ha klare og entydige reaksjoner, og en må kjenne reaksjonenes størrelse for kjente mengder av mineralet i blandinger av bestemt gradering og kornform.

For kvartsbestemmelse spesielt kan det ofte være nyttig å gløde vekk reaksjoner som overlapper kvartsutslaget, fra f.eks. kloritt og kis.

Nedenfor er nevnt en del vanlige mineraler med en kort beskrivelse av de mest karakteristiske utslag som også er vist i fig. 9.3. Utover dette må en basere seg på litteratur og kartotek over DTA-kurver for en rekke mineraler.

Kvarts	Endotermt utslag ved $573^{\circ}\text{C}$ , kan brukes til kvantitativ bestemmelse med god nøyaktighet.
Kalkspat	Endotermt utslag ved $650 - 750^{\circ}\text{C}$ , kan brukes til kvantitativ bestemmelse.
Kloritt	Endotermt utslag ved $600^{\circ}\text{C}$ , kan brukes til kvantitativ bestemmelse. Mer uregelmessig eksotermt utslag ved $750 - 820^{\circ}\text{C}$ .
Hydroglimmer	Endotermt utslag ved $550 - 580^{\circ}\text{C}$ , kan brukes til kvantitativ bestemmelse.
Kaolin	Endotermt utslag ved $600^{\circ}\text{C}$ , eksotermt ved $900 - 1000^{\circ}\text{C}$ .

Montmorillonitt	De ulike typer montmorillonitt har forskjellige utslag, vanlig er kraftige endoterme utslag mellom 100 - 250 <sup>0</sup> C og 600 — 700 <sup>0</sup> C; oftest også et endotermt utslag ved 900 <sup>0</sup> C.
Kis	Kisen oksyderer med kraftig eksotermt utslag.  Kopperkis: 380 - 420 <sup>0</sup> C Svovelkis: 430 - 450 <sup>0</sup> C Magnetkis: 480 - 520 <sup>0</sup> C  For kvantitativ analyse må innholdet av kis i prøven ikke være større enn 2%. I så tilfelle må prøven fortynnes med finmalt feltspat for å unngå sekundære reaksjoner.
Grafitt	Følsomt eksotermt utslag ved 550 - 700 <sup>0</sup> C, kan brukes til kvantitativ analyse.
Epidot	Endotermt utslag mellom 900 og 1000 <sup>0</sup> C.
Hornblende	Endotermt utslag ved 970 - 1020 <sup>0</sup> C.
Pyroksener	Endoterme utslag ved 750 - 800 <sup>0</sup> C.
Feltspat	Ikke identifiserbar.
Glimmer	Ikke identifiserbar.
Litteratur	

MACKENZIE, R.C. (1970): "Differential Thermal Analyses", Vol. 1 , Fundamental Aspects. Academic Press, London & New York.

MACKENZIE, R.C. (1970): 'Differential Thermal Analyses", Vol. 2, Applications. Academic Press, London & New York.

SCHULTZE, D. (1971 "Differential-thermoanalyse". VEB Deutcher veriag der Wissenschaften, Berlin.

SELMER-OLSEN, R. (1961): "En regional undersøkelse av norske leirers finfraksjon basert på DTA". Rapport til NTNf, upublisert.

TODOR, DN. (1976): "Thermal analyses of minerals". Abacces Press.

NEEB, P.-R. (1992): "Byggeråstoffer — Kartlegging, undersøkelser og bruk." Tapir Forlag. 374 s.



## Appendix 7.A All results X-Ray Diffraction (XRD) analysis

Sample/test	Finefraction <6 µm	Bulk	Remarks
<b>AD-02,</b> <b>Box 12</b> <b>(1)</b>  <b>41,2-42,2 m</b>	No swelling clay minerals.	Laumontite (56%) Clinopyroxene/diopside (15%) Quartz (11%) Plagioclase/albite (10%) Chlorite (4%) Magnetite (3%) Magnesite (<1%)	A small change in the peaks of chlorite (lower and wider) is detected after glycol-treatment, indicating swelling chlorite.
<b>AD-02</b> <b>Box 12</b> <b>(2)</b>  <b>41,20-42,20 m</b>	No swelling clay minerals	Laumontite (43%) Pumpellyite (21%) Clinopyroxene (diopside) (13%) Quartz (13%) Plagioclase (albite) (5%) Chlorite (2%) Magnetite (2%) Muscovite (1%) Calcite (<1%) Hematite (<1%)	Additional analysis, by Silje Elin Skrede
<b>AD-05</b> <b>Box 5</b>  <b>17,70-17,90 m</b>	No swelling clay minerals	Plagioclase (54%) Clinopyroxene (16%) Laumontite (12%) Pumpellyite (9%) Chlorite (5%) Muscovite (2%) Quartz (1%) Calcite (<1%) Magnetite (<1%) Epidote (<1%) Hematite (<1%) Rutile (<1%)	Additional analysis, by Silje Elin Skrede

<p><b>AD-02</b> <b>Box 8</b></p> <p><b>29,7-30,15 m</b></p>	<p>No swelling clay minerals.</p>	<p>Plagioclase (60%) Quartz (10%) Amphibole (7%) Laumontite (7%) Clinopyroxene (6%) Chlorite (4%) Muscovite (2%) Magnetite (3%) Calcite (1%) Epidote (&lt;1%) Hematite (&lt;1%) Rutile (&lt;1%)</p>	<p>Additional analysis, by Silje Elin Skrede.</p> <p>Very weak swelling, unknown cause.</p>
<p><b>AD-06,</b> <b>Box 25</b></p> <p><b>86.30-87.30 m</b></p>	<p>No swelling clay minerals.</p>	<p>Plagioclase/albite (38%) Clinopyroxene/diopside (19%) Quartz (13%) Microcline intermediate (12%) Chlorite (9%) Laumontite (3%) Magnetite (3%) Hematite (1%) Magnesite (&lt;1%) Pyrotite 3T (&lt;1%)</p>	<p>A very small change in the peaks of chlorite (lower and wider) is detected after glycol-treatment.</p>
<p><b>AD-07,</b> <b>Box 12</b></p> <p><b>38.35-41.00 m</b></p>	<p>No swelling clay minerals.</p>	<p>Microcline intermediate (22%) Chlorite (22%) Laumontite (15%) Plagioclase/albite intermediate (13%) Analcime (12%) Clinopyroxene/diopside (10%) Hornblende RoundRobin (4%) Quartz (&lt;1%) Chalcopyrite (&lt;1%)</p>	<p>A small change in the peaks of chlorite (lower and wider) is detected after glycol-treatment, indicating swelling chlorite.</p>

<p><b>AQD-02, Box 12 (1)</b></p> <p><b>42.25-45.60 m</b></p>	<p>No swelling clay minerals.</p>	<p>Plagioclase/albite (42%) Clinopyroxene/diopside (18%) Phrenite (16%) Chlorite (12%) Calcite (5%) Hematite (4%) Laumontite (2%) Magnesite (1%)</p>	
<p><b>AQD-02, Box 12 (2)</b></p> <p><b>42.25-45.60 m</b></p>	<p>No swelling clay minerals.</p>	<p>Plagioclase (47%) Pumpellyite (19%) Clinopyroxene (17%) Laumontite (6%) Chlorite (5%) Muscovite (3%) Hematite (2%) Quartz (&lt;1%) Calcite (&lt;1%) Magnetite (&lt;1%) Epidote (&lt;1%) Rutile (&lt;1%)</p>	<p>Additional, by Silje Elin Skrede</p>
<p><b>AQD-02, Box 5</b></p> <p><b>16.70-20.60 m</b></p>	<p>Montmorillonite  Montmorillonite-chlorite (mixed layer)</p>	<p>Plagioclase/albite (35%) Calcite (15%) Clinopyroxene/diopside (14%) Enstatite (14%) Montmorillonite (9%) Quartz (7%) Laumontite (6%) Mixed-layer smectite (not quantified)</p>	
<p><b>AQD-02, Box 6</b></p> <p><b>20.60-24.60 m</b></p>	<p>Corrensite (mixed layer)  Montmorillonite</p>	<p>Plagioclase/albite intermediate (49%) Yugawaralite (18%) Clinopyroxene/diopside (13%) Hematite (9%) Monmorillonite (8%) Calcite (&lt;1%) Corrensite (not quantified)</p>	

<b>APH-02, Box 18  59.80-63.40 m</b>	Corrensite	Plagioclase/albite (41%) Clinopyroxene/diopside (22%) Chlorite (9%) Hematite (7%) Laumontite (7%) Calcite (6%) Epidote (6%) Magnesite (1%) Pyrotite 3T (<1%) Corrensite (not quantified)	
--	------------	---	--

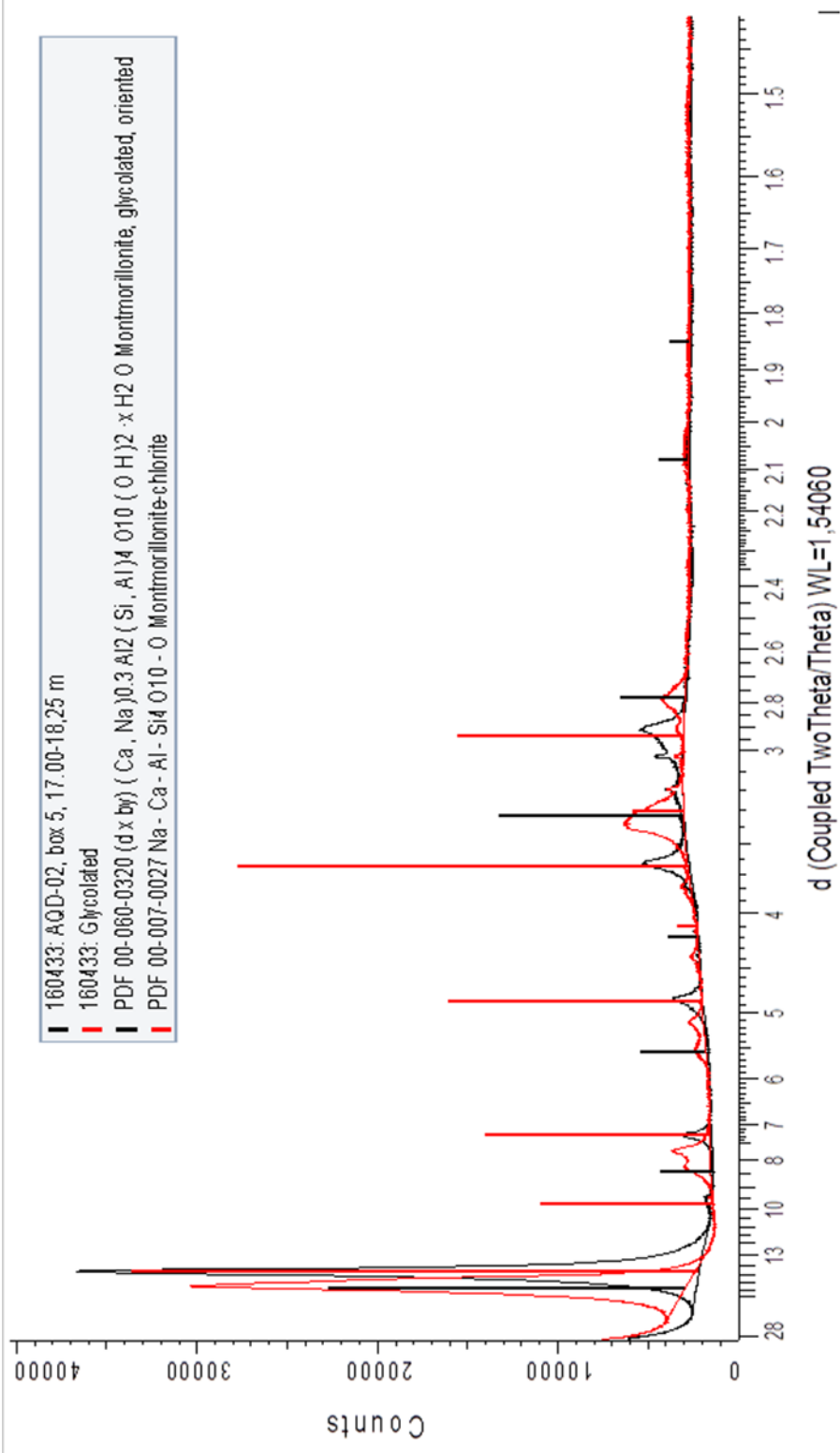

160433: AOD-02, box 5, 17.00-18.25 m

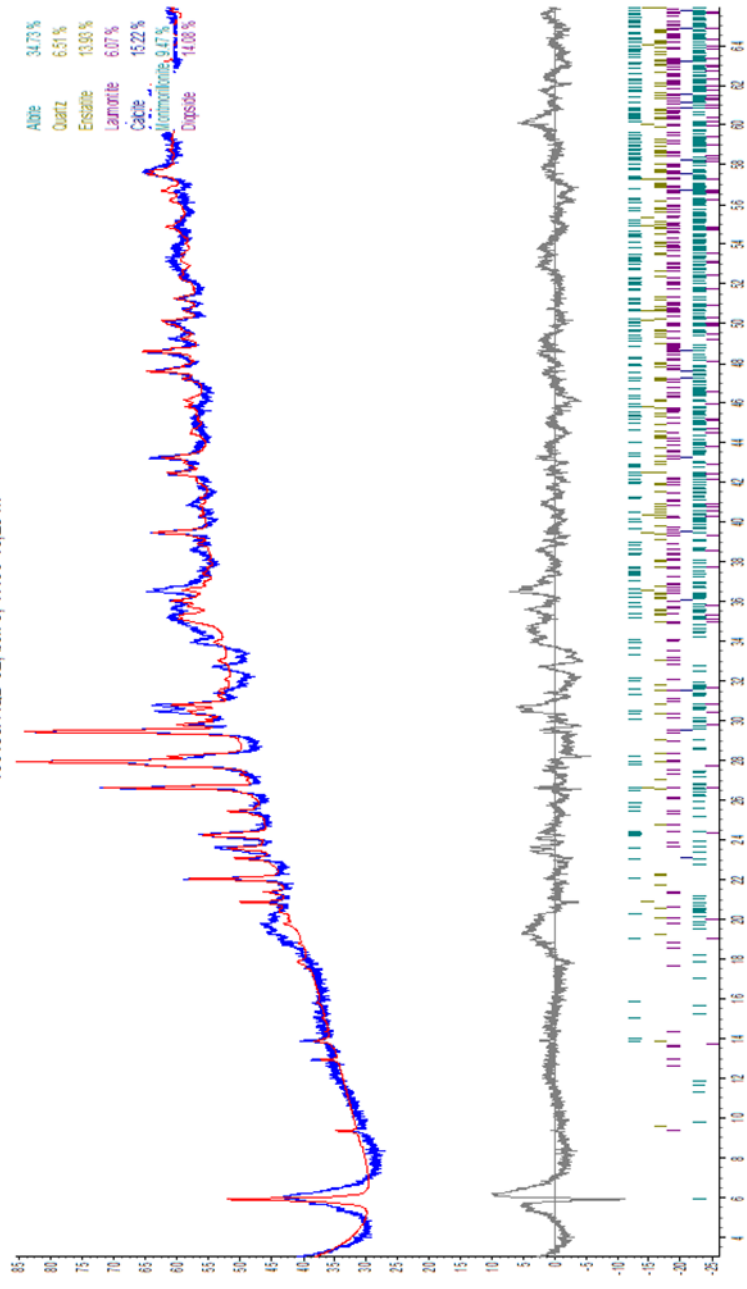

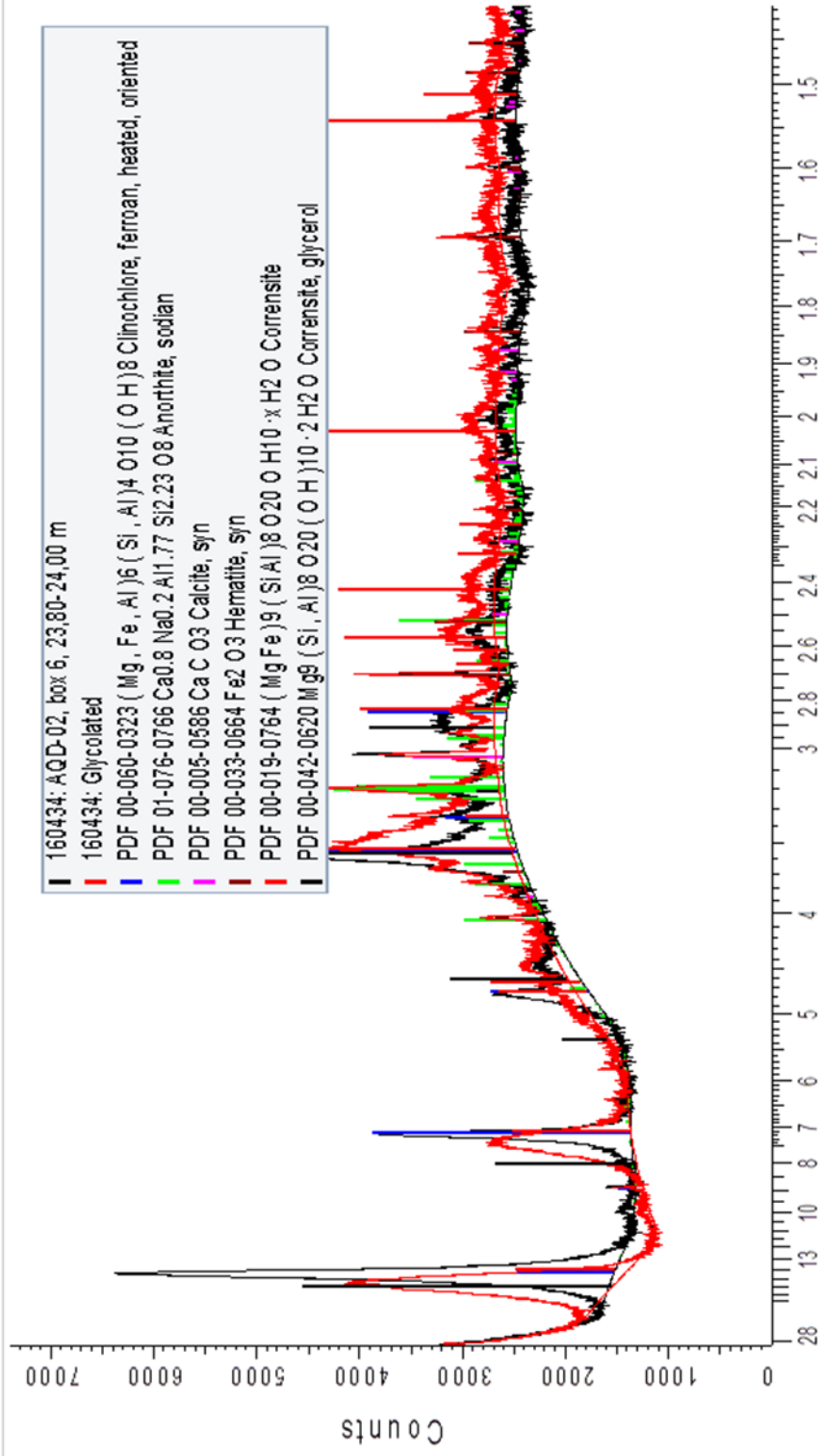

d (Coupled TwoTheta/Theta) WL=1,54060

160434: AQD-02, box 6, 23.80-24.00 m

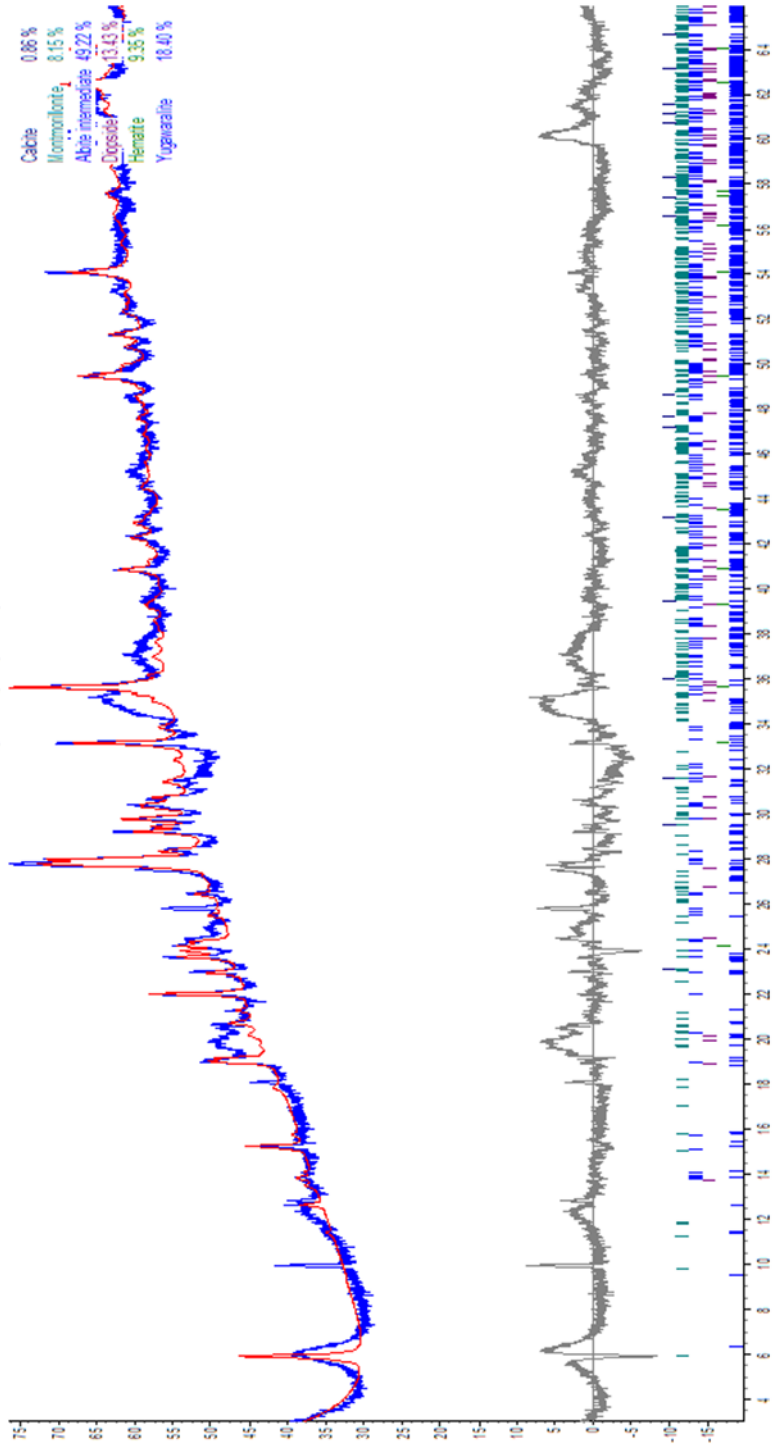



160435: AD-02, box 12, 41, 20-42, 20 m

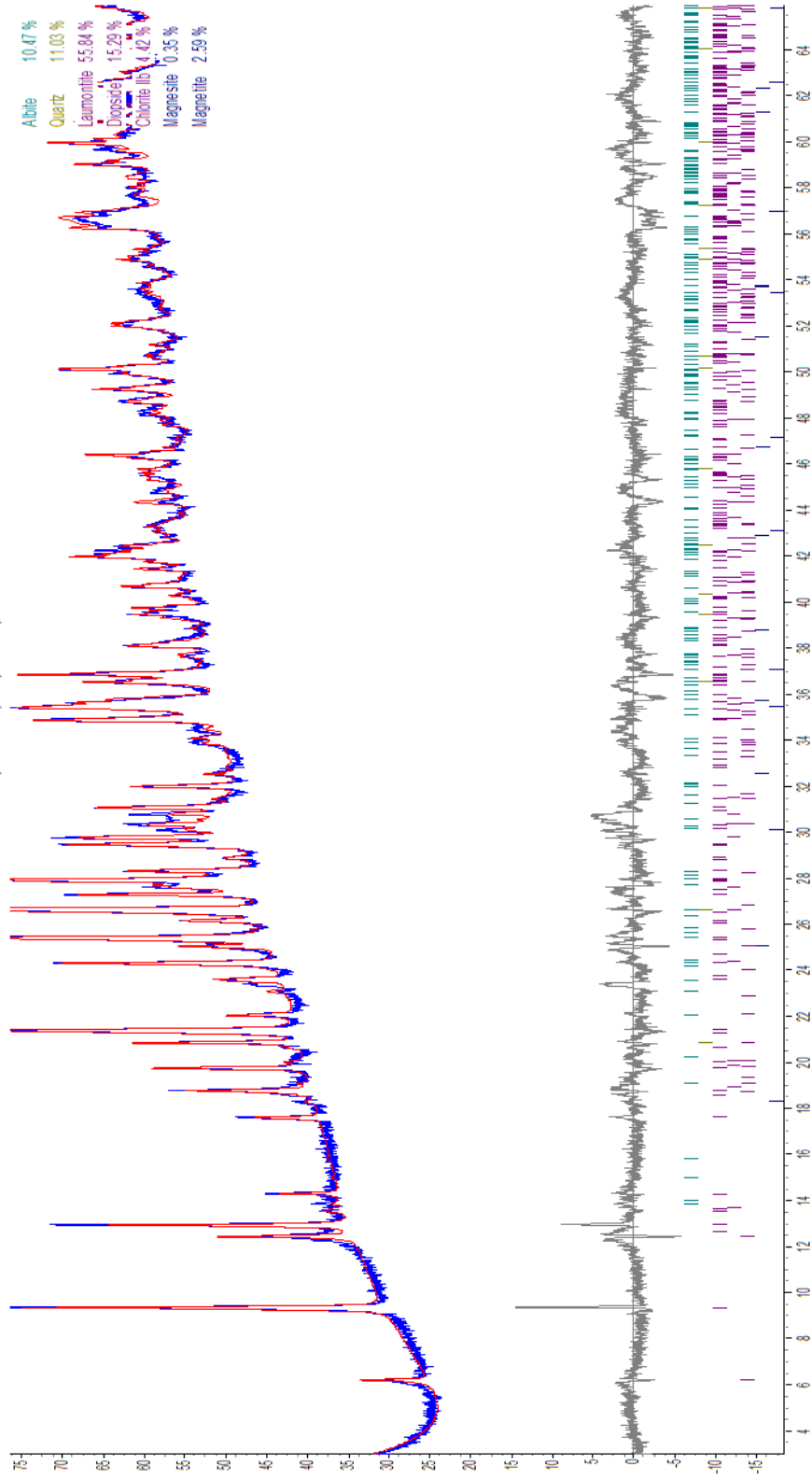

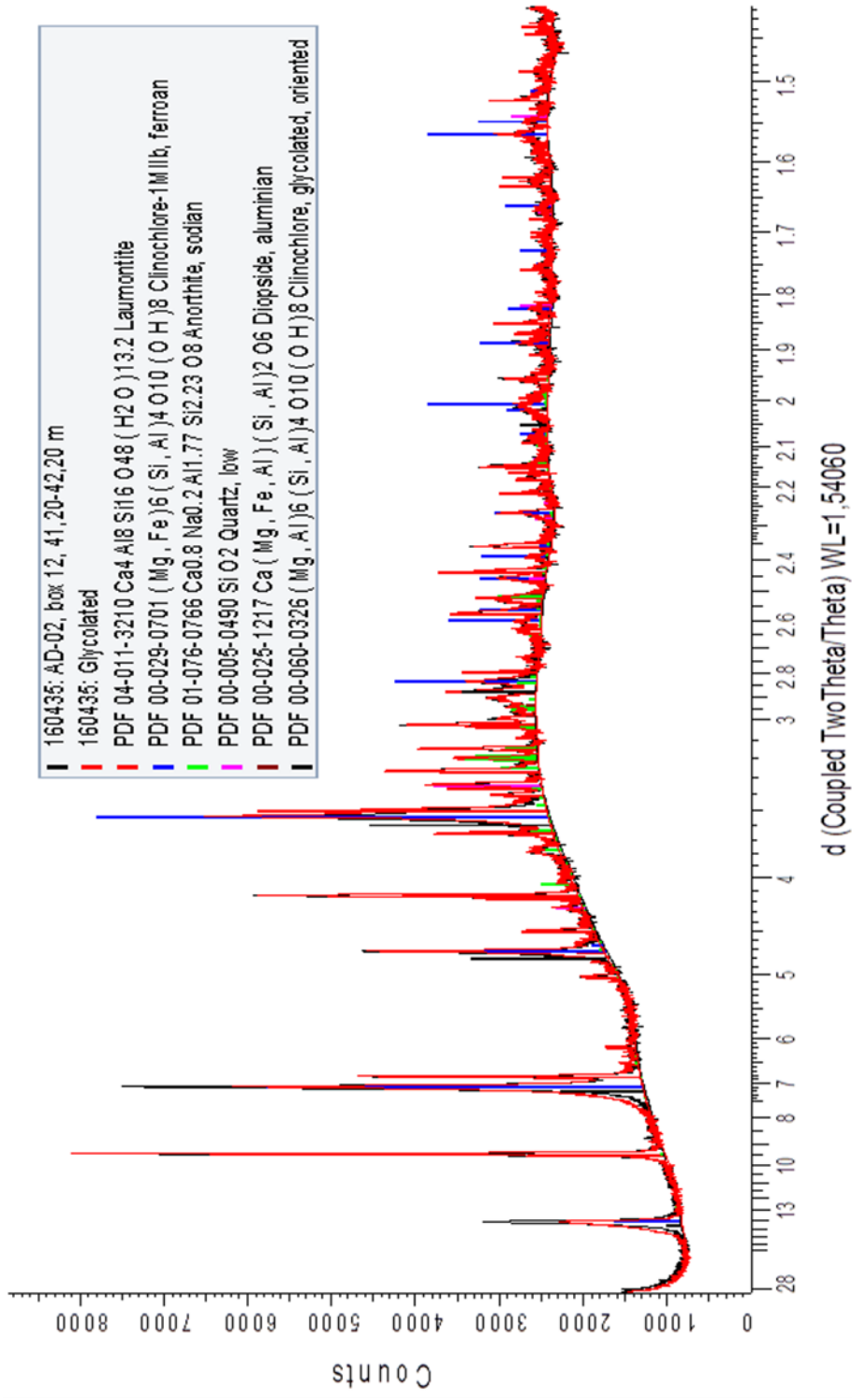

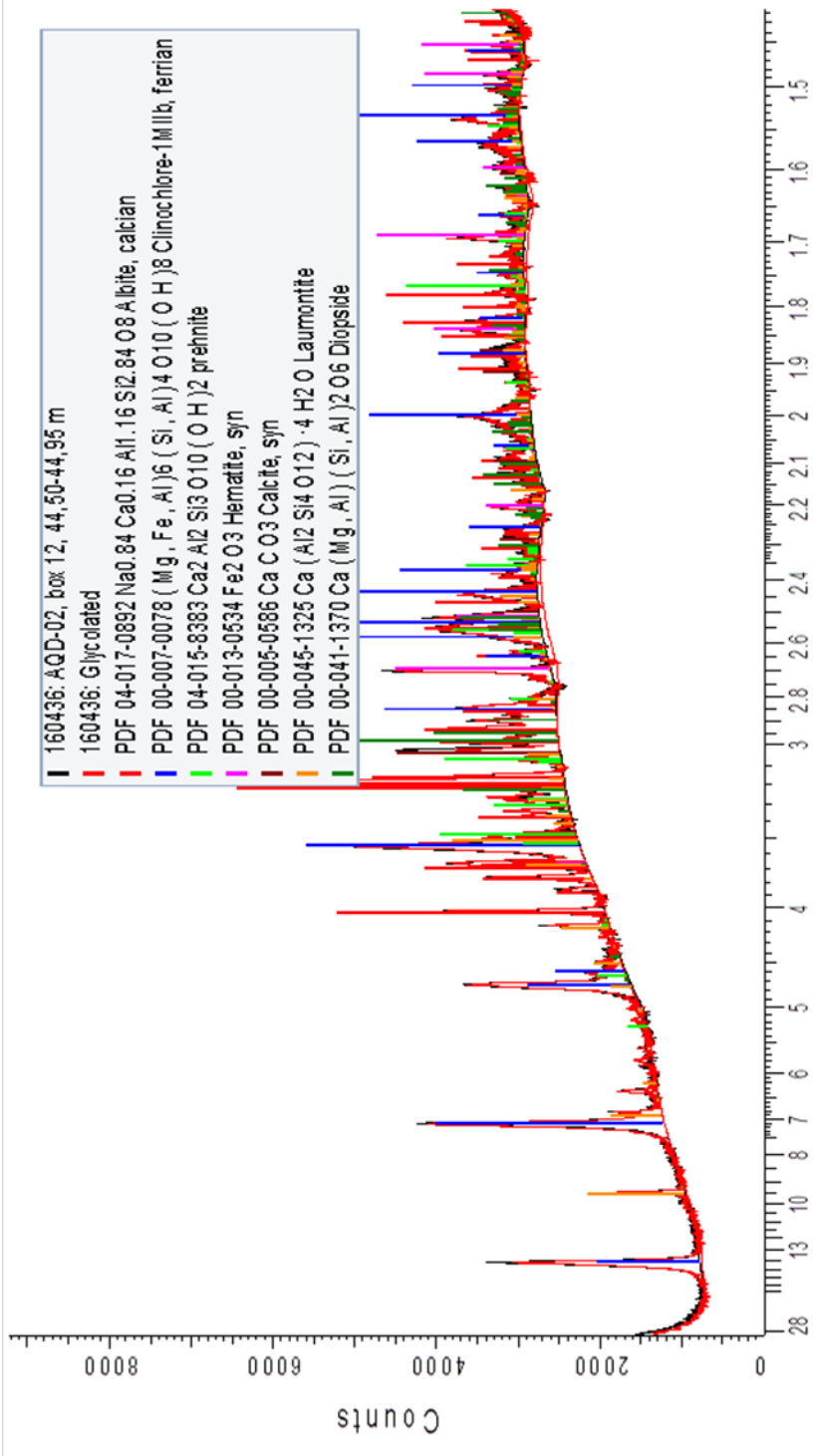

d (Coupled TwoTheta/Theta) WL=1,54060

1

160436: AQD-02, box 12, 44,50-44,95 m

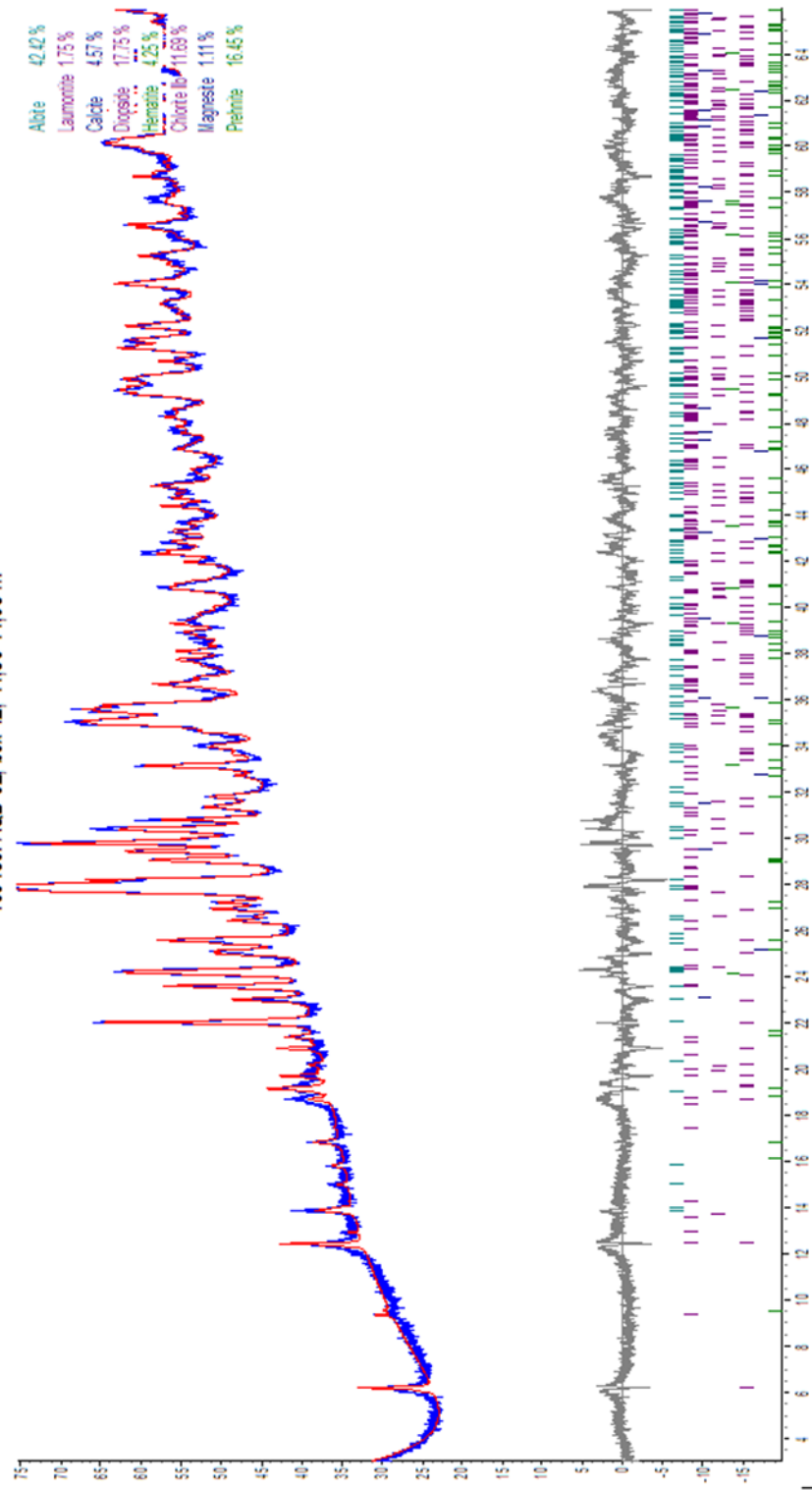

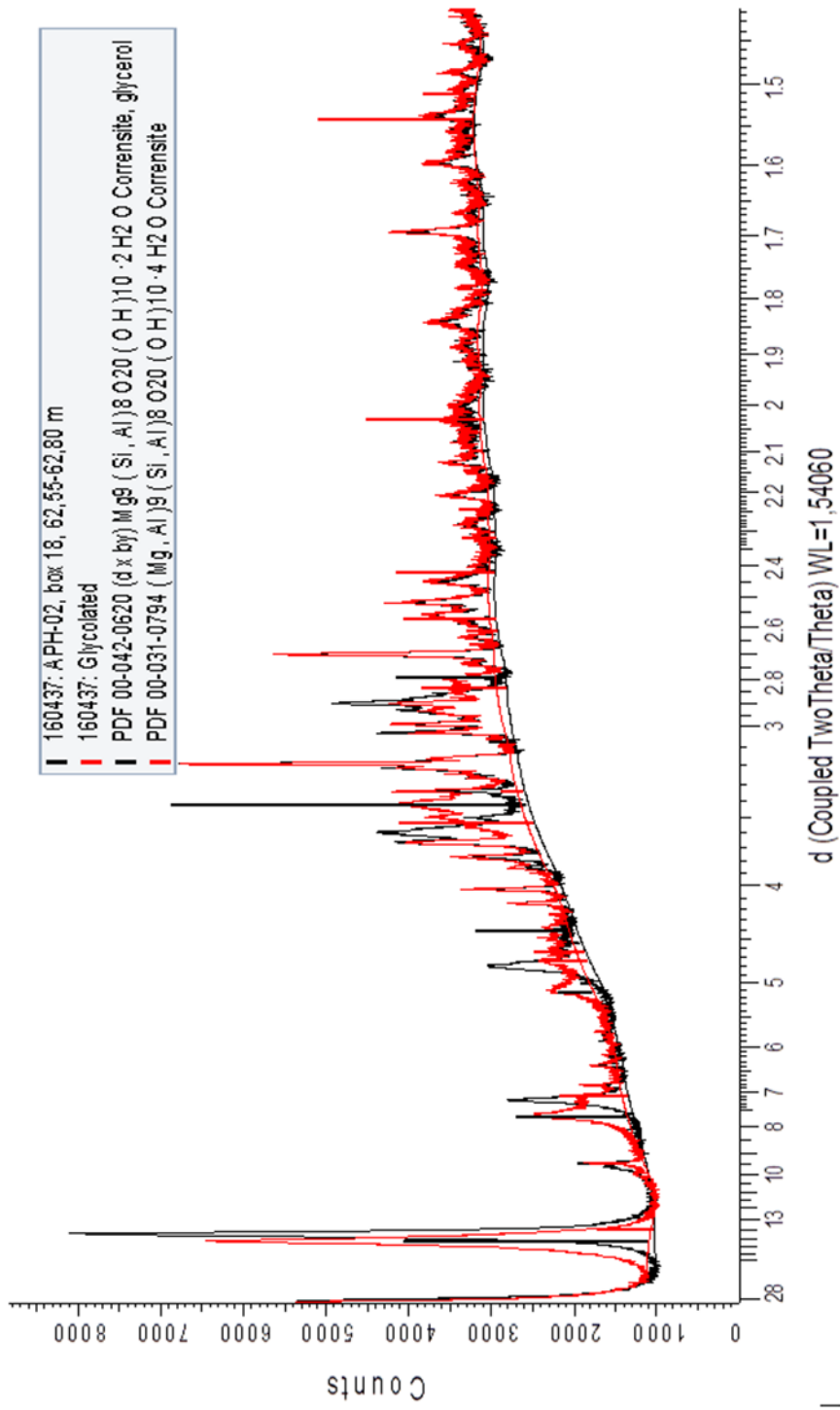

160437: APH-02, box 18, 62.55-62.80 m

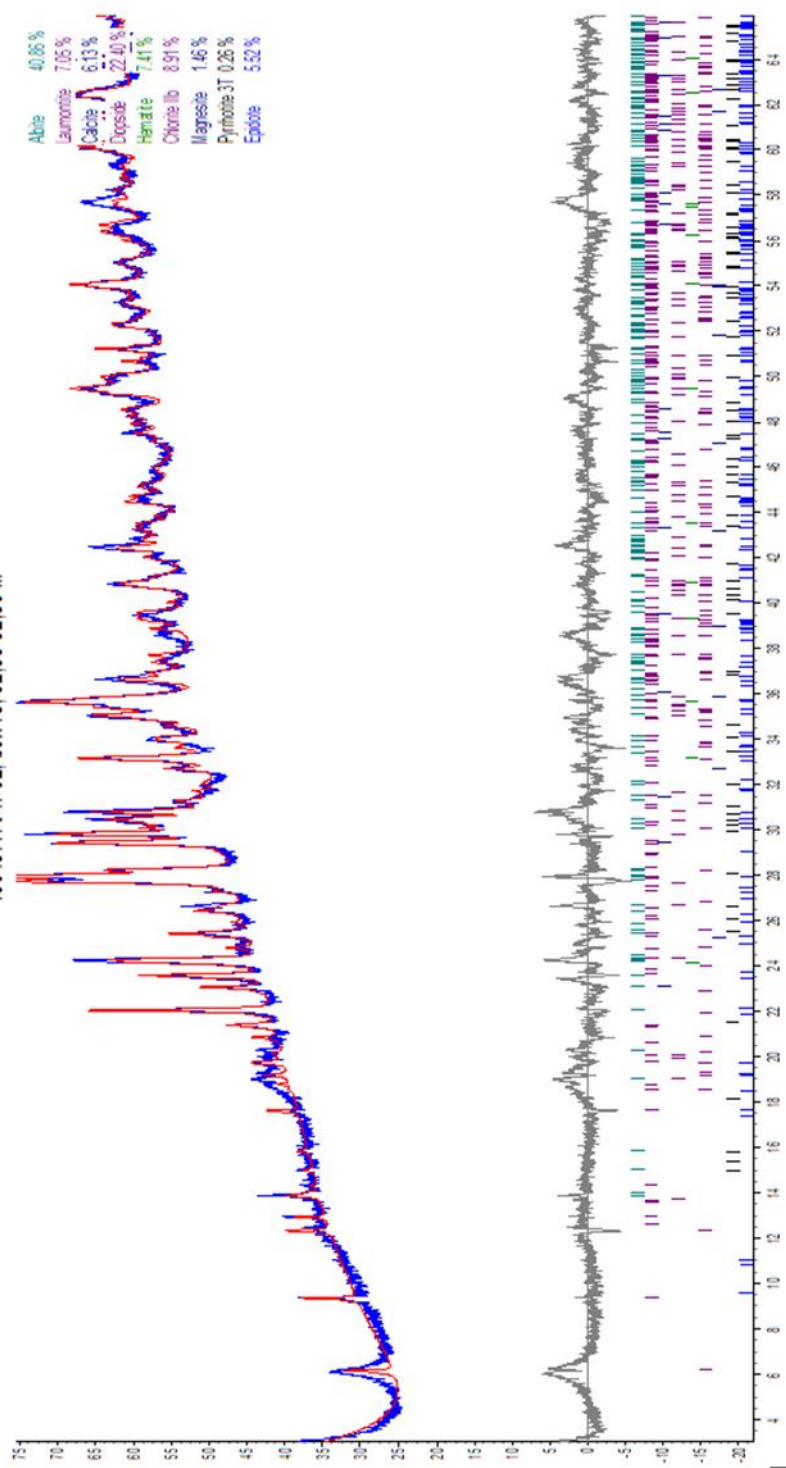

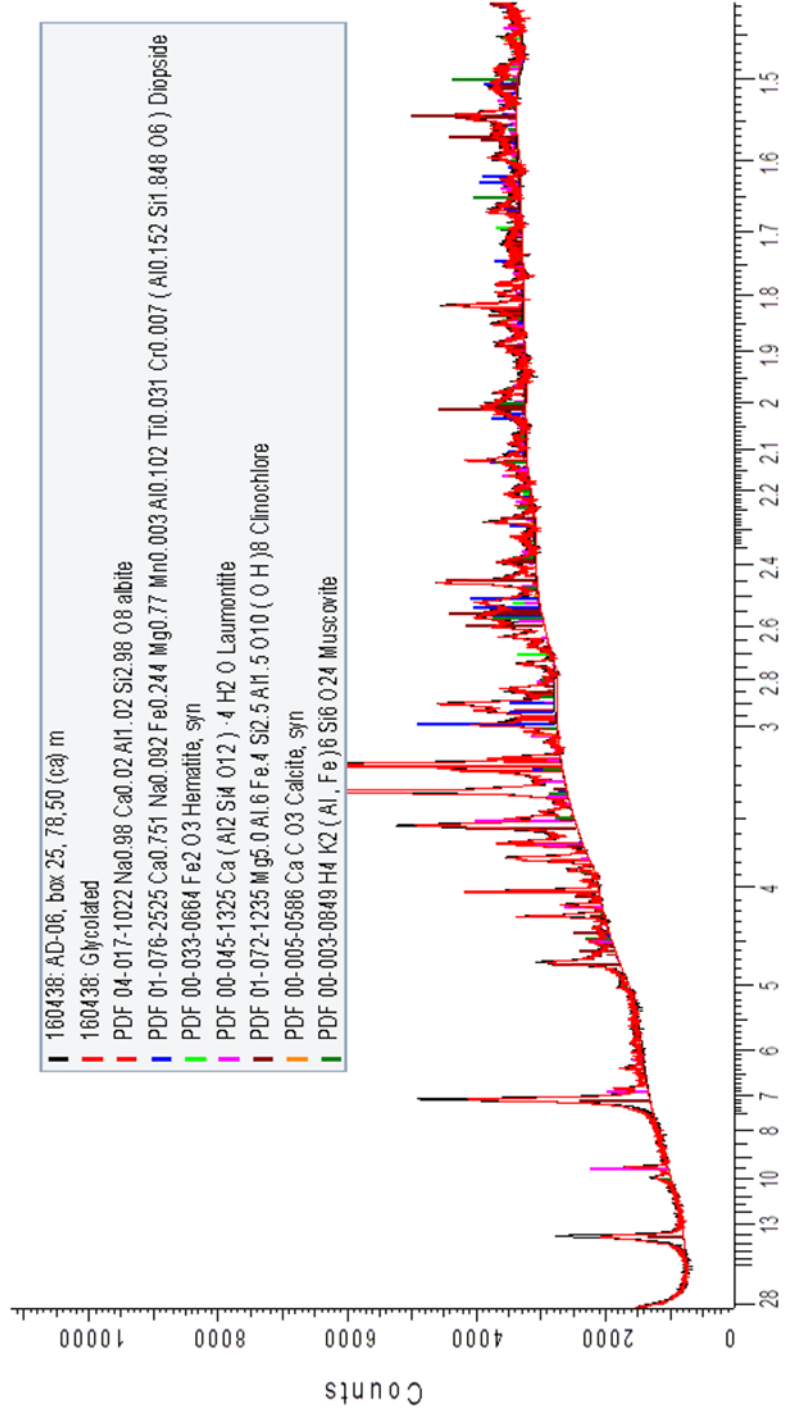

d (Coupled Two Theta(Theta)) WL=1,54060

160438: AD-06, box 25, 78,50 (ca) m

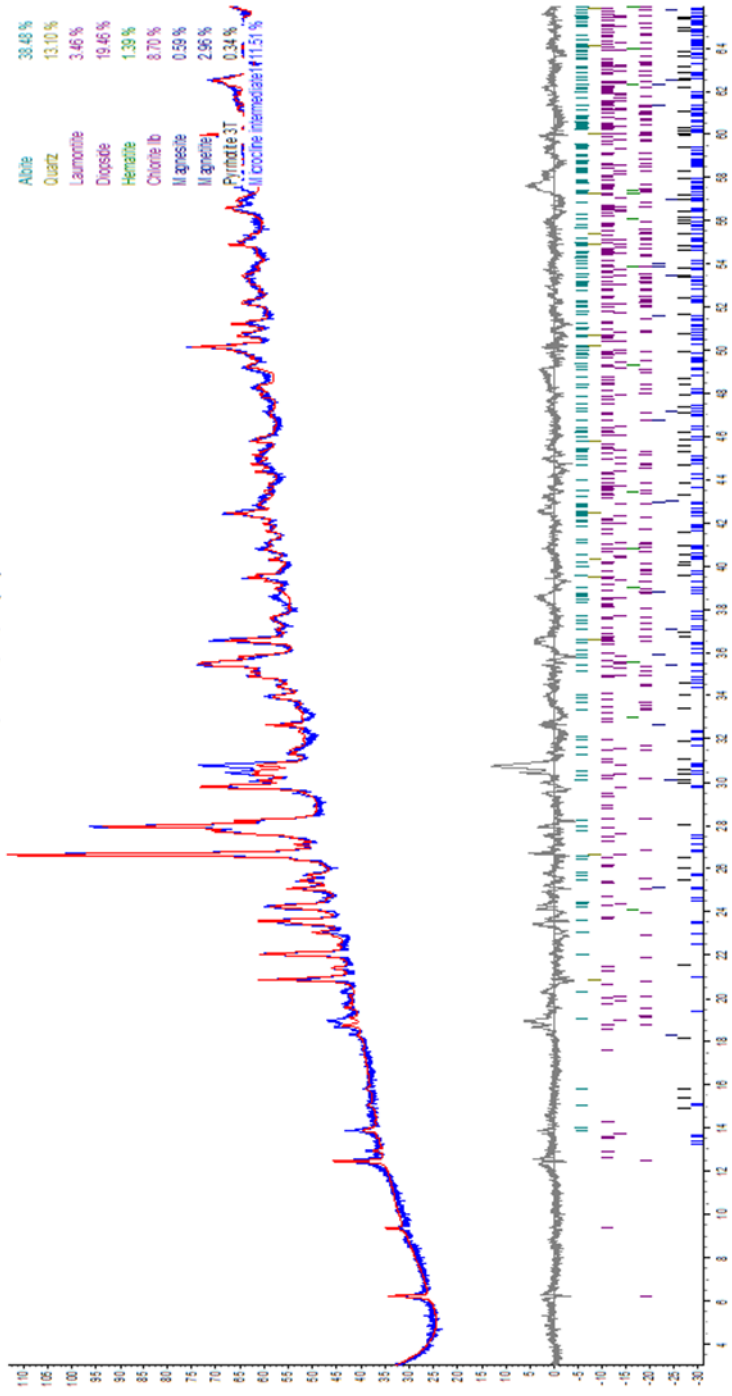



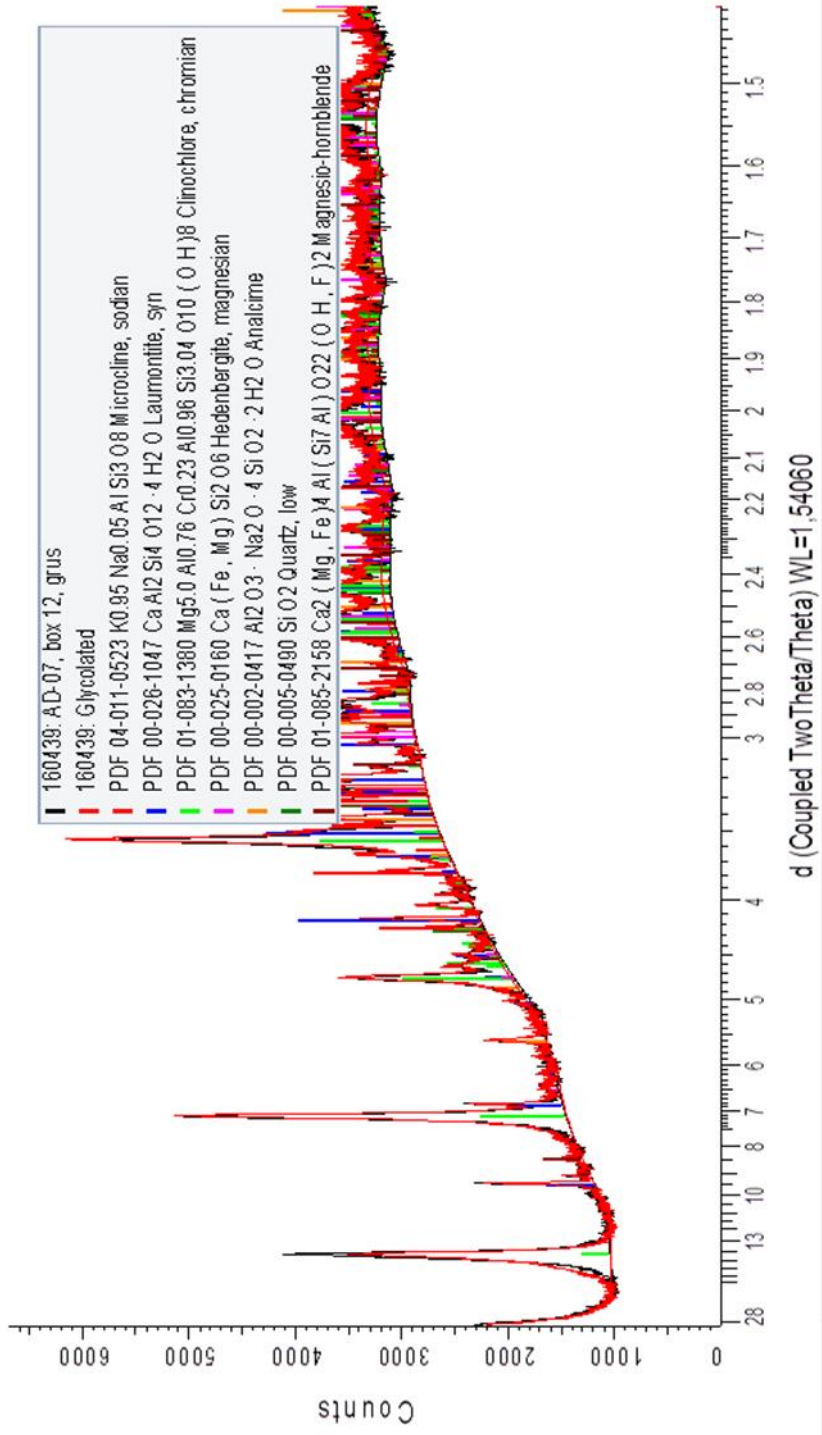

160439: AD-07, box 12, grus

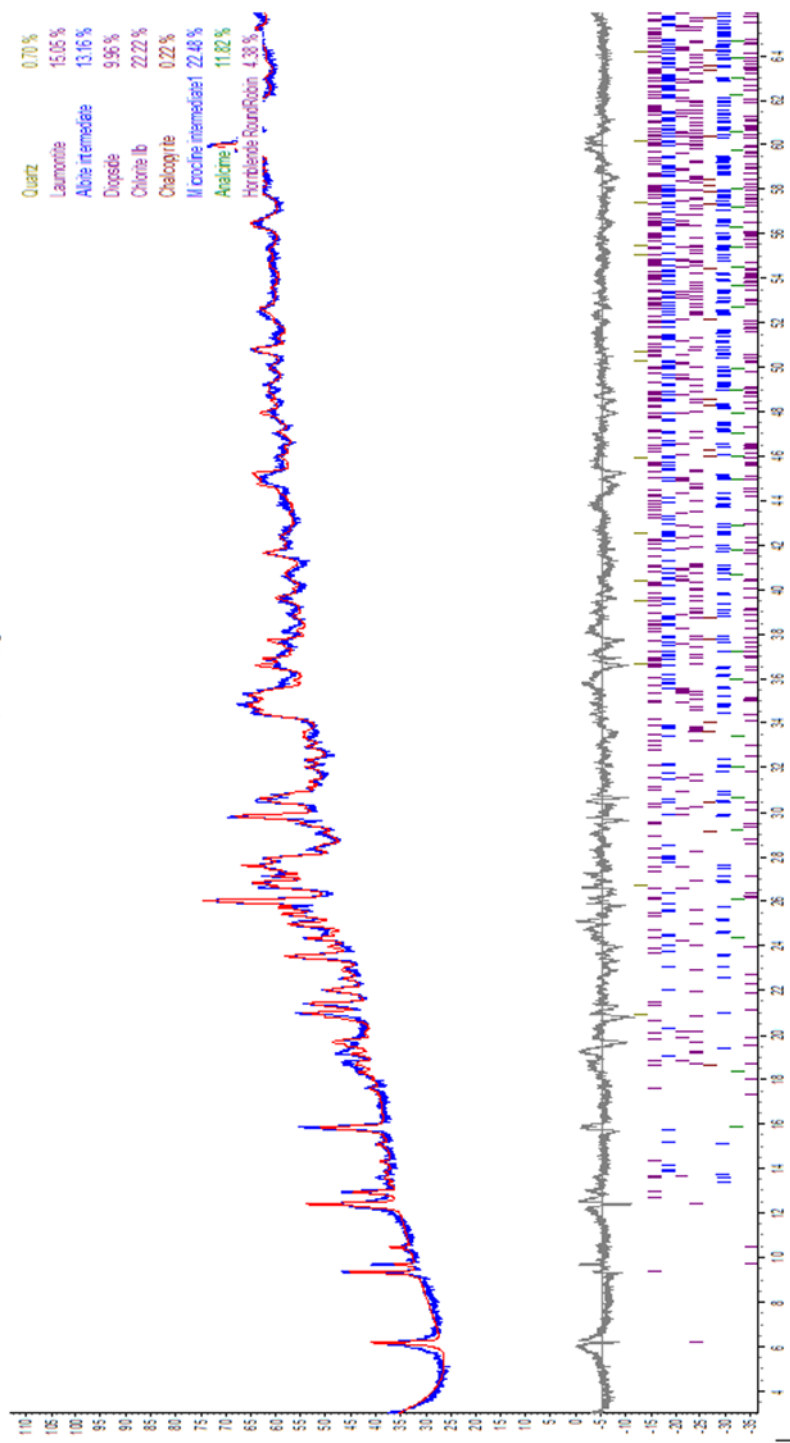

**Additional analyses on samples AD-02 (box 12), AD-07 (box 12) and APH-02 (box 18)**

The following tests are performed on powder extracted from intact rock structure samples. AD-02 (box 12) showed no differences from the previous analysis. The curves from APH-02 and AD-07 are given below.

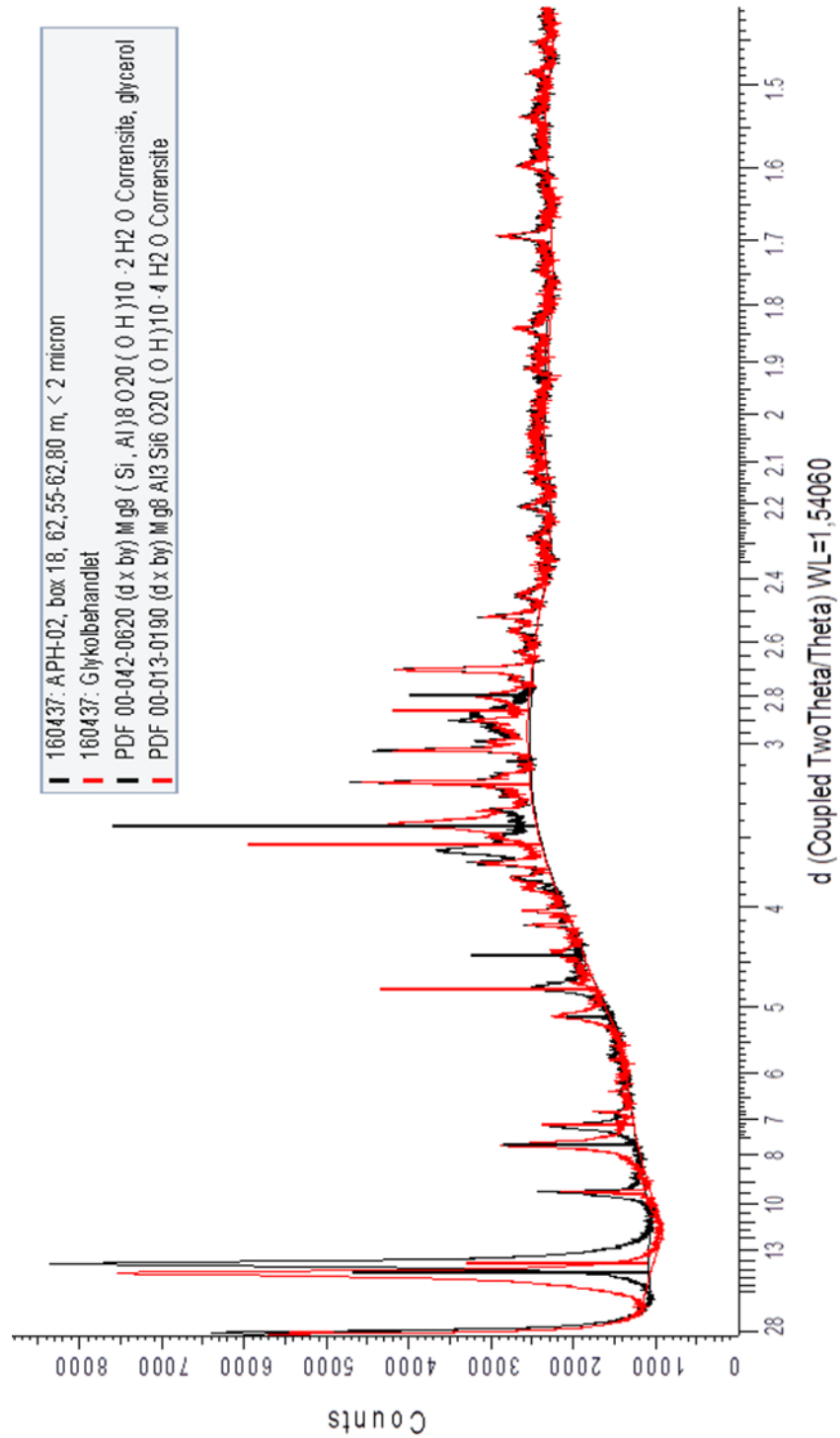

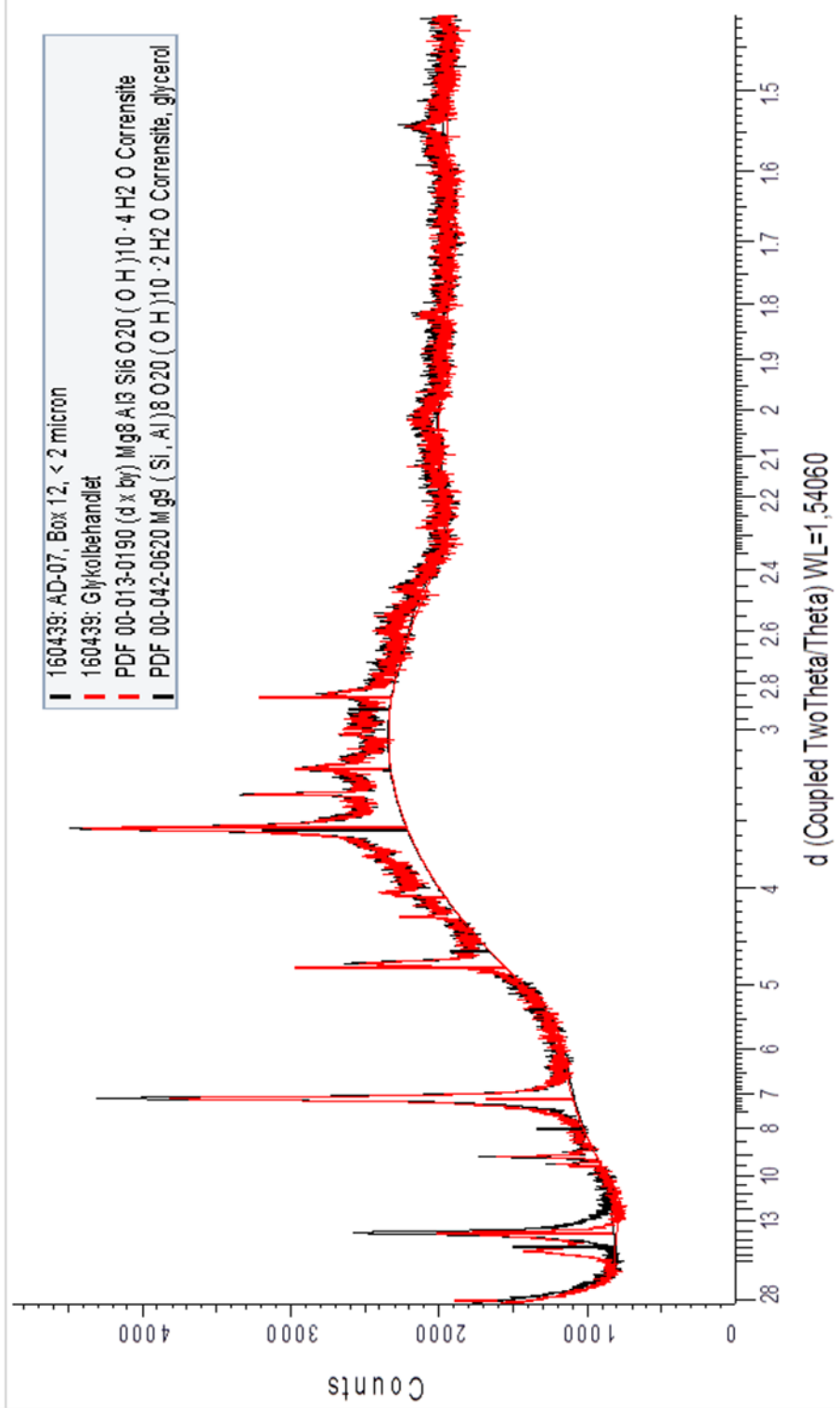

Analyses performed on additional samples used in the UCS-test, performed by  
Silje-Elin Skrede:



Fakultet for ingeniørvitenskap og teknologi  
Institutt for geologi og bergteknikk

1 av 6

Vår dato  
07.10.2016  
Deres dato  
07.10.2016

Vår referanse  
KD/L3-16097  
Deres referanse

Silje-Elin Skrede

**XRD-analyse av 4 borekjerner**

Analysen er utført på nedmalt bergartsmateriale på ein Bruker D8 ADVANCE. Identifisering av mineralfaser vart utført ved hjelp av DIFFRAC.SUITE.EVA programvare i kombinasjon med databasen PDF-4+. Kvantifisering ved Rietveld-raffinering vart gjort i Topas med ei grannsemnd på om lag 1-2 masseprosent. Alle verdiar i tabellen er i masseprosent og normalisert til 100 %. Eventuelle avvik frå 100 % er grunna avrunding.

Prøve mrk.	AD-05 Box 5 17,7-17,9	AD-02-Box 12 41,2-42,2	AD-02 Box 8 29,7-30,15	AQD-02 Box 12 44,5-44,95
J.nr.	160482	160483	160484	160485
Kvarts	1	13	10	<1
Kalsitt	<1	<1	1	<1
Plagioklas	54	5	60	47
Muskovitt	2	1	2	3
Kloritt	5	2	4	5
Amfibol	-	-	7	-
Magnetitt	<1	2	3	<1
Epidot	<1	-	<1	<1
Hematitt	<1	<1	<1	2
Laumontitt	12	43	7	6
Rutil	<1	-	<1	<1
Klinopyroksen	16	13	6	17
Pumpellyitt	9	21	<1	19

Kristian Drivenes  
Førsteamanuensis

Torill Sørlokk  
Overingeniør

Vår dato 16.9.2016 Vår referanse L.T / 16-094

Norges teknisk-naturvitenskapelige universitet

Jnr 160482; AD-05 Box 5 17,7-17,9

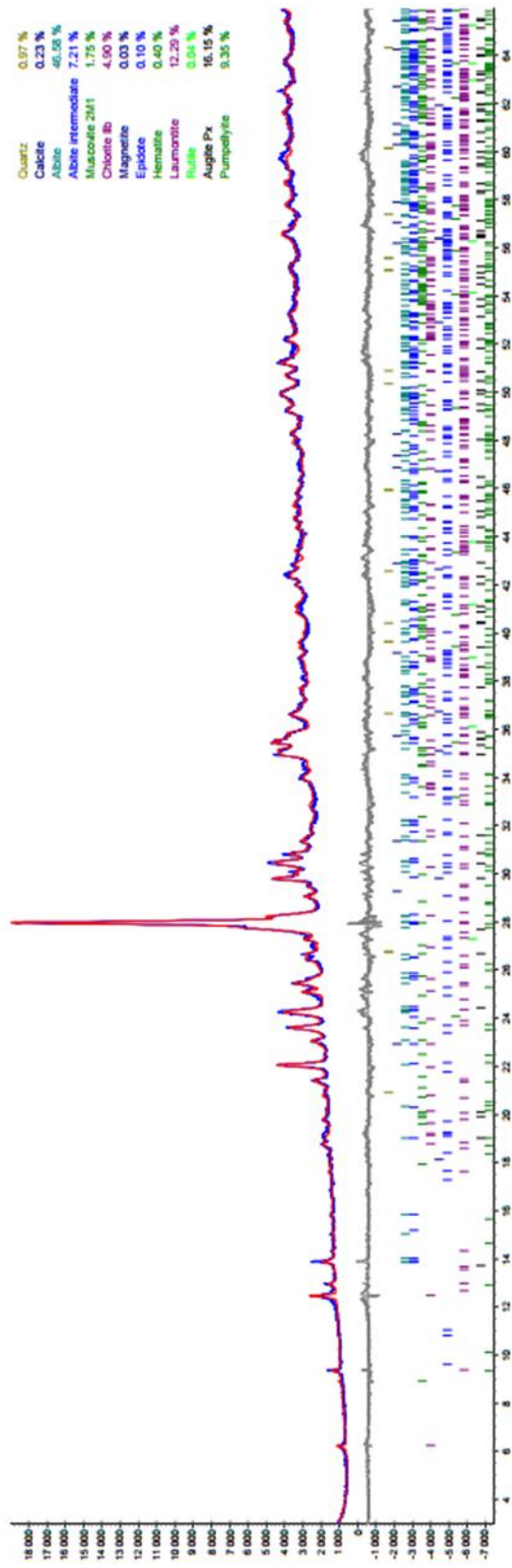

Vår dato 16.9.2016 Vår referanse LT / 16-094

Norges teknisk-naturvitenskapelige universitet

Jnr 160483; AD-02 Box 12 41,2-42,2

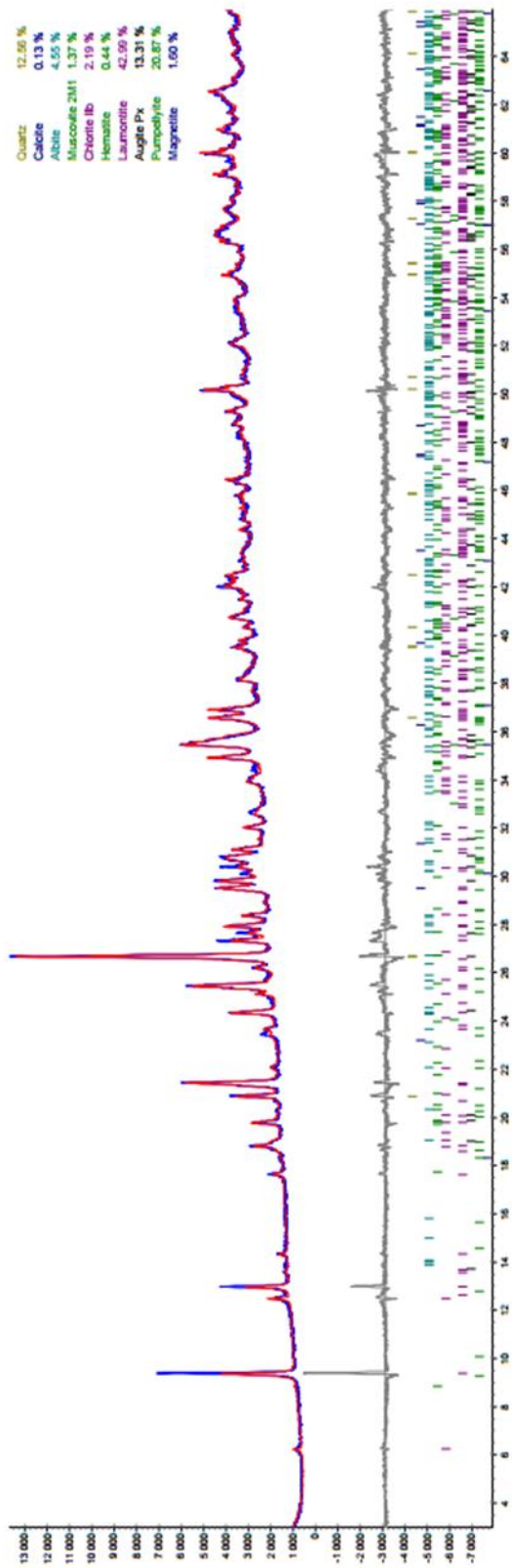

Vår dato 16.9.2016 Vår referanse LT / 16-094

Norges teknisk-naturvitenskapelige universitet

Jnr 160484; AD-02 Box 8 29,7-30,15

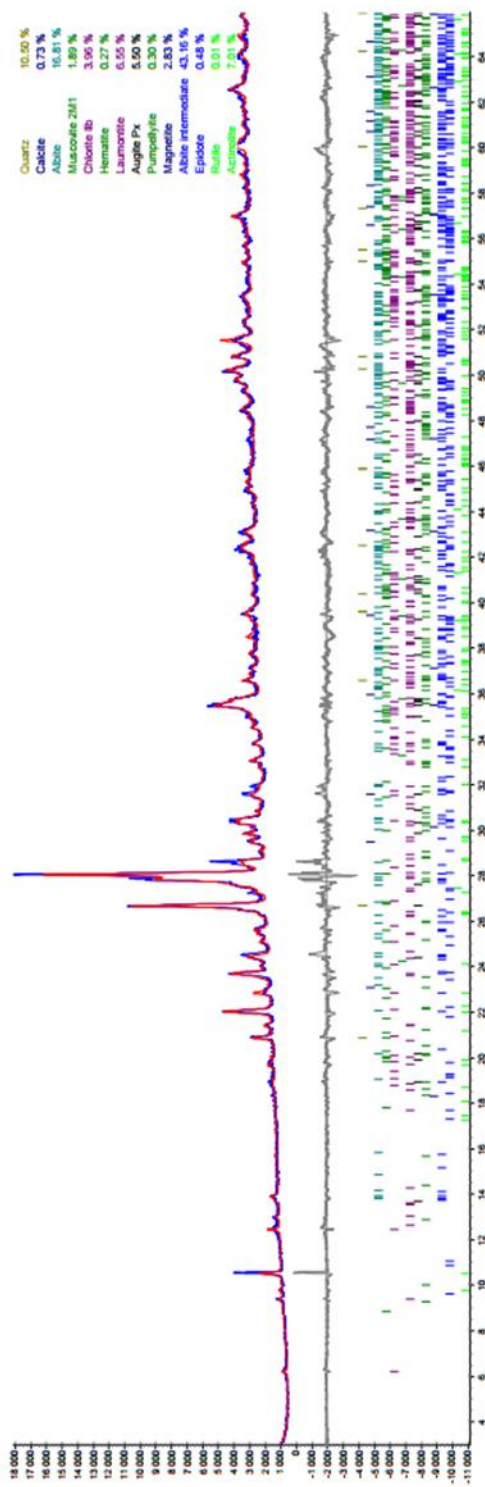



Norges teknisk-naturvitenskapelige universitet

Vår dato 16.9.2016 Vår referanse LT / 16-094

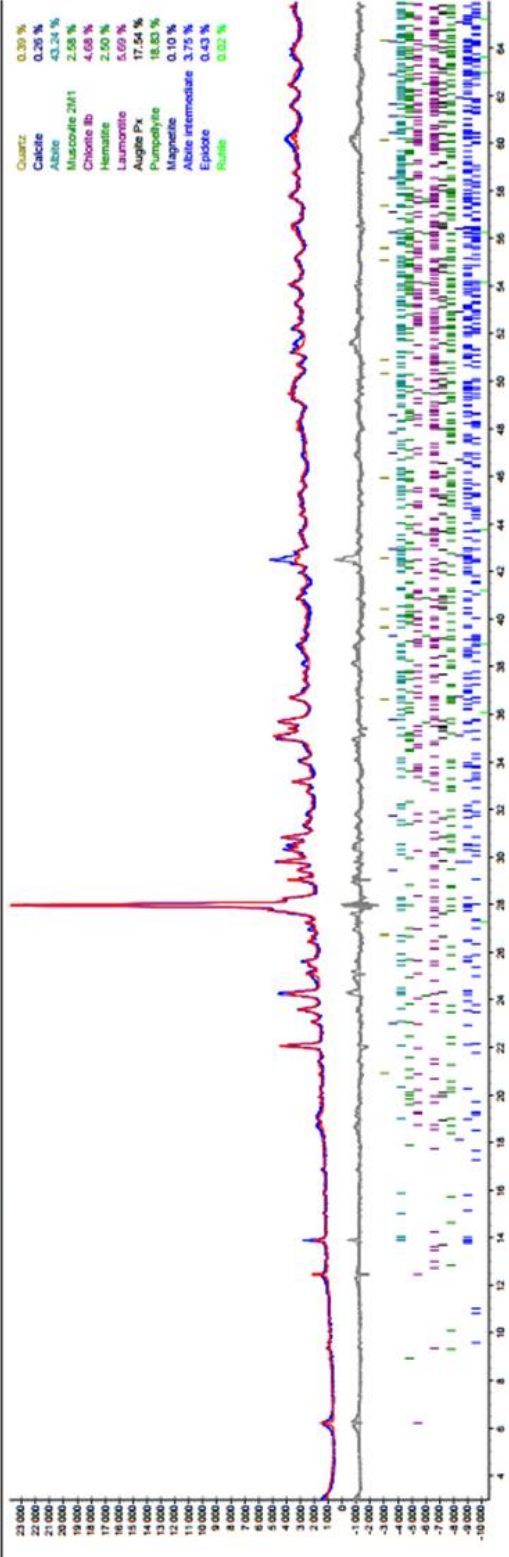

Jnr 160485; AQD-02 Box 12 44,5-44,95

## Appendix 7.B UCS-results and failure modes

### Definitions

According to Farmer (2012):

**Uniaxial strength** = the greatest stress that a specimen can maintain when subjected to stress in a single direction (in case of cylindrical specimen, axial direction). The maximum load carried by the specimen during the test is divided by the cross-sectional area



**E-modulus, E** = the ratio of normal stress to strain for a material at a specified stress level when subjected to stress in a single direction. The stress-strain curve is seldom linear for rock materials, thus the standard value quoted is usually the slope of a tangent to the curve at a stress equal to  $0.5 \sigma_{cf}$ .

**Poisson ratio,  $\nu$**  = the ratio between transverse and longitudinal strain of a specimen subjected to uniaxial stress

### Graphs and failure modes of the UCS-tests on dry samples

All specimens are of cylindrical shape. Table A.7.B.1 below show an overview of the test results and central data of the dry specimen tested.

*Table A.7.B.1: Failure modes in pictures of samples in dry UCS-tests.*

Sample (dry)	Picture	Mode of failure
AD-02, box 12		<p>Axial splitting with complex failure/multiple fracturing.</p> <p>The sample length was shortened and the radius extended.</p>
AD-02, box 8		<p>Axial splitting with complex failure.</p> <p>The fracture surface was irregular and granulated.</p>
AD-05, box 5		<p>Axial splitting.</p>

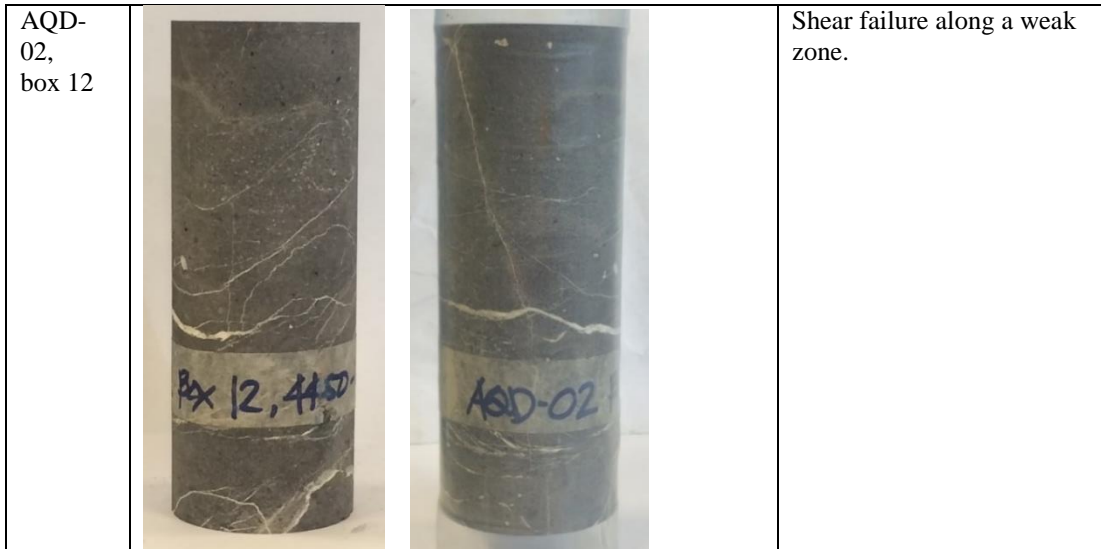

The following graphs show the development of stresses and failure of each sample tested in dry condition. The vertical axis shows the stresses in MPa and the horizontal axis shows the strain.

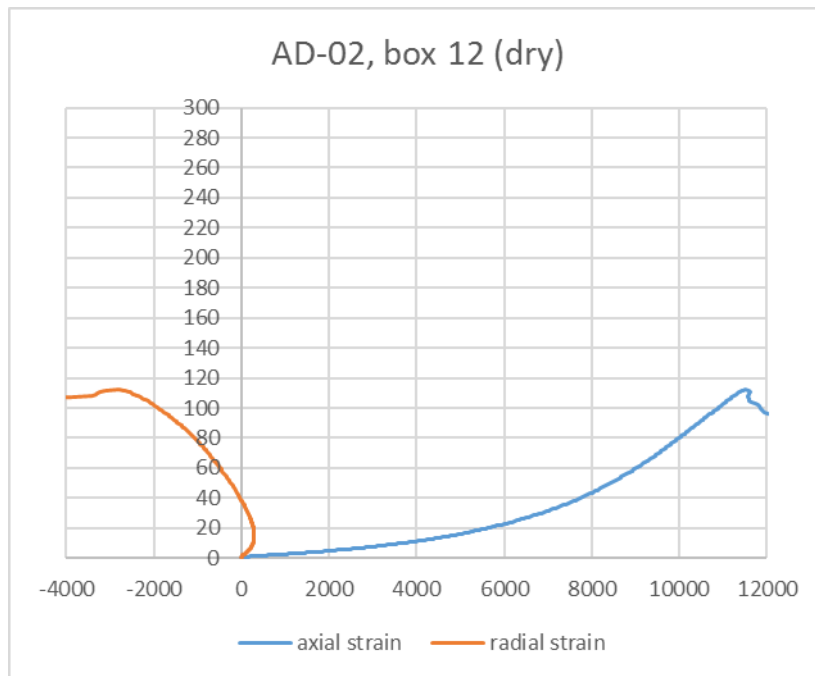

AD-02, box 8 (dry)

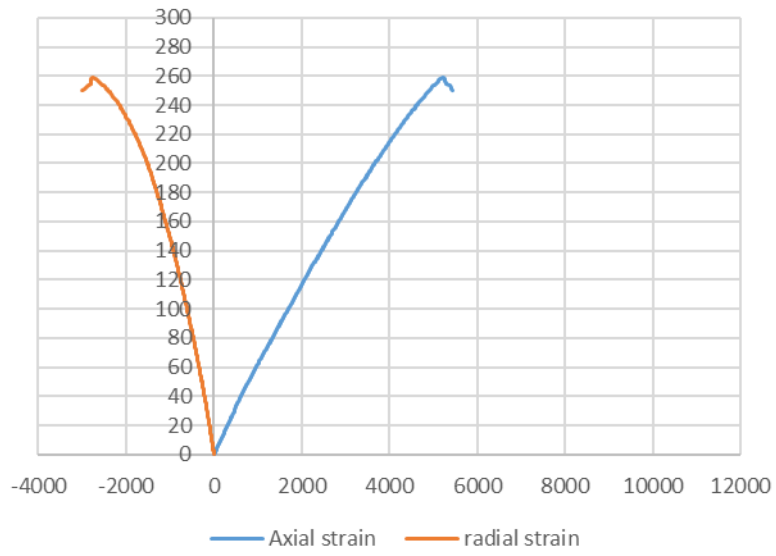

AD-05, box 5 (dry)

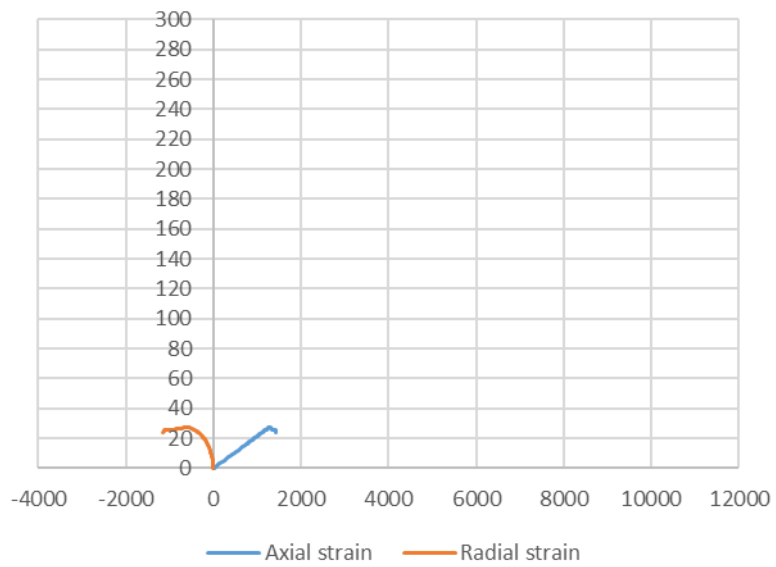

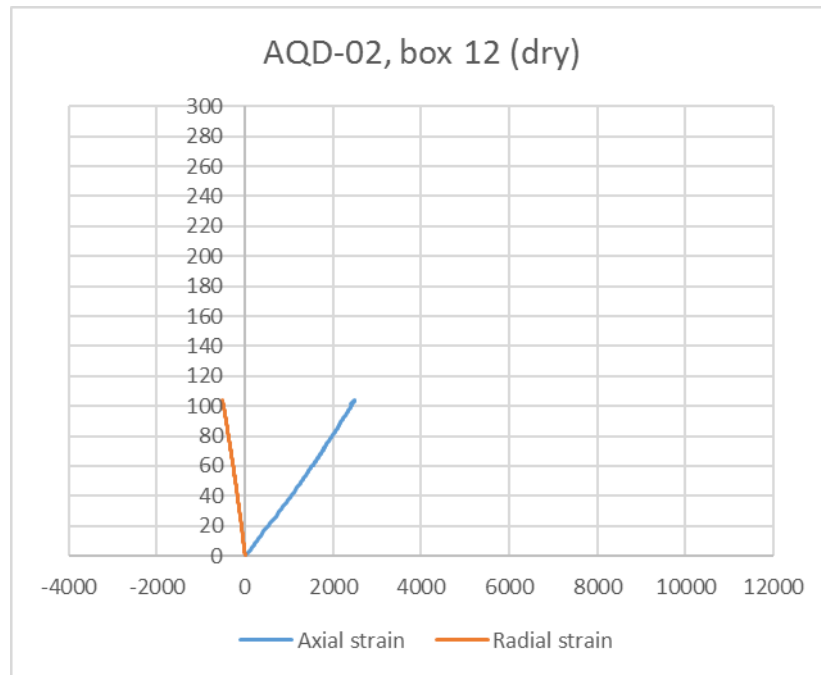



**Graphs and failure modes of the UCS-tests on wet samples**

All samples are of cylindrical shape. The samples tested are from the rock categories “Rock type strong”, andesitic type.

Table A.7.B.2 show the samples and failure modes in pictures.

Table A.7.B.2: Failure modes in pictures of samples in wet UCS-tests.

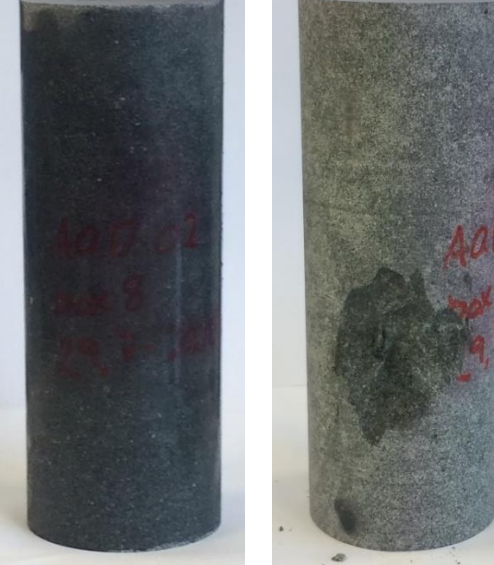
Sample (wet)	Picture	Mode of failure
AD-02, box 12		Shear failure, probably along a weak zone
AQD-02, box 8		Complex fracturing due to minor pre-existing cracks
AD-02, box 3		Complex fracturing

The following graphs show the development of stresses and failure of each sample tested in wet condition. The vertical axis shows the stresses in MPa and the horizontal axis shows the strain.

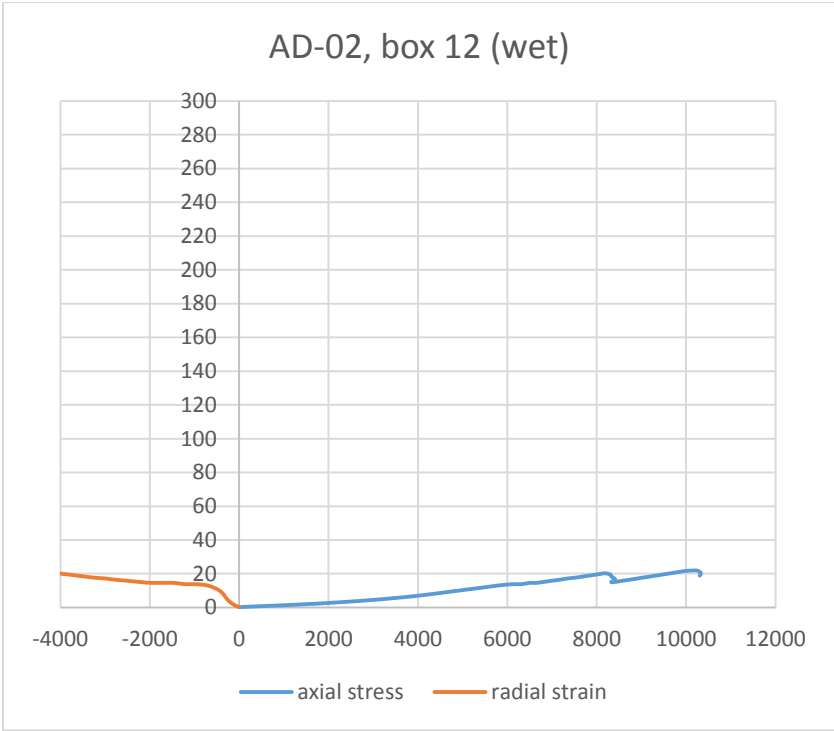



AQD-02, box 8 (wet)

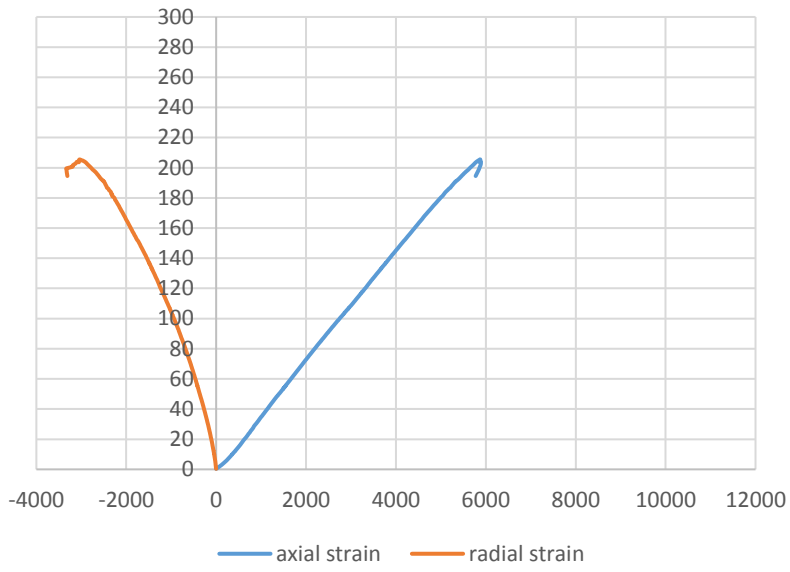

AD-02, box 3 (wet)

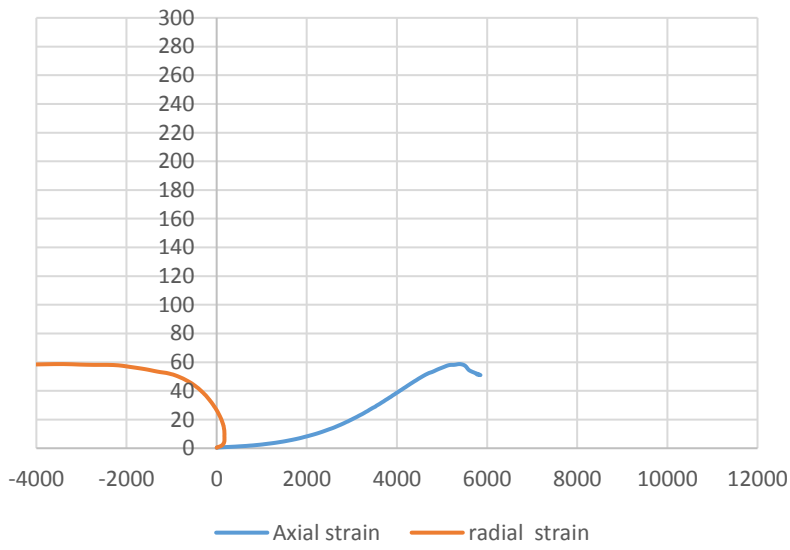

# Appendix 7.C DTA graphs

AD-02, box 12 (1)

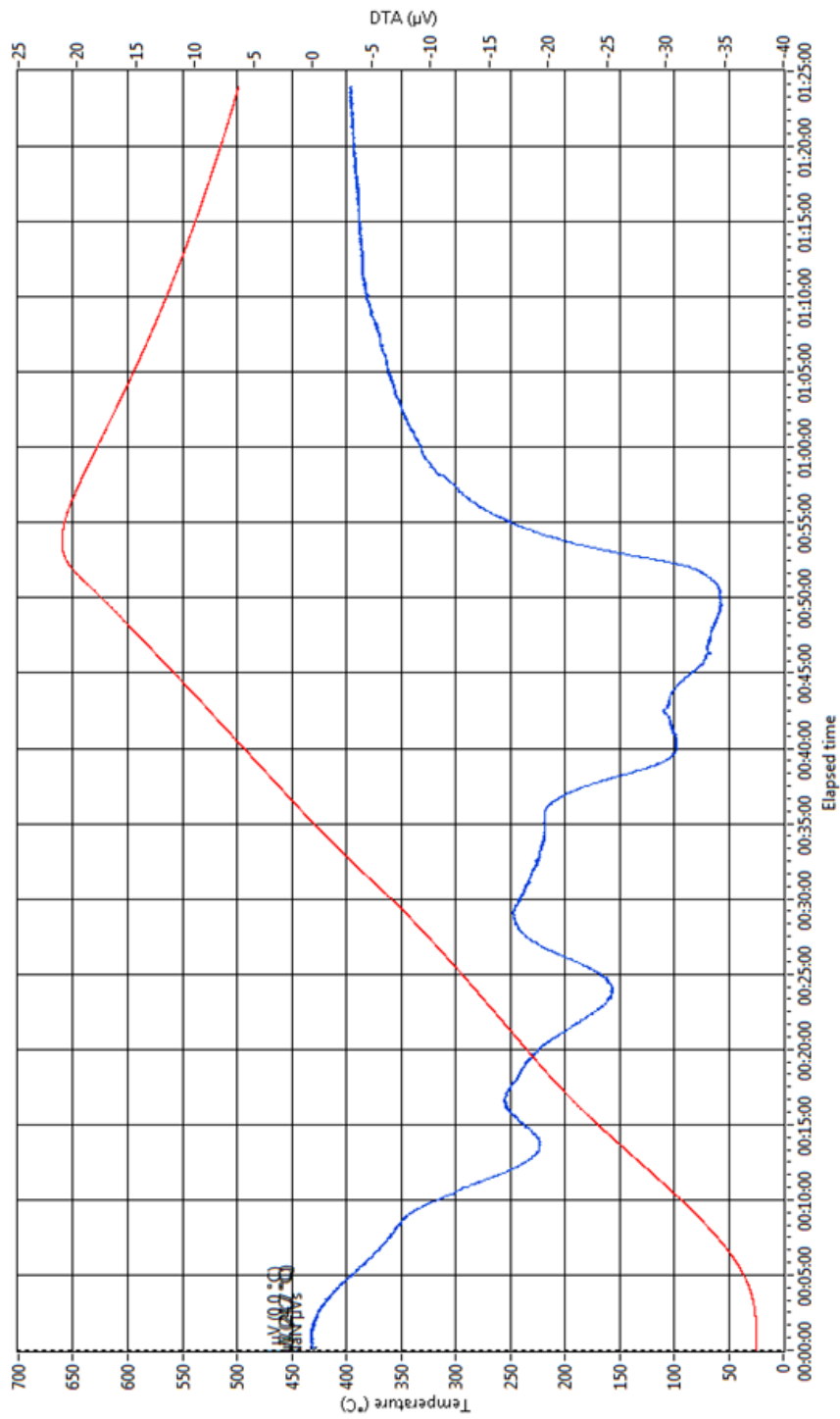

AD-06, box 25

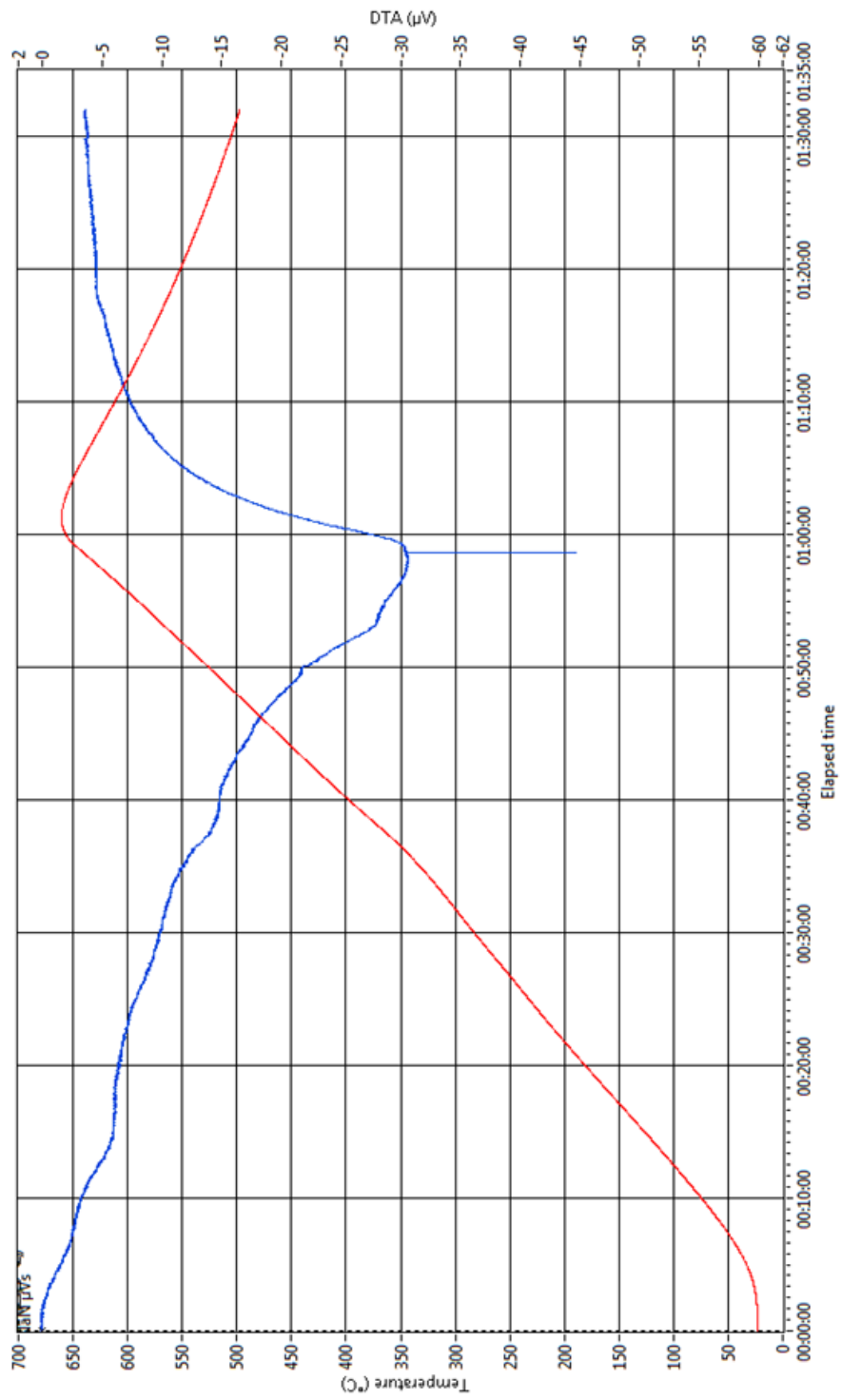

AD-07, box 12

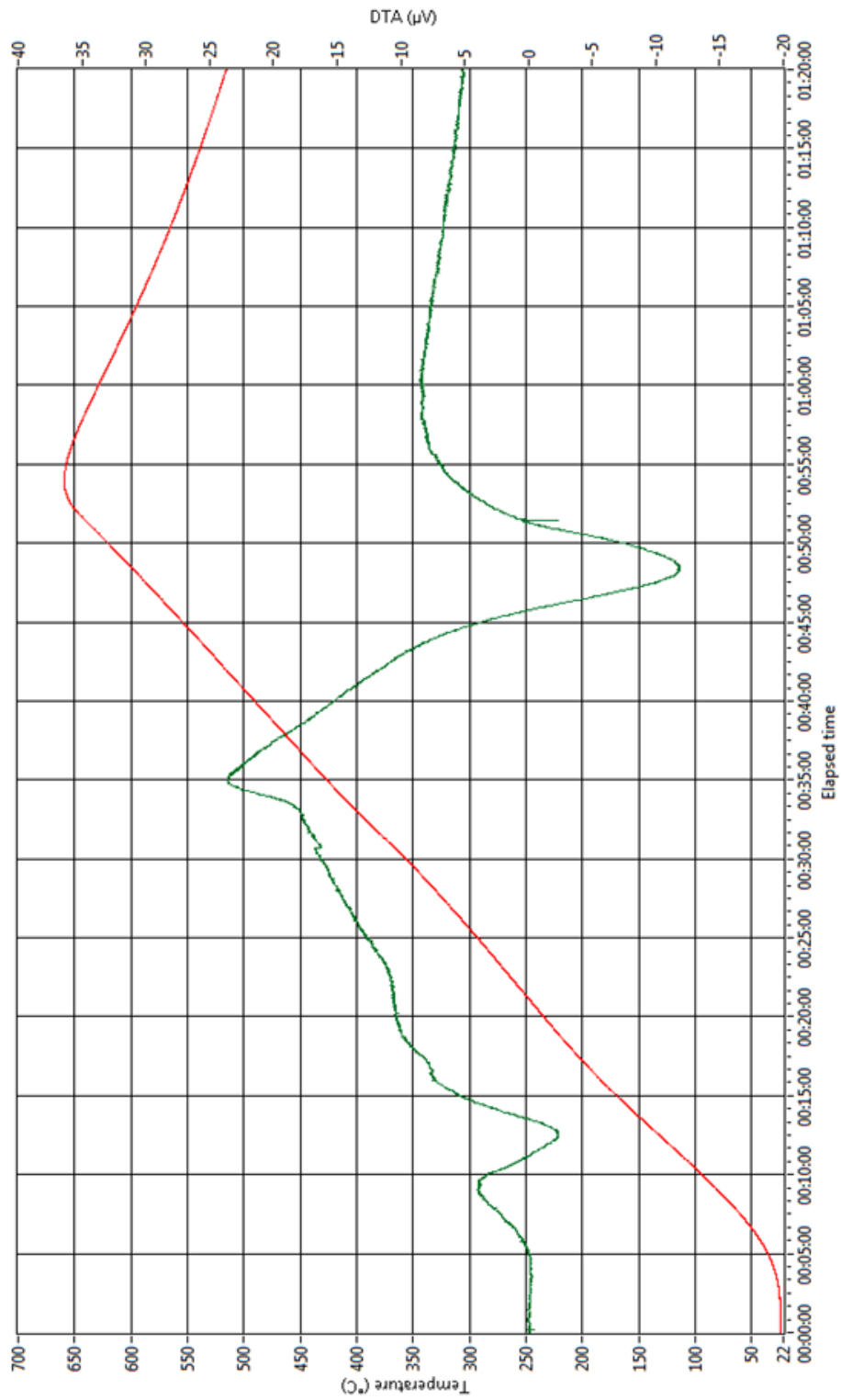

AQD-02, box 12 (1)

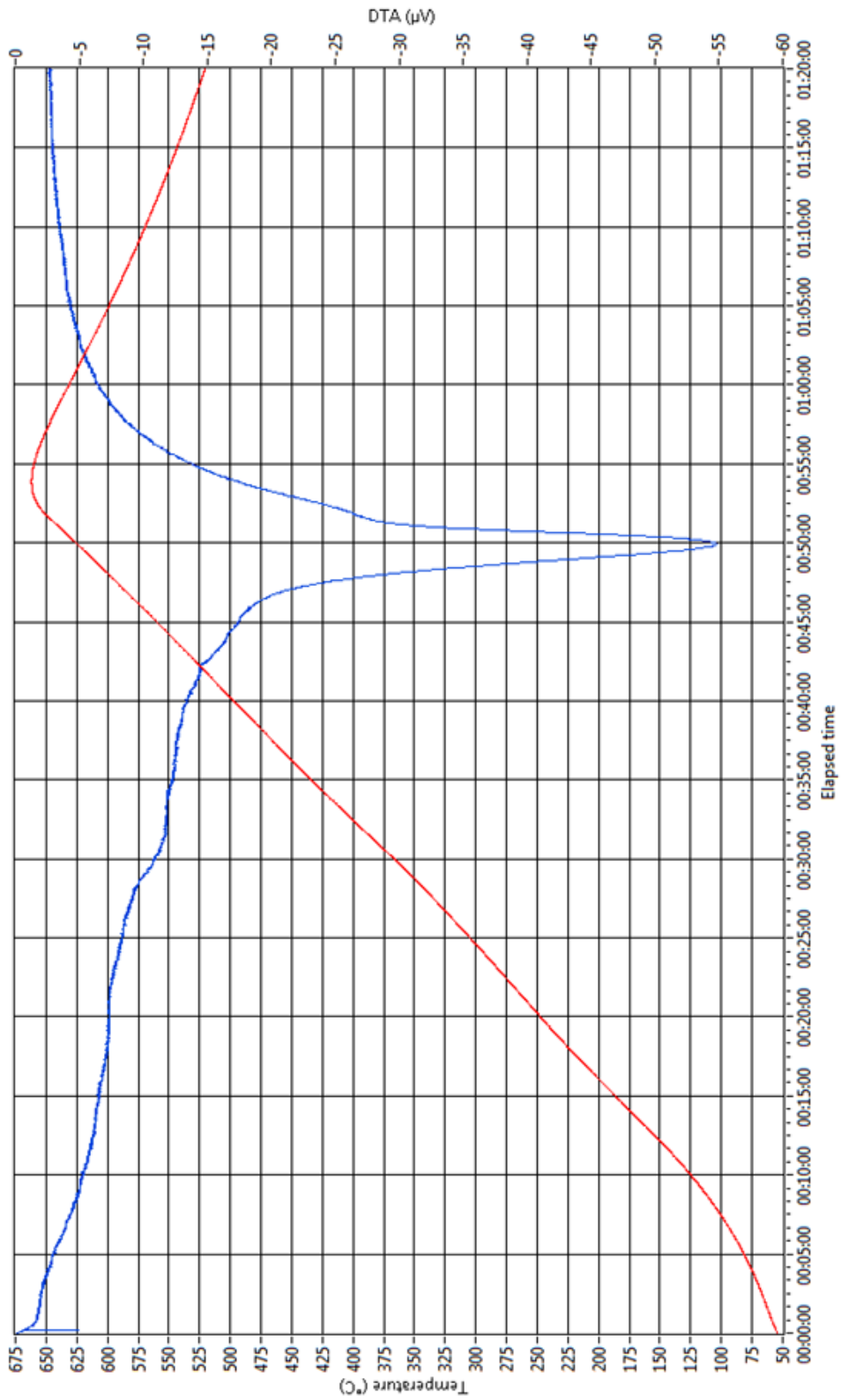

AQD-02, box 5

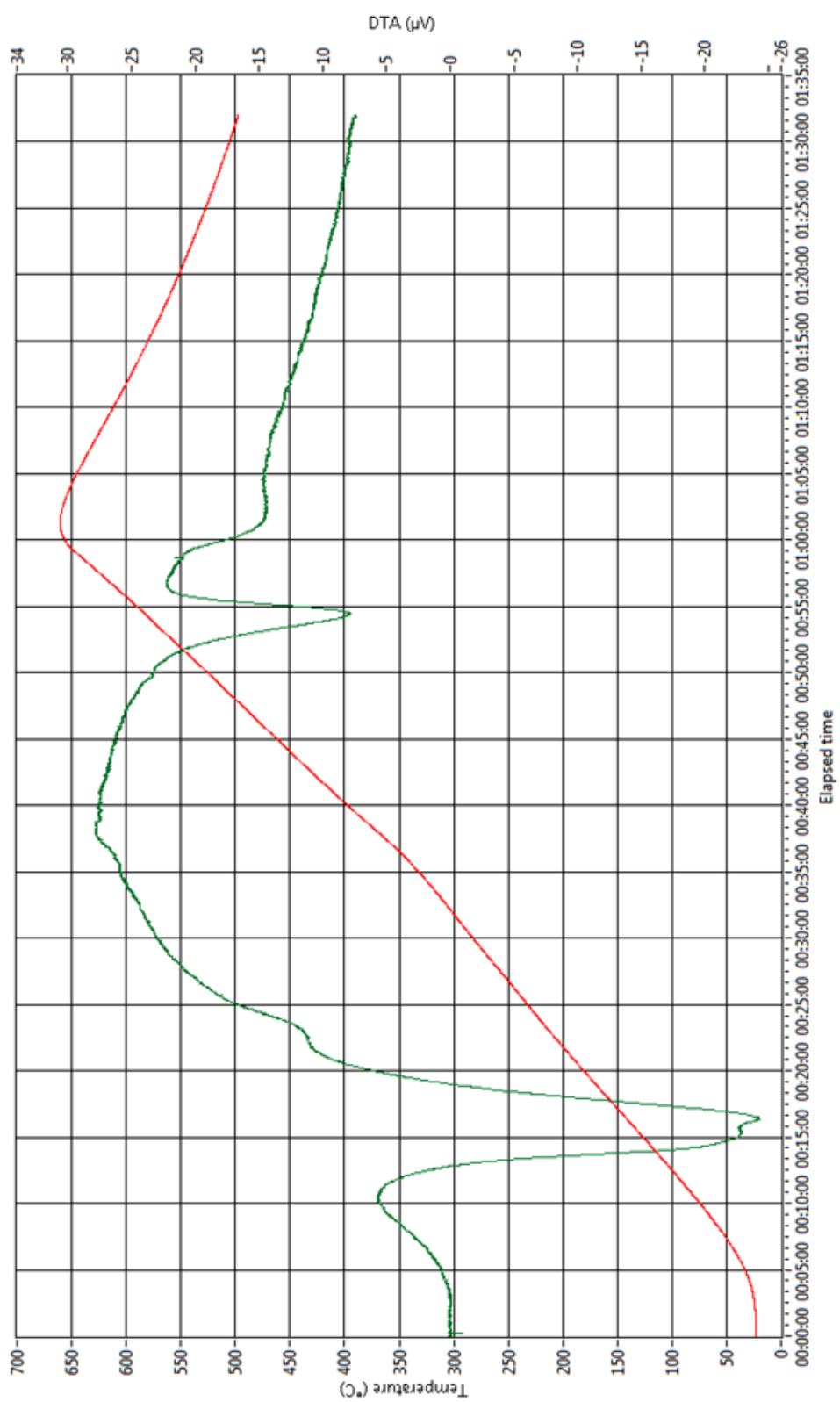

AQD-02, box 6

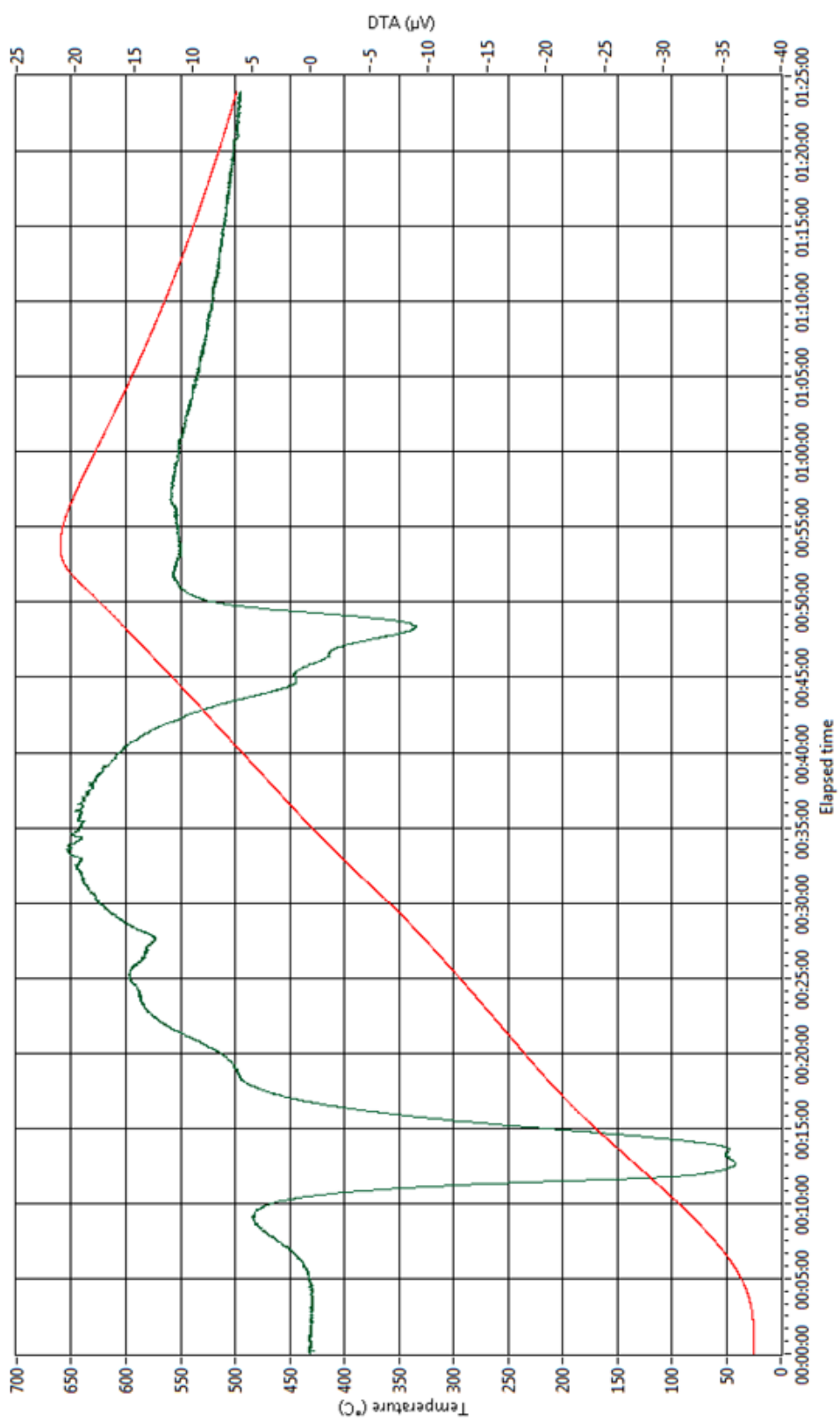

APH-02, box 18

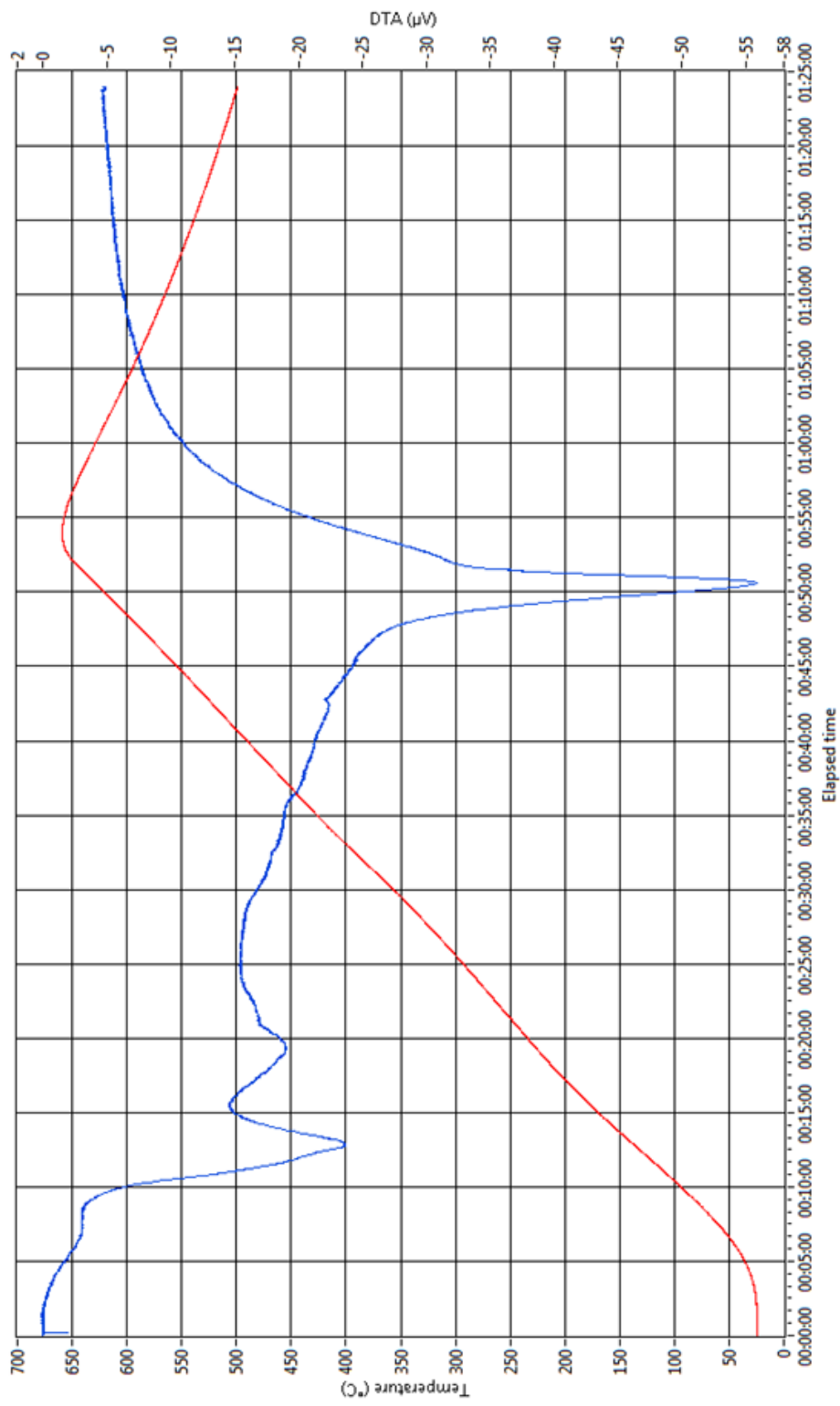



**DATA AND GRAPHS NTNU**

***ORIGINAL TEST SUITE SAMPLES***

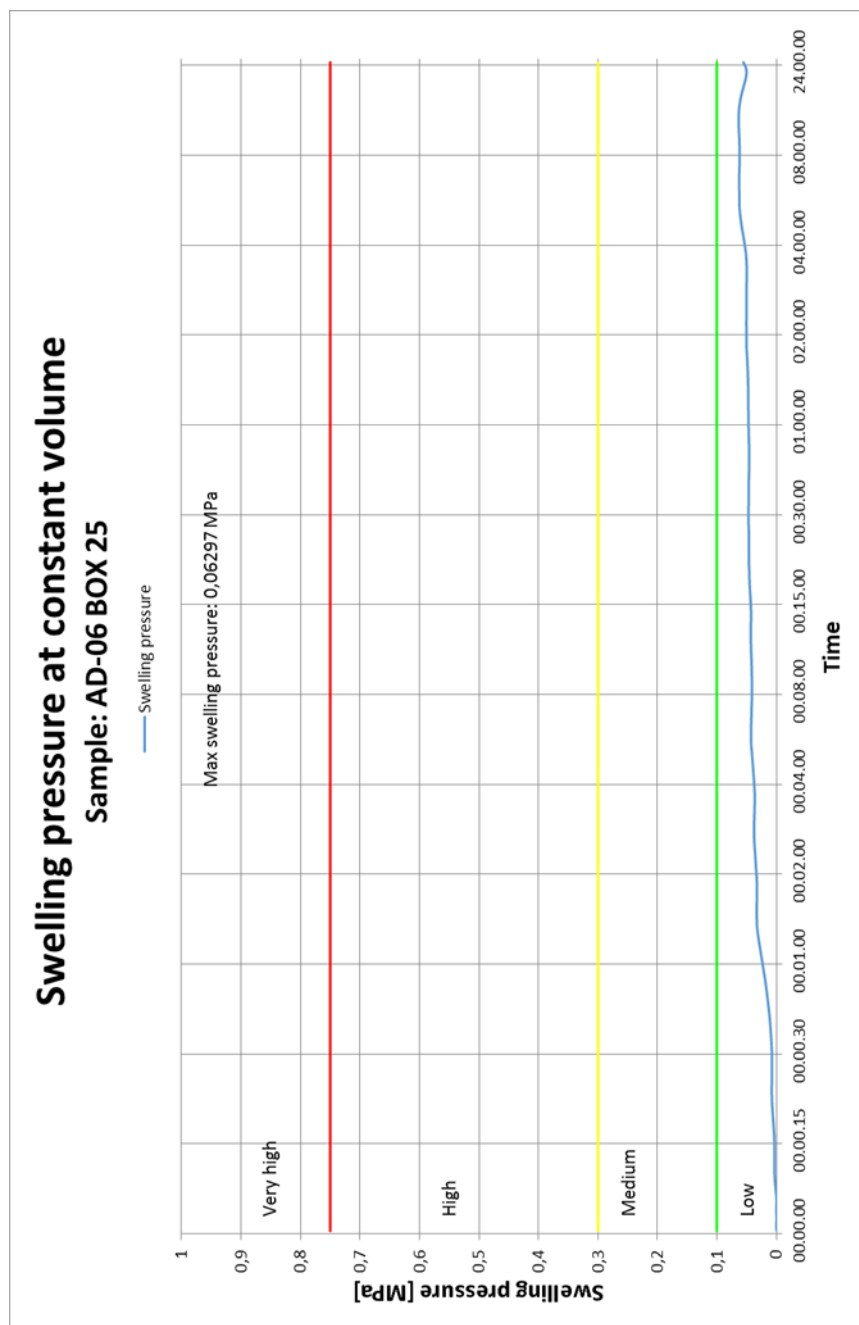

# Swelling pressure at constant volume

Sample: AD-07 BOX 12

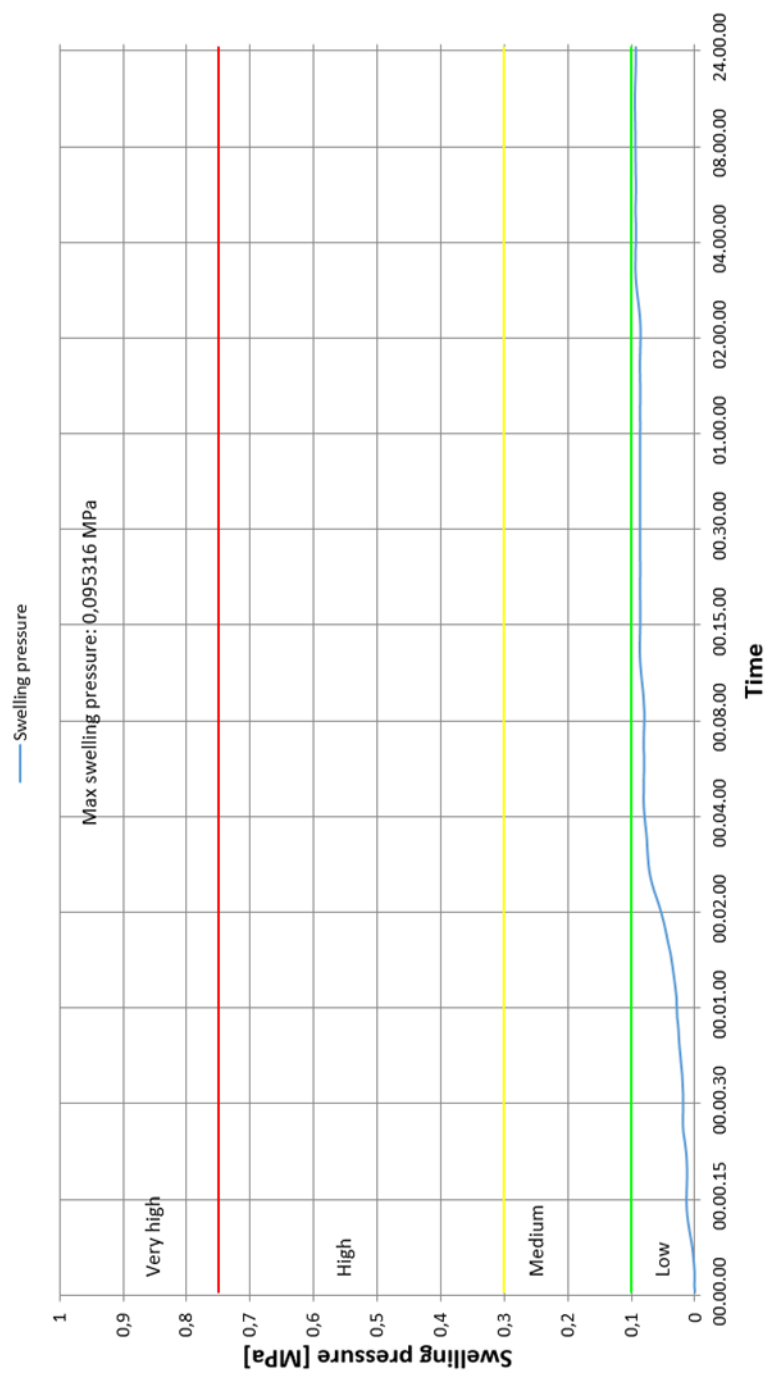

# Swelling pressure at constant volume

Sample: AD-06 BOX 25

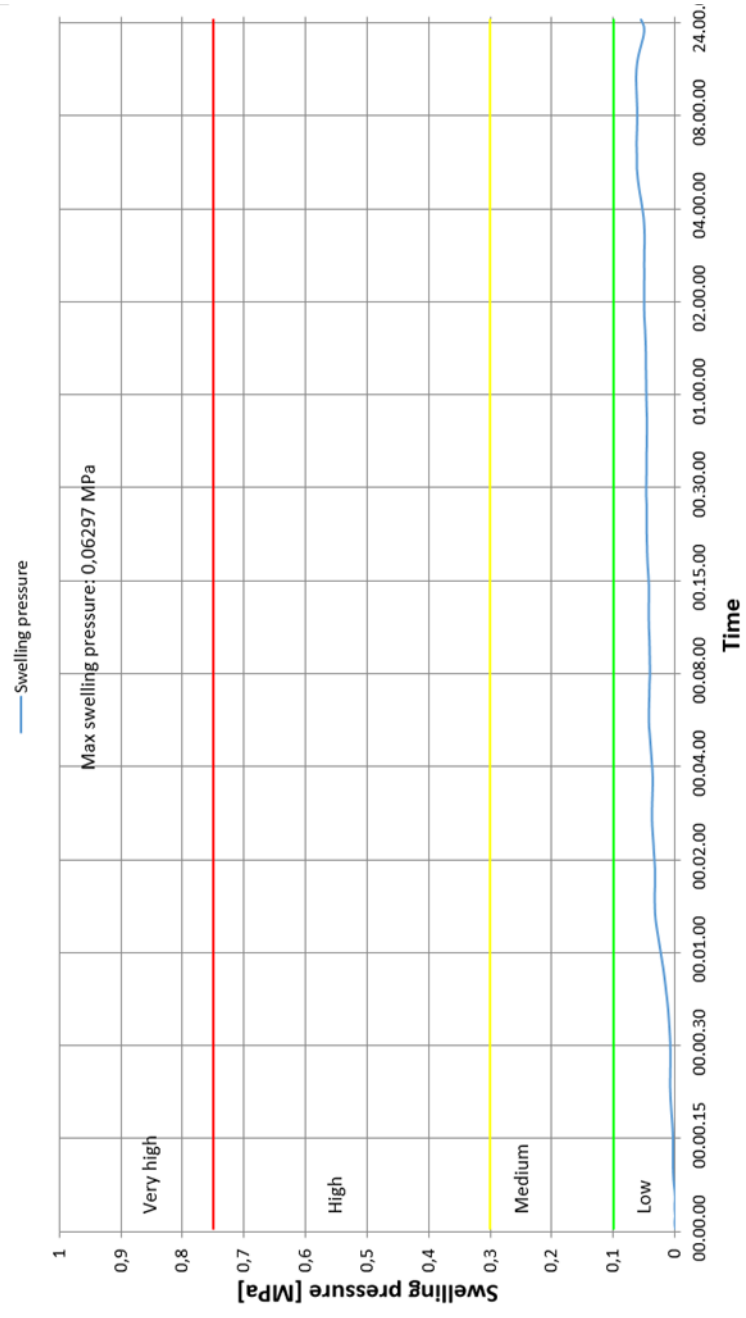

# Swelling pressure at constant volume

## Sample: AQD-02 BOX 12

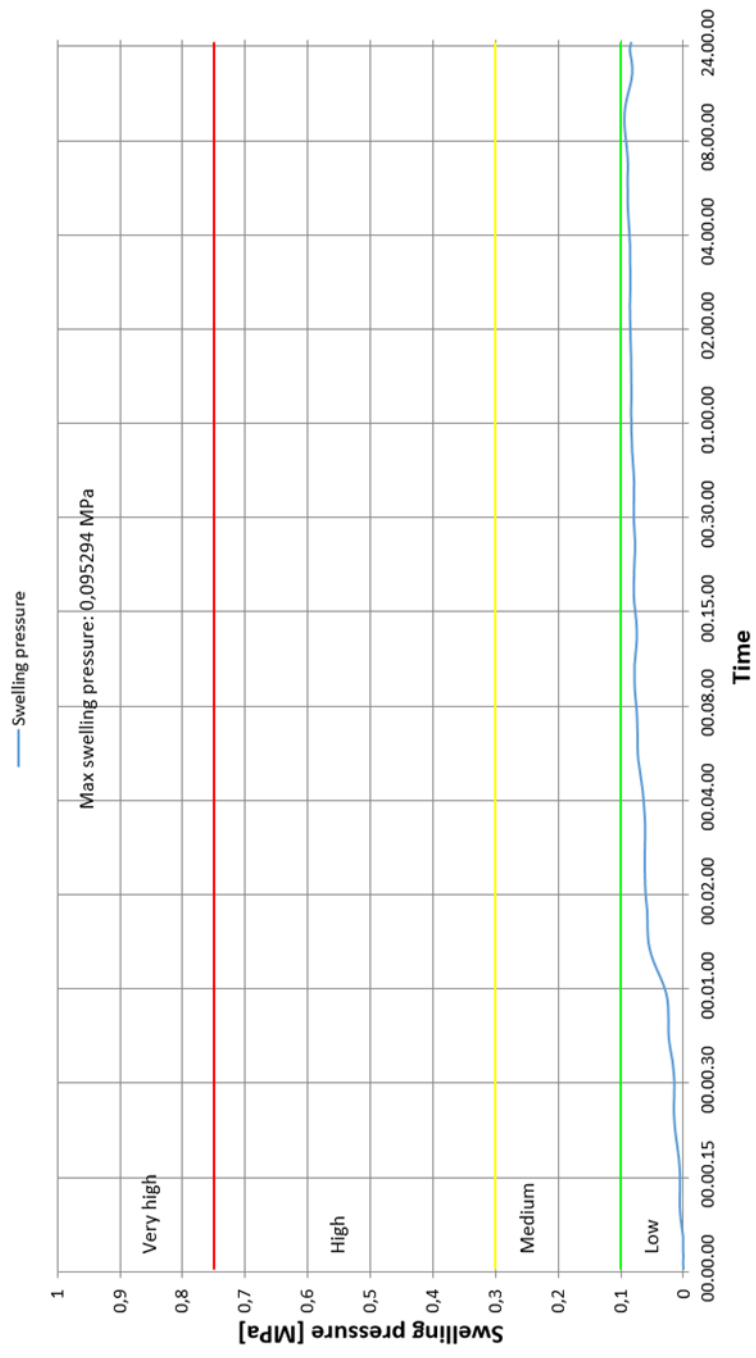

# Swelling pressure at constant volume

Sample: AQD-02 BOX 5

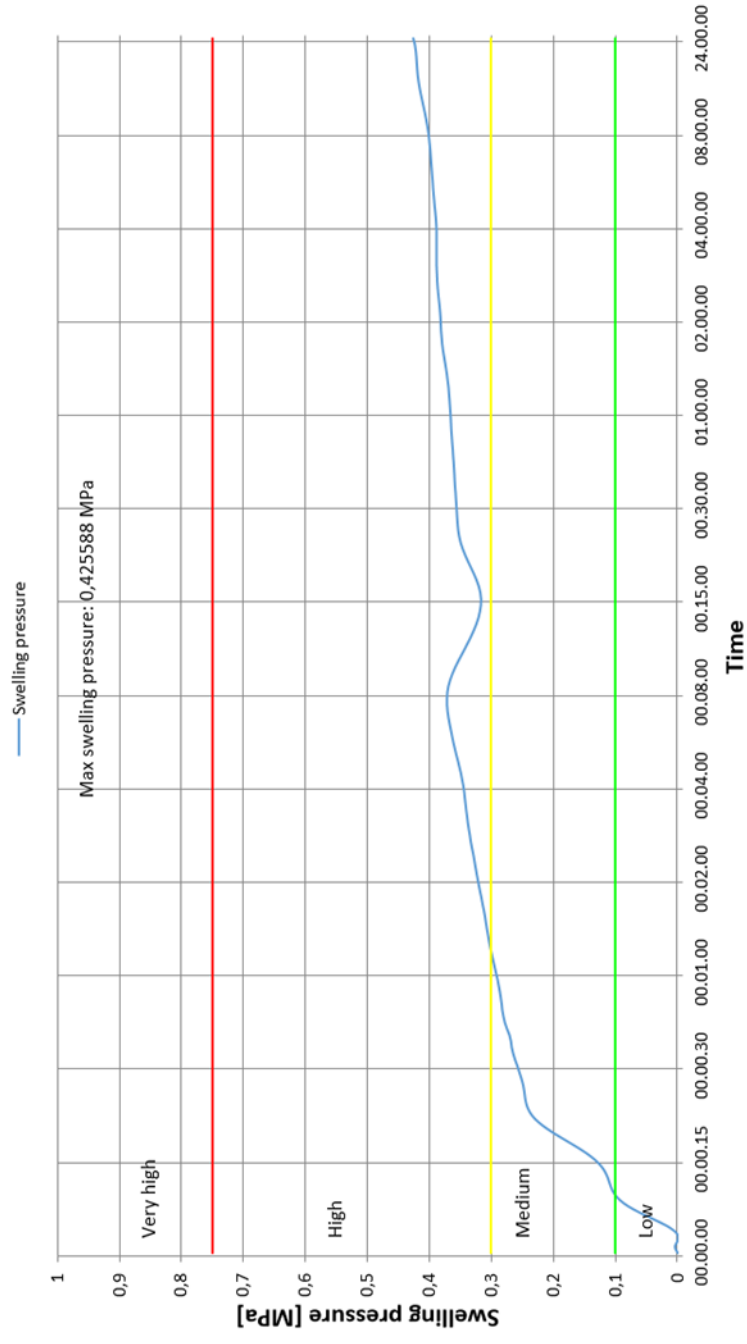

# Swelling pressure at constant volume

Sample: APH-02 BOX 18

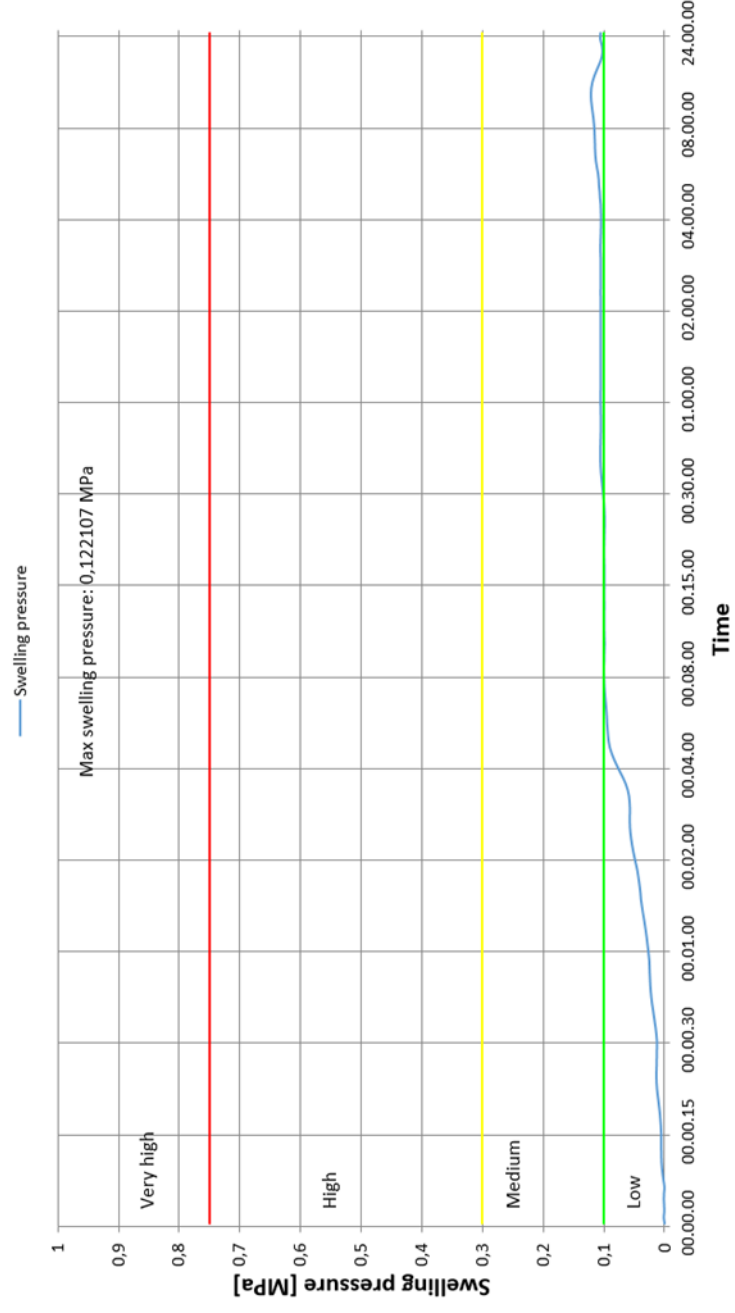

# Swelling pressure at constant volume

Sample: AQD-02 BOX 6

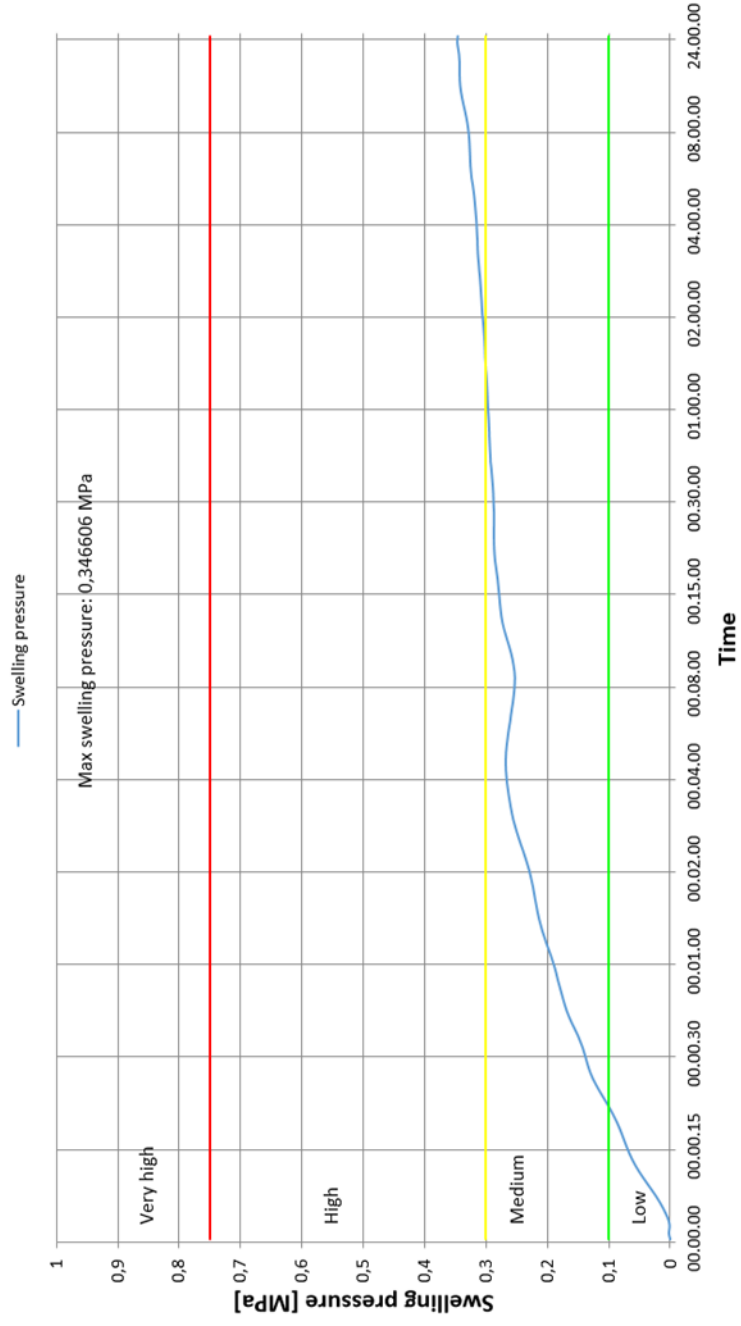

*ADDITIONAL TESTS (by Silje Elin Skrede)*

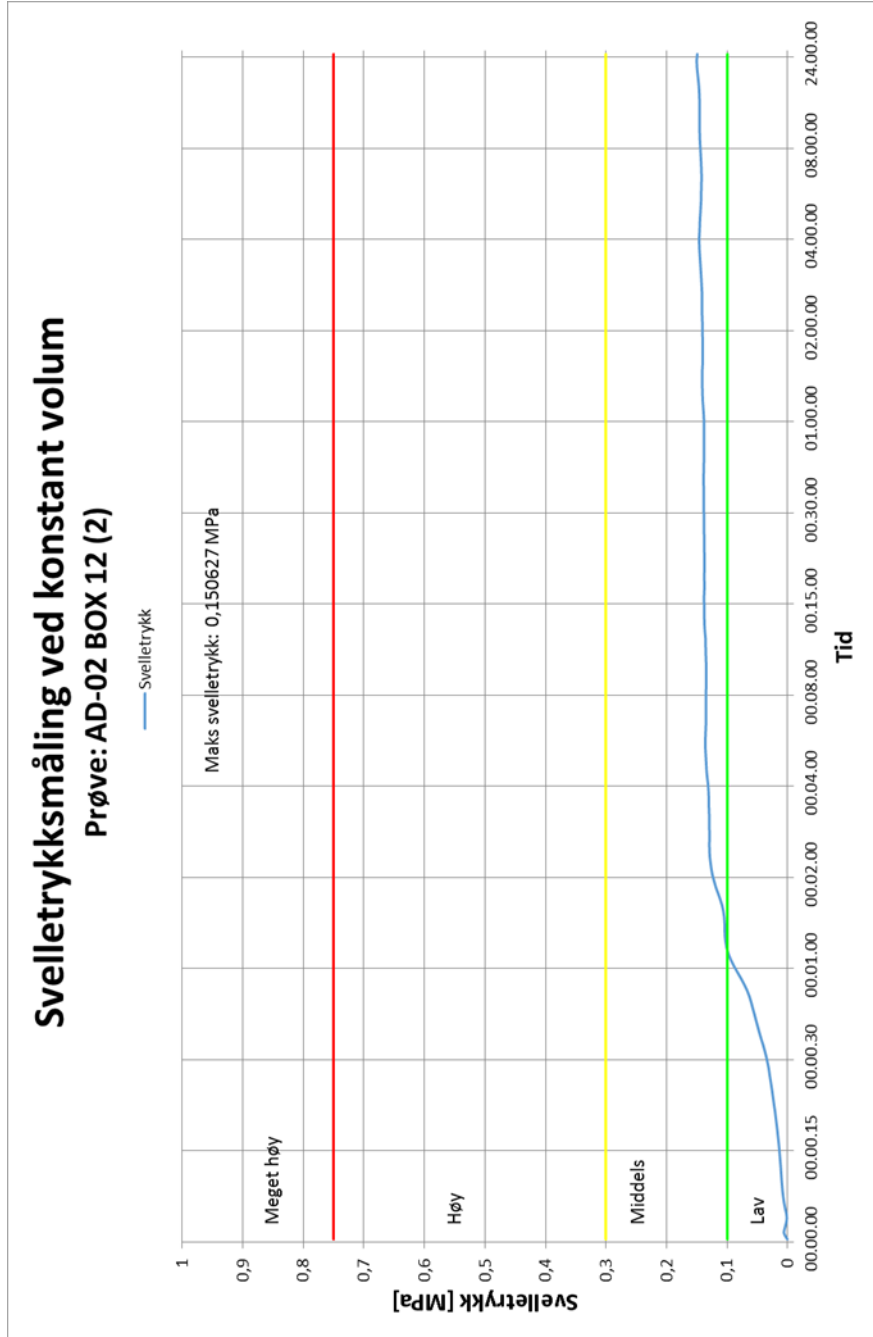



# Svelletrykksmåling ved konstant volum

Prøve: AD-02 BOX 8

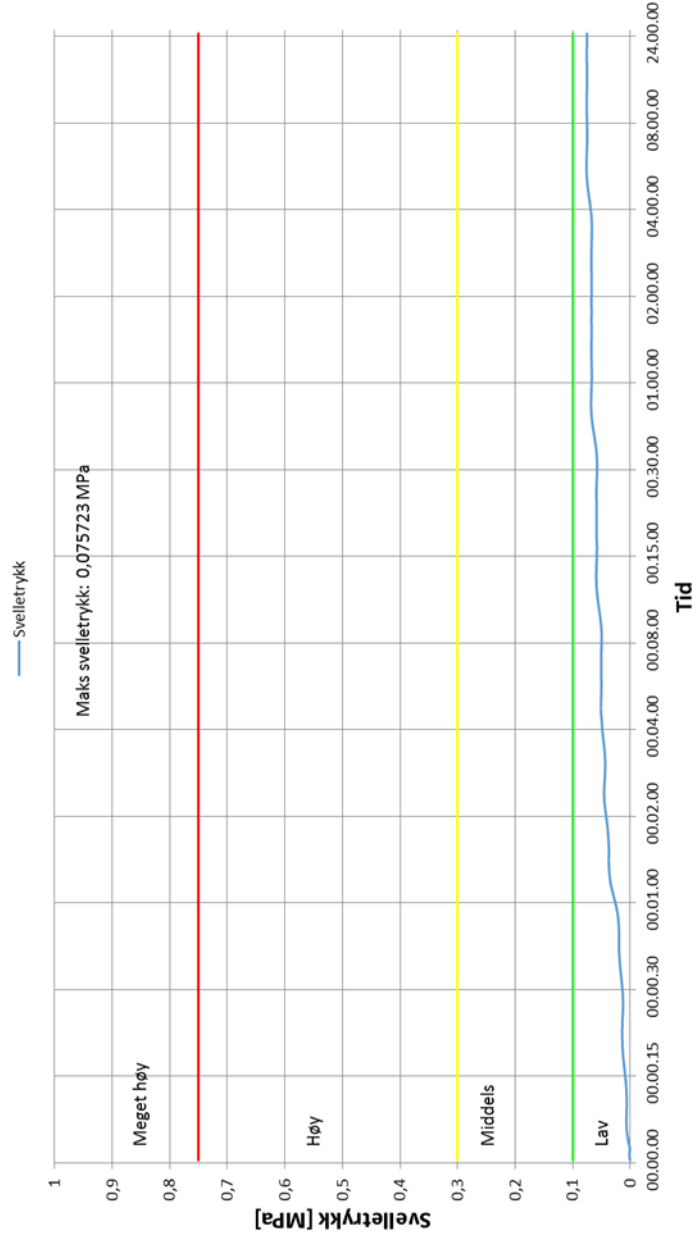

# Svelletrykksmåling ved konstant volum

Prøve: AD-05 BOX 5

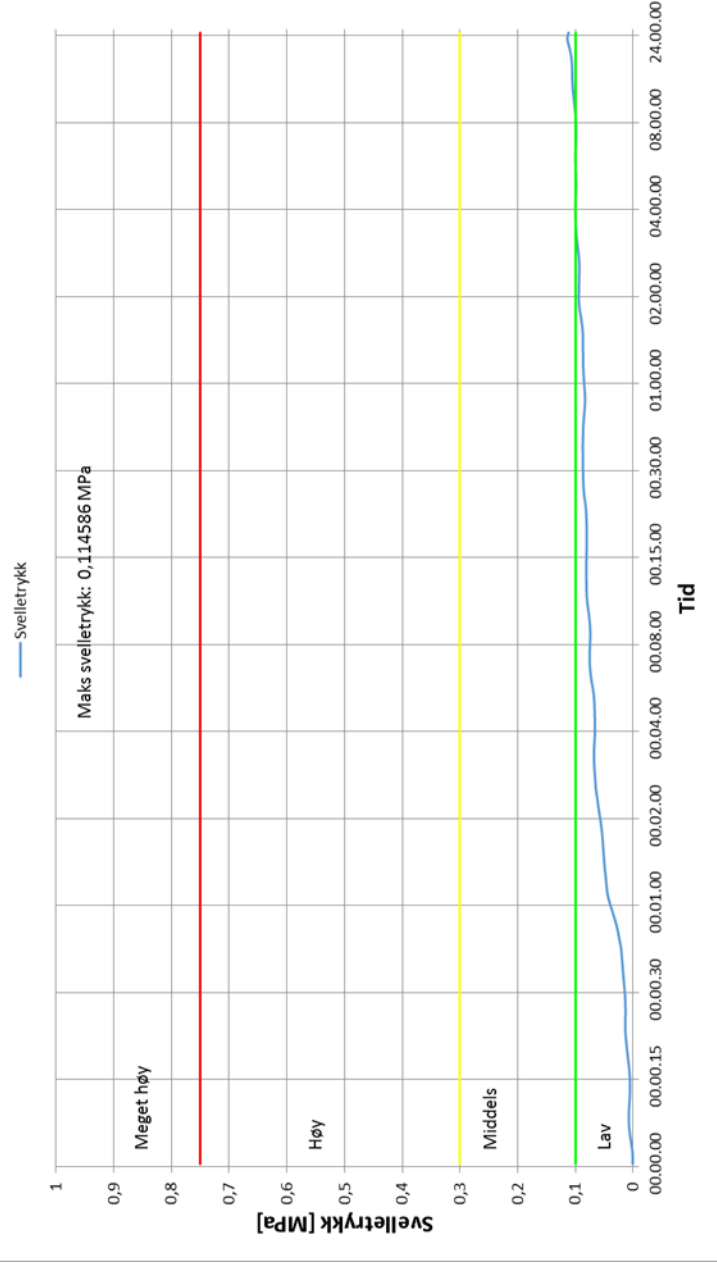

# Svelletrykksmåling ved konstant volum

## Prøve: AQD-02 BOX 12(2)

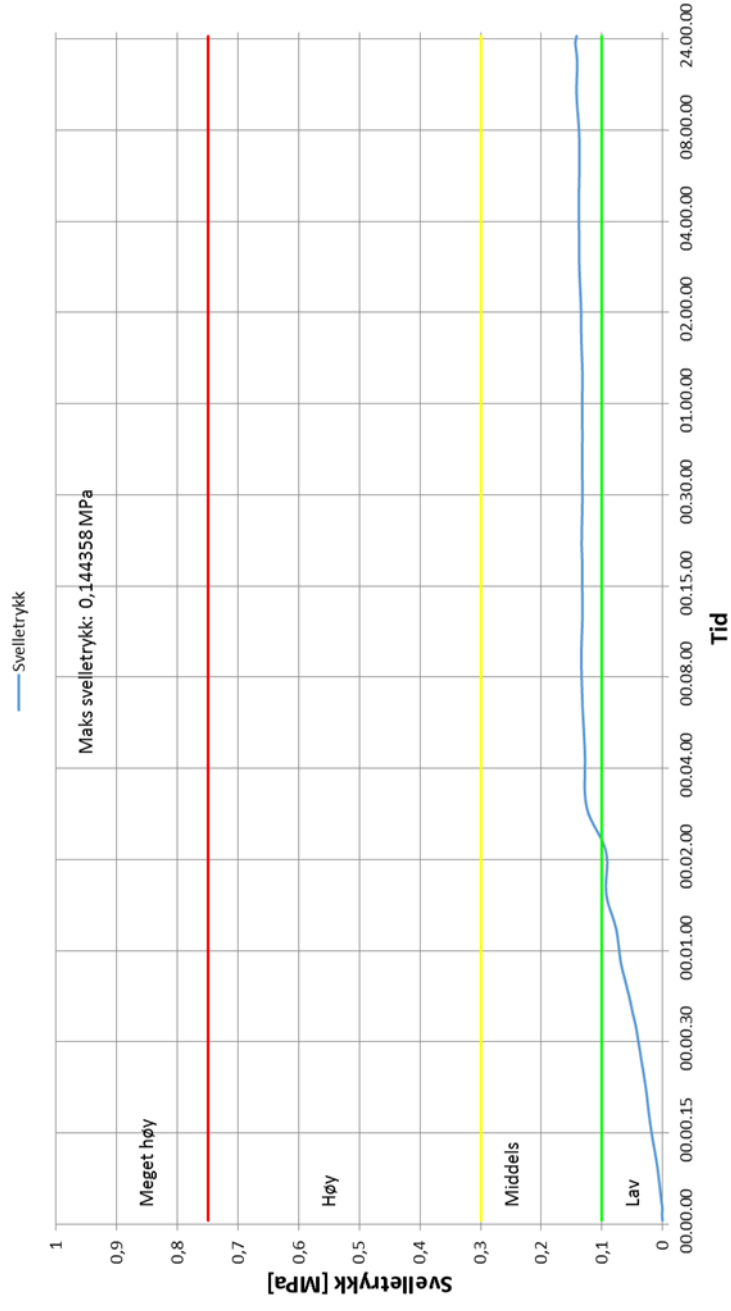

**DATA AND GRAPHS KIT**

**SWELLING STRESS CURVE**  
Sample: AD-02, box 12

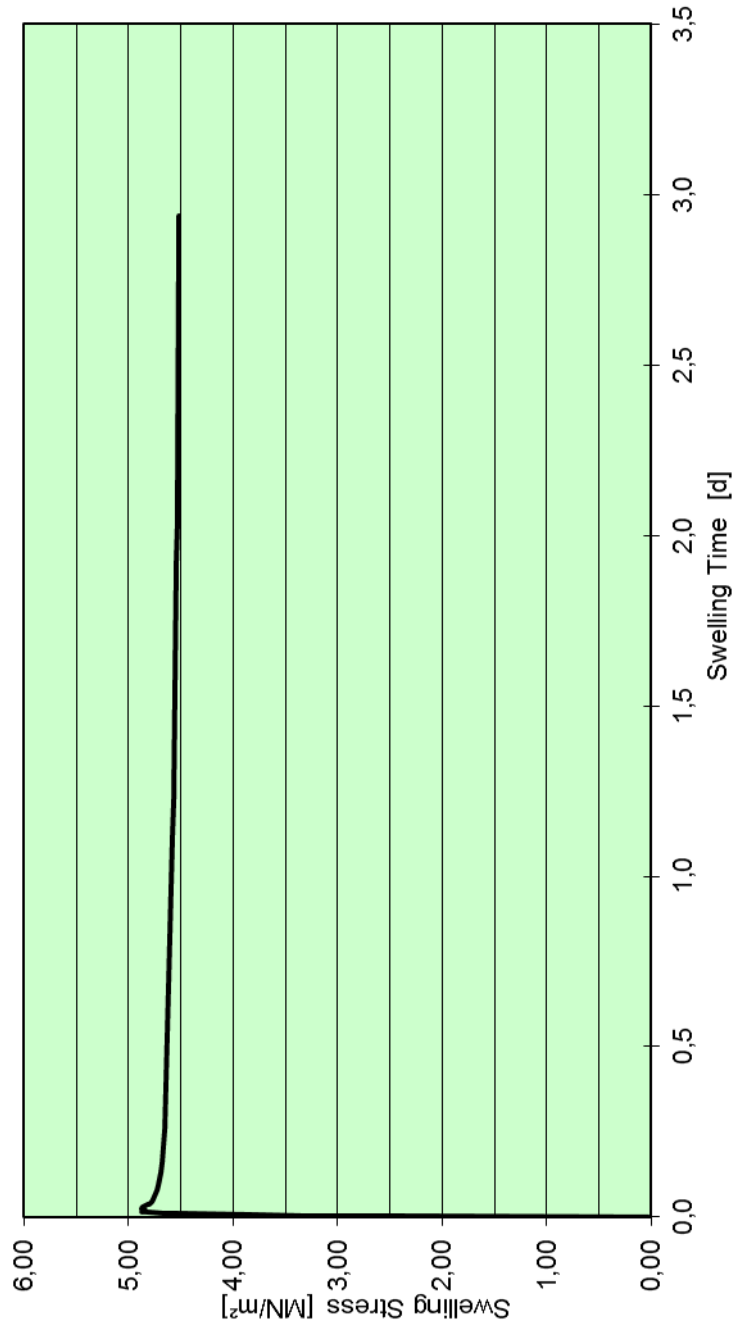

**QUELLDRUCKKURVE**  
**Probe: AD-06, box 25**

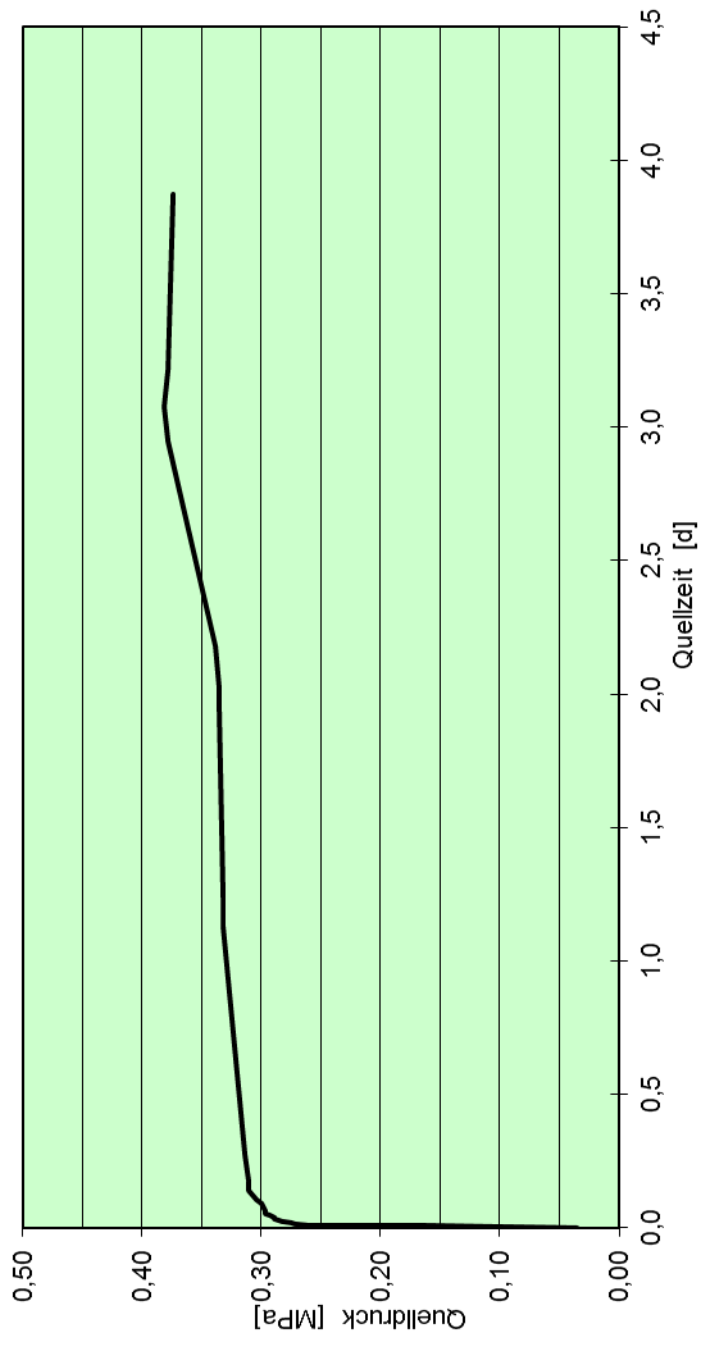

**SWELLING STRESS CURVE**  
Sample: AD-07, box 12

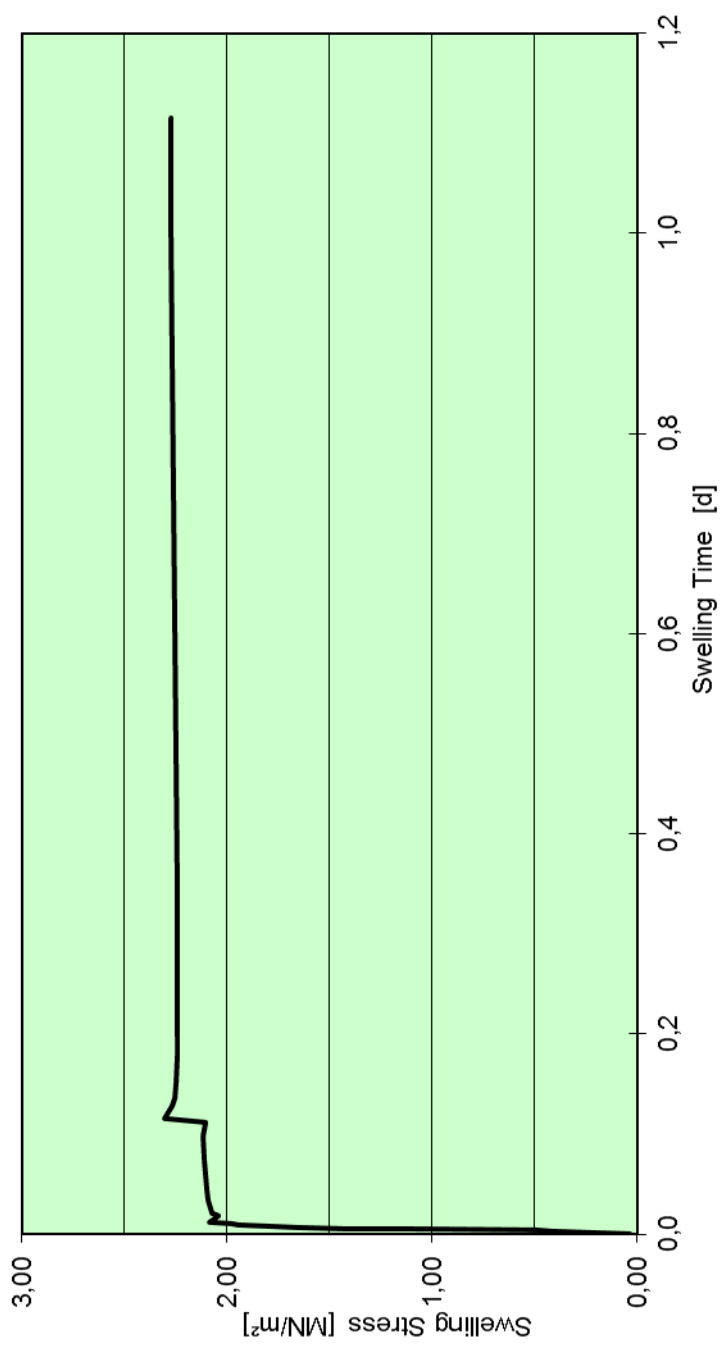

**SWELLING STRESS CURVE**  
Sample: AQD-02, box 12

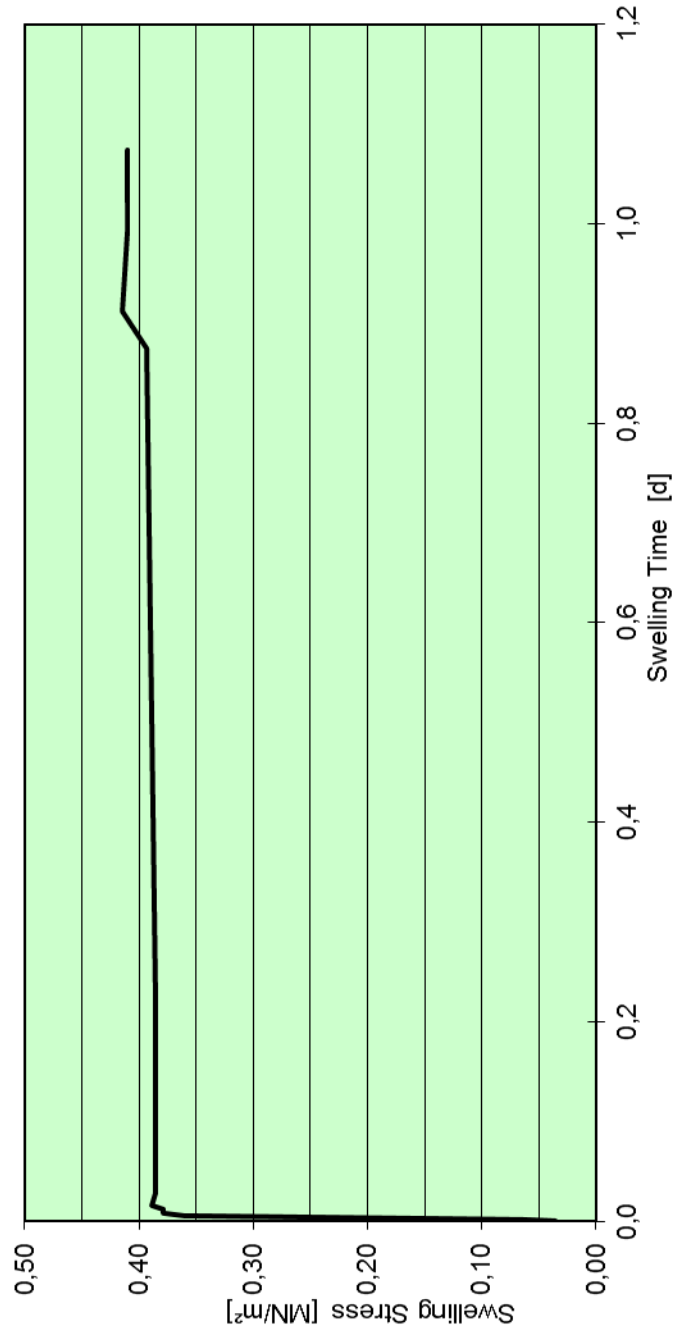

**QUELLDRUCKKURVE**  
**Probe: AQD - 02, box 5**

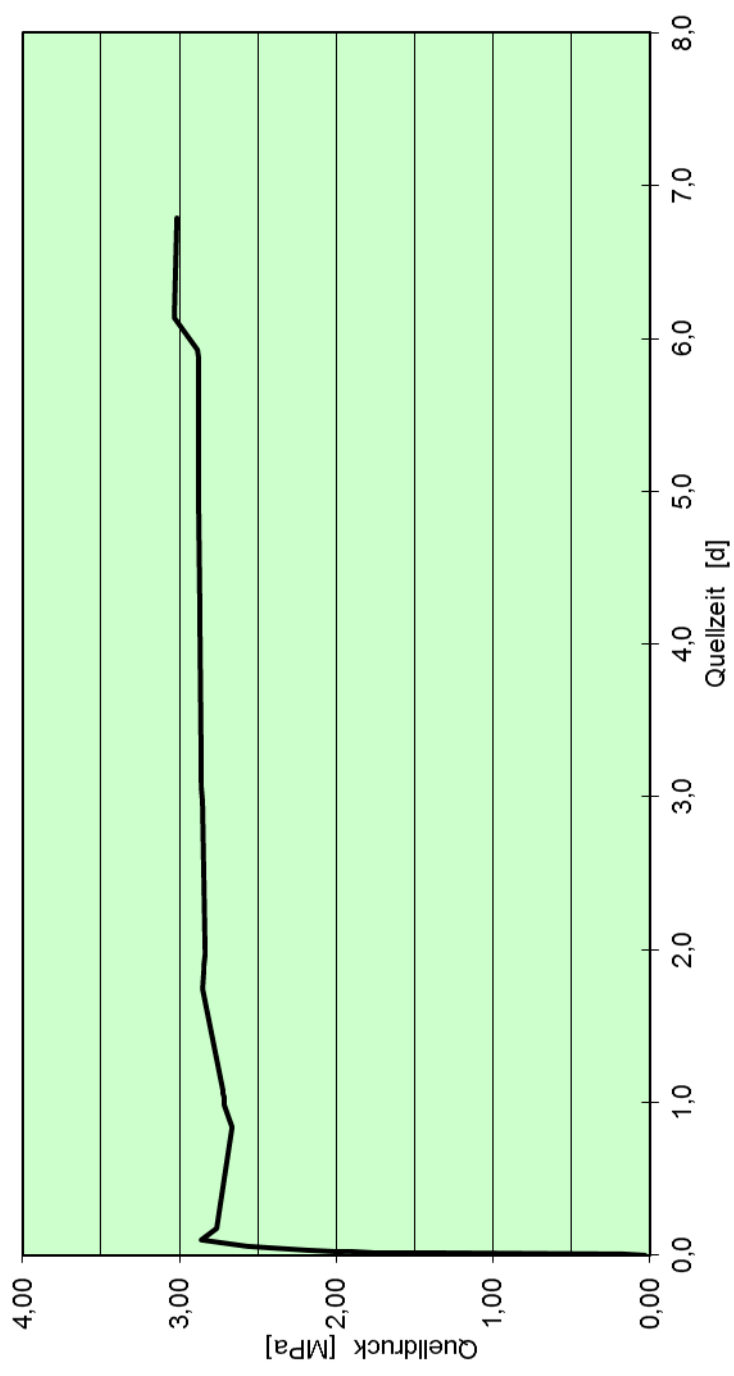



**QUELLDRUCKKURVE**  
**Probe: AQD-02, box 6**

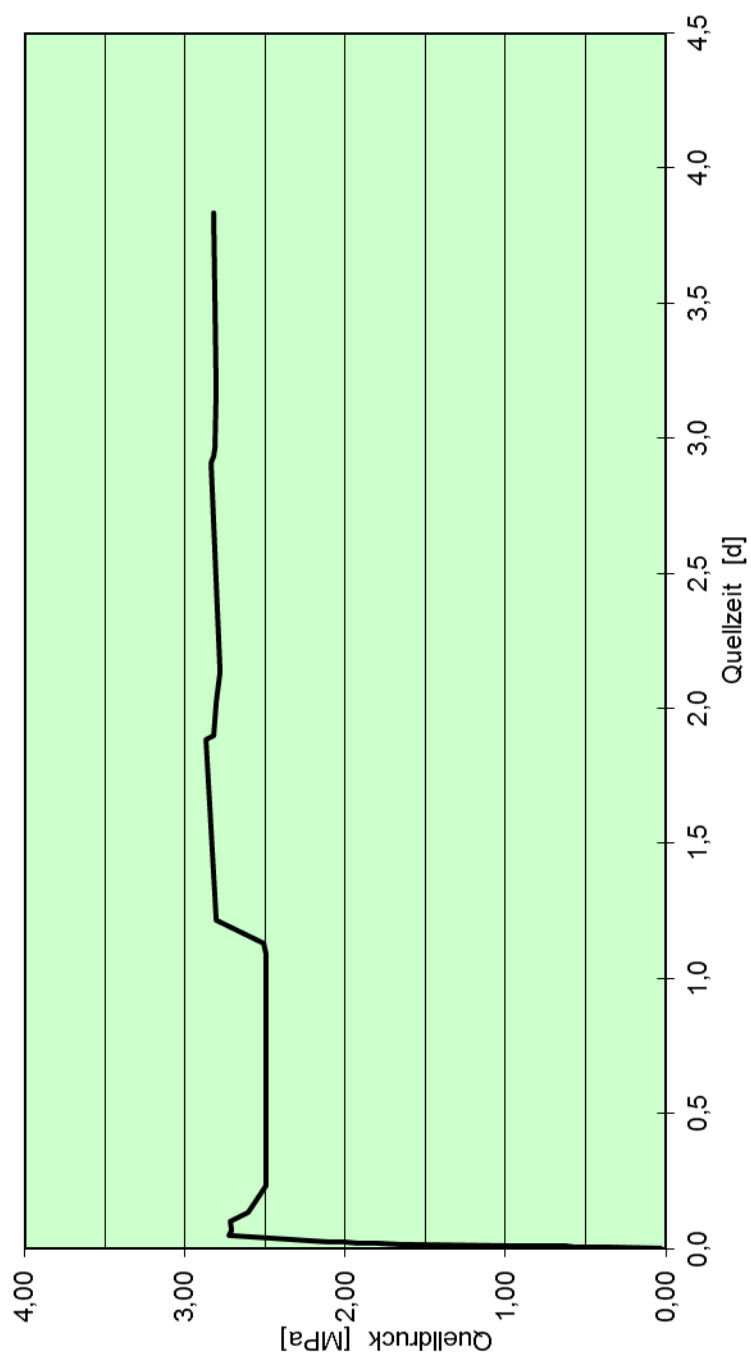

**QUELLDRUCKKURVE**  
**Probe: APH-02, box 18**

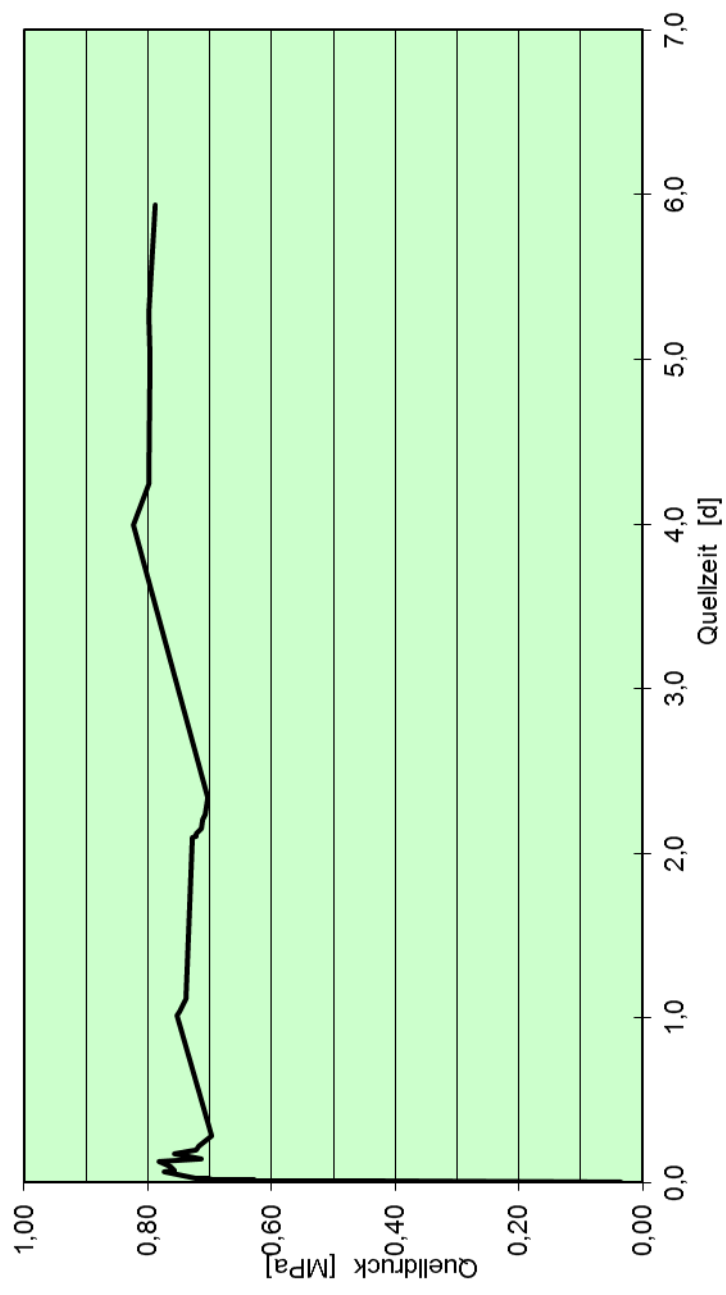

## Appendix 7.E Intact rock structure data and graphs in oedometer tests and swelling characterization.

### **SWELLING CHARACTERIZATION**

The characterization of maximum swelling pressure used at NTNU is summarized in Table A.7.E.1. There exists no corresponding system of characterization at KiT.

*Table A.7.E.1: Swelling characterization based on maximum swelling pressure (NTNU 2016).*

<b>Swelling pressure (MPa)</b>	<b>Swelling characterization in swelling pressure tests (NTNU, 2016)</b>
<b>&lt;0.10</b>	<b>Low</b>
<b>0.10 – 0.30</b>	<b>Medium</b>
<b>0.30 – 0.75</b>	<b>High</b>
<b>&gt;0.75</b>	<b>Very high</b>

### **DATA AND GRAPHS NTNU**

The swelling pressure index is calculated from the formula:

F/A

where F is the maximum axial swelling force recorded and A is the cross sectional area of the specimen (ISRM, 1979 (1977)).

## Swelling pressure at constant volume

Sample: AD-02 BOX 12

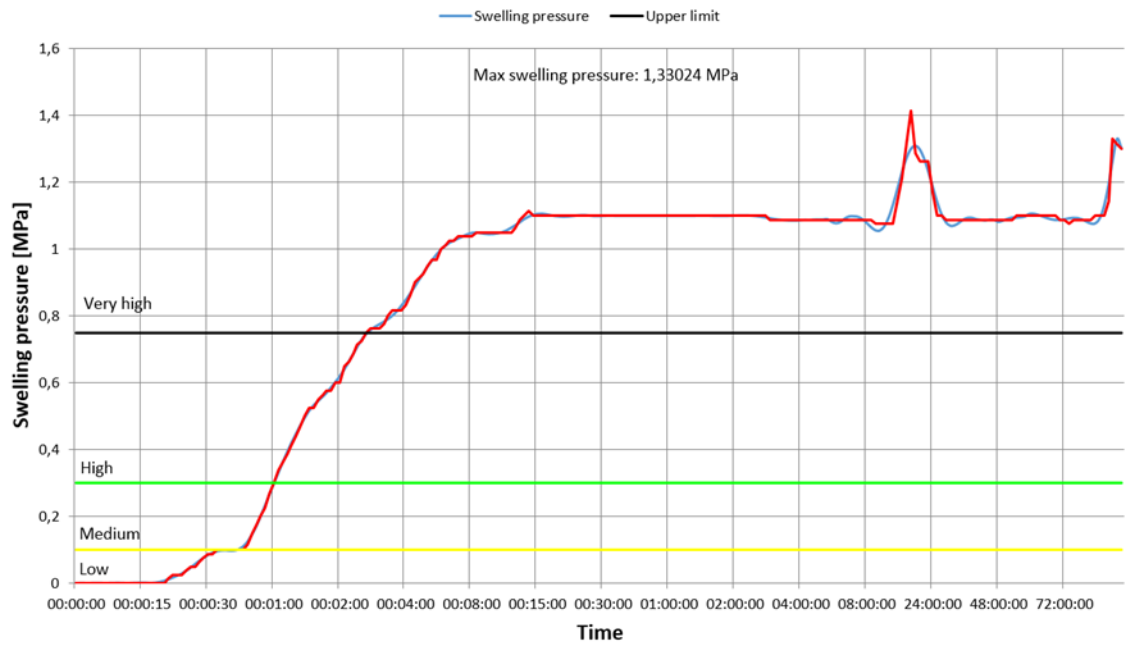

## Swelling pressure at constant volume

Sample: AD-06 BOX 25

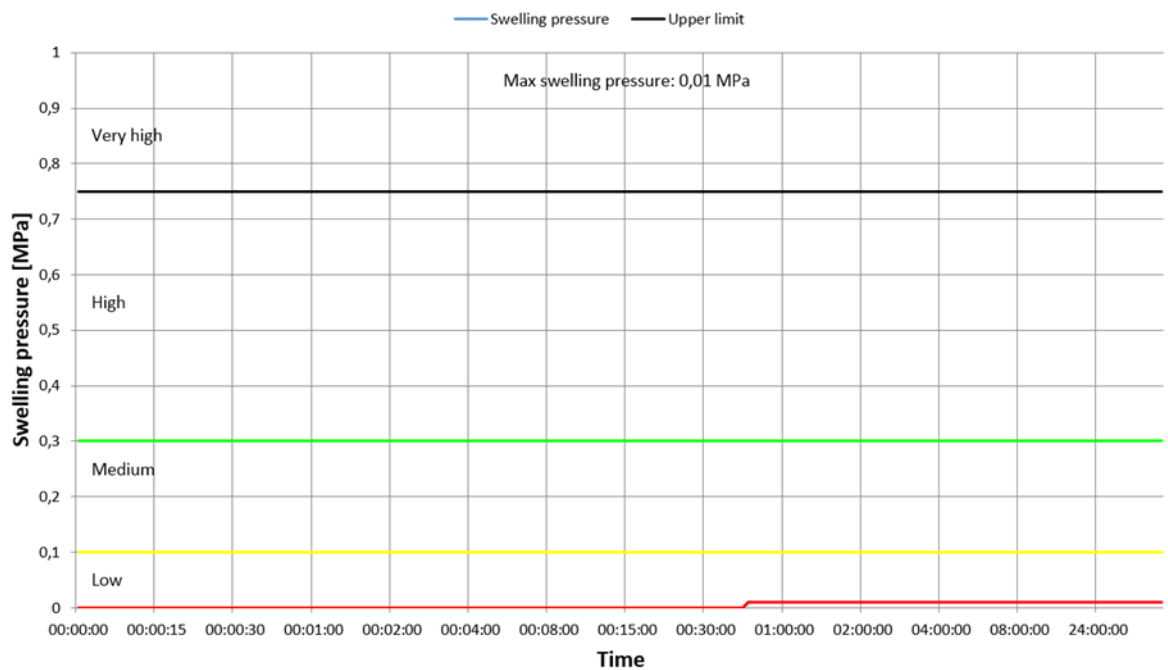

# Swelling pressure at constant volume

Sample: AD-07 BOX 12

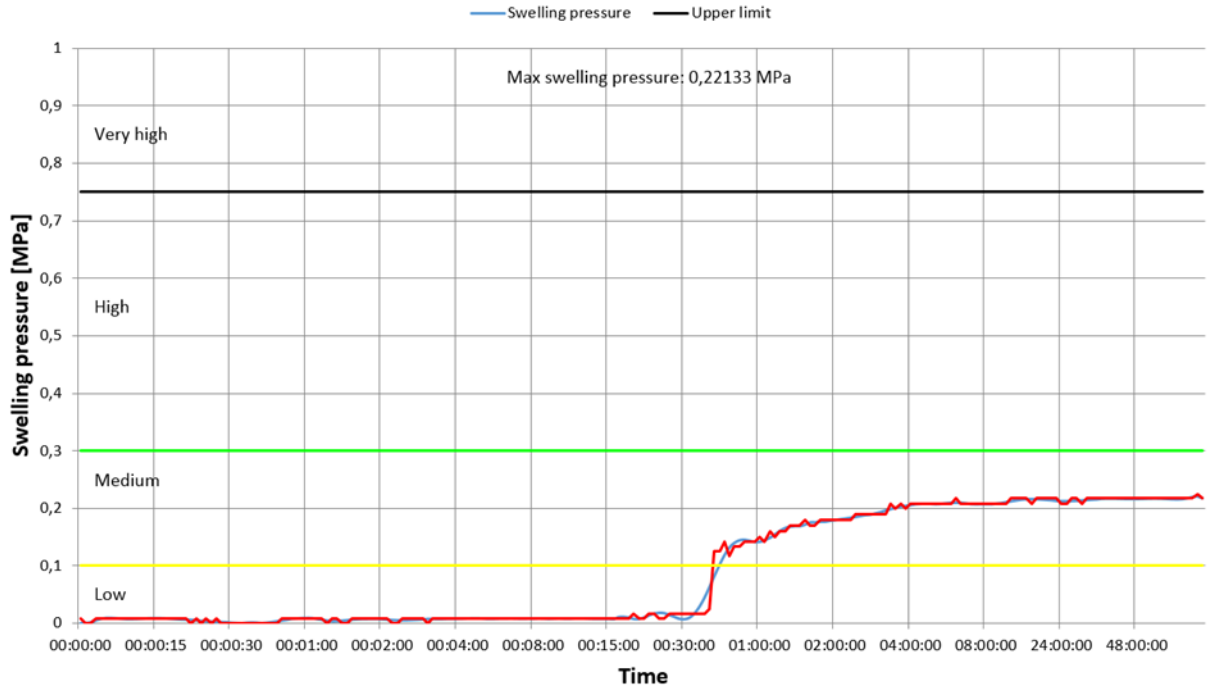

# Swelling pressure at constant volume

Sample: AQD-02 BOX 12

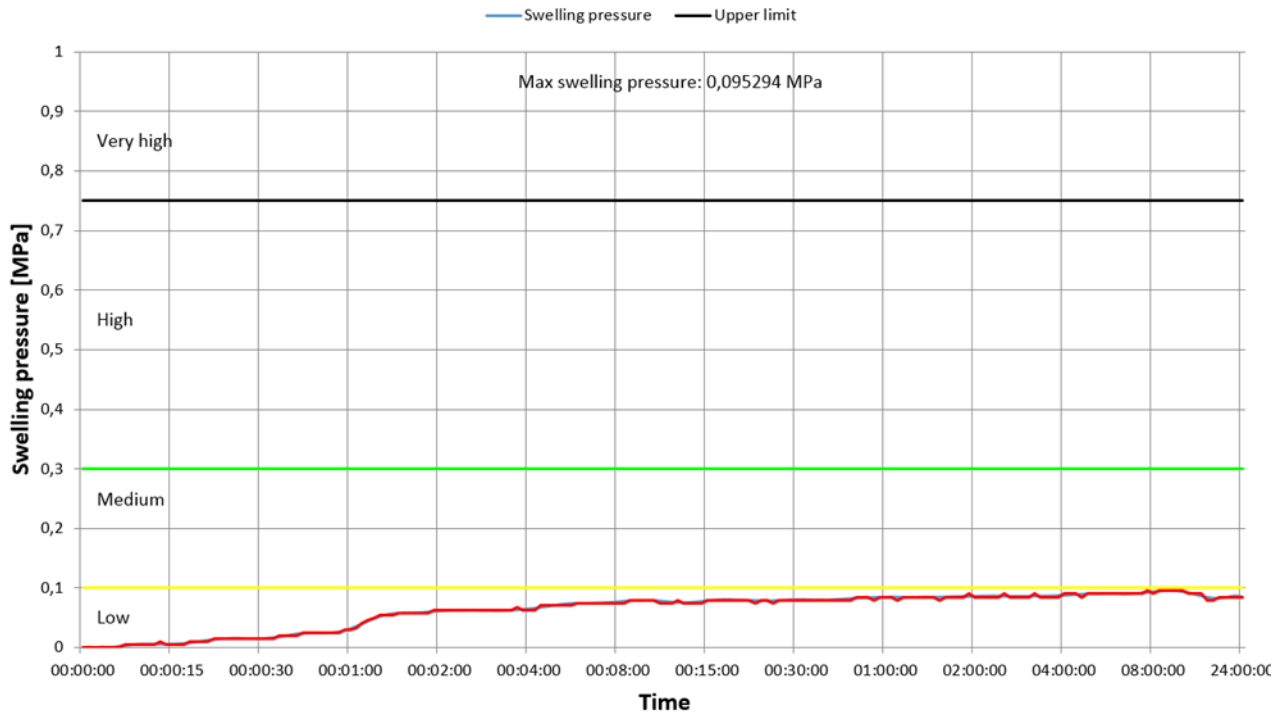

# Swelling pressure at constant volume

Sample: AQD-02 BOX 6

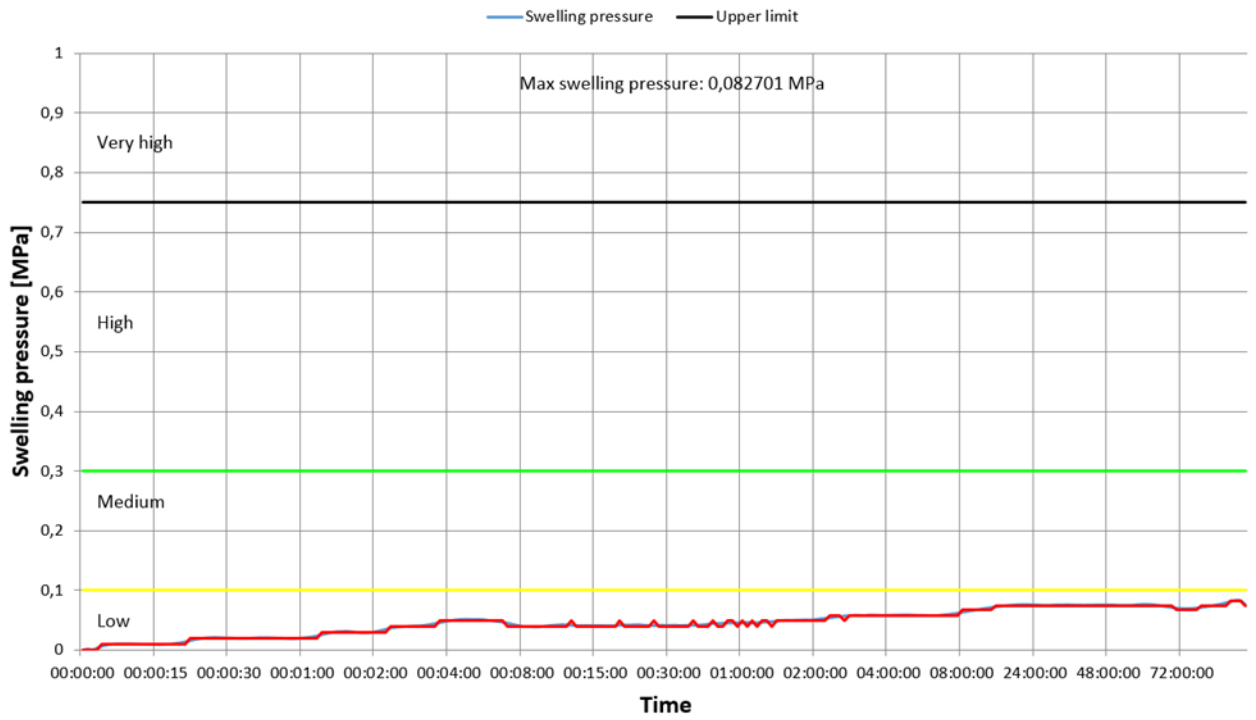

# Swelling pressure at constant volume

Sample: APH-02 BOX 18

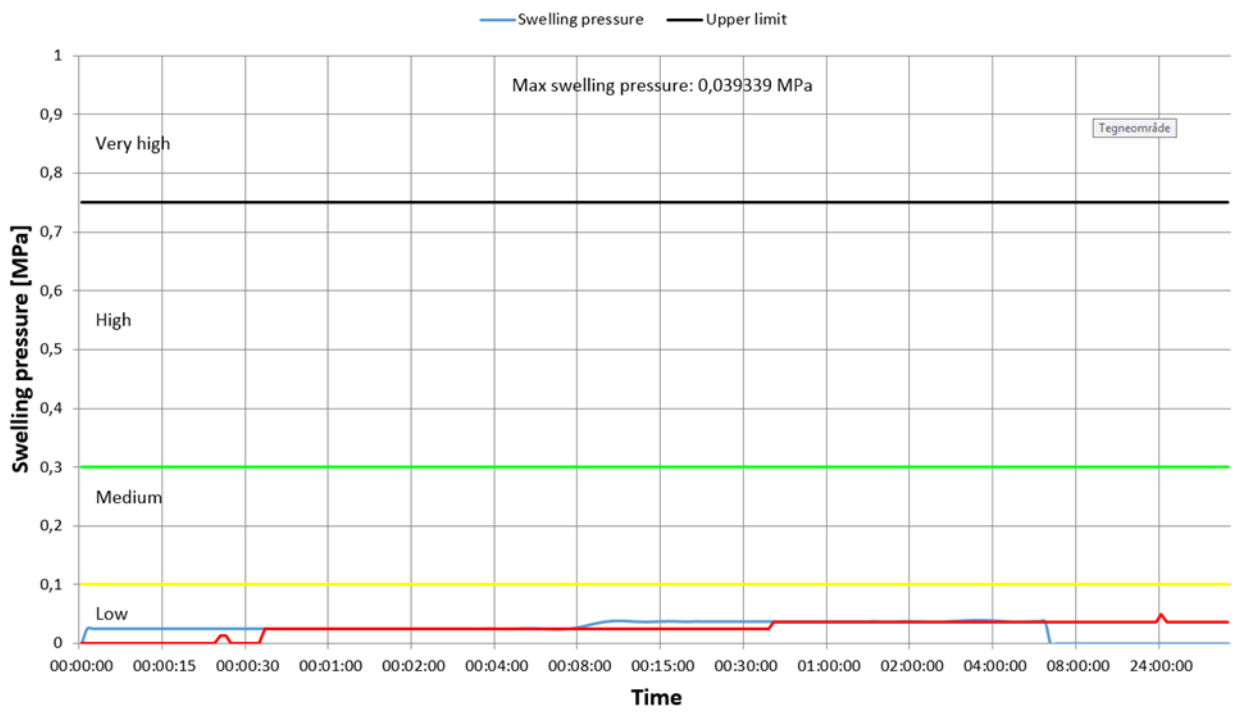

## DATA AND GRAPHS KiT

The intact rock structure tests are performed as cyclic tests. Blue line corresponds to the right axis, showing the strain/deformation allowed in the cycles. Red line corresponds to the left axis, showing the maximum stress/swelling pressure in the cycles. The bottom axis shows the number of cycles, where the swelling pressure (red dot) and deformation allowed (blue triangle) can be read vertically.

9 AD-02 box12		
Zyklusnummer	Quelldruck	Axialdehnung
	$\sigma_q$	$\epsilon_a$
	[MPa]	[cm/m]
1	2,077	0,000
2	1,679	0,000
3	1,578	0,000
4	1,741	0,000
5	1,911	0,000
6	1,845	0,000
7	0,613	0,128

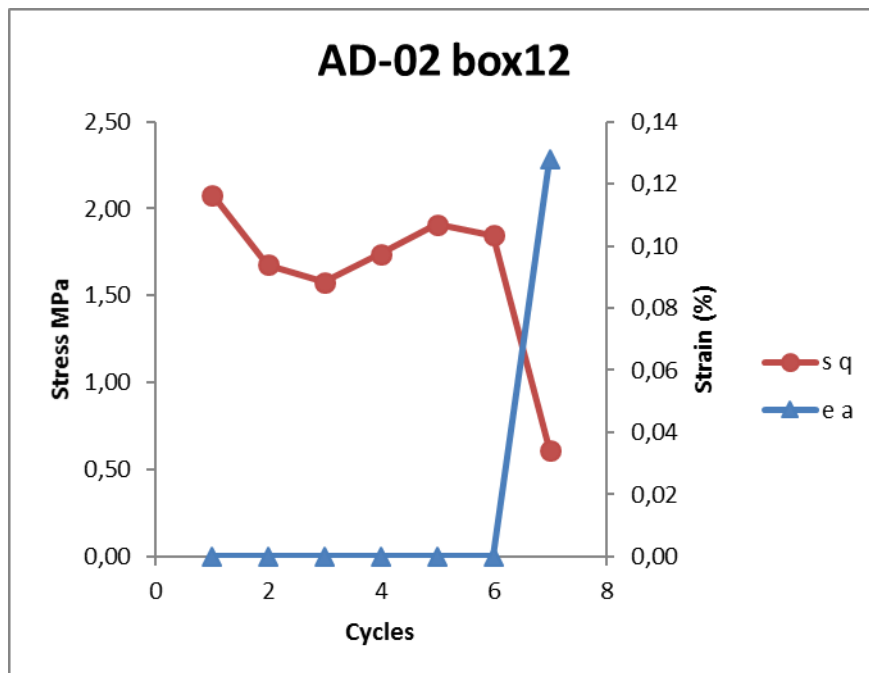

4D AD 06 box 25		
Zyklusnummer	Quelldruck	Axialdehnung
	$\sigma_q$	$\epsilon_a$
	[MPa]	[cm/m]
1	0,049	0,000
2	0,042	0,000
3	0,045	0,000

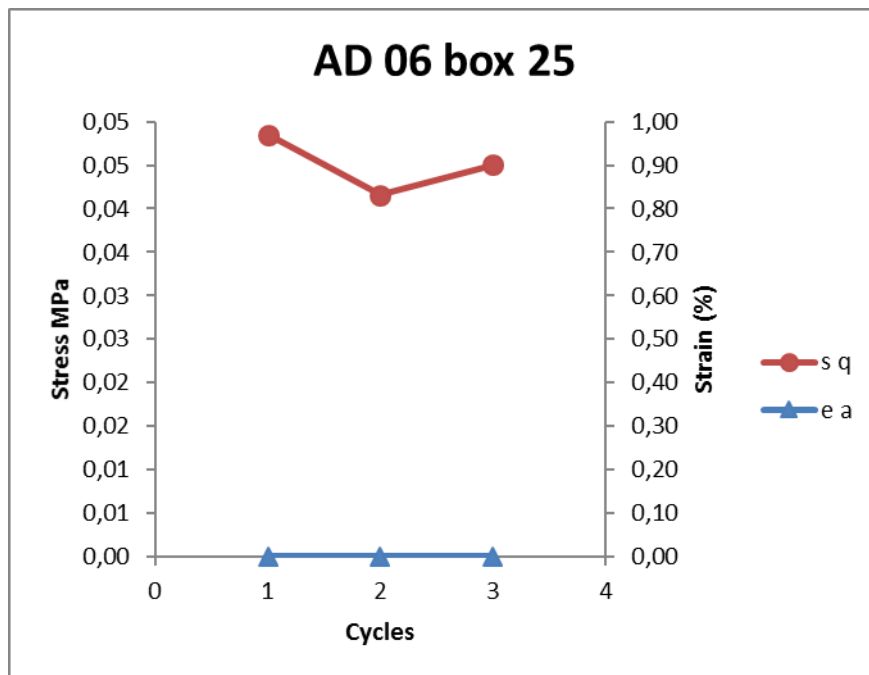



4D		AD-07 box12	
Zyklus- nummer	Quelldruck	Axial- dehnung	
	$\sigma_q$	$\epsilon_a$	
	[MPa]	[cm/m]	
1	0,128	0,000	
2	0,135	0,000	
3	0,146	0,000	
4	0,166	0,000	
5	0,177	0,000	

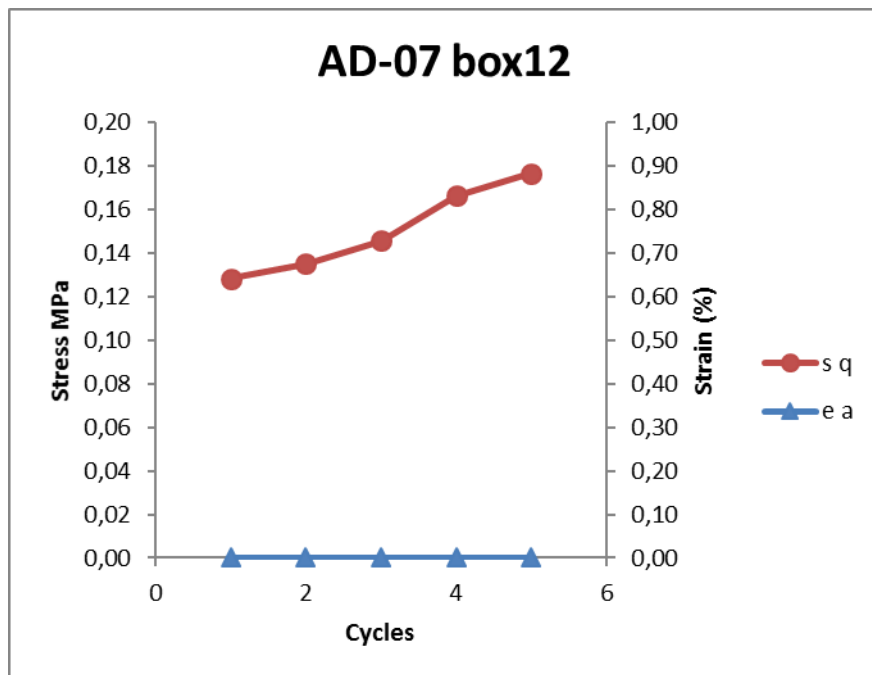

AQD-02 box 12

Zyklusnummer	Quelldruck	Axialdehnung
	$\sigma_q$	$\varepsilon_a$
	[MPa]	[cm/m]
1	0,042	0,000
2	0,042	0,000
3	0,042	0,000

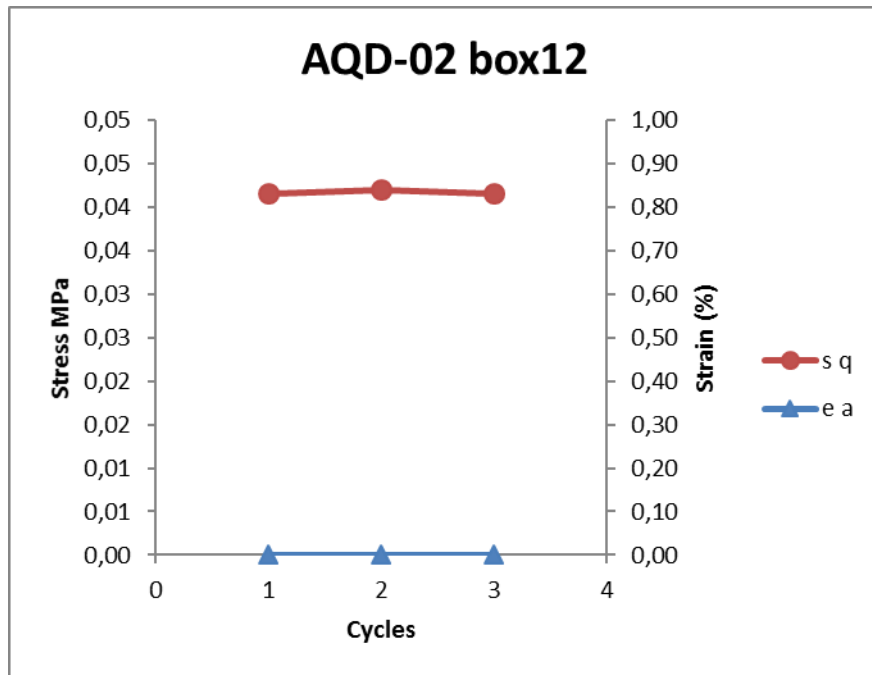

2D		AQD-02, box 5	
Zyklus- nummer	Quelldruck	Axial- dehnung	
	$\sigma_q$	$\epsilon_a$	
	[MPa]	[cm/m]	
1	0,378	0,000	
2	0,257	0,000	
3	0,253	0,000	
4	0,125	0,112	
5	0,198	0,112	

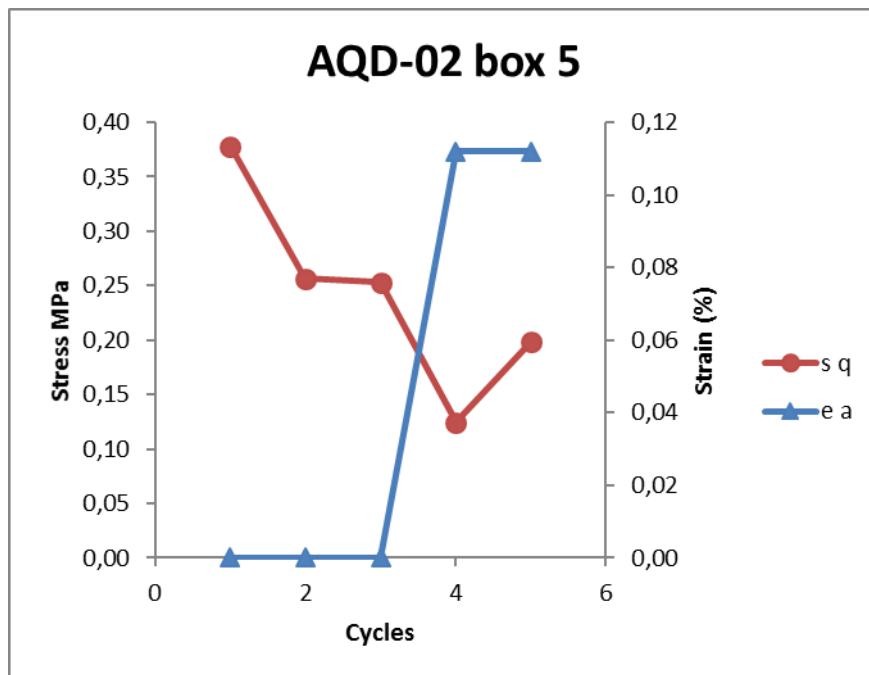

3E		AQD-02, box 6	
Zyklus- nummer	Quelldruck	Axial- dehnung	
	$\sigma_q$	$\epsilon_a$	
	[MPa]	[cm/m]	
1	0,166	0,000	
2	0,169	0,000	
3	0,176	0,000	
4	0,090	0,058	
5	0,135	0,058	
6	0,187	0,058	
7	0,183	0,058	
8	0,048	0,168	

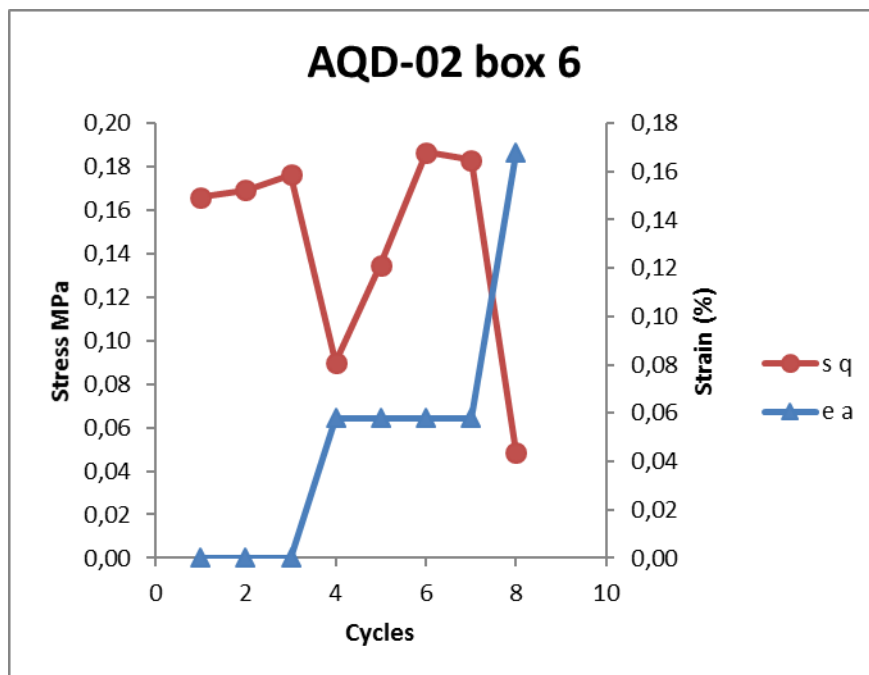

5C		APH-02, box 18	
Zyklus- nummer	Quelldruck	Axial- dehnung	
	$\sigma_q$	$\epsilon_a$	
	[MPa]	[cm/m]	
1	0,491	0,000	
2	0,481	0,000	
3	0,518	0,000	
4	0,172	0,089	
5	0,518	0,089	
6	0,477	0,089	
7	0,573	0,089	
8	0,738	0,089	

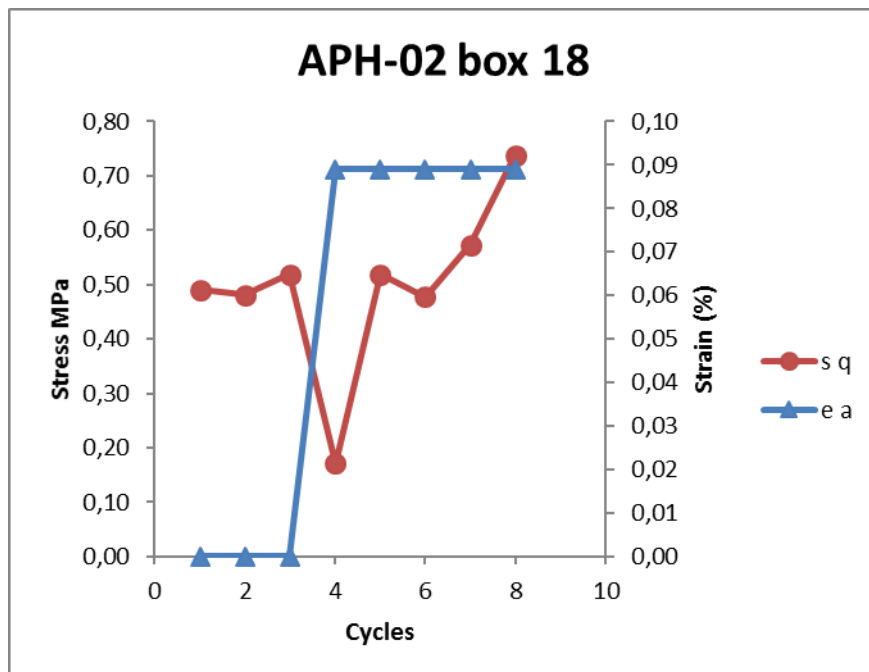

## Appendix 8.A Failure modes and classification in the UCS-test

### **Failure modes in uniaxial compression strength tests**

Mechanical failure in rocks generally means either fracturing or permanent deformation as a result of compression, and general rock failure criterion can be reduced to parameters representing lithology and uniaxial compressive strength (PetroWiki.com 2016). Failure in the uniaxial compressive strength test initiates at the boundary of an excavation when the compressive strength of the rock is exceeded by the stress induced on that boundary (Hoek et al., 2002). The failure propagates from this initiation point and eventually stabilizes when the local strength is higher than the induced stresses (Hoek et al. 2002).

Rock failure in uniaxial compression occurs in two modes, shown in Figure 8.A.1 (Goel & Singh 2011);

- 1) Local axial splitting or cleavage parallel to the applied stress, and
- 2) Shear failure

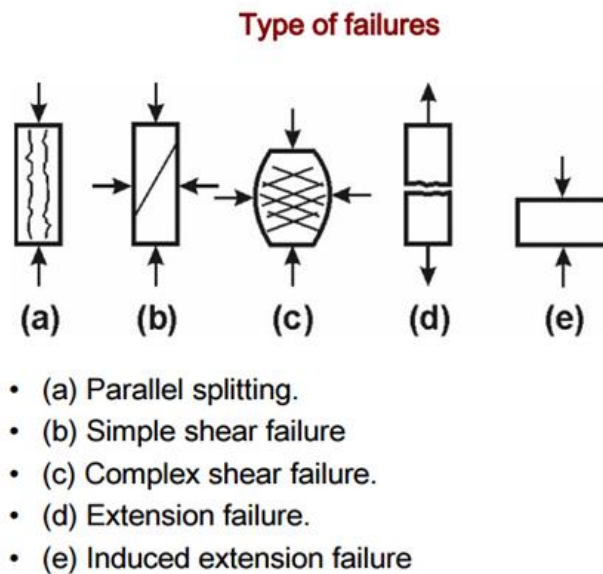

*Figure 8.A.1: Different types of rock failure (Figure obtained from lecture notes made by Krishna Panthi, NTNU)*

Local cleavage fracture characterizes fracture initiation at 50 to 95% of the compressive strength and is continuous throughout the entire loading history, while axial cleavage fracture is a local stress-relieving phenomenon that depends on the strength anisotropy, brittleness and grain size characteristics of the rock (Goel & Singh 2011). In this mode the planes of failure propagate the length of the sample.

Shear failure appear in the development of boundary faults which are followed by interior fractures oriented approximately 30 degrees to the sample axis (Goel & Singh 2011). Simple shear is described as failure along one or more planes parallel to each other situated angled to the direction of maximum compression (Szwedzicki 2007). When fracturing takes place along two or more planes situated angled to the direction of compression without being parallel to each other, the mode is called multiple shear. Multiple fracturing is often related to disintegration of the samples along many planes in random directions or due to initial microfractures in the rock structure.

The stress situation and thus the failure modes of naturally occurring rocks is dependent on factors which in many cases are unknown, such as forming processes, geological

environment, weathering, and spatial lithological differences. Because of the highly inherent variability it is difficult to obtain sufficient numbers of field specimens with uniform properties (Kuo et al. 2004).

### **The importance of loading rate and moisture content**

Loading rate is an important factor in the UCS of rocks; brittle rocks typically exhibit a pseudo-viscous effect which is reflected in a strength increase with increasing strain rate (Moore & Lockner 1995). According to Handy (1971), loading rate should be selected at a value which will produce failure in a test time between 2 and 15 min. ISRM (2007) suggests between 5 and 10 min or a stress rate between 0.5 and 1.0 MPa. However, Gercek (2007) has pointed out that a stress rate range of between 0.5 and 1.0 MPa produces considerably different test times for different rock types, depending in part on their brittleness. In the tests performed in this study, the decision of load rate is taken during the tests based on the development of axial and radial strain of each sample (annotated  $\epsilon_a$  or  $\epsilon_r$  respectively).

The moisture content should normally represent field conditions, but this is difficult to achieve if the tests are not carried out immediately after extraction. If data and measurements on in-situ moisture content is available, the field conditions may be obtained in the laboratory. However, re-saturation of dry samples is followed by great uncertainty if the porosity and permeability of the rock is unknown, since these factors influence how much time is needed to insure the wanted degree of saturation. Another tangle is that the pH value of groundwater may affect the UCS in saturated conditions (Goel & Singh 2011), which is not automatically considered in the tests. However, the results make possible assumptions on how the tested rock respond on water.



## Classification of uniaxial compressive strength due to ISRM

The ISRM (1978) suggestion of a classification of rock material based on uniaxial compressive strength and simple field measurements. Table 8.A.1 show a modified version of the classification system of ISRM (1978).

*Table 8.A.1: Classification according the ISRM standard (modified version of ISRM/Barton 1978)*

<b>Grade</b>	<b>Approx. range of UCS-values (MPa)</b>	<b>Classification</b>	<b>Rock examples</b>
<b>R0</b>	0.25 – 1.0	<i>Extremely weak rock</i>	Stiff fault gouge
<b>R1</b>	1.0 – 5.0	<i>Weak rock</i>	Highly weathered or altered rock
<b>R2</b>	5.0 – 25	<i>Weak rock</i>	Chalk, rocksalt, potash
<b>R3</b>	25 – 50	<i>Medium strong rock</i>	Claystone, coal, concrete, schist, shale, siltstone
<b>R4</b>	50 – 100	<i>Strong rock</i>	Limestone, marble, phyllite, sandstone, schist, shale
<b>R5</b>	100– 250	<i>Very strong rock</i>	Amphibolite, sandstone, basalt, gabbro, gneiss, granodiorite, limestone, marble, rhyolite, tuff
<b>R6</b>	> 250	<i>Extremely strong rock</i>	Fresh basalt, chert, diabase, gneiss, granite, quartzite

# Appendix 9 Comparison of apparatus set-up, procedures and results (NTNU and KiT)

## Part 1: Comparison of apparatus set-up and procedures

### APPARATUS CONFIGURATION

A comparison of the apparatus configurations is shown in Table 9.A.1.

Table 9.A.1: Complete overview of differences in apparatus configuration

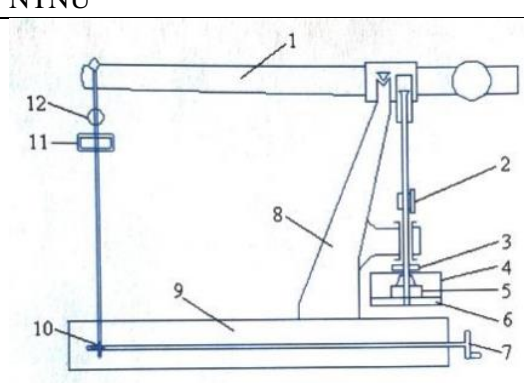
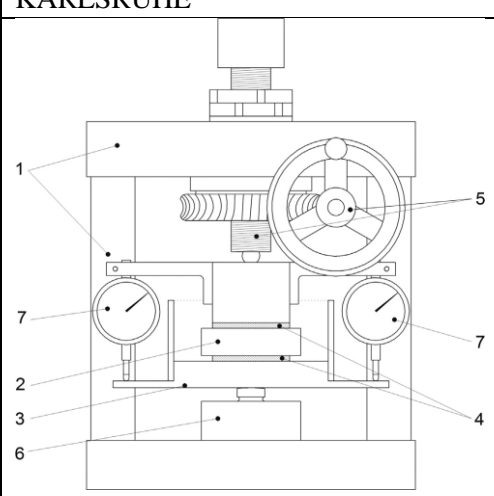
	NTNU	KARLSRUHE
Illustrative configuration	 <ol style="list-style-type: none"> <li>1) Balance lever, with the ratio of 1:10</li> <li>2) Dial gauge with a sensitivity of 0.001 mm to measure the height (volume) of the specimen</li> <li>3) Adjustment screw</li> <li>4) Container</li> <li>5) Cylindrical test cell</li> <li>6) Steel base plate of the container</li> <li>7) Wheel</li> <li>8) Frame</li> <li>9) Base</li> <li>10) Worm gear</li> <li>11) Pressure ring</li> <li>12) Dial gauge with a sensitivity equivalent to 0.05tons/m<sup>2</sup> to measure the pressure.</li> </ol>	 <ol style="list-style-type: none"> <li>1) rigid frame</li> <li>2) ring with rock specimen</li> <li>3) watering cell</li> <li>4) porous metal plates</li> <li>5) spindle</li> <li>6) load cell</li> <li>7) dial gauges</li> </ol>

Control of apparatus stiffness and deformation potential.	Not known.	Yes, recently checked.
Corrections due to deformation of the porous plates	No.	Yes.
Placement of dial gauges	<ul style="list-style-type: none"> <li>- One dial gauge placed about 20 cm above the specimen.</li> <li>- Limited correction of the deformation of apparatus components between the dial gauge and specimen during the tests.</li> </ul>	<ul style="list-style-type: none"> <li>- Two dial gauges placed at opposite diameter ends of the loading plate.</li> <li>- Deformation of apparatus is avoided by the abutting of dial gauges and sample, and by manually corrections during the tests.</li> </ul>
Administration during tests	<ul style="list-style-type: none"> <li>- Automatic volume control.</li> <li>- Automatic recording of swelling displacement and pressure.</li> </ul>	<ul style="list-style-type: none"> <li>- Manual volume control by reading the dial gauges and manually increase/decrease the load.</li> <li>- Manual recording of swelling displacement and pressure.</li> </ul>

## TEST PREPARATION PROCEDURES

### POWDER SAMPLES

Differences in powder sample preparation are shown in Table 9.A.2.

*Table 9.A.2: Differences in powder sample preparation*

	NTNU	KiT
<b>Powder mass</b>	20 g	100 g
<b>Sample diameter</b>	20 mm	60-61 mm
<b>Sample height/thickness</b>	Not measured	17-19 mm
<b>Sample density</b>	Not measured	~2.00 g/cm <sup>3</sup>
<b>Compaction load</b>	None	200-300 Kn
<b>Compaction duration</b>	None	45 minutes
<b>Pre-load</b>	2 MPa	0.1 Kn
<b>Pre-loading duration</b>	24 hours	None
<b>Unloading duration</b>	2 hours	None

## INTACT ROCK STRUCTURE SPECIMEN (DISCS)

Differences in intact rock structure specimen preparation are shown in Table 9.A.3.

*Table 9.A.3: Differences in intact rock structure specimen preparation*

	<b>NTNU</b>	<b>KiT</b>
<b>Method of sample preparation</b>	Over-coring (drilling). Need for corrections of samples by use of epoxy.	Preparing by use of a lathe. No need of corrections of samples.
<b>Fitness of specimen to ring</b>	Specimen adjusted to ring.	Ring adjusted to specimen.
<b>Mass of disc (dry)</b>	Not measured	~135 g
<b>Disc diameter</b>	~35.7 mm	60-61 mm
<b>Disc height</b>	~5.0 mm	18-19 mm
<b>Pre-load</b>	2 MPa	0.1 kN
<b>Pre-loading duration</b>	24 hours	None
<b>Unloading duration</b>	2 hours	None

## TEST PROCEDURE AND CONDITIONS OF TESTING

The differences in procedure and conditions of testing are shown in Table 9.A.4.

*Table 9.A.4: Differences in procedure and condition of testing*

	NTNU	KiT
<b>Acclimatized test room</b>	No	Yes (20 degrees, air-humidity 45%)
<b>Deformation/volume control during swelling</b>	Automatic continuous adjustment.	Manually adjustment in intervals from 1 min until several hours, regarding on swelling pressure development and day/night time.
<b>Duration of wetting/swelling</b>	24 hours	Days or weeks depending on the swelling pressure development
<b>Determination of adsorbed water during tests</b>	None	Yes, by weighing the samples before and after tests

Part 2: Comparison of the results

A comparison of the results on powder samples and intact rock structure is shown in Figure 9.A.1.

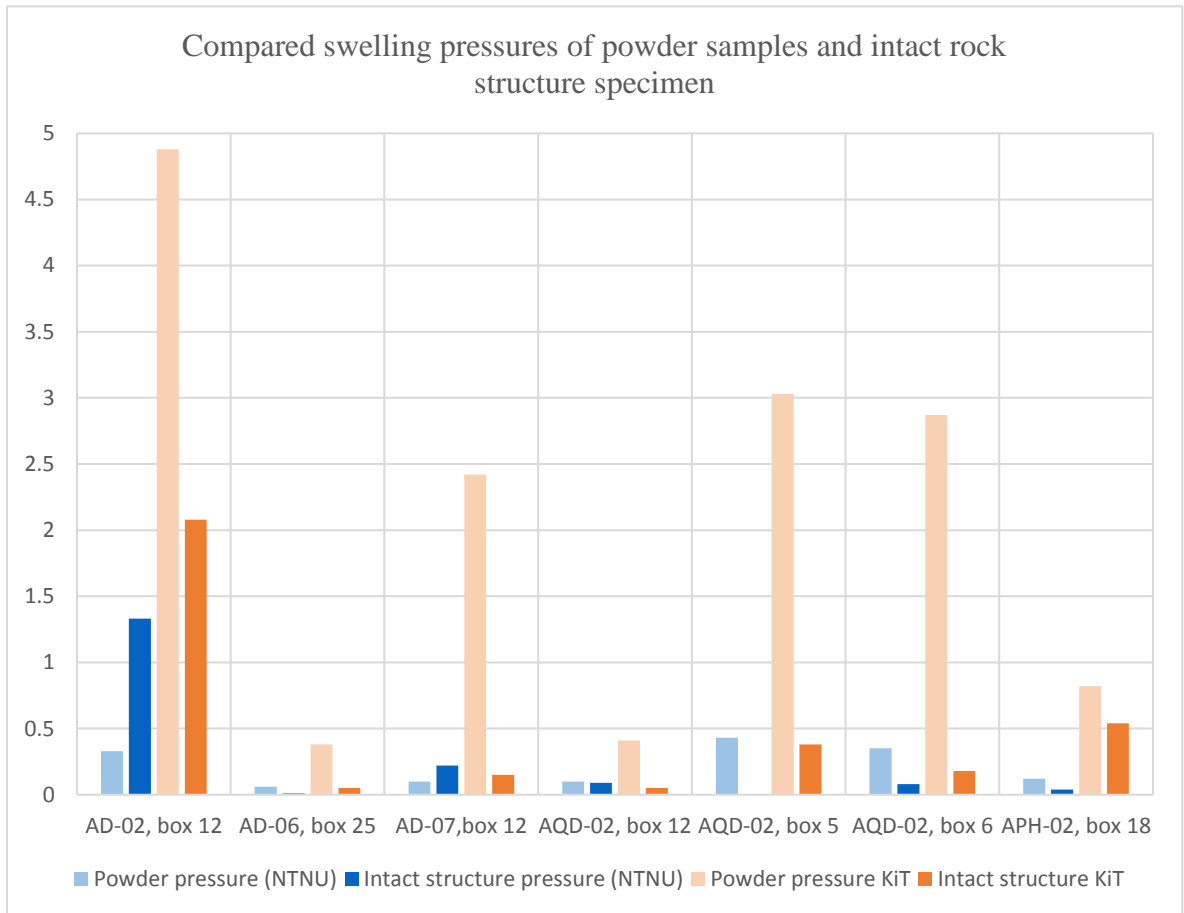

*Figure 9.A.1: Comparison of oedometric swelling pressure results (NTNU/KiT)*

A comparison of the intact rock structure specimen is given in Table 9.A.5.

Table 9.A.5: The results of cyclic swelling pressure tests, showing the maximum swelling pressure obtained in each cycle.

Disc tests	NTNU	KARLSRUHE							
	Only cycle	1.cycle	2. cycle	3. cycle	4. cycle	5. cycle	6.cycle	7. cycle	8. cycle
<b>AD-02, box 12</b>	1.33	<b>2.08</b>	1.68	1.58	1.74	1.91	1.85	0.61*	-
<b>AD-06, box 25</b>	0.01	<b>0.05</b>	0.04	<b>0.05</b>	-	-	-	-	-
<b>AD-07, box 12</b>	0.22	0.13	0.14	0.15	0.17	<b>0.18</b>	-	-	-
<b>AQD-02, box 12</b>	0.09	0.04	0.04	0.04	-	-	-	-	-
<b>AQD-02, box 5</b>	-	<b>0.38</b>	0.26	0.25	0.13*	0.20*	-	-	-
<b>AQD-02, box 6</b>	0.08	0.17	0.17	0.18	0.09*	0.14*	<b>0.19*</b>	0.18*	0.05*
<b>APH-02, box 18</b>	0.04	0.49	0.48	0.52	0.17*	0.52*	0.48*	0.57*	<b>0.74*</b>

\* = Controlled deformation is allowed by reducing the load acting on the specimen.

### The development of swelling pressures in AD-02 (box 12)

#### – intact rock structure specimen

The figures 9.A.2.A and 9.A.2.B show the development of swelling pressure in AD-02 (box 12) under different testing conditions. The blue line represents the swelling rate when the tests are prepared and performed by the NTNU standard, and the orange line represent the corresponding conditions at KiT.

Figure 9.A.2.A show the entire development the first 24 hours of the test. Figure 9.A.2.B show the first 37 min of the test, where the differences in swelling rate become clearer.



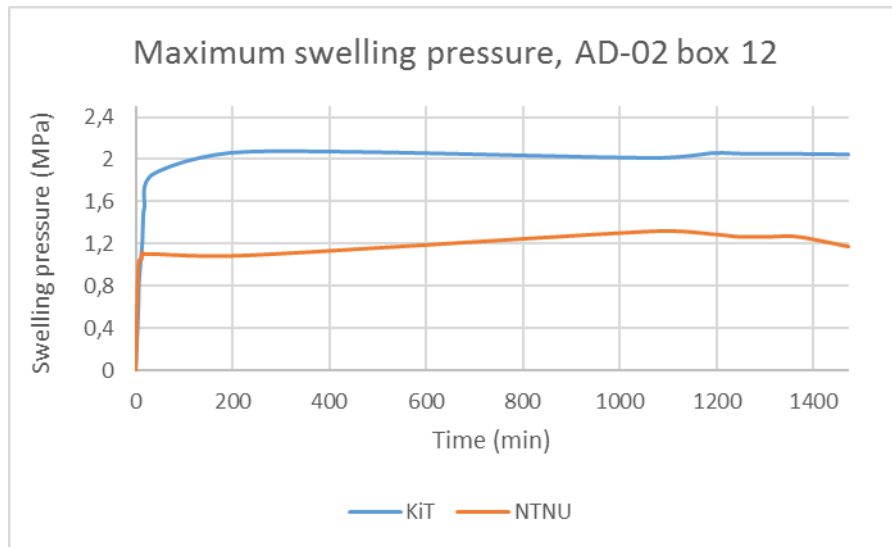

A)

Figure 9.A.2.A: The development of swelling pressure in AD-02 (box 12) in 24 hours

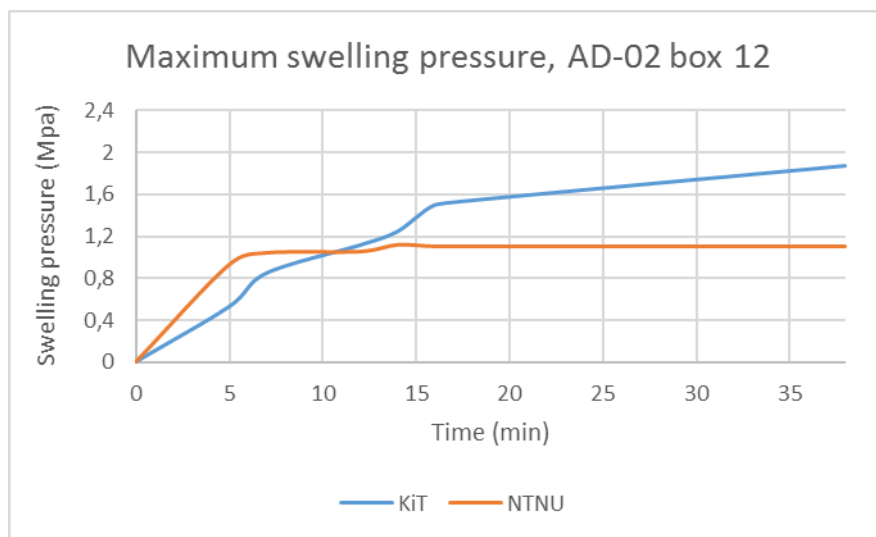

B)

Figure 9.A.2.B: The development of swelling pressure in AD-02 (box 12) the first 49 minutes of the test.

As can be seen from the above figures, the swelling pressure rate is more rapid in the start of the test at NTNU, but flattens out earlier and reach a steady state before a slow increase happen after about 5-6 hours (300 min) until maximum is reached after about 19 hours (1150 min). At KiT the swelling pressure is more evenly increasing from start to the reach of maximum (after approximately 3-4 hours) before stabilized.

Appendix 10 Sample of special interest: Andesitic rock  
with a high laumontite content

**AD-02 (box 12)**

Some of the samples show results which indicate alternative swelling mechanisms compared to the traditional explanations frequently presented in the literature. In the following, a summary of the characteristics of sample AD-02 (box 12) are presented.



*Figure 10.A.1: Sample AD-02 (box 12)*

## **Mineralogical characteristics**

The main minerals constituting samples of AD-02 (box 12) according to the first XRD-analysis performed, are laumontite (56%), clinopyroxene (15 %), quartz (11 %) and plagioclase (10 %). The sample show agglomeration of “white dots” distributed evenly throughout the rock matrix, assumed to be laumontite minerals filling pore cavities or to be replacements of plagioclase minerals. Sporadically occurring and narrow white “stripes” are also present, which may be laumontite minerals precipitated in micro-cracks.

Laumontite is a member of the zeolite group, and is typically associated with albite, calcite, chlorite, quartz, and clay minerals in zeolite facies assemblages, which occur in many areas of volcanogenic sediment accumulation (Association 2008). Assuming that zeolites in general are secondary minerals, the percentage of laumontite is suspicious. However, additional XRD-analyses show approximately the same result, thus there exists no indication of the laumontite measurements to be misleading.

One possible explanation for the high laumontite content is that the rocks have undergone alteration processes, resulting in replacement of plagioclase by laumontite. Andesitic rocks are high in silicate minerals, and plagioclase is vulnerable to both weathering and alteration. Another explanation could be that laumontite precipitated in the gas cavities due to high initial porosity and percolating of hydrothermal fluids through the rock after formation, a process which may have a spatial variation within short distances of the rock mass.

The DTA of the sample was primarily performed to detect swelling clay minerals, but did not show the typical endothermic peaks as of montmorillonite (normally occurring at 100-250 °C). The diagram in Figure 10.A.2 show that several thermal reactions find place during the heating of the sample powder, but the peak occurring in the “clay window” are much more diffuse than what is expected when swelling clay minerals are present. However, the existence of small amounts of montmorillonite cannot be absolutely declined based on the analysis.

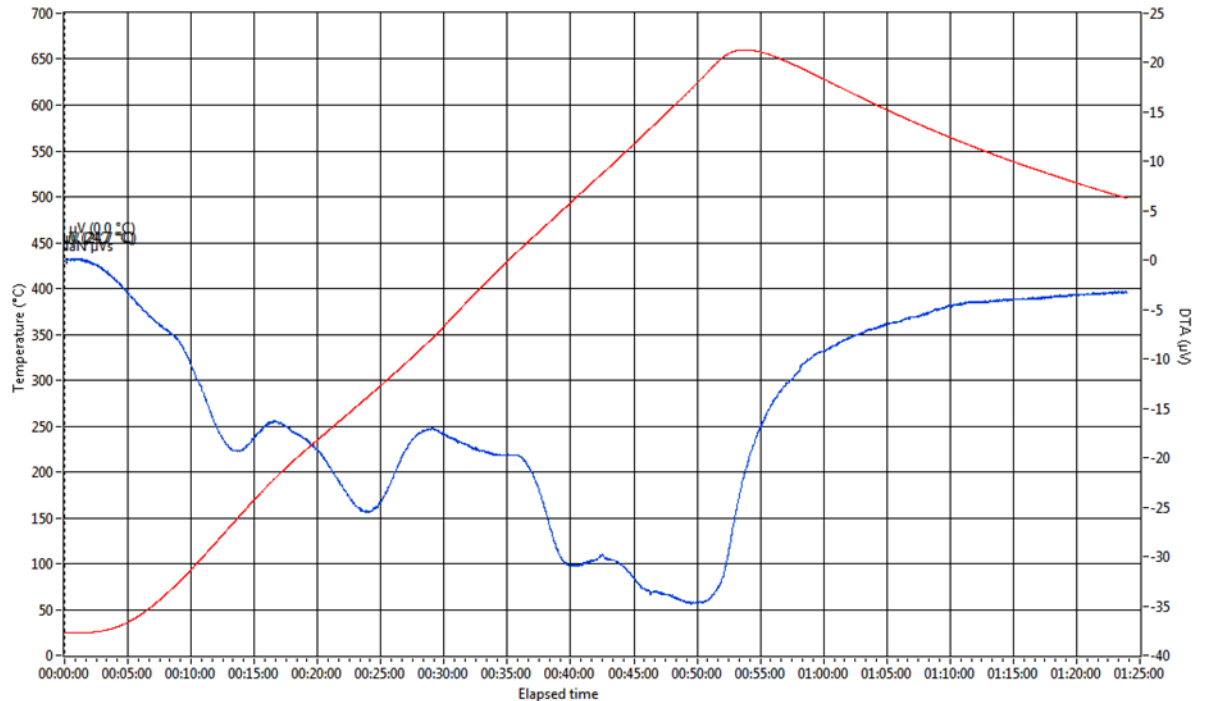

*Figure 10.A.2: Review of DTA on AD-02 (box 12)*

### **Strength characteristics**

The dry sample of AD-02 (box 12) show a high uniaxial compressive strength, measured to be 112,5 MPa. The development of the axial strain is slow and follow an exponential formed curve before failure occur (Figure 10.A.3.a). The reason for this may be a high initial porosity of the rock, where the pores are gradually squeezed and closed during loading. Another possible explanation is existence of several micro-cracks and/or fissures in the rock which are closed during loading, or a combination of both mechanisms working together. Thus, the realistic strength of the rock material appear first after all the pores and/or fissures are closed and the load work directly on the rock structure. The failure mode of multiple fracturing and disintegration may be due to propagating micro-cracks oriented in different directions within the rock.

The uniaxial compressive strength for the wetted sample show a remarkable lower value, measured to be 21.9 MPa. However, the axial strain follows much the same pattern as of the dry sample, and the failure occur in two stages before the final compressive strength is reached (Figure 10.A.3.b). The failure mode is of simple shear,

which may be explained by an invisible (by eye) weakness plane in the sample, which in case also may be the reason why failure happen at a much earlier stage. Swelling of laumontite previous to the test may have contributed to a general degradation of the strength, but to evidence this hypothesis, more samples need to be tested and compared.

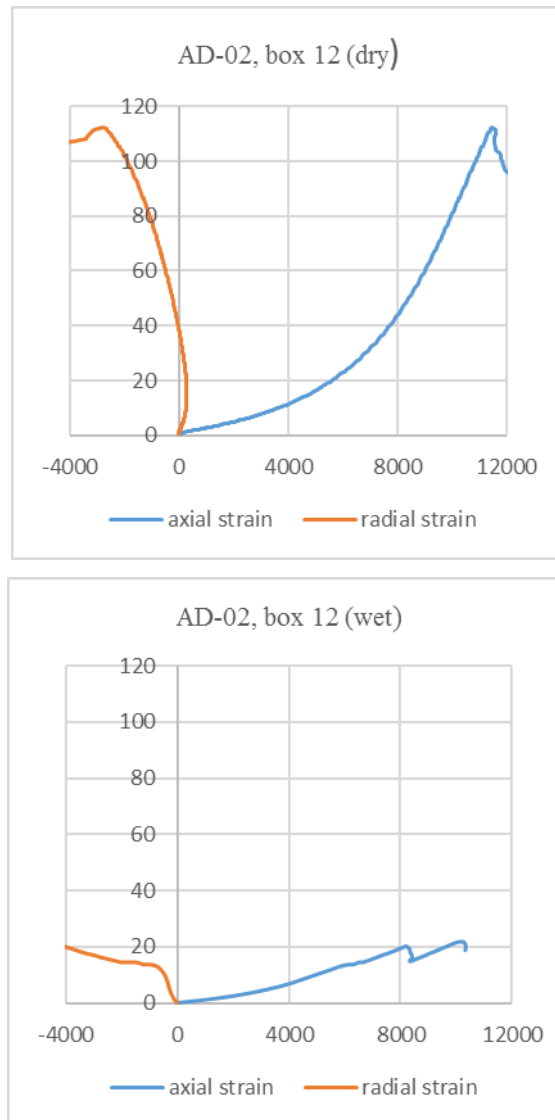

*Figure 10.A.3 (dry and wet): The development of radial and axial strain in the UCS-tests of AD-02 (box 12). The vertical axis shows the stress given in MPa.*

### **Swelling characteristics**

AD-02 box 12 show a surprisingly high swelling pressure with a maximum value of 2,08 MPa (measured at KiT) and 1,33 MPa (measured at NTNU), which is a swelling

magnitude associated with high content of swelling clay minerals in the rock. Since the XRD-analysis of the sample show no swelling clay minerals, the traditional and expected explanation was conquered and a new main hypothesis grounded in the high laumontite content (56%) was created.

When swelling occur in igneous rocks as basalt and andesite, the expansion of swelling clay minerals and active zeolites, as laumontite, are the most frequent mechanisms. As previously mentioned, moisture expansion of rocks with high porosity may also be a possible explanation for swelling of rocks, especially in cases where no swelling clay is detected. These types of swelling may happen within the rock mass, in contrast to the swelling gouge fillings in faults and cracks as typical for Norwegian geological environments. As soon as the rock are exposed to moisture change, the swelling potential will be activated and swelling pressure develops if volume change is constrained. In case of AD-02 box 12, swelling clay is eliminated as a possible cause, thus the high swelling pressures must have another explanation. The high laumontite-content is a likely cause since laumontite hydrates in contact with water and expands without damaging the crystal structure (Marosvolgyi 2010). This permits the rock to adapt both drying and wetting cycles without losing the swelling potential. However, if the quantity of active minerals is high enough and the material strength is degraded during the wetting-swelling phase, fissuring and/or crazing may occur and an increase of the rock porosity may result in further swelling and/or disintegration (Sumner et al. 2009). The eventual increase in porosity may also permit moisture expansion to contribute to a lower durability and strength of the rock after swelling has occurred, especially if the rock is allowed to deform, as normally is the case in tunnels.

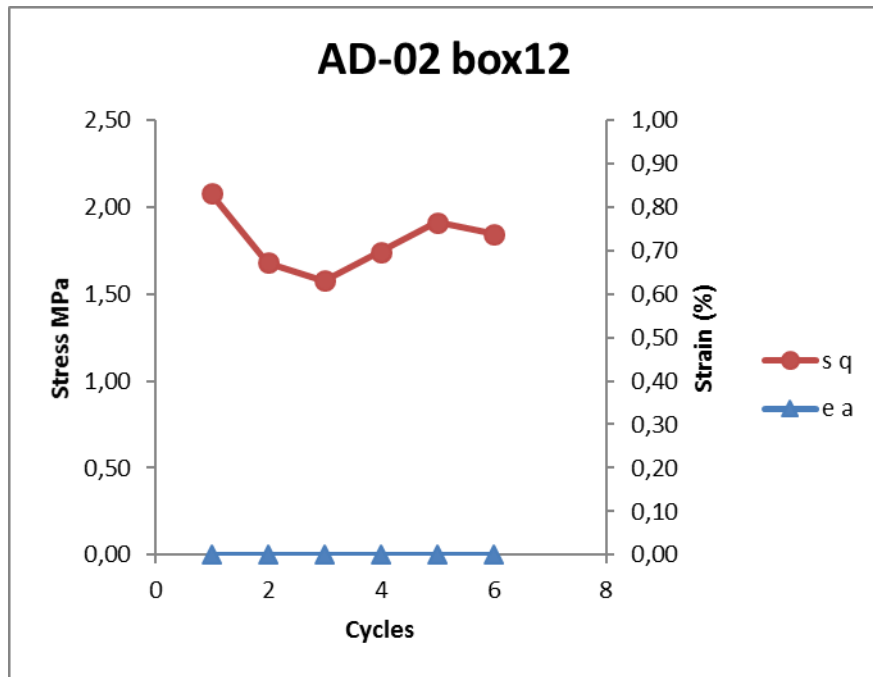

Figure 10.A.4: Review of the cyclic test behavior of AD-02 (box 12)

## Appendix 11.A      Uncertainties in laboratory work for in-situ considerations

### **GENERAL UNCERTAINTIES IN LABORATORY WORK**

There are some more or less obvious limitations for laboratory tests, and it is important to keep in mind these drawbacks when considering the design of the construction and need for rock support. Advanced constitutive modelling and careful back-analysis of laboratory tests can be used to determine the behavior of “ideal” specimens (see Rocchi et al. 2013), but will not be further reviewed in this thesis.

#### **Sample disturbances**

In the preliminary phase of a project the samples available are usually obtained from borehole cores, and thus sample disturbances from the drilling process will influence the properties measured. The disturbances may include damage to the microstructure, changes in effective stress compared to geostatic conditions and decrease of the degree of saturation (Rocchi et al. 2013). These processes start during drilling and continue during extraction of the samples, transport to laboratory, storage, specimen preparation and assembly in the testing apparatus (Rocchi et al. 2013). The magnitude of disturbance will depend on the characteristics and sensitivity of the material, but may alter the behavior of “nominally undisturbed” specimens from that of “ideal” specimens, and thus also influence the laboratory test results (Rocchi et al. 2013). It is an unavoidable fact that undisturbed samples are difficult to assess, and thus the results may to some degree be misleading if the purpose is to identify the undisturbed conditions in-situ.

Usually swelling rocks are very sensitive to changes in water content and stress rate (Hawkins & McConnel 1992). Depending on the standardization used, the preparation may involve exposure to temperature, air, humidity, structural entanglements or decomposition, tension release, loads and other types of stress during the procedure. A solution for this chosen by some researchers, is to consequently disturb all the samples completely by drying and grinding them, with the intention to create similar conditions before testing. This may produce a fundament for comparison of different samples, but



will in most cases counteract the direct comparability to in situ conditions even further. In addition to the nature of the problems relating to comparability of samples and in-situ rock, different institutes embrace different preparation procedures, for example different grain sizes of the pulverized samples, which impede the correlation of test results in projects with similar issues and objectives.

### **State of stress**

The state of stress in an underground excavation will depend on complex factors including the overburden, horizontal stresses, discontinuities in the rock mass, tectonics, elastic properties of the rock material in addition to the general material properties discussed earlier (Stille & Palmström 2008). These stresses are difficult to simulate and transform to laboratory scale, and in many cases in-situ stress measurements are not performed prior to investigations of swelling behavior, or at all. In oedometric swelling tests, the axial and radial restraint and the deformation of specimen due to swelling affect the maximum swelling stress induced and measured. Some researchers have tried to assume the in-situ stress situation for implementation in swelling tests under conditions of constant load, but these assumptions are very controversial. The stress-situation surrounding an excavation will not only depend on the fore-mentioned factors, but also be affected of the methods of excavation, the shape of the cavity, the distance of cavity from weakness-zones or other discontinuities, and more on (Stille & Palmström 2008).

The oedometric tests under conditions of zero volume change can be argued the best way of simulating the “worst case” swelling pressure induced by a piece of rock of immediate vicinity from the floor of a cavity when exposed to water, since the rock is naturally radially constrained by its rock surroundings and the axial swelling pressure is the main concern regarding the dimensioning of support. However, there are many ways of turning this argument around, and neither method will perfectly reflect an in-situ state of stress.

### **Volume**

The volume of laboratory specimens are many times smaller than the rock mass to be considered, which is naturally since the size of samples are dimensioned for the test

apparatus. The properties of a rock mass generally depend on factors which is impossible to directly incorporate by examining the properties of a small sample.

The deformation and strength properties of rock cores measured in the laboratory usually do not precisely reflect in situ properties of large scales, since the latter are strongly influenced by joints, faults, inhomogeneity, weakness planes, states of stress and other factors (Handy 1971). The correlation between sample size upon rock strength has been thoroughly discussed in geotechnical literature and it is generally assumed that there is a significant reduction in strength with increasing sample size (Hoek & Brown 1997). Therefore, laboratory strength values for intact specimens must be employed with proper judgement in engineering applications.

In case of the investigation of swelling behavior, the use of laboratory measured swelling pressure as input parameter for modelling rock support involves critical uncertainties which should be carefully considered. For example, the hydraulics of a rock mass are of great importance when considering how much of the swelling minerals in the rock which is exposed to water. A specimen in an oedometric cell filled with water are exposed to humidity in very different manner than a corresponding piece of rock in-situ due to volume versus surface area. The degree of permeability in a rock mass will control the transport of water, and the hydraulics of a small volume of rock will not play a similar role compared to the corresponding piece of rock within a rock mass. The swelling pressure induced by the specimen under laboratory conditions will therefore not directly reflect the behavior it would have in-situ, since the degree of watering and thus the amount of swelling minerals exposed to water is unknown. The gap between the size of the sample tested and the rock mass volume under consideration, is one important factor which complicates the transformation of laboratory results to in-situ conditions.

### **Spatial and temporal variations**

A direct concern following the sample size is the character and composition of the chosen samples and to which extent these are representative for the rock mass to be evaluated. The content of swelling minerals in the rock can vary within a small distance, and the same issue applies for fissures and small discontinuities. Further, the storage

history and exposure for air, temperature and humidity are factors which may influence the characteristics of the specimen compared to its origin. To get a representative picture of the character of the rock mass of concern, many samples must be tested.

The time available to extract the desired information from the samples are in most cases restricted. The span for a sample to reach its swelling potential (swelling rate) is dependent on both the internal and external factors controlling swelling, and the conditions in-situ is hard to simulate in terms of estimating the rate at which swelling occur. Important concerns as the penetration rate of water, which changes with the permeability of the rock mass and the thickness of the swelling rock layer, usually cannot be derived from laboratory swelling tests (Schädlich et al. 2013). The rate of swelling stress is presumably essentially dependent on the penetration rate of water into the swelling rock. Thus, the water permeability of the rock has an influence on the swelling rate and thus on the swelling time parameter (Wittke-Gattermann 2003).

Another issue in this context, is the magnitude of swelling stress obtained from laboratory swelling tests compared to in-situ measurements, in projects where both kind of tests are performed. As an example; in the Gipskeuper formation which is studied by several authors, laboratory testing revealed swelling pressures up to 16 MPa while in-situ measurements showed swelling pressures which hardly exceeded 5 MPa (Schädlich et al. 2013). Similar phenomena are confirmed by Serafeimidis & Anagnostou (2013) and others.