



NTNU – Trondheim
Norwegian University of
Science and Technology

Analysis and modelling of recent large floods on the river Gaula

Ku Pak Peng Aquije Lei

Hydropower Development

Submission date: June 2015

Supervisor: Knut Alfredsen, IVM

Norwegian University of Science and Technology
Department of Hydraulic and Environmental Engineering



M.Sc. THESIS IN **HYDROPOWER DEVELOPMENT**

Candidate: Ku Pak Peng Aquije Lei

Title: Analysis and modelling of recent large floods on the river Gaula.

1 BACKGROUND

The river Gaula is an unregulated river in the Sør Trøndelag and has a history of floods and is characterized by rapid response to rainfall. It has experienced some large floods in 2009, 2010 and 2011, and particularly the 2011 flood did severe damages in the upper river and was also characterized by high intensity and very local rainfall. The purpose of this thesis is an analysis of the floods in Gaula, how do they appear and what forcing control the largest floods. A hydrological model will be set up for Gaula to further analyze the floods. After the recent flood discussions came up locally on the efficiency of the proposed hydropower regulation in Gaula to dampen the floods and remove damage potential. The regulation plans were abandoned after Gaula was protected from hydropower development in 1988. To investigate the effect of increased storage, a modelling study will be undertaken to see how the once proposed regulation of Gaula would have influenced the flood levels.

2 MAIN QUESTIONS FOR THE THESIS

1. Data collection and analysis of the floods from 2009, 2010 and 2011. This involves analysis of rainfall, general weather patterns in the region and radar based maps of frontal movement and spatial rainfall distribution. Within this task, data for task 2 should be prepared and evaluated.
2. Set up and calibrate an HBV model implemented in the ENKI framework for daily simulation, and further calibrate the model for hourly simulation of the flood peaks. The foundation for this will be gauged precipitation, but available radar precipitation should be used to evaluate the input precipitation fields for ENKI. Evaluate the calibration for the available gauges in the catchment and decide on a calibration setup for further analysis with a focus on the ability of the model to predict well in all regulated catchments.
3. Evaluate the model performance for floods for the different years, and look at how sub-basins respond to the different flood episodes.

4. Setup the nMag model for the most recent (Guttormsen, 1982) plan for regulating Gaula. Evaluated the regulation impacts on flood level at the gauges in the river.

3 SUPERVISION, DATA AND INFORMATION INPUT

Professor Knut Alfredsen will be the formal supervisor of the thesis work.

Discussion with and input from colleagues and other research or engineering staff at NTNU, SINTEF, power companies or consultants are recommended. Significant inputs from others shall, however, be referenced in a convenient manner.

The research and engineering work carried out by the candidate in connection with this thesis shall remain within an educational context. The candidate and the supervisors are therefore free to introduce assumptions and limitations, which may be considered unrealistic or inappropriate in a contract research or a professional engineering context.

4 REPORT FORMAT AND REFERENCE STATEMENT

The thesis report shall be in the format A4. It shall be typed by a word processor and figures, tables, photos etc. shall be of good report quality. The report shall include a summary, a table of content, lists of figures and tables, a list of literature and other relevant references and a signed statement where the candidate states that the presented work is his own and that significant outside input is identified.

The report shall have a professional structure, assuming professional senior engineers (not in teaching or research) and decision makers as the main target group.

The summary shall not contain more than 450 words it shall be prepared for electronic reporting to SIU. The entire thesis may be published on the Internet as full text publishing through SIU. Reference is made to the full-text-publishing seminar during NORADS winter-seminar. The candidate shall provide a copy of the thesis (as complete as possible) on a CD in addition to the A4 paper report for printing.

The thesis shall be submitted no later than 10th of June 2015.

Trondheim 15th of January 2015

Knut Alfredsen
Professor



NTNU – Trondheim
Norwegian University of
Science and Technology

Analysis and Modelling of Recent Large Floods on the Gaula River

Ku Pak Peng Aquije Lei

Hydropower Development
Submission Date: June 2015
Supervisor: Knut Alfredsen, IVM

Norwegian University of Science and Technology
Faculty of Engineering Science and Technology
Department of Hydraulic and Environmental Engineering

FOREWORDS

This Master's thesis titled "Analysis and modelling of recent large floods on the river Gaula" is carried out under the supervision of Professor Knut Alfredsen, Department of Hydraulic and Environmental Engineering, Norwegian University of Science and Technology, Trondheim, Norway.

The thesis work started in January 2015 and was completed in June 2015.

I hereby confirm that all the work carried in this thesis is my own and significant outside efforts have been acknowledged.

Ku Pak Peng Aquije Lei

June 2015

Trondheim, Norway

ACKNOWLEDGEMENT

I would like to start thanking Professor Knut Alfredsen who suggested me this subject and picked my curiosity into finding more about hydrological models and power plant operations. That first stone thrown into the river made me want to know how deep it was. For being supportive through the entire semester and available for any doubt I had even when he was clearly busy.

To fellow colleague Ekaterina Lobintceva for her help in the introduction into ArcGIS and ENKI.

To Teklu T. Hailegeorgis, PhD. For his guidance into setting up the model in ENKI and for his availability for questions.

A special thanks to Prof. Ånund Killingtveit for clearing up the last barrier to finish this study by helping me to understanding how nMag works.

Last but not least, to all my fellow classmates at HPD for their support and company in this journey that is close to end.

ABSTRACT

In order to study the flood from 2009, 2010 and 2011 that have been impacting the Gaula waterway, a hydrological and operational model have been built.

A brief description of the study is given as an introduction, followed by the description of the study place which is located in Midtre Gaudal in Sør Trondelag, it comprises of four (04) unregulated catchments being Gaulfoss the biggest and the rest of them being part of Gaulfoss.

Daily and Hourly data have been collected, analyzed and formatted so they can be compatible with ENKI platform. Once the model is set and the parameters assigned, the calibration can be started. While processing the results it was possible to see that even though R2 was the simulated discharge was not meeting the aforementioned floods.

An exercise has been made by using radar data and scale the precipitation value and evaluate how much does this affects the model.

As a second part of the study, the hydropower system developed in Samla Plan (Habberstad, 1984) was used to build an operational model in nMag to see how good this system would have work with the mentioned floods.

Discussions, comments and conclusions included in the study.

TABLE OF CONTENT

ACKNOWLEDGEMENT	V
ABSTRACT	VII
TABLE OF CONTENT	IX
LIST OF FIGURES	XI
LIST OF TABLES	XIV
1 INTRODUCTION	1
1.1 MOTIVATION	1
1.2 BACKGROUND	1
1.3 OBJECTIVES OF THE STUDY	2
1.4 METHODOLOGY OF THE SUBJECT	2
1.5 STRUCTURE OF THE THESIS	2
1.6 LIMITATIONS	2
2 STUDY PLACE DESCRIPTION	3
3 DATA COLLECTION, QUALITY AND ANALYSIS	5
3.1 TOPOGRAPHY AND WATERCOURSE	5
3.2 RUNOFF DATA.....	6
3.3 PRECIPITATION DATA.....	12
3.4 TEMPERATURE DATA	14
3.5 GLOBAL RADIATION AND HUMIDITY DATA	15
3.6 RADAR DATA	17
3.7 CATCHMENT AREAS.....	17
4 ENKI MODELLING	21
4.1 INPUT DATA FORMATING	21
4.1.1 Topography	21
4.1.2 Catchment.....	23
4.1.3 Lakes	25
4.1.4 Hydrological data	25
4.2 MODEL SETUP.....	26
4.3 RESULTS AND DISCUSSION.....	29
4.3.1 Daily	30
4.3.2 Hourly.....	36

- 4.3.3 Radar data..... 43
- 5 NMAG MODELLING..... 45**
- 5.1 SAMLA PLAN DESCRIPTION 45
- 5.2 INPUT DATA 46
 - 5.2.1 Daily runoff data 46
 - 5.2.2 Description of reservoirs and power plants 47
 - 5.2.3 Network connection 50
- 5.3 MODEL SETUP..... 51
- 5.4 RESULTS AND DISCUSSION..... 54
- 6 CONCLUSIONS AND RECOMMENDATIONS..... 59**
- 6.1 DATA COLLECTION, QUALITY AND ANALYSIS 59
- 6.2 ENKI MODELLING..... 59
- 6.3 nMAG MODELLING 60
- 7 REFERENCES..... 61**
- 8 APPENDIXES 63**

LIST OF FIGURES

Figure 2-1. Study Place Location within Norway and municipalities.	3
Figure 3-1. Consistency Inspection - Gaulfoss vs Hugdal Bru Runoff Stations.....	6
Figure 3-2. Hugdal Bru Hourly Data - Before and After Correction (2008-2012).....	7
Figure 3-3. Double Curve Mass - Gaulfoss vs Hugdal Bru - Before and After Correction.....	7
Figure 3-4. Gaulfoss Runoff Station – Daily vs Daily Average (Hourly) Data (2008-2012)....	8
Figure 3-5. Double Mass Curve – Gaulfoss vs Hugdal Bru – Daily Data (2006-2014)	9
Figure 3-6. Double Mass Curve – Gaulfoss vs Lillebudal Bru – Daily Data (2006-2014)	9
Figure 3-7. Double Mass Curve – Gaulfoss vs Eggafoss – Daily Data (2006-2014)	9
Figure 3-8. Double Mass Curve – Gaulfoss vs Lillebudal – Hourly Data (2008-2012).....	10
Figure 3-9. Double Mass Curve – Gaulfoss vs Eggafoss – Hourly Data (2008-2012).....	10
Figure 3-10. Gaulfoss Station Daily Runoff Hydrograph	11
Figure 3-11. Hugdal Brus Station Daily Runoff Hydrograph	11
Figure 3-12. Lillebudal Brus Station Daily Runoff Hydrograph	11
Figure 3-13. Eggafoss Station Daily Runoff Hydrograph.....	12
Figure 3-14. Precipitation Stations Location.....	13
Figure 3-15. Catchment at Study Place	17
Figure 3-16. Catchment Area	18
Figure 3-17. Catchment Hypsographic Curves	18
Figure 3-18. Catchment Specific Runoff	19
Figure 3-19. Catchment Hypsographic Curves	19
Figure 4-1. DEM – 25 x 25m grid size	22
Figure 4-2. DEM – 1000 x 1000m grid size	22
Figure 4-3. Export raster platform print screen.....	23
Figure 4-4. Comparison between Catchments Areas Drawn by LAVVAN and ARCHYDRO	23
Figure 4-5. Resampled Catchment Area (1000 x 1000m)	24
Figure 4-6. Adding subroutines to model.....	27
Figure 4-7. Subroutines linkage flow chart.....	27

Figure 4-8.Adding parameters.....	28
Figure 4-9.Daily Data – R2 Results	30
Figure 4-10.Daily Data – Verification (Gaulfoss- Hugdal Bru)	31
Figure 4-11.Daily Data – Verification (Lillebudal Bru - Eggafoss)	31
Figure 4-12.Gaulfoss Daily Data – Reference vs Simulated Discharge	32
Figure 4-13.Hugdal Bru Daily Data – Reference vs Simulated Discharge.....	32
Figure 4-14.Lillebudal Bru Daily Data – Reference vs Simulated Discharge	33
Figure 4-15.Eggafoss Daily Data – Reference vs Simulated Discharge.....	33
Figure 4-16.Gaulfoss Daily Data – Flood Simulation – Comparison Reference vs Simulated Discharge.....	34
Figure 4-17.Hugdal Daily Data – Flood Simulation – Comparison Reference vs Simulated Discharge.....	34
Figure 4-18.Lillebudal Daily Data – Flood Simulation – Comparison Reference vs Simulated Discharge.....	35
Figure 4-19.Eggafoss Daily Data – Flood Simulation – Comparison Reference vs Simulated Discharge.....	35
Figure 4-20.Daily Data – Flood Simulation Efficiency	36
Figure 4-21.Hourly Data – R2 Results.....	37
Figure 4-22.Hourly Data – Verification (Gaulfoss- Hugdal Bru).....	37
Figure 4-23.Hourly Data – Verification (Lillebudal Bru - Eggafoss).....	38
Figure 4-24.Gaulfoss Hourly Data – Reference vs Simulated Discharge	38
Figure 4-25.Hugdal Bru Hourly Data – Reference vs Simulated Discharge	39
Figure 4-26.Lillebudal Bru Hourly Data – Reference vs Simulated Discharge.....	39
Figure 4-27.Eggafoss Hourly Data – Reference vs Simulated Discharge	40
Figure 4-28.Gaulfoss Hourly Data – Flood Simulation – Comparison Reference vs Simulated Discharge.....	40
Figure 4-29.Hugdal Bru Hourly Data – Flood Simulation – Comparison Reference vs Simulated Discharge	41
Figure 4-30.Lillebudal Bru Hourly Data – Flood Simulation – Comparison Reference vs Simulated Discharge	41

Figure 4-31.Eggafoss Hourly Data – Flood Simulation – Comparison Reference vs Simulated Discharge.....	42
Figure 4-32.Hourly Data – Flood Simulation Efficiency.....	42
Figure 4-33.Radar Data Overlapped with Study Place’s Catchments Areas	43
Figure 4-34.2011 Flood in Eggafoss Runoff Station	44
Figure 5-1.Samla Plan for Gaula sketch (Guttormsen, 1984)	46
Figure 5-2.Sketch of Hydropower Development 1982 – Samla Plan	47
Figure 5-3.Hydropower Development Flow Chart	51
Figure 5-4.Hydropower Development Flow Chart – Variation	53
Figure 5-5.Øyungen Relative Reservoir Elevation	54
Figure 5-6.Øyungen Spill Flow.....	55
Figure 5-7.Øvre Fora Relative Reservoir Elevation.....	55
Figure 5-8.Øvre Fora Spill Flow	56
Figure 5-9.Rå Relative Reservoir Elevation	56
Figure 5-10.Rå Spillway	57
Figure 5-11.CtrlPoint – Flow Before and After Impoundment and Power Plant.	57

LIST OF TABLES

Table 3-1. Runoff Stations Location	6
Table 3-2. Correlation between Runoff Stations.....	8
Table 3-3. Precipitation Stations	12
Table 3-4. Temperature Stations Location	15
Table 3-5. Global Radiation Stations Location	16
Table 3-6. Humidity Stations Location	16
Table 4-1. ENKI Input Data Format Requirement.....	21
Table 4-2. Hydrological *.txt format	25
Table 4-3. ENKI parameter and calibration interval values.....	28
Table 5-1. Hydropower Units and Reservoirs.....	45
Table 5-2. Reservoirs Description.....	48
Table 5-3. Hydropower Plants Description.....	48
Table 5-4. Transfer Description	48
Table 5-5. Transfer Description	49
Table 5-6. Area, Specific Runoff and Annual Discharge	50
Table 5-7. Module Numbers and Flow Destination.....	50

1 INTRODUCTION

1.1 MOTIVATION

Floods in Norway are caused generally when the precipitation and the snowmelt processes overlap, like the floods in 2009 and 2010 by July and June respectively with the exception on the 2011 flood which took place by mid-August. The latter also was special due to a different behavior within Gaula watershed compared with the previous floods.

Most of these floods carry with them heavy economical losses and damages to the society when they are not foreseen. Therefore, by focusing on the last three (03) main floods in Gaula and with the available hydrological data a distributed hydrological model was built to evaluate how good it would simulate the floods.

In 1993, Gaula waterway was protected against hydropower utilization under the Verneplan IV for vassdrag (IV Conservation Plan for Waterways). But previous in the 80s, a plan was built in order to study the hydropower potential in this area. (Habberstad, 1984)

The question made here is if the plan would have helped on damping the floods, therefore an operational model was built in nMag for this purpose with the latest hydropower alternative described.

1.2 BACKGROUND

The river Gaula is an unregulated river in the Sør Trøndelag and has a history of floods and is characterized by rapid response to rainfall. It has experienced some large floods in 2009, 2010 and 2011, and particularly the 2011 flood did severe damages in the upper river and was also characterized by high intensity and very local rainfall. The purpose of this thesis is an analysis of the floods in Gaula, how do they appear and what forcing control the largest floods. A hydrological model will be set up for Gaula to further analyze the floods. After the recent flood discussions came up locally on the efficiency of the proposed hydropower regulation in Gaula to dampen the floods and remove damage potential. The regulation plans were abandoned after Gaula was protected from hydropower development in 1988. To investigate the effect of increased storage, a modelling study will be undertaken to see how the once proposed regulation of Gaula would have influenced the flood levels.

1.3 OBJECTIVES OF THE STUDY

Within the objectives of the study:

- Analysis and quality evaluation on the collected data to get a good set of input data as possible.
- Develop, calibrate and evaluate a hydrological model in ENKI.
- Develop, run and evaluate a operational model in nMag.

1.4 METHODOLOGY OF THE SUBJECT

- Data collection and analysis of the floods from 2009, 2010 and 2011. This involves analysis of rainfall, general weather patterns in the region and radar based maps of frontal movement and spatial rainfall distribution. Within this task, data for task 2 should be prepared and evaluated.
- Set up and calibrate an HBV model implemented in the ENKI framework for daily simulation, and further calibrate the model for hourly simulation of the flood peaks. The foundation for this will be gauged precipitation, but available radar precipitation should be used to evaluate the input precipitation fields for ENKI. Evaluate the calibration for the available gauges in the catchment and decide on a calibration setup for further analysis with a focus on the ability of the model to predict well in all regulated catchments.
- Evaluate the model performance for floods for the different years, and look at how sub-basins respond to the different flood episodes.
- Setup the nMag model for the most recent (Guttormsen, 1984) plan for regulating Gaula. Evaluated the regulation impacts on flood level at the gauges in the river.

1.5 STRUCTURE OF THE THESIS

Chapter 2 – Study place description

Chapter 3 – Data collection, quality and analysis

Chapter 4 – ENKI modelling which will calibrate daily and hourly data to simulate runoff.

Chapter 5 – nMag modelling to run a model on the operational level using an existing hydropower development plan

1.6 LIMITATIONS

The modelling period in ENKI for daily data is from 2006 to 2014, eight (years) which the 1st year will serve as “burning”, the last two (02) years for validation. So we ended up with five

(5) years calibration and in the case of the hourly data the calibration period is just two (02) years. These are low numbers but for a higher number of years a higher simulation time is required especially for the hourly simulation. So as a first attempt the collected data is acceptable but the results might not be as accurate.

2 STUDY PLACE DESCRIPTION

The study place is located Gaula watershed, in the municipality of Sør-Trøndelag and part of Hedmark. It comprises four (04) unregulated catchments areas corresponding to four (04) runoff stations available in the area, being Gaulfoss catchment the one that covers the entire study place.

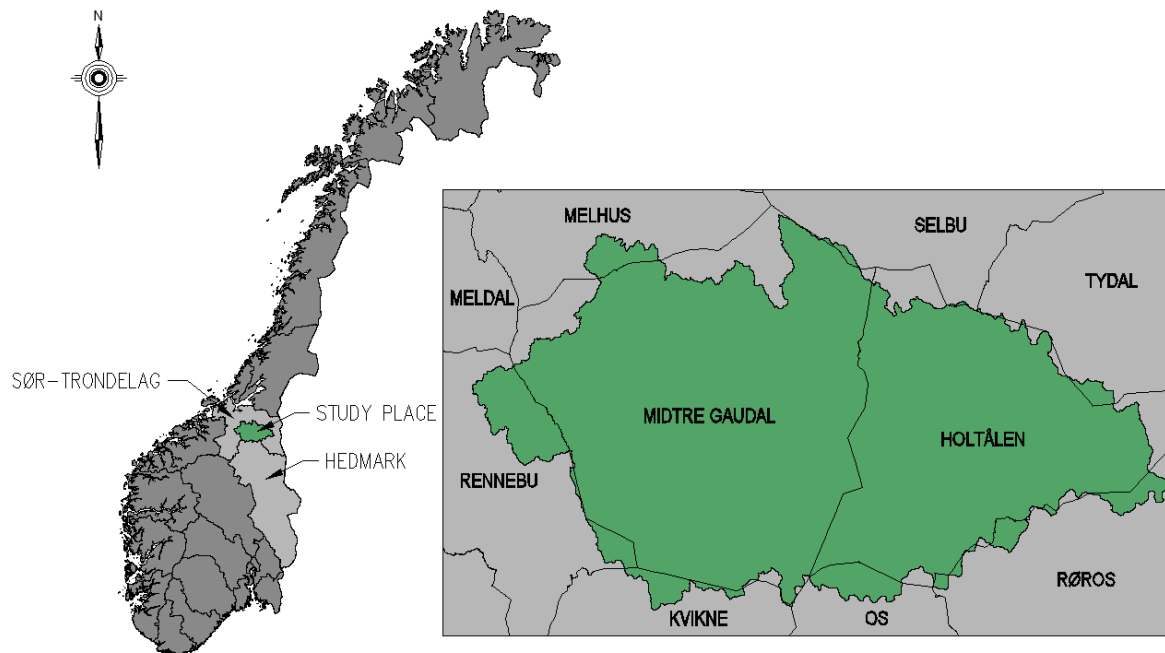

Figure 2-1. Study Place Location within Norway and municipalities.

Gaula river crosses the entire study place which begins in Holtålen near Kjølifjellet, passing by Midtre Gaudal. On its way to Gaulfoss runoff station, it is joined by Sokna river in the village of Støren in Midtre Gaudal.

3 DATA COLLECTION, QUALITY AND ANALYSIS

The data were collected from different sources which are detailed in their respective sections. Except the topography and the watercourse, 2 types of data were required.

- Daily data, from 2006 to 2014; and,
- Hourly data, from 2008 to 2012.

3.1 TOPOGRAPHY AND WATERCOURSE

Both data were obtained from Norge digitalt WEB and the properties of the downloaded information are:

Geographic Coordinate System	UTM WGS84 32N
Elevation curves	@ 5m
Format	shapefile

For the purpose of this Project, the data from the following locations had been downloaded.

County	Sør-Trøndelag	
Municipalities	Tydal	Holtålen
	Selbu	Røros
	Klebu	Orkdal
	Skaun	Meldal
	Melhus	Rennebu
	Midtre Gauldal	Oppdal

County	Hedmark	
Municipalities	Tolga	
	Tynset	
	Os	

The quality of the topography and the watercourse and lakes were assured by comparing these with the one from LAVVAN. Visual inspection has been applied. Further inspections and adjustment has been made in the section ENKI MODELLING – Data Quality.

3.2 RUNOFF DATA

For the purpose of modelling in ENKI, the amount of available runoff data and its quality is very important since it will be compared to the simulated discharge flows.

Four (04) runoff stations have been identified on the study place which are described on Table 3-1.

Table 3-1. Runoff Stations Location

Station N ^o	Station Name	E (m)*	N (m)*	Altitude (m)	Source
122.9.0.1001.1	Gaulfoss ¹²	562019	6998269	60	NVE
122.17.0.1001.1	Hugdalen bru ¹²	563144	6985540	130	NVE
122.14.0.1001.1	Lillebudalen bru ¹²	578910	6966858	513	NVE
122.11.0.1001.1	Eggafoss ¹²	611019	6975229	285	NVE

* Geographic Coordinate System WGS84 32N

¹ Daily Data - ² Hourly Data

A map showing the location of the runoff stations and their respective catchments can be found in Appendix A Drawing A-03

Once collected the daily and hourly data, visual inspection has been applied, looking for negative values and flat regions.

The consistency of the information has been analyzed. First visually by comparing two runoff stations. For example, between hourly Gaulfoss and Hugdalen Bru runoff stations. The latter is located in Sokna River which is tributary to Gaula where Gaulfoss station is located. This means that the data from Gaulfoss has to be higher than the one from Hugdalen Bru. Following this criteria, the following figure has been plotted.

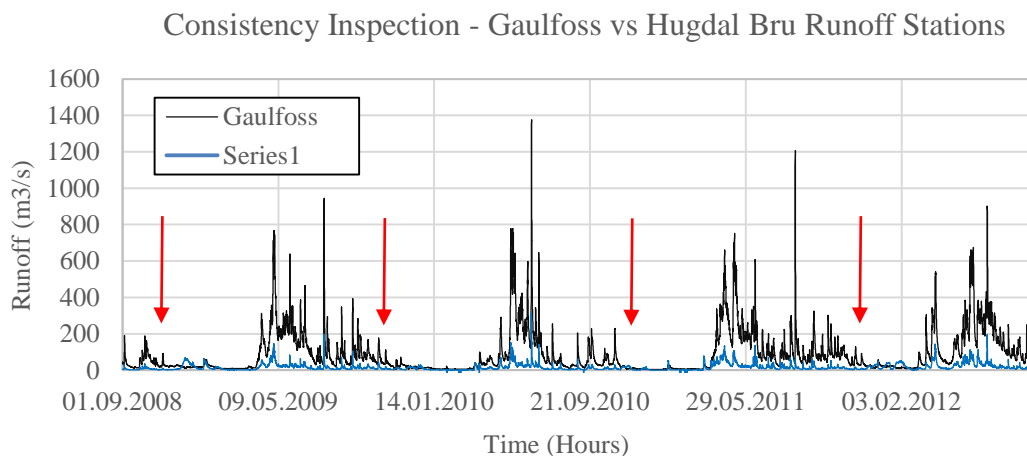

Figure 3-1. Consistency Inspection - Gaulfoss vs Hugdalen Bru Runoff Stations

It can be seen in the last figure that Hugdal Bru’s data shows the mentioned inconsistency on the winter periods (red arrows) compared with Gaulfoss. These might have been due to ice formation close to the gauging station forcing the water level to raise.

This was solved by matching the daily average (hourly data) with its daily counterpart (daily data). A scaling factor was calculated and applied to the hourly data. The following figure plot the hourly data before and after the correction in Hugdal Bru.

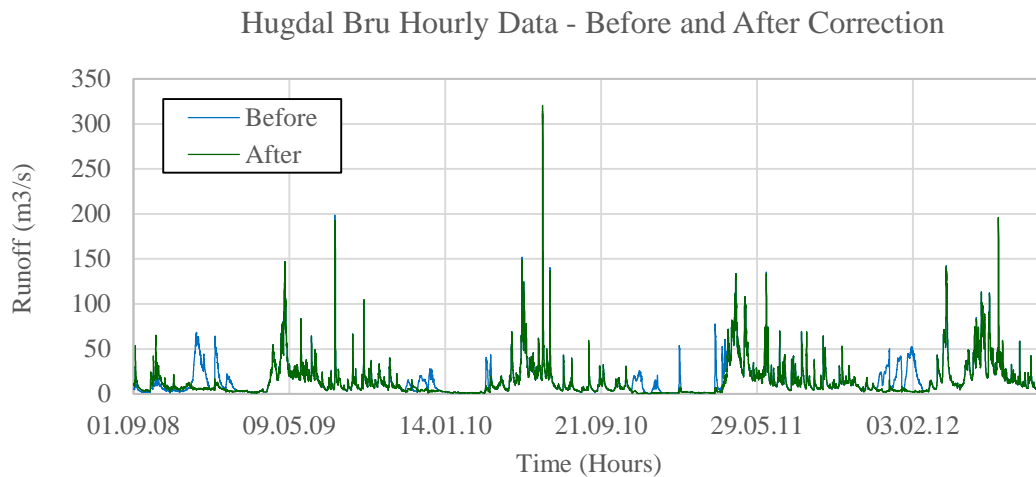

Figure 3-2. Hugdal Bru Hourly Data - Before and After Correction (2008-2012)

Then a double mass curve (2008-2012) was plotted to review their consistency and it can be seen that the curve after the correction has a better consistency with Gaulfoss station.

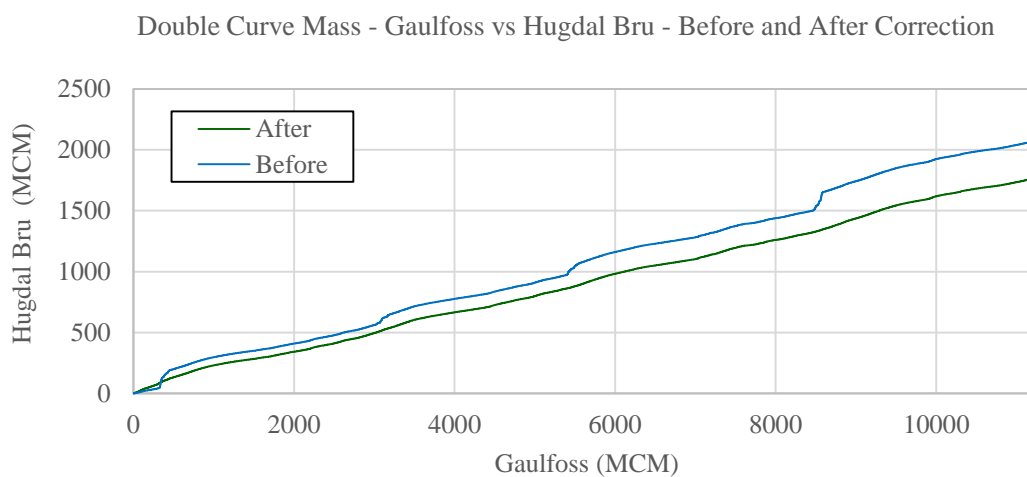

Figure 3-3. Double Curve Mass - Gaulfoss vs Hugdal Bru - Before and After Correction

This method was applied also to Lillebudal Bru and Eggafoss stations Hourly data, which were also compared with Gaulfoss due to the better correlation between them, shown in the next table.

Table 3-2. Correlation between Runoff Stations

Correlation	Gaulfoss	Hugdals Bru	Lillebudal Bru	Eggafoss
Gaulfoss	1.00	0.89	0.90	0.94
Hugdals Bru	0.89	1.00	0.78	0.76
Lillebudal Bru	0.90	0.78	1.00	0.86
Eggafoss	0.94	0.76	0.86	1.00

First of all, since Gaulfoss station data is going to be the base for the quality analysis of the other stations, Gaulfoss hourly data was contrasted with its daily data with a double mass curve (2008-2012) and it is shown in the following figure. Then its consistency is confirmed.

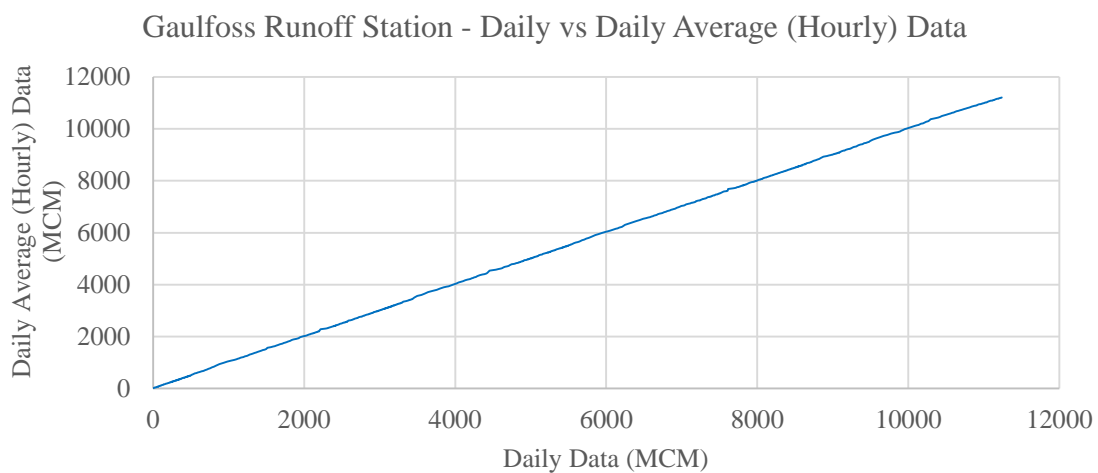

Figure 3-4. Gaulfoss Runoff Station – Daily vs Daily Average (Hourly) Data (2008-2012)

Consistency for the daily data was analyzed between the stations with the double curve mass (2006-2014) obtaining the following graphs and shows that they have an acceptable correlation.

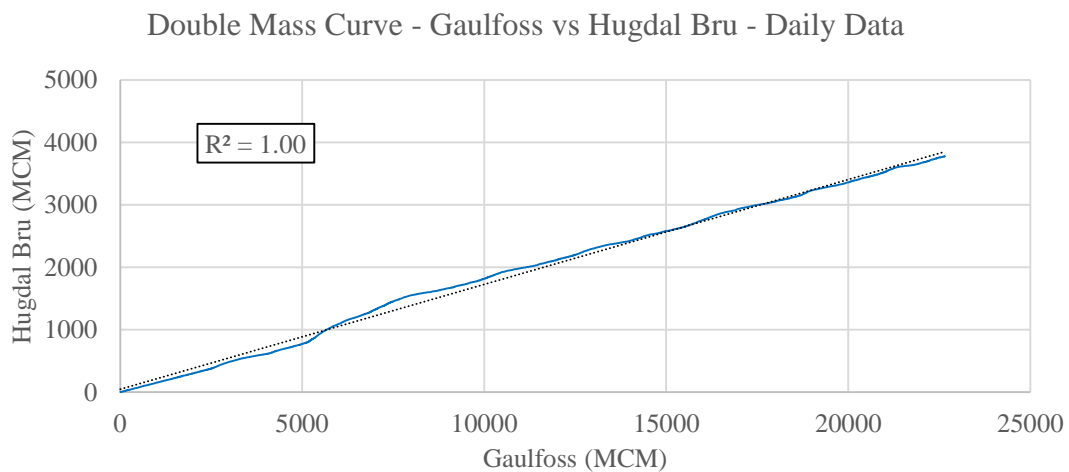

Figure 3-5. Double Mass Curve – Gaulfoss vs Hugdal Bru – Daily Data (2006-2014)

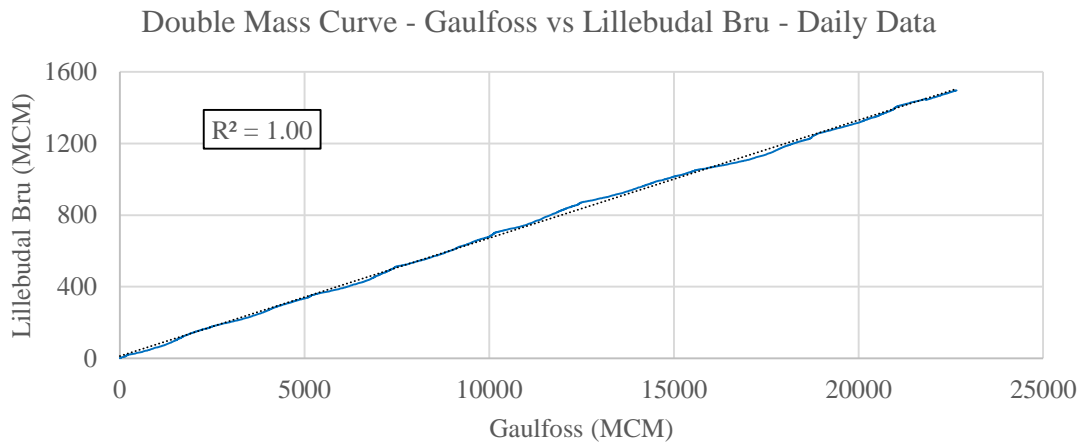

Figure 3-6. Double Mass Curve – Gaulfoss vs Lillebudal Bru – Daily Data (2006-2014)

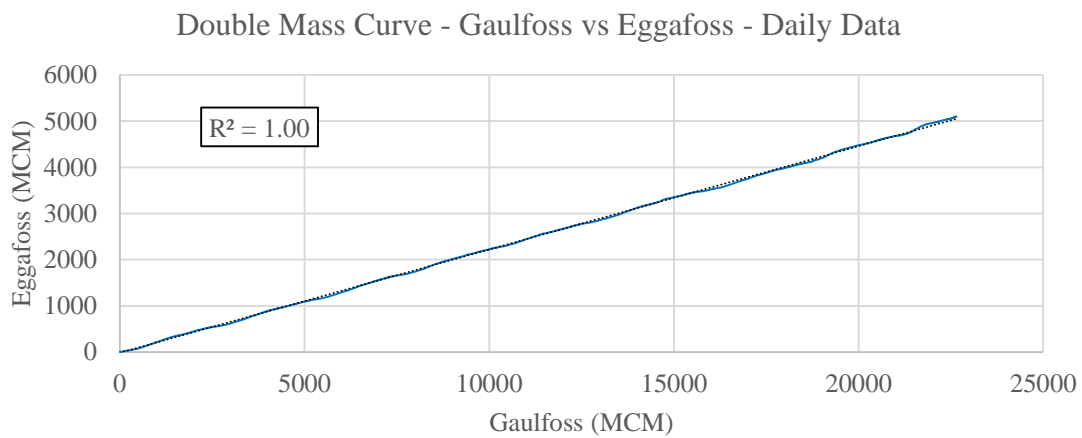

Figure 3-7. Double Mass Curve – Gaulfoss vs Eggafoss – Daily Data (2006-2014)

As for the hourly data, same procedure was applied, analyzing its consistency and correcting them, if necessary, by comparing the daily average (hourly data) and the daily data (explained in the previous example). Then the following figures resulted.

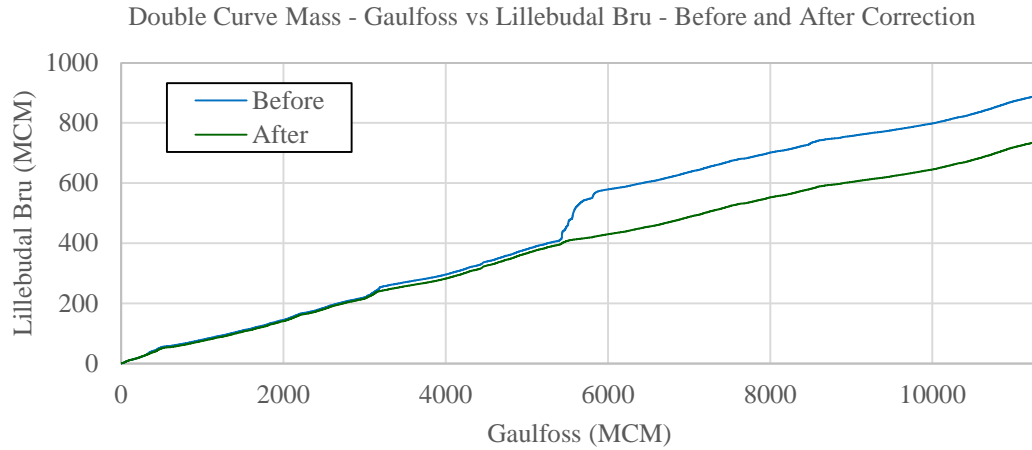

Figure 3-8. Double Mass Curve – Gaulfoss vs Lillebudal – Hourly Data (2008-2012)

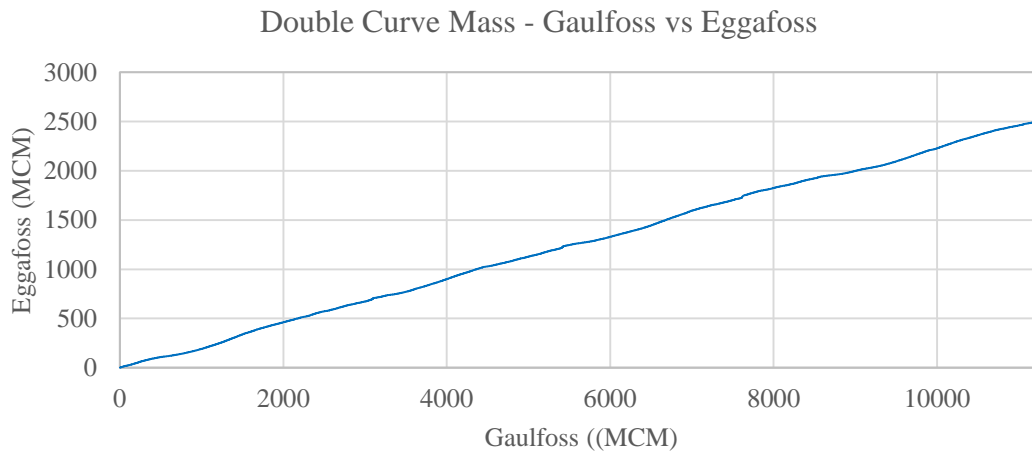

Figure 3-9. Double Mass Curve – Gaulfoss vs Eggafoss – Hourly Data (2008-2012)

The following figures show the daily runoff hydrographs after the data quality procedure. It can be seen on these the three (03) floods covered by this study.

The 2009 and 2010 flood can be observed Gaulfoss, Hugdal Bru and Lillebudal Bru while the one in 2011 can be found in Gaulfoss and Eggafoss.

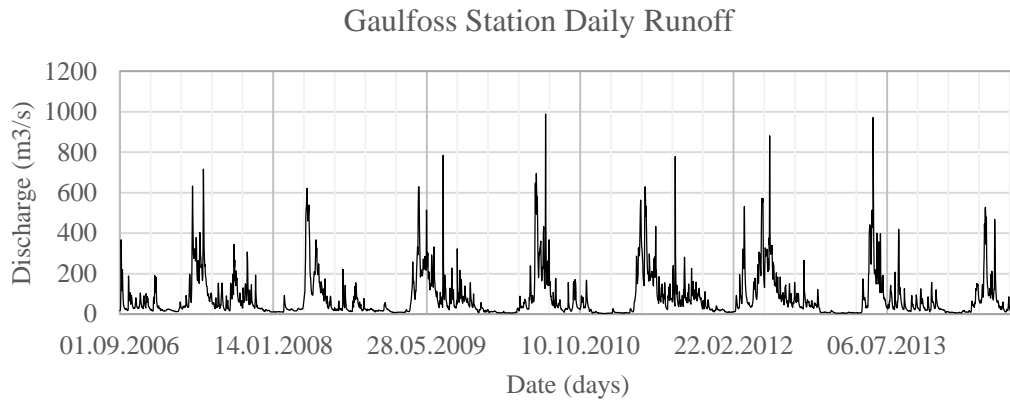

Figure 3-10. Gaulfoss Station Daily Runoff Hydrograph

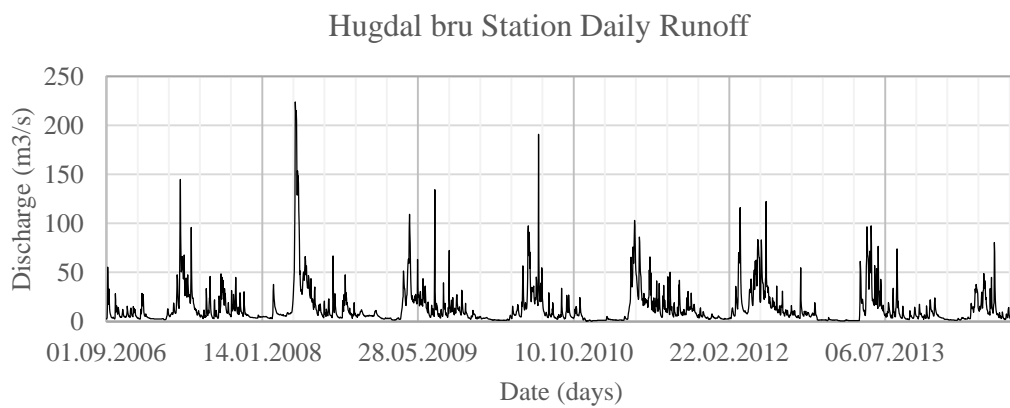

Figure 3-11. Hugdalen Bru Station Daily Runoff Hydrograph

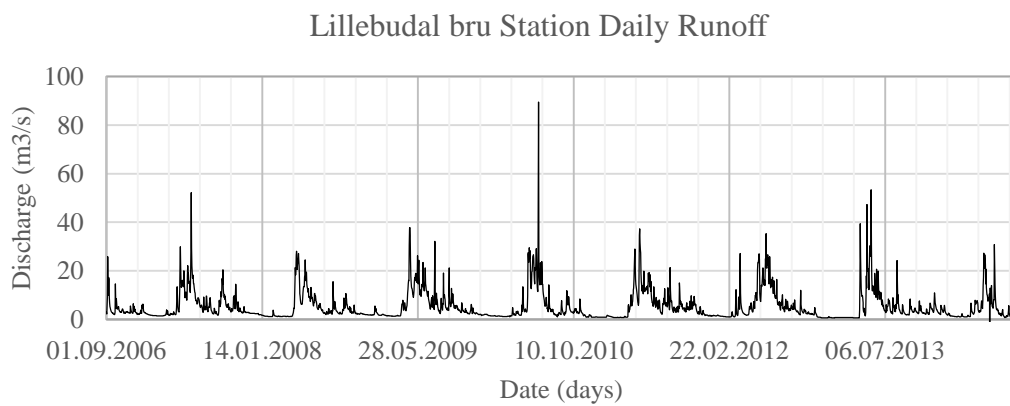

Figure 3-12. Lillebudalen Bru Station Daily Runoff Hydrograph

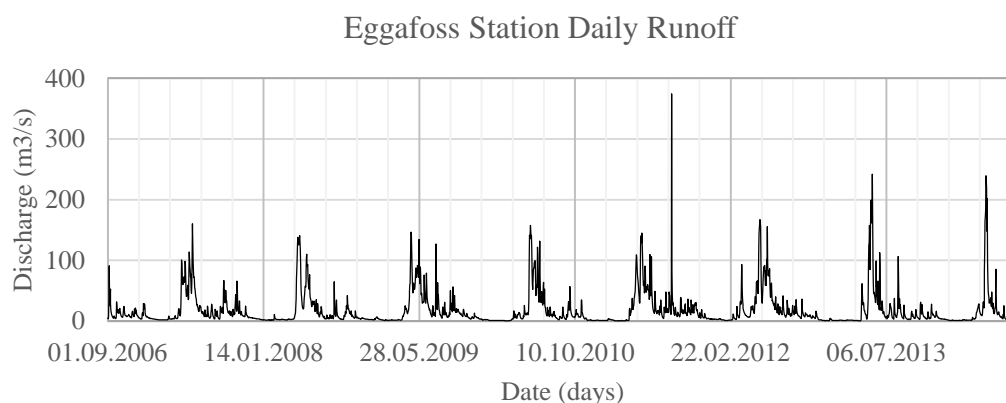

Figure 3-13. Eggafoss Station Daily Runoff Hydrograph

A set of hydrographs is shown in Appendix B.

3.3 PRECIPITATION DATA

Several precipitation stations have been identified in the study place which are described in the following table.

Table 3-3. Precipitation Stations

Station N ^o	Name	E (m)*	N (m)*	Altitude (m)	Source
10380	Røros Lufthavn ¹	620824	6940696	625	Eklima
10600	Aursund ¹	625634	6951625	685	Eklima
10800	Sølandet ¹	644130	6953017	760	Eklima
66620	Rennebu - Ramstad ¹	542511	6970712	223	Eklima
66730	Berkåk - Lyngholt ¹	551844	6965643	475	Eklima
67240	Støren - Vårvoll ¹	565293	6991281	65	Eklima
67540	Røsbjørgen ¹	576988	6986221	330	Eklima
67770	Haltdalen III ¹	610575	6976964	290	Eklima
67780	Ålen ¹	612277	6971057	397	Eklima
68270	Løksmyr ¹	572201	7012191	173	Eklima
68290	Selbu II ¹	600890	7012214	160	Eklima
68420	Aunet ¹	629747	6994376	302	Eklima
68840	Stugudal - Kåsen ¹	645482	6977149	730	Eklima
66850	Kvikne i Østerdal ¹	565264	6941243	549	Eklima
67280	Soknedal ¹²	559802	6980956	299	Eklima
67560	Kostøy ¹²	579117	6983909	127	Eklima
-	Berkak ¹²	551902	6967425	425	TrøndEnergi
-	Kvikne ¹²	565679	6939987	550	TrøndEnergi
-	Rennebu ¹²	541719	6971371	509	TrøndEnergi

-	Ya ¹²	580048	6939488	885	TrøndEnergi
-	Luso ¹²	575025	6998673	415	TrøndEnergi
-	Aurs_Glåmos ¹²	623904	6951429	632	TrøndEnergi
-	Amote ¹²	541407	7001658	227	TrøndEnergi
-	Øvredølvad ²	560343	6929915	848	TrøndEnergi
-	Syrstad ²	536844	6989367	150	TrøndEnergi
-	Meldal ²	535432	6988010	145	TrøndEnergi
-	Sellisjøen ¹²	636168	6992671	510	Statkraft
-	Hersjøen ¹²	610178	7011563	420	Statkraft
-	Alvdal ²	584899	6887437	478	Bioforsk
-	Soknedal ²	562947	6978224	500	Bioforsk
-	Kvithamar ²	593621	7041332	28	Bioforsk
-	Skjetlein ²	564946	7024171	44	Bioforsk
-	Meldal ²	536257	6988776	140	Bioforsk
-	Rennebu ²	542582	6970594	211	Bioforsk

* Geographic Coordinate System WGS84 32N

¹ Daily Data - ² Hourly Data

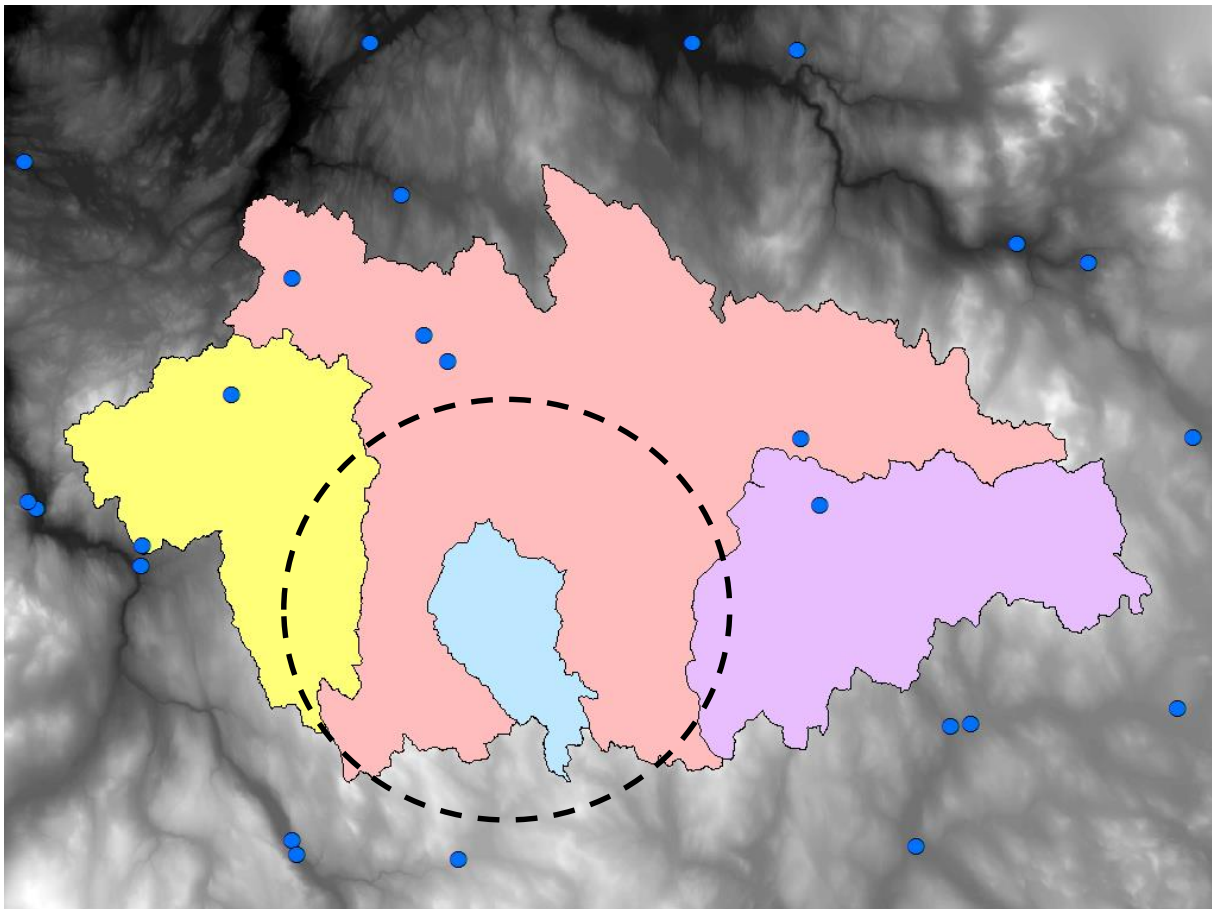

Figure 3-14. Precipitation Stations Location

Figure 3-14 shows the precipitation stations location and its density within the study place. It can be noted that there is a “hole” in the density of stations where Lillebudal catchment is located. This might have an impact at the correlation result for Lillebudal Bru catchment leading to a lower correlation value when analyzing Gaulfoss catchment.

Visual inspection and correlation evaluation between stations of available data has been done. Even though ENKI calculates by default missing data, this was done to help the evaluation of the correlation of the whole period.

The following equation was used:

$$P_3 = \frac{AvgP_3}{AvgP_2} P_2$$

Where:

P_3 = Missing precipitation data

P_2 = Observed precipitation data

$AvgP_3$ = Average precipitation from the incomplete precipitation station

$AvgP_2$ = Average precipitation from complete precipitation station

A map showing the location of the daily and hourly precipitation stations can be found in Appendix A Drawing A-04 and A-07, respectively. Graphs showing the daily and hourly precipitation data can be found in Appendix C.

3.4 TEMPERATURE DATA

Visual inspection and correlation evaluation between stations of available data has been done. Even though ENKI calculate by default missing data, this was done to help the evaluation of the correlation of the whole period.

Table 3-4 shows the temperature stations found at the study place.

Table 3-4. Temperature Stations Location

Station N ^o	Name	E (m)*	N (m)*	Altitude (m)	Source
10380	Røros Lufthavn ¹²	620824	6940696	625	Eklima
10800	Sølendet ¹²	644130	6953017	760	Eklima
66730	Berkåk - Lyngholt ¹	551844	6965643	475	Eklima
67280	Soknedal ¹²	559802	6980956	299	Eklima
67560	Kostøy ¹²	579116.8	6983908.7	127	Eklima
68290	Selbu II ¹²	600890	7012214.4	160	Eklima
9580	Tynset - Hansmoen ¹²	589907.4	6905406.3	482	Eklima
-	Alvdal ²	584898.8	6887437.4	478	Bioforsk
-	Soknedal ²	562947	6978224	500	Bioforsk
-	Kvithamar ²	593620.8	7041331.6	28	Bioforsk
-	Skjetlein ²	564945.5	7024171.4	44	Bioforsk
-	Meldal ²	536256.9	6988775.8	140	Bioforsk
-	Rennebu ²	542581.5	6970593.8	211	Bioforsk

* Geographic Coordinate System WGS84 32N

¹ Daily Data - ² Hourly Data

The following equation was used:

$$T_3 = T_2 + (AvgT_3 - AvgT_2)$$

Where:

T_3 = Missing temperature data

T_2 = Observed temperature data

$AvgT_3$ = Average temperature from the incomplete precipitation station

$AvgT_2$ = Average temperature from complete precipitation station

A map showing the location of the daily and hourly temperature stations can be found in Appendix A Drawing A-05 and A-08, respectively. Graphs showing the daily and hourly temperature data can be found in Appendix D.

3.5 GLOBAL RADIATION AND HUMIDITY DATA

On the following tables, global radiation and humidity station locations within the study area are shown.

Table 3-5. Global Radiation Stations Location

Station N ^o	Name	E (m)*	N (m)*	Altitude (m)	Source
-	Alvdal ¹²	584899	6887437	478	Bioforsk
-	Kvithamar ¹²	593621	7041332	28	Bioforsk
-	Skjetlein ¹²	564946	7024171	44	Bioforsk
-	Soknedal ¹²	562947	6978224	500	Bioforsk
-	Meldal ¹²	536257	6988776	140	Bioforsk
-	Rennebu ¹²	542582	6970594	211	Bioforsk

* Geographic Coordinate System WGS84 32N

¹ Daily Data - ² Hourly Data

A map showing the location of the daily and hourly global radiation stations can be found in Appendix A Drawing A-06 and A-09, respectively. Graphs showing the daily and hourly global radiation data can be found in Appendix E.

Table 3-6. Humidity Stations Location

Station N ^o	Name	E (m)*	N (m)*	Altitude (m)	Source
10800	Sølandet ¹	644130	6953017	760	Eklima
66730	Berkåk - Lyngholt ¹	551844	6965643	475	Eklima
67280	Soknedal ¹	559802	6980956	299	Eklima
67560	Kostøy ¹	579117	6983909	127	Eklima
68290	Selbu II ¹	600890	7012214	160	Eklima
9580	Tynset - Hansmoen ¹	589907	6905406	482	Eklima
-	Alvdal ²	584899	6887437	478	Bioforsk
-	Soknedal ²	562947	6978224	500	Bioforsk
-	Kvithamar ²	593621	7041332	28	Bioforsk
-	Skjetlein ²	564946	7024171	44	Bioforsk
-	Meldal ²	536257	6988776	140	Bioforsk
-	Rennebu ²	542582	6970594	211	Bioforsk

* Geographic Coordinate System WGS84 32N

¹ Daily Data - ² Hourly Data

A map showing the location of the daily and hourly humidity stations can be found in Appendix A Drawing A-05 and A-09, respectively. Graphs showing the daily and hourly humidity data can be found in Appendix F.

3.6 RADAR DATA

Radar data was collected for the flood of 2011, which is going to be compared with the precipitation grid obtained in ENKI in the hourly simulation.

3.7 CATCHMENT AREAS

The catchment areas corresponding to each of the runoff stations have been drawn using Lavvann as shown in the next figure. This will help us to assure the quality of the catchment areas that will be drawn by Archydro.

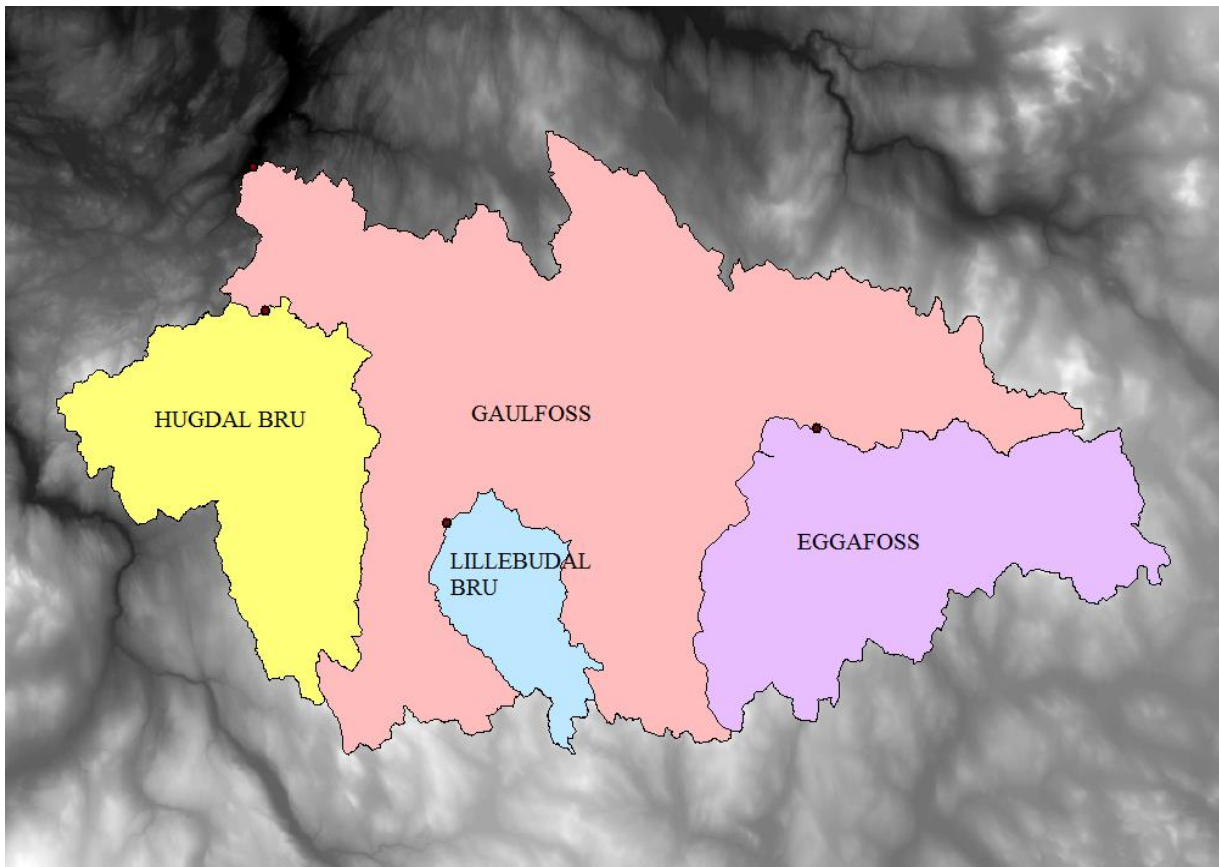

Figure 3-15. Catchment at Study Place

Figure 3-15 shows the catchments arrangement in the study place, being Gaulfoss the one with the largest area, surrounding the other catchments, and Lillebudal Bru the smallest. A chart showing the areas of each catchment is shown in figure 3-16.

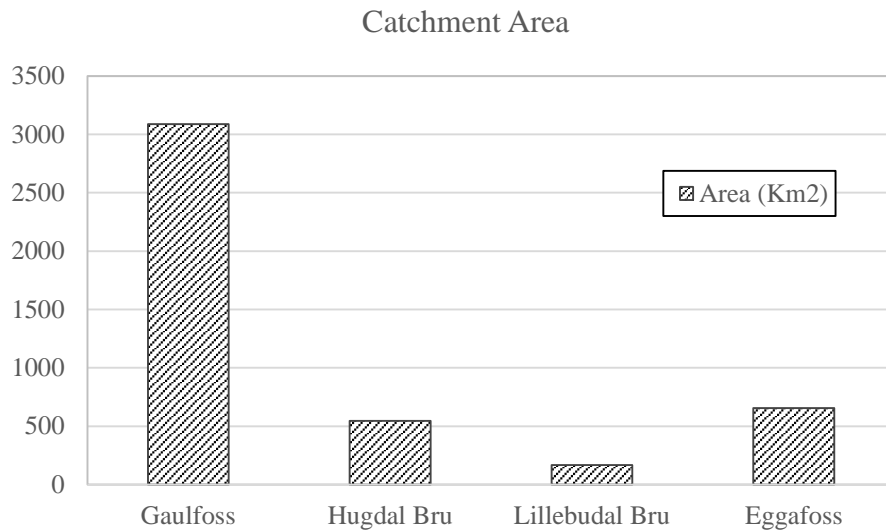

Figure 3-16. Catchment Area

Beside from the catchment outline and areas, Lavvan also provides the first insight into the catchments characteristics and properties; as shown for example, in figure 3-17 the hypsographic curves.

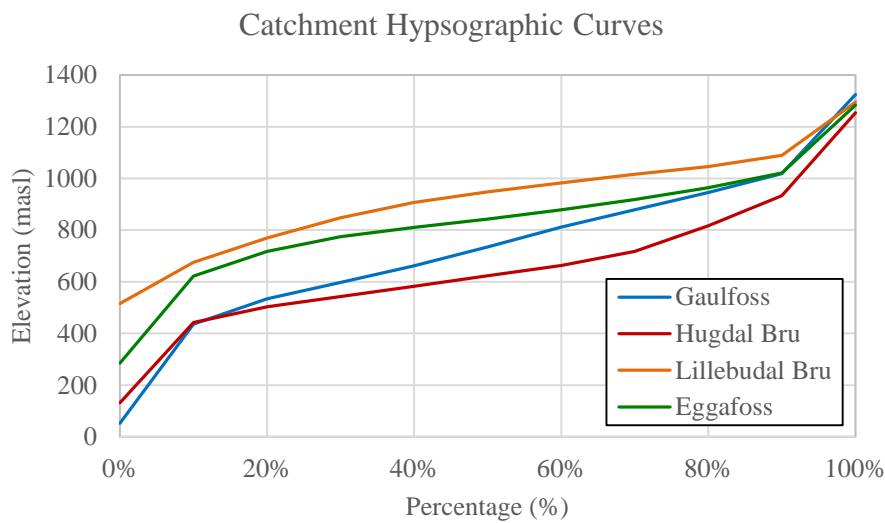

Figure 3-17. Catchment Hypsographic Curves

It can be seen in figure 3-17 that Hugdal Bru’s catchment has the lowest elevation average while Lillebudal Bru has the highest value followed by Eggafoss. These will allow us to picture the elevation distribution of the catchment as a whole.

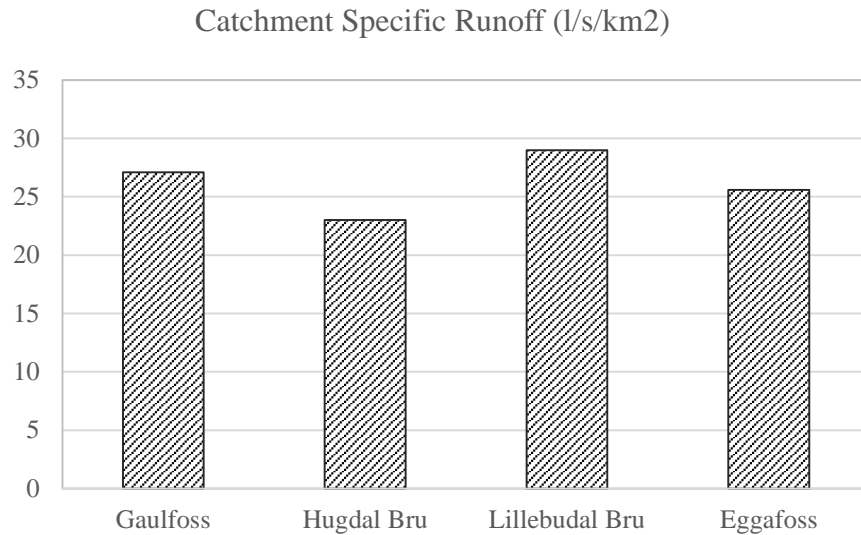

Figure 3-18. Catchment Specific Runoff

Figure 3-18 shows the catchment specific runoff in terms of discharge per km². The differences between the values are not big and the specific runoff of Gaulfoss is approximately the average from the other three which makes sense since Hugdal Bru, Lillebudal Bru and Eggafoss are part of the Gaulfoss catchment.

Appendix G groups the information obtained from Lavvann about the referred catchments.

Additionally for the purpose of the second part of the study, Specific runoff and area of catchments at proposed locations is shown in the following table, to be used at nMag set up.

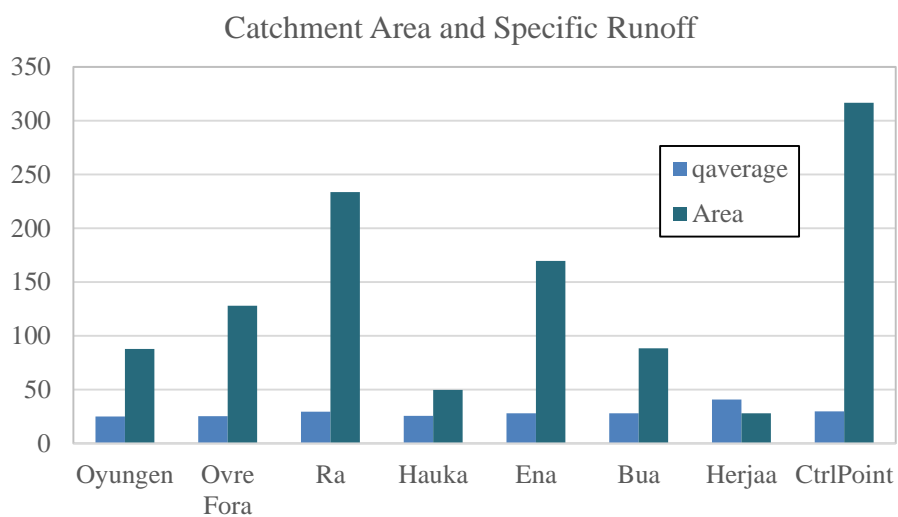

Figure 3-19. Catchment Hypsographic Curves

4 ENKI MODELLING

ENKI is a modular framework for implementing hydrological or other environmental models. Both lumped and distributed models are supported. ENKI builds a model from a set of user-defined subroutines, which operate on GIS data within a spatial region.

ENKI modelling system contains tools for model setting and calibration which will define sets of parameters in the different catchments within the study place until the convergence of the results.

The objective of this section is to simulate discharge flows with the precipitation, temperature, global radiation and humidity data, and compare it with the runoff data. Then see how well the model react to the floods from 2009, 2010 and 2011.

Input data for ENKI has been built with the previously collected data which are formatted to be compatible with ENKI. The following table shows the current and required format for each type of input data.

Table 4-1. ENKI Input Data Format Requirement

Collected Data	Current Format	Required Format	Platform and Requirements
Topography	*.shp	*.rst	GIS - Topography to DEM (Grid cell 1000 x 1000 m) SAGAGIS - *.tiff to *.rst
Catchment	-	*.rst	ARCHYDRO using DEM and Runoff Station Location SAGAGIS - *.tiff to *.rst
Lakes	*.shp	*.rst	GIS - Lakes (Grid cell 1000 x 1000 m) SAGAGIS - *.tiff to *.rst
Hydrological Data	*.xlsx	*.txt	Specific format which includes stations characteristics.

4.1 INPUT DATA FORMATING

4.1.1 Topography

- Open topography data (elevation curves) in arcmap.
- Convert it to DEM with “from topo to raster” toll under 3D Analyst, specifying the size of the required grid cell (1000 x 1000m). In this case, a smaller grid size (25 x 25m) has been use at first and after obtaining the catchments areas it was transformed to the required grid size with the “resample tool”

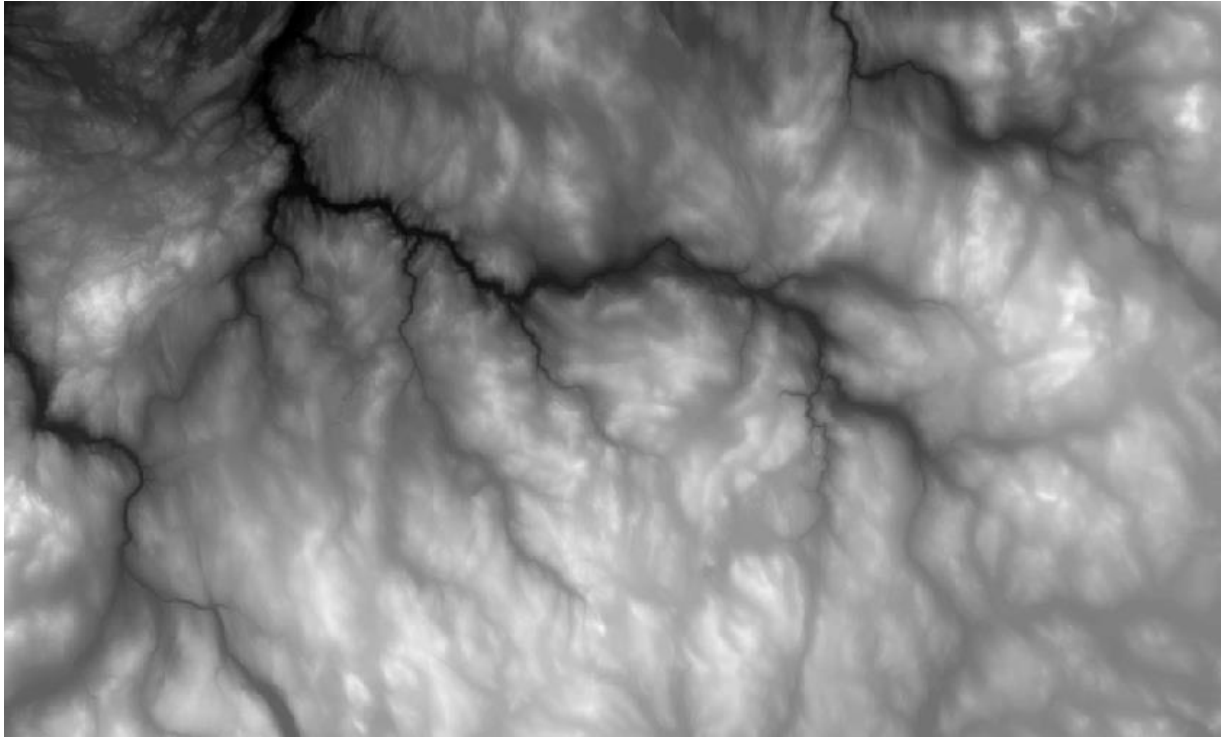

Figure 4-1. DEM – 25 x 25m grid size

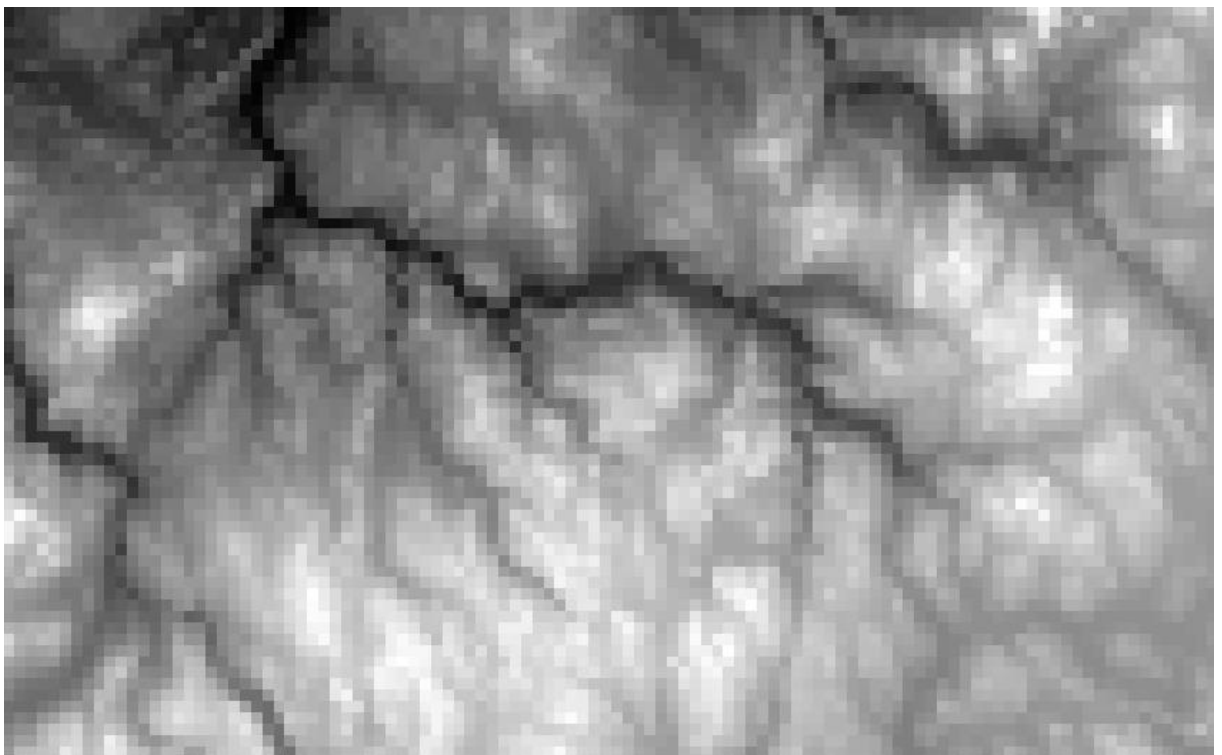

Figure 4-2. DEM – 1000 x 1000m grid size

- Under “conversion tools” convert “raster to float”
- Export data with *.tiff format right clicking on the float file – Data – Export Data

- Convert *.tiff file to *.rst using SAGAGIS by importing the file in Import/Export - GDAL/OGR – Import raster and then Export raster as shown in Figure 4-3

Data Objects	
Grids	
Grid system	1000; 109x 94y; 539486.803574x 6930977.473513y
>> Grid(s)	1 object (DEM1000)
Options	
File	C:\Users\Pak Peng\Desktop\Dem1000
Format	Idrisi Raster A.1
Data Type	match input data
Set Custom NoData	<input type="checkbox"/>
NoData Value	-9999
Creation Options	

Figure 4-3. Export raster platform print screen

4.1.2 Catchment

- By using the resulted DEM (25 x 25 m), catchments for the runoff stations have been drawn using ARCHYDRO tool set.
- Visual inspection for quality was done by comparing the resulted areas with the ones drawn in Lavvann
- The following figure shows the comparison between both drawn catchments.

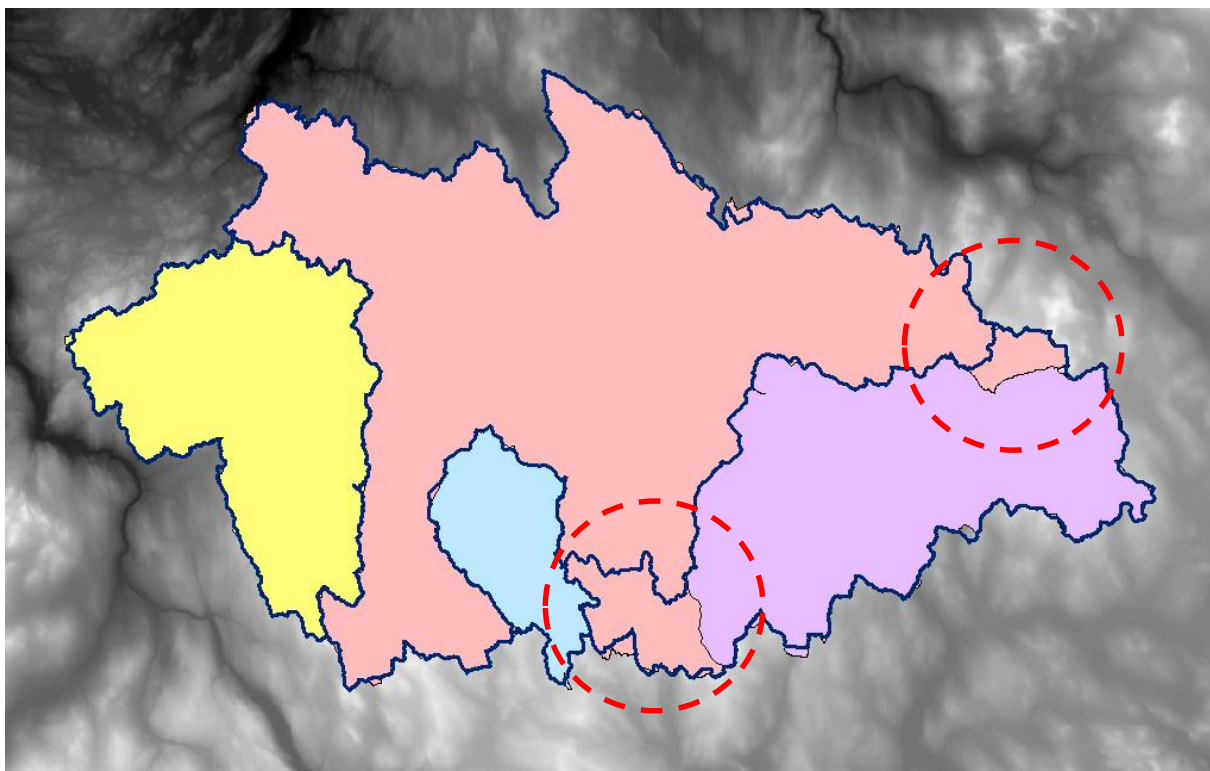

Figure 4-4. Comparison between Catchments Areas Drawn by LAVVAN and ARCHYDRO

It can be seen that Eggafoss catchment drawn by Archydro has a different dimension from the one drawn by Lavvann. This happens due to an error in the transformation process from the elevation curves to DEM. To fix this the DEM needs to be edited and it is done with the Raster Editor Tool and following these steps:

- Activate Raster Editor Tool;
- Click on Raster Editor and followed by “Start Editing”;
- Select the shapefile wanted to be edited; in this case, DEM and click on “OK”;
- Click on “Select Edit” button; and,
- Start selecting the cells needed to be edited by changing their values so the drainage flow can be readdressed.
- Redo the catchments with ARCHYDRO to review.

By “resampling” the corrected catchments areas to 1000 x 1000 m grid size, Figure 4-4 resulted.

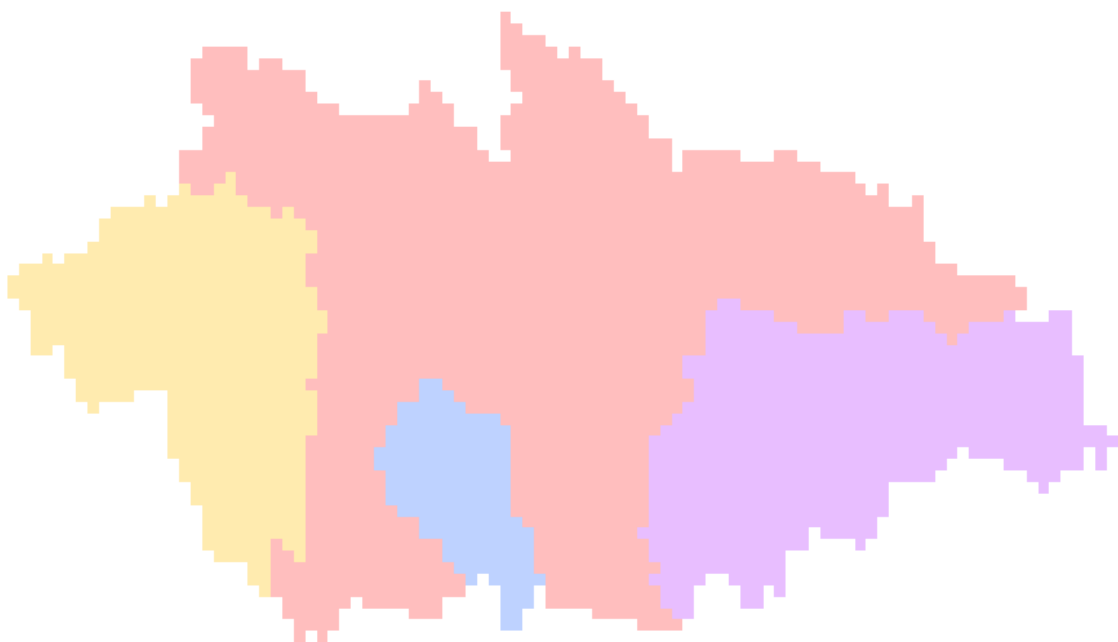

Figure 4-5. Resampled Catchment Area (1000 x 1000m)

- Change catchment value field to HydroID in Layer Properties – Symbology.
- Convert “Polygon to raster” under “conversion tools”.
 - In “value field” assign HydroID.
 - Environment Setting – Process Extents – assign the previous created DEM (1000 x 1000 m)
- Then, convert “raster to float” (conversion tools)

-
- Then “reclassify” (3D Analyst) changing the ID to the corresponding assigned runoff station ID and assign “No Data” field -9999
 - Export data with *.tiff format right clicking on the float file – Data – Export Data
 - Convert *.tiff file to *.rst using SAGAGIS by importing the file in Import/Export - GDAL/OGR – Import raster and then Export raster as shown in Figure 4-3

4.1.3 Lakes

- Open “lakes” in arcmap.
- Select “feature to raster” under conversion tools.
 - Grid size assign 1000.
 - Environment Setting – Process Extents – assign the previous created DEM (1000 x 1000 m)
- Under “conversion tools” convert “raster to float”
- Export data with *.tiff format right clicking on the float file – Data – Export Data
- Convert *.tiff file to *.rst using SAGAGIS by importing the file in Import/Export - GDAL/OGR – Import raster and then Export raster as shown in Figure 4-3

4.1.4 Hydrological data

This format procedure is valid for all the hydrological data that are going to be included as input for ENKI.

- Open *.xlsx file in excel.
- Rearrange the information following table 4-2.
 1. East Coordinate
 2. North Coordinate
 3. Network name
 4. Station name
 5. Station number
 6. Station elevation
 7. Geographic coordinate system
 8. ID
 9. Missing data number assignment
 10. Number of values within the period
 11. Start of hydrological data

Table 4-2. Hydrological *.txt format

1	2	xcoord	562018.56	563144.42	578910.33	611018.89
	3	ycoord	6998268.76	6985539.99	6966858.15	6975228.84
	4	Network	Qstats08	Qstats08	Qstats08	Qstats08
	5	Name	Gaulfoss	Hugdalen bru	Lillebudalen bru	Eggafoss
	6	STNR	122.9.0.1001.1	122.17.0.1001.1	122.14.0.1001.1	122.11.0.1001.1
	7	HOH	60	130	513	285
	8	Refsystem	utm-32n	utm-32n	utm-32n	utm-32n
	9	Point ID	0	1	2	3
	10	Missing	-9999	-9999	-9999	-9999
	11	Nvalues	3397	3397	3397	3397
		01.09.2006	16.78	2.53	3.06	4.55
		02.09.2006	21.24	3.20	2.27	3.80
		03.09.2006	21.94	3.30	5.74	7.25

4.2 MODEL SETUP

Two models were built, for daily data and for hourly data. Both models followed the same procedure to set up.

- Create a new “Region” and assign the corresponding geographic coordinate system and DEM.
- Add Catchment.rst and Lake.rst under Region – Add raster.
- Create a new input database under “Input” and import the hydrological *.txt files. When doing this, 2 files must have appeared under the name Qstats and Qstatselev for example.
- Click on Qstatselev and “Set files” to save the data. Then “Write data” to import the properties to it. This must be done to all the hydrological data.
- Under “Model” select “Change” to add subroutines, as shown in figure 4-6.

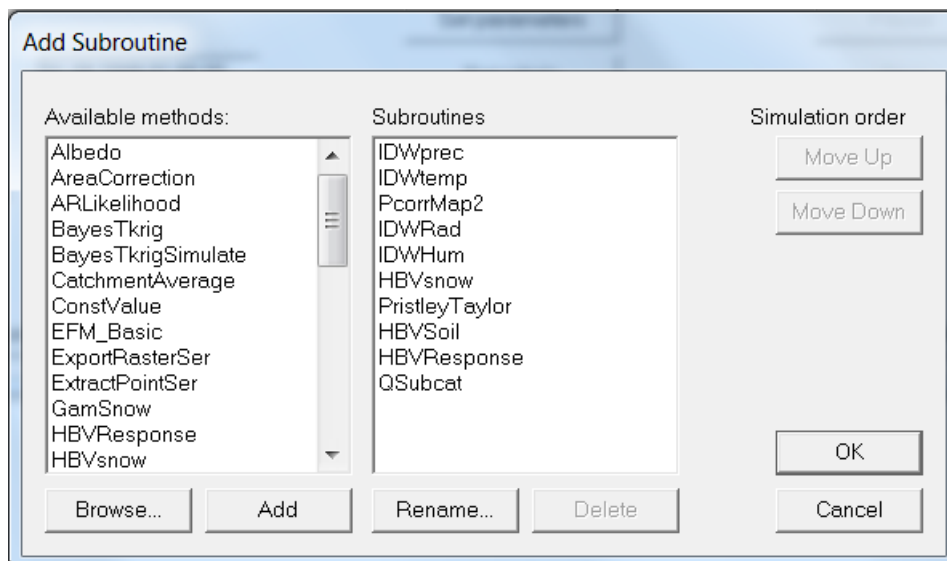

Figure 4-6. Adding subroutines to model

- The subroutines were linked as shown in figure 4-7 and it shows the input and output data for each of them.

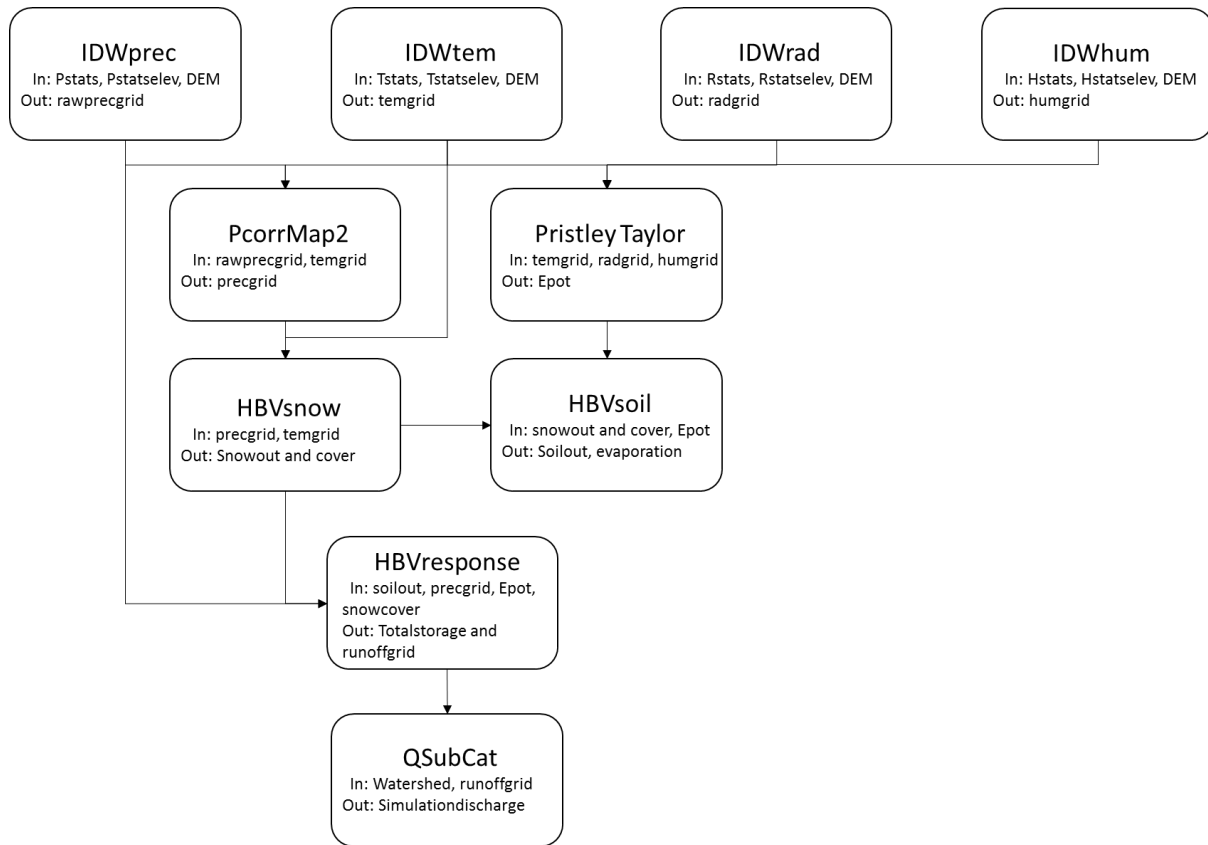

Figure 4-7. Subroutines linkage flow chart.

- Also parameters have to be defined in each subroutine creating a new scalar value and selecting a name for it as shown in figure 4-8
- Click on “set parameters” and add the values following table 4-3.
- Click on “set output” to select the calibration period and the comparison type (Temporal R2) to obtain the correlation between the simulated discharge and the runoff data.

From the period, three (03) sections have been defined:

- 1st section for “burning”
 - Daily data: 2006 – 2007
 - Hourly Data: 2008 – 2009
- 2nd section for “calibration”
 - Daily data: 2007 – 2012

- Hourly Data: 2009 – 2011
- 3rd section for “validation”
 - Daily data: 2012 – 2014
 - Hourly Data: 2011 – 2012

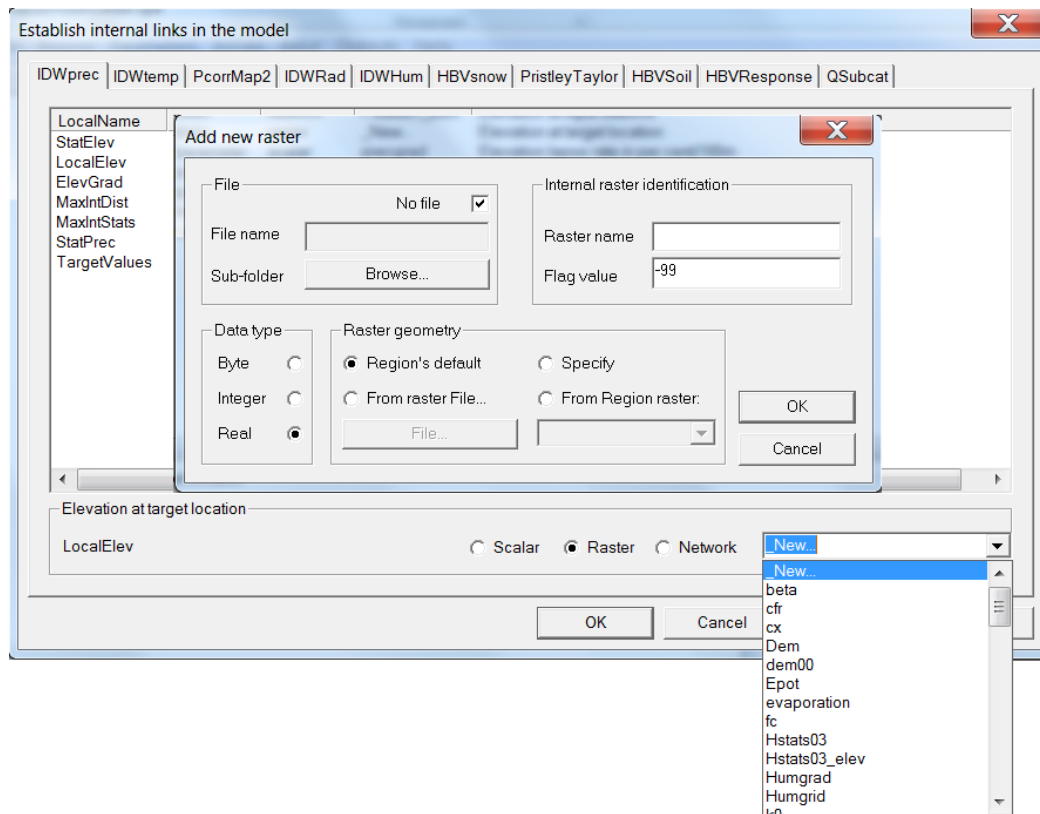

Figure 4-8. Adding parameters.

- Click on “Setup MC Autocal” and add the calibration intervals on the free parameters by selecting “uniform” under “distribution” – table 4-3. Then select the Monte Carlo method SCE-UA which is a “Global shuffled complex evolution. Slow and robust for difficult cases” – “Numerous case studies have demonstrated that the SCE-UA algorithm is consistent, effective, and efficient in locating the optimal model parameters of a hydrological model”(Vrugt et al., 2003)

Table 4-3. ENKI parameter and calibration interval values

Parameter	Description	Value	Calibration Interval
PrecGrad	Elevation lapse rate (percent/100 m)	0	0 10
MaxIntDist	Maximum distance to included station	500000	
MaxIntStats	Maximum number of stations included	23	
Tempgrad	Elevation lapse rate (units/100 m)	-0.65	

Radgrad	Elevation lapse rate (units/100 m)	0		
Humgrad	Elevation lapse rate (units/100 m)	0		
CX	Degree-day factor	4	3	6
CRF	Refreezing coefficient	0.01	0	0.01
TS	Zero-melt temp treshold	0.5	-1	2
TX	Precip type temp treshold	1	-1	2
LW	Maximum liquid content (frac)	0.1	0	1
s00	Snow distribution low limit	2.30		
s25	Snow distribution 25% quartile	1.00		
s50	Snow distribution median	0.90		
s75	Snow distribution 75% quartile	0.80		
s100	Snow distribution high limit	0.30		
LandAlbedo	Albedo of snow free surface	0.1		
PTalpha	Prisley-Taylor alpha parameter	1.26		
FC	Field capacity	200	50	600
LP	Treshold for minimum SM/FC	0.9	0.7	0.99
BETA	Nonlinearity in unsaturated storage	2	1	5
K2	Outlet coefficient quick outflow upper tank	0.3	0.10	0.60
K1	Outlet coefficient slow outflow upper tank	0.1	0.01	0.15
K0	Outlet coefficient outflow lower tank	0.05	0.01	0.10
Perc	Percolation rate from upper to lower tank	0.6	0.50	5
tresh	Treshold height for fast outflow in upper tank	20	10	60
Lakep	Lake portion of catchment (0 - 1)	0.02		
Rcorr	Bias correction factor for rain	1.05	1.05	1.20
Scorr	Bias correction factor for snow	1.2	1.15	1.50

SOURCE. Hydrological models.(Killingtveit and Sælthun, 1995)
SINTEF (Lena Tøfte-10.2014)

- Start calibration by clicking on “MC param run”
- Once the calibration has finished, export results at “output database”
- Use the resulted and selected parameters to validate the data on the third section.

4.3 RESULTS AND DISCUSSION

The calibration ended after approximately 9000 iterations for daily data and 2000 iterations for hourly data. Each of them with a different correlation value corresponding to a unique free parameter set for each of the runoff stations

The results were processed to get the highest correlation for each station and the optimum for the catchment as a whole.

4.3.1 Daily

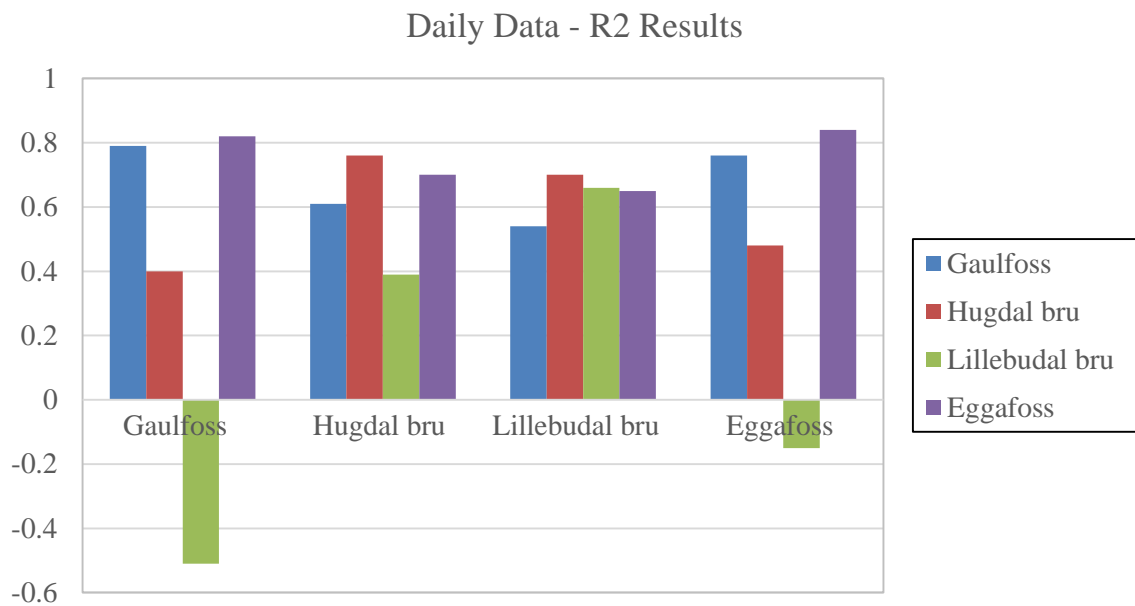

Figure 4-9. Daily Data – R2 Results

Figure 4-9 shows the R2 values of the stations when either of them has the maximum R2 registered. For instance, the first group of columns on the left are the R2 values when Gaulfoss has the highest correlation. As mentioned previously, in section 3, Lillebudal will have a low correlation value when Gaulfoss is analyzed as its maximum. This might have been caused by the lack of information in that zone. Judging by this case, ENKI might have a limitation to model ungauged zones, considering that Hugdal Bru, Lillebudal Bru and Eggafoss are inside of Gaulfoss.

The following figures show the verification done by using the parameters resulted of the calibration and the highest R2 registered for each station. When doing the validation, most of the R2 values drop 10% of the original value; except by Hugdal Bru which validation R2 is 30% lower. This could be because Hugdal Bru's runoff was relatively higher in the first years and lower in the validation period making the correlation to go off.

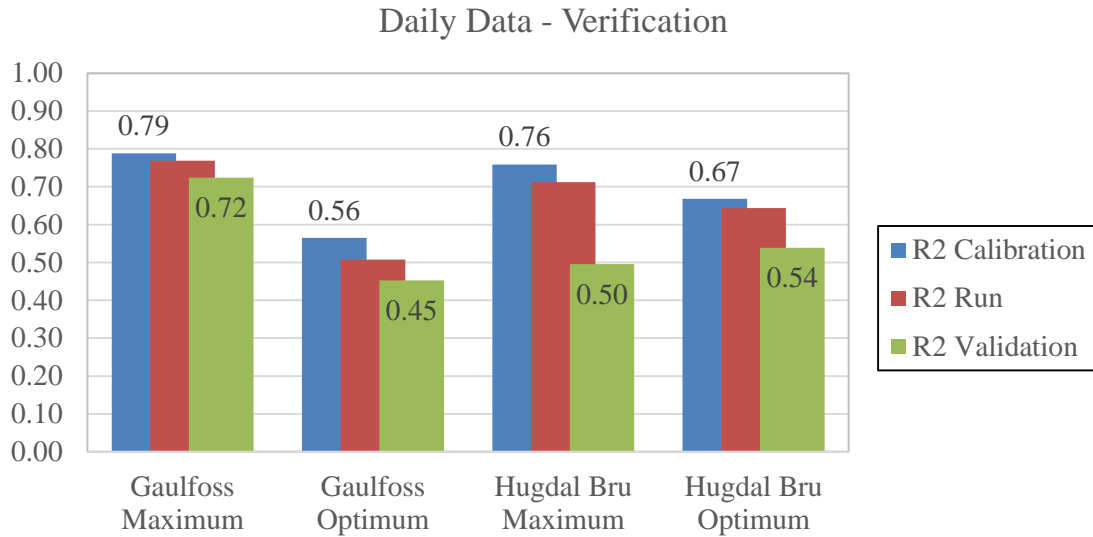

Figure 4-10. Daily Data – Verification (Gaulfoss- Hugdal Bru)

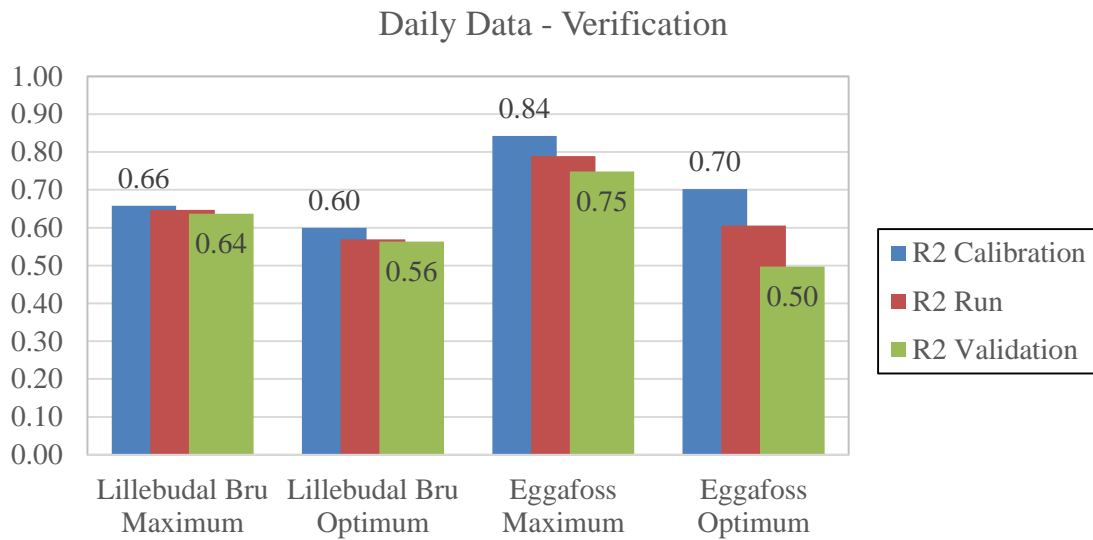

Figure 4-11. Daily Data – Verification (Lillebudal Bru - Eggafoss)

The following figures plot the reference flow against the simulated flow for each stations resulted from parameters corresponding to their highest R2 respectively.

It can be seen that even though the simulated discharge does not meet the highest values from the reference flow, it follows well the behavior of it by having good timing.

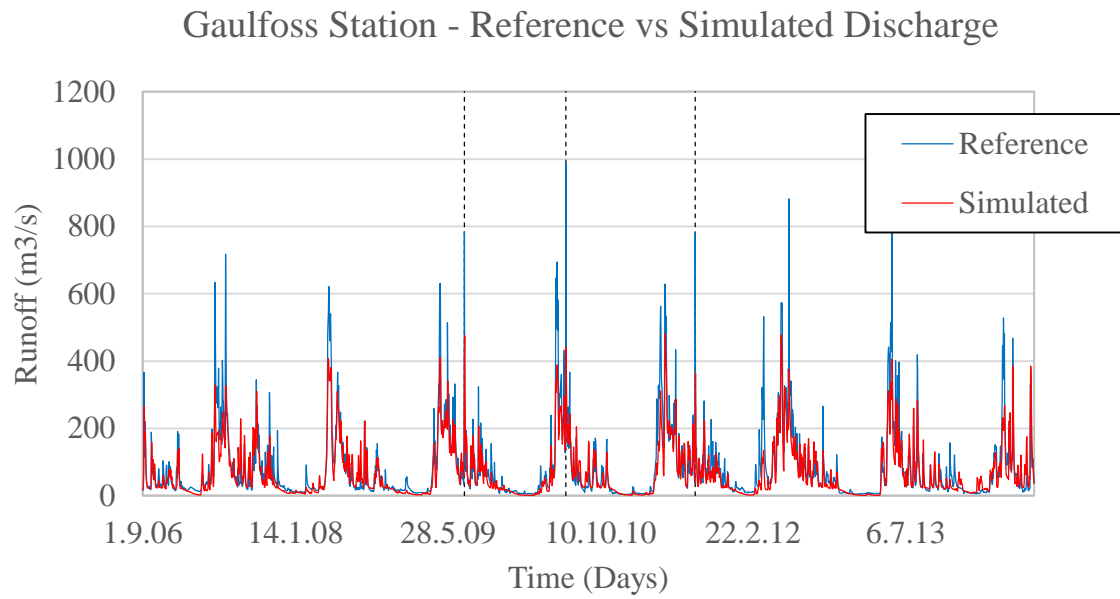

Figure 4-12. Gaulfoss Daily Data – Reference vs Simulated Discharge

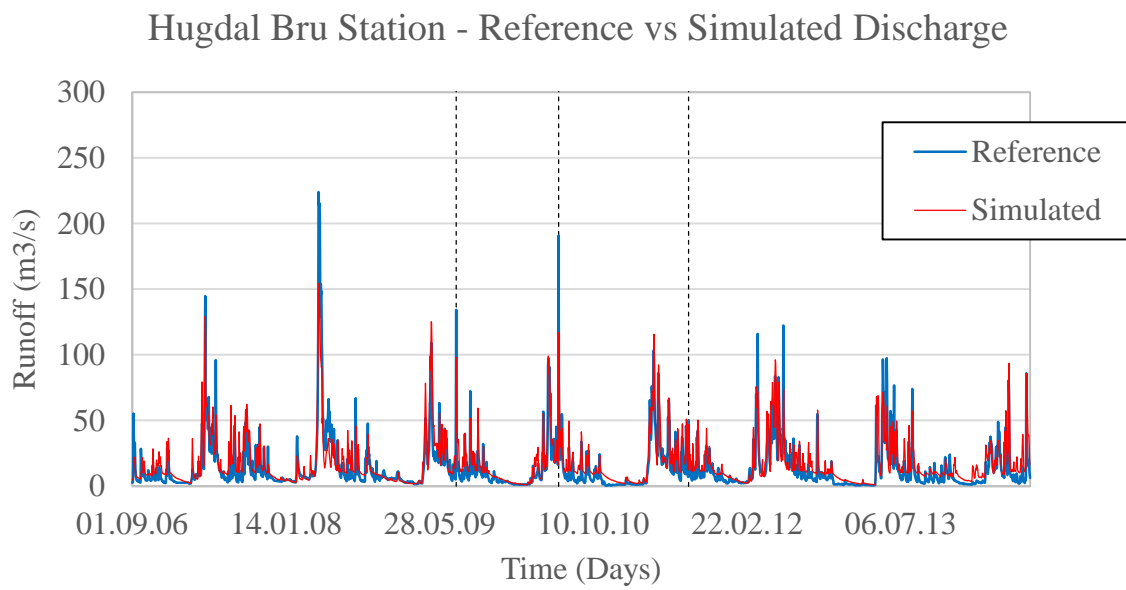

Figure 4-13. Hugdalen Bru Daily Data – Reference vs Simulated Discharge

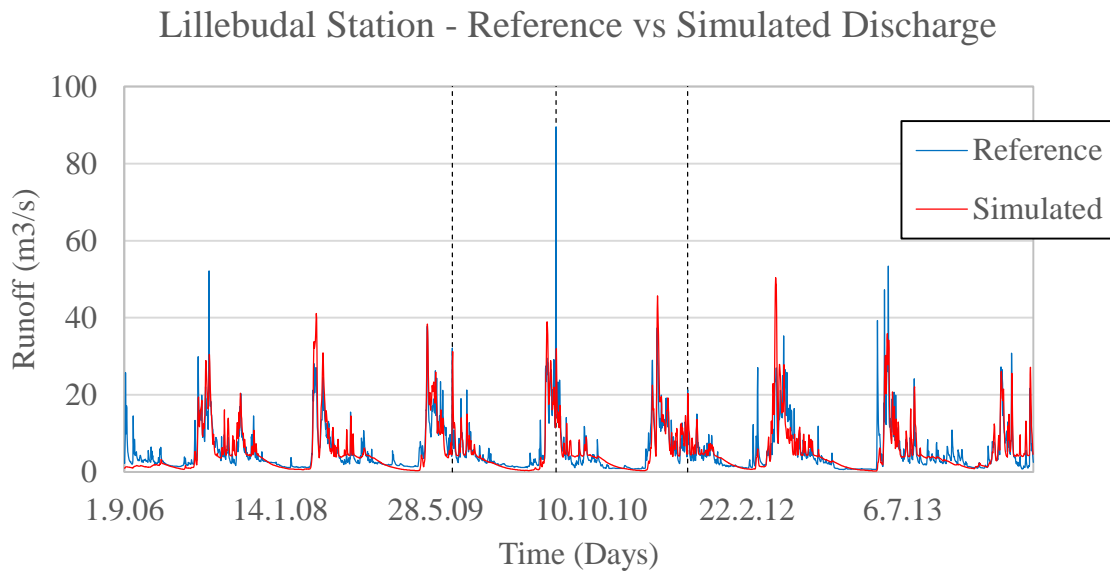

Figure 4-14.Lillebudal Bru Daily Data – Reference vs Simulated Discharge

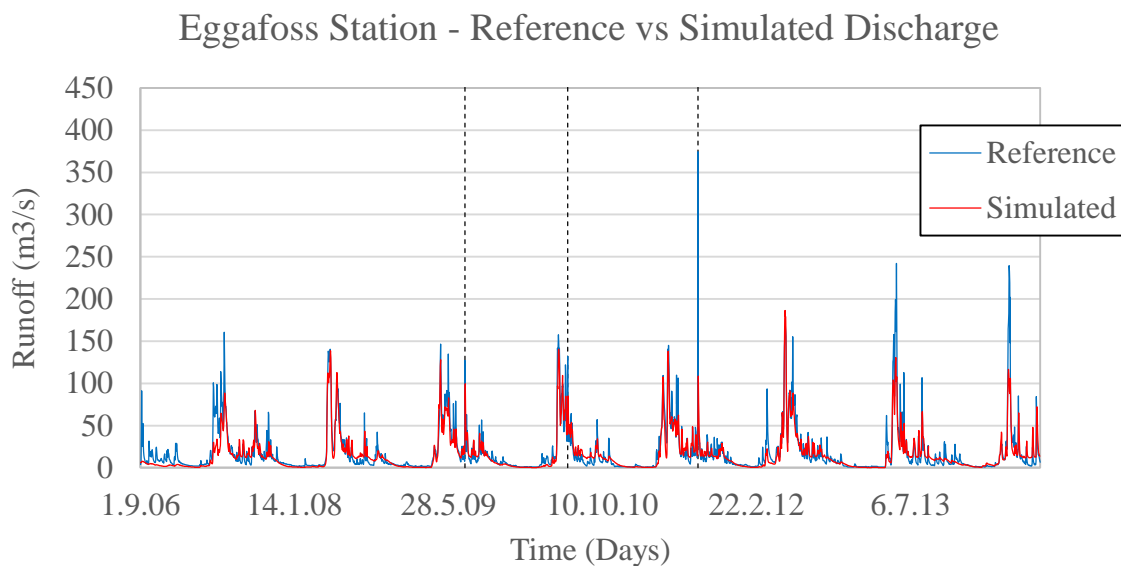

Figure 4-15.Eggafoss Daily Data – Reference vs Simulated Discharge

In figure 4-14 and 4-15, it can be seen that at the beginning of the plot the simulated discharge mismatch to the reference discharge. This might be because of the initial state.

One of the purposes of this thesis is to analysis whether or not ENKI can simulate the behavior of the runoff with the available hydrological data. The following tables summarize how well the simulated discharge reach up to the reference flows in the floods of 2009, 2010 and 2011.

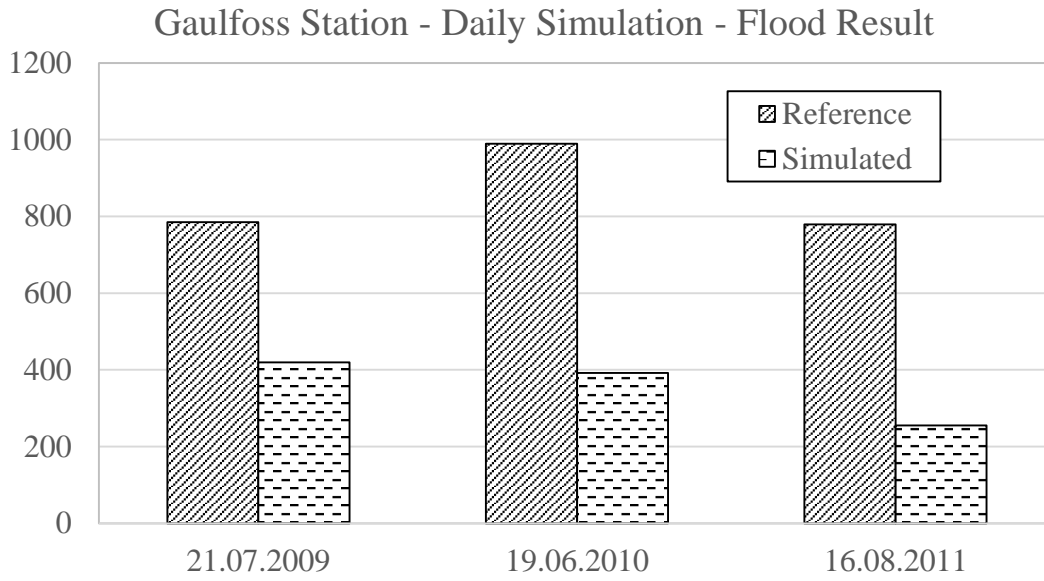

Figure 4-16. Gaulfoss Daily Data – Flood Simulation – Comparison Reference vs Simulated Discharge

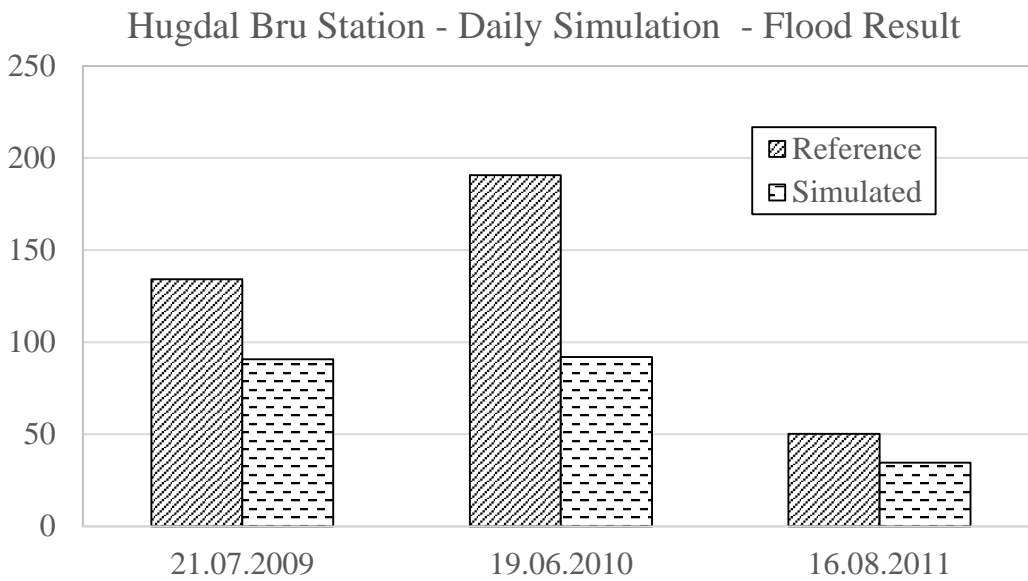

Figure 4-17. Hugdalen Daily Data – Flood Simulation – Comparison Reference vs Simulated Discharge

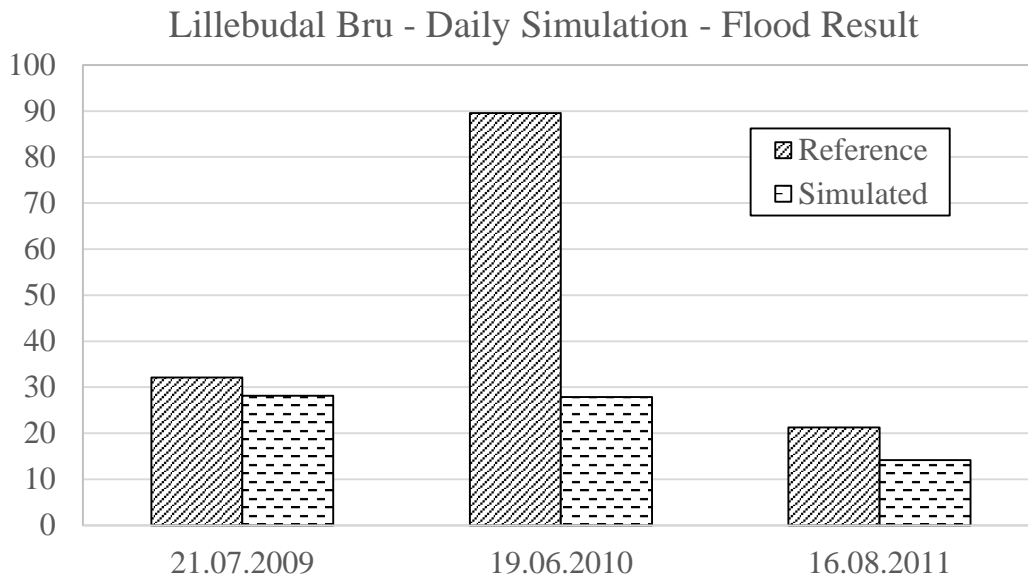

Figure 4-18.Lillebudal Daily Data – Flood Simulation – Comparison Reference vs Simulated Discharge

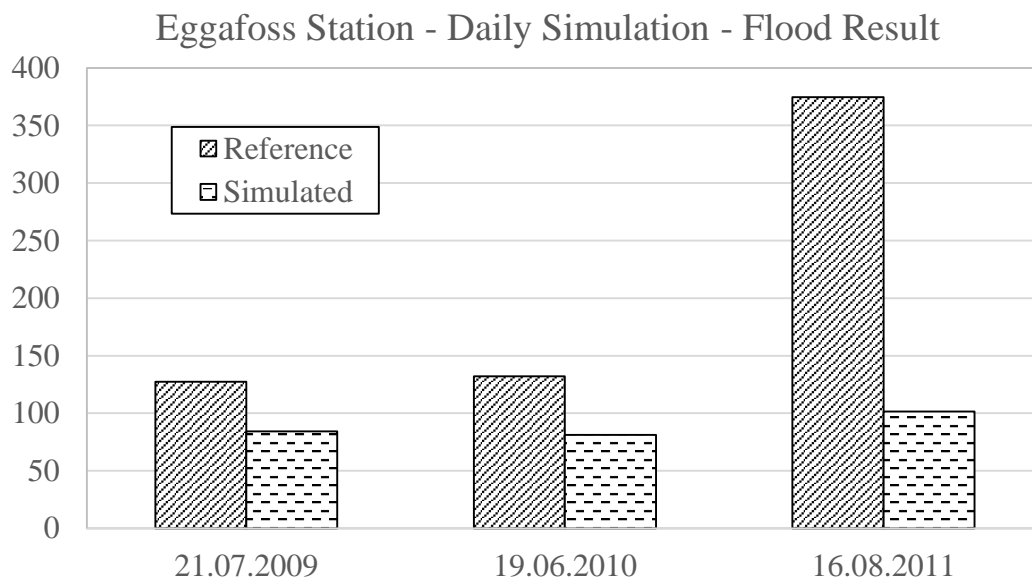

Figure 4-19.Eggafoss Daily Data – Flood Simulation – Comparison Reference vs Simulated Discharge

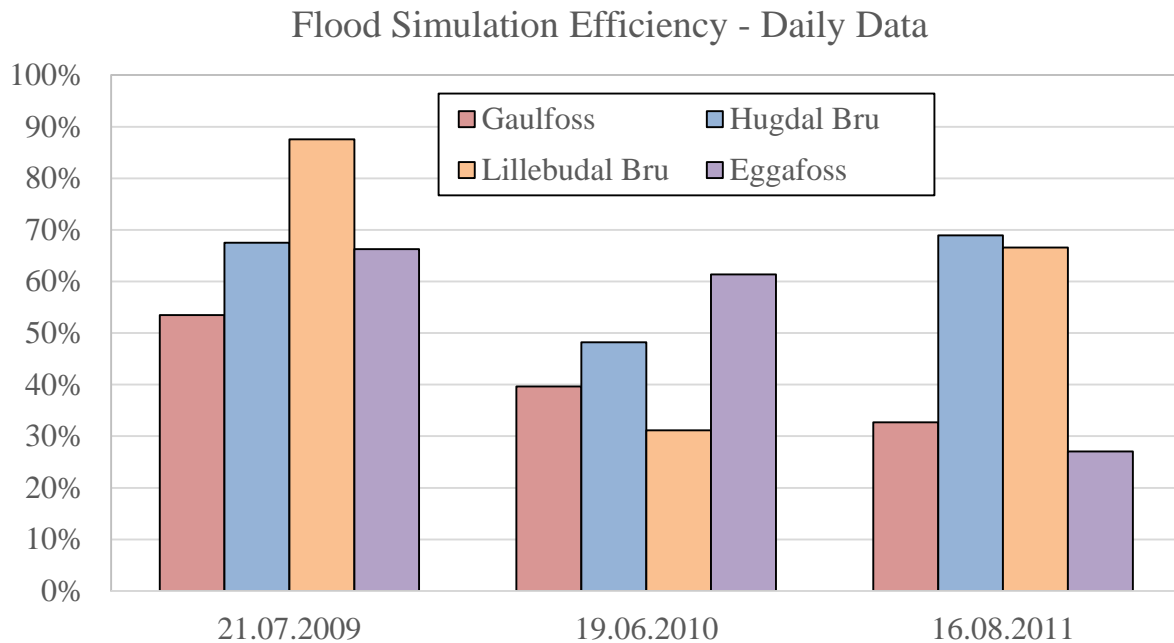

Figure 4-20. Daily Data – Flood Simulation Efficiency

It can be seen from the figures above that in most of the cases the simulation of the flood does not reach 70% of the observed value.

The impact of the 2010 and 2011 floods were highest in Lillebudal and Eggafoss respectively and in none of them the simulated discharge had reached 35% (figure 4-18 and 4-19)

4.3.2 Hourly

Figure 4-21 shows the R2 values of the stations when either of them has the maximum R2 registered. For instance, the first group of columns on the left are the R2 values when Gaulfoss has the highest correlation. As mentioned previously, in section 3, Lillebudal will have a low correlation value when Gaulfoss is analyzed as its maximum. This might have been caused by the lack of information in that zone. Judging by this case, ENKI might have a limitation to model ungauged zones, considering that Hugdal Bru, Lillebudal Bru and Eggafoss are inside of Gaulfoss.

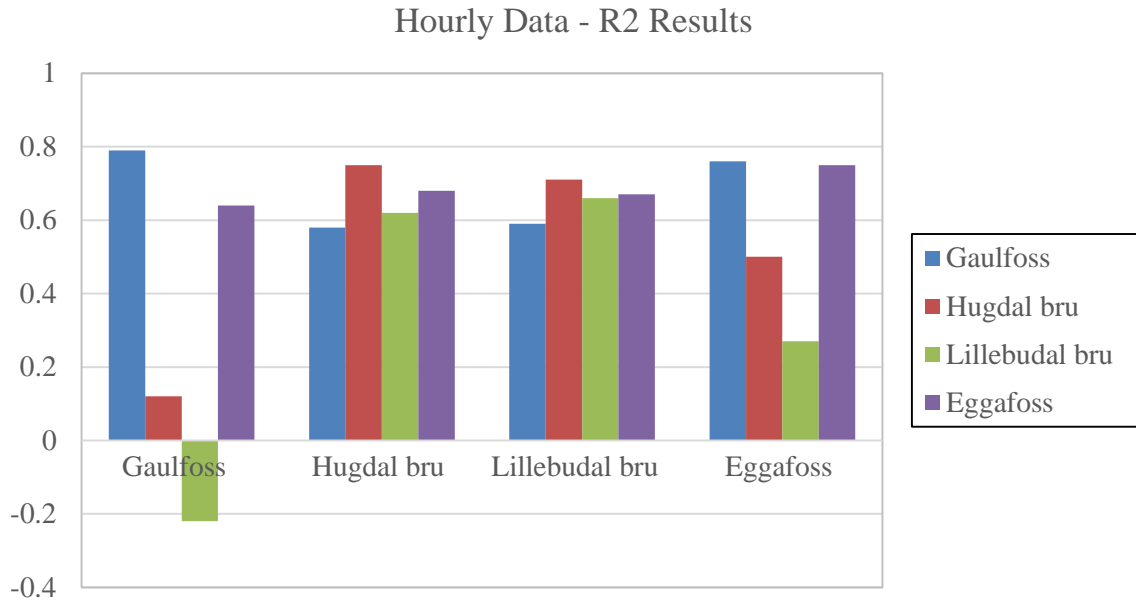

Figure 4-21.Hourly Data – R2 Results

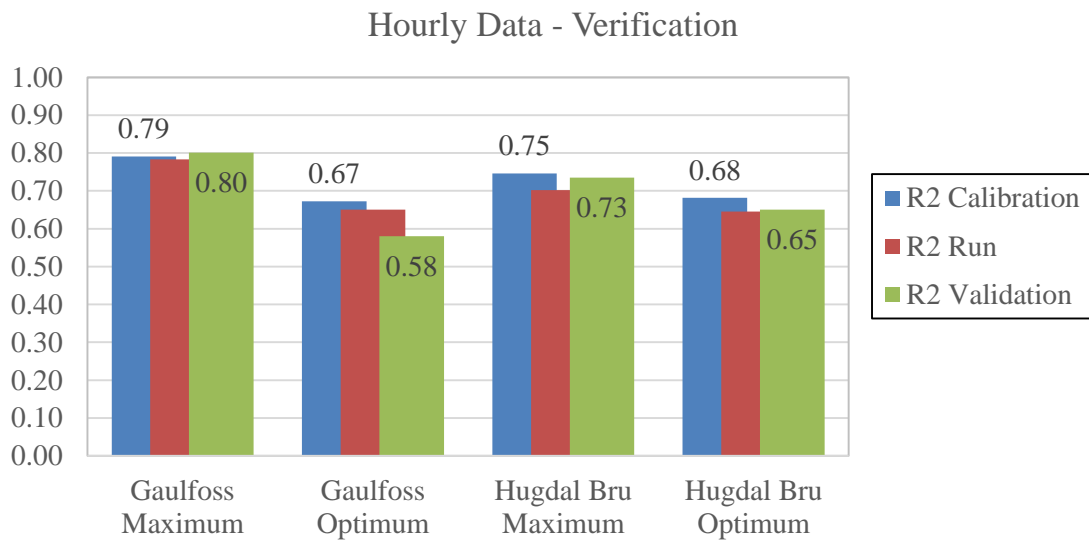

Figure 4-22.Hourly Data – Verification (Gaulfoss- Hugdal Bru)

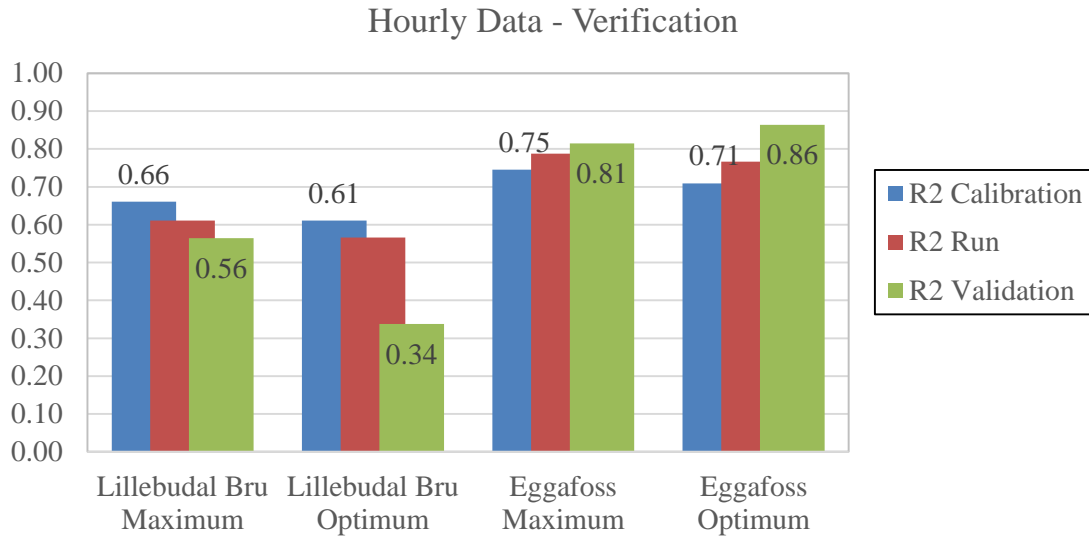

Figure 4-23.Hourly Data – Verification (Lillebudal Bru - Eggafoss)

The validation of the hourly data in the period of 2011 and 2012 is within the 10% of drop from its original value. In the hourly case, it can be seen in some cases the correlation in the validation period goes up as seen in figure 4-23 when Eggafoss has the highest R2.

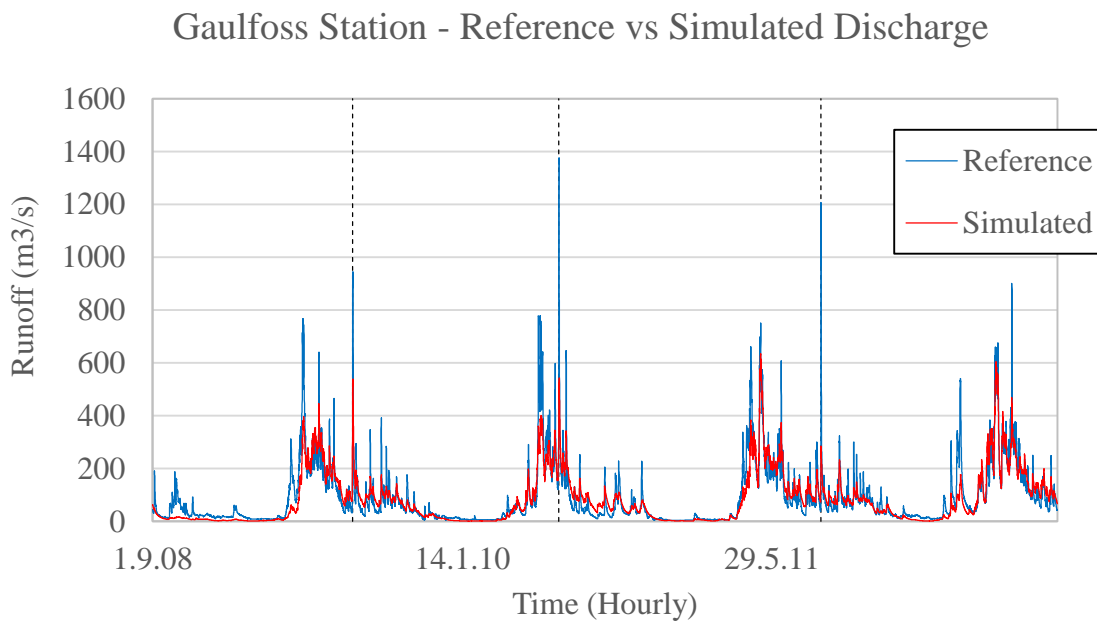

Figure 4-24.Gaulfoss Hourly Data – Reference vs Simulated Discharge

Hugdalen Bru Station - Reference vs Simulated Discharge

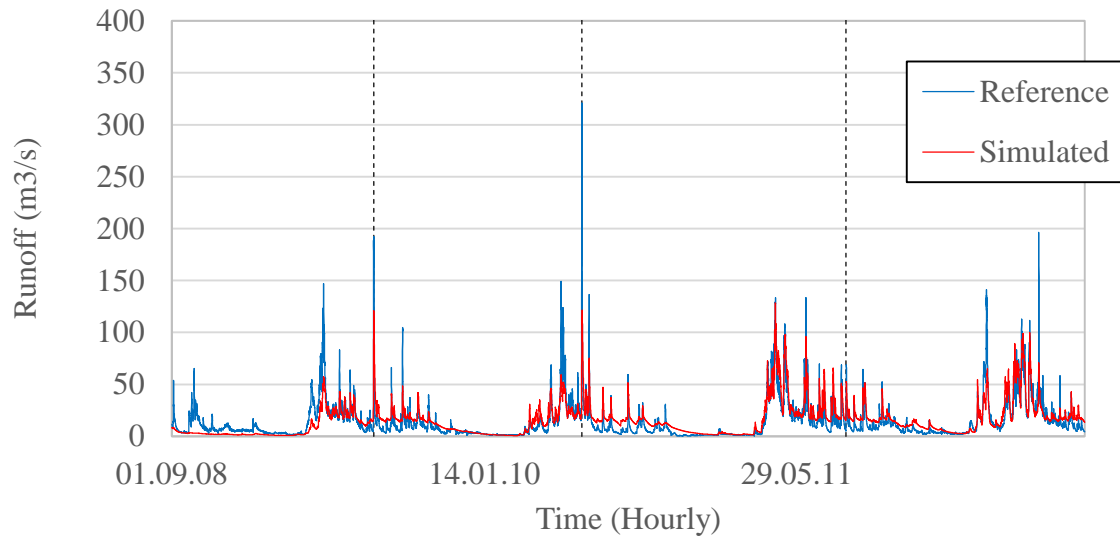

Figure 4-25. Hugdalen Bru Hourly Data – Reference vs Simulated Discharge

Lillebudalen Bru Station - Reference vs Simulated Discharge

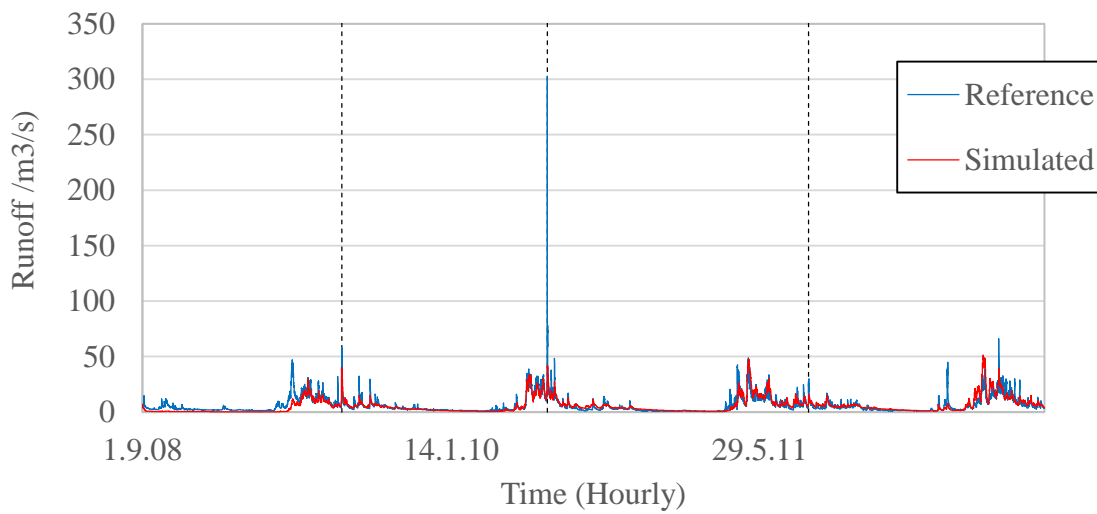

Figure 4-26. Lillebudalen Bru Hourly Data – Reference vs Simulated Discharge

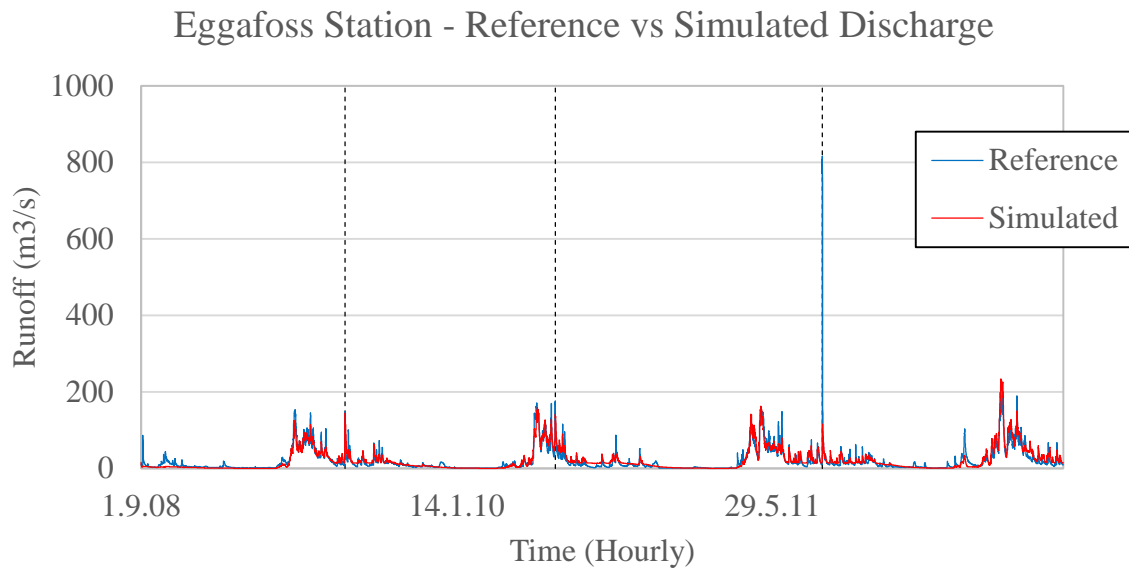

Figure 4-27. Eggafoss Hourly Data – Reference vs Simulated Discharge

Figures 4-24 to 4-27, plot the reference flow against the simulated flow for each stations resulted from parameters corresponding to their highest R2 respectively.

It can be seen that even though the simulated discharge does not meet the highest values from the reference flow, it follows well the behavior of it by having good timing.

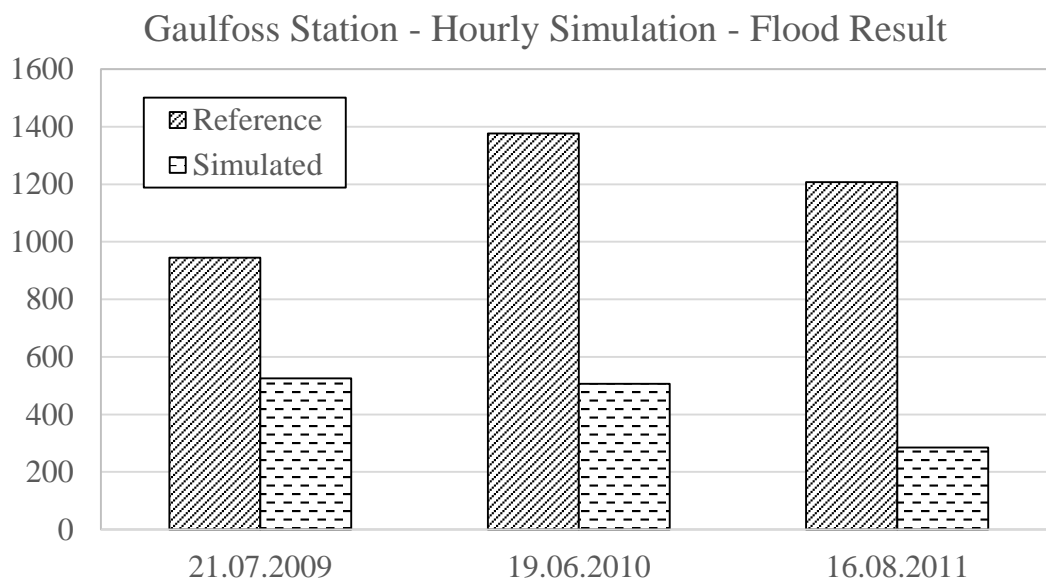

Figure 4-28. Gaulfoss Hourly Data – Flood Simulation – Comparison Reference vs Simulated Discharge

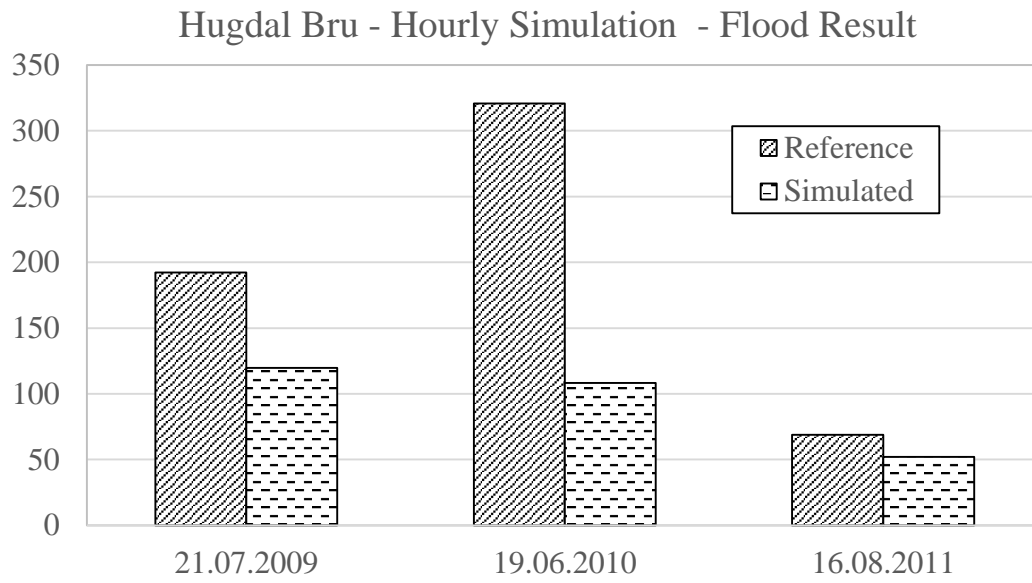

Figure 4-29. Hugdalen Bru Hourly Data – Flood Simulation – Comparison Reference vs Simulated Discharge

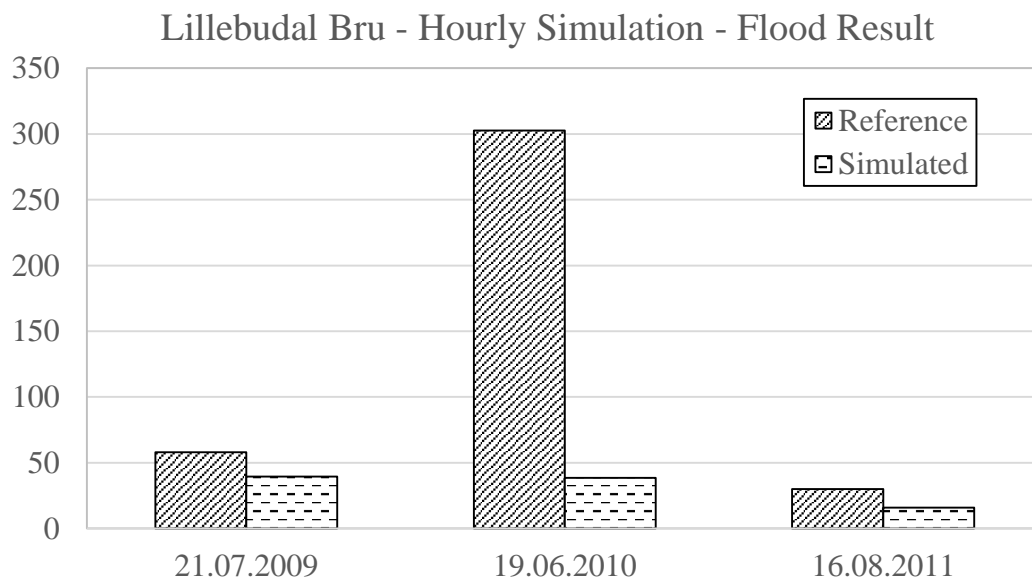

Figure 4-30. Lillebudalen Bru Hourly Data – Flood Simulation – Comparison Reference vs Simulated Discharge

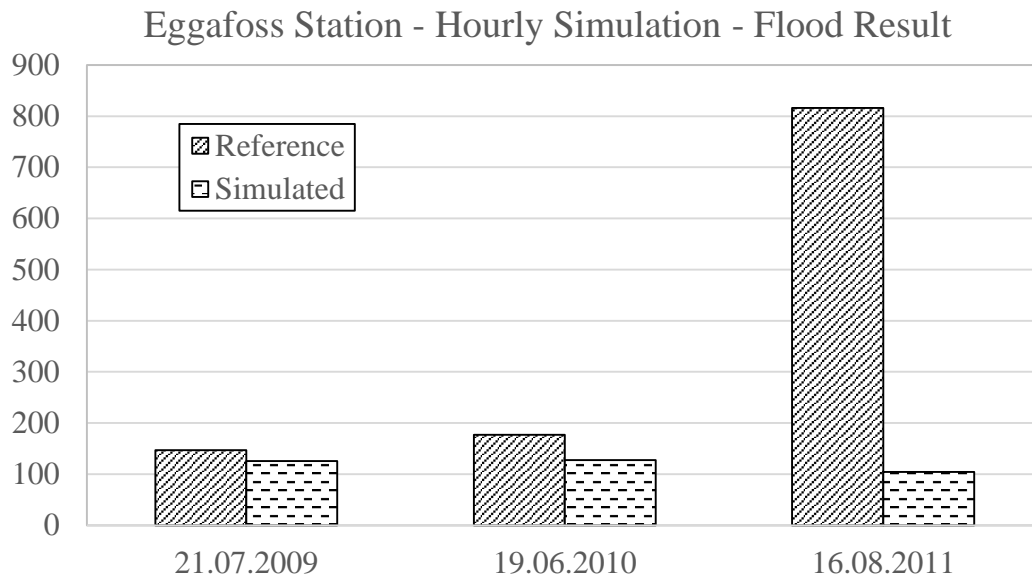

Figure 4-31. Eggafoss Hourly Data – Flood Simulation – Comparison Reference vs Simulated Discharge

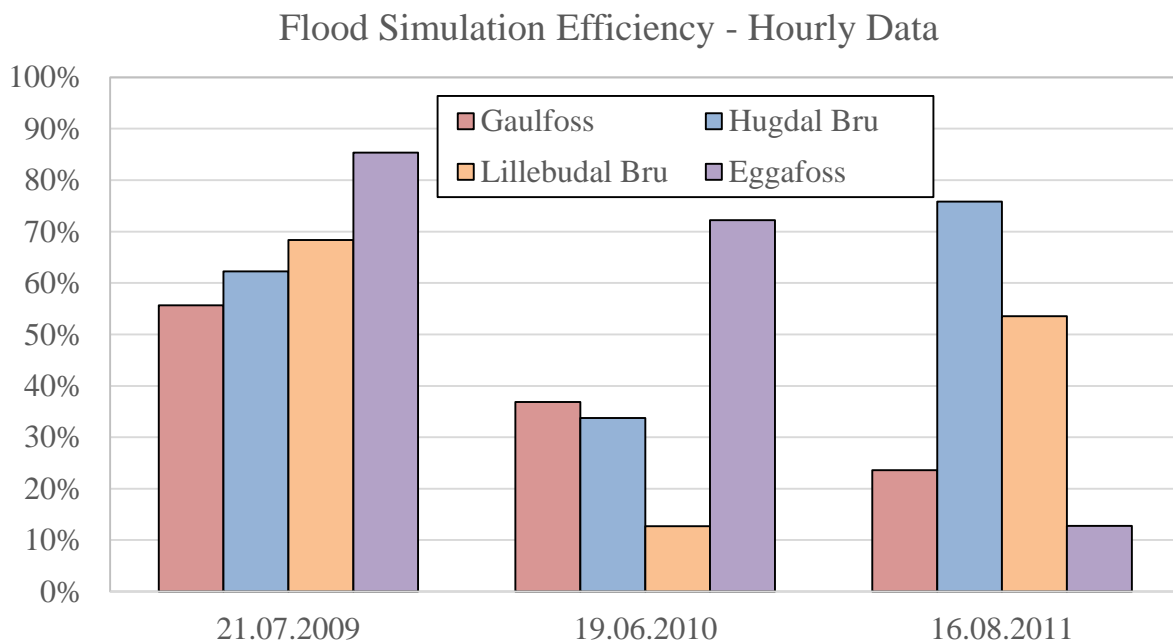

Figure 4-32. Hourly Data – Flood Simulation Efficiency

It can be seen from the figures above that in most of the cases the simulation of the flood does not reach 60% of the observed value.

The impact of the 2010 and 2011 floods were highest in Lillebudal and Eggafoss respectively and in none of them the simulated discharge had reached 15% (figure 4-30 and 4-31)

This could lead us to think that the ENKI does not do a good simulation flood wise.

4.3.3 Radar data

In the other hand, radar data for precipitation from the flood of 2011 has been acquired. A comparison between this and the collected hourly precipitation data has been done. To do this, the radar data was imported into arcmap and georeferenced, in this way the actual location of the study place can be seen in the radar data map, as shown in figure 4-33.

A simple comparison was made based on the values on the observed precipitation data and the radar data according to the intensity per hour for the 2011 flood.

This new data was inserted in the complete hourly precipitation and simulated in ENKI with the parameter set which Eggafoss station got the highest correlation. Eggafoss was selected because the 2011 flood has a large impact in this catchment compared to Hugdal Bru and Lillebudal Bru.

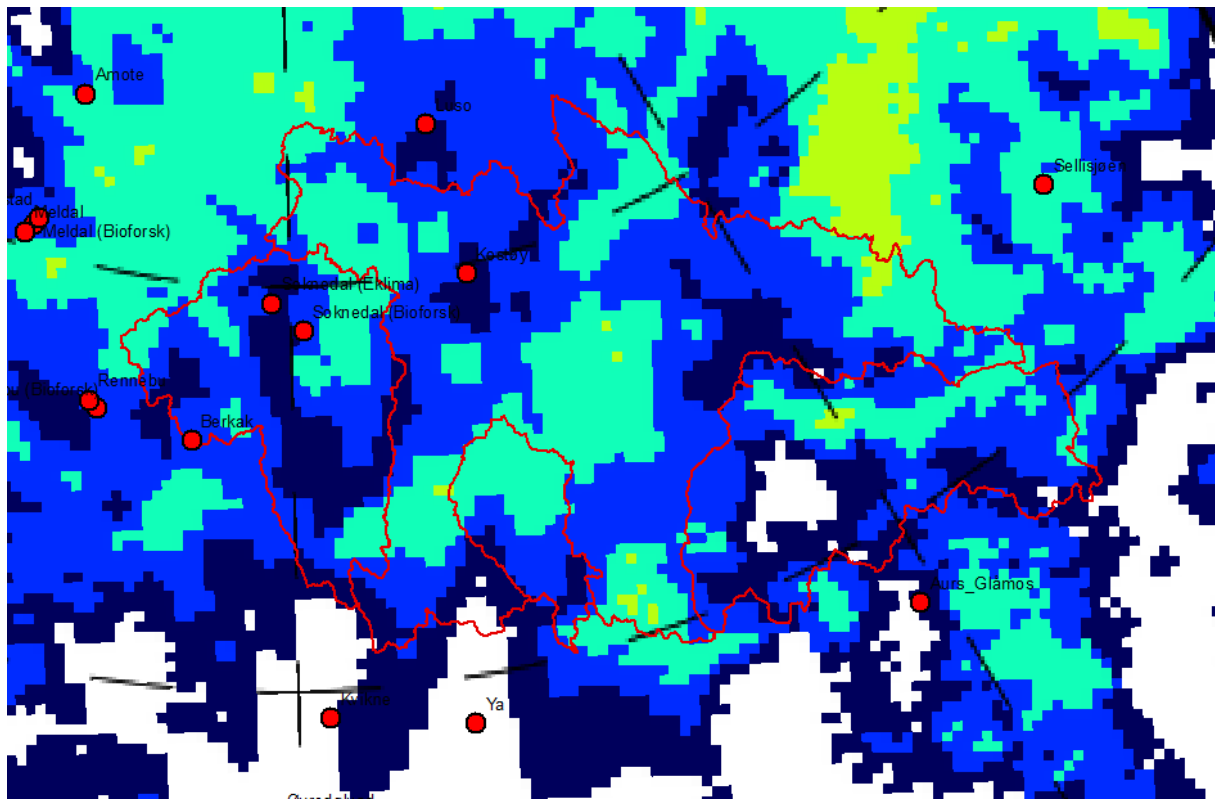

Figure 4-33. Radar Data Overlapped with Study Place's Catchments Areas

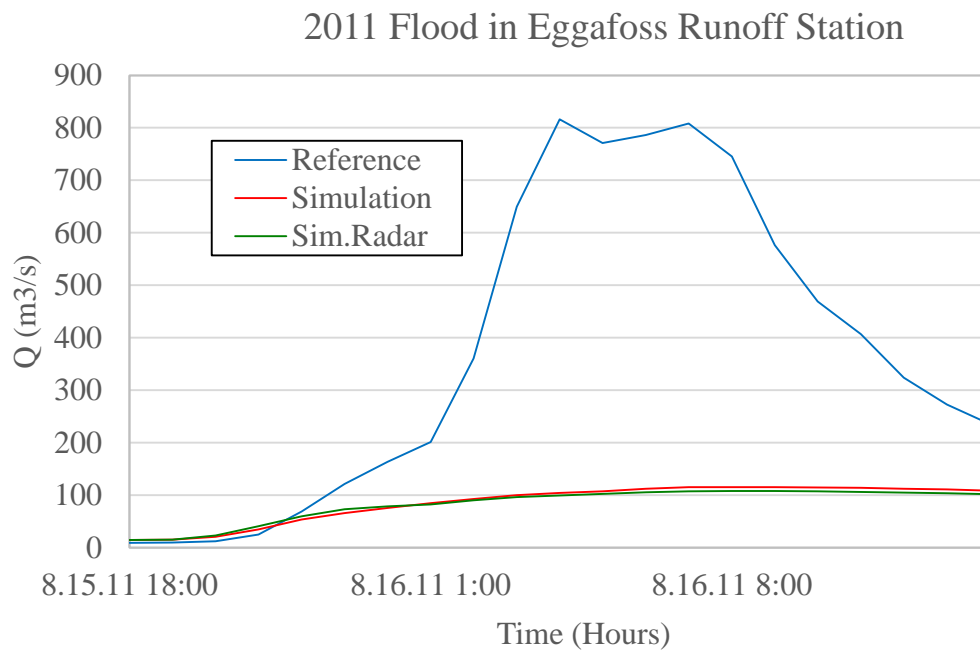

Figure 4-34.2011 Flood in Eggafoss Runoff Station

It can be seen that even though the hourly precipitation data close to the zone of Eggafoss catchment was increased, it doesn't not reflect a notable change in the simulated discharge. The reason could be that even when the data from the precipitation stations were changed they still are just points and they won't get the variations of the storm around it.

5 NMAG MODELLING

In 1993, Gaula waterway was protected against hydropower utilization under the Verneplan IV for vassdrag (IV Conservation Plan for Waterways). But previous in the 80s, a plan was built in order to study the hydropower potential in this area (Habberstad, 1984).

As part of the study, the hydropower development plan described on Samla Plan was reproduced in nMag. The objective is to study the behavior of the reservoirs and if it help in damping the impacts of 2009, 2010 and 2011 Floods in the area.

5.1 SAMLA PLAN DESCRIPTION

A total of 10 power plants and 15 reservoirs have been identified and considered in the study for Gaula waterway (Habberstad, 1984) shown in table 5-1

Table 5-1. Hydropower Units and Reservoirs

Power Plant	Reservoir	LRV (masl)	HRV (masl)	Volume (MCM)
	Inntaksmag.*	635	648	1.5
Reitan	Nersjøen	805	809.5	2.5
	Busjøen	836	848	16.5
	Holdsjøen	837	846	6
Svølja	Inntaksmag.*	290	325	10
	St.Bellingsjø	945	950	4
Holta	L.Bellingsjø	703	707	2
	Bellinga	545	557	9
	Holta	390	415	17
Øyungen	Øyungen	786	789	18
Øvre Fora	Øvre Fora	830	860	180
Singsås	Rå	550	600	51
Rognes	Inntaksmag.*	145	146	0.5
Stavilla	Ila	470	495	32
Gaulfossen	Inntaksmag.*	45	50	1.5

* It is the impoundment created by the intake

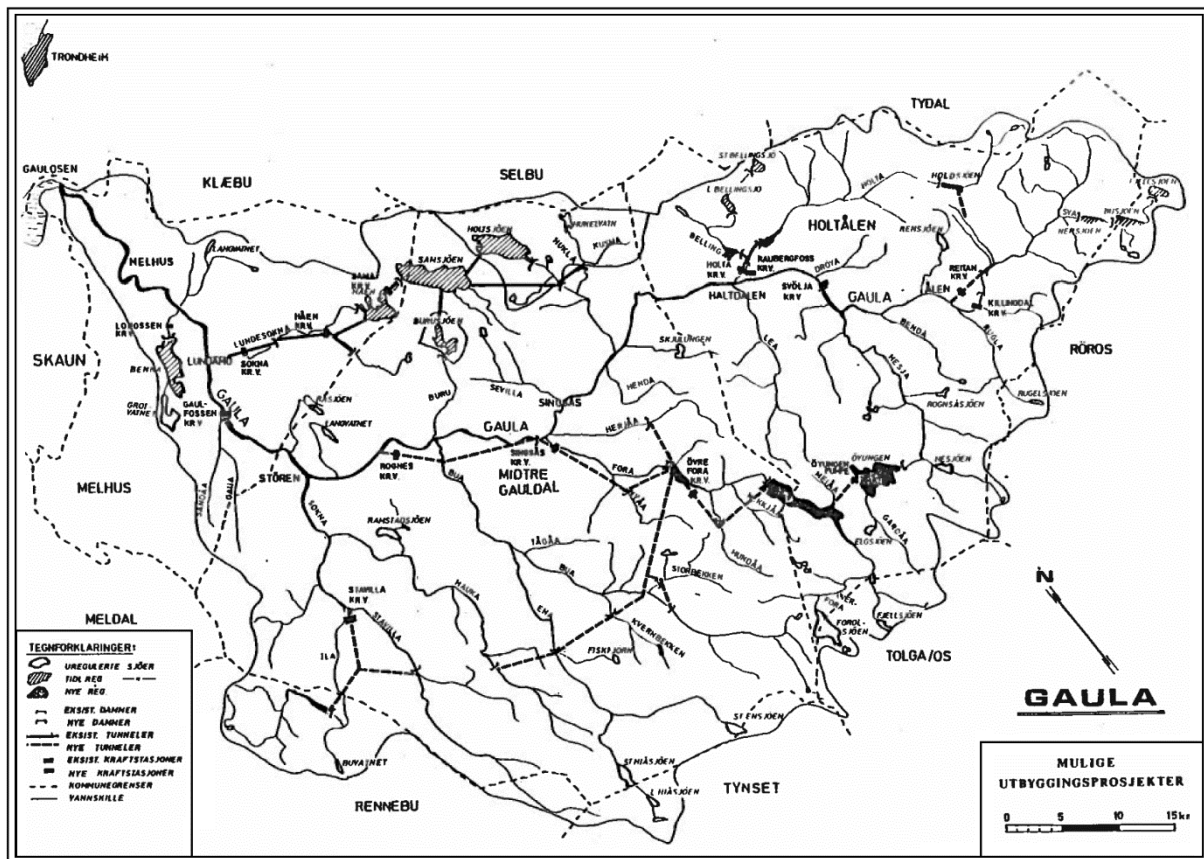

Figure 5-1. Samla Plan for Gaula sketch (Guttormsen, 1984)

Figure 5-1 shows the network for existing and potential hydropower plants back in 1982

In this opportunity, the network formed by Øyungen - Øvre Fora and Singsås power plant are going to be modelled in nMag due to their reservoirs having the larger storage capacity therefore a highest chance in flood damping.

5.2 INPUT DATA

The input data for nMag includes:

- Daily runoff data;
- Description of reservoirs and power plants; and,
- Network connection.

5.2.1 Daily runoff data

Daily runoff data from Hugdal Bru, Lillebudal Bru and Eggafoss were formatted to be compatible with nMag platform. It requires the information to be in *.prn file (formatted text – space delimited) and a “key” which is located in the first line of each file. This “key” helps nMag the way to read the compiled information.

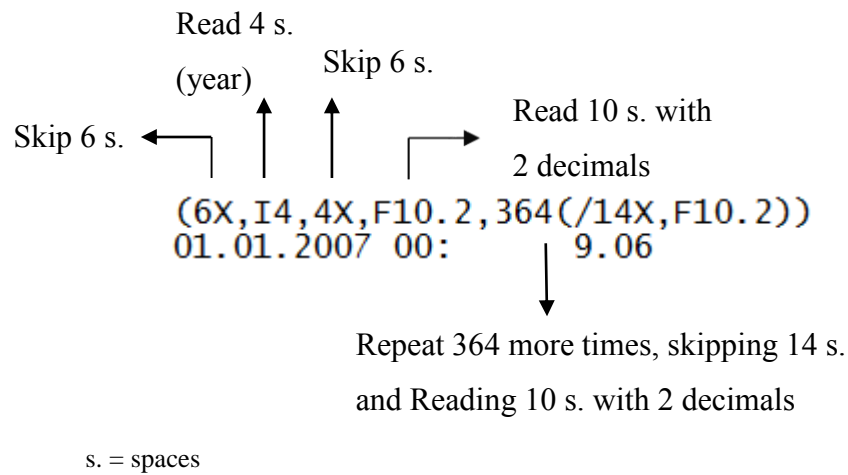

5.2.2 Description of reservoirs and power plants

Based on Samla Plan (Habberstad, 1984), figure 5-2 shows the network between the hydropower plants and reservoirs.

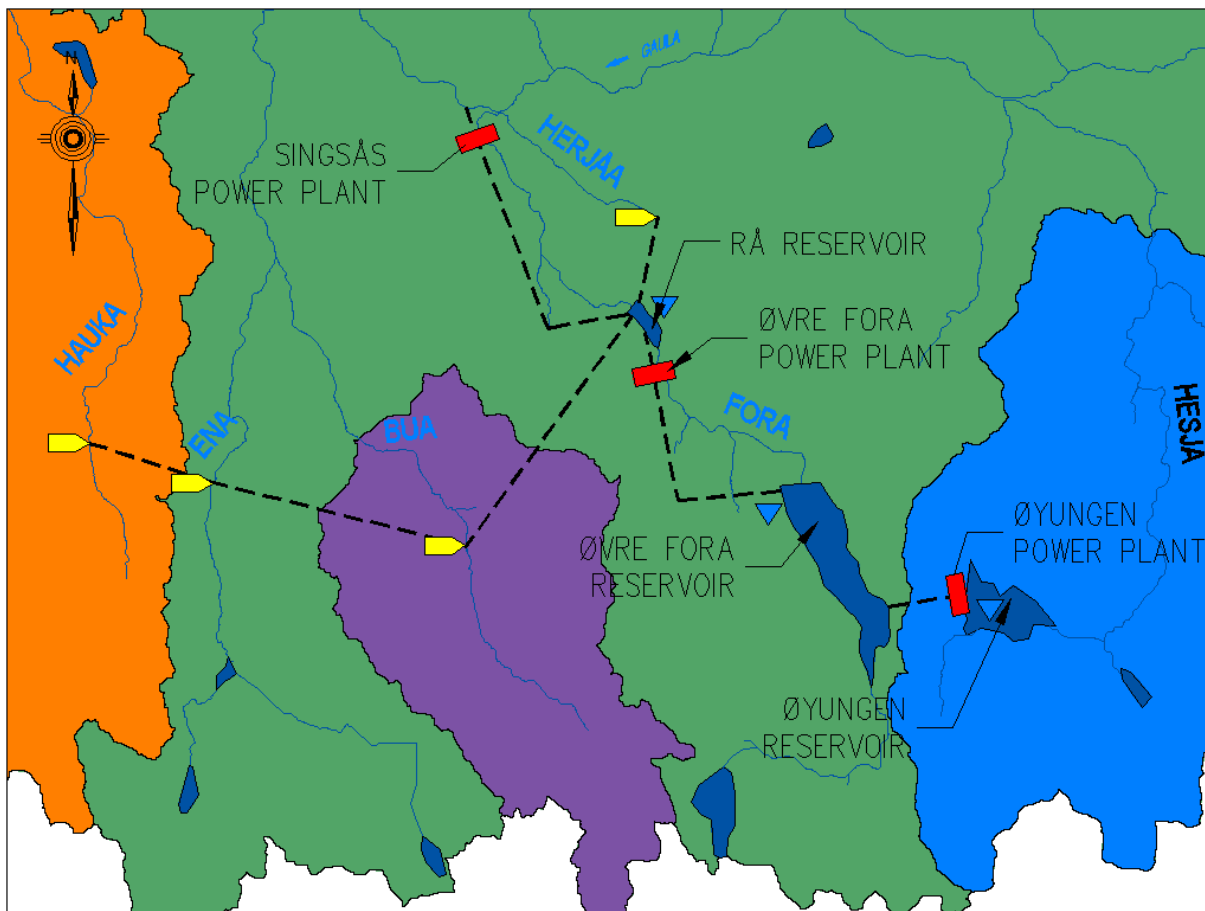

Figure 5-2. Sketch of Hydropower Development 1982 – Samla Plan

It can be seen that Øyungen power plant delivers water from Øyungen reservoir to Øvre Fora reservoir and then to Rå reservoir through Øvre Fora power plant. Rå reservoir store the water from four (04) transfer locations - Hauka, Ena, Bua and Herjåa rivers, the flow coming from Øvre Fora power plant and the local catchment which end up in Gaula river passing by Singsås power plant.

Description for the reservoirs, power plants and transfers are shown in table 5-2, 5-3 and 5-4, respectively.

Table 5-2. Reservoirs Description

Reservoir	LRV (masl)	HRV (masl)	Volume (MCM)
Øyungen	786	789	18
Øvre Fora	830	860	180
Rå	550	600	51

Table 5-3. Hydropower Plants Description

Power Plant	H (m)	Q (m ³ /s)	P (MW)
Øyungen	74	6	3.9
Øvre Fora	266	30	70
Singsås	443	30	116.5

Table 5-4. Transfer Description

Name	Q (m ³ /s)
Hauka	13
Ena	32
Bua	30
Herjåa	14

By looking at the reservoir description, it can be seen that the elevation of Øyungen reservoir is lower than the elevation of Øvre Fora. This is because Øyungen delivers water to Øvre Fora in flooding season.

Øvre Fora power plant will run through the year except on spring which will work as a pump to get water from Rå reservoir to Øvre Fora reservoir.

The data required by nMag for reservoir was shown in table 5-2 while the required for the power plants is shown in table 5-5.

Table 5-5. Transfer Description

Power Plant	H	Q	P (MW)	EEKV	H intake	H tailwater	k*
Øyungen Pumpe	74	6	3.9	0.181	780	712	0.0014
Øvre Fora Pumpe	266	30	70	0.648	825	564	0.0022
Singsås	443	30	116.5	1.079	545	107	0.0028

* Headloss Coefficient

The following equations (Pennington, 1998) were used to obtain the values for EEKV and k.

$$EEKV = \frac{P(kW)}{3600Q}$$

$$k = \frac{h_f}{Q^2} \quad h_f = f \frac{1000LV^2}{2gD} \quad n = \left(\frac{D}{4}\right)^{\frac{1}{6}} \sqrt{\frac{f}{8g}}$$

Where:

EEKV = Energy equivalent

k = Headloss coefficient

h_f = Headloss due to friction

f = Darcy-Weisbach friction factor

L = Conduit length

V = Mean velocity

g = gravity acceleration

D = Diameter of conduit

n = Manning number

It also requires an annual discharge for the reservoirs and transfer locations. As mentioned in the section 3.7 Catchment Area, specific runoff and area of catchments were obtained with Lavvann on these locations, shown in figure 3-9. Table 5-6 summarizes the calculation of the annual discharge and the value to enter in nMag.

Table 5-6. Area, Specific Runoff and Annual Discharge

Name	Area (km ²)	Specific Discharge (l/s/km ²)	Mean Discharge (m ³ /s)	Annual Discharge (MCM)	nMag
Øyungen	87.6	24.9	2.2	68.8	68.8
Øvre Fora	128	25.2	3.2	101.7	101.7
Rå	233.7	29.4	6.9	216.7	115.0
Hauka	49.6	25.5	1.3	39.9	39.9
Ena	169.6	27.8	4.7	148.7	148.7
Bua	88.3	28	2.5	78.0	78.0
Herjåa	27.9	40.6	1.1	35.7	35.7
CtrlPoint	316.7	29.8	9.4	297.6	80.9

5.2.3 Network connection

Figure 5-3 shows the flow chart between the hydropower units, reservoirs and transfers. It worth noting that on spring flood Øvre Fora stops producing to pump water from Rå to Øvre Fora reservoir.

The number corresponding to each unit represents the module number which is going to be used to assign the destination of the release flow, bypass flow and spill flow, and it is shown in table

Table 5-7. Module Numbers and Flow Destination

N ^o	Reservoir	Release	Bypass	Spill
1	Øyungen/Øyungen	2	8	8
2	Øvre Fora/Øvre Fora	3	3	3
3	Rå/Singsås	8	8	8
4	Hauka	3	3	3
5	Ena	3	3	3
6	Bua	3	3	3
7	Herjåa	3	3	3
8	CtrlPoint	0	0	0

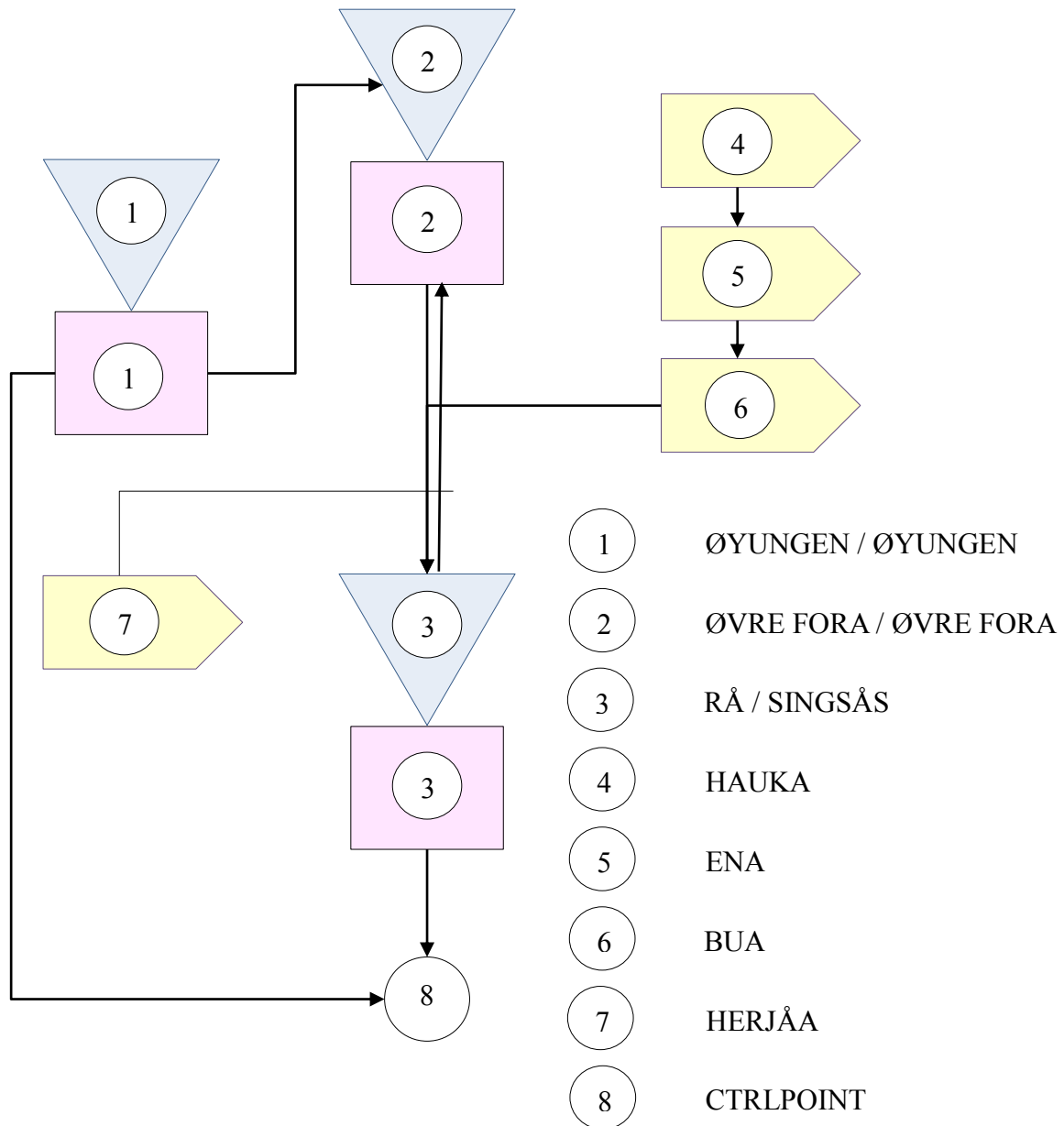

Figure 5-3. Hydropower Development Flow Chart

5.3 MODEL SETUP

The platform of nMag is friendly and the procedure to set up the model is straight forward:

- Open nMag and in “File” create a new file.
- To enter the data, click on “ParamEdit” and select the type of unit and enter the information collected in the previous section (reservoirs, power plant, interbasin transfer and control point).
- NMag does not have a unit for pump, so a variation in the network was made so it can work as required. Instead of transferring water to Rå; Hauka, Ena, Bua and Herjåa are

going to transfer it to a “dummy” reservoir/hydropower unit called Fora Pumpe with module number 10. Fora Pumpe is going to release to Øvre Fora reservoir and the bypass and spill flow directed to Rå reservoir. The data for this module is the same as Rå/Singsås unit except by the storage capacity which is 1MCM

- In “restriction data”, a setting is made for Fora Pumpe. It will release all the available flow as bypass in the year except on spring (day 120 – day 180). It means that in those days it will pump to Øvre Fora reservoir.
- In “operational strategy”, strategy to manage the reservoir has been made.
 - In the case of Øyungen and Rå, a guide curve specification has been assumed and included where the reservoir is going to be emptied by day 120 to receive the flow from the spring floods and filled up by the day 180.
 - In the other hand, Singsås needs to stop producing during the pumping of Fora Pumpe (day 120 – day 180) so a release specification has been configured so.
 - The same way for Fora Pumpe, release specification has been configured with the difference that it will work between day 120 and day 180 and stops the rest of the year (when it will bypass the flow to Rå reservoir)
- In “hydrological data”, the runoff data have to be imported by inserting the stations and typing the name of the runoff station and the file’s extension (*.prn) and assign it to each module. The average annual runoff is needed because nMag is going to scale the runoff data to the one of the respective module.

After the variations, a new network chart flow is built as shown in figure 5-4.

- In “job control” click in “new simulation” and configure the “text output level” by adding the module number to be shown at the resulting *.txt file.
- Click on “simulate”

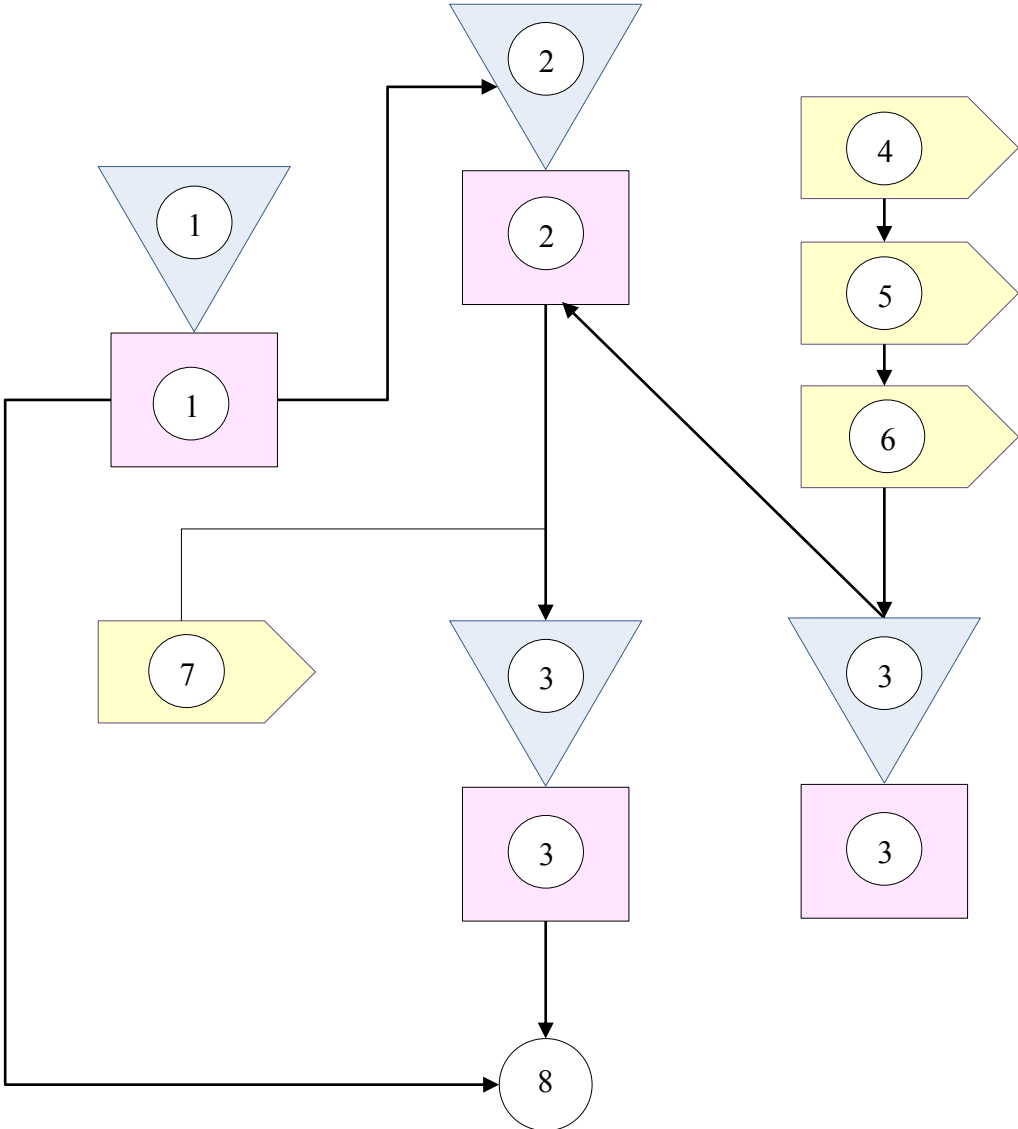

Figure 5-4. Hydropower Development Flow Chart – Variation

5.4 RESULTS AND DISCUSSION

Once the simulation is done, the results were processed focusing on the reservoir behavior resulting figure 5-5, 5-7 and 5-9.

In figure 5-5, it can be seen the behavior of the Øyungen reservoir elevation follows the guide curve specification (dashed line) catching the spring flood in its impoundment. Except for one point where it spills which it coincides with the flood of august 2011 (figure 5-6). According to the results, the inflow at 16.08.2011 was 43.49 m³/s but the spill was registered on the next day which means that the mentioned inflow was stored entirely in the reservoir. It is worth to note that the 2011 flood carried a lot of damage nearby Gaula for its intensity.

As it is, Øyungen reservoir might have been able to damping the flood affecting its watershed but the conditions downstream will remain the same since the watershed area for Øyungen is barely 15% of Eggafoss and the mitigated flood by Øyungen was 12% of the highest registered in Eggafoss.

To know if a good located reservoir with the appropriate storage will be able to mitigate the flood of 2011, evaluations have to be done by studying alternatives.

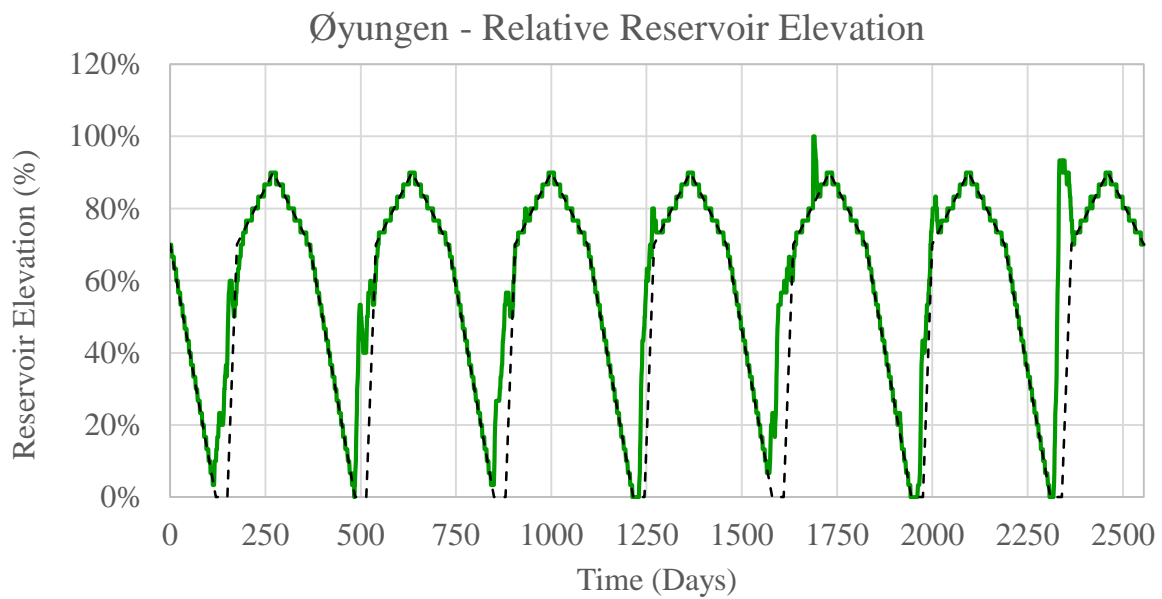

Figure 5-5. Øyungen Relative Reservoir Elevation

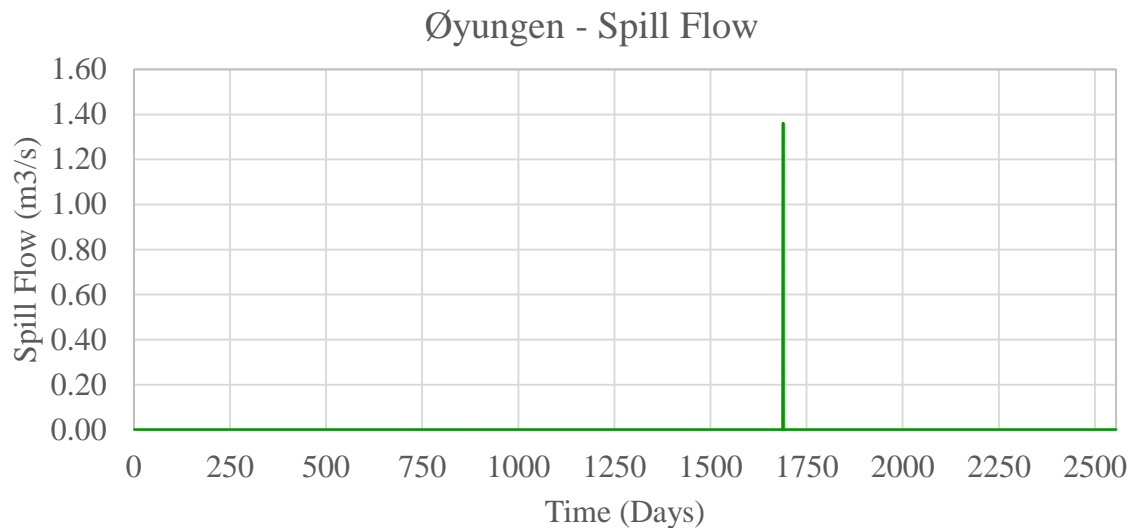

Figure 5-6. Øyungen Spill Flow

Øvre Fora reservoir which stores water from Øyungen, Rå (pump) and transfers from Hauka, Ena, Bua and Herjåa has the potential of damping flood because of its storage. In figure 5-7 can be seen the reservoir level on Øvre Fora, having spilling moments shown in figure 5-8.

The spills are received in Rå reservoir which behavior is described in figure 5-8 and the resulting spills (figure 5-9). Even though, spills were registered at Øvre Fora, these were stored at Rå's and there were no spills in the latter except on June 2010 which coincides with that years flood.

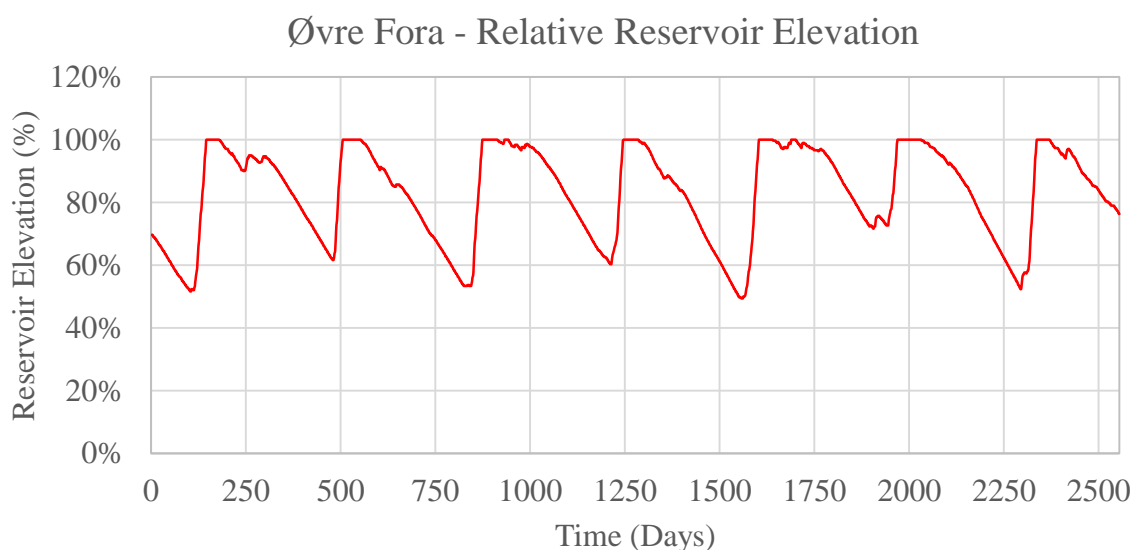

Figure 5-7. Øvre Fora Relative Reservoir Elevation

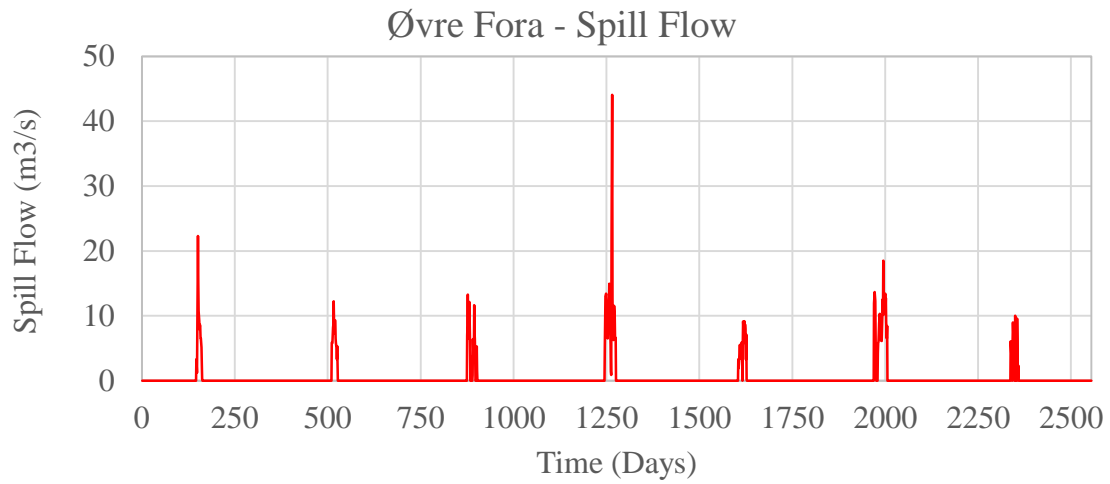

Figure 5-8.Øvre Fora Spill Flow

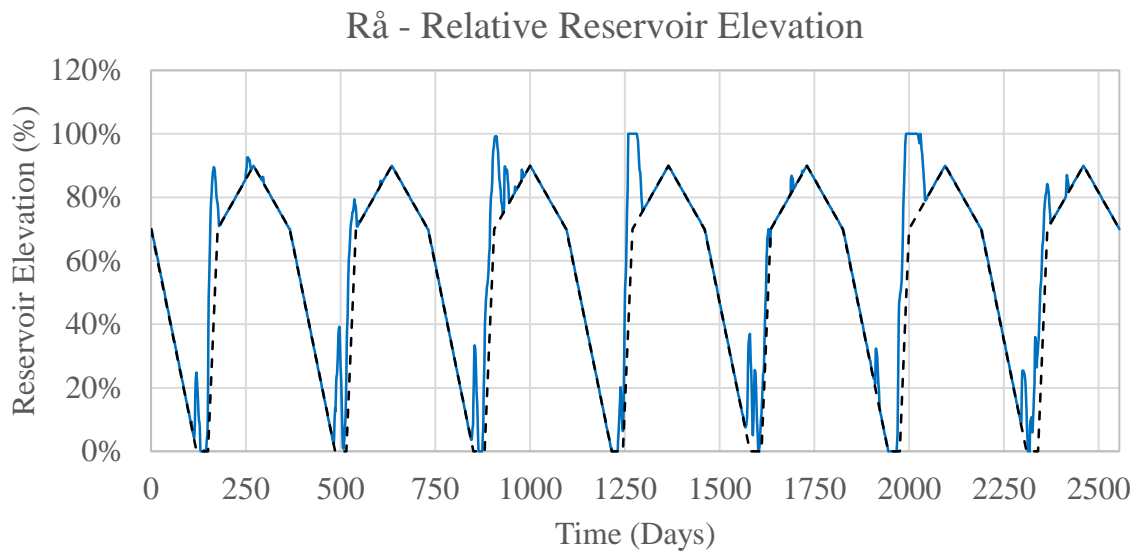

Figure 5-9.Rå Relative Reservoir Elevation

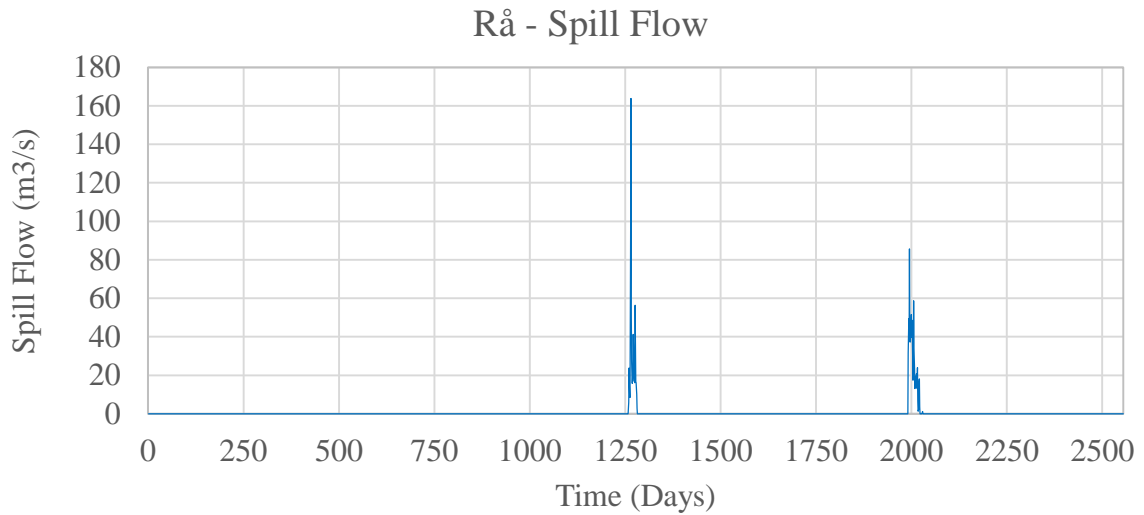

Figure 5-10.Rå Spillway

The following figure shows the flow at the Ctrlpoint before and after the introduction of the hydropower units. It can be seen that on regular years the system get to reduce the flow in the spring time while increasing it the rest of the year, except of the flood of June 2010.

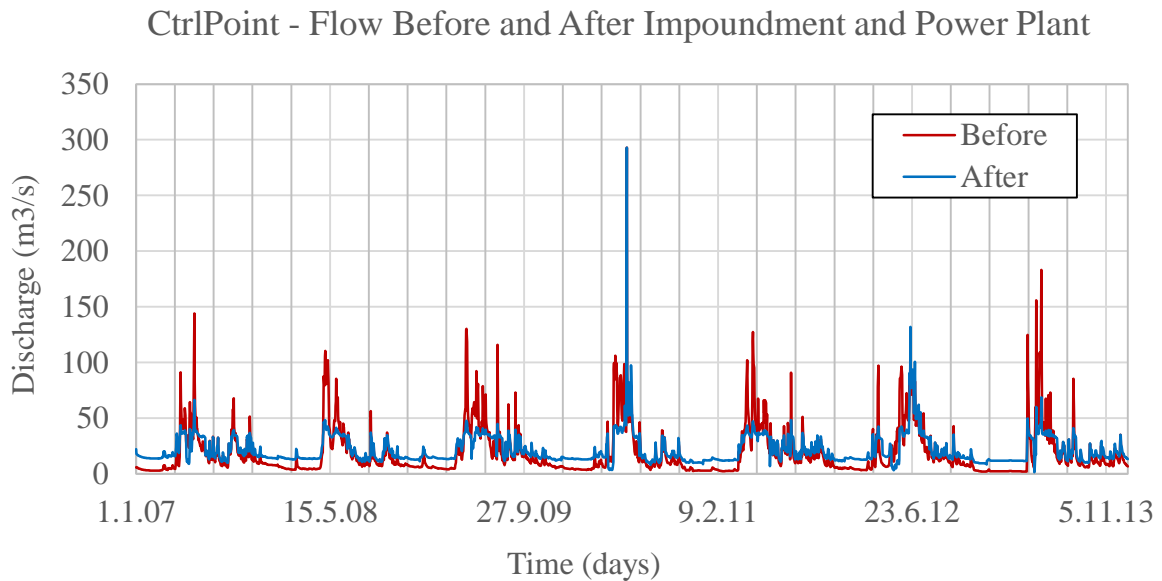

Figure 5-11.CtrlPoint – Flow Before and After Impoundment and Power Plant.

It worths to note that Samla plan system, beside from generating energy, it helps to damping the regular spring floods but the floods like the one in 2010 and 2011, where the intensity is big and the duration time is short.

To always think of damping a flood of this magnitude will imply to keep the reservoirs level at their lowest always, because the timing for these kind of flood is uncertain, which will decrease the soundness and viability as a hydropower project.

6 CONCLUSIONS AND RECOMMENDATIONS

6.1 DATA COLLECTION, QUALITY AND ANALYSIS

From the point of view of the data collection, it is very important to not just obtain the larger number of hydrological stations as possible but take a good time to analyze it visually isolated or by comparing it to another station, like the case of Hugdal's hourly runoff data which in some period has a larger runoff than Gaulfoss station which was downstream and it is located at Gaula river which Sokna was just a tributary.

By knowing the location distribution of the stations, one could anticipate some results which is the case of Lillebudal catchment where there is no presence of daily nor hourly data stations and it could be the reason why it had a bad performance when using Gaulfoss parameters sets to simulate its discharge.

6.2 ENKI MODELLING

While preparing the input data in arcmap, like the catchments it is recommended to draw a catchment by yourself or use Lavvann if applicable. So it can be contrasted to the one obtained in ARCHYDRO. If not, measures have to be taken to ensure that the used data is correct.

It is worth to remain that the raster type data like DEM, lakes and catchments have a 1000 x 1000 m grid size which will reduce the accuracy of the results. It would take and really large amount of time otherwise to run or calibrate, making it time costly.

By evaluating the results, ENKI has a good performance for simulating runoff which could match the timing and simulate an approximate value.

Due to Gaulfoss catchment contains Hugdal Bru, Lillebudal Bru and Eggafoss catchments; its parameter could be used to simulate their runoff data which according to the results was not the case for Hugdal Bru nor Lillebudal Bru, getting a low R2 when applying so. Because of this one could imply that ENKI could have a limitation to model ungauged zones.

The capacity of ENKI to simulate floods with the available hydrological data will depends on the magnitude of the flood. If the flood is low then it would be reachable otherwise like the flood of 2011 in Eggafoss or 2010 in Lillebudal, they would be out of sight.

The reason behind this it could be because the precipitation data stations are just points feeding a specific value to the system in its locations; if there is an increase in precipitation for example 200m on the other side, it will not react. That is why is recommended to use radar precipitation data in the calibration in further studies so the complete range of the storm over the area can be taken into account.

6.3 NMAG MODELLING

From Samla Plan – Gaula (Habberstad, 1984), Øyungen, Øvre Fora and Singsås hydropower unit have been used to analysis the damping capacity of their reservoir because from the system they have the largest storage capacity in the zone.

Although nMag is a good operational platform, items like a turbine/pump station cannot be configured. The solution left is to generate “dummy” units to complement the system.

Even though Øyungen release water to Øvre Fora, the bypass and the spill flow return to Gaula river. According to the results the reservoir managed to store the flood of 2011 corresponding to its area. It is worth to note that Øyungen catchment is part of the Eggafoss catchment being 15% of Eggafoss and the mitigated flood by Øyungen was 12% of the highest registered in Eggafoss. To be able to store the larger amount of the flood flow this reservoir would have to be relocated and the storage increased.

Øvre Fora, by having the largest reservoir of the three has a potential to store flood flows which it does with the spring floods (figure 5-8) but floods as large as the one in 2010 will just pass through it. The capacity to store that flood actually will depends on how empty is the reservoir, sadly if we keep the reservoir down waiting for flood to come (which is uncertain) we would be facing with a no attractive project.

7 REFERENCES

- GUTTORMSEN, O. 1984. *Foldempningsmuligheter i Gaula Kombinert med Regulering for Kraftproduksjon.*
- HABBERSTAD, J. 1984. *Samlet Plan for Vassdrag.*
- KILLINGTVEIT, Å. & SÆLTHUN, N. R. 1995. *Hydrology*, Trondheim, Norwegian Institute of Technology. Department of Hydraulic Engineering.
- PENNINGTON, M. S. 1998. Hydraulic roughness of bored tunnels.
- VRUGT, J. A., GUPTA, H. V., BOUTEN, W. & SOROOSHIAN, S. 2003. A Shuffled Complex Evolution Metropolis algorithm for optimization and uncertainty assessment of hydrologic model parameters. *Water Resources Research*, 39.

8 APPENDIXES

APPENDIX A



LOCATION WITHIN NORWAY

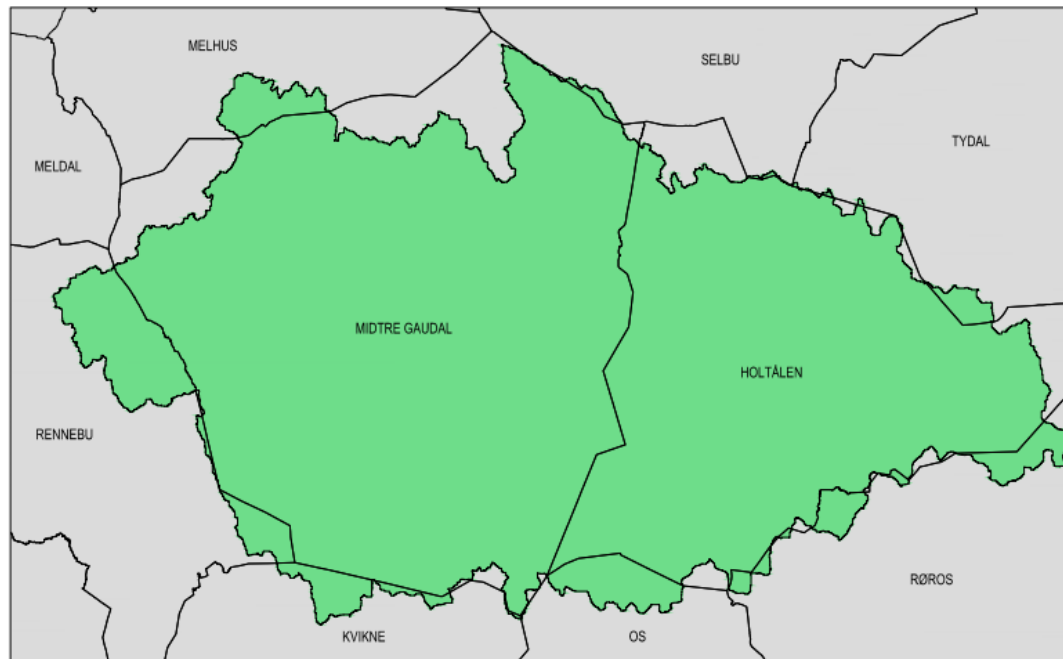

CATCHMENT LOCATION WITHIN COUNTIES



KEY PLAN

LEGEND

-  LAKE
-  RIVER

STUDY PLACE CATCHMENT PLANT VIEW

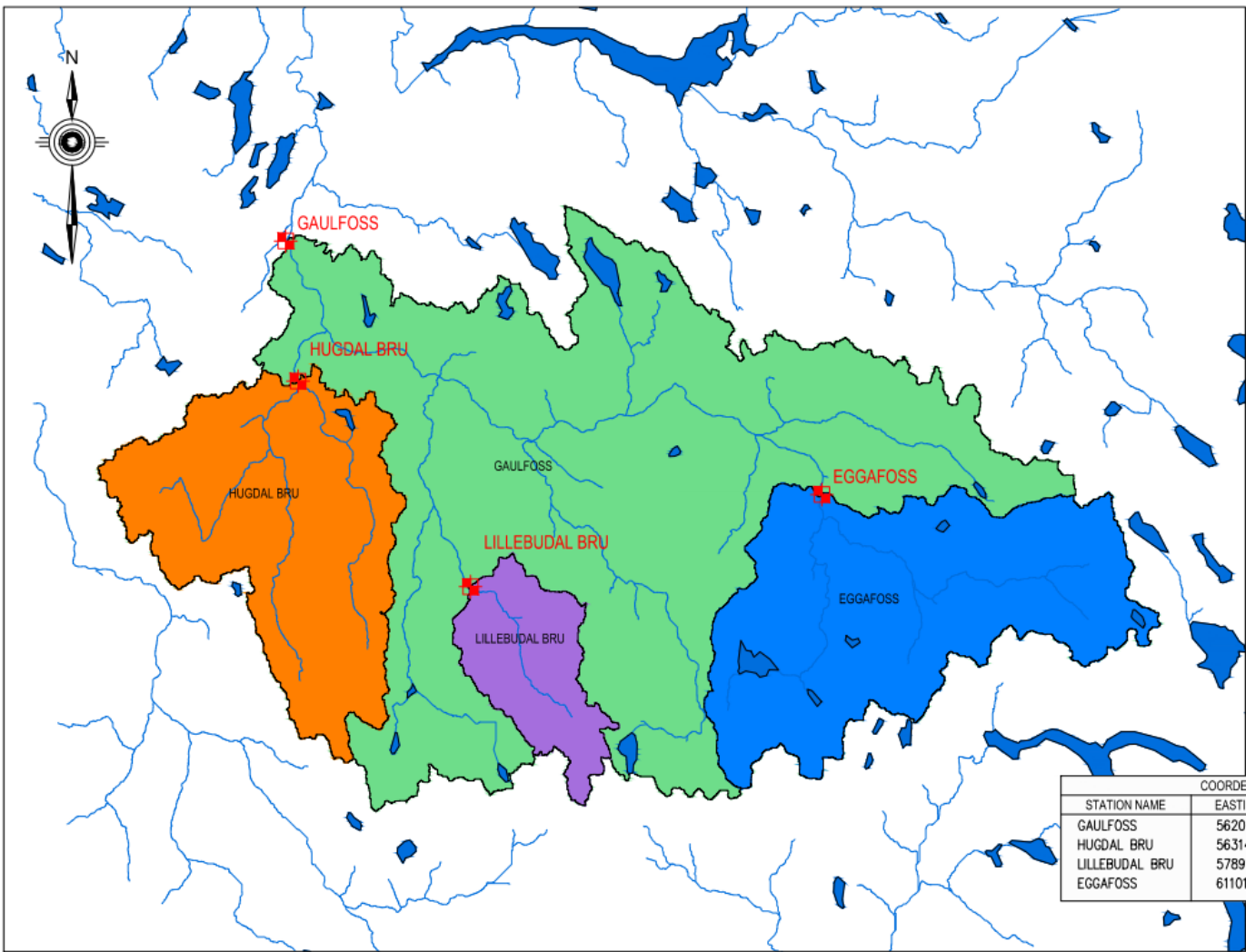

KEY PLAN

STATION NAME	AREA (m ²)
GAULFOSS	3087.0
HUGDAL BRU	545.7
LILLEBUDAL BRU	168.1
EGGAFOSS	645.6

COORDINATES - UTM WGS84 32N			
STATION NAME	EASTING (m)	NORTHING (m)	ELEVATION (m)
GAULFOSS	562018.55	6998268.76	60
HUGDAL BRU	563144.42	6985539.99	130
LILLEBUDAL BRU	578910.32	6966858.15	513
EGGAFOSS	611018.88	6975228.84	285

PLANT VIEW

A-03 : DAILY AND HOURLY DISCHARGE STATIONS LOCATION AND CATCHMENTS

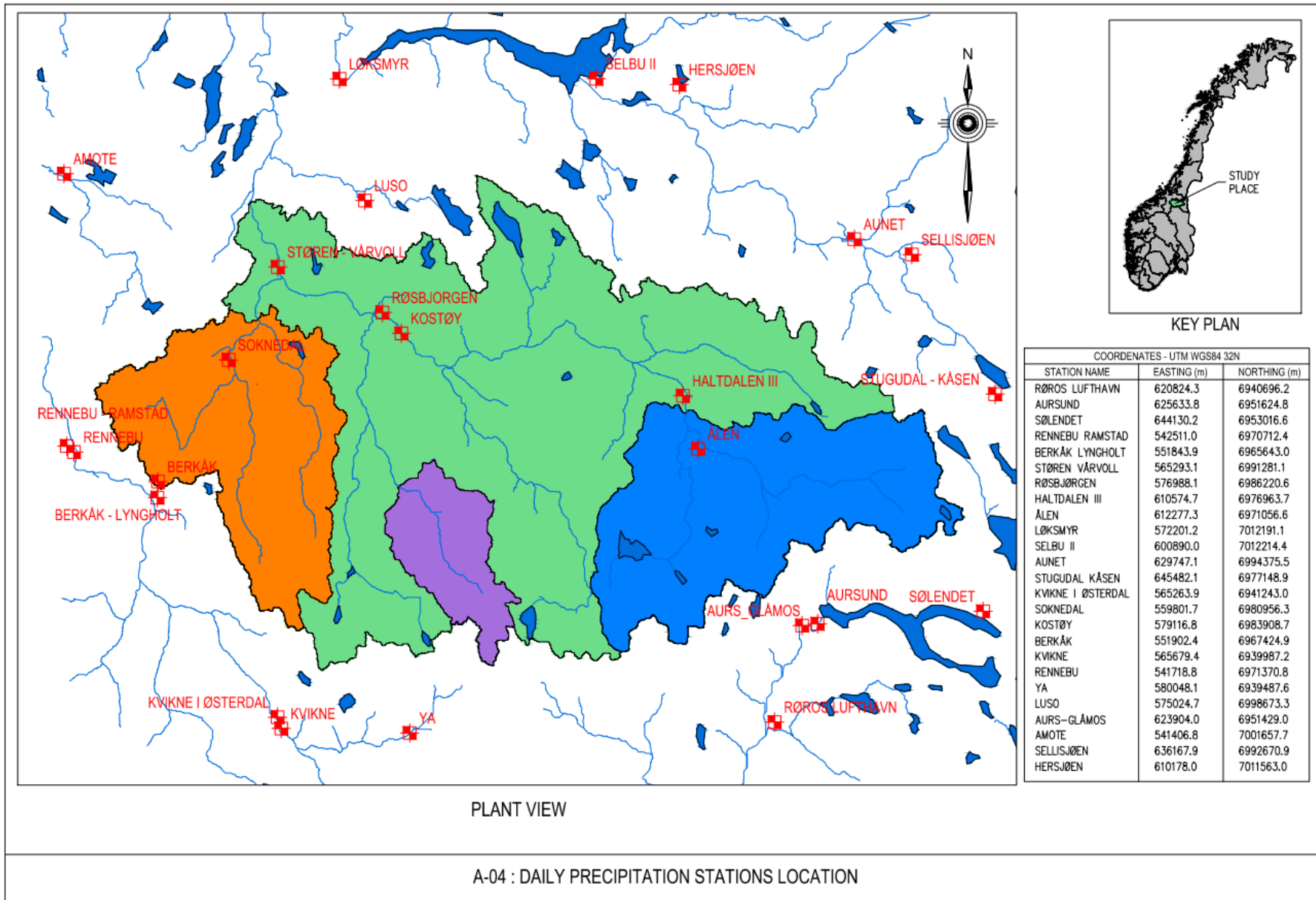

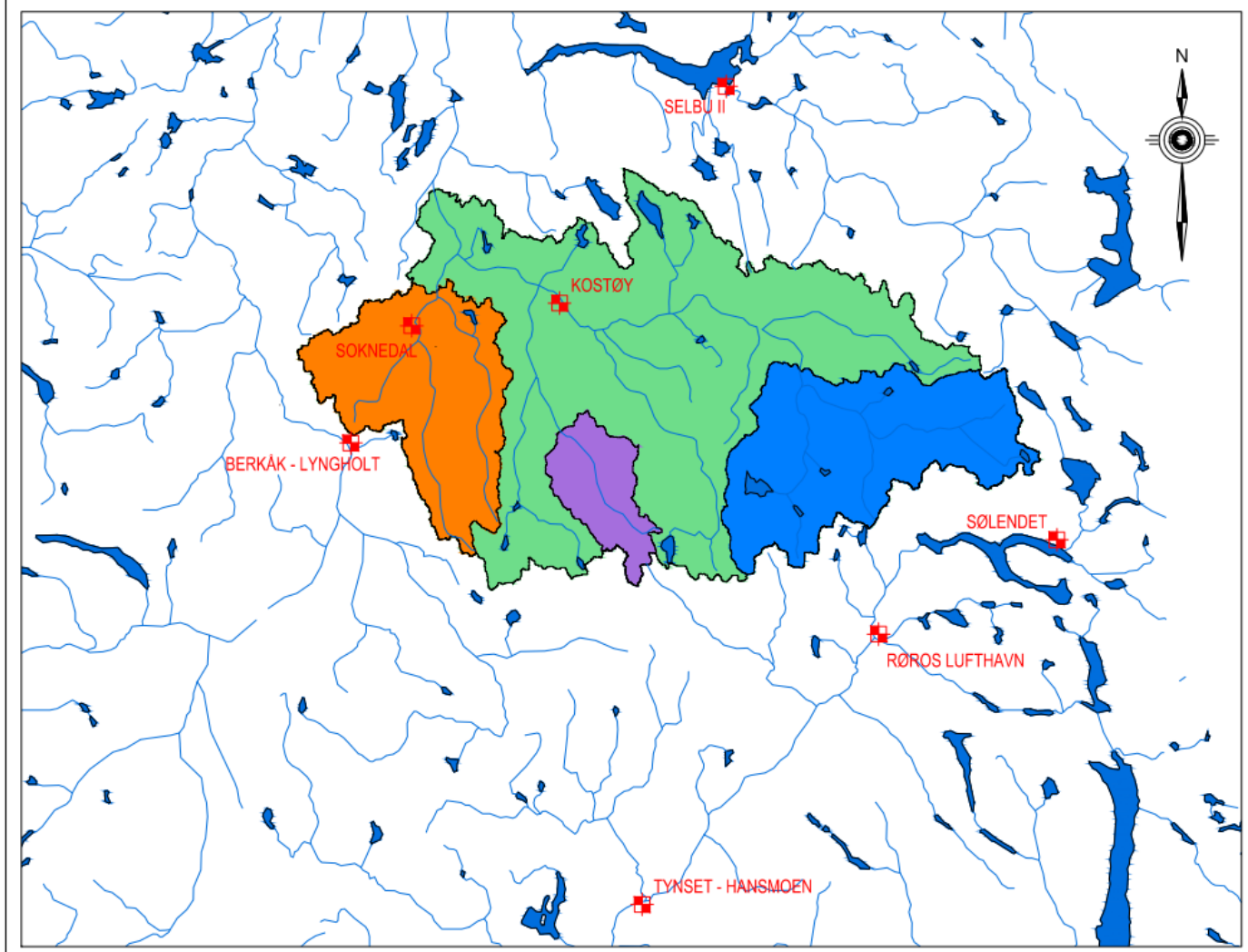

COORDINATES - UTM WGS84 32N

STATION NAME	EASTING (m)	NORTHING (m)
RØROS LUFTHAVN*	620824.3	6940696.2
SØLENDET	644130.2	6953016.6
BERKÅK LYNHOLT	551843.9	6965643.0
SOKNEDAL	559801.7	6980956.3
KOSTØY	579116.8	6983908.7
SELBU II	600890.0	7012214.4
TYNSET HANSMOEN	589907.4	6905406.3

* TEMPERATURE STATION ONLY

PLANT VIEW

A-05 : DAILY TEMPERATURE AND HUMIDITY STATIONS LOCATION

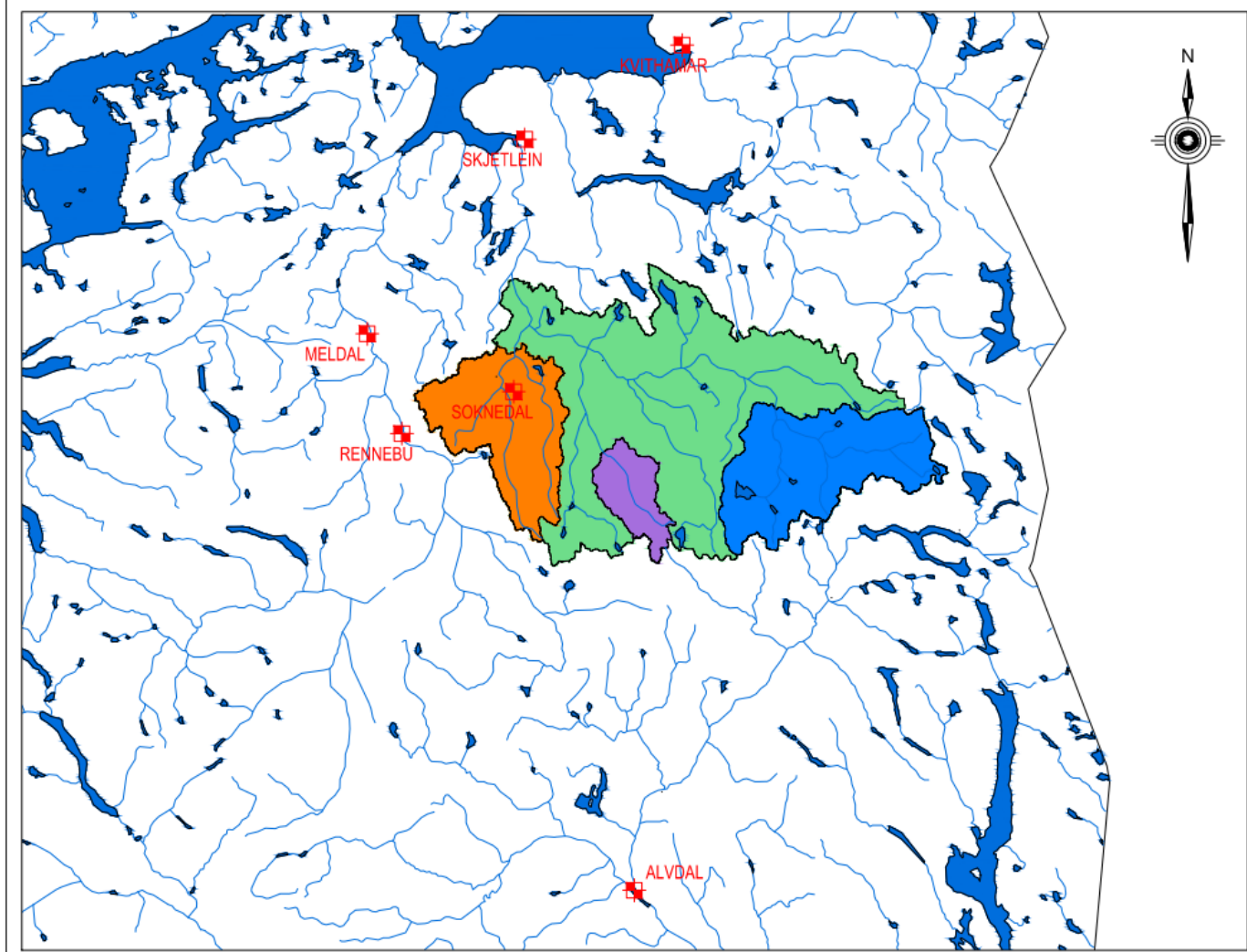

PLANT VIEW



KEY PLAN

COORDINATES - UTM WGS84 32N		
STATION NAME	EASTING (m)	NORTHING (m)
ALVDAL	584898.8	6887437.4
KVITHAMAR	593620.8	7041331.6
SKJETLEIN	564945.5	7024171.4
SOKNEDAL	562947.0	6978224.0
MELDAL	536256.9	6988775.8
RENNEBU	542581.5	6970593.8

A-06 : DAILY GLOBAL RADIATION STATIONS LOCATION

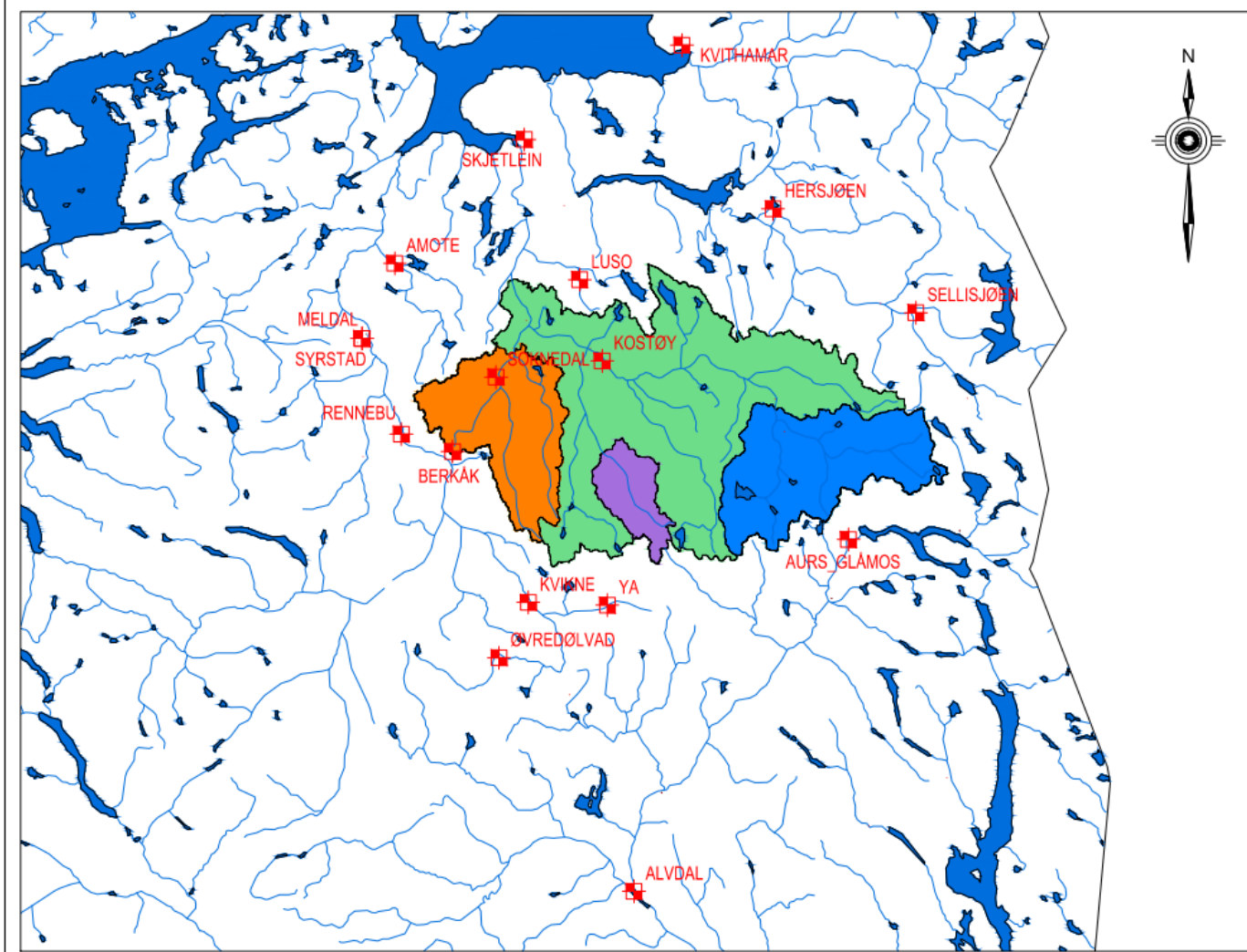

KEY PLAN

COORDINATES - UTM WGS84 32N		
STATION NAME	EASTING (m)	NORTHING (m)
SOKNEDAL	559801.7	6980956.3
KOSTØY	579116.8	6983908.7
BERKÅK	551902.4	6967424.9
KVIKNE	565679.4	6939987.2
RENNEBU	541718.8	6971370.8
YA	580048.1	6939487.6
LUSO	575024.7	6998673.3
AURS-GLAMOS	623904.0	6951429.0
AMOTE	541406.8	7001657.7
ØVREDØLVAD	560343.2	6929914.8
SYRSTAD	536843.5	6989366.9
MELDAL	535432.0	6988010.4
SELSJØEN	636167.9	6992670.9
HERSJØEN	610178.0	7011563.0
ALVDAL	584898.8	6887437.4
KVITHAMAR	593620.8	7041331.6
SKJETLEIN	564945.5	7024171.4
SOKNEDAL	562947.0	6978224.0
MELDAL	536256.9	6988775.8
RENNEBU	542581.5	6970593.8

PLANT VIEW

A-07 : HOURLY PRECIPITATION STATIONS LOCATION

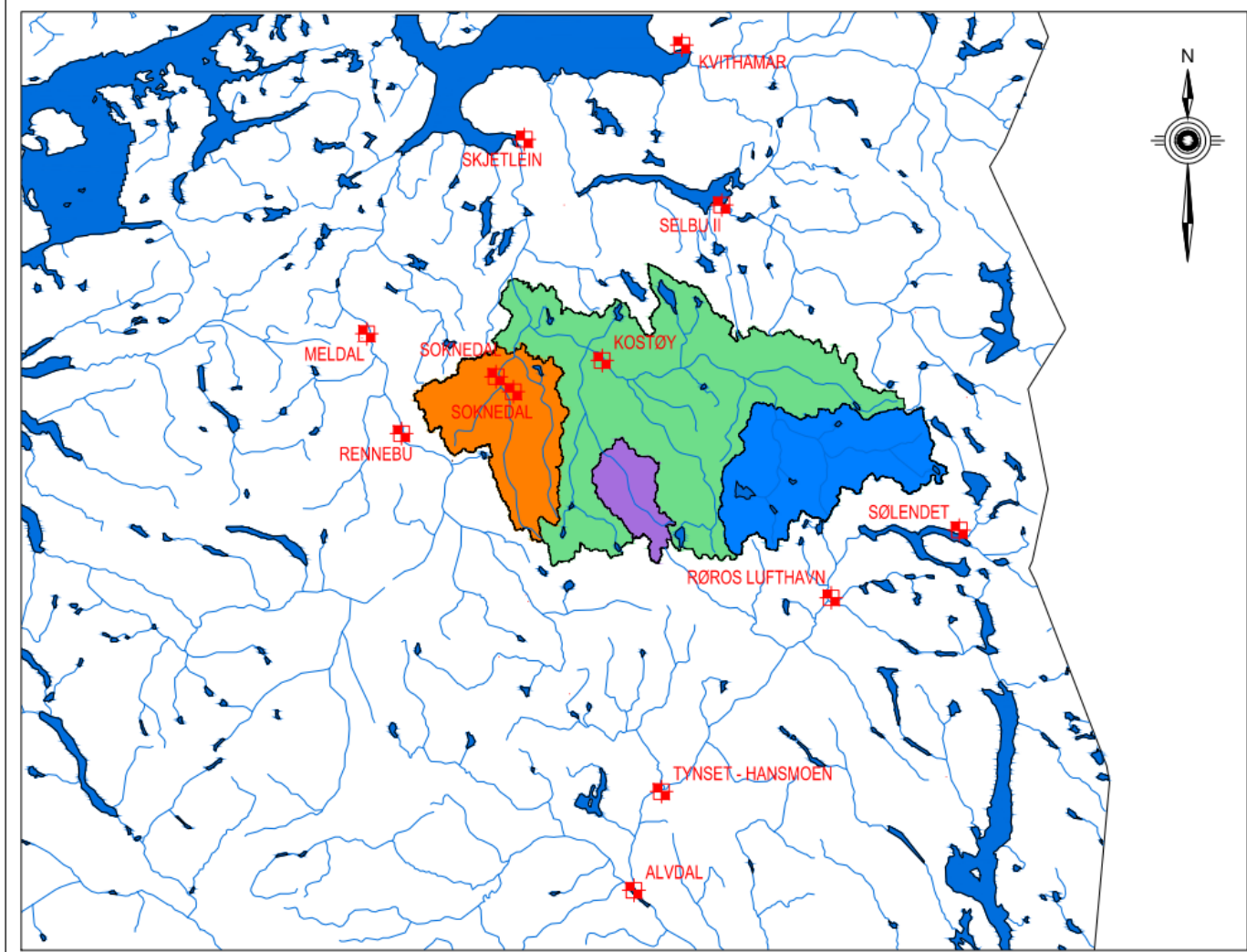

KEY PLAN

COORDINATES - UTM WGS84 32N		
STATION NAME	EASTING (m)	NORTHING (m)
RØROS LUFTHAVN	620824.3	6940696.2
SØLENDET	644130.2	6953016.6
SOKNEDAL	559801.7	6980956.3
KOSTØY	579116.8	6983908.7
SELBU II	600890.0	7012214.4
TYNSET HANSMOEN	589907.4	6905406.3
ALVDAL	584898.8	6887437.4
KVITHAMAR	593620.8	7041331.6
SKJETLEIN	564945.5	7024171.4
SOKNEDAL	562947.0	6978224.0
MELDAL	536256.9	6988775.8
RENNEBU	542581.5	6970593.8

PLANT VIEW

A-08 : HOURLY TEMPERATURE STATIONS LOCATION

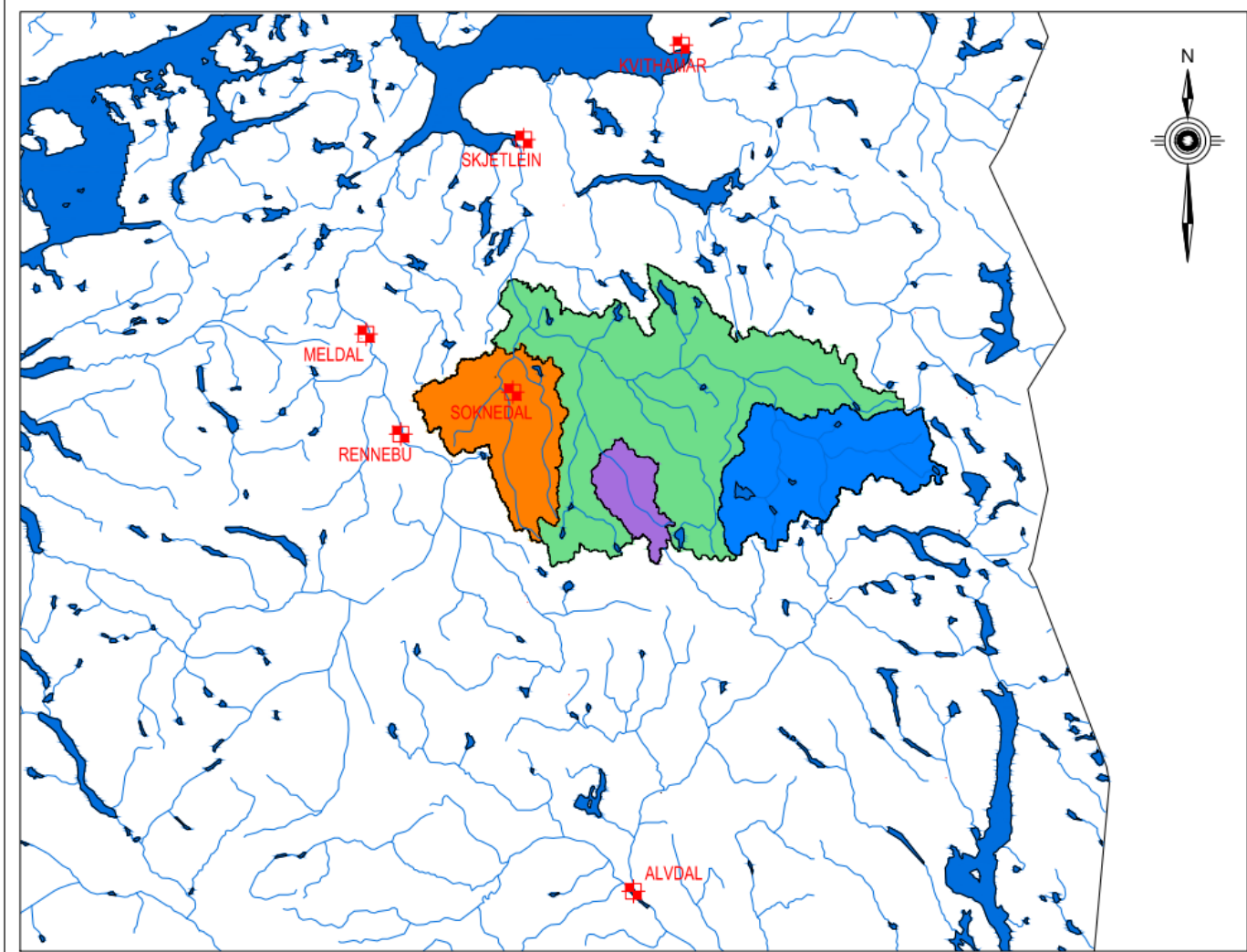

KEY PLAN

COORDINATES - UTM WGS84 32N		
STATION NAME	EASTING (m)	NORTHING (m)
ALVDAL	584898.8	6887437.4
KVITHAMAR	593620.8	7041331.6
SKJETLEIN	564945.5	7024171.4
SOKNEDAL	562947.0	6978224.0
MELDAL	536256.9	6988775.8
RENNEBU	542581.5	6970593.8

PLANT VIEW

A-09 : HOURLY HUMIDITY AND GLOBAL RADIATION STATIONS LOCATION

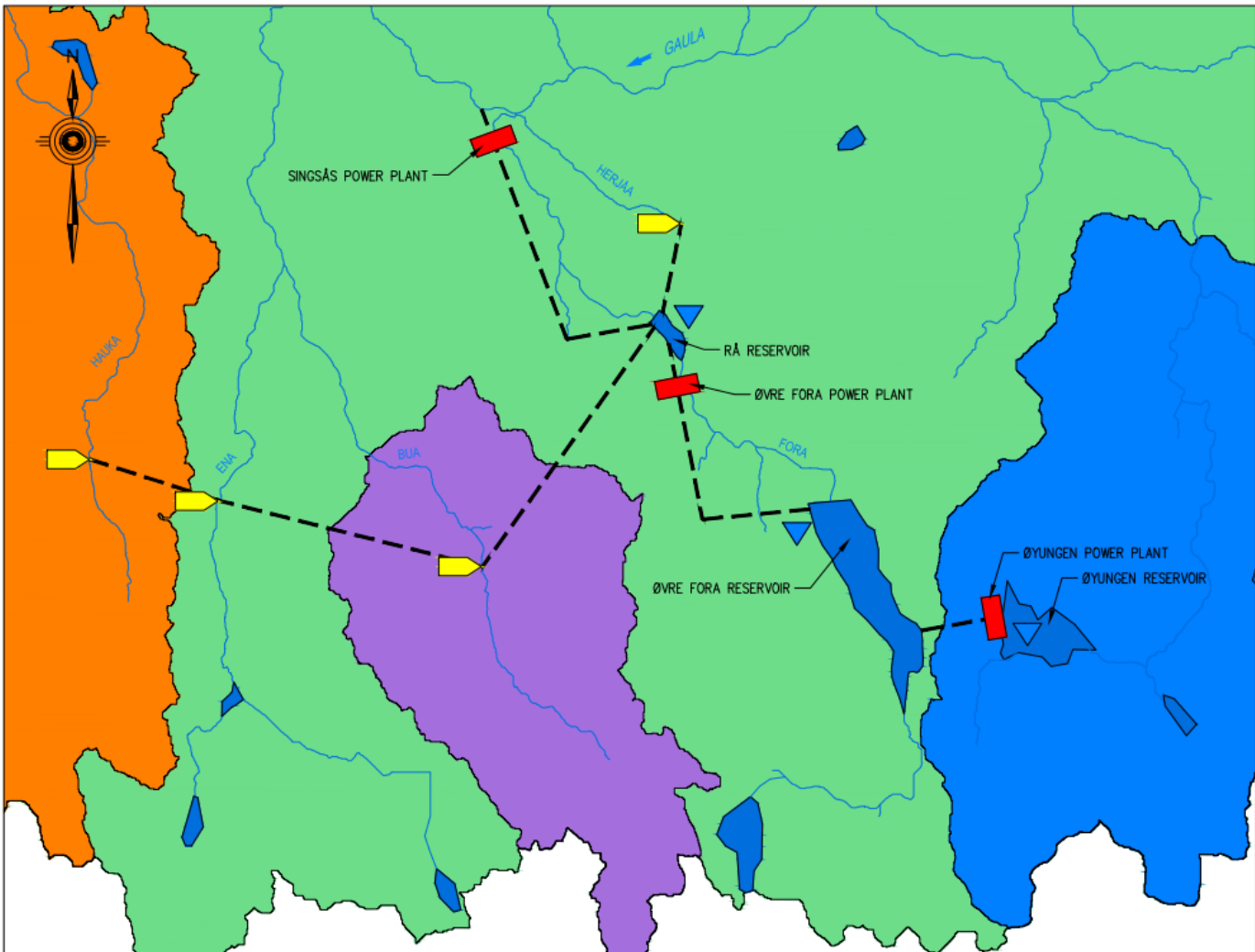

KEY PLAN

LEGEND

- LAKE
- RIVER
- RESERVOIR
- TRANSFER
- POWER PLANT

HYDROPOWER DEVELOPMENT SKETCH 1982

A-10 : HYDROPOWER DEVELOPMENT SKETCH 1982 FOR NMAG

APPENDIX B

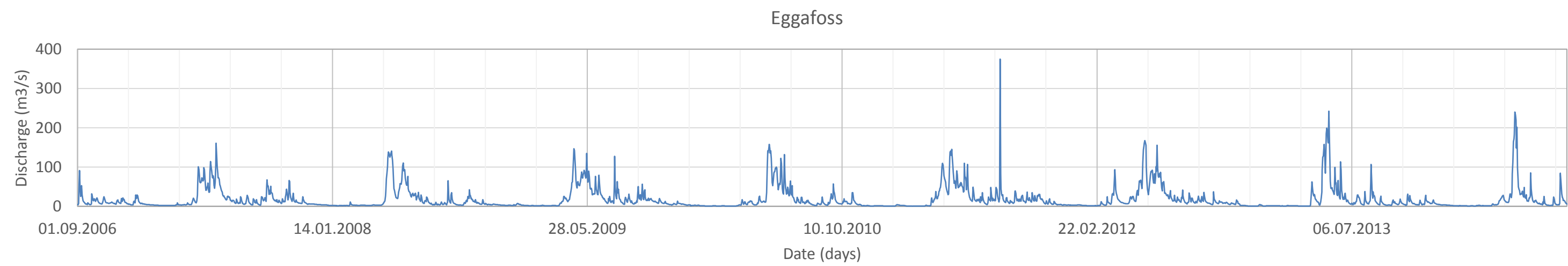
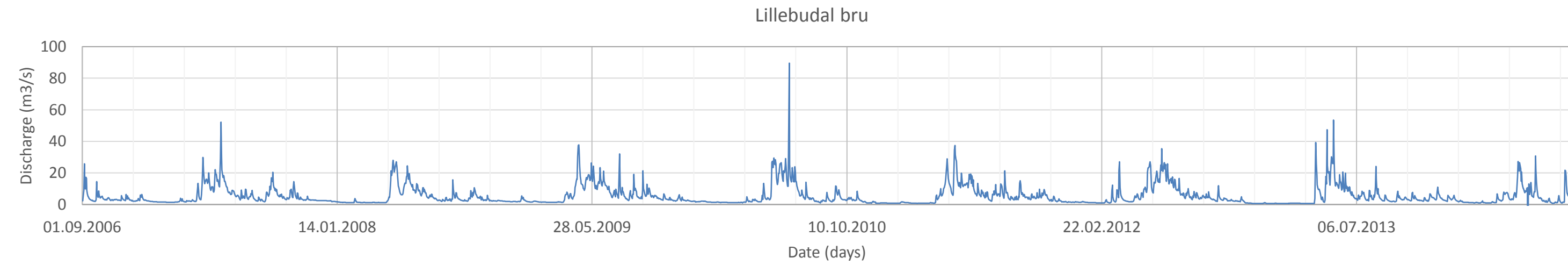
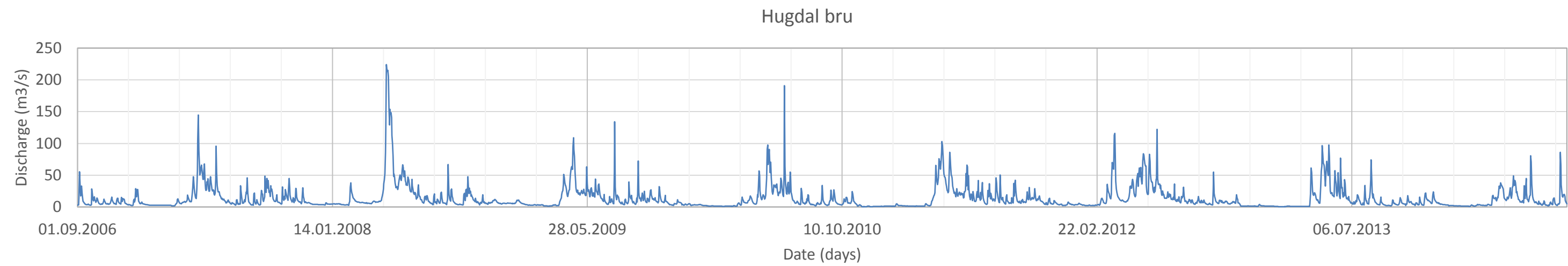
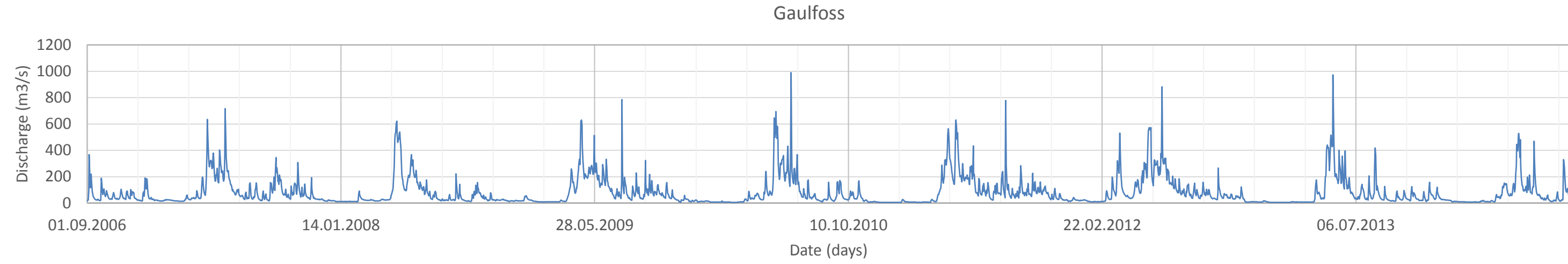

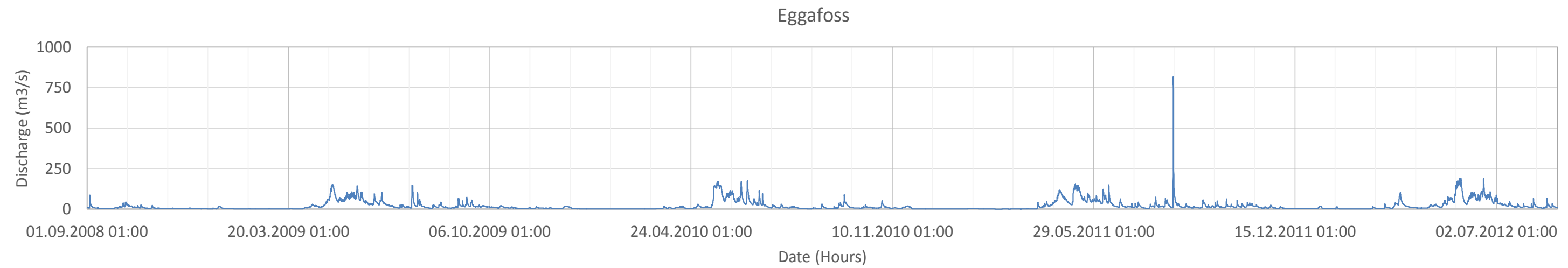
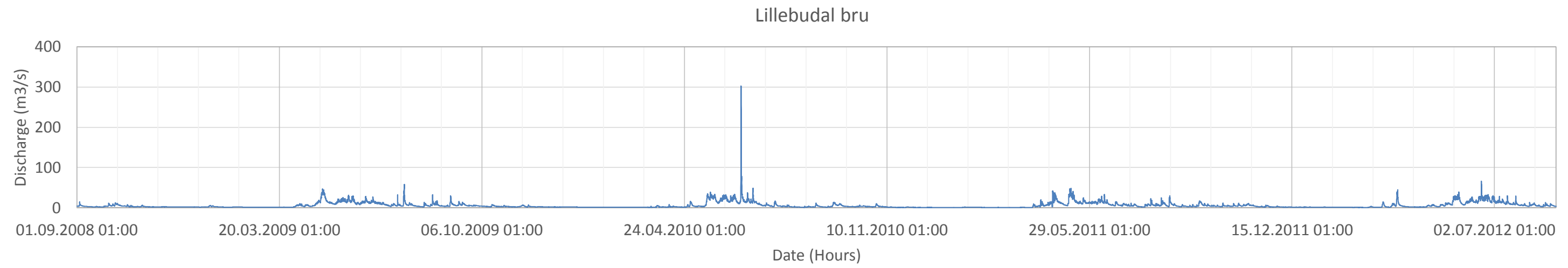
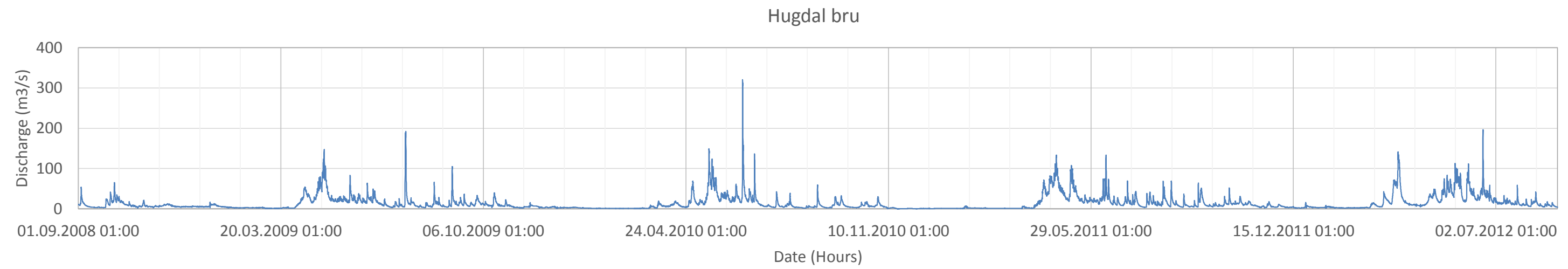
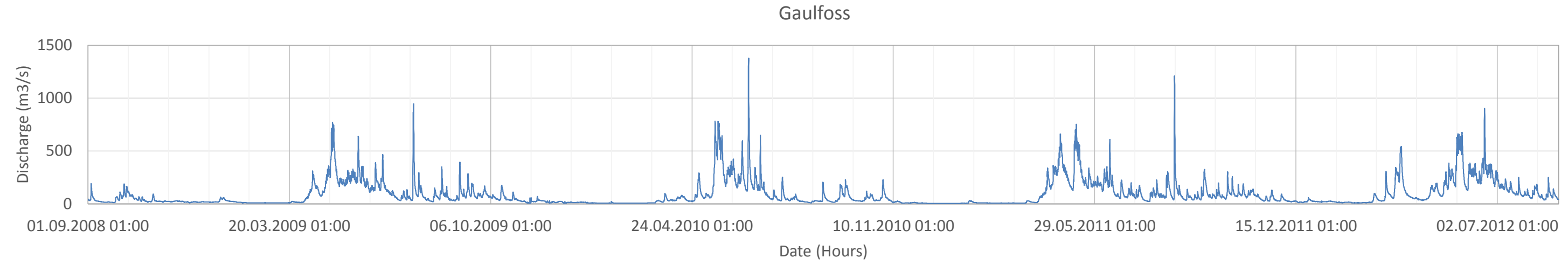

APPENDIX C

Røros Lufthavn

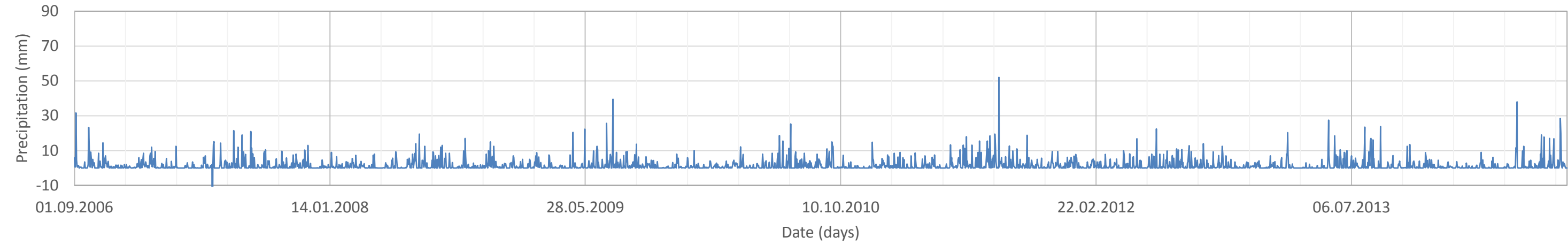

Aursund

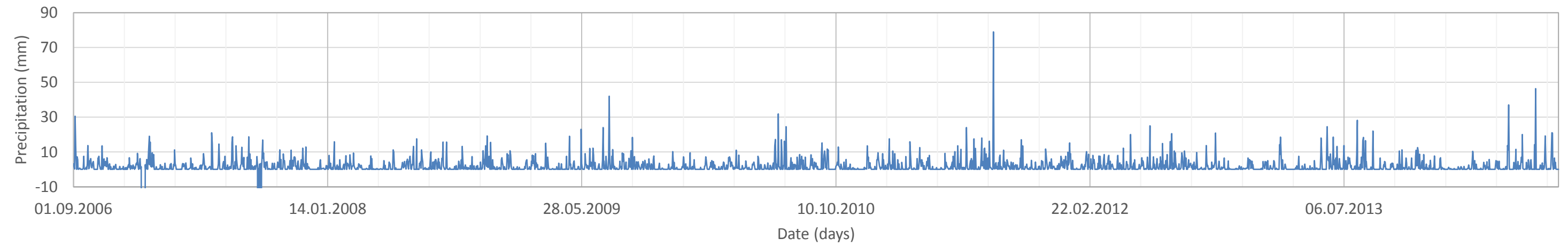

Sølendet

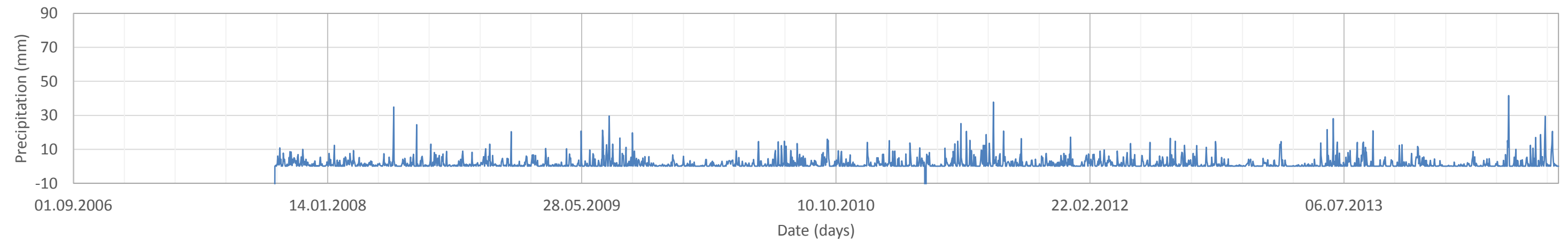

Rennebu - Ramstad

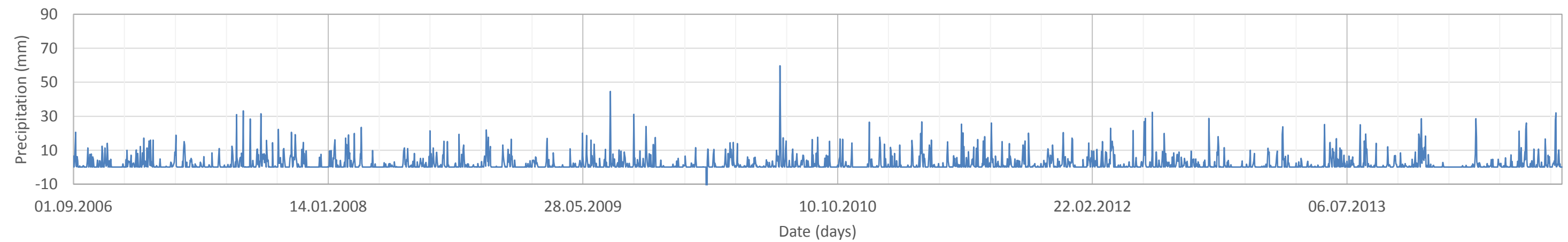

Berkåk - Lyngholt

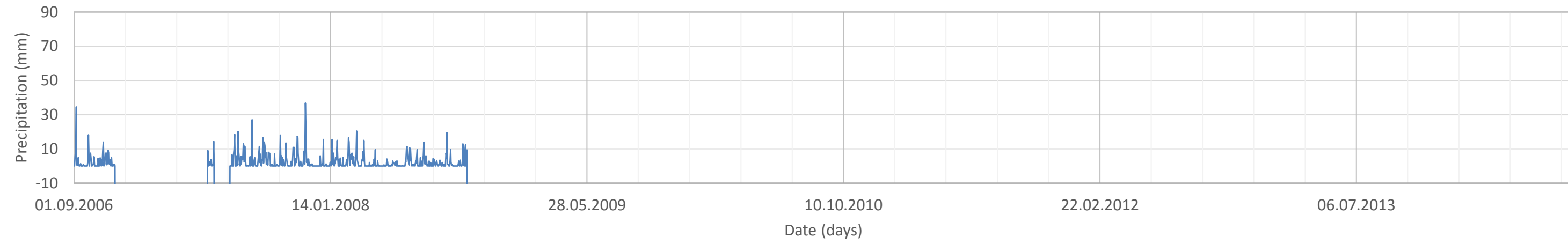

Støren - Vårvoll

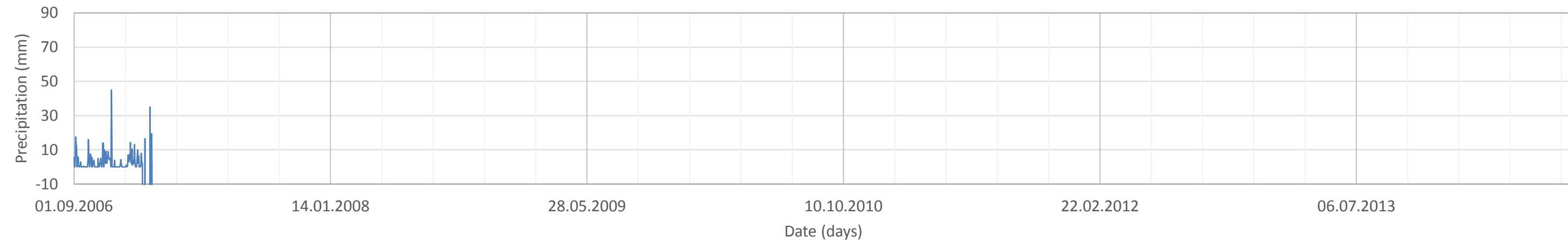

Røros Lufthavn

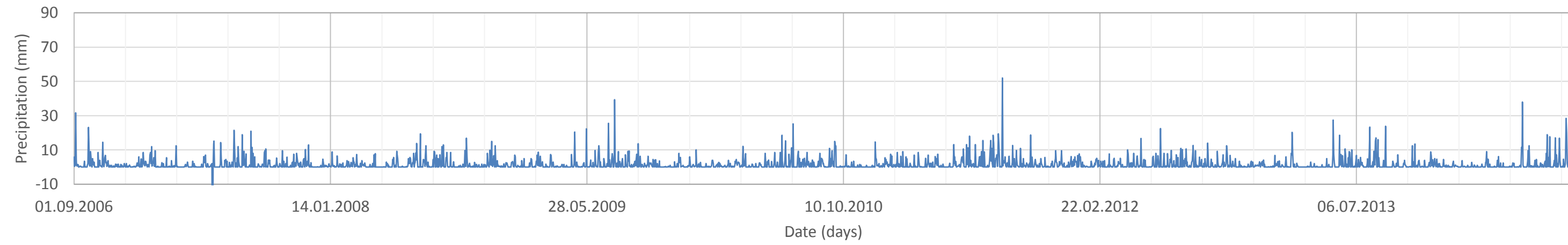

Røsbjørgen

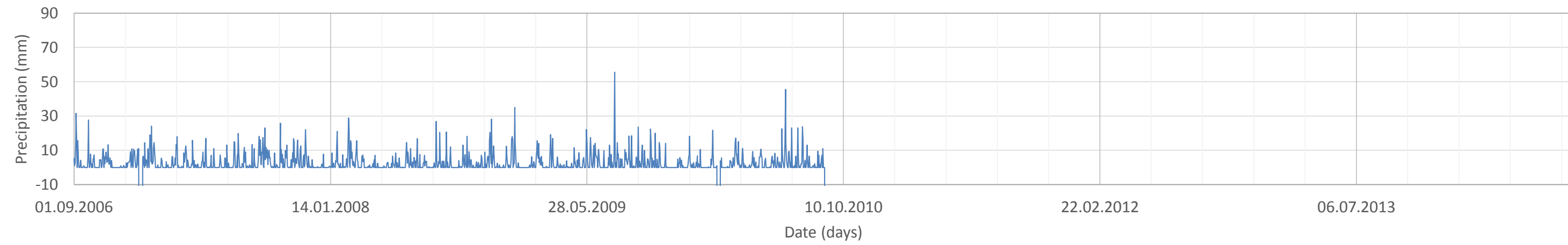

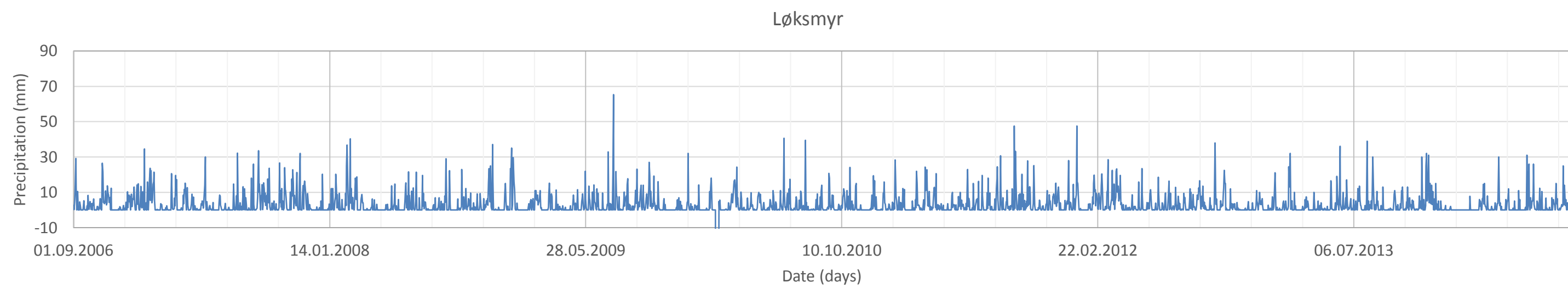
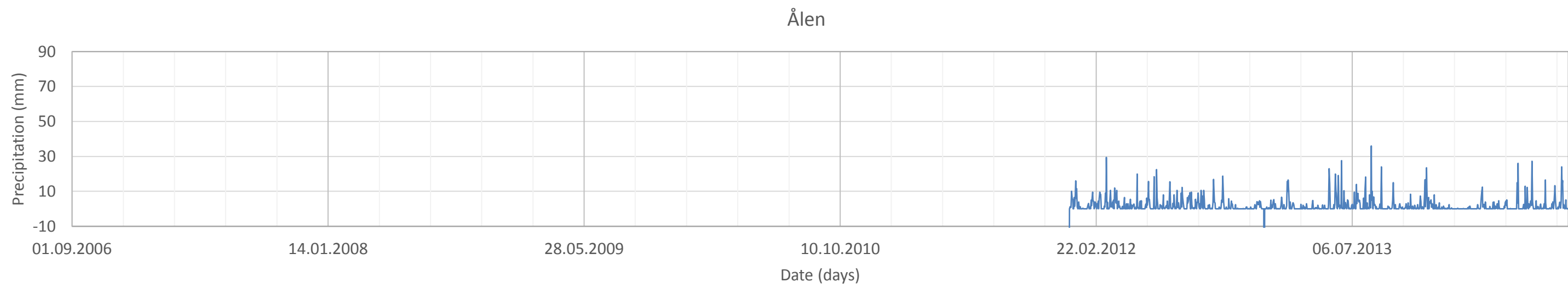
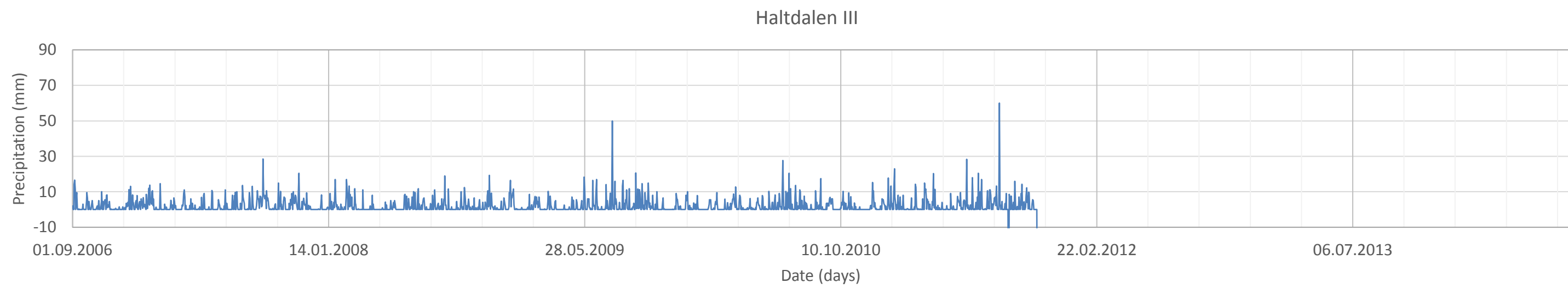
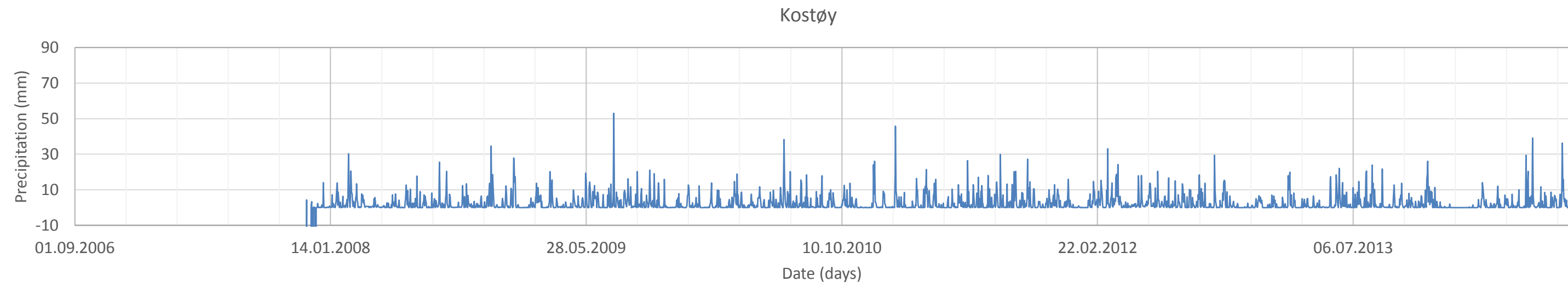

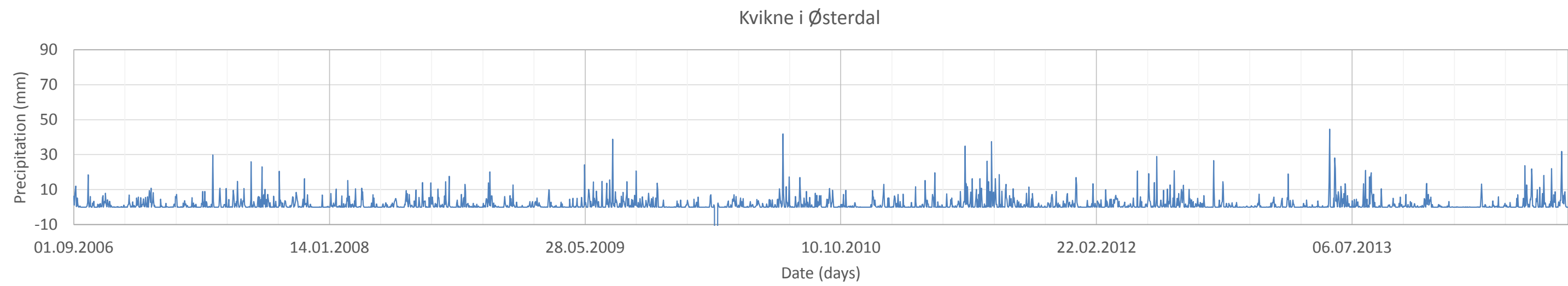
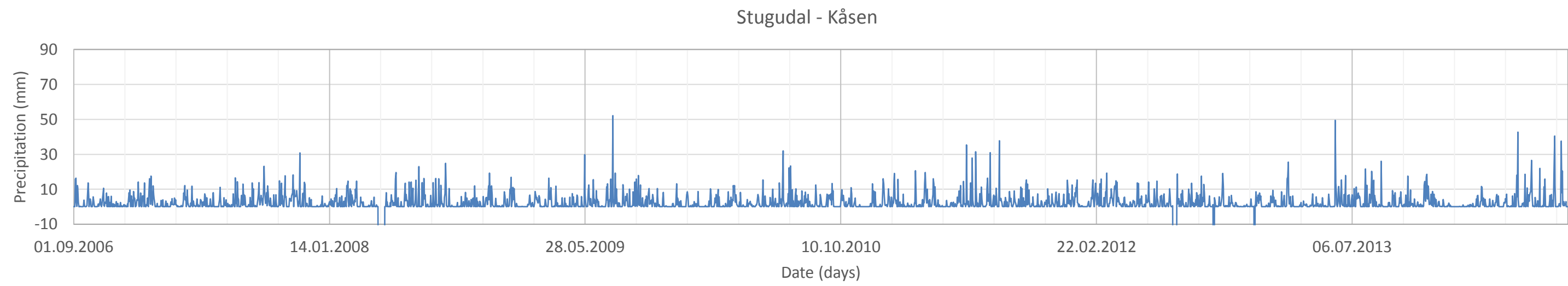
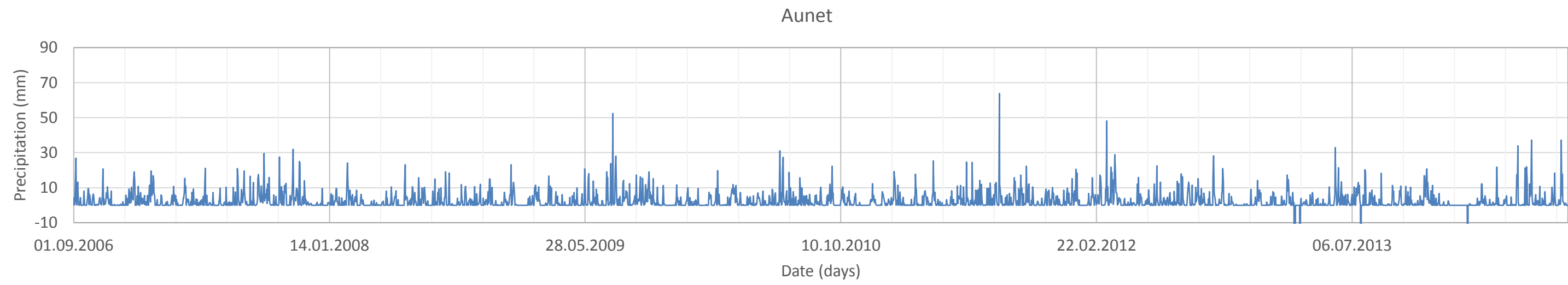
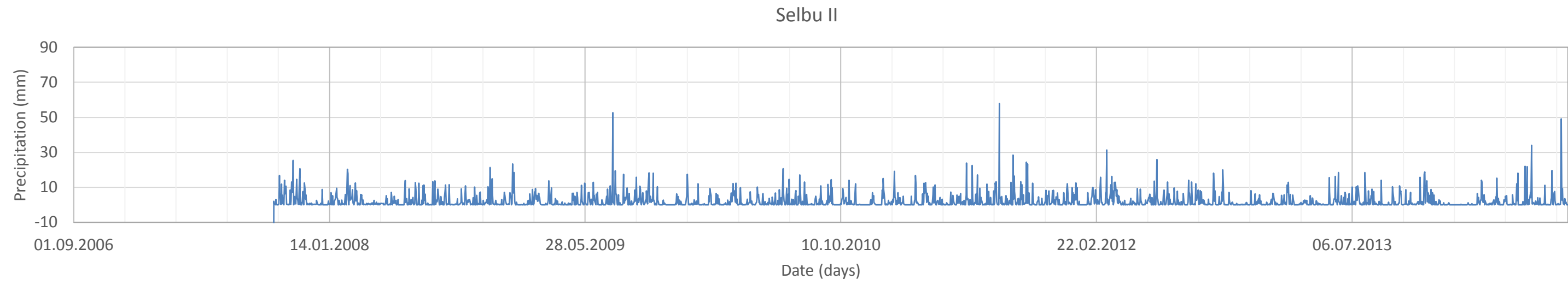

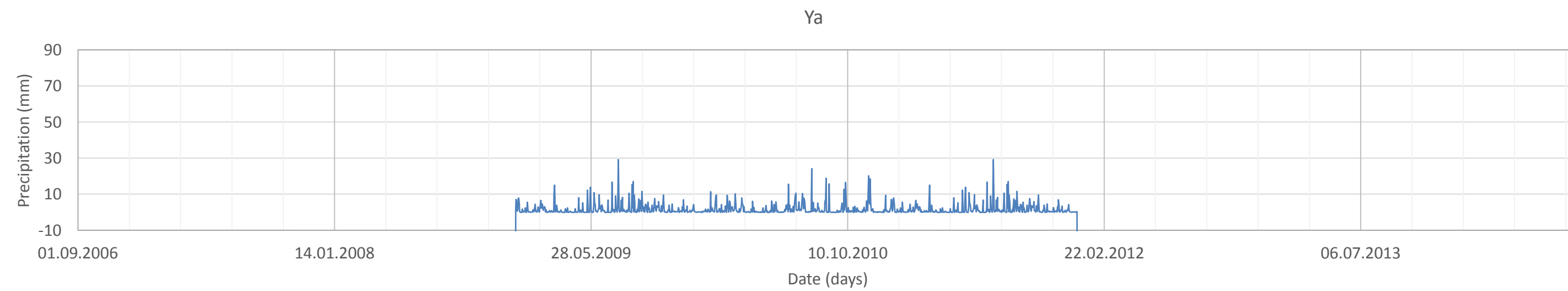
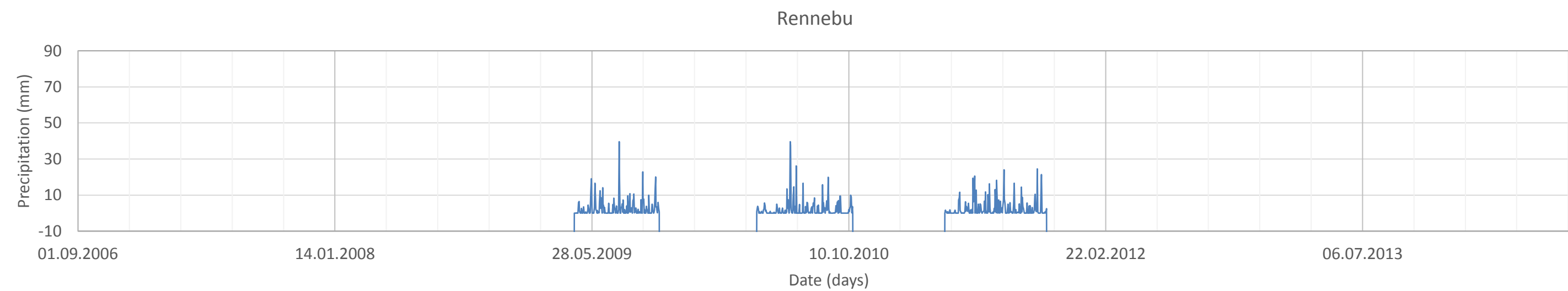
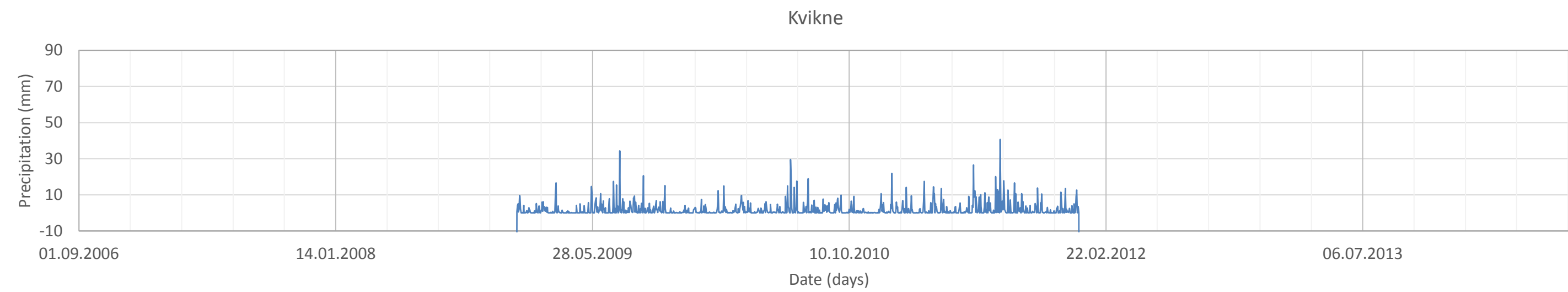
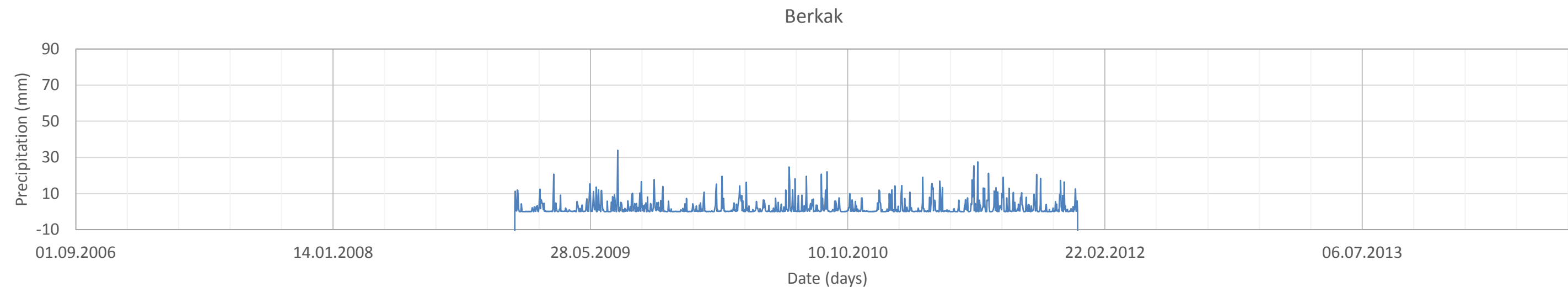

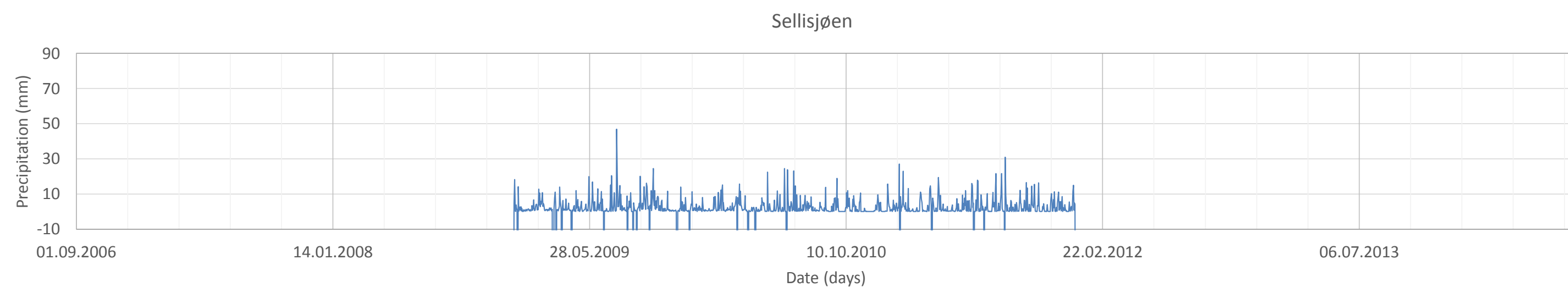
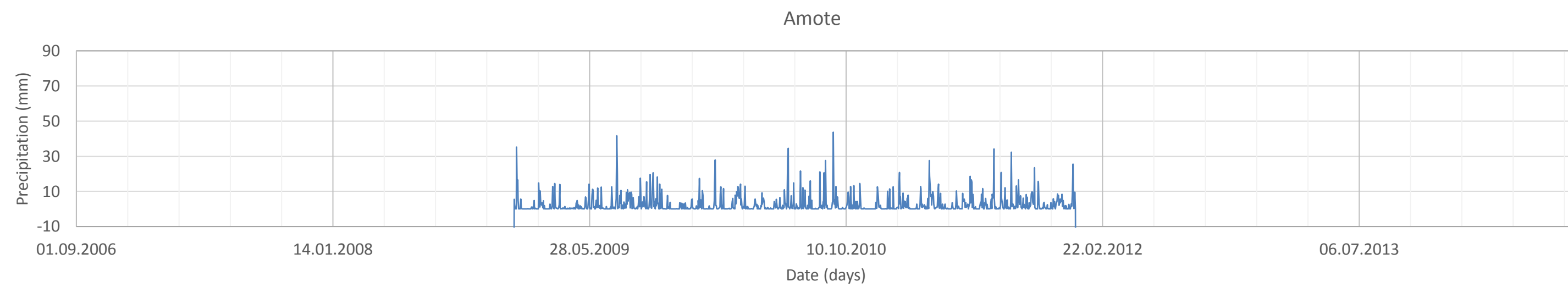
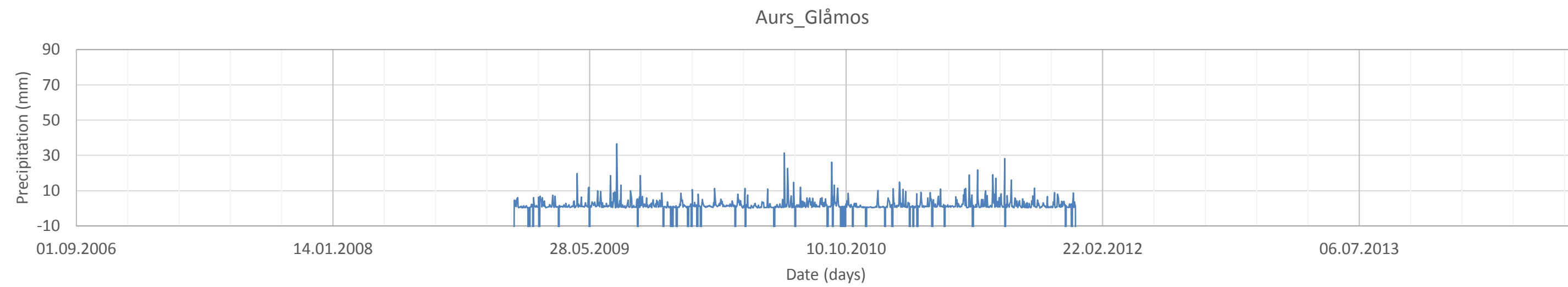
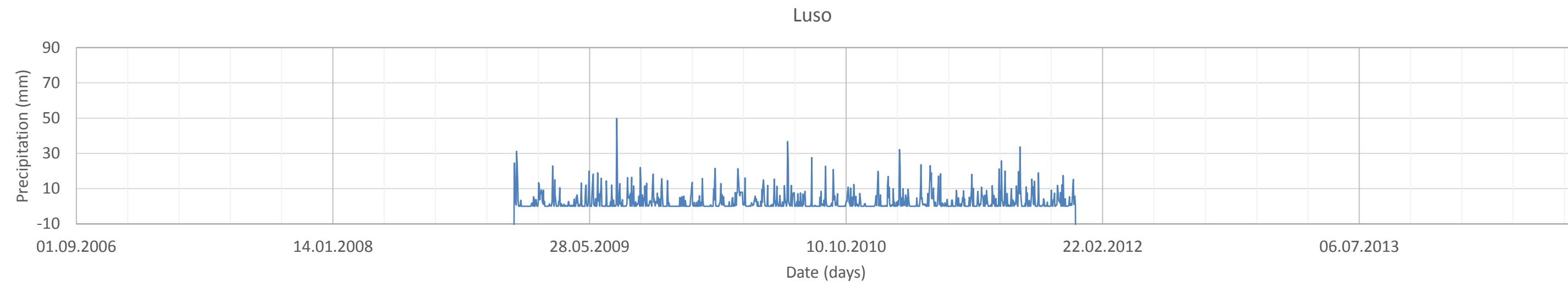

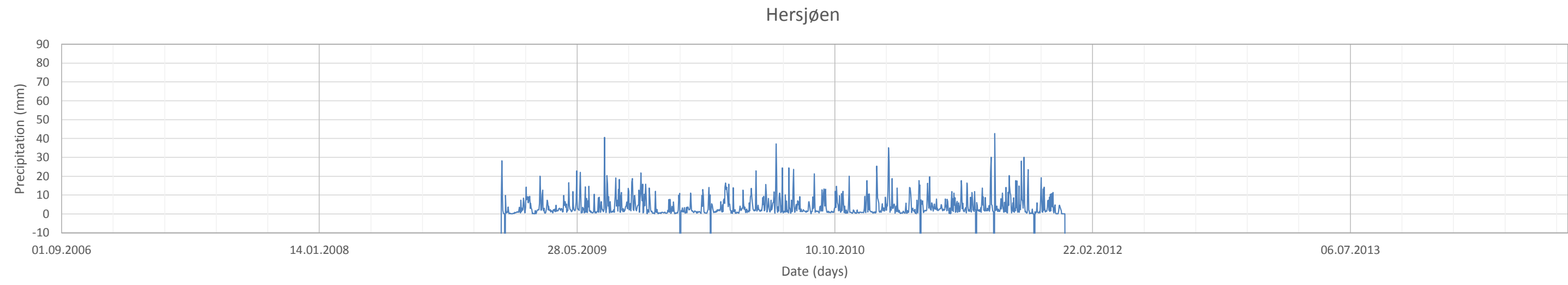

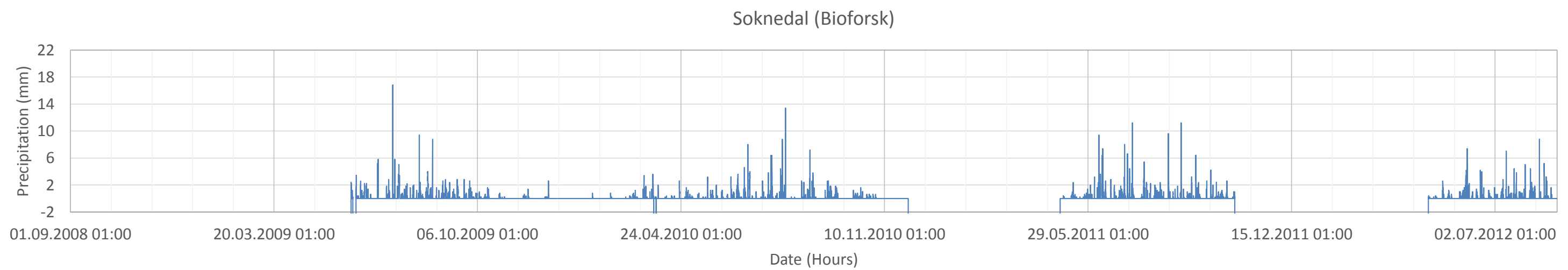
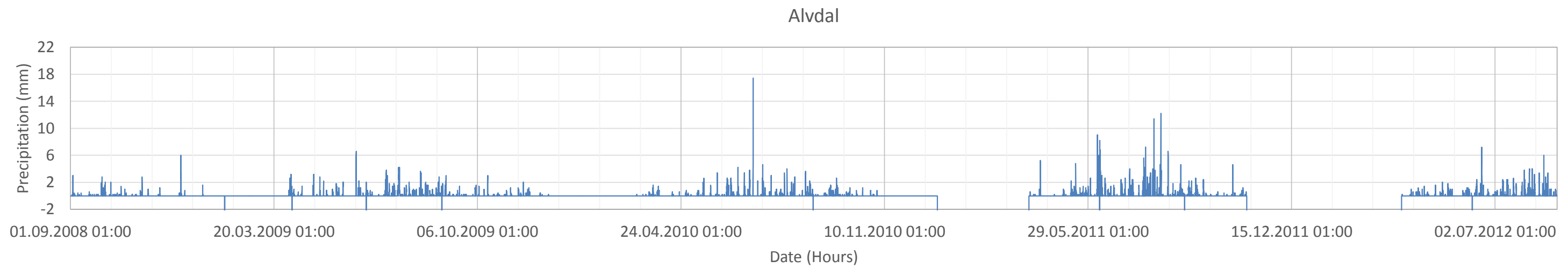
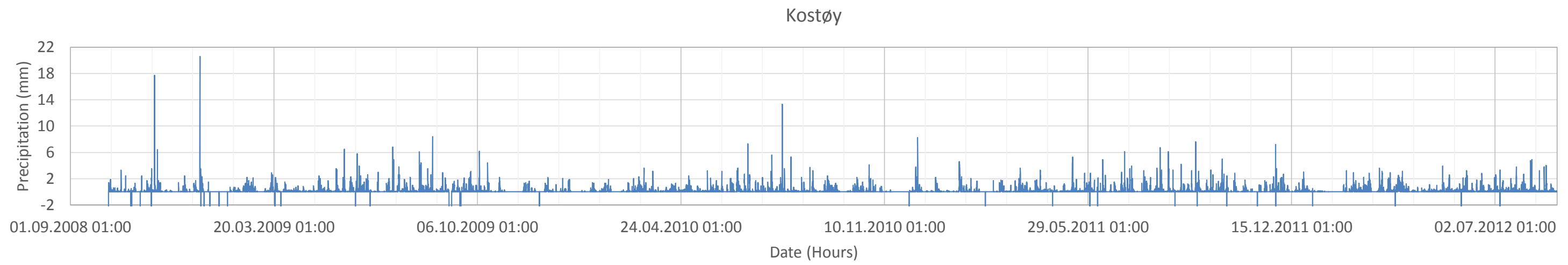
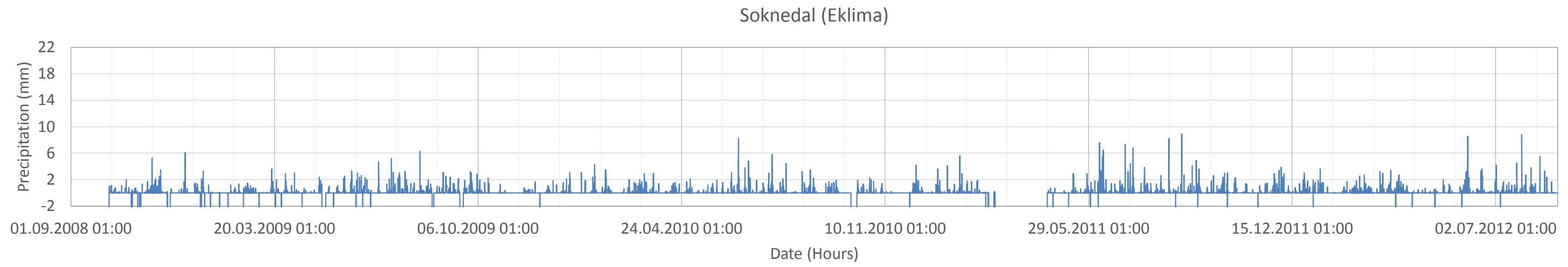

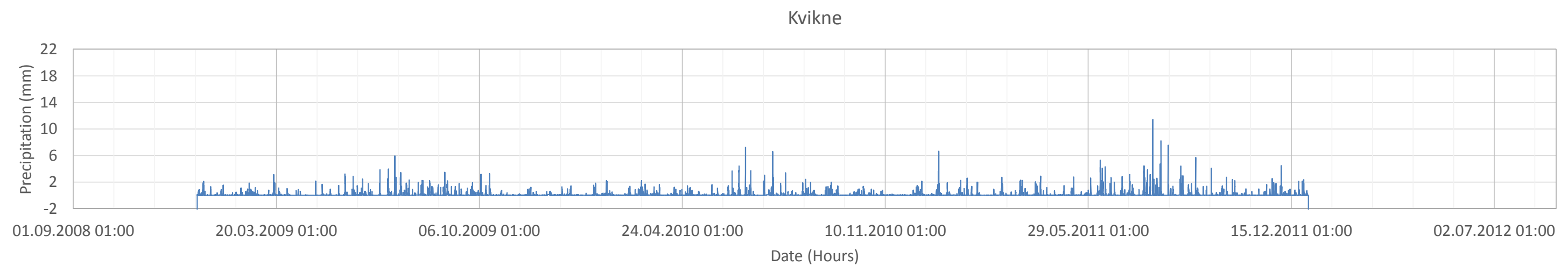
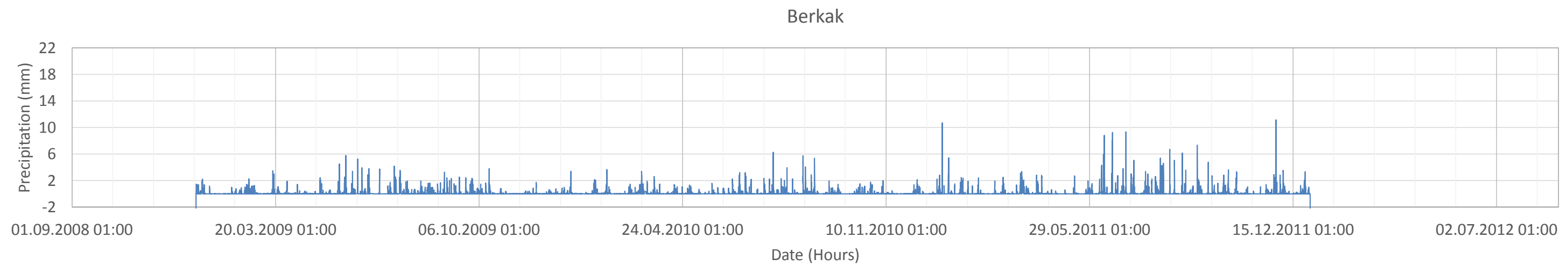
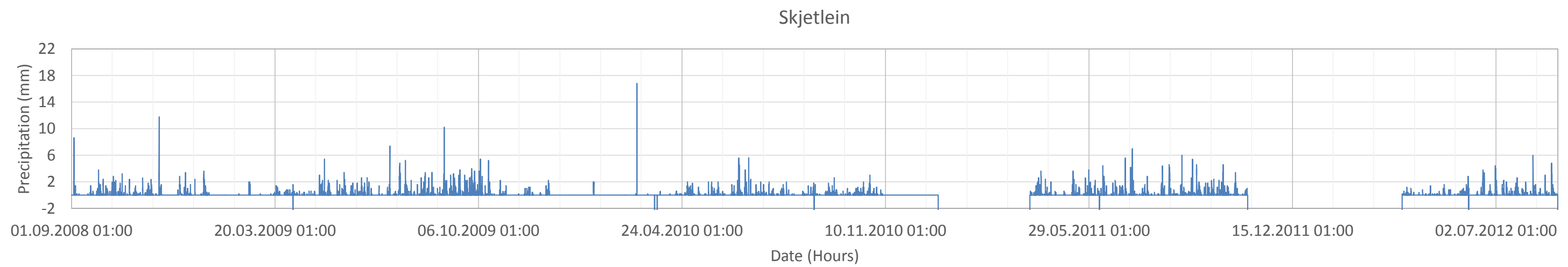
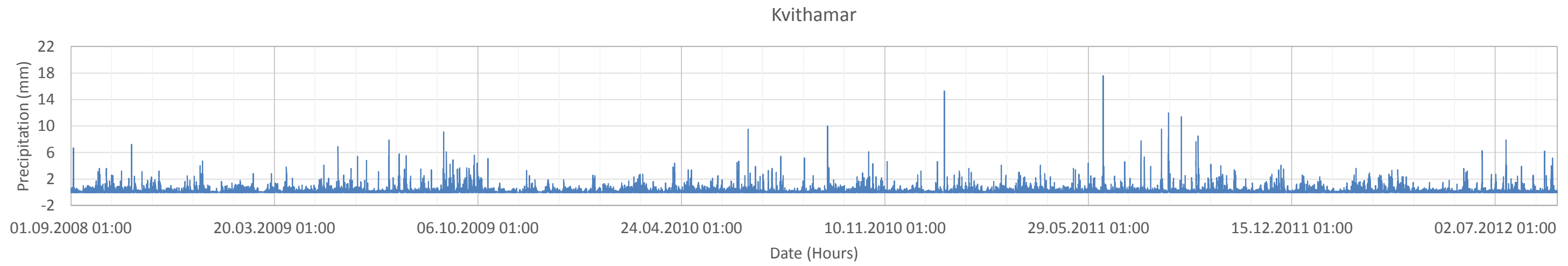

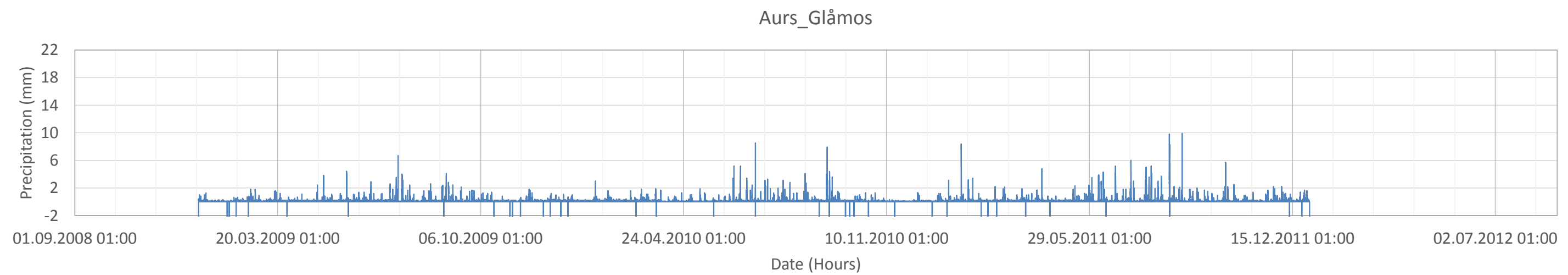
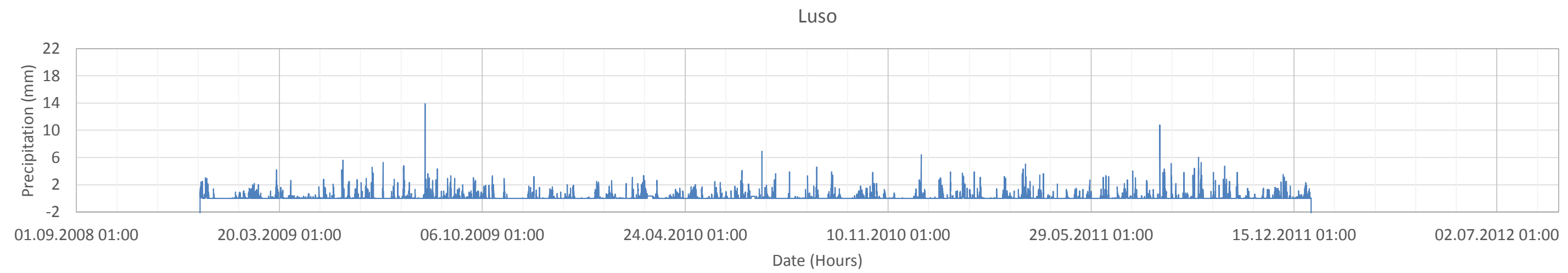
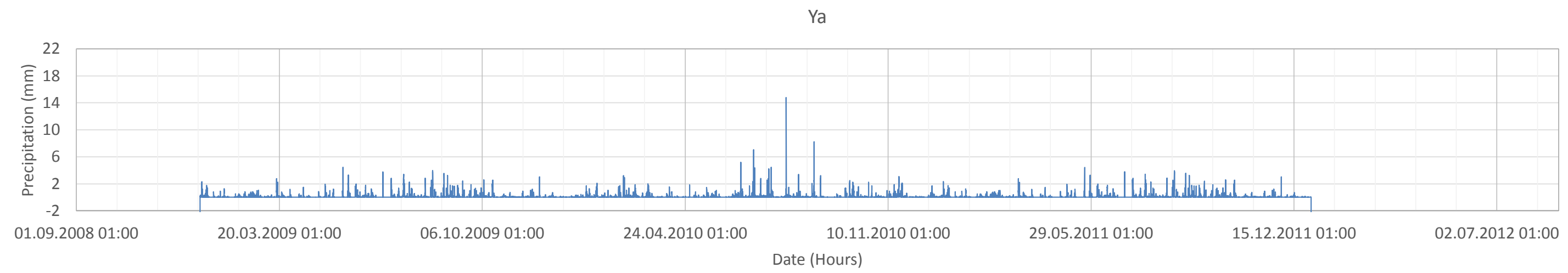
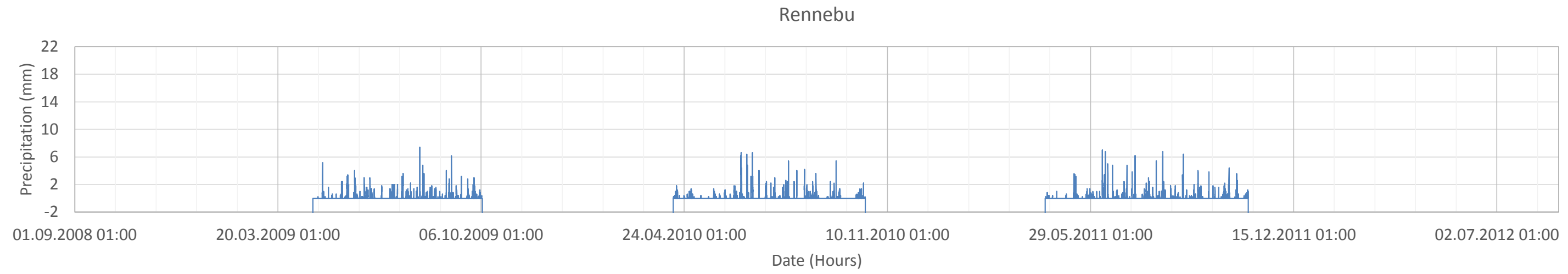

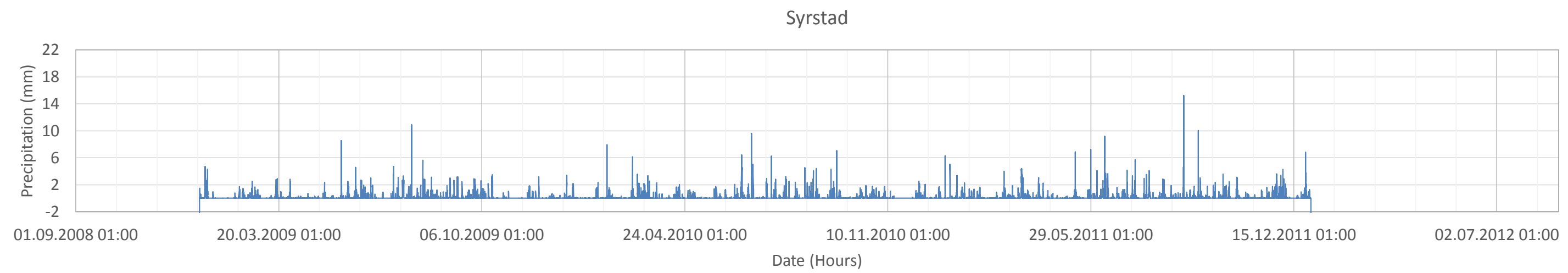
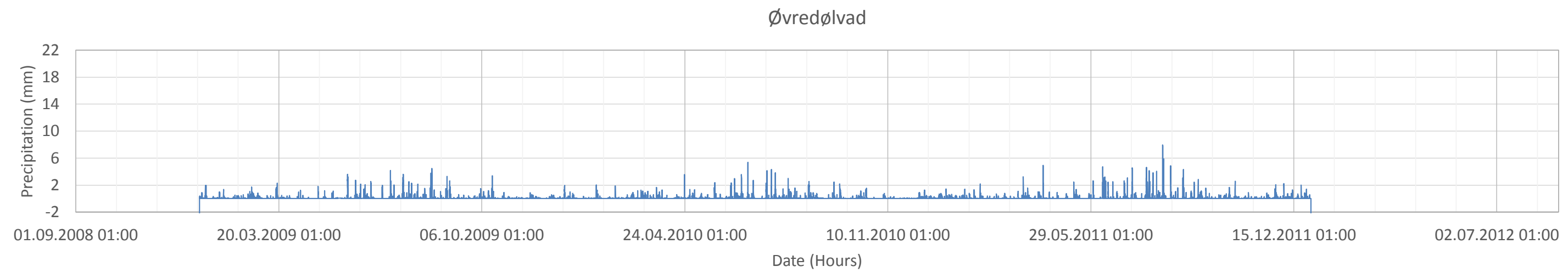
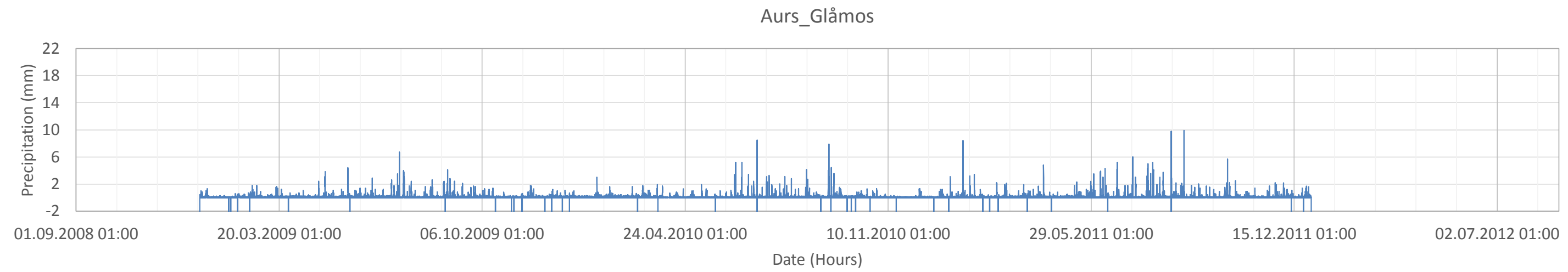
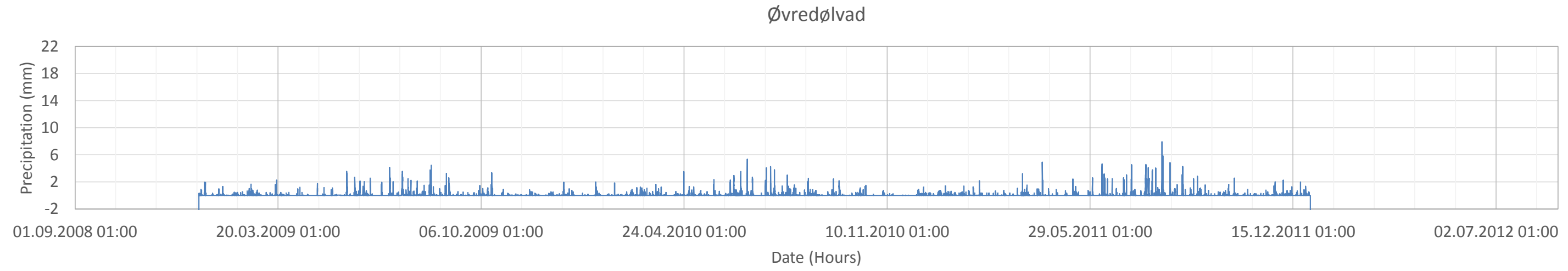

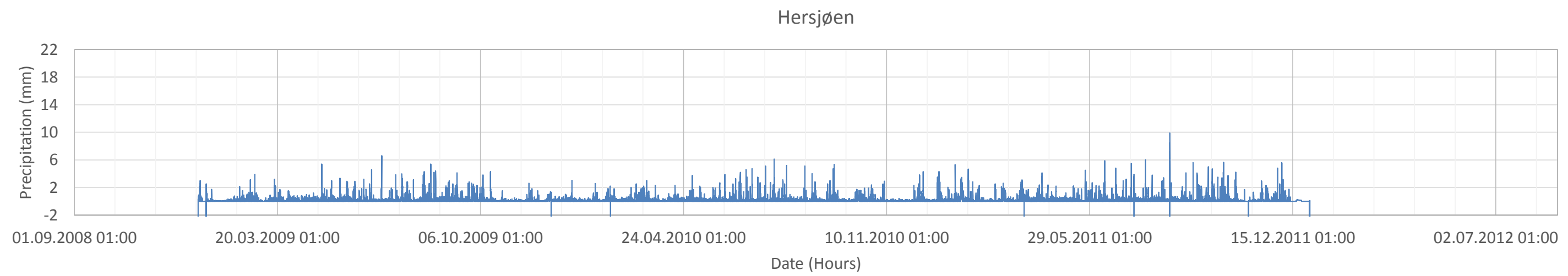
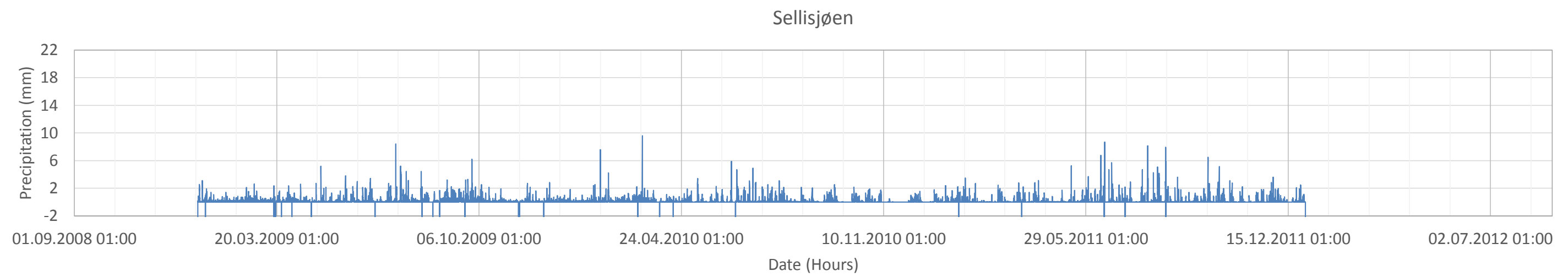
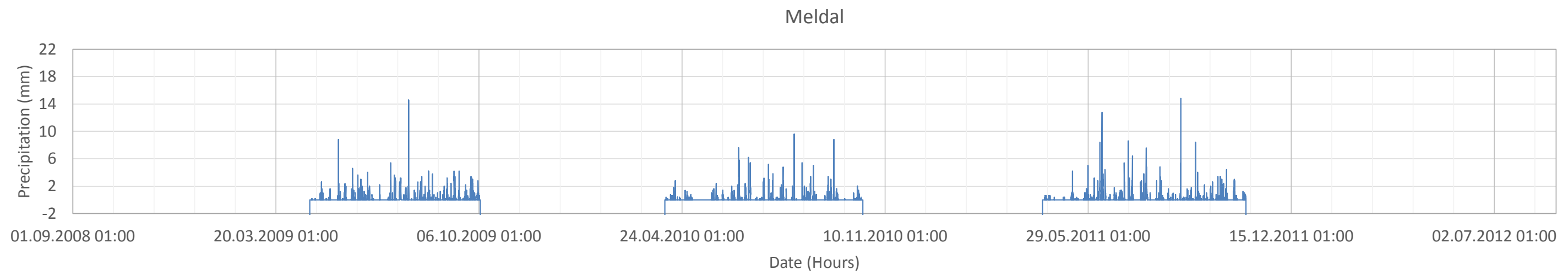
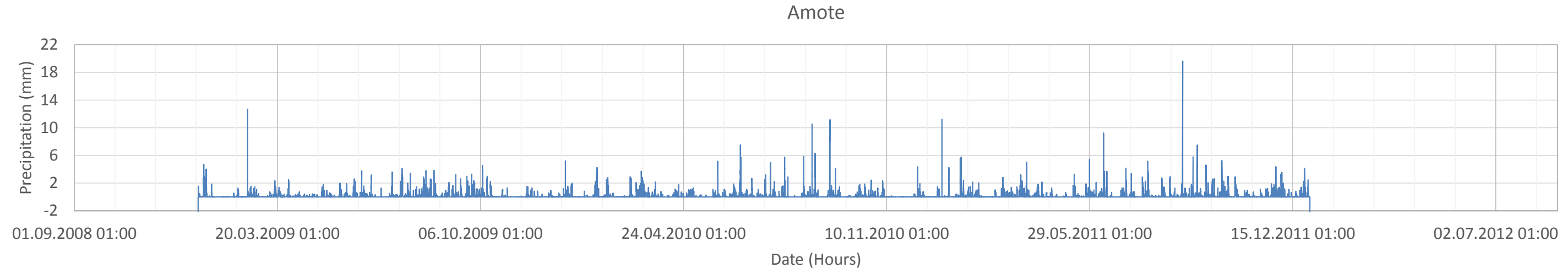

APPENDIX D

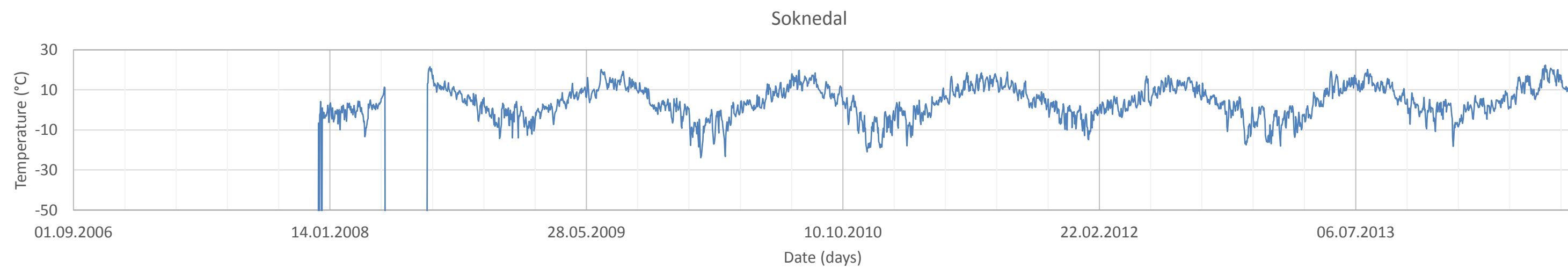
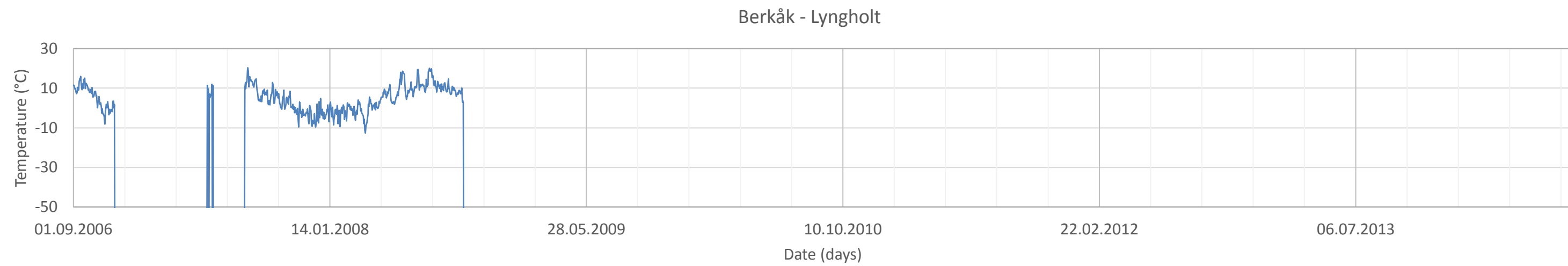
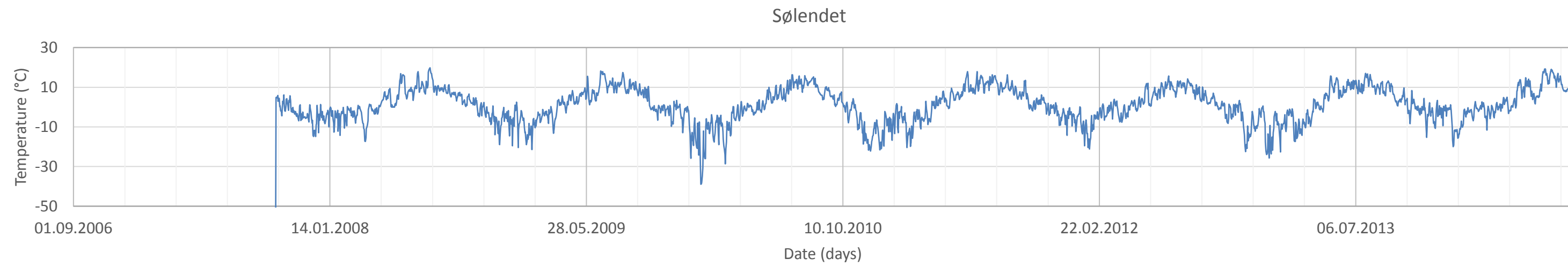
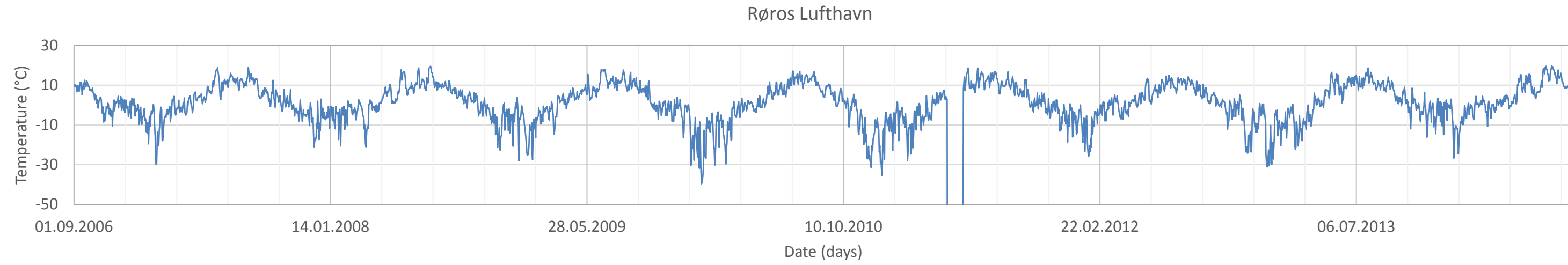

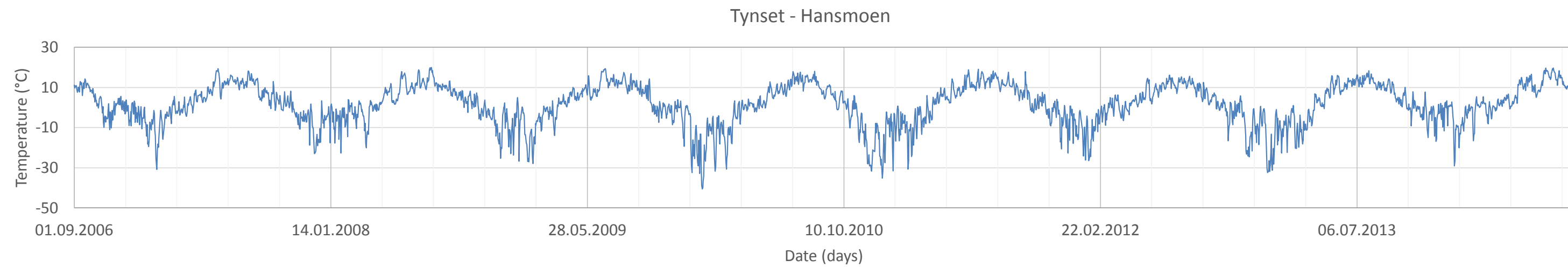
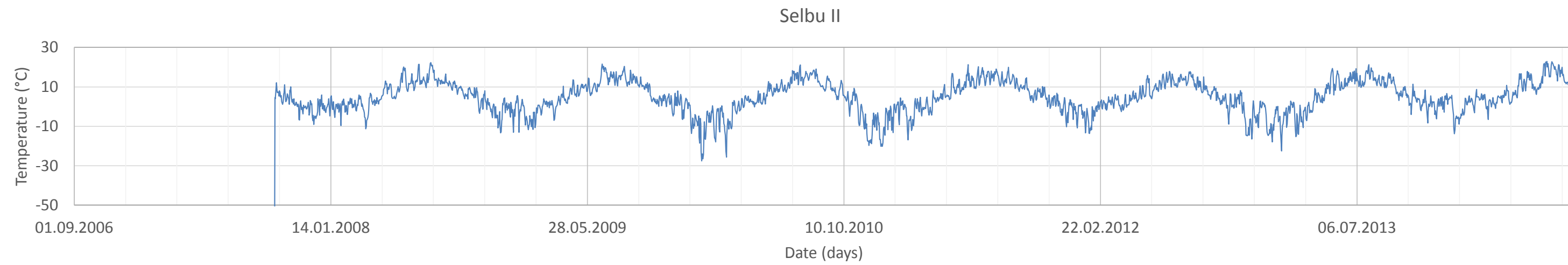
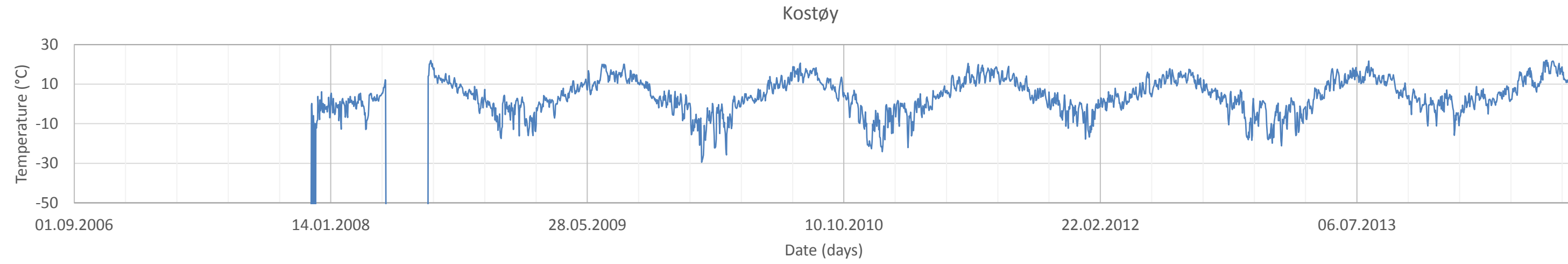

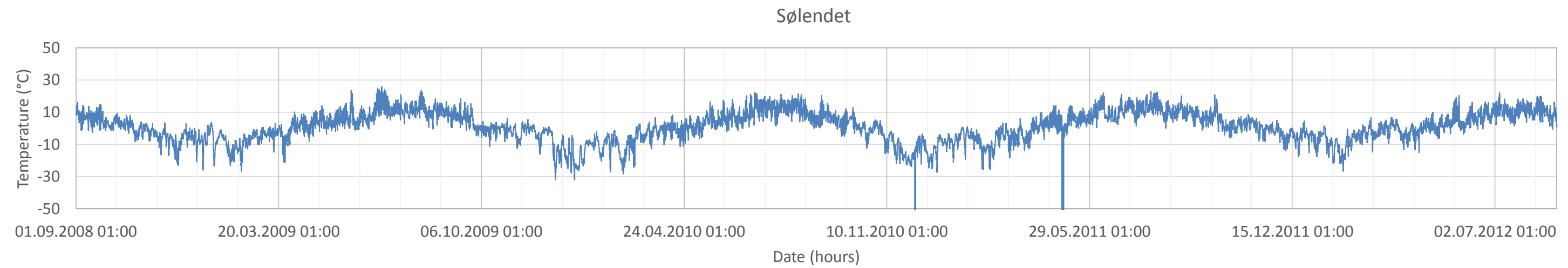
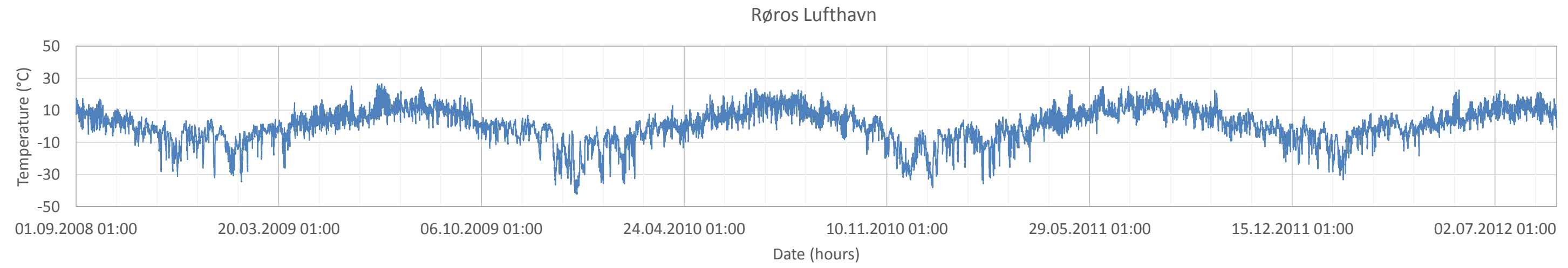
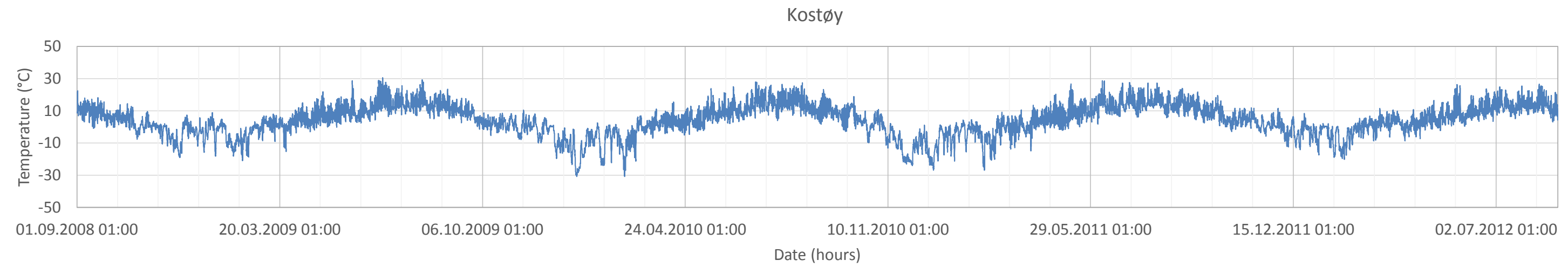
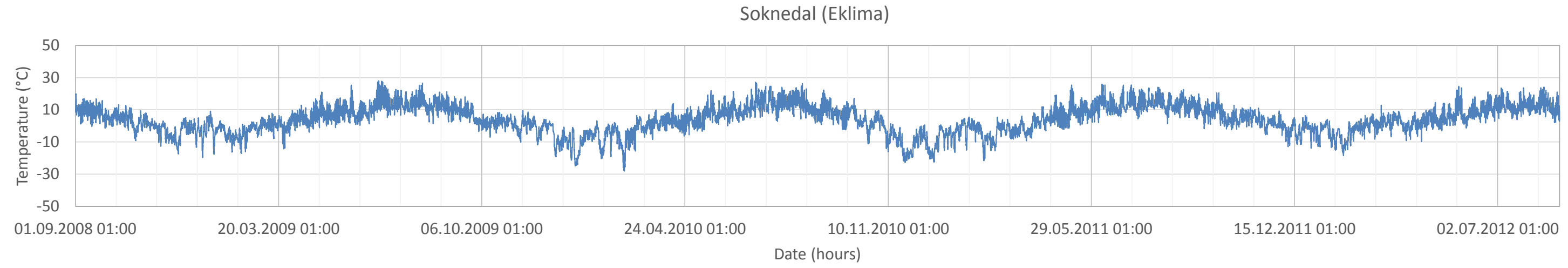

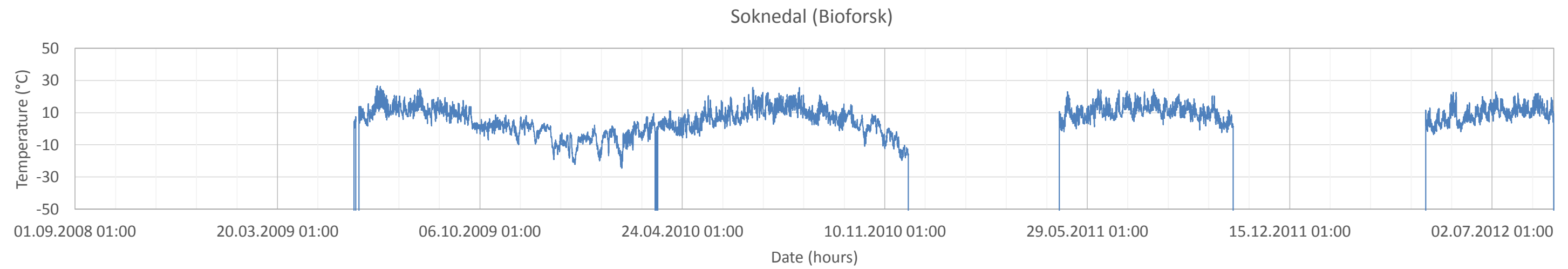
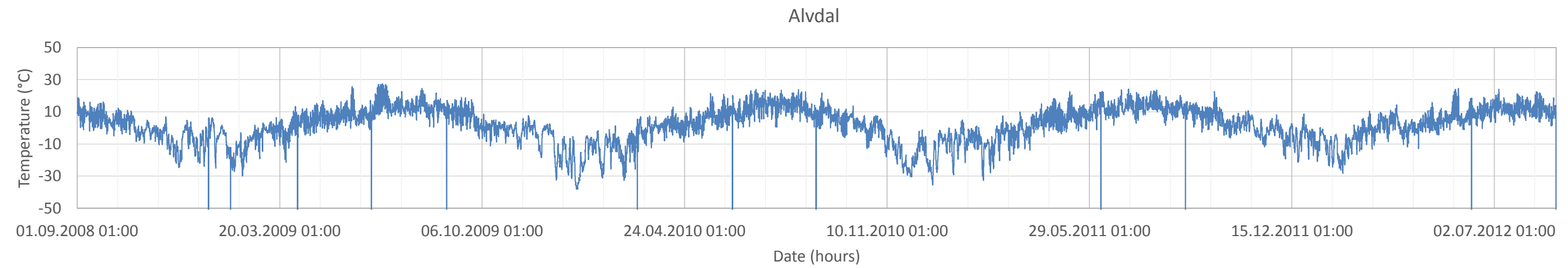
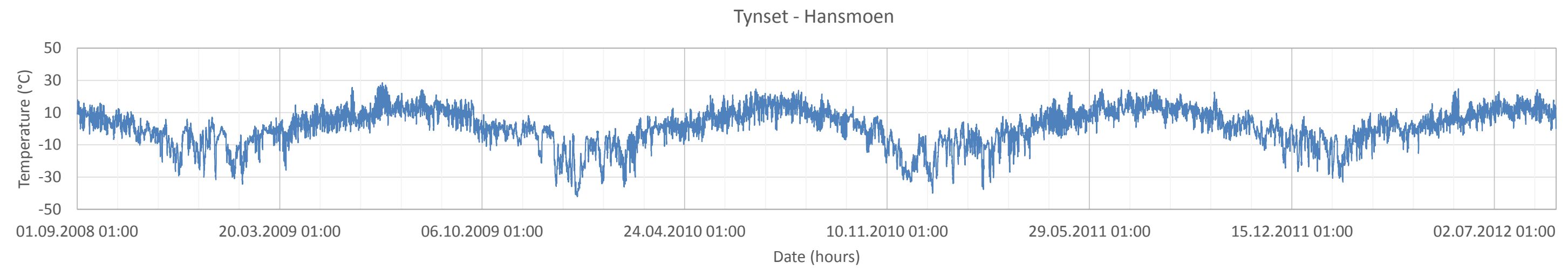
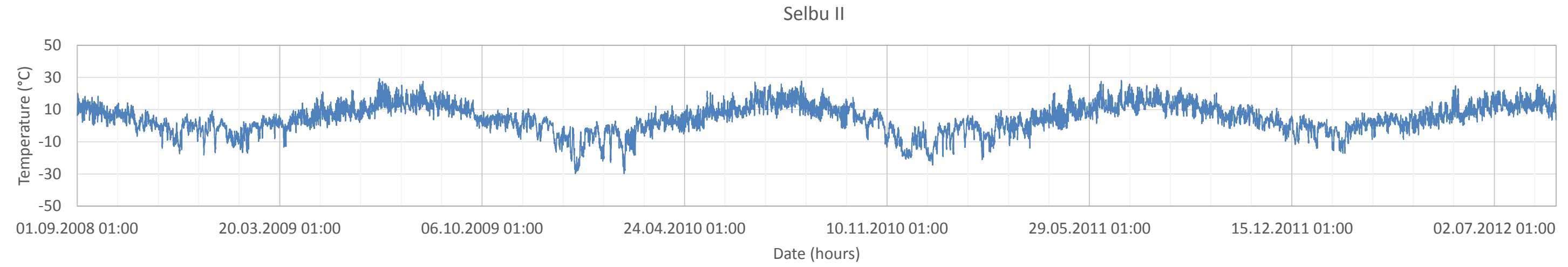

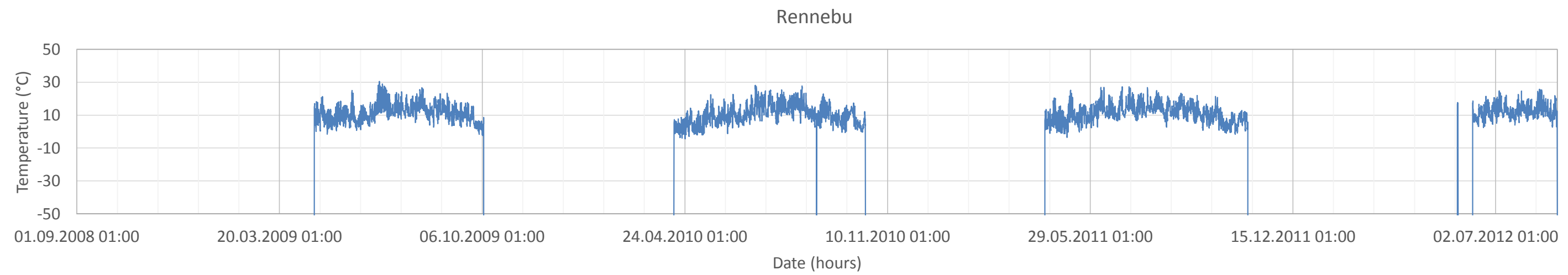
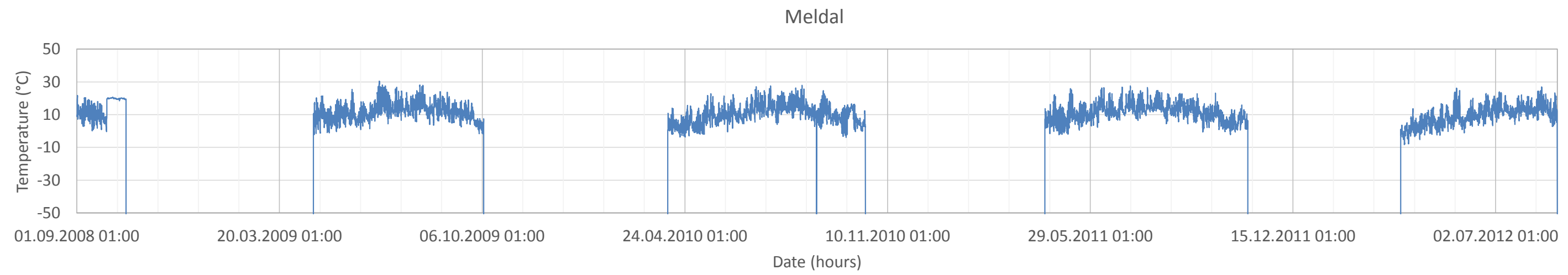
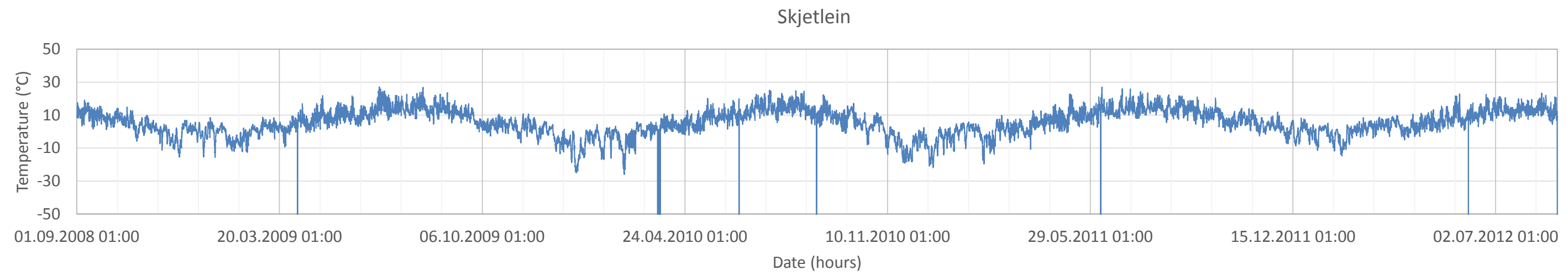
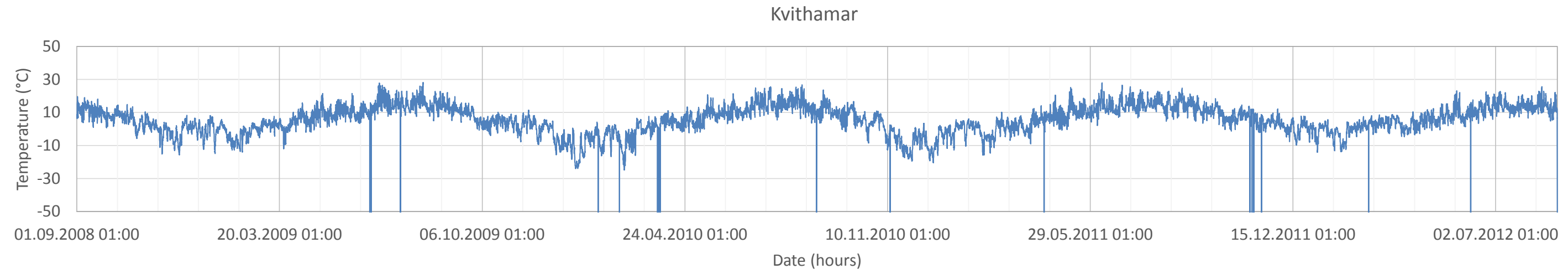

APPENDIX E

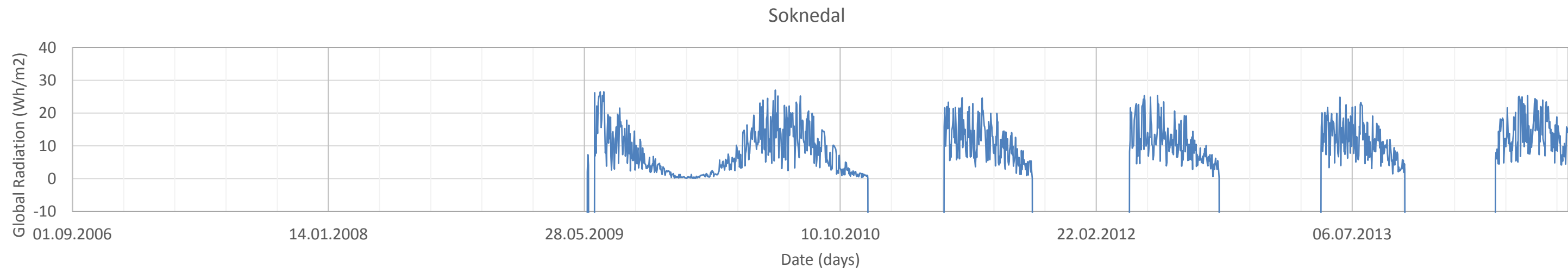
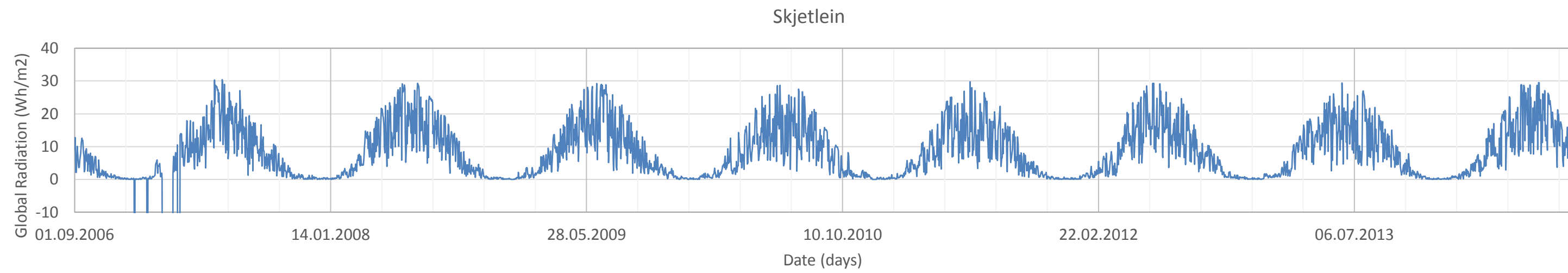
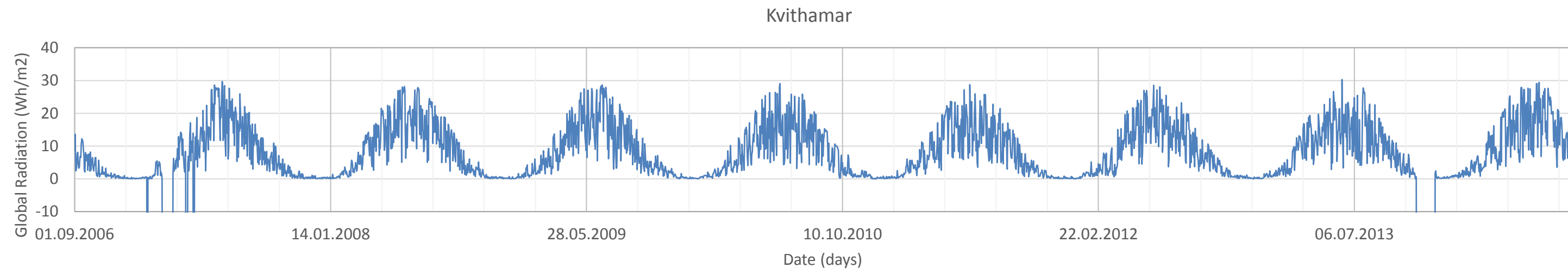
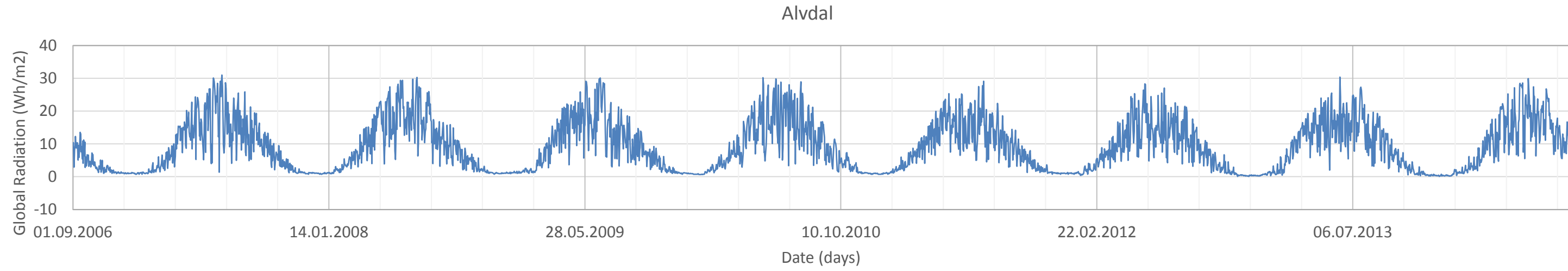

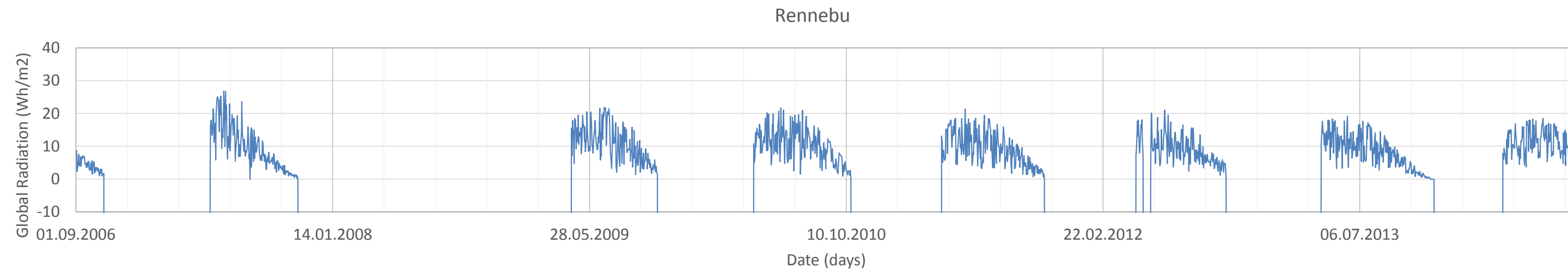
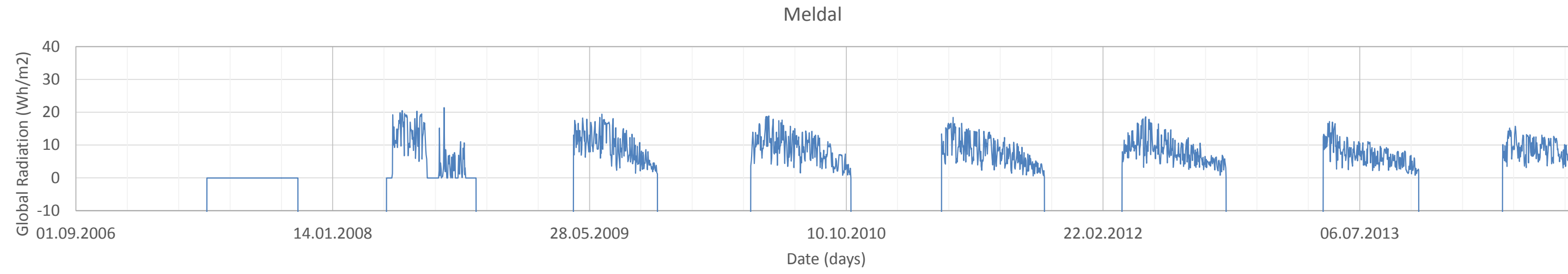

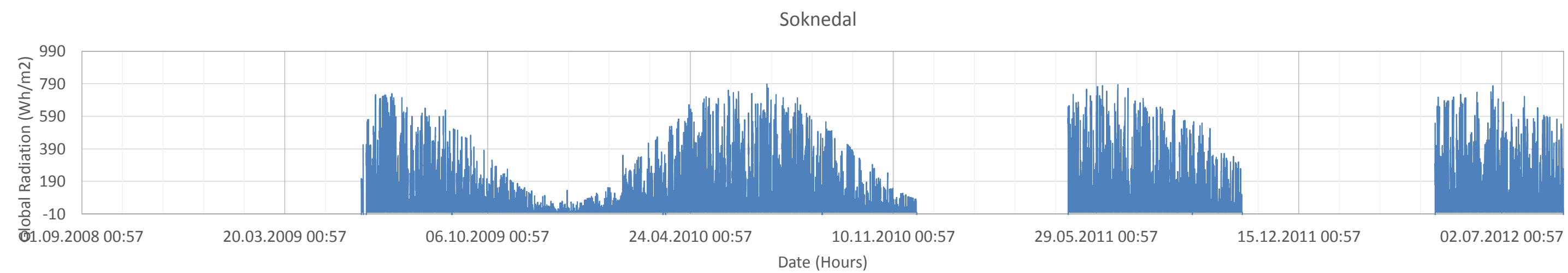
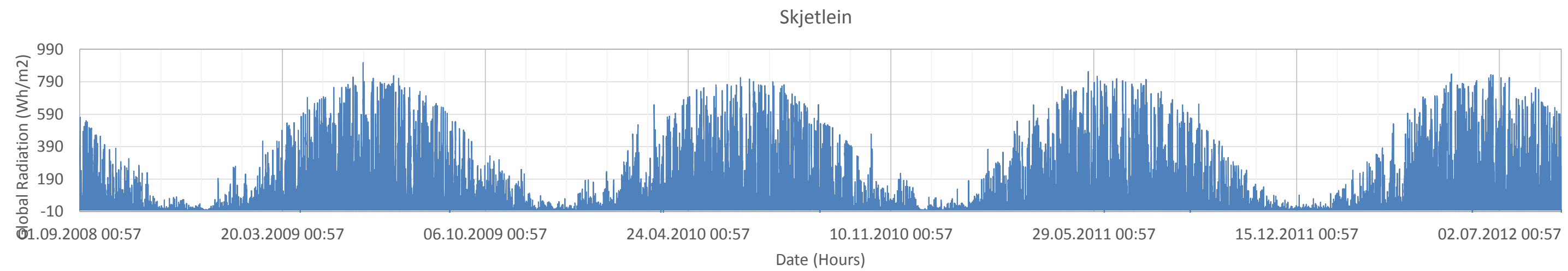
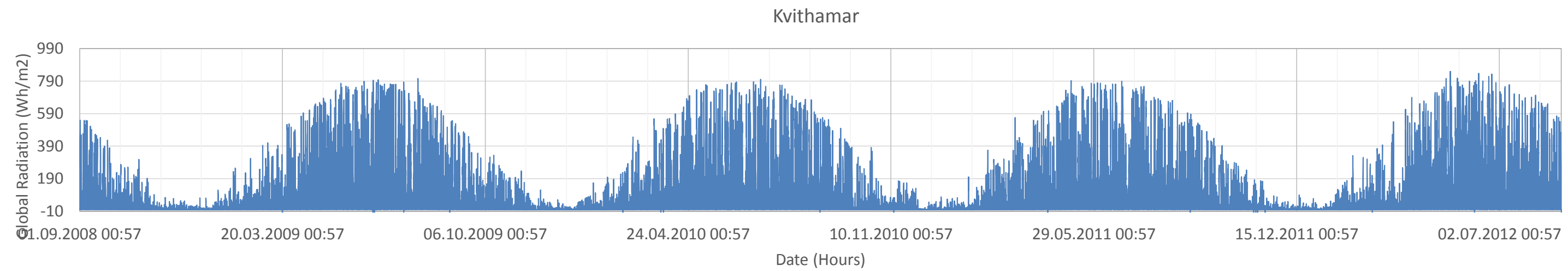
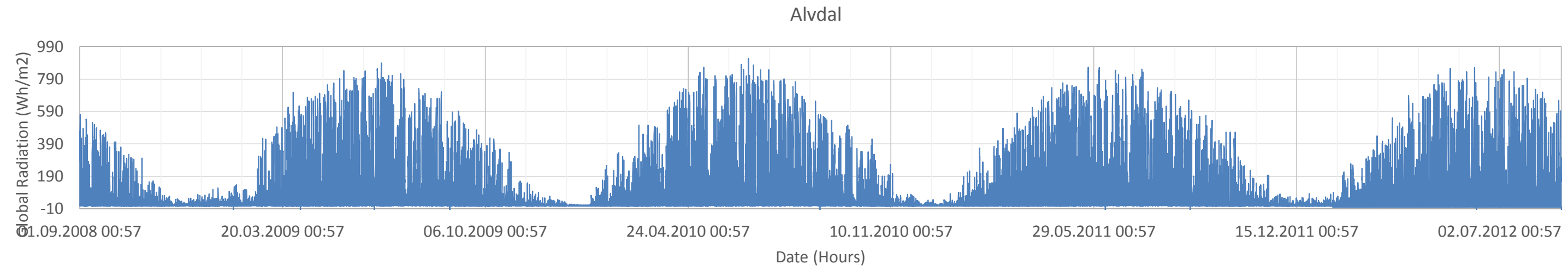

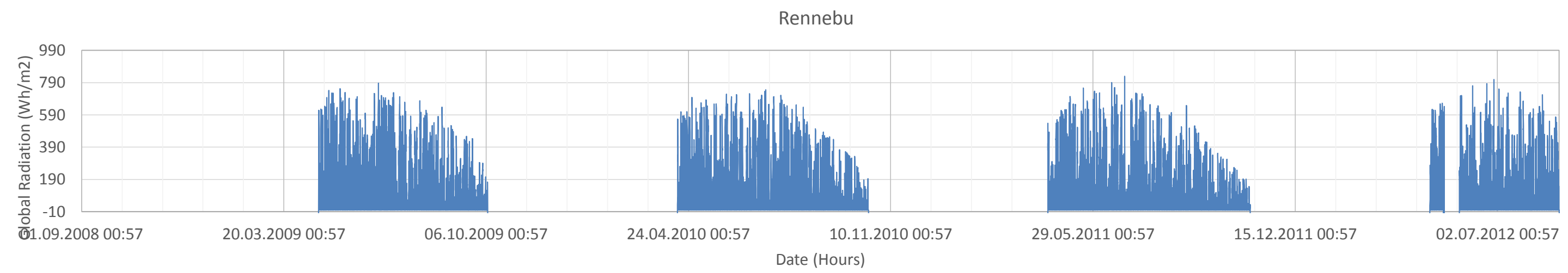
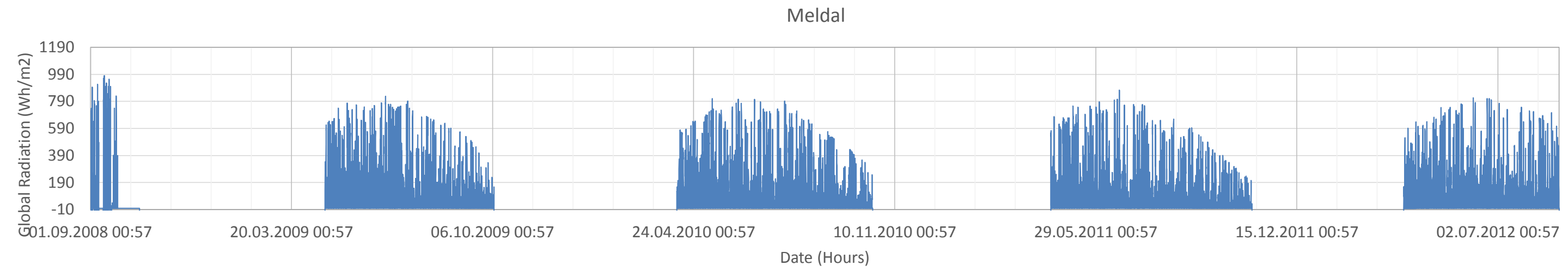

APPENDIX F

Røros Lufthavn

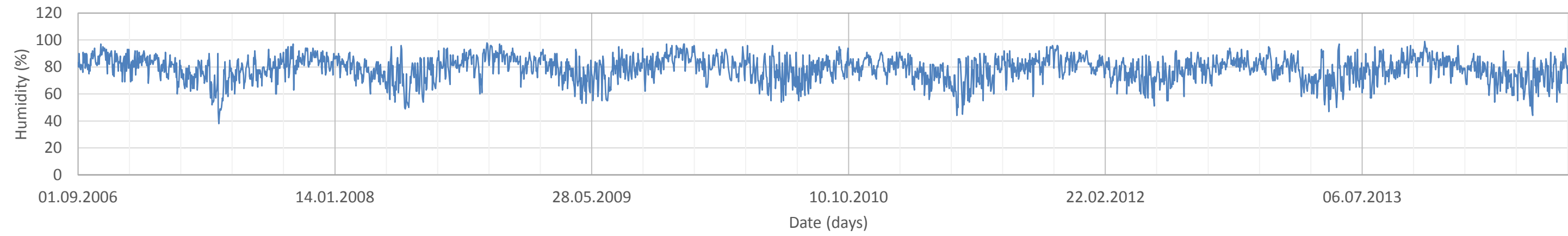

Sølendet

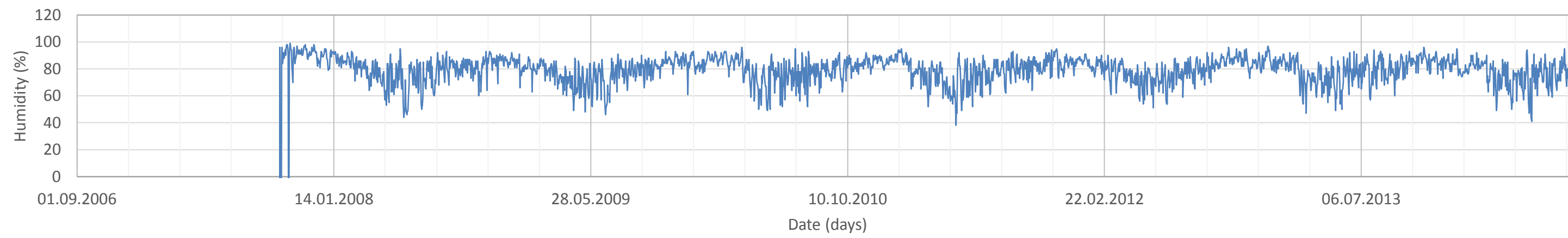

Berkåk - Lyngholt

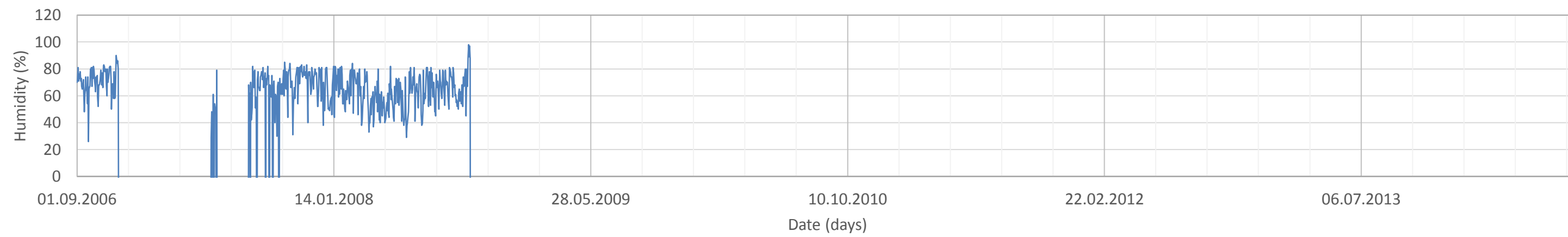

Soknedal

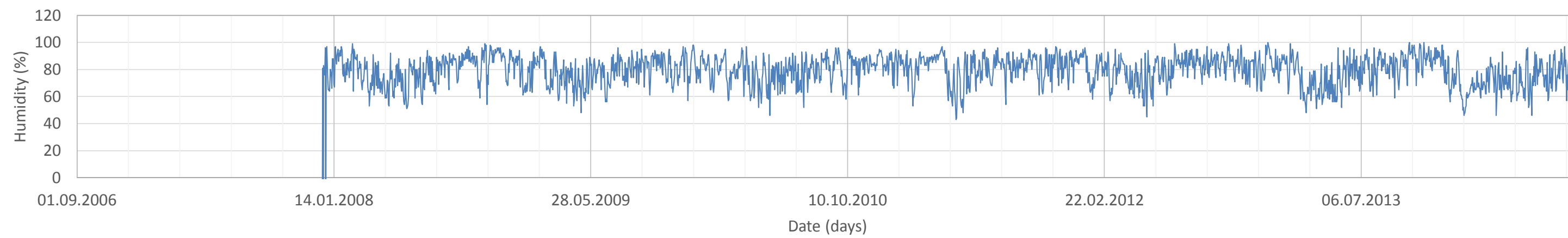

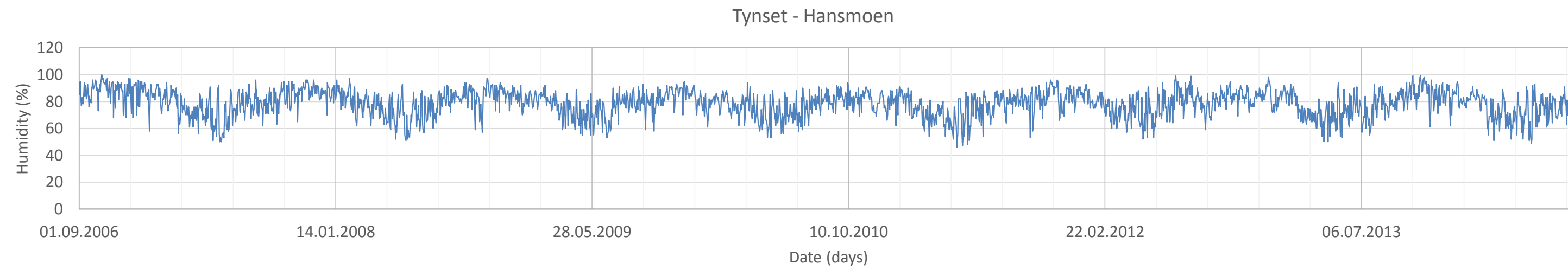
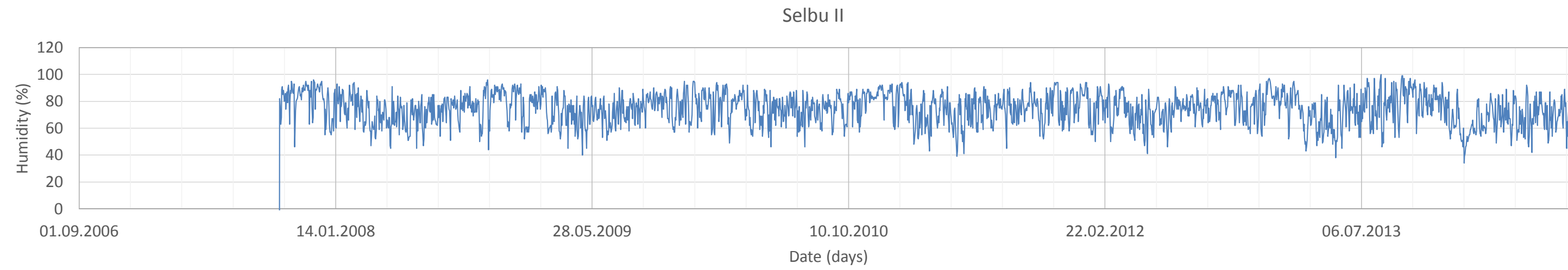
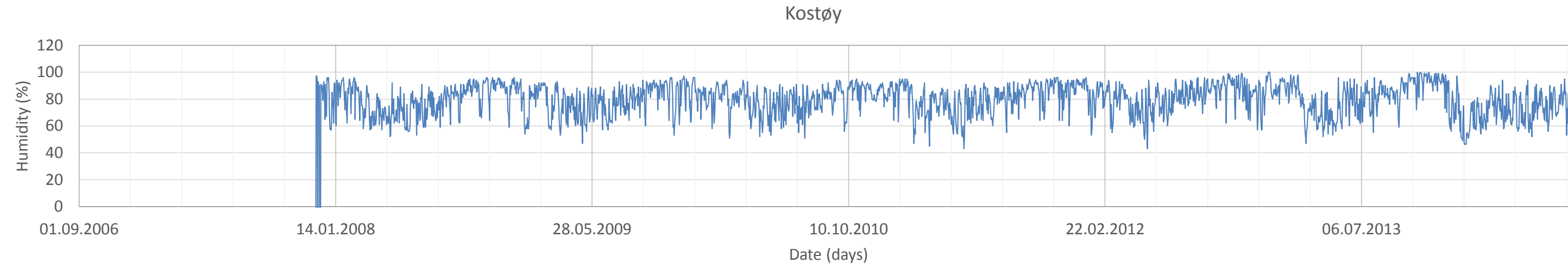

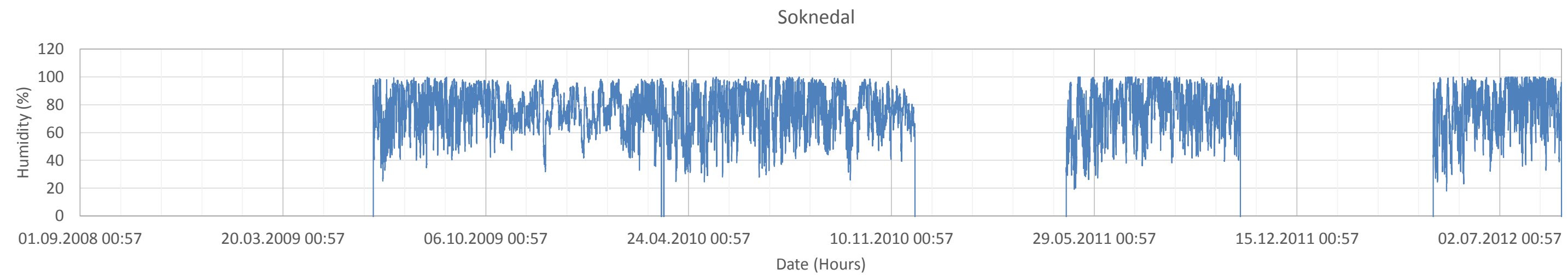
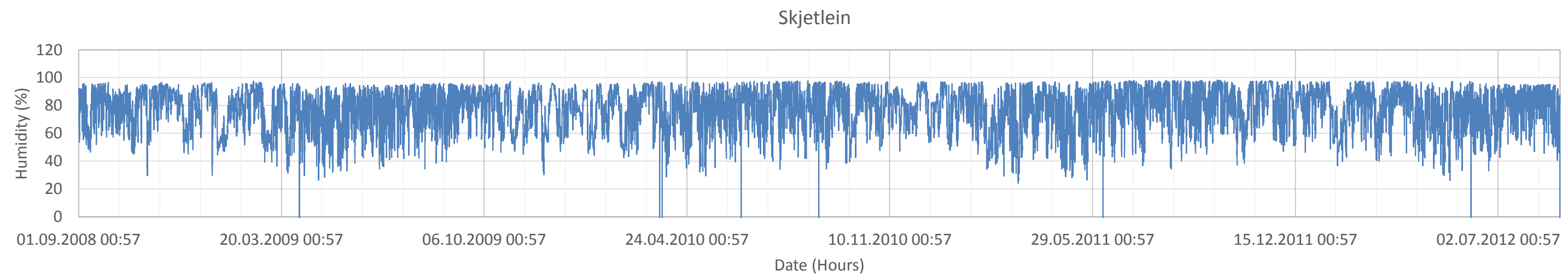
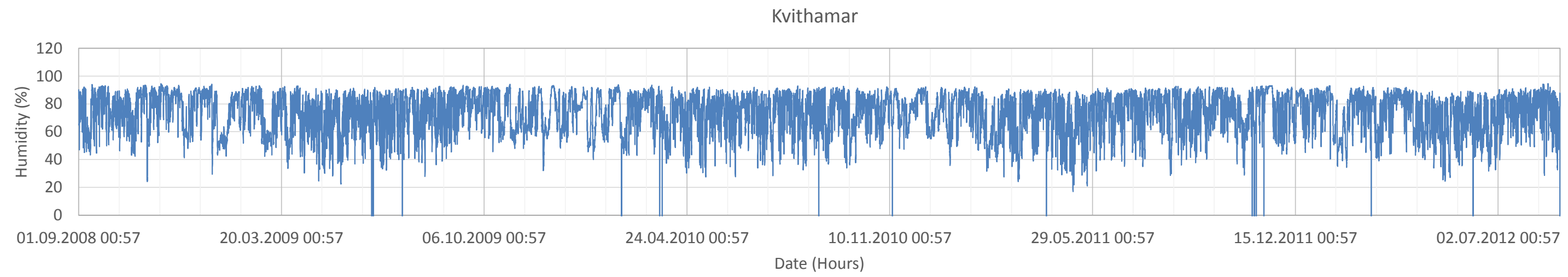
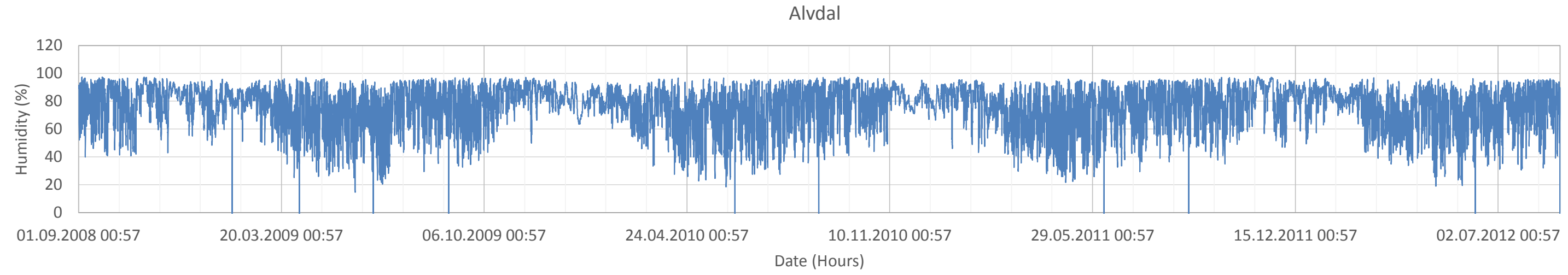

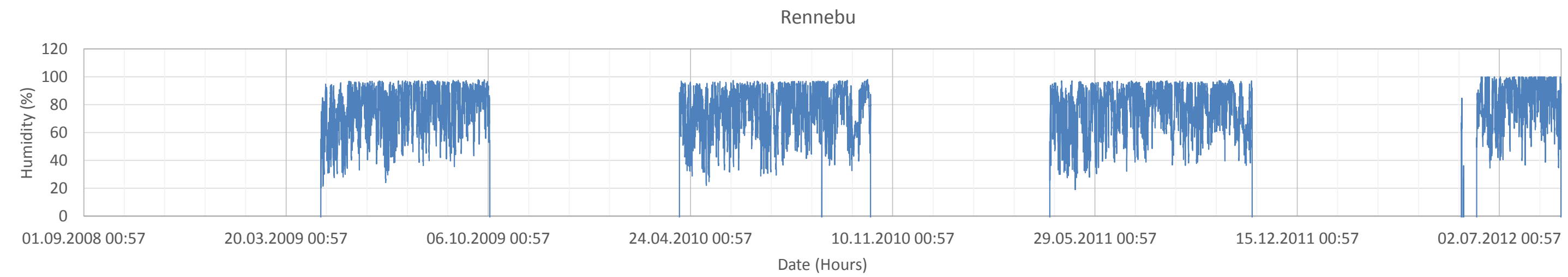
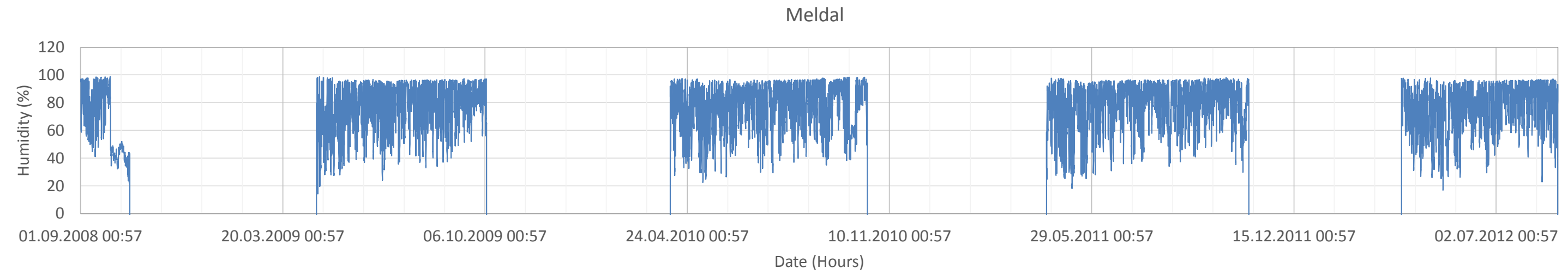

APPENDIX G

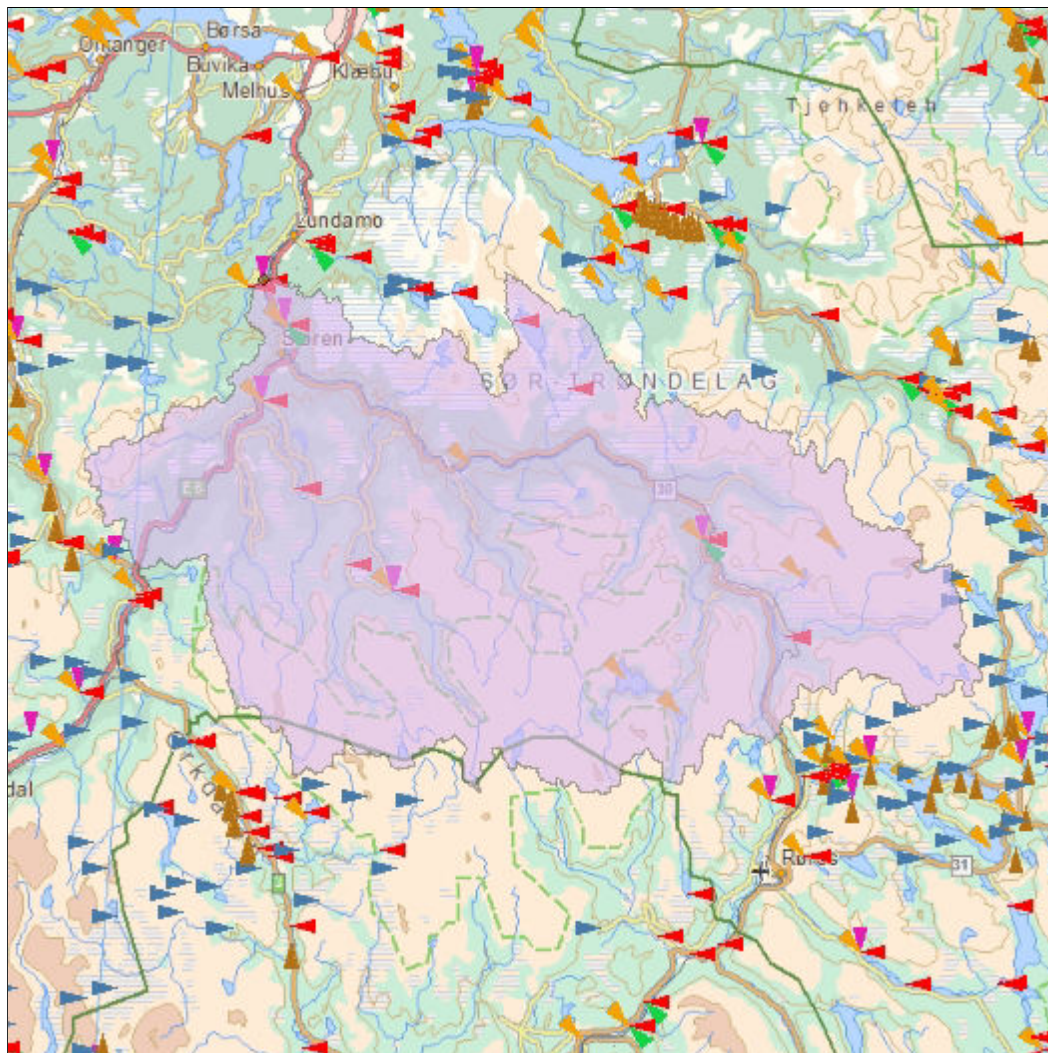

Norges
vassdrags- og
energidirektorat

Kartbakgrunn: Statens Kartverk
Kartdatum: EUREF89 WGS84
Projeksjon: UTM 33N

Nedbørfeltgrenser, feltparametere og vannføringsindekser er automatisk generert og kan inneholde feil. Resultatene må kvalitetssikres.

Lavvannskart

Vassdragsnr.: 122.B40
Kommune: Melhus
Fylke: Sør-Trøndelag
Vassdrag: GAULA

Vannføringsindeks, se merknader

Middelvannføring (61-90)	27,1 l/s/km ²
Alminnelig lavvannføring	0,0 l/s/km ²
5-persentil (hele året)	0,0 l/s/km ²
5-persentil (1/5-30/9)	0,0 l/s/km ²
5-persentil (1/10-30/4)	0,0 l/s/km ²
Base flow	0,0 l/s/km ²
BFI	0,0

Klima

Klimaregion	Midt
Årsnedbør	920 mm
Sommernedbør	416 mm
Vinternedbør	504 mm
Årstemperatur	0,6 °C
Sommertemperatur	6,9 °C
Vintertemperatur	-3,9 °C
Temperatur Juli	8,9 °C
Temperatur August	9,5 °C

Feltparametere

Areal (A)	3087,0 km ²
Effektiv sjø (S_{eff})	0,0 %
Elvelengde (E_L)	116,8 km
Elvegradient (E_G)	7,9 m/km
Elvegradient ₁₀₈₅ (G_{1085})	7,0 m/km
Feltlengde (F_L)	87,1 km
H_{min}	52 moh.
H_{10}	436 moh.
H_{20}	534 moh.
H_{30}	597 moh.
H_{40}	662 moh.
H_{50}	735 moh.
H_{60}	812 moh.
H_{70}	878 moh.
H_{80}	945 moh.
H_{90}	1019 moh.
H_{max}	1325 moh.
Bre	0,0 %
Dyrket mark	2,7 %
Myr	14,5 %
Sjø	2,1 %
Skog	36,7 %
Snaufjell	35,8 %
Urban	0,1 %

Det er generelt stor usikkerhet i beregninger av lavvannsindekser. Resultatene bør verifiseres mot egne observasjoner eller sammenlignbare målestasjoner.

I nedbørfelt med høy breprosent eller stor innsjøprosent vil tørrværsavrenning (baseflow) ha store bidrag fra disse lagringsmagasinene.

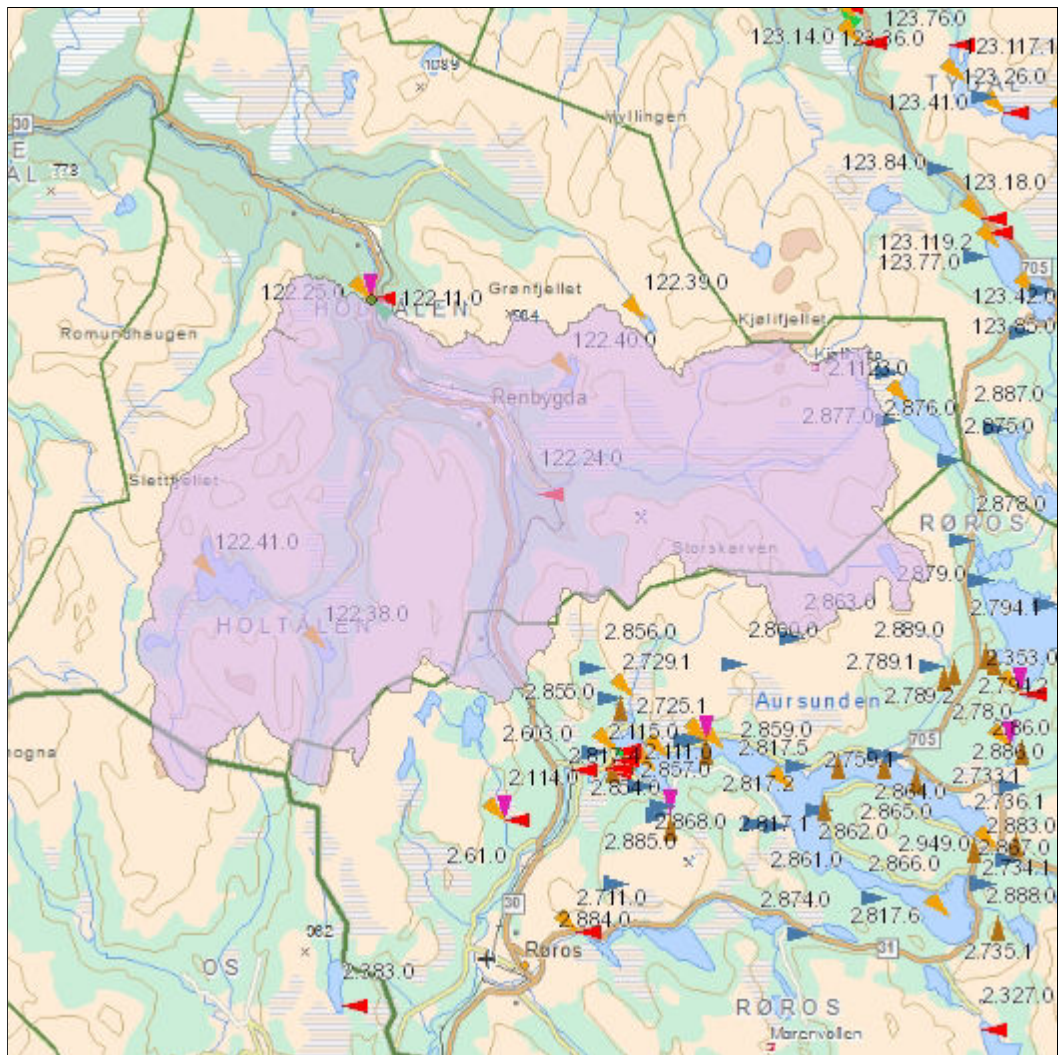

Norges
vassdrags- og
energidirektorat

Kartbakgrunn: Statens Kartverk
Kartdatum: EUREF89 WGS84
Projeksjon: UTM 33N

Nedbørfeltgrenser, feltparametere og vannføringsindekser er automatisk generert og kan inneholde feil. Resultatene må kvalitetssikres.

Lavvannskart

Vassdragsnr.: 122.F0
Kommune: Holtålen
Fylke: Sør-Trøndelag
Vassdrag: GAULA

Vannføringsindeks, se merknader

Middelvannføring (61-90)	25,6 l/s/km ²
Alminnelig lavvannføring	0,0 l/s/km ²
5-persentil (hele året)	0,0 l/s/km ²
5-persentil (1/5-30/9)	0,0 l/s/km ²
5-persentil (1/10-30/4)	0,0 l/s/km ²
Base flow	0,0 l/s/km ²
BFI	0,0

Klima

Klimaregion	Midt
Årsnedbør	963 mm
Sommernedbør	434 mm
Vinternedbør	529 mm
Årstemperatur	-0,2 °C
Sommertemperatur	6,4 °C
Vintertemperatur	-4,8 °C
Temperatur Juli	8,4 °C
Temperatur August	9,1 °C

Feltparametere

Areal (A)	654,6 km ²
Effektiv sjø (S_{eff})	0,2 %
Elvelengde (E_L)	45,4 km
Elvegradient (E_G)	15,1 m/km
Elvegradient ₁₀₈₅ (G_{1085})	14,5 m/km
Feltlengde(F_L)	33,0 km
H_{min}	285 moh.
H_{10}	622 moh.
H_{20}	717 moh.
H_{30}	774 moh.
H_{40}	811 moh.
H_{50}	843 moh.
H_{60}	878 moh.
H_{70}	918 moh.
H_{80}	964 moh.
H_{90}	1021 moh.
H_{max}	1284 moh.
Bre	0,0 %
Dyrket mark	2,1 %
Myr	12,6 %
Sjø	2,8 %
Skog	24,6 %
Snaufjell	43,9 %
Urban	0,0 %

Det er generelt stor usikkerhet i beregninger av lavvannsindekser. Resultatene bør verifiseres mot egne observasjoner eller sammenlignbare målestasjoner.

I nedbørfelt med høy breprosent eller stor innsjøprosent vil tørrværsavrenning (baseflow) ha store bidrag fra disse lagringsmagasinene.

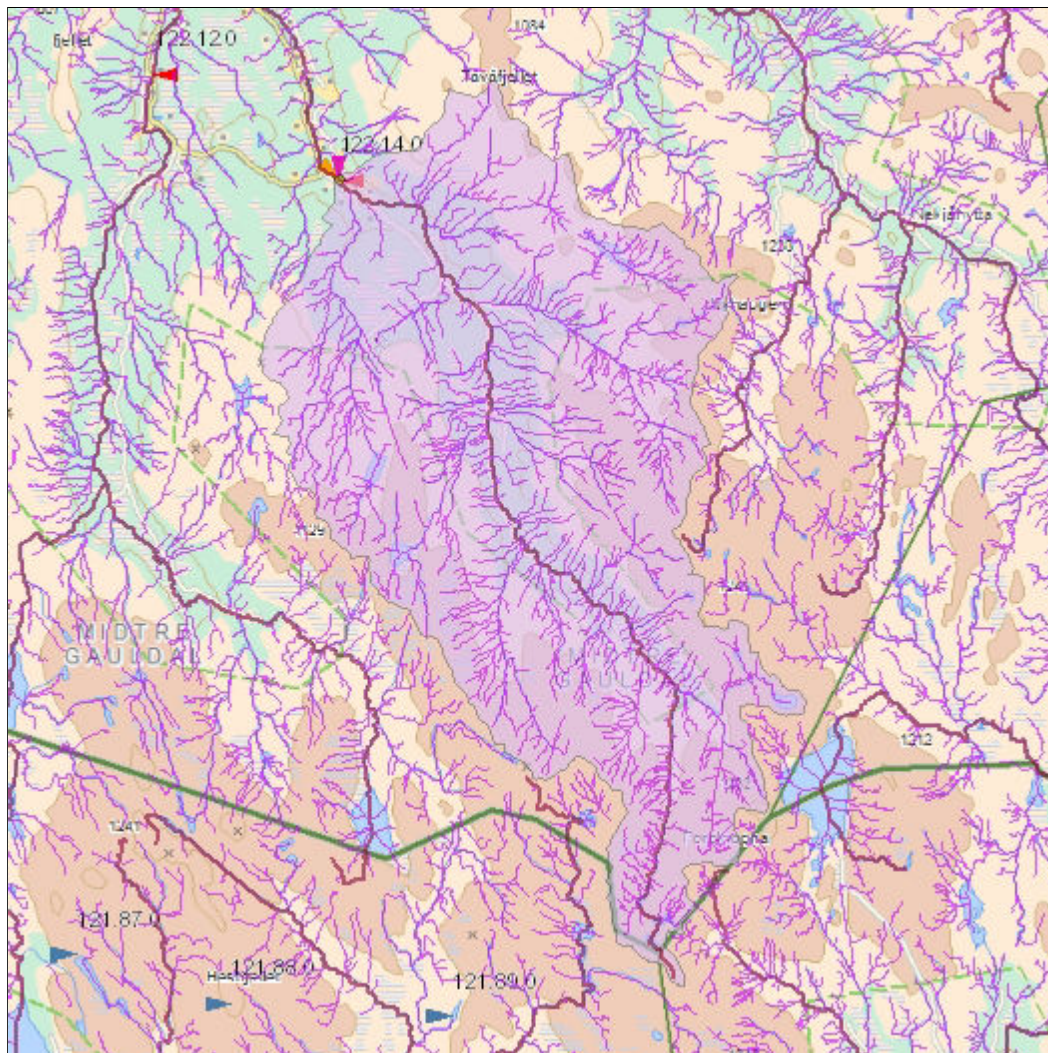

Norges
vassdrags- og
energidirektorat

Kartbakgrunn: Statens Kartverk

Kartdatum: EUREF89 WGS84

Projeksjon: UTM 33N

Nedbørfeltgrenser, feltparametere og vannføringsindekser er automatisk generert og kan inneholde feil. Resultatene må kvalitetssikres.

Lavvannskart

Vassdragsnr.: 122.CB

Kommune: Midtre Gauldal

Fylke: Sør-Trøndelag

Vassdrag: BUA

Vannføringsindeks, se merknader

Middelvannføring (61-90)	29,0 l/s/km ²
Alminnelig lavvannføring	0,0 l/s/km ²
5-persentil (hele året)	0,0 l/s/km ²
5-persentil (1/5-30/9)	0,0 l/s/km ²
5-persentil (1/10-30/4)	0,0 l/s/km ²
Base flow	0,0 l/s/km ²
BFI	0,0

Klima

Klimaregion	Midt
Årsnedbør	984 mm
Sommernedbør	435 mm
Vinternedbør	549 mm
Årstemperatur	-0,8 °C
Sommertemperatur	5,7 °C
Vintertemperatur	-5,4 °C
Temperatur Juli	7,7 °C
Temperatur August	8,4 °C

Feltparametere

Areal (A)	168,1 km ²
Effektiv sjø (S_{eff})	0,0 %
Elvelengde (E_L)	29,1 km
Elvegradient (E_G)	19,9 m/km
Elvegradient ₁₀₈₅ (G_{1085})	20,3 m/km
Feltlengde(F_L)	23,2 km
H_{min}	516 moh.
H_{10}	675 moh.
H_{20}	769 moh.
H_{30}	847 moh.
H_{40}	907 moh.
H_{50}	948 moh.
H_{60}	983 moh.
H_{70}	1016 moh.
H_{80}	1046 moh.
H_{90}	1089 moh.
H_{max}	1295 moh.
Bre	0,0 %
Dyrket mark	0,5 %
Myr	9,0 %
Sjø	1,1 %
Skog	21,7 %
Snaufjell	65,3 %
Urban	0,0 %

Det er generelt stor usikkerhet i beregninger av lavvannsindekser. Resultatene bør verifiseres mot egne observasjoner eller sammenlignbare målestasjoner.

I nedbørfelt med høy breprosent eller stor innsjøprosent vil tørrværsavrenning (baseflow) ha store bidrag fra disse lagringsmagasinene.

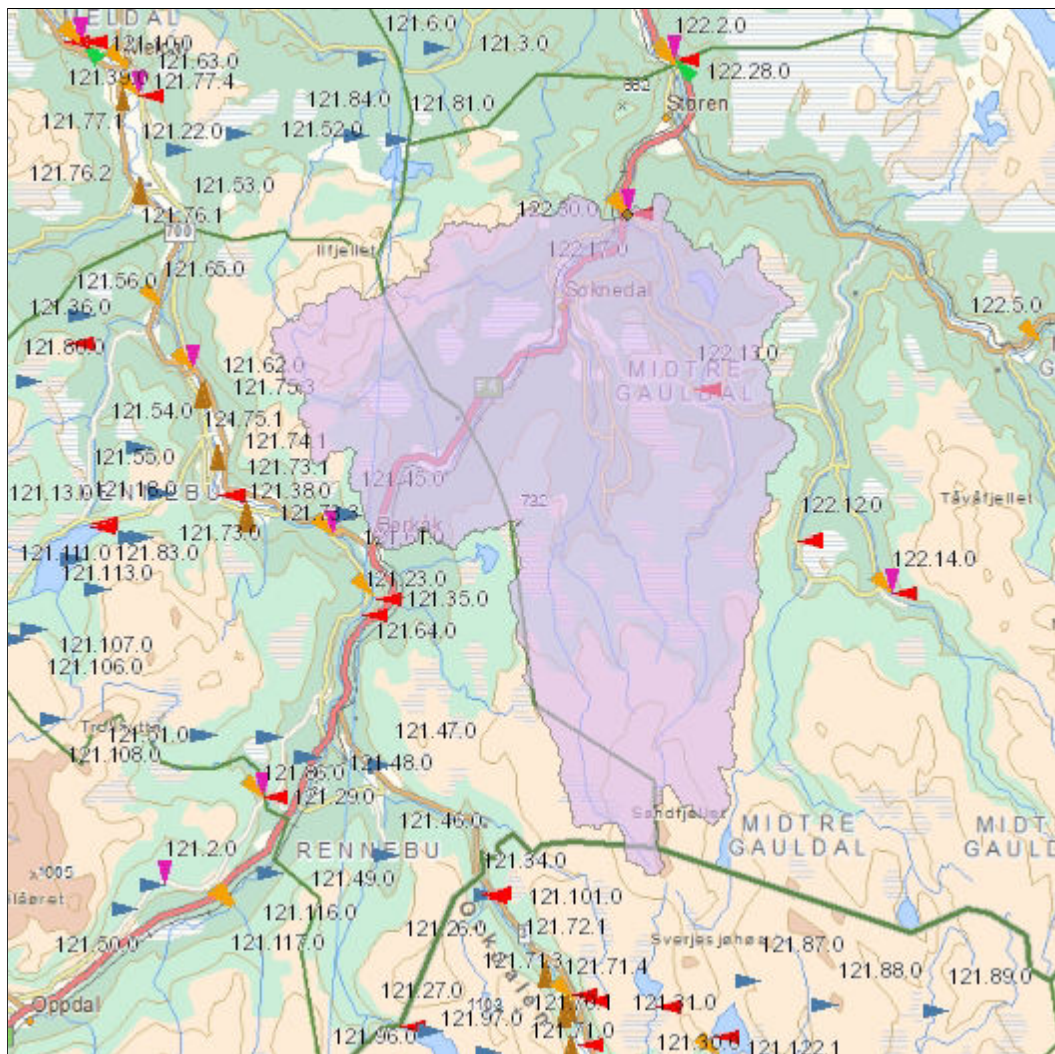

**Norges
vassdrags- og
energidirektorat**

Kartbakgrunn: Statens Kartverk

Kartdatum: EUREF89 WGS84

Projeksjon: UTM 33N

Nedbørfeltgrenser, feltparametere og vannføringsindekser er automatisk generert og kan inneholde feil. Resultatene må kvalitetssikres.

Lavvannskart

Vassdragsnr.: 122.BA0

Kommune: Midtre Gauldal

Fylke: Sør-Trøndelag

Vassdrag: SOKNA

Vannføringsindeks, se merknader

Middelvannføring (61-90)	23,0 l/s/km ²
Alminnelig lavvannføring	0,0 l/s/km ²
5-persentil (hele året)	0,0 l/s/km ²
5-persentil (1/5-30/9)	0,0 l/s/km ²
5-persentil (1/10-30/4)	0,0 l/s/km ²
Base flow	0,0 l/s/km ²
BFI	0,0

Klima

Klimaregion	Midt
Årsnedbør	817 mm
Sommernedbør	379 mm
Vinternedbør	437 mm
Årstemperatur	1,3 °C
Sommertemperatur	7,4 °C
Vintertemperatur	-3,0 °C
Temperatur Juli	9,3 °C
Temperatur August	9,8 °C

Feltparametere

Areal (A)	545,7 km ²
Effektiv sjø (S_{eff})	0,0 %
Elvelengde (E_L)	45,0 km
Elvegradient (E_G)	22,3 m/km
Elvegradient ₁₀₈₅ (G_{1085})	21,1 m/km
Feltlengde (F_L)	35,0 km
H_{min}	132 moh.
H_{10}	443 moh.
H_{20}	503 moh.
H_{30}	543 moh.
H_{40}	583 moh.
H_{50}	623 moh.
H_{60}	663 moh.
H_{70}	717 moh.
H_{80}	816 moh.
H_{90}	933 moh.
H_{max}	1254 moh.
Bre	0,0 %
Dyrket mark	6,0 %
Myr	16,7 %
Sjø	1,0 %
Skog	53,6 %
Snaufjell	20,7 %
Urban	0,1 %

Det er generelt stor usikkerhet i beregninger av lavvannsindekser. Resultatene bør verifiseres mot egne observasjoner eller sammenlignbare målestasjoner.

I nedbørfelt med høy breprosent eller stor innsjøprosent vil tørrværsavrenning (baseflow) ha store bidrag fra disse lagringsmagasinene.

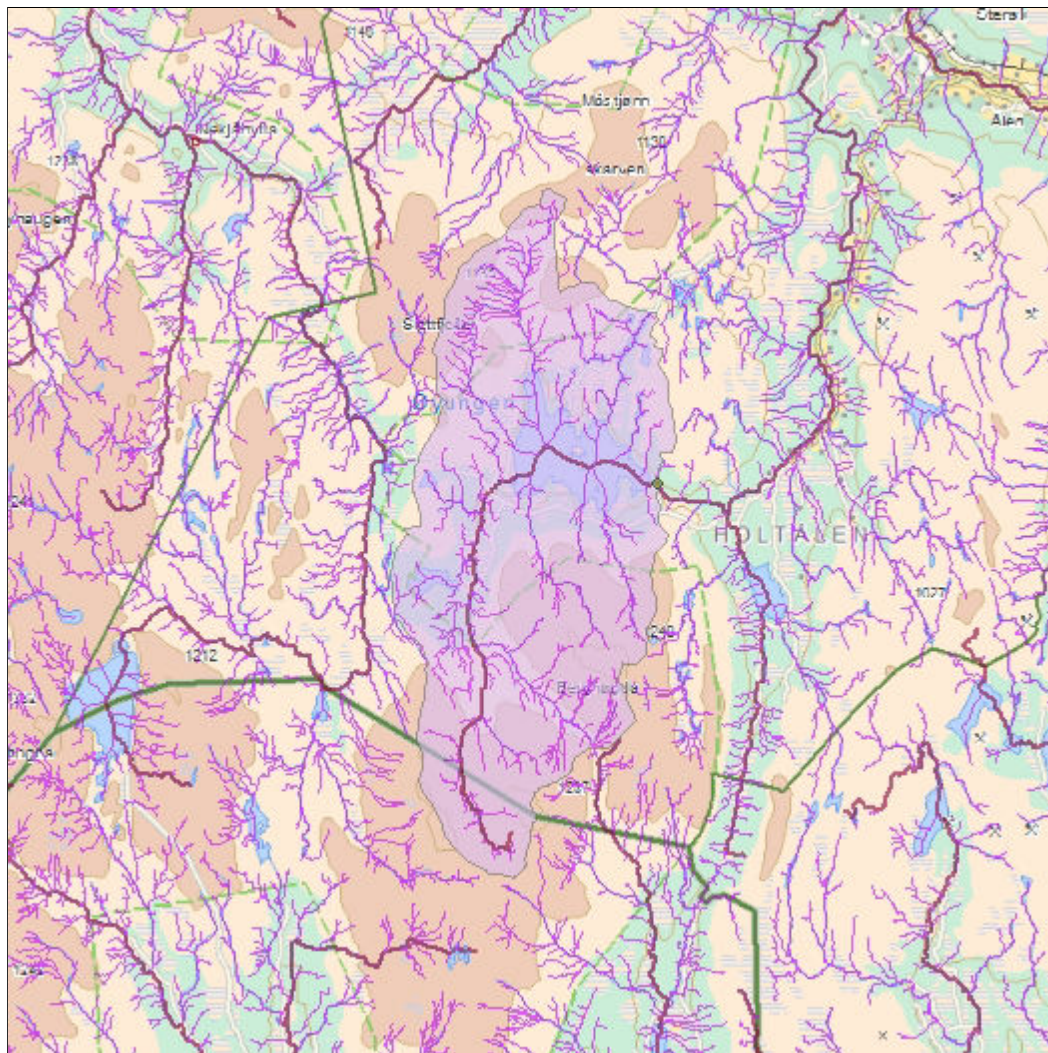

**Norges
vassdrags- og
energidirektorat**

Kartbakgrunn: Statens Kartverk
Kartdatum: EUREF89 WGS84
Projeksjon: UTM 33N

Nedbørfeltgrenser, feltparametere og vannføringsindekser er automatisk generert og kan inneholde feil. Resultatene må kvalitetssikres.

Lavvannskart

Vassdragsnr.: 122.FB1
Kommune: Holtålen
Fylke: Sør-Trøndelag
Vassdrag: HESJA

Vannføringsindeks, se merknader

Middelvannføring (61-90)	24,9 l/s/km ²
Alminnelig lavvannføring	0,0 l/s/km ²
5-persentil (hele året)	0,0 l/s/km ²
5-persentil (1/5-30/9)	0,0 l/s/km ²
5-persentil (1/10-30/4)	0,0 l/s/km ²
Base flow	0,0 l/s/km ²
BFI	0,0

Klima

Klimaregion	Midt
Årsnedbør	1017 mm
Sommernedbør	451 mm
Vinternedbør	566 mm
Årstemperatur	-1,0 °C
Sommertemperatur	5,6 °C
Vintertemperatur	-5,7 °C
Temperatur Juli	7,6 °C
Temperatur August	8,3 °C

Feltparametere

Areal (A)	87,6 km ²
Effektiv sjø (S_{eff})	7,0 %
Elvelengde (E_L)	17,9 km
Elvegradient (E_G)	19,9 m/km
Elvegradient ₁₀₈₅ (G_{1085})	18,8 m/km
Feltlengde (F_L)	11,2 km
H_{min}	785 moh.
H_{10}	797 moh.
H_{20}	823 moh.
H_{30}	853 moh.
H_{40}	884 moh.
H_{50}	935 moh.
H_{60}	985 moh.
H_{70}	1028 moh.
H_{80}	1067 moh.
H_{90}	1123 moh.
H_{max}	1248 moh.
Bre	0,0 %
Dyrket mark	0,1 %
Myr	10,0 %
Sjø	8,6 %
Skog	14,2 %
Snaufjell	55,8 %
Urban	0,0 %

Det er generelt stor usikkerhet i beregninger av lavvannsindekser. Resultatene bør verifiseres mot egne observasjoner eller sammenlignbare målestasjoner.

I nedbørfelt med høy breprosent eller stor innsjøprosent vil tørrværsavrenning (baseflow) ha store bidrag fra disse lagringsmagasinene.

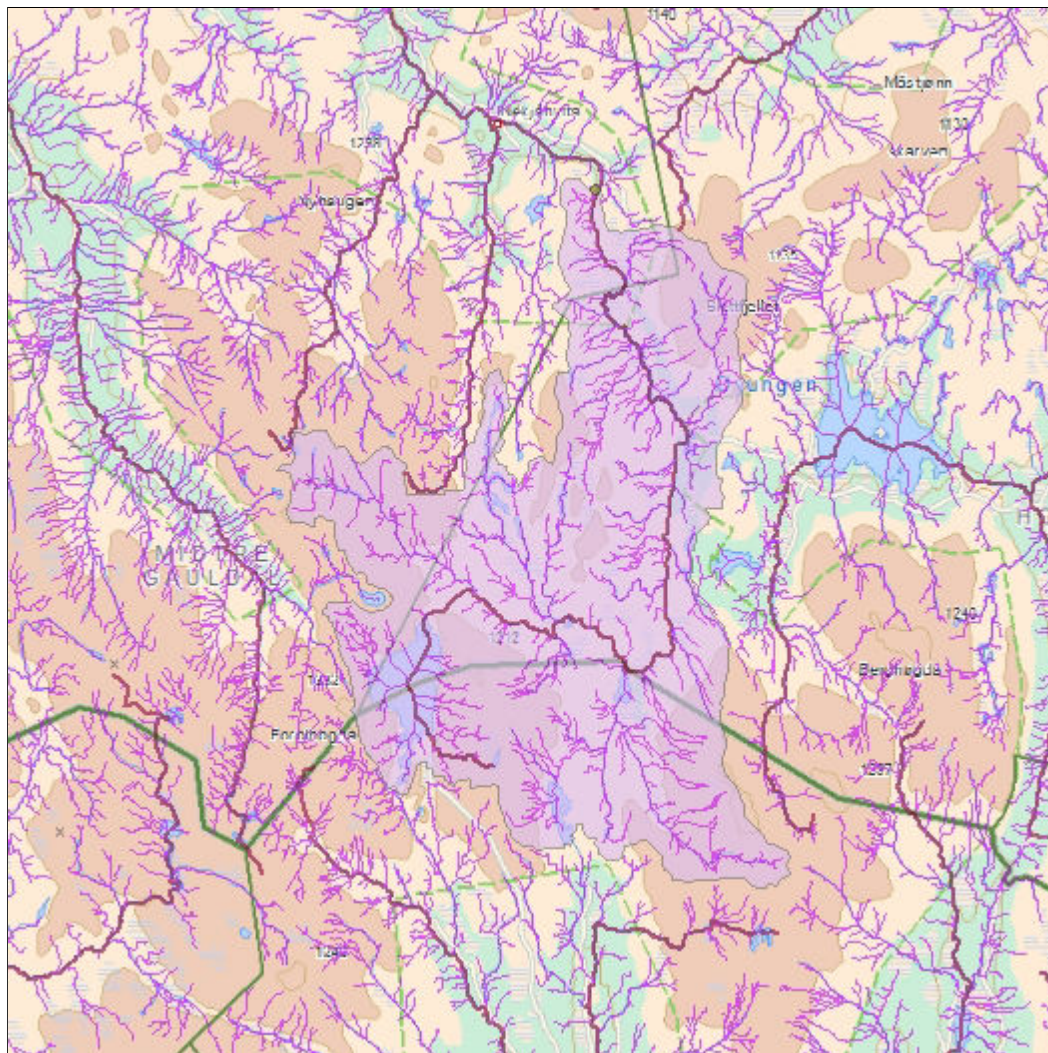

**Norges
vassdrags- og
energidirektorat**

Kartbakgrunn: Statens Kartverk
Kartdatum: EUREF89 WGS84
Projeksjon: UTM 33N

Nedbørfeltgrenser, feltparametere og vannføringsindekser er automatisk generert og kan inneholde feil. Resultatene må kvalitetssikres.

Lavvannskart

Vassdragsnr.: 122.DD
Kommune: Midtre Gauldal
Fylke: Sør-Trøndelag
Vassdrag: FORA

Vannføringsindeks, se merknader

Middelvannføring (61-90)	25,2 l/s/km ²
Alminnelig lavvannføring	0,0 l/s/km ²
5-persentil (hele året)	0,0 l/s/km ²
5-persentil (1/5-30/9)	0,0 l/s/km ²
5-persentil (1/10-30/4)	0,0 l/s/km ²
Base flow	0,0 l/s/km ²
BFI	0,0

Klima

Klimaregion	Midt
Årsnedbør	1040 mm
Sommernedbør	455 mm
Vinternedbør	586 mm
Årstemperatur	-1,6 °C
Sommertemperatur	5,4 °C
Vintertemperatur	-6,7 °C
Temperatur Juli	7,5 °C
Temperatur August	8,2 °C

Feltparametere

Areal (A)	128,0 km ²
Effektiv sjø (S_{eff})	0,5 %
Elvelengde (E_L)	30,7 km
Elvegradient (E_G)	10,2 m/km
Elvegradient ₁₀₈₅ (G_{1085})	6,8 m/km
Feltlengde (F_L)	19,0 km
H_{min}	796 moh.
H_{10}	872 moh.
H_{20}	898 moh.
H_{30}	929 moh.
H_{40}	955 moh.
H_{50}	982 moh.
H_{60}	998 moh.
H_{70}	1028 moh.
H_{80}	1068 moh.
H_{90}	1112 moh.
H_{max}	1325 moh.
Bre	0,0 %
Dyrket mark	0,0 %
Myr	9,6 %
Sjø	5,0 %
Skog	2,8 %
Snaufjell	66,1 %
Urban	0,0 %

Det er generelt stor usikkerhet i beregninger av lavvannsindekser. Resultatene bør verifiseres mot egne observasjoner eller sammenlignbare målestasjoner.

I nedbørfelt med høy breprosent eller stor innsjøprosent vil tørrværsavrenning (baseflow) ha store bidrag fra disse lagringsmagasinene.

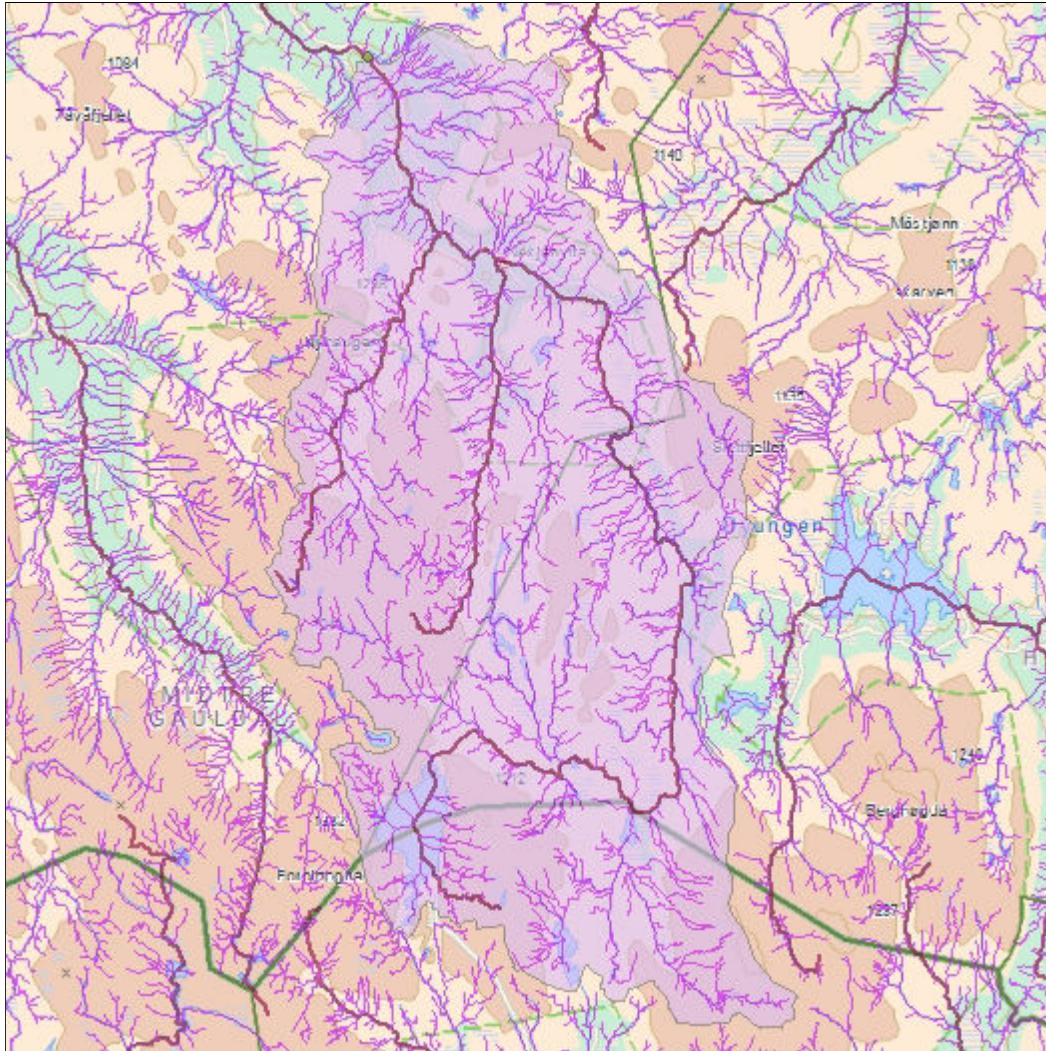

**Norges
vassdrags- og
energidirektorat**

Kartbakgrunn: Statens Kartverk
Kartdatum: EUREF89 WGS84
Projeksjon: UTM 33N

Nedbørfeltgrenser, feltparametere og vannføringsindekser er automatisk generert og kan inneholde feil. Resultatene må kvalitetssikres.

Lavvannskart

Vassdragsnr.: 122.DB0
Kommune: Midtre Gauldal
Fylke: Sør-Trøndelag
Vassdrag: FORA

Vannføringsindeks, se merknader

Middelvannføring (61-90)	29,4 l/s/km ²
Alminnelig lavvannføring	0,0 l/s/km ²
5-persentil (hele året)	0,0 l/s/km ²
5-persentil (1/5-30/9)	0,0 l/s/km ²
5-persentil (1/10-30/4)	0,0 l/s/km ²
Base flow	0,0 l/s/km ²
BFI	0,0

Klima

Klimaregion	Midt
Årsnedbør	1024 mm
Sommernedbør	448 mm
Vinternedbør	576 mm
Årstemperatur	-1,0 °C
Sommertemperatur	5,6 °C
Vintertemperatur	-5,8 °C
Temperatur Juli	7,6 °C
Temperatur August	8,3 °C

Feltparametere

Areal (A)	233,7 km ²
Effektiv sjø (S_{eff})	0,2 %
Elvelengde (E_L)	42,4 km
Elvegradient (E_G)	13,2 m/km
Elvegradient ₁₀₈₅ (G_{1085})	11,9 m/km
Feltlengde (F_L)	27,9 km
H_{min}	549 moh.
H_{10}	824 moh.
H_{20}	868 moh.
H_{30}	898 moh.
H_{40}	930 moh.
H_{50}	956 moh.
H_{60}	985 moh.
H_{70}	1007 moh.
H_{80}	1048 moh.
H_{90}	1100 moh.
H_{max}	1325 moh.
Bre	0,0 %
Dyrket mark	0,0 %
Myr	9,6 %
Sjø	3,2 %
Skog	10,3 %
Snaufjell	65,3 %
Urban	0,0 %

Det er generelt stor usikkerhet i beregninger av lavvannsindekser. Resultatene bør verifiseres mot egne observasjoner eller sammenlignbare målestasjoner.

I nedbørfelt med høy breprosent eller stor innsjøprosent vil tørrværsavrenning (baseflow) ha store bidrag fra disse lagringsmagasinene.

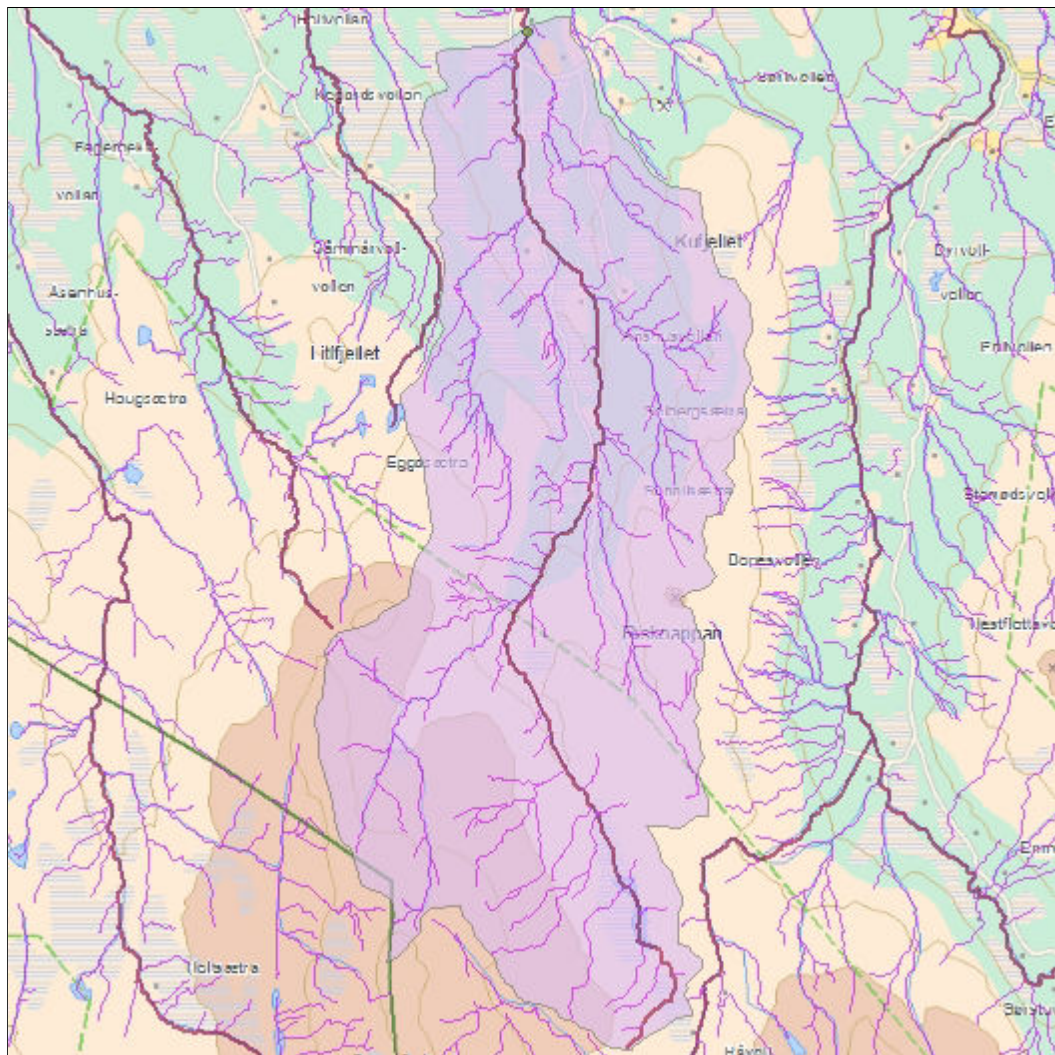

**Norges
vassdrags- og
energidirektorat**

Kartbakgrunn: Statens Kartverk
Kartdatum: EUREF89 WGS84
Projeksjon: UTM 33N

Nedbørfeltgrenser, feltparametere og vannføringsindekser er automatisk generert og kan inneholde feil. Resultatene må kvalitetssikres.

Lavvannskart

Vassdragsnr.: 122.BAC
Kommune: Midtre Gauldal
Fylke: Sør-Trøndelag
Vassdrag: HAUKA

Vannføringsindeks, se merknader

Middelvannføring (61-90)	25,5 l/s/km ²
Alminnelig lavvannføring	0,0 l/s/km ²
5-persentil (hele året)	0,0 l/s/km ²
5-persentil (1/5-30/9)	0,0 l/s/km ²
5-persentil (1/10-30/4)	0,0 l/s/km ²
Base flow	0,0 l/s/km ²
BFI	0,0

Klima

Klimaregion	Midt
Årsnedbør	846 mm
Sommernedbør	392 mm
Vinternedbør	454 mm
Årstemperatur	-0,3 °C
Sommertemperatur	6,1 °C
Vintertemperatur	-4,8 °C
Temperatur Juli	8,1 °C
Temperatur August	8,7 °C

Feltparametere

Areal (A)	49,6 km ²
Effektiv sjø (S_{eff})	0,0 %
Elvelengde (E_L)	16,0 km
Elvegradient (E_G)	21,9 m/km
Elvegradient ₁₀₈₅ (G_{1085})	24,1 m/km
Feltlengde (F_L)	13,5 km
H_{min}	620 moh.
H_{10}	685 moh.
H_{20}	740 moh.
H_{30}	793 moh.
H_{40}	848 moh.
H_{50}	889 moh.
H_{60}	931 moh.
H_{70}	957 moh.
H_{80}	993 moh.
H_{90}	1062 moh.
H_{max}	1225 moh.
Bre	0,0 %
Dyrket mark	0,8 %
Myr	16,0 %
Sjø	0,8 %
Skog	27,0 %
Snaufjell	54,8 %
Urban	0,0 %

Det er generelt stor usikkerhet i beregninger av lavvannsindekser. Resultatene bør verifiseres mot egne observasjoner eller sammenlignbare målestasjoner.

I nedbørfelt med høy breprosent eller stor innsjøprosent vil tørrværsavrenning (baseflow) ha store bidrag fra disse lagringsmagasinene.

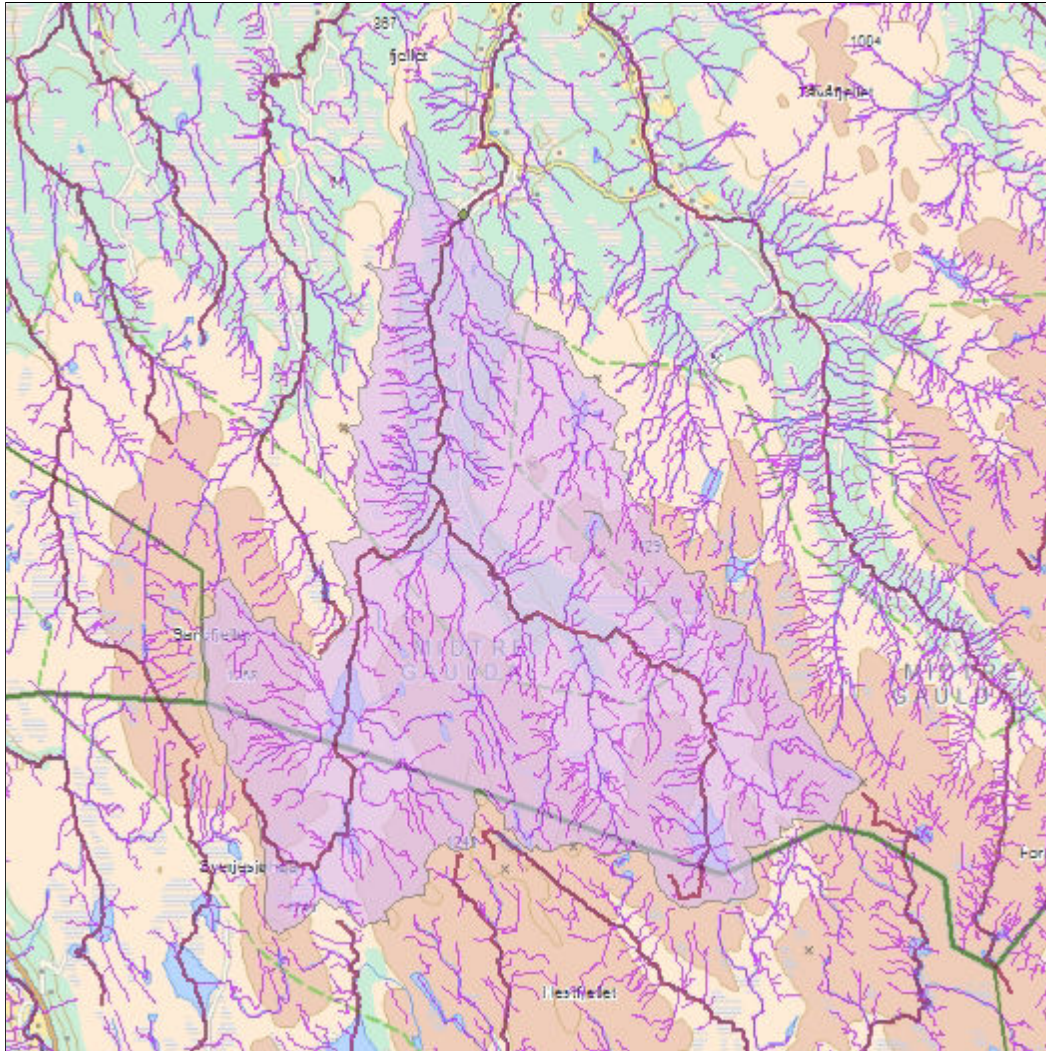

**Norges
vassdrags- og
energidirektorat**

Kartbakgrunn: Statens Kartverk

Kartdatum: EUREF89 WGS84

Projeksjon: UTM 33N

Nedbørfeltgrenser, feltparametere og vannføringsindekser er automatisk generert og kan inneholde feil. Resultatene må kvalitetssikres.

Lavvannskart

Vassdragsnr.: 122.CAA0

Kommune: Midtre Gauldal

Fylke: Sør-Trøndelag

Vassdrag: ENA

Vannføringsindeks, se merknader

Middelvannføring (61-90)	27,8 l/s/km ²
Alminnelig lavvannføring	0,0 l/s/km ²
5-persentil (hele året)	0,0 l/s/km ²
5-persentil (1/5-30/9)	0,0 l/s/km ²
5-persentil (1/10-30/4)	0,0 l/s/km ²
Base flow	0,0 l/s/km ²
BFI	0,0

Klima

Klimaregion	Midt
Årsnedbør	924 mm
Sommernedbør	418 mm
Vinternedbør	506 mm
Årstemperatur	-1,2 °C
Sommertemperatur	5,6 °C
Vintertemperatur	-6,1 °C
Temperatur Juli	7,7 °C
Temperatur August	8,3 °C

Feltparametere

Areal (A)	169,6 km ²
Effektiv sjø (S_{eff})	0,3 %
Elvelengde (E_L)	27,7 km
Elvegradient (E_G)	18,2 m/km
Elvegradient ₁₀₈₅ (G_{1085})	13,8 m/km
Feltlengde (F_L)	19,7 km
H_{min}	619 moh.
H_{10}	757 moh.
H_{20}	852 moh.
H_{30}	912 moh.
H_{40}	942 moh.
H_{50}	969 moh.
H_{60}	995 moh.
H_{70}	1025 moh.
H_{80}	1064 moh.
H_{90}	1124 moh.
H_{max}	1256 moh.
Bre	0,0 %
Dyrket mark	0,1 %
Myr	15,2 %
Sjø	3,0 %
Skog	13,0 %
Snaufjell	66,4 %
Urban	0,0 %

Det er generelt stor usikkerhet i beregninger av lavvannsindekser. Resultatene bør verifiseres mot egne observasjoner eller sammenlignbare målestasjoner.

I nedbørfelt med høy breprosent eller stor innsjøprosent vil tørrværsavrenning (baseflow) ha store bidrag fra disse lagringsmagasinene.

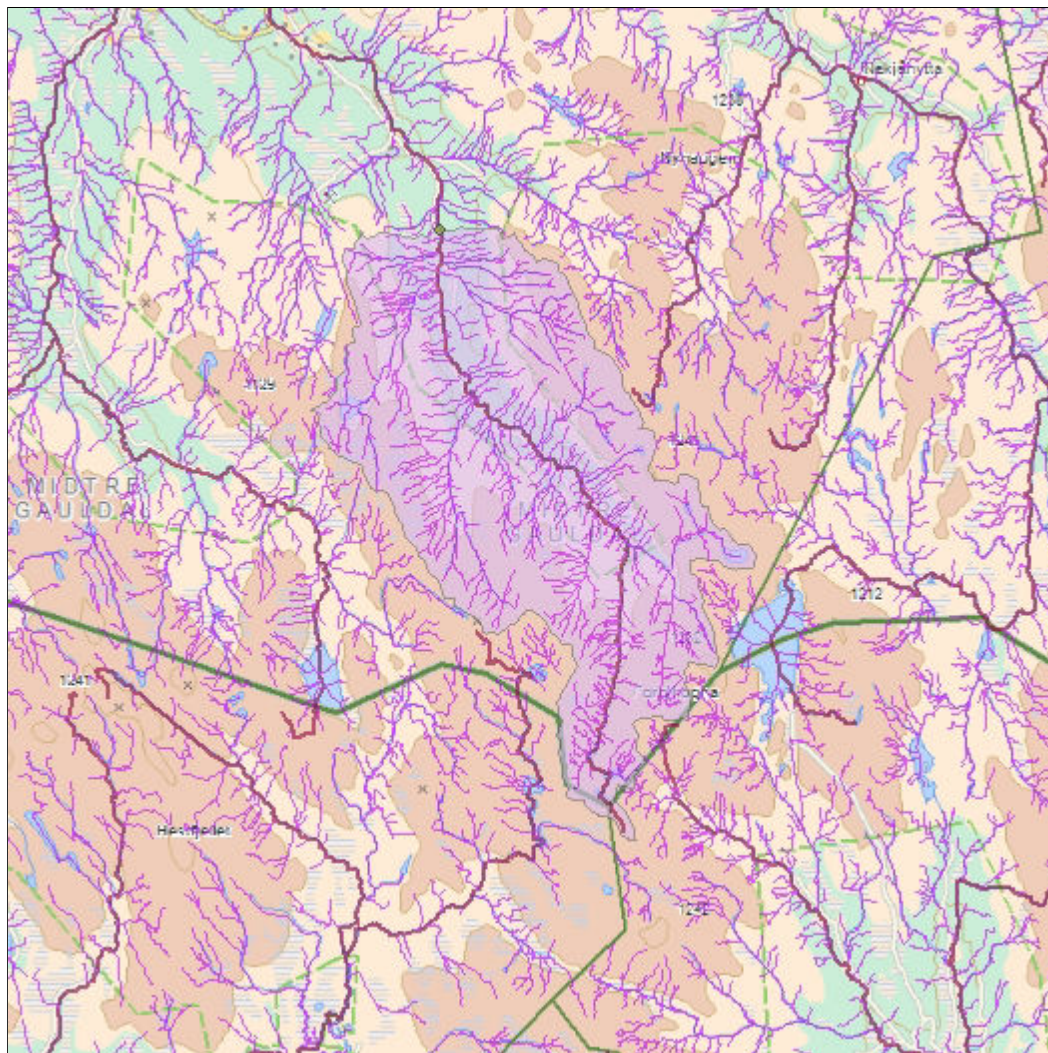

**Norges
vassdrags- og
energidirektorat**

Kartbakgrunn: Statens Kartverk
Kartdatum: EUREF89 WGS84
Projeksjon: UTM 33N

Nedbørfeltgrenser, feltparametere og vannføringsindekser er automatisk generert og kan inneholde feil. Resultatene må kvalitetssikres.

Lavvannskart

Vassdragsnr.: 122.CB
Kommune: Midtre Gauldal
Fylke: Sør-Trøndelag
Vassdrag: BUA

Vannføringsindeks, se merknader

Middelvannføring (61-90)	28,0 l/s/km ²
Alminnelig lavvannføring	0,0 l/s/km ²
5-persentil (hele året)	0,0 l/s/km ²
5-persentil (1/5-30/9)	0,0 l/s/km ²
5-persentil (1/10-30/4)	0,0 l/s/km ²
Base flow	0,0 l/s/km ²
BFI	0,0

Klima

Klimaregion	Midt
Årsnedbør	1020 mm
Sommernedbør	445 mm
Vinternedbør	575 mm
Årstemperatur	-1,4 °C
Sommertemperatur	5,4 °C
Vintertemperatur	-6,3 °C
Temperatur Juli	7,5 °C
Temperatur August	8,2 °C

Feltparametere

Areal (A)	88,3 km ²
Effektiv sjø (S_{eff})	0,0 %
Elvelengde (E_L)	21,0 km
Elvegradient (E_G)	22,1 m/km
Elvegradient ₁₀₈₅ (G_{1085})	23,0 m/km
Feltlengde (F_L)	16,9 km
H_{min}	632 moh.
H_{10}	766 moh.
H_{20}	853 moh.
H_{30}	921 moh.
H_{40}	970 moh.
H_{50}	1005 moh.
H_{60}	1029 moh.
H_{70}	1050 moh.
H_{80}	1078 moh.
H_{90}	1112 moh.
H_{max}	1295 moh.
Bre	0,0 %
Dyrket mark	0,2 %
Myr	8,2 %
Sjø	1,1 %
Skog	15,9 %
Snaufjell	72,4 %
Urban	0,0 %

Det er generelt stor usikkerhet i beregninger av lavvannsindekser. Resultatene bør verifiseres mot egne observasjoner eller sammenlignbare målestasjoner.

I nedbørfelt med høy breprosent eller stor innsjøprosent vil tørrværsavrenning (baseflow) ha store bidrag fra disse lagringsmagasinene.

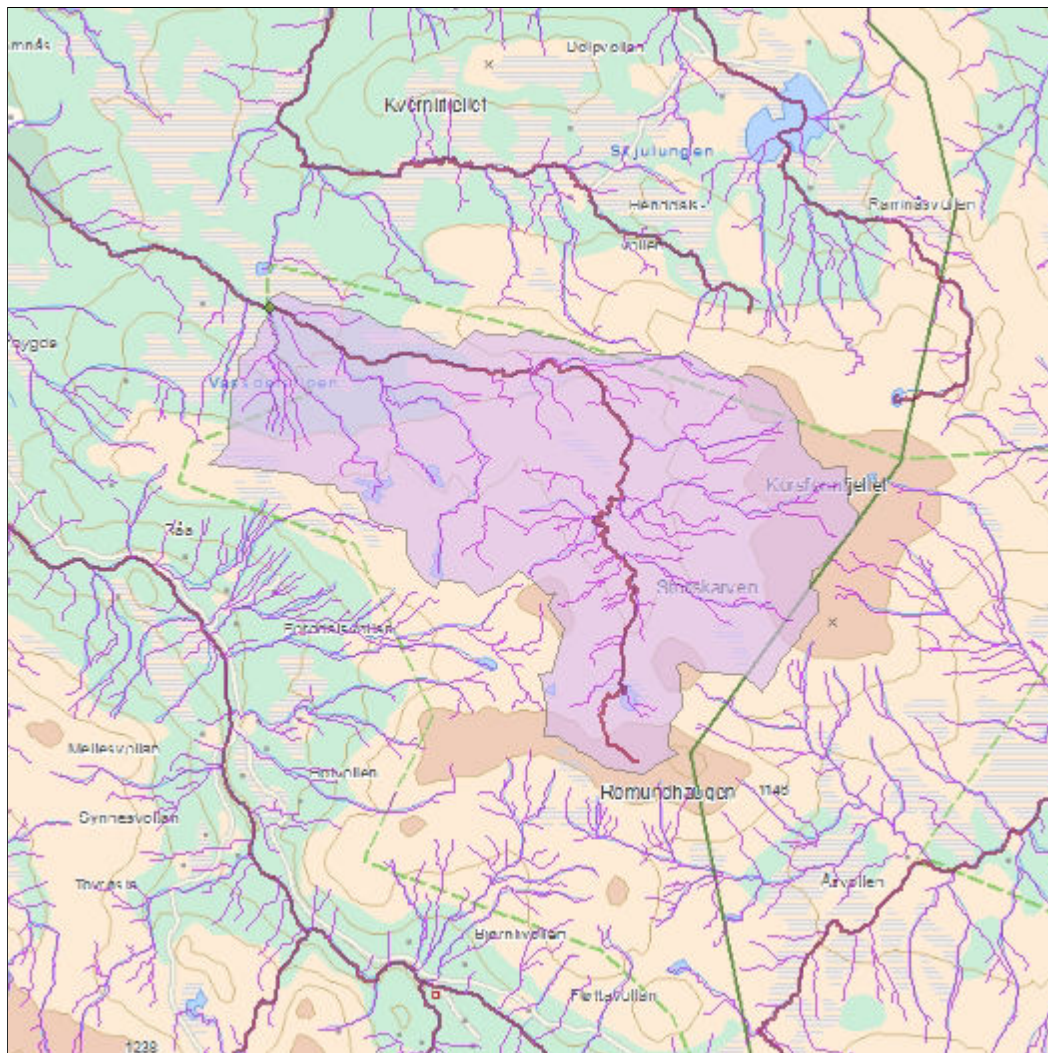

Norges
vassdrags- og
energidirektorat

Kartbakgrunn: Statens Kartverk
Kartdatum: EUREF89 WGS84
Projeksjon: UTM 33N

Nedbørfeltgrenser, feltparametere og vannføringsindekser er automatisk generert og kan inneholde feil. Resultatene må kvalitetssikres.

Lavvannskart

Vassdragsnr.: 122.E1Z
Kommune: Midtre Gauldal
Fylke: Sør-Trøndelag
Vassdrag: HERJÅA

Vannføringsindeks, se merknader

Middelvannføring (61-90)	40,6 l/s/km ²
Alminnelig lavvannføring	0,0 l/s/km ²
5-persentil (hele året)	0,0 l/s/km ²
5-persentil (1/5-30/9)	0,0 l/s/km ²
5-persentil (1/10-30/4)	0,0 l/s/km ²
Base flow	0,0 l/s/km ²
BFI	0,0

Klima

Klimaregion	Midt
Årsnedbør	949 mm
Sommernedbør	426 mm
Vinternedbør	523 mm
Årstemperatur	0,1 °C
Sommertemperatur	5,9 °C
Vintertemperatur	-4,1 °C
Temperatur Juli	7,7 °C
Temperatur August	8,5 °C

Feltparametere

Areal (A)	27,9 km ²
Effektiv sjø (S_{eff})	0,1 %
Elvelengde (E_L)	12,6 km
Elvegradient (E_G)	31,8 m/km
Elvegradient ₁₀₈₅ (G_{1085})	24,4 m/km
Feltlengde (F_L)	8,3 km
H_{min}	648 moh.
H_{10}	755 moh.
H_{20}	808 moh.
H_{30}	860 moh.
H_{40}	882 moh.
H_{50}	903 moh.
H_{60}	928 moh.
H_{70}	948 moh.
H_{80}	980 moh.
H_{90}	1013 moh.
H_{max}	1127 moh.
Bre	0,0 %
Dyrket mark	0,0 %
Myr	7,9 %
Sjø	1,5 %
Skog	11,1 %
Snaufjell	79,3 %
Urban	0,0 %

Det er generelt stor usikkerhet i beregninger av lavvannsindeks. Resultatene bør verifiseres mot egne observasjoner eller sammenlignbare målestasjoner.

I nedbørfelt med høy breprosent eller stor innsjøprosent vil tørrværsavrenning (baseflow) ha store bidrag fra disse lagringsmagasinene.

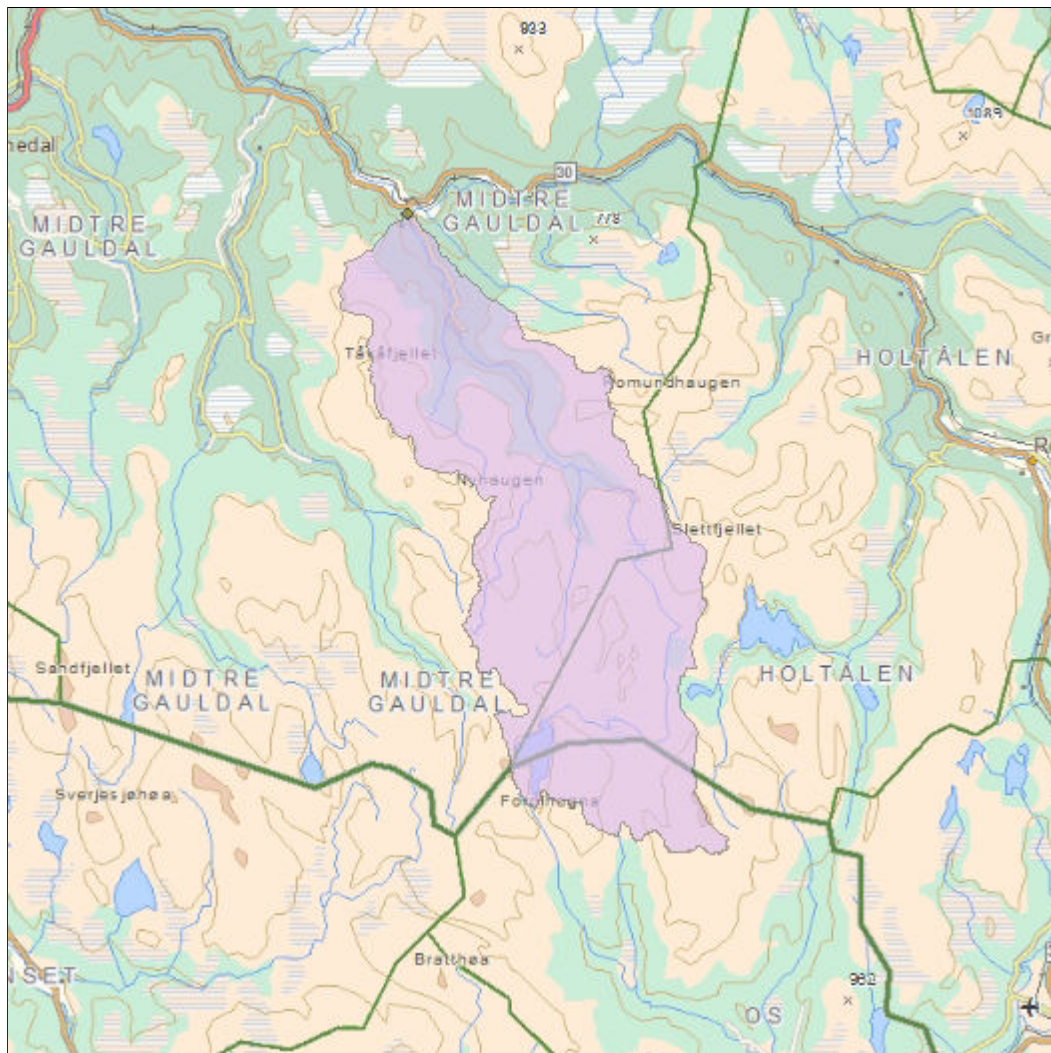

**Norges
vassdrags- og
energidirektorat**

Kartbakgrunn: Statens Kartverk
Kartdatum: EUREF89 WGS84
Projeksjon: UTM 33N

Nedbørfeltgrenser, feltparametere og vannføringsindekser er automatisk generert og kan inneholde feil. Resultatene må kvalitetssikres.

Lavvannskart

Vassdragsnr.: 122.DA
Kommune: Midtre Gauldal
Fylke: Sør-Trøndelag
Vassdrag: FORA

Vannføringsindeks, se merknader

Middelvannføring (61-90)	29,8 l/s/km ²
Alminnelig lavvannføring	0,0 l/s/km ²
5-persentil (hele året)	0,0 l/s/km ²
5-persentil (1/5-30/9)	0,0 l/s/km ²
5-persentil (1/10-30/4)	0,0 l/s/km ²
Base flow	0,0 l/s/km ²
BFI	0,0

Klima

Klimaregion	Midt
Årsnedbør	1000 mm
Sommernedbør	440 mm
Vinternedbør	559 mm
Årstemperatur	-0,5 °C
Sommertemperatur	6,0 °C
Vintertemperatur	-5,1 °C
Temperatur Juli	8,0 °C
Temperatur August	8,7 °C

Feltparametere

Areal (A)	316,7 km ²
Effektiv sjø (S_{eff})	0,1 %
Elvelengde (E_L)	54,4 km
Elvegradient (E_G)	17,3 m/km
Elvegradient ₁₀₈₅ (G_{1085})	15,8 m/km
Feltlengde (F_L)	37,7 km
H_{min}	171 moh.
H_{10}	636 moh.
H_{20}	774 moh.
H_{30}	846 moh.
H_{40}	886 moh.
H_{50}	922 moh.
H_{60}	955 moh.
H_{70}	989 moh.
H_{80}	1021 moh.
H_{90}	1080 moh.
H_{max}	1325 moh.
Bre	0,0 %
Dyrket mark	0,8 %
Myr	9,6 %
Sjø	2,4 %
Skog	18,3 %
Snaufjell	57,1 %
Urban	0,0 %

Det er generelt stor usikkerhet i beregninger av lavvannsindekser. Resultatene bør verifiseres mot egne observasjoner eller sammenlignbare målestasjoner.

I nedbørfelt med høy breprosent eller stor innsjøprosent vil tørrværsavrenning (baseflow) ha store bidrag fra disse lagringsmagasinene.