



NTNU – Trondheim
Norwegian University of
Science and Technology

Structural Topology Optimization

Basic Theory, Methods and Applications

Steffen Johnsen

Master of Science in Mechanical Engineering

Submission date: June 2013

Supervisor: Terje Rølvåg, IPM

Norwegian University of Science and Technology
Department of Engineering Design and Materials

THE NORWEGIAN UNIVERSITY
OF SCIENCE AND TECHNOLOGY
DEPARTMENT OF ENGINEERING DESIGN
AND MATERIALS

**MASTER THESIS SPRING 2013
FOR
STUD. TECHN. STEFFEN JOHNSEN**

STRUCTURAL TOPOLOGY OPTIMIZATION

Basic Theory, Methods and Applications

Strukturell topologioptimalisering

Grunnleggende teori, metoder og anvendelser

Multidisciplinary modeling and optimization is one of the main tasks in the EC project SupLight. In SupLight two industrial cases are selected for design/parameterization and optimization. These are one control arm from Raufoss Technology (RT) and an aircraft door control arm from Hellenic Aerospace Industry (HAI).

The main objective is to benchmark how topology optimization can be applied and implemented to optimize products produced in recycled aluminum. The goal is to replace virgin aluminum in products without sacrificing weight, quality, reliability or costs.

The following tasks must be completed:

1. Study topology optimization theory and use (in NX8, Abaqus or equivalent) and document the process in an A3 knowledge brief.
2. Identify BCs, load cases and product requirements and setup the optimization criteria.
3. Mesh the hinge and control arm.
4. Setup the optimization process based on chosen software and requirements based on (2).
5. Perform topology optimization of the hinge and the control arm and document and evaluate the results based on (2), wrt. ease of use and feasibility.

If time and resources are available:

6. Perform reversed engineering of the two cases.

The thesis should include the signed problem text, and be written as a research report with summary both in English and Norwegian, conclusion, literature references, table of contents, etc. During preparation of the text, the candidate should make efforts to create a well arranged

and well written report. To ease the evaluation of the thesis, it is important to cross-reference text, tables and figures. For evaluation of the work a thorough discussion of results is appreciated.

Three weeks after start of the thesis work, an A3 sheet illustrating the work is to be handed in. A template for this presentation is available on the IPM's web site under the menu "Masteroppgave" (<http://www.ntnu.no/ipm/masteroppgave>). This sheet should be updated one week before the Master's thesis is submitted.

The thesis shall be submitted electronically via DAIM, NTNU's system for Digital Archiving and Submission of Master's thesis.

The contact person is (navn på veileder i utlandet, bedrift eller lignende)



Torgeir Welo
Head of Division



Terje Rølvåg
Professor/Supervisor



NTNU
Norges teknisk-
naturvitenskapelige universitet
Institutt for produktutvikling
og materialer

Preface

The thesis is written as a product of the master thesis work carried out at the Department of Engineering Design and Materials at the Norwegian University of Science and Technology during the spring of 2013. The thesis serves as a contribution to WP3 in the EC SuPLight project, but is also aimed at increasing knowledge of topology optimization in general.

The work has been highly rewarding, giving me the opportunity to study and gain knowledge in the subject of numeric optimization and its usefulness in optimization of load-carrying structures with regard to topology. Working with a variety of software and computer systems has aided a greater understanding for the vast possibilities of available tools. I consider this thesis as a great ending to my education at NUST. In many ways, the thesis has helped gathering loose threads and culminates in a better overall understanding of the product development process.

The undersigned wishes to thank Prof. Terje Rølvåg for his contribution to the thesis, as well as Carl Hougsrud Skaar and Espen Nilsen for their companionship, useful discussions and support. Last, but not least, I wish to thank my parents and my girlfriend for their continued support and encouragement.



Steffen Johnsen
Trondheim, June 7th, 2013

Abstract

The thesis is written as an introduction to topology optimization, aiming to help knowledge development in design optimization techniques, as well as aiding the adaptation of a sustainable culture with direct application to similar products like the two test cases supplied by the EC SuPLight project. These components are; a Door Connection Joint for a business jet and a Front Lower Control Arm from a McPherson suspension. The thesis has no intention of covering all aspects concerning topology optimization, but to investigate best practice and give advice on how to understand the process and how to setup an optimization run. The thesis is especially discussing how to make sure that results can be trusted and that they can be used in real life engineering applications. This is found to be a subject of both loading and boundary condition definitions, as well as choice of optimization algorithms and general approach.

The thesis begins with an elaboration of basic topology optimization theory; discussing topology optimization history, mathematical algorithms, available software and general workflow when performing topology optimization. In particular, the widely used SIMP-algorithm and the MinMax approach are elaborated, as well as proposing solution strategies for obtaining suitable results, depending on the desired properties. The thesis further discusses the use of Abaqus ATOM for optimizing the two test cases, evaluating previously stated optimization solution strategies as well as manually performing multi-disciplinary topology optimization on the Door Connection Joint. A process description of the NX topology optimization module is also included. Simulation results from minimizing volume and constraining displacements suggest geometries that for the Door Connection Joint and the FLCA are 11.2% and 6.41% lighter than the original parts, respectively. The thesis ends with an evaluation of the quality of results, ease of use and reliability of such optimization, as well as proposing significantly lighter, reengineered designs for both components. Reengineered geometries for the Door Connection Joint and FLCA are

7.11% and 5.92% lighter, respectively. Using topology optimization as an initial approach to expanding the solution space and finding the optimal solution is found to be very efficient, and use is expected to increase rapidly as knowledge and availability of tools increase. Pushing performance limits, topology optimization reduce product versatility, making the engineer's role in development just as important as before.

Sammendrag

Oppgaven er skrevet som en innføring i topologioptimalisering, med den hensikt å bidra til kunnskapsutvikling innen teknikker for optimalisering, samt legge til rette for en bærekraftig kultur for utvikling av tilsvarende produkter som i de to testkomponentene angitt i SuPLight EU- prosjektet. Disse komponentene er; en dørhengsel til et jettfly og en nedre kontrollarm i et McPherson hjuloppheng. Oppgaven har ikke til hensikt å dekke alle aspekter ved topologioptimalisering, men derimot å redegjøre for hensiktsmessige fremgangsmåter og gi råd om hvordan man skal forstå prosessen og sette opp en slik optimalisering. Oppgaven diskuterer spesielt hvordan man skal kunne være sikker på at man kan stole på resultatene, og at disse kan benyttes i virkelige tekniske applikasjoner.

Oppgaven begynner med en utdypning av grunnleggende teori vedrørende topologioptimalisering hvor både historie, matematiske algoritmer, tilgjengelig programvare og generell arbeidsflyt diskuteres. Spesielt utdypes teorien bak den mye benyttede SIMP- algoritmen og MinMax- tilnærmingen. Oppgaven foreslår dessuten strategier for å oppnå ønskede simuleringsresultater, avhengig av hvilke produktegenskaper en søker. Avhandlingen drøfter videre bruken av Abaqus ATOM for å optimalisere de to testkomponentene og vurderer ulike tilnærminger til optimalisering av disse, samt utfører en manuell multi- disiplinær topologioptimalisering av dørhengselen. En prosessbeskrivelse av topologioptimaliseringsmodulen i NX er også inkludert. Simuleringsresultater som fremkommer ved å minimere volumet og sette begrensninger på forskyvninger gir geometrier som for dørhengselen og kontrollarmen er henholdsvis 11.2% og 6.41% lettere enn de originale delene. Avhandlingen avsluttes med en evaluering av kvaliteten på resultatene, brukervennlighet og pålitelighet ved bruk av optimaliseringsverktøy, samt foreslår betydelig lettere endelige design for begge komponenter. De nye designene for dørhengselen og kontrollarmen er henholdsvis 7.11% og 5.92% lettere. Å benytte topologioptimalisering som en første tilnærming til å utvide løsningsrommet og finne den optimale løsningen er ansett som svært effektivt,

og bruken er forventet å øke raskt ettersom kunnskap om og tilgjengelighet til verktøyet øker. Bruken av topologioptimalisering gir økt ytelse, men reduserer allsidigheten til produktet, noe som gjør at ingeniørens rolle i utviklingen er like viktig som før.

Contents

1	Introduction	1
1.1	Background	1
1.2	Target of thesis	5
1.3	Delimitation of thesis	9
2	Topology optimization theory	10
2.1	History	10
2.2	General optimization theory and applications	11
2.2.1	Types of optimization	13
2.2.2	Topology optimization algorithms	16
2.2.3	Multidisciplinary Topology Optimization	28
2.3	Available software for Topology Optimization	32
2.3.1	Topology optimization software	32
2.4	Topology optimization workflow	33
2.4.1	Generating the design space	35
2.4.2	Meshing the design space	37
2.4.3	Defining loads and boundary conditions	37
2.4.4	Defining design responses	38
2.4.5	Defining objectives and objective functions	39
2.4.6	Defining constraints	39
2.4.7	Post-processing of optimization results; smoothing and interpretation of optimization results	41
3	Process description using the Abaqus ATOM optimization module	45
3.1	Software	45

3.1.1	Abaqus	45
3.1.2	Unigraphics NX	45
3.2	Establishing baseline	46
3.2.1	Boundary conditions, load cases and product requirements	46
3.2.2	Baseline results	61
3.3	Model preparation, meshing and setup of static analysis	70
3.3.1	Generating the design space	70
3.3.2	Meshing	72
3.3.3	Setting up the FE-analysis	74
3.4	Setup of topology optimization	75
3.4.1	Creating the topology optimization task	75
3.4.2	Defining design responses	84
3.4.3	Defining the objective and constraints	85
3.4.4	Submitting the topology optimization process	93
3.5	Topology optimization results	94
3.5.1	Door Connection Joint	94
3.5.2	FLCA	96
3.5.3	Manual Multi-Disciplinary Optimization	99
3.6	Post-processing of simulation results	103
3.6.1	Smoothing of chosen optimization output	108
4	Process description using NX Topology Optimization	111
4.1	Software	111
4.1.1	Unigraphics NX	111
4.2	Model preparation, meshing and setup of static analysis	113
4.2.1	Meshing	113
4.3	Setup of topology optimization	114
4.3.1	Creating the topology optimization and defining element groups	114
4.3.2	Defining geometric constraints (restrictions)	115
4.3.3	Defining design responses	118
4.3.4	Defining the objective and performance constraints	118
4.3.5	Geometry extraction settings, solution control parameters and submitting the optimization process	119
4.4	Topology optimization results	121

5	Reengineering of optimization output using UGS NX	126
5.1	Reengineered geometry	126
5.1.1	Door Connection Joint	129
5.1.2	FLCA	129
6	Views on implementation, ease of use and quality of results	140
7	Conclusion and further work	147
	Bibliography	148
A	A3 brief on generation of design space using Unigraphics NX	152
B	A3 brief on optimization using Abaqus ATOM	154
C	A3 brief on optimization using Unigraphics NX	168
D	A3 brief on reengineering of geometries	178

List of Figures

1.1	Work Packages in SuPLight project	3
1.2	Traditional approach to design of structural parts and components	4
1.3	Topology optimization approach to design of structural parts and components	4
1.4	FLCA; Original CAD geometry and boundary interference components	5
1.5	FLCA; Placement in McPherson suspension (image courtesy of [1])	6
1.6	Door Connection Joint; Original CAD geometry	7
1.7	Door Connection Joint; Placement on the Falcon 900 Business Jet (image courtesy of [2])	8
2.1	2D topology equivalent domains	13
2.2	Optimization techniques	13
2.3	Different types of optimization a) sizing optimization b) shape optimization c) topology optimization	14
2.4	Topology optimization process loop (image courtesy of [3])	16
2.5	Topography optimization of cover plate (courtesy of [4])	17
2.6	Discrete model of design space with loads and boundary conditions	20
2.7	Work scheme of topology optimization using the SIMP-algorithm (courtesy of [5])	22
2.8	Numerical instability; (a) Design problem, (b) Example of checkerboards, (c) Solution for 600 element discretization, (d) Solution for 5400 element discretization and (e) Non-uniqueness example (courtesy of [6])	24
2.9	RAMP-model; a) Design space b) Resulting topology	25
2.10	Door Connection Joint; 1) SIMP vs. 2) RAMP algorithms used at part with concentrated loads (no pressure loads)	26

2.11	The <i>Material- or Micro-approach</i> ; a) Perforated microstructure with rectangular holes in square unit cells and b) Layered microstructure constructed from two different isotropic materials (courtesy of [7])	27
2.12	Objective functions; a) Minimizing vs. b) Minimizing the Maximum strain energy (courtesy of [8])	29
2.13	Pareto-frontier	30
2.14	1) Pareto frontier and 2) corresponding Pareto optimal solution; $V \equiv 0.66$ and $J = 190$	31
2.15	Topology optimization workflow	34
2.16	NX-user interface for defining the design space	36
2.17	1) Manufacturing constraints and 2) geometries feasible/infeasible of forging	41
2.18	Results extraction; Smoothing 2D-elements	42
2.19	Results extraction; Smoothing as an iterative procedure (courtesy of [4])	42
2.20	Results extraction; Varying control parameters in Abaqus	43
3.1	Door Connection Joint; Area specifications	46
3.2	Door Connection Joint; Performance objectives	47
3.3	Door Connection Joint; Free mesh using 2 mm CTETRA10 elements 1) Overall meshed model and 2) Closeup picture of mesh	48
3.4	Door Connection Joint; NX environment for defining loads and constraints	49
3.5	Door Connection Joint; Placement of local CSYS for easier definition of 1) LC1 and 2) LC2	50
3.6	Door Connection Joint; Applied boundary conditions and loads	51
3.7	Door Connection Joint; SuPLight ambiguous specifications of load directions and constraints	52
3.8	FLCA; Definition of global CSYS on design space	53
3.9	FLCA; Area specifications	54
3.10	FLCA; Performance objectives	55
3.11	FLCA; Free mesh using 2 mm CTETRA10 elements 1) Overall meshed model and 2) Closeup picture of mesh	57
3.12	FLCA; NX environment for defining loads and constraints	58
3.13	FLCA; Loads and constraints for stiffness simulations	59
3.14	Fatigue properties, 6062 T6; 121 MPa at $R = -1$ and 10^6 cycles (50% p.f) (courtesy of EduPack 2012)	60
3.15	Door Connection Joint; Displacement in LC1 direction	62

3.16	Door Connection Joint; Displacement in LC2 direction	63
3.17	FLCA; Displacement w/7 kN load in X-direction	65
3.18	FLCA; Displacement w/7 kN load in X-direction at reference node	66
3.19	FLCA; Displacement w/7 kN load 1) Y-direction	67
3.20	FLCA; Displacement w/7 kN load in Y-direction at reference node	68
3.21	FLCA; Buckling factor for the first buckling mode	69
3.22	FLCA; Cable fastener removed prior to volume analysis	70
3.23	Specification of functional surfaces on Door Connection Joint (courtesy of [9])	71
3.24	Door Connection Joint; 1) Original part and 2) Design space	72
3.25	FLCA; 1) Original part and 2) Design space	73
3.26	Abaqus mesh; C3D10 elements	73
3.27	Door Connection Joint; 1) Overall meshed model and 2) closeup picture of mesh	74
3.28	FLCA; 1) Overall meshed model and 2) closeup picture of mesh	75
3.29	Door Connection Joint; Translation constraint in Abaqus	76
3.30	Door Connection Joint; Kinematic coupling definition in Abaqus	77
3.31	Door Connection Joint; Applied concentrated loads in Abaqus	78
3.32	FLCA; Constraints in Abaqus	79
3.33	FLCA; Kinematic coupling definition in Abaqus	80
3.34	FLCA; Applied concentrated loads in Abaqus	81
3.35	Setup of Abaqus ATOM topology optimization workflow	82
3.36	Abaqus; Creating the topology optimization task	83
3.37	Abaqus; Defining design responses	84
3.38	Abaqus; Defining the objective and performance constraints	86
3.39	Abaqus; Defining the geometric constraints	87
3.40	Door Connection Joint; Frozen areas geometric constraints	89
3.41	Door Connection Joint; Symmetry plane	90
3.42	FLCA; Frozen areas geometric constraints (red areas constrained)	91
3.43	FLCA; Symmetry plane	92
3.44	Abaqus; Submitting the topology optimization process	93
3.45	Door Connection Joint; Minimizing volume while maintaining stiffness results	94
3.46	Door Connection Joint; Minimizing volume while maintaining stiffness results	95
3.47	Door Connection Joint; Results from topology optimization min- imizing volume while maintaining stiffness	97
3.48	FLCA; Minimizing the volume while maintaining stiffness	98

3.49	FLCA; Results from topology optimization minimizing volume while maintaining stiffness	99
3.50	FLCA; VonMises stress	100
3.51	Door Connection Joint; Solution process for MinMax strain energy while constraining volume	101
3.52	Door Connection Joint; Evaluation of large tensile displacements when minimizing strain energy	102
3.53	Door Connection Joint; MinMax strain energy, constrained by upper limit on volume fraction. Image showing percentage of weight reduction from reference geometry.	104
3.54	Door Connection Joint; Pareto curve for strain energy and displacement vs. volume fraction of reference volume; LC1 load direction	105
3.55	Door Connection Joint; Pareto curve for strain energy vs. volume fraction of reference volume; LC2 load direction	106
3.56	Door Connection Joint; Pareto curve for displacement of reference node vs. volume fraction of reference volume; LC1 and LC2 direction	107
3.57	Abaqus; Post-processing of simulation results	108
3.58	Door Connection Joint; 1) STL file extracted from Abaqus ATOM and 2) parameters for the extracted surface <i>ISO = 0.3, No. smoothing cycles = 5</i>	109
3.59	FLCA; 1) STL file extracted from Abaqus ATOM and 2) parameters for the extracted surface <i>ISO = 0.3, No. smoothing cycles = 5</i>	110
4.1	Setup of NX topology optimization process	112
4.2	NX mesh; CTETRA10 elements	113
4.3	Door Connection Joint; Meshing of design space in UGS NX	114
4.4	Door Connection Joint; Creating the topology optimization process	115
4.5	Door Connection Joint; Defining element groups	116
4.6	Door Connection Joint; Defining geometric constraints (restrictions)	117
4.7	Door Connection Joint; Defining design responses	118
4.8	Door Connection Joint; Defining the objective	119
4.9	Door Connection Joint; Defining (performance) constraints	120
4.10	Door Connection Joint; Smoothing and submitting the topology optimization	121
4.11	Door Connection Joint; Results extraction	122

4.12	Door Connection Joint; Surface extracted 1) side view and 2) half view	123
4.13	Door Connection Joint; Results visualization	124
4.14	Door Connection Joint; Results graph	125
5.1	NX; Reengineering the geometry from topology optimization using splines in sketches	127
5.2	NX; Reengineering the geometry from topology optimization using the extrude function	128
5.3	Door Connection Joint; Reengineered geometry from minimizing volume and constraining displacement	130
5.4	Door Connection Joint; Displacement in LC1 direction	131
5.5	Door Connection Joint; Displacement in LC2 direction	132
5.6	Door Connection Joint; Reengineered geometry from minimizing strain energy with prescribed volume fraction [−10%]	133
5.7	Door Connection Joint; 3D printed results from topology optimization in Abaqus	134
5.8	FLCA; Reengineered geometry from minimizing volume and constraining displacement	135
5.9	FLCA; Stiffness in X-direction of reengineered geometry	136
5.10	Door Connection Joint; Stiffness in Y- direction of reengineered geometry	137
5.11	FLCA; Buckling factor in X-direction of reengineered geometry	138
5.12	FLCA; 3D printed results from topology optimization in Abaqus	138
5.13	FLCA; 3D printed results from topology optimization in Abaqus	139
6.1	Development of parts with normal procedure and using optimization	141
6.2	Performance vs. versatility; Implication of optimizing components	142
6.3	Door Connection Joint; Load direction sensitivity and implications on topology	142
6.4	FLCA; Invalid topology optimization results	143
6.5	Work load; Topology optimization approach vs. traditional approach	145

List of Tables

3.1	Material properties; Aluminium 7075 T7351	51
3.2	Material properties; Aluminium 6082 T6	60
3.3	Door Connection Joint; Results from baseline simulation	64
3.4	FLCA; Results from baseline simulation	70
3.5	Results table door joint; Comparison of 1) original part and 2) optimized parts	96
3.6	Results table FLCA; Comparison of 1) original part and 2) optimized parts	98
5.1	Door Connection Joint; Reengineered geometry performance properties	130
5.2	FLCA; Reengineered geometry performance properties	135

Nomenclature

ALM	Additive Layer Manufacturing
ATOM	Abaqus Topology Optimization Module
BC's	Boundary Conditions
CSYS	Coordinate System
FE	Finite Element
FLCA	Front Lower Control Arm
HAI	Hellenic Aerospace Industry
IGES	Initial Graphics Exchange Specification
LC	Load Case
MCDM	Multi Criteria Descision Making
MDO	Multi Disciplinary Optimization
MEMS	Micro- Electro- Mechanical Systems
MOA	Multi Objective Analysis
RT	Raufoss Technology
SIMP	Solid Isotropic Material with Penalization
SOA	Single Objective Analysis
STL	STereoLitography

SuPLight Sustainable and efficient Production of Light weight solutions
UI User Interface

Chapter 1

Introduction

1.1 Background

The art of structure is where to put the holes.

Robert Le Ricolais, 1894-1977

With the vast development of computers and commercially available software during the last decades, computer aided design, engineering and manufacturing have been widely utilized for use in commercial companies and research. The use of optimization algorithms for efficient design of products is rapidly increasing due to continuously increasing computational power. First used in the development of aeronautic applications, other areas which demand high performance and cost savings have embraced the technology and possibilities available today. This includes, but is not limited to, the automobile industry, oil industry and electronics industry. Topology optimization is particularly powerful for enhancing creativity and suggesting solutions not initially apparent to the engineer. The method is unique as it provides optimal solutions for the given loads, boundary conditions and specified design responses. Engineering experience will always be required to evaluate results, but is naturally limited when faced with conflicting constraints and the demand of finding optimal solutions.

The project initiator is Prof. Terje Rølvåg, contributing to the EC SuP-Light (Sustainable and efficient Production of Light weight solutions) project,

aiming to reduce the environmental impact of production of structural parts. One way to achieve a more sustainable world, is through efficient use of recycled aluminium. Reducing the weight of a component will drastically improve its environmental impact and reduce costs, making it an ever desirable factor in the highly iterative work of designing and dimensioning components. The main target of the project is hence to contribute to knowledge transfer and understanding of topology optimization, as well as evaluate the ease of use of commercially available topology optimization algorithms. It is also of major importance to evaluate to which degree commercial software provide results that are transparent to the user, as many companies fear to use such because of the uncertainty of the solution process. The report is written as a process study¹, including theory and evaluation of two test cases, specified by the SuPLight project participants. Questions like “Does topology optimization reduce the need for engineers and professional skills?” and “Can I trust the results of my simulation?” are important when evaluating the concept of topology optimization.

SuPLight Project The master thesis is the written as a contribution to the EC project SuPLight. The main objective of the SuPLight project is to provide knowledge of “Sustainable lightweight industry solutions based on wrought alloy aluminium” [10].

Sub goals include:

- Advanced lightweight products from low grade input re-used materials (M61,M62)
- **Optimization of product weigh/performance ratio trough advanced optimization algorithms (M34)**
- More than 75 % post-consumer recycled wrought aluminium alloys (M61, M62)
- New methodologies and tools for holistic eco-design of products, processes and manufacturing (M42)
- New industry models for sustainable manufacturing of lightweight solutions (M52)

¹An organized, systematic investigation of a particular process designed to identify all of the state variables involved and to establish the relationships among them.

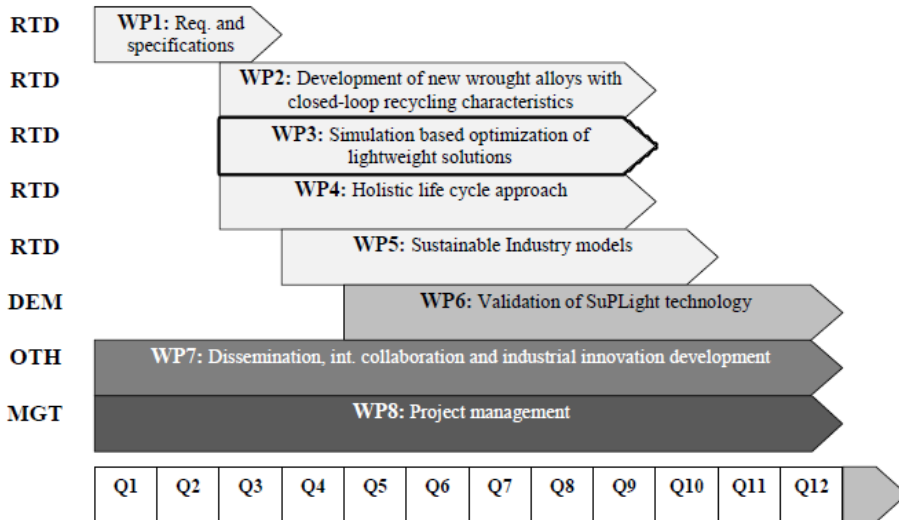

Figure 1.1: Work Packages in SuPLight project

- Lightweight solutions in a closed-loop life cycle perspective (M83)

The sub-goal marked in bold text is subject for analysis in this master thesis. Figure 1.1 shows the sub-goals as work packages, whereas the thesis will focus on WP3.

The project duration is 01.06.2011 – 31.05.2014, including a total of 11 partners from 7 countries. The project has a total budget of 4270 million Euro, and is coordinated by SINTEF. Test cases, including CAD-models and simulation boundary conditions, are described in section 1.1. Models and information are provided by Raufoss Technology (RT) and Hellenic Aerospace Industry (HAI).

The traditional approach to design of structural components is time consuming and often lead to ineffective designs, as shown in figure 1.2. A target for this thesis is to evaluate to which degree topology optimization can improve the weight/performance ratio of components and save time, and thus provide an alternative approach to dimensioning components. To which degree the user can interpret results and understand the assumptions behind the choices and rationales that has been performed by the software is considered especially important. The topology optimization approach is shown in figure 1.3.

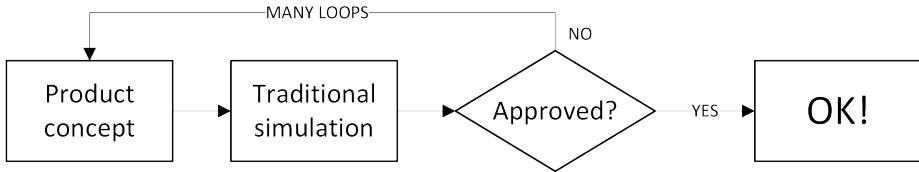

Figure 1.2: Traditional approach to design of structural parts and components

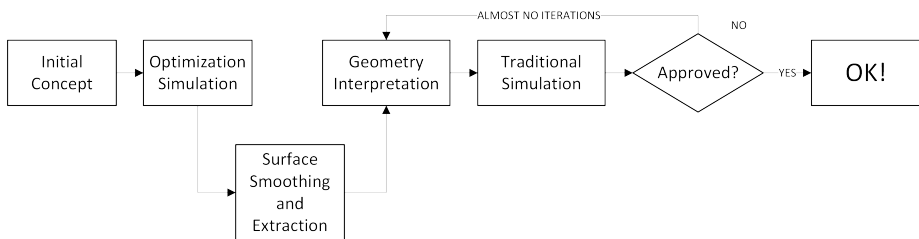

Figure 1.3: Topology optimization approach to design of structural parts and components

Test cases Two test cases have been proposed for analysis. Both cases include parts that are highly stressed, still vital for the safety and continued use of the unit on which it is assembled:

- A left-sided Front Lower Control Arm (FLCA), an important part of a McPherson front suspension on Opel Insignia (2008-). The control arm is produced by Raufoss Technology, entirely from wrought 6062 T6 aluminium.
- A baggage compartment Door Connection Joint on a Falcon 900 Business Jet Aircraft. The plane is produced by the Greek company HAI on behalf of Dassault Aviaton. The door joint is made entirely from 7075 T7351 aluminium, and is machined from a solid block using a 5-axis CNC milling machine.

The overall relevant sustainability objective for WP3 is to reduce the weight of both components by 10%, but at the same time maintain performance objectives such as stiffness, buckling strength and ease of production. Specific performance targets are presented in section 3.2. As far as the selected software enable the

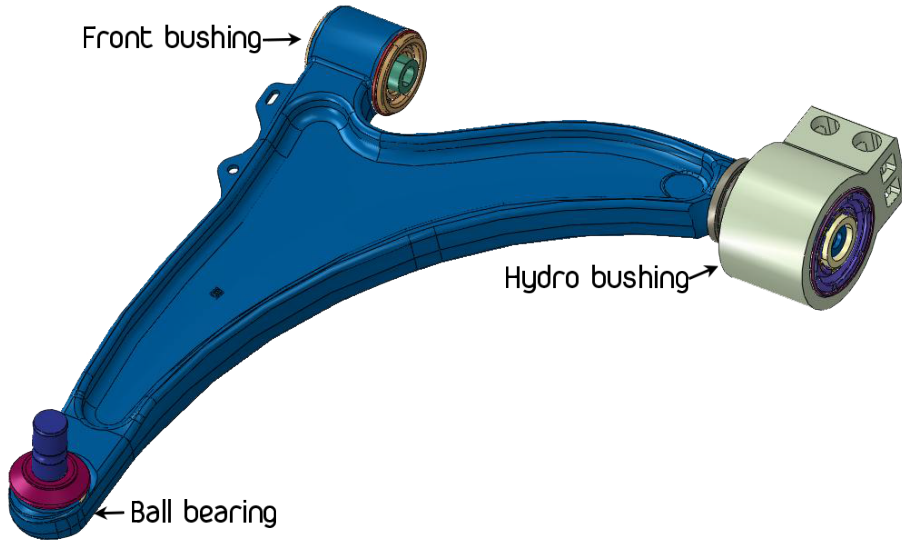

Figure 1.4: FLCA; Original CAD geometry and boundary interference components

use of design responses² that cover these targets, they have been used to control simulation results.

1.2 Target of thesis

The main target is to provide the reader with knowledge about the theoretical basics of topology optimization and information on how to perform topology optimization using commercial simulation software. The aim is also to perform topology optimization on the two test cases presented in section 1.1 in order to display the powerful creative capabilities of such tools, and comment on its performance with regard to ease of use and quality of results.

²Topic covered in section 2.4.4

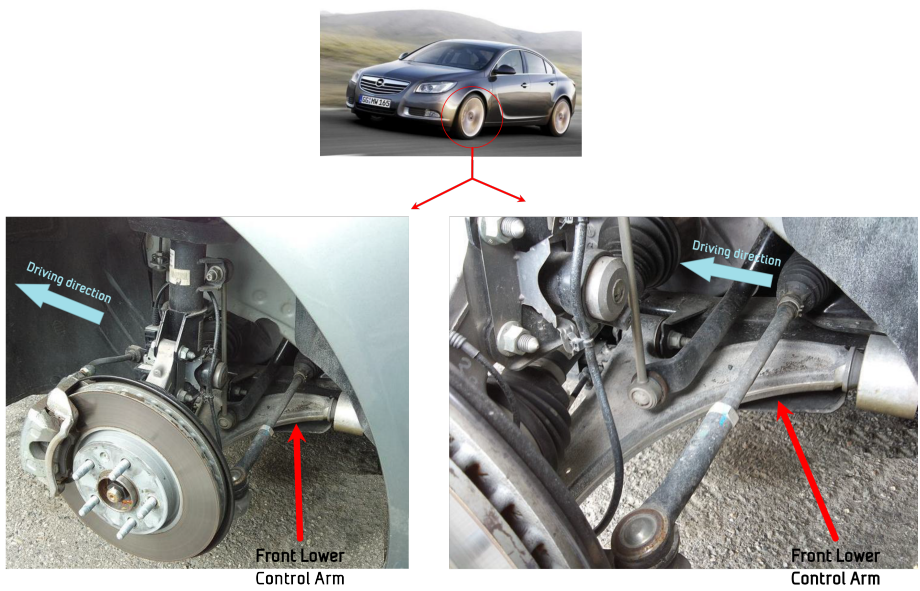

Figure 1.5: FLCA; Placement in McPherson suspension (image courtesy of [1])



Figure 1.6: Door Connection Joint; Original CAD geometry

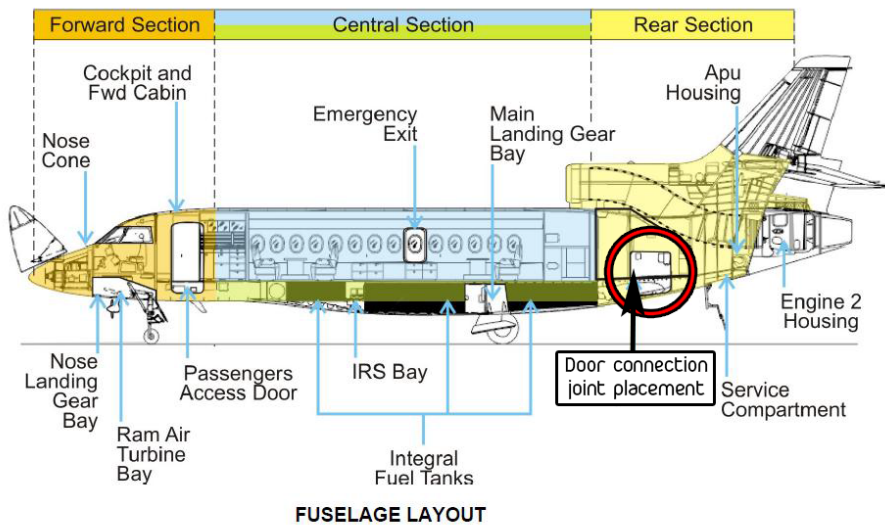

Figure 1.7: Door Connection Joint; Placement on the Falcon 900 Business Jet (image courtesy of [2])

1.3 Delimitation of thesis

The thesis will mainly focus on the subject of topology optimization with regard to basic theory and practical structural applications using Abaqus and NX, and aim to provide a better understanding of topology optimization for the experienced FE-user. The thesis will mainly focus on the geometrical approach to topology optimization for load supporting, 3D continuum structures experiencing static strains within elastic limits for isotropic materials.

Chapter 2

Topology optimization theory

2.1 History

to·pol·o·gy

/tə'pələjē/ 

Noun

1. The study of geometric properties and spatial relations unaffected by the continuous change of shape or size of figures.
2. A family of open subsets of an abstract space such that the union and the intersection of any two of them are members of the family, and...

The first concepts of seeking optimal shapes of structural elements was performed in the 16th and 17th century by Galileo Galilei. In his book “Discorsi”, he investigated the fracture process of brittle bodies, whereas also the shape of bodies was considered with regard to strength. With ever increasing computational capabilities, a new area of Computer Aided Engineering has emerged, often referred to as Structural Optimization. The work of Gottfried Wilhelm Leibniz (1646-1716) in the fields of mathematics and natural sciences can be seen as the basis of any analytic procedure [7], while the work of Leonard Euler (1707-1783) on the theory of extremes provided the basis for the development of the calculus of variations. With contributions to the work of Euler, Lagrange (1736-1813)

and Hamilton (1805-1865) contributed in completing the variational calculus. This has later turned out to be the basis of several types of optimization problems, as the theory of topology optimization combines mechanics, variational calculus and mathematical programming to obtain better design of structures, according to [11]. Euler, Lagrange and a few significant others also made initial investigations on finding the optimal shape of one-dimensional load bearing structures under arbitrary load. Using variational calculus, they derived optimal cross-sections for columns, torsion bars and cantilever beams [7].

2.2 General optimization theory and applications

Topology optimization is aimed at finding the best use of material within a given design space (often referred to as ground space), fulfilling requirements on stiffness, displacement, eigenvalues, etc. In short, the optimization seeks to find the optimal load path for a particular load and boundary condition. With the rise of the Finite Element Method (FEM), algorithm-based optimization has become available not only to the expert user.

Topology optimization is often also referred to as *layout optimization* or *generalized shape optimization* in literature, while in this thesis, *topology optimization* is used to reference the theory. Topology may be used to improve not only structural performance, but also thermal properties, fluid flow, electric boards (MEMS), electromagnetic applications and bio-mechanic properties. All subjects but the first are omitted in this thesis. The basis is, however, the same as for topology optimization of load-carrying structures. One can roughly separate topology optimization into two approaches; the *Material- or Micro-approach* vs. the *Geometrical or Macro-approach*, whereas the last approach is the most used in commercial software today [7]. The inherent differences between the two approaches will be clarified at a later stage in the thesis. Theory also separates between *gradient-based* and *non-gradient-based* algorithms, whereas the difference will be explained later. Keep in mind that combinations of both approaches and algorithms exist.

Topology optimization can roughly be divided into treatment of two different types of domains; *continuum* and *discrete* structures. Discrete structures often refer to larger constructions like bridges, cranes and other truss structures, while continuum structures often refer to smaller, single piece parts and components. As already mentioned in section 1.3, continuum structures are of main interest in this thesis.

When performing optimization, one must also distinguish between the *num-*

ber of objectives. If there is one objective, or the objective consists of a weighted average of objectives, the process is referred to as a *Single Objective Analysis* (SOA). If there is more than one objective, the process is said to be a *Multi-Disciplinary Optimization* (MDO) or a *Multi-Objective Analysis* (MOA). In this thesis, the MDO-name is used. The definition of Multi-Disciplinary Optimization given by the Multi-Disciplinary Optimization Technical Committee of the American Institute of Aeronautics and Astronautics (AIAA) states: "Optimal design of complex engineering systems which requires analysis that accounts for interactions amongst the disciplines (or parts of the system) and which seeks synergy to exploit these interactions", ref. [12]. As a result, objectives must originate from separate, conflicting disciplines or systems in order to be seen as Multi-Disciplinary. In a Multi-Disciplinary problem the notion of "optimal" changes as the target is to find a good compromise between conflicting properties, rather than a single solution. A Multi-Disciplinary optimization results in many different solutions, whereas the boundary between feasible and infeasible solutions is defined as the Pareto frontier. On the Pareto frontier none of the objectives can be improved without compromising at least one of the other variables. The alternative to solving Multi-Disciplinary optimization problems is consequently to solve one objective with means of weighted functions with which the problem is transformed into a single-objective problem using weights: $F(x) = w_1 \cdot f_1 + w_2 \cdot f_2 + \dots + w_i \cdot f_i$, according to [13].

Additionally, one must separate between the use of topology optimization for *static* and *dynamic* systems. As previously stated, the thesis is concerned with treating the static, steady-state case (alternatively a quasi-static state). However, treating dynamic systems is also possible and often solved by maximizing eigenfrequencies. Topology optimization is also applicable for use with assemblies. This is straightforward, as the definition and selection of design spaces, objectives, etc., is similar to the standard procedure. Contact, gluing and such must then be defined to gain validity.

As in every type of optimization, using too strict constraints, there might not exist a real-world solution to the problem. This is an issue of convergence, and is discussed in the theory part discussing different algorithms, see section 2.2.2.

In order to obtain reasonable results from topology optimization, the number of discrete, finite element nodal points should be high [11]. This follows from the fact that the nodal points are used as variables, and that the resolution and accuracy of the resulting geometry is directly related to the mesh size, as only whole elements can be removed or altered. Mesh dependency will be covered in section 2.4.2.

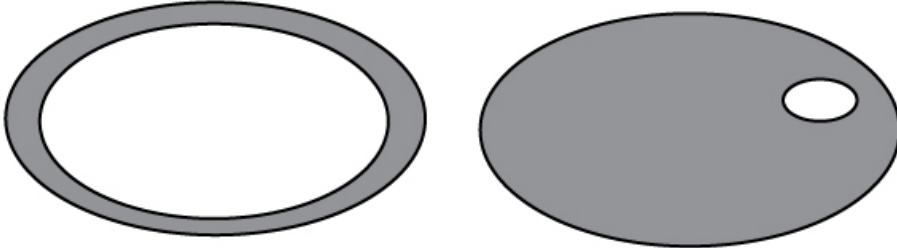

Figure 2.1: 2D topology equivalent domains

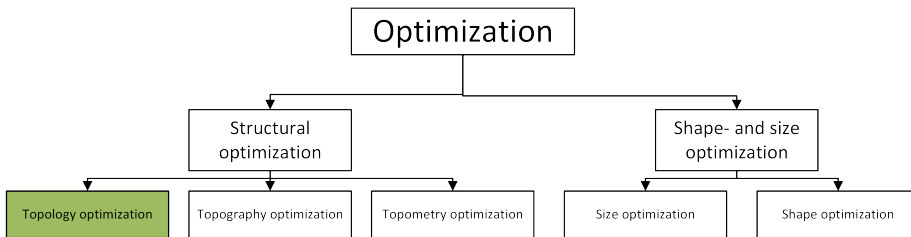

Figure 2.2: Optimization techniques

It is important to have a good understanding of the general definition of topology optimization when evaluating and interpreting optimization results. For two objects to be topologically equivalent, they must belong to the same topology class. An object will belong to another topology class if the neighborhood relations of the single elements that establish a domain are violated, as described in [7]. This means that the size and position of a hole will not change the topology, but the introduction of new supports, holes or equivalent will. These implications are shown in figure 2.1.

2.2.1 Types of optimization

Optimization of structures can roughly be divided into 1) shape- and size optimization and 2) structural optimization [11, 14]. The different types of optimization are briefly discussed beneath, focusing on the fundamental differences between them, explained graphically in figure 2.2 and 2.3.

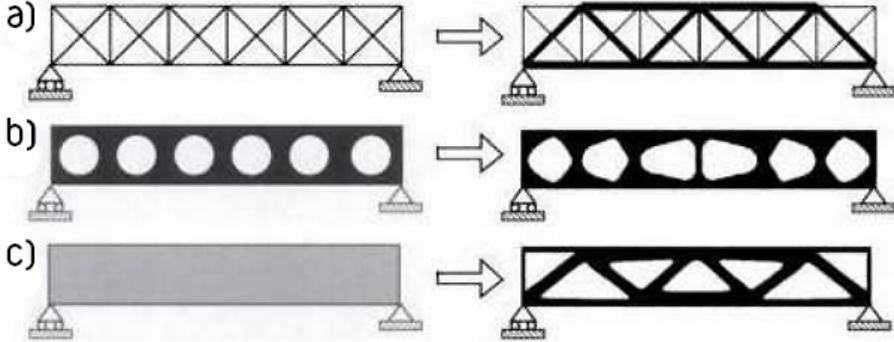

Figure 2.3: Different types of optimization a) sizing optimization b) shape optimization c) topology optimization

2.2.1.1 Shape- and size-optimization

Shape- and size-optimizations are mainly concerned with increasing strength and finding the best compromise between many different design parameters for a previously prescribed layout. For small, continuum structures, the main concern is reducing stress concentrations and increasing fatigue life. This topic is further covered in [15, 16].

Shape Optimization with regard to shape takes into consideration the specified design parameters of a model and varies these until the desired design responses and constraints are fulfilled. This included changing fillets, chamfers, radius, material thickness, etc. The optimization algorithms will not include or remove holes, rather adjust the ones specified in the analysis.

Size Size optimization, on the other hand, will often handle issues concerning truss-like structures; bridges, support bars, space frames, etc. If having no lower limit of a member cross section area, the optimization can fully remove a non-supporting member if its radius or height is included in the parameters available for variation. If all possible combinations of connections between specified connection nodes have been modeled and parameterized, size optimization can be seen as a simplified approach to topology optimization, ref. section 2.2.1.2.

Sizing optimization is also concerned with changing the thickness of plates in

sheet metal constructions, in order to find the optimum solution with regard to weight, stress, displacements, etc. Used solely to change the thickness of distinct plates or members, size optimization can be seen as a somewhat simplified type of topometry optimization, explained briefly in section 2.2.1.2.

2.2.1.2 Structural optimization

Structural optimization can, contrary to shape- and size optimization, introduce new holes, voids and trusses in the structure.

Topology First introduced by Bendsøe and Sigmund, and extensively treated in [11], topology optimization is a powerful optimization technique designed to provide engineers with a tool for evaluating and expanding the solution space and increasing creativity when designing and dimensioning load-carrying structures, both on a micro- and macro-scale. By assigning a valid design space and the proper BC's (Boundary Conditions); loads, design responses and constraints, commercially available software are able to predict the optimal structure for the application. Using a variety of different algorithms, including the most simple and known of which is the SIMP (Single Isotropic Material with Penalization), the software will perform many iterations of the consecutive activity of redesign and simulation to reach a solution. Explanation of the different algorithms is found in section 2.2.2.

The normal loop of optimization is shown in figure 2.4. The work order and general sequence of work is valid for most commercial software.

By default, all types of discrete topology optimization algorithms have the disadvantage that the product of the optimization is a non-smooth structural geometry. As many engineering applications require smooth geometric shapes, a smoothing procedure has to be performed. Depending on the optimization geometric constraints, the resulting geometry is usually highly organic in shape, requiring a manual process of interpreting and implementing the results into a parameterized model suitable for production purpose.

Topography Topography optimization is similar to topology optimization, but is concerned with varying the element (2D) offset from the component mid-plane [14]. This optimization theory is widely used on sheet-metal structures, as can be seen in [4], ref. figure 2.5. Keeping the element thickness constant, but varying the surface topography, one can obtain the structural integrity needed for the component to solve a specific problem. This kind of optimization is es-

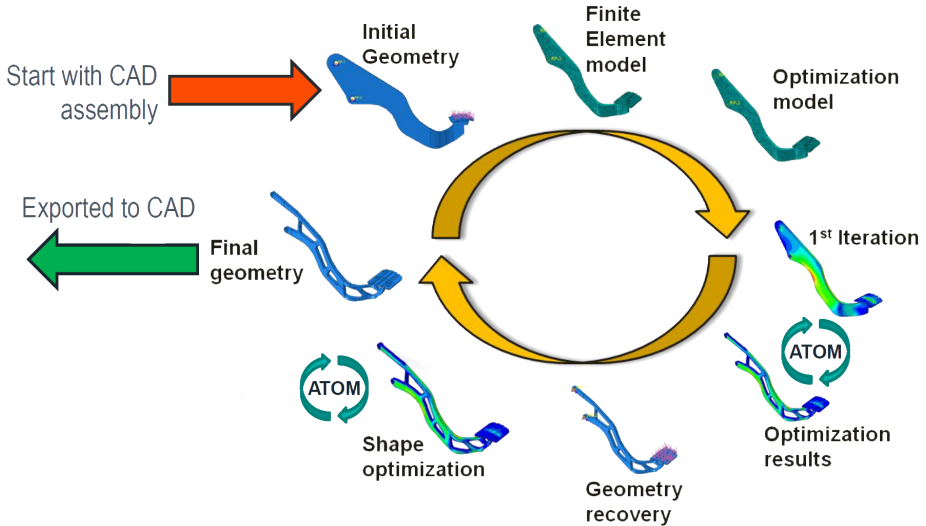

Figure 2.4: Topology optimization process loop (image courtesy of [3])

pecially useful when working with sheet-metal products suitable for production using deep-drawing, press forming, hydro forming, etc.

Topometry Topometry optimization is similar to topography optimization, but the algorithm will maintain a zero element offset from the mid-plane, and rather change the element thickness. This method is not used as much as the one previously discussed, as production without the use of ALM (Additive Layer Manufacturing)-technology is both difficult and expensive. Topometry optimization is therefore omitted in this thesis, but remains a promising area for further analysis and use as the ALM-technology is more widely used.

2.2.2 Topology optimization algorithms

The following sections about optimization algorithms are based on the work of [7, 11].

Topology optimization for continuum structures can be defined as a material distribution problem, where the target is to find a material distribution in the form of a body occupying a domain Ω^{mat} which is part of a larger reference domain Ω , in R^2 or R^3 . Ω is often called the *design space*, or *ground structure*,

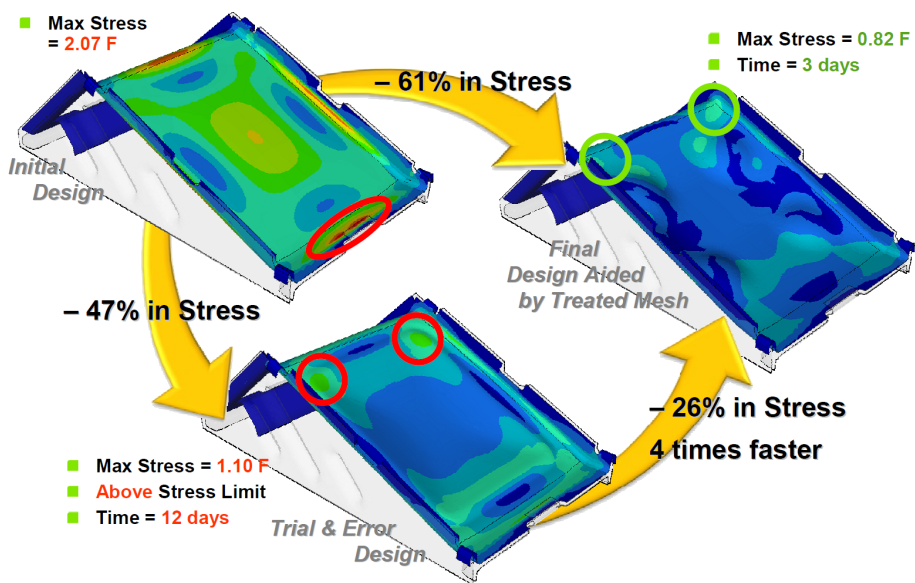

Figure 2.5: Topography optimization of cover plate (courtesy of [4])

and is chosen to allow for definition of applied loads and boundary conditions. Some of the most widely used algorithms are based on the search for a minimum compliance design. This is often referenced in software as minimizing strain energy, or compliance (often referred to as the stress/strain-relation). Since $Stiffness \propto \frac{1}{Compliance}$, minimizing the compliance will maximize the stiffness. Equation array 2.1 defines the minimum compliance design in a mathematical form, whereas the first line shows the internal virtual work of an elastic body at the equilibrium u and for an arbitrary virtual displacement v . The resulting equation is the equilibrium equation written in its weak, variational form. The index E is used to show that a_E depends on the design variables.

$$\begin{aligned}
a(u, v) &= \int E_{ijkl}(x) \epsilon_{ij}(u) \epsilon_{kl}(v) d\Omega \\
\epsilon_{ij}(u) &= \frac{1}{2} \left(\frac{\partial u_i}{\partial x_j} + \frac{\partial u_j}{\partial x_i} \right) \\
l(u) &= \int_{\Omega} f u d\Omega + \int_{\Gamma_T} t u ds \\
\min(u \in U, E) &= l(u) \\
a_E(u, v) &= l(v), \text{ for } v \in U \text{ and } E \in E_{ad}
\end{aligned} \tag{2.1}$$

Symbols used in 2.1 have the following definitions

U	Kinematically admissible displacement fields
f	Body forces
t	Boundary tractions
E_{ad}	Admissible stiffness tensors for design problems

The various possible definitions of E_{ad} is the subject of different optimization algorithms.

When working with a FE (Finite Element)-analysis, the problem must be stated in a discrete manner. Assuming a constant E for each element, the discrete form of can be expressed as

$$\begin{aligned}
\min(u, E_e) &= f^T u \quad , \text{ so that} \\
K(E_e)u &= f \\
E_e &\in E_{ad} \\
K &= \sum K_e(E_e) \quad , \text{ summing } i = 1..N \text{ elements}
\end{aligned} \tag{2.2}$$

u	Displacement vector
f	Load vector
K	Global element stiffness matrix
K_e	Stiffness matrix for element e , dep. on the stiffness E_e in the element

Given the equations above, the target is the optimal subset Ω^{mat} of material points. The set E_a of admissible stiffness tensors consists of those tensors that fulfill the equalities in equation 2.3.

$$\begin{aligned}
 E_{ijkl} &= 1_{\Omega^{mat}} E_{ijkl}^0, \text{ given that} \\
 1_{\Omega^{mat}} &= \begin{cases} 1 & \text{if } x \in \Omega^{mat} \\ 0 & \text{if } x \in \Omega \setminus \Omega^{mat} \end{cases} \\
 \int_{\Omega} 1_{\Omega^{mat}} d\Omega &= Vol(\Omega^{mat}) \leq V
 \end{aligned} \tag{2.3}$$

Where V is a limit value stating the material at our disposal. In most simulations, this value is denoted $V_{rel} \in \{0..1\}$, and gives the allowable fraction of the design space volume.

As noted above, topology optimization has only one variable, which is the density and related stiffness of each element. Expressing the stiffness tensor E_{ijkl}^0 as a value that depends continuously on a function of the density of the material, the density become the design variable [11]. Varying the density will therefore influence the stiffness tensor of the element, E_e , and total material distribution. Proving that intermediate values¹, referred to as relaxation of the design variables [6], has a real physical implementation, has been subject to research and discussion. The difference between topology algorithms is how they handle intermediate density values, as we would mainly like “material or no material” elements that can easily be interpreted into a design using isotropic materials. A Black/White-model is defined as having a pure 0-1 design, implied that all possible values of the density of an element are 0 or 1. Because the density is treated as a continuous variable, this condition would not be possible without some kind of evaluation of the intermediate values. Without further processing, this approach would suffer from lack of convergence and produce mesh dependent topologies. Other problems, such as checker-boarding,

¹Relative density values $\rho \in \{0..1\}$

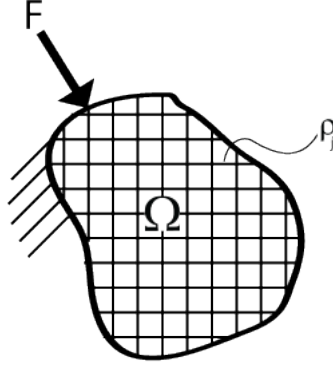

Figure 2.6: Discrete model of design space with loads and boundary conditions

one-element hinges, etc. are also found to be problematic without introducing further bounds on the algorithm, as further discussed in the following section.

$$\begin{aligned} E_{ijk}(\rho = 0) &= 0 \\ E_{ijkl}(\rho = 1) &= 1 \implies E_{ijkl}^0 \end{aligned} \quad (2.4)$$

Different algorithms for the interpolation between 0 and E_{ijkl}^0 are presented below. Be aware that these are just a few of the many possible algorithms. Additional algorithms are omitted because of their lack of use for 3D continuum structures or because they are still at an experimental stage, hence not implemented into commercial software. For practical applications, discrete models (e.g. Finite Element) of the domain of interest and algorithms are used to perform the structural analysis, as illustrated in figure 2.6. Here, the domain will be divided into N finite elements.

2.2.2.1 SIMP-model

The *Solid Isotropic Microstructure with Penalization* (SIMP)-model, also known as the *penalized, proportional stiffness model*, is a gradient-based model [17] expressed in mathematical terms as presented in equation 2.5. The method is widely used, and one out of two possible algorithms for use with Abaqus ATOM.

$$E_{ijkl}(x) = \rho(x)^p E_{ijkl}^0, \quad p > 1 \quad (2.5)$$

$$\int_{\Omega} \rho(x) d\Omega \leq V; \quad 0 \leq \rho(x) \leq 1, \quad x \in \Omega$$

The algorithm interpolates between extreme values as shown in equation 2.4. Choosing the value $p > 1$ makes intermediate densities unfavorable because the $\frac{Stiffness}{Volume}$ ratio will decrease. Values of p exceeding 3 is assumed to perform well for both 2D and 3D-structures, as discussed in [7].

The workflow of the the SIMP-algorithm can be seen in figure 2.7, following the description in [17].

SIMP usually starts with a uniform distribution of densities in the elements of the design domain and a volume fraction equal to the one specified. The first step in the iterative analysis is solving the equilibrium equations, followed by a sensitivity analysis calculating the derivatives of the design variables (ref. the element densities). Simulation settings provide the possibility to limit the magnitude of the density updates. To ensure numerical stability, filtering techniques are applied before the densities are updated using the minimum compliance criteria, followed by a new finite element analysis. This procedure is repeated until convergence has been reached, as described in figure 2.7. Further discussion on numerical stability is discussed below.

Methods to ensure numerical stability and valid solutions Numerical stability is an important issue when working with optimization algorithms, and is currently one of the main areas of research, as well as finding other ways of performing topology optimization.

Implementing a lower bound on relative densities, e.g. $\rho_{min} = 0.001$ (can be adjusted in the Abaqus ATOM environment), giving admissible densities of $0 < \rho_{min} < \rho < 1$, prevents singularities in the finite element analysis.

The following paragraph is based on [6, 17, 11]. Other significant causes of numerical problems treated in literature are, as earlier mentioned; checkerboards, mesh dependence and local optima, as well as the mere existence of a solution suitable for engineering interpretation (convergence). The different problems are shown in figure 2.8. The latter is, partially, dependent on the discretization of Ω into N finite elements, as the real-world problem is ill-posed and is generally not solvable. In order to prevent scattering and rapid changes in the topology (thus ensure the convergence of a solution), further bounds are implemented in the algorithm. An upper limit to the perimeter of the set Ω (thus reducing the number of holes by limiting the surface area) and local or global gradients of ρ will solve the problem. The latter is found to be the most time consuming when solving the analysis, together with solving the equilibrium

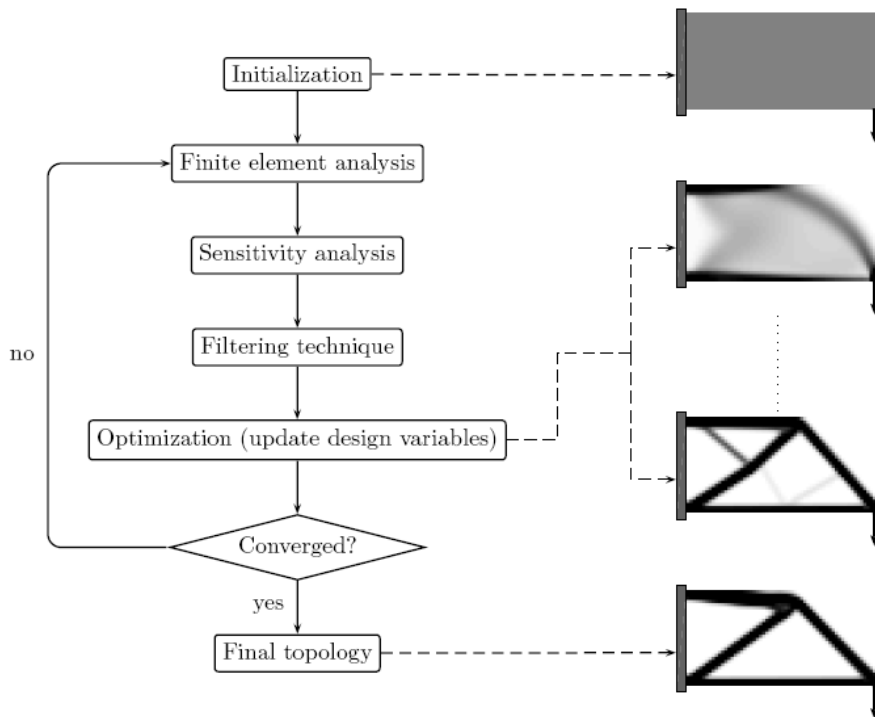

Figure 2.7: Work scheme of topology optimization using the SIMP-algorithm (courtesy of [5])

equations.

Early beliefs suggested that checker-boarding was some sort of optimal microstructure, but has later been found to be a result of bad numerical modeling. The solution to the checkerboard-problem is solved by using higher order elements (CTETRA10, etc.), as well as filtering techniques from image processing. The image filter makes the design sensitivity of each element dependent on the weighted average of neighboring elements. Both solutions implies significantly increased computational time, however they are required in order to obtain robust results.

In its original form, the SIMP-model is suffering from mesh-dependence. Work referenced in [6] suggests that solutions to the checkerboard problem can help solve this problem as well. The problem with mesh-dependence is also linked to the problem of local minima. Gradient-based algorithms are known to have a weakness of not finding the global minima, rather finding local minima, and only small changes in initial simulation parameters (density update limits, initial volume fraction, etc.) can result in non-re-producible designs. Different approaches to the problem have been suggested by various researchers, e.g. the continuation scheme; to gradually increase the intermediate density penalty factor p through the process, as this will ensure that the process is convex, gradually converging to the desired 0-1 design. Starting out with a low value of p will ensure that the solver does not “jump” to a 0-1 solution too soon, avoiding local minima effectively. Commercial software normally has one or more of these algorithms implemented, ensuring that the optimization results are valid and truly optimal.

2.2.2.2 RAMP-model

As the second out of two possible interpolation algorithms in Abaqus ATOM, the *Rational Approximations of Material Properties* (RAMP)-model is briefly presented to enlighten the use or possible misuse of the algorithm. The RAMP-method as first presented in [18], was formulated to solve the problem of design dependent loads, like pressure loads from wind, water, snow, etc. As element density is updated, the initial surface properties of the design are no longer valid, and loads are no longer unambiguous. As an alternative approach to the initial formulation, a mixed displacement-pressure formulation can be used, defining the void phase to be an incompressible hydrostatic fluid transferring pressure loads without further parameterization of the surface [19], as shown in figure 2.9.

Figure 2.10 is included to show the possible error of choosing the RAMP-

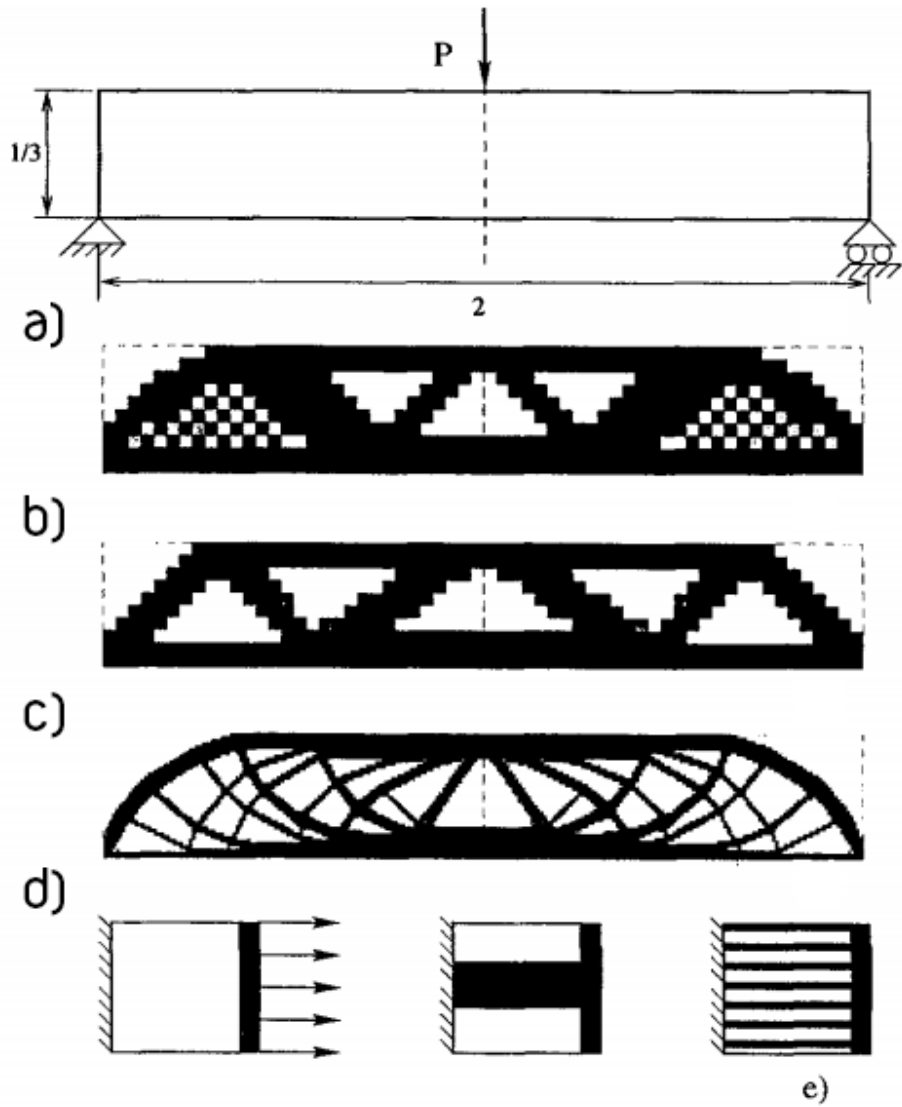

Figure 2.8: Numerical instability; (a) Design problem, (b) Example of checkerboards, (c) Solution for 600 element discretization, (d) Solution for 5400 element discretization and (e) Non-uniqueness example (courtesy of [6])

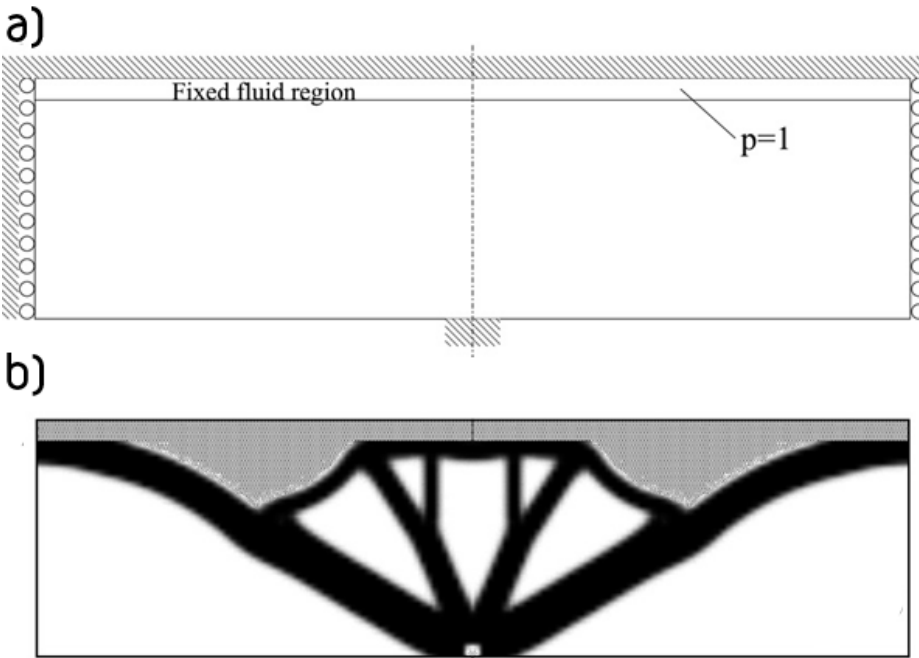

Figure 2.9: RAMP-model; a) Design space b) Resulting topology

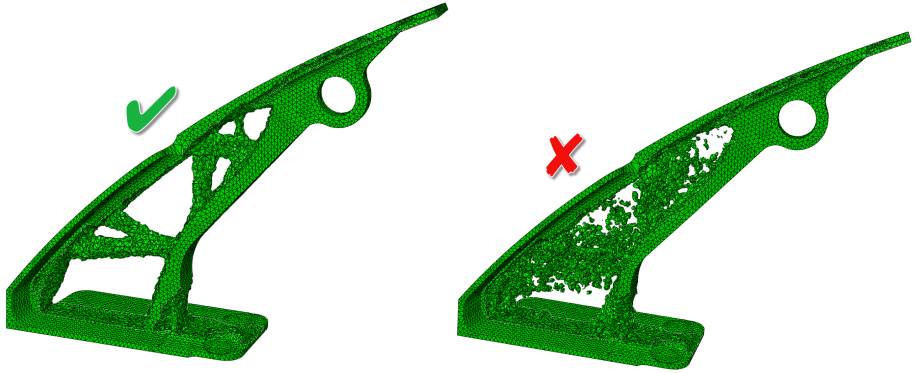

Figure 2.10: Door Connection Joint; 1) SIMP vs. 2) RAMP algorithms used at part with concentrated loads (no pressure loads)

model when performing topology optimization without the use of pressure loads. If not specified, the solver will use the default algorithm, normally the SIMP-algorithm.

2.2.2.3 Other topology optimization algorithms

Other gradient-based algorithms for topology optimization include, but are not limited to, the *Homogenization Based Optimization* (HBO). Figure 2.11 shows the *hole-in-cell microstructure* and the *layered microstructure* that can be used to cover the range of density values from 0 (void) to 1 (solid). By homogenizing values of the 0-1 areas, the effective mechanical properties can be determined [7]. The HBO algorithm represents the *Material- or Micro-approach* as presented in section 2.2.

Non-gradient-based algorithms include, but are not limited to, the *simulated biological growth* (SBG), *particle swarm optimization* (PSO), *evolutionary structural optimization* (ESO), *bidirectional ESO* (BESO) and *metamorphic development* (MD) [17]. These algorithms are based on binary design variables (solid-void) and problems with “grey” areas (intermediate values) is not an issue. Some of these algorithms have already been implemented in commercial software, e.g. the BESO-algorithm, where the engineers specify areas of structural interest (areas for loads, BC’s, etc.) and the algorithm adds material until constraints and objectives are met [7].

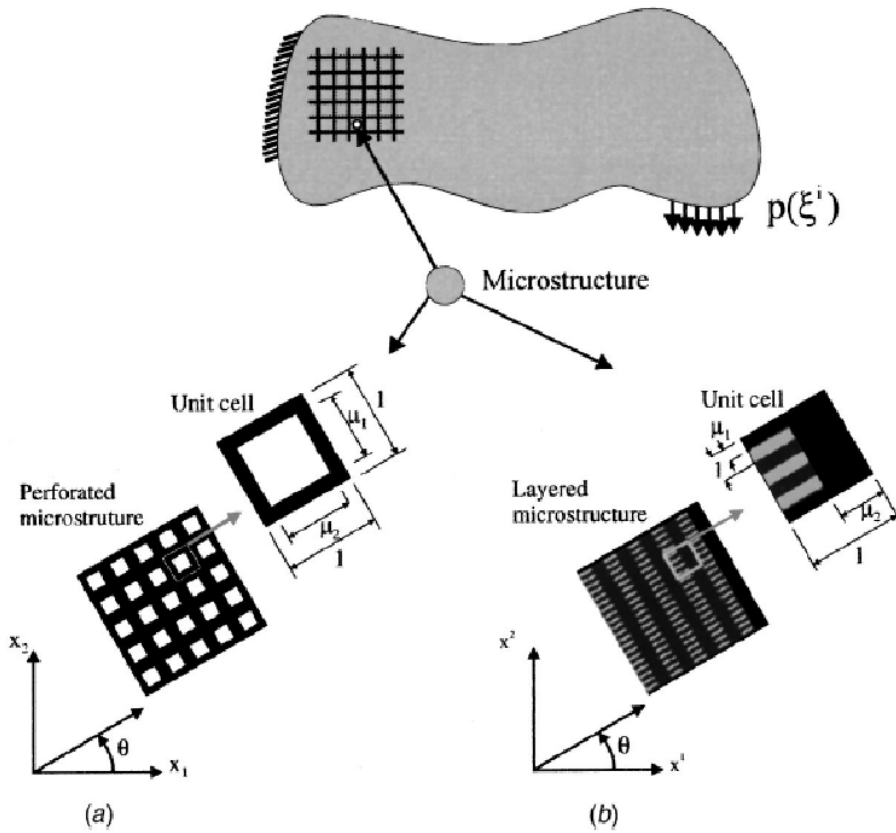

Figure 2.11: The *Material- or Micro-approach*; a) Perforated microstructure with rectangular holes in square unit cells and b) Layered microstructure constructed from two different isotropic materials (courtesy of [7])

A topic of research and development is the use of topology optimization to design components made of composites and non-isotropic materials. Using composite materials, "grey" areas can be interpreted in physical terms by composite material design, effectively changing the properties of the material and hence the effective stiffness contribution. The use of composites is therefore seen as an alternative to searching for macroscopic, 0-1 designs obtained by reducing the space of admissible designs by some sort of restrictions [11]. Available topology optimization algorithms in commercial software are expected to increase rapidly in the future as more algorithms are tested and implemented.

2.2.2.4 Formulations for evaluating the objective function

Formulations for evaluating the objective function aim to minimize, maximize, or minimize the maximum of a specified design response. The latter is not as intuitive as the two first, and is elaborated below for clarification.

The "minimizing the maximum"-formulation is often referred to as the *Min-Max*-formulation, or the *Bound formulation*. It is so far the most widely implemented formulation in commercial software aimed at handling multiple load cases. The formulation was proposed as a less time consuming alternative to creating Pareto frontiers and automatically selecting the appropriate optimum [20, 21]. The formulation inserts an objective β which acts as a new objective, simultaneously acting as an upper bound on all other objectives, treating the original objectives as constraints. The problem can be expressed as:

$$\begin{aligned}
 & \min_x : \{ \max \{ f_i(x) \} \} \quad i = 1, 2, \dots, m \\
 & \quad \quad \quad \updownarrow \\
 & \min_{x, \beta} : \beta \\
 \text{s.t.} \quad & f_i - \beta \leq 0 \quad i = 1, 2, \dots, m
 \end{aligned} \tag{2.6}$$

Figure 2.12 demonstrates the difference in optimal designs when using the MinMax-formulation instead of merely minimizing the strain energy.

2.2.3 Multidisciplinary Topology Optimization

Pareto optimal solutions are solutions where multiple design responses are conflicting [13, 22]. A topology Ω is "Pareto-optimal" if no other topology Ω' exists with smaller compliance and identical volume, ref. [23, 11]. The designer may specify a certain performance target (volume, displacement, etc.), but without

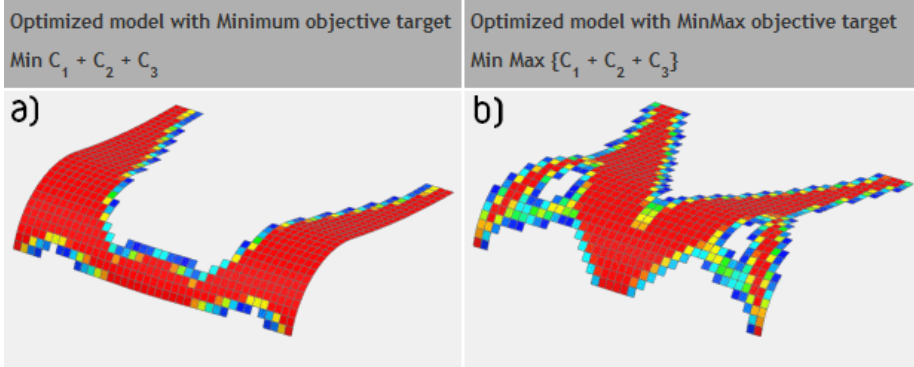

Figure 2.12: Objective functions; a) Minimizing vs. b) Minimizing the Maximum strain energy (courtesy of [8])

performing multiple simulations or utilizing software with MDO capabilities, there will be uncertainty about the correspondence between conflicting properties. In most situations, the relationship is not linear, but rather convex (or a combination of concave and convex). This fact is illustrated in figure 2.13 and shown in a practical example using the “199 Matlab algorithm for Pareto optimal topology” in section 2.2.3.1. The topic is also covered in [24], and used as a background for the thesis. The topic is explored in this thesis using the Door Connection Joint as an example, applying a manual approach to MDO in order to visualize how changing volume targets affect the overall performance of the structure, making *Multi Criteria Decision Making*² (MCDM) possible. The motivation for running a MDO compared to a significantly less computational demanding SOA, is increased knowledge of possibilities, aiding the engineer to make a better overall trade-off between conflicting variables.

2.2.3.1 199-line Matlab algorithm for Pareto optimal topology

The 199-line algorithm is based on the article “A 99-line topology optimization code written in Matlab” [25] by Sigmund, the author of [23]. The article shows that the SIMP-based topology optimization can be implemented in a compact Matlab script. The 199-line Matlab algorithm, on the other hand, is set to

²A set of rules that can be defined by the engineer so that the software itself can automatically extract the optimal solution. Typically only implemented in large systems with many variables.

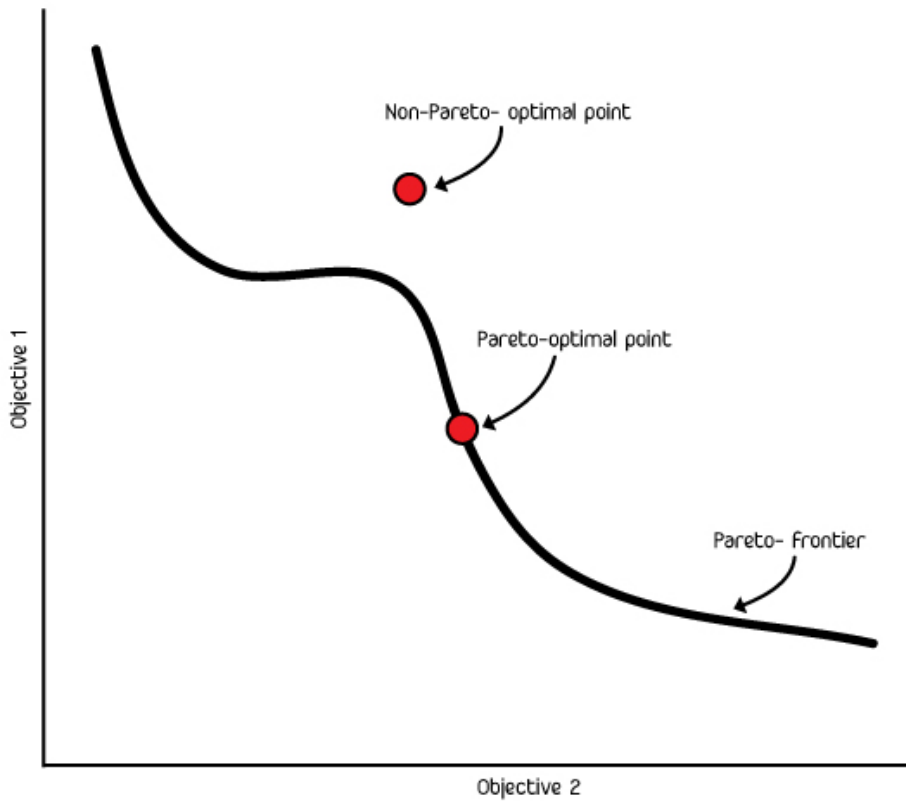

Figure 2.13: Pareto-frontier

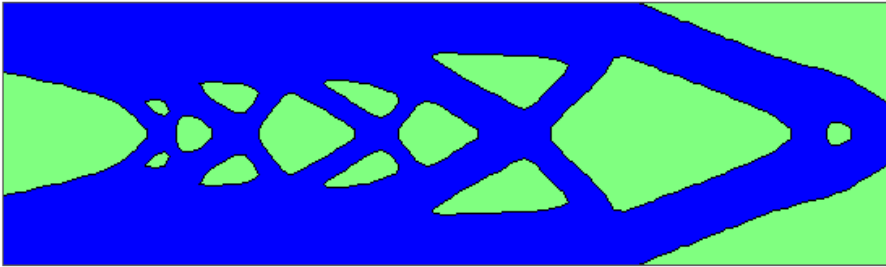
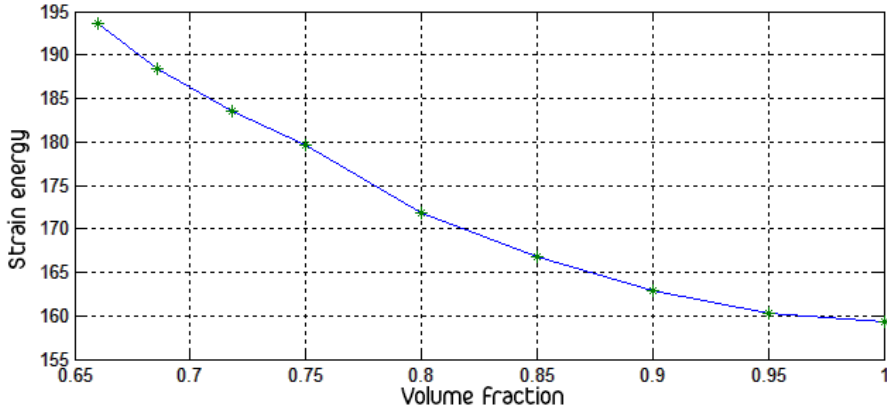

Figure 2.14: 1) Pareto frontier and 2) corresponding Pareto optimal solution; $V \equiv 0.66$ and $J = 190$

perform multiple simulations with different volume targets, giving a Pareto optimal frontier based on the concept of topological sensitivity, further based on the calculation of The Topological Derivative as described in [26]. Optimizing with different volume targets and plotting the results give a Pareto frontier that, using the SIMP-method, gives the relationship between the volume and the strain energy of the problem under analysis. Figure 2.14 shows the topology optimization results after applying a transversal force to a cantilever beam, plotting strain energy [J] vs. volume fraction.

Dips or changes in the graph represents that the solutions shifts into a completely different topology class, hence changing the number and/or the orienta-

tion of supports. In short, the material distribution is altered significantly.

2.3 Available software for Topology Optimization

The following list reflects a variety of commercially available software for 3D topology optimization. Most high-end CAE-software incorporates optimization algorithms, including wizards and help-functions for setting up and solving the analysis. The built in functionality in these software are mainly capable of SOA, or will at best perform an analysis with multiple objectives weighted and summed up to a single objective. Manually performing multiple simulations with different targets and plotting these will imitate a MDO. This enables the user to evaluate the results with regard to Pareto optimal solutions, hence increase the transparency and viability of the analysis. A practical example of this is shown in section 3.5.3.

2.3.1 Topology optimization software

2.3.1.1 Commonly used commercial software

Altair; Hyperworks OptiStruct With the release of the Hyperworks OptiStruct software in 1994, Altair was one of the first to provide commercial software for use in structural optimization. The software is widely used also today, and serves as a benchmark for other software suppliers. Unlike other commercial software, OptiStruct provide capabilities for optimizing with regard to buckling strength as well as the more traditional approaches. Use of the software is omitted because of limited capabilities in the student edition of the software.

Dassault Systèmes; Simulia Abaqus ATOM In 2011, with the release of Abaqus 6.11, Dassault Systemès included the *Abaqus Topology Optimization Module* (ATOM), capable of both implicit and explicit (typically linear and geometrical non-linear) structural optimization. The module is more comprehensive than the one found in the NX optimization module, as it is capable of handling a weighted sum of objectives. Post-processing of results can be done directly in the software, however the preparation of design spaces is recommended to be done using more suited modeling software.

FE Design Tosca Structure The TOSCA Structure is one of most trusted software for topology optimization. Used as a stand-alone module, the program is compatible with most high-end FEA-software.

Siemens Unigraphics NX/ MSC Nastran topology optimization module With the release of NX8 in October 2011, Siemens incorporated a topology optimization module in the Advanced simulation-module of their high-end CAD/CAE-software NX. The module is implemented so that it can be configured in the pre-processor environment of SESTATIC101 and SEMODES103 analysis, and viewed with the post-processing capabilities within the program. The optimization module is based on algorithms found in the FE-Design Tosca Structure software, adopted for the UI in NX.

Ansys The topology optimization algorithm in Ansys became available for use in 2009. It is based on the FE-Design Tosca Structure, similar to UGS NX. Additionally, the software has been developed to be suitable both for structural as well as fluid flow problems.

2.3.1.2 Other software for topology optimization

Other software for topology optimization of 3D structures includes, but is not limited to, COSMOSWorks Structure and Pro/MECHANICA Structure. For exploration of 2D topology-optimization and real-time optimization using basic optimization algorithms, see software found at www.topopt.dtu.dk or download the TopOpt app from Google Play/Apple Store. The program use and theory is elaborated in [27]. The reader is encouraged to try out the software, as the real-time visualization of the optimization progress gives a better understanding of the concept.

2.4 Topology optimization workflow

The following sections describe topology optimization workflow in general, and aim to provide a guide for best practice. Specific setup of the two test cases in the Abaqus ATOM interface is covered in chapter 3 and in appendix B. Specific setup of the Door Connection Joint in NX is covered in chapter 4, and in appendix C. Figure 2.15 shows the general workflow presented in a flowchart.

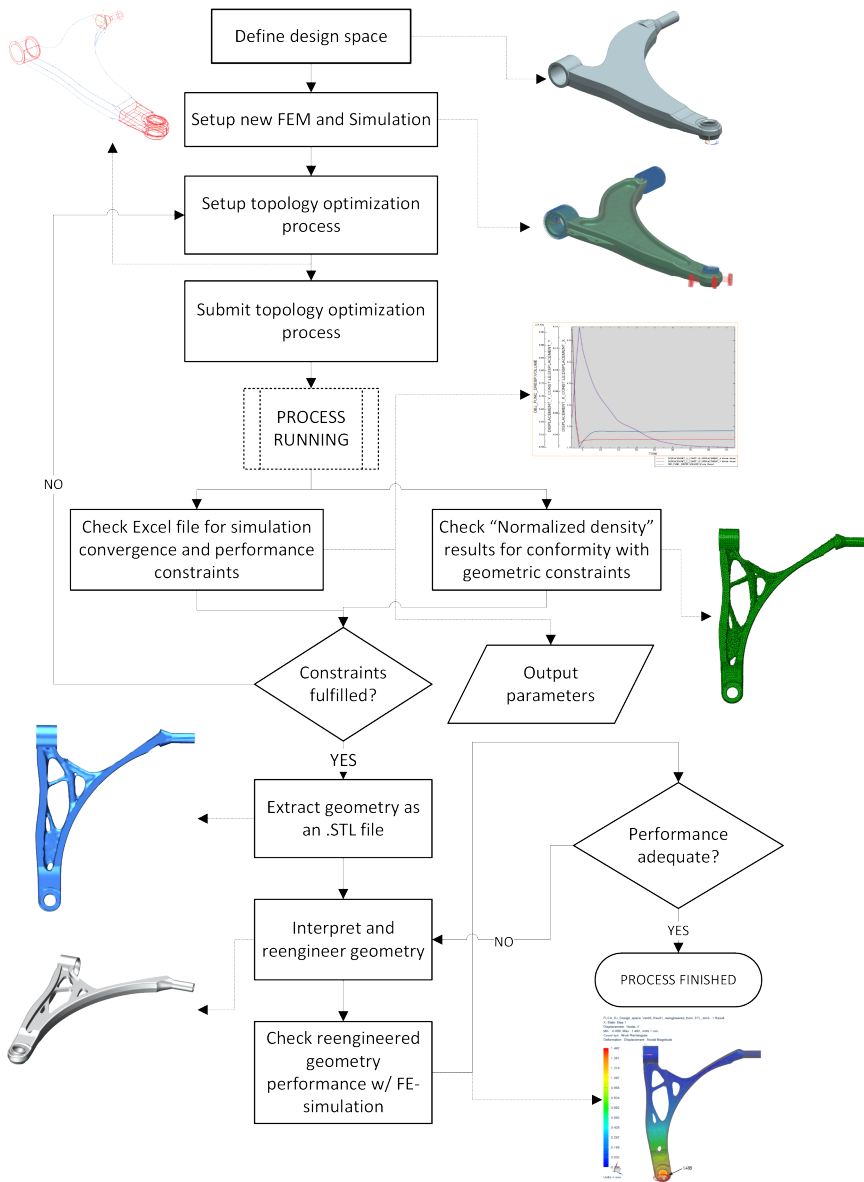

Figure 2.15: Topology optimization workflow

2.4.1 Generating the design space

Topology optimization is mainly a tool for enhancing creativity and exploring alternative designs. Shape- and size-optimization algorithms require that the designer provide a parametric model, using a variety of algorithms for perturbing these parameters, searching for the desired properties. Topology optimization, on the other hand, only requires the engineer to provide a solid body. As discussed in section 2.2.2, the algorithms change the relative density of the elements created when meshing the model. Using the SIMP-model, the relative density is a continuous value ranging from 0 (void/ hole) to 1 (the real density of the material). Reducing the density of an element will reduce the stiffness of that particular element, and its contribution to the overall stiffness will decrease. The algorithms can only decrease or increase the density of elements that were present at the beginning of the analysis. This means that no material will be added during the optimization beyond what was already present. It is therefore important to define a design space that is as large as possible within the constraints of the surrounding environment (other parts, operational specifications, size specifications, etc.). The larger the design space, the better the proposed solutions, as the number of possible configurations will increase.

Best practice when defining the design space is to use the Synchronous Modeling functionality in the NX Modeling-environment (See Toolbar or click Insert > Synchronous Modeling), as shown in figure 2.16. The most widely used functionalities are 1) Replace face and 2) Delete face, which will assist you in removing features and closing voids. Special features that the engineer would like to maintain or voids/ holes that have a vital shape must be modeled in a precise manner and geometrically constrained before the simulation starts, otherwise they may be removed or altered. The main disadvantage with not constraining these areas is the disability to measure and compare reference volumes to the final results. The design space is the maximum permissible volume for the algorithm to work within. The resulting geometry will only occupy a fraction of this volume.

The Trim Body command (Insert > Trim > Trim Body) is also useful, as this makes it possible to Wave-link geometry into the design space .prt and trim the imbricated volumes of the design space, leaving only the available volume in the design space.

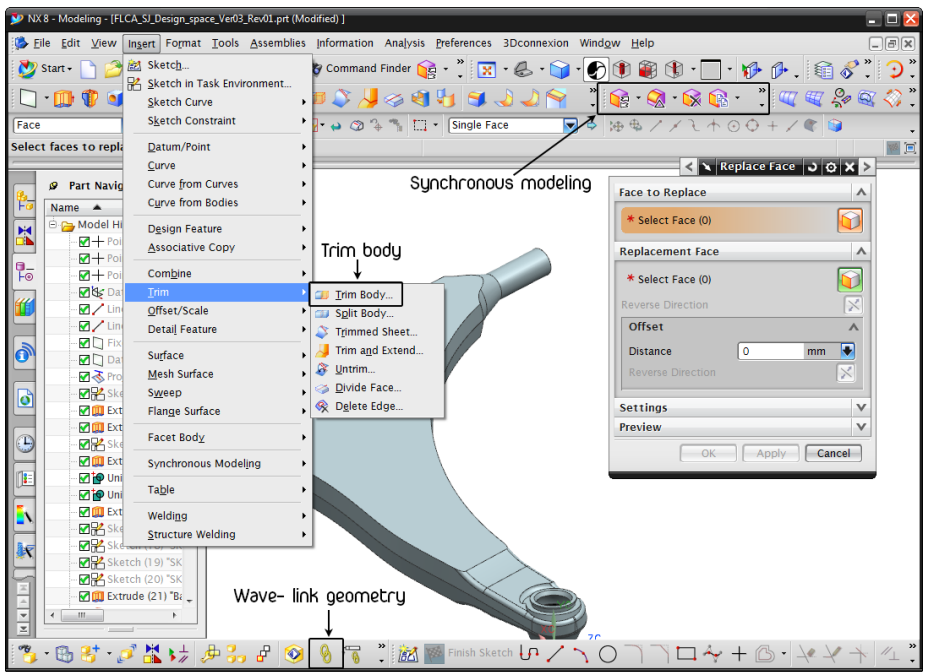

Figure 2.16: NX-user interface for defining the design space

2.4.2 Meshing the design space

As already discussed, higher-order elements like CTETRA10 (Nastran) or C3D10 (Abaqus) are preferred, in order to avoid numerical instability. Overall mesh size defines the coarseness of the solution, and should be evaluated depending on the type and size of structure under analysis. Initial simulations should be done with a relatively coarse mesh, as computational time is rapidly increasing for decreasing mesh size. Refining the mesh in particular areas of interest can be advantageous in order to save simulation time. Usually, free meshing with mapped meshing allowed at suitable areas give the best results for irregular components. In addition to the above mentioned, general guidelines for meshing should be followed.

2.4.3 Defining loads and boundary conditions

Loading and constraining the design space is generally done similar to any other FE-simulation. Important notes for defining loads and BC's for topology optimization are the following:

- Pressure loads require special attention, as the topology optimization algorithm may change the surface on which the pressure is applied, altering the overall load case. In Abaqus, this may be counteracted by using the RAMP-formulation, as described in 2.2.2.2.
- Topology optimization using the SIMP-method (minimizing compliance) is not sensitive to the magnitude of the load, but rather the ratio between multiple load cases.
- The designer must decide whether the load and BC areas should be frozen or take part in the topology optimization.
- Multiple load scenarios should be defined in different sub-cases or solution steps in order for the software to differentiate between the scenarios. This is of great importance when defining design responses and the overall characteristics of the objective. Other approaches to multiple loads include:
 - Adding all loads into one load case and obtaining geometry capable of handling the aggregated state of different loads.
 - Solving the topology optimization problem for each load and manually interpreting the results.

- It is of great importance to provide reasonable loads and BC's, when performing topology optimization. Results can be expected to have a high load direction sensitivity. Neglecting to include a load or to overly simplify loading will strongly influence the proposed geometry. The engineer is therefore encouraged to include all expected and possible variations of load directions and utilize the MinMax-formulation or equivalent in order to secure the robustness of the outcome.

2.4.4 Defining design responses

When performing optimization, a variety of different values and parameters can be evaluated and controlled. These parameters are called design responses, and must be specified prior to defining the simulation objective and constraints. Typical design responses are:

- Volume/ weight
- Strain energy
- Displacement
- Reaction forces/ moments
- Eigenvalues
- Buckling loads
- Moment of inertia
- Rotation
- Center of gravity

Available design responses depends on the software in use, but one can normally expect to find at least the first four responses in most software. Best practice when defining design responses is:

- If possible, define individual design responses for small areas of the design space, such as fillets, holes, functional surfaces and other areas of interest. The more specific the area or region, the better the simulation results will be, leaving less chance of detecting other mechanisms than the one intended.

- Use external CSYS to define control points or additional coordinate systems for easier reference of loads and boundaries and specification of design responses. When defining a displacement constraint, it is important to specify the coordinate system and direction of interest.

2.4.5 Defining objectives and objective functions

As discussed in section 2.2, most commercially available software provide Single Objective Analysis capabilities. The objective of the analysis is therefore the *optimal criteria* for the simulation. The optimization is considered a success if this value converges with increasing no. of iterations, while fulfilling all constraints. The objective must be chosen as one of the previously defined design responses. Typically, you will set your design objective target to Minimum. This implies that the sum, maximum or minimum design response value in the region is minimized. Using strain energy as an objective, the topology resulting in the lowest overall strain energy of multiple load cases will be favored. The Maximum objective target may be useful for maximizing a negative displacement or for maximizing the natural frequency of a specific mode [28]. Best practice is, especially for uncertain loading direction and magnitude, to use the MinMax- formulation as described in 2.2.2.4, giving robust designs. Be aware that all restrictions and compromises like the MinMax- formulation will lower the performance of certain properties and create a solution that is less optimal for one specific load, but reasonably good for more loads. Best practice is to choose the design response that has the highest uncertainty as the design objective. If the target volume is specified, choose an approach that has volume as a constraint. If the stiffness is specified, make sure that displacements are specified as constraints.

Please note that if you want to maximize the eigenfrequency, a lower limit on the volume (as distinct from the other two methods that require an upper limit) must be introduced. This is because the eigenfrequency is determined by the relationship $\sqrt{\frac{k}{m}}$. By minimizing the volume the eigenfrequency will increase, ultimately giving an infinite high eigenfrequency when the volume goes to zero.

2.4.6 Defining constraints

In topology optimization, there are two different types of constraints; geometric and performance constraints. The latter controls the algorithm and makes sure that performance targets are met with regard to stiffness, volume, eigenfrequen-

cies, etc. The first controls the geometry and its visual impression.

2.4.6.1 Performance constraints

Optimization constraints are scalar values checked against FE- solver results for each consecutive iteration. Constraints can be specified both as absolute or relative values. The latter is converted into an absolute value by the software as a fraction of the initial value at the very start of the optimization. Usual optimization constraints are, but not limited to; volume, eigenfrequencies (upper/lower bounds or bands) and nodal displacements. Remaining design responses after defining the objective must be specified as performance constraints.

2.4.6.2 Geometric constraints

A particularly useful functionality when performing topology optimization is the ability to define restrictions, in particular geometric constraints, designed to ensure manufacturability. Most software can control the following:

Frozen areas Areas or elements of the body constrained with a relative density of 1 throughout the simulation, thus experiencing no density updates.

Symmetry conditions The entire design space or specific parts of the design space may be specified as symmetric. Symmetry conditions apply both to point symmetry, circular symmetry and planar symmetry.

Cast conditions Probably the most important geometric constraint, designed to counteract the existence of undercuts and internal voids; hollow spaces that make the part impossible to produce with conventional production methods. Specifications of production methods like casting, forging, stamping and extrusion is thus possible.

Member size Specifying upper or lower limits for member size ensures that no cross section is too small or too big.

As a rule of thumb the number of and extent of geometric constraints should be kept as low as possible. Introducing geometric constraints will inevitably reduce the solution space and result in a less optimal solution. Examples of properties that can be specified with geometric constraints can be seen in figure 2.17.

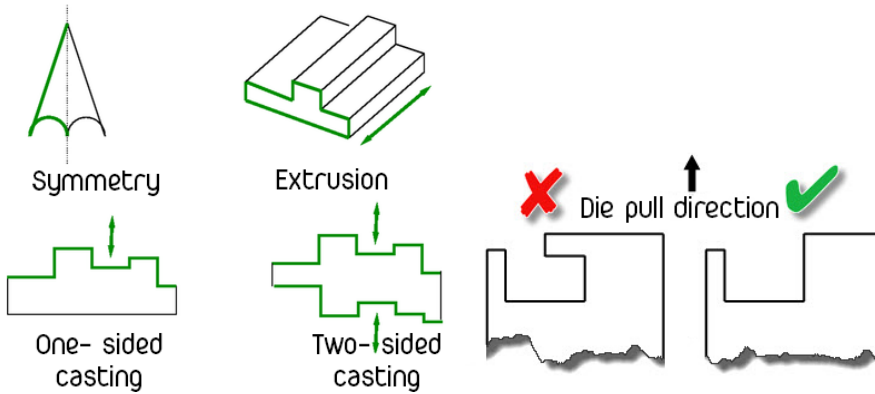

Figure 2.17: 1) Manufacturing constraints and 2) geometries feasible/infeasible of forging

2.4.7 Post-processing of optimization results; smoothing and interpretation of optimization results

2.4.7.1 Smoothing

In order to obtain usable results from the optimization, the geometry must be extracted as an input file for further processing, IGES slices or most commonly an STL-file. This process is often called *smoothing*, and involves an iterative procedure where the sharp-pointed surface obtained by removing single tetrahedral elements is evened out, as illustrated in figure 2.18 and 2.19.

Varying a large amount of parameters makes it possible to extract a vast amount of different geometries. As can be seen in figure 2.20, varying the ISO value is of great importance to how the extracted model will look like, compared to the other parameters. The ISO-value is used to calculate where on the interior edges of the elements new nodes are created. Increasing the ISO-value shifts the surface toward the inside of the model, which results in a decrease in the model volume [28].

Procedures for smoothing and extracting geometry in Abaqus is covered in chapter 3 on both test cases.

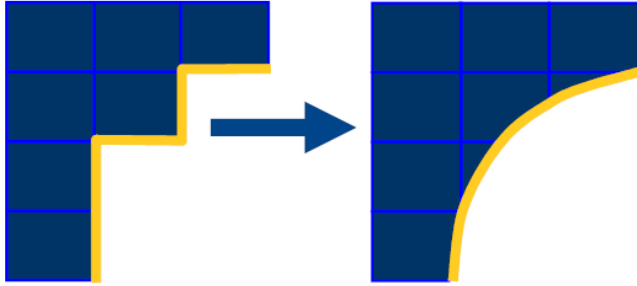

Figure 2.18: Results extraction; Smoothing 2D-elements

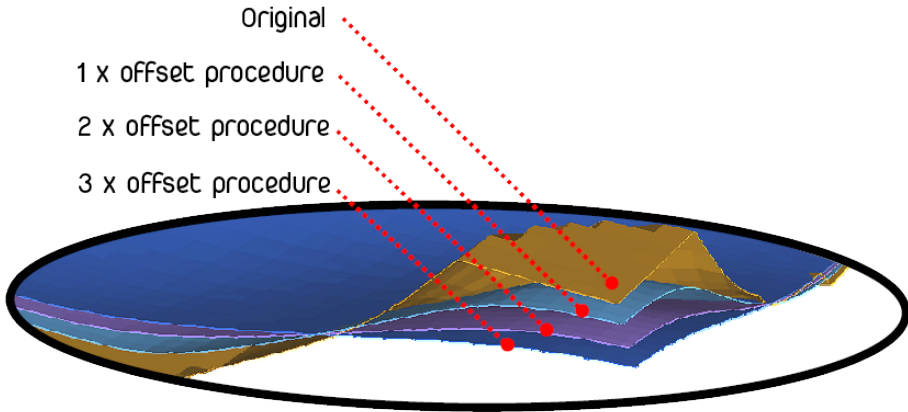

Figure 2.19: Results extraction; Smoothing as an iterative procedure (courtesy of [4])

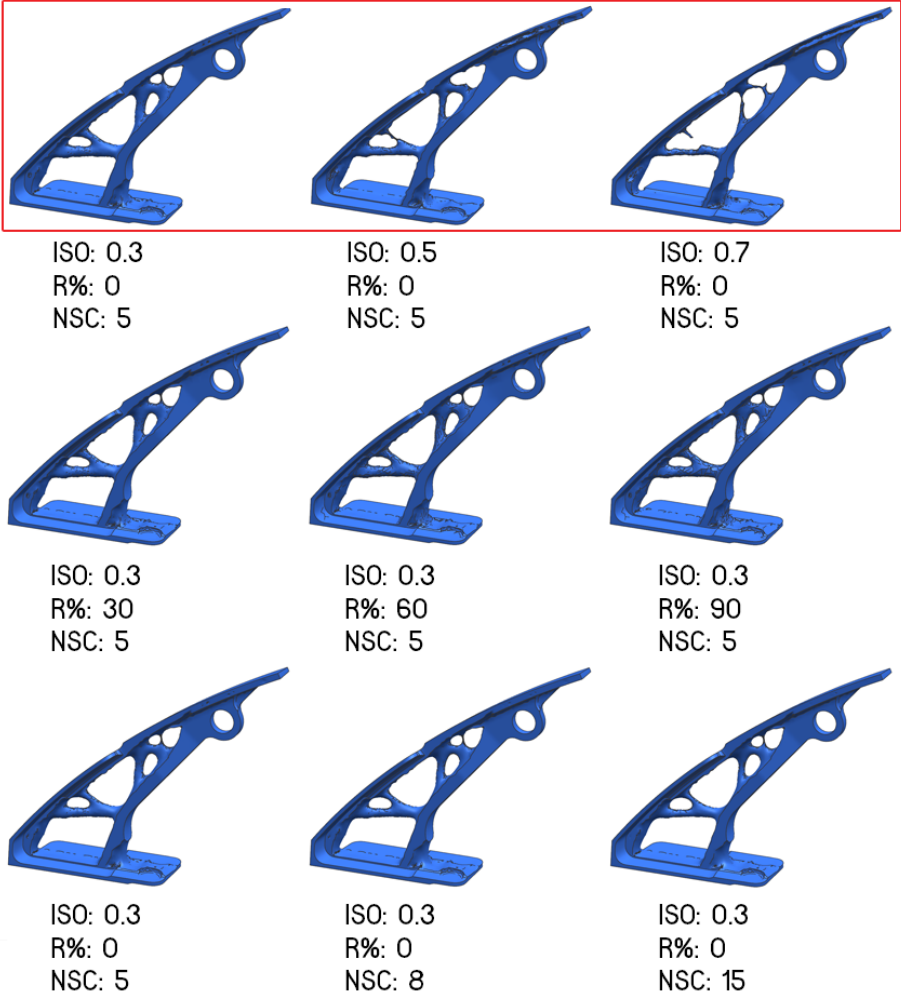

Figure 2.20: Results extraction; Varying control parameters in Abaqus

2.4.7.2 Interpretation and reengineering of extracted geometry

Reversed engineering takes into account that you have performed a successful optimization run with the chosen approach. At this point, the highly organic part must be interpreted by the engineer and reengineered in a way that enables easy manufacture, given the desired production method. An important part of the post-processing is to understand the implications of all features. As a tool for creativity and design exploration, there is no single answer to what is the correct geometry. However, the designer must follow the same constraints as specified when establishing the geometric constraints in the optimization run.

In order to perform reversed engineering of the optimization results, two main procedures can be performed; 1) extracting an .STL-file from the result file, import this file as a facet body into a copy of the design space part and use it as a template for remodeling the latter, or 2) extract an .IGES file with sections showing the part partitioned into a specified number of sections. For Abaqus users, it is also possible to 3) extract an input (.inp) file, but this option is mainly for continued use in the Abaqus environment of the resulting geometry. For NX users, you may extract a .BDF-file into the Advanced simulation environment in order to perform further analysis on the smoothed geometry. In general, the reengineered model should, as with most designed parts, be prepared as a parameterized model in order to facilitate the use of shape-and size optimization algorithms in order to reduce stress concentrations, improve fatigue life and improve performance.

Reengineering tools are shown in appendix D, and reengineering of results are described in chapter 5.

Chapter 3

Process description using the Abaqus ATOM optimization module

3.1 Software

3.1.1 Abaqus

Abaqus CAE is a commercially available software with main capabilities within simulation of a variety of problems, both structural, thermal, fluid, magnetic, etc. In order to perform optimization with Abaqus, an ATOM license is required in order to submit the analysis. Abaqus was chosen because of its wide use in the academic environment at NUST, as well as its record for being a proven finite element software. Simulations were performed with Abacus/CAE 6.11-1.

3.1.2 Unigraphics NX

Unigraphics NX is a powerful tool for both modeling and simulation of structural and thermal problems. In the following process description, NX has been utilized to calculate the baseline and final result values, as well as preparing the design space and reengineering the optimization results. Modeling was done using Unigraphics NX8.02.2 and simulations using Nastran 8.0 and Nastran 8.5¹.

¹Baseline calculations for the Door Connection Joint

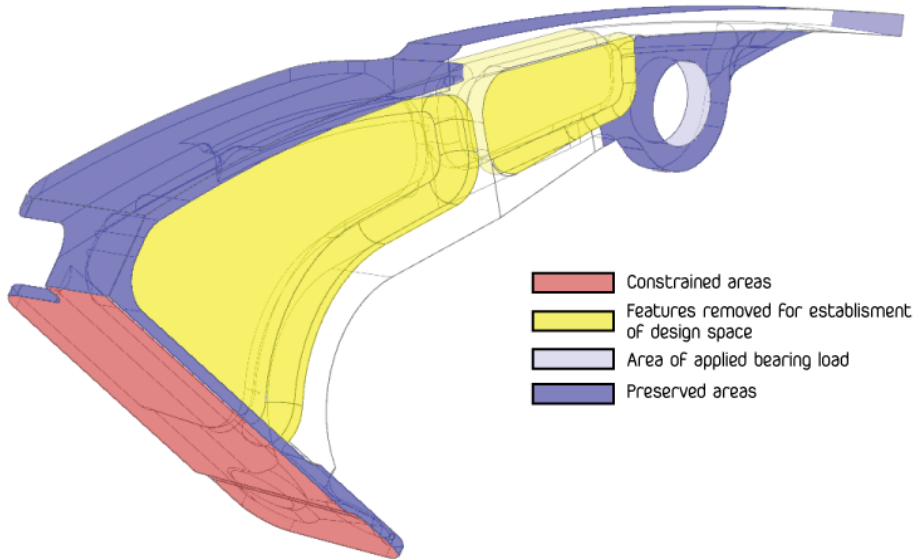

Figure 3.1: Door Connection Joint; Area specifications

3.2 Establishing baseline

3.2.1 Boundary conditions, load cases and product requirements

Performance requirements and SuPLight simulation targets for the test cases have been specified by Raufoss Technology and Hellenic Aerospace Industry, and can be seen in figure 3.2 and 3.10[9, 1].

3.2.1.1 Door Connection Joint

The Door Connection Joint is subject to complex forces. Simplified load cases are evaluated in the baseline, as shown in figure 3.6. Figure 3.1 specifies constrained areas, frozen areas and features removed when creating the design space.

As specified in the SuPLight performance objective list shown in figure 3.2, the following parameters are relevant for WP3 and have been calculated:

Performance objectives

Material properties must be as minimum as existing product

- Yield Strength, $R_p0.2$

Mechanical properties

- The predicted life- time for a constant amplitude loading $F_x = 1.25 \pm 1.25 \text{ kN}$ shall be the same as current design.
- Light weight (reduction of 10% from)

Production properties

- New designs must not affect the machining time

Figure 3.2: Door Connection Joint; Performance objectives

- Deformation at $F = 2.5 \text{ kN}$, both in the LC1 and the LC2 direction as defined in figure 3.6. Value obtained as the maximum expected value experienced during cyclic load $F = 1.25 \pm 1.25 \text{ kN}$
- Volume (proportional with weight, assuming isotropic material properties).

When performing topology optimization, manufacturing properties must be specified. The Door Connection Joint is produced by machining a solid block of aluminium, and requirements state that the production time must not exceed the time used at present. As the main target of weight reduction is inconsistent with this second target, measures are only taken to maintain the production feasibility. This means; no internal voids or cavities (impossible to machine) as well as the least amount of work piece reorientation and pre-machining preparations.

Specifications, standards and methods The baseline for the door joint is calculated using general engineering standards. All units are SI units, or a combination of such.

Meshing The Door Connection Joint was free meshed with 2 mm CTETRA10 elements, as well as applying RBE2-elements inside the bearing housing to imitate the bearing and bolt assembly when installed on the business jet. Mesh can be seen in figure 3.3

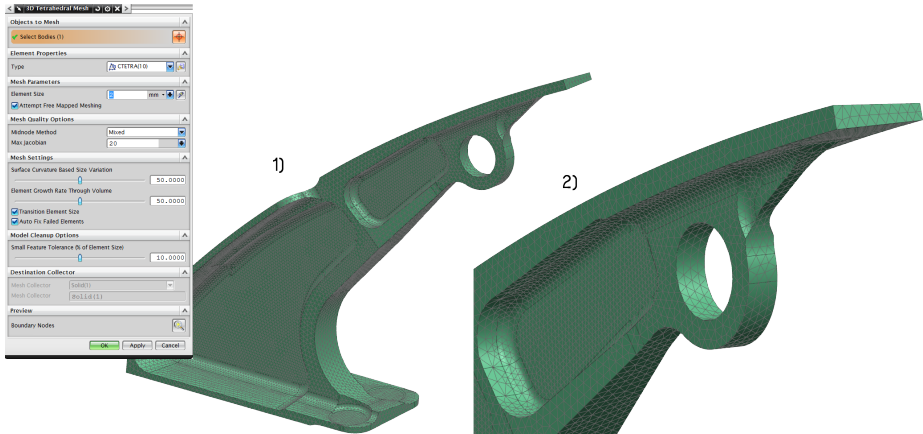

Figure 3.3: Door Connection Joint; Free mesh using 2 mm CTETRA10 elements
 1) Overall meshed model and 2) Closeup picture of mesh

Loads and constraints In order to specify simulation constraints, local cylindrical CSYS were placed at the center of the bearing housing and at the base of the structure, as shown in figure 3.5. Applied loads and boundary constraints have orientations as illustrated in figure 3.6. Loads are applied as bearing loads to separate sub-cases and solved independently of the other. Results are read out in the specific load directions by assigning results to the work coordinate system of interest.

LC1 The force is parallel to the lower, straight edge of the underside of the upper part of the joint, directed in the X-direction of CSYS 1) in figure 3.5

LC2 The force is directed at an angle of 40 degrees upward of LC1, parallel to the sides of the structural part of the hinge. The base plate is tilted somewhat to the side, but the force is assumed not to introduce sideways bending. The force direction corresponds to the Z-direction of CSYS 2) in figure 3.5.

Translation constraints are placed on the bottom surface of the Door Connection Joint to simulate the attachment of the joint to the fuselage. As previously described, rivet attachments and constraints by surface contact are omitted. The constraint can be seen in figure 3.6.

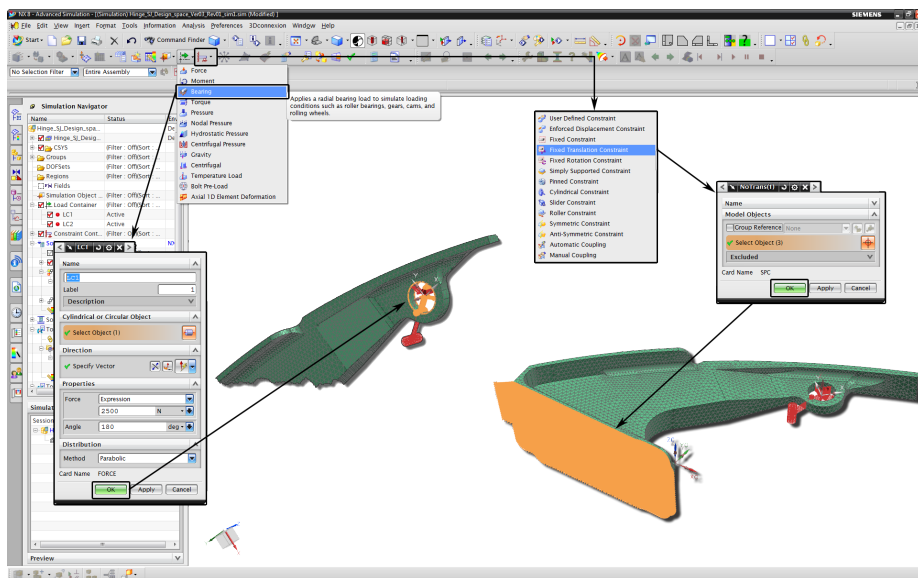

Figure 3.4: Door Connection Joint; NX environment for defining loads and constraints

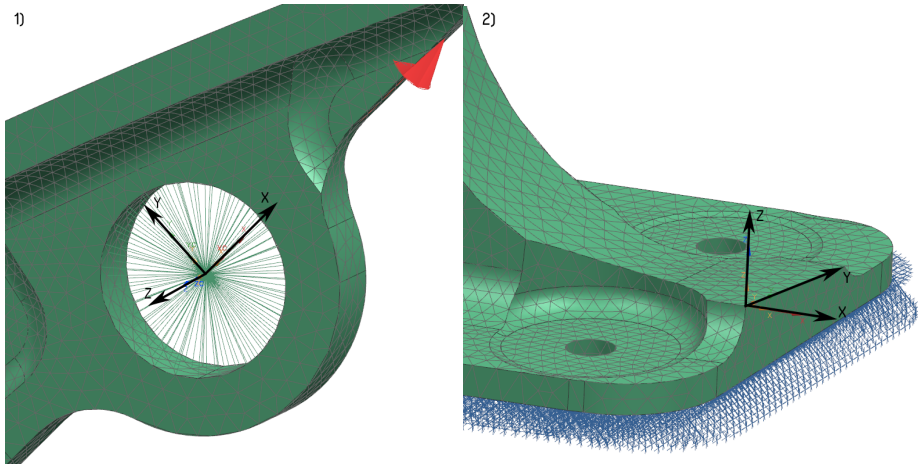

Figure 3.5: Door Connection Joint; Placement of local CSYS for easier definition of 1) LC1 and 2) LC2

Tools The simulation preparations have been performed with UGS NX8.0.2.2. The simulations are performed in NX Nastran 8.5, using the SESTATIC101 linear elastic analysis module.

Design drivers The main design driver is the deformation in the load directions due to elastic strains and volume.

Materials Material properties used in the simulations are specified by HAI and have properties as shown in table 3.1. Properties in bold are necessary for performing simulations.

Remarks and sources of error Sources of error in the calculations are the following:

- The constraint of the Door Connection Joint depends on its interaction with the baggage door. Because of company protocols, HAI could not supply accurate data for the application beyond what is given in the SuPLight documentation. The anticipated constraints are therefore simplified to a case without the need for contact analysis and complicated load patterns.

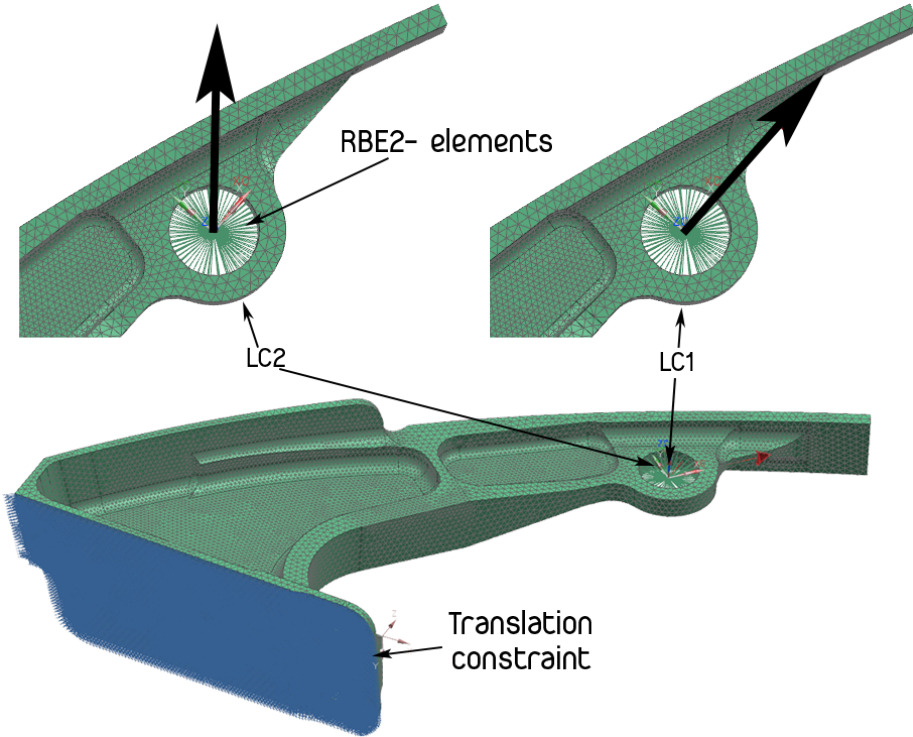

Figure 3.6: Door Connection Joint; Applied boundary conditions and loads

Table 3.1: Material properties; Aluminium 7075 T7351

Aluminium 7075 T7351		
Mass Density	2810	kg/m^3
Mechanical		
Young's Modulus	72000	MPa
Poisson's Ratio	0.33	-
Shear Modulus	26900	MPa
Strength		
Yield Strength	435	MPa
Ultimate Tensile Strength	505	MPa

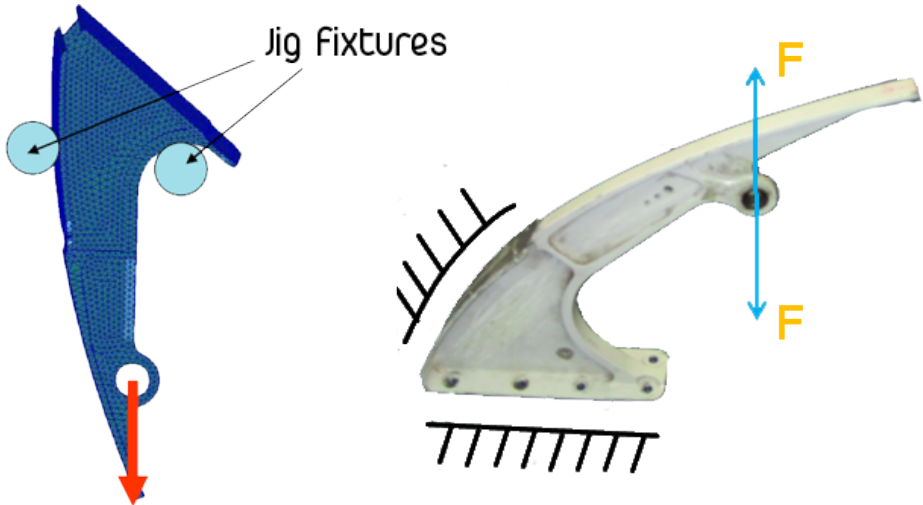

Figure 3.7: Door Connection Joint; SuPLight ambiguous specifications of load directions and constraints

Specifying two load directions follows from the definition of simulation and physical test procedures in the SuPLight documentation, as shown in figure 3.7.

- The Door Connection Joint is connected to the airplane fuselage using 5 rivets, while in the simulations, the entire contact area between the joint and the body has been constrained from translation.

3.2.1.2 Front Lower Control Arm

The global CSYS is defined so that the positive X-axis is parallel, but opposite to the driving direction of the car, while the positive Z-axis is defined normal to the mid-surface of the control arm. The CSYS can be seen in figure 3.8. The FLCA is connected to the front sub-frame of the car with two bushings and one ball bearing, respectively a pinned bushing at the front and a hydro-bushing at the rear.

As specified in the paragraph containing mechanical properties in the SuPLight performance objective list shown in figure 3.10, the following parameters are relevant for WP3 and have been calculated:

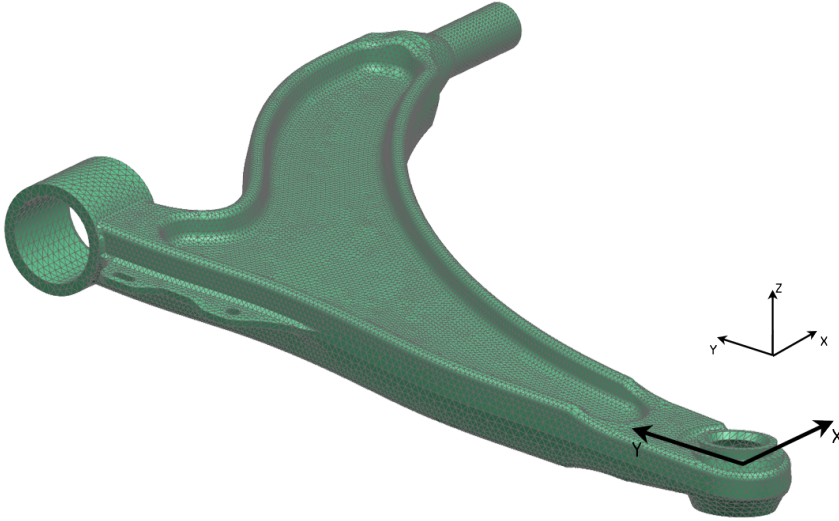

Figure 3.8: FLCA; Definition of global CSYS on design space

- Deformation at $F = 7\text{ kN}$ in both X-and Y-direction (Ref. the global CSYS). Value obtained as the maximum expected value experienced during cyclic load $F = 0.5 \pm 6.5\text{ kN}$.
- Volume (proportional with weight, assuming an isotropic material)
- Buckling load for the first buckling mode, calculated in the positive X-direction.
- Stress level at $F_x = 7\text{ kN}$, giving a rough estimate of the maximum admissible stress level in the construction to maintain a fatigue life of 10^6 cycles.

The two first parameters are used to control the analysis, while the two last are checked for the reengineered part.

Additionally, manufacturing constraints must be specified. The control arm is produced by forging a cylindrical billet before removing the flash and machining functional surfaces. This requires that the design of the component must have the following properties:

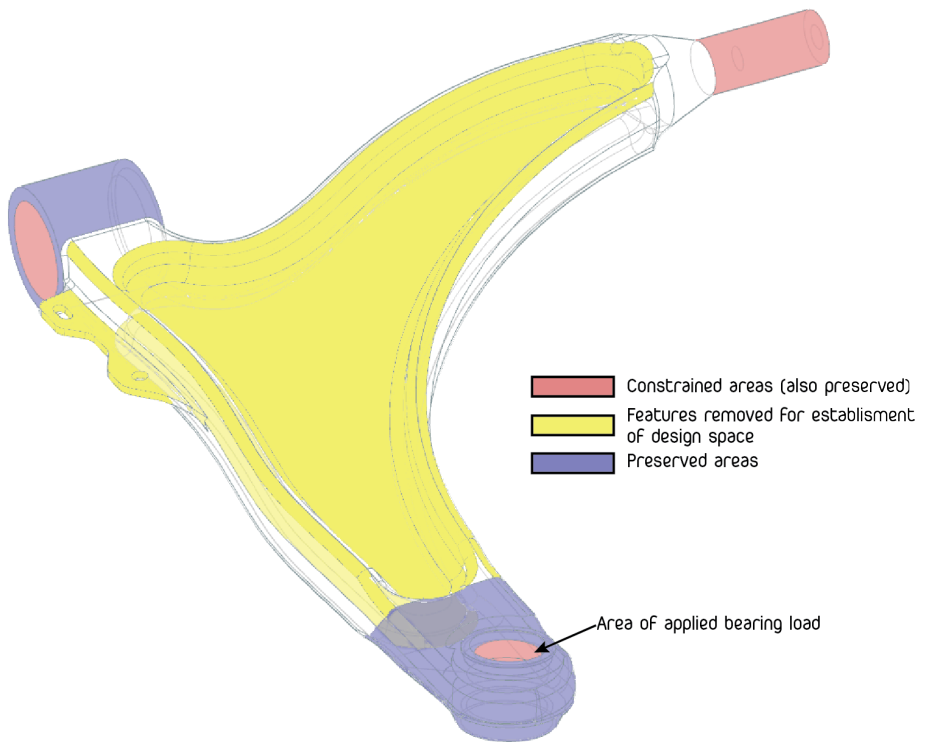

Figure 3.9: FLCA; Area specifications

Performance objectives

Material properties must be as minimum as existing product

- Yield Strength, $R_p0.2$
- Tensile Strength, $R_m0.2$
- Elongation, A_5
- Hardness, $HV10$
- Fatigue, R (10^6) cycles
- Corrosion resistance

Material structure must be as minimum as existing product

- Grain size
- Particle size

Mechanical properties

- Stiffness in both x- and y- direction shall be the same as current design
- Buckling load in x- direction shall be at the same level as current design
- The predicted life- time for a constant amplitude loading $F_x = 0.5 \pm 6.5 \text{ kN}$ shall be the same as current design
- Light weight (reduction of 10% from)

Figure 3.10: FLCA; Performance objectives

- No inner voids or complex geometries that make forging impossible.
- Symmetric geometry mirrored about the X-Y-plane.

Raufoss Neumann, a subdivision of RT, additionally specified a maximum stress level of 200 MPa for $N_f = 200 \cdot 10^3$ cycles ($R = -1$). Fatigue assessments are not included in the analysis because the refinement of the structure with regard to stresses is due at a later stage of the product development process. The value will, however, give a rough estimate for whether the proposed solution is feasible for handling the required 10^6 cycles specified.

Specifications, standards and methods The baseline for the FLCA is calculated using general engineering standards. All units are SI units, or a combination of such.

Meshing The FLCA was free meshed with 2 mm CTETRA10 elements, as well as applying RBE2-elements inside the ball bearing housing to imitate the assembly of the system. Mesh can be seen in figure 3.11.

Loads and constraints In order to specify simulation constraints, an additional local cylindrical CSYS was automatically placed at the front bushing when defining constraints. The cylindrical CSYS is defined by the orientation of the cylinder axis of the front bushing. Both the front and rear bushings restrict the FLCA from moving in the global X-axis, as well as in the radial direction, but maintain a free rotation about the X-axis. Constraining the ball bearing inner surface against movement in the global Z-direction imitates the McPherson spring and shock assembly at steady-state condition.

In order to calculate the stiffness in X-and Y-direction, sub-cases were defined with distributed bearing loads of 7 kN to the ball bearing in the respective directions. Results were read out in the specific load direction by assigning results to the work coordinate system of interest. For the buckling analysis, the force in X-direction was maintained, but its magnitude was changed to unit value (1 N). See figure 3.12 and 3.13 for illustrations of loads and constraints.

Tools Simulation preparations are performed with UGS NX8.0.2.2. The simulations are performed in NX Nastran 8.0, using the SESTATIC101 linear elastic and SEBUCKL105 buckling analysis solvers.

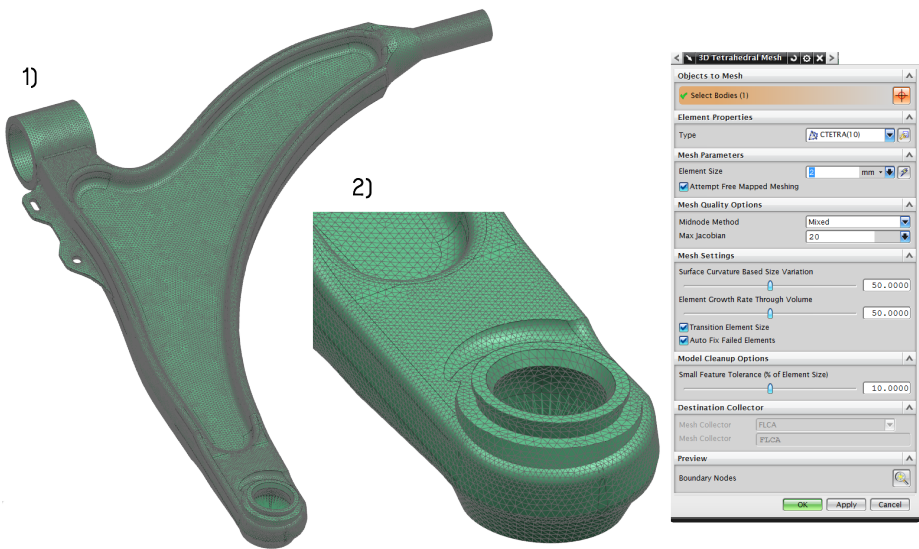

Figure 3.11: FLCA; Free mesh using 2 mm CTETRA10 elements 1) Overall meshed model and 2) Closeup picture of mesh

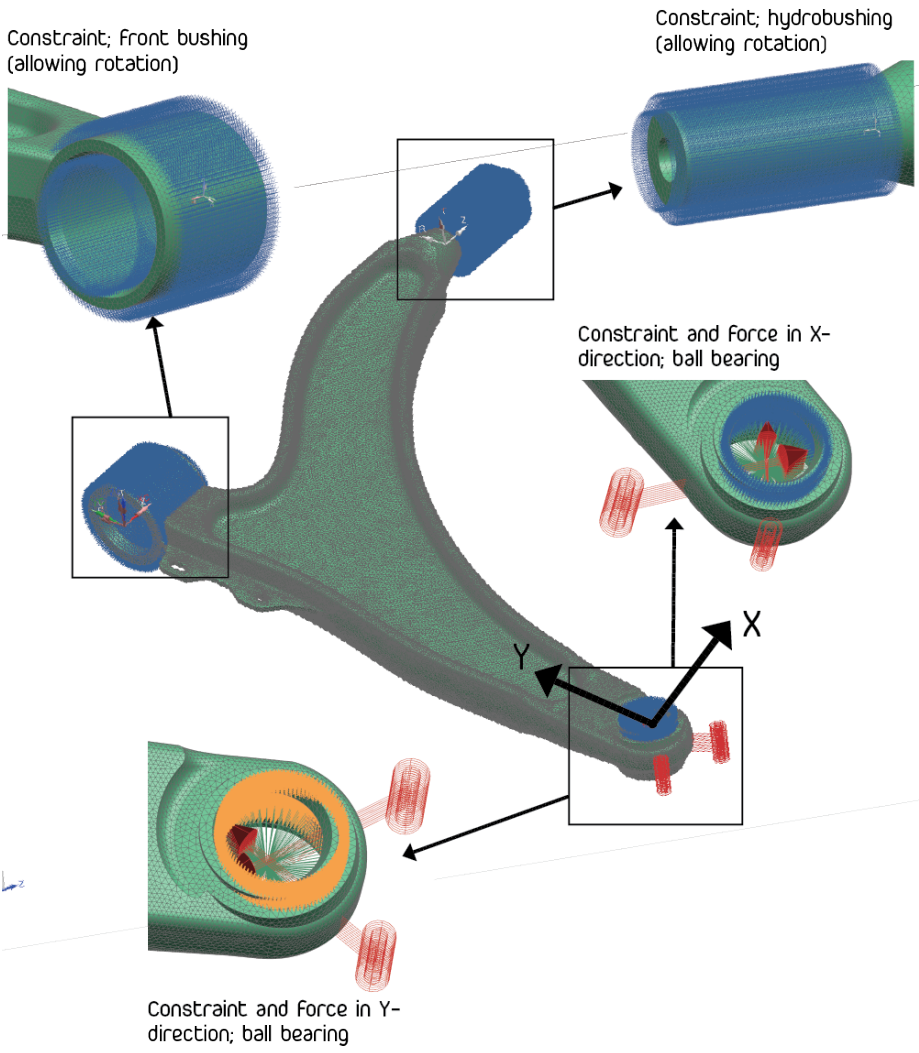

Figure 3.13: FLCA; Loads and constraints for stiffness simulations

Table 3.2: Material properties; Aluminium 6082 T6

Aluminium 6082 T6		
Mass Density	2700	kg/m^3
Mechanical		
Young's Modulus	70000	MPa
Poisson's Ratio	0.33	-
Shear Modulus	26315	MPa
Strength		
Yield Strength	320	MPa
Ultimate Tensile Strength	350	MPa

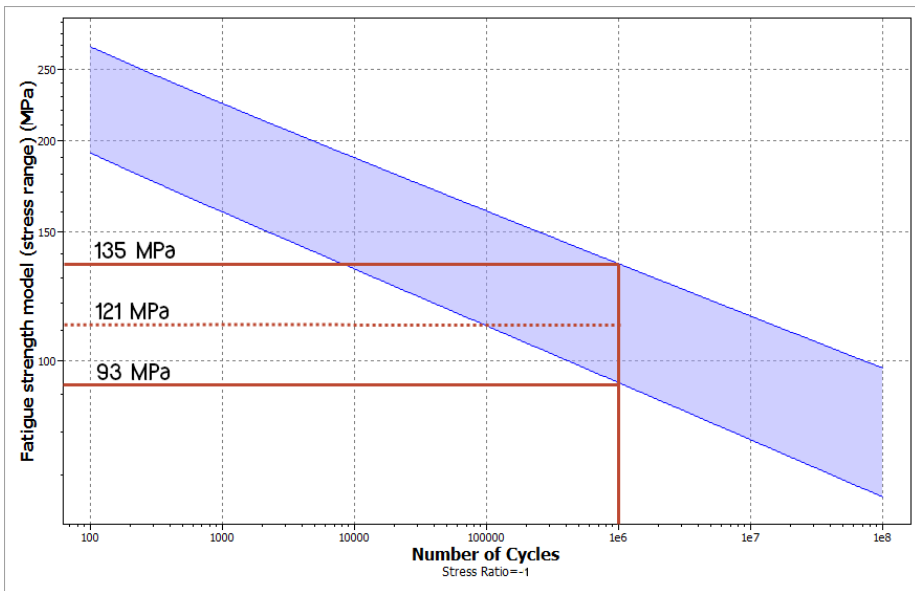

Figure 3.14: Fatigue properties, 6062 T6; 121 MPa at $R = -1$ and 10^6 cycles (50% p.f) (courtesy of EduPack 2012)

displacement error is expected to be low, as the curvature of the ball bearing surface is large compared to the uncertainty of selecting the correct node.

- Stress concentrations are substantial, because bushings are modeled with infinite stiffness. This is not considered a problem, as further analysis will not be influenced by the max stress level, rather stresses at larger areas of interest.

3.2.2 Baseline results

3.2.2.1 Door Connection Joint

Displacement The reference point for displacement was set at the very tip of the joint. The point was chosen because it would not be affected during topology optimization, as well as being well defined. Displacements are found to be 0.077 mm in LC1 direction and 0.644 mm in LC2 direction, as can be seen in figure 3.15 and 3.16.

Parameterized_Hinge_sim1 : Solution 1 Result
Subcase - Static Loads 1, Static Step 1
Displacement - Nodal, X
Min : -0.0001, Max : 0.1007, Units = mm
Coord sys : Work Rectangular
Deformation : Displacement - Nodal Magnitude

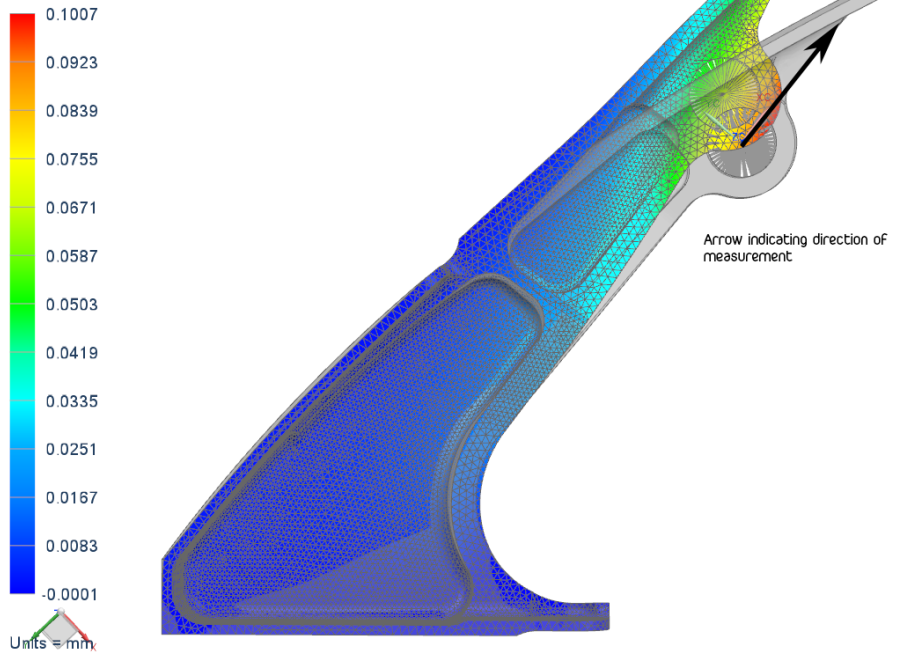

Figure 3.15: Door Connection Joint; Displacement in LC1 direction

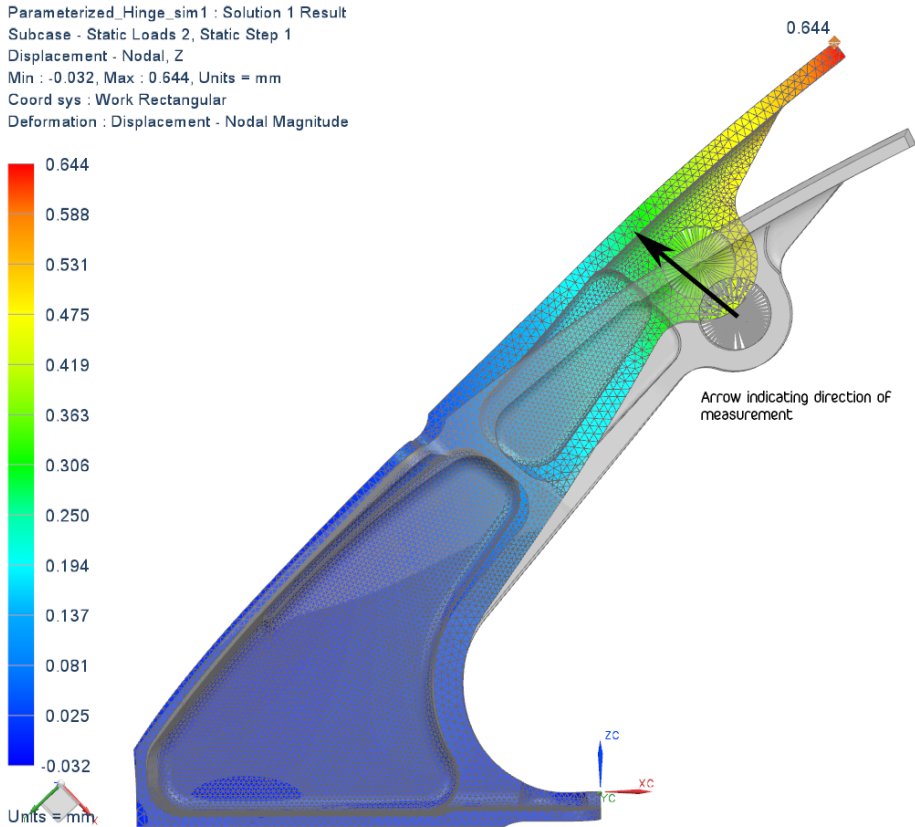

Figure 3.16: Door Connection Joint; Displacement in LC2 direction

Volume The volume of the Door Connection Joint was found to be 72301.5 mm^3 , using the Analysis > Measure Bodies-command in NX. For simplicity of comparison, rivet holes were removed prior to the volume analysis.

Results summary The values in table 3.3 are product demand specifications for the new Door Connection Joint geometry found through topology optimization. In particular, the volume is required to be within 90% of the initial volume, hence $V_{desired} = 65071.4 \text{ mm}^3$. The displacement values in the table are measured in the load directions at the specified reference node.

Table 3.3: Door Connection Joint; Results from baseline simulation

Parameter	Comments	Value	Unit	
Displacement	LC1 [$F = 2.5 \text{ kN}$]	Force direction	0.077	mm
		Magnitude	0.272	mm
	LC2 [$F = 2.5 \text{ kN}$]	Force direction	0.644	mm
		Magnitude	0.829	mm
Volume	Design space	72301.5	mm ³	

3.2.2.2 Front Lower Control Arm

Displacement Results from the static analysis can be seen in figure 3.18 and 3.20. Results show that the displacements are 1.418 mm and 0.044 mm in the X- and Y-direction, respectively. The reference point for measurements is located at the ball bearing surface as shown in figure 3.18 and 3.20.

FLCA_ALL_Baseline_Ver01_Rev01_sim1 : Stiffness_sim Result
Stiffness_x_direction, Static Step 1
Displacement - Nodal, X
Min : -0.023, Max : 1.486, Units = mm
Coord sys : Work Rectangular
Deformation : Displacement - Nodal Magnitude

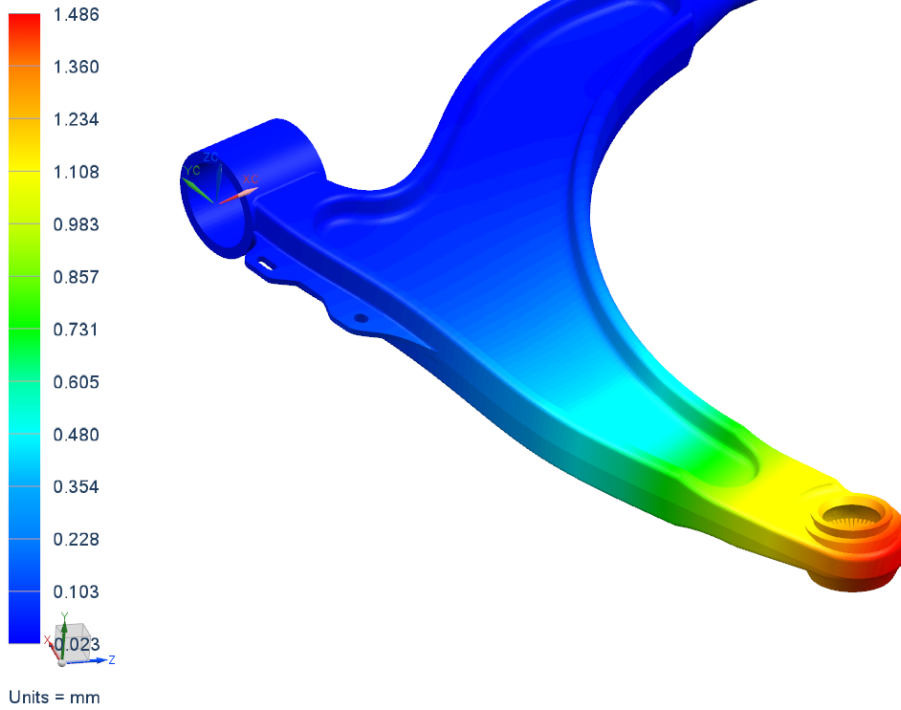

Figure 3.17: FLCA; Displacement w/7kN load in X-direction

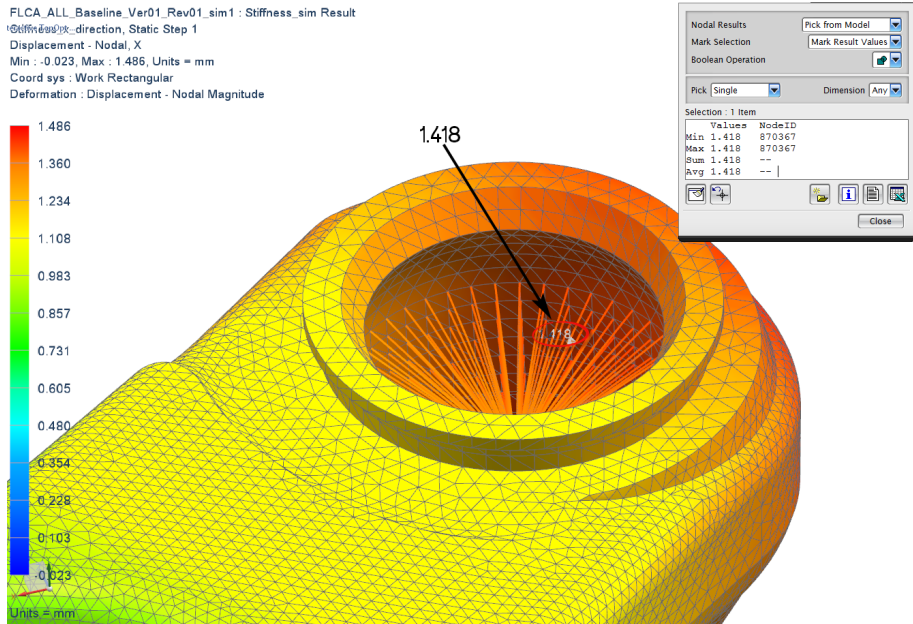

Figure 3.18: FLCA; Displacement w/7 kN load in X-direction at reference node

FLCA_ALL_Baseline_Ver01_Rev01_sim1 : Stiffness_sim Result
Stiffness_y_direction, Static Step 1
Displacement - Nodal, Y
Min : -0.0027, Max : 0.0532, Units = mm
Coord sys : Work Rectangular
Deformation : Displacement - Nodal Magnitude

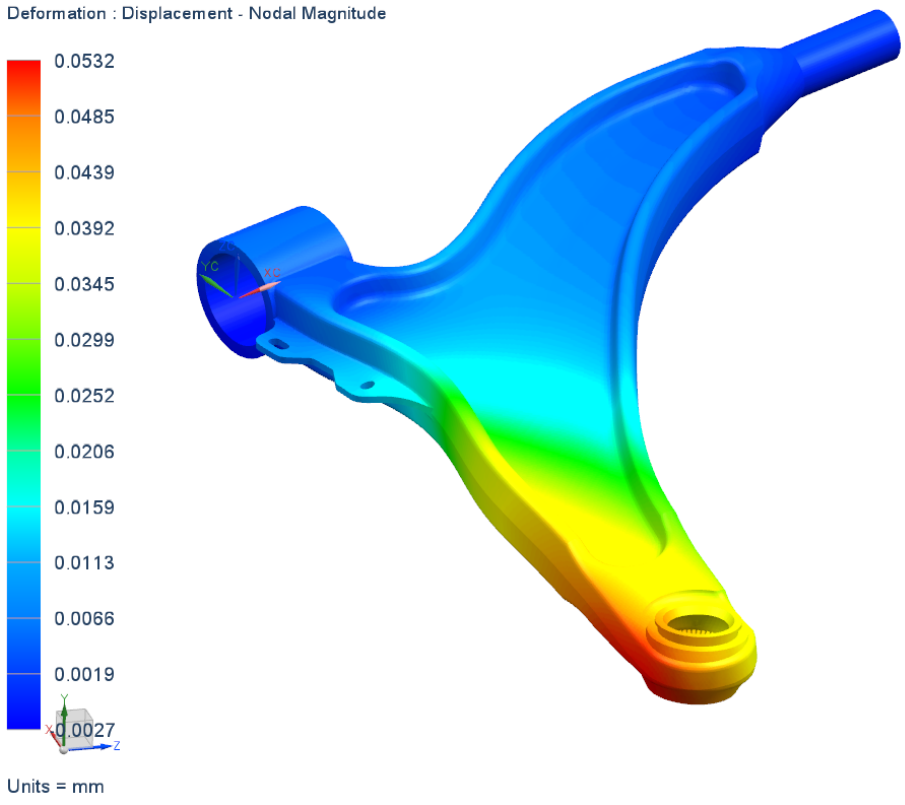

Figure 3.19: FLCA; Displacement w/7 kN load 1) Y-direction

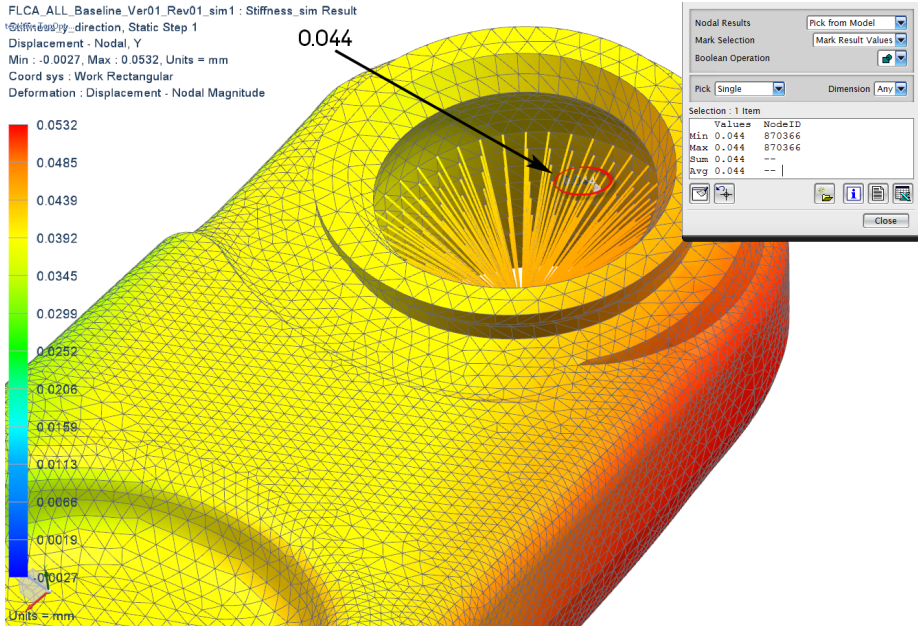

Figure 3.20: FLCA; Displacement w/7 kN load in Y-direction at reference node

Buckling Analysis results provide buckling values for the ten modes. The first mode represents the lowest eigenvalue associated with buckling. The buckling factor for the first mode is $9.5398 \cdot 10^4$, corresponding to a failure load of 95380 N. The first buckling mode can be seen in figure 3.21.

Volume Using Analysis > Measure bodies > Volume resulted in a volume measurement of 534687.7 mm^3 . Cabel fastening plate as shown in figure 3.22 was removed prior to the analysis to simplify comparison against simulation results.

Results summary Simulation results are summarized in table 3.4. These values will work as product demand specifications for the control arm with a geometry found through topology optimization, except the volume, which is required to be within 90% of the initial volume, hence $V_{desired} = 481218.9 \text{ mm}^3$. Displacements are measured at the specified reference node.

FLCA_ALL_Baseline_Ver01_Rev01_sim1 : Buckling_sim Result
Subcase - Buckling Method, Mode 1, Eigenvalue = 9.538e+004
Displacement - Nodal, Magnitude
Min : 0.000, Max : 1.016, Units = mm
Coord sys : Work Rectangular
Deformation : Displacement - Nodal Magnitude

Eigenvalue = 9.538e+004

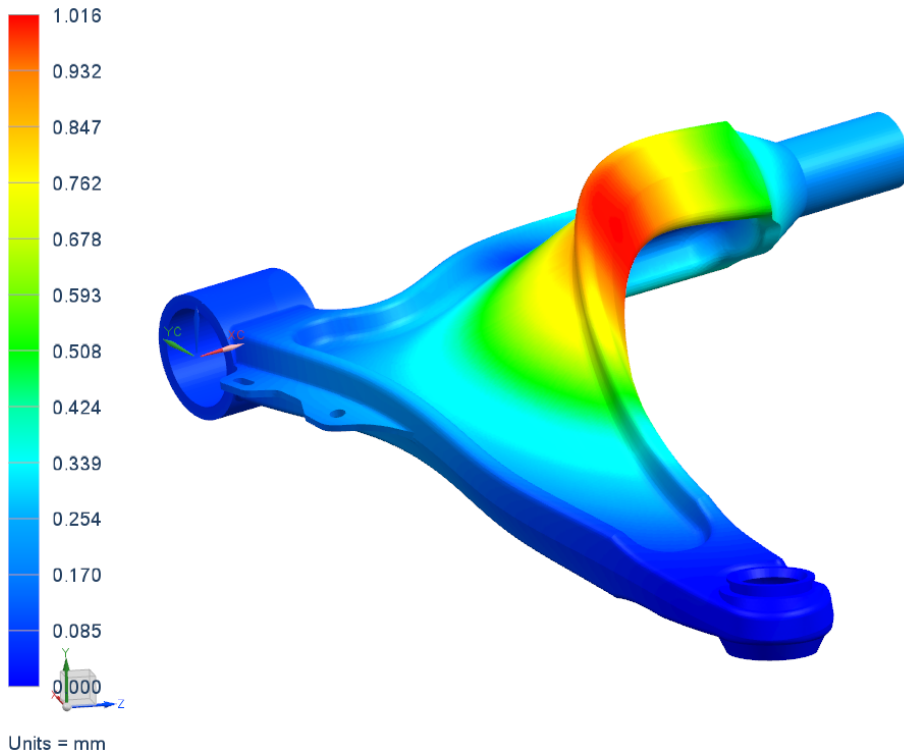

Figure 3.21: FLCA; Buckling factor for the first buckling mode

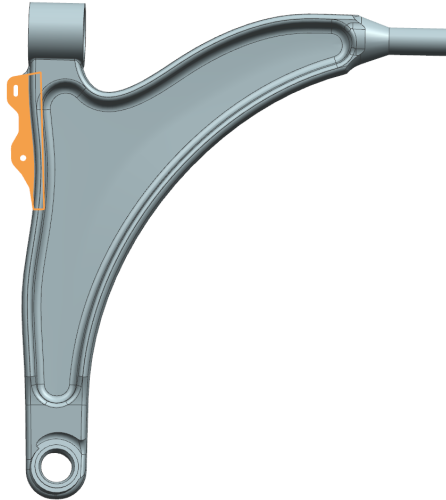

Figure 3.22: FLCA; Cable fastener removed prior to volume analysis

Table 3.4: FLCA; Results from baseline simulation

Parameter	Comments		Value	Unit
Displacement	X-direction	Force direction	1.418	<i>mm</i>
	Y-direction	Force direction	0.044	<i>mm</i>
Buckling load	X-direction	-	95380	<i>N</i>
Volume	-		534687.7	<i>mm</i> ³

3.3 Model preparation, meshing and setup of static analysis

3.3.1 Generating the design space

3.3.1.1 Door Connection Joint

The design space was generated by filling all cavities with material, while retaining the outer shape and characteristics of the part, as specified by HAI in figure 3.23. Special care was taken not to change or add geometry in the surrounding area of the bearing hole. Most of the work was done using NX Synchronous

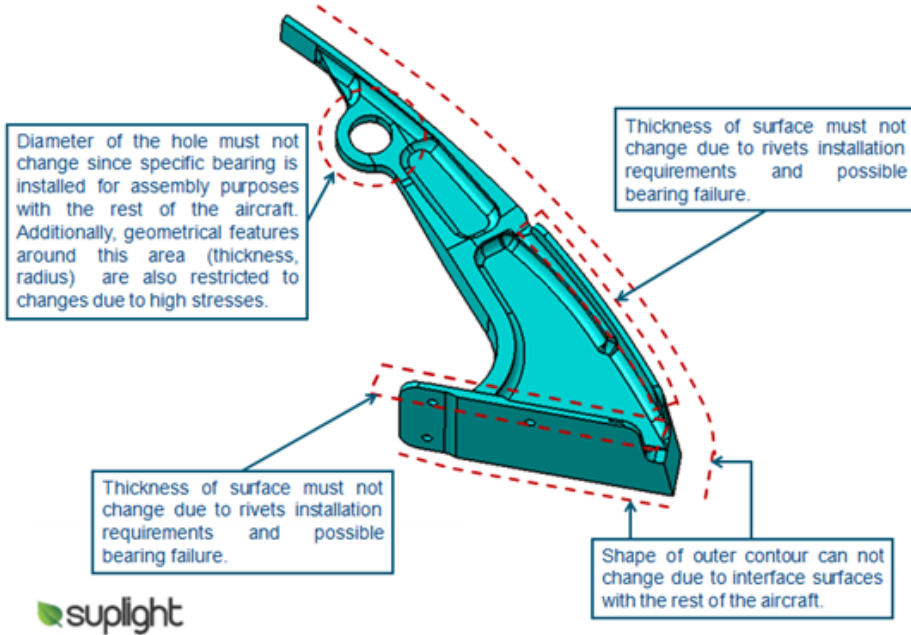

Figure 3.23: Specification of functional surfaces on Door Connection Joint (courtesy of [9])

modeling capabilities such as Delete face and Replace face. The design space can be seen in figure 3.24 and in appendix A.

The design space has a volume of 122968.07 mm^3 , equivalent to 1.70 times the original volume, hereby referred to as the reference volume. In order to save 10% weight, the resulting volume after the optimization must be within 52.92% of the reference volume. This value is used to normalize results when graphing results.

3.3.1.2 FLCA

The FLCA design space was generated by filling all cavities with material, while retaining the shape of the outer surfaces to maintain functionality within the

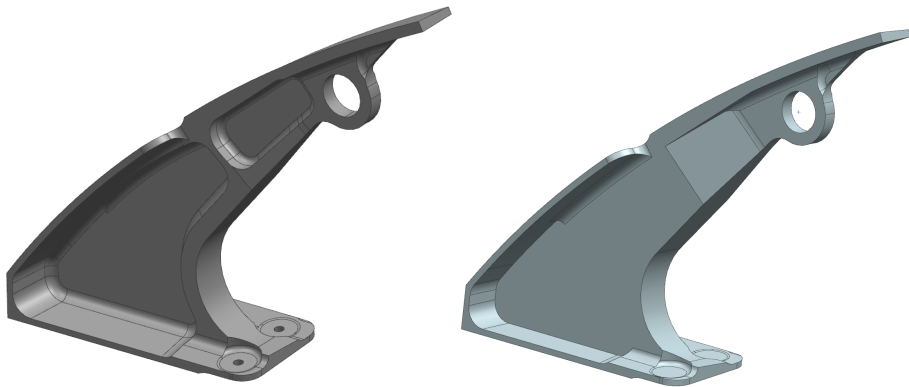

Figure 3.24: Door Connection Joint; 1) Original part and 2) Design space

suspension. Regions that are significant to the assembly of the control arm, such as the front bearing, hydro-bushing support and ball bearing are maintained at their original shape. These areas are frozen and not taken as a part of the permissible design space during the optimization process. The design space can be seen in figure 3.25.

The design space has a volume of 1099702 mm^3 , equivalent to 2.06 times the original volume, hereby referred to as the reference volume. In order to save 10% weight, the resulting volume after the optimization must be within 43.76% of the reference volume. This value is used to normalize the results when graphing results.

3.3.2 Meshing

Because of the irregular geometry of both test cases, free meshing was performed, using general purpose Abaqus C3D10 elements, as illustrated in figure 3.26. Be aware that simulation times stated below are highly dependent on factors such as the necessary number of iterations, algorithm of choice, mesh size, available computational power and total workload on the computer.

3.3.2.1 Door Connection Joint

The Door Connection Joint was free-meshed with full integration, higher order C3D10 tetrahedral elements with an overall mesh size of 2 mm, with mapped

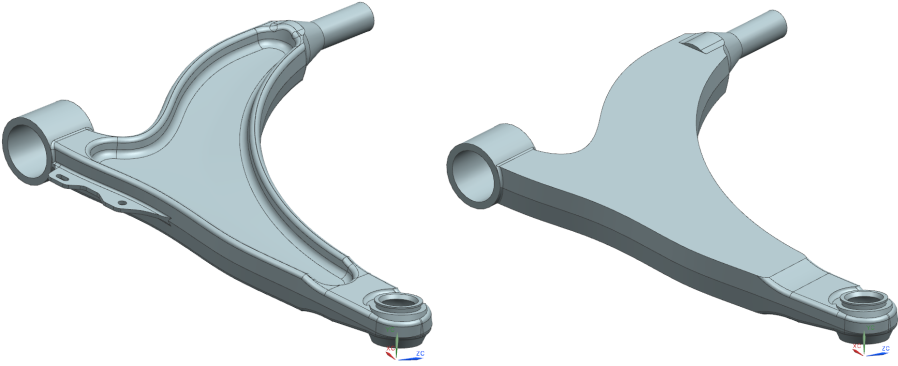

Figure 3.25: FLCA; 1) Original part and 2) Design space

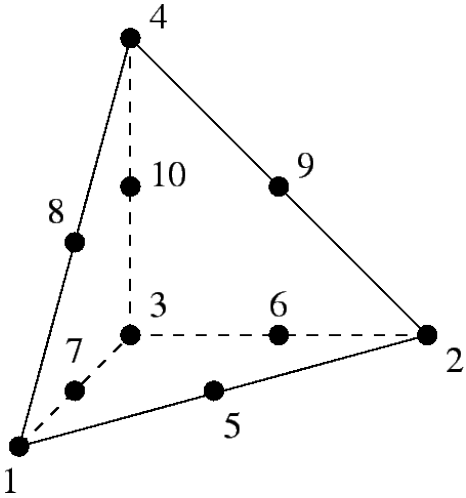

Figure 3.26: Abaqus mesh; C3D10 elements

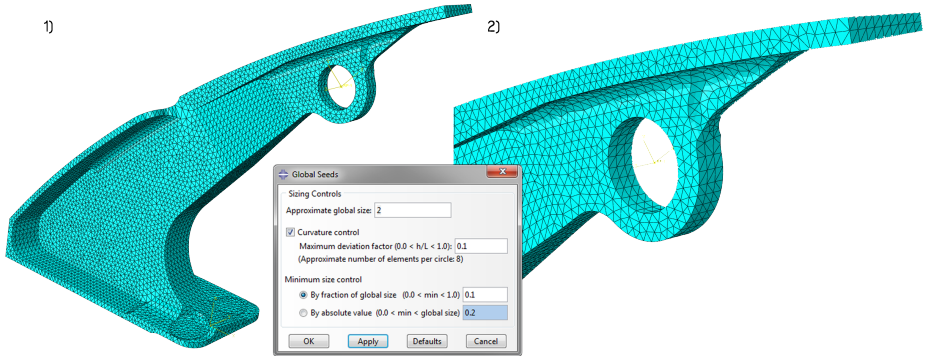

Figure 3.27: Door Connection Joint; 1) Overall meshed model and 2) closeup picture of mesh

meshing allowed where appropriate. The total element count was 115904. This provided adequate resolution to the resulting geometry, as well as keeping simulation time acceptably low at approximately 8 hours per simulation run with approximately 35 iterations per run. Mesh is shown in figure 3.27.

3.3.2.2 FLCA

The FLCA was free-meshed with full integration, higher order C3D10 tetrahedral elements with an overall mesh size of 4 mm, with mapped meshing allowed where appropriate. The total element count was 107778. This provided adequate resolution to the resulting geometry, as well as keeping simulation time acceptably low at approximately 6 hours per simulation run with approximately 45 iterations per run. Mesh is shown in figure 3.28.

3.3.3 Setting up the FE-analysis

Similar loads and BC's to both baseline simulations are applied in the Abaqus environment, however concentrated loads at the center of a kinematic coupling distribute the loads onto the bearing surfaces.

3.3.3.1 Door Connection Joint

The Door Connection Joint no-translation constraint is shown in figure 3.29. Figure 3.30 and 3.31 show the kinematic coupling and concentrated LC1 and

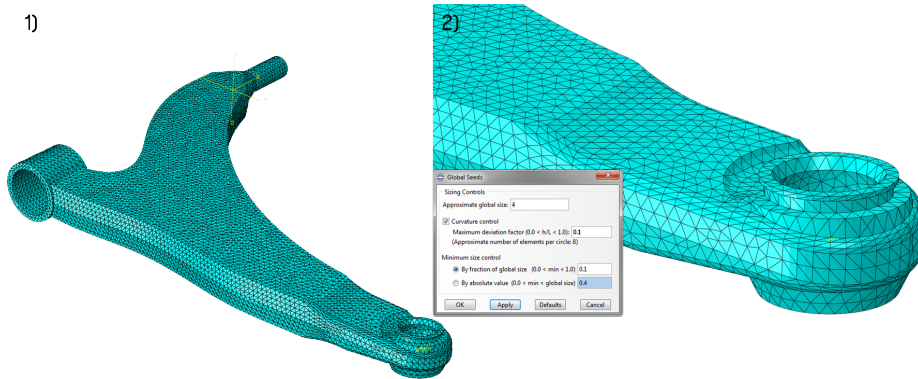

Figure 3.28: FLCA; 1) Overall meshed model and 2) closeup picture of mesh

LC2 loads. Notice that LC2 has a total resultant force of 2.5 kN , applied as decomposed loads in two directions.

3.3.3.2 FLCA

The FLCA cylindrical constraint is shown in figure 3.32, allowing rotation around the coincident cylinder axis of the inner and outer bushing and hydrobushing contact surface but constraining movement in radial and axial direction. Figure 3.33 and 3.34 show the kinematic coupling and concentrated loads in X and Y direction.

3.4 Setup of topology optimization

For bigger images and a step-by-step description on how to setup optimization using Abaqus ATOM, see appendix B. Figure 3.35 shows the workflow for setup of the Abaqus ATOM topology optimization process.

3.4.1 Creating the topology optimization task

The first requirement when setting up a new topology optimization simulation, is to setup the model under analysis with properties, loads, boundary conditions and mesh as you would do with any other FE-simulation. Then go to *Module: Optimization* and navigate through the menus as illustrated in figure 3.36. Be

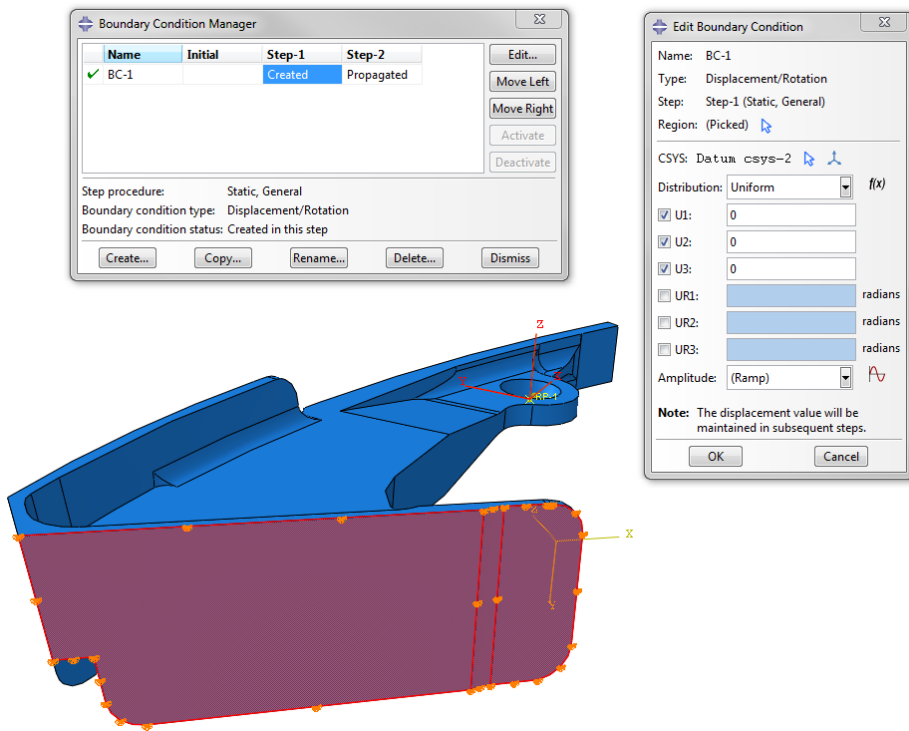

Figure 3.29: Door Connection Joint; Translation constraint in Abaqus

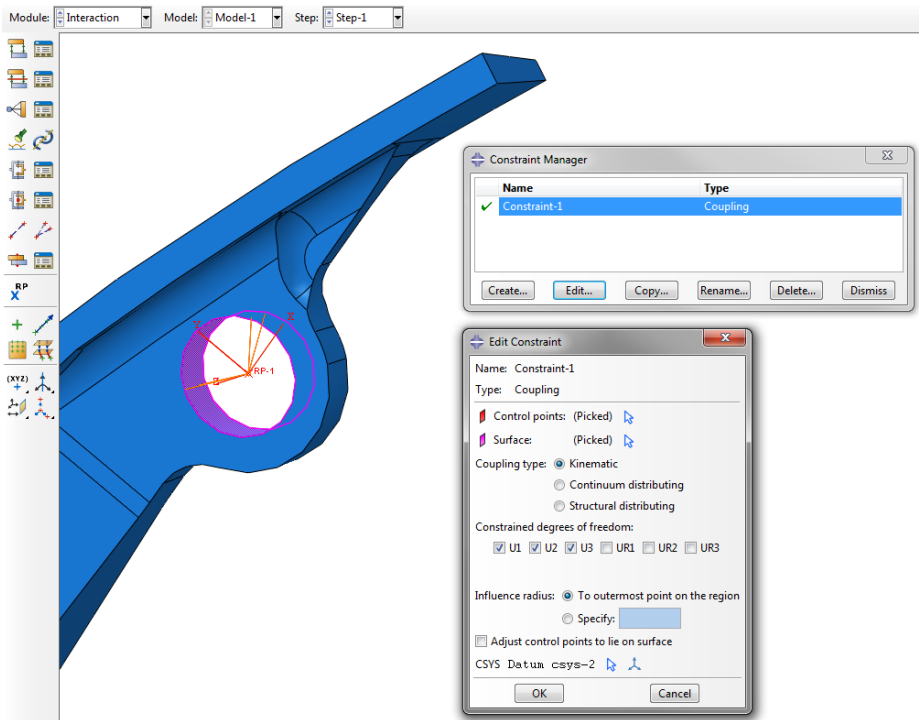

Figure 3.30: Door Connection Joint; Kinematic coupling definition in Abaqus

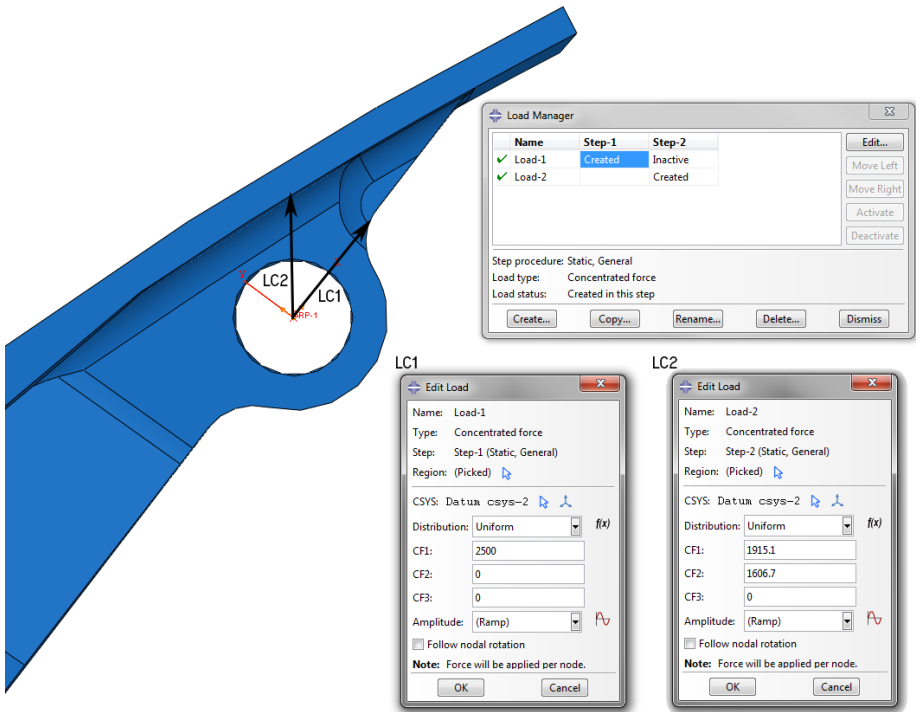

Figure 3.31: Door Connection Joint; Applied concentrated loads in Abaqus

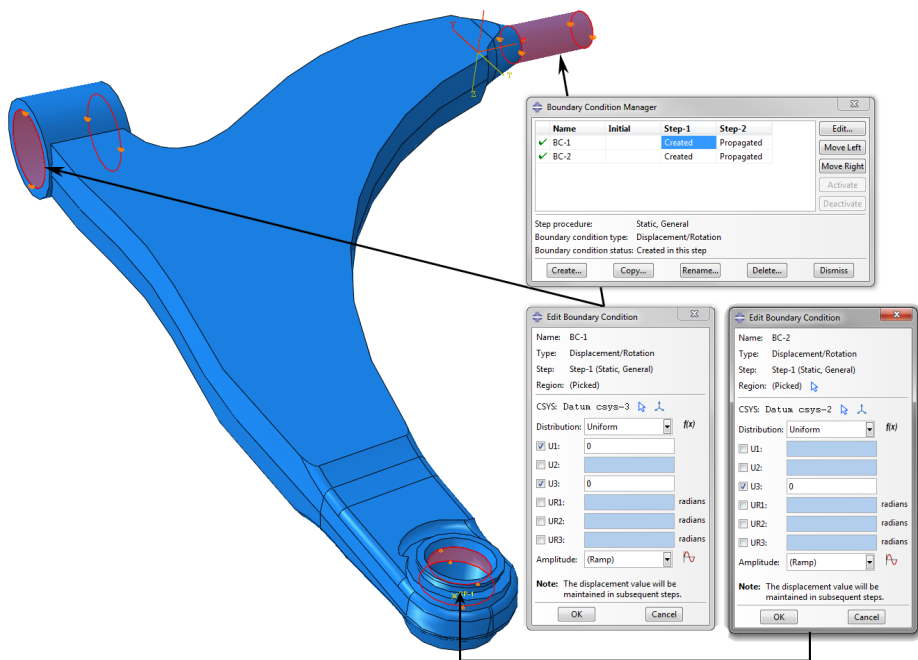

Figure 3.32: FLCA; Constraints in Abaqus

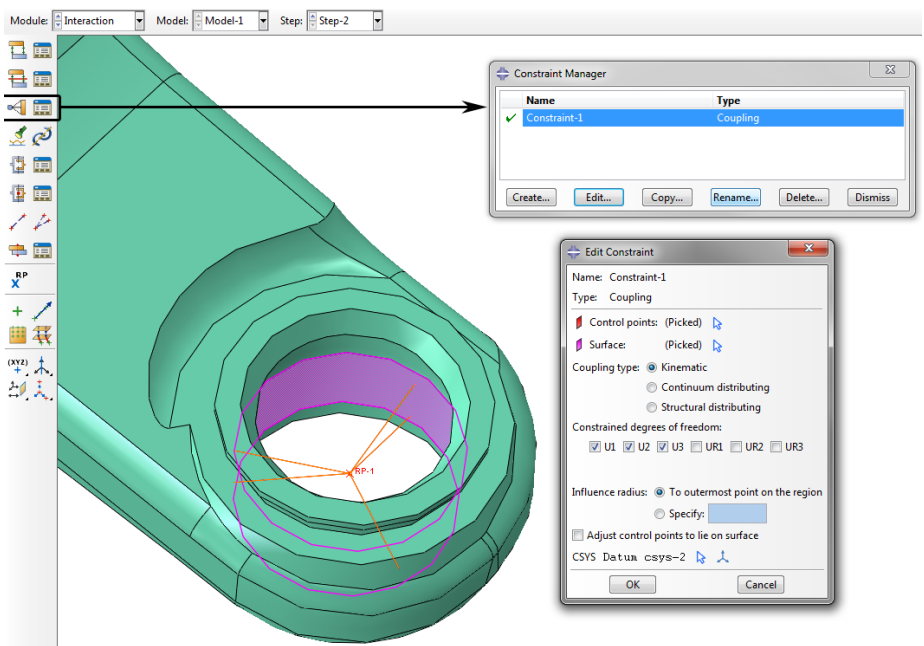

Figure 3.33: FLCA; Kinematic coupling definition in Abaqus

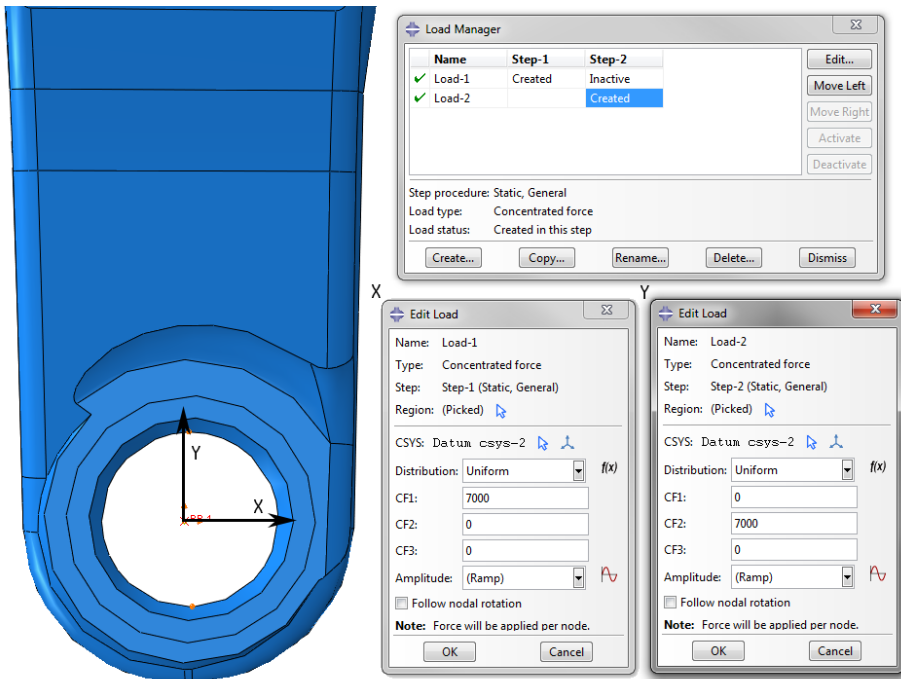

Figure 3.34: FLCA; Applied concentrated loads in Abaqus

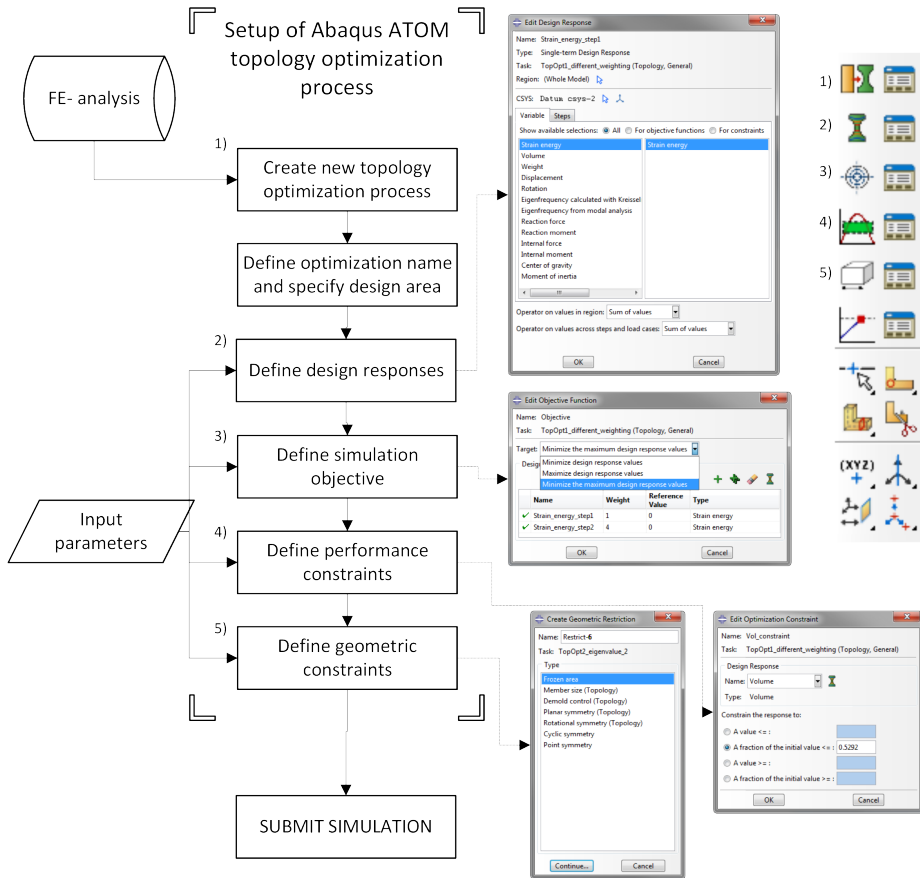

Figure 3.35: Setup of Abaqus ATOM topology optimization workflow

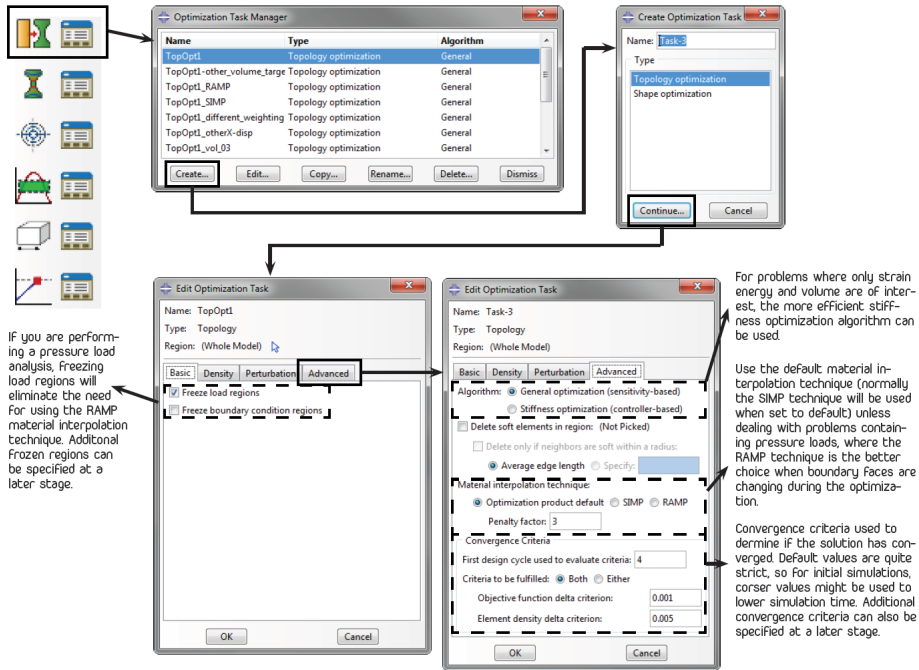

Figure 3.36: Abaqus; Creating the topology optimization task

aware that most simulation control settings may be edited at any time during the setup, though the main algorithm can only be selected when defining new tasks, as this choice affects possible options on design responses, objectives and constraints. The SIMP-based *General optimization* is recommended, but if only strain energy and volume design responses are of interest, the faster *Stiffness optimization* may be chosen. The default material interpolation technique will adapt to the problem under analysis, and should not be changed. The same is valid for the penalty factor, as a lowered penalty factor might lead to solutions without a clear 0-1 geometry, while increasing the value might give invalid solutions (local minima) because of high sensitivity to intermediate densities.

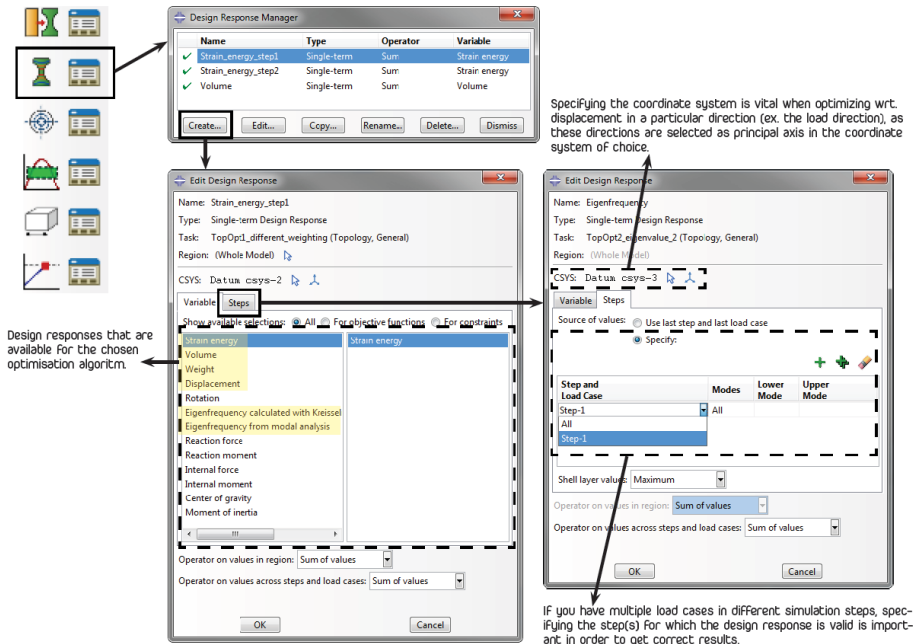

Figure 3.37: Abaqus; Defining design responses

3.4.2 Defining design responses

For further explanation on how to define design responses in Abaqus ATOM, see figure 3.37.

3.4.2.1 Door Connection Joint

The following design responses were defined for the Door Connection Joint:

- Volume for the entire design space
- Displacement in LC1-and LC2-direction measured at the reference node, specified at two different time-steps.

3.4.2.2 FLCA

The following design responses were defined for the FLCA:

- Volume for the entire design space
- Displacement in X-and Y-direction measured at the reference node, specified at two different time-steps.

3.4.3 Defining the objective and constraints

In order to reach a valid solution, best practice is to specify multiple design responses for particular areas in the model. When choosing a smaller area to control, the solution accuracy will improve. For example, it is better to specify a threshold value for rotation of a smaller area, as well as setting a maximum displacement limit on specified nodes and use the MinMax-formulation to reduce the displacement in the most highly loaded step for each consecutive design cycle.

In general, three different approaches are recommended for optimizing a structure using Abaqus ATOM:

1. Minimize (or minimize the maximum) strain energy, constrained with an upper limit on the relative volume fraction.
2. Minimize the volume, constrained with an upper limit on displacement, moment of inertia, reaction forces, CoG or rotation (or a combination of these).
3. Maximize eigenfrequencies, constrained with a **lower** limit for volume or/and limits for other design responses that are independent of loads (as eigenvalue analysis are performed without external forces applied).

Variations of the above mentioned approaches are also possible, but less used.

Figure 3.38 and 3.39 describes the basic procedure in Abaqus for defining the objective function and constraints. As previously mentioned, Abaqus is capable of handling a weighted sum of objectives. E.g. if you wish to minimize the maximum strain energy, you can define one or more load cases to be of higher priority than the other(s).

As a rule of thumb, a general analysis should be performed before geometric constraints are introduced, as they will increase computational time as well as limit the available design space, giving a less optimal solution. Demold control is probably one of the most important geometric constraints, as it ensures that production methods like casting, stamping, forging and machining can be used. If the design space loads and BC's introduce some kind of torsion or angular momentum in the part, internal voids and holes will be present, as material is

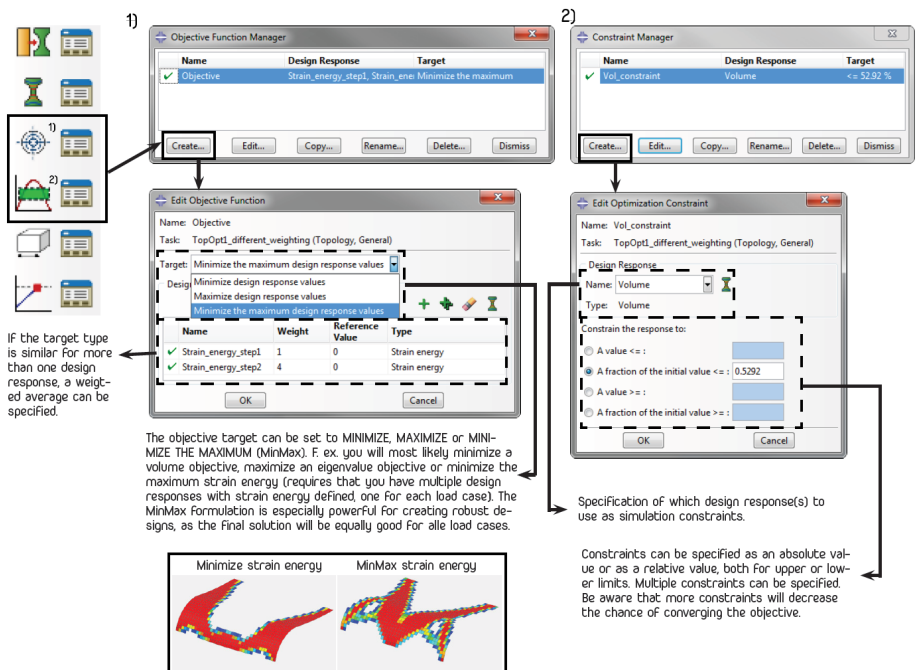

Figure 3.38: Abaqus; Defining the objective and performance constraints

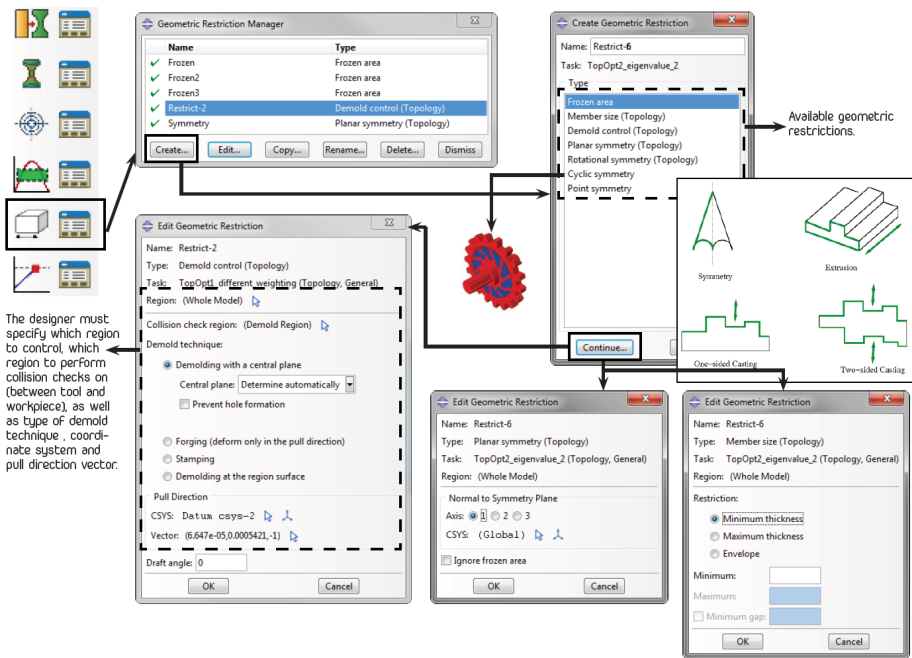

Figure 3.39: Abaqus; Defining the geometric constraints

preferred at the outer premises of the design space, due to an increase in the second moment of inertia. Symmetry constraints can be specified as planar, rotational, cyclic or for a point. Using the symmetry constraint, solutions will look more aesthetic, and they will be easier to produce. Frozen faces or regions will not be affected, and will remain the same after the analysis has ended. This is particularly useful to maintain areas of geometric significance, as the algorithm is forced to shave off weight from other areas of the design space. Specifying a lower or upper limit for the member size will restrict the results from having too thin or thick members that cannot be produced.

3.4.3.1 Door Connection Joint

Simulation constraints scalar values are obtained from the baseline simulation results in section 3.2.2.

	Design response	Value	Unit
Objective	Minimize volume	N/A	mm^3
Performance constraints	Displacement LC1 direction	≤ 0.077	mm
	Displacement LC2 direction	≤ 0.644	mm
Geometric constraints	Frozen areas (fig. 3.40), planar symmetry and manufacturing	N/A	-

An alternative objective and performance constraint definition for the Door Connection Joint is presented beneath, and discussed further in section 3.5.3.

	Design response	Value	Unit
Objective	MinMax strain energy from LC1 and LC2 load	N/A	J
Performance constraints	Volume fraction	≤ 0.5292	-
Geometric constraints	Frozen areas (fig. 3.40), planar symmetry and manufacturing	N/A	-

Geometric constraints are shown in figure 3.40, and symmetry plane is shown in figure 3.41. Symmetry and manufacturing constraints are applied for the entire design space, but are not enforced in frozen areas. Frozen areas for the Door Connection Joint are applied to the surface of the geometry.

3.4.3.2 FLCA

Simulation constraints are obtained from the baseline simulation results in section 3.2.2.

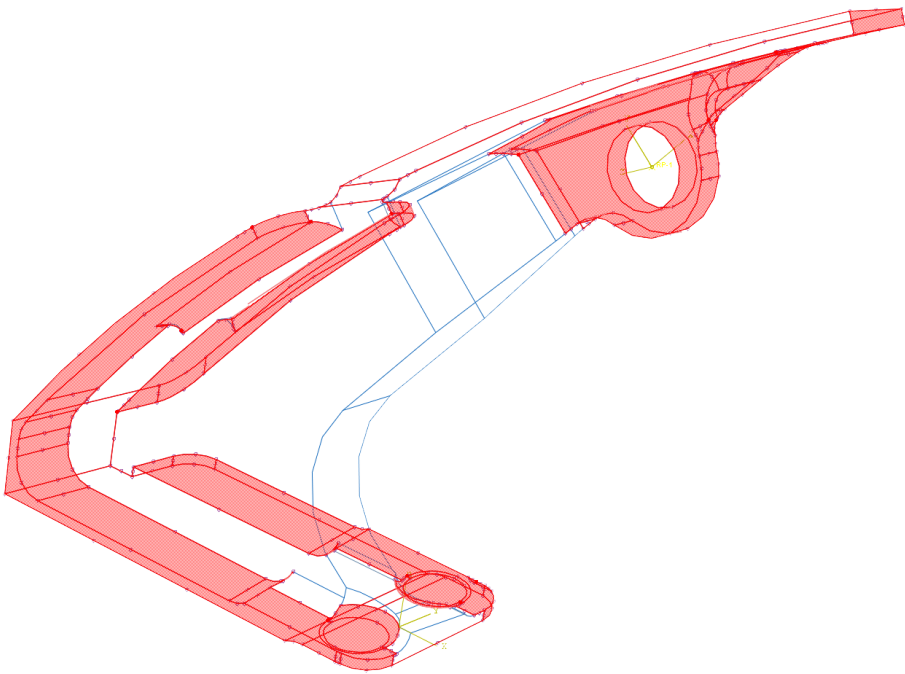

Figure 3.40: Door Connection Joint; Frozen areas geometric constraints



Figure 3.41: Door Connection Joint; Symmetry plane

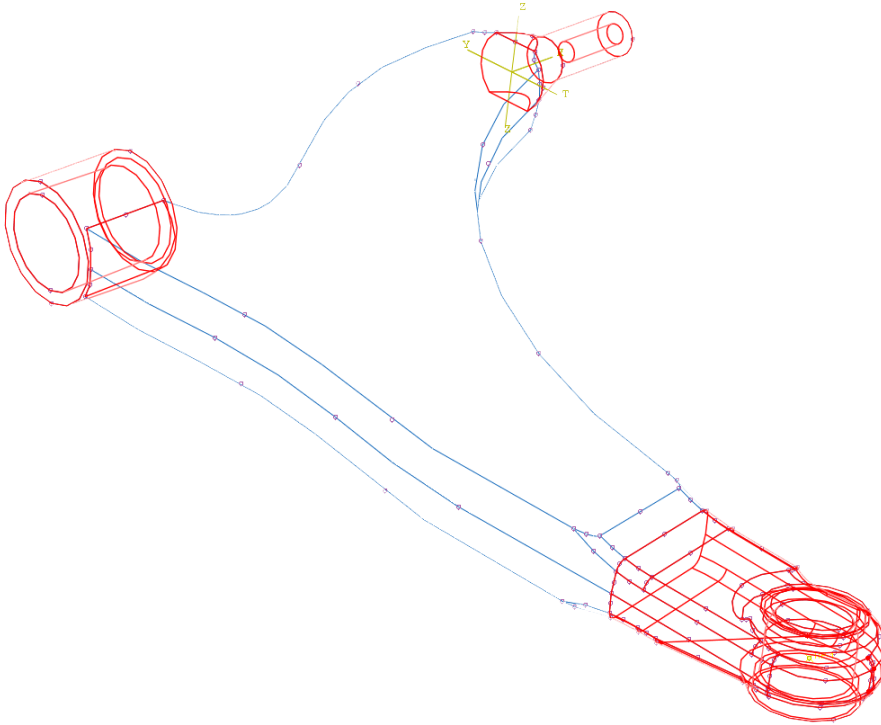

Figure 3.42: FLCA; Frozen areas geometric constraints (red areas constrained)

	Design response	Value	Unit
Objective	Minimize volume	N/A	-
Constraints	Displacement X-direction	0.044	mm
	Displacement Y-direction	1.418	mm
Geometric constraints	Frozen areas (fig. 3.40), planar symmetry and manufacturing	N/A	-

Geometric constraints for the FLCA are shown in figure 3.42, and symmetry plane is shown in figure 3.43. Symmetry and manufacturing constraints are applied for the entire design space, but are not enforced in frozen areas. Frozen areas for the FLCA are applied to separate regions, using the *Partition Cell*-tool to divide the solid body. This method is preferred instead of applying constraints to surfaces, as this might result in internal voids if not manufacturing constraints

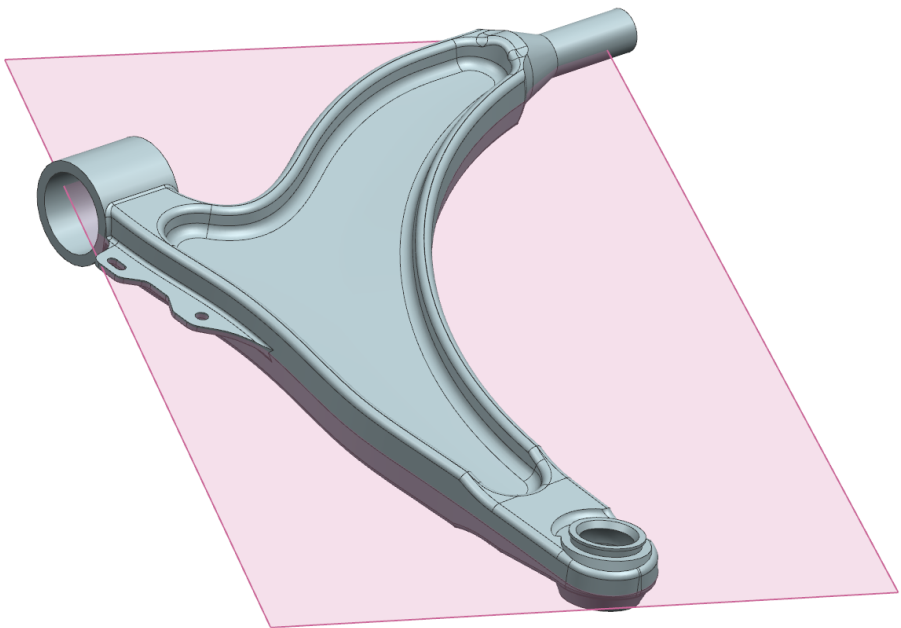

Figure 3.43: FLCA; Symmetry plane

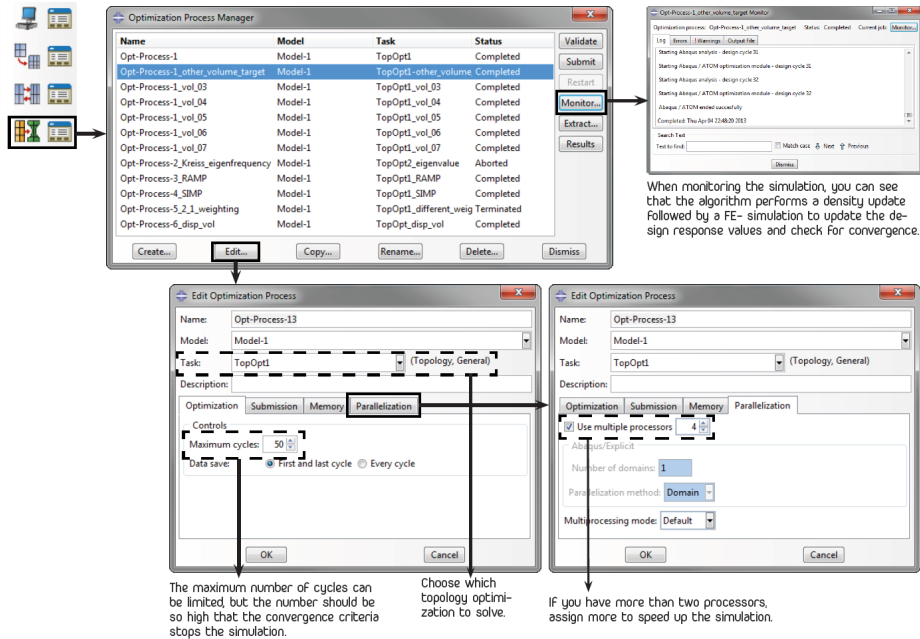

Figure 3.44: Abaqus; Submitting the topology optimization process

are applied as well.

3.4.4 Submitting the topology optimization process

In order to run the simulation, an optimization process must be made in the *Module: Job*. Specifications on the number of processors, maximum number of cycles and which topology optimization task to be used may be specified. In the *Optimization Process Manager*; Clicking Submit will start the simulation, clicking Monitor will let you see the progress for each iteration, while clicking Results will let you see the iterations so far, visualized on the part. Features are shown in figure 3.44.

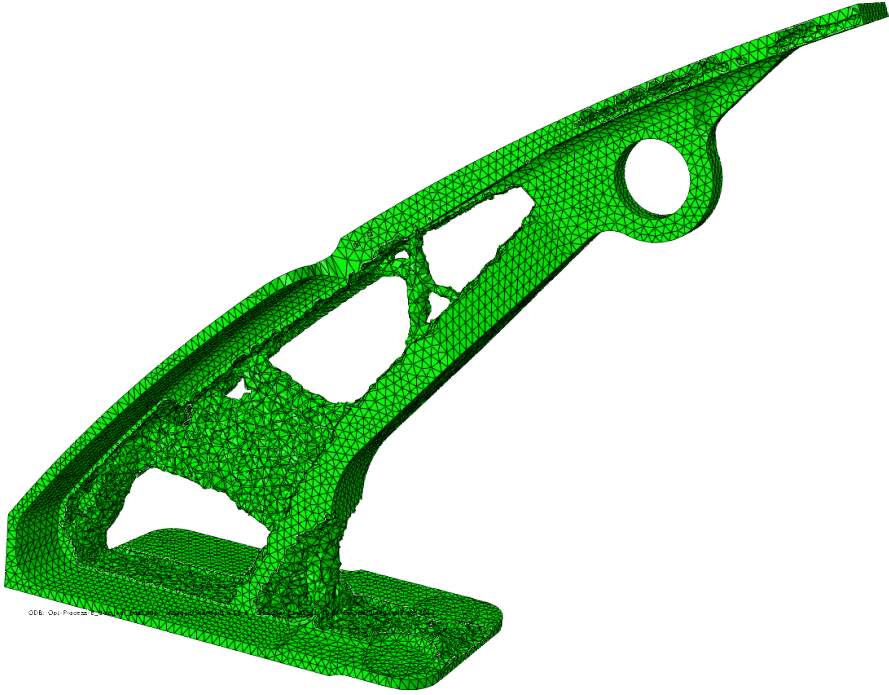

Figure 3.45: Door Connection Joint; Minimizing volume while maintaining stiffness results

3.5 Topology optimization results

3.5.1 Door Connection Joint

Results from the optimization of the Door Connection Joint can be seen in table 3.5, figure 3.45 and 3.46. Figure 3.47 shows the normalized displacements vs. the volume fraction of the reference volume when minimizing the volume and maintaining stiffness and the convergence for both loading directions. The graph shows an increase in stiffness in both LC1 and LC2 direction for a unity normalized reference volume. The final change in stiffness in both LC1 and LC2 direction is, however, assumed to be equal to zero. The proposed solution is therefore considered to be equally stiff as the reference geometry, while being

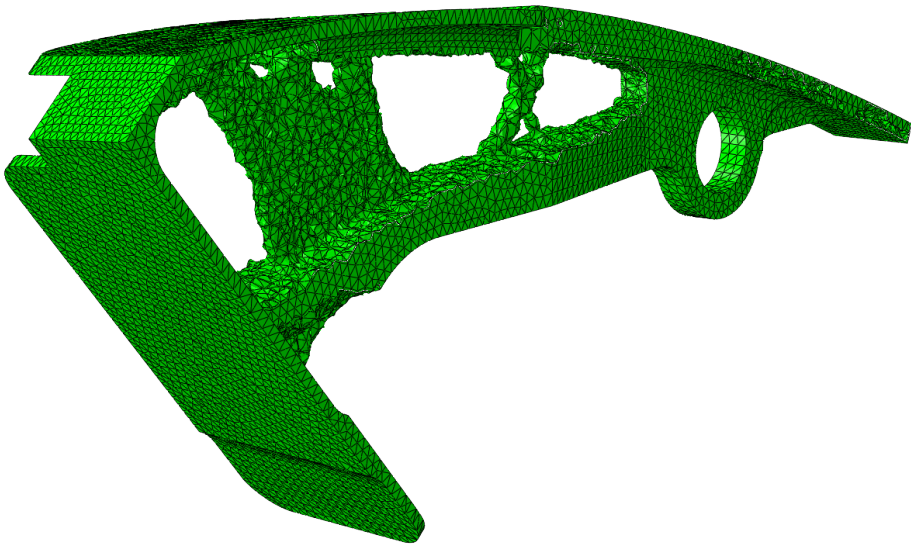

Figure 3.46: Door Connection Joint; Minimizing volume while maintaining stiffness results

Table 3.5: Results table door joint; Comparison of 1) original part and 2) optimized parts

	Door Connection Joint				
	Original part	Design space	SuPLight target	Optimization result	Target vs. results; difference
Volume [mm^3]	72302	122968	65071	64215	-11.2%
Displacement-tensile [mm]	0.077	N/A	0.077	0.0769	-0.081%
Displacement-bending [mm]	0.644	N/A	0.644	0.643	-0.136%

11.2% lighter. Results also obey all geometric constraints, and results look reasonable from an engineering perspective. The optimization is considered to be a success.

3.5.2 FLCA

Results from the optimization of the FLCA can be seen in table 3.6 and figure 3.48. Figure 3.49 shows how the solution has converged for both X-and Y-direction. When iterations enter the green area of the graph, solutions are considered to be successful, as the weight is lower and the stiffness is equal or higher than the reference part. The final change in stiffness in X-and Y-direction is minimal and assumed to be equal to zero. The proposed solution is therefore considered to be equally stiff as the reference geometry, while being 6.41% lighter. Figure 3.50 shows VonMises stresses with a maximum color bar limit of 121 MPa, corresponding to the fatigue limit at 10^6 cycles. Except irrelevant peak stresses in the bushing transition², maximum relevant stresses are below the fatigue limit. Results also obey all geometric constraints, and results look reasonable from an engineering perspective. The optimization is considered to be a success.

²Bushing is not as infinite stiff (as modeled), and peak stresses will be significantly reduced.

Normalized displacement (LC1 and LC2)
 VS.
 volume fraction of reference volume

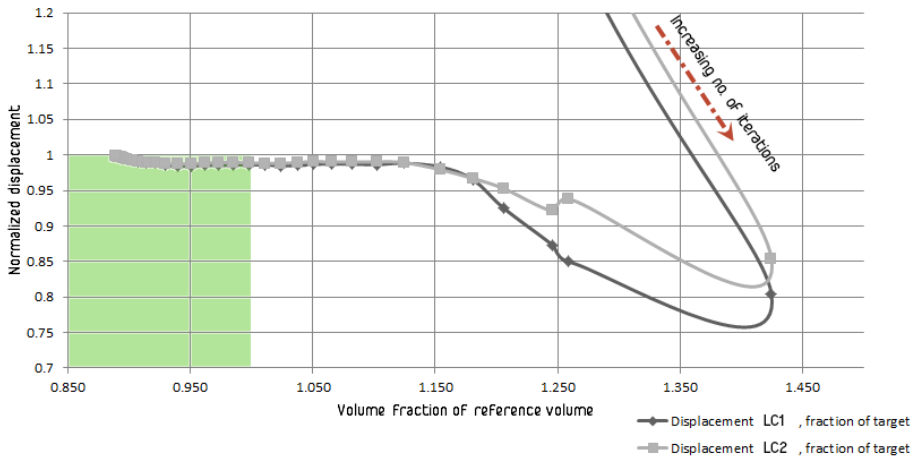

Figure 3.47: Door Connection Joint; Results from topology optimization minimizing volume while maintaining stiffness

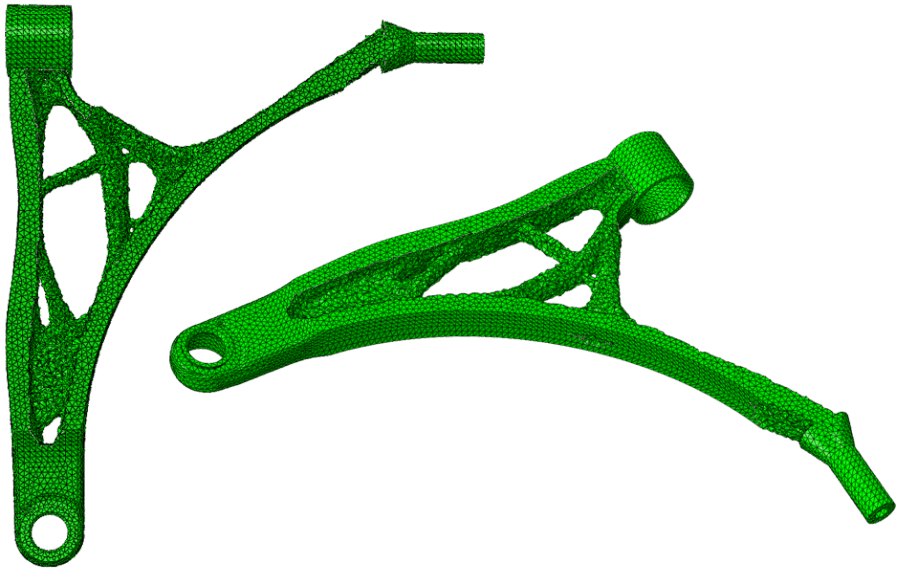

Figure 3.48: FLCA; Minimizing the volume while maintaining stiffness

Table 3.6: Results table FLCA; Comparison of 1) original part and 2) optimized parts

	FLCA				
	Original part	Design space	SuPLight target	Optimization result	Target vs. results; difference
Volume [mm^3]	534687.7	122968.07	481218.9	500389 .0	-6.41%
Displacement-X [mm]	1.418	N/A	1.418	1.416	-0.110%
Displacement-Y [mm]	0.044	N/A	0.044	0.0439	-0.157%

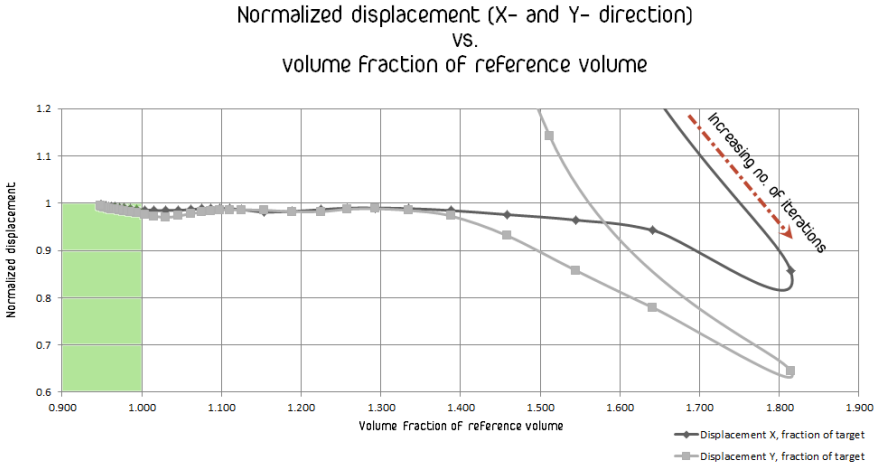

Figure 3.49: FLCA; Results from topology optimization minimizing volume while maintaining stiffness

3.5.3 Manual Multi-Disciplinary Optimization

Results presented in section 3.5.1 are per definition single-objective. In order to visualize the strengths of a MDO, the alternative objective and constraint definition for the Door Connection Joint has been used as a basis.

MinMax strain energy, constrained by upper limit on volume fraction

An initial simulation was performed with the aim of saving 10% weight. The solution process and results are shown in figure 3.51. The setup of the simulation is equivalent to the one previously shown for the Door Connection Joint, except from the design response, objective and constraint definition. The solution process was set to MinMax the strain energy from the two load cases, while specifying an upper volume fraction limit. Equal weights were applied to the two load cases. This resulted in an increased strength of +5.6% in the LC2 direction and a loss of stiffness in the LC1 direction of -26.4%. The large negative difference in stiffness in LC1- direction can be explained by looking at the different loading mechanism for the part under analysis. The LC1 force results in a straightening of the curved shape of the joint. As both solution approaches tend to remove material inside the permissible design space, the one

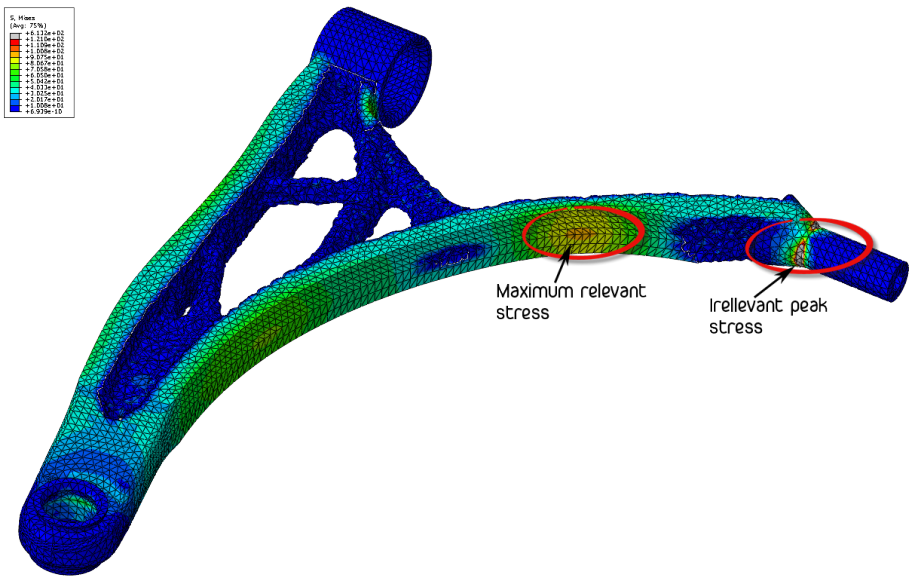

Figure 3.50: FLCA; VonMises stress

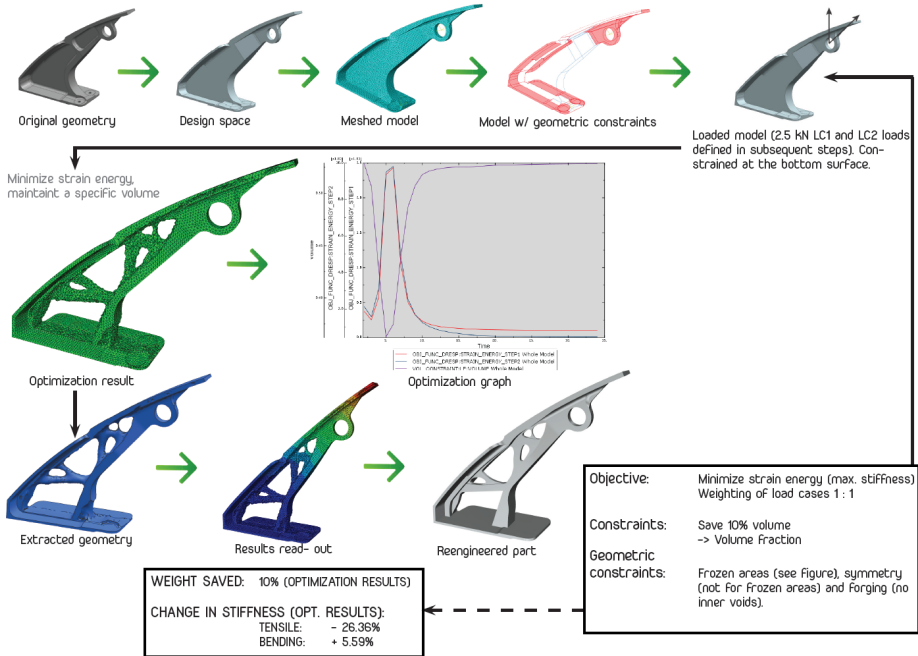

Figure 3.51: Door Connection Joint; Solution process for MinMax strain energy while constraining volume

with the stiffest structure at the lower part of the joint is the stiffest in LC1 direction. This is shown in figure 3.52, where X_1 denotes the difference between the two approaches in how much the curved top surface bends inwards, and X_2 denotes the resulting difference in displacement in LC1 direction.

For this particular solution method, Multi-Disciplinary Optimization results have been made available by manually changing the volume fraction target of the simulations and making the optimization process Multi-Disciplinary. Results are plotted in figure 3.54 and 3.55, showing strain energy vs. volume fraction for the LC1 and LC2 load direction, respectively. In figure 3.54, the red line showing the displacement at the reference node is included to show the relation between strain energy and displacement. As discussed in section 2.2.3, the curves have the characteristic shape of Pareto curves. Topology optimization results for various reference volume fractions are shown in figure 3.53. The percentage

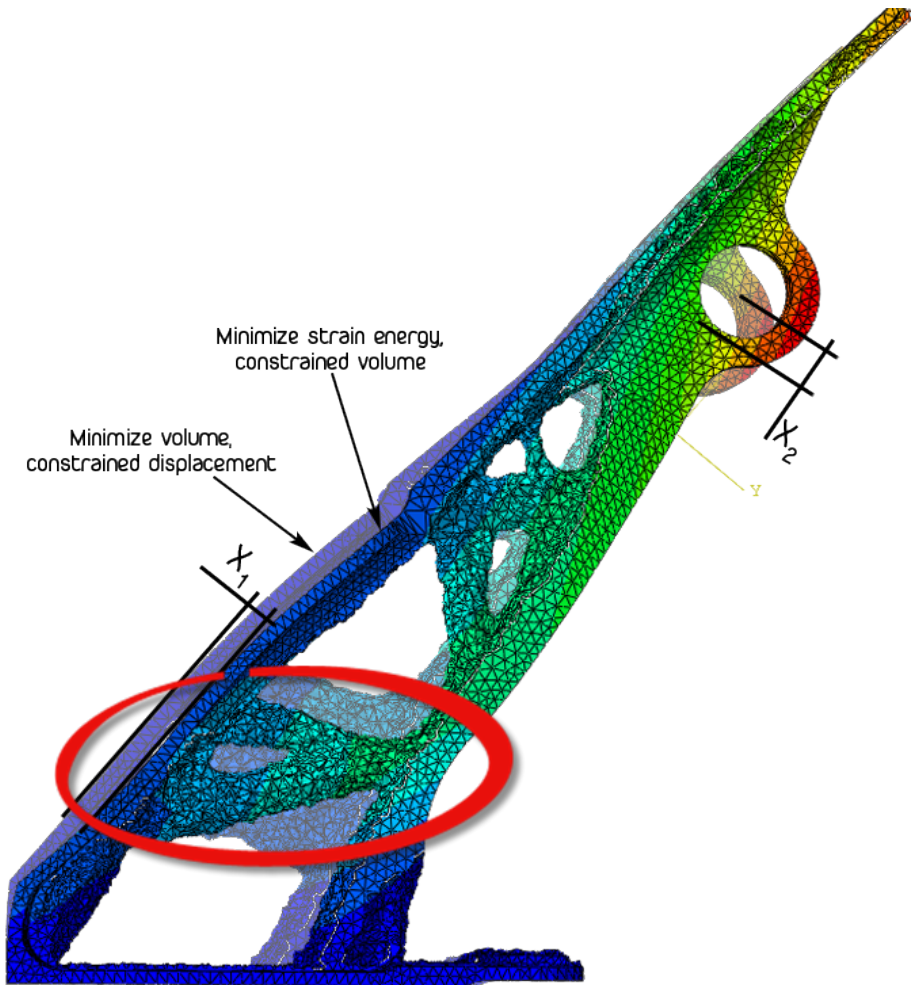

Figure 3.52: Door Connection Joint; Evaluation of large tensile displacements when minimizing strain energy

illustrates the change in weight from the reference volume.

Because the strain energy is a measure of stiffness, the same tendencies can be seen by studying the displacement at the reference node and plotting it vs. the corresponding volume fraction of the reference volume, as seen in figure 3.56. As the axis of the graphs are normalized, a volume fraction of 0.9 corresponds to the simulation target, while a normalized displacement less than 1 corresponds to a smaller displacement than the reference volume, hence the part has become stiffer.

Knowing the curvature and shape of the Pareto curve helps the engineer to make a well-considered choice of design, as the sensitivity of the strain energy is visualized and easily interpreted. From figure 3.56 it is clear that there is a definite shift just below the target volume, as both the LC1 and LC2 displacements increase rapidly for lowering the volume fraction. This means that the gradient of the change in displacement is increased after a specific value, implying that a small change of volume fraction will result in a large displacement increase. The graph also predicts that with equal objective weighting (1 : 1) when minimizing strain energy in LC1 and LC2 load direction results in an **improvement** in bending stiffness while **decreasing** the stiffness in the tensile direction for a specified 10% weight saving. Adjusting the objective weighting may result in favorable results, but this requires a lot of trial and error and is not recommended when a specific stiffness is required. Minimizing volume give better results and is less time consuming, as discussed in section 3.5.1.

3.6 Post-processing of simulation results

Figure 3.57 shows the general workflow when post-processing simulation results. Post-processing of results is important to verify that the simulation has converged, and that the design constraints are within limits. Graphs can be generated by the software by clicking the Graph-icon in the *Visualization Manager*, selecting the design responses of interest and plotting these. When viewing contour plots that are dependent on direction, the user can specify which coordinate system to be used by clicking (in the Visualization environment) Results > Options > Transformation > User-specified, and choosing the CSYS of interest.

Results surface extraction is done by clicking (in the *Job* environment) Optimization Process Manager > Extract. As shown in figure 3.57, varying the ISO-value will have the largest impact on the resulting STL-file. Increasing the *Number of Smoothing Cycles* (NSC) gives a smoother surface, while increasing the *Reduction percentage* (R%) will give a coarser surface as the surface com-

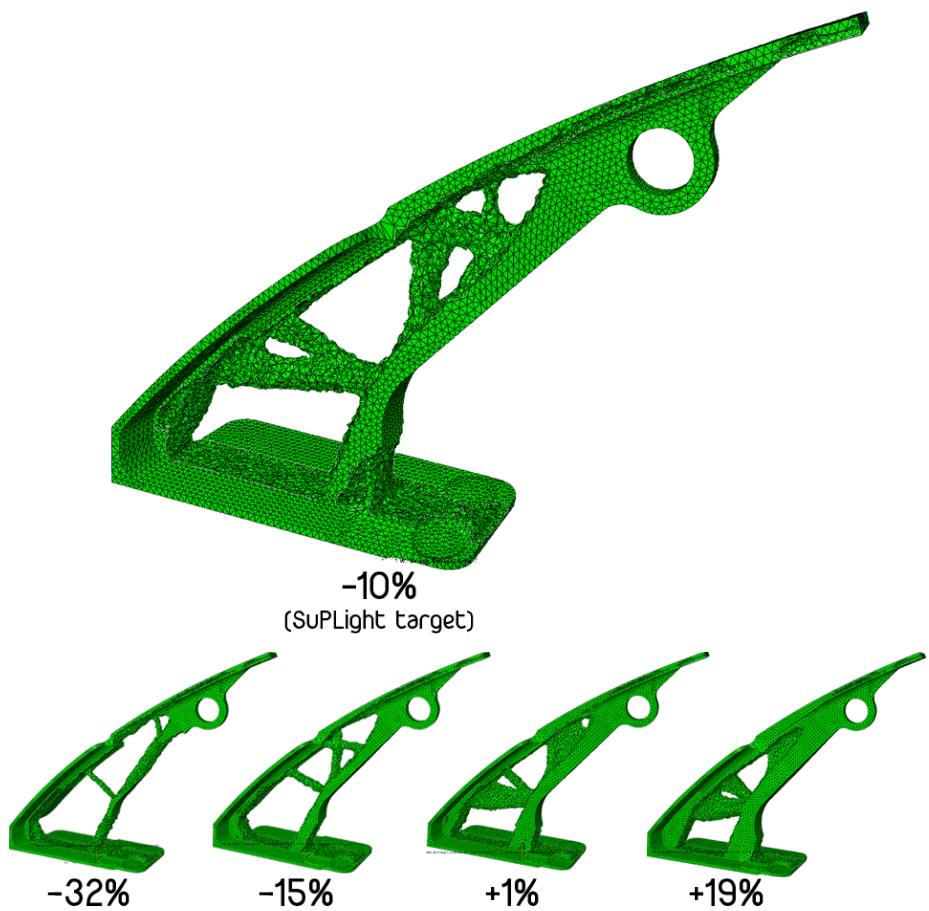

Figure 3.53: Door Connection Joint; MinMax strain energy, constrained by upper limit on volume fraction. Image showing percentage of weight reduction from reference geometry.

Pareto curve; Discrete Topology optimization runs
 Objective: MinMax strain energy in LC1 direction (max. stiffness)
 Constraints: Volume Fraction and geometric const.

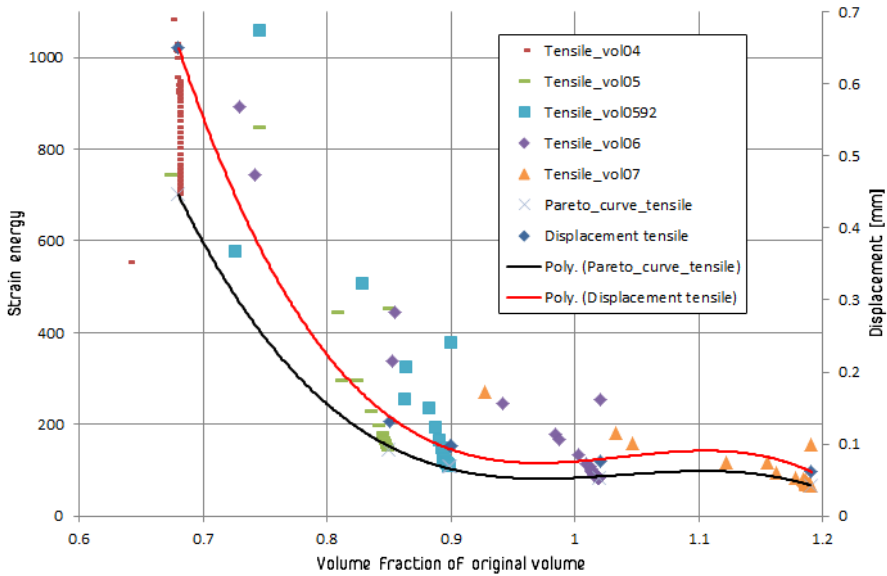

Figure 3.54: Door Connection Joint; Pareto curve for strain energy and displacement vs. volume fraction of reference volume; LC1 load direction

Pareto curve; Discrete Topology optimization runs
 Objective: MinMax strain energy (max. stiffness) in LC2 direction
 Constraints: Volume Fraction and geometric const.

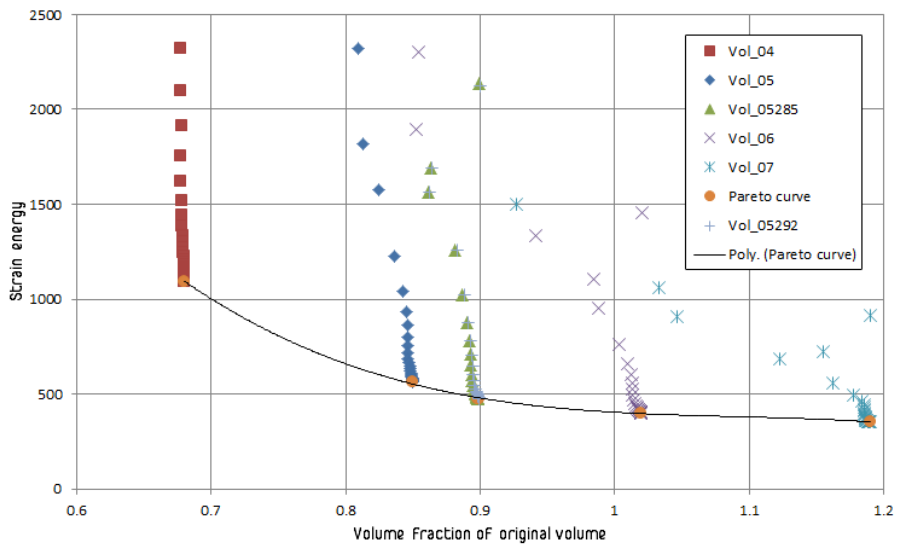

Figure 3.55: Door Connection Joint; Pareto curve for strain energy vs. volume fraction of reference volume; LC2 load direction

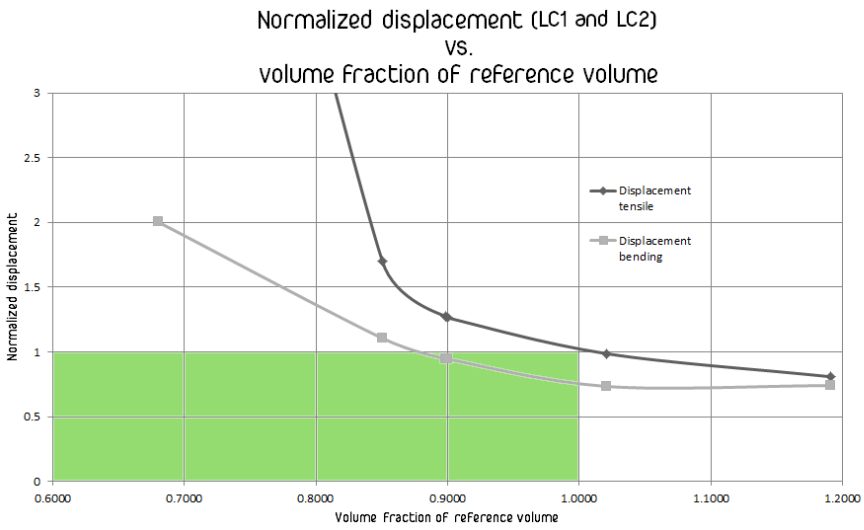

Figure 3.56: Door Connection Joint; Pareto curve for displacement of reference node vs. volume fraction of reference volume; LC1 and LC2 direction

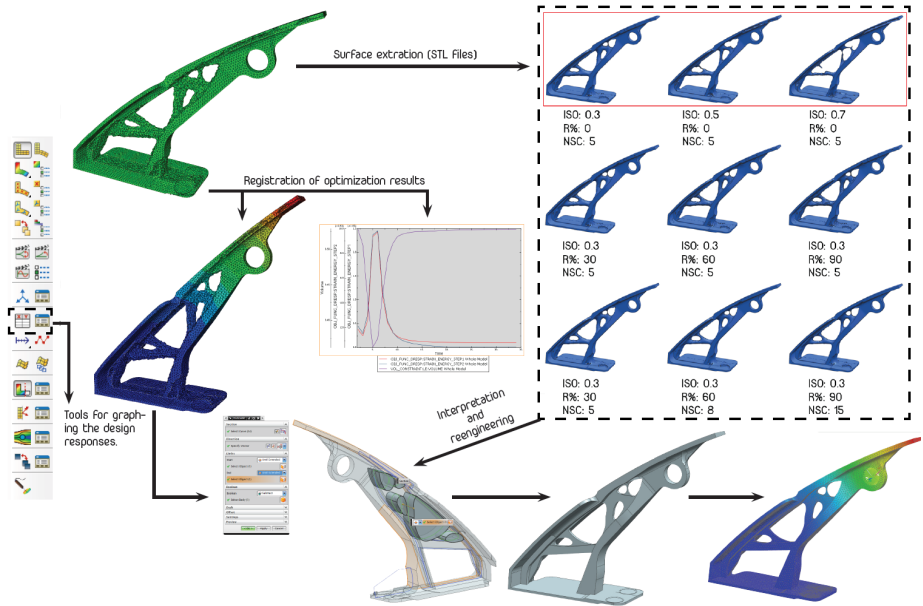

Figure 3.57: Abaqus; Post-processing of simulation results

plexity will be reduced. Interpretation of the geometry is discussed in chapter 5.

3.6.1 Smoothing of chosen optimization output

3.6.1.1 Door Connection Joint

Smoothing and STL-file extraction of the Door Connection Joint was done using default parameters; ISO=0.3, no reduction and 5 smoothing cycles. The result can be seen in figure 3.58.

3.6.1.2 FLCA

The FLCA smoothing was also done using default parameters; ISO=0.3, no reduction and 5 smoothing cycles. The result can be seen in figure 3.59.

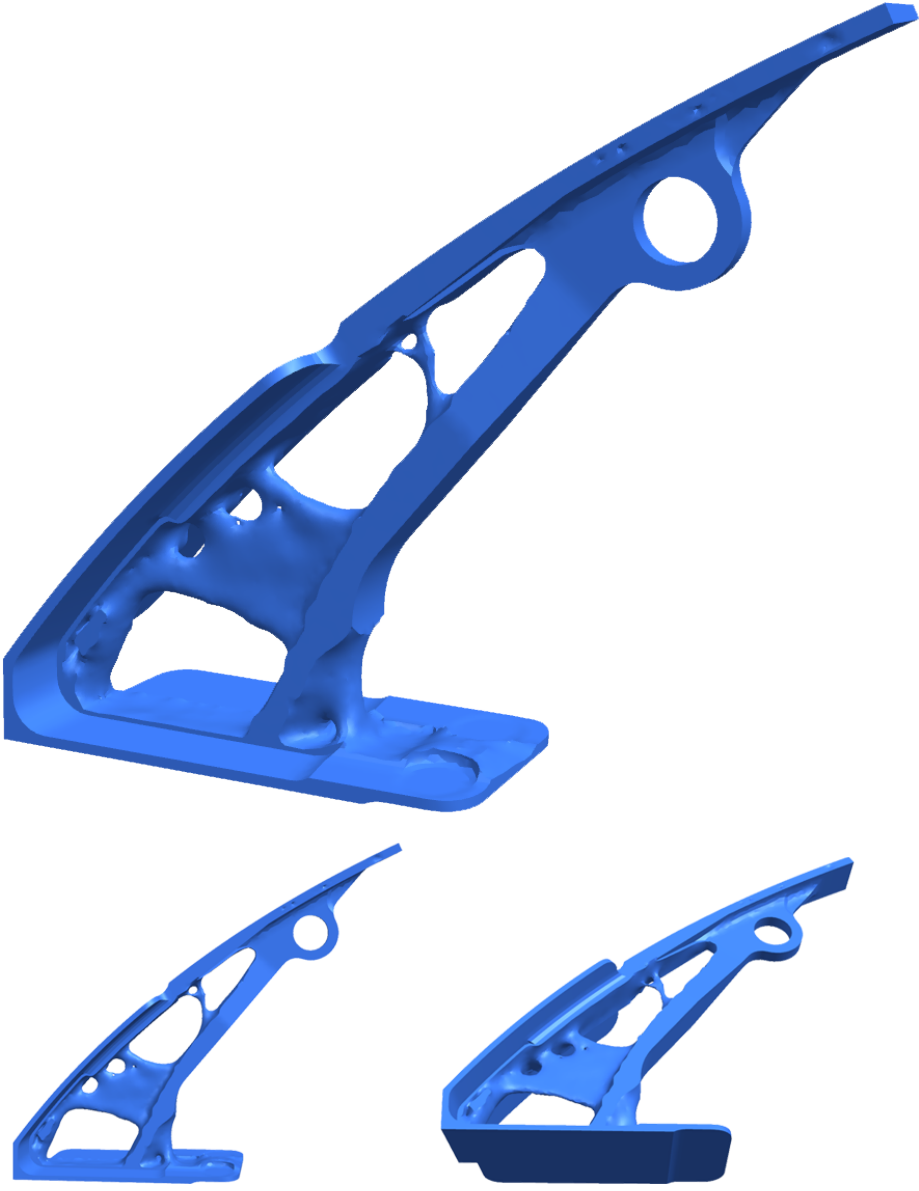

Figure 3.58: Door Connection Joint; 1) STL file extracted from Abaqus ATOM and 2) parameters for the extracted surface $ISO = 0.3$, *No. smoothing cycles* = 5

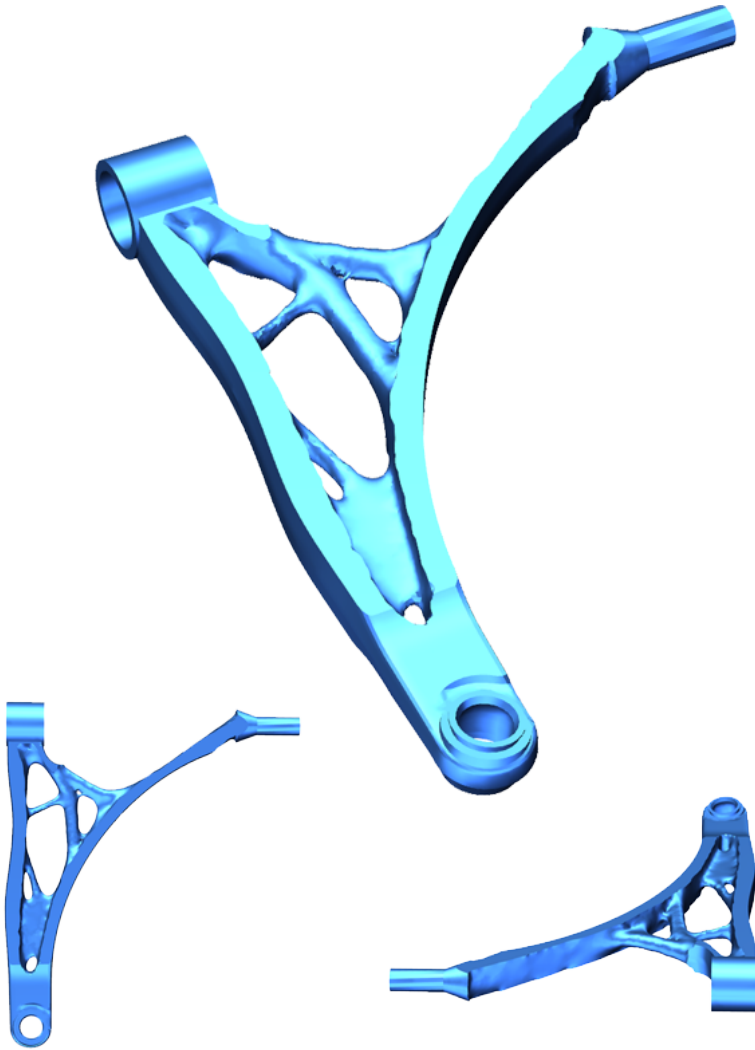

Figure 3.59: FLCA; 1) STL file extracted from Abaqus ATOM and 2) parameters for the extracted surface $ISO = 0.3$, *No. smoothing cycles* = 5

Chapter 4

Process description using NX Topology Optimization

The following chapter is similar to the previous, however Unigraphics NX is used for optimization instead of Abaqus ATOM. For simplicity, only the setup and basic results for the Door Connection Joint is included, as the main purpose is to show that NX has similar optimization capabilities as Abaqus ATOM. Baseline values, the design space, loads and boundary constraints are similar to those in the Abaqus ATOM chapter, and is therefore omitted. Application of the aforementioned loads and boundary conditions are done similar to the NX baseline calculations. For bigger images and a step-by step description on how to setup optimization using NX, see appendix C. Figure 4.1 shows the general workflow for setting up a topology optimization in NX.

4.1 Software

4.1.1 Unigraphics NX

In this process description, Unigraphics NX 8.0 is used for topology optimization simulations. NX Topology optimization is a powerful tool for enhancing creativity and finding optimal distributions of material given a design space, loads and boundary conditions and an objective. NX is capable of handling a single, non-weighted objective. NX is also limited to handling only one displacement constraint. Results presented are therefore not comparable to the ATOM

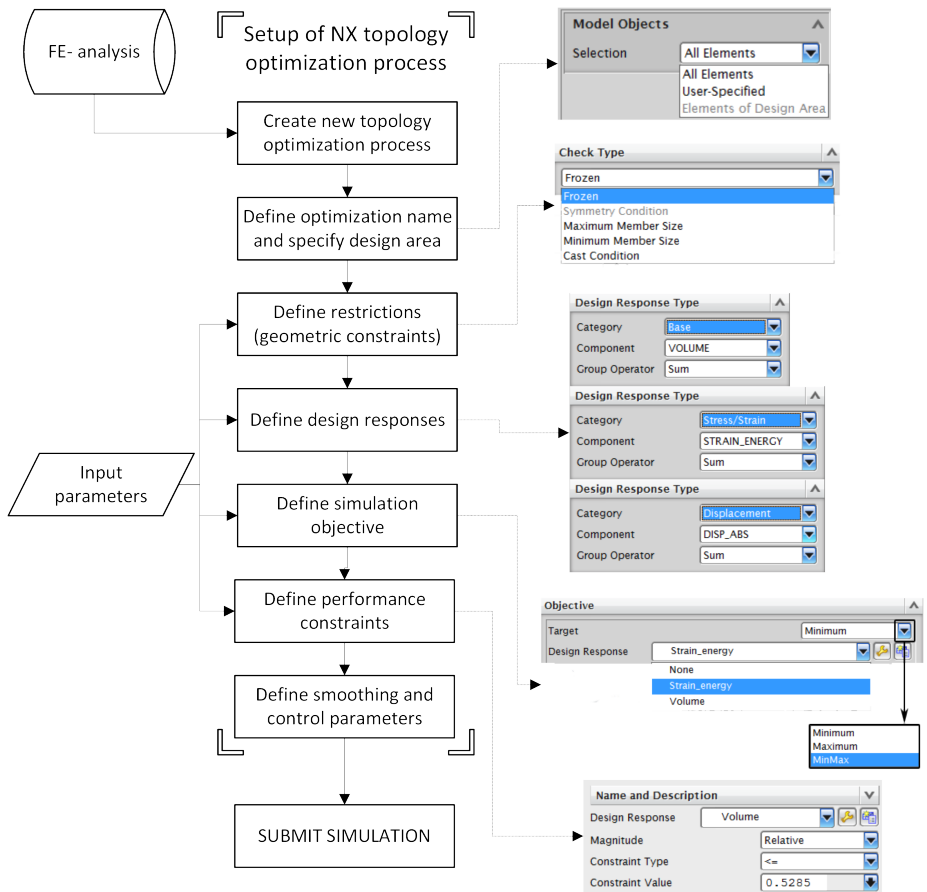

Figure 4.1: Setup of NX topology optimization process

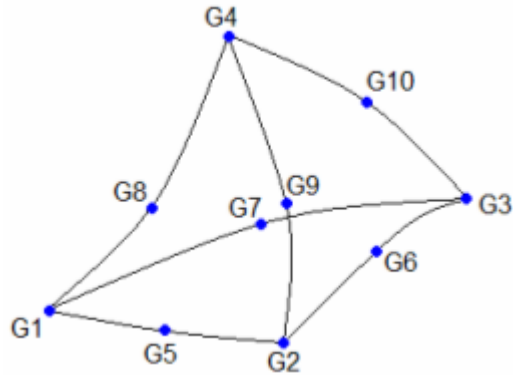

Figure 4.2: NX mesh; CTETRA10 elements

solution in the previous chapter.

Specific problems in NX 8.0 and 8.5 have been found using the following tools:

- MinMax strain energy from separate subcases
- Cast condition geometric constraint

The combined effect of handling only one displacement constraint, problems with the MinMax approach and the Cast condition geometric constraint is that only the setup is discussed, while results are presented only to show how they can be obtained and how they are represented.

4.2 Model preparation, meshing and setup of static analysis

4.2.1 Meshing

The meshing of the design space was done using 3 mm overall size CTETRA10 tetrahedral elements, as shown in figure 4.3. The model was free meshed because of irregular geometry.

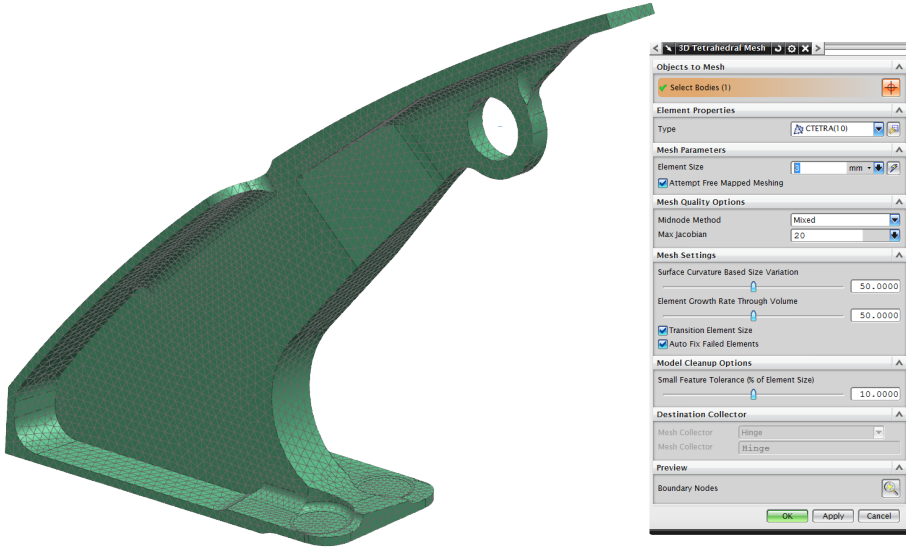

Figure 4.3: Door Connection Joint; Meshing of design space in UGS NX

4.3 Setup of topology optimization

4.3.1 Creating the topology optimization and defining element groups

NX Topology optimization is a part of the NX Advanced simulation environment, and can be added to the simulation as a New Solution Process after defining the initial FE-simulation file. The tool is easily configured using the NX Topology Optimization step-by-step wizard. The tool is designed to handle static, structural simulations of 2D and 3D continuum structures, as well as multiple loads, contact forces, assemblies, etc.

Defining element groups simplifies the geometric constraints definition. In the following example, groups for 1) Frozen areas and 2) Symmetry areas are defined. Best practice have been found to define areas by using the 3) Related Elements selection method. Be aware that only surface elements are selected with this method, and depending on Cast condition settings, internal voids and undercuts may appear. Using the Split Body command for creating separate bodies enable choosing regions of elements if more suitable (*Modeling environ-*

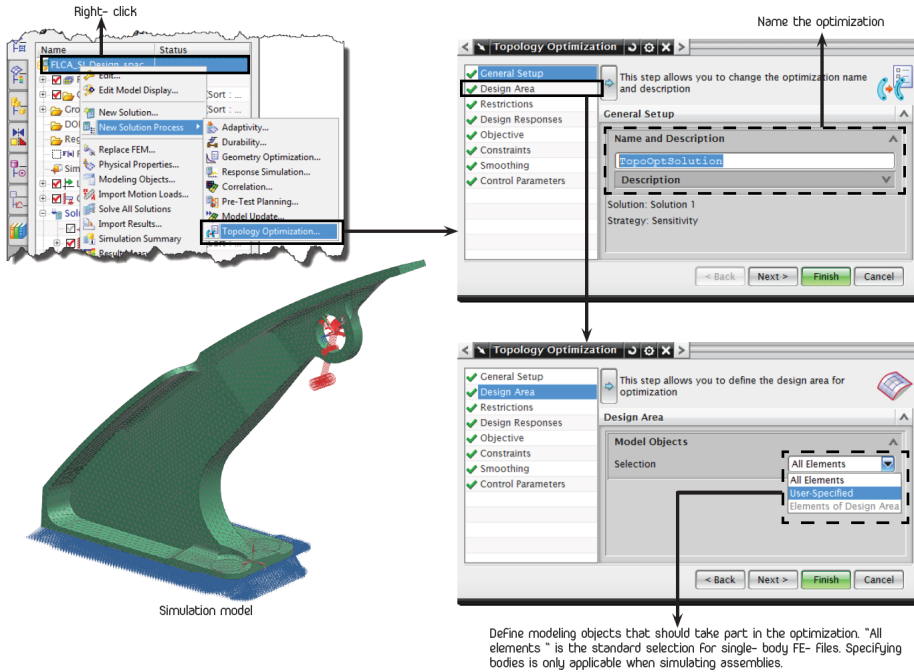

Figure 4.4: Door Connection Joint; Creating the topology optimization process

ment; Insert > Trim > Split Body). Figure 4.4 and 4.5 show the previously described procedures.

4.3.2 Defining geometric constraints (restrictions)

Guidelines for defining geometric constraints in NX are similar to those presented in the Abaqus ATOM chapter. Figure 4.6 shows the procedure in NX. Previously defined Element Groups form the basis of both the Frozen and Symmetry constraints. The symmetry plane for the Door Connection Joint is bisector the two parallel surfaces of the design space.

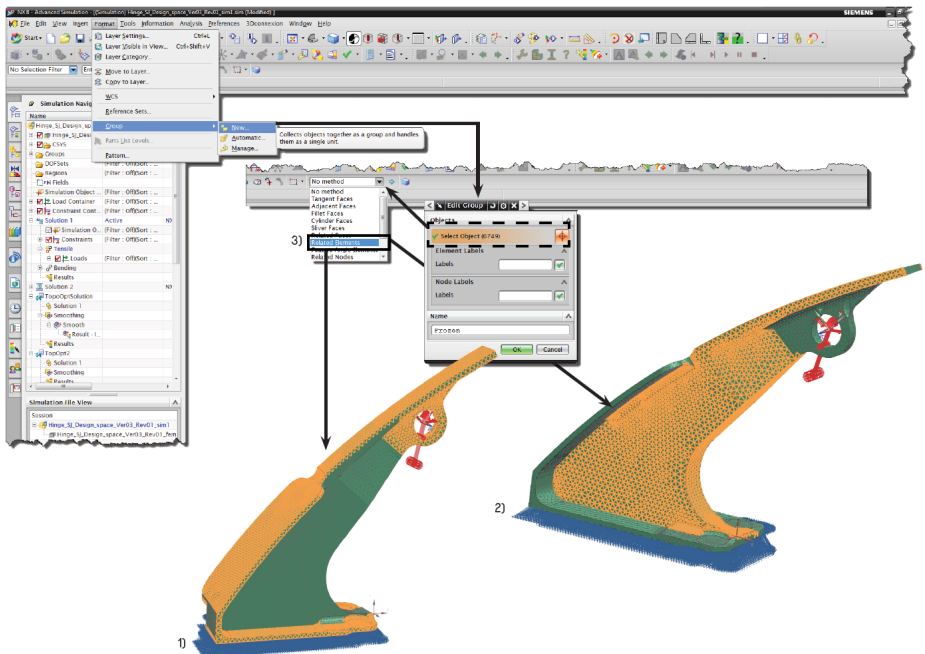

Figure 4.5: Door Connection Joint; Defining element groups

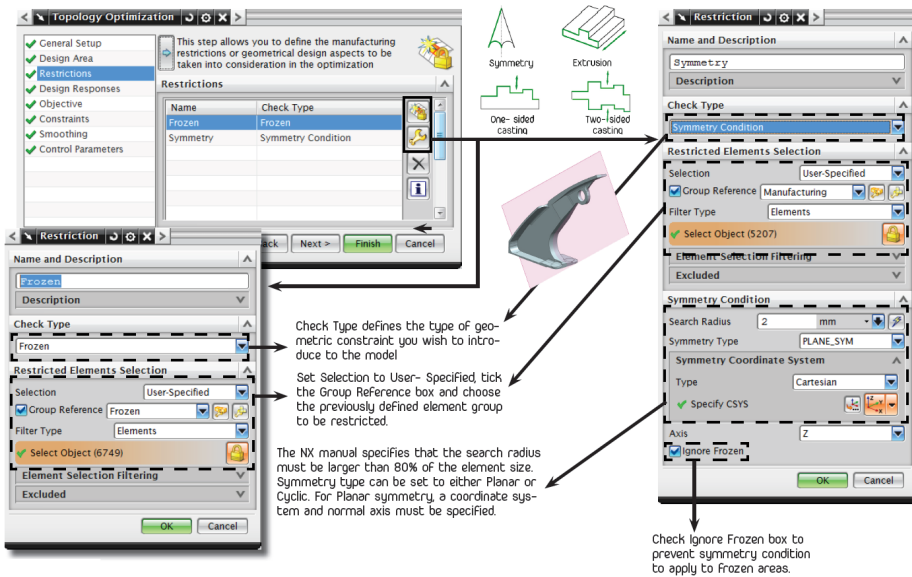

Figure 4.6: Door Connection Joint; Defining geometric constraints (restrictions)

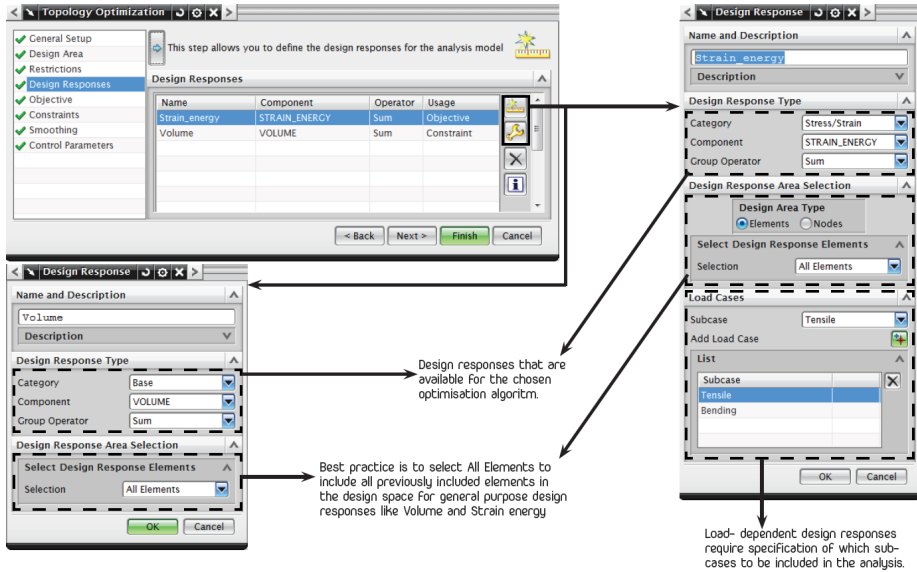

Figure 4.7: Door Connection Joint; Defining design responses

4.3.3 Defining design responses

Design responses can be seen as the simulation variables. They are defined before the simulation objective and performance constraints are set. Design responses may be specified for the entire model, or for specific regions of the geometry. For certain design responses, e.g. strain energy and displacement, Load Cases must be specified. The Group Operator can be used to change the interpretation of the Design Response of interest, changing between Sum, Maximum, Minimum (value), etc. Defining design responses in NX is shown in figure 4.7.

4.3.4 Defining the objective and performance constraints

Process descriptions are shown in figure 4.8 and 4.9. Objective and constraint definition for the Door Connection Joint using NX is shown below:

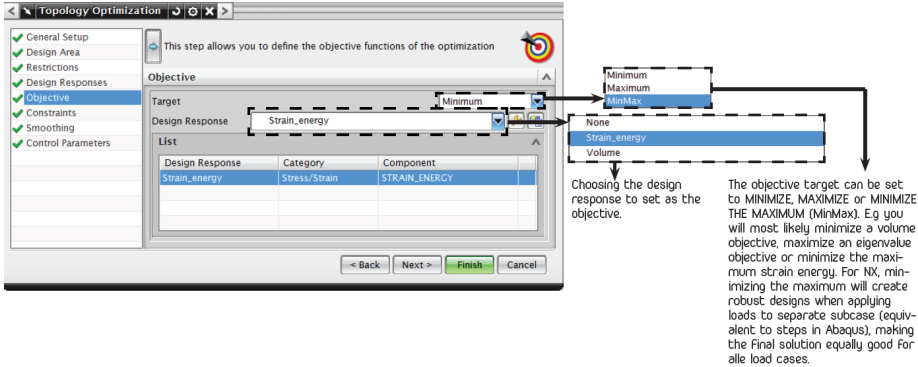

Figure 4.8: Door Connection Joint; Defining the objective

	Design response	Value	Unit
Objective	Minimize strain energy LC1 and LC2 direction	N/A	J
Performance constraints	Volume fraction	≤ 0.5292	-
Geometric constraints	Frozen areas (fig. 3.40) and planar symmetry.	N/A	-

4.3.5 Geometry extraction settings, solution control parameters and submitting the optimization process

Extracting geometries may be specified using the Smoothing process. In general, standard values are reasonable and give good results. Advanced setup is therefore omitted. Desired output control variables may also be specified to control the simulation process. Control parameters for the simulation run as seen in figure 4.10 are: 1) The Maximum Number of Iterations will stop the simulation before if the solution diverges. The number should be so high that the simulation stops by itself when convergence is achieved. 2) Sensitivity Approach Parameters may be adjusted to reach convergence if initial simulations fail. Setting Density Update to Conservative and lowering the Density Move value will reduce the extent and magnitude of element density updates, aiding the search for a valid solution. 3) Choose between saving the First and Last .OP2 result files, None or All. The first is recommended.

Submitting the simulation is done by finishing the wizard and clicking Solve

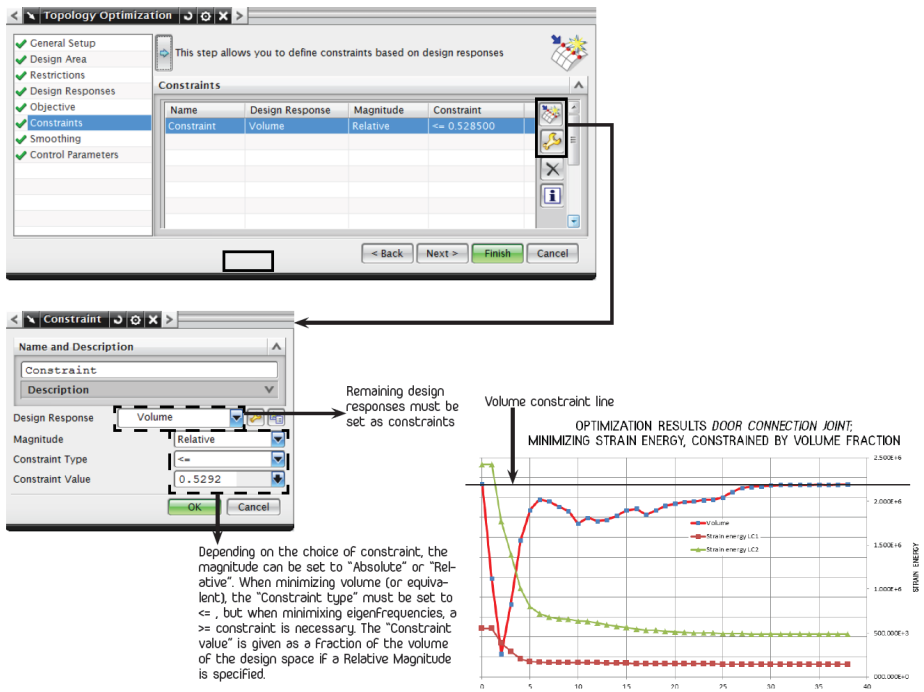

Figure 4.9: Door Connection Joint; Defining (performance) constraints

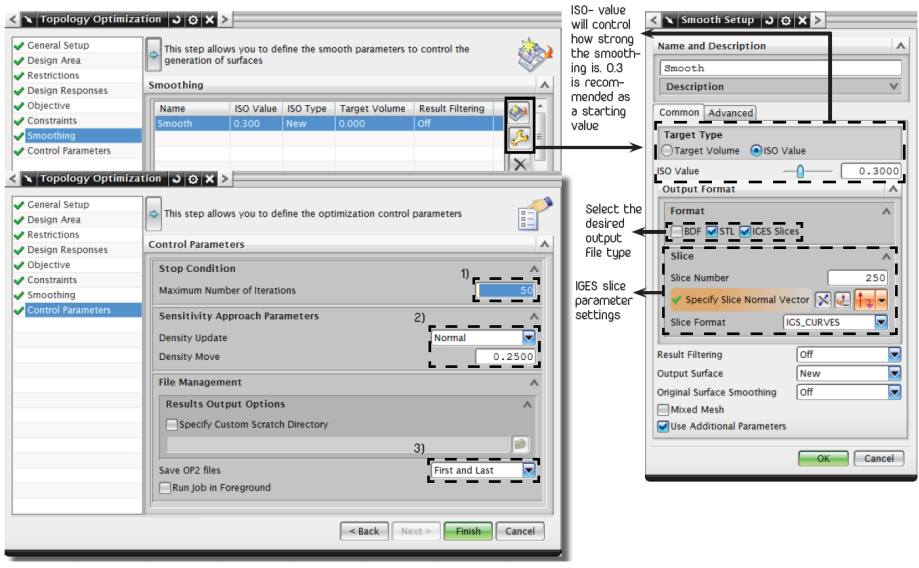

Figure 4.10: Door Connection Joint; Smoothing and submitting the topology optimization

(right-click process tab and click Solve). Simulation times in NX are considerably lower than using Abaqus ATOM, durations being as low as approximately one hour for the simulation of interest.

4.4 Topology optimization results

This section is mainly included to show the reader how to extract values from the simulation. Figure 4.11 shows the results extraction process, while figure 4.12 shows the STL surface extracted. Notice that image 2) in the previously mentioned figure shows that the model has internal voids making it impossible to produce by machining, because no manufacturing constraints were specified.

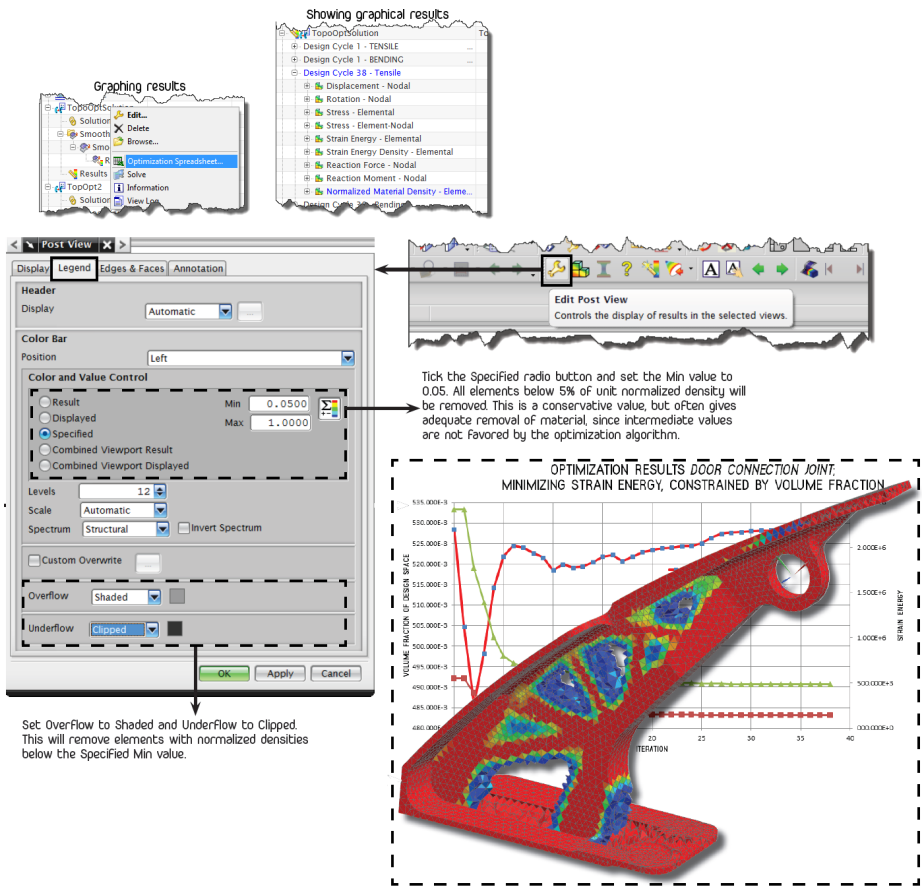

Figure 4.11: Door Connection Joint; Results extraction

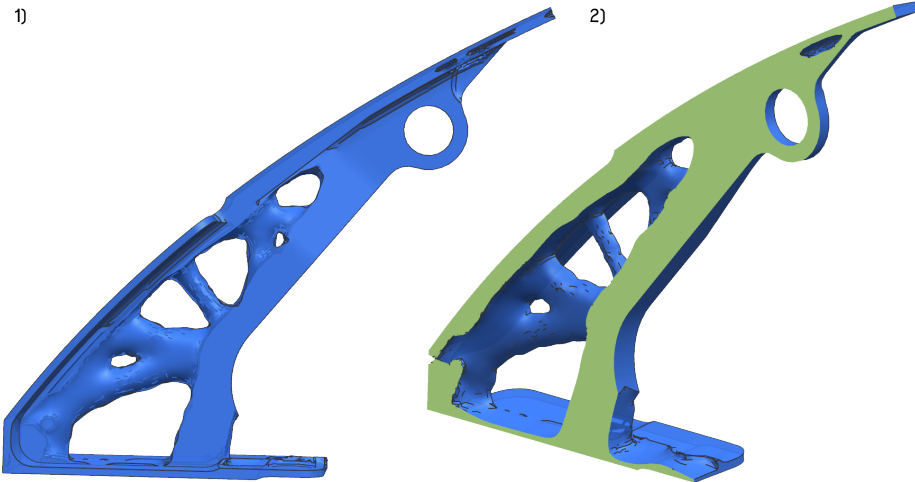

Figure 4.12: Door Connection Joint; Surface extracted 1) side view and 2) half view

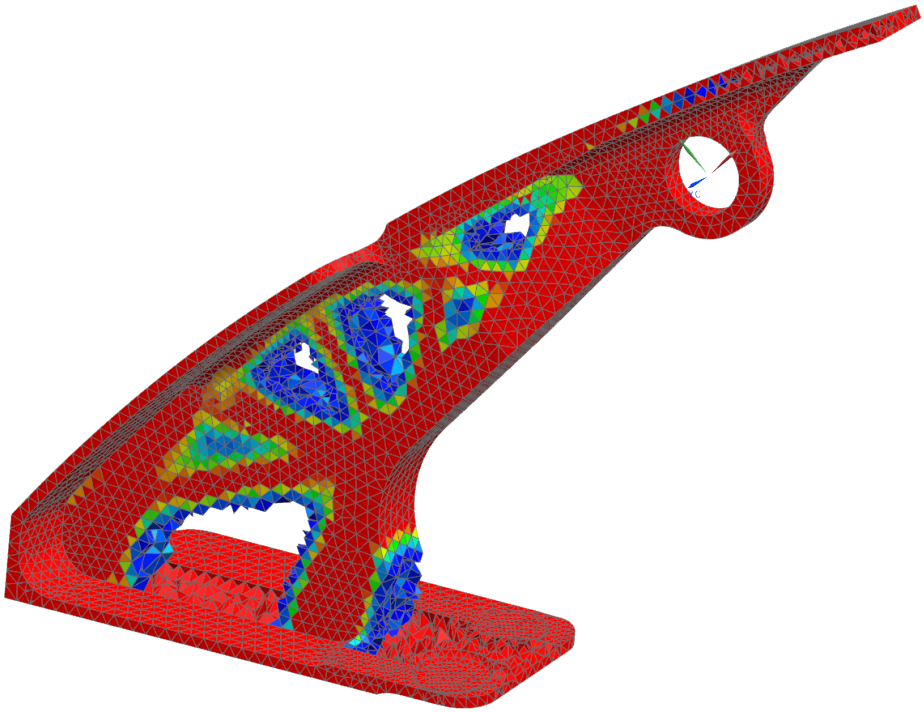

Figure 4.13: Door Connection Joint; Results visualization

OPTIMIZATION RESULTS *DOOR CONNECTION JOINT*;
 MINIMIZING STRAIN ENERGY, CONSTRAINED BY VOLUME FRACTION

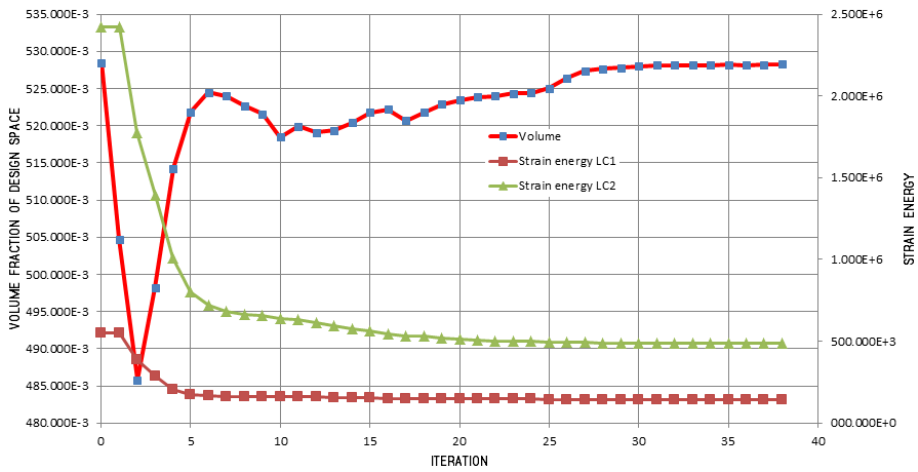

Figure 4.14: Door Connection Joint; Results graph

Chapter 5

Reengineering of optimization output using UGS NX

5.1 Reengineered geometry

In this section, procedure 1) discussed in section 2.4.7.2 is described, as this is found to be best practice. For both the Door Connection Joint and the FLCA, solutions from minimizing the volume while constraining displacements are reengineered and analyzed, confirming that performance targets are met.

Best practice for reengineering planar symmetric parts using UGS NX is as follows:

- Extract optimization geometry from preferred topology optimization software as a STereoLitography (STL)-file.
- Open the design space part file (.prt)
- Evoke the Model environment
- Click File > Import > STL and follow the import procedure to retrieve the extracted geometry. It should normally position itself on top of the design space.
- Create a symmetry plane, bisector two parallel surfaces in the design space . This plane should interfere with the previously defined geometric symmetry constraint.

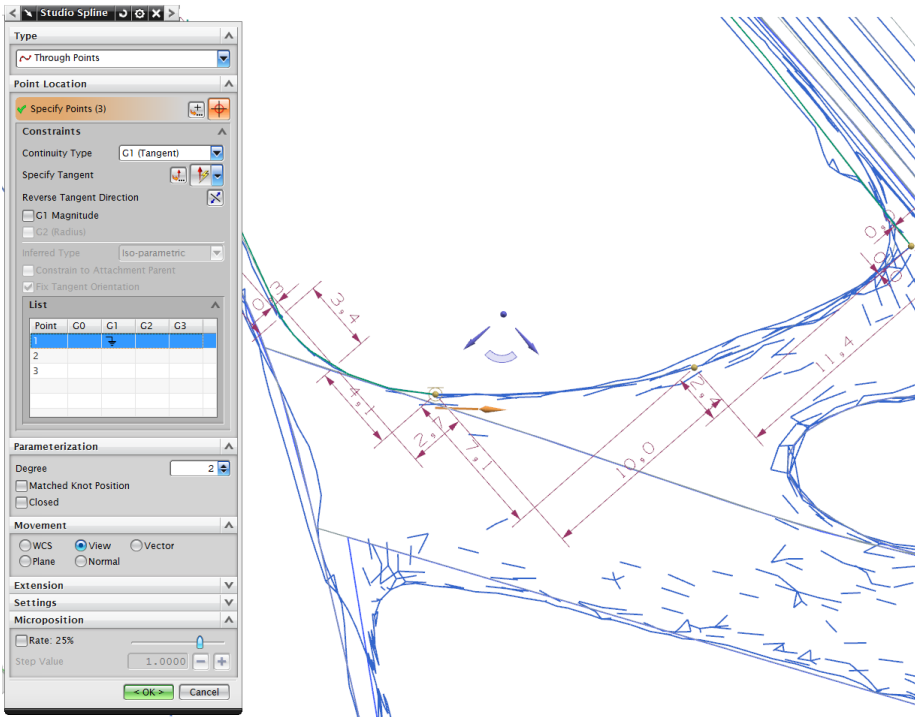

Figure 5.1: NX; Reengineering the geometry from topology optimization using splines in sketches

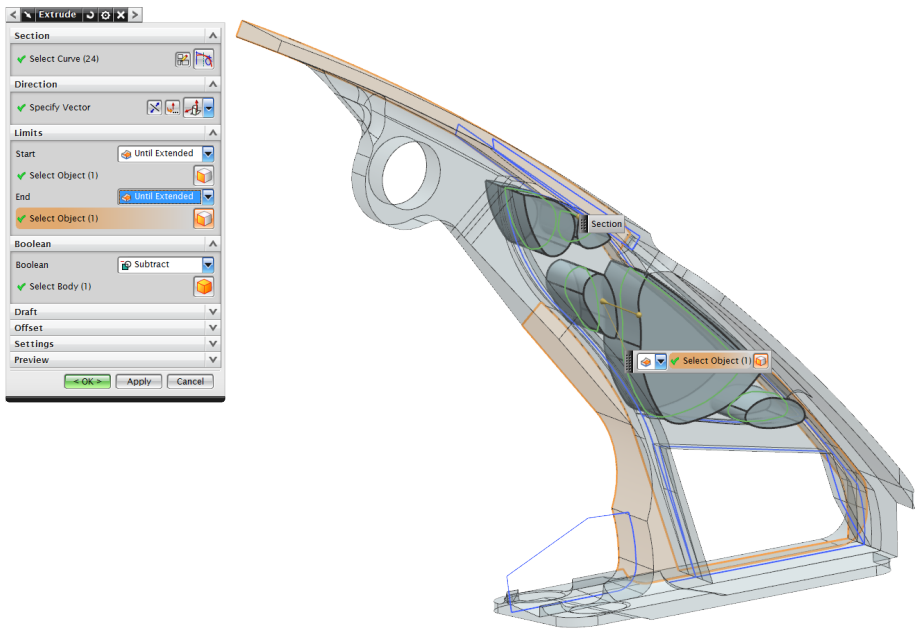

Figure 5.2: NX; Reengineering the geometry from topology optimization using the extrude function

- Create a new sketch on the datum plane.
- Orient view to be normal to datum (symmetry) plane.
- Start the Studio Spline (click S) and position splines on top of the boundary lines in the topology optimization part.
- Extrude sketches with the Boolean function set to “Subtract” in order to remove material.
- Use fillets, chamfers and other design tools to imitate results.

Reengineered geometries have been prepared in UGS NX 8.0, using the Modeling environment. Extracted STL-geometries as described in section 3.6.1 are used as a basis for reengineering.

5.1.1 Door Connection Joint

The reengineered geometry of the Door Connection Joint for minimizing volume and constraining displacement can be seen in figure 5.3. The volume of the geometry is 67161 mm^3 , giving a 7.11% weight loss, compared to the reference geometry. Simulation results are shown in figure 5.4 and 5.5, confirming that the proposed reengineered geometry has adequate stiffness. Performance properties from simulations are summarized in table 5.1. Notice that displacement values are slightly lower than in the baseline, hence the part is also marginally stiffer.

The reengineered geometry of the Door Connection Joint from minimizing strain energy and constraining volume can be seen in figure 5.6. This rendering is included to show another approach to reengineering optimization results. The volume of the geometry is 66430 mm^3 , giving a 8.12% weight reduction. Simulations are not included for this geometry, as performance requirements are not met in the initial optimization results.

Figure 5.7 shows the Door Connection Joint printed in plastic in full scale using a 3D-printer. Outputs have been printed to visualize the process, and aid knowledge development. All files are printed from STL- files. Extracted geometry is therefore suitable for printing with ALM- methods.

5.1.2 FLCA

The reengineered geometry of the FLCA for minimizing volume and constraining displacement can be seen in figure 5.8. The volume of the geometry is 503029.1 mm^3 , giving a 5.92% weight loss. Simulation results are found in figure



Figure 5.3: Door Connection Joint; Reengineered geometry from minimizing volume and constraining displacement

Table 5.1: Door Connection Joint; Reengineered geometry performance properties

	Door Connection Joint			
	Original part	Original vs. simulation results difference	Reengineering results	Original vs. reengineering results difference
Volume [mm^3]	72302	-11.2%	67161	-7.11%
Displacement-LC1-direction [mm]	0.077	+0.081%	0.074	-3.90%
Displacement-LC2-direction [mm]	0.644	+0.136%	0.640	-0.62%

Hinge_min_vol_from_STL_sim1 : Solution 1 Result
LC1, Static Step 1
Displacement - Nodal, X
Min : -0.0004, Max : 0.0991, Units = mm
Coord sys : Work Rectangular
Deformation : Displacement - Nodal Magnitude

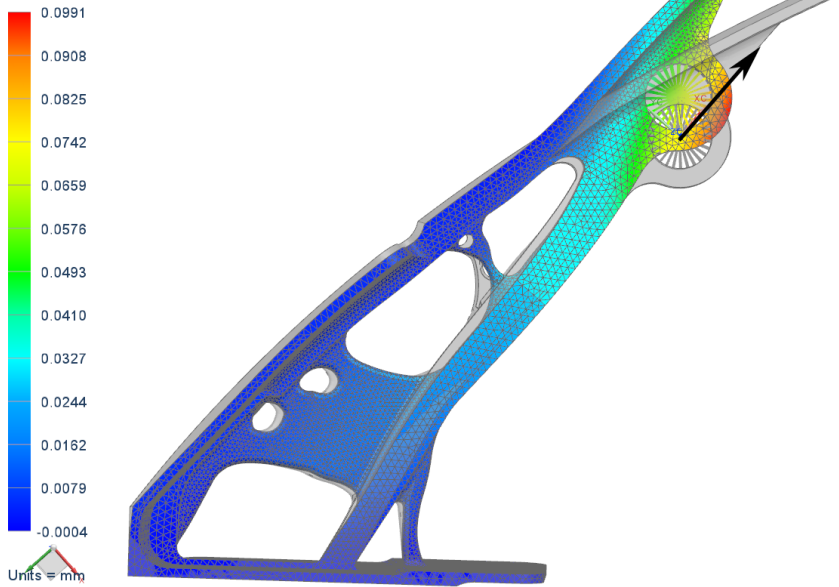

Figure 5.4: Door Connection Joint; Displacement in LC1 direction

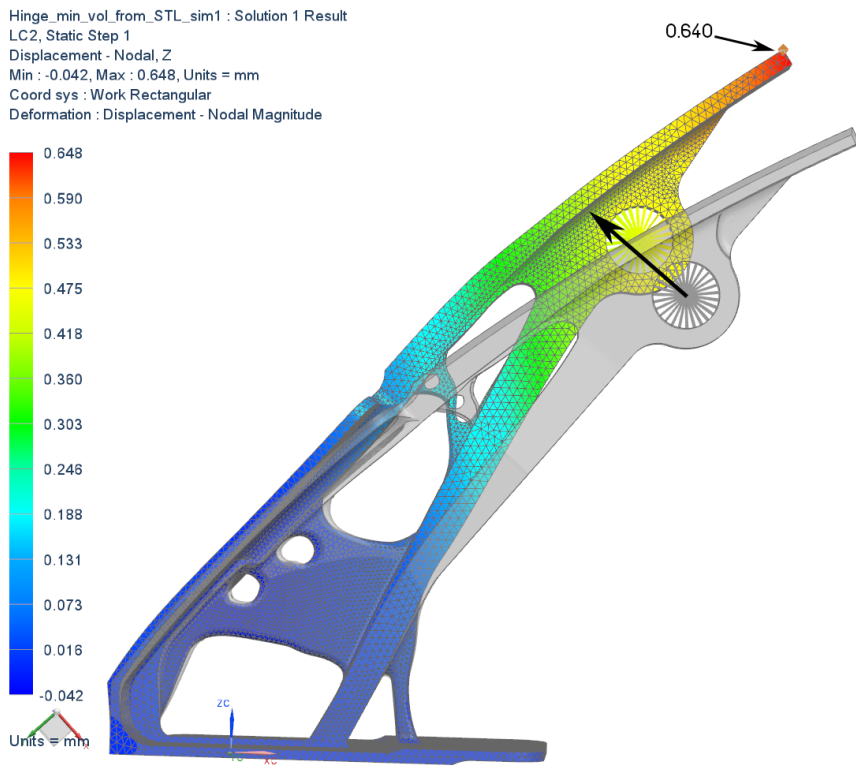

Figure 5.5: Door Connection Joint; Displacement in LC2 direction

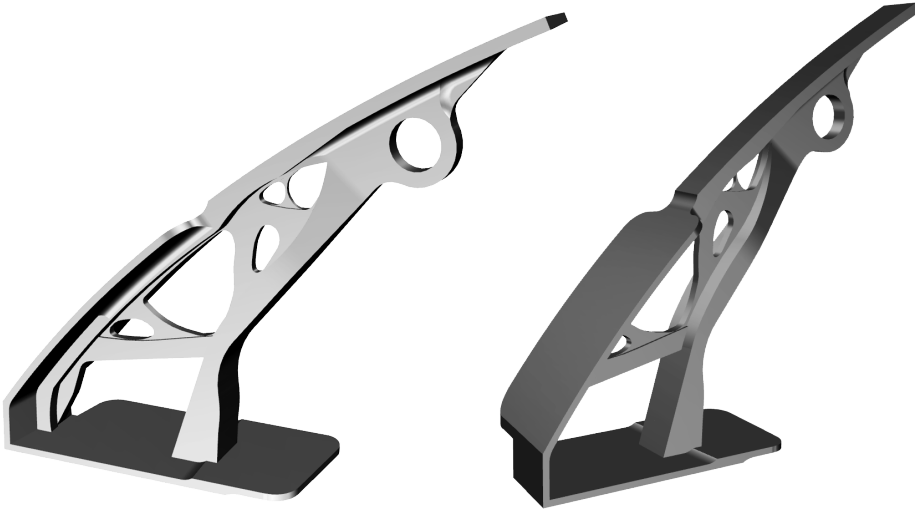

Figure 5.6: Door Connection Joint; Reengineered geometry from minimizing strain energy with prescribed volume fraction [-10%]

5.9 and 5.10, confirming that the proposed reengineered geometry has adequate stiffness. Performance properties from simulations are summarized in table 5.2.

In the baseline, the buckling factor for the first buckling mode was simulated, as this was promoted as one of the most important performance parameters of the FLCA. Optimization using the ATOM did not enable the possibility to constrain buckling performance, but the reengineered geometry have been simulated in the exact same way as in the baseline. Result can be seen in figure 5.11, showing a 9.88% improvement in buckling load.

Figure 5.13 shows the FLCA optimization result and reengineered geometry, printed in 66% of full size.

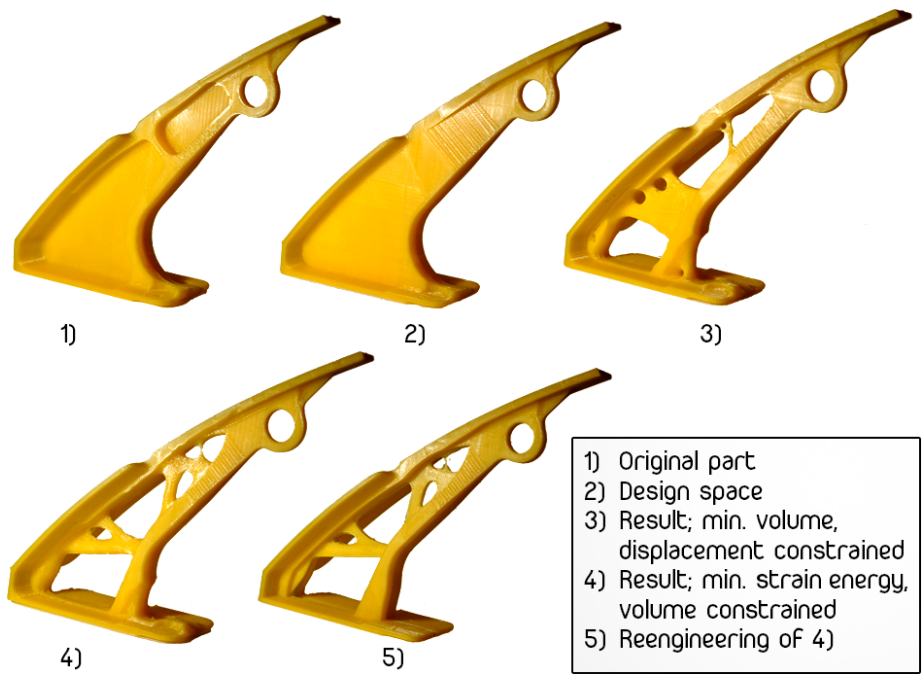

Figure 5.7: Door Connection Joint; 3D printed results from topology optimization in Abaqus

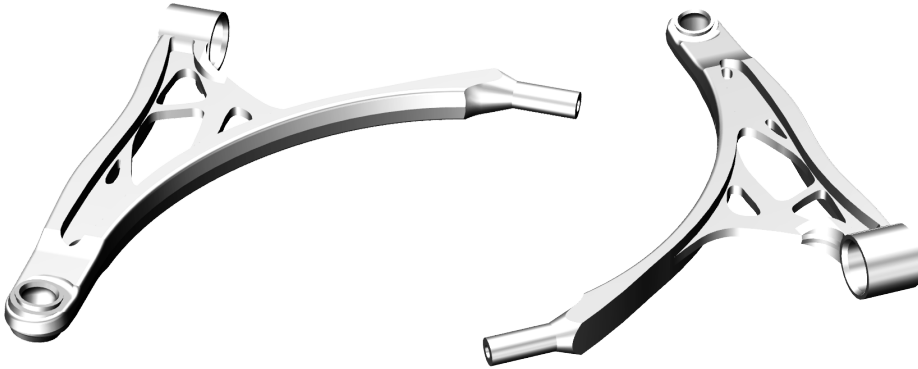

Figure 5.8: FLCA; Reengineered geometry from minimizing volume and constraining displacement

Table 5.2: FLCA; Reengineered geometry performance properties

	FLCA			
	Original part	Original vs. results difference	Reengineering results	Original vs. reengineering results difference
Volume [mm^3]	534688	-6.41%	503029	-5.92%
Displacement-X-direction [mm]	1.418	+0.110%	1.418	0%
Displacement-Y-direction [mm]	0.044	+0.157%	0.044	0%
Buckling load [N]	95380	N/A	104800	+9.88%

FLCA_SJ_Design_space_Ver03_Rev01_reengineered_from_STL_sim3 : 1 Result
X, Static Step 1
Displacement - Nodal, X
Min : -0.099, Max : 1.482, Units = mm
Coord sys : Work Rectangular
Deformation : Displacement - Nodal Magnitude

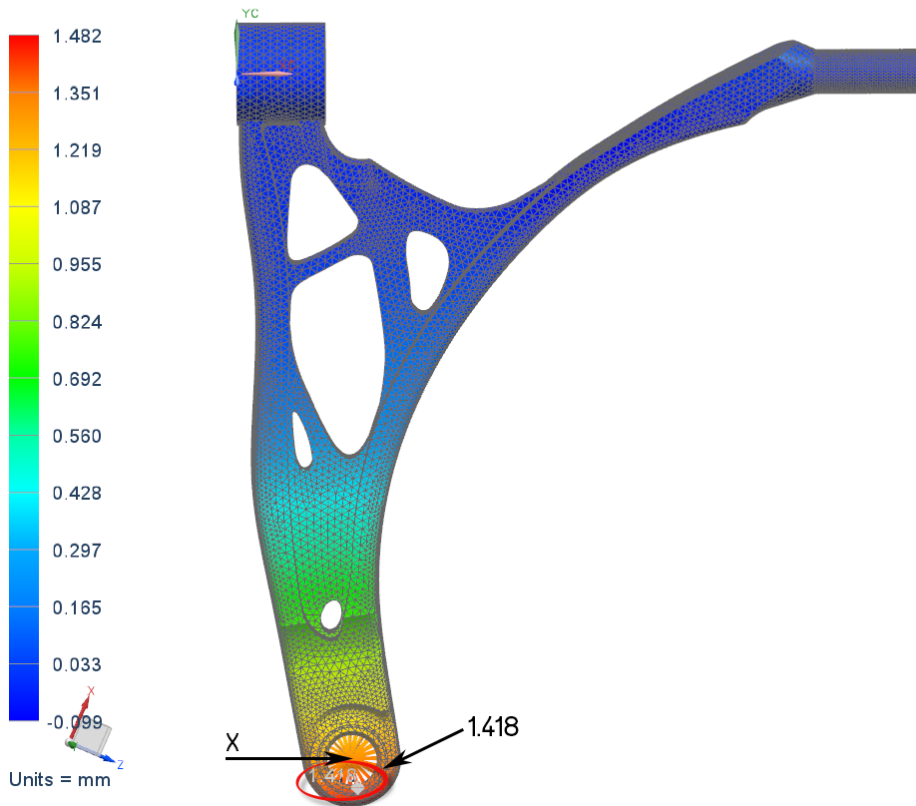

Figure 5.9: FLCA; Stiffness in X-direction of reengineered geometry

FLCA_SJ_Design_space_Ver03_Rev01_reengineered_from_STL_sim3 : 1 Result
Y, Static Step 1
Displacement - Nodal, Y
Min : -0.0021, Max : 0.0460, Units = mm
Coord sys : Work Rectangular
Deformation : Displacement - Nodal Magnitude

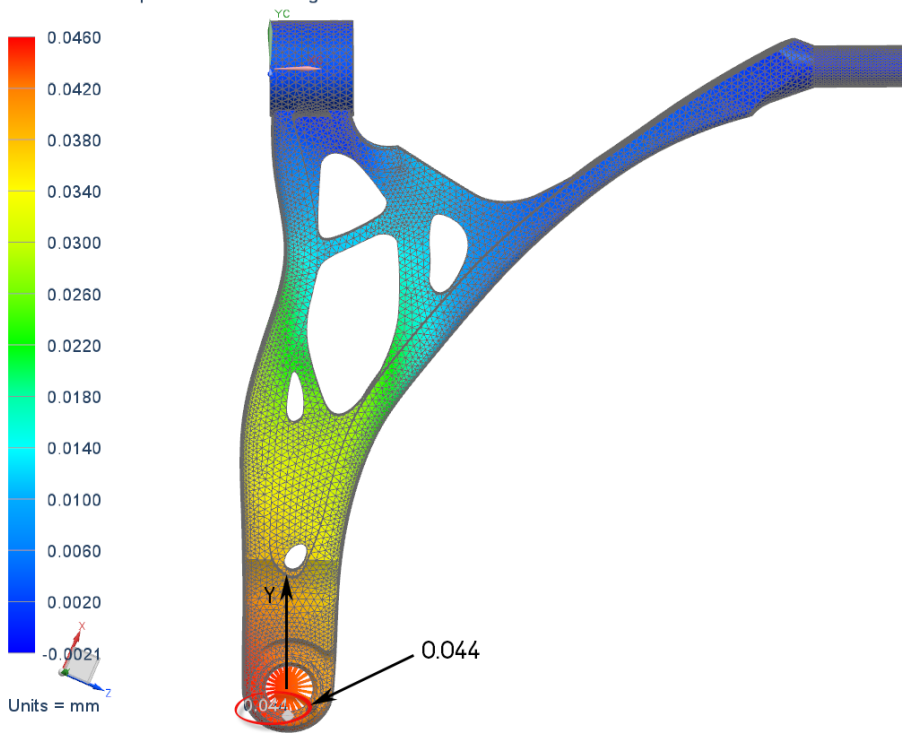

Figure 5.10: Door Connection Joint; Stiffness in Y- direction of reengineered geometry

FLCA_SJ_Design_space_Ver03_Rev01_reengineered_from_STL_sim3 : Solution 1 Result
Subcase - Buckling Method, Mode 1, Eigenvalue = 1.048e+005
Displacement - Nodal, Magnitude
Min : 0.001, Max : 1.018, Units = mm
Deformation : Displacement - Nodal Magnitude

Eigenvalue = 1.048e+005

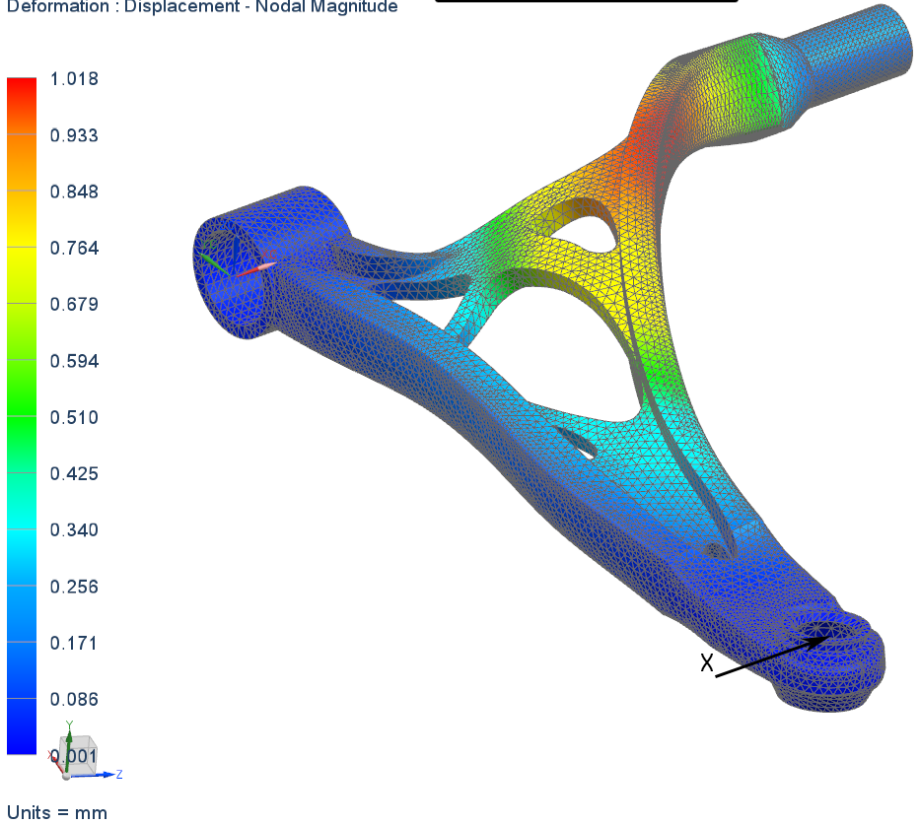

Figure 5.11: FLCA; Buckling factor in X-direction of reengineered geometry

Figure 5.12: FLCA; 3D printed results from topology optimization in Abaqus

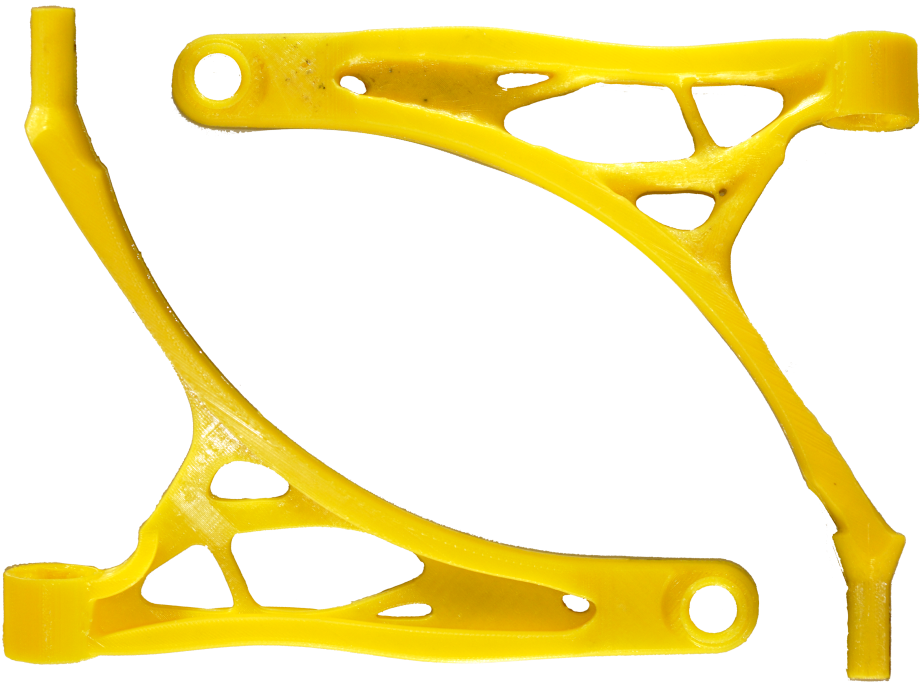

Figure 5.13: FLCA; 3D printed results from topology optimization in Abaqus

Chapter 6

Views on implementation, ease of use and quality of results

The following section is devoted to my subjective views on topology optimization, discussing ease of use and quality of results. For topology optimization to be a useful tool for engineering purpose, the engineer must trust the solution process and results. In my opinion, basic knowledge of the process and mathematical theory makes it easier to trust results and to understand the differences between valid and invalid results. Reading the theory and process description sections in this thesis should be sufficient to get you started with optimization without fearing the output.

In my opinion, results from topology optimization should not be expected to be frightening or difficult to understand. Topology optimization results are merely FE-models that are iteratively updated and analyzed in the same way as an engineer would do, only more precisely updated and less time consuming. The only difference is that the engineer is replaced by algorithms as described in section 2.2.2, and how the process is pre- and post-processed. This is illustrated in figure 6.1.

Some people are worried that as an engineering tool, topology optimization will reduce the need for engineers and knowledge of how to design and dimension components. In my opinion, the opposite is true. Engineers are still required to setup the process, evaluate results and reengineer the geometry. With the

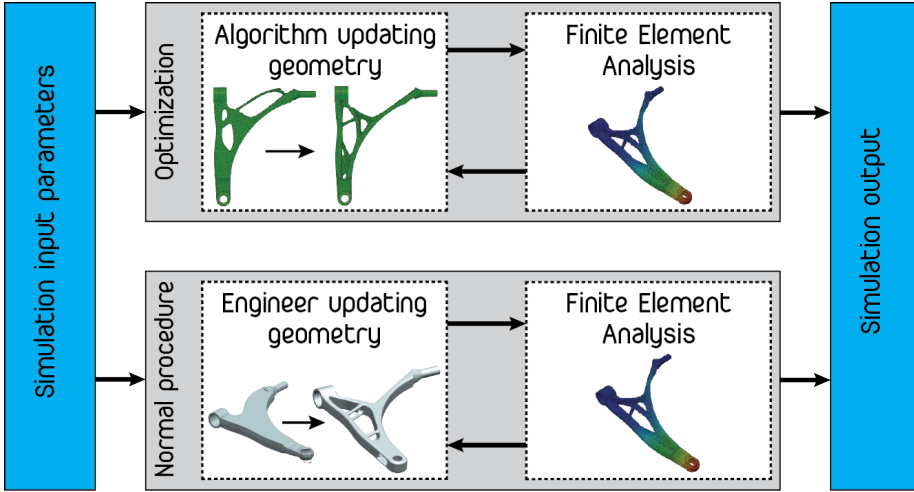

Figure 6.1: Development of parts with normal procedure and using optimization

utilization of optimization algorithms, gradually becoming more stable and sophisticated, engineers are able to push performance limits. This development may be compared to the development and utilization of advanced material and material processing techniques, like tempering processes. Increasing material strength and tailoring material properties increase performance, but simultaneously reduce versatility and tolerances for changes in operation parameters. The same is true for optimized parts; Performance is increased, but the vulnerability to changes in load direction, combination of loads and other factors will increase. This is illustrated in figure 6.2. As previously stated, including all possible loads and load directions is important to reduce the possibility of faulty optimization results. This is illustrated for the Door Connection Joint in figure 6.3, showing the alternative topology obtained by introducing an alternative load direction of LC2, orthogonally on LC1. Insufficient knowledge of loads and boundary conditions is often a source of bad designs, regardless of whether the geometry is improved using the traditional approach or use topology optimization algorithms. It is however worth noting that if the design engineer knows that there is uncertainty in loads, he will often subconsciously take this into account when dimensioning. The algorithm is more efficient and will cynically try to obey constraints as formulated, and is less flexible for handling uncertainties.

As shown in figure 6.4, incorrect setup of the optimization may result in in-

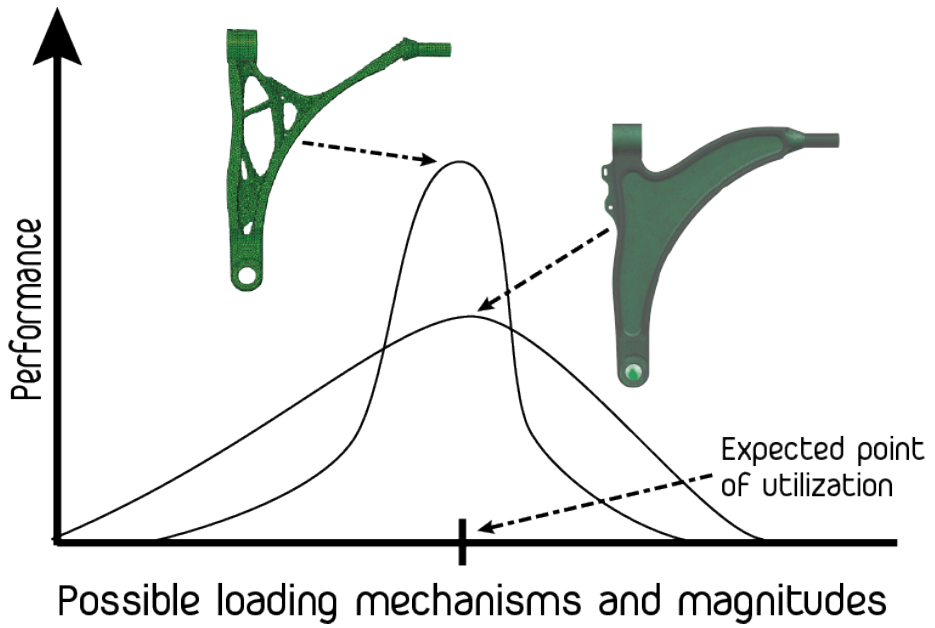

Figure 6.2: Performance vs. versatility; Implication of optimizing components

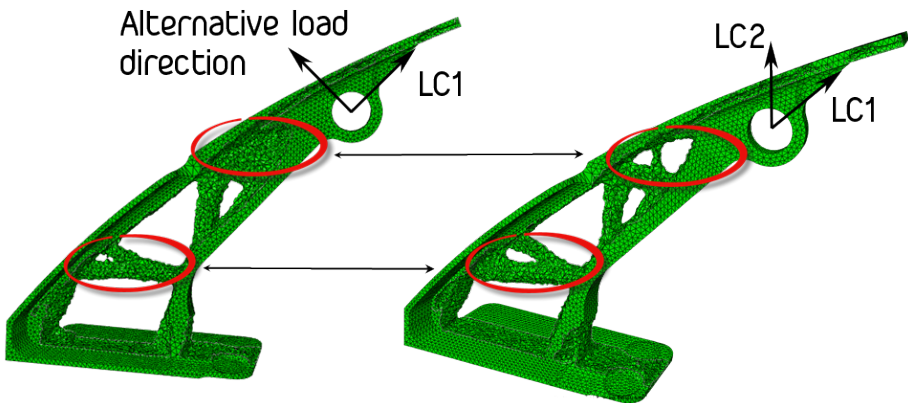

Figure 6.3: Door Connection Joint; Load direction sensitivity and implications on topology

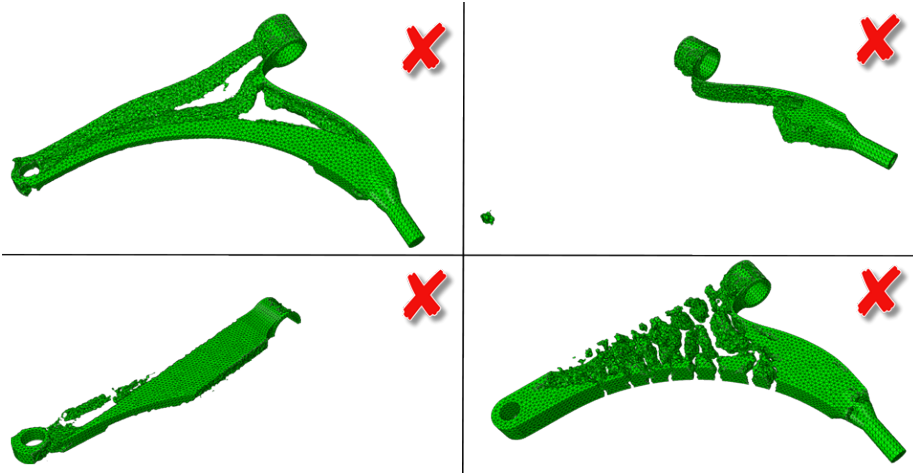

Figure 6.4: FLCA; Invalid topology optimization results

valid results, or no results at all. Through my work with topology optimization, problems are found to occur due to these causes:

- Incorrect setup of initial FE-analysis (insufficient knowledge about the CAE software of choice).
- Incorrect specification of the *Cast condition* geometric constraint.
- Too strict performance constraints that causes the process to diverge and stop after the maximum number of allowed iterations.

From an engineering perspective, valid solutions are found to be material efficient and intuitively reasonable. Smooth transitions and surfaces ensure low stress concentrations and a close to fully-stressed design. The introduction of irregular sized holes provides geometries with a high number of triangles, ensuring that the main loading mechanism is truss-like; mainly giving tensile or compression stresses. Valid solutions are therefore considered to be of good quality. Solution validity is confirmed by checking simulation graphs, plotting objective and constraints values vs. the number of iterations. Visual inspection of the geometry will normally confirm symmetry and manufacturing constraints validity.

Assuming that one is familiar with the theory of topology optimization and possess basic knowledge of how to setup the analysis in the analysis program of choice, setting up the optimization process is very fast. The topology optimization approach is more front and end work loaded compared to the traditional approach being mid work loaded, as illustrated in figure 6.5. As soon as the optimization is clearly defined, the solution process will run by itself without user interference. The dip in work load for the topology optimization approach thus illustrates that the solution process is running, leaving the engineer waiting for results. The engineer is then required to interpret and reengineer results at the end of the process. As illustrated by the colored areas beneath the graphs, the total work load of the traditional approach is higher. Be aware that the horizontal axis of the graph refers to the product development process as a whole. The total amount of time from start to ending is considerably lower using the topology optimization approach, further reducing total work load.

Labor intensive tasks not experienced in the traditional approach are:

- Defining the design space
- Setting up the topology analysis process (using ATOM/ NX Topology optimization module, etc.)
- Solving the analysis
- Reengineering the geometry

An important issue with topology optimization is that it requires powerful computers with high processing capabilities and memory. For larger simulations a minimum of 16 GB RAM or more is recommended, as well as an Intel i7 processor (or equivalent) or better. If one does not possess such equipment, it is recommended to set up the simulation on the available computer and run the simulation on a sufficiently powerful workstation. Storage space is also critical, as the presented simulation runs for the Door Connection Joint and FLCA required 8 GB and 10 GB of storage, respectively.

Considering the aforementioned limitations and personal reflections, I consider the tool to be very useful and relatively easy to use. In my opinion, applying the correct loads and boundary conditions as well as reengineering the geometry are the most challenging tasks encountered. Most of the time spent during the master thesis was used to gain knowledge of the theory and testing different approaches to optimization. To address challenges in energy use and higher demands for performance, I believe it is absolutely necessary to include

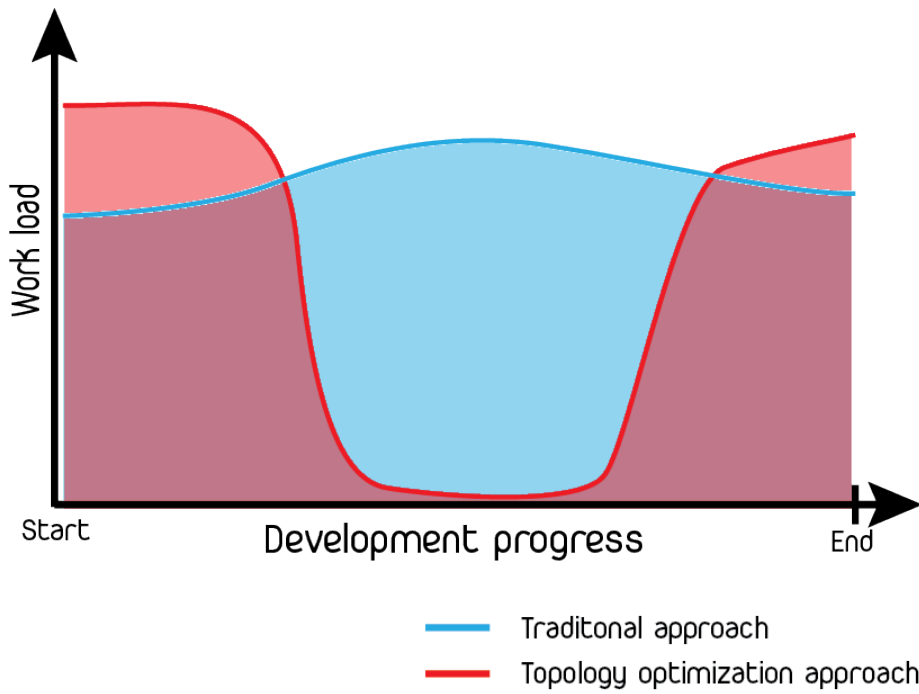

Figure 6.5: Work load; Topology optimization approach vs. traditional approach

optimization as a natural part of product development for engineering applications. As an alternative approach to developing new components, topology optimization can also be used to define an upper performance limit and help engineers decide whether existing components are fully utilizing their potential and if it is cost effective to do changes in the geometry.

The danger of using systematic methods in connection to construction work is to believe that one with certainty reaches a good result, only the approach is followed. Unfortunately, this is not the case. The most effective way of working is therefore an appropriate mix of being systematic and using intuition.

Eskild Tjalve

The quote from Tjalve (found in [29]) was originally intended as a comment to the use of specific methods for product development, but is just as relevant today as a comment to the use of computers and algorithms to aid in development and product design. All in all, the topology approach is very powerful and will in most cases propose solutions that from an engineering perspective give excellent properties. Often the distinction between false and reasonable results is clearly visible, yet it is solely on the shoulders of the engineer to provide both input parameters and to interpret the results in a satisfactory way. When technology takes on traditional tasks of humans, humans must learn to control the technology and use this to obtain the best possible outcome. Human intuition is still required.

Chapter 7

Conclusion and further work

The thesis has mainly focused on the subject of topology optimization with regard to basic theory and practical application using Abaqus and NX, and aim to provide a better understanding of topology optimization for the experienced FE user. The Front Lower Control Arm supplied by Raufoss Technology and Door Connection Joint supplied by the Hellenic Aerospace Industry through the EC SuPLight-project have been subjects for optimization with focus on the geometrical approach to topology optimization for load supporting, 3D continuum structures experiencing strains within elastic limits using isotropic materials. The use of topology optimization for product development may initially seem scary and difficult to understand. Complex mathematical algorithms intended for complex products does not inspire confidence and reassurance, however the thesis aim to provide basic knowledge making it easier to understand implication of settings.

As part of the WP3 delivery in the SuPLight project, topology optimization results from simulations on the Door Connection Joint and FLCA show that it is possible to save respectively 11.2% and 6.41% weight while maintaining stiffness in all anticipated load directions, while preserving manufacturability. Results were obtained by setting the objective to minimize the volume while constraining displacements in load directions to be within limits as calculated in initial baseline simulations. Additionally, frozen areas, symmetry and demold control was specified to ensure manufacturability. Reengineered geometries are heavier than the optimization results, giving a total weight saving of 7.11% and 5.92%, respectively. The initial goal of the SuPLight project was to save 10% weight, however several assumptions, including the available design spaces, load

directions and load magnitudes have been made throughout the process. As previously mentioned, these parameters are highly normative for the outcome of the analysis. The ultimate weight goal is most likely achievable by evaluating load cases and especially the design space, as well as performing size-optimization on the proposed geometries.

For optimization of existing products with known and adequate stiffness, minimization of the volume and restricting displacements give the best results. For the development of new components or in other cases demanding geometries to be as stiff as possible within a certain volume, minimizing the strain energy and setting an upper limit on the volume would be more appropriate.

Topology optimization as an engineering tool is found to be easy to use, giving results that expands the solution space and go beyond constraints and common beliefs about what is proper design. Suggested solutions are often relatively complex, which is expected when performance limits are pushed beyond current standards. In addition to being a creative tool for finding better solutions, the use of topology optimization tools will likely help reduce development time.

Further work Further work on topology optimization should be carried out in the following areas:

- Investigation of non-gradient based algorithms (such as the BESO-algorithm) and corresponding software that provides other solution methods for topology optimization.
- Investigating the use of other design objectives (and software), such as an in-depth analysis of using eigenfrequencies and buckling strength as design objectives.
- Studying the use of topology optimization within assemblies and with boundary conditions like contact forces, gluing, the use of RBE-elements, etc.
- Studying the use of topology optimization for dynamic problems where load direction and magnitude change frequently.
- Investigation and possible development of algorithms where load magnitude and direction can be expressed with a certain amount of uncertainty, for combined proportional and non-proportional simultaneous loading.

Bibliography

- [1] Deliverable 6.1; new industrial models for sustainable and efficient production. Presentation.
- [2] SuPLight. Deliverable 1.5; definition of hai test case component. Presentation.
- [3] Dassault Systèmes. Topology and shape optimization with abaqus. Presentation, 2011.
- [4] Rodrigo Benevides. Boosting the concept of topography optimized parts. Presentation; Altair HTC Congress, 2011.
- [5] S. Wang. *Krylov Subspace Methods for Topology Optimization on Adaptive Meshes*. PhD thesis, University of Illinois, 2007.
- [6] O. Sigmund and J. Petersson. Numerical instabilities in topology optimization: A survey on procedures dealing with checkerboards, mesh-dependencies and local minima. *Structural Optimization*, 16(1):68–75, 1998.
- [7] Hans A. Eschenauer. Topology optimization of continuum structures: A review. 2001.
- [8] *NX8.0 Documentation*, 2012.
- [9] SuPLight. Deliverable 6.2; design of hai test case component. 2012.
- [10] Suplight web page. feb 2013.
- [11] M.P. Bendsøe and O. Sigmund. *Topology Optimization; Theory, Methods and Applications*. Springer, 2 edition, 2004.
- [12] Esteco. *modeFrontier User Manual*, 4 edition, 2008.

- [13] Wikipedia; pareto efficiency, 2013.
- [14] Marco Cavazzuti and Luca Splendi. Structural optimization of automotive chassis: Theory, set up, design. Technical report, MilleChili Lab, Dipartimento di Ingegneria Meccanica e Civile, Modena, Italy.
- [15] Carl Skaar. Parametrization and multiobjective optimization. Master's thesis, Norwegian University of Science and Technology, 2013.
- [16] Espen Nilsen. Parametrization and multiobjective optimization. Master's thesis, Norwegian University of Science and Technology, 2013.
- [17] Mohammad Rouhi. Topology optimization of continuum structures using element exchange method. Master's thesis, Mississippi State University, 2009.
- [18] M. Stolpe and K. Svanberg. An alternative interpolation scheme for minimum compliance topology optimization. *Structural Multidisciplinary Optimization*, 22:116–124, 2001.
- [19] P.M. Clausen O. Sigmund. Topology optimization using a mixed formulation: An alternative way to solve pressure load problems. *Computer Methods in Applied Mechanics and Engineering*, (196):1874–1889, 2006.
- [20] Jorn S. Hansen Kai A. James and Joaquim R.R.A. Martins. Structural topology optimization for multiple load cases using a dynamic aggregation technique. *Engineering Optimization*, 2009.
- [21] Niels Olhoff Martin P. Bendsøe and John E. Taylor. A variational formulation for multicriteria structural optimization. *Journal of Structural Mechanics*, 1983.
- [22] Wikipedia; multi- objective optimization, 2013.
- [23] Krishnan Suresh. A 199-line matlab code for pareto-optimal tracing in topology optimization. 2010.
- [24] Chen Y et al. Multiobjective topology optimization for finite periodic structures. *Comput Struct*, 2009.
- [25] O. Sigmund. A 99 line topology optimization code written in matlab. 2001.

- [26] Claudio Padra Raúl A. Feijòo, Antonio A. Novotny and Edgardo O. Taroco. The topological shape sensitivity analysis and its applications in optimal design. 2002.
- [27] D. Tscherniak and O. Sigmund. A web- based topology optimization program. 2001.
- [28] Dassault Systèmes. *Abaqus User Manual*, 2011.
- [29] Mette Mo Jakobsen. *Produktutvikling; Verktøykasse for utvikling av konkurransedyktige produkter*. Fortuna Forlag, 1997.

Appendix A

A3 brief on generation of design space using Unigraphics NX

TOPOLOGY OPTIMIZATION process description; generating design space

Topic: Generating the design space

Name: Steffen Johnsen

Date: 10.04.2013

Approved by: Terje Rølvåg

When performing a topology optimization, the algorithm changes the relative density of the elements created when meshing the model. The relative density is a continuous value ranging from 0 (void/ hole) to 1 (the real reality of the material). Reducing the density of an element will also reduce the stiffness of that particular element, and its contribution to the overall stiffness will decrease. The algorithms can only decrease or increase the density of elements that were present at the beginning of the analysis. This means that no material will be added during the optimization beyond what was already present. It is therefore of great importance to define a design space that is as large as possible within the constraints of the surrounding environment (tother parts, operational specifications, size specifications, etc.). The larger the design space, the better the proposed solutions will be, since the number of possible configurations will increase.

Best practice when defining the design space is to use the Synchronous modeling functionality in the NX Modeling environment (See Toolbar or click Insert > Synchronous Modeling). The most widely used functionalities are 1) Replace Face and 2) Delete face, that will assist you in removing features and closing voids. Make sure to preserve all features that are important for the functionality of the part. These can be frozen for later use, so that they are not affected by the density updates.



1)

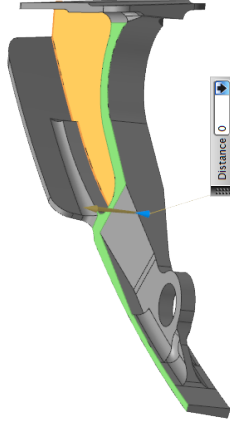
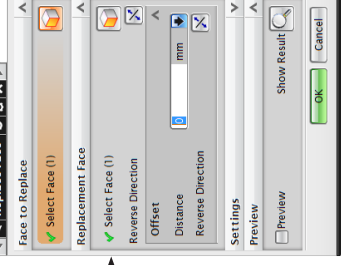

Replace Face

2)

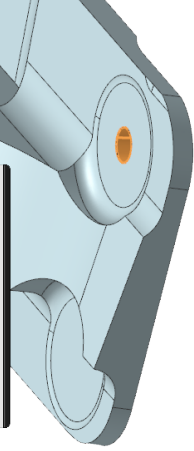

Delete face

Original part

Design space

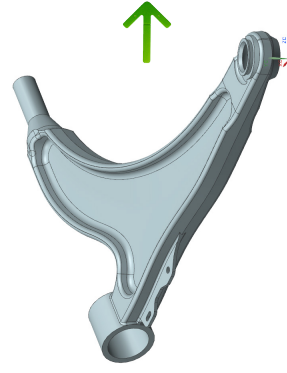
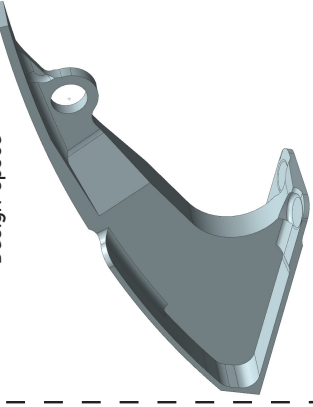
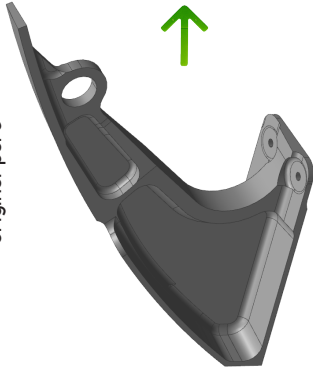

Appendix B

A3 brief on optimization using Abaqus ATOM

TOPOLOGY OPTIMIZATION process description using Abaqus ATOM

Topic: Introduction to topology optimization using Abaqus ATOM

Name: Steffen Johnsen

Date: 10.04.2013

Approved by:
Terje Rølvåg

Abaqus ATOM is one of the most powerful commercial software today for topology optimization.

This knowledge brief is aimed at providing knowledge transfer and understanding of the process involved with setting up and understanding the results of a topology analysis.

As a Single Objective Analysis software with capabilities of specifying weighted objectives, Abaqus ATOM can solve a vast amount of different problems, including, but not limited to problems of structural, thermal, flow, electrical and magnetic nature.

The process description assumes that the reader is familiar with the UI of the CAE- system and is capable of setting up a standard linear structural simulation. The reader should also possess basic knowledge of FE- theory.

Topology optimization is particularly powerful for enhancing creativity and visualizing solutions not initially apparent to the engineer. The method is unique as it provides optimal solutions for the given boundary conditions and specified design responses. Engineering experience will always be required to evaluate results, but is naturally limited when faced with conflicting constraints and the ability to find optimal solutions.

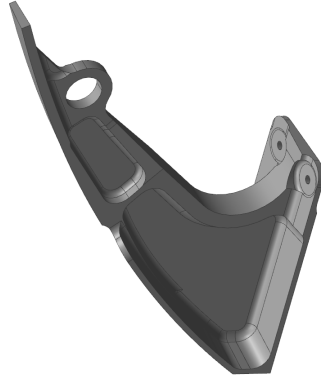

Original part

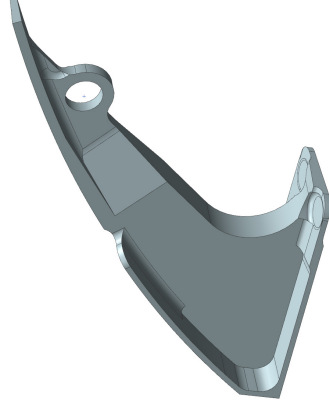

Design space

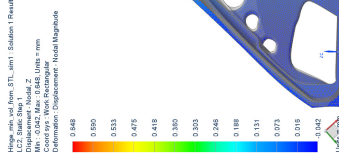

Reference simulation

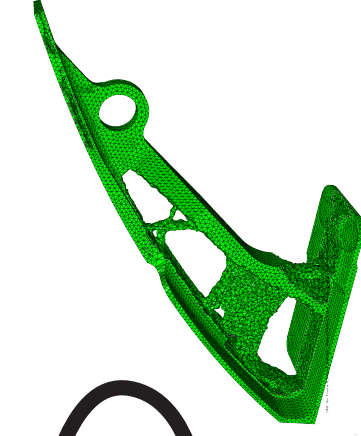

Optimization result



Reengineered part



TOPOLOGY OPTIMIZATION process description using Abaqus ATOM

Topic: Creating a new topology optimization

Name: Steffen Johnsen

Date: 10.04.2013

Approved by:
Terje Rølvåg

To create a new topology optimization simulation, setup a the model under analysis with properties, boundary conditions and mesh as you would do with any other FE- simulation.

Then navigate to Module -> Optimization and navigate through the menus you can see on the next pages.

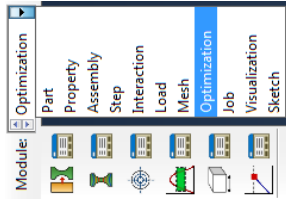

If you are performing a pressure load analysis, Freezing load regions will eliminate the need for using the RAMP material interpolation technique. Additional Frozen regions can be specified at a later stage.

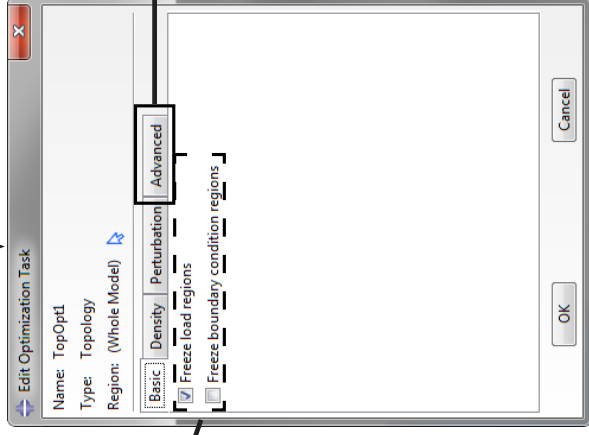
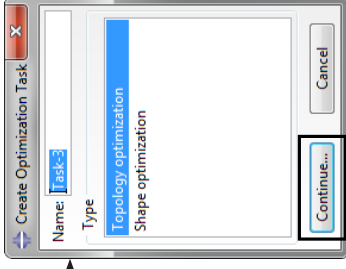
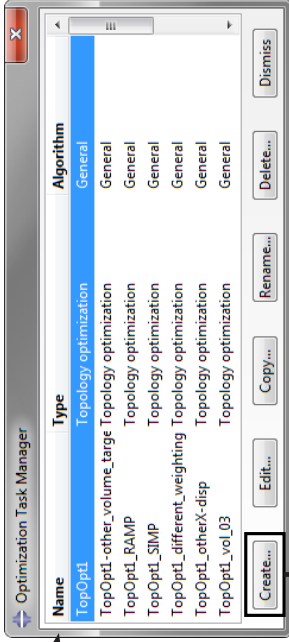
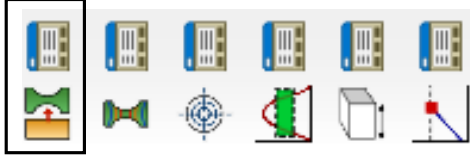

For problems where only strain energy and volume are of interest, the more efficient stiffness optimization algorithm can be used.

Use the default material interpolation technique (normally the SIMP technique will be used when set to default) unless dealing with problems containing pressure loads, where the RAMP technique is the better choice when boundary faces are changing during the optimization.

Convergence criteria used to determine if the solution has converged. Default values are quite strict, so for initial simulations, corner values might be used to lower simulation time. Additional convergence criteria can also be specified at a later stage.



TOPOLOGY OPTIMIZATION process description using Abaqus ATOM

Topic: Defining design responses for the optimization

Name: Steffen Johnsen

Date: 10.04.2013

Approved by:
Terje Rølvåg

Design responses can be seen as the simulation variables. They are defined before the simulation objective and constraints are set.

Design responses may be specified for the entire model, or for specific regions of the geometry.

Best practice when defining design responses:

- If possible, define the design responses for smaller areas. These areas might be specific regions of interest, such as fillets, holes and functional surface. The more specific the area or region, the better the simulation will run, leaving less chance of detecting other mechanisms than the one intended.
- Use the Tools -> Datum -> Point or CSYS to define control points or additional coordinate systems for easier reference of loads and boundaries and specification of design responses. When defining a displacement constraint, it is important to specify the coordinate system and direction of interest.

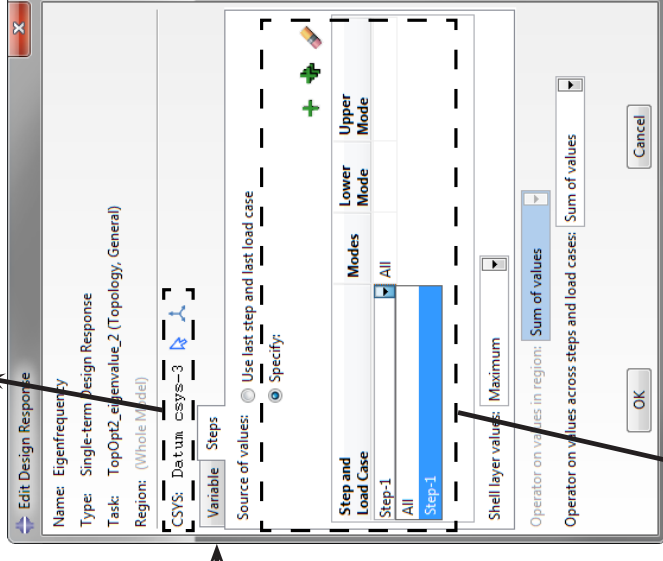
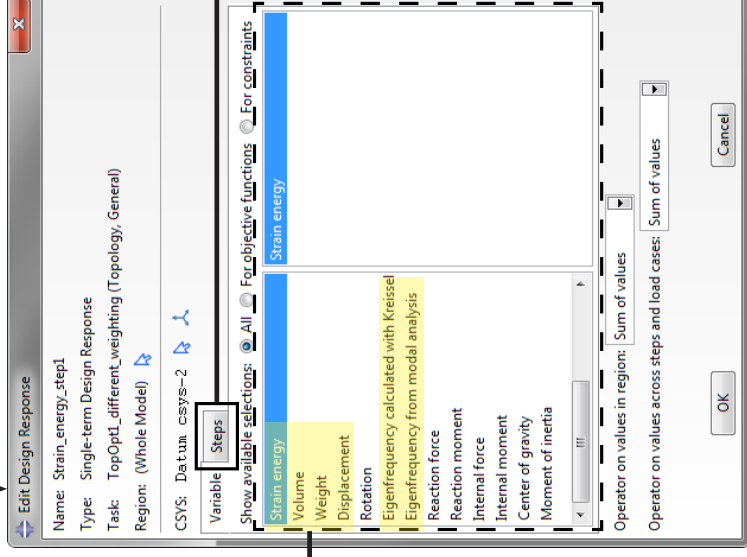

Specifying the coordinate system is vital when optimizing wrt. displacement in a particular direction (ex. the load direction), as these directions are selected as principal axis in the coordinate system of choice.

Design responses that are available for the chosen optimisation algorithm.

If you have multiple load cases in different simulation steps, specifying the step(s) for which the design response is valid is important in order to get correct results.



TOPOLOGY OPTIMIZATION process description using Abaqus ATOM

Topic: Defining the objective definition and constraints

Name: Steffen Johnsen

Date: 10.04.2013

Approved by:
Terje Rølvåg

In general, there are three different approaches to optimizing a structure using Abaqus:

- 1) Minimize (or minimize the maximum) strain energy, constrained with an upper limit on the relative volume fraction.
- 2) Minimize the volume, constrained with an upper limit for displacement, moment of inertia, reaction forces, CoG or rotation (or a combination of these).
- 3) Maximize eigenfrequencies, constrained with a LOWER limit for volume or/and limits for other design responses that are independent of loads (as eigenvalue analysis are performed without external forces applied).

Best practice when defining the objectives and constraints:

- Choose the design response that has the highest uncertainty. If the target volume is specified, choose an approach that has volume as a constraint.
- If you have more than one load case, the MinMax formulation will provide a solution that has better overall robustness.

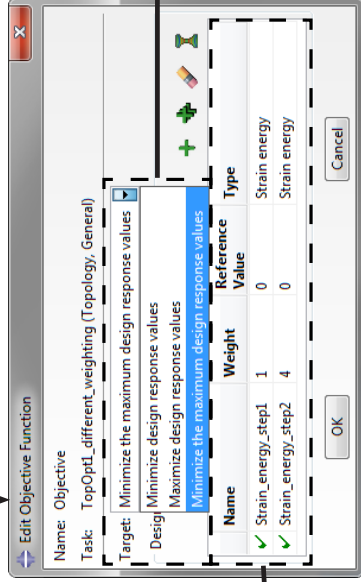
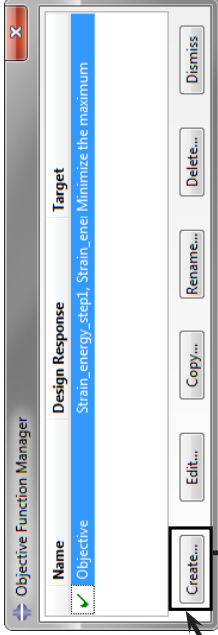

If the target type is similar for more than one design response, a weighted average can be specified.

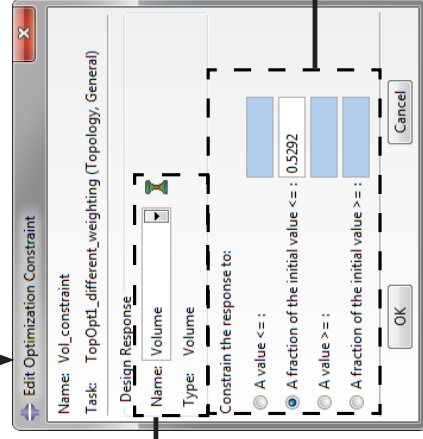
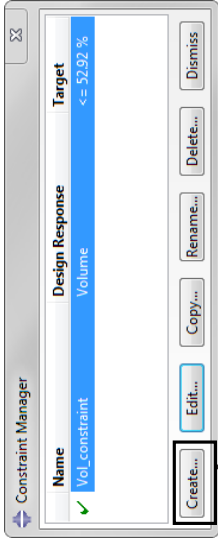

Specification of which design response(s) to use as simulation constraints.

Constraints can be specified as an absolute value or as a relative value, both for upper or lower limits. Multiple constraints can be specified. Be aware that more constraints will decrease the chance of converging the objective.

The objective target can be set to MINIMIZE, MAXIMIZE or MINIMIZE THE MAXIMUM (MinMax). F. ex. you will most likely minimize a volume objective, maximize an eigenvalue objective or minimize the maximum strain energy (requires that you have multiple design responses with strain energy defined, one for each load case). The MinMax formulation is especially powerful for creating robust designs, as the final solution will be equally good for all load cases.

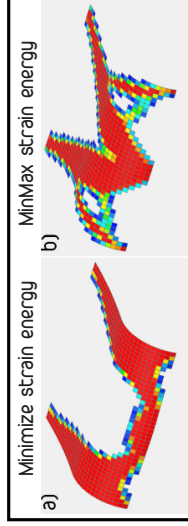

suplight

TOPOLOGY OPTIMIZATION process description using Abaqus ATOM

Topic: Defining geometric constraints

Name: Steffen Johnsen

Date: 10.04.2013

Approved by: Terje Rølvåg

As a rule of thumb, a general analysis should be performed before geometric constraints are introduced, as they will increase computational time as well as limit the available design space, giving a less optimal solution.

Demold control is probably one of the most important geometric constraints, as it ensures that production methods like casting, stamping, forging and machining can be used. If the design space BC's introduce some kind of torsion or angular momentum in the part, internal voids and holes will be made, as material is preferred at the outer premises of the design space. This is done to increase the second moment of inertia.

Symmetry constraints can be specified as planar, rotational, cyclic or for a point. Using the symmetry constraint, solutions will look more aesthetic, and they will be easier to produce.

Frozen faces will not be affected, and will remain the same after the analysis has ended. This is particularly useful to maintain areas of geometric significance, as the algorithm is forced to shave off weight from other areas of the design space.

Specifying an lower or upper limit for the member size will restrict the results from having too thin or thick members that cannot be produced.

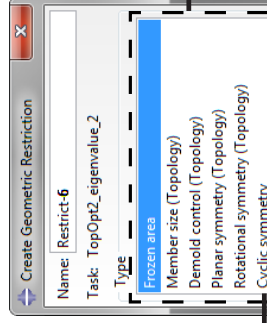
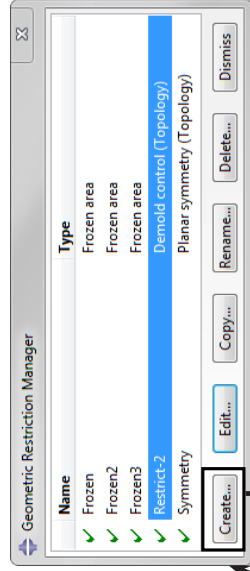
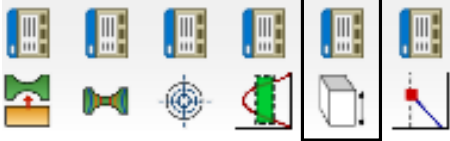

Available geometric restrictions.

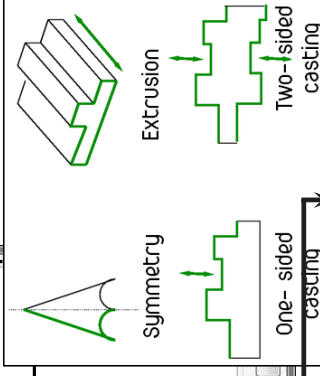

The designer must specify which region to control, which region to perform collision checks on (between tool and workpiece), as well as type of demold technique, coordinate system and pull direction vector.

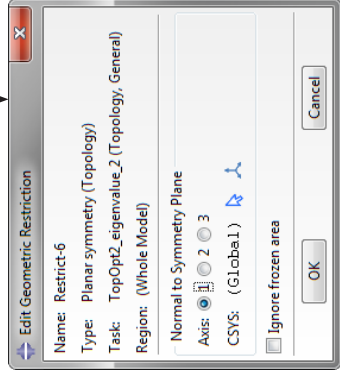

TOPOLOGY OPTIMIZATION process description using Abaqus ATOM

Topic: Running the topology optimization

Name: Steffen Johnsen

Date: 10.04.2013

Approved by: Terje Rølvåg

In order to run the simulation, an optimization process must be made. In the optimization Process Manager, Clicking Monitor will let you see the progress for each iteration, while clicking Results will let you see the iterations so far, visualized on the part.



Name	Model	Task	Status
Opt-Process-1	Model-1	TopOpt1	Completed
Opt-Process-1_other_volume_target	Model-1	TopOpt1-other_volume	Completed
Opt-Process-1_vol_03	Model-1	TopOpt1_vol_03	Completed
Opt-Process-1_vol_04	Model-1	TopOpt1_vol_04	Completed
Opt-Process-1_vol_05	Model-1	TopOpt1_vol_05	Completed
Opt-Process-1_vol_06	Model-1	TopOpt1_vol_06	Completed
Opt-Process-1_vol_07	Model-1	TopOpt1_vol_07	Completed
Opt-Process-2_kreiss_eigenfrequency	Model-1	TopOpt2_eigenvalue	Aborted
Opt-Process-3_RAMP	Model-1	TopOpt1_RAMP	Completed
Opt-Process-4_SIMP	Model-1	TopOpt1_SIMP	Completed
Opt-Process-5_2_1_weighting	Model-1	TopOpt1_different_weig	Terminated
Opt-Process-6_disp_vol	Model-1	TopOpt_disp_vol	Completed

Optimization process: Opt-Process-1_other_volume_target Status: Completed Current job: Monitor

Log | Errors | Warnings | Output File |

Starting Abaqus/ATOM optimization module - design cycle 31
Starting Abaqus/ATOM optimization module - design cycle 32
Starting Abaqus/ATOM optimization module - design cycle 33
Abaqus/ATOM ended successfully
Completed: Thu Apr 04 22:46:20 2013
Search Text
Text to find: Match case Next Previous

When monitoring the simulation, you can see that the algorithm performs a density update followed by a FE- simulation to update the design response values and check for convergence.

Name: Opt-Process-13
Model: Model-1
Task: TopOpt1
Description: (Topology, General)

Optimization | Submission | Memory | Parallellization

Use multiple processors
- Abaqus/Explicit
Number of domains: 4
Parallellization method: Domain
Multiprocessing mode: Default

Controls
Maximum cycles: 50
Data saved: First and last cycle Every cycle

The maximum number of cycles can be limited, but the number should be so high that the convergence criteria stops the simulation.

Choose which topology optimization to solve.

If you have more than two processors, assign more to speed up the simulation.



TOPOLOGY OPTIMIZATION process description using Abaqus ATOM

Topic: Post- processing of optimization results

Name: Steffen Johnsen

Date: 10.04.2013

Approved by: Terje Rølvåg

Post- processing of results is important to verify that the simulation has converged, and that the design constraints are within limits. Graphs can be generated by the software by clicking the Graph- icon in the visualization manager (see illustration below), by selecting the design responses of interest and plotting these.

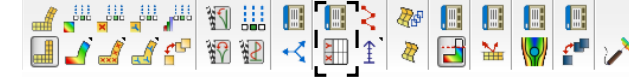

When viewing results that are dependent on direction, the user can specify which coordinate system to be used by clicking (in Visualization environment) Results -> Options -> Transformation -> User- specified, and choosing the correct CSYS of interest. Results surface extraction can be done by clicking (in the Job environment) Optimization Process Manager -> Extract. As the figure in the upper right corner shows, varying the ISO- value (or Target volume) will have the largest impact on the resulting STL- file. Increasing the Number of Smoothing Cycles (NSC) will give a smoother surface, while increasing the Reduction percentage (R%) will give a coarser surface as the surface complexity will be reduced.

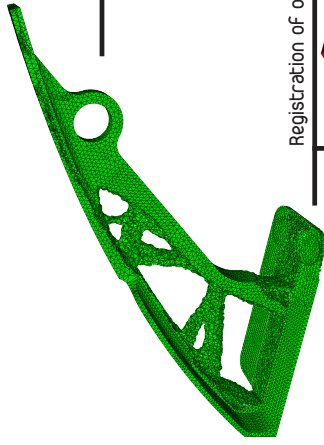

Surface extraction (STL Files)

Registration of optimization results

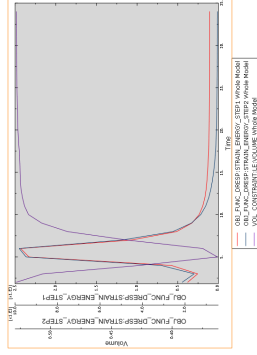
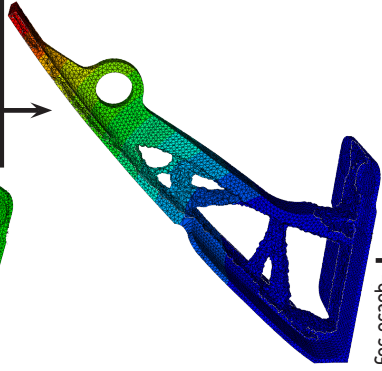

Tools for graphing the design responses.



Interpretation and regeneration

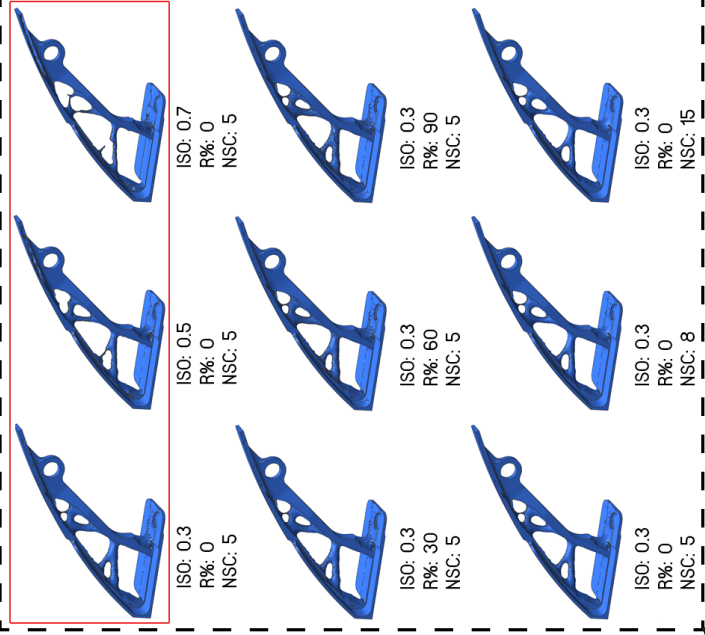
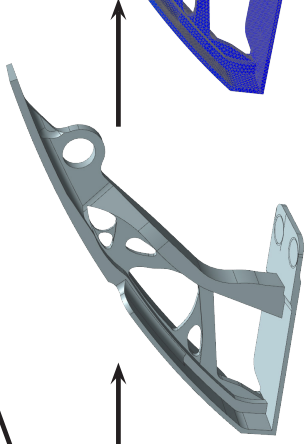
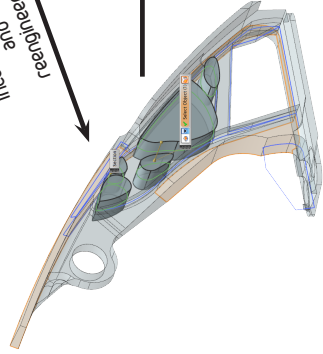

suplight

TOPOLOGY OPTIMIZATION process description using Abaqus ATOM

Topic: Topology optimization; minimize strain energy with upper volume limit, summary

Name: Steffen Johnsen

Date: 15.04.2013

Approved by:
Terje Rølvåg

1. Setup a normal static analysis containing all boundary conditions. Both linear analysis and geometric nonlinear analysis are supported.
2. Evoke the Optimization environment, and create a new Optimization task, and define a name for the optimization. Make sure to choose whether to use the General algorithm or the stiffness algorithm.
3. Define all Design responses in the Design Response Manager (all properties that will be influenced in the analysis; volume, eigenfrequencies, strain energy, displacement, etc.)
4. Choose which Design response(s) to use as an Objective in the Objective Function Manager. Weigh multiple objectives against each other and choose whether to maximize, minimize or minimize the max (preferred).
5. Define scalar constraints for the remaining Design responses.
6. Define Geometric Constraints (symmetry, frozen areas, cast condition, etc.). Use as few as possible, and run the First- optimization without to see what is demanded.
7. Create an Optimization process in the Job Manager and specify which topology optimization to run. Start the optimization process.
8. Monitor progress by clicking Monitor during the optimization process in the Job Manager.
9. When optimization has converged: Look at results by clicking Results in the Job Manager.
10. In the Job Manager: Click Extract and extract an STL- File from the Final result. Make a copy of the .prt- File with the design space, import the STL file and use modeling tools and transform the part to look like the optimization result, or import the STL into an empty part and build the new part from scratch.

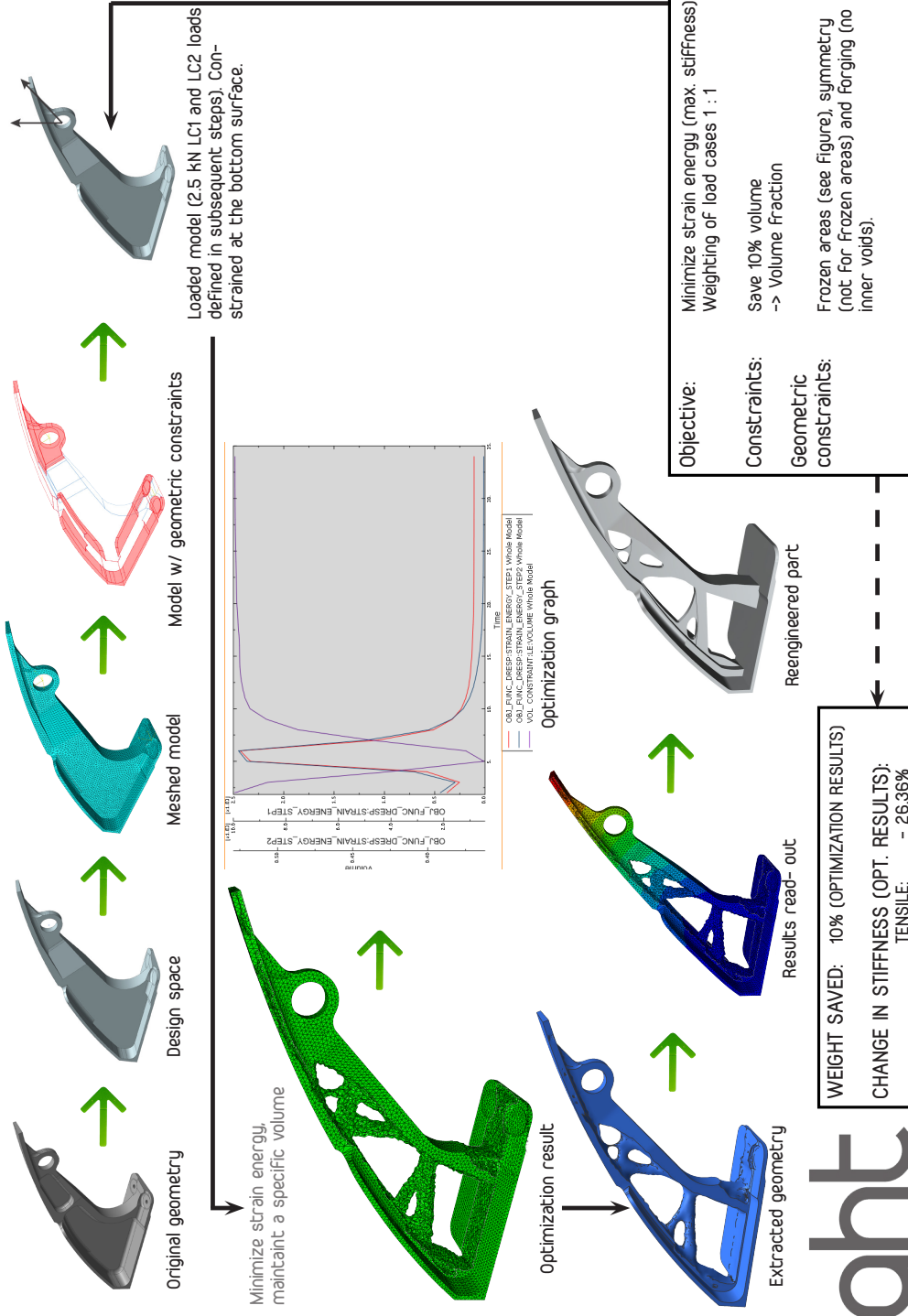

suplight

TOPOLOGY OPTIMIZATION process description using Abaqus ATOM

Topic: Topology optimization; MDO with displacement and strain energy vs. volume

Name: Steffen Johnsen

Date: 05.04.2013

Approved by:
Terje Rølvåg

Using a MDO (multi-disciplinary optimization)- approach to the simulation makes it possible to display Pareto curves.

The simulations have been performed with the objective to MINIMIZE STRAIN ENERGY, hence maximize stiffness, as well as maintaining a volume less than a SPECIFIED VOLUME CONSTRAINT. As both INX and Abaqus are able to perform optimization with a single objective (or in the case of Abaqus; a weighted average of the specified objectives), multiple simulations have been performed with different volume constraints, ranging from 5% to 119% of the reference volume.

The upper graph shows the displacement wrt. the displacement of the reference geometry. The lower graph displays the same properties in the LC2 load case, but with strain energy as a measure of the structural stiffness, also showing the iterations during each optimization run. All curves display the boundary between feasible and infeasible solutions; hence the line represents the best possible result given the chosen constraints. This gives the designer knowledge of how changing one parameter will change another, and facilitates a reflected choice of final design.

TV = Target Volume
DS = Design Space
RV = Reference Volume

Normalized displacement vs. volume fraction of reference volume

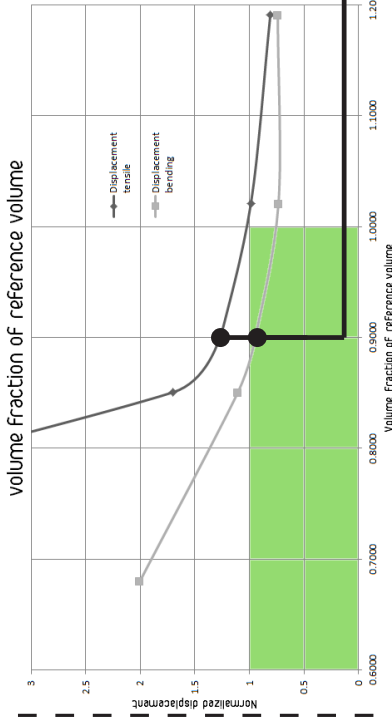

Pareto curve; Discrete Topology optimization runs
Objective: MinMax strain energy (max. stiffness) in LC2 direction
Constraints: Volume fraction and geometric const.

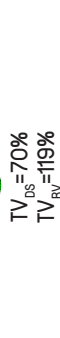
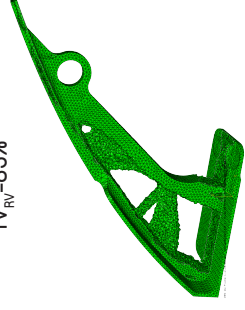
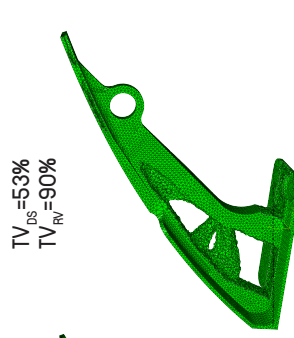
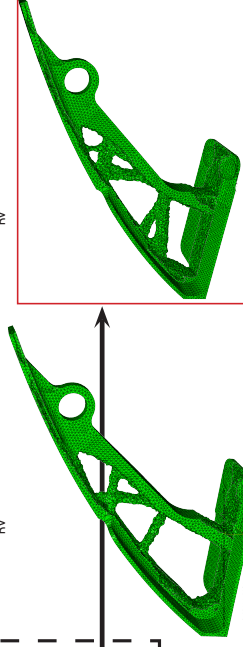
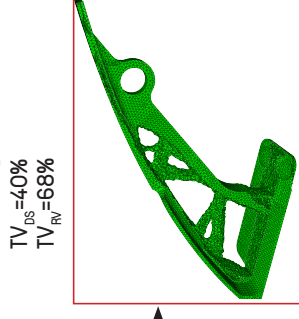
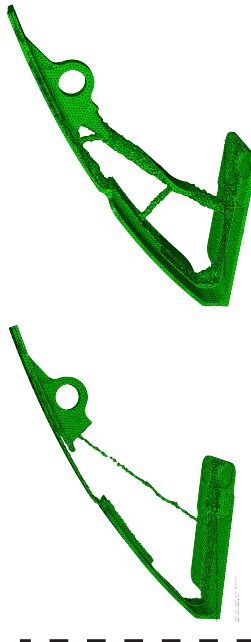
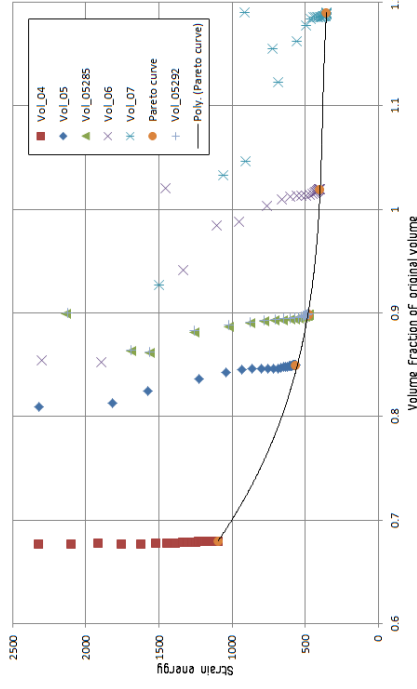

TOPOLOGY OPTIMIZATION process description using Abaqus ATOM

Topic: Topology optimization; minimize volume and maintain displacement, summary

Name: Steffen Johnsen

Date: 15.04.2013

Approved by:
Terje Røhlvåg

1. Setup a normal static analysis containing all boundary conditions. Both linear analysis and geometric nonlinear analysis are supported.
2. Evoke the Optimization environment, and create a new Optimization task, and define a name for the optimization. Make sure to choose whether to use the General algorithm or the Stiffness algorithm.
3. Define all Design responses in the Design Response Manager (all properties that will be influenced in the analysis; volume, eigenfrequencies, strain energy, displacement, etc.)
4. Choose which Design response(s) to use as an Objective in the Objective Function Manager. Weigh multiple objectives against each other and choose whether to maximize, minimize or minimize the max (preferred).
5. Define scalar constraints for the remaining Design responses.
6. Define Geometric Constraints (symmetry, frozen areas, cast condition, etc.). Use as few as possible, and run the First optimization without to see what is demanded.
7. Create an optimization process in the Job Manager and specify which topology optimization to run. Start the optimization process.
8. Monitor progress by clicking Monitor during the optimization process in the Job Manager.
9. When optimization has converged: Look at results by clicking Results in the Job Manager.
10. In the Job Manager: Click Extract and extract an STL - File from the Final result. Make a copy of the .prt - File with the design space, import the STL file and use modeling tools and transform the part to look like the optimization result, or import the STL into an empty part and build the new part from scratch.

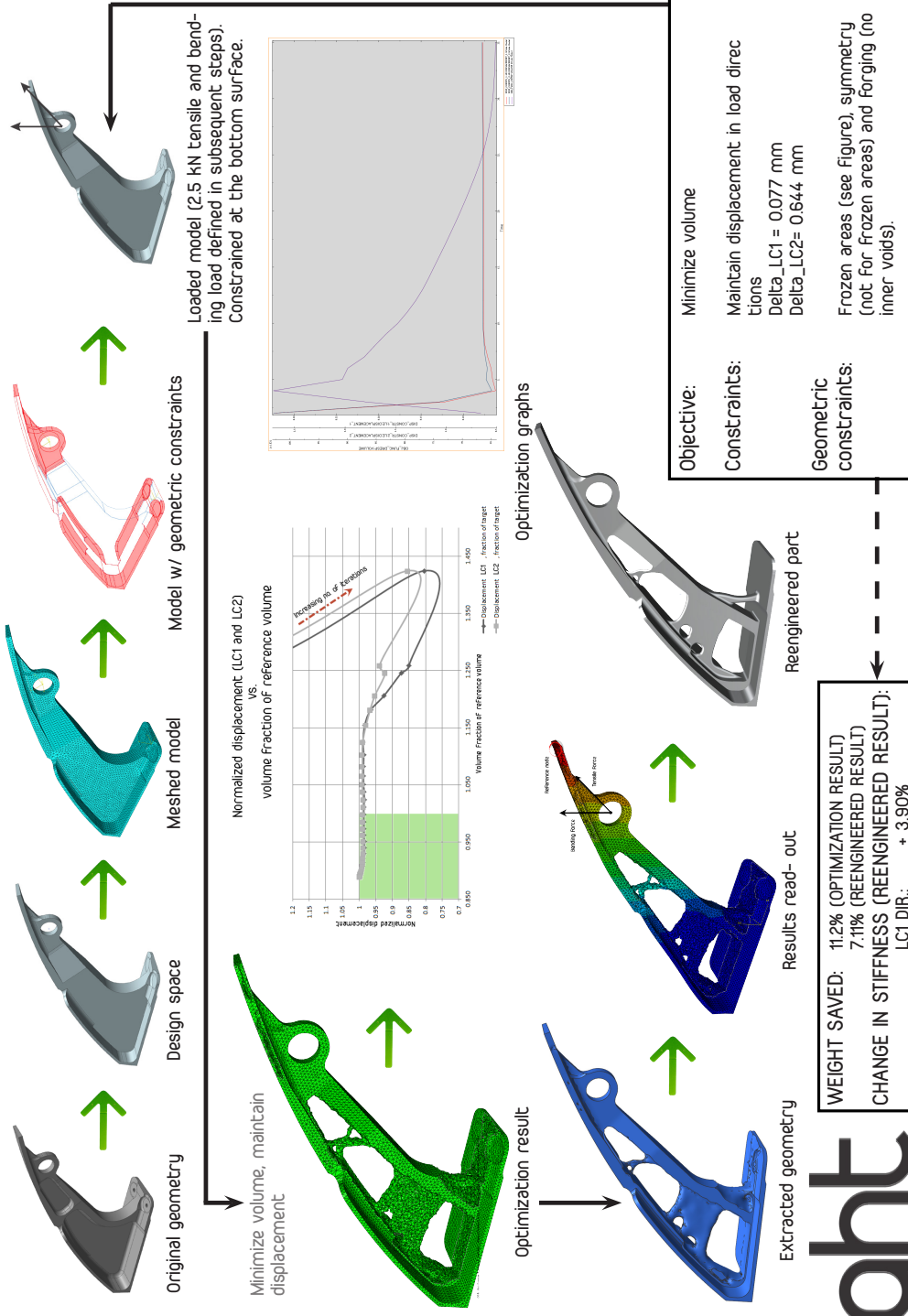

TOPOLOGY OPTIMIZATION process description using Abaqus ATOM

Topic: Topology optimization; minimize volume and maintain displacement in Force direction

Name: Steffen Johnsen

Date: 05.04.2013

Approved by:
Terje Rølvåg

Another method when performing topology optimization is based on MINIMIZING VOLUME (objective) and PRESCRIBING THE DISPLACEMENT. The solution method then provides a solution with a PRESCRIBED STIFFNESS (if the solution converges) and the LOWEST POSSIBLE VOLUME. These constraints can be specified for the overall displacement magnitude of a load case or for specific directions. This sheet shows the HAI hinge optimized with this method and similar geometric constraints as specified earlier in the brief.

Constraints:

$\Delta_{\text{tensile}} = 0.077 \text{ mm}$

$\Delta_{\text{bending}} = 0.644 \text{ mm}$

The graph shows the resulting displacement and corresponding volume, normalized with regards to the reference geometry (the original part). Nodes in the graph represents iterations in a single optimization run.

Results show that the stiffness is maintained, and that there is a net weight saving of 11.2%. The gross weight saving after interpreting the results into a solution that is easier to manufacture will probably be closer to 10%, still fulfilling the initial target weight saving.

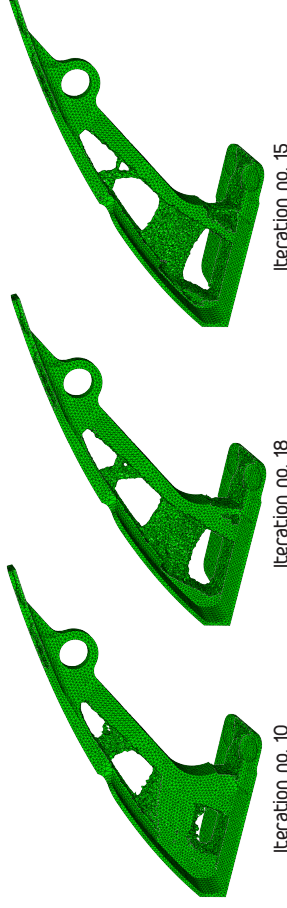

Iteration no. 10

Iteration no. 18

Iteration no. 15

Volume/weight saving = 11.2%

Stiffness in tensile = +0.081%

Stiffness in bending = +0.136%

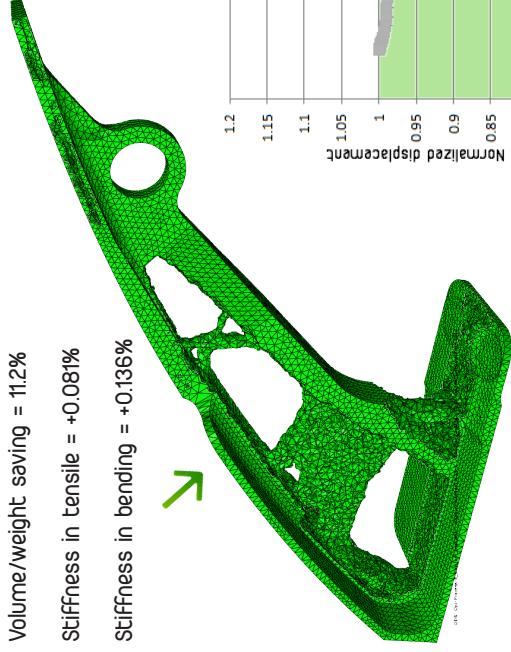

Iteration no. 32 (last)

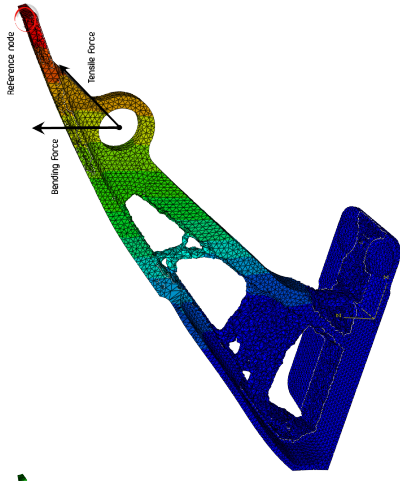

Normalized displacement (LC1 and LC2)

vs.

volume fraction of reference volume

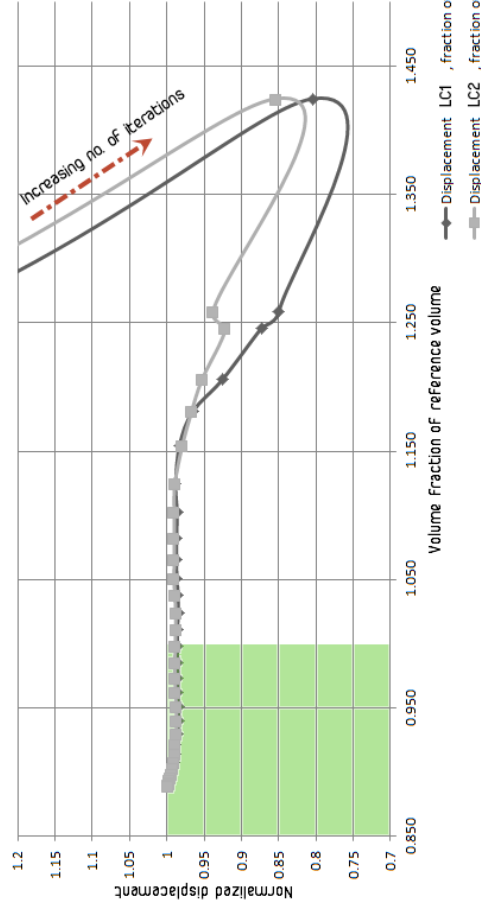

 **suplight**

TOPOLOGY OPTIMIZATION process description using Abaqus ATOM

Topic: Topology optimization; minimize volume and maintain displacement, summary

Name: Steffen Johnsen

Date: 15.04.2013

Approved by:
Terje Rølvåg

1. Import model and partition geometry into regions. This will make it easier to define frozen areas later in the analysis.
2. Setup a normal static analysis containing all boundary conditions. Both linear analysis and geometric nonlinear analysis are supported.
3. Evoke the Optimization environment, and create a new Optimization task, and define a name for the optimization. Make sure to choose whether to use the General algorithm or the Stiffness algorithm.
4. Define all Design responses in the Design Response Manager (all properties that will be influenced in the analysis; volume, eigenfrequencies, strain energy, displacement, etc.)
5. Choose which Design response(s) to use as an Objective in the Objective Function Manager. Weigh multiple objectives against each other and choose whether to maximize, minimize or minimize the max (preferred).
6. Define scalar constraints for the remaining Design responses.
7. Define Geometric Constraints (Symmetry, Frozen areas, cast condition, etc.). Use as few as possible, and run the first optimization without to see what is demanded. For the FLCA, whole regions should be set to Frozen.
8. Create an Optimization process in the Job Manager and specify which topology optimization to run. Start the optimization process.
9. Monitor progress by clicking Monitor during the optimization process in the Job Manager
10. When optimization has converged. Look at results by clicking Results in the Job Manager.
11. In the Job Manager: Click Extract and extract an STL - File from the final result. Make a copy of the .prt- File with the design space, import the STL file and use modeling tools and transform the part to look like the optimization result, or import the STL into an empty part and build the new part from scratch.

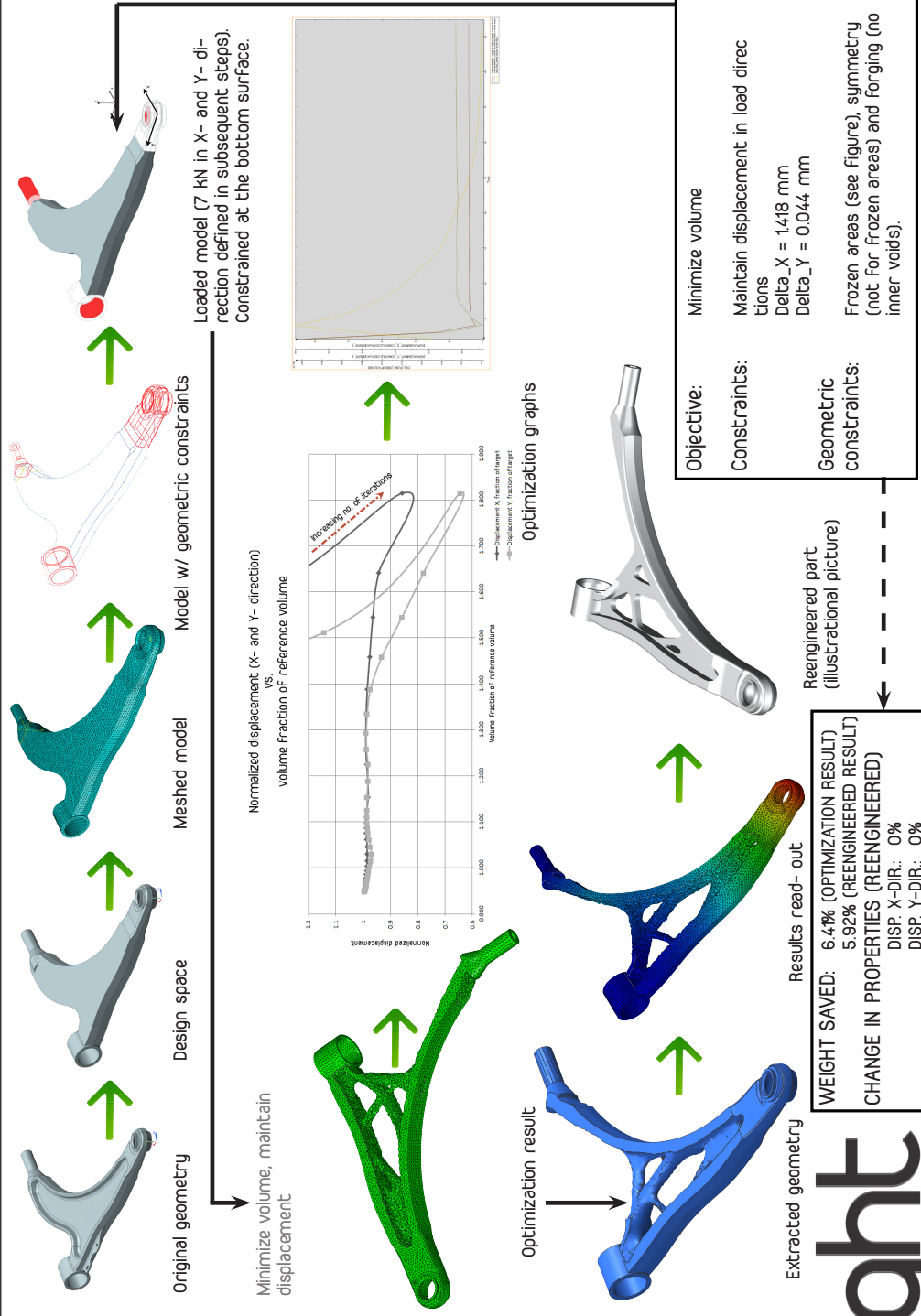

TOPOLOGY OPTIMIZATION process description using Abaqus ATOM

Topic: Topology optimization; minimize volume and maintain displacement in Force direction

Name: Steffen Johnsen

Date: 05.04.2013

Approved by:
Terje Rølvåg

The method used when performing topology optimization is based on MINIMIZING VOLUME (objective) and PRESCRIBING THE DISPLACEMENT. The solution method then provides a solution with a PRESCRIBED STIFFNESS (if the solution converges) and the LOWEST POSSIBLE VOLUME, given the design space and constraints. These constraints can be specified for the overall displacement magnitude of a load case or for specific directions. This sheet shows the Front Lower Control Arm optimized with this method and similar geometric constraints as described on the previous page.

Constraints:

$\Delta x_y = 1.418 \text{ mm}$
 $\Delta y_x = 0.044 \text{ mm}$

The graph shows the resulting displacement and corresponding volume, normalized with regards to the reference geometry (the original part). Nodes in the graph represent iterations in a single optimization run.

Results show that the stiffness is maintained, and that there is a net weight saving of 6.41%. The gross weight saving after interpreting the results into a solution that is easier to manufacture will probably be closer to 5%, still fulfilling the initial target weight saving.

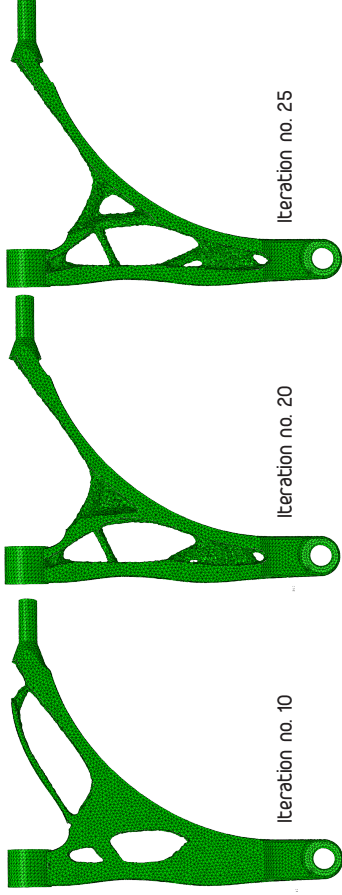

Volume/weight saving = 6.41%

Stiffness in X-direction = +0.110%

Stiffness in Y-direction = +0.157%

Normalized displacement (X- and Y- direction)
vs.

volume fraction of reference volume

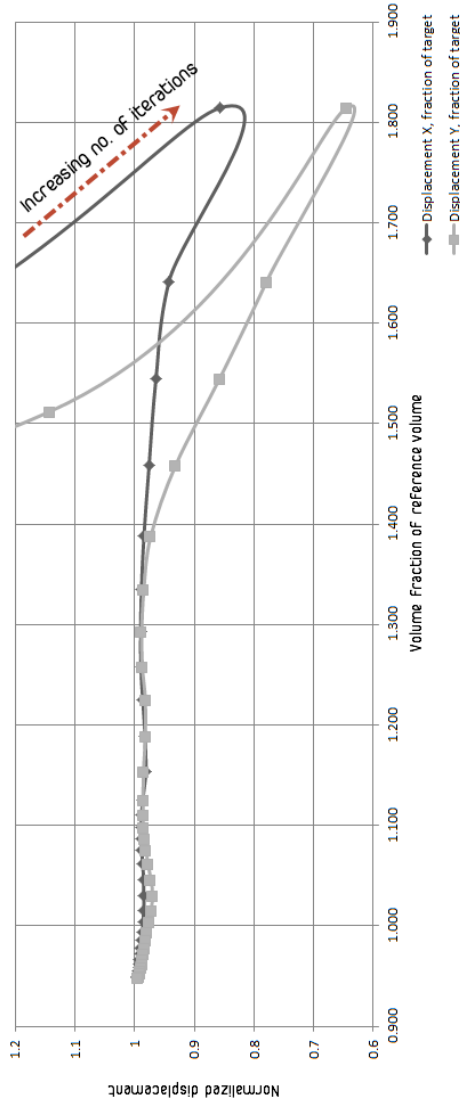

Iteration no. 47 (last)

 **suplighthouse**

Appendix C

A3 brief on optimization using Unigraphics NX

TOPOLOGY OPTIMIZATION process description using Unigraphics NX

Topic: Creating a new topology optimization simulation

Name: Steffen Johnsen

Date: 28.05.2013

Approved by:
Terje Rølvåg

NX Topology optimization is a powerful tool for enhancing creativity and finding optimal distributions of material given a design space, loads and boundary conditions.

NX Topology optimization is a part of the NX Advanced simulation environment, and can be added as a New Solution Process after defining the initial FE- simulation file. The tool is easily configured using the Topology Optimization step-by- step wizard.

The optimization tool is capable of handling a Single Objective Analysis, that is an analysis aiming to optimize one variable, while treating other variables (later referred to as design responses) as constraints.

The NX topology optimization is also capable of handling multiple loads, contact forces, assemblies, etc.

The tool is designed to handle static, structural simulations of both 2D and 3D continuum structures.

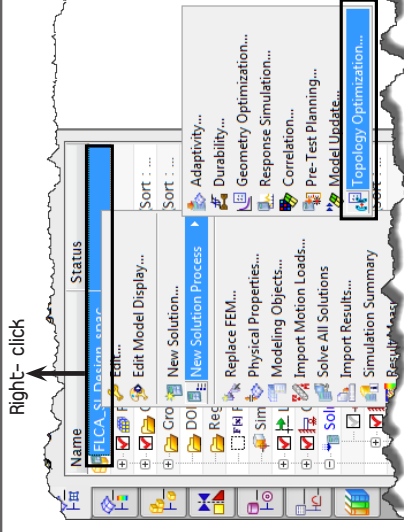

Right- click

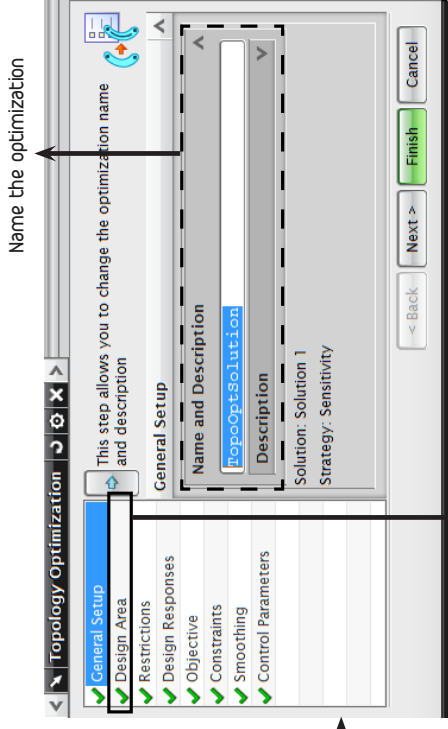

Name the optimization

This step allows you to change the optimization name and description

General Setup
Name and Description
Description: Solution 1
Strategy: Sensitivity

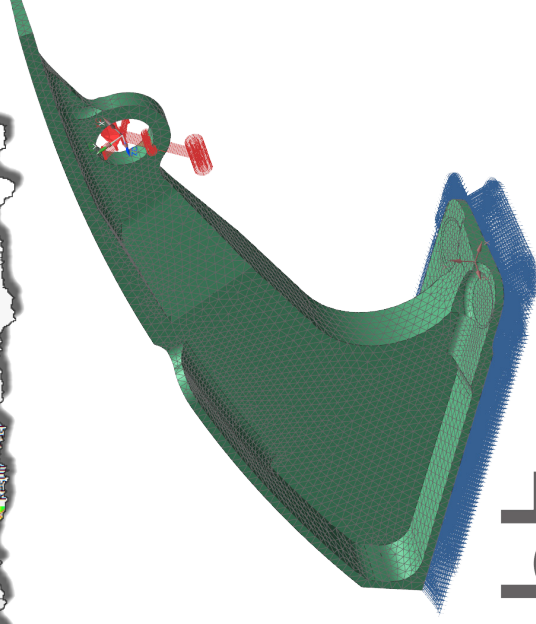

Simulation model

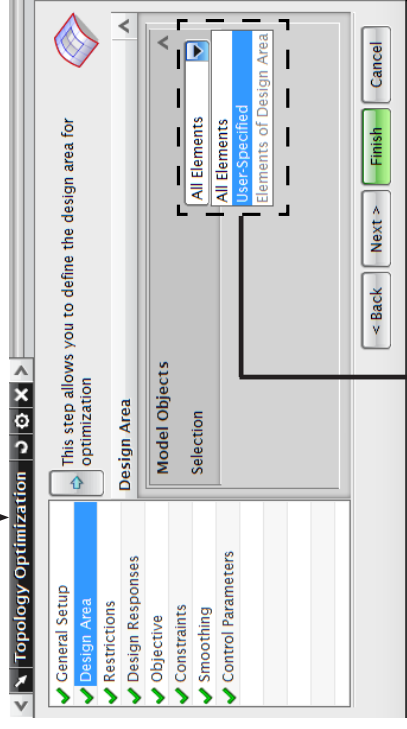

This step allows you to define the design area for optimization

Design Area
Model Objects
Selection
All Elements
User-Specified
Elements of Design Area

Define modeling objects that should take part in the optimization. "All elements" is the standard selection for single- body FE- files. Specifying bodies is only applicable when simulating assemblies.

suplight

TOPOLOGY OPTIMIZATION process description using Unigraphics NX

Topic: Defining element groups

Name: Steffen Johnsen

Date: 28.05.2013

Approved by: Terje Rønlivåg

Defining element groups simplifies the geometric constraints definition. In the following example, groups for 1) Frozen areas and 2) Manufacturing areas are defined.

Best practice have been found to define areas by using the 3) Related Elements selection method.

Be aware that only surface elements are selected with this method, and depending on Cast condition settings (see A3 sheet on Geometric constraints), internal voids and undercuts may appear. Using the Split Body command for creating separate bodies enable choosing regions of elements if more suitable (Modeling environment).

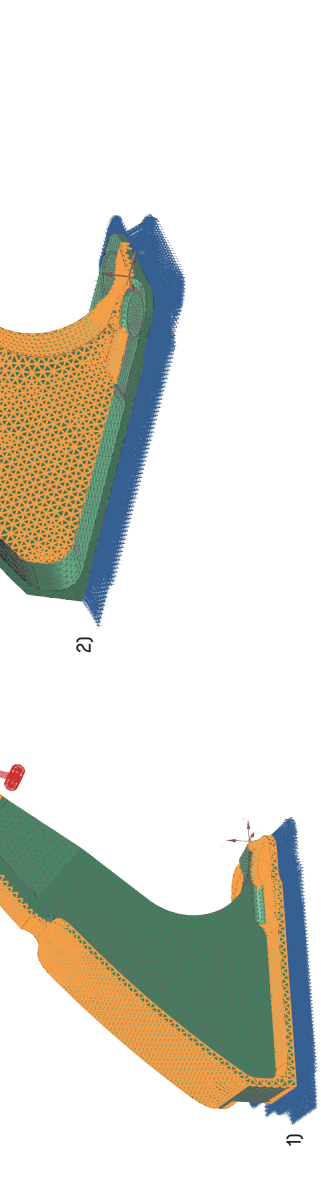
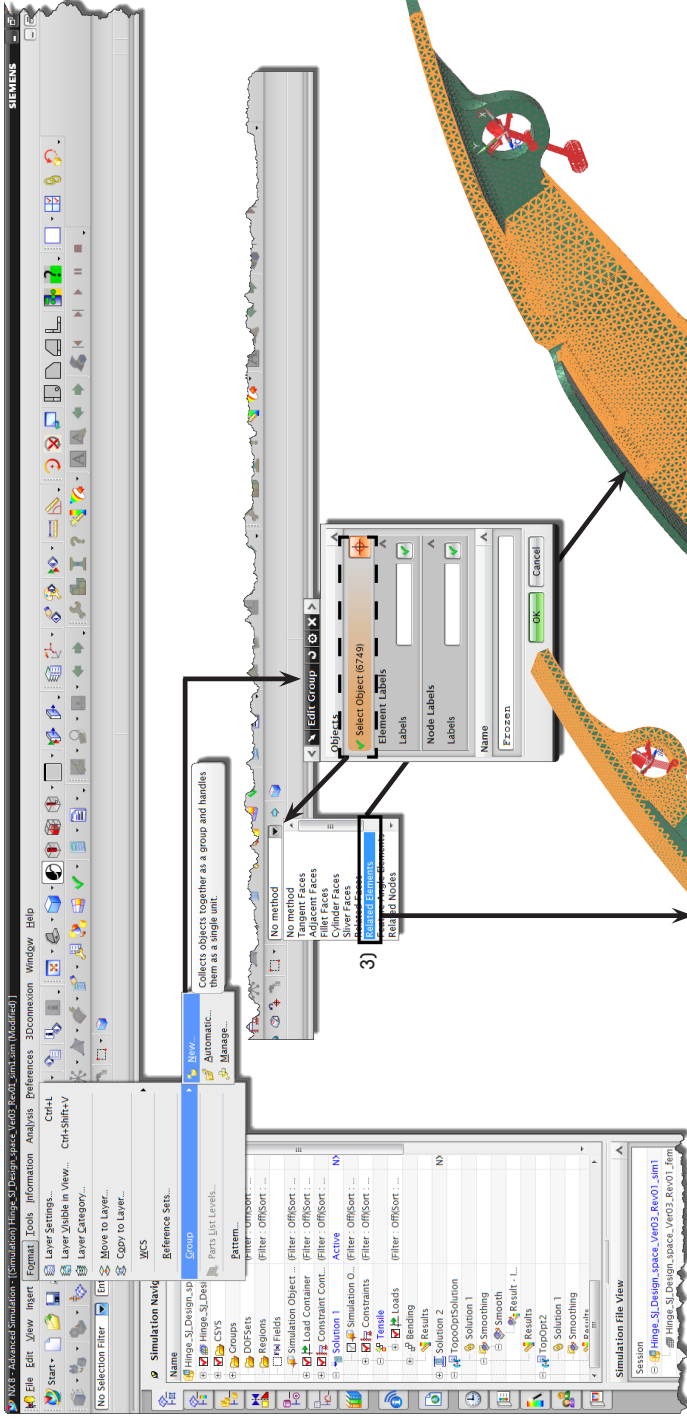

TOPOLOGY OPTIMIZATION process description using Unigraphics NX

Topic: Defining geometric constraints (restrictions)

Name: Steffen Johnsen

Date: 28.05.2013

Approved by:
Terje Rølvåg

As a rule of thumb, a general analysis should be performed before geometric constraints are introduced, as they will increase computational time as well as limit the available design space, giving a less optimal solution.

Cast condition is probably one of the most important geometric constraints, as it ensures that production methods like casting, stamping, forging and machining can be used. If the design space BC's introduce some kind of torsion or angular momentum in the part, internal voids and holes will be made, as material is preferred at the outer premises of the design space. This is done to increase the second moment of inertia. Cast condition specification is omitted, because significant simulation errors occurred. No apparent fault were found, however the problem may still be a result of faulty setup.

Symmetry constraints can be specified as planar or cyclic. Using the symmetry constraint, solutions will look more aesthetic, and they will be easier to produce.

Frozen faces will not be affected, and will remain the same after the analysis has ended. This is particularly useful to maintain areas of geometric significance, as the algorithm is forced to shave off weight from other areas of the design space.

This step allows you to define the manufacturing restrictions or geometrical design aspects to be taken into consideration in the optimization

Name	Check Type
Frozen	Frozen
Symmetry	Symmetry
Symmetry Condition	Symmetry Condition

Check Type: Frozen

Restricted Elements Selection: Elements

Selection: Select Object (6749)

Group Reference: Frozen

Filter Type: Elements

Element Selection Filtering: Element Selection Filtering

Excluded: []

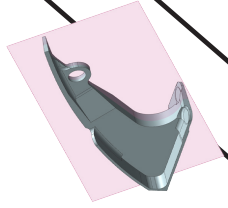
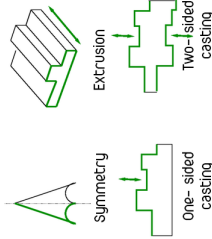

Check Type defines the type of geometric constraint you wish to introduce to the model

Set Selection to User-Specified, tick the Group Reference box and choose the previously defined element group to be restricted.

The NX manual specifies that the search radius must be larger than 80% of the element size. Symmetry type can be set to either Planar or Cyclic. For Planar symmetry, a coordinate system and normal axis must be specified.

Name and Description: Symmetry Condition

Description: Symmetry Condition

Check Type: Symmetry Condition

Restricted Elements Selection: Elements

Selection: Select Object (5207)

Group Reference: Manufacturing

Filter Type: Elements

Element Selection Filtering: Element Selection Filtering

Excluded: []

Symmetry Condition: Search Radius: 2 mm, Symmetry Type: PLANE_SYM, Symmetry Coordinate System: Cartesian, Type: Specify CSYS, Axis: Z, Ignore Frozen: [x]

Check Ignore Frozen box to prevent symmetry condition to apply to Frozen areas.

suplight

TOPOLOGY OPTIMIZATION process description using Unigraphics NX

Topic: Defining design responses for the optimization

Name: Steffen Johnsen

Date: 28.05.2013

Approved by:
Terje Rølvåg

Design responses can be seen as the simulation variables. They are defined before the simulation objective and constraints are set.

Design responses may be specified for the entire model, or for specific regions of the geometry.

For certain design responses, e.g. strain energy and displacement, Load Cases must be specified.

The Group Operator can be used to change the interpretation of the Design Response of interest, changing between Sum, Maximum, Minimum (value), etc.

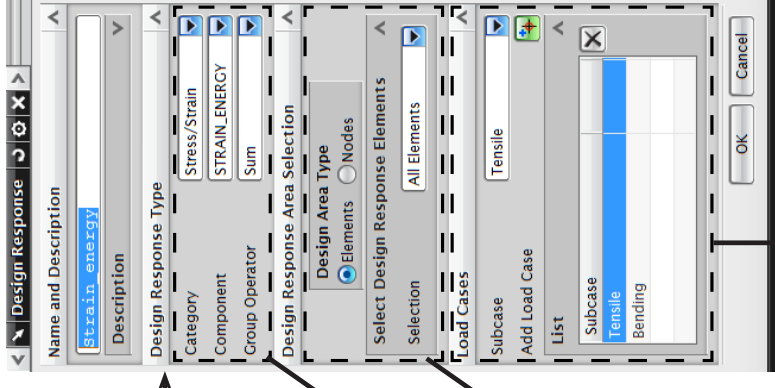
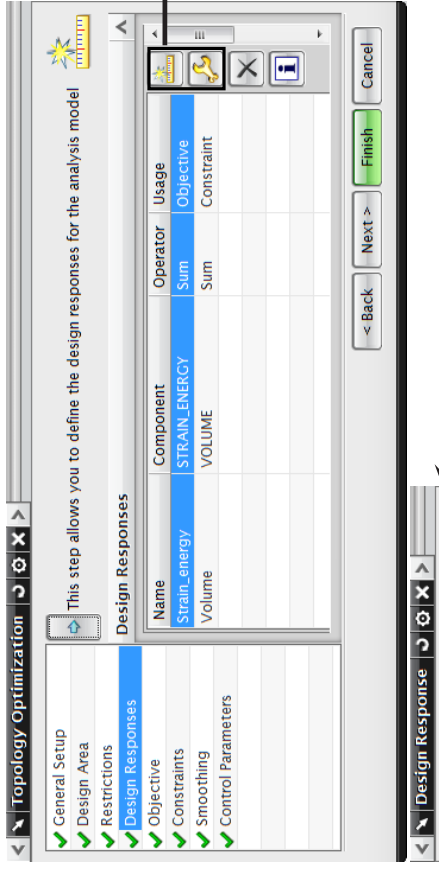

Design responses that are available for the chosen optimisation algorithm.

Best practice is to select All Elements to include all previously included elements in the design space. For general purpose design responses like Volume and Strain energy

Load- dependent design responses require specification of which sub-cases to be included in the analysis.

TOPOLOGY OPTIMIZATION process description using Unigraphics NX

Topic: Defining the objective definition

Name: Steffen Johnsen

Date: 28.05.2013

Approved by:
Terje Rølvåg

In general, there are three different proposed approaches to optimizing a structure using NX:

- 1) Minimize (or minimize the maximum) strain energy, constrained with an upper limit on the relative volume fraction.
- 2) Minimize the volume, constrained with an upper limit for displacement, moment of inertia, reaction forces, CoG or rotation (or a combination of these).
- 3) Maximize eigenfrequencies, constrained with a LOWER limit for volume or/and limits for other design responses that are independent of loads (as eigenvalue analysis are performed without external forces applied).

Best practice when defining the objectives and constraints:

- Choose the design response that has the highest uncertainty, if the target volume is specified, choose an approach that has volume as a constraint.
- If you have more than one load case, the MinMax Formulation will provide a solution that has better overall robustness.

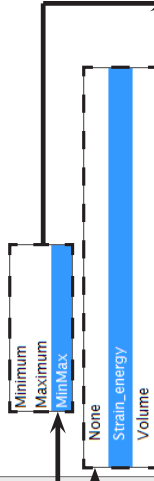
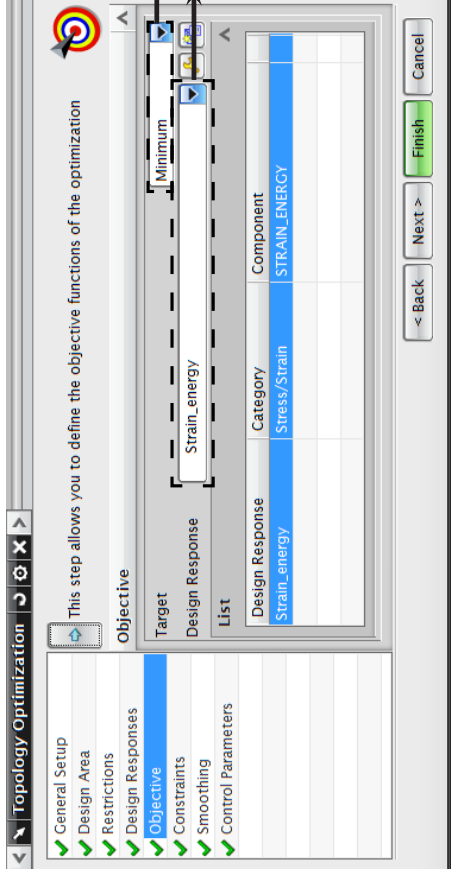

Choosing the design response to set as the objective.

The objective target can be set to MINIMIZE, MAXIMIZE or MINIMIZE THE MAXIMUM (MinMax). Eg you will most likely minimize a volume objective, maximize an eigenvalue or minimize the maximum strain energy. For NX, minimizing the maximum will create robust designs when applying loads to separate subcase (equivalent to steps in Abaqus), making the Final solution equally good for all load cases.



TOPOLOGY OPTIMIZATION process description using Unigraphics NX

Topic: (Performance) constraints

Name: Steffen Johnsen

Date: 28.05.2013

Approved by:
Terje Rølvåg

Performance constraints must be specified, otherwise the objective will go toward the objective without any limitations.

Performance constraints must be specified on all remaining design responses after defining the objective.

Values may be specified as Relative or Absolute, but are treated as scalar values.

Too strict constraints may result in invalid solutions or solution convergence.

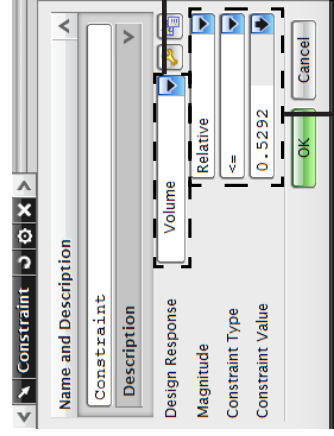
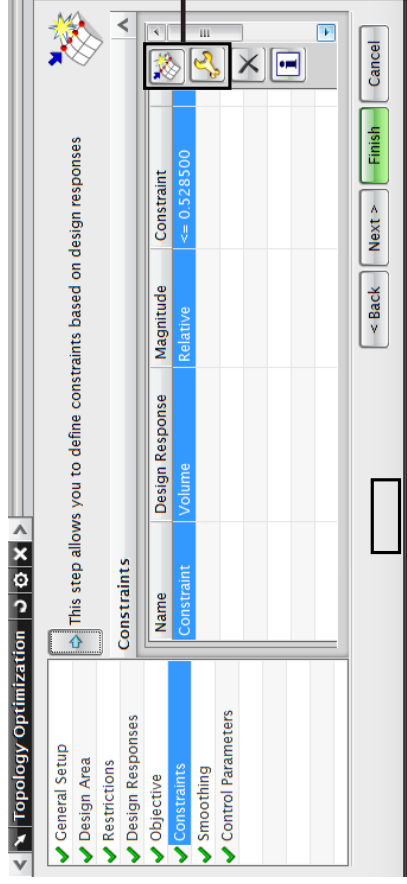

Volume constraint line

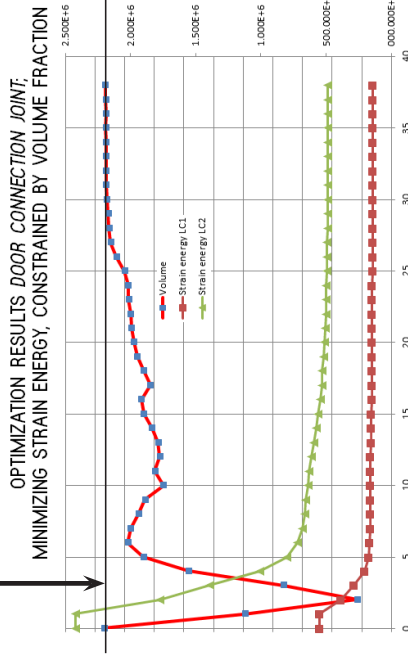

Depending on the choice of constraint, the magnitude can be set to "Absolute" or "Relative". When minimizing volume (or equivalent), the "Constraint type" must be set to \leq , but when minimizing eigenfrequencies, a \geq constraint is necessary. The "Constraint value" is given as a Fraction of the volume of the design space if a Relative Magnitude is specified.

suplight

TOPOLOGY OPTIMIZATION process description using Unigraphics NX

Topic: Settings for extracting geometry (smoothing), control parameters and solving

Name: Steffen Johnsen

Date: 28.05.2013

Approved by:
Terje Rølvåg

Extracting geometries may be specified using the Smoothing process. Desired output control variables may be specified. In general, standard values are recommended and give good results. Advanced setup is therefore omitted.

Control parameters for the simulation run are:

- 1) The Maximum Number of Iterations will stop the simulation before if the solution diverges. The number should be so high that the simulation stops by itself when convergence is achieved.
- 2) Sensitivity Approach Parameters may be adjusted to reach convergence if initial simulations fail. Setting Density Update to Conservative and lowering the Density Move value will reduce the extent and magnitude of element density updates, aiding the search for a valid solution.
- 3) Choose between saving the First and Last .OP2 result files, None or All. The First is recommended.

Click Finish and Solve (right-click process tab and click Solve) to obtain results.

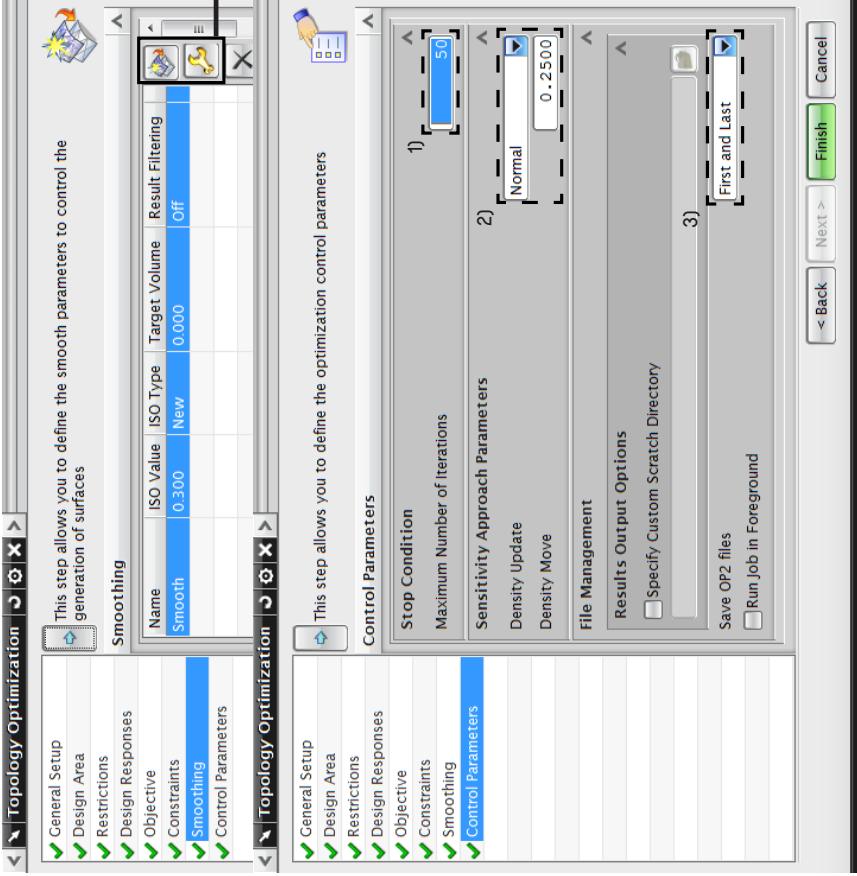
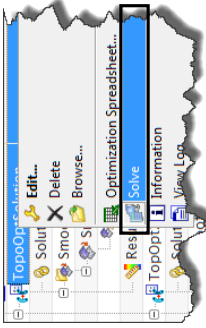

ISO- value will control how strong the smoothing is. 0.3 is recommended as a starting value

Select the desired output File type

IGES slice parameter settings

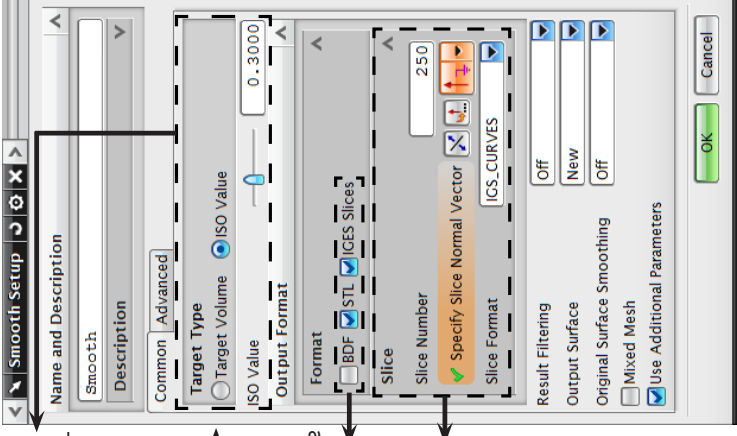

suplight

TOPOLOGY OPTIMIZATION process description using Unigraphics NX

Topic: Post- processing of optimization results; showing the optimized geometry and graphs

Name: Steffen Johnsen

Date: 25.05.2013

Approved by:
Terje Rølvåg

Post- processing of results is important to verify that the simulation has converged, and that the design constraints are within limits. Graphs can be generated by the software by right-clicking the process tab and selecting Optimization Spreadsheet.

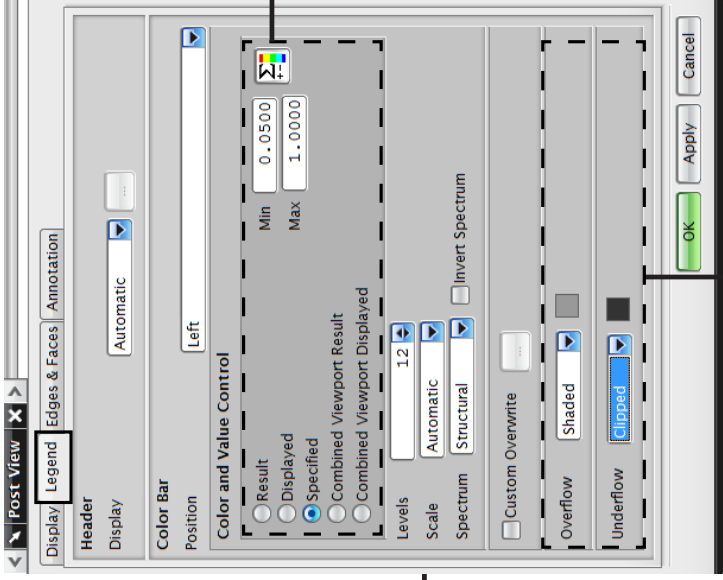
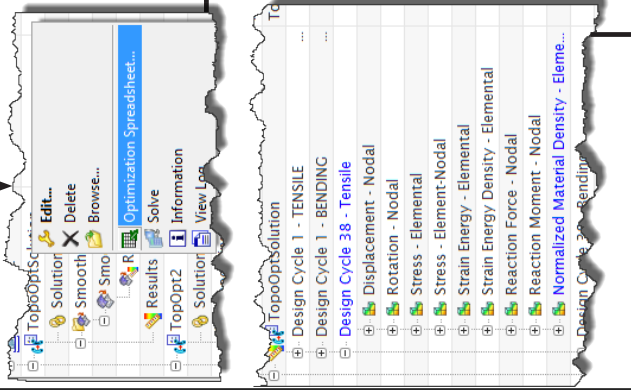

Set OverFlow to Shaded and UnderFlow to Clipped. This will remove elements with normalized densities below the Specified Min value.



Tick the Specified radio button and set the Min value to 0.05. All elements below 5% of unit normalized density will be removed. This is a conservative value, but often gives adequate removal of material, since intermediate values are not favored by the optimization algorithm.

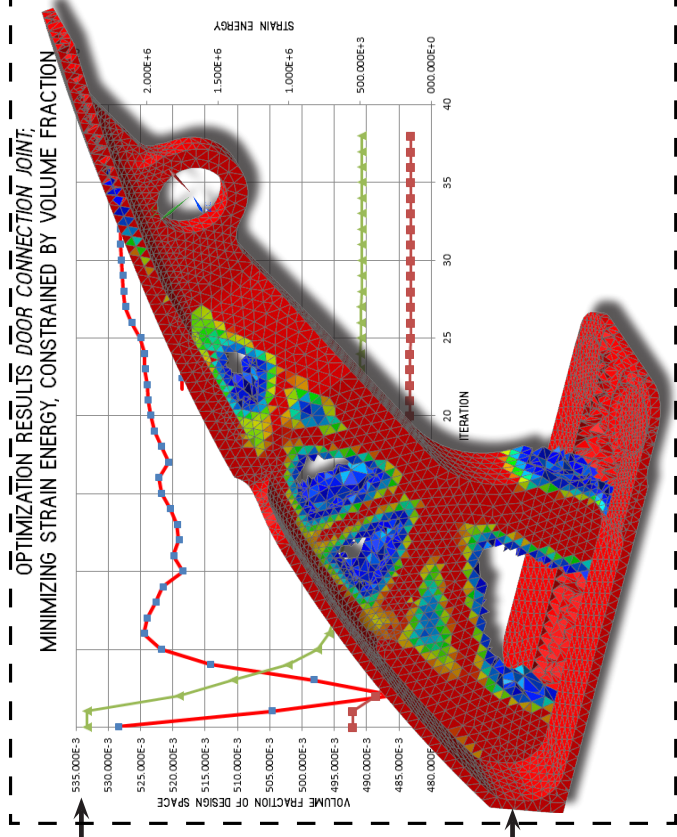

TOPOLOGY OPTIMIZATION process description using Unigraphics NX

Topic: Topology optimization; minimize strain energy with upper volume limit, summary

Name: Steffen Johnsen

Date: 28.05.2013

Approved by:
Terje Rølvåg

1. Setup a normal static analysis containing all boundary conditions.
2. Evoke the Topology Optimization sub-process wizard, create a new Optimization process, and define a name for the optimization.
3. Define the Design Area
4. Define restrictions (Geometric constraints) to suit the desired output.
5. Define all Design responses (all properties that will be influenced in the analysis: volume, eigenfrequencies, strain energy, displacement, etc.)
6. Choose which Design response to use as an Objective and optimization Target.
7. Define scalar Performance Constraints
8. Define Geometric Constraints (symmetry, Frozen areas, cast condition, etc.). Use as few as possible, and run the first optimization without to see what is demanded.
9. Setup the Smoothing and model extraction process.
10. Adjust Control Parameters.
11. Submit the simulation.
12. When optimization has converged: Look at results by clicking Results and find the Normalized Density. Specify result limits, Underflow and Overflow characteristics.
13. Make a copy of the .prt- File with the Design Space, import the STL file and use modeling tools and transform the part to look like the optimization result; or import the STL into an empty part and build the new part from scratch.

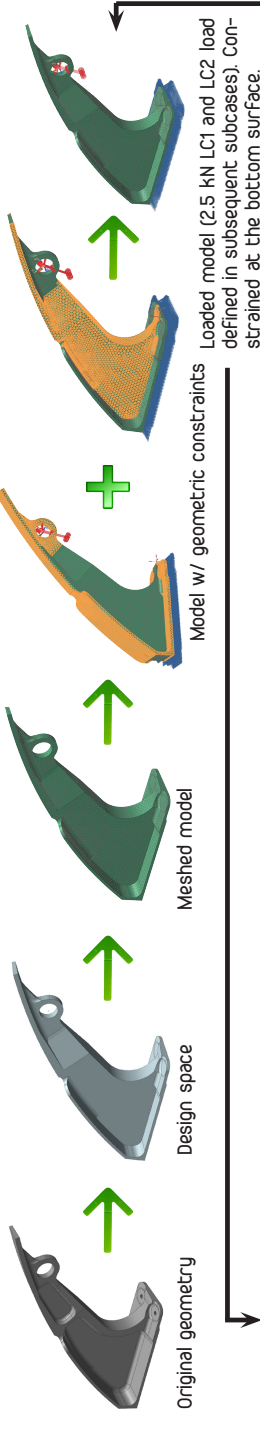

Minimize strain energy, maintain a specific volume

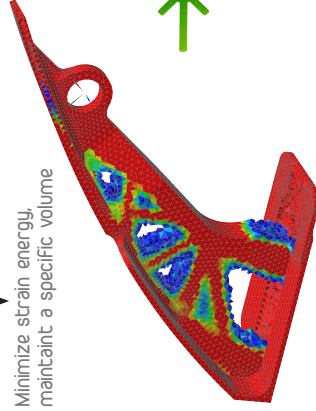

Optimization result

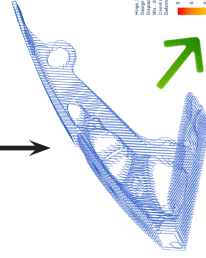

Extracted geometry (IGES slices shown)

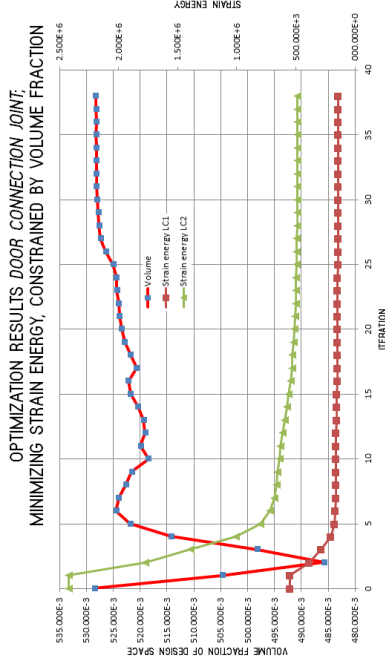

Optimization graph

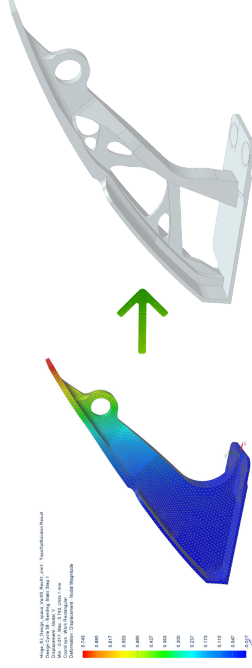

Reengineered part (illustration picture)

Results read-out

Objective: Minimize strain energy (max. stiffness)

Constraints: Save 10% volume
-> Volume Fraction

Geometric constraints: Frozen areas (see Figure) and symmetry (not for Frozen areas).

suplight

Appendix D

A3 brief on reengineering of geometries

TOPOLOGY OPTIMIZATION process description; reengineering using UGS NX

Topic: Topology optimization; reengineering the results

Name: Steffen Johnsen

Date: 29.05.2013

Approved by:
Terje Rønlvåg

Best practice for reengineering planar symmetric parts:

- Extract optimization geometry from preferred topology optimization software as an Stereolithography (STL)- File.
- Open the design space .prt
- Evoke the Model environment
- Create a datum plane, bisecting two parallel surfaces in the design space.
- Click File -> Import -> STL and follow the import procedure to retrieve the extracted geometry. It should normally position itself on top of the design space.
- Create a new sketch on the datum plane
- Orient view to be normal to symmetry plane
- Start the Studio Spline (click S) and position splines on top of the boundary lines in the topology optimization part.
- Extrude sketches and use Boolean: Subtract to remove material.
- Use fillets, chamfers and other design tools to imitate results.

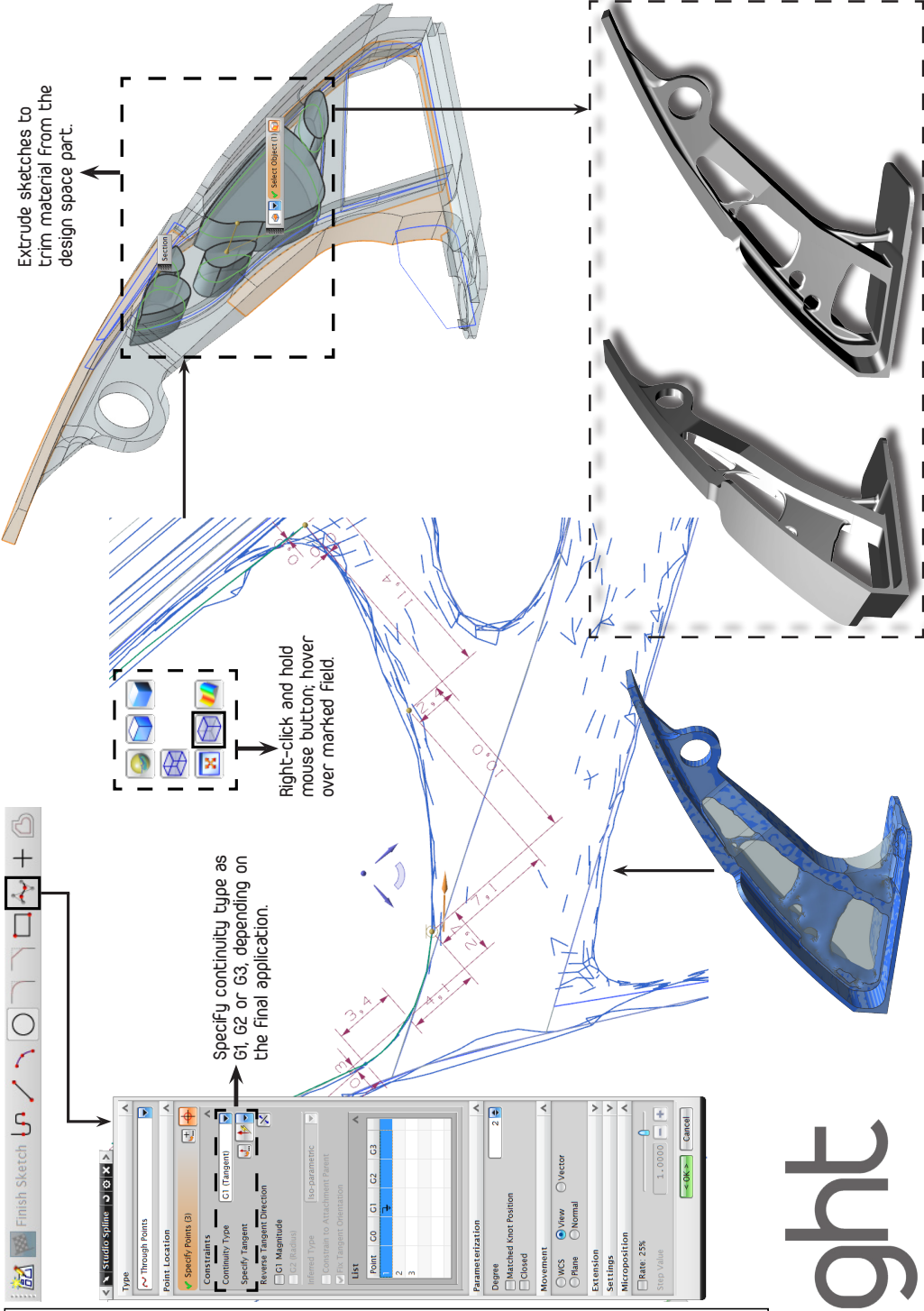

 **suplight**