



NTNU – Trondheim
Norwegian University of
Science and Technology

DEVELOPMENT OF SPINEBOARD

Mariann Ervik

Master of Science in Mechanical Engineering

Submission date: July 2012

Supervisor: Knut Einar Aasland, IPM

Norwegian University of Science and Technology
Department of Engineering Design and Materials

Preface

This 30 credit thesis was written in the course TMM4901 Engineering Design, Calculation and Manufacture, Master Thesis in the spring of 2012.

The work was conducted at the Department of Engineering Designs and Materials at the Norwegian University of Science and Technology.

This thesis was written for and conducted in collaboration with Laerdal Medical AS.

Prior to this master thesis a 15 credit preliminary study to the development of a new spineboard was conducted. I recommend that the reader first familiarizes themselves with the content of the preliminary study (find it enclosed in Appendix G).

All CAD/CAE work conducted during this project is based on a self-taught approach to the CAX software using computer-aided self training software and help guides included in the software.

Acknowledgements

I would like to thank Knut Einar Aasland for his guidance during the master thesis project and the staff at Laerdal Medical for their invaluable feedback and accommodating attitude during my stays in Stavanger. A special thanks to Trond Sagland and Hilde Tertnes for their follow-ups during the project.

Thanks to Halvard Stoever for providing the equipment necessary to conduct tests and Bjarne Stolpnessaether and Arne Gellein for their help on creating a mock-up of the finished product.

Lastly, thanks to the staff at Vinjes Ambulance Service, Trondheim, St. Olavs Hospital Emergency Room, Radiology and Ambulance Departments and the Norwegian Air Ambulance, Stavanger for their time and insight into their work.

Summary

This master's thesis is the continuation of a preliminary study conducted in the fall of 2011. The project is defined by NTNU in cooperation with Laerdal Medical. Laerdal Medical AS is a major manufacturer of medical equipment and training products based in Stavanger, Norway. They now want to make an addition to their spinal product line and offer a lower cost, but quality alternative to their existing spineboard (the BaXstrap spineboard).

A spineboard is a long, flat and rigid board mainly used for the immobilization and transportation of trauma patients with suspected spinal injuries.

As a basis for comparison of stiffness of the old and proposed new alternative, physical tests of the BaXstrap spineboard were conducted.

The new spineboard concept proposes a transition from the current rotational molding process of the BaXstrap to injection molding the new spineboard in two parts and joining them by hot plate welding.

Through a part breakdown approach to the spineboard, constraint and possibilities for all design features of the spineboard were reviewed. This was based on extensive research through current literature, standards, competitor reviews, discussions with Laerdal and user interviews. From two final design concepts, a curved and tapered spineboard with features continued from the BaXstrap was chosen and another design iteration was performed.

The results of this project has, in addition to an extensive product specification, been a CAD model, CAE analysis and a physical foam mock-up of the final design iteration of the proposed new spineboard. CAE analysis showed that the new spineboard can have better resistance to torsion and bending than the BaXstrap.

Descriptions of the CAD model structures and how to prepare mesh and load cases for CAE analysis of the spineboard will be used as a basis for further development of the spineboard at Laerdal Medical.

Sammendrag

Denne masteroppgaven er en videreføring av en forstudie gjennomført høsten 2011. Oppgaven er definert ved NTNU i samarbeid med Lærdal Medical. Lærdal Medical AS er en stor produsent av medisinsk utstyr og opplæringsprodukter basert i Stavanger, Norge. De ønsker nå å introdusere et nytt spineboard (ryggbrett) i tillegg til det spineboardet de har idag. Målet er å kunne tilby et alternativ med høy kvalitet til en lavere pris enn dagens brett.

Et spineboard er et lang, flatt og rigid brett som i hovedsak blir brukt til immobilisering og transport av traumepasienter med hvor det ikke kan utelukkes at pasienten har fått skade på ryggraden.

Som grunnlag for sammenligning av stivhet av det gamle og det foreslåtte nye spineboardet, ble det gjennomført fysiske tester av BaXstrap-brettet.

For det nye konseptet foreslås en overgang fra dagens rotasjonsstøping av BaXstrap til åsprøytstøpe det nye spineboardet i to deler som sammenføres ved speilsveising.

Ved å stykke opp de ulike trekkene ved et spineboard, ble muligheter og begrensninger for hvert enkelt trekk ved brettet gjennomgått. Dette var basert på omfattende undersøkelser gjennom litteraturstudie, standarder, vurdering av konkurrenter, diskusjoner med Lærdal og bruker-intervjuer. Fra to endelige designkonsepter ble et kurvet og konisk spineboard med flere designtrekk likt BaXstrap valgt. Nok en designiterasjon ble gjennomført.

Resultatene fra dette prosjektet har, i tillegg til en omfattende produktkravspesifikasjon, vært en CAD-modell, CAE-analyse og en fysisk skummodell det endelige designet for et nytt spineboard. CAE-analyse viste at den nye spineboard kan oppnå bedre bøye- og torsjonsegenskaper enn BaXstrap.

Beskrivelser av strukturen til CAD-modellen og hvordan man forbereder modellen for CAE-analyse av spineboardet vil bli brukt som grunnlag for videre utvikling av spineboard ved Lærdal Medical.

NORGES TEKNISK-
NATURVITENSKAPELIGE UNIVERSITET
INSTITUTT FOR PRODUKTUTVIKLING
OG MATERIALER

MASTEROPPGAVE VÅR 2012
FOR
STUD.TECHN. MARIANN ERVIK

UTVIKLING AV SPINEBOARD
Development of spineboard

Laerdal Medical er et av Norges ledende firmaer innenfor medisinsk-tekniske produkter. Et av de volummessig mindre produktene deres er spineboard. Et spineboard er et medisinsk produkt – et brett – som skal støtte opp, immobilisere og transportere pasienter med mulige skader på nakke og rygg. Laerdals produkt på dette området møter hard konkurranse fra andre aktører over hele verden og prisene er presset, spesielt i USA, der markedet også er størst.

Kandidaten har i sin prosjektoppgave gjort en konseptutvikling av et nytt og forbedret spineboard. En hovedsak med dette, er at det benytter sprøytstøping istedenfor rotasjonsstøping. Det er også laget en stor, omfattende og god produktkravspesifikasjon for slike brett.

I denne oppgaven skal kandidaten gå videre med basis i prosjektoppgaven, og utvikle det fram til en prototype av et nytt brett. Det skal lages et opplegg for modellering og beregninger som kan utnyttes av Laerdal for liknende produkt i framtida. Hensikten med dette er å finne fram til måter å realisere et spineboard med høyere kvalitet til lavere pris.

Konkret skal oppgaven inneholde:

- Simulering av dagens brett
- Verifisering av simuleringene gjennom fysiske tester
- Videreutvikling av konsept
- Dimensjonering vha. FEM-analyser og materialvalg
- Estimering av produksjonskostnad ut ifra analyser, vha. tall fra Laerdal (marketing operations og leverandører)

I tillegg til prosjektrapporten, skal det leveres en PU-journal i instituttets A3-format.

Besvarelsen skal ha med signert oppgavetekst, og redigeres mest mulig som en forskningsrapport med et sammendrag på norsk og engelsk, konklusjon, litteraturliste, innholdsfortegnelse, etc. Ved utarbeidelse av teksten skal kandidaten legge vekt på å gjøre teksten oversiktlig og velkrevet. Med henblikk på lesning av besvarelsen er det viktig at de nødvendige henvisninger for korresponderende steder i tekst, tabeller og figurer anføres på

begge steder. Ved bedømmelse legges det stor vekt på at resultater er grundig bearbeidet, at de oppstilles tabellarisk og/eller grafisk på en oversiktlig måte og diskuteres utførlig.

Senest 3 uker etter oppgavestart skal et A3 ark som illustrerer arbeidet leveres inn. En mal for dette arket finnes på instituttets hjemmeside under menyen undervisning. Arket skal også oppdateres ved innlevering av masteroppgaven.

Besvarelsen skal leveres i elektronisk format via DAIM, NTNUs system for Digital arkivering og innlevering av masteroppgaver.

Kontaktperson hos Laerdal Medical AS: Trond Sagland

Torgeir Welo
Instituttleder

Knut Aasland
Faglærer

 **NTNU**
Norges teknisk-
naturvitenskapelige universitet
Institutt for produktutvikling
og materialer

Presisering av Mariann Erviks masteroppgave

I oppgaveteksten står det at kandidaten skal simulere dagens brett og verifisere dem gjennom fysiske tester.

Etter samråd med bedriften har vi funnet at dette ikke er fornuftig bruk av tid på det nåværende stadiet av utviklingen, men at fysiske tester likevel skulle gjennomføres for å ha et sammenligningsgrunnlag i utviklingen av det nye produktet.

Trondheim 8/6-2012



Knut Aasland

veileder

Contents

1	Introduction	1
1.1	Framework	1
1.2	Background	1
1.3	Planning	2
1.4	Report structure	6
2	Physical test data for the BaXstrap spineboard	7
2.1	Equipment utilized	7
2.2	Setup	7
2.3	Resistance to torsion	9
2.4	Resistance to bending	10
2.5	Comments to EN1865 spineboard stiffness requirements	11
3	Requirements for the new spineboard	13
3.1	Technical requirements	13
3.2	User defined requirements	13
3.3	Key improvement areas	16
3.3.1	Production cost	16
3.3.2	Tapering	16
3.3.3	Lying surface	16
3.3.4	Log rolling feature	17
4	Manufacturing	19
4.1	Injection molding	19
4.2	Joining	20
4.2.1	Ultrasonic welding	20
4.2.2	Vibration welding	21
4.2.3	Hot plate welding	22
4.2.4	Choice of joining method	24
4.3	Design for manufacturing	25
4.4	Materials	28
4.4.1	Classification of polymers	28
4.4.2	Selection of material	29

5	Design	31
5.1	Design process	31
5.2	Part breakdown and explanation of terms	32
5.3	Geometry grid	32
5.4	Lying area	34
5.5	Head area	35
5.6	Lying area curvature	35
5.7	Contour curve	37
5.8	Taper length and angle	38
5.9	Holes	40
5.9.1	Corner handholds	40
5.9.2	Side handholds	41
5.9.3	Clip holes	42
5.9.4	Child slots	42
5.10	Handholds-to-ground distance	43
5.11	Ground support	43
6	Design concepts	45
6.1	Symmetric	45
6.2	Tapered twin	47
6.3	Evaluation of design concepts	47
7	CAD model	49
8	CAE	55
8.1	Software	55
8.2	Cross section analysis	55
8.3	Simplification of model	57
8.4	Mesh type	57
8.5	Element type	58
8.6	Mesh quality	59
8.7	Material	60
8.8	Load cases	60
8.8.1	Resistance to bending	60
8.8.2	Resistance to torsion	60
8.9	Results	61
8.9.1	Resistance to bending	61

8.9.2	Resistance to torsion	61
8.10	Weight	62
9	Economic evaluation	65
10	Final design and specifications	67
10.1	Design optimisation	67
10.2	Final design: NeWstrap working title	69
10.3	Product side by side	70
10.4	NeWstrap cross sections	70
10.5	Human modeling	70
10.6	Hot plate parting line	72
10.7	Mock-up	72
10.8	Customer test	77
11	Conclusion and further work	81
A	Media	84
B	Roll-up poster	85
C	Meeting log	86
C.1	People who contributed	87
C.2	Vinjes Ambulance Service, Trondheim (Mar 16, 2012)	88
C.3	Strategic Marketing, Laerdal Medical AS, Stavanger (Mar 28, 2012)	89
C.4	Norwegian Air Ambulance Crew, Stavanger (Mar 29, 2012)	89
C.5	Regional Sales, Laerdal Medical AS, Trondheim (Apr 10, 2012)	90
C.6	Presentation, Norwegian University of Science and Technology, Trondheim (Jun 6, 2012)	90
C.7	Vinjes Ambulance Service, Trondheim (Jun. 27, 2012)	90
D	BaXstrap test report	94
D.1	Introduction	94
D.2	Equipment	94
D.3	Setup and execution	95
D.3.1	Resistance to torsion setup, part one	95
D.3.2	Resistance to torsion setup, part two	96
D.3.3	Resistance to bending	98

D.4	Results	100
D.4.1	Resistance to torsion, part one	100
D.4.2	Resistance to torsion, part two	100
D.4.3	Resistance to bending	103
D.5	Comments to the NS-EN 1865:2000 requirements	104
E	Project design history	109
F	Draft	124
G	Project report: <i>Concept development of a new spineboard - a preliminary study</i>	126

List of Figures

1	Laerdal immobilization products	2
2	Physical tests equipment	7
3	Physical tests setup	8
4	Torsional properties of the BaXstrap	10
5	Bending properties of the BaXstrap	11
6	Injection molding machine	20
7	Vibration welding process	21
8	Hot plate welding process	23
9	Diagrams for injection molding part design	27
10	The design process combines reverse and forward engineering	32
11	Explanation of the terms used in Section 5 Design	33
12	Gridline sketch for new CAD model	34
13	Human relative head varies with age	36
14	Extracted cross sectional geometry of the BaXstrap spineboard	36
15	Lying area curvature for the new spineboard	37
16	Contour gridlines for the new spineboard	38
17	Top view contour sketches	38
18	Top view contour design history	39
19	Maximum percentage of spineboard length that can be tapered.	40
20	Proposed dimensions for the holes in the new spineboard	42
21	Creation of webbing during molding BaXstrap spineboard.	43
22	Ground support alternatives for the new spineboard	44
23	Sketch of the Symmetric Spineboard concept	45
24	Cross sections of the Symmetric Spineboard	46
25	Tapered Twin Spineboard concept	47
26	Model preparation for meshing	57
27	Fixing failure elements and free edges during meshing	59
28	Load case for resistance to bending analysis	60
29	Load case for resistance to torsion analysis	61
30	Bending analysis of the NeWstrap	62
31	Torsion analysis of the NeWstrap	62
32	Design changes made to the Tapered Twin concept	67
33	The final design iteration for this project	69
34	Product side by side	71

35	Cross sections for the new spineboard	72
36	Human modeling with the new spineboard	73
37	Split parts to be welded together	74
38	Simple CAD draft for milling of the mock-up	74
39	New spineboard mock-up	76
40	User test of the design features of the new spineboard	78
41	Placement of the NeWstrap spineboard in an ambulance	79
42	New spineboard roll-up poster	85
43	NeWstrap side by side comparison with Ferno Najo board	92
44	NeWstrap underside and contour comparison with Ferno Najo board	93
45	Physical tests equipment	95
46	Torsion test setup according to standard	96
47	Equipment setup for the torsion test	97
48	Setup for the torsion test	98
49	Setup for the bending test	98
50	Equipment setup for the bending test	99
51	Resistance to torsion, results part one	101
52	Resistance to torsion, results part two	102
53	Torsional properties of the BaXstrap	103
54	Bending properties of the BaXstrap	104
55	Deflection of the BaXstrap, plotted against time	106
56	Detailed view of the second bend test between loading	107

List of Tables

1	Product specification from the preliminary study	3
2	Product development process	4
3	Torsional properties of the BaXstrap spineboard	9
4	Bending properties of the BaXstrap spineboard	12
5	Technical requirements of the new spineboard	14
6	Functional requirements of the new spineboard	15
7	Comparison of the joining processes	24
8	Hot plate welding vs. Vibration welding	26
9	Requirements for the selection of a new shell material	29
10	The human hand size	41
11	Evaluation of the two design concepts	48
12	Cross sectional resistance to bending and twisting	56
13	Comparison of old and new spineboard concept	66
14	Torsional properties of the BaXstrap spineboard, part one	100
15	Torsional properties of the BaXstrap spineboard, part two	105
16	Bending properties of the BaXstrap spineboard	108

1 Introduction

1.1 Framework

The master thesis project at the Dept. of Engineering Designs and Materials, Norwegian University of Science and Technology (hereafter NTNU) constitutes the 10th semester and 30 credits.

This project was conducted between Jan. 30, 2012 and Jul. 2, 2012. The work has taken place in Trondheim, with the exception of a 4 day long stay at Laerdal Medical in Stavanger.

Advisor at NTNU, Trondheim has been Associate Professor Knut Einar Aasland. Advisor at Laerdal Medical AS, Stavanger has been Senior R& D Product Expert Trond Sagland.

This report uses information from the preliminary study to the master thesis. When referred to the preliminary study, a short summary will be given, but the full preliminary study report can be found in the appendix.

The report uses SI-units (International System of Units, abbr. from French).

1.2 Background

Prior to the master thesis, a preliminary study to the project was conducted. The report from this study is called *Concept development of a new spineboard - a preliminary study* [1] and will be referred to as the *project report*. It accounts for 50 % of the credits of the 9th semester of the mechanical engineering grade at NTNU.

Spineboards are typically rectangular rigid boards on which injured individuals are placed. The intention of a spineboard is to provide a means of support, immobilization and transportation of a patient following the event of an emergency situation where spinal cord injuries are known or suspected.

The basis for the task given by Laerdal was to come up with a new concept for a spineboard that could increase spineboard gross margins significantly. The reason for this is an increasingly tough price competition on spineboards in the United States over the last years.

The Laerdal immobilization product family today consists of adjustable and non-adjustable adult and pediatric extrication collars, three different head immobilizers and one alignment pad, and one adult rigid spineboard and one spineboard pad for pediatric patients. The spineboard is called *the BaXstrap spineboard* and has existed in its present form since 1996. All immobilization products from Laerdal are shown in Figure 1.

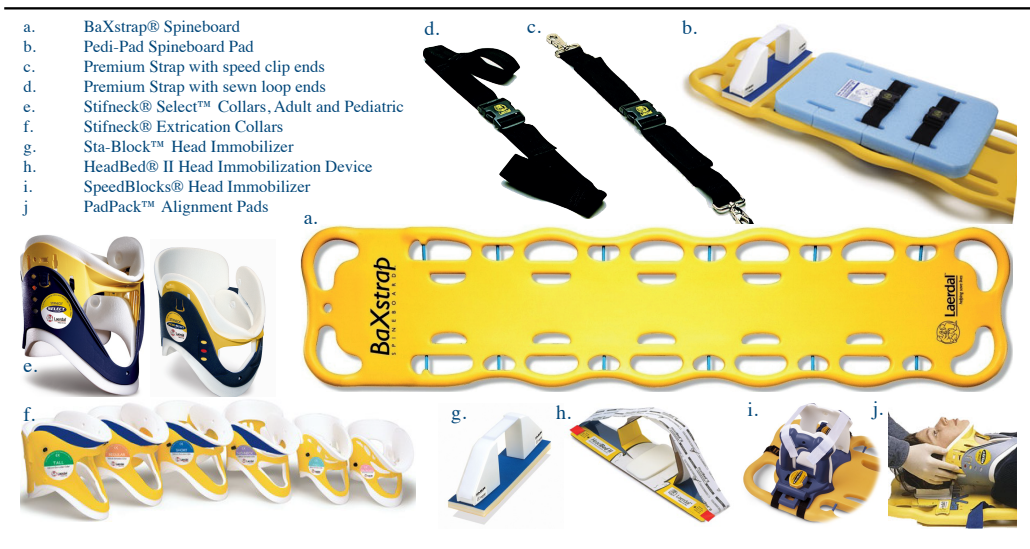

Figure 1: Range of Laerdal Medical immobilization products 2012

Due to contract issues with the manufacturer of the existing spineboard, this implies finding a different manufacturing method than the one used today.

The project report proposes injection molding on the background of an evaluation of investment cost, labor intensity and raw material cost in conjunction with expert advice from Laerdal’s engineering department. While joining the two halves together can potentially be done by various welding or gluing methods, the study enhances hot plate welding as a feasible method.

The project report lays some constraint for further development of design of the new spineboard. It should continue the large, raised handholds and curvy design of the BaXstrap, have a tapered foot end and a curved lying area. These constraints were based on current literature, applicable standards, current literature, interviews with various users of spineboard and Laerdal’s strategic marketing department. In addition to these, minimum technical and functional requirements from applicable standards must be met. A product specification, including economic, technical and functional requirements with references to applicable standards, was made as a result of the research for the preliminary study. As it forms the basis for the master thesis, a copy is shown in Table 1.

1.3 Planning

The content of this project is based on the IPM model (Norwegian abbr. Dept. of Engineering Designs and Materials) which describes a generic development process. Table 2

Product Specification				
Demand	Target value	Source	Importance	
		1 Must 2 Important 3 Relatively of less importance		
1 Economic				
1.1	Unit price	\$ 50		1
1.2	R&D	\$ 30,000		1
1.3	Sourcing	\$ 25,000		1
1.4	Tooling	\$ 650,000 (1 year payback for total investment)		1
2 Technical				
2.1	Mass	Max 8 kg	EN1865:2000	1
2.2	Geometry, tolerances included.	Must fit standard transport compartments	EN1865:2000	1
2.2.1	Length	Min/max 1830/1980 mm		
2.2.2	Width	Min/max 400/500 mm		
2.2.3	Depth	Max 70 mm (folded and unfolded)		
2.3	Loading capacity	Min 150 kg	EN1865:2000	1
2.4	Speed pins capacity	Min 300 lb pull strength		1
2.5	Flammability	No progressive smoldering or flaming when tested in accordance with EN1021-1	EN1865:2000 EN1021-1	1
2.6	Storing temperature	Min/max -30°C/70°C	EN1865:2000	1
2.7	Operating temperature	Min/max 0°C/40°C Shall function for at least 20 minutes when placed in an environment at -5°C after storage at a room temperature of 20°C, still requiring the given variations of storage temperature (2.6) prior to this	EN1798:2007	1
2.8	Deformation of the lying area	No remaining deformation when tested in accordance with EN1865	EN1865:2000	1
2.9	Resistance to torsion	No remaining deformation when tested in accordance with EN1865	EN1865:2000	1
2.10	Rugged construction			1
2.11	Materials	Easy to clean, washable, petrol-oil resistant, latex free, non toxic and must allow preliminary x-ray diagnostics		1
2.12	Marking and instructions	Each device must be accompanied by the information needed to use it safely and properly, taking account the training and knowledge of users	EN980:2008 EN1041:2008	1
3 Functional				
3.1	Lying part	The design must be so that it will give maximum support for the head and whole torso	EN1865:2000	1
3.2	Design platform	Must identify with the Laerdal spinal product family design platform		1
3.3	Nesting			3
3.4	Color variation	Must offer Laerdal Yellow Can offer olive green (every additional color must be tested, financial gain must validate the color variation offerings)		1
3.5	Tapered design			1
3.6	Child slots	If center slots are demanded, they should aim to be formed in a way that is dissimilar to the projected form of internal organs in the thorax and pelvis region		3
3.7	Hand holds size	Width min. 80 mm		1
3.8	Ground-hand holds clearance	Min. 20 mm		1
3.9	Fully sealed construction		EN1865:2000	1
3.10	Surface	Finish must be impervious to workplace fluids. It must be easy to slide a patient over the lying area		1
3.11	Cleaning	No shapes or configurations must impose any constraints on the ability of health care personnel to clean, disinfect or sterilize the device	AAMI TIR12:1994	1
3.12	Angled edges	Log rolling must be easy		1
3.13	Pins	Min. 8 pins (see also 4.2)		1
3.14	Intuitive design	The use of the device must be intuitive to the operators of the board, given their training and knowledge		1
3.15	Recycling	The potential of recycling should be considered in the design process	AAMI TIR12:1994	2
3.16	Compatibility			1
3.16.1	Head immobilizers	Head area must include a min. 410x250 mm flat rectangle to fit most head immobilizers available on the market		
3.16.2	Strapping systems	Must be compatible to most strapping systems available on the market, including speed clip strapping systems (see also 3.12)		
3.16.3	Helicopter hoist	Design must allow the use of helicopter hoist gear		
4 Other				
4.3	Graphics	It should be possible to add custom graphics to the spineboard. All surfaces must pass a tape test (adhesive tape is used to secure the patient and to fasten some head immobilizers).		3

Table 1: This product specification from the project report forms the basis for this master thesis [1].

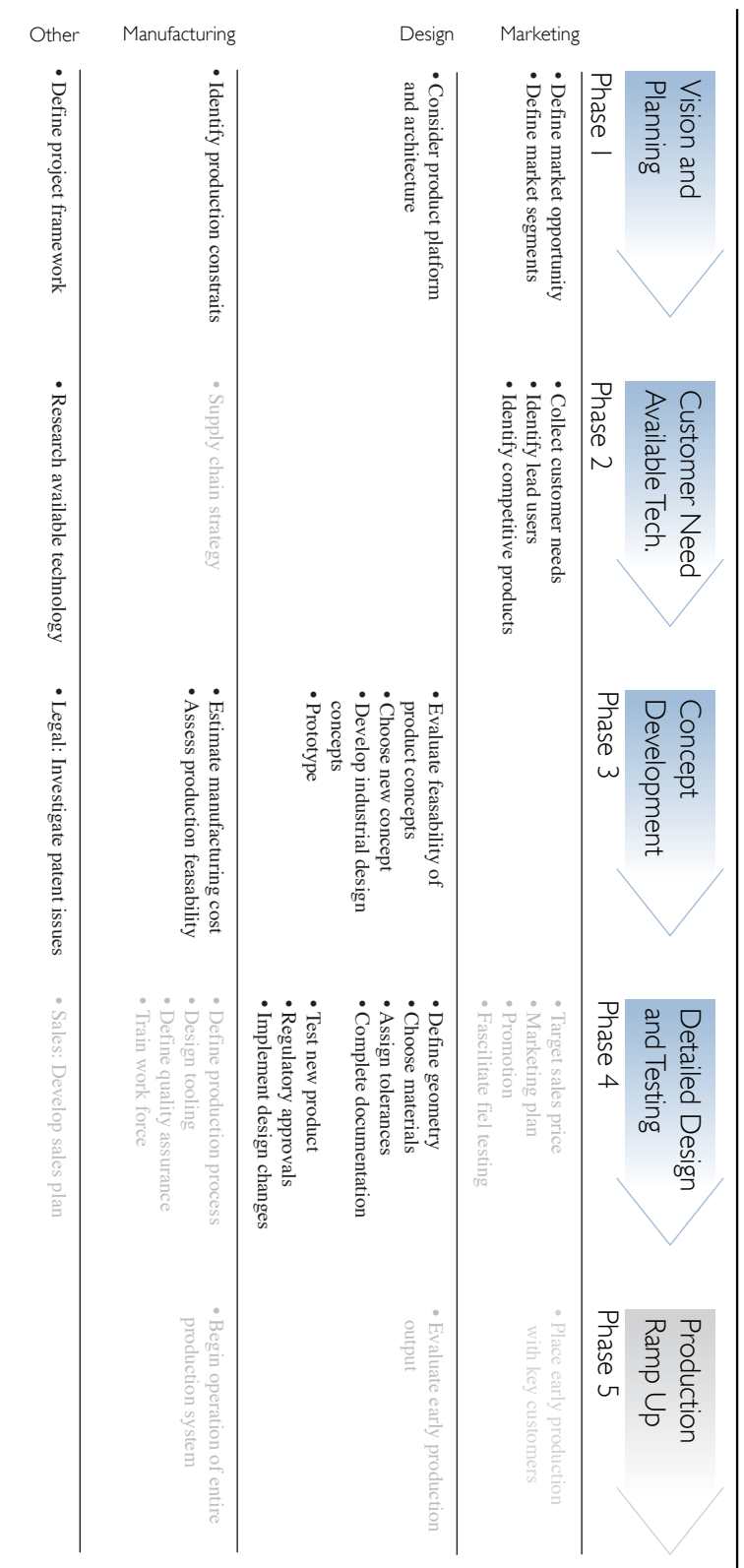

Table 2: An alteration of a generic product development process

shows an extension of this model that has been adapted with respect to this project from Ashby and Johnson's *Materials and Design* [2].

The contents of the preliminary were limited to the first three stages: 1 Vision and Planning, 2 Customer Needs and Available Technology and 3 Concept Development.

The plan for the master thesis project was to go into depth on Design category of phase 3 and 4. Objectives that are highlighted in Table 2 that were part of further developing the new spineboard concept during this project were:

Evaluate product concepts The basis was formed through a product specification in the preliminary study. Concepts were constructed and evaluated during the master thesis project.

Develop industrial design concepts Standards, patents, current literature, user interviews and review of competitors formed the basis for new design concepts.

Choose new concept This was done in cooperation with Laerdal Medical.

Prototype Creating a prototype was too expensive, but a mock-up of the design at a late stage was made.

Define geometry New target values were added to the product specification.

Test new product The mock-up was used as a basis for discussions with users of spineboards.

Implement design changes Changes were made to the design during the entire project based on user feedback (including feedback from Laerdal's Strategic Marketing department) and design for manufacturing and strength. As the final design is not ready for production based on this report, the final design includes recommendations for further design changes that can be made to the spineboard.

A short description of the scope of this report, adapted from the assignment text, follows:

Scope of master thesis project:

Based on the work of the preliminary report conducted prior to this master thesis, the candidate shall continue development of a new spineboard to the prototype stage. Modeling and analysis shall be described such that Laerdal can use this information in further development of this and other similar products in the future. The new spineboard shall be of high quality, but have lower manufacturing cost.

1.4 Report structure

Section 1 gives an introduction to the background and scope of this master thesis project. Additional background information such as definitions of terms, literature review, competitors, users, use methods and use situations can be found in the Preliminary Study in Appendix G.

Section 2 includes a summary of a test report conducted to measure resistance to bending and torsion in the BaXstrap spineboard. The full written test report can be found in Appendix D.

Section 3 expands the product specification from the preliminary study with target values and key improvement areas for the new spineboard based on further research and discussions with Laerdal.

Section 4 reviews manufacturing of the new spineboard with respect to the updated product specification.

Section 5 includes a detailed description of constraints and possibilities for all spineboard design features, through a part breakdown approach.

Based on these, Section 6 contains two initial design concepts that are evaluated. One concept is chosen.

To ensure that all models delivered to the company can be altered or re-build easily, Section 7 includes a description of how the CAD model was created with respect to possible pitfalls that may be encountered when designing these types of models.

Section 8 describes how CAE was used to determine the bending and torsional properties of the new product.

An economic evaluation of the new manufacturing process was originally part of the assignment, but due to confidentiality this section has been given lower priority. Section 9 compares some key values of the BaXstrap spineboard to the new spineboard.

Section 10 rounds up the design process with describing the final design iteration that was conducted during this project. It also includes the creation of a mock-up for the final design with a following customer test.

Appendix A includes an overview of all material that was delivered in addition to this report. Appendix B is a facsimile of a roll-up poster that was created. Appendix C gives an overview of meetings during the project. Appendix E is a condensed summary of the CAD file history, where pitfalls encountered can be reviewed. Appendix F shows a draft of the final CAD model.

2 Physical test data for the BaXstrap spineboard

Physical tests of the BaXstrap bending and torsion properties were conducted to form a basis for comparison of the new design to the BaXstrap spineboard. While there exists test reports for the BaXstrap spineboard, including bending and torsion requirement verification according to NS-EN 1865, these tests do not include any detailed results of the spineboard's stiffness properties.

Section 2 include a summary of the performed tests and results. A detailed test report can be found in Appendix D.

2.1 Equipment utilized

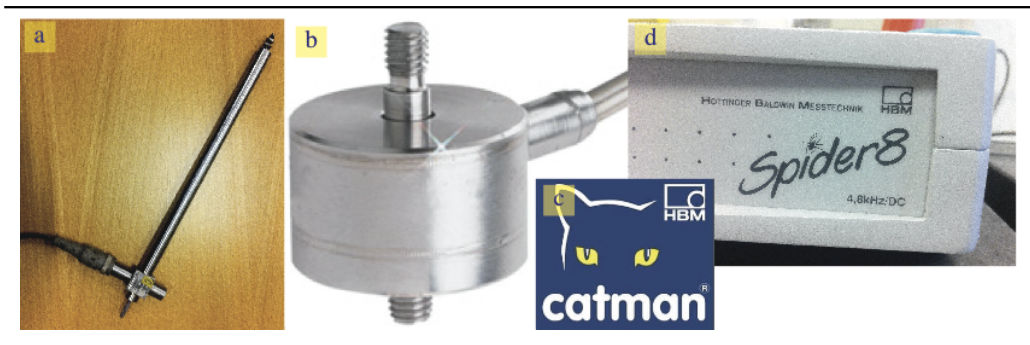

Figure 2: Equipment utilized for load/distance-measurement

Logging the results was done using three distance measurers (Figure 2a), one load cell for tension and compression with thread studs (Figure 2b) and HMB Catman Software CatmanEasy (Figure 2c). The software transforms information from the HMB Spider8 unit (Figure 2d), which is connected to the distance measurers and load cell.

The complete list of equipment used for the torsion and bending test can be found in Appendix D.

2.2 Setup

The tests were set up in the VTL Fatigue Lab (Norwegian abbr. Verkstedtekniske Laboratorier) at the Department of Engineering Design and Materials, NTNU Trondheim. The BaXstrap spineboard was shipped from Laerdal Medical AS, Stavanger. All other equipment was provided by NTNU.

The setup for the bending and torsion test were based on the NS-EN 1865:2000 Standard. Two tests were performed: the first to check bending properties; the second to

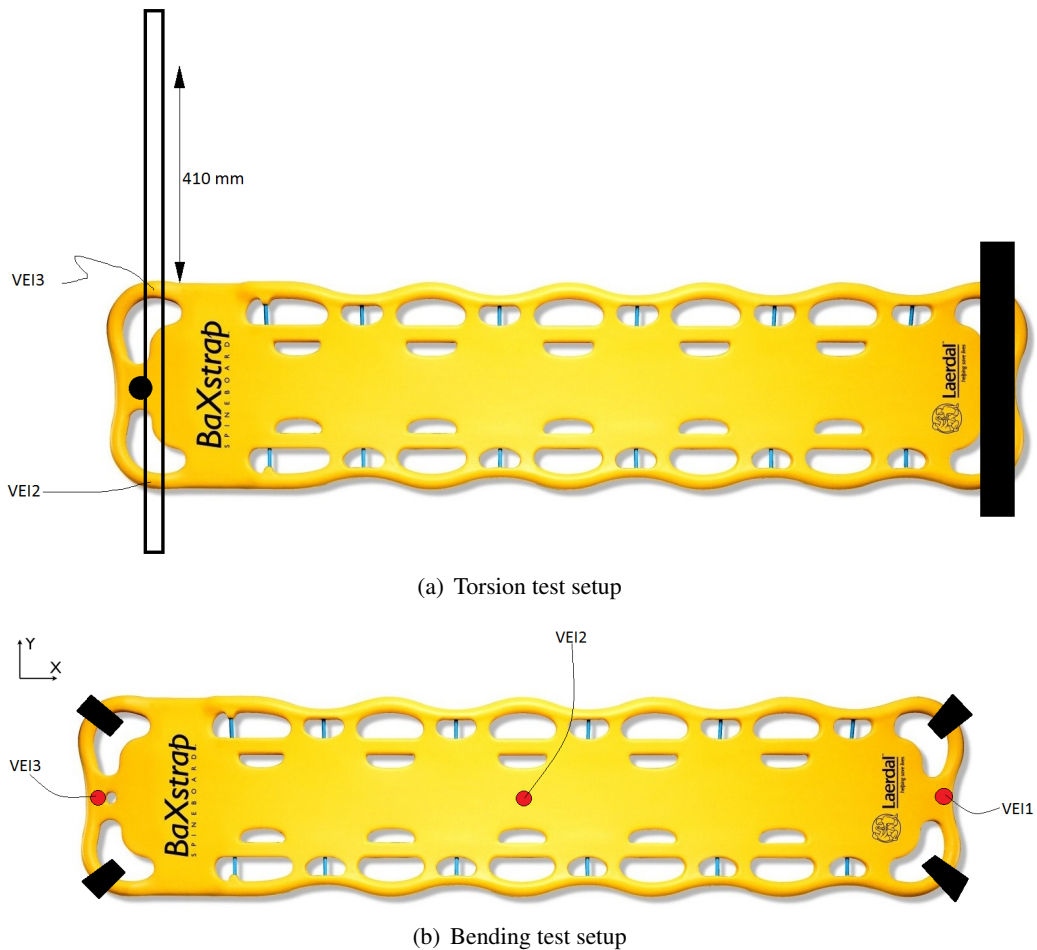

Figure 3: Physical tests setup

check torsion properties.

Figure 2.2 shows the setup for the torsion and bending test, respectively. Black solid areas indicate fixed areas.

In the torsion test (Figure 3(a)), the spineboard was clamped at one end and supported only by a vertical rod underneath the top center of the board. A metal bar was fixed to the two corner hand holds and a load cell fastened onto the bar, 410 mm (one board width) from the board. As the standard requires a maximum load of 100 N, this could easily be done just by pulling on the load cell. Two distance measurers, D1 and D2, were mounted underneath the two corner hand holds to check for symmetric values while twisting the board.

For the testing of bending properties (Figure 3(b)), the spineboard was hanged by two metal bars using velcro straps to support each of the four corners of the board. The metal

bars were supported 300 mm from the board on each side, as required by the standard. One distance measurer D2 was secured under the center of the spineboard to check the ZX-deformation, and two distance measurers, D1 and D3, were secured between the corner hand holds to check the symmetry and to check the deformation in the ZY-plane.

2.3 Resistance to torsion

The test shows a deflection of 28 mm on average at the two corner handholds when the spineboard is twisted by pulling on a load cell to 10 kg at a 410 mm distance from the board. Details of three tests are listed in Table 3. The required moment of force to twist the spineboard 0,1 rad, or $\approx 5,7^\circ$, is 34400 Nmm (see Figure 4 for a detailed view of the moment of force while loading and unloading).

There is a 1 - 1,5 mm difference in the measured deflection for the two distance measurers. This is because the metal tube that was used, was not long enough to be strapped onto the board symmetrically. The difference in deflection increases by 0,4 mm throughout the test because the test measures vertical deflection while the true deflection moves along the arc that is created when the spineboard twists.

Test index	Weight [kg]	Distance D2 [mm]	Distance D3 [mm]	Delta [mm]
Torsion04				
	-5	-13,3	14,3	1,0
	-6	-16,2	17,3	1,1
	-7	-19,5	20,7	1,2
	-8	-22,5	23,9	1,4
	-9	-25,3	26,7	1,4
	-10	-27,8	29,2	1,4
Torsion05				
	-5	-12,6	13,5	0,9
	-6	-15,7	16,7	1,0
	-7	-18,6	19,6	1,0
	-8	-21,0	22,1	1,1
	-9	-23,5	24,7	1,2
	-10	-26,9	28,2	1,3
Torsion07				
	-5	-12,5	14,0	1,5
	-6	-15,4	17,0	1,6
	-7	-18,5	20,1	1,6
	-8	-21,7	23,4	1,7
	-9	-24,8	26,6	1,8
	-10	-28,2	30,1	1,9

Table 3: Torsional properties of the BaXstrap spineboard

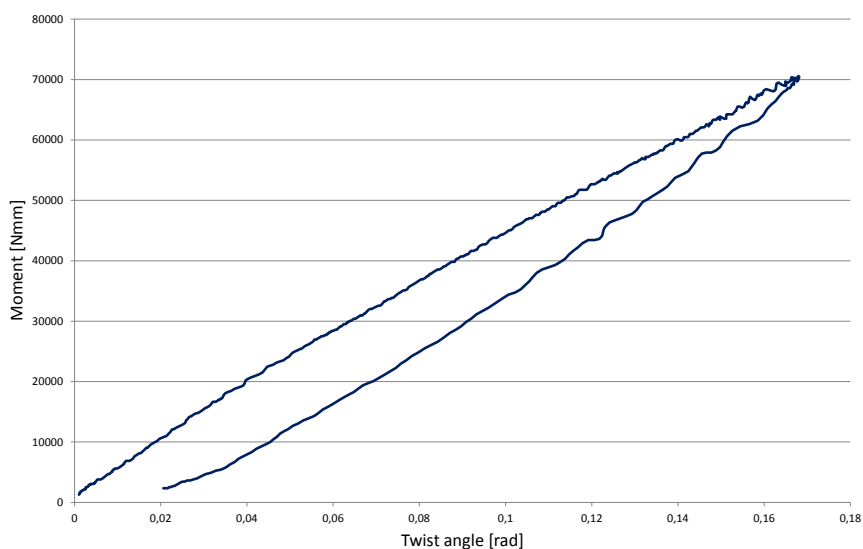

Figure 4: The graph shows the moment of force needed to twist the spineboard up to 0,17 radians

2.4 Resistance to bending

The deflection was measured at 1 Hz frequency while 5, 10, 15 and 17 kg sand bags were distributed onto the lying surface incrementally. Between each load, the board was given about 10 seconds to come to rest. Details for these tests are given in Table 4.

In the three tests, there is a variation of 3,6 mm in the result at the maximum weight load (135 kg). The first two tests, Bending01 and Bending02, were logged while loading sand bags onto the board and the third test, Bending03, was logged while unloading. If we look at details from each test where the deflection is measured against time, we can roughly calculate that the spineboard deflects about 1 mm in 20 seconds after adding the weight. This explains the difference in the first and second result. In addition, the spineboard was only given 2 hours to rest between the tests, which is less than the board needs to completely relax.

Bending properties of the BaXstrap spineboard

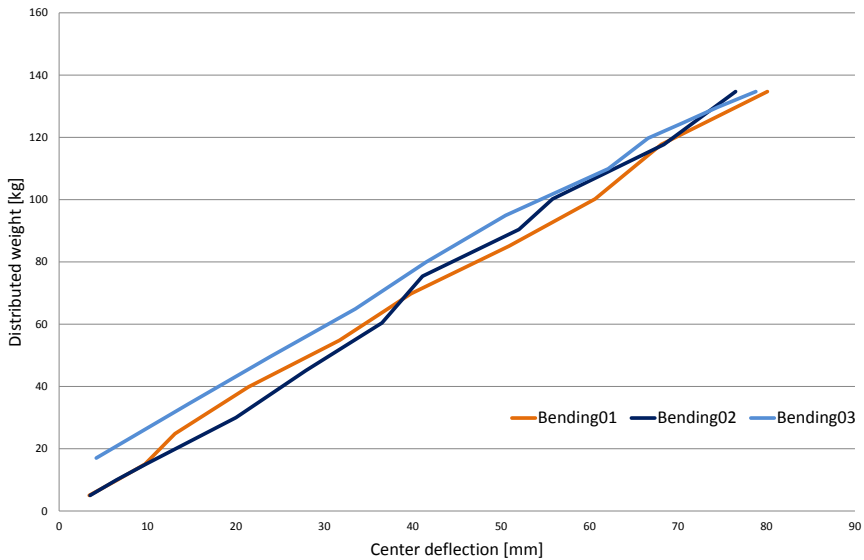

Figure 5: The graph shows the deflection in the center of the spineboard given the applied incremental loads

2.5 Comments to EN1865 spineboard stiffness requirements

In NS-EN 1865:2000, the spineboard’s resistance to torsion is required to be as follows: The two foot end corners of the board are clamped, while the other two are supported from underneath and have a metal bar fixed across the top side of the corners (or pulled out handles, as will be the case for some spineboards). A 100 N weight is fixed to the metal bar, 300 mm from the board. The fourth, free corner should move more than 50 mm, measured vertically from its initial position.

As the standard uses a spineboard with pull-out handles, this will always give the most conservative result. For rigid plastic spineboards that have curves and ground support underneath their corner hand holds, the tipping point will come closer to the center and give a larger deflection because of this.

The setup for the twisting test in Section 2.3 was changed from the setup in the standard to produce numbers that are easily comparable to constraints from computer simulations.

Test index	Weight [kg]	Distance2 [mm]	Average Distance (1:3) [mm]	Distance2 - Average Distance(1:3) [mm]
Bending01 (Loading, 360s)				
	5,0	4,	0,5	3,5
	10,0	7,4	0,9	6,5
	15,0	11,0	1,2	9,8
	24,8	22,1	2,1	20,0
	39,8	31,0	3,1	27,9
	54,8	40,4	3,9	36,5
	69,8	46,0	4,9	41,1
	85,1	57,6	5,6	52,0
	100,2	62,1	6,3	53,8
	117,7	75,5	7,1	68,4
	134,7	84,5	8,0	76,5
Bending02 (Loading, 300s)				
	5,0	3,8	0,4	3,4
	10,0	7,5	0,9	6,6
	15,0	11,0	1,3	9,7
	24,8	15,0	1,9	13,1
	39,8	24,1	2,7	21,4
	54,8	35,0	3,3	31,7
	69,8	43,8	4,0	39,8
	85,1	55,4	4,5	50,9
	100,2	65,6	5,0	60,6
	117,7	73,6	5,5	68,1
	134,7	86,1	6,0	80,1
Bending03 (Unloading, 275s)				
	17,0	4,3	0,1	4,2
	34,5	14,9	0,2	14,7
	49,6	24,4	0,5	23,9
	64,9	34,4	0,9	33,5
	79,9	42,9	1,4	41,5
	94,9	52,3	1,8	50,5
	109,9	64,6	2,5	62,1
	119,7	69,7	3,1	66,6
	124,7	74,1	3,5	70,6
	129,7	78,5	4,0	74,5
	134,7	83,6	4,8	78,8

Table 4: Bending properties of the BaXstrap spineboard

3 Requirements for the new spineboard

In the project report *Concept development of a new spineboard - a preliminary study* [1], a product specification to the new spineboard was made. It contains economic, technical and functional minimum requirements for the new board. There was not enough foundation to determine all target values during the preliminary study. This has been reviewed through further research and interviews during this project. The requirements in this section include the target values in addition to minimum requirements.

3.1 Technical requirements

Technical requirements of the product specification from the preliminary study [1] are mainly adapted from the NS-EN 1865:2000 Standard as minimum requirements. During discussions with the Laerdal Strategic Marketing Division in Stavanger and New York, technical requirements have been specified to include goals for the new product. Selling the new product in the very competitive US market, requires a spineboard that is cheaper than the BaXstrap, but does not sacrifice important selling features such as low weight and loading capacity. In short, the technical *wants* for the new spineboard is a spineboard that can be produced at half the cost, but has the same rigid quality as the BaXstrap spineboard. Table 5 lists the technical requirements with the target value for the new spineboard and the minimum requirement with reference to the applicable standard. Target values are based on values that seem achievable with the new production method as well as what features are necessary to make the spineboard a real competitor in the US market.

3.2 User defined requirements

Functional requirements are more closely related to visible customer needs. This section includes visual design features and features directly related to how the spineboard is used (see Table 6) Quantified values for the new spineboard are listed in the 'Target value' column and minimum values, with respect to current standards when applicable, are listed in the 'Minimum value' column. The relative importance rating is as follows: 1. Absolute must, 2. Important, 3. Less important.

TECHNICAL REQUIREMENTS				
Demand	Target value	Minimum value	Importance	
T1	Mass	6 kg	Max. 8 Kg (EN1865:2000)	1
T2	Geometry (including tolerances)		Must fit standard transport compartments. Values according to EN1865:2000	1
T2.1	Length	1830 mm	Min/max 1830/1980 mm	
T2.2	Width	410 mm	Min/max 400/500 mm	
T2.3	Depth	50 mm	Max. 70 mm (folded and unfolded)	
T3	Loading capacity	360 kg	Min. 150 kg	1
T4	Speed plus capacity	300 lb pull strength		1
T5	Flammability		No progressive smoldering or flaming when tested in accordance with EN1021-1	1
T6	Storing temperature		Min/max 30°C/70°C (EN1865:2000)	1
T7	Operating temperature		Min/max 0°C/40°C Shall function for at least 20 minutes when placed in an environment at -5°C after storage at room temperature 20 °C; still requiring the given variations of storage temperature (T6) prior to this (EN1798:2007)	1
T8	Deformation of the lying area	<90 mm at the center of the board at 135 kg distributed load	No remaining deformation when tested in accordance with EN1865	1
T9	Resistance to torsion	< 29 mm max. deflection when twisting the board with 61500 Nmm (100 N (410*1,5) mm from the center of the board)	No remaining deformation when tested in accordance with EN1865	1
T10	Rugged construction			1
T11	Material elasticity	10 - 17 GPa (preferably closer to 10 GPa)		2
T12	Other material properties		Easy to clean, washable, petrol-oil resistant, latex free, non toxic and must allow preliminary x-ray diagnostics	1
T13	Marking and instructions		Each device must be accompanied by the information needed to use it safely and properly, taking into account the training and knowledge of users (EN1980:2008, En1041:2008)	1

Table 5: Technical requirements of the new spineboard

FUNCTIONAL REQUIREMENTS			Importance
Demand	Target value	Minimum value	
F1	Lying area Curved lying area	The design must be so that it will give maximum support for the head and whole torso (EN1865:2000)	1
F2	Design platform Use BaXstrap geometry as basis for head and torso lying area	Must identify with the Laerdal spinal product family design platform.	1
F3	Nesting		3
F4	Color variation Laerdal Yellow	Must offer Laerdal Yellow. Additional colors must be tested.	1
F5	Tapered	Bottom 35 - 40 % of the total length tapered at 2 - 5° angle.	1
F6	Child slots	No child slots.	2
F7	Hand holds size	140 x 55 mm (top view). Can be less wide (40-55mm) in the foot area. Large corner hand holds must be a priority.	1
F8	Ground-to-hand clearance	holds 25 mm for head and torso area. Min. 15 mm at the foot end of the board.	1
F9	Fully sealed construction	(EN1865:2000)	1
F10	Surface	Finish must be impervious to workplace fluids. It must be easy to slide a patient over the lying area.	1
F11	Cleaning	All external radiuses > 2 mm (Internally 0,1 mm)	2
F12	Angled edges	25 ° angle to ground at the periphery of the device Log rolling must be easy.	1
F13	Pins	12 pins Min 8	1
F14	Intuitive design	The use of the device must be intuitive to the operators given their training and knowledge.	1
F15	Recycling	The potential of recycling should be considered in the design process (AAMI TIR12:1994)	1
F16	Compatibility		1
F16.1	Head immobilizers	410 x 250 mm flat rectangle at head area Head area must include a min. 410 x 250 mm flat rectangle to fit most head immobilizers on the market.	
F16.2	Strapping systems	Produced with 16 hand holds and 12 speed clip holes. Must be compatible to most strapping systems available on the market, including speed clip strapping systems	
F16.3	Helicopter hoist	Design must allow the use of helicopter hoist gear	

Table 6: Functional requirements of the new spineboard

3.3 Key improvement areas

The BaXstrap spineboard was introduced to the market in 1996/1997. The patent, of Sep. 14th 1999, promotes the need for a more rigid spineboard than the current market could offer. Today, the BaXstrap is still among the strongest spineboards on the market. The stiffness, along with a curved lying area, large hand holds and hand holds-to-ground distance are its greatest selling features. On the down side, it is expensive (US \$ 200) and due to the curved geometry, users feel that it looks larger than it really is.

The strategy for the new product, is to introduce it to the market as a second spineboard. All though the new spineboard should continue the positive selling features that Laerdal are known for trough the BaXstrap, it is important that the new spineboard has some distinct differences from the BaXstrap.

3.3.1 Production cost

By accepting a significant investment cost, this thesis proposes production of the new spineboard by using injection molding and hot plate welding. The increase in gross margins should be large enough to have a payback time of two years.

3.3.2 Tapering

There is a strong user demand for a spineboard that is tapered at the foot end. This feature will lower the weight, give the product a slimmer expression and increase the flexibility as the spineboard can more easily be used offshore and in helicopters. For the use of spineboards during car extrications, it is essential that the spineboard has an end that is as slim as possible to fit both the spineboard and one rescuer in the car door.

3.3.3 Lying surface

Rigid plastic long spineboards are either flat or curved in the lying area. There are pros and cons regarding this feature, which will be discussed in Section 5.4. The BaXstrap spineboard is known for its curves. As this is an important selling feature, it is one that Laerdal intends to keep in their second spineboard. There is a correlation between the curved lying surface and the large hand holds-to-ground distance, which is another important selling feature for the BaXstrap.

3.3.4 Log rolling feature

Large hand holds and 27 mm maximum raised hand holds allows the Laerdal website to describe the BaXstrap as both 'easy to grab' and 'easy to pick up'. A $\varnothing 32$ mm tube surrounds the periphery of the hand holds around the entire spineboard, securing a firm grip. This large radius does, however, move the tipping point away from the patient during a log roll. The new product should try to incorporate tapered sides of the board without sacrificing any of the other functional requirements listed in Table 6.

4 Manufacturing

4.1 Injection molding

The cycle time of injection molding can be divided into five steps: plastification, injection, holding, cooling and ejection. The selected material, normally supplied by pellets, are put into a hopper on the injection molding machine, see Figure 6. The pellets are transferred to the heated barrel where they are forced against the wall of the barrel. The screw itself has three sections. The first half of the screw is called the feed zone. It has a constant screw thread depth which packs the pellets together and removes the air. The second section, the melt zone, has a decreasing thread depth. This reduces the plastic volume and plasticizes the material. The last section has a constant thread depth again, but much smaller than at the feed zone. The tip of the screw has a one-way valve which allows the material to flow only towards the nozzle.

Most of the heat required to melt the pellets is generated by the friction between the barrel and the screw. The additional heat needed to melt the pellets is provided by the external heaters. While the rotation of the screw feeds the molten pellets forward, the screw itself is pushed backwards by the accumulation of the melt in front of the screw tip.

When the ejection chamber is full with molten plastic, the rotation of the screw stops and a valve is opened into the mold. The screw is pushed forward and the melt flows through the nozzle into the cavity.

When the cavity is completely filled, the screw is held in the forward position to maintain a holding pressure. This allows a little more material to enter the mold as plastics shrink from the melt temperature as they cool. This is the holding, or packing step of the injection molding cycle.

The mold cools the plastic. The cooling rate is dependent on the thickness of the part, but can be improved by letting coolant flow through holes in the mold plates. During cooling, the screw starts rotating again and moves backward, starting the next plasticizing stage.

When sufficient cooling time has been allowed for the part to solidify, the mould opens and the part is ejected. The mold then closes and the injection cycle starts again.

[3] [4]

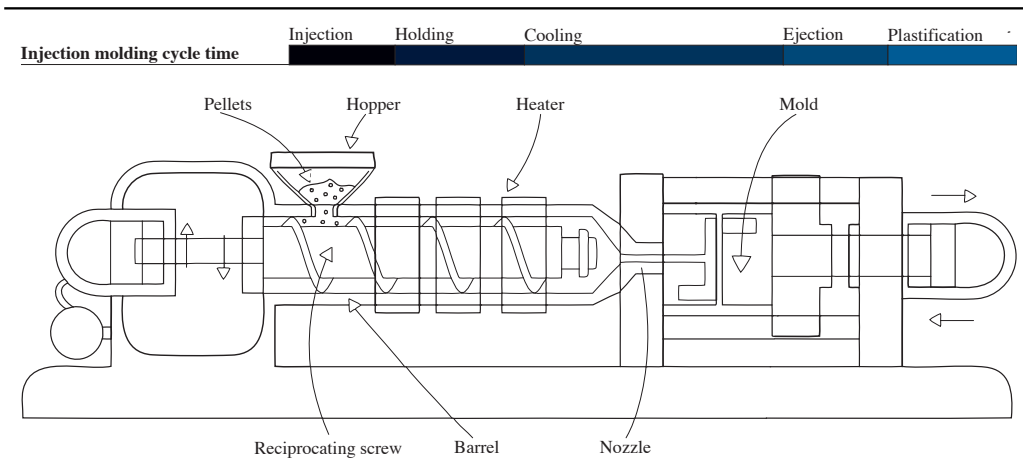

Figure 6: Injection molding machine and cycle time [Altered generic model, adapted from http://en.wikipedia.org/wiki/File:Injection_molding.png]

4.2 Joining

4.2.1 Ultrasonic welding

Ultrasonic welding is the process by which two pieces of plastic are joined together through the use of high-frequency acoustic vibrations. For the process one half of the component is placed on a fixed anvil and the second half is placed on top. An extension, connected to the transducer on the welding machine (called a *horn*) is then lowered down on top of the two components. Once the horn is in place a high frequency, low-amplitude acoustic vibration is applied to the moulding in a small welding zone. This vibration causes the acoustic energy to be converted into heat energy and the two components are welded together in a short space of time, typically less than one second.

Parts that will be ultrasonically welded together are designed with very small amounts of extra material on the join line on one half, with a slight recess in the second half. This means that when the parts are welded together there is sufficient material for the parts to fuse together with a strong joint.

Benefits of ultrasonic welding:

- Neat weld seams. This means that the process can be used for joins that will be visible once final assembly has been completed.
- High level of quality. Very little human error due to automated process.
- Low cycle times.

Due to the high energies that would be involved it is simply too dangerous to weld together large component parts using ultrasonic welding. Even with ultrasonic welding of small components the operator must wear ear defenders due to the acoustic dangers caused by the two parts vibrating together. To weld large parts these vibrations would be substantially larger and the energy involved could be a danger to surrounding operators.

4.2.2 Vibration welding

In this process, vibration occurs by transverse reciprocating motion controlled electromagnetically by a swing frame assembly containing precision springs, electromagnets and an electromagnetic drive assembly which controls the amplitude and frequency of the vibrating head.

Friction is achieved through motion between two parts, one fixed, the other reciprocating at a controlled amplitude and frequency while clamped under pressure. Melt occurs only at the interface of the joint area of the plastic part halves.

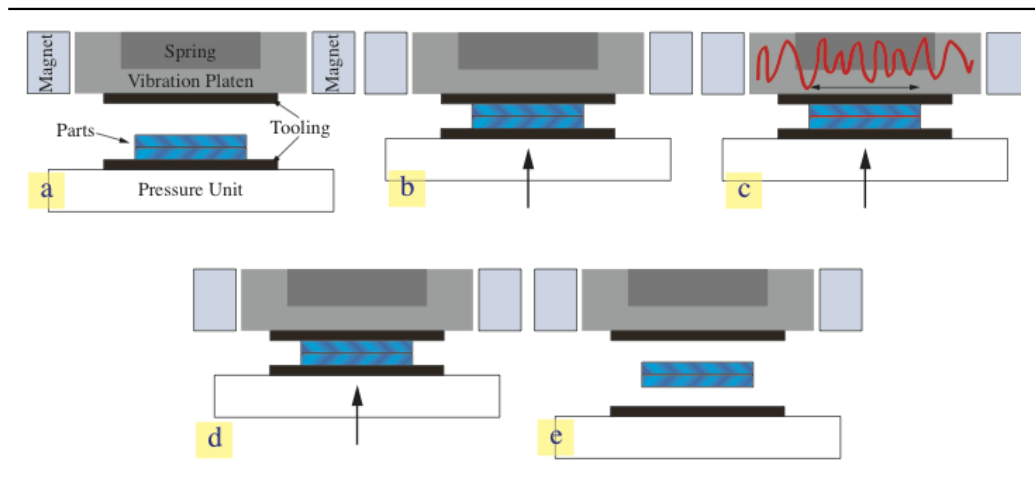

Figure 7: Vibration welding process

Part halves are placed into and securely gripped by precision holding fixtures which insure adequate support and accurate alignment of the part halves throughout the vibration welding process (7 a.).

The lower holding fixture rises upward to close against the upper holding fixture, compressing the part halves to be welded together (7 b.).

Friction (heat) begins by vibration on the swing frame assembly. This is controlled by alternating the energy of electromagnets. This pulsation propels the vibrating plate and the upper tooling fixture alternately left and right (7 c.).

Vibration halts and the holding fixtures maintain clamping force, allowing the parts to cool under pressure 7 d.).

When cooling is complete, the lower fixture lowers and the finished part may be unloaded 7 e.).

Benefits of vibration welding:

- Ability to weld large parts and complex shapes.
- Fast cycle times.
- Compatible with most thermoplastics.
- No consumables, fumes or emissions.
- High strength, hermetic welds are typical.
- Heat confined to weld interface.
- Easily automated.
- Low cost, quick change tooling.
- Low maintenance.
- Low power consumption.

4.2.3 Hot plate welding

This thermal welding technique can produce strong, air-tight welds in thermoplastic parts. Thermal heat is introduced to the interface of each part half by a precision temperature controlled plate consisting of multiple uniform temperature distribution cartridge heaters.

Figure 8 shows basic sketches of the process. The plate assembly can be horizontal or vertical. For simplicity, the horizontal version is shown in the figure.

Part halves are placed into and securely gripped by precision holding fixtures which insure adequate support and accurate alignment of the part halves throughout the hot plate welding process (Figure 8 a.).

To heat the part joint area, a thermally heated plate is placed between the part halves. The holding fixtures close to compress and melt the part halves to be welded against the plate, displacing material at the joint area only (Figure 8 b.).

Compression and material displacement continue until precision hard-stops built into the tooling are met. Thermal heat continues to conduct into the material even though compression and displacement have stopped (Figure 8 c.).

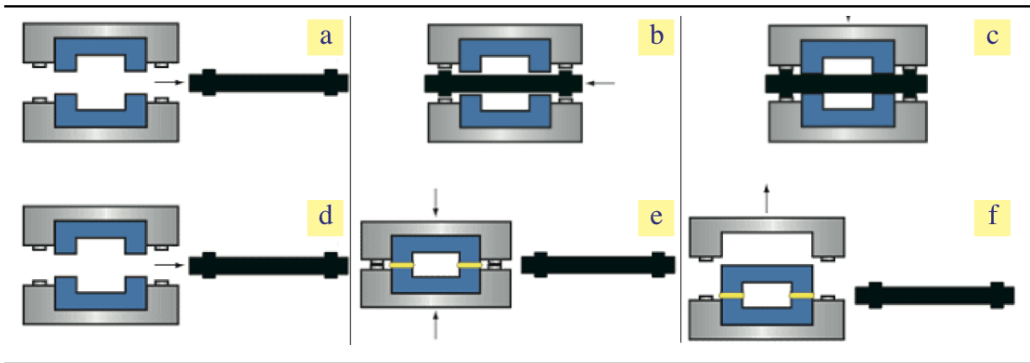

Figure 8: Hot plate welding process (Adapted from <http://www.forwardtech.com/>)

After the joint area reaches molten temperature, the holding fixtures open and the heat plate is withdrawn (Figure 8 d.).

The holding fixtures then close, forcing the two parts together until hard-stops on the holding fixtures come into contact with one another (Figure 8 e.).

When cooling is complete, the gripping mechanism in one of the holding fixtures releases the part, the holding fixtures open and the finished part may be removed (Figure 8 f.).

Benefits of hot plate welding:

- Ability to weld large parts and complex shapes and compound contours with little regard to part and joint geometry.
- Can weld tall, thin, non-supported interior walls.
- Highest joint strength of any weld process when welding PP, PE, TPE and EPDM materials.
- Significantly smoother flash than other assembly methods such as vibration welding.
- Compatible with most thermoplastics.
- High strength, hermetic welds are typical.
- Multiple parts per cycle can be welded.
- Easily automated.
- Relatively low equipment cost.
- Nature of the process is simple and highly forgiving of part tolerances when compared with other assembly processes.

4.2.4 Choice of joining method



	ULTRASONIC	VIBRATION	HOT PLATE
Applicable part size	S - M	M - L	M - L
Material (must be thermoplastic)			
Amorphous	✓	✓	✓
Semi-crystalline	Small parts	✓	✓
Cost			
Energy	\$	\$\$	\$\$\$
Labor	\$	\$\$	\$\$
Equipment	\$	\$\$	\$\$
Tooling	\$	\$\$\$	\$\$
Performance			
Weld strength	Medium	High	High
Cycle time			
Resultant stress levels	Medium	Medium	Medium
Part requirements			
Hermetic seals	✓	✓	✓
Thinned wall parts	✓		Part dependent
Uniform/solid flash			✓
Multi-level or curved joints	Part dependent	✓	✓
Welding internal surfaces	✓	Part dependent	✓

Table 7: Comparison of the described joining processes

Table 7 gives an overview over the described joining processes. Ultrasonic welding is difficult due to the size of the part. Several welders combined or robotic ultrasonic welding can be utilized, but due to the complex geometry of the part, this alternative is excluded.

Vibration welding is good for welding large and complex shapes. Cycle times and operating costs are low, but the process is far more sensitive to part variations than hot plate welding. As the new spineboard might use internal walls for reinforcement and will have a complex contour shape in the parting plane, vibration welding might be a poor choice for joining the two parts.

Table 8 compares vibration and hot plate welding.

Hot plate welding has the highest cycle time and operating costs of all three processes. But it is less sensitive to molded part variation, which might be an issue for the large injection molded parts. It produces very high joint strengths and the smoothest flash of any comparable joining process. A fully sealed and smooth construction is of very high importance for spineboards. For this reason, and the possibility of having a multi-curved parting line (Laerdal has expressed that they want a curved expression for this addition

to the spinal product family), hot plate welding is here assumed to be the best joining method for this product.

4.3 Design for manufacturing

The most important factor of designing for injection molding is the wall thickness of the product. Non-uniform walls and/or heavy wall sections can cause warpage, dimensional control issues, shrinkage, voids and surface shrink marks.

These commonly regarded guidelines are adapted and cross checked from various online guides for injection mold part design (efunda.com, polymerhouse.com), limited to the design features that applies for designing a new spineboard.

Wall thickness

Firstly, from a cost standpoint, the walls should be as thin as possible to utilize the least material and have the fastest molding cycles. In this case, the required stiffness of the spineboard must decide the minimum wall thickness. When the minimum thickness is established, the maximum flow length must decide on the number of gates needed for the mold.

The outer shell of the new spineboard should have a uniform thickness. This provides for even flow of the melt during injection, see Figure 9 a. If a change in wall thickness is necessary, the transition should be gradual - preferably in a 3:1 ratio (Figure 9 b.). The gradual transition avoids stress concentrations and abrupt cooling differences. The gating should be designed so the melt flows from the thicker to the thinner section to avoid restricted flow.

Parting line

Mismatch on the parting line should be specified to let the molder know what is acceptable for the engineer.

Radii

Sharp corners cause stress concentrations and should be avoided.

Two general rules for selection the right radius/thickness (r/T) ratio can be established:

- Internal radius should equal from $0,25T$ (minimum) to $0,75T$ (better).
- Outer radius is calculated by (internal radius + T).

COMPARISON OF JOINING METHODS

Hot plate welding	Vibration welding
Slower cycle times. Typical 15 - 45 seconds for high temperature welding. Typical 30 - 60 seconds for low temperature welding.	Faster cycle times. Typical 8 - 15 seconds.
Can weld tall, thin, non-supported inside and outside walls.	Cannot weld tall, thin, non-supported either: <i>a.</i> inside walls or <i>b.</i> outside walls perpendicular to the direction of vibration.
Direct control of temperature at weld joints.	No direct control of temperature at weld joint.
Process works well for a variety of materials (few limitations).	
Complex to weld Nylon. Involves ultra high-temperature heat plate cores which must be scrubbed with metal brushes every cycle to clean off build-up of residual material. Yields the strongest bonds compared to most other welding methods.	Easy welding of Nylon.
Almost no part size limitations.	Can be difficult to weld very large parts.
Can weld parts with contours in both directions.	Can weld parts with contours in one direction only.
Weld plane limited to 45° maximum from flat plane.	Weld plane limited to 10 ° maximum from flat plane in axis parallel to vibration.
Less sensitive to molded part variations.	More sensitive to part variations.
Lower initial capital equipment costs.	Higher initial equipment costs.
Higher tooling costs (requires heat plate).	Lower and less complex tooling costs.
Heat plate assembly requires higher maintenance costs (low temperature welding requires replacement of heaters and Teflon inserts).	Lower tooling maintenance.
Slower tooling change-over times.	Faster tooling change-over times.
Process creates solid, smooth flash bead with virtually no particulate.	Process can create flash that can break off (application and material dependent).
Virtually no smoke or fumes during welding process at low temp; will create smoke and fumes when welding at high temp.	Virtually no smoke or fumes during welding process.
Higher power consumption (required for heaters).	Lower power consumption.

Table 8: Hot plate welding vs. Vibration welding

Draft

All part walls should have a 2°- 3° draft per side whenever possible, with a minimum of 1° draft, see Figure 9 c.

Ribs and bosses

Proper rib design involves five main issues: thickness, height, location, quantity, and moldability.

Generally, taller ribs provide greater support. To avoid mold filling, venting and ejection problems, standard rules of thumb limit rib height to approximately three times the rib-base thickness, see Figure 9 d. Because of the required draft for ejection, the tops of tall ribs may become too thin to fill easily. Additionally, very tall ribs are prone to buckling under load

Ribs usually project from the main wall in the mold-opening direction and are formed in blind holes in the mold steel. To facilitate part ejection from the mold, ribs generally require at least one-half degree of draft per side. More than one degree of draft per side can lead to excessive rib thickness reduction and filling problems in tall ribs.

Enough space between ribs must be maintained for adequate mold cooling: for short ribs allow at least two times the wall thickness.

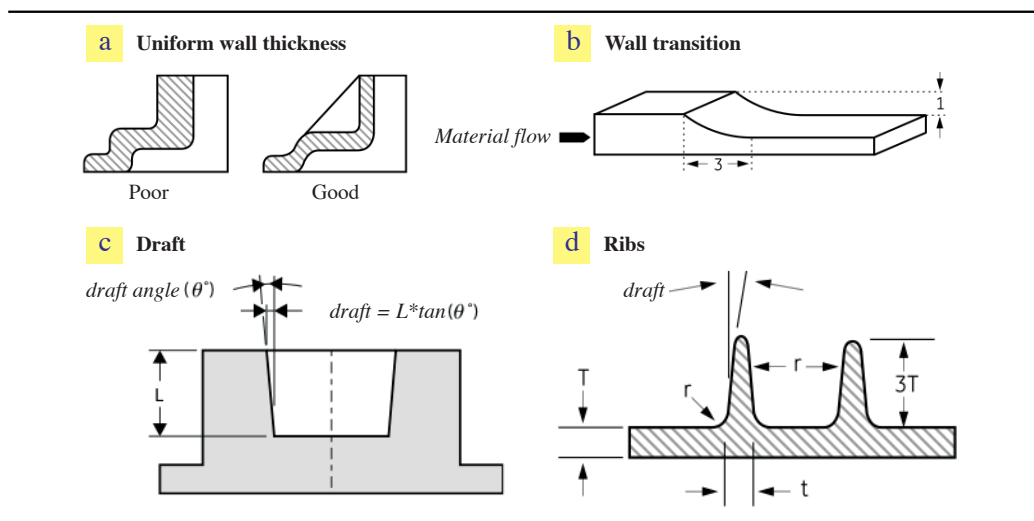

Figure 9: Diagrams for injection molding part design

4.4 Materials

While most rotational molded products are made from polyethylene, injection molding allows a very broad selection of materials. By choosing injection molding to manufacture the spineboard shell, Laerdal aims to use a material that is stiffer and harder than HDPE, which is used as the shell material for the BaXstrap spineboard.

4.4.1 Classification of polymers

Polymer chains may be linear, or possibly with additional chemical groups forming branches along the primary chain. If a polymer is made up of the same repeating units of monomers, it is called a homopolymer; otherwise, if it is made up of different types of monomers arranged in some sequence, then it is called a copolymer.

The molecular structure leads to two types of materials: thermoplastics and thermosets. Thermoplastics turn to a liquid when heated, and they solidify when cooled sufficiently. Their molecules are not chemically joined with each other during processing. The materials can be reversibly softened and hardened by heating and cooling. Thermosets are polymers that chemically react during processing to form a three-dimensional cross-linked polymer chain network. The chemical reaction is irreversible. Once hardened, the material cannot be converted back to a melt by heating.

Both thermoplastics and thermosets are used in injection molding. The main difference in processing is the mold temperature. For thermoplastics, the mold walls are colder than the melt, while for thermosets the mold walls are hotter than the material in the cavity.

Based on their chain conformation and morphology, thermoplastic polymers can be classified as amorphous, semi-crystalline, liquid Crystalline.

Many materials used in injection molding processing are not neat resins, but composite materials. The term *composite material* refers to a structure made up of two or more components, insoluble in one another, which, when combined, enhance the behavior of the resulting material. Composite properties are dominated by the microstructure of the fabricated part rather than the properties of the constituent materials. Among various possible reinforcements, glass and carbon fibers are commonly used in injection molding. Reinforcing fibers could be roughly divided into short fibers and long fibers. Short fibers are slender, but their typical length is smaller than the typical dimension of the apparatus. The aspect ratios (length/diameter) of short-fibers are smaller than 100, typically about 20, while the aspect ratios of long fibers are greater than 100. In general, the mechanical properties of a short-fiber composite are not as good as a composite with

long fibers, but short-fiber composites are easier to be processed at high production rate with methods such as injection molding.

4.4.2 Selection of material

From the requirements for the new spineboard set forth in Section XX, several requirements relate directly to the selection of a new material. They are summed up in Table 9.

SHELL MATERIAL			
Demand		Minimum value	Maximum value
M1	Cost per kg	NOK 30 / USD 5	NOK 60 / USD 10
M2	Total weight		7 kg
M3	Storing temperature	-30°C	70 °C
M4	Easily washable		
M5	Petrol oil resistant		
M6	Non toxic		
M7	Latex free		
M8	No progressive smoldering or flaming		
M9	Possible to injection mold		
M10	Possible to hot plate weld		

Table 9: Requirements for a new reinforced injection molded shell material

Additionally, Laerdal wants a shell material with Young’s modulus from 10 - 17 GPa. It is likely that this value should be targeted closer to 10 GPa due to material cost.

As the new spineboard will be manufactured in two parts, the material must be weld-able, which means a thermoplastic material should be selected.

By removing additional stiffening elements from the shell (maybe except for foam filling, also due to insulation properties), and keeping in mind that low weight is of crucial importance, the material must most likely be reinforced with fibers. Glass fiber should be preferred over carbon fiber, due to the cost.

While this thesis does not conclude on any specific material, it has been indicated from Laerdal that using glass-filled polyamide may be a good alternative.

For CAE simulations done during this project, it was concluded that static linear analysis would provide enough information. This means that two material parameters

are essential to do the calculations: Young's modulus and Poisson's ratio. Additionally, the material density was used to calculate the weight of the shell.

The values used in this project were:

Young's modulus 10 GPa

Poisson's ratio 0,4

Density 1,2 kg/m³

5 Design

5.1 Design process

Design and development processes are in general iterative processes, and this one is no exception. Section 5 *Design* and Section 6 *Design concepts* sums up the features that constitutes the final design of the new spineboard. They are not necessarily given in the chronological order as they evolved through the project, but a detailed design history is given in Appendix E.

Very early in the project it became clear that many geometric constraints would form the design of the new spineboard. This was due to standard requirements, but also because Laerdal wanted to continue the curvy design and large handholds of the BaXstrap spineboard.

Computer-aided design has been an important drawing tool through the project. The basic dimensions of the board was strictly constrained by standard requirements and curve extractions from the BaXstrap spineboard. Transitions were constrained by minimum radiuses and tangent constraints to curves or planes. Because of all the constraints and the need for quantified values, hand drawn models soon became insufficient to illustrate new ideas and changes to the existing design.

Combining reverse and forward engineering

The general product design process designs a concept from various performance and technical parameters, and then uses CAD to build a digital product model. This is called *forward engineering*.

Reverse engineering is a process that analyzes the structure of an existing product in order to recreate that product. It is especially useful for complex, irregular free-form products.

Figure 10 shows how these two have been combined in this project. The generic forward engineering design process is shown to the right. Designing new concepts were based on the product requirements of Figure 1 in Section 1.2, but also to a great extent on the existing Laerdal spineboard and other products available. A scanned 3D model of the BaXstrap spineboard was provided by Laerdal and used to extract holes dimensions and cross sections curves.

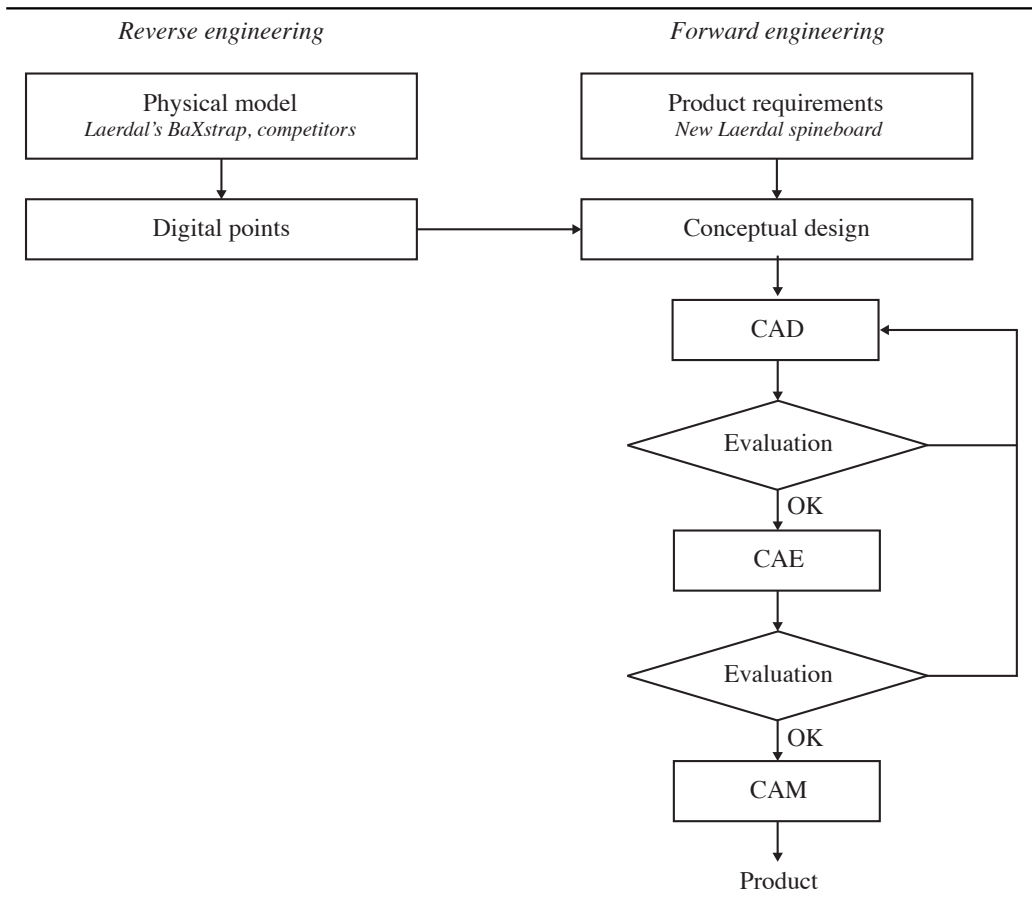

Figure 10: This design process combines reverse and forward engineering due to a great amount of geometry constraints (Adapted from [5] page 68)

5.2 Part breakdown and explanation of terms

The new spineboard will be a fully sealed one-piece plastic construction, but it is difficult to create a new design by looking at the spineboard as a whole. Figure 11 shows how this breakdown has been done in this project. At the same time, it gives an explanation of terms (in *italic* in Figure 11) that are used to describe design features of the spineboard.

The following sub-sections describe the design constraints and possibilities for all these key areas of the spineboard.

5.3 Geometry grid

To ensure that all sketches made in the new spineboard CAD file will create a spineboard of the right size, the sketches should all be constrained to a basic grid. This grid includes

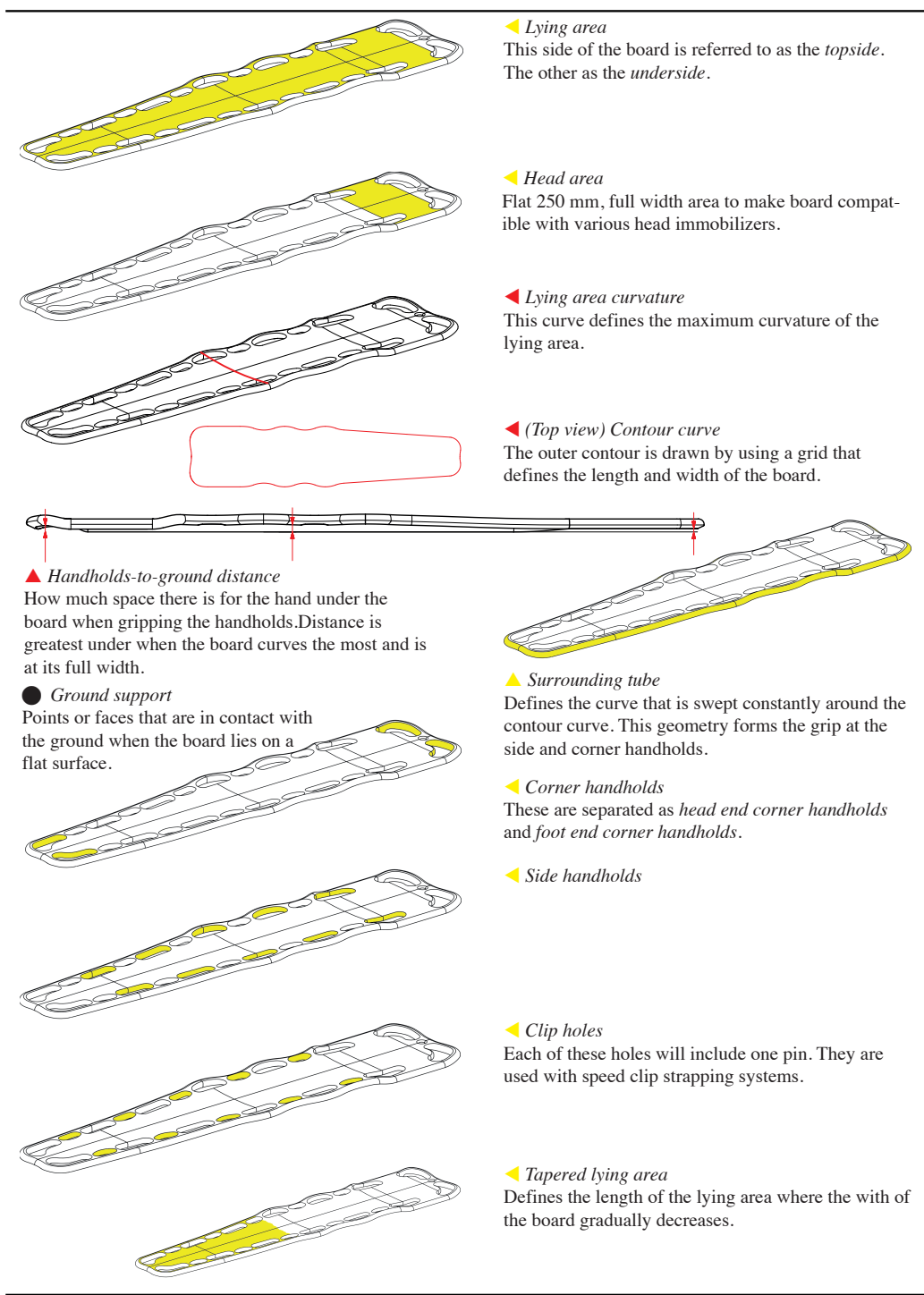

Figure 11: Explanation of the terms used in Section 5 Design

the board length and width, the placement of the head area and the taper length and taper angle, see Figure 12.

The size of the new spineboard has been evaluated based on the preliminary study (Appendix G) and discussion with the Laerdal Strategic Marketing Department. The width of spineboards are generally divided into two categories: 410 mm as the standard with, or 460 mm, an extra wide board. The width of the new spineboard should be 410 mm and the length should be 1830 mm, similar to the BaXstrap. Early in the project the length of the CAD models created was 1890 mm, which is why this value is found in Figure 12. It was changed to 1830 mm after a meeting with Laerdal Strategic Marketing.

The maximum allowed total thickness of the spineboard is 70 mm.

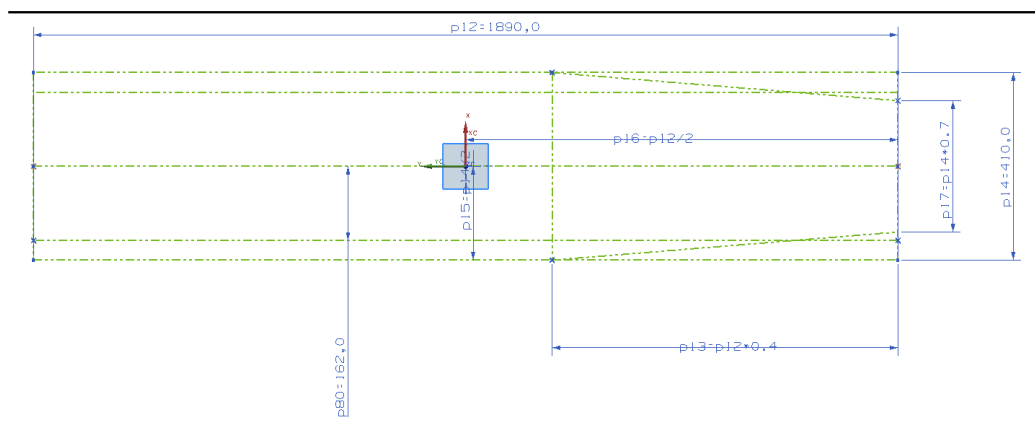

Figure 12: Gridlines sketch for new CAD models of the spineboard

5.4 Lying area

When reviewing competing products worldwide, the great variety in designs for spineboards becomes clear. The lying area of spineboards are generally flat or curved (Except for the head area which must be flat to fit various head immobilizers).

Arguments presented by rescue personnel in user interviews during this project did not suggest that one is better than the other. Having a curved lying area means that the patient is lying more comfortably, which makes it less likely that they move around and aggravate their injuries. Another feedback was that the curved surface could mean that a heavier patient will not fit properly, and therefore not have full support for the spine. Rescue services like the Air Ambulance, which use heart compression machines, use the spineboard as a rigid surface to place the machines and patients during transport. These machines have either curved or flat surfaces in contact with the spineboard. An

argument presented at a visit to the Air Ambulance in Stavanger was that the flat type heart compression machine could not be used with a curved spineboard in danger of the machine being placed at an incline. At the same time, the curved machine was not stable enough on the flat board during transport.

Curve means raised handholds and allows the boards to nest compactly. But with raised handholds, the thickness of the board is increased. From interviews with users, the impression is that the total thickness of the board is not a user concern. So, from another perspective, the board should not be thicker than necessary to keep the weight low, and under 70 mm, requested by the standard.

So the ultimate argument is evidently that the new spineboard is sellable. Having a curved lying surface is a key selling feature for Laerdal with their BaXstrap spineboard, and a feature that they want to keep. This means that the lying area should be curved for maximum support of the spine, i.e. at least under the upper body and hip area. On the BaXstrap, the board curves all the way down to the feet. Whether or not the board should curve all the way down on the new spineboard should be reviewed. There is a trade-off between a flat (thinner) board at the foot end and the handholds-to-ground distance at the foot end corner handholds. But a thinner foot end can give the new spineboard a more lean expression than the BaXstrap. It also creates a board that requires less space during car extrication.

5.5 Head area

Market requires a flat 250 * *board width* rectangle in the head area in order to fit most head immobilizers available. This flat surface must be in-line with the lowest point on the curved surface. The human head size, relative to the body size, varies with age. Figure 13 demonstrates this. To compensate, rescue personnel use padding under the head or under the torso. It is important that the new spineboard requires the same amount of padding for adults and children as any other comparable spineboard would.

5.6 Lying area curvature

Laerdal has expressed that they want to continue to have a curved lying area, so the first step was to examine the curvature of the existing product. It is hard to measure these values on the real board, so a scanned CAD file provided by Laerdal was used, see Figure 14. The feature *Intersectional Curves* (using Siemens NX 7.5) provided two cross sectional curves - one at the widest area of the board, and one between holes.

Extracted dimensions in Figure 14 show that the lying area radius is constant: 635

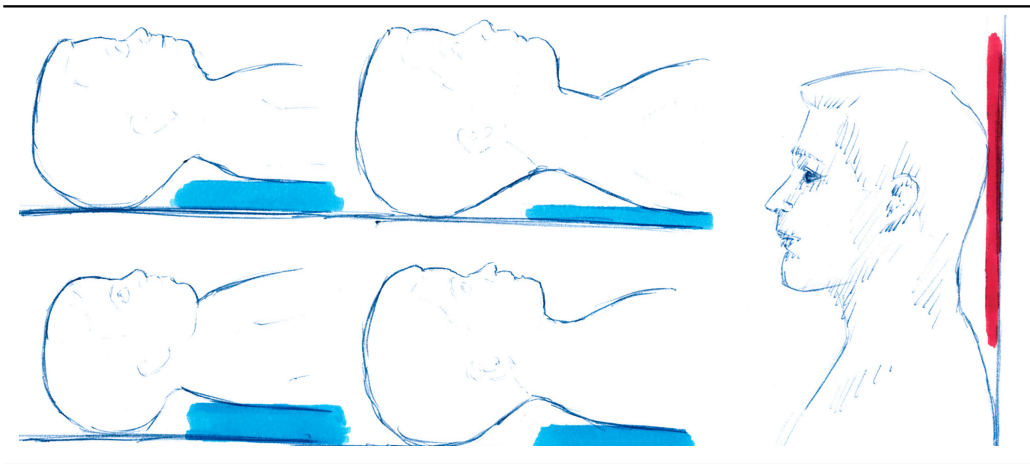

Figure 13: As humans grow, their heads become smaller relative to their bodies (Adapted from [6])

mm. On the actual spineboard, a radius of about 10 mm joins the lying area to the surrounding Ø32 tube. This is missing in the scan. A scan of a product of this size is for practical reasons simplified. It is difficult to determine to what extent this scan has been simplified, so the extracted values must be used carefully.

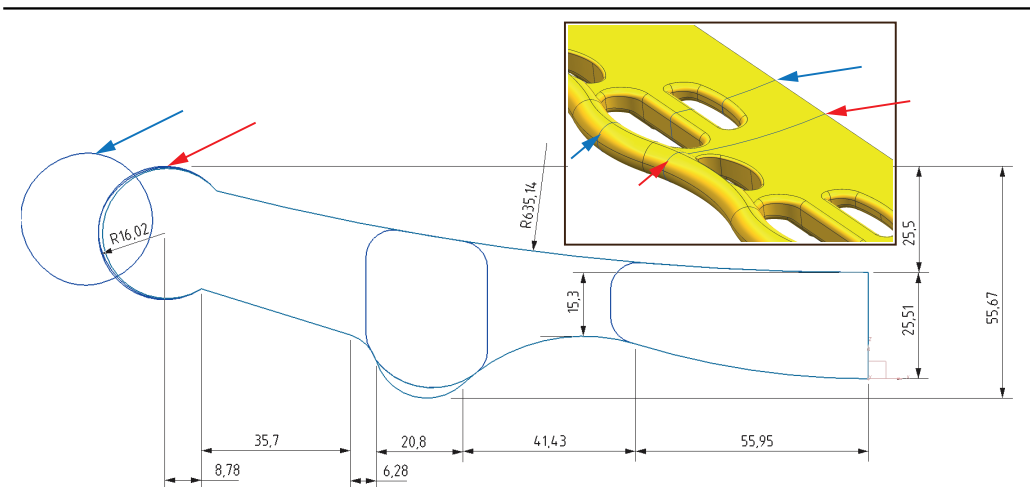

Figure 14: Extracted cross sectional geometry from the BaXstrap spineboard scan

The projected distance in the vertical direction between the lowest and highest point in the lying area is 25,5 mm in the scan. The total thickness can be measured to 55,7 mm (this is 2 mm less than the specified value, which emphasizes that there are some inaccuracies in this scan).

User interviews conducted during this project suggests that the curvature should be reduced somewhat in the new spineboard, to give the new board a leaner expression and to secure that larger individuals get the best support for the spine while lying on the board. However, remembering the trade-off between a curved lying area and handholds-to-ground distance, the handholds must be raised in another way to compensate for the reduced lying area curvature.

The proposed new lying area curve is shown in Figure 15. The new curve reduced the total thickness with approximately 10 mm relative to the BaXstrap, which must be compensated for on the underside of the board. The curve has a 100 mm extension beyond the width of the board, this is done purely to maintain tangency in the CAD model (a full summary of how the CAD model was build is given in Section 7).

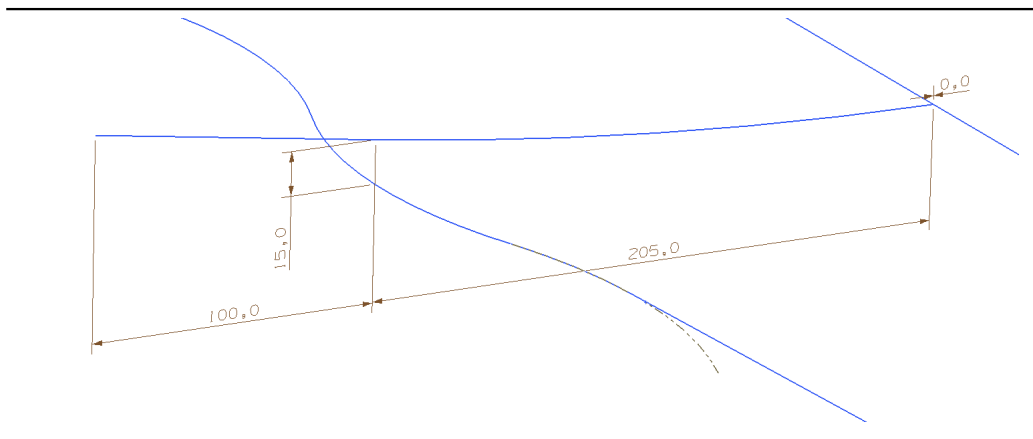

Figure 15: The proposed lying area curve for the new spineboard

5.7 Contour curve

The gridlines in Figure 16 constraints the maximum geometry of the new spineboard to 410 x 1830 mm like the BaXstrap. A 250 mm flat head area must be included in the design. The taper length should be 35 - 40 % and the taper angle must be explored. The foot end of the board should be as narrow as possible without sacrificing function, structural integrity or overall expression.

Based on this, several sketches constrained within the requirements in Figure 16 were made, see Figure 17. Based on these, CAD software was used to draw the sketches with correct dimension. Variations were explored by altering the sketches, see a condensed history of this development in Figure 18.

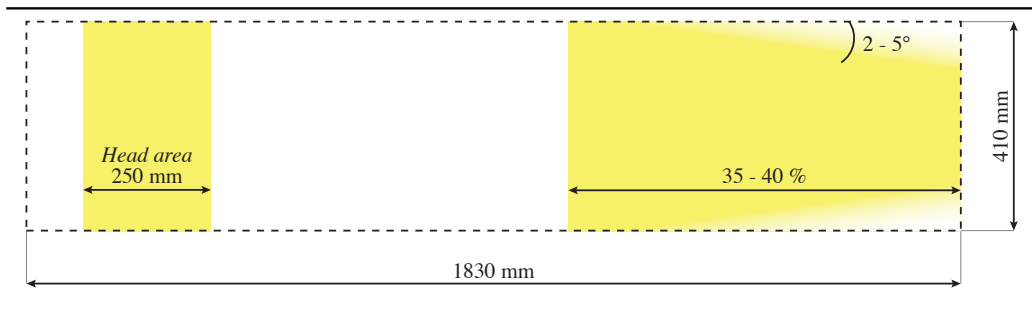

Figure 16: Gridlines that constrain the geometry of the new spineboard.

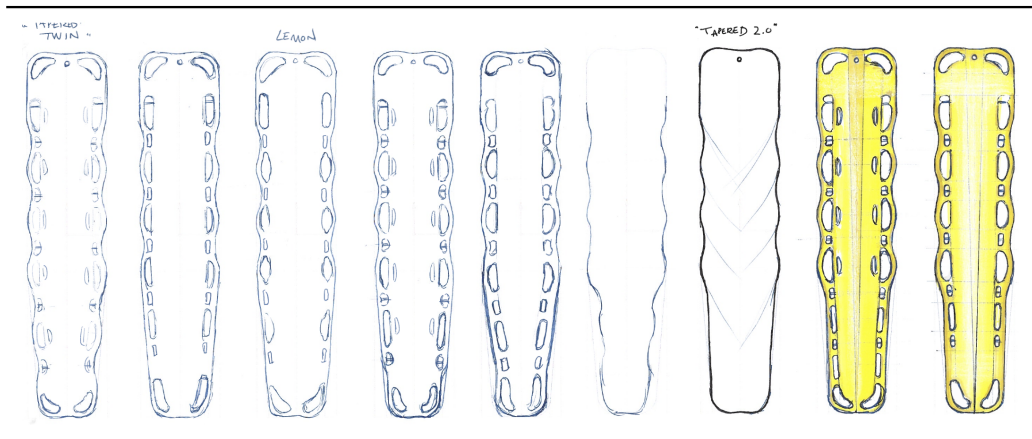

Figure 17: Several attempts were made to design the contour of the new spineboard

5.8 Taper length and angle

The preliminary study strongly suggested a tapered spineboard. Analysis of other spineboards on the market suggests that 30 - 40 % of the total length is tapered. Female bodies have wider hips and it is important that the hip area has the maximum width of 410 mm. This constrains where the spineboard can begin to taper.

Figure 19 illustrate two female bodies placed onto a 1830 mm long spineboard with their heads 50 mm from the top of the spineboard. *Woman1* is the average height of an american woman (20+ years), 1620 mm tall [7]. Assuming that the widest area of the hips is half the height of the woman [8], 53 % of the spineboard will be possible to taper to fit her.

If the woman is taller, her hips will be placed lower on the spineboard. The 95th percentile of american women over 20 years is 1732 mm, with a standard error of 6 % [7]. In Figure 19, *Woman2* is added to illustrate a 1830 mm tall woman (95th percentile, included one standard error). To fit her, it is possible to taper 47 % percent of the board.

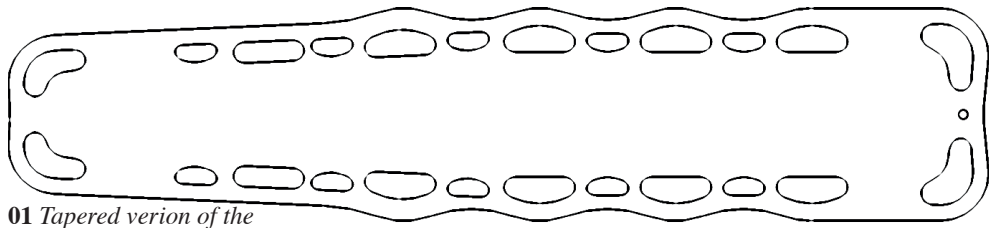

01 Tapered version of the BaXstrap

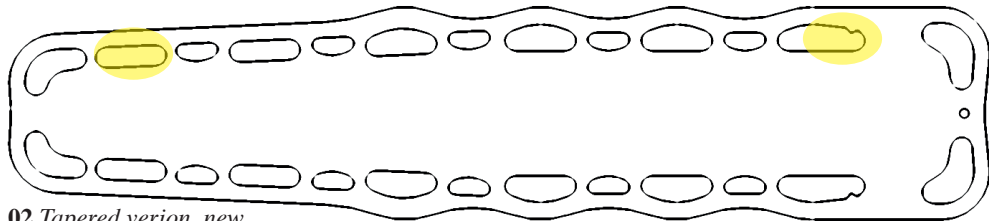

02 Tapered version, new handhold layout

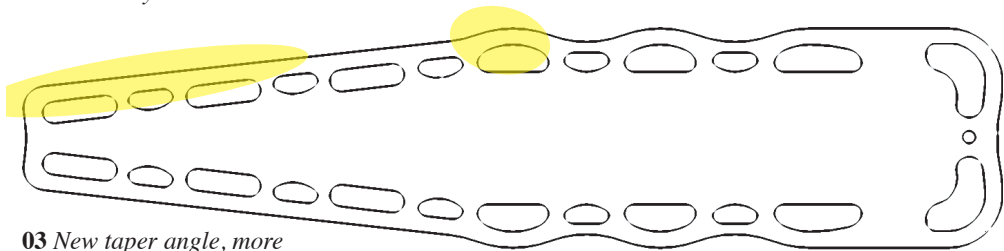

03 New taper angle, more tapered length

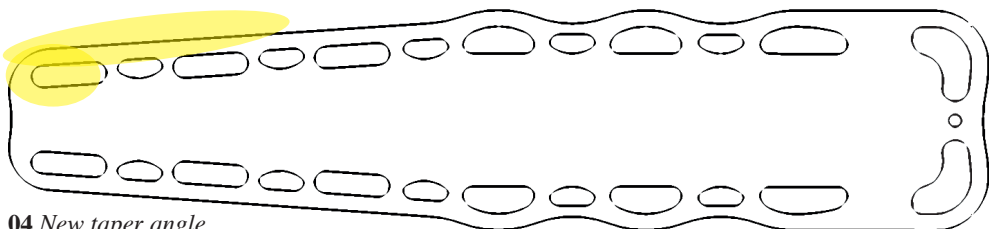

04 New taper angle.

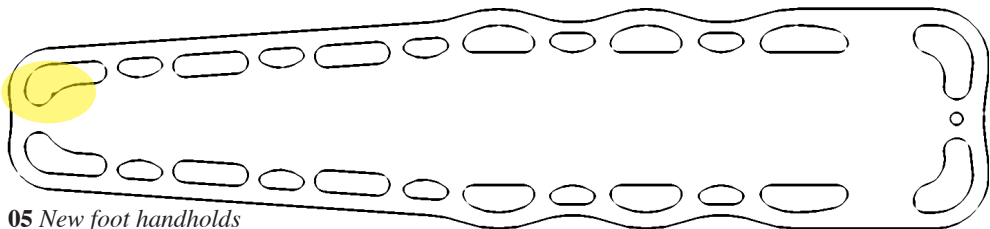

05 New foot handholds

Figure 18: Development history of a new top view contour design

If the woman was 2000 mm tall, 42 % of the board length could be tapered. Compared to other spineboards on the market, that usually tapers maximum 40 % of the

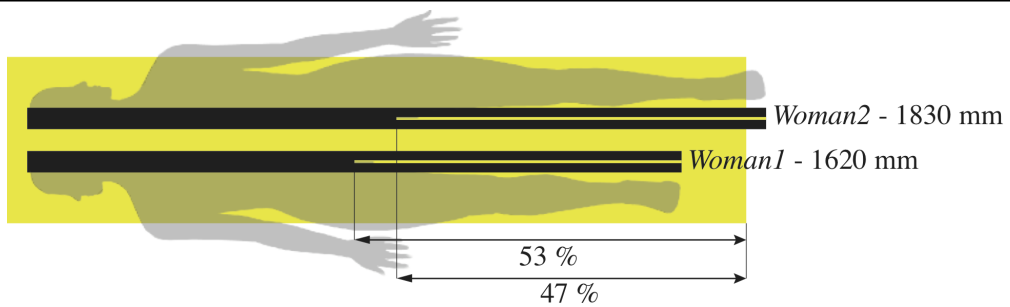

Figure 19: The maximum percentage of the spineboard length that can be tapered to fit the 95th percentile of women in the US is 47 %.

length, it is clear that they are designed to fit «all» women. Tapering more of the new spineboard will reduce its weight, but the overall expression of the design must be considered. 42 % will be the target value.

5.9 Holes

A key selling feature for the Laerdal spineboard is the large and raised handholds. With this design, it allows for use with gloves which increases the flexibility of the product. To verify the minimum size to fit the hand, the 99th percentile for a male hand is used. Table 10 is used (Extracted information from Exhibit 14.1.4.7 and 14.3.2.1 in *Human Feature Design Guide* [9]).

- **Hand breadth** 100 mm (male hand, 99th percentile)
- **Hand breadth with arctic glove** 133 mm (grasping $\varnothing 30$ mm handle)

By designing for flexibility, the corner and side handholds must have a breadth of minimum 133 mm. The absolute minimum value should be 100 mm.

5.9.1 Corner handholds

On the BaXstrap spineboard, the head and foot end corner handholds are identical. Figure 20 d. shows a sketch of the head end corner handholds for the new design. Values were extracted from the BaXstrap scanned CAD file and simplified with regard to tangent curves and radiuses greater than 5 mm.

The breadth of the foot end corner handholds correlates with the total breadth of the board. In Figure 20 c, the breath of the foot end corner handholds is given by the total breadth of the board at the lower end, *minus* the diameter of the surrounding tube ($\varnothing 30$

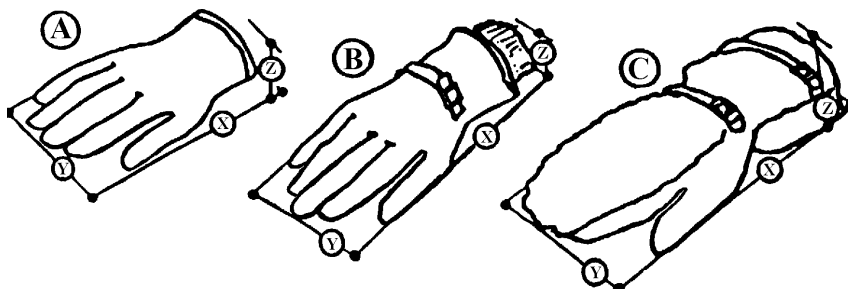

A Anti-contact glove // B Wet cold glove // C Artic glove

Hand position	C Artic glove		
Grasping handle	X (length)	Y (breadth)	Z (height)
25 mm diameter [mm]	356	132	114
30 mm (interp.) [mm]	361	133	117
50 mm diameter [mm]	381	137	127

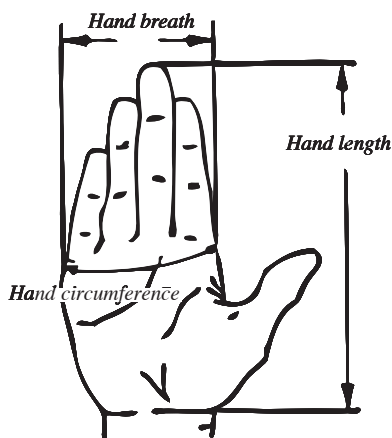

Hand breadth	Percentiles				
Sample	1st	5th	50th	95th	99th
Men [mm]	81	84	90	98	100
Women [mm]	71	73	79	86	89

Table 10: The human hand size and additive effect of gloves

mm) and the distance between the foot end corner handhold and the center of the board (15 mm).

5.9.2 Side handholds

As the curved contour curve of the BaXstrap should be continued in in the new spineboard, the form of the handholds are constrained by this curve. By keeping the lines closest to the center of the board straight, it breaks with the outer curved contour and gives the

board a leaner look.

Dimensions, with respect to flexibility for large hands and gloves, is 134 x 51 mm, see Figure 20 b.

5.9.3 Clip holes

The clip holes are kept separate from the handholds. They should be in line with the handholds and outer contour of the board.

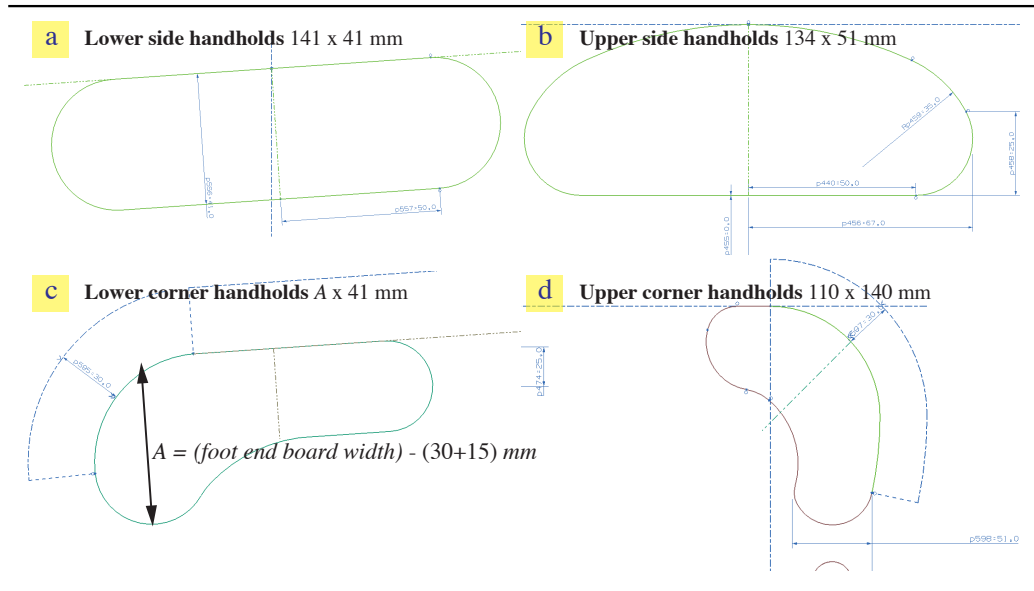

Figure 20: Proposed dimensions for the holes in the new spineboard

5.9.4 Child slots

With the sample of interviews and references available during this project, it has been very hard to determine whether or not the child slots should be continued in the new design. While they are used in marketing the BaXstrap spineboard, there may have been additional reasons to include them in the design of the BaXstrap in the mid 1990s.

Child slots benefits:

Less padding required for strapping children onto the board.

Differentiation Differentiated the spineboard from other boards when introduced to the market.

Webbing Creates webbing during rotational molding that secures the stiffening rods to the shell material, see Figure 21.

Reasons to remove child slots:

X-ray image quality They interfere with x-ray image quality as they can camouflage conditions such as a collapsed lung.

Correlation Has no positive correlations with other features of the board (increases stiffness somewhat, but this can be obtained by using ribs).

Differentiation Can be one way of differentiating the new spineboard from the BaXstrap spineboard.

In consultation with the Laerdal strategic marketing department on Mar. 28, 2012, it was decided that further work on the new spineboard could continue without including child slots.

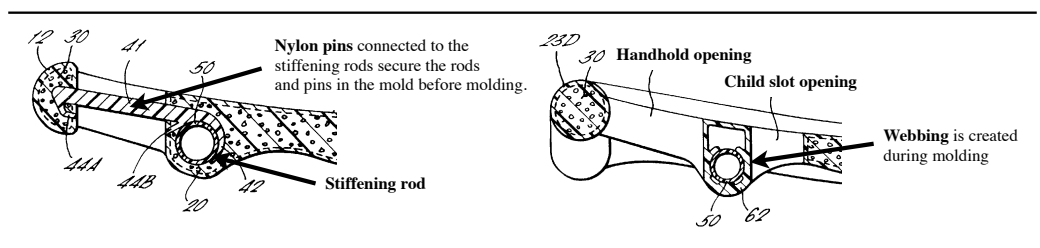

Figure 21: Webbing created during rotational molding of the BaXstrap spineboard.

5.10 Handholds-to-ground distance

The handholds-to-ground distance should be minimum 20 mm to secure good gripping of the spineboard when it is on the ground. This value is the most important under the corner handholds.

5.11 Ground support

The constraints present for choosing the ground support for the new spineboard is:

- Curved top surface
- $\varnothing 30$ handholds
- Maximum thickness and width 60 x 410 mm
- Minimum 20 mm handholds-to-ground distance

These constraints and 4 alternatives for ground support is shown in Figure 22.

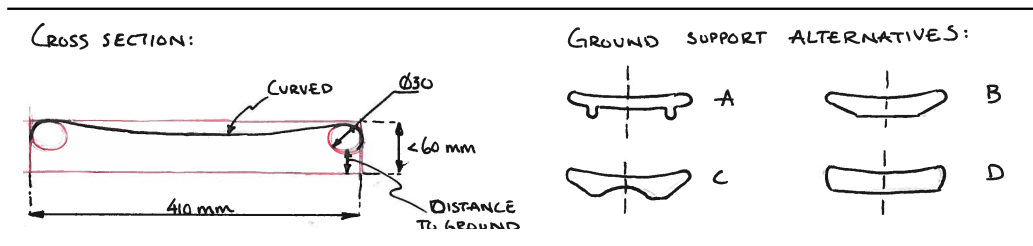

Figure 22: Ground support alternatives for the new spineboard

6 Design concepts

This chapter reviews the two main concepts that were the results of the preliminary study (project report) and further research during the master thesis project. They are based on applicable standards (complete list in Appendix G, Section 5), current literature (Appendix G, Section 4), US patent 5950627 and design patent 403423, a review of competing products on the market and interviews and discussions with health care personnel, radiologists and staff at Laerdal Medical (see complete list of people references in Appendix C.1).

6.1 Symmetric

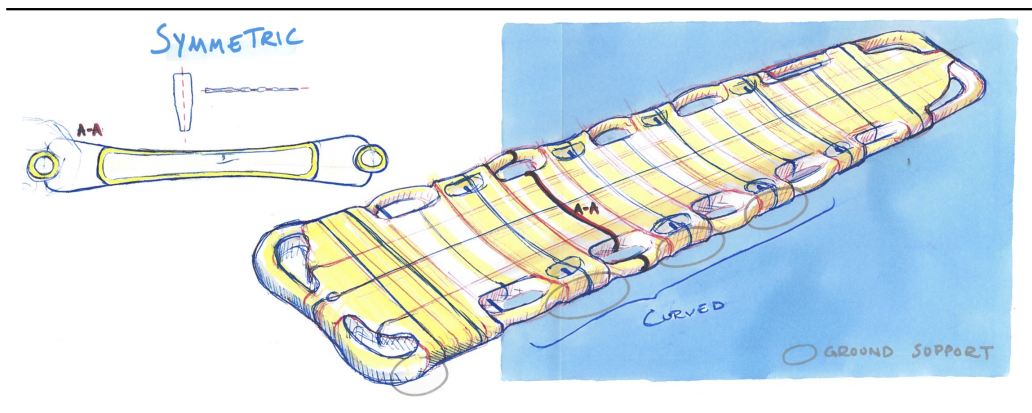

Figure 23: Sketch of the Symmetric Spineboard concept

For this concept, the idea was to create a spineboard that could be manufactured by joining together two identical parts as the top and bottom of the board. By doing so, investment molding costs can be reduced with about NOK 1,000,000.

The fact that the lying area should be curved is crucial in order to make this design work while keeping both adequate handholds-to-ground distance and the lowest weight possible. The sides of the lying area forms six points for ground support, see the sketch in Figure 23. There should also be two ground support points above the head area to have a stable board, this is indicated by a grey circle in the sketch. Because the head area must be flat and there is no space between the head area and the top corner handholds, this area for ground support is more challenging and not solved at this stage.

The cross section in the sketch shows that there is a trade off between the total thickness of the spineboard (and consequently weight) and the handholds-to-ground distance. The handholds are designed as a swept tube that intersects the board itself between the

handhold areas. The handholds will have a fixed 30 mm diameter. So, because of the symmetry, having a handholds-to-ground distance of 15 mm, means that the total thickness of the spineboard will be 60 mm, which is about the same total thickness as the BaXstrap. The absolute maximum total thickness for a spineboard, according to standard NS-EN 1865:2000, is 70 mm. This leaves a maximum possible handholds-to-ground distance of 20 mm. It is important to note that market requirements may differ from those of the standards.

Figure 24 shows 4 cross sections of the symmetric board. The board becomes flatter (thinner) towards the foot end handholds. This is beneficial for car extrication, where the foot end of the board is slid into the car.

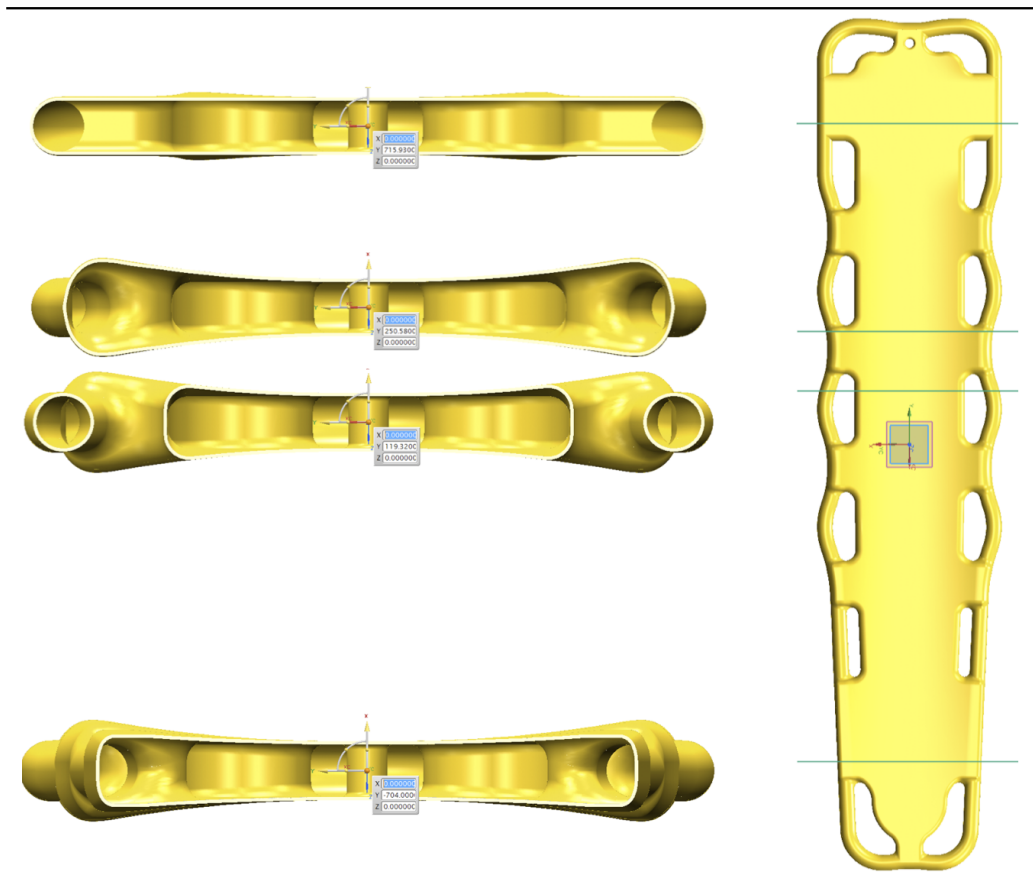

Figure 24: Cross sectional views of the Symmetric Spineboard

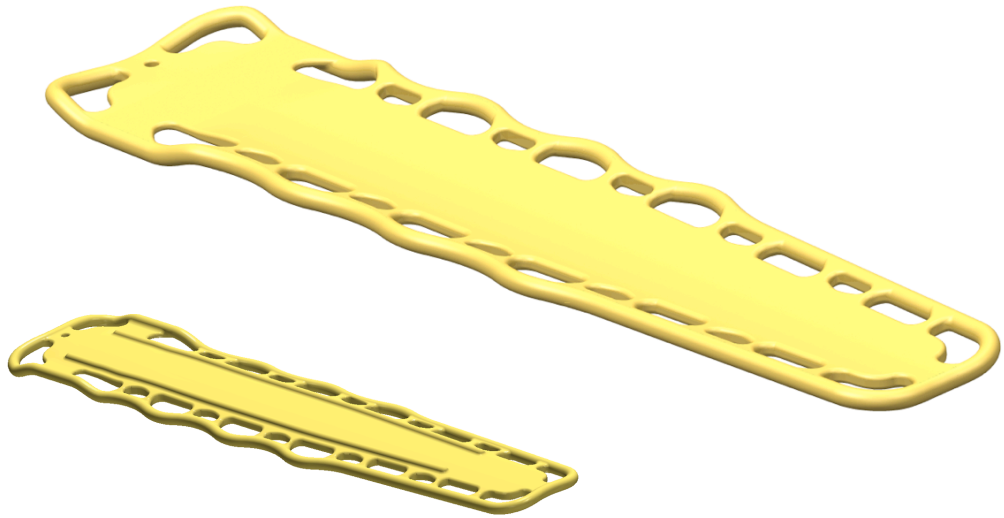

Figure 25: Tapered Twin Spineboard concept

6.2 Tapered twin

The next concept was based on using familiar features of the BaXstrap and alter geometry from it to create new features.

Contour geometry from section xx used to create a lying area with the same curve as that of the BaXstrap, except for the flat head area. The thickness of the board is more or less constant, and ground support was added last, as two longitudinal smooth runners on the underside of the board.

All though a mold change is required to produce this spineboard, it is easily recognizable, weighs less and has raised handholds along the entire contour of the board. This concept allows for a thinner board, which gives it a leaner expression.

6.3 Evaluation of design concepts

The two concepts were evaluated during a meeting at Laerdal Medical AS, Stavanger on Mar. 28, 2012 (full reference in Appendix C.3) with representatives from Laerdal Strategic Marketing (Stavanger and New York) and Engineering

Some features that are common for both boards were brought up and accepted:

- Curved contour
- Curved lying area
- Tapered foot end

Table 11 shows the benefits and challenges of the two concepts that were discussed during this meeting.

COMPARISON OF THE SYMMETRIC AND TT CONCEPT	
Symmetric	Tapered Twin
<p>Benefits:</p> <ul style="list-style-type: none"> - Reduced investment costs - Horizontal parting line 	<p>Benefits:</p> <ul style="list-style-type: none"> - Easy to recognize BaXstrap key features - Slim expression - Better handholds-to-ground distance
<p>Challenges:</p> <ul style="list-style-type: none"> - Weight - Total board thickness. There is a trade-off between handholds-to-ground distance, handles diameter and total board thickness - Flatter head end corner handholds 	<p>Challenges:</p> <ul style="list-style-type: none"> - High investment costs - Complex parting line

Table 11: Evaluation of the two design concepts

Based on the discussions, it became clear that Laerdal wants a good handhold grip and raised handholds similar to those of the BaXstrap. By this constraint, the symmetric design will have to have a total thickness of 70 mm, which is 10 mm more than the BaXstrap. Creating a thicker board is not acceptable, and this also increases the weight of the board.

Higher tooling investment cost is something that Laerdal can accept, and is why the selected concept to move forward with is the Tapered Twin concept.

7 CAD model

Creating a good CAD model has been very important for this project. In addition to keeping track of geometry, radiuses, draft angle and shell thickness, which are important for the injection molding process, the model can be used to measure the required amount of material for the new product.

This section includes a step-by-step guide to building a spineboard model of the complex geometry described in this thesis. The purpose of this is to give the company insight into how the model was build so that alterations can be made easily and to define possible pitfalls that may be encountered. Large size companies like Laerdal often have internal guidelines for CAD structures that obviously are not taken into account during CAD work conducted during this project.

As a conclusion of the CAD work done in this theses, there are two main challenges that are important to keep in mind when constructing and altering the CAD model:

1. That the spineboard is constructed within the maximum geometry allowed (which makes advanced surface modeling more difficult).
2. Maintaining good quality surfaces (G2 continuity) while keeping all radiuses above a minimum value.

The model is build by using features found in the Modeling application and Studio Surface application in Siemens NX 7.5. The guide refers to features in the Modeling application by default. Although all features can be added into the same application, the guide referrers specifically to the Studio Surface application when this is where the features are found by default in the software.

The spineboard is symmetric about at least one plane and can be symmetric about all three planes.



01 Create gridlines. 1830*205 mm equals one symmetric half on the board. Create minor gridlines for holes references. Choose taper length (here 38%) and taper angle (here 3,9 degrees).

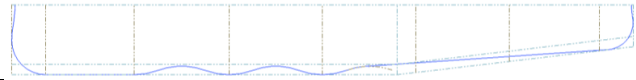

02 Top view contour. Use the grid to constrain this sketch.

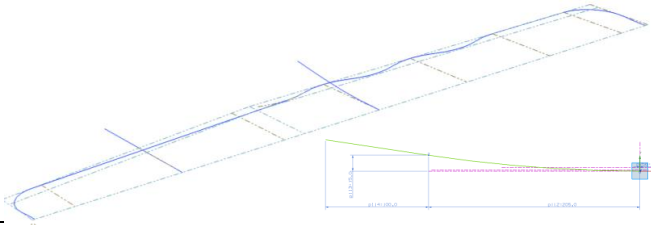

03 Two sketches will be the basis for the top lying area: one flat and one curved. The curved line is made from one curve and one straight line segment.

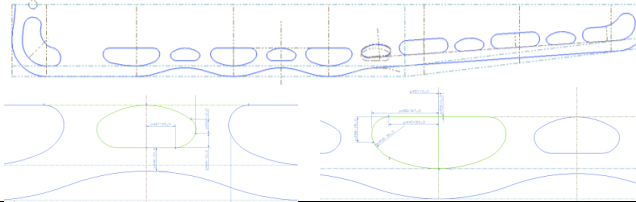

04 Create holes and constrain them to the grid (01 and 02). Use *Mirror Curve* in the Sketch environment to draw symmetric shapes faster. Use the *Pattern Curve* feature in the Sketch environment to copy similar features along the gridlines.

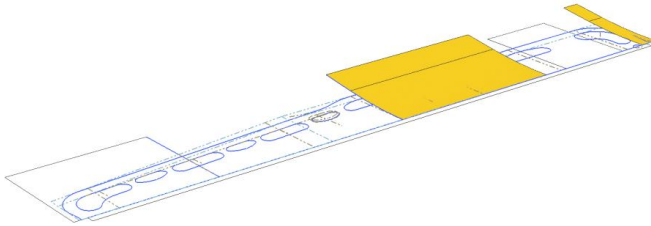

05 Extrude the lying area sketches (03). The two flat sheets (white) forms the head and foot area and the curved, yellow sheets form the upper body and very top of board. Create and extrude a line in the symmetric plane. This will be used for a tangent constraint, so that the two symmetric parts of the boards join perfectly together.

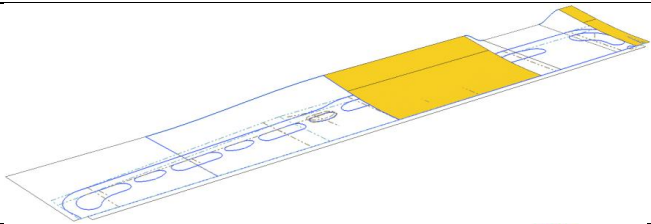

06 In the Shape Studio application, use *Bridge Curves* to create a contour for connecting the curved and flat sheets.

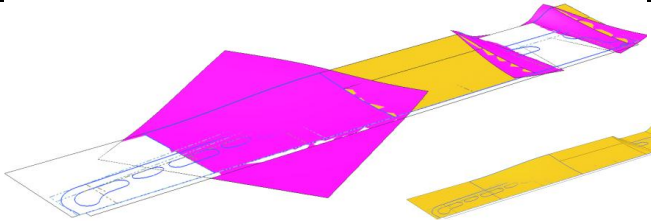

07 Use *N-sided surface* to connect the sheets. Use all border sheets as constraint faces to form tangent continuity. Trim the surfaces (purple) using *Trimmed Sheet*.

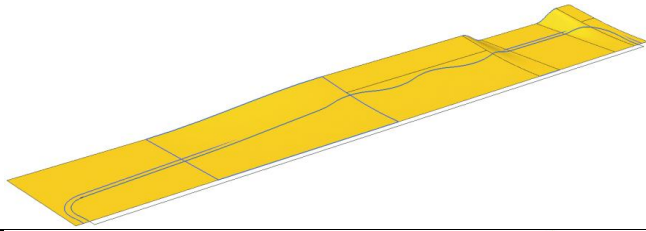

08 Offset the contour sketch towards the board center. Project it vertically to the lying surface using *Projected curve* in the Studio Surface application. This will be the curve from which a handholds tube will be swept around.

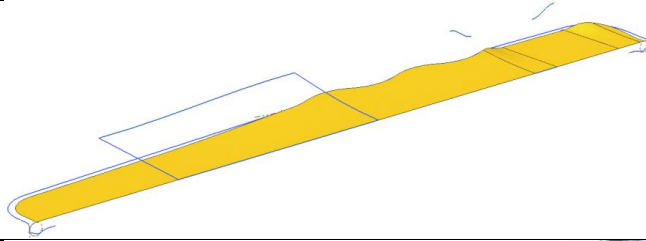

09 Trim the lying surface sheets with the *Trimmed Sheet* feature. Use edges and the projected curve (08) as boundary objects.

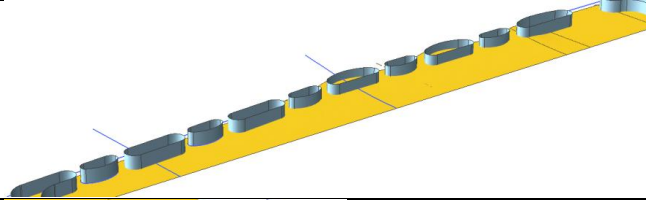

10 Extrude the holes as sheets.

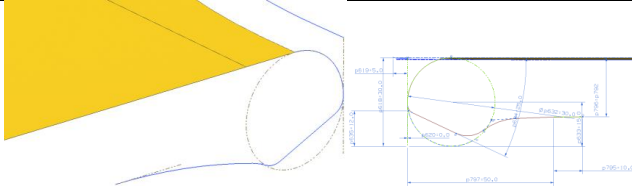

11 Create a sketch that will be swept around the edge of the board. The diameter here is 30mm and the taper angle is 25 degrees. The top of the sketch must have a tangency constraint to the lying surface. Use the gridlines to ensure that the board becomes the right size. Mirror the sketch so that there is one on each side (see picture in 09). This is so that the sketch will intersect with the guide when sweeping the sketch along it.

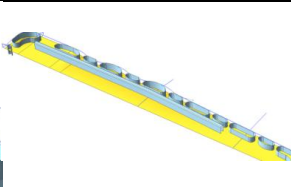
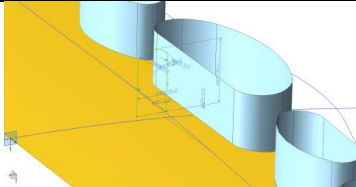

12 Create a sketch that will form the ground support runners. Keep in mind the total thickness of the board and the required ground-to-handholds distance at the foot end handholds. Sweep it along a tangent curve projected onto the lying surface.

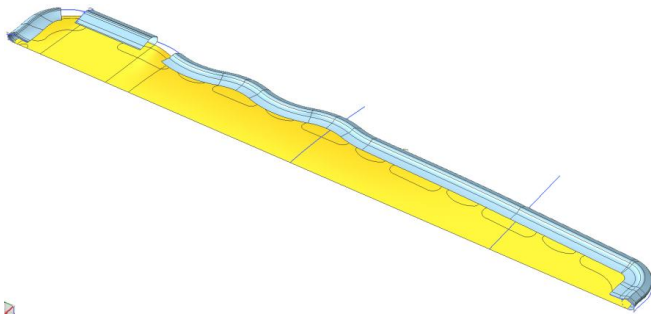

13 Use the *Swept* feature two times (from both sketches on each side) along the edge of the lying surface. In the *Swept* dialog window, set *Alignment method* = Parameter and *Orientation method* = Fixed. Sweep along the guide until shown in the picture. The head section is created from a different sketch. Use *Extrude* to create a sheet from this sketch under the flat head area.

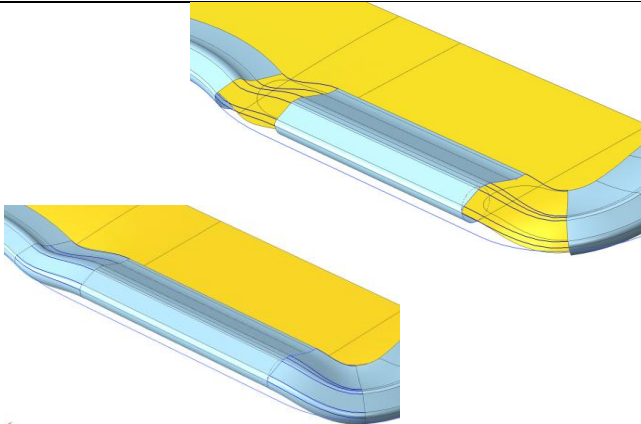

14 In the Studio Surface application, use *Bridge Curves* to create multiple tangent curves to create the transition between the head area and the rest of the swept sketch (13) on both sides. Connect the sheets by using the *Trough Curve Mesh* in the Modeling application. In the *Trough Curve Mesh* dialog window, the *Primary curves* should be the edges of the sheets and *Cross section curves* should be the bridge curves. Use tangent continuity on all border faces.

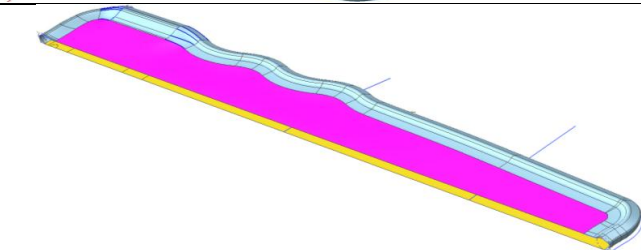

15 Use *N-sided surface* to create the bottom surface for the board (purple). Should have tangent continuity to all border surfaces, including tangency a flat surface in the symmetric plane.

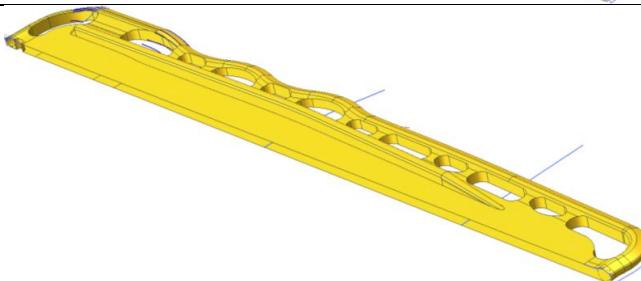

16 Use the *Trough Curves* feature to create a transition between the ground support runners (12) and the underside surface (15). Sew all faces (*Sew* feature in the Studio Surface application).

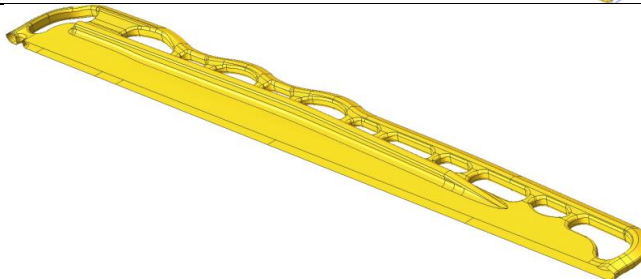

17 Use *Face Blend* to create a blend transition between the runners (12) and the underside surface (15). This has 10 mm blend radius. The ideal feature to use for blending the handholds would be *Face Blend* with three defining face chains, but the complex geometry hinders this. Instead, use *Edge Blend*. Blend radius here is 6 mm.

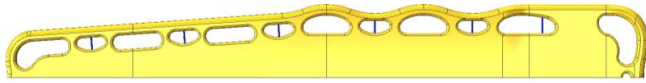

18 Create pins (blue) by drawing one sketch on each of the flat holes walls shown in the picture. Choose the correct diameter of the pins (here 5 mm). *Extrude* them normal to the wall they were drawn on.

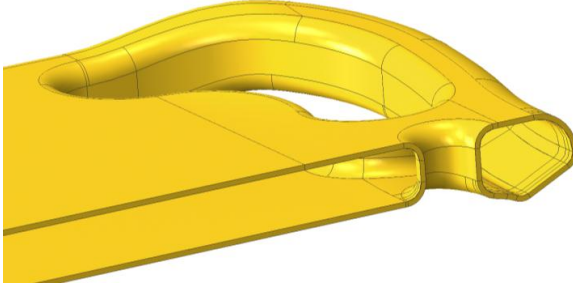

19 Use the *Thickening* feature in the Studio Surface application. By being careful with radiuses and tangencies while creating the CAD structure, features such as *Thicken*, *Offset Surface* and *Shell* can create a shelled out model. The *Offset Surface* feature can be used along the way to ensure that the geometry works. Remember to offset surfaces inwards, so that the final model does not become too large. An alternative method to go about the shelling problem, is to create the inner surface as a sheet and offset surfaces outwards (easier because radiuses are increased), but this means that the final wall thickness must be fixed. Or else, the entire model must be altered. For the current model, it is possible to offset all surfaces inwards by maximum 2.7 mm.

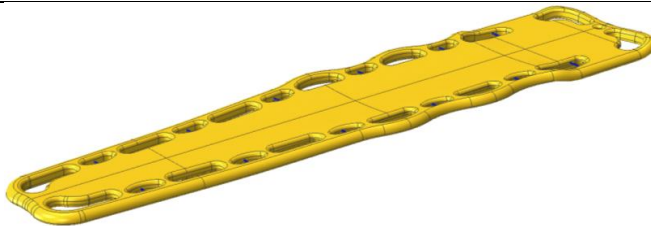

20 Trim the solid body at the symmetric plane and use the *Mirror Body* feature about the symmetric plane on all solid bodies. *Unite* the parts.

8 CAE

8.1 Software

NX is a complete 3D CAD software package provided by Siemens PLM Systems. Version 7.5 was used in this project. Applications utilized were Modeling, Studio Surface and Advanced Simulation. For simulations, the standalone FEA software Nastran was used with NX 7.5 as its interface.

8.2 Cross section analysis

A simplified way of looking at the spineboard is to consider it as a beam and look at the cross section of it.

The second moment of inertia (I_{axis}) is a term used to describe the capacity of a cross sections ability to resist bending. It is always considered with respect to a reference axis. It is a mathematical property that describes how a surface area of a cross section is distributed about the reference axis. The reference axis is usually a centroidal axis.

The polar moment of inertia (I_p) is calculated by the sum of the second moment of inertia about both axes in the cross section. The polar moment of inertia describes the sections ability to resist twisting.

The CAD software can be used to quickly extract properties such as area, mass, center of gravity and second moment of inertia.

Some relevant options for spineboard cross sections were reviewed by sketching and editing in the NX sketch environment. One BaXstrap cross section (extracted from a scanned CAD file provided by Laerdal) and a rectangular shape were used as references. Results are given in Table 12.

While the density of the existing shell material, HDPE, has a typical density of 0,95 kg/m³, the new selected material has a typical density of 1,20 kg/m³, which indicates that a reduction in shell thickness should be evaluated. The BaXstrap is rotational molded, so the shell thickness varies, but can be roughly estimated to 3 mm on average.

To obtain the values in Table 12, four different cross sections with 1, 2 and 3 mm shell thickness were evaluated using the *Section Inertia* feature. The cross sectional area and the second moment of inertia about both axes (I_{xx} and I_{zz}) were extracted. The polar moment of inertia was calculated by $I_p = I_{xx} + I_{zz}$. Additionally, I_{xx} and I_p were viewed relative to the area of the cross section to get an idea of the resistance to bending and torsion relative to (what indicates) the weight of the board.

All cross sections were drawn inside a 410 x 50 mm rectangle to give comparable

results. The purpose was to evaluate relative values (the cross section changes along the length of the board, so absolute values are difficult to evaluate here). The most critical value is resistance to bending and area utilized in the cross section.

Cross section 04 has the highest resistance to bending relative to its area, followed by Cross section 05. Cross section has the desired curved topside and suggests a shape that can be used for the new spineboard design.

















	Shell thickness [mm]	A [mm ²]	I _x [mm ⁴]	I _z [mm ⁴]	I _p [mm ⁴]	I _x /A	I _p /A
01 Reference Rectangle 410*50 mm							
	1	916	5,12E+05	1,55E+07	1,60E+07	5,59E+02	1,75E+04
	2	1824	9,78E+05	3,06E+07	3,16E+07	5,36E+02	1,73E+04
	3	2724	1,40E+06	4,54E+07	4,68E+07	5,14E+02	1,72E+04
02 Reference BaXstrap 368*55 mm							
	3 mm average	2399	4,83E+05	2,93E+07	2,98E+07	2,01E+02	1,24E+04
03 Rectangle 410*(30+20) mm. 20 mm legs							
	1	905	2,40E+05	1,38E+07	1,40E+07	2,65E+02	1,55E+04
	2	1804	4,50E+05	2,72E+07	2,77E+07	2,49E+02	1,53E+04
	3	2597	6,34E+05	4,05E+07	4,11E+07	2,44E+02	1,58E+04
04 410*50 mm. Tapered sides, curved underside							
	1	867	3,37E+05	1,33E+07	1,36E+07	3,89E+02	1,57E+04
	2	1728	6,42E+05	2,63E+07	2,69E+07	3,72E+02	1,56E+04
	3	2583	9,15E+05	3,90E+07	3,99E+07	3,54E+02	1,55E+04
05 410*50 mm. Tapered sides, curved topside, flat underside							
	1	858	2,54E+05	1,29E+07	1,32E+07	2,96E+02	1,53E+04
	2	1709	4,75E+05	2,55E+07	2,60E+07	2,78E+02	1,52E+04
	3	2555	6,84E+05	3,78E+07	3,85E+07	2,68E+02	1,51E+04
06 410*50 mm. Tapered sides, curved topside, curved underside							
	1	859	2,02E+05	1,29E+07	1,31E+07	2,35E+02	1,53E+04
	2	1712	3,80E+05	2,55E+07	2,59E+07	2,22E+02	1,51E+04
	3	2558	5,36E+05	3,78E+07	3,83E+07	2,10E+02	1,50E+04

Table 12: Cross sectional resistance to bending and twisting for 1, 2 and 3 mm shell thickness

8.3 Simplification of model

The model used for the simulations was Version 14 (Appendix E). Due to the complex geometry, the model was simplified by removing small blends, see Figure 26.

A further simplification was done in the .fem file, by merging small faces to allow for increased mesh element size.

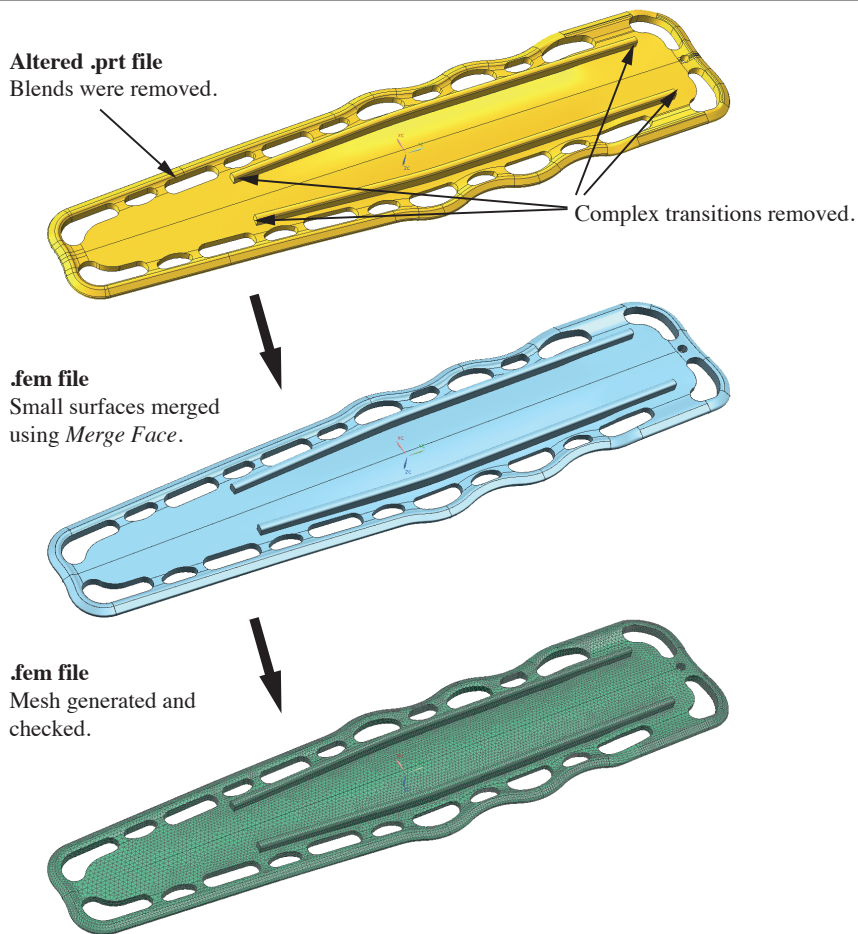

Figure 26: The geometry was altered to prepare the model for meshing

8.4 Mesh type

A rule of thumb when meshing 3D models, is that there shall be a minimum of two elements per thickness of the model. For the spineboard 3D model, which has a shell thickness of 2 mm, using a 3D mesh is not suitable as it creates far too many nodes for this type of calculation.

The 2D mesh is created on the mid-surface of the selected faces. This must be compensated for by creating a mid-surface from the shell in the 3D model.

8.5 Element type

The software offers a number of different element types. The types relevant to linear static analysis, however, are triangular and quadrilateral elements. The triangular elements can have 3 (linear) or 6 nodes (3 extra mid-nodes). Likewise, the quadrilateral can have 4 or 8 (4 extra mid-nodes) nodes. Elements with mid-nodes use parabolic interpolation, which allows the use of non-linear geometry and can offer a more accurate result in some cases. Using more nodes must always be evaluated to match the wanted results. The general rule of thumb here is to keep it as simple as possible.

Linear elements were used during these simulations. Quadrilateral elements were used to the extent possible.

Meshing method

When the geometry is as complex and on such a large component as the spineboard, the approach for creating a 2D mesh is to automatically generate an unstructured mesh (known as a *free* mesh). The mesh quality must then be checked. The mesh or failed elements might have to be altered. Because the software automatically generates the mesh, it is important to understand how the mesh is generated.

The software can use two different meshing methods to generate the mesh. The *subdivision* meshing method uses a recursive subdivision technique to generate the mesh on the selected faces. It divides and then subdivides the geometry repeatedly to create the mesh. First, an initial set of elements is created before cleaning and smoothing operations are done to improve the overall quality of the mesh.

The second method is a hybrid technique which combines the subdivision technique with a *paver* technique. With this method, the software starts by creating a more structured mesh around the surface's outer boundary and interior holes. It then uses the subdivision technique to generate the rest of the mesh.

The spineboard model has many holes and other interface boundaries. Although many interface boundaries were removed (by merging faces before generating the mesh), the paver algorithm is preferred in these simulations.

8.6 Mesh quality

The software includes many tools for checking the quality of the mesh. Those important to this analysis were:

Free nodes Free nodes that are not connected to any elements must be deleted. They can be detected by turning off the mesh display and setting the node display marker (in the Model Display Preferences) to *asteric*.

Element shapes Each type of element has an ideal shape. As elements in a model deviate from their ideal shape, quality decreases. Failed models are identified when using the Element Shapes check. The elements that fail are the ones that exceed default Threshold Values in the software. Threshold values are not solver specific and can be changed based on the accuracy that are wanted from the analysis. An example of a failed element is shown in Figure 27.

Free edges (Element outline) Free edges are element edges that are unconnected to any other element. They are displayed by using the Element Outline check. An example of a free edge and how it was fixed is shown in Figure 27.

Duplicate nodes Duplicate nodes can occur when the model has several meshes. They are displayed using the Node check and should be deleted to prevent singularities.

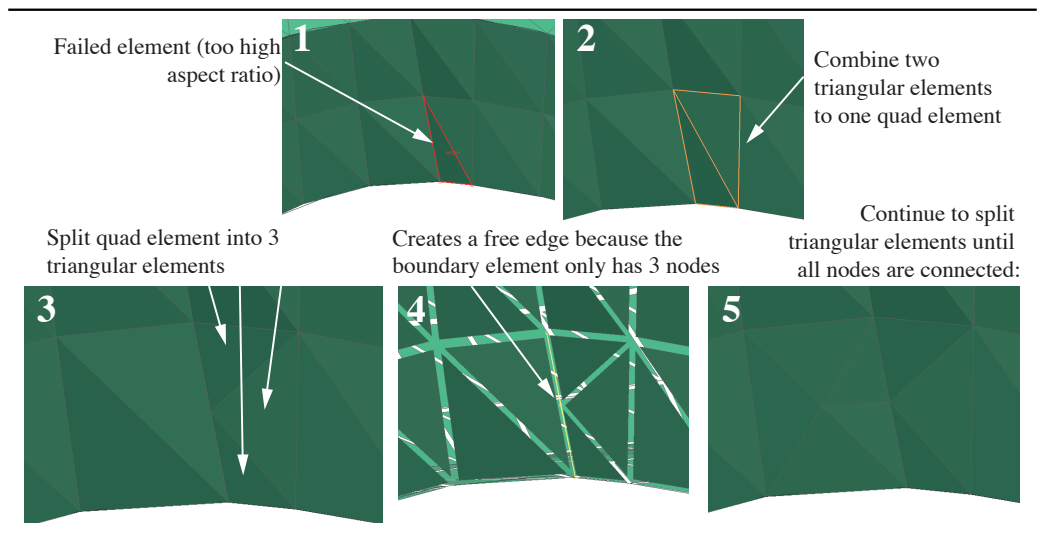

Figure 27: One example of how failure elements and free edges can be fixed during meshing

8.7 Material

In the software the material properties for the default material Nylon was altered. The material properties used were:

Youngs modulus 10 GPa

Poissons ratio 0,4

Mass density 1,2 kg/m³

Material type Isotropic

In the mesh collector, the default thickness was set to 2 mm.

8.8 Load cases

8.8.1 Resistance to bending

In the .sim file, fully fixed constraints were added to the lower side of all four corner handholds. A load pointing in the -Z direction was distributed evenly in the lying area. One 9,81 m/s² gravity force was added. The load case is shown in Figure 28.

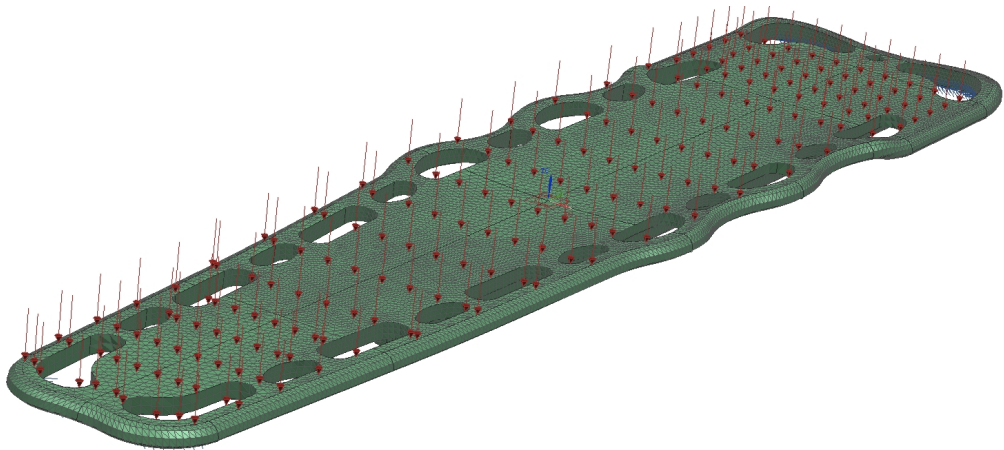

Figure 28: Load case for resistance to bending analysis

8.8.2 Resistance to torsion

For this analysis the head end corner handholds were fully fixed at their top and bottom insides of the handholds. The translation was fixed in the center of the board, between the

two foot end corner handholds. One moment load of 61500 Nmm was added as shown in Figure 29.

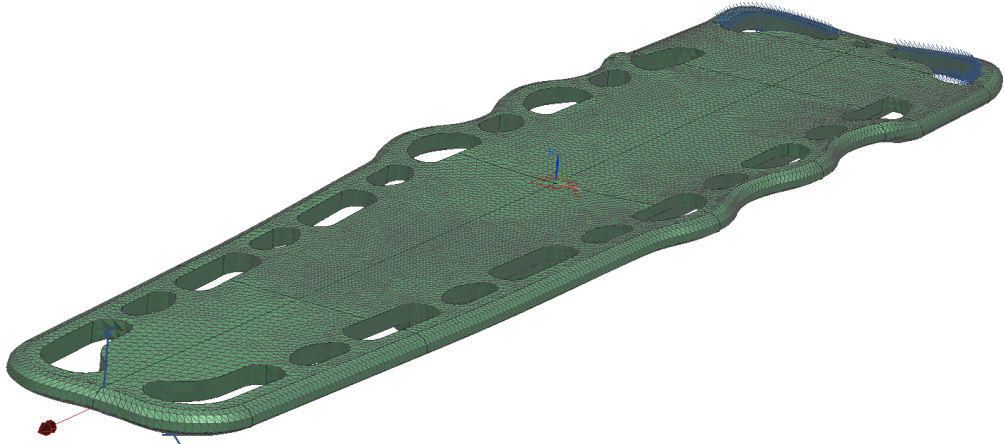

Figure 29: Load case for resistance to torsion analysis

8.9 Results

For the bending case, the distributed load was set to 135 kg, which equals the amount of weight that was used for conducting the physical tests of the BaXstrap.

8.9.1 Resistance to bending

The maximum magnitude (displacement in all three directions) deflection was 28 mm for 135 kg distributed load, see Figure 30.

From the physical tests of the BaXstrap the deflection under the center of the board was 76 mm on average. A part of this result was due to creep in the material. Creep is not taken into account during these analysis, but by using a stiffer material, such as reinforced polyamide, creep will account for less deflection.

8.9.2 Resistance to torsion

The maximum displacement in the Z-direction was 11,4 mm. Maximum magnitude displacement is shown in Figure 31. Based on the standard requirement of NS-EN 1865, this is acceptable (50 mm maximum according to the standard). Compared to the physical tests of the BaXstrap, this is about 16 mm less than the BaXstrap.

Displacement - Nodal, Magnitude
Min : 0.00, Max : 28.03, Units : mm
Deformation : Displacement - Nodal Magnitude

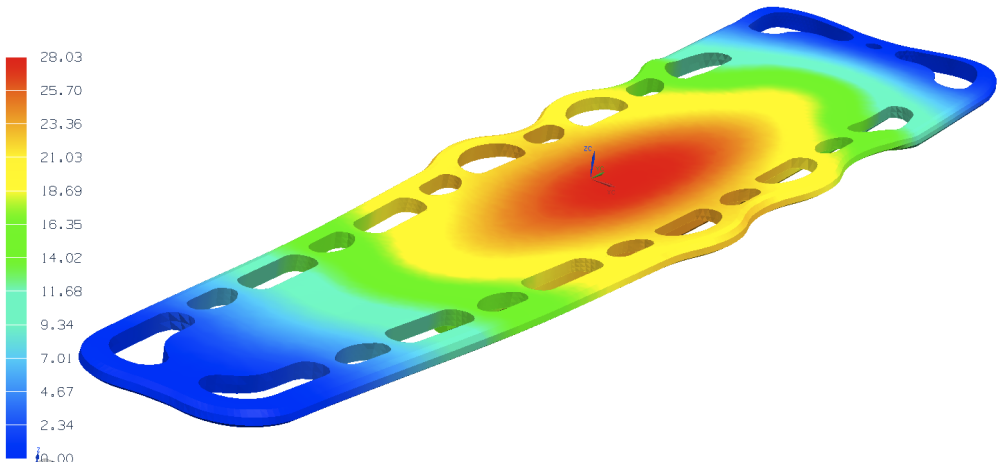

Figure 30: 2mm shell 135kg 9.81 gravity

Displacement - Nodal, Magnitude
Min : 0.000, Max : 11.568, Units : mm
Deformation : Displacement - Nodal Magnitude

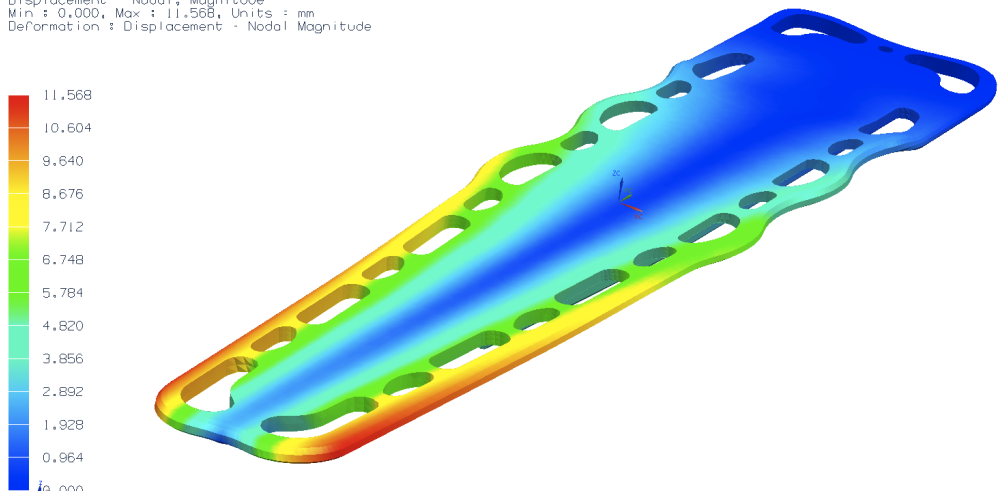

Figure 31: 2mm shell torsion 61500 Nmm 9.81 gravity

8.10 Weight

The volume of the 2 mm shell is 2714903 mm³. With a material density of 1,2 kg/m³, this gives a shell weight of 3,2 kg. An additional weight of 1 - 1,5 kg can be estimated for an internal reinforcing rib structure. This gives the spineboard a total weight of 4,2 - 4,7 kg before possible foam filling. They foam may have to be added to the board due to insulation properties.

In conclusion, the weight will be lower than the targeted value of 6 kg.

9 Economic evaluation

To give an economic evaluation of the new concept was originally a part of the assigned master thesis, but in order to keep this thesis non-confidential (i.e. not comparing manufacturing costs of the new spineboard to the BaXstrap spineboard), this section has been given low priority during this project. As the manufacturing cost for the new spineboard relies on factors that are not processed in this thesis (such as mold and tooling design), it provides little insight to estimate an absolute cost for the new production process.

This section will be limited to a comparison between the old and new board where some points that define the spineboard manufacturing cost are given (Table 13).

Based on factors such as lower cycle times, less required manual labor and more possibilities for automation, it is assumed that the manufacturing cost will be substantially lower by injection molding and welding the new spineboard. While the shell material is more expensive in the new product, the overall material cost is reduced because it can be manufactured without internal stiffening rods.

Whether or not the high investment cost and risk for the new manufacturing method can be accepted, relies on the number of manufactured spineboards and estimated payback time.

COMPARISON OF SPINEBOARD CONCEPTS

BaXstrap spineboard	New spineboard
Production process	
<i>Rotational molded</i> <i>Foam filled</i> <i>Trimmed excess material</i> Requires more manual labor (preparation of molds and removing excess material) and longer cycle time.	<i>Injection molded</i> <i>Foam filled or hollow internal rib structure</i> <i>Hot plate welded</i> Automatic molding and welding process. Requires storage of molded units prior to welding. Large investment costs. Low cycle times.
Reinforcement	
<i>Internally molded carbon fibre rods</i>	<i>Rib structure</i>
Material	
<i>HDPE</i> <i>Polyurethane foam</i> <i>Carbon fiber rods</i> The reinforcement rods constitutes for a substantial part of the material costs.	<i>Glass fibre reinforced polyamide</i> <i>(Polyurethane foam)</i> Material cost NOK 30 - 60 /kg

Table 13: Comparison of old and new spineboard concept

10 Final design and specifications

10.1 Design optimisation

After deciding to move forward with the «Tapered Twin» design concept during the Laerdal work week, developing the design continued with discussions and interviews with the people who know the spineboards the best. Among these were:

- Instructor at the Norwegian Air Ambulance in Stavanger
- The Air Ambulance crew in Stavanger
- Laerdal staff in Stavanger
- Academic leader and instructor at Vinjes Ambulance Service in Trondheim
- Laerdal regional sales representative for Mid and North Norway

Design changes made to the «Tapered Twin» model were (drawn onto a draft in Figure 32):

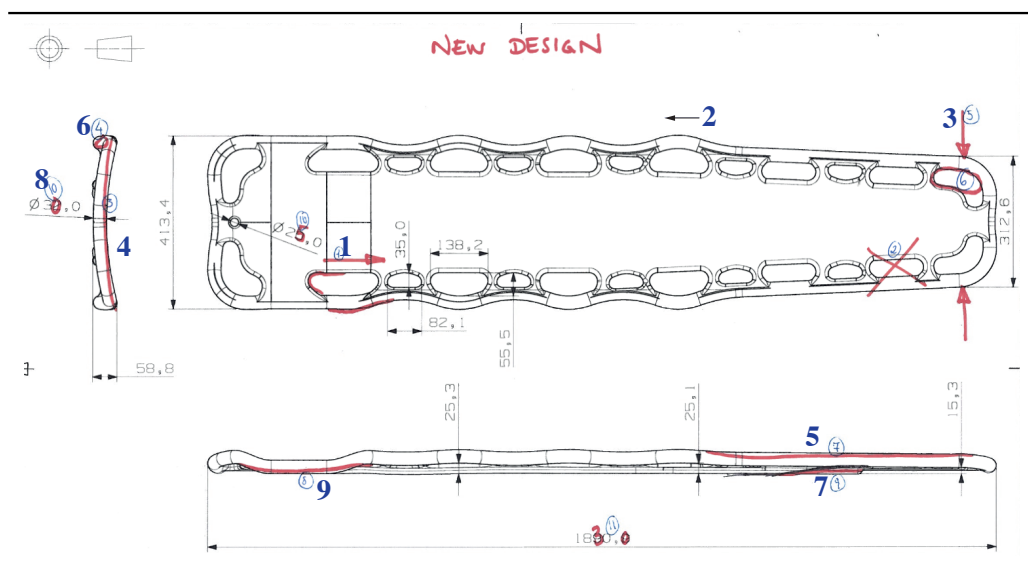

Figure 32: Design changes made to the Tapered Twin concept

1. Moved side handholds down and changed spineboard length to 1830 mm

Due to an error, the length of the board had until this point (and in the Tapered Twin model) had been 1890 mm. By consultations with the Laerdal Strategic Marketing department, the length of the new spineboard should be the same as for the

BaXstrap. The head area is also smaller in Figure 32 than it needs to be, so all side handholds were shifted towards the foot end. The lowest side handhold was removed.

2. **Increased taper length**

From sketches and design studies conducted during this project (some examples in Figure 18 in Section 5), it was concluded that the wanted lean expression of the board was best obtained by tapering the board from the narrowest point on the curved side contour. In Section 5.8 it was concluded that it was okay to have a taper length of 40 % of the board length.

3. **Increased taper angle**

The board should be as narrow as possible at the foot end while there is still adequate space for immobilizing the legs of the patient.

4. **Reduced lying area curvature**

The curvature in the lying area of the Tapered Twin CAD model was replicated from the BaXstrap scan. The optimal curvature tries to balance two factors: a. Curve the lying area so much that the patient feels (more) secure and comfortable on the spineboard; b. Reduce the curvature enough so that as many patients as possible can fit comfortably into it.

5. **Flattened foot end of board**

While flattening the topside of the foot end of the board reduces the handholds-to-ground clearance by a few mm, benefits of this feature is that the board becomes slimmer and requires less space during car extrication.

6. **Tapered surrounding tube**

By tapering the surrounding tube, the tipping point of the side of the spineboard will lie closer to the patient. It will also make the board look thinner because the whole $\varnothing 30$ tube is not visible from most angles. This feature and sketch is shown in Picture 11 in the guide in Section 7.

7. **Straight ground support with smooth transition to foot end**

Since the board is tapered, its center of gravity will lie above the center towards the head end of the board. This means that the ground support can be removed towards the foot end without sacrificing the stability of the board when its on the ground. Additionally, less patient weight is distributed at the foot end, so the board should be stable. This makes the board require less space during car extrication and reduced the board weight a little.

8. Changed diameter of surrounding tube from $\varnothing 32$ to $\varnothing 30$ mm

The diameter was reduced by 2 mm to improve the handholds-to-ground distance.

9. Raised underside head area while tapering surrounding tube

In the Tapered Twin model, the surrounding tube touched the ground under the head area. Space is required here to be able to fix head immobilizers to the board while it is on the ground.

10.2 Final design: NeWstrap working title

This project does not conclude on a name for the new spineboard, so «*NeWstrap*» was chosen as a working title for the new design. The name looks similar to BaXstrap, so that a logo similar to the BaXstrap logo easily could be made for the mock-up of the new spineboard.

Figure 33 shows CAD file version 14 and the final design iteration for this project. All design changes from the previous section were implemented based on the Tapered Twin design concept.

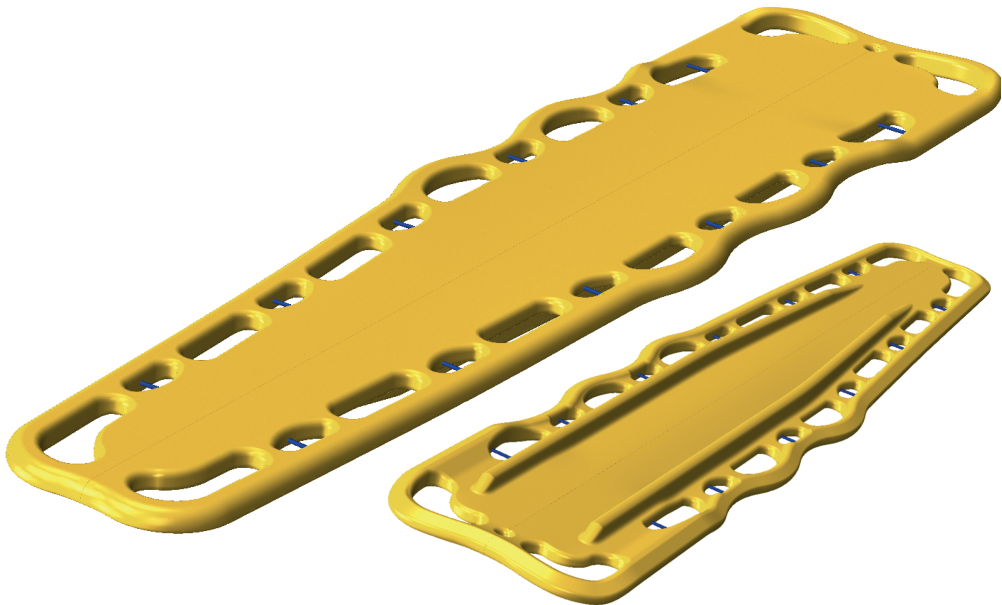

Figure 33: The final design iteration for this project

10.3 Product side by side

Before there existed any physical mock-up of the spineboard, high resolution images of new spineboard CAD model were exported from the CAD software to be able to visualize how the two spineboards will look next to each other, see Figure 34.

A 2400 x 850 mm vinyl roll-up poster of the full scale new spineboard was printed. During the presentation of the 2012 Laerdal master thesis, this roll-up was used to view the new spineboard in comparison to the BaXstrap. A facsimile of the roll-up can be found in Appendix B.

10.4 NeWstrap cross sections

Figure 35 show the cross section varies with the length of the new spineboard.

The head area cross section is flat on top and has a geometry on the sides that allows for clipping on head immobilizers on the underside of the board.

As the cross sections move towards the foot end of the board, the topside flattens out and the ground support gradually decreases towards the underside of the board. At the lowest cross section, the board is completely flat on the top- and underside. This is done so that the spineboard requires less space (in thickness and in width) during car extrication.

10.5 Human modeling

Figure 36 show an average and large female and male human lying on top of the new spineboard. As the humans are rigid bodies in the CAD software, viewing the humans on the spineboard from other angles does not provide any additional information.

The average male and female humans were generated by setting the stature and weight in the Human model feature in NX 7.5 to 50 % - the large humans by setting stature and weight to 99 %. The software uses the ANSUR database to determine weight and height of the humans.

The large male in Figure 36 show that the taper angle should be reduced slightly. While there is a trade-off between a wider foot end and the board weight, reducing the taper angle is in accordance with having wider corner handholds at the foot end and should be considered during the next iteration of design changes.

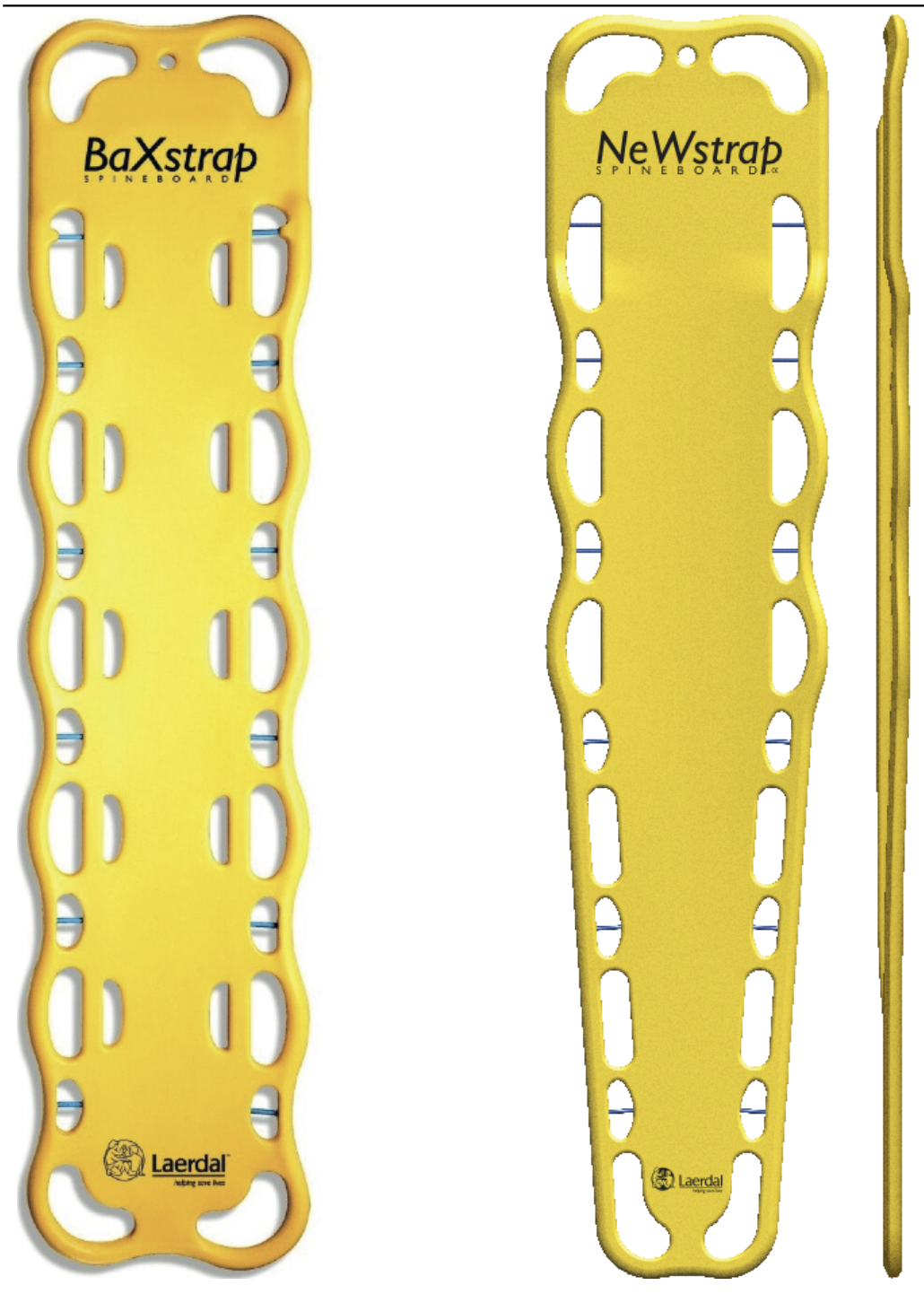

Figure 34: Product side by side

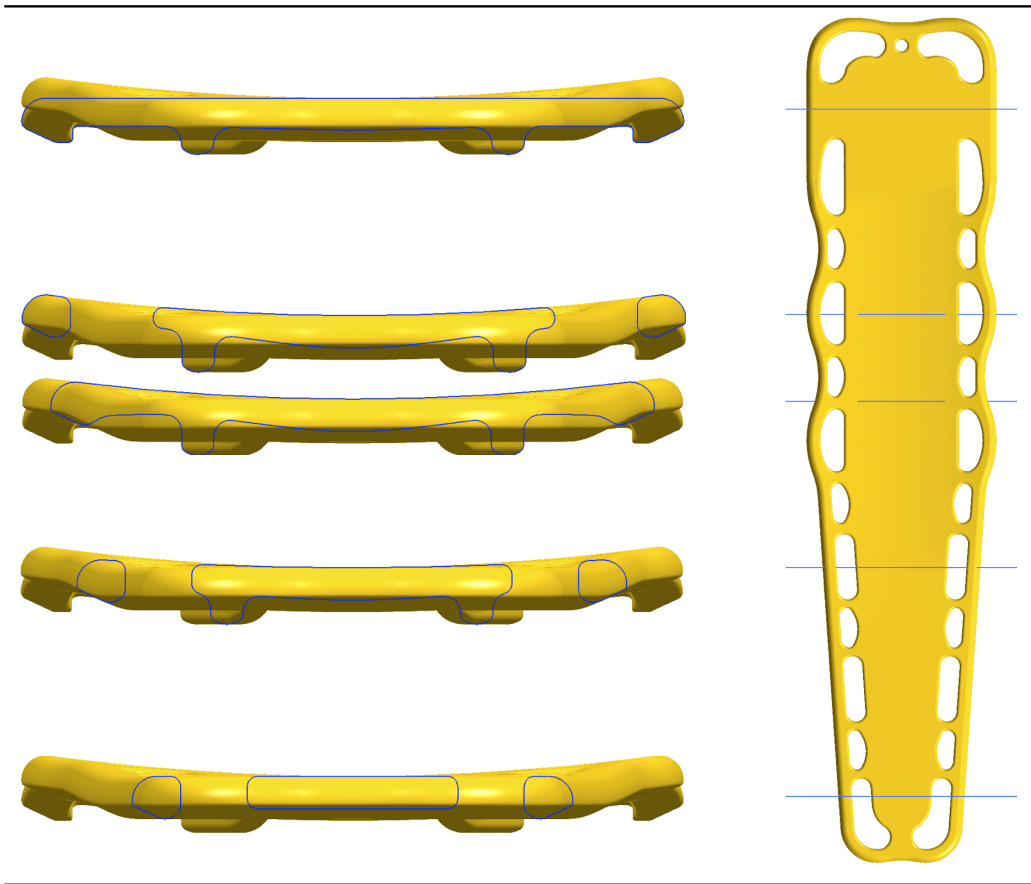

Figure 35: Five cross sections of the «NeWstrap» spineboard

10.6 Hot plate parting line

Creating the parting line for this product can be challenging due to the complex geometry. For injection molded parts it is important that the draft angle is positive around the entire parting line.

The center of the surrounding tube and a longitudinal curve in the center of the board was used to create a parting line. The plane that separated the two parts, was then clipped in a rectangular form and extruded to form the hot plate. The two parts (not shelled out in this case) and the hot plate is shown in Figure 37.

10.7 Mock-up

One of the very last things done in this project was to produce a mock-up of the final design. I wanted to use the opportunity to get customer feedback, as several oral agree-

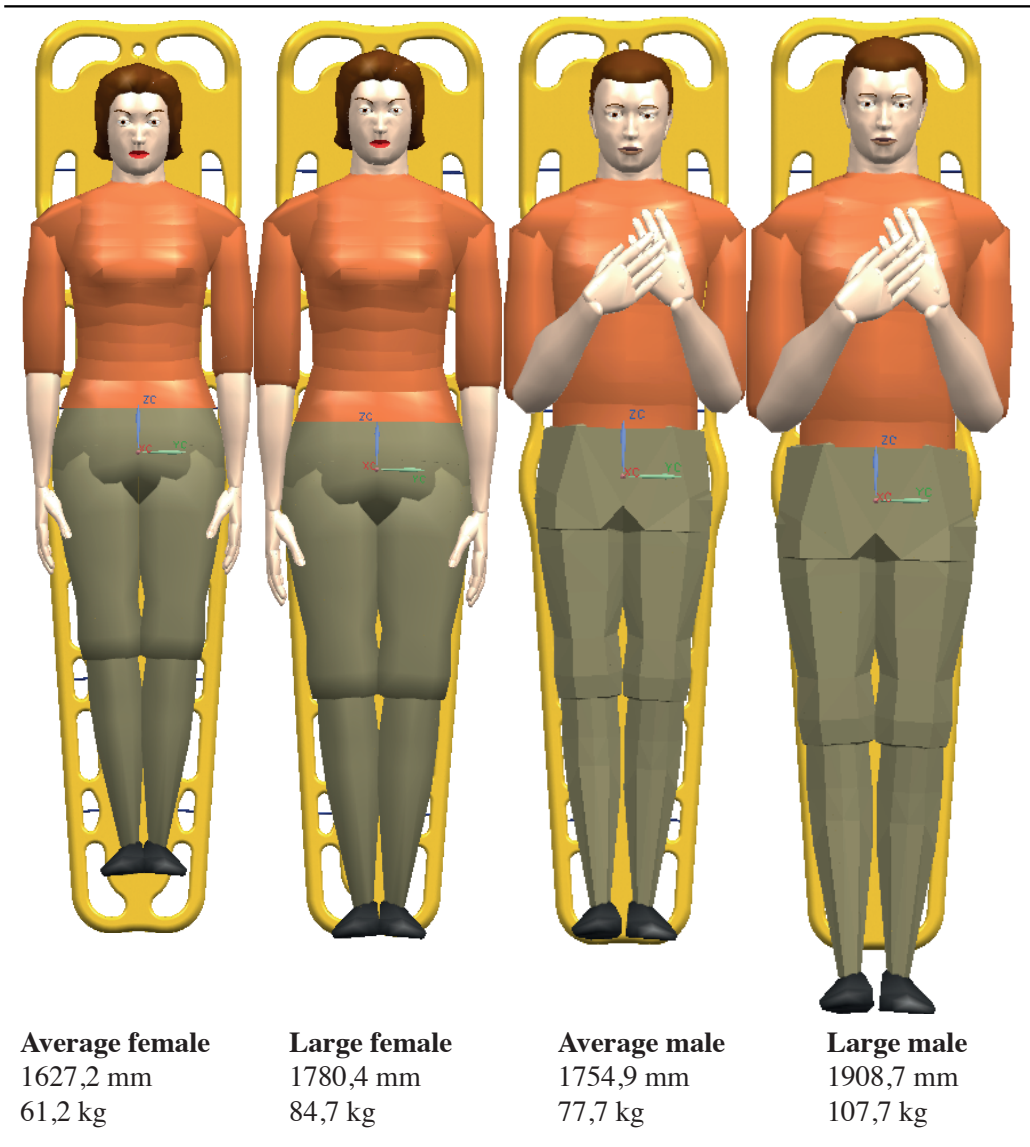

Figure 36: Human modeling with the new spineboard

ments on follow-ups were approved earlier in the semester (Meeting log in Appendix C).

Material

High density foam was provided by the department. They come as 1500*500*100 mm sheets.

A simple draft was extracted from the CAD drawing to determine the need for material for the mock-up (see Figure 38). The dimensions of the new spineboard is 1830*410*48

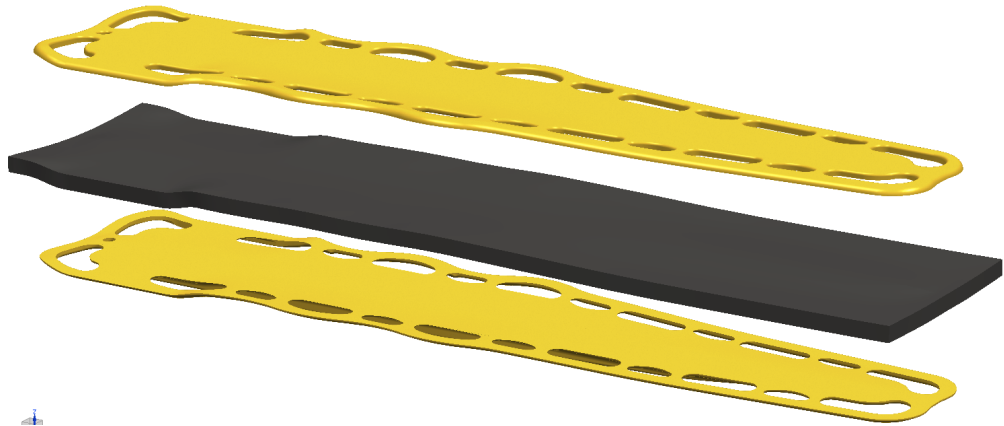

Figure 37: Split spineboard and hot plate created using the parting line

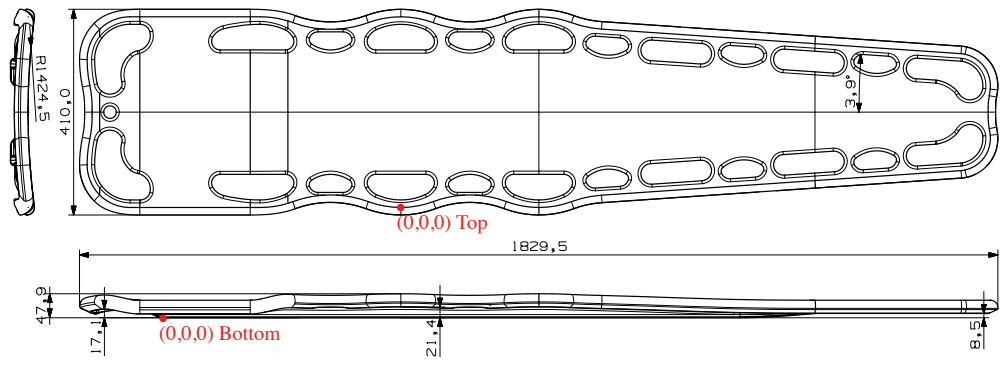

Figure 38: Simple draft of the new spineboard, showing milling start points on both sides of the board.

mm. One plate plus a remaining 600*500*10 mm cut of another sheet was used. Two sheets were used rather than cutting the one 100 mm thick sheet into two 50 mm sheets because the saw blade «eats» away a few mm and some inaccuracy could occur.

Cutting

To reduce the amount of milling required, the sheets were cut. 50 mm were cut off the width of the sheets using a Formula S35 circular saw (350 mm blade diameter, 118 mm cutting height), see Figure 39 a.

A Friggi band saw in the Sintef Materials Technology workshop had maximum dimensions of 500*655 mm, enough to cut the 450 mm wide sheet on its side (Figure 39 b - d). The final dimensions of the sheets were 1500*450*55 and 600*450*55 mm.

Joining

The joining surfaces were sanded until plane to each other. The largest sheet was fixed before the smallest sheet pressed towards it. The 450*55 area was joined using Araldite adhesive.

Milling

Starting coordinates were found using the CAD model. They are marked in the simple draft in Figure 38. The bottom half of the spineboard had to be milled first to create a more stable fixation of the board for milling on the other side. Reference holes were drilled to the sheet before fixing it to the milling machine surface (Figure 39 f - g). The finished milled model is shown in Figure 39 k, next to the BaXstrap spineboard.

Sanding

The milling tool left several 1 - 1,5 mm tracks in the foam model, see Figure 39 j. Grade 80 sand paper was used to smooth out the surface of the board before applying paint.

Coating

A sample of the foam material was painted to check the quality and surface finish (Figure 39 h). Three coats of regular interior yellow paint were applied to the foam model. Drying time was 12 hours for the two first coatings (Figure 39 m) and 24 hours for the third (Figure 39 n).

Graphics

The purpose of the mock-up was to get customer feedback. I concluded that the more real and «finished» I could make the mock-up look, the more likely it would be that I would get feedback based on associations to other spineboards available and not based on the fact that this is an unfinished product. The font used in the BaXstrap logo is «Gill Sans», so a «twin» logo for the new spineboard, with the working title «NeWstrap» was made. This, in addition to a vector graphic Laerdal Medical logo was printed as individually cut letter stickers by Vizuelli AS, Harstad, see Figure 39 i.

Finished mock-up

Figure 39 o - p show the finished mock-up of the «NeWstrap» spineboard next to the existing BaXstrap spineboard.



Figure 39: The process of making a mock-up of the new spineboard.

10.8 Customer test

After the mock-up was finished, a meeting with the crew at Vinjes Ambulance Service was arranged. The feedback from the meeting in brief (full reference in Appendix C.7):

- Looks very familiar to the BaXstrap spineboard.
- More pins gives more options to secure the straps. Six on each side is enough, more is okay.
- Tapered foot end is very good. This one may be too narrow. The patient can have a fracture in their leg which requires splints.
- The foot end corner handholds are not wide enough for an optimal grip. They should be more like the head end ones.
- Thinner at the foot end is a good idea. Spineboards are important tools during car extrication.
- The tapered ends have a good angle for log rolling.
- The lying area looks flat. A more curved lying area is more comfortable for the patient which makes them feel more secure on the board.
- Good insulation is important. Patients must not be placed on cold, uninsulated surfaces.

It was heavily stressed that it is difficult to give a good review of the spineboard without using it for a test period. Still, seeing, gripping, carrying and lying on the mock-up gives some indications on features that are good and features that must be reviewed again.

Figure 40 demonstrates gripping and tilting of the mock-up. The person in the pictures is a male with average size hands. Figure 41 shows how the mock-up fits into the compartment in an ambulance.



Figure 40: User test of the design features of the new spineboard



Figure 41: Placement of the NeWstrap spineboard in an ambulance

11 Conclusion and further work

A substantiated design for a new Laerdal spineboard has been presented. The result is a CAD file (14.prt) which includes model feature history and a draft. Additionally, a poster of the new spineboard in full size and a high density foam model has been created.

The thesis proposes, in cooperation with Laerdal Research and Development, a spineboard manufactured by injection molding two shell parts which are joined together by hot plate welding. This combination of manufacturing methods is not common for the size and complexity of the product presented. Due to this, more information on materials and design of molds and tooling must be retrieved.

FE analysis of the new spineboard shell with a much stiffer shell material was compared to physical tests of the existing Laerdal spineboard. The analysis showed that the new spineboard can have better resistance to bending and torsion than the BaXstrap. Further work on designing an internal structure for the injection molded shells should be done.

Trough descriptions of the CAD model structure and how to prepare mesh and load cases for the spineboard, a strategy for improving the new spineboard has been presented. With this basis and a comprehensive product specification developed in this thesis, Laerdal should continue the development of a second spineboard.

The next step for in the development process should be to evaluate the design and recommendations presented to create a prototype for the new spineboard.

References

- [1] M. Ervik, "Concept development of a new spineboard - a preliminary study," Dept. of Engineering Designs and Materials, Norwegian University of Science and Technology, Tech. Rep., 12 2011.
- [2] M. F. Ashby and K. Johnson, *Materials and design: the art and science of material selection in product design*, 2nd ed. Butterworth-Heinemann, 2010.
- [3] L.-E. Rännar, "On optimization of injection molding cooling," Ph.D. dissertation, Norwegian University of Science and Technology, Department of Engineering Design and Materials, 2008.
- [4] R. Zengh, R. I. Tanner, and X.-J. Fan, *Injection Molding - Integration of Theory and Modeling Methods*. Springer Berlin Heidelberg, 2011.
- [5] Z. Zhou, S. Xie, and D. Chen, *Fundamentals of Digital Manufacturing Science*. Springer, 2012.
- [6] J. A. Nemeth, "A new approach to stabilization of the cervical spine in infants," *The Academy Today*, vol. 1, no. 1, 2005.
- [7] M. A. McDowell, C. D. Fryar, C. L. Ogden, and K. M. Flegal, *National Health Statistics Report*, no. 10, 10 2008. [Online]. Available: <http://www.cdc.gov/nchs/data/nhsr/nhsr010.pdf>
- [8] R. Drillis and R. Contini, "Body segment parameters," *Biomechanics of Sport*, no. 1166-03, pp. 88–118, 1966. [Online]. Available: <http://scholar.google.com/scholar?q=intitle:model+for+body+segment+parameters#1>
- [9] D. Wagner, J. A. Birt, M. D. Snyder, and J. D. Duncanson, "Human factors design guide," U.S. Department of Transportation, Federal Aviation Administration Technical Center, Tech. Rep. DOT/FAA/CT-96/1, 1 1996.
- [10] S.-J. Liu and H.-F. Cheng, "The influence of interface geometry on the joint strengths of hot plate welded composites," vol. 29, no. 4, p. 497.
- [11] "Laerdal medical website," 12 2012. [Online]. Available: www.laerdal.com
- [12] E. A. Campo, *The complete part design handbook : for injection molding of thermoplastics*. Hanser Publishers, Munich, 2006.

A Media

This section includes an overview of the material that was delivered in addition to this report. Due to file size, the additional material was delivered directly to Knut Aasland on a DVD. The physical hand-ins were also given to him.

Description // *type*

1. Foam mock-up of the new spineboard
2. One BaXstrap spineboard
3. Final design poster // 850*2400 mm vinyl rollup poster
4. CAD models
5. Full scale illustrations and vector graphics of all figures used in this document
6. files
7. Presentations
8. Other material such as sketches used during the development process

B Roll-up poster

Mariann Ervik
Development of a new spineboard
Master Thesis 2012

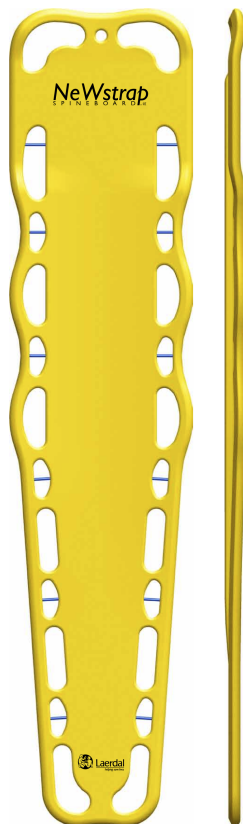

NTNU
Department of Engineering Design
and Materials



NB! Dette feltet vises ikke når rollupen er slått opp!
(Eventuell bakgrunnsfarge eller bilde kan gjerne gå helt ned i dette feltet.)
(Fjern dette feltet på originalen!)

Figure 42: New spineboard roll-up poster

C Meeting log

The development process of this master thesis would not have been possible without the contribution from the people who operate, inreview and sell spineboard as part of their work. During the work on the preliminary study and master thesis, these were the people I interviewed and engaged in discussions with about the use of spineboards:

- Emergency rescue personnel at the Trondheim Ambulance Service (Vinjes)
- Instructors at Trondheim Ambulance Service (Vinjes)
- Staff at St. Olavs Hospital Emergency Room, Trondheim
- Radiologists at St. Olavs Hospital, Trondheim
- Helicopter crew at the Norwegian Air Ambulance, Stavanger
- Instructor at the Norwegian Air Ambulance, Stavanger
- Laerdal Medical Strategic Marketing Department, Stavanger and New York
- Employees at Laerdal Medical Research and Development Department, Stavanger
- Laerdal Medical Regional Sales Representative for Mid and North Norway

To try to get a nuanced picture of the user wants for a new spineboard design, I frequently repeated questions such as: Should the foot end be tapered? Should the lying area be curved? What is the practical importance of child slots? How do you grip and operate the spineboard? In what situations is the spineboard used?

This section includes a summary (partly in form of key words) of the most significant meetings during this spring.

The meeting log does not include regular meetings with advisor and other staff at NTNU.

C.1 People who contributed

1. Vinjes Ambulance Service, Trondheim
 - 1.1. Svein Dragsnes, *Technical Manager*
 - 1.2. Kay Kolmannskog, *Academic Leader*
2. St. Olavs Hospital, Trondheim
 - 2.1. Merethe Hole, *Radiographer*
 - 2.2. Nimal Liyanaarchchi, *Radiographer*
 - 2.3. Emergency room staff on 2011-09-xx
 - 2.4. Morten Dragsnes, *Division Manager, Ambulance Division*
3. Norwegian Air Ambulance, Stavanger
 - 3.1. Janne Stoeylen Baadholm, *Instructor*
 - 3.2. Crew on 2012-03-29
4. Laerdal Medical, Stavanger and New York
 - 4.1. Trond Sagland, *Senior R&D Product Expert*
 - 4.2. Hilde Tertnes, *Strategic Marketing Director*
 - 4.3. Steve Tidwell, *Associate Strategic Marketing Manager*
 - 4.4. Gunnar Norvik Andersen, *Regional Representative*
 - 4.5. Jan Vastvedt, *Manager R& D, Materials, Mechanics & Mechatronics*
5. Norwegian University of Science and Technology
 - 5.1. Knut Aasland, *Associate Professor, Department of Engineering Design and Materials*
 - 5.2. Bjarne Stolpnessaeter, *Staff Engineer, Department of Engineering Design and Materials*
 - 5.3. Halvard Stoewer, *Staff Engineer, Department of Engineering Design and Materials*
 - 5.4. Arne Gellein, *Senior Technician, SINTEF Materials and Chemistry*

C.2 Vinjes Ambulance Service, Trondheim (Mar 16, 2012)

Kay Kolmannskog, *Academic Leader, Vinjes Ambulance Service*

This was a follow up call for the master thesis after a visit and interview with Technical Manager Svein Dragsnes at the Ambulance Service on September 14th 2011. The main purpose for this call was to explore the practical significance of a. child slots, and b. the deformation of the spineboard while carrying a patient.

The first subject was immobilizing children onto spineboards. The spineboard used in Trondheim ambulances is the Ferno Najo Board. This board is 7 kg, has a flat lying area and contains no openings except for its 22 handholds at the periphery of the board. Kay said that he has never experienced a rescue where the child has been immobilized to a long spineboard. "For every rescue we have to prioritize and make the best choice for the child given the situation and state its in. Immobilizing on a spineboard can be extremely uncomfortable and scary for a child. If we were to use a spineboard, I guess the child would have to be unconscious and we would use extra padding during the immobilization", he said. To my questions regarding alternatives and how to choose the right one, he answered: "We would try to use more comfortable alternatives, like a vacuum mattress or splints. A vacuum mattress is by no means a replacement for spineboards, but they would be better for longer transportation. The spineboard is more of a tool, it is great for car extrication."

I asked if there are any challenges related to the use of spineboards during car extrication. Kay continued: "It is important that the board is as narrow as possible at the foot end. Remember that the paramedic has to stand next to the board when it goes through the car door. That leaves very little space for the spineboard. The board that we use today is tapered at the foot end. Low weight is also very important, the spineboards are, after all, quite heavy." I asked what he ment about heavy. "Between 5 and 10 kg", he said. While still on the topic of car extrication, I asked if the thickness of the board was an issue as well, but Kay could not see that it was. "The spineboard that we have today is fine," he said.

The second topic was the deformation of spineboards. I asked if there was any significant deformation in the center of the board when a patient was carried on it. "No. Well, there is some movement in the board, but it has never been a problem as far as I know. Of course, if the patient is very heavy, there is bound to be some movement in the board, but that is just how it is. We just have to do our job the best way we know how," Kay answered.

C.3 Strategic Marketing, Laerdal Medical AS, Stavanger (Mar 28, 2012)

Hilde Tertnes, *Strategic Marketing Director, Laerdal Medical Norway*

Steve Tidwell, *Associate Strategic Marketing Manager, Laerdal Medical USA*

Trond Sagland, *Senior R&D Product Expert, Laerdal Medical Norway*

Helge Anglevik, *Senior Development Engineer, Laerdal Medical Norway*

Mariann Ervik, *Graduate Student, NTNU*

Laerdal is looking for a 2nd generation of spineboards to extend their spinal product line to include the rigid and curved BaXstrap and a new, cheaper version. The production costs for the new spineboard is targeted at half the cost of the BaXstrap spineboard.

First reactions to the TT design is that it looks cool. "When can we get it?" Important to keep features such as curved, approx. same weight, speed clips and good handles.

Mixed reactions to the symmetric design. Looks flat and will look big seen from the side. Weight might be an issue. The fact that such a design allows to cut investment costs by about half, is a good reason not to scrap this concept yet, but try to improve the design.

C.4 Norwegian Air Ambulance Crew, Stavanger (Mar 29, 2012)

Janne Stoeysten Baadholm, *Instructor, Norwegian Air Ambulance*

Crew on 2012-03-29

The Norwegian Air Ambulance use some high end equipment that is too expensive for other institutions such as the Ambulance service. They use heart compression machines. During my visit, we looked at two different heart compression machines. The first one, called Lukas, has a curved underside. The other one has a flat underside. When asking about curved lying areas in spineboards, the crew told me that they often use the spineboard as rigid support under the compression machines. With the flat type compression machine, a curved spineboard cannot be used in danger of placing the heart compression machine on it at an angle. But the curved type compression machine is more stable on a curved spineboard.

It was clear that the financial situation for the Air Ambulance differed from that of the Ambulance service. But using high end spineboards is difficult because it is likely that they will disappear. Different rescue services often give away the patient while still immobilized to the spineboard. In return, to keep their unit operable, they exchange spineboards.

C.5 Regional Sales, Laerdal Medical AS, Trondheim (Apr 10, 2012)

Gunnar Norvik Andersen, *Regional Representative, Laerdal Medical Norway*

Working as a Sales representative, Andersen is often in contact with users of the spineboard. I shared the work of my project so far and was provided with some information on what users look for in a spineboard. He suggested that the spineboard could be narrower at the foot end and should also be tapered around the edges. A common perception among users is that the BaXstrap spineboard is bigger than it actually is.

C.6 Presentation, Norwegian University of Science and Technology, Trondheim (Jun 6, 2012)

Jan Vastvedt, *Manager R&D, Materials, Mechanics and Mechatronics*

Knut Aasland, *Associate Professor, Department of Engineering Design and Materials*

All students with 2012 master thesis assigned by Laerdal Medical AS

C.7 Vinjes Ambulance Service, Trondheim (Jun. 27, 2012)

Morten Dragsnes, *Division Manager, Ambulance Division*

I brought the mock-up of the new spineboard to Vinjes Ambulance headquarters on Jun. 27 where I had arranged to meet with Morten Dragsnes, Division Manager of the St. Olavs Hospital Ambulance Division in addition to the staff present. The last two crew members on watch, however, was called out just two minutes after I arrived, so I had the meeting with Morten, left the board there and came back the next day to be pick up the board and take some pictures (trusting that a note that this was a foam model would prevent that it was broken).

Mortens first reaction to the model was that it looked really familiar to the existing Laerdal spineboard, except smaller (narrower). He also thought that it had more holes to fix straps. While using the model actively, we went to the different sections of the board separately.

It was hard to see that the board was curved in the lying area. Morten stated the importance that the patient feels safe and comfortable (or less uncomfortable) lying on these boards. But he confirmed that only the torso area needed to be curved - not necessarily the foot area.

This board will have six pins on each side. «It is good that there are a lot of possibilities to clip the straps. A lot of boards do not have enough of these. And in one board I can think of, it is impossible to get the strap next to the shoulder to fit properly.»

From the mock-up, it was clear to me that the foot end corner handholds were not raised enough, so I asked about these handholds. He said that they should be raised, but not by sacrificing the total thickness of the board. After all, less weight is lifted at this end of the board.

I explained that car extrication is, from what I can understand, one of the most important areas where Ambulance spineboards are used and that this is the reason why the new spineboard is flat on top and has no ground support at the foot end of the board. We took a look at the ground support, which is completely smooth and in that way different from the BaXstrap. While I got positive feedback on the thinner foot area, I was reminded that it is not necessarily a good thing that the ground support is smooth. When the board lies on top of a stretcher, it is important that there is little movement between the two. All though the spineboard is fixed to the stretcher by straps, additional prevention of movement is a plus.

Insulating properties was mentioned, and Morten talked more about how the spineboard is used. «The patient does not and should not spend much time on the spineboard. We cannot leave the patient on a thin board close to the ground, it is too cold.»

The grip of the handholds were good, despite the tapered edge of the board. Log rolling was demonstrated and I was told that the taper angle on the edge was good for this purpose.

The grip of the foot end corner handholds were not good. If the board was wider at the foot end, the handholds could have a shape more similar to the top corner handholds. Carrying the board on the sides at the bottom corner handholds does not provide a good grip. It is much better to carry it like at the head end on this board.

I asked about the with of the board at the foot end after a few people of different height and weight had tried to lie on it. «It can definitively not be any narrower,» Morten replied. «The patient might have big shoes and other heavy clothing. If the patient had a leg fracture, we might need to use splints as well. On this board, it looks like it might be hard to fix the straps to the pins. But we really would need to try the board before we know how it is to use.»

In addition to the picture of the new spineboard placed in the compartment in the ambulance, I took some pictures of the mock-up next to the Ferno Najos spineboard, which is the main spineboard used in ambulances in the Mid Norway region, see Figures 43 and 44.



Figure 43: NeWstrap side by side comparison with Ferno Najo board



Figure 44: NeWstrap underside and contour comparison with Ferno Najo board

D BaXstrap test report

D.1 Introduction

These tests were conducted as a part of the master thesis *Development of a new spineboard* at NTNU in Feb 2012. This document considers bending and torsion requirements of spineboards based on NS-EN 1865:2000. The purpose of the measured properties is use for evaluation of new design concepts during further development of a new product.

This report consists of two parts:

1. Resistance to torsion
2. Resistance to bending

D.2 Equipment

The complete list of equipment used for the torsion and bending tests, respectively, are listed below:

Resistance to torsion [Description // Quantity]

- Laerdal BaXstrap spineboard // 1
- Support // 2
- Metal bar, minimum length 1140 mm // 1
- Mass / load cell // 10 kg / 1
- Base clamp // 2
- Distance measurers // 2

Resistance to bending [Description // Quantity]

- Laerdal BaXstrap spineboard // 1
- Support // 4
- Mass (sandbags) // 130 kg
- Metal bar, minimum length 1140 mm // 2
- Rope or straps with no or little deflection // 4
- Distance measurers // 3



Figure 45: Equipment utilized for load/distance-measurement

- Weight scale // 1

Logging the results was done using three distance measurers (Figure 45a), one load cell for tension and compression with thread studs (Figure 45b) and HMB Catman Software CatmanEasy (Figure 45c). The software transforms information from the HMB Spider8 unit (Figure 45d), which is connected to the distance measurers and load cell.

D.3 Setup and execution

Before the tests could start, double bags were filled with sand using a 100 kg capacity mechanical weight scale. They were filled with 5, 10, 15 and 17 kg of sand. Smaller size sand bags would mean more log points and cause less movement in the spineboard when placed on it (due to better handling).

The setup for resistance to torsion is described in two parts because the first method, based closely on the setup description from the standard, gave results that are difficult to replicate during a virtual test.

D.3.1 Resistance to torsion setup, part one

Initially the spineboard was set up as explained by the NS-EN 1865:2000 standard. A metal bar was fixed at the head side corner handholds and the foot end was clamped. The standard states that the head and foot end corners should be supported, so the spineboard remained placed on a surface with the metal bar just outside the surface (see Figure 46).

The load was limited to 10 kg for testing resistance to torsion, so it was not necessary to include any mass for this test. It would be sufficient simply to pull the load cell downwards until 10 kg was reached. The load cell was hanged on the metal bar, 410 mm (one board width) from the closest spineboard corner.

The standard requires to measure the deflection on the far end corner fixed to the metal bar. With a 10 kg load one board length from the other corner, the deflection on the far end corner should be no more than 50 mm. So a distance measurer was fastened underneath this corner. To measure any inaccuracies, a distance measurer was fastened below the other head end corner as well. The metal bar was not long enough to be fixed centered on the spineboard, so some extra weight on one side would account for a minor imbalance to the measured distance. Figure 47 show the placement of the load cell and distance measurers during the torsion test.

The logging frequency was set to 10 Hz. Three tests were run.



Figure 46: Setup for the torsion test, according to NS-EN 1865:2000

D.3.2 Resistance to torsion setup, part two

The deflection in the setup according to the standard depends on the geometry of the spineboard (see comments to the standard in Section D.5). To get some results on resistance to torsion that could easily be replicated during virtual testing, the spineboard could not be supported on the ground.

The spineboard was set up according to the diagram in Figure 48. Black solid areas indicate fixation and support. The spineboard was still clamped at the foot end, but instead of lying on the surface, it was only supported by a vertical rod in the top center of the spineboard.

The metal bar, load cell and distance measurers were placed like in part one. The

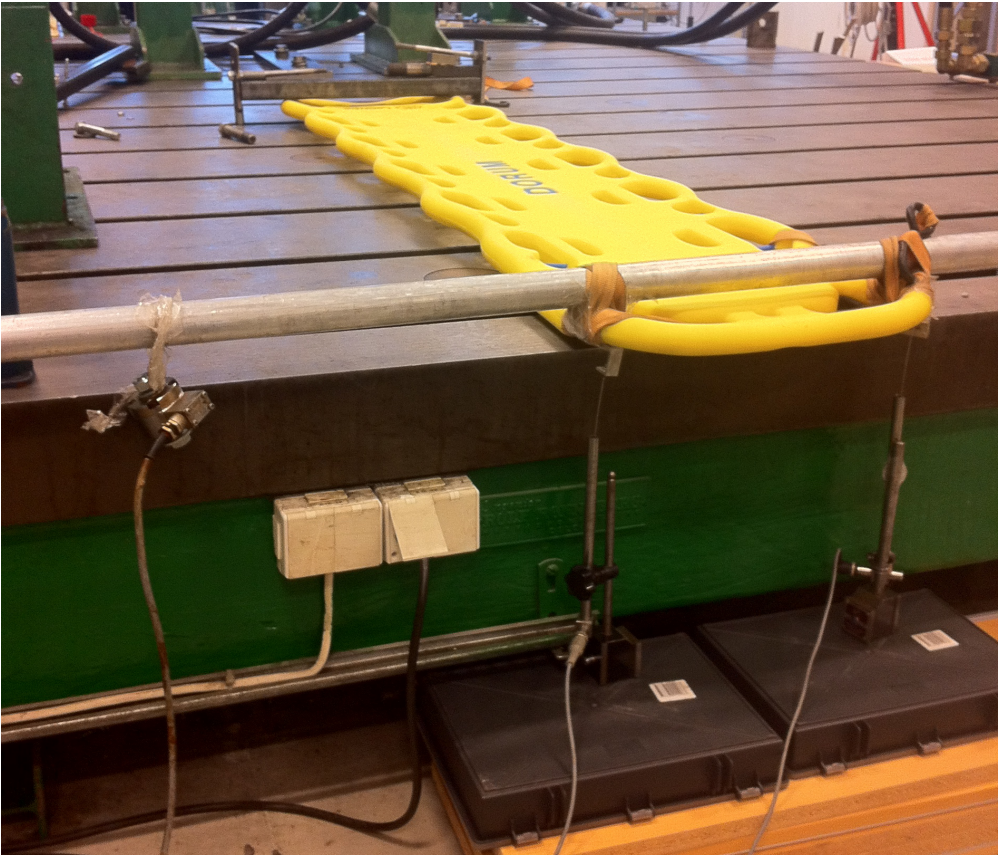

Figure 47: Equipment setup for the torsion test

distance measurers are indicated by VEI2 and VEI3 and the 410 mm distance indicate where the load cell hanged on the metal bar.

The logging frequency was set to 10 Hz. Four tests were run.

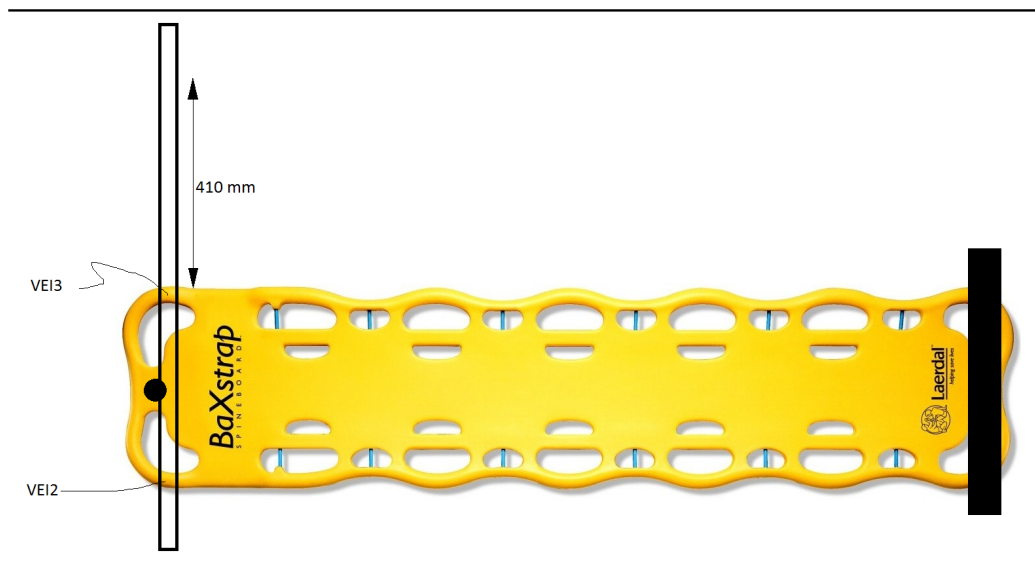

Figure 48: Setup for the torsion test

D.3.3 Resistance to bending

Figure 49 shows a diagram of the bending test setup. Black solid areas indicate support and distance measurers are marked with VEI1, VEI2 and VEI3.

The spineboard was hanged by velcro straps to two metals bars supported 300 mm from the spineboard in each of the four corners of the spineboard.

Distance measurers were placed underneath the center of the spineboard and underneath the center of the foot and head end (between the two supports at each end).

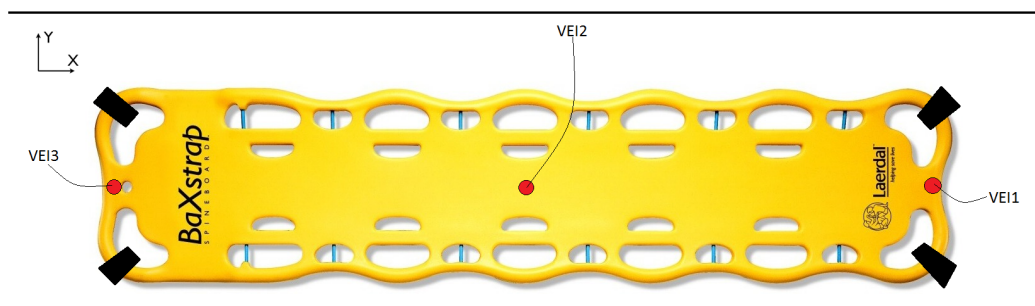

Figure 49: Setup for the bending test



Figure 50: Equipment setup for the bending test

Weight was distributed evenly in the lying surface of the spineboard using 5, 10, 15 and 17 kg bags filled with sand.

The deflection was measured at 1 Hz frequency while 5, 10, 15 and 17 kg sand bags were distributed onto the lying surface incrementally. Between each load, the board was given about 10 seconds to come to rest. Three tests were run. The bending tests were done in the same day. The third test was logged while unloading the spineboard from the second test.

D.4 Results

D.4.1 Resistance to torsion, part one

The measured deflection at distance measurer D2 during the three tests were 33,3 mm, 31,9 mm and 29,1 mm. Distance measurer D3 deflected to about 4-5 mm before it stopped due to the support under the spineboard. The results, given in Table 14 are not very detailed because this test merely shows that the spineboard deflects less than that of the requirement in standard NS-EN 1865. The values are well under 50 mm at the 10 kg load.

Details test results are shown as graphs in Figure 51.

Test index	Weight [kg]	Distance D2 [mm]	Distance D3 [mm]
Torsion01	-5	-15,5	4,6
	-10	-33,3	5,2
Torsion02	-5	-15,0	4,0
	-10	-31,9	4,3
Torsion03	-5	-14,4	4,0
	-10	-29,1	4,0

Table 14: Torsional properties of the BaXstrap spineboard, part one

D.4.2 Resistance to torsion, part two

Graphs in Figure 53 and values in Table 15 show the torsional properties of the BaXstrap spineboard given as force per deflection and moment per angle. Details from each tests are shown in the graphs in Figure 52. The graphs show average values of the part two resistance to torsion tests. The resistance to torsion was calculated to 0,3 mm/N, or 2,94 Nmm/rad, see graphs in Figure 53.

Distance
measurers

D2

D3

Units:

[mm / kg]

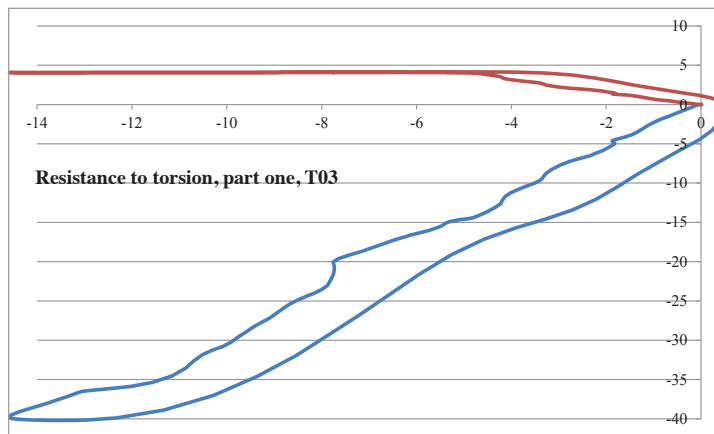
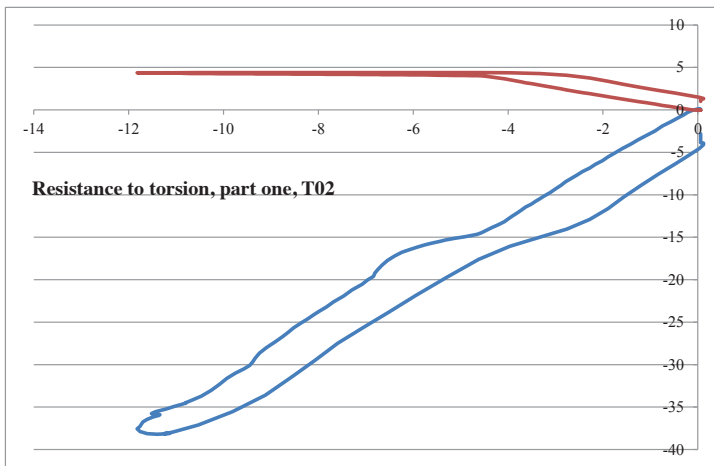
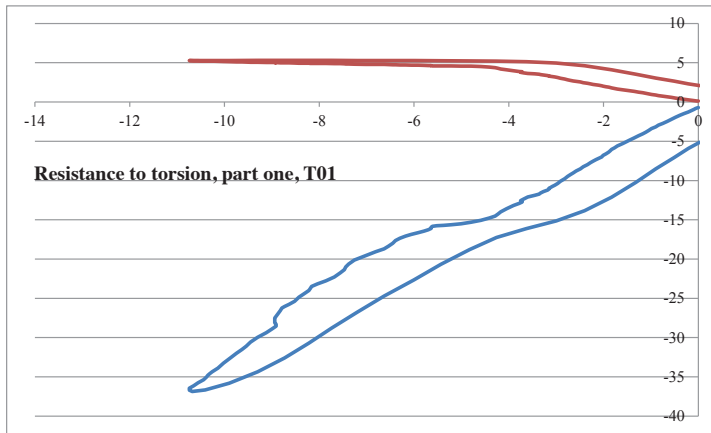

Figure 51: Results for resistance to torsion test, part one

Distance
measurers

D2

D3

Units:

[mm / kg]

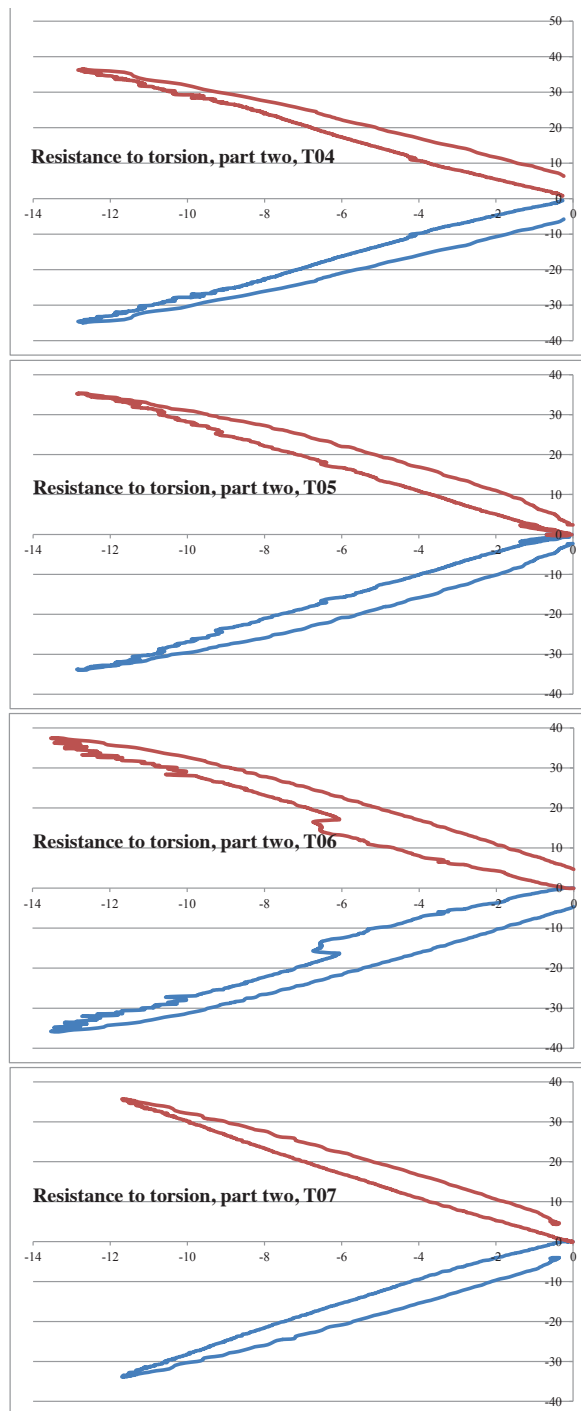

Figure 52: Results for resistance to torsion test, part two

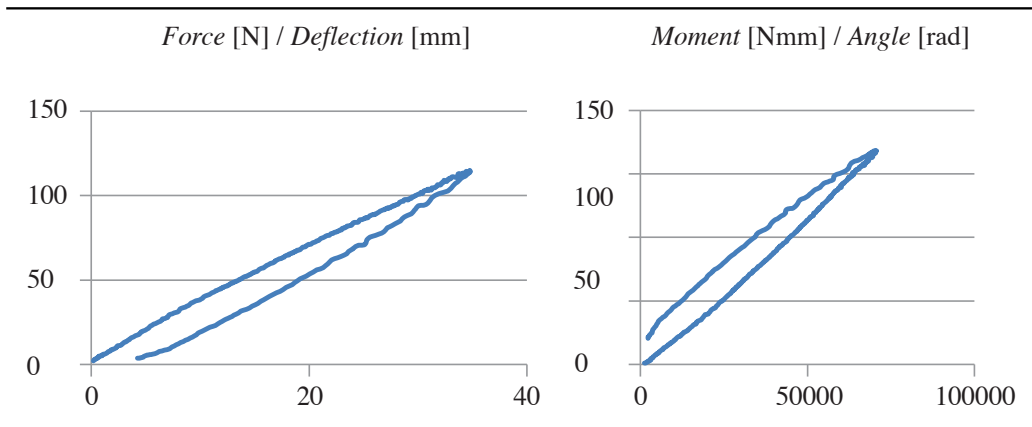

Figure 53: Torsional properties of the BaXstrap

D.4.3 Resistance to bending

The deflection in the center of the spineboard (D2) was measured to 84,5 mm, 86,1 mm and 83,6 mm at 135 kg distributed load, see Table 16 and detailed graphs of the deflection plotted against time in Figure 55. This value represents bending in two planes and possibly a minor deflection in the straps that supports the spineboard. Distance measurers at the ends of the spineboard, D1 and D3, showed 8 mm, 6 mm and 4,8 mm on average. The value differed slightly from the two because the weight was not evenly distributed onto the board. Subtracting the average deflection at the ends of the spineboard, gives a center deflection of 76,5 mm, 80,1 mm and 78,8 mm, which gives a deflection of 0.6 mm/kg. Figure 54 shows the deflection in the center of the spineboard (distance D2) after the average deflection at the ends (D1 and D3) is subtracted.

In the three tests, there is a variation of 3,6 mm in the result at the maximum weight load (135 kg). The first two tests, Bending01 and Bending02, were logged while loading sand bags onto the board and the third test, Bending03, was logged while unloading. Figure XX shows details from the three bending tests. From the graphs, it can roughly be calculated that the spineboard deflects about 1 mm in 20 seconds after adding the weight, see details from test B02 in Figure 56. This explains the difference in the first and second result. In addition, the spineboard was given only 2 hours to rest between the tests, which is less than the board needs to completely relax.

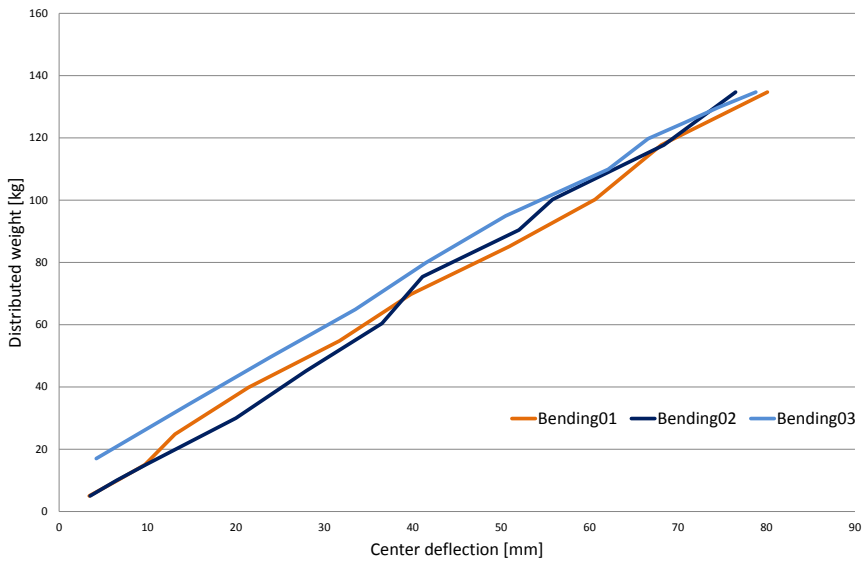

Figure 54: Deflection in the center of the spineboard

D.5 Comments to the NS-EN 1865:2000 requirements

In NS-EN 1865:2000, the spineboard’s resistance to torsion is required to be as follows: The two foot end corners of the board are clamped, while the other two are supported from underneath and have a metal bar fixed across the top side of the corners (or pulled out handles, as will be the case for some spineboards). A 100 N weight is fixed to the metal bar, 300 mm from the board. The fourth, free corner should move more than 50 mm, measured vertically from its initial position.

As the standard uses a spineboard with pull-out handles, this will always give the most conservative result. For rigid plastic spineboards that have curves and ground support underneath their corner hand holds, the tipping point will come closer to the center and give a larger deflection because of this.

The setup for the twisting test in Section 2.3 was changed from the setup in the standard to produce numbers that are easily comparable to constraints from computer simulations.

Test index	Weight [kg]	Distance D2 [mm]	Distance D3 [mm]	Delta [mm]
Torsion04	-5	-13,3	14,3	1,0
	-6	-16,2	17,3	1,1
	-7	-19,5	20,7	1,2
	-8	-22,5	23,9	1,4
	-9	-25,3	26,7	1,4
	-10	-27,8	29,2	1,4
Torsion05	-5	-12,6	13,5	0,9
	-6	-15,7	16,7	1,0
	-7	-18,6	19,6	1,0
	-8	-21,0	22,1	1,1
	-9	-23,5	24,7	1,2
	-10	-26,9	28,2	1,3
Torsion06	-5	-9,8	10,4	0,6
	-6	-12,5	13,2	0,7
	-7	-19,4	20,3	0,9
	-8	-22,3	23,2	0,9
	-9	-24,9	26,0	1,1
	-10	-27,0	28,1	1,1
Torsion07	-5	-12,5	14,0	1,5
	-6	-15,4	17,0	1,6
	-7	-18,5	20,1	1,6
	-8	-21,7	23,4	1,7
	-9	-24,8	26,6	1,8
	-10	-28,2	30,1	1,9

Table 15: Torsional properties of the BaXstrap spineboard, part two

Distance
measurers

D1

D2

D3

Units:

[mm / s]

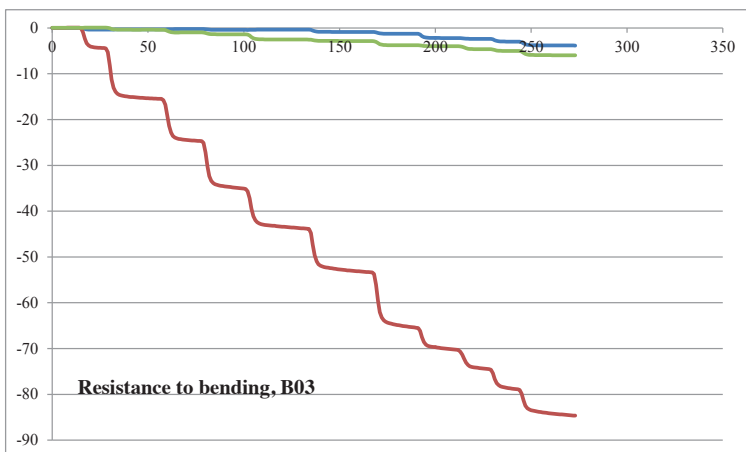
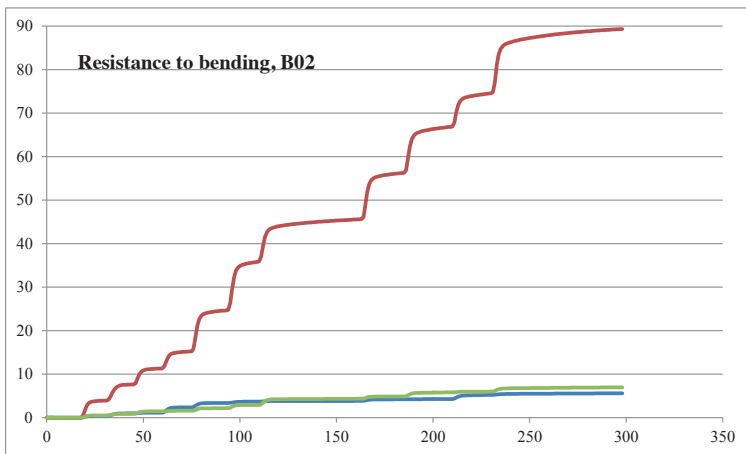
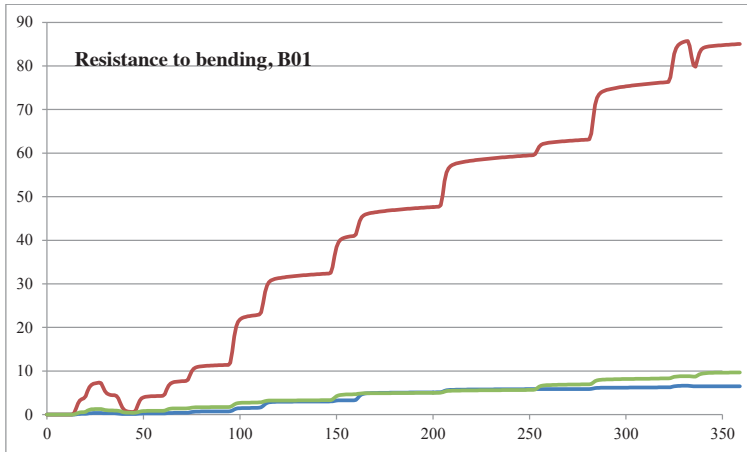

Figure 55: Deflection of the BaXstrap, plotted against time

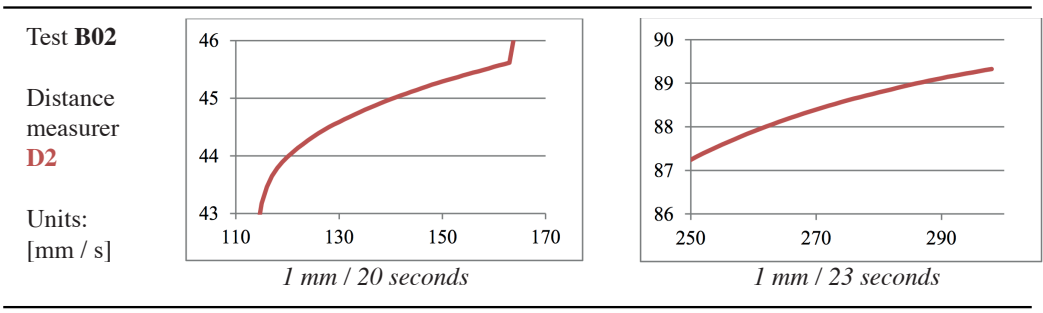

Figure 56: Detailed view of the second bend test between loading

Test index	Weight [kg]	Distance2 [mm]	Average Distance (1:3) [mm]	Distance2 - Average Distance(1:3) [mm]
Bending01 (Loading, 360s)				
	5,0	4,	0,5	3,5
	10,0	7,4	0,9	6,5
	15,0	11,0	1,2	9,8
	24,8	22,1	2,1	20,0
	39,8	31,0	3,1	27,9
	54,8	40,4	3,9	36,5
	69,8	46,0	4,9	41,1
	85,1	57,6	5,6	52,0
	100,2	62,1	6,3	53,8
	117,7	75,5	7,1	68,4
	134,7	84,5	8,0	76,5
Bending02 (Loading, 300s)				
	5,0	3,8	0,4	3,4
	10,0	7,5	0,9	6,6
	15,0	11,0	1,3	9,7
	24,8	15,0	1,9	13,1
	39,8	24,1	2,7	21,4
	54,8	35,0	3,3	31,7
	69,8	43,8	4,0	39,8
	85,1	55,4	4,5	50,9
	100,2	65,6	5,0	60,6
	117,7	73,6	5,5	68,1
	134,7	86,1	6,0	80,1
Bending03 (Unloading, 275s)				
	17,0	4,3	0,1	4,2
	34,5	14,9	0,2	14,7
	49,6	24,4	0,5	23,9
	64,9	34,4	0,9	33,5
	79,9	42,9	1,4	41,5
	94,9	52,3	1,8	50,5
	109,9	64,6	2,5	62,1
	119,7	69,7	3,1	66,6
	124,7	74,1	3,5	70,6
	129,7	78,5	4,0	74,5
	134,7	83,6	4,8	78,8

Table 16: Bending properties of the BaXstrap spineboard

E Project design history

CAD models were actively used to discover and explore design constraints for the new spineboard during the project. Creating tangent surfaces with sufficiently large radiuses so that the surface of the board could be offset inwards proved to be the most difficult problem area to work around.

Freeform surface modeling would be ideal for this complex spineboard geometry, but it could only be used to a certain extent due to the many geometry constraints related to this product. Instead, the application *Shape Studio* in *Siemens NX 7.5* was used to create splines and surfaces tangent to their borders where possible.

The version history for the final design, with explanatory pictures extracted from the CAD software, is summed up in this appendix section. A short text describes solutions chosen to build the model, what worked and what features that did not obtain the desirable results. This trial and error process is the background for Section XX which explains how the final model was build.

Version 01

perspective trimetric view:

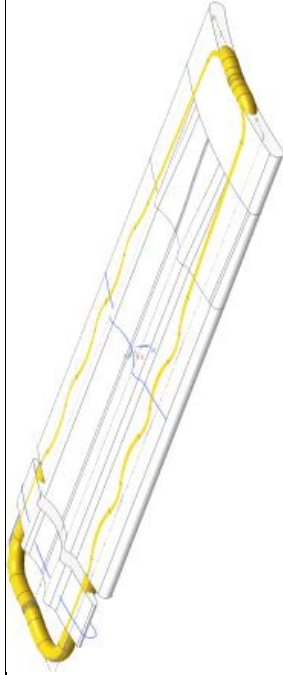

Comments

Model structure // Problem areas

Created by *Extruding* three cross sections (head, body and feet area). Idea was to connect them with *Trough Curves* before trimming them with the surrounding tube curve.

Difficult to get a tangent transition between the top center of the surrounding tube (yellow) and the extruded lying area (white).

Version 02

perspective trimetric view:

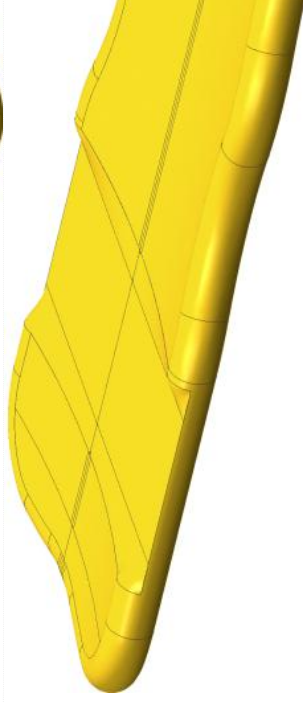
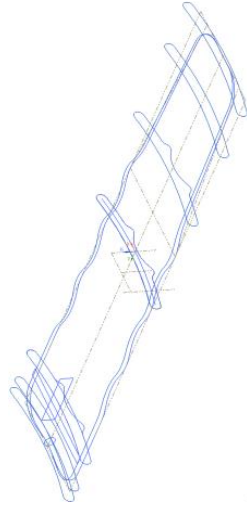
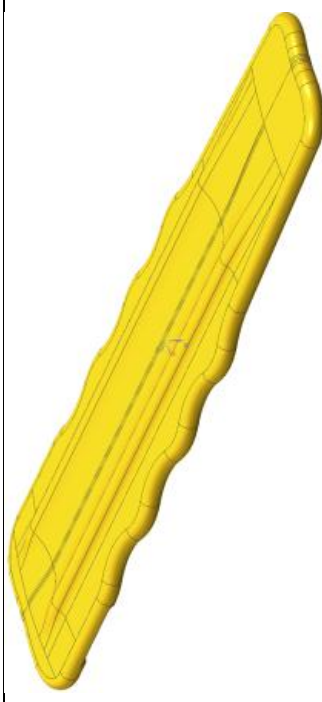
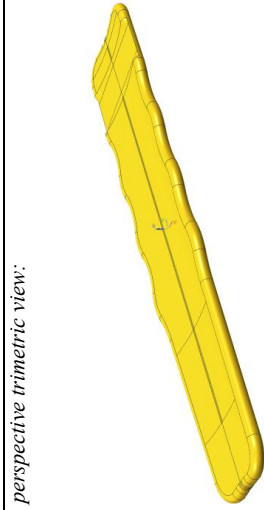

Comments

Model structure // Problem areas

Created by using the *Trough Curves* feature on cross sections along the entire length. Surrounding tube for handholds created by *Sweep*. Head area clipped flat and joined to the curved surface by two *N-sided surfaces*.

Trough curves feature produces complex surfaces on the underside of the board, which creates a conflict with removing holes from the board.

Head area has an edgy transition to the rest of the surface (*white*).

Version 03

perspective trimetric view:

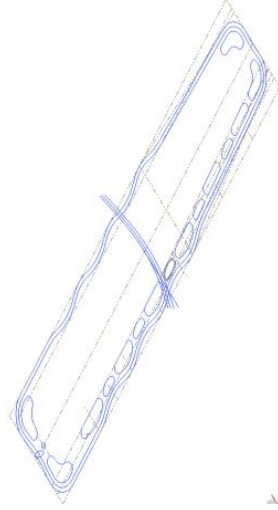

Comments

Model structure // Problem areas

From here on out, the models were first built without ground support longitudinal runners. These should be added to the board after the underside surface is modeled. The complete curves for handholds were made using some values from the BaXstrap 3D scan provided by Laerdal.

Obtaining tangency between the surrounding tube and the lying area was attempted by using a sheet cut by the surrounding curve, and then adding a radius (*white* in the top right corner) between them. This was inspired by the geometry of the BaXstrap, which has a discrete such radius.

The top center of the surrounding tube should be tangent to the entire lying area surface.

Version 04

perspective trimetric view:

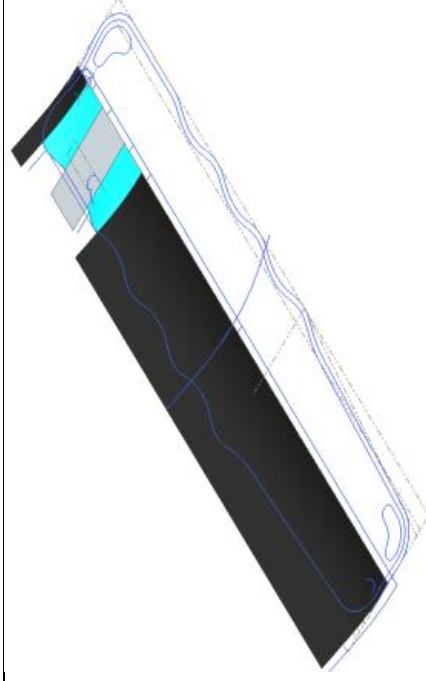
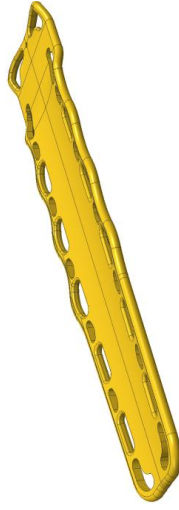

Comments

Model structure // Problem areas

The black sheet lying area was created using geometry from the BaXstrap scan. The transition between the lying area (*black*) and the flat head area (*grey*) was created by using *N-sided surfaces*, tangent to all bordering surfaces (*cyan*).

From Version 03, these sheets were adjusted to be tangent with the top center of the surrounding tube.

The areas marked with *red* shows that it is not possible to have tangency between the top center of the swept surrounding tube and the lying surface (*black*). Studying the geometry more closely showed that this is because the circle swept along the surrounding curve is not swept completely constant around curve. This is why the problem area (*red*) only occurs on the side and not on the head and foot end sides.

Difficult to get a good blend radius (by using *Edge Blend* and *Soft Blend*) between the handholds and lying surface.

Version 05

perspective trimetric view:

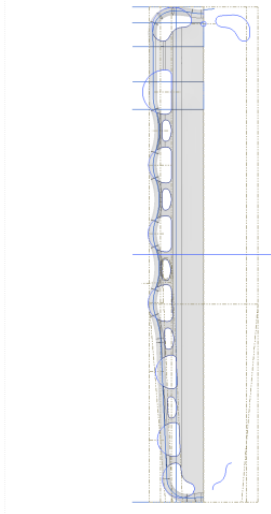
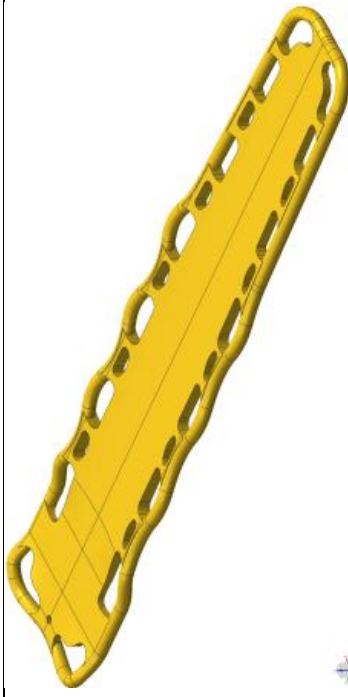
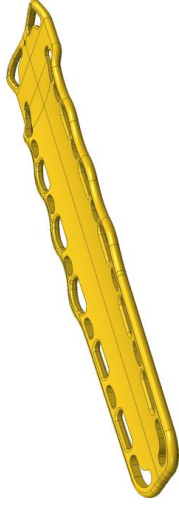

Comments

Model structure // Problem areas

Made the handholds

completely round by altering the geometry of the handholds.

Still proved somewhat difficult to blend the faces of the handholds to the lying surface.

Still having an issue with lying surface-to-surrounding tube tangency.

Version 06

perspective trimetric view:

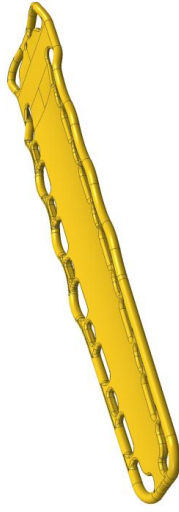

Comments

Model structure // Problem areas

Used *Extruded curves* and tangent *N-sided surfaces* to create a top and underside surface to the board. The underside surface (*green*) and the topside surface (*purple*) are parallel with a distance of smaller than the diameter of the surrounding tube to use less material. A blend was created between the sheet and the surrounding tube on this side.

The sheets are still trimmed using the surrounding curve, which means that the topside surface still cuts into the tube when it is tangent to the top center of the tube.

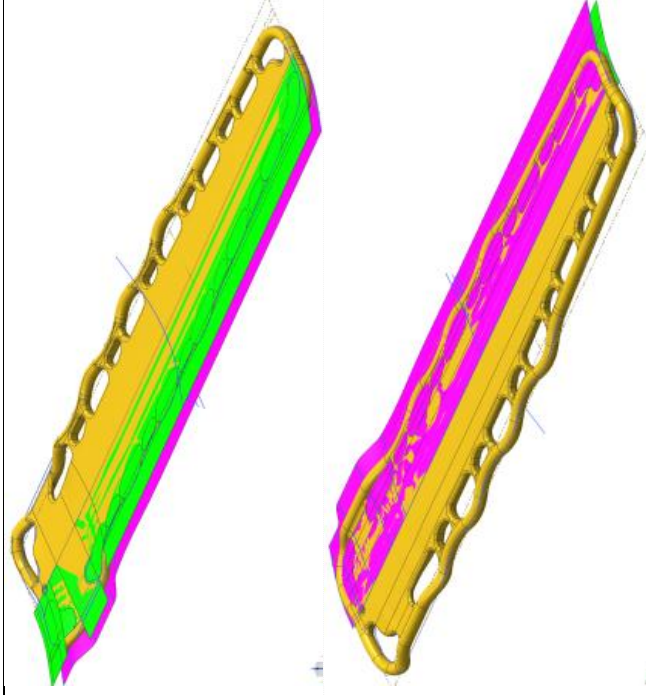

Version 07

perspective trimetric view:



Comments

Model structure // Problem areas

V06 with underside

longitudinal runners for ground support. The runners were made by extruding a sketch along a curve projected to the underside of the board. *Edge blend* was used on all intersecting lines between the runners and the underside surface.

Version 08

perspective trimetric view:

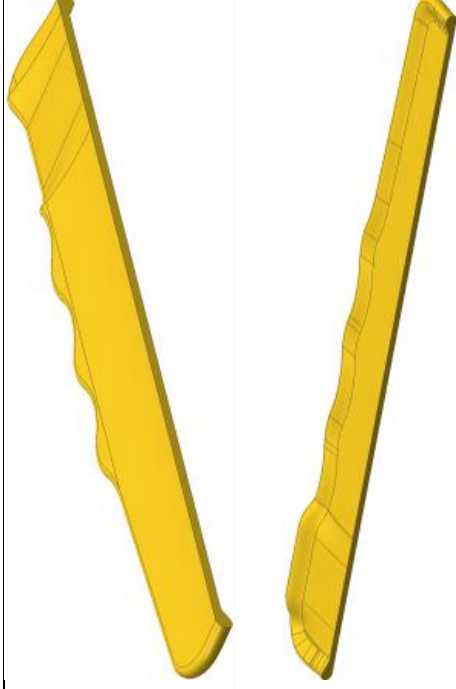
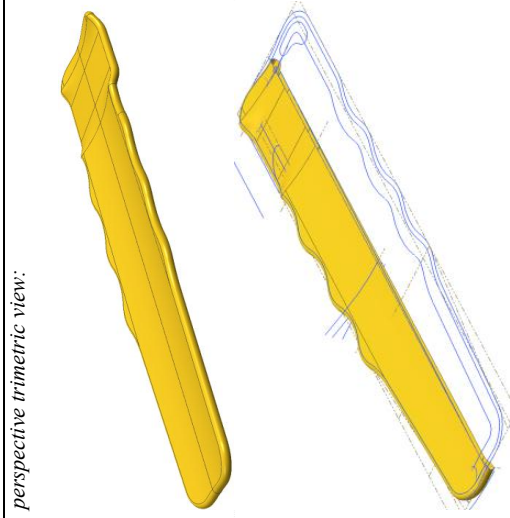

Comments

Model structure // Problem areas

Model created using sheets. All surfaces were constrained to be tangent to each other. In the symmetric split plane, they were constrained to be tangent to a horizontal plane.

Transition between surrounding tube and underside surface should be smoother, and the board should be thicker.

Version 09

perspective trimetric view:



Comments

Model structure // Problem areas

The sheet on the topside was created using both flat (*white*) and curved (*black*) sections. The underside sheet was changed and the surrounding tube was tapered.

Thickness of the board at the head is too thin, which makes radiuses on the side of the head area small.

Version 10

perspective trimetric view:

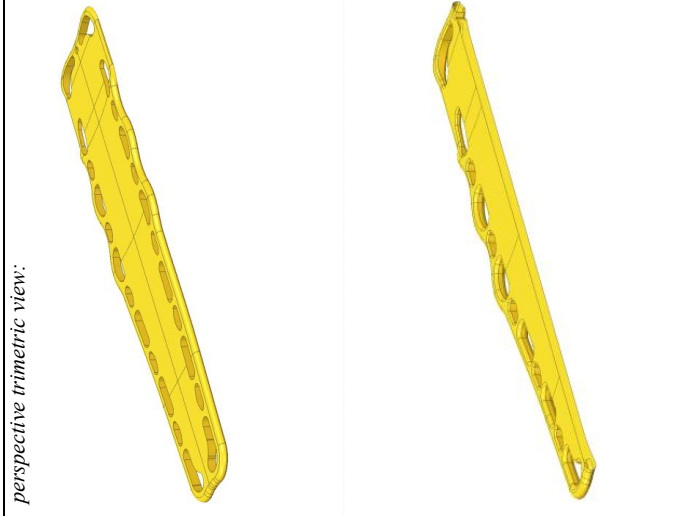

Comments

Model structure // Problem areas

V09 refined and all holes geometry was included and blended to the lying surface. The sheets were thickened to 2mm using *Thicken*.

The *Thicken* function can offset the sheet in both directions. In this case it was offset 2 mm outwards, making the board larger than it should be. The maximum length the sheet could be offset in the inward direction was 3 mm. The picture to the right shows the 3 mm offset in *blue*. The *red* shows that the sides of the head area are what constrains further inward offset of the surface.

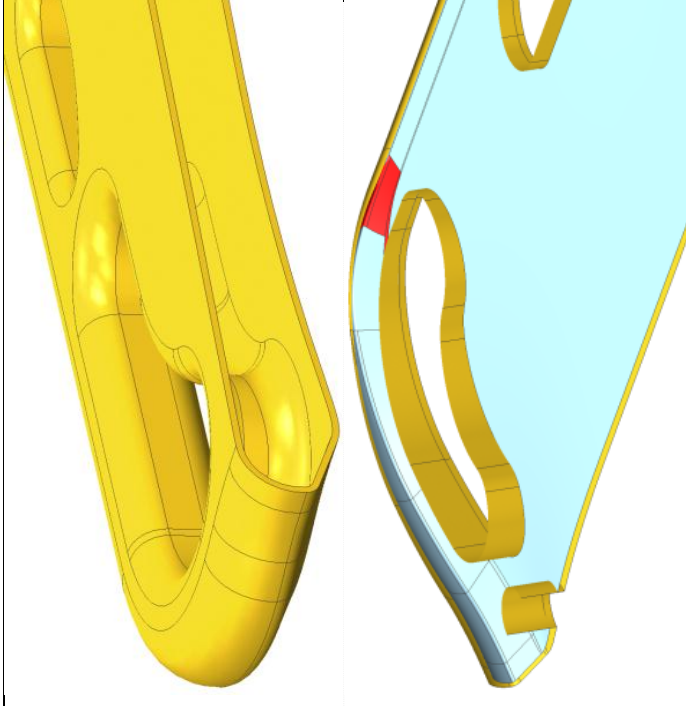

Version 11

perspective trimetric view:

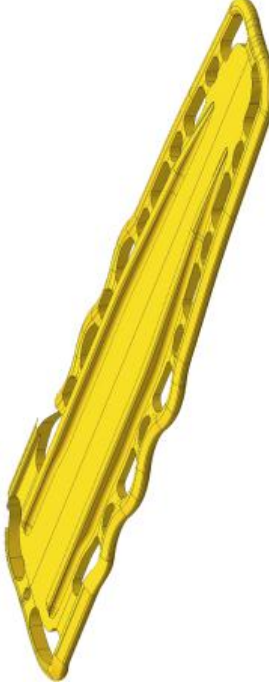
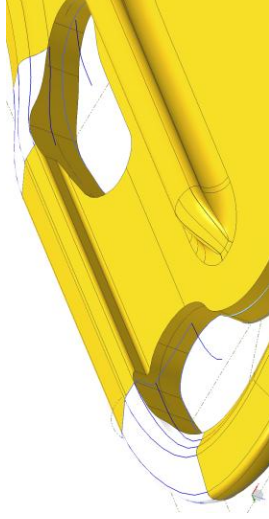
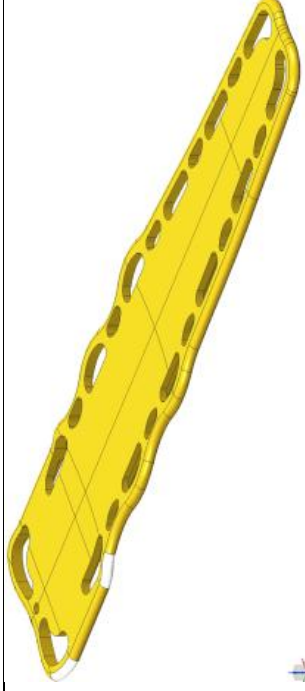
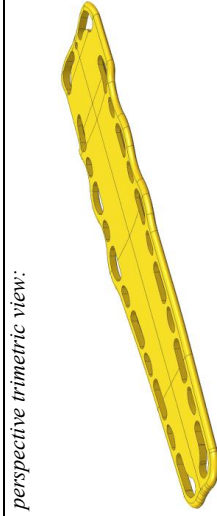

Comments

Model structure // Problem areas

Longitudinal runners were created with a smooth transition to the underside of the board on the foot end.

Adjustments were made to the underside geometry under the head area.

The *white* transitions were made using *Trough Curve Mesh* on several *Bridge*

Curves created by edges on the surrounding tube. The *Trough curve mesh* face was constrained to be tangent to all border faces.

All surfaces are tangent to each other, but this model is complex and includes some small radiuses under the head area. This makes it incompatible with the *Offset surface* and *Thicken* functions.

Version 12

perspective trimetric view:

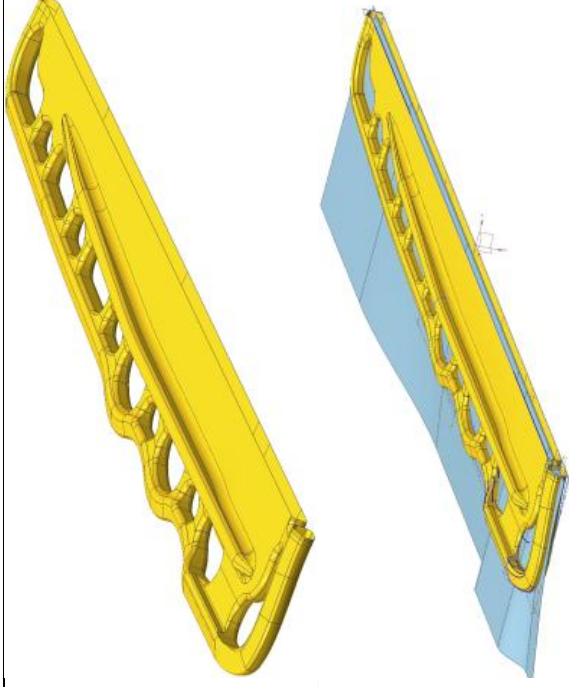
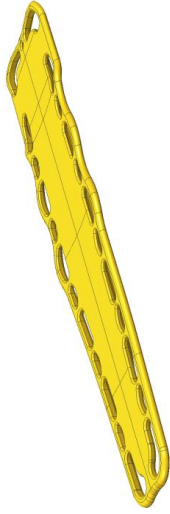

Comments

Model structure // Problem areas

Blending the V11 geometry was possible.

The *Face Pair Midsurface* feature was unsuccessfully used to attempt to create a split plane that created two parts with positive draft angles for injection molding.

Version 13

perspective trimetric view:

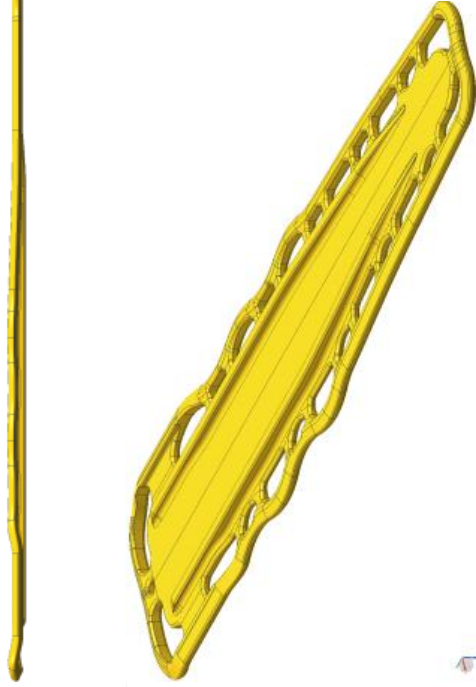
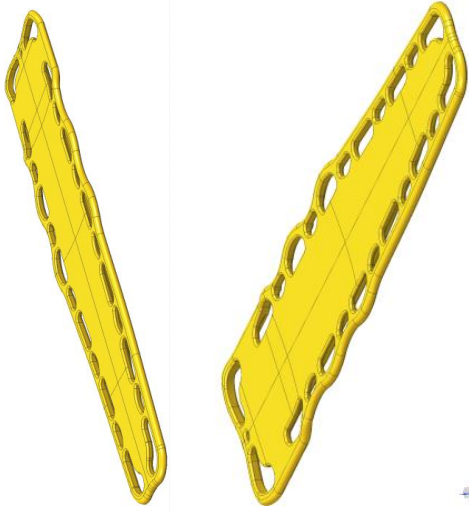

Comments

Model structure // Problem areas

This model was used to make the mock-up.

Version 14

perspective trimetric view:

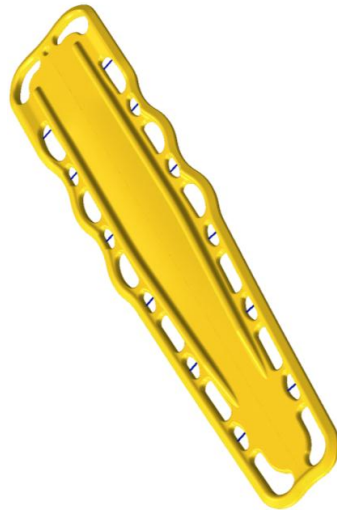

Comments

Model structure // Problem areas

Minimum value checked by increasing *Offset surface* until failure offset and choosing *Show failure data* (top right picture). Splines and *Trough Curves* were used to create the most complex faces with the correct continuity (bottom right figure).

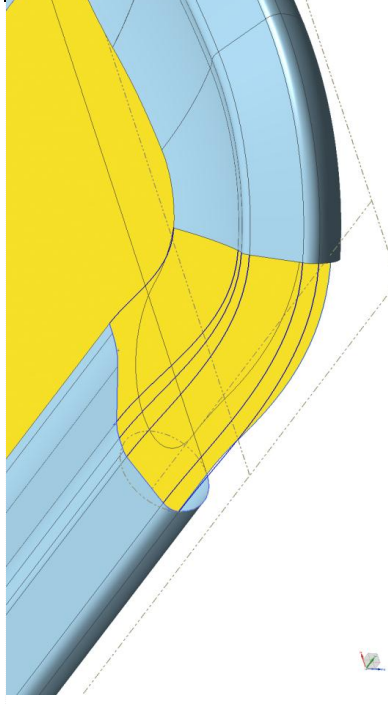
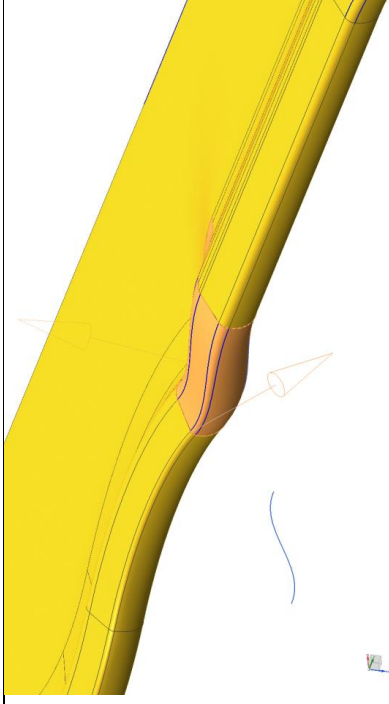

F Draft

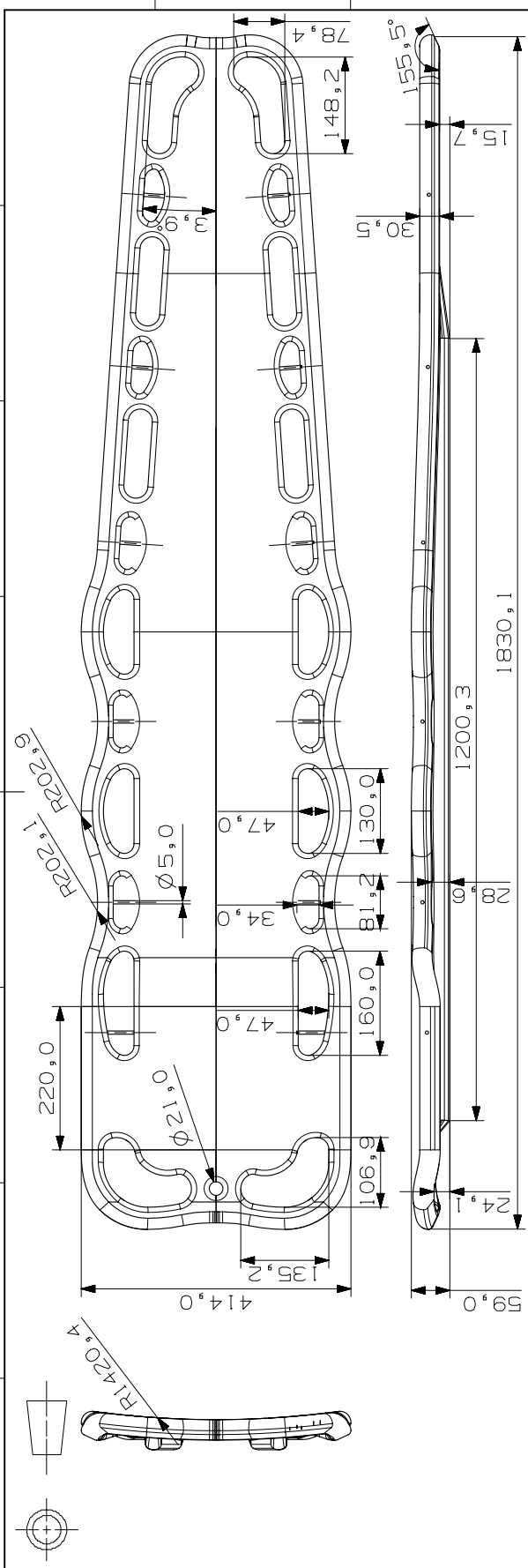

SIEMENS

TITLE		New Laerdal Spineboard	
FIRST ISSUED	2012		
DRAWN BY	ME		
CHECKED BY			
APPROVED BY			
SIZE/DWG NO.	A3	REV	14
SCALE	1:1	SHEET 2 OF 2	

3D CAD MASTER PART NAME: V14

ALL DIMENSIONS IN MM

1 2 3 4 5 6 7 8

G Project report: *Concept development of a new spineboard - a preliminary study*

Concept development of a new spineboard

- a preliminary study

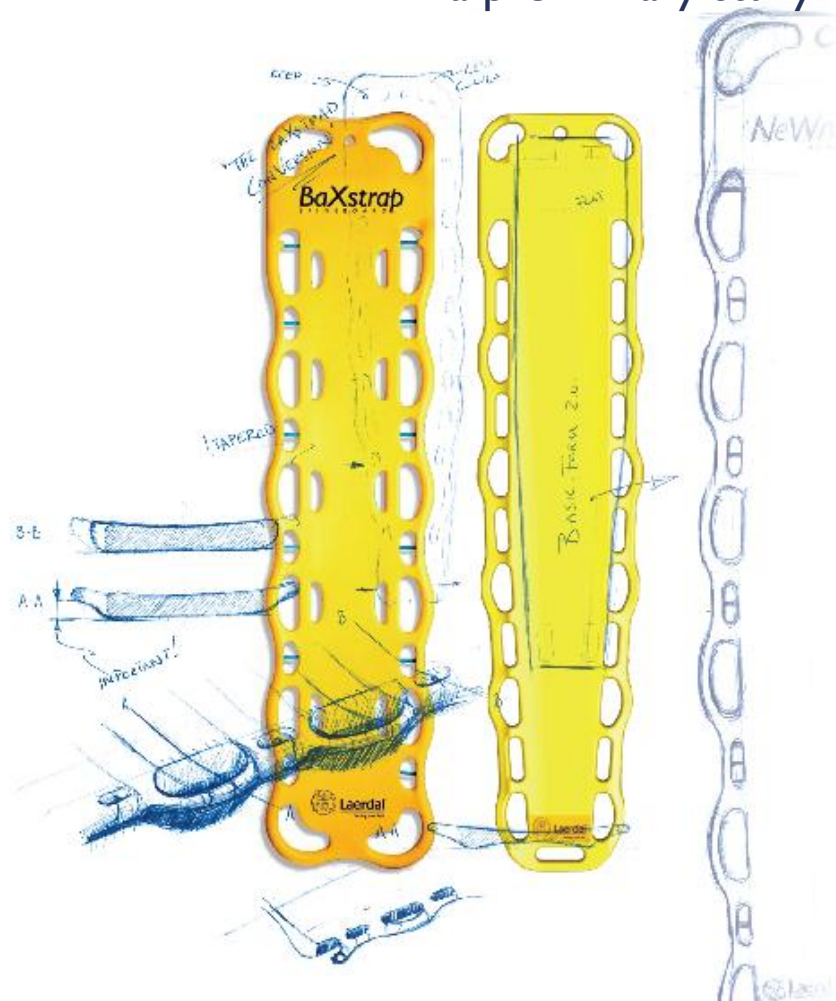

Preface

This 15 credit report is written in the course TMM4501 Engineering Design, Calculation and Manufacture, Specialization Project in the Fall of 2011. Parallel to the project, the course TMM4506 Engineering Design, Calculation and Manufacture, Specialization Course included the two 3.75 credit specialization courses TMM1 Product Architectural Modeling and TMM2 Product Simulation.

The work was conducted at the Department of Engineering Design and Materials, Faculty of Engineering Science and Technology, Norwegian University of Science and Technology.

I would like to thank Knut Aasland for his guidance on this report and the staff at Laerdal Medical for their invaluable feedback throughout this project.

Summary

This project is defined by NTNU in cooperation with Laerdal Medical. Laerdal Medical AS is a major manufacturer of medical equipment and training products based in Stavanger, Norway. Today their family of spinal products offer one spineboard. Due to an increasingly competitive world market (with special attention to the US market), Laerdal is looking for alternative manufacturing methods and design for a new spineboard.

This project report is a preliminary study to the development of a new spineboard. A spineboard (backboard, spinal board or long spinal board) is a long, flat and rigid board used for the immobilization and transportation of trauma patients. The review of relevant literature, patents and standards, market evaluation and user interviews form the basis for the proposal of a new spineboard concept.

The primary users for the spineboard are trauma victims, EMS personnel and radiographers. Since trauma patients can be anywhere and in any condition, the spineboard must be flexible in terms of functioning in a wide range of environments. The typical use for spineboards is to log roll and slide a patient onto the board with neck support and strapping the patient to the spineboard.

The biggest challenges that spineboards in general face is the extensive discomfort of the rigid lying area and the compromise of x-ray imaging quality. In addition, they must strive to become lighter and cheaper in order to stay competitive.

Laerdal's existing spineboard holds a 5% world market share and is among the stiffest on the market, but its main disadvantage is its cost. A lot of spineboards offer special features in addition to the minimum of requirements. These features compromise the optimization of cost, stiffness or weight and must be extensively evaluated against production cost and market in order to be included.

Manufacturing the new spineboard as two injection molded parts joined together by hot plate welding is a feasible new concept that has the advantages of a large selection of materials (including short fiber reinforced plastic), low cycle times and low demand for manual labor. Although it is considered to be a low risk, the possibility of conflict with the manufacturing process of US patent 7303705 should be reviewed.

The new design for the spineboard should continue the large, elevated handholds and curvy design of Laerdal's existing spineboard, have a tapered foot end and a curved lying area. There is not enough foundation in this report to decide on removing the child slots

from the spineboard to better x-ray diagnostics. This should only be done on the basis of significant market research.

The recommendation for further work in the master's thesis that follows in the Spring of 2012 is to evaluate the three way trade-off between the stiffness, weight and production cost of the new spineboard through CAE. Based on this, computerized testing and detailed should be conducted.

NORGES TEKNISK-
NATURVITENSKAPELIGE UNIVERSITET
INSTITUTT FOR PRODUKTUTVIKLING
OG MATERIALER

PROSJEKTOPPGAVE HØSTEN 2011 FOR STUD.TECHN. MARIANN ERVIK

KONSEPTUTVIKLING AV SPINEBOARD

Laerdal Medical er et av Norges ledende firmaer innenfor medisinsk-tekniske produkter. De er særlig kjent for sine "Anne-dokker", treningsdokker for hjerte-lunge-redning, men har også mange andre produkter både rettet mot trening og mot behandling og håndtering av pasienter.

Et spineboard er et medisinsk produkt som skal støtte opp, immobilisere og transportere pasienter med mulige skader på nakke og rygg.

Laerdal har et slikt produkt i dag. Dette er imidlertid et produkt som møter hard konkurranse fra andre aktører over hele verden og prisene er presset, spesielt i USA, der markedet også er størst. Det stilles strenge krav til spesifikasjoner og utforming siden dette er et medisinsk produkt. De fleste brett på markedet er produsert med et rotasjonsstøpt skall og en skumfylt kjerne med langsliggende avstivere. Både avstivere og produksjonsmetode har høy kostnad og det er derfor ønskelig å se på konsepter for et nytt brett med bruk av andre (billigere) materialer og en enklere produksjonsprosess (sprøyttestøping er et hett alternativ).

Når Laerdal skal utvikle et nytt produkt, står forenkling og kostnadsreduksjon i fokus.

I denne oppgaven skal kandidaten finne fram til et nytt konsept for spineboard. Det skal søkes etter alternative løsninger, som gjerne kan være helt annerledes enn det som fins i dag.

I oppgave skal kandidaten:

- dokumentere brukerkrav/markedskrav til et spineboard
- generere alternative konsepter
- evaluere konseptene mot bruker- og markedskravene
- velge ett konsept som det anbefales å gå videre med – dette må gjøres i samråd med Laerdal
- utvikle en produktkravspesifikasjon for det endelige produktet
- i den grad tida tillater det: lage en 3D-modell av konseptet som kan brukes til dimensjonering og materialvalg

Hvis oppgaven gir et godt resultat, kan den videreføres i masteroppgave.

I tillegg til prosjektrapporten, skal det leveres en PU-journal i instituttets A3-format.

Ved bedømmelsen legges det vekt på at problemstillingen presenteres klart, at besvarelsen er skikkelig gjennomarbeidet og at kandidaten gir en selvstendig framstilling av stoffet med egne vurderinger, der også de egne bidragene i samarbeidsprosjektet gjøres rede for.

Besvarelsen skal ha med oppgavetekst og skal forsynes med innholdsfortegnelse. I forord skal det stå hvilke fordypningsemner kandidaten tar. Rapporten innledes med en klar formulering av problemstillinger bearbeidet i prosjektet, et sammendrag av viktige resultater, og konklusjoner. Rapporten skal være på maksimum 30 sider, inklusive skisser innarbeidet i tekst. Eventuelle tabeller, tegninger, detaljerte skisser, fotografier, med videre, kan medtas i et bilag som regnes i tillegg til de 30 sider. I besvarelsen henvises til de respektive steder i vedleggene, men besvarelsen skal skrives slik at den kan leses uten vedlegg.

Figurer og tabeller skal inneholde alle nødvendige påskrifter. Litteraturhenvisninger skal være fullstendige med angivelse av forfatter, bok (artikkel), tittel, forlag, årstall og sidenummer. Henvisninger foretas ved nummer i teksten og dette refererer til en nummerert litteraturliste bak i rapporten.

Tre (3) uker etter utlevering av prosjektoppgaven innleverer kandidaten et A3-ark med tekst og bilder som beskriver hva oppgaven går ut på (en papirversjon og et elektronisk eksemplar i pdf-format). Mal for arket finnes på instituttets hjemmeside under menyen undervisning.

Senest 3 uker før innlevering av prosjektoppgaven skal kandidaten innlevere et A3 ark som illustrerer resultatet av arbeidet (en papirversjon og et elektronisk eksemplar).

Prosjektarbeidene presenteres som muntlige foredrag 21.oktober 2011. Det er obligatorisk frammøte for alle prosjektkandidater under foredragene.

Innleveringsfrist for prosjektbesvarelsen er 21.desember 2011. Besvarelsen leveres i to papirversjoner og elektronisk på CD eller DVD.

Kontaktpersoner hos Laerdal Medical AS: Jan Vastvedt



Knut Aasland
Faglærer



NTNU
Norges teknisk-
naturvitenskapelige universitet
Institutt for produktutvikling
og materialer

Contents

1	Introduction	1
1.1	Background	1
1.2	Objectives	1
1.3	Definitions	3
2	Project framework and planning	5
2.1	Process	5
2.2	Method	6
2.3	Vision and planning	7
3	Use of spineboards	10
3.1	Users	10
3.1.1	Rescue personnel	10
3.1.2	Radiographers	11
3.1.3	Patients	12
3.2	Use situations	12
3.3	Method of use	12
4	Review of literature and intellectual property	15
4.1	Advantages and disadvantages of spinal immobilization	15
4.2	Patient comfort	16
4.3	Early removal of spineboards	16
4.4	Translucency of spineboards	18
4.5	Intellectual property	19
4.5.1	Overview of patents	19
4.5.2	Existing patented knowledge	20
5	Formal requirements	23
5.1	Use characteristics	23
5.2	Technical	24
6	Market	26
6.1	BaXstrap spineboard - curved and strong	26
6.2	Competitors	27
6.2.1	World markets, different solutions	27
6.2.2	US Competitors	28

7	Concept study	31
7.1	Available technology	31
7.2	Classification tree	33
7.3	Concept combination table	33
7.4	Evaluation	35
8	Evaluation of an injection molded spineboard	39
8.1	Product specification	39
8.2	Quality function deployment	39
8.2.1	QFD overview	41
8.2.2	Evaluation of new concept trough QFD - input	41
8.2.3	Evaluation of new concept trough QFD - results	43
8.3	Design platform	44
9	Conclusion/further work	47
A	CAD models	51
B	Competitor matrices	53

1 Introduction

1.1 Background

Laerdal Medical (hereafter Laerdal) is a major manufacturer of medical equipment and medical training products based in Stavanger, Norway. The company was founded as a print shop by Aasmund Sigurd Laerdal in 1940. After producing soft plastic toys in the early 50s, it expanded into manufacturing of realistic wound simulations and medical training products.

Today Laerdal has sales operations in 23 countries and manufacturing and R&D operation units in four different locations with a total of 1400 employees. They offer products for CPR training, airway management, life support training, spinal motion restriction, trauma training, monitoring, defibrillation and patient simulation.

The spinal motion restriction (or immobilization) category consists of extrication collars, three different head immobilizers and one spineboard that can be combined with a pediatric pad, see Figure 1.

In general terms, spineboards are typically rectangular boards on which injured individuals are placed. The intention of a spineboard is to provide a means of support, immobilization and transportation of a patient following the event of an emergency situation where spinal cord injuries are known or suspected [1]. The great utility of the spineboard has led to it becoming one of the standard pieces of equipment typically found in an ambulance (where the scarcity of space permits only the most useful pieces of equipment).

1.2 Objectives

The company wants to find an alternative production method and design for a spineboard that can increase the overall gross margin for Laerdal spineboards.

This project should review customer needs and demands in the market to generate alternative concepts for a new spineboard. The new concepts should be measured against these requirements and wishes to eliminate all but one final concept. The result should be a product specification of the new concept.

A further scope of this project is to develop a CAD model that can be used for defining design and materials.



Spineboards
 BaXstrap® Spineboard
 Laerdal® Pedi-Pad Spineboard Pad

Extrication collars
 Stifneck® Select™ Collars - Adult and Paediatric
 Stifneck® Extrication Collars

Head immobilizers
 Sta-Blok™ Head Immobilizer
 SpeedBlocks® Head Immobilizer
 HeadBed® II Head Immobilization Device
 PadPack™ Alignment Pads

Figure 1: Laerdal Medical's spinal products [2]

1.3 Definitions

Buckle straps Inexpensive reusable straps for securing the patient to the spineboard. Typically made from plastic or fabric. Can be applied by single paramedic. (Other strapping devices are webbing and spider straps.)

Cervical collar A head and neck stabilizer that stabilizes the top seven vertebrae, C1 through C7. Can be rigid or adjustable and are typically made from plastic with foam padding. If the devices have not been subjected to severe body fluids contamination, many collars can be disinfected and re-used.

Head blocks Head immobilization devices that are placed beside the patient's head and secured to the spineboard at the same time as the patient. Made from plastic wrapped foam, soft foam, hard styrofoam, paper or cloth. Inexpensive head block made from soft foam can not be reused if contaminated with body fluids. Paper head blocks can not be disinfected or used in rain or snow.

Head restraint systems Secured to the spineboard before securing the patient on it. Made from plastic wrapped foam blocks, vinyl foam blocks or cardboard and adhered to the spineboard by tape, adhesive or Velcro. Except for single use cardboard head immobilizers, these systems can be disinfected and reused, but are expensive.

Immobilization To make immobile or immovable. Prevent, restrict or reduce normal movement in the body, limbs or joints. In the case of spinal injuries, immobilization is done to prevent further

injuries during transportation of the patient.

Scoop stretcher A type of backboard that is used when you are not able to log roll the patient. May be aluminium or plastic. Blades are fixed to a tubular structure, the two parts are put on each side of the casualty and then clipped together. Length adjustable.

Short vest device A device usually used to extricate patients from automobiles or to immobilize children. Typically made from vinyl and fabric with fabric straps. Used in conjunction with a cervical collar.

Spider straps Single piece reusable construction with Velcro straps for securing patient on spineboard. Can be applied by single paramedic. Can be expensive. (Other strapping devices are buckle straps and webbing)

Spinal board (Spineboard, long spinal board or backboard) A long, flat and rigid board used for the immobilization and transportation of patients with suspected spinal injuries. Backboards is also used as a designation for a firm surface for CPR.

Spinal cord injury (SCI) Injury caused to the spinal cord (tubular nervous tissue and support cells that extends from the brain) that is caused by trauma. The symptoms can vary from pain to paralysis to incontinence.

Stretcher A litter, often made from canvas stretched on a frame and used for carrying the sick, wounded or dead. Can also be on wheels, adapted for use in ambulances and hospitals.

Trauma A serious or critical bodily injury, wound, or shock produced by a sudden physical injury.

Vacuum mattress (Vacmat) A sealed polymer bag (larger than an adult human body) enclosed with small polystyrene balls. When under pressure, the balls are free and the mattress can be moulded. When the air is pumped out of the mattress, the balls are pressed together and the ma-

tress becomes rigid.

Vacuum splints Smaller versions of the full body vacuum mattress that can fix parts of the body.

Webbing A single reusable long fabric strap that is laced across the patient to secure them to a spineboard. Can be applied by single paramedic, but is best applied by two. (Other strapping devices are buckle straps and spider straps.)

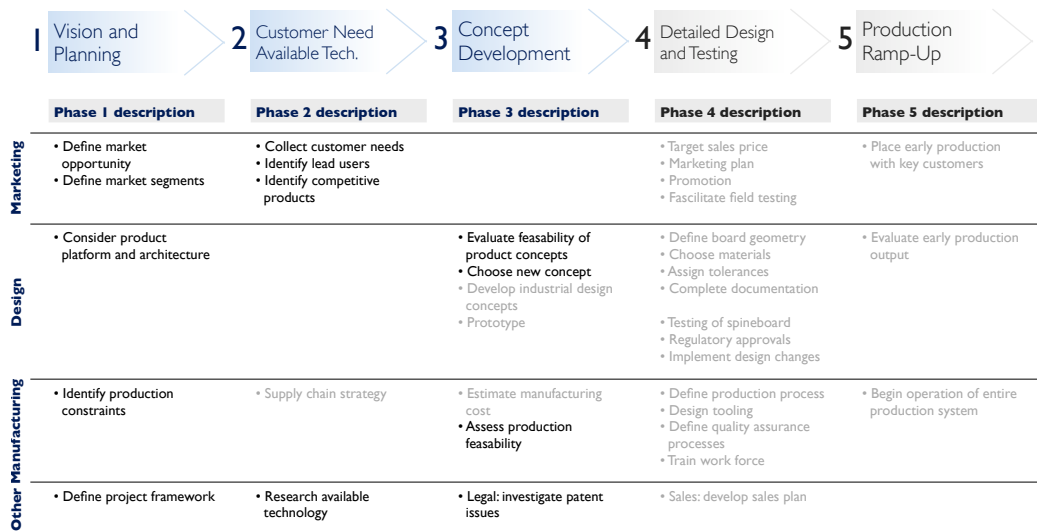

Figure 2: An alteration of a generic product development process

2 Project framework and planning

This section includes an overview of the methodology and a project plan including the three first stages of generic product development process. The first stage (planning) is discussed in section 2.3.

2.1 Process

The content of this project report follows the IPM (Dept. of Engineering Designs and Materials) development process. It has been altered to fit the objectives of the current project using a generic development process from Ashby and Johnson's *Materials and Design* [3].

This project is limited to the three first stages of the model (1 vision and planning, 2 customers, competitors and literature review and 3 concept development). The process of extensive industrial design and building experimental prototypes for testing is excluded due to the short time span of the project and therefore marked with grey like the two last stages leading up to production.

2.2 Method

The overall concept study was conducted by creating a five-step concept generation method as illustrated in Figure 3. Although the method is presented as a numbered sequence, concept generation will always be an iterative process [3].

The method was initiated with getting an understanding of the problem. This was done in cooperation with Laerdal and is summed up in a mission statement in Section 2.3. In addition to defining the basis for the project, this first step has undergone continuous improvement through out the project.

The second and third step were to conduct a search for solutions externally and internally. External search consisted of searching published literature and patents, talking to experts of materials and production processes at the Norwegian University of Science and Technology, reviewing competitors and interviewing lead users of the spineboard. Local interviews with users were set up in Trondheim, Norway. They included the staff of Vinjes Ambulance Service and two radiologists at St. Olavs Hospital. E-mails were sent to various ambulance services in Norway and a visit to the St. Olavs Hospital emergency room was made. The information obtained through user interviews is used to support the identification of the users and use method in Section 3. A review of the literature¹ is given in Section 4

A patent search was carried out to gain technical knowledge on existing solutions for spineboards and devices related to spineboards. A "side-effect" of this is the knowledge of what concepts are already protected and must be avoided (or licensed). An overview of the patent search is described in section 4.5.1.

Standards that could be applicable to spineboards were reviewed. All requirements that were found to be important for developing a new concept are summed up in section 5.

Section 6 gives an overview of the advantages of Laerdal's existing spineboard and a review of other spineboards on the market.

The two final steps of the concept generation method includes systematical exploring and reflecting over the new concepts. Step 4 uses product development tools such as a

¹The literature search was carried out using the PubMed and MEDLINE databases with the keywords: 'spineboard', 'long "spine OR spinal" board', 'backboard', 'spinal immobilization', 'pre hospital immobilization' and 'cervical immobilization'. The search was limited to articles published during the last 10 years.

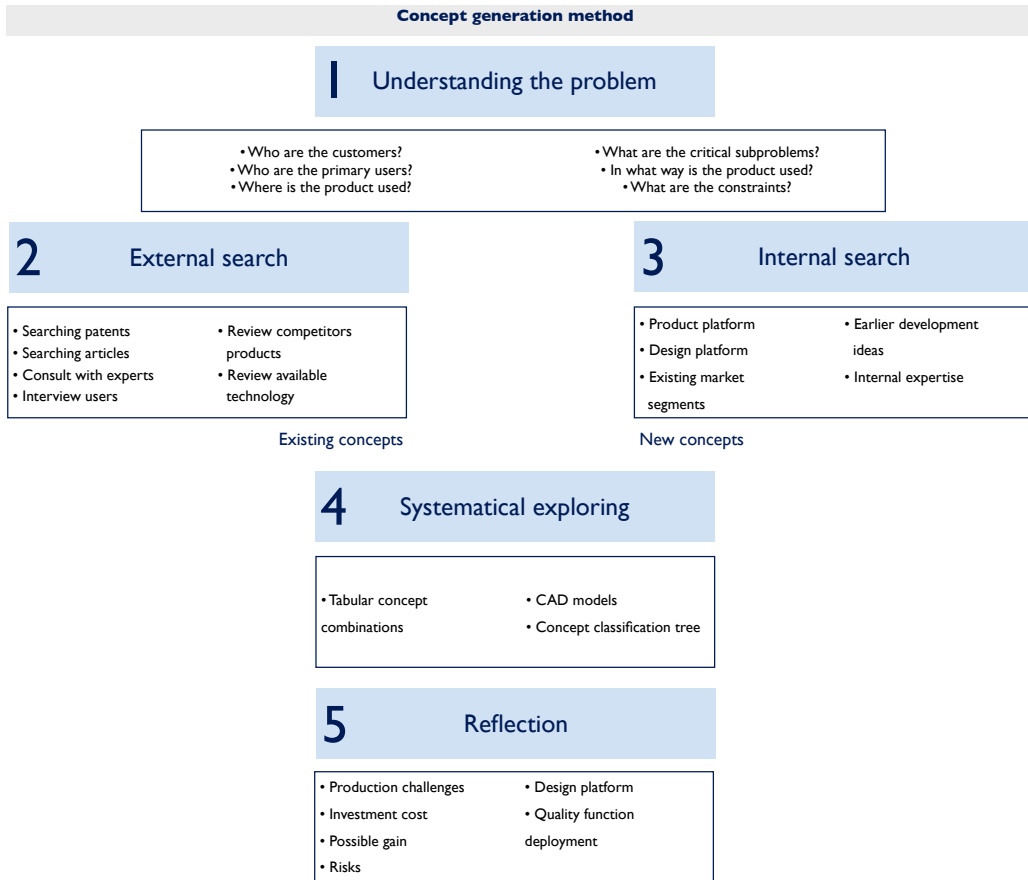

Figure 3: Method

concept classification tree and a concept combination tree in Section 7. Step 5 is given as a discussion in Section 8.

2.3 Vision and planning

The market opportunity is formed by Laerdal’s strategic marketing operations. With special attention to the US market, there is a need for a cheap spineboard that is sufficiently rigid and at the same time considers updated customer needs and demands.

Figure 1 in the introduction gives an overview of the Laerdal spinal product family. There are three alternatives strategies to choose when developing a new Laerdal spineboard.

1. Alter materials for the existing spineboard to obtain lower production costs.

2. Develop a new board as an expansion to the product family and increase market shares by expanding the product portfolio.
3. Develop a new board to phase out the existing spineboard.

This project report considers how we can choose a concept for developing *a new spineboard*. It is assumed that the new spineboard is developed in addition to the existing one, as the possibility of withdrawing the existing spineboard from some or all markets is a decision that must be based on extensive market and economic analysis.

Legal agreements between Laerdal and the current manufacturing company defines the constraint of choosing a new production method for the new concept.

The vision forms a basis for this concept study and is summed up in the mission statement in Figure 4.

Mission Statement: Spineboard	
Product Description	<ul style="list-style-type: none"> • A flat board on which injured victims are placed that has the intention of providing a means of support, immobilization and transport
Key Business Goals	<ul style="list-style-type: none"> • Expand spinal product family with one spineboard • 50% gross margin for second spineboard • Payback time 1 year
Primary Market	<ul style="list-style-type: none"> • Emergency medical transport equipment
Secondary Markets	<ul style="list-style-type: none"> • Other rescue institutions • Hospital, radiology
Assumptions and Constraints	<ul style="list-style-type: none"> • New method of manufacturing • Use existing design platform • Second product offers low end price
Stakeholders	<ul style="list-style-type: none"> • Purchasing • Marketing and sales • Manufacturing • Legal department • Maintenance (users) • Recycling

Figure 4: Mission statement

3 Use of spineboards

This section gives a description of the primary users of the spineboard, an overview of the use of the product in different environments and a storyboard of the typical use of the spineboard.

3.1 Users

An overview of stakeholders and users (here defined by the people who handle the product daily), in specific, is given in Figure 5. The users are described in greater detail in this section.

3.1.1 Rescue personnel

This user group are all people who handle the spineboard in a medical emergency situation. Emergency medical service (hereafter EMS) include all personnel trained in the rescue, stabilization and advanced treatment of traumatic or medical emergencies (i.e. first aid squads, ambulance service and fire department personnel).

These trained professionals are experts in improvisation and prioritizing. A typical method of use is described in Section 3.3, but rescue personnel will do what is necessary based on the number of people at the scenery and what equipment they have available. Some towels and duct tape might serve the purpose of a head immobilizer and strapping systems.

This user group is also concerned with the handling of the spineboard. They must log roll, grip, lift and carry it so the design must fit all these purposes. Carrying the standard spineboard requires two EMS providers.

In addition to using the spineboard in emergency situations, EMS providers are also responsible for maintaining the product. It requires cleaning and, if infected with body fluids, disinfection. In their daily work life, maintenance of equipment should be as efficient as possible. For the spineboard this means that it must withstand cleaning with regular cleaning products (soap, bleach) and be designed with no small radiuses or corners that makes it harder to clean in any way.

The spineboards must fit in the storage compartments of the transportation units and must be able to store. When EMS leaves a patient on a spineboard in the hospital, they must



Figure 5: Stakeholders of the spineboard



Figure 6: Spineboards are subjected to various environments

swap spineboards with the hospital or in another way make sure that the ambulance is fully operable.

3.1.2 Radiographers

Often the radiographer is called to the emergency department to take high quality diagnostic radiographs while the trauma team administers care to a critically injured patient. A portable x-ray machine in the emergency room is used to image the chest or pelvis region. These images are sometimes taken with the patient on the spineboard. The radiographer is under great pressure to perform because the radiograph should be done quickly and be of good quality on the first attempt. Imaging the patient on a spineboard sets an even higher standard for the radiographer because of the increase in object-to-image distance (which can cause some clipping of the anatomy) and imaging artifacts caused by the spineboard itself.

There is a varying protocol in different hospitals of whether or not to remove the patient from the spineboard onto a hospital stretcher upon immediate arrival at the emergency room. Although more hospitals are concluding that it is safe to remove patients from the spineboard prior to the initial radiographic imaging [4], it is difficult to conclude that this is a tendency and not a trend. In some complex cases it is absolutely necessary to keep the patient immobilized until x-rays (or MRI and CT scans) are performed. For this reason it is important to include the radiographer as one of the key users of the product.

3.1.3 Patients

Immobilized patients are victims of trauma where possible injuries to the spinal cord can not be excluded. The reason for immobilizing these patients is to prevent further injuries during transport to an emergency department.

For this user group, the priorities of the EMS providers is everything. Patients can resist being immobilized, but in practice, they have little choice in the methods of use during emergency rescue.

These users might be conscient or unconscious and might be suffering severe stress or shock. In short, they may be found anywhere and be in any condition.

Being immobilized on a spineboard is uncomfortable and can be painful, only after minutes on the spineboard and there is a risk for pressure sores if the patient is left on the spineboard too long (hours) [5]. This pain from the firm lying area may be confused with the pain of their injury and strapping systems on spineboards can make it harder to breath.

3.2 Use situations

Spineboards are most commonly found as standard equipment in emergency transportation all over the world. Figure 6 shows the wide range of environments that the spineboard can be exposed to. Because a person can suffer spinal injuries everywhere, the spineboard can be subjected to a wide range of temperatures, hard impacts in rough terrain (and elsewhere), wet and cold environment in water and mountain rescue, body fluids and space saving compartments in emergency transportation vehicles.

3.3 Method of use

Spineboards are being used to immobilize all patients with a potential spinal injury to prevent further damage to the patient. The meaning of this is explained in this section.

Guidelines will vary slightly between different emergency institutions, but the typical use situation for the spineboard can be verified using US guidelines for spinal stabilization during emergency transport and early in-hospital immobilization following spinal cord injury (provided by National Guideline Clearinghouse www.guideline.gov).

It should be noted that this is not a complete description of how to immobilize a patient, but a summary that focuses on the use of spineboards. This typical example on method of use follows the illustration in Figure 7.

There are five criterias that EMS providers should look for to determine the potential risk of spinal injury: altered mental status, evidence of intoxication, suspected extremity fracture or distracting injury, focal neurological deficit and spinal pain or tenderness.

The first step for immobilizing a patient, is to stabilize the head and neck (1). A neck collar is secured to the patient (2) before the patient is transferred onto a spineboard. This usually happens using the log rolling technique (3,4) and then sliding the patient upwards into the right position on the spineboard. Dependent on the size of the patient, immobilization might require additional padding under the head or back since the relative head size varies with age (see Figure 8). Strapping is applied to the upper half of the patients body (5) before a head immobilizer is secured to the patient and spineboard. This can be done by using head immobilizers that are secured to the spineboard prior to the patient or by using head blocks that are secured to the patient and spineboard using adhesive tape (6). Finally, the strapping is completed and hands are secured. Additional padding is applied during the securing of the straps, e.g. between the feet. Additional adhesive tape may be used to secure the feet of the patient (7).

This is usually the procedure for immobilizing patients where transportation time is relatively short and there is no risk of hypothermia. But all means of immobilization will in reality depend on the number of rescuers and immobilization equipment available.

Guidelines also state that in the emergency department, the patient should be transferred from the spineboard onto a firm padded surface as soon as possible while maintaining spinal alignment. If spinal or spinal cord injury is confirmed, the spine immobilization should be maintained until definitive treatment. If prolonged immobilization on a spineboard is anticipated, measures to prevent skin breakdown should be initiated.

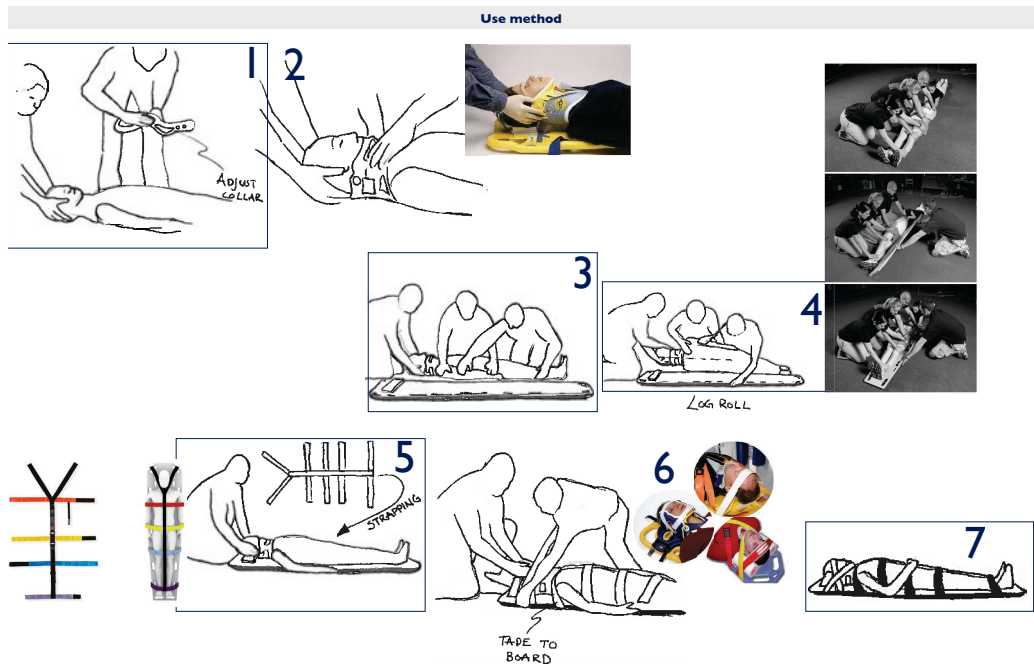

Figure 7: A typical use method of the spineboard.

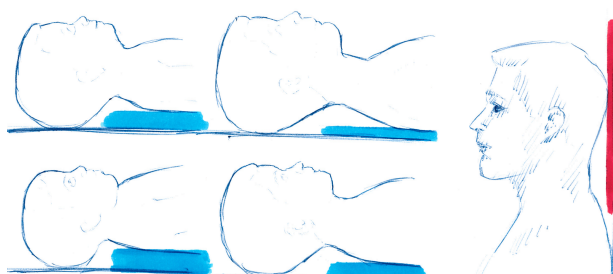

Figure 8: As humans grow, their heads become smaller relative to their bodies (adapted from the American Academy of Orthotists & Prosthetits [6])

4 Review of literature and intellectual property

Available literature discusses the advantages and disadvantages of immobilization and provides a critical view of the current immobilization protocol. Full body immobilization is done to patients with a suspected spinal injury to prevent further damage. The consequences of immobilization is discomfort, pain, pressure sores, restricted respiratory function, time consume and reduced x-ray image quality.

This section reviews some relevant issues in current reasearch of spineboard related topics.

4.1 Advantages and disadvantages of spinal immobilization

Full body spinal immobilization is initiated in all cases² where there the patient has a suspected injury to the spinal cord since these injuries might be life threatening. With this criteria, many patients will have been immobilized without having suffered damage to the spinal cord. It is, however, extremely difficult to prove that the current protocol of full body immobilization is necessary to its full extent. One way to study this is to review patients with spinal fractures who were *not* immobilized before diagnosed.

Davis et al. identified 34 patients with delayed diagnosis out of a selection of 740. 10 of these developed permanent neurological damage [7]. Platzer et al. found a delayed diagnosis in 18 of 347 patients with cervical injuries where 2 of these developed a permanent deficit [8]. If one assumes that 2.3% of trauma patients have cervical injuries [7] and that the same rate of deterioration would have occurred if all patients were left unprotected, the number of patients to immobilize to prevent one incident of permanent neurological damage is 150 and 392, respectively [9].

On the other hand, neurological deterioration in spinal cord injured patients with good immobilization of the spine must be considered. If mechanical injury is excluded, there are well-established mechanisms for spinal injury progression including haematoma, cord oedema, hypotension, inflammation and vascular changes such as reduced microcirculation [9].

Spinal immobilization restricts respiratory function and increases the risk of aspiration.

²More severe life threatening injuries where time-to-hospital is of the importance will not allow for full body spinal immobilization, but these cases are complex and the priorities are decided on by the EMS providers.

Totten et al. demonstrated that immobilization with a collar and backboard or vacuum mattress restricted measures of respiratory function by on average 15% [10].

The risks of prolonged immobilization on a spineboard are pressure sores and neurological damage due to restlessness in patient with spinal fractures [5].

4.2 Patient comfort

Kosashvili et al. [11] studied the biomechanical properties of immobilization on a standard spineboard with other rigid immobilization surfaces using computers to generate a diagram indicating pressure distribution and surface contact area for 12 volunteers.

The results include the comparison between the pressure distribution on a rigid aluminium backboard (1), aluminium backboard + blanket (2) and aluminium backboard + layer of foam (3). An outtake from the article is reproduced in Figure 9.

The backboard's median surface contact area was doubled when covering it by a standard military blanket and tripled when covered by a 3 cm layer of foam. Using a 5 cm layer of foam increased the surface contact area by 11 times.

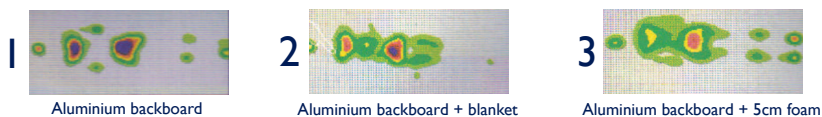

Figure 9: Pressure distribution of various lying areas from the Journal of Trauma (2009)

4.3 Early removal of spineboards

A retrospective study from 2005 raises the question *Is there a reason for spine board immobilization in the emergency department for patients with a potential spinal injury?* [12] The study analyzed the neurologic outcome in in trauma patients with spinal fractures where 107 patients were left on the board for primary survey and 90 patients who were removed from the spineboard upon immediate arrival at the hospital. The study concluded that there was no difference between the two groups of patients.

An interview done with the staff of the emergency department staff at St. Olavs Hospital in Trondheim, Norway on Sept. 14, 2011 [13] revealed that the spineboard is almost without exception removed immediately upon arrival. One case like this could indicate

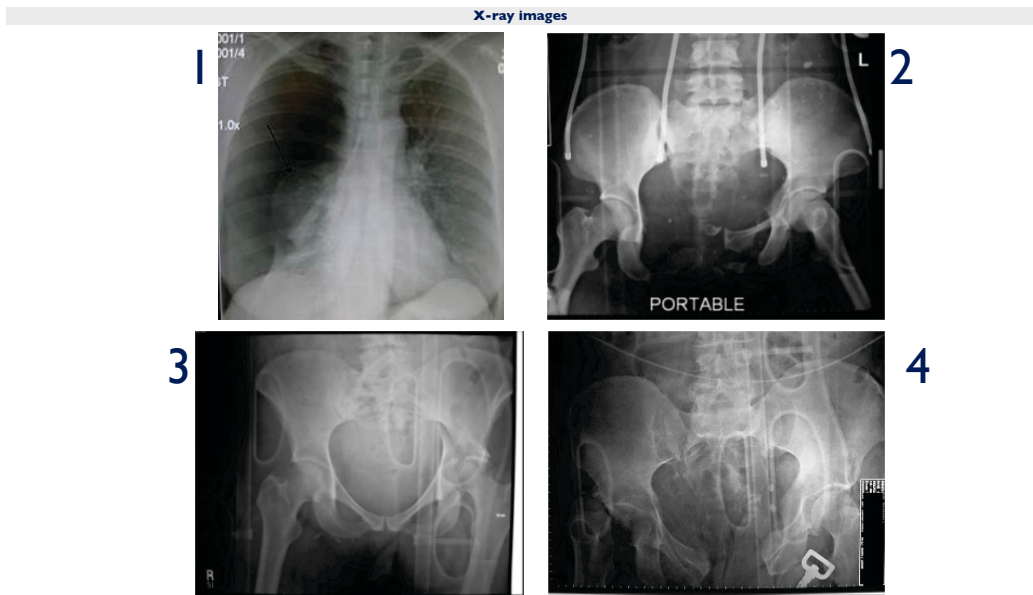

Figure 10: Examples of x-ray images of patients on spineboards (Article 26, www.ceessentials.net [15])

that this may also be the standard procedure at other hospitals as well. A review published in 2003 and a follow up audit published in 2008 on current spinal board usage in emergency departments across the UK gives a more nuanced view of the issue.

The initial examination was done in 2002 with 84 responders. The result was 4.5% of hospitals removed the spinal board immediately on arrival of the patient in the department; 47.5% of hospitals removed the spinal board following clearance of the lumbar and thoracic spine by a senior clinician after log roll; 43% of hospitals routinely kept patients on spinal boards until all relevant radiology investigations had been performed [14].

In 2006, 100 accident and emergency departments who responded to a follow up survey. 21% of hospitals removed the spinal board immediately on arrival in the department; 58% of hospitals removed the spinal board following clearance of the lumbar and thoracic spine by a senior clinician; 21% of hospitals routinely kept patients on spinal boards until all relevant radiology investigations had been performed [4].

4.4 Translucency of spineboards

Images 2, 3 and 4 in Figure 10 are included to give some examples of what radiographs of patients on spineboards look like. It is extremely important that images for trauma in the emergency room result in the best radiograph on the first attempt. The larger object-to-image distance when the patient is lying on a spineboard during imaging causes significant image magnification (adjusting the source-to-image distance to the maximum can only partly compensate for this) [15].

Images 2, 3 and 4 all appear to be taken of patients on spineboards with longitudinal runners and speed-clips. The two latter appear to be BaXstrap spineboards. They all show adequate contrast and detail, but images 3 and 4 are inadequate for complete diagnosis because some parts of the anatomy are not included. Image 4 also include an obscuring structure of a metal strap from the spineboard that should have been removed. In comparison, Image 2 show a great job of not clipping the anatomy (of a radiographer under great pressure to perform).

The three images show examples of pelvis radiographs and the form of the BaXstrap reinforcement runners, child slots and handles are clearly seen in images 3 and 4. Comparing this to Image 1, a radiograph of a collapsed right lung (black arrow) of a patient not lying on a spineboard, it is easy to understand how the increase in density of the hole's curvature can possibly camouflage the collapsed lung.

Although there is research available on the x-ray translucency of different materials, very little research is available on the use of spineboards during x-ray diagnostics. An evaluation of spineboards for x-ray diagnostics from 2001 examined five spineboards with regard to their feasibility for plain film radiography and computed tomography (CT) [16]. Image artifacts, image quality and resolution of anatomic details were evaluated with an anthropomorphic phantom. The study concluded that three of the boards generated lateral artifacts due to a narrow width of 41-42 cm. Image quality was impaired in 4 out of 5 boards because of image artifacts. The spineboard that passed the test was the Ferno Millenia spineboard, which is available as an 18" (46 cm) wide board with no center runners and a very simple rectangular geometry.

4.5 Intellectual property

The term *intellectual property* refers to the legally protectable idea, concepts, names, designs and processes associated with new products. The legal mechanisms of intellectual property are intended to provide a reward to those who create new useful inventions, while at the same time encouraging the sharing of information for the long-run benefit of society.

Four types of intellectual property are relevant to product design and development: patents, trademarks, copyright and trade secrets.

4.5.1 Overview of patents

A patent is a temporary national monopoly granted by a government to an inventor to exclude others from using an invention. [17] In the United States, the duration of a product patent is 20 years from the filing date for patents filed after Jun. 8, 1995. For most engineered goods, two basic types of patents are relevant: design patents and utility patents. (A third type of patent covers plants.) Design patents provide the legal right to exclude someone from producing and selling a product with the identical ornamental design described by the design patent. Because design patents must be limited to ornamental design, they can be of limited value for engineered goods. Utility patents, however, are very important to the product category described in this project report.

Utility patents includes inventions relating to a new process, machine, article of manufacture, composition of matter or a new and useful improvement of one of these things - in short, almost all inventions embodied by new products. Utility patented inventions are required to fulfill three criterias: useful, novel and nonobvious (where the two latter are the two difficult criterias to obtain).

To the concept study that follows in this project paper, a patent search is an important way to measure (or map) the existing knowledge and inventions in this field. Since the paper aims to design a new concept for a spineboard, the new invention must be compared to existing inventions.

Mapping conflicting patents is an intricate process which is often outsourced to patent research competent companies. By doing a patent search using online databases, one can expect to discover the most important patents related to a product, but certainly not all. Online patent databases typically include about 90 % of existing patents and one has to

consider that there are different patent systems for different countries. Additionally, some products may be given diffuse titles that make them harder to find.

4.5.2 Existing patented knowledge

This section gives a summary of the current patent that formed the basis for the Laerdal BaXstrap and includes information on some newer patented solutions. The section excludes inventions related to head immobilization, long board padding solutions, strapping devices and vacuum mattresses.

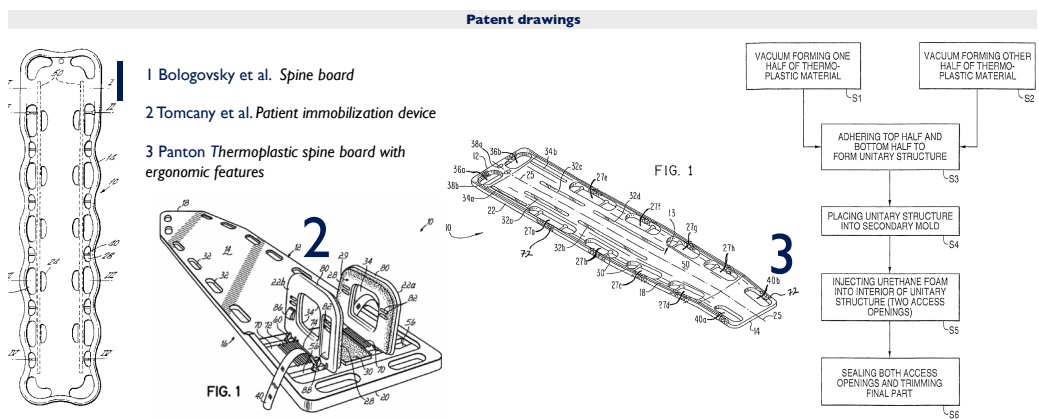

Figure 11: Patent drawings

Spine board

Inventor: Bologovsky et. al.

Patent number 5950627, Sep. 14, 1999 [18]

The invention that we know as the Laerdal BaXstrap spineboard and its design was patented with Laerdal Medical Corp. as the assignee (Image 1 in Figure 11). It was an improved version of the existing spine boards employed by paramedics for transporting injured patients. The patent promotes the need for a spine board that is as rigid after many cycles loadings as it is when first loaded with a patient (yet also lightweight), stiffening elements placement which allow x-ray imaging, better systems for permitting the use of a broad array of strapping elements and the need for a spine board that is resistant to microbial growths and that is easy to clean.

This patent includes 16 independent claims (60 claims in total). The main claim of the patent is a spineboard with an outer shell, stiffening elements and several pediatric

holes for facilitating the securement of children. In the following, the patent claims a spineboard shell with antimicrobial material in integral with the shell, a manufacturing method for a spineboard where carbon reinforcement tubes are mounted to the inner wall of a rotational mold and the outer shell is rotomolded from liquid polymer and speed pins sealed hermetically along the shell.

Patient immobilization device

Inventor: Tomcany et al.

Patent number 7165278, Jan. 23, 2007 [19]

This is a backboard with two integrated opposed paddles for head support (Image 2 in Figure 11). The patent document addresses issues with several of the head immobilizers on the market. Common for all reusable head immobilizers is the demand for storage space in emergency medical vehicles and the possibility of misplacing or losing them. Reusable blocks that are utilized with foam or vinyl may suffer premature deterioration due to repeated cleaning and may not be possible to clean if subjected to bodily fluids. Disposable head immobilizers (typically made from cardboard) are easier to store in ambulances and does not have to be recovered after use, but they require frequent purchases, control of inventory, central storage and distribution. In cases where the patient must be intubated, the head immobilizer should be rigid enough to prevent dislodging of the intubation tube when the patient is panicing or having a seizure.

Thermoplastic spine board with ergonomic features

Inventor: Pantan, Jr.

Patent number 7303705, Dec. 4, 2007 [20]

The object of this invention is to provide an improved spine board with several ergonomic features with respect to emergency medical or other rescue personnel (Image 3 in Figure 11). The patent states the need for a board that assemblies with existing head immobilizers on the market, that is made from plastic (not wood due to their tendency to splinter in rough handling and higher risk of being a carrier of infectious pathogens), but at the same time insures structural integrity, bouyancy and absence of infectious growth sites. The claims of this patent includes a method for making a vacuum-formed, foam-filled, thermoplastic spineboard. The figure illustrates the process the patent claims. Another scope of the invention is a radio chip integrated in the hollow structure. When interrogated by a signal originating from a signal source external to the board, the radio chip will transmit a signal for identifying the spineboard.

5 Formal requirements

A spinal board from Laerdal must satisfy all the standards required so that the product can be distributed and sold throughout the world. The relevant standards are:

- **AAMI TIR12:1994** [21] Designing, testing and labeling reusable medical devices for re-processing in health care facilities: A guide for medical device manufacturers
- **ISO NS-EN 9001:2008** [22] Quality management systems – requirements
- **ISO 10993**[23] Biological evaluation of medical devices
- **ISO 13485:2003** [24] Medical devices - Quality management systems - Requirements for regulatory purposes
- **NS-EN 980:2008** [25] Symbols for use in the labeling of medical devices
- **NS-EN 1041:2008** [26] Information supplied by the manufacturer of medical devices
- **NS-EN 1789:2007** [27] Medical vehicles and their equipment - road ambulances
- **NS-EN 1865:2000** [28] Ambulance equipment (latest edition is the one of 2010-11-01)
- **NS-EN-ISO 14971:2001** [29] Medical devices. Application of risk management to medical devices (ISO 14971:2000, Corrigendum AC:2001 incorporated)
- **ASTM F1557:1994** [30] Standard guide for full body spinal immobilization devices characteristics (US)

A summary of important requirements to consider when developing a new spineboard are listed in the rest of this section. They are divided into use requirements (daily use characteristics and motion restriction) and technical requirements (construction, design and materials).

5.1 Use characteristics

5.1.1 It is not expected that the full body spinal immobilization device (FBSID) will be used alone to provide the entire scope of required immobilization. Clinical situations may require differing combinations of devices for adequate total spinal immobilization. [AATM F1557-94 (Reapproved in 2007)]

5.1.2 The FBSID shall incorporate a means to accommodate the ergonomically sound handling and lifting of the device when fully loaded. [AATM F1557-94 (Reapproved in 2007)]

- 5.1.3** The FBSID shall allow x-ray to be taken through it and be MRI compatible. [AATM F1557-94 (Reapproved in 2007)] The lying part shall allow preliminary x-ray diagnostics. [EN1865:2000]
- 5.1.4** The FBSID shall support lower extremities in such a manner that it prevents motion of the pelvis and spine. [AATM F1557-94 (Reapproved in 2007)]
- 5.1.5** The FBSID shall allow for the use of adjunct devices as necessary such that immobilization is provided, including flexion, extension, rotation, distraction, lateral motion, and axial compression motion. [AATM F1557-94 (Reapproved in 2007)]

5.2 Technical

- 5.2.1** The usable length of the FBSID shall be a minimum of 1830 and maximum of 1980 mm. Width: minimum 400 mm, maximum 500 mm. Depth maximum 70 mm (unfolded and folded). [EN1865:2000]
- 5.2.2** The mass shall be (as low as possible and) not more than 8 kg. [EN1865:2000]
- 5.2.3** The loading capacity shall be a minimum of 150 kg. [EN1865:2000] A device intended for use with adult patients shall accommodate the 95th percentile adult American male. [AATM F1557-94 (Reapproved in 2007)]
- 5.2.4** The FBSID shall be of a sturdy lightweight construction. It shall be equipped with a minimum of 3 handholds on each longitudinal side and a minimum of 2 handholds at both the foot and head ends. The handles shall be easily accessible and give a safe grip for lifting or lowering and carrying the board. [EN1865:2000]
- 5.2.5** The FBSID shall maintain all use characteristics throughout its lifetime as indicated by manufacturer's recommendations. [AATM F1557-94 (Reapproved in 2007)]
- 5.2.6** The FBSID shall be disposable, or easily cleaned, consistent with CDC and OSHA decontamination procedures, without deterioration of the product or the retention of cleaning agents that may be harmful to the patient. [AATM F1557-94 (Reapproved in 2007)] The lying part shall be designed in such a way that it prevents the ingress of fluids. The material shall be easy to clean, washable, perol-oil resistant. [EN1865:2000]

- 5.2.7** The FBSID shall withstand temperatures ranging from +70°C to -30°C. [EN1865:2000]
Unless otherwise marked on the device, the device shall function throughout the temperature range from 0°C to 40°C and function for at least 20 minutes when placed in an environment at -5°C after storage in room temperature (20°C). [EN1789:2000]
- 5.2.8** There shall be 3 quick-release patient restraints. [EN1865:2000]
- 5.2.9** Deflection: The FBSID shall not bend permanently or break during the deformation test: Place the spineboard on supports positioned 300 mm from the ends of the spineboard. Load the spineboard with 250 kg, distributing the weight evenly along the length of the spineboard. Unload the spineboard and examine for deflections.
Torsion: There shall be no remaining deformation after the torsion test: Fix the spineboard in both handholds at one end. On the other end one handhold shall be fixed and a lever that is twice the width of the spineboard shall be fitted to the free end and in the middle of the lever at the fixed handhold. The lever shall be loaded with 100 N on the completely free end of the lever. The free end of the spineboard shall not lift itself more than 50 mm. No remaining deformation shall occur. [EN1865:2000]



Figure 12: Laerdal Medical's BaXstrap spineboard

6 Market

6.1 BaXstrap spineboard - curved and strong

In 2011 approximately 9100 BaXstrap spineboards were sold world wide. This product holds a global market share of about 5%.

The BaXstrap spineboard (Figure 12) was introduced to the market in 1997/1998 by Laerdal Medical Corporation. Spine boards had then been used by physicians and emergency medical technicians for a number of years in transport of injured or incapacitated patients. The BaXstrap was developed by industrial designers to be an improvement of the various existing spineboards at the time. The new spineboard was designed primarily for emergency medical technicians, paramedics and firefighters with the positioning factors 'curved and strong'.

The curved design of the BaXstrap spineboard differs a lot from other spineboards in all world markets. This unique design that conveys a strong look has been a positioning factor for the BaXstraps, and it is expected that the design platform should be kept in the case of expanding the Laerdal spinal product family.

The BaXstrap spineboard is still one of the stiffest boards on the market. Its greatest competitive feature is its strength and warranty (10 year "limited lifetime warranty"). The biggest challenge the product faces is the price of the board. The US is where the margins are lowest, due to a massive pressure in the market.

Key features for the BaXstrap spineboard are listed in Figure 13.

Laerdal BaXstrap features	
Geometry	<ul style="list-style-type: none"> • Width 410 ± 8 mm • Length 1829 ± 38 mm • Height 58 ± 2,5 mm • Shell thickness 2,29 - 3,81 mm (mold location dependent) • Hand holds 50 mm × 130 mm
Weight	<ul style="list-style-type: none"> • 6,1 kg
Bouyancy	<ul style="list-style-type: none"> • Not quantified, floats 50 kg person close to the surface during water rescue
Loading capacity	<ul style="list-style-type: none"> • Withstands distributed patient weight of 363 kg with no remaining deformation after unloading • Tested for a maximum distributed weight of 1100 kg without breaking
Resistance to torsion	<ul style="list-style-type: none"> • Resistant to torsion in accordance with EN1865
Materials	<ul style="list-style-type: none"> • High density polyethylene shell • Polyurethane foam filling • Carbon fiber reinforcement rods • Nylon speed clips
Production	<ul style="list-style-type: none"> • One piece rotational molded shell • Integrally molded carbon fiber rods • Foam filled • Optional in-molded characters
Operating temperature	<ul style="list-style-type: none"> • -14°C to 43°C
Storing temperature	<ul style="list-style-type: none"> • -34°C to 52°C
Translucency	<ul style="list-style-type: none"> • X-ray, CT and MRI compatible
Warranty	<ul style="list-style-type: none"> • Limited Lifelong Warranty
Design	<ul style="list-style-type: none"> • Compatible with most head immobilizers and strapping systems available on the market • Child slots for pediatric patients • Speed strapping holes do not interfere with hand holds • Seamless and blended edges for easy cleaning • Countered design for better patient comfort, placement and gripping • Extra large hand holds that will fit gloves • Top center hole for fastening of head immobilizer or hanging device on the wall
Colors	<ul style="list-style-type: none"> • Yellow, olive green

Figure 13: Key features of the BaXstrap spineboard

6.2 Competitors

6.2.1 World markets, different solutions

The best selling spineboards are the low to medium cost rigid polymer spineboards. In this section, they will be referred to as *standard* spineboards as the section reviews spineboards that offer some special features. A tabular summary and illustration is given in Figure 14. Another example of a spineboard which may not be sold yet, is that of the second patent in Section 4.5.2, *Patient immobilization device*. These features are positioning the products in the vast market of full body immobilization devices, but there may be significant trade-offs with optimization of weight, stiffness, cost or cleaning.

Italian company Spencer's newest addition to their spineboard family is TanGo, a spineboard with an integrated modular pediatric board. With the pediatric board nesting in the adult board, it functions like a regular adult board. The pediatric spineboard can be removed relatively quickly by turning two handles. It is modular in the sense that it has four possible placements for the head (head and foot end, front and back side). In this way it can fit the head of a wide range of pediatric patients directly, without the extra padding in the back. The disadvantages of this spineboard is the weight which pushes the maximum

allowed weight for spineboards (8 kg) and that it has more surface area to clean.

Two Australian companies, NEANN and DHS Emergency, produces a range of thin carbon fibre and fiberglass spineboards. The loading capacity is given to be 160 kg. The most lightweight alternative is the DHS 390CF carbon fibre spineboard with its 5 kg. However, online prices of these products range from around US \$ 700 for fibreglass spineboard and around US \$ 1100 for the carbon fibre spineboard.

6.2.2 US Competitors

This section focuses on the US market, where Ferno and IronDuck are the strongest competitors. Two examples of a best-seller and a low end spineboard are the Ferno NAJO RediBoard Iron Duck BASE Board, respectively.

The RediBoard is a 16” (410 mm) wide head-foot and top-bottom symmetric spineboard [31]. It is a HDPE construction with foam filling and most likely reinforcing internal runners. It has a load capacity of 272 kg and a high buoyancy of 125 kg (its height is 60 mm). The spineboard is a popular one despite weighing 7.3 kg due to its geometry. The price is around US \$160 (in comparison, the BaXstrap spineboard costs around US \$200).

Iron Duck’s BASE Board is a 16” low end spineboard at around US \$130 [32]. The construction and weight of the BASE Board is the same as for the RediBoard, but the BASE Board is tapered at the foot end and has a depth of only 40 mm. The load capacity is 227 kg and the buoyancy is 113 kg.

A detailed tabular overview with photos of the spineboard product lines of the US competitors with their attributes are given in Appendix B.

Special featured spineboards			
Feature	Qualities	Disadvantages	Brand example
Foldable	<ul style="list-style-type: none"> • Stair case rescue • Fits smaller rescue units 	<ul style="list-style-type: none"> • Contains metal in the center of the board 	Ultra Spac Sav (Iron Duck, US)
No metal scoop	<ul style="list-style-type: none"> • No log rolling • Better handling 	<ul style="list-style-type: none"> • Expensive • Contains metal (is not a problem for x-ray diagnostics) 	CombiCarrier II (Heartwell Medical, US)
Wheels and foot support	<ul style="list-style-type: none"> • Single person can transport board • Better working conditions • Patient movement is better secured 	<ul style="list-style-type: none"> • More difficult to clean due to small radiuses 	WauK Board (Granger Plastics, US)
18" wide	<ul style="list-style-type: none"> • Fits large victims • Fits sports or work gear • More suitable for x-ray diagnostics (if the board does not contain center slots or internal runners) 	<ul style="list-style-type: none"> • Heavier 	Milenna Backboard (Ferno, US)
Composite sandwich	<ul style="list-style-type: none"> • Ultra thin • Carbon fiber boards are very lightweight • Better suited for car rescue • Extreme mountain rescue • Fits combined spineboard-vacuum mattress solution due to thickness and curvature 	<ul style="list-style-type: none"> • Expensive materials 	Long Spine Board (NEANN, AU) 889P Fibreglass Backboard (Ferno, AU) 390CF Carbon Fibre Backboard (DHS Products, AU)
Padding	<ul style="list-style-type: none"> • Patient comfort • Less risks of pressure sores • Less risk of hypothermia 	<ul style="list-style-type: none"> • Maintenance, difficult to clean • May require replacement of padding if contaminated with bodily fluids 	RescuePad (Rapid Deployment Products, US)
Pediatric spineboard	<ul style="list-style-type: none"> • Scaled down to fit children 	<ul style="list-style-type: none"> • Requires an extra board 	Pedi Light (Rapid Deployment Products, US)
Integrated pediatric board	<ul style="list-style-type: none"> • Additional pediatric board does not require extra storage in the transport compartment 	<ul style="list-style-type: none"> • Additional weight • May obscure x-ray diagnostics 	Tango (Spencers, IT)
Child slots	<ul style="list-style-type: none"> • Securing children demands less padding 	<ul style="list-style-type: none"> • May obscure x-ray diagnostics 	BaXstrap (Laerdal, NO)



Figure 14: Special features offered in spineboards in different parts of the world

7 Concept study

The mission statement of this project demands a new spineboard that will increase overall gross margins for the spineboard products. At the same time the new concept must be produced in a different way than the BaXstrap and be sold for a lower price than the BaXstrap (< US \$200).

The BaXstrap is, as mentioned earlier manufactured by placing stiffening carbon rods with nylon speed-clips in a rotational mold and rotomolding the shell from high density polyethylene. Rotational molding is a process that requires a lot of manual work and long cycle times. The material selection is very limited (in practice, PE is the material to use), but the advantages of the process is that it can produce a seamless container which can handle a large surface-to-thickness ratio.

This section looks at the possibility of developing a new product based on a new manufacturing method that continues the benefits of rotational molding and at the same time insures that all standard, sales and user requirements are met.

7.1 Available technology

Blow molding

Extrusion blow molding is typically used for containers and large hollow structures such as car bumpers. This process is automated, quick and can provide a good surface-to-thickness ratio for large components. A tubular parison of molten thermoplastic is extruded (usually vertically) and clamped between a pair of female moulds, so that the bottom of the tube is pinch-sealed. Air is then introduced from the extrusion die and the parison is inflated to take the shape of the mold. A short cooling stage follows before the mold opens and the molding is ejected. This manufacturing process meets the requirements of producing a seamless shell with a very short cycle time. But the material selection is limited to thermoplastics and the correct placement of reinforcement will be difficult. Manual labouring of trimming and sealing is required. Tooling costs for extrusion blow molding are high.

Injection molding

Polymer granules are fed into a spiral press where they mix and soften to a consistency that can be forced through one or more channels (spurs) into the die. The polymer solidifies under pressure and the component is then ejected. The material selection is much

broader than in the other processes and it is also possible to use thermoplastic based composites (short fiber reinforced plastic) if the filler-loading is not too large. Using this manufacturing method means molding the upper and lower half of the spineboard separately and then joining the two. Depending on the materials, joining could be done by gluing or hot plate welding. The tolerance for the mold is low, but the tooling costs are in general high for this process. High molding pressure is required. The constraint of producing a top-bottom symmetric spineboard halves the mold costs.

Resin transfer molding

Resin transfer molding uses a closed mold, in two or more parts with injection points and vents to allow air to escape. Reinforcement is cut out to shape and placed in the mold, together with any inserts or fittings. The mold is closed and a low viscosity thermosetting resin is injected under low pressure through a mixing head in which hardener is blended with the resin. The mold is allowed to cure at room temperature. The reinforcement can be a 25% volume fraction of a continuous glass or carbon fiber mat. Tooling costs are low and the process is not very labor intensive. Materials can, however, be expensive and the cycle time long. Post processing is required.

Vacuum forming

A thermoplastic sheet is heated to its softening point and sucked against the contours of a mold before it is cooled and solidified against the mold. This process also requires the spineboard to be joined from two separate parts. The shape complexity of the product must be low, which is not a problem for the spineboard. It also allows for the use of short fiber reinforced plastics. Although the capital and tooling costs are relatively low, the starting materials (sheets) are more expensive than for injection molding (pellets) and the process will be very labor intensive. Excessive trimming is required.

Hand lay-up

An open mold is coated with resin to give the product a smooth surface. When this has cured, glass or carbon fiber is laid on by hand, thermoset resin is applied and the layer is rolled to distribute the resin fully through the fibers. The process is repeated until the desired thickness is reached. Ribs and foam panel inserts are possible. Investment costs for this process are relatively cheap and works well for small batches of spineboards. But starting materials are expensive and the process is labor-intensive. In addition, getting consistent results is highly dependent on the skills and experience of the operator.

Hot plate welding

Hot plate welding makes butt (plate to plate) joints between thermoplastic components.

The components to be joined are held in fixtures that press them against an electrically heated and PTFE coated platen which melts the surface and softens the material beneath it. The pressure is lifted, the tool withdrawn and the hot surfaces are pressed together and held there until they have cooled. This welding technique can be used for joining (similar materials over) large areas with thicknesses varying from 1-30 mm. If the joint has a curved or angular profile, shaped heating tools can be used. The joint strength is usually equal to that of the parent material, so the hot-plate method creates a strong bond that is impermeable to water. Equipment and tooling are moderately cheap. The use of this process with injection molded or vacuum formed components, require the cycle time to be about the same cycle time for manufacturing the two components. In this way, the two processes can be done in parallel with the required labor of one operator.

7.2 Classification tree

A concept classification tree is used to divide the space of possible solutions for manufacturing a non-metallic, rigid and buoyant structure (Figure 15) An evaluation of the different concepts are given based on the advantages and disadvantages of investment cost, grade of labor intensity and the raw material cost (which corresponds to the spineboard unit cost).

The criteria are rated an absolute importance on a from 1 to 3. It is assumed that the new product can have an acceptable payback time given relatively large investment cost, so this criteria is rated the least important. The cost of starting materials are rated that most important to achieve a low cost product. Grading these criteria in each of the manufacturing processes is also done on a 1 to 3 scale, where 1 is the most cost efficient. The evaluation adds up to an absolute number where a low number indicates that the production process should be prioritized in the evaluation of the manufacturing processes against solutions to meet customer needs.

7.3 Concept combination table

Using the concept combination table is a systematical way of considering solution fragments. The rows are established by the various subproblems that have been identified in this paper: enhance patient comfort while providing good spinal support, provide good handling and adequate x-ray translucency and design a means of flexibility. The concept combination table in Figure 16 show possible solutions for these problems that should be

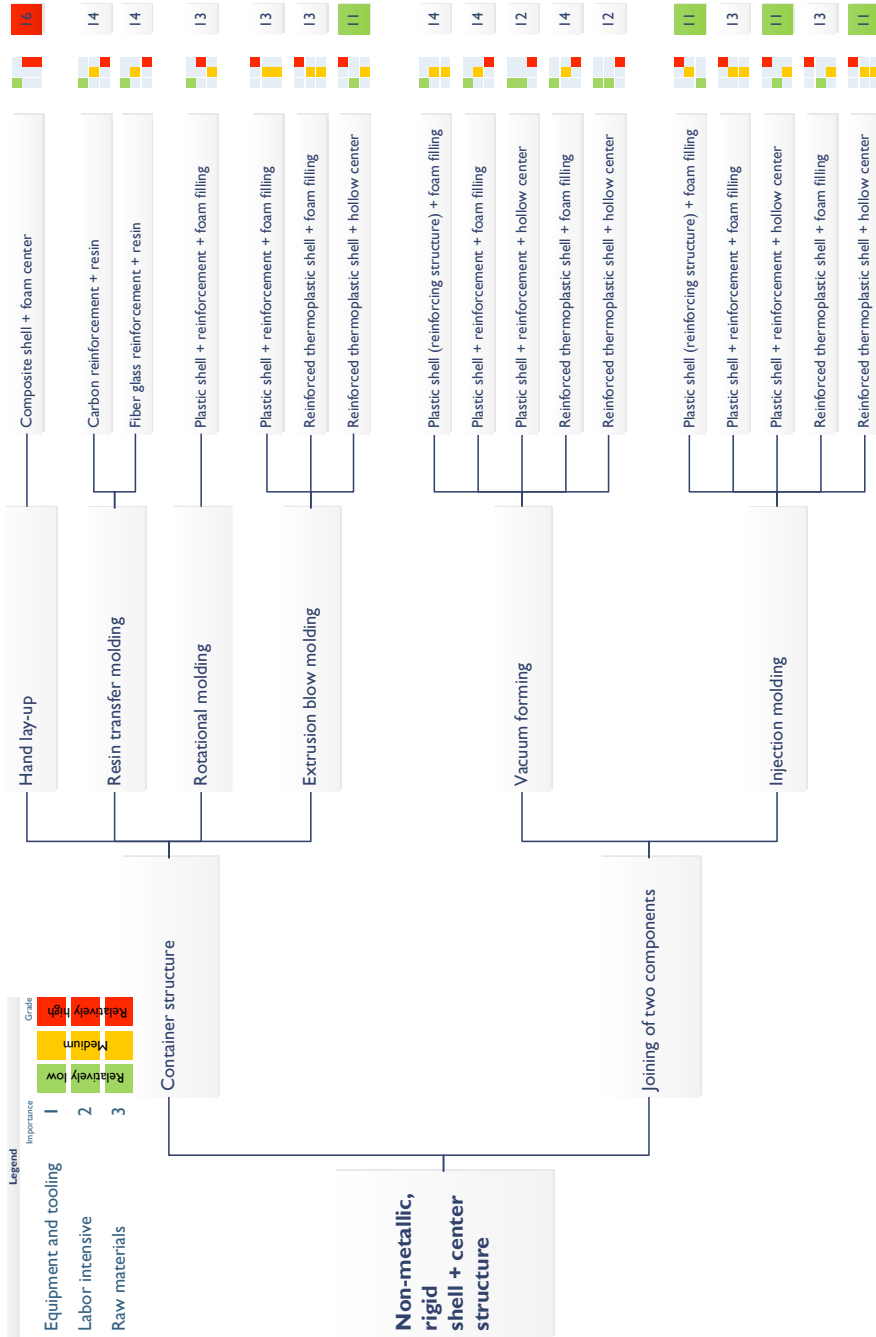

Figure 15: Classification tree

evaluated against the favored manufacturing method in the classification tree. The new concept can include several of the solutions listed in each row, but trade-offs between them and the manufacturing processes should be evaluated. Two possible paths through the combination table are discussed in the next section.

7.4 Evaluation

Blue path Light and thin

















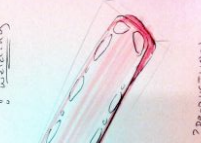

The blue line in Figure 16 shows the path of a very thin spineboard with elevated edges. This makes it a better solution for extricating patients from cars. The solution offers the optimal nesting feature and will result in better image quality due to the clear center section and the reduced image-to-object distance. Child slots is not an option in this case, since there is no lying area-to-ground distance. The lying area could be elevated, but this is a major trade-off with the initial key advantage of the solution, namely that it is thin. The geometry makes the spineboard perfect to use with a vacuum mattress (which cannot be carried by two people and suffers the risk of suddenly breaking the vacuum and losing its stiffness). The spineboard does not require a lot of extra space and the elevated handles offers a good support for the mattress.

Obtaining the necessary stiffness with a thin board can be done by using fiber mats around a foam center by hand lay-up or resin transfer molding. In order to reduce the weight from that of conventional polymer spineboards, carbon fiber should be favored. The investment costs are very low, but the manufacturing process and raw materials cost calls for a selling price that is far beyond that of the BaXstrap spineboard. The number of potential buyers of such a high end board might be high enough to make a good world wide profit on this solution, but in the US, this is a high risk solution. A safer option is to increase market shares by offering a low end spineboard.

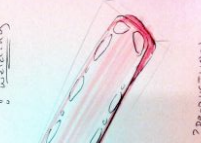
Pink path Good handling and low cost

Looking to the other end of the solution span, the low cost solutions are reviewed. With the basis of creating a spineboard for perfect handling, the pink path emerges. This solution includes large, elevated handles and a curved lying area. The trade-off between curvature and depth of the spineboard should be carefully considered. The foot end should be tapered and thinner to make it better for car extrication than many of today's conventional spineboards. The dashed lines show that there is a positive correlation with almost all the other solutions in the table. Padded surface should not be included because this complicates cleaning procedures and makes the spineboard more expensive. Design-

Concept combination table

<p>Spinal support and patient comfort</p>  <p>Padded surface</p>	<p>Additional opening or slit in the board</p>	<p>Child slots</p> 	<p>Adult and pediatric top and bottom</p> 	<p>Wider (18") spineboard</p> 	<p>Translucency</p> 	<p>Handling</p>  <p>Rubber grip</p>
<p>PINK COMBINATION</p>  <p>8 materials ? PRODUCTION SLOW MOLD</p>	<p>Additional opening or slit in the board</p>	<p>Child slots</p> 	<p>Adult and pediatric top and bottom</p> 	<p>Wider (18") spineboard</p> 	<p>Translucency</p> 	<p>Handling</p>  <p>Rubber grip</p>
<p>BLUE COMBINATION</p>  <p>Composite SANDWICH Strip used through middle giving support CENTER resistant to mechanical stress GRIP</p>	<p>Additional opening or slit in the board</p>	<p>Child slots</p> 	<p>Adult and pediatric top and bottom</p> 	<p>Wider (18") spineboard</p> 	<p>Translucency</p> 	<p>Handling</p>  <p>Rubber grip</p>

Legend

This table shows two possible combinations of solutions to combine with a new manufacturing process. The full colored lines indicate solutions that must be included. The striped lines of the pink path indicate solutions that are also possible to include in the combination.

- PINK COMBINATION
- MUST INCLUDE
- CAN ALSO INCLUDE
- BLUE COMBINATION
- MUST INCLUDE

Figure 16: Tabular view of solutions to customer needs

ing the spineboard to fit external padding solution such as a foam, air or vacuum mattress is better because the spineboard can be bought separately (customers might already own these products). Creating an 18" spineboard can be done by altering the new concept so that a wider spineboard has the adequate stiffness. The possibility of offering the 18" spineboard without the additional 16" spineboard, is a complex marketing decision that this report does not hold the foundation for.

The pink path solution can be manufactured by blow molding, vacuum forming or injection molding. Given the evaluation of the classification tree and the difficulty of reinforcement placement in blow molding, the five concepts for injection molding should be considered. Other than that a high stiffness with a very thin spineboard cannot be obtained with the material offerings of injection molding, the manufacturing process in itself does not sacrifice any of the solutions in the combination table. Due to this, the injection molding concept undergoes a more thorough evaluation of the trade-offs and evaluation against customer needs in the next section.

8 Evaluation of an injection molded spineboard

The injection molding concept is able to respond to a majority of the customer needs as well as meeting the formal requirements for spineboards. It has some clear advantages in terms of material offerings, short cycle times and low demand for manual labor. This section includes a product specification for the new concept and a thorough evaluation of the most important customer needs against the sub-solutions of the injection molding concept. Lastly, this section includes an evaluation of the new concept against the existing design platform.

8.1 Product specification

A product specification with target values and standard references is given in Figure 17. The main categories are economic (investment and production unit cost), technical (geometry and various demands for selecting materials) and functional (design features) requirements.

The economic requirements are based on an evaluation from the Laerdal market operation that includes a gross margin of about 50% and one year payback time for the total investment cost.

The technical category includes the minimum requirements from applicable standards, and the requirements for design features are based on the minimum demands of customers. Additionally, a requirement regarding graphics is included. The selection of materials and production processes should allow for adding graphics (either in-molded or post molding).

8.2 Quality function deployment

The key purpose of quality function deployment (hereafter QFD) is to ensure that the eventual design of a product or service actually meets the needs of its customers. Customers have not been considered explicitly since the concept generation and therefore it is appropriate to check that what is being proposed for the design of the product or service will meet their needs [33].

Product Specification				
Demand	Target value	Source	Importance	
I Must 2 Important 3 Relatively of less importance				
1 Economic				
1.1	Unit price	\$ 50		1
1.2	R&D	\$ 30.000		1
1.3	Sourcing	\$ 25.000		1
1.4	Tooling	\$ 650.000 (1 year payback for total investment)		1
2 Technical				
2.1	Mass	Max 8 kg	EN1865:2000	1
2.2	Geometry, tolerances included.	Must fit standard transport compartments	EN1865:2000	1
2.2.1	Length	Min/max 1830/1980 mm		
2.2.2	Width	Min/max 400/500 mm		
2.2.3	Depth	Max 70 mm (folded and unfolded)		
2.3	Loading capacity	Min 150 kg	EN1865:2000	1
2.4	Speed pins capacity	Min 300 lb pull strength		1
2.5	Flammability	No progressive smoldering or flaming when tested in accordance with EN1021-1	EN1865:2000 EN1021-1	1
2.6	Storing temperature	Min/max -30°C/70°C	EN1865:2000	1
2.7	Operating temperature	Min/max 0°C/40°C Shall function for at least 20 minutes when placed in an environment at -5°C after storage at a room temperature of 20°C, still requiring the given variations of storage temperature (2.6) prior to this	EN1798:2007	1
2.8	Deformation of the lying area	No remaining deformation when tested in accordance with EN1865	EN1865:2000	1
2.9	Resistance to torsion	No remaining deformation when tested in accordance with EN1865	EN1865:2000	1
2.10	Rugged construction			1
2.11	Materials	Easy to clean, washable, petrol-oil resistant, latex free, non toxic and must allow preliminary x-ray diagnostics		1
2.12	Marking and instructions	Each device must be accompanied by the information needed to use it safely and properly, taking account the training and knowledge of users	EN980:2008 EN1041:2008	1
3 Functional				
3.1	Lying part	The design must be so that it will give maximum support for the head and whole torso	EN1865:2000	1
3.2	Design platform	Must identify with the Laerdal spinal product family design platform		1
3.3	Nesting			3
3.4	Color variation	Must offer Laerdal Yellow Can offer olive green (every additional color must be tested, financial gain must validate the color variation offerings)		1
3.5	Tapered design			1
3.6	Child slots	If center slots are demanded, they should aim to be formed in a way that is dissimilar to the projected form of internal organs in the thorax and pelvis region		3
3.7	Hand holds size	Width min. 80 mm		1
3.8	Ground-hand holds clearance	Min. 20 mm		1
3.9	Fully sealed construction		EN1865:2000	1
3.10	Surface	Finish must be impervious to workplace fluids. It must be easy to slide a patient over the lying area		1
3.11	Cleaning	No shapes or configurations must impose any constraints on the ability of health care personnel to clean, disinfect or sterilize the device	AAMI TIR12:1994	1
3.12	Angeled edges	Log rolling must be easy		1
3.13	Pins	Min. 8 pins (see also 4.2)		1
3.14	Intuitive design	The use of the device must be intuitive to the operators of the board, given their training and knowledge		1
3.15	Recycling	The potential of recycling should be considered in the design process	AAMI TIR12:1994	2
3.16	Compatibility			1
3.16.1	Head immobilizers	Head area must include a min. 410x250 mm flat rectangle to fit most head immobilizers available on the market		
3.16.2	Strapping systems	Must be compatible to most strapping systems available on the market, including speed clip strapping systems (see also 3.12)		
3.16.3	Helicopter hoist	Design must allow the use of helicopter hoist gear		
4 Other				
4.3	Graphics	It should be possible to add custom graphics to the spineboard. All surfaces must pass a tape test (adhesive tape is used to secure the patient and to fasten some head immobilizers).		3

Figure 17: Product specification for the new spineboard

8.2.1 QFD overview

- **Customer requirements** - the competitive factors which customers find significant. Their relative importance is scored in a five-point scale with *accurate* scoring the highest.
- **Functional requirements** - the sub-solutions of the new concept that will operationalize customer requirements within the product.
- **Relationship matrix** - based on the judgement of the designer, the relationship matrix represents the relationship between the customer requirements and the design characteristics. All the relationships are studied, but in many cases, where the cell of the matrix is blank, there is none.
- **Bottom matrix** - this is a technical assessment of the product which contains the absolute importance of each design characteristic, also translated into a ranked relative importance. The degree of technical difficulty to achieve high levels of performance in each design characteristic is indicated on a 1-5 scale.
- **Triangular "roof"** - this captures any information about the correlations between the various design characteristics. [33]

8.2.2 Evaluation of new concept through QFD - input

Customer requirements are chosen based on the key selling features of spineboards. Standard and regulatory requirements that are commonly understood are not included in order to minimize the information that needs to be addressed. Requirements that are commonly satisfied by most products on the market, but still important enough to include are rated a 3 on the importance scale.

Requirement 1 is a patient need, requirements 2-8 are EMS provider needs, requirement 9 is a radiologist need and requirement 10 is held by the purchasers.

Customer requirements and importance rating

1. **Support and comfort** A fundamental requirement for spineboards is that they must support the spine. The support that the spineboard offers will depend on the shape of the lying area. How comfortable the spineboard is will depend on the material that the patient is lying on and if this is a rigid plastic material, the curvature of the lying area will be of importance. The requirement is rated 5 because it is one of the most important key selling features and because of the large amount of available research on patient comfort.
2. **Easy to operate** In this requirement lies all needs that EMS providers have related to handling the spineboard. The hand holds must be ergonomically placed and fit the hands

with a appropriate hand-ground clearance, it must be easy to log roll and secure the patient and it must be easy to clean and disinfect.

3. **Lightweight** The weight of the spineboard should be as low as possible.
4. **Durable** The warranty that the company can offer is a major sales factor. The spineboards subjected to normal wear and tear over a number of years and must handle daily impact and various temperatures and fluids.
5. **Buoyant** During water rescue it is important that the spineboard floats. A normal adult should be able to float close to the surface on the spineboard, but it must not have a buoyancy that is so high that it makes it difficult to slide the spineboard beneath the patient in the water. This requirement is rated an importance of 3 because the buoyancy should be targeted at a certain value and it is not a factor that the new spineboard can achieve to a higher much higher extent than its competitors. It is, however, an important customer requirement.
6. **Flexible** The spineboard should be as flexible as possible. This means that it can be used for rescue in wet, hot and cold environments, used for water and mountain rescue as well as in car wrecks, stores in all compartments and may be stackable.
7. **Compatible** A spineboard will normally never be used for immobilization alone and customers that are looking to buy a spineboard will usually all ready own several types of immobilization devices. A new spineboard should be compatible with as many head immobilizers and strapping systems as possible, but there are criterias for this that make this a requirement that is easy to target.
8. **Stiff** The deflection in the middle of the spineboard should be as low as possible when subjected to a distributed weight of a patient lying on top of it because any movement to the spine of the patient could potentially worsen patient's injury. Offering better stiffness than the minimum requirement a major competitive factor. In the QFD matrix this requirement is rated a 3 with the thought of being a cheap, lightweight board that targets the rigid capacity at a value a bit above the minimum requirement. The opposite case, a cheap spineboard with an acceptable weight that is extremely rigid will be discussed in the QFD results evaluation.
9. **X-ray translucent** Diagnostics of x-ray images of a patient on a spineboard must be possible. The spineboard should be compatible with x-ray, CT and MRI.
10. **Low unit price** The price of a product is fundamentally important. The reason that this requirement is rated 3 is that although the purchasers decide on what spineboard to buy, they must comply with the wishes of the users of the spineboard and any special needs they might have. Some customers are willing to pay more if the product offers some special features.

8.2.3 Evaluation of new concept trough QFD - results

Relative importance of functional requirements

All requirements that were included in the QFD matrix obtained a relationship value of 3 or more with the customer requirements, i.e. all of them have a strong or moderate relationship with fulfilling the customers needs. The functional requirements that obtain the highest importance score were to have a curved lying area, lower the weight and have large hand holds.

A requirement that obtained among the lowest scores was to remove the child slots. This might indicate that the functional importance of the child slots may be more important than the quality of the x-ray images.

The suggestion of having a symmetric design does also have a low relative importance in the QFD. The reason for choosing a symmetric design is to half the mold tooling investment cost so it is natural that this does not show a great response to customer requirements. The QFD also shows that it has only negative correlations with the other functional requirements. A symmetric design means most likely a thicker spineboard which adds to the weight. In-molded speed clips on a symmetric design is also a challenge.

Tapered design is a third requirement that scores low on importance. This is, however, a requirement with no trade-offs so this solution should be included.

There are no trade-offs with the manufacturing process of injection molding the shell.

In the relationship values for the customer requirements, four of the requirements have weak or moderate relationships with the functional requirements. These are customer requirements that the new concept tries to target and areas where it is difficult to be a lot better than the competitors.

In the case of developing a spineboard that has an acceptable weight, but has a "wow-factor" of extreme rigidness, the fuctional requirement of offering a more rigid board (currently scored 3) will become more much more important to satisfy overall customer needs than a low price.

As shown in the correlation matrix (the roof) of the QFD, there is a three way trade-off between lowering the weight,

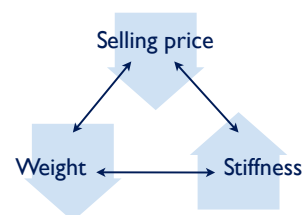

Figure 18: *

lowering the price and increasing the rigidity of the new spineboard. A market strategy will be important to decide how to use this trade-off.

8.3 Design platform

Developing an extensive industrial concept is not a part of the scope for this project. The concept study does, however, state that the design platform should be considered. Figure 20 show some sketches and models that suggest a proposal for the design of an additional 16” spineboard to the Laerdal spinal product family. The new spineboard is presented in Laerdal yellow with the continuation of the curvy design. Handholds are large and have an adequate handholds-to-ground clearance. Tapered design has the advantage of being more suitable for car rescue and reduces the weight of the spineboard somewhat. The head area is a flat, rectangular area in line with the lying area. The lying area itself is curved to provide a better support to the spine. Edges are angled to make log rolling easy. The design maintains the possibility of creating a top-bottom symmetric design. If this is not done, the possibility of creating a two-sided spineboard with different colors to fit adult and pediatric patients on each side can be considered.

Product planning

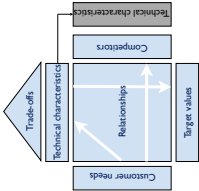

Assembly part deployment

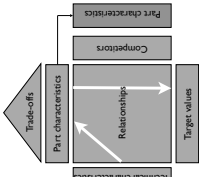

Process planning

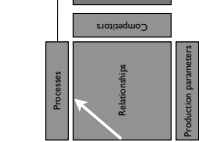

Process/quality control

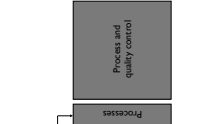

Legend

- Strong relationship 9
- ◊ Moderate relationship 3
- △ Weak relationship 1
- †† Strong positive correlation
- † Positive correlation
- Negative correlation
- ▶ Strong negative correlation
- ▲ Objective is to minimize
- ▼ Objective is to maximize
- X Objective is to hit target

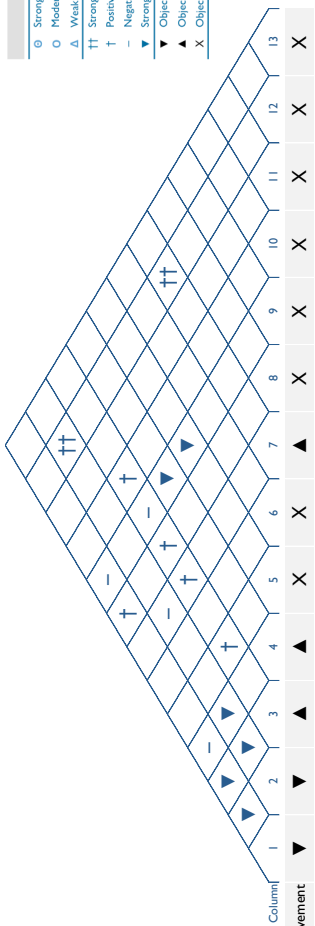

Row	Max relationship value	Relative importance	Importance	Weight	Unit price	Reinforcement	Speed clips	Curved lying area	Large hand holds	Durable materials	Tapered design	Symmetric design	Foam filling	Child slots	Injection molded shell	Flat rectangular head area	
1	9	13.2	5	Comfortable, supports the spine	○	○	○	○	X	▲	X	X	X	X	X	X	X
2	9	13.2	5	Easy to operate (rescue, log roll, lift and carry)	○	○	○	○	○	○	○	○	○	○	○	○	○
3	9	10.5	4	Lightweight	○	○	○	○	○	○	○	○	○	○	○	○	○
4	9	7.9	3	Durable (long-lasting, withstands wear and tear, resistant to impacts)	△	△	△	△	△	△	△	△	△	△	△	△	△
5	1	7.9	3	Booyant	△	△	△	△	△	△	△	△	△	△	△	△	△
6	3	13.2	5	Flexible (suitable for use in various environments)	△	△	△	△	△	△	△	△	△	△	△	△	△
7	3	10.5	4	Compatible	△	△	△	△	△	△	△	△	△	△	△	△	△
8	9	7.9	3	Stiff	○	○	○	○	○	○	○	○	○	○	○	○	○
9	3	7.9	3	X-ray translucent	○	○	○	○	○	○	○	○	○	○	○	○	○
10	9	7.9	3	Low unit price	○	○	○	○	○	○	○	○	○	○	○	○	○

Target value	6 kg	\$50	200 kg loading capacity, torsion with EN1865	8 pins, 300 lb pull strength	80 mm width	None	None	None	400 x 250 mm
Difficulty (0= Easy to accomplish, 10=Extremely difficult)	4	5	4	4	4	4	4	4	4
Max relationship value in column	9	9	9	3	9	9	3	3	9
Importance	147.4	71.1	118.4	71.1	110.5	118.4	110.5	39.5	23.7
Relative importance	15.5	7.5	12.4	7.5	16.6	12.4	11.6	4.1	2.5

Column

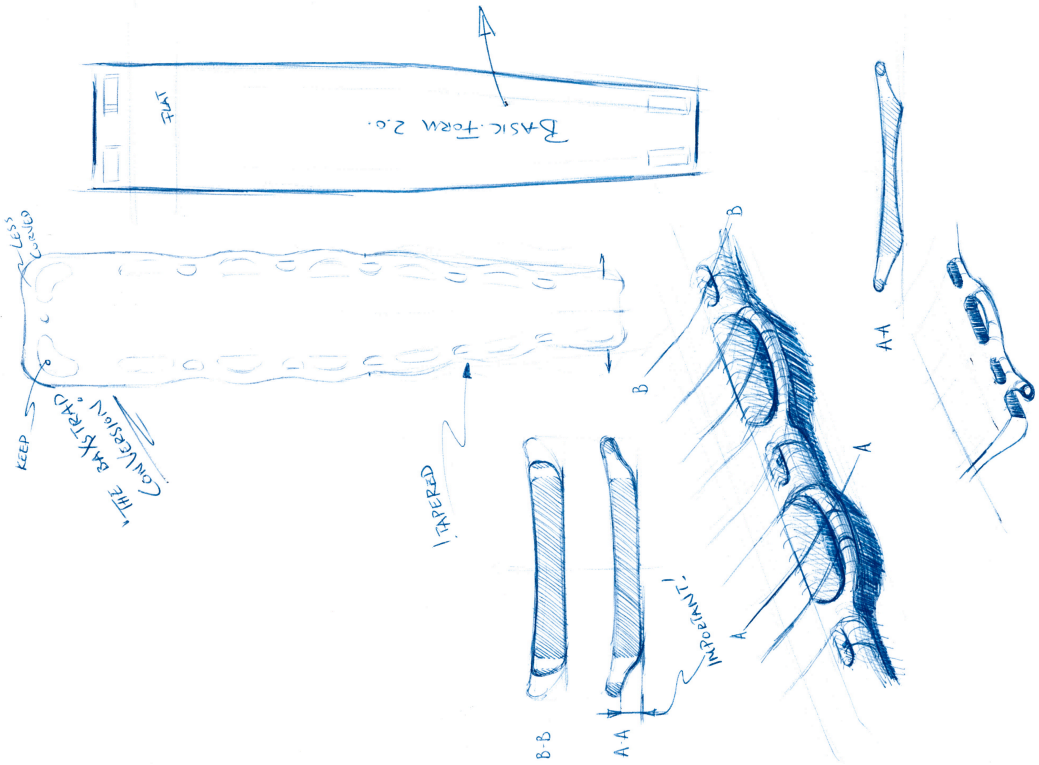
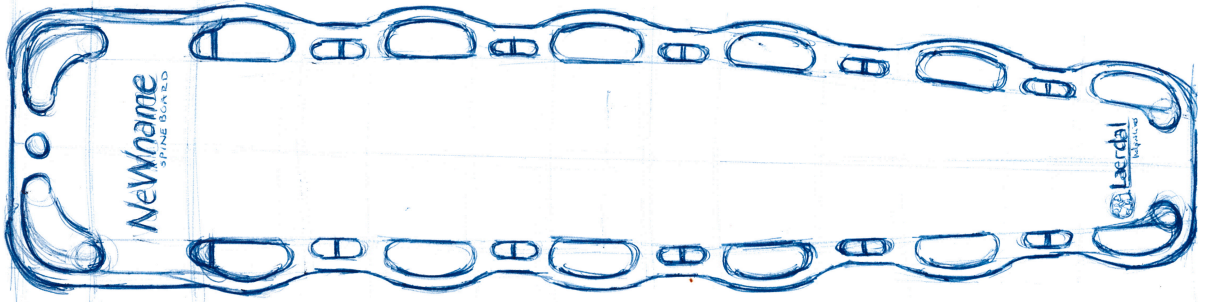
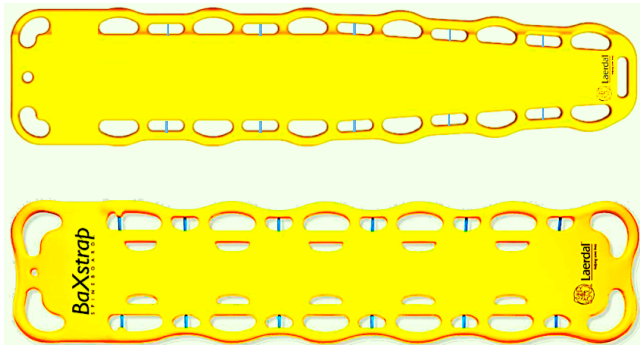

9 Conclusion/further work

The advantages and economic feasibility of a new spineboard concept based on an injection molded shell has been presented. Based on standards and customer needs, a product specification for the new concept has been conducted.

Laerdal should offer a low end spineboard to expand their product portfolio. With the vast selection of materials available for injection molding, it may be possible to offer a low end spineboard with the same stiffness as the BaXstrap.

The solutions of the new concept were measured against the most important customer needs through QFD analysis. Curved lying area, reduced weight, increased reinforcement and large hand holds were found to be the most important, but the QFD showed little value in designing a symmetric spineboard and removing the child slots. Removing the child slots demands for additional market research. The new spineboard should be tapered despite of the low importance score because this feature has entirely positive correlations with the other features. The three way trade-off between cost, weight and reinforcement should be explored through mechanical and economic calculations.

A patent search revealed that there exists a patented solution for a spineboard manufactured as two vacuum formed thermoplastic halves joined together and filled with foam. Possible conflict with the claims of this patent should be reviewed in the continuation of the development process.

The work of this preliminary study will continue in Ervik's master's thesis in the Spring of 2012.

Further work should include computerized simulations to review the possibility of reducing weight and lowering the price while maintaining or reducing the stiffness relative to the BaXstrap. Appendix A includes CAD models that should be used for this work. Simulations of various materials, reinforcement structures, geometry and welding technique should be conducted. With this information, an estimate of manufacturing cost should be established.

References

- [1] "Product specification - BaXstrap," Product Specification, Laerdal Medical AS, 2003.
- [2] "Laerdal medical website," 12 2012. [Online]. Available: www.laerdal.com
- [3] M. F. Ashby and K. Johnson, *Materials and design: the art and science of material selection in product design*, 2nd ed. Butterworth-Heinemann, 2010.
- [4] M. Stagg and M. Lovell, "A repeat audit of spinal board usage in the emergency department," *Injury*, vol. 39, no. 3, pp. 323 – 326, 2008. [Online]. Available: <http://www.sciencedirect.com/science/article/pii/S0020138307002240>
- [5] D. Vickery, "The use of the spinal board after the pre-hospital phase of trauma management," *Emergency Medicine Journal*, vol. 18, no. 1, pp. 51–54, 2001. [Online]. Available: <http://emj.bmj.com/content/18/1/51.abstract>
- [6] J. A. Nemeth, "A new approach to stabilization of the cervical spine in infants," *The Academy Today*, vol. 1, no. 1, 2005.
- [7] J. Davis, D. L. Phreaner, D. B. Hoyt, and R. C. Mackersie, "The etiology of missed cervical-spine injuries," *Journal of Trauma*, vol. 34, pp. 342–346, 1993.
- [8] P. M. Platzer, N. M. Hauswirth, M. M. Jandl, S. M. Chatwani, V. M. Vecsei, and C. M. Gaebler, "Delayed or missed diagnosis of cervical spine injuries," *Journal of Trauma - Injury infection and critical care*, vol. 61, pp. 150–151, 2006. [Online]. Available: www.oandp.org/academytoday/2005apr/4
- [9] S. Abram and C. Bulstrode, "Routine spinal immobilization in trauma patients: What are the advantages and disadvantages?" *The Surgeon*, vol. 8, no. 4, pp. 218–222, 2010.
- [10] V. Y. Totten and D. B. Sugarman, "Respiratory effects of spinal immobilization," *Prehospital Emergency Care*, vol. 3, pp. 347–352, 1999.
- [11] Y. Kosahvili, D. Backstein, Y. B. Ziv, O. Safir, A. Blumenfeld, and Y. Mirovsky, "A biomechanical comparison between the thoracolumbosacral surface contact area (sca) of a standard backboard with other rigid immobilization surfaces," *Journal of Trauma*, vol. 66, pp. 191–194, 2009.
- [12] P. H. W. Lubbert, M. E. Schram, and L. P. H. Leenen, "Is there a reason for spine board immobilization in the emergency department for patients with a potential spinal injury?" *European Journal of Trauma*, vol. 31, no. 4, pp. 375–378, 2005.
- [13] 9 2011, interview with radiographers Kari Merethe Hole and Nimal Liyanaarachchi, St. Olavs Hospital, Trondheim, Norway.
- [14] M. Malik and M. Lovell, "Current spinal board usage in emergency departments across the uk," *Injury*, vol. 34, no. 5, pp. 327 – 329, 2003. [Online]. Available: <http://www.sciencedirect.com/science/article/pii/S0020138302003145>
- [15] N. J. Jr., "Film critique of the lower extremity." [Online]. Available: <http://www.ceessentials.net/article26.html>
- [16] U. Linsenmaier, M. Krotz, K. G. Kanz, W. Russ, E. Papst, J. Rieger, W. Mutscher,

- and K. J. Pfeifer, "Evaluation of spine boards for x-ray diagnostics," *RöFo. Fortschritte auf dem gebiet der rontgenstrahlen und der bildgebenden Verfahren*.
- [17] K. T. Ulrich and S. D. Eppinger, *Product Design and Development*, 3rd ed. McGraw-Hill, 2003.
- [18] Bologovsky, Cline, Mohberg, and Sunderland, "Spine board," U.S. Patent US 5,950,627, Sep 14, 1999.
- [19] Tomcany and Helmsderfer, "Patient immobilization device," U.S. Patent US 7,165,278 B2, Jan 23, 2007.
- [20] Panton, "Thermoplastic spine board with ergonomic features," U.S. Patent US 7,303,705, Dec 4, 2007.
- [21] *Designing, testing and labeling reusable medical devices for reprocessing in health care facilities: A guide for device manufacturers*, Association for the Advancement of Medical Instrumentation Std. AAMI-TIR 12, 2004.
- [22] *Quality management systems - requirements*, Standard Norge Std. NS-EN ISO 9001, 2008.
- [23] *Biological evaluation of medical devices*, Standard Norge Std. NS-EN ISO 10 993, 2006.
- [24] *Medical devices - Quality management systems - Requirements for regulatory purposes*, Standard Norge Std. NS-EN ISO 13 485, 2003.
- [25] *Symbols for use in the labeling of medical devices*, Standard Norge Std. NS-EN 980, 2008.
- [26] *Information supplied by the manufacturer of medical devices*, Standard Norge Std. NS-EN 1041, 2008.
- [27] *Medical vehicles and their equipment, road ambulances*, Standard Norge Std. NS-EN 1789, 2007.
- [28] *Specifications for stretchers and other patient handling equipment used in road ambulances*, Norges Standardiseringsforbund Std. NS-EN 1865, Rev. 1, 2000.
- [29] *Medical devices, Application of risk management to medical devices*, Norges Standardiseringsforbund Std. NS-EN ISO 14 971 (Corrigendum AC:2001 incorporated).
- [30] *Standard guide for full body spinal immobilization devices characteristics*, ASTM International Std. ASTM F1557).
- [31] "Ferno website," 12 2012. [Online]. Available: www.ferno.com
- [32] "Iron duck website," 12 2012. [Online]. Available: www.ironduck.com
- [33] N. Slack, S. Chambers, and R. Johnston, *Operations Management*, 5th ed. Prentice Hall, 2007.

A CAD models

As a part of the research prior to this project paper, a CAD model of the existing spineboard (BaXstrap) was made. This was firstly because the only existing digital model of the product was a scan of a spineboard consisting of a number of surfaces that would be difficult to sew together to a massive model. Secondly, the work gave a valuable insight in the geometry of the spineboard. The basis for creating the CAD model are technical drawings generated from the scanned BaXstrap. Since the scan has been modified to contain a number of surfaces that makes the file small enough to work with (about 1400 surfaces), the measurements are not accurate. It is, however, likely that the new model falls in to the required geometry given the tolerances stated in the Laerdal BaXstrap features Figure 13. A real version of the BaXstrap was also used in this work to verify the measurements.

A further purpose of this model is to use it for simulations of a new concept spineboard. The new BaXstrap CAD model can be shelled out to the correct thickness (or thickness variations) and used to create a model of the internal foam filling. This model can in turn be used simulate a deformation-loading graph to be verified with test data from BaXstrap deformation tests. When the simulations of the BaXstrap CAD model match the deformation test data, new simulations can be run for other spineboard designs. The models are shown in the Figure below.



Figure 21: Models of the existing and proposal for new spineboard



B Competitor matrices

This section includes feature matrices of the product lines for the following competitors:

1. Iron Duck
2. Ferno
3. Allied Health Care
4. Rapid Deployment Products
5. EP&R
6. Hartwell Medical

Iron Duck

www.ironduck.com

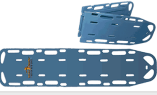

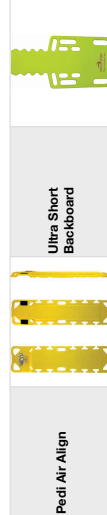

	Pictures	Product Category	Dimensions	Weight [kg]	Price [USD]	Materials	Patents	Production process	Special features / advantages	Disadvantages	Load and torsion	Buoyancy	Translucency	Warranty	Colors and custom logo options
BASE Board		\$ Low Spineboard Fully translucent	1829 406 44	7.3	\$126 w/p (ironduck) \$130 w/p (buy/emp)	HDPE shell, non-toxic Eco-friendly polyurethane foam		Rotomolded shell Foam filled			Load capacity 227 kg	113 kg	100 % x-ray, MRI and CT	4 year warranty	Red Yellow Blue Orange Lime green Olive drab Black Custom print
Ultra Vue	 	Spineboard Fully translucent	1829 406 44	7.3	\$153 w/p (ironduck) \$157 w/p (buy/emp)	HDPE shell, non-toxic Eco-friendly polyurethane foam		Rotomolded shell Foam filled	- 16" or 18" - Available with or without 12 or 22 speed clips	- Flat surface uncomfortable but does not compromise CPR efforts.	Load capacity 453 kg	113 kg	100 % x-ray, MRI and CT		Red Yellow Blue Orange Lime green Olive drab Black Custom print
Ultra Space Save Backboard		Foldable Spineboard Contains metals	1829 406 51 (folded) 914x406x102	8,6	\$353 12p (ironduck) \$330 w/p (buy/emp)	HDPE shell, polyurethane foam, SS mechanical pivot, internal aluminum runners		2 Rotomolded one piece shell	- 12 pediatric child slots - Foldable	*NOTE: As you begin to use this product you are going to notice a slight bow in the board. This feature is designed to be there and is perfectly normal. This bow increases the load capacity of the board and will flatten out then you apply 25 to 30 pounds of weight.	Load capacity 227 kg Minimal deflection at 1000+ lbs	Not given	No		Red Yellow Blue Orange Lime green Olive drab Black Custom print

Other products







Allied Healthcare / Life Support Products

www.alliedhpl.com









	Pictures	Product Category	Dimensions	Weight [kg]	Price [USD]	Materials	Patents	Production process	Special features / advantages	Disadvantages	Load and torsion	Buoyancy	Translucency	Warranty	Colors and custom logo options
XTRA		Spineboard	1803 400 47	6.9	\$151 (lifemedicalsupplier) \$125 (dealmed) \$138 w/p (buyemp)	High density polymer	Patent pending design	Has stiffers outside the handholds	- Zero or 14 pins - 100 % recyclable (so what is the life time?)		Load capacity 227 kg	Claims high buoyancy	Clear center		High visibility yellow Red Orange Blue Custom logo in up to 3 colors (no min. qty)
HDX Best-value		Spineboard	1829 406 38 (incl. runners)	6.2	\$110 w/p (buyemp)	High density polymer			- Zero, 10 or 20 pins - 100 % recyclable (so what is the life time?)		Load capacity 227 kg		Clear center		Yellow Red Orange Blue Custom logo and labeling
Stabilizer		Spineboard	1829 406 57	7.3		High density polyethylene		Thick plastic, manufactured without foam-fill or reinforcement rods	- Internal slots for infant and pediatric immobilization		Load capacity 227 kg				High visibility green Red Blue Pad printed graphics, molded-in logos and labeling
SpinoX		Spineboard	1842 457 64	7.7	\$192 (dealmed) \$215 (buyemp)	High density polyethylene		Plastic shell	- Internal slots for infant and pediatric immobilization		Load capacity 227 kg				High visibility green Red Blue Pad printed graphics, molded-in logos and labeling

Other products





Infant/Pediatric immobilization Board															
Miller Full Body Spino/Liter		LIFE-LITE Emergency Stretcher		Half Back											

Rapid Deployment Products

www.prolitespineboards.com





	Pictures		Product Category	Dimensions	Weight [kg]	Price [USD]	Materials	Patents	Production process	Special features / advantages	Disadvantages	Load and torsion	Buoyancy	Translucency	Warranty	Colors and custom logo options
Rescue Pad			Spineboard Padding	1889 452 80	6,6 6,3 without padding	\$268 (alimed) \$250 padded w/p \$48 replacement pad (buymed)	Plastic shell, foam filling, stiffening rods, speed clips are optional	US 7,028,357 D511,885	Rationally molding Resin transfer molding technique	- Speed clips installs for \$19 - Includes padding - Attachable IV-pole - Extra large handholds	- Unsuitable for use without padding due to beveled edges - Thick - Harder to clean - Log rolling more difficult?	Load capacity 204 kg Max load test 635 kg	-Will float extremely large victims» (web)	Clear center	Life time warranty, including warp	Yellow In-mold graphics for fee
XT XT 18			Spineboard	1829 407 57	6,3 (7,3 for 18")	\$183 (if medical/supplier) \$186 w/p (buymed)				- Available in 16" or 18" - Speed clips optional	- Less colors for 18" board	Load capacity 453 kg	113 kg	Clear center	Life time warranty, including warp	White Orange Red Neon Yellow Neon Green Black Blue Non-veft. black for TEMS Custom colors for fee In-mold graphics for fee
Pro Eco			Spineboard	1829 407 57	7,2	\$124 (if medical/supplier) \$145 w/p (buymed)				- Speed clips optional		Load capacity 453 kg	113 kg	Clear center	4 year warranty, including warp	Neon yellow Custom colors for fee In-mold graphics for fee
Pro Lite			Spineboard	1829 407 57	6,4	\$149 (3+ units) \$255 (medical/supplier) \$275 (if medical/supplier) \$197 w/p (buymed)				- Compatible to all head immobilization devices - Natural curvature	- Pediatric system is a different board	Load capacity 453 kg	113 kg	Clear center	Life time warranty, including warp	White Orange Red Neon Yellow Neon Green Black Blue Custom color for fee
Pro Slide			Great for transfer	1829 407 80	2,7		HDPE Anti-Static Plastic							Clear center	Life time warranty, including warp	Custom graphics for fee

Other products

			
Pro Slide Pediatric	Pedi Light	Speedboard	DragOne Board
AMP Carrier			

Emergency Products Research

www.epandf.com

	Pictures	Product Category	Dimensions	Weight [kg]	Price [US\$]	Materials	Patents	Production process	Special features / advantages	Disadvantages	Load and torsion	Buoyancy	Translucency	Warranty	Colors and custom logo options
Bak-Pak II		Spineboard	1829 406 29	5.2	\$195 (buyemp)	LLD polyethylene construction Foam filled		Rotationally molded	- Thin - Translucent		Load capacity 204 kg		100 % x-ray translucent	Life time warranty	Tactical black Burgundy Lime green Orange Cool white Blue Kelly green Olive drab Red Yellow
Bak-Pak Ultra		Spineboard	1829 406 44 overall (19 middle)	4.5	\$214 w/p (poolcenter) \$212 w/p (code=2) \$199 w/s (litemedsupplie r)	Carbon fiber stiffers in hand Shell: IMDPE			- Fits pediatric patients - Board of choice for the U.S Military (epandf.com) - Thinnest, stacks two in 3 in.		Load capacity 204 kg Max load test 635 kg		Clear center section, x-ray compatible	Life time warranty	Custom graphics Tactical black Burgundy Lime green Orange Cool white Blue Kelly green Red Yellow
Maxi-Wide		18" wide Spineboard	1854 457 44	6.3	\$195 with pins	MDPE plastic Foam filled Stiffeners			- EP&F can offer a wide product		Load capacity 453 kg				Custom graphics Tactical black Burgundy Lime green Orange Cool white Blue Kelly green Olive drab Red Yellow
MC-Pak Their newest product		\$ Low Spineboard	1829 406 51)	7.7	\$189 (crestlinecoach) \$100 (bpmedsupplie rs)				- All strength in shell, no stiffers - Child slots - Pins in all boards	- 8 pins ok?	Load capacity 272 kg		100 % x-ray translucent	90 day warranty	Flourescent green

	Pictures	Product Category	Dimensions	Weight [kg]	Price [USD]	Materials	Patents	Production process	Special features / advantages	Disadvantages	Load and torsion	Buoyancy	Translucency	Warranty	Colors and custom logo options
CombiCarrier II		Scoop stretcher Backboard	1867 419 56	7,1	>\$700 \$900 \$756 \$784 (crestlinecoach) (buyemp)	Shell: High Density Polyethylene Pins: Fiberglass Filling: Urethane Foam Latches:	Patient Carrier 5,765,243 (1998)	Rotational molding, foam filling [patent]	Splitting, less movement of patient.	Lower load capacity. No information regarding compatibility	Load capacity 205 kg.	Yes, undefined	Clear center section, x-ray compatible	5 years all damages. For disposable and soft goods 90 days.	Green

