



Norwegian University of  
Science and Technology

# Tradeoffs between a 2+1 Lane Road Design and a Narrow 2+2 Lane Road Design

**Lars Hissingby Trandem**

Civil and Environmental Engineering

Submission date: June 2016

Supervisor: Kelly Pitera, BAT

Norwegian University of Science and Technology  
Department of Civil and Transport Engineering





Report Title: Tradeoffs between a 2+1 Lane Road Design and a Narrow 2+2 Lane Road Design	Date: 10.06.2016		
	Number of pages (incl. appendices): 169		
	Master Thesis	X	Project Work
Name: Lars Hissingby Trandem			
Professor in charge/supervisor: Kelly Pitera			
Other external professional contacts/supervisors:			

<p><b>Abstract:</b></p> <p>This thesis looks at the tradeoffs between a 2+1 lane road design and a narrow 2+2 lane road design, taking into account elements like design, traffic safety, capacity and level of service, costs and non-monetized impacts. The tradeoffs are discussed through a literature review, level of service calculations according to the Highway Capacity Manual and a case study examining a narrow 2+2 road configuration built within Norway.</p> <p>The results of this research indicate that when considering safety alone, the 2+1 lane road design has a slight advantage over the narrow 2+2 lane road design regarding traffic safety because of wider lanes and shoulders, assumed lower mean speed and possibly less rutting. The size of the presumed safety advantage is not possible to quantify from the content of this thesis.</p> <p>Focusing on capacity and level of service, the narrow 2+2 lane road design provides higher capacity than what the 2+1 lane road design can offer. Whether the higher capacity and level of service make the narrow 2+2 lane road design more economical beneficial (as part of a benefit cost analysis) than the 2+1 lane road design depend on the expected amount of traffic. As long as the average travel speed, which is dependent on volume, for the 2+1 lane road was not significantly lower than for the narrow 2+2 lane road design, the 2+1 lane road design resulted in the highest benefit-cost ratio for the case scenarios. When it comes to the non-monetized impacts, there are such small differences between the two designs that there is no basis to distinguish them. Other elements like location of the road and route alignment are more likely to have a bigger impact when less than two meters separates the cross section widths.</p>
---

Keywords:

1. 2+1 lane road design
2. Narrow 2+2 lane road design
3. Traffic Safety
4. Capacity and Level of Service

Lars H. Trandem

(sign.)



## Preface

This Master thesis is written at the Norwegian University of Science and Technology, Department of Civil and Transport Engineering. The thesis is written during the spring 2016 and counts for 30 study points. The topic for the thesis was chosen autumn 2015, and throughout the project work that autumn the method and research questions for the master thesis was established.

The thesis is divided into three parts. Part one is the process report which is more or less a traditional master thesis, which purpose is to elaborate the content of the article. Part two is the article “Tradeoffs between a 2+1 Lane Road Design and a Narrow 2+2 Lane Road Design” written by Lars Hissingby Trandem and Kelly Pitera. The paper is made with the purpose of presenting it on the European Transport Conference 2016 in October. Part three consists of the appendixes.

I want to thank my supervisor Kelly Pitera for good supervision, valuable comments and feedback, and contribution to the progress of the work. I am also grateful for the help provided by Anders Straume at SINTEF for giving me access to EFFEKT and an introduction to the program, and Arvid Kr. Sagbakken at Statens vegvesen Region øst for helping me out with information about the E16 - Kløfta-Kongsvinger project.

Trondheim, 10.06.2016

*Lars H. Trandem*

---

Lars Hissingby Trandem



## Summary

This thesis examines whether you can achieve the same positive effect regarding traffic safety, while also increasing the capacity and level of service of the road by building a narrow 2+2 lane road instead of a 2+1 lane road, with minimal increase in construction costs. While the safety, costs and traffic operations aspects of the different road designs are the most important to evaluate, the non-monetized impacts like landscape, local surroundings and outdoor activities, biodiversity, cultural heritage and natural resources are also considered, as is standard in Norwegian consequence analysis methodology.

An extensive literature review was carried out for evaluating different aspects of the 2+1 lane road design and the narrow 2+2 lane road design regarding design, safety, capacity and level of service, monetized impacts and non-monetized impacts. In addition, the methods in Highway Capacity Manual are applied for calculation and evaluation of the level of service, and the program EFFEKT is used to estimate the monetized impacts, in connection with a case study of a project in Norway where a narrow 2+2 lane road configuration has been used.

The overall impression is that the 2+1 lane road design has a slight advantage over the narrow 2+2 lane road design regarding traffic safety because of wider lanes and shoulders, assumed lower mean speed and possibly less rutting. The size of the presumed safety advantage is not possible to quantify from the content of this thesis.

Based on the findings presented in this thesis the capacity and level of service provided by the narrow 2+2 lane road design is higher than what the 2+1 lane road design can offer. Whether the higher capacity and level of service make the narrow 2+2 lane road design more economical beneficial than the 2+1 lane road design seems to depend on the expected amount of traffic. As long as the average travel speed for the 2+1 lane road was not significantly lower than for the narrow 2+2 lane road, the 2+1 lane road design scored the highest benefit-cost ratio for the case scenarios. When it comes to the non-monetized impacts it seems to be so small differences between the two designs that there is no basis to distinguish them. Other elements like location of the road and route alignment are more likely to have a bigger impact when less than two meters separates the cross section widths.





## Sammendrag

Denne masteroppgaven ser på om det er mulig å oppnå de samme positive effektene for trafiksikkerhet, og samtidig oppnå bedre kapasitet og trafikkflyt ved å bygge en smal 2+2-felts veg istedenfor en 2+1-felts veg, til en liten økning i konstruksjonskostnadene. Ved siden av trafiksikkerhet, kapasitet og operasjonelle ytelser, og kostnader som er ansett som de viktigste områdene, vil de ikke-prissatte konsekvensene som landskapsbilde, nærmiljø og friluftsliv, naturmangfold, kulturmiljø og naturressurser bli vurdert.

For å vurdere de ulike aspektene ved 2+1 designet og det smale 2+2 designet er det utført et omfattende litteraturstudium. I tillegg til litteraturstudiet er Highway Capacity Manual og metodene som er beskrevet der benyttet til å beregne service nivået (level of service) til de to designene, og programmet EFFEKT er brukt til å estimere de prissatte konsekvensene i forbindelse med en case studie av et prosjekt i Norge hvor den smale firefelts løsningen er testet ut.

Helhetsinntrykket tilsier at 2+1 designet er noe sikrere enn den smale 2+2 løsningen på grunn av bredere kjørebane og skuldre, antatt lavere gjennomsnittshastighet og mindre spordannelse. Det er ikke mulig å kvantifisere dette overtaket ut fra innholdet i denne oppgaven.

Funnene tilsier at kapasiteten og service nivået (level of service) for den smale 2+2-felts løsningen bedre enn hva 2+1-felts løsningen kan tilby. Om den økte kapasiteten og høyere service nivåer gjør det smale 2+2-felts designet mer økonomisk lønnsomt enn 2+1-felts løsningen ser ut til å avhenge av den forventede trafikkmengden. Så lenge gjennomsnittshastigheten for 2+1-felts løsningen ikke var betraktelig lavere enn hva som var tilfellet for den smale 2+2-felts løsningen, gav 2+1-felts løsningen høyest netto nytte per budsjettkrone for case studie scenarioene.

De ikke-prissatte konsekvensen virket å være mer avhengig av vegens plassering i terrenget, linjevalg og området rundt vegen, enn selve bredden på tverrsnittet. Siden det skiller i underkant av to meter mellom bredden på tverrsnittet for de to løsningene, ble det vurdert til at forskjellen var for liten til å kunne skille de to designene fra hverandre med tanke på de ikke-prissatte konsekvensene.



# TABLE OF CONTENTS

<b>PREFACE</b>	<b>III</b>
<b>SUMMARY</b>	<b>V</b>
<b>SAMMENDRAG</b>	<b>VII</b>
<b>TABLE OF CONTENTS</b>	<b>IX</b>
<b>LIST OF FIGURES</b>	<b>XII</b>
<b>LIST OF TABLES</b>	<b>XIV</b>
<b>LIST OF ATTACHMENTS</b>	<b>XVI</b>
<b>PART 1 PROCESS REPORT</b>	<b>1</b>
<b>1 INTRODUCTION</b>	<b>3</b>
1.1 Background	3
1.2 Motivation and Research Questions	4
1.3 Outline	5
<b>2 METHOD</b>	<b>7</b>
2.1 Literature	7
2.2 Calculating Level of Service	8
2.3 Case Study and EFFEKT	9
<b>3 THEORETICAL BACKGROUND</b>	<b>11</b>
3.1 Design	11
3.1.1 2+1 Lane Road Design	11
3.1.2 Narrow 2+2 Lane Road Design	15

<b>3.2</b>	<b>Traffic Safety</b>	<b>17</b>
3.2.1	Accident Types and Statistics	18
<b>3.3</b>	<b>Capacity and Level of Service</b>	<b>24</b>
3.3.1	Uninterrupted-flow Facilities and Interrupted-flow Facilities	25
3.3.2	Capacity	25
3.3.3	Quality of Service and Level of Service	26
3.3.4	Freeway Facilities	26
3.3.5	Two-lane Highways	34
3.3.6	Results from Other Research	36
<b>3.4</b>	<b>Non-monetized Impacts</b>	<b>39</b>
3.4.1	What Factors Seems to Influence the Non-monetized Impacts?	41
<b>3.5</b>	<b>Monetized Impacts</b>	<b>42</b>
<b>4</b>	<b>CALCULATIONS AND FINDINGS</b>	<b>43</b>
<b>4.1</b>	<b>Traffic Safety</b>	<b>43</b>
4.1.1	Lane and Shoulder Width	43
<b>4.2</b>	<b>Capacity and Level of Service</b>	<b>46</b>
4.2.1	An Analysis of the Level of Service of a Narrow 2+2 Lane Road Design	46
4.2.2	An Analysis of the Level of Service of a 2+1 Lane Road Design	62
4.2.3	Comparing the Narrow 2+2 Lane Road and the 2+1 Lane Road Results	87
<b>4.3</b>	<b>Operation, Maintenance and Rutting</b>	<b>88</b>
<b>5</b>	<b>CASE STUDY</b>	<b>91</b>
<b>5.1</b>	<b>E16 Kløfta-Kongsvinger</b>	<b>91</b>
<b>5.2</b>	<b>EFFEKT</b>	<b>97</b>
5.2.1	Project Data	98
5.2.2	Road Network Data	99
5.2.3	Results	103
<b>6</b>	<b>DISCUSSION AND CONCLUSION</b>	<b>109</b>
<b>6.1</b>	<b>Traffic Safety</b>	<b>109</b>
<b>6.2</b>	<b>Capacity and Level of Service</b>	<b>110</b>

<b>6.3 Recommendations</b>	<b>111</b>
<b>6.4 Conclusion</b>	<b>112</b>
<b>BIBLIOGRAPHY</b>	<b>114</b>
<b>PART 2 SCIENTIFIC PAPER</b>	<b>117</b>
<b>PART 3 APPENDIXES</b>	<b>137</b>

# List of Figures

FIGURE 1: CROSS SECTION OF A 2+1 LANE ROAD, NORWAY. POSTED SPEED LIMIT OF 90 KM/H AND INTENDED USED FOR AADT 6 000 - 12 000. .... 12

FIGURE 2: ALTERNATING MIDDLE LANE. THE PICTURE IS RETRIEVED FROM (POTTS & HARWOOD, 2003, P. 3)..... 12

FIGURE 3: PASSING LANE. THE PICTURE IS RETRIEVED FROM (STATENS VEGVESEN, 2014F P. 69) ..... 14

FIGURE 4: CROSS SECTION OF THE NARROW 2+2 LANE ROAD. POSTED SPEED LIMIT OF 90 KM/H AND INTENDED USED FOR AADT 8 000 - 12 000. .... 15

FIGURE 5: HOW THE DESIGN OF A 2+2 LANE ROAD WORKS. (BAGDADE, NABORS, MCGEE, MILLER, & RETTING, 2012, P. 18)..... 16

FIGURE 6: ROAD CLASS H6, NATIONAL MAIN ROADS AND OTHER MAIN ROADS, AADT >12 000 AND SPEED LIMIT 60 KM/H. THE PICTURE IS RETRIEVED FROM (STATENS VEGVESEN, 2014B P. 50). .... 16

FIGURE 7: ROAD CLASS H7, NATIONAL MAIN ROADS AND OTHER MAIN ROADS, AADT>12 000 AND SPEED LIMIT 80 KM/H. THE PICTURE IS RETRIEVED FROM (STATENS VEGVESEN, 2014B P. 53). .... 16

FIGURE 8: ROAD CLASS H8, NATIONAL MAIN ROADS AND OTHER MAIN ROADS, AADT 12 000 - 20 000 AND SPEED LIMIT 100 KM/H. THE PICTURE IS RETRIEVED FROM (STATENS VEGVESEN, 2014B P. 55). .... 17

FIGURE 9: ROAD CLASS H9, NATIONAL MAIN ROADS AND OTHER MAIN ROADS, AADT>20 000 AND SPEED LIMIT 100 KM/H. THE PICTURE IS RETRIEVED FROM (STATENS VEGVESEN, 2014B P. 57). .... 17

FIGURE 10: BASIC FREEWAY SEGMENT. THE PICTURE IS RETRIEVED FROM (TRANSPORTATION RESEARCH BOARD, 2000 P. 13-2)..... 28

FIGURE 11: LOS A. THE PICTURE IS RETRIEVED FROM (TRANSPORTATION RESEARCH BOARD, 2010 P. 11-5) ..... 30

FIGURE 12: LOS B. THE PICTURE IS RETRIEVED FROM (TRANSPORTATION RESEARCH BOARD, 2010 P. 11-5) ..... 31

FIGURE 13: LOS C. THE PICTURE IS RETRIEVED FROM (TRANSPORTATION RESEARCH BOARD, 2010 P. 11-5) ..... 31

FIGURE 14: LOS D. THE PICTURE IS RETRIEVED FROM (TRANSPORTATION RESEARCH BOARD, 2010 P. 11-5) ..... 32

FIGURE 15: LOS E. THE PICTURE IS RETRIEVED FROM (TRANSPORTATION RESEARCH BOARD, 2010 P. 11-5) ..... 32

FIGURE 16: LOS F. THE PICTURE IS RETRIEVED FROM (TRANSPORTATION RESEARCH BOARD, 2010 P. 11-5) ..... 33

FIGURE 17: LOS CRITERIA FOR TWO-LANE HIGHWAYS. THE PICTURE IS RETRIEVED FROM (TRANSPORTATION RESEARCH BOARD, 2010 P. 15-7)..... 35

FIGURE 18: REGULAR AND NARROW DESIGN. THE PICTURE IS RETRIEVED FROM (NG & SMALL, 2012 P. 1266).....	36
FIGURE 19: COMPARISON OF LEVEL OF SERVICE ANALYSIS RESULTS. THE PICTURE IS RETRIEVED FROM (POTTS & HARWOOD, 2003 P. 26).....	38
FIGURE 20: IMPACT ASSESSMENT. ADAPTED FROM (STATENS VEGVESEN, 2014G P. 51) .....	39
FIGURE 21: COMPILATION OF THE NON-MONETIZED IMPACTS. THE PICTURE IS RETRIEVED FROM (STATENS VEGVESEN, 2007 P. 53).....	41
FIGURE 22: METHODOLOGY FOR CALCULATING LOS FOR A BASIC FREEWAY SEGMENT. ADJUSTED FROM (TRANSPORTATION RESEARCH BOARD, 2010 P. 11-10).....	47
FIGURE 23: CROSS SECTION OF THE NARROW 2+2 LANE ROAD. ....	48
FIGURE 24: SPEED FLOW CURVES FOR BASIC FREEWAY SEGMENTS UNDER BASE CONDITIONS. THE PICTURE IS RETRIEVED FROM (TRANSPORTATION RESEARCH BOARD, 2010 P. 11-3)..	51
FIGURE 25: LOS CRITERIA FOR BASIC FREEWAY SEGMENTS. THE PICTURE IS RETRIEVED FROM (TRANSPORTATION RESEARCH BOARD, 2010 P. 11-7).....	61
FIGURE 26: ROAD CLASS H5, NATIONAL MAIN ROADS AND OTHER MAIN ROADS, AADT 6 000 - 12 000 AND SPEED LIMIT 90 KM/H. THE PICTURE IS RETRIEVED FROM (STATENS VEGVESEN, 2014B P. 47).....	62
FIGURE 27: METHODOLOGY FOR CALCULATING LOS FOR A TWO-LANE HIGHWAY WITH PASSING LANE. ADJUSTED FROM (TRANSPORTATION RESEARCH BOARD, 2010 P. 15-13) ..	63
FIGURE 28: CROSS SECTION OF 2+1 LANE ROAD.....	64
FIGURE 29: THE EFFECT OF A PASSING LANE ON PERCENT TIME-SPENT FOLLOWING. THE PICTURE IS RETRIEVED FROM (TRANSPORTATION RESEARCH BOARD, 2010 P. 15-29). ....	80
FIGURE 30: THE EFFECT ON PTSF FROM THE PASSING LANE. THE PICTURE IS RETRIEVED FROM (TRANSPORTATION RESEARCH BOARD, 2010 P.15-31).....	83
FIGURE 31: THE IMPACT OF A PASSING LANE ON AVERAGE TRAVEL SPEED. THE PICTURE IS RETRIEVED FROM (TRANSPORTATION RESEARCH BOARD, 2010 P. 15-32).....	85
FIGURE 32: THE LOCATION OF THE E16 PROJECT BETWEEN KLØFTA AND KONGSVINGER. THE PICTURE IS ADJUSTED FROM ("E16 KLØFTA-KONGSVINGER [PICTURE]," 2016; "GOOGLE.MAPS [PICTURE]," 2016; "NORTHERN EUROPE [PICTURE]," 2016).....	91
FIGURE 33: TWO-LANE ROADWAYS WITH DIFFERENT PASSING LANE FREQUENCY. THE PICTURE IS RETRIEVED FROM (POTTS & HARWOOD, 2003, P. 21).....	92
FIGURE 34: A PICTURE OF E16 BETWEEN KLØFTA AND NYBAKK. THE PICTURE IS RETRIEVED FROM ("GOOGLE.MAPS [PICTURE]," 2016).....	93
FIGURE 35: EVALUATION OF THE PROJECT KLØFTA-NYBAKK, SEEN IN THE LIGHT OF THE WHOLE PROJECT KLØFTA-KONGSVINGER. THE PICTURE IS RETRIEVED FROM (SOLLI & BETANZO, 2015 P. VII) .....	94
FIGURE 36: COMPARISON OF THE COST PER METER FOR KLØFTA-NYBAKK WITH THE AVERAGE COST PER METER FOR OTHER ROAD CLASSES. THE PICTURE IS RETRIEVED FROM (SOLLI & BETANZO, 2015 P. 24).....	95

FIGURE 37: THE OLD ROAD (BLUE) AND THE NEW ROAD (GREEN) BETWEEN KLØFTA AND NYBAKK. THE PICTURE IS ADJUSTED FROM VEGKART (STATENS VEGVESEN, 2016D). .....	97
FIGURE 38: SIMPLIFIED ROAD SYSTEM USED IN EFFEKT. ....	98
FIGURE 39: THE DESIGN OF THE ROAD THAT IS ALTERNATIVE 0. THE PICTURE IS RETRIEVED FROM (STATENS VEGVESEN, 2007 P. 15).....	99
FIGURE 40: NUMBER OF ACCIDENTS WITH PERSON INJURIES FOR THE STRETCH BETWEEN KLØFTA AND KONGSVINGER FROM 1996 TO 2014. THE PICTURE IS RETRIEVED FROM (SOLLI & BETANZO, 2015 P. 36) .....	99
FIGURE 41: THE CROSS SECTION DESIGN OF ALTERNATIVE 1.....	100
FIGURE 42: 2+1 LANE ROAD DESIGN.....	101

## List of Tables

TABLE 1: THE DATA IN THE TABLE ARE TAKEN FROM POTTS AND HARWOOD (2003), EXCEPT THE VALUES FOR NORWAY WHICH ARE FOUND IN THE NORWEGIAN STANDARD FOR ROAD AND STREET DESIGN (STATENS VEGVESEN, 2014B). ....	13
TABLE 2: SHOWS THE PERCENTAGE OF PEOPLE KILLED, SERIOUSLY INJURED AND MINOR INJURED FOR HEAD-ON COLLISIONS AND RUN-OFF-ROAD CRASHES. (HØYE ET AL., 2014) 18	
TABLE 3: THE EXPECTED CHANGE IN KAB CRASHES WHEN REBUILDING DIFFERENT ROAD DESIGNS INTO A NARROW 2+2 LANE ROAD. ....	44
TABLE 4: INPUT DATA IN METRIC VALUES AND U.S. CUSTOMARY UNITS, AND THE CORRESPONDING FFS ADJUSTMENT FACTORS. ....	50
TABLE 5: THE CALCULATED DEMAND VOLUMES FOR AADT 6 000, 12 000 AND 20 000.....	54
TABLE 6: THE CALCULATED HEAVY-VEHICLE ADJUSTMENT FACTOR FOR 10% AND 15% HEAVY VEHICLES.....	56
TABLE 7: VALUES FOR DEMAND FLOW RATE ( $V_p$ ) VARYING DEPENDING OF THE INPUT FACTORS. THE VALUES FOR $V_p$ ARE ACHIEVED BY USING EQUATION 4. THE PROPORTION OF THE PEAK-HOUR VOLUME TRAVELLING IN THE PEAK DIRECTION IS ASSUMED TO BE 67%.....	57
TABLE 8: VALUES FOR DEMAND FLOW RATE ( $V_p$ ) VARYING DEPENDING OF THE INPUT FACTORS. THE VALUES FOR $V_p$ ARE ACHIEVED BY USING EQUATION 4. THE PROPORTION OF THE PEAK-HOUR VOLUME TRAVELLING IN THE PEAK DIRECTION IS ASSUMED TO BE 55%.....	58
TABLE 9: THE RELATIONSHIP BETWEEN CAPACITY OF A BASIC FREEWAY SEGMENT AND THE FREE-FLOW SPEED. (TRANSPORTATION RESEARCH BOARD, 2010 P. 11-18) .....	59
TABLE 10: VALUES FOR THE SPEED(S) DEPENDING ON THE FFS CURVE AND THE DEMAND FLOW RATE ( $V_p$ ). $D = 67%$ .....	60



TABLE 11: VALUES FOR THE SPEED (S) DEPENDING ON THE FFS CURVE AND THE DEMAND FLOW RATE ( $V_p$ ). $D = 55\%$ .....	60
TABLE 12: DENSITY VALUES FOR DIFFERENT DEMAND FLOW RATES AND SPEEDS. $D=67\%$ . ....	60
TABLE 13: DENSITY VALUES FOR DIFFERENT DEMAND FLOW RATES AND SPEEDS. $D=55\%$ . ....	60
TABLE 14: LEVEL OF SERVICE FOR DIFFERENT SPEEDS AND DEMAND FLOW RATE. $D = 67\%$ ....	61
TABLE 15: LEVEL OF SERVICE FOR DIFFERENT SPEEDS AND DEMAND FLOW RATE. $D = 55\%$ ....	61
TABLE 16: VALUES FOR THE 1 LANE DIRECTION.....	66
TABLE 17: DEMAND VOLUMES FOR ANALYSIS DIRECTION AND OPPOSING DIRECTION FOR DIFFERENT AADT VALUES.....	68
TABLE 18: VALUES FOR ONE-DIRECTION DEMAND FLOW RATE FOR DIFFERENT AADT VALUES. ....	69
TABLE 19: GRADE ADJUSTMENT FACTORS FOR AVERAGE TRAVEL SPEED.....	69
TABLE 20: $E_{T,D}$ AND $E_{T,O}$ FOR THE DIFFERENT AADT VALUES. ....	70
TABLE 21: HEAVY VEHICLE ADJUSTMENT FACTORS FOR AVERAGE TRAVEL SPEED. ....	71
TABLE 22: THE DEMAND FLOW RATE FOR AVERAGE TRAVEL SPEED FOR BOTH THE ANALYSIS DIRECTION AND THE OPPOSING DIRECTION, FOR DIFFERENT AADT VALUES.....	71
TABLE 23: THE VALUES FOR $F_{NP,ATS}$ WHEN THE FFS = 60 MI/H AND THERE ARE 100% NO PASSING ZONES. ....	72
TABLE 24: THE AVERAGE TRAVEL SPEED (MI/H) FOR AADT VALUES 6 000, 12 000 AND 20 000... ..	73
TABLE 25: GRADE ADJUSTMENT FACTOR, $F_{G,PTSF}$ .....	74
TABLE 26: PASSENGER CAR EQUIVALENT FOR TRUCKS. ROLLING TERRAIN. ....	75
TABLE 27: HEAVY VEHICLE ADJUSTMENT FACTORS FOR PTSF. ....	75
TABLE 28: THE DEMAND FLOW RATE FOR DETERMINATION OF PTSF (PC/H).....	76
TABLE 29: VALUES FOR THE COEFFICIENTS A AND B.....	77
TABLE 30: VALUES FOR BASE PERCENT TIME-SPENT-FOLLOWING IN THE ANALYSIS DIRECTION ( $BPTSFD$ ).....	78
TABLE 31: ADJUSTMENT FACTOR FOR NO-PASSING-ZONE.....	78
TABLE 32: VALUES FOR PERCENT TIME-SPENT-FOLLOWING (PTSFD).....	78
TABLE 33: AVERAGE TRAVEL SPEED (MI/H) AND PERCENT TIME-SPENT-FOLLOWING (%) IN THE ANALYZE DIRECTION FOR AADT VALUES 6 000, 12 000 AND 20 000.....	79
TABLE 34: LEVEL OF SERVICE FOR A TWO-LANE HIGHWAY WITH NO PASSING LANE. ....	79
TABLE 35: THE DIRECTIONAL DEMAND FLOW RATE, $V_D$ (PC/H) FOR DIFFERENT AADT VALUES. ....	81
TABLE 36: THE EFFECTED DOWNSTREAM LENGTH OF THE ROAD WAY IN MILES FOR DIFFERENT AADT VALUES.....	81
TABLE 37: VALUES OF $F_{PL,PTSF}$ FOR DIFFERENT AADT VALUES. ....	84
TABLE 38: VALUES FOR PERCENT TIME-SPENT-FOLLOWING FOR SEGMENT AS AFFECTED BY THE PRESENCE OF A PASSING LANE. ....	84
TABLE 39: VALUES $F_{PL,ATS}$ FOR DIFFERENT AADT VALUES. ....	86
TABLE 40: VALUES FOR $ATS_{PL}$ .....	86

TABLE 41: SERVICE LEVELS FOR A 2+1 LANE ROAD.....	87
TABLE 42: LEVEL OF SERVICE FOR NARROW 2+2 LANE ROAD AND 2+1 LANE ROAD FOR DIFFERENT AADT VALUES AND DIRECTIONAL SPLITS.....	88
TABLE 43: INPUT DATA AND RESULTS FROM THE «SLITAGEMODELL».....	90
TABLE 44: ARGUMENTS FOR AND AGAINST THE NARROW 2+2 LANE ROAD CONFIGURATION (SOLLI & BETANZO, 2015 P. 28).....	96
TABLE 45: THE ASSUMED EFFECTS FROM THE NARROW 2+2 LANE ROAD DESIGN ON ACCIDENTS.....	100
TABLE 46: THE ASSUMED EFFECTS FROM THE NARROW 2+1 LANE ROAD DESIGN ON ACCIDENTS.....	102
TABLE 47: SCENARIO 1, SUMMARY OF THE RESULTS FROM EFFEKT.....	104
TABLE 48: SCENARIO 2, SUMMARY OF THE RESULTS FROM EFFEKT.....	105
TABLE 49: SCENARIO 3, SUMMARY OF THE RESULTS FROM EFFEKT.....	106

## List of Attachments

APPENDIX 1: TASK DESCRIPTION -----	A
APPENDIX 2: ALTERNATIVE CROSS SECTION DESIGNS -----	E
APPENDIX 3: KAB CRASHES CALCULATIONS -----	H
APPENDIX 4: LEVEL OF SERVICE CALCULATIONS -----	I
APPENDIX 5: RESULTS FROM EFFEKT -----	J
APPENDIX 6: ABSTRACT SUBMITTED FOR THE EUROPEAN TRANSPORT CONFERENCE 2016 -----	N

# PART 1

# PROCESS REPORT



# 1 INTRODUCTION

## 1.1 Background

In Norway, a new, alternative road design consisting of a 16 to 16,5 meter wide cross-section in a 2+2 configuration is being considered to see if it could be an acceptable and feasible solution compared to the more common 2+1 lane road design configuration, in situations where the traffic volume is not high enough to justify the costs of building a normal four-lane road. The practice in Norway is to use the estimated traffic volume 20 years after the predicted opening year as the design value for the road (Statens vegvesen, 2014b). At annual average daily traffic (AADT) 8 000 - 12 000 median barrier is used, and at AADT above 12 000 four-lane road including median with barrier is used (Statens vegvesen, 2011). When looking at the standard road designs in the Norwegian Public Roads Administration's standard for road and street design (Statens vegvesen, 2014b), it seems natural that the 2+1 lane road design and the narrow 2+2 lane road configuration will be relevant in situations where the AADT ranges from 8 000 to 12 000, which also was the intended range when the narrow 2+2 lane road design was first proposed (Statens vegvesen, 2005a). The posted speed limit will be 90 km/h.

The cross section of the 2+1 lane road design consists of in total three lanes, two lanes in one direction and one lane in the opposite direction, divided by a median barrier. The direction of the middle lane is alternating giving both directions, at regular intervals, the advantage of a passing lane. This design is normally used in rural areas with mid-range traffic volumes to prevent head-on accidents and thereby increase the safety of a standard two-lane road. While the 2+1 design with continuously three lanes is widely used in Sweden (Carlsson, 2009), the practice in Norway is to have a cross section varying between two and three lanes (2/3 lane road). The passing lane frequency required is based upon the AADT and given in the Norwegian Public Roads Administration's standard for geometrical design of roads (Statens vegvesen, 2014f).

## 1.2 Motivation and Research Questions

There is interest in examining if you can achieve the same positive effect regarding traffic safety, and also increase the capacity and level of service of the road by building a narrow 2+2 lane road instead of a 2+1 lane road, with minimal increase in construction costs. This assumes that the 2+2 narrow road has a greater capacity than the 2+1 lane road. In addition to the safety, costs and traffic operational aspects of the different road designs the non-monetized impacts like landscape, local surroundings and outdoor activities, biodiversity, cultural heritage and natural resources should also be considered, as is standard in Norwegian consequence analysis methodology.

Therefore in this trade-off analysis between the 2+1 lane road design and the narrow 2+2 lane road configuration the following elements will be addressed:

- Design
- Traffic safety
- Capacity and level of service
- Monetized impacts, and
- Non-monetized impacts

The first three points will be looked into by examining existing research and literature for comparative roadway designs. Then through a case study of the project E16 Kløfta-Kongsvinger, in Norway, where the narrow 2+2 lane road design has been implemented in a trial, the aspects of the monetized and non-monetized impacts will be discussed. A program called EFFEKT that performs benefit-cost analyses for road and transportation projects in Norway will be used in the case study.

Based on the findings in the existing literature and the case study, tradeoffs between the narrow 2+2 lane road and the 2+1 lane road will be discussed and recommendations for the use of such road configurations will be given. In the evaluation of E16 Kløfta-Nybakk performed by Solli and Betanzo (2015), it emerges that the Norwegian Public Roads Administration decided to not continue with the narrow 2+2 lane road configuration. The arguments against the narrow 2+2 lane road design that were listed in the report (Solli & Betanzo, 2015) were that the road could be perceived as a freeway even though it is not designed according to the criteria for a freeway, lead to construction of more four-lane roads

and thereby more intervention in the nature and the landscape, and that other roads where the need for an ordinary four-lane road could be inappropriately scaled down to narrow four-lane road to save money. The opinion among politicians is somewhat opposite. The Minister of Transport and Communications Ketil Solvik-Olsen is more positive to the narrow four-lane road design, because he wants to avoid that 2/3 lane roads need to be upgraded after a few years to a higher cost than what would have been the case if a narrow 2+2 lane road was built in the first place, as reported in the media (Jacobsen, 2015).

### **1.3 Outline**

This master thesis consists of three parts. Part one includes the process report, consisting of six chapters. Part two consists of the paper prepared for the European Transport Conference 2016 and part 3 is the appendix.

#### **Part 1 - Process Report**

##### **Chapter 1- Introduction**

The introduction gives an overview of the background information for this thesis, and defines the scope and motivation for the research.

##### **Chapter 2 - Method**

This chapter gives an overview of the methods used in this thesis and why they are used.

##### **Chapter 3 - Theoretical Background**

Theory and previous research related to the topics of this thesis are presented here.

##### **Chapter 4 - Calculations and Findings**

The level of service calculations performed for the narrow 2+2 lane road design and the 2+1 lane road configuration make up the largest part of this chapter. Also some minor calculations of KAB crashes and rutting depth are presented here.

## Chapter 5 - Case Study

In this chapter the E16 Kløfta-Kongsvinger project is presented together with previous evaluations of the project and the narrow 2+2 lane road design that was tested out. Besides summing up former evaluations, new calculations of the monetized impacts for the 2+1-road and the narrow 2+2-road for different scenarios on the section Kløfta-Nybakk are performed by using EFFEKT.

## Chapter 6 - Discussion and Conclusion

In this chapter the content of chapter 3, 4 and 5 is discussed and conclusions drawn.

## **Part 2 - Scientific Paper**

This part consists of the scientific paper prepared for the European Transport Conference 2016. The paper contains the most important things from part 1, and can be read as a stand-alone document.

## **Part 3 - Appendixes**

Supplementary information can be found in this part. The following documents are attached:

Appendix 1	Task Description
Appendix 2	Alternative Cross Section Designs
Appendix 3	KAB Crashes Calculations
Appendix 4	Level of Service Calculations
Appendix 5	Results from EFFEKT
Appendix 6	Abstract Submitted for the European Transport Conference 2016



## **2 METHOD**

This study is based on examining existing research and literature related to the two road designs, 2+1 lane road and narrow 2+2 lane road, and the topics: design, traffic safety, capacity and level of service, monetized impacts and non-monetized impacts. In addition the program EFFEKT is used for the case study, and the methods in Highway Capacity Manual are applied for calculation and evaluation of the level of service.

The choice of literature review, as the primary method, was based upon the wide scope of this study, and the need for covering a broad area of subjects related to road building. A literature review gives the opportunity to focus on the characteristics of the two designs, and their affect on the addressed subjects in a general way. Each road and transportation project is different, so this overview approach of strength and weaknesses for each of the designs could perhaps provide some guidance for more than one specific situation. Also a full scale test, trying out the two designs would not have been feasible. Instead the choice fell upon including a case study of an already existing trial project in Norway, testing out a narrow 2+2 lane road design, to get some insight in the practical experience with this configuration.

### **2.1 Literature**

The literature review consists of scientific articles, different Norwegian standards related to road and traffic engineering, the Highway Capacity Manual, reports and evaluations associated to the project E16 Kløfta-Kongsvinger, and different web-pages, mainly news and articles on the Norwegian Public Roads Administration's web site. The Norwegian standards are used to relate the tradeoff analysis to Norwegian road building practice. There has also been a focus on finding Norwegian studies regarding the subjects, since these studies mainly use traffic data from Norway, and therefore assumed more suitable and relevant for Norwegian conditions.

The search for literature started out wide, to get an overview of the two designs and which subjects to include in the tradeoff analysis. When the design of the two roadway types were established, information on the subjects design, traffic safety, capacity and level of service, monetized impacts and non-monetized impacts were further examined, since these were the

subjects that were found important for the trade-off analysis. By using search engines as Google, Google Scholar, and Oria which searches through the NTNU libraries printed and electronical collection of books, articles, previous master thesis etc., and the home page of the Transportation Research Board, SINTEF, Institute of Transport Economics and the Norwegian Public Roads Administration, information on the respective subjects were looked into. Typical words that were used in the searches were: safety, lane width, shoulder width, capacity and level of service, mid-barrier, median barrier and 2+1 road. The bibliography of the articles and reports that were found relevant were frequently used to find more literature on the topics. The tradeoff analysis's wide specter of topics creates a huge amount of relevant data. The great amount of available data makes it hard to go thoroughly through all previous research, but the ones found most relevant are mentioned and assumed to capture the main features of the existing research and literature.

It was easier to find information about the 2+1 lane road design than for the narrow 2+2 lane road design. The 2+1 design have been used in countries like Sweden, Germany and Finland, and especially in Sweden the performance of the design has been investigated. The digest from Potts and Harwood (2003) is summing up the practice of 2+1 roads in Europe to look at the possibility to use this design in the United States. When it comes to the narrow 2+2 road, articles about additional lanes and smaller shoulder width and lane width, and the impact of this design features have been tried linked to the narrow 2+2 design.

## **2.2 Calculating Level of Service**

To get insight in the capacity and level of service of the two designs, the latest edition of the Highway Capacity Manual was used. An old Norwegian standard used the Highway Capacity Manual 1985 as basis for evaluating capacity of road stretches, but there was not found any newer Norwegian standards. The method for evaluating level of service is therefore as described in the Highway Capacity Manual 2010. When choosing values for the parameters used in the calculations, the Norwegian conditions and the characteristics of the two designs have been important. Since the 2+1 design does not fit to any of the categories in the Highway Capacity Manual, some adaptations were made to the two-lane highway method, so it could be used for the evaluation of the level of service for the 2+1 lane road design.

### **2.3 Case Study and EFFEKT**

To look at the monetized and non-monetized impacts for the two designs, a case study of the E16 Kløfta-Kongsvinger project was conducted and the program EFFEKT used. EFFEKT is a program that can be used to evaluate the monetized impacts of road and transportation projects. Data from previous and already existing evaluations of the project were used to fill in the required information in EFFEKT. Besides the existing information about the narrow 2+2 lane road design, assumptions and adaptations were made in the program to simulate/create the effects of a 2+1 lane road design. In EFFEKT the 2+1 design is not a standard option, so adjustment and adaptations were made to a normal two-lane road design to make its performance similar to the a 2+1 design. The user manual for the program was used to create the case study project in EFFEKT, get an understanding of the different steps that was required for the calculations and fill in the essential information.



## **3 THEORETICAL BACKGROUND**

### **3.1 Design**

In this chapter the characteristics of the 2+1 lane road design and the 16,5 meter wide 2+2 lane configuration will be given. The features: lane width, shoulder width, design of the cross section, speed limit and the traffic volumes they are intended to serve or serving will be described.

#### **3.1.1 2+1 Lane Road Design**

The experience with three-lane highways in Canada and Germany are that they increase the quality of service and safety for two-lane highways in a cost effective way when the requirements for building a four-lane road is not met, or there are other concerns like costs and environmental issues that prevent the four-lane road as an option. (Frost & Morrall, 1998)

When looking at the tradeoffs between a narrow 2+2 road and a 2+1 road solution the design of the cross section of the 2+1 road is defined as in Figure 1. The design of the cross section is given in the Norwegian Public Roads Administration's standard for road and street design (Statens vegvesen, 2014b). It is road class H5, National main roads and other main roads, AADT 6 000-12 000 and speed limit 90 km/h with an overtaking lane. Since this is the current standard for building a road with three lanes in Norway there are not done any modifications to this design. If there is interest in developing a new 2+1 lane road design to be used in Norway the most common Swedish designs, which can be found in Appendix 2, should be considered.

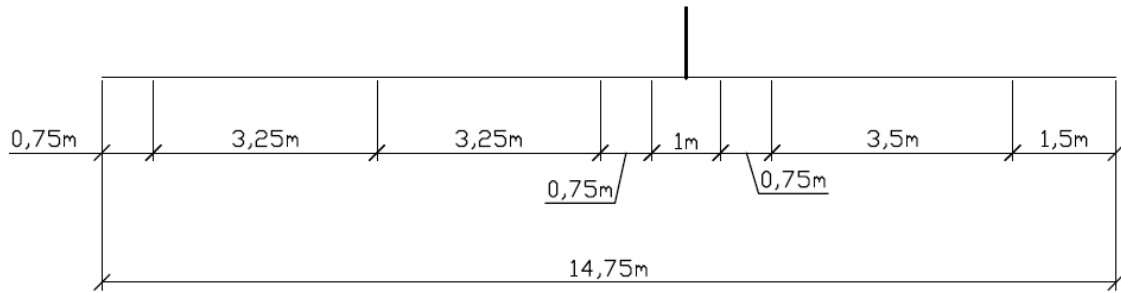

*Figure 1: Cross section of a 2+1 lane road, Norway. Posted speed limit of 90 km/h and intended used for AADT 6 000 - 12 000.*

How the 2+1 lane road design works can be seen in Figure 2. The direction of the middle lane is alternating giving both directions, at regular intervals, the advantage of a passing lane.

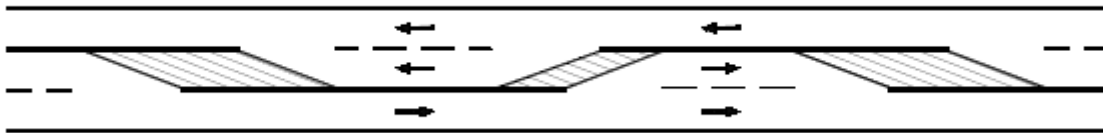

*Figure 2: Alternating middle lane. The picture is retrieved from (Potts & Harwood, 2003, p. 3)*

The 2+1 lane road design is used, among others countries, in Germany, Sweden and Finland (Potts & Harwood, 2003). Characteristics regarding the 2+1 lane road design for those countries are given in the “Research Results Digest, Application of European 2+1 Roadway Designs” (Potts & Harwood, 2003). The findings in the digest are further summarized and presented in Table 1 to give a more extensive description of the 2+1 lane road design and other countries experience and use of it.

Table 1: The data in the table are taken from Potts and Harwood (2003), except the values for Norway which are found in the Norwegian standard for road and street design (Statens vegvesen, 2014b).

Country	The amount of 2+1 roads [km]	Length of passing lane [km]	Width of cross section [m]	Median barrier [Yes/No]	Speed limit [km/h]	Traffic volume [veh/day]	Maximum traffic volume observed [veh/day]	Estimated capacity [veh/h] in one direction
Germany	>360	1-2	11-12	No	100 70 (interchange, intersection)	8 000 - 22 000	30 000	-
Sweden	>400	1-2	13-14	Yes	90-110 (cars) 80 (trucks)	4 000 - 20 000	-	1 600- 1 700  1 300-1 400 (good LOS)
Finland	48	1,5	13-15	No, but considering.	100 (cars) 80 (trucks)	14 000	20 000 - 25 000	1 500-1 600
Norway (2/3-lane road)	-	≥ 1	14,75	Yes	90	6 000 -12 000	-	-

### 3.1.1.1 Design of the Passing Lane

The minimum length for the passing lane is given in the Norwegian standard for geometric design of roads (Statens vegvesen, 2014f), and can be seen in Figure 3. From Table 1 it can be seen that the length of the passing lane are somewhere between 1-2 km for the included countries. The optimal length of the passing lane is dependent on the demand flow rate (pc/h). As the traffic volume increases the optimal length of the passing lane increases (Transportation Research Board, 2010). For this tradeoff analysis a length of 1,5 km will be assumed for the passing lane, since that is the middle value of the range, and therefore assumed suitable for AADT 8 000-12 000.

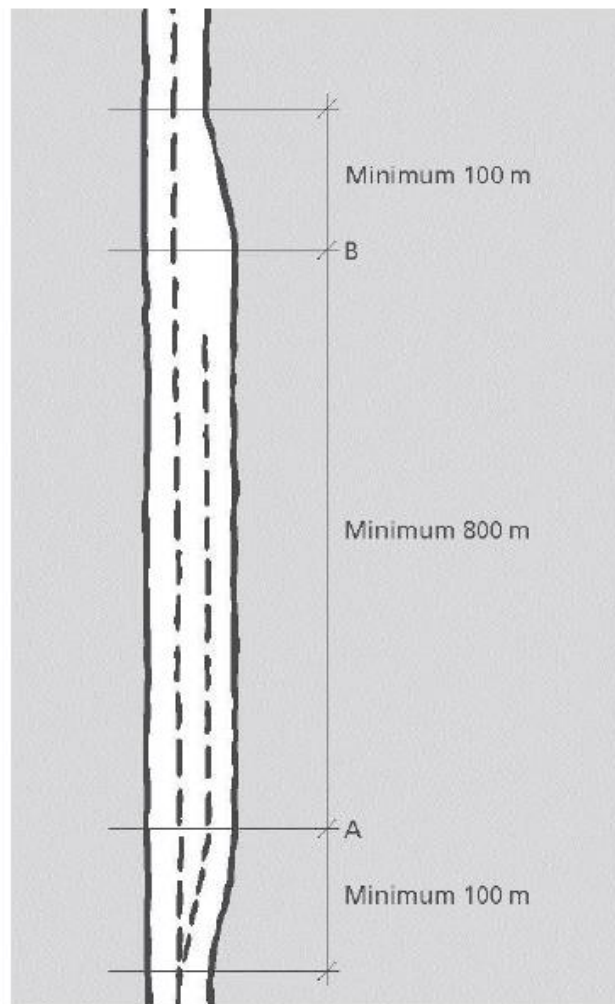

Figure 3: Passing lane. The picture is retrieved from (Statens vegvesen, 2014f p. 69)



### 3.1.2 Narrow 2+2 Lane Road Design

The cross section of the narrow 2+2 lane road design is defined as in Figure 4, and Figure 5 shows how the design works. This design has been chosen as the basis for the narrow 2+2 lane road design, because it has been tried out in a road project in Norway between Slomarka and Kongsvinger, and just a 0,5 meter narrower design is used for the section Kløfta-Nybakk. A more thorough description of that project will be given in Chapter 5. The narrow 2+2 lane road design is intended to serve an annual average daily traffic around 8 000 to 12 000, and have a speed limit of 90 km/h.

When looking into the Norwegian standard for road and street design (Statens vegvesen, 2014b), and the road classes given there, there seems to be hard to do any big changes to the 16,5 meter wide cross section. The road must be dimensioned for heavy vehicles with length = 22 meters, width = 2,6 meters and turn radius = 12,5 meters. With a lane width of 3,25 meters the heavy vehicles would have a lateral clearance of 32,5 centimeter on each side, less when including the side mirrors, so reducing the lane width any further than 3,25 meters is not an option. When looking at the shoulder widths, none of the road classes in the standard have a shoulder width that is less than 0,75 meter. Reducing the shoulder width would most likely influence the traffic safety and lifetime of the pavement. The vertical stress under the base and the sub-base layer increases as the load is closer towards the pavement edge (Aksnes, Hoff, & Mork, 2002). To reduce pavement edge damages and profit from longer lifetime and less maintenance the recommendations are to use about one meter wide shoulders (Aksnes et al., 2002).

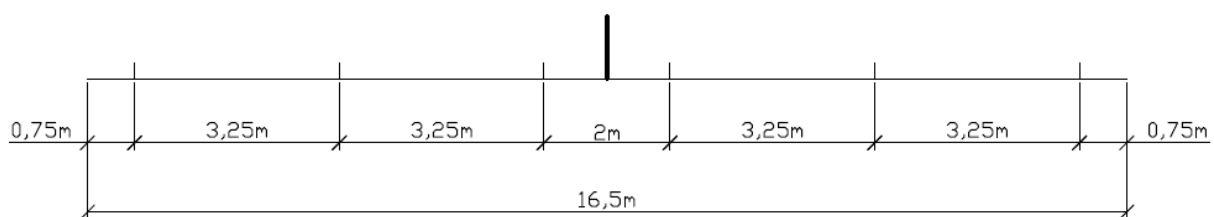

*Figure 4: Cross section of the narrow 2+2 lane road. Posted speed limit of 90 km/h and intended used for AADT 8 000 - 12 000.*

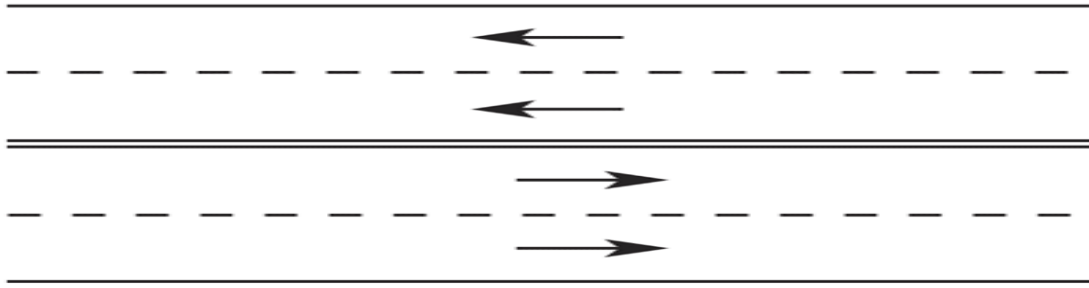

Figure 5: How the design of a 2+2 lane road works. (Bagdade, Nabors, McGee, Miller, & Retting, 2012, p. 18)

The four-lane road designs found in the Norwegian standard for road and street design are shown in Figure 6, Figure 7, Figure 8 and Figure 9. The existing four-lane roads which have a higher speed limit than 60 km/h are wider than the narrower trial design. Some Swedish cross section designs for 15-17 meter wide four-lane roads can be found in Attachment 2.

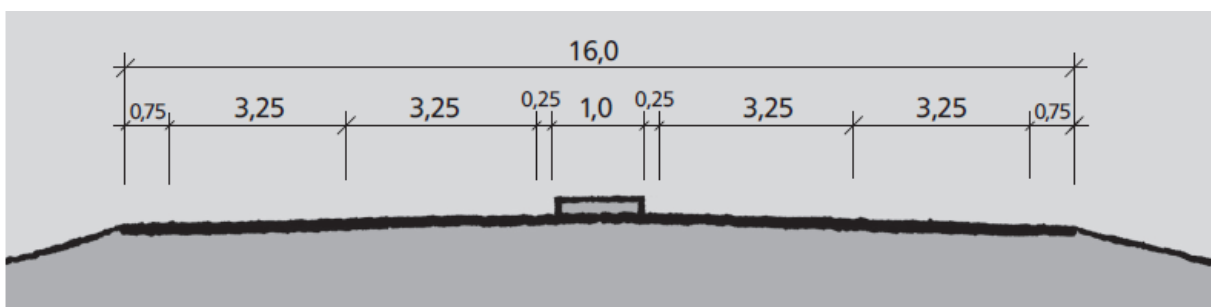

Figure 6: Road class H6, National main roads and other main roads, AADT >12 000 and speed limit 60 km/h. The picture is retrieved from (Statens vegvesen, 2014b p. 50).

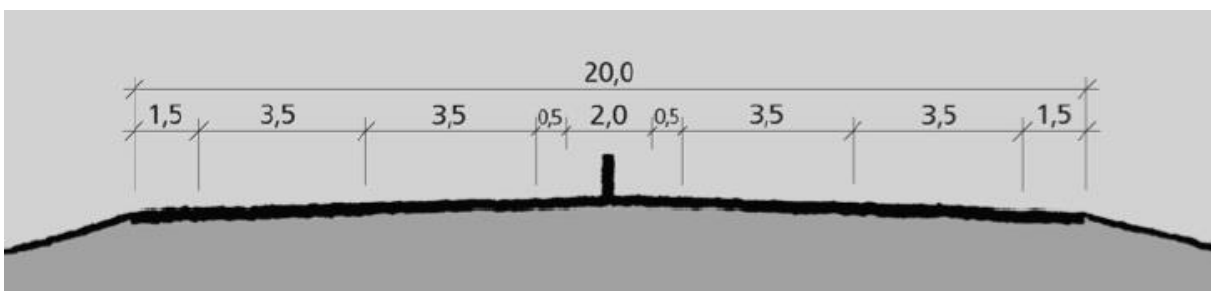

Figure 7: Road class H7, National main roads and other main roads, AADT >12 000 and speed limit 80 km/h. The picture is retrieved from (Statens vegvesen, 2014b p. 53).

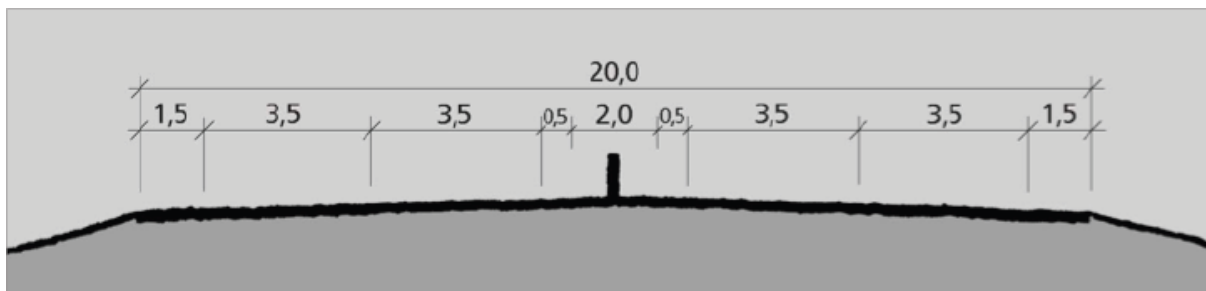

Figure 8: Road class H8, National main roads and other main roads, AADT 12 000 - 20 000 and speed limit 100 km/h. The picture is retrieved from (Statens vegvesen, 2014b p. 55).

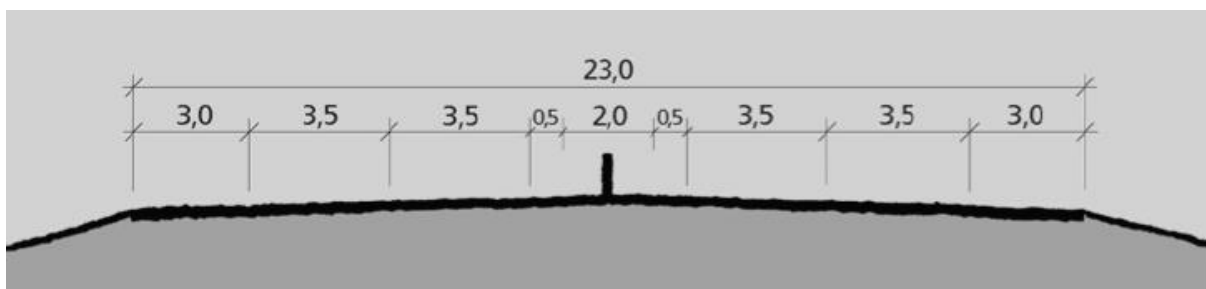

Figure 9: Road class H9, National main roads and other main roads, AADT > 20 000 and speed limit 100 km/h. The picture is retrieved from (Statens vegvesen, 2014b p. 57).

### 3.2 Traffic Safety

Traffic safety is an important part of the policy in Norway, and since 1970 there have been taken measures to reduce the number of people killed in traffic. The goal is to achieve zero people killed or seriously injured in traffic, called “vision zero” (Statens vegvesen, 2010). To reach this goal the transport system, the vehicles and the regulations for behavior have to be made in such a way that they increase the safety (Statens vegvesen, 2010). The traffic safety work can be divided into two parts. Part one is to prevent unwanted actions that create accidents, and part two is to create barriers so the consequence of an accident is reduced if it first were to occur (Løtveit, 2012). An example of the first part is training, while for the second part median barrier and reduced speed are good examples (Løtveit, 2012). When evaluating the two designs in this trade-off analysis the focus will be on barriers reducing the consequence.

Both the ethical aspect and the costs related to traffic accidents makes traffic safety a very important subject in the tradeoff analysis between the 2+1 lane road design and the narrow 2+2 lane road design, and are further discussed in this chapter.

### 3.2.1 Accident Types and Statistics

Haldorsen (2015) looked at the fatal accidents in Norway in the period from 2005-2014. The findings shows that 37% of all the fatal accidents are head-on collisions and that 40% of the people killed in traffic are killed in head-on collisions (Haldorsen, 2015). The second highest accident type that is represented is run-off-road crashes, showing that 34% of the fatal accidents are run-off-road crashes and 33% of the people killed in traffic died in run-off-road crashes (Haldorsen, 2015). Within this tradeoff analysis both these accident types are relevant and the type of median barrier, lane and shoulder width, and number of lanes.

The numbers from “Trafikksikkerhetshåndboken” (Høye, Elvik, Sørensen, & Vaa, 2014) showed in Table 2 are similar to the ones found by Haldorsen (2015). In Table 2 the numbers for seriously injured and minor injured are also given in addition to fatal accidents. This shows that head-on collisions and run-off-road crashes are highly represented among the serious injured also and not only the killed. So by looking into measures or design features that affect head-on collisions and run-off-road crashes would be helpful when evaluating the safety of the 2+1 lane road design and the narrow 2+2 lane road design, and to be able to achieve “vision zero”.

*Table 2: Shows the percentage of people killed, seriously injured and minor injured for head-on collisions and run-off-road crashes. (Høye et al., 2014)*

	Killed	Seriously injured	Minor injured
Run-off-road crashes	31%	31%	24%
Head-on collisions	41%	32%	18%

The different factors contributing to the fatal accidents can be grouped in factors concerning the road user, the vehicle, the road and the road environment, and to the weather- and driving

conditions (Haldorsen, 2015). It is mainly the road and road environment that will be affected by the road design. During the period from 2005-2014 the conditions regarding the road and road environment is evaluated to have been a contributing factor in 27% of the fatal accidents. Things like the route alignment, sight obstacle, untidy road environment and insufficient road marking and signs are the most common causes. They are rarely the direct cause of the accident, but one of the underlying factors that have contributed to that the accident has developed into a fatal accident. (Haldorsen, 2015) The factor contributing to most fatal accidents in larger or smaller degree is lack of driving skills, which was involved in 47% of the fatal accidents in 2014. (Haldorsen, 2015)

### **3.2.1.1 Head-on Collisions and Median Barriers**

The purpose of a median barrier is to prevent vehicles from entering the opposite driving direction, and thereby reduce the number of head-on collisions. The median barrier can be made of different materials and have different designs. Typical solutions are concrete barrier, steel barrier or cable barrier. Which provide differences in the stiffness and therefore also the properties of the barrier. It seems to be less serious damage connected to crashing into the more yielding ones than the stiff ones, but they are not so effective in preventing the car to enter the opposite driving lane. (Høyve et al., 2014)

For the 2+1 road and the narrow 2+2 road cable barrier or steel barrier would be preferable because these two solutions require less space than the larger concrete barriers. In Sweden the use of cable barrier is common, but at the project E16 Kløfta-Kongsvinger they have used a steel barrier. (Statens vegvesen, 2014i)

Both the 2+1 configuration and the narrow 2+2 design have a median barrier, so they are both designed to prevent head-on collisions. This is important for reducing the number of people killed in traffic and accidents with serious injuries. In Sweden they have great experience with the 2+1 lane road design and its capability of reducing the number of fatalities. In the report "Evaluation of 2+1-roads with cable barrier, Final report" (Carlsson, 2009) the results show that compared to the 13 meter wide 1+1 roads the 2+1 roads have reduced the fatalities with 76%. The reduction in fatalities is not necessarily single-handed from the median barrier, but could also come from the effect of an extra lane or other inequalities. They also have 50 km with 16 meter wide 2+2 roads which seems to provide a 75% reduction in fatalities. When

looking at the number of seriously injured and killed the reduction is 63% for 2+1 roads with cable barrier and 59% for 16 meter wide 2+2 roads (Carlsson, 2009). The effect of median barrier seems to be quite good when it comes to reducing the number of accidents with fatal and seriously injured, and the 2+1 roads performing slightly better than the 16 meter wide 2+2 roads regarding traffic safety.

For four-lane roads with median/median barrier and two-/three-lane roads with median barrier the cost for the society per kilometer driven is in average 15 øre in form of accident costs, while for roads without median or median barrier, and AADT > 4 000 and speed limit 80 km/h the cost is around 50 øre (Statens vegvesen cited in Løtveit, 2012 p. 20) It seems that median with and without barrier is effective when it comes to reducing the accident costs, even though the total reduction in accident costs probably can't be assigned to the median barrier alone. Roads with four lanes or two-/three-lane roads have often improved horizontal and vertical alignment, broader shoulders, wider and additional lanes, and in general a higher standard, than a two-lane road.

### **3.2.1.2 Run-off-road Crashes**

A sufficient clear zone free from hazards adjacent to the road results in less severe run-off road accidents. To provide this sufficient clear zone and reduce the severity of run-off-road accidents measures like removing the dangerous roadside elements, mitigating the dangerous elements, or replacing dangerous elements with less dangerous constructions is preferable rather than building side barriers to prevent serious accidents. "The side barrier is a dangerous element and should only be used if it is more dangerous to drive out of the way than into the barrier." (Statens vegvesen, 2014d, p. 11)

Different studies (Karlaftis & Golias, 2002; Lee & Mannering, 2002) have looked into the impacts different factors have on the frequency and severity of rural roadway accidents. Lee and Mannering (2002) found that by avoiding cut side slopes, decreasing the distance from outside shoulder to guardrail, decreasing the number of isolated trees along the road, and increasing the distance from outside shoulder edge to light poles can reduce the frequency of run-off-road crashes while the severity is dependent on the complex interaction of roadside features. Karlaftis and Golias (2002) found median width and access control to be the most

important factors regarding crash rates for rural multilane roads followed by friction and lane width, when the effect of annual average daily traffic was cancelled out.

Both the 2+1 road and the narrow 2+2 road are designed and constructed with same base rules when it comes to keeping a sufficient clear zone free from hazards adjacent to the road to reduce the severity if a vehicle should run off the road. Since the environment adjacent to the road is assumed equal other factors like the width of the lane, shoulder width and number of lanes which varies for the 2+1-road and the narrow 2+2-road could make one of the designs more preferable than the other.

### **3.2.1.3 Lane Width, Shoulder Width and Number of Lanes**

“The lane width of a roadway influences the comfort of driving, operational characteristics, and, in some situations, the likelihood of crashes.” (AASHTO, 2013 p. 4-7) When looking at national main roads and other main roads(H1-H9) in the Norwegian standard for road and street design (Statens vegvesen, 2014b) the lane width is varying between 3-3,5 meter for different values of AADT, speed limit and number of lanes. The safety effects of wider lanes are uncertain. Wider lanes provide more space, and may give the driver a better opportunity to correct a mistake that could have led to a crash. In spite of that fact the wider lanes could make the driver more comfortable and lead to increased speed, which then will reduce the safety effect from the wider lanes. (Stamatiadis, Pigman, Sacksteder, Ruff, & Lord, 2009)

It is hard to isolate the effect from each factor, since lane width, shoulder width and number of lanes are related to each other, and also to other parameters like speed, traffic volume, and horizontal and vertical alignment. Roads with wide lanes and shoulders are typically designed for high speed and traffic volumes, and have a high standard alignment, while smaller roads designed for lower speeds and traffic volumes, have smaller lane and shoulder widths, and varying quality regarding the alignment. Sakshaug, Lervåg and Giæver (2004) looked at how the shoulder width and driving lane width influenced the traffic safety without being able to draw any clear conclusion about the effect of increasing the shoulder width on the cost of the width of the driving lane. On the trial stretches Sakshaug, Lervåg and Giæver found that the vehicles move to left, when the shoulder is increased on the behalf of the driving lane, but less than what the border line is moved. This means that the distance to the asphalt edge is

increased while the safety distance between the oncoming vehicles is decreased (Sakshaug, Lervåg, & Giæver, 2004). How this is related to the accident risk is not known.

There have been different studies (Bauer, Harwood, Hughes, & Richard, 2004; Dixon, Fitzpatrick, & Avelar, 2015) looking at the safety effect of reducing lane width and shoulder width. Bauer et al. (2004) found that by widening the number of lanes of an urban freeway in one direction of travel from 4 to 5, by reducing lane and shoulder width, resulted in increases of 10% to 11% in accident frequency. When converting an urban freeway from 5 to 6 lanes smaller increases in accident frequency were found, but these were not statistically significant. The increase in number of lanes results from a decrease in lane and shoulder width. Dixon et al. (2015) developed a model that could be used to estimate the predicted amount of crashes related to changes in total lane width, right shoulder width and left shoulder width. There were safety improvements associated with increased lane width, additional lanes, increased left shoulder and increased right shoulder. It is pointed out in one of the scenarios in the paper that the adverse safety effects of reduced shoulder widths are larger than the positive safety effects of adding an equal amount to the total lane width.

It is hard to determine the effect of additional travel lanes since the road standard for a two-lane road is quite different from a four lane-road when it comes to characteristics like alignment, design of intersections, lane width, shoulder width and safety measures like median barrier and side barriers. Calculations with accident data from Norway shows that an increase in number of travel lanes leads to a higher number of accidents per million vehicle kilometers, but lower accident costs. Number of accidents are approximately 25% higher per vehicle kilometers for four-lane roads compared to two-lane roads, but the accident costs are approximately 25% lower for the four-lane roads (Høye, Elvik, & Sørensen, 2011). The lower accident costs could be explained by that a higher standard on four-lane roads reduces the severity and number of meeting accidents and run-off-road crashes. (Høye et al., 2011)

#### **3.2.1.4 Speed**

The relationship between speed and traffic safety are discussed in different studies (Aarts & Schagen, 2006; Elvik, 2013, 2014; Elvik, Christensen, & Amundsen, 2004; Hauer, 2009; Ragnøy, 2004). It seems to be commonly known that the accidents that occur will be more severe if the mean speed increases. Whether the probability of getting involved in a crash



increases for higher speeds or deviation from the mean speed or both is more uncertain. For the last years the focus has been on decreasing the speed on the most vulnerable roads, and campaigns focusing on the consequences of speeding, have been sent on television (Statens vegvesen, 2014a). The report by Ragnøy (2004) documents the effect on driving speed and accidents from the Norwegian Public Roads administration's decision of lowering the speed from 90 km/h to 80 km/h and from 80 km/h to 70 km/h on selected road sections. The results show a clear reduction in driving speed, damages and accidents when lowering the speed limit from 80 km/h to 70 km/h. The speed is reduced with 4,1 km/h from 75,3 km/h to 71,2 km/h, and number of accidents are reduced with 21,2%. There are also a 46,6% reduction in number of people killed and seriously injured. (Ragnøy, 2004) The results of lowering the speed limit from 90 m/h to 80 km/h shows reduction in speed, but an increase in the number of accidents of 31,1% and number of people killed and seriously injured increased with 14,5%. Number of very seriously injured shows a reduction of 14,8%. (Ragnøy, 2004 p. 29) The report states that the results are uncertain and hard to interpret, and need to be looked through and closer explained. Also Haldorsen (2015) sees high speed as a contributing factor to fatal accidents and the damages related to the fatal accidents. In the period 2005-2014 high speed according to the conditions or speed above the speed limit has been a contributing factor in 42% of the fatal accidents (Haldorsen, 2015p. 13).

The posted speed limit for the 2+1 lane road and the narrow 2+2 lane road is the same, 90 km/h, so in theory the road users are driving in 90 km/h regardless the design, and no difference to the traffic safety is found. Although this is a fair assumption, speeding is considered as a widely tolerated traffic offence (Elvik, 2010), so the speed chosen by the driver could be different from one of the designs to the other. Increased lane and shoulder width, making the driver more comfortable and leading to higher speed, is already mentioned as a factor that could influence the speed level. An argument against the narrow 2+2 lane road that was listed by Solli and Betanzo (2015) was that the road design could be perceived as a motorway. In addition to reduced lane and shoulder widths, the narrow 2+2 design has a lower standard regarding the road alignment and therefore also a lower speed limit than a standard motorway in Norway. A misunderstanding of the usage of the road design together with speeding considered as an acceptable traffic offence, the average travel speed of the road could be higher than what it is designed for and potentially lead to increased number of accidents.

### **3.2.1.5 Rutting**

A narrow driving lane gives the drivers less space to move laterally in the lane, which leads to concentration of the pavement wear and creation of rutting. Increased rutting will affect the maintenance costs, and could also have negative impact on the traffic safety.

In the report “The condition of the road surface and safety - The importance of rut depth, roughness (IRI) and changes in cross-slope for road safety” (Christensen & Ragnøy, 2006), Christensen and Ragnøy (2006) found that increased rut depth increases the accident risk, but the relationship was not linear. The relationship between roughness (IRI) and accident risk were found to be negative linear, where an increase in IRI entails a reduced accident risk (Christensen & Ragnøy, 2006). One thing that is pointed out in the report to explain that increased IRI decreases the accident risk is that the drivers reduce their speed, and then the reduction in speed is what leads to the reduction in accident risk.

## **3.3 Capacity and Level of Service**

There are different ways to evaluate the capacity and service level of a road or road network and its different segments. You can do manual calculations and evaluations by using the methods showed in the Highway Capacity Manual or use traffic modelling software programs for evaluating different scenarios. The former Norwegian standard for capacity calculations on road stretches (Statens vegvesen, 1990) went out of use in June 2014, when the Norwegian Public Roads Administration changed the numbering system for the standards, and has not been replaced (Statens vegvesen, 2015b). The methods in the former standard is based upon the 1985 version of the Highway Capacity Manual, and it appears that this method is the most common method in Norway for calculations done by hand. Apart from that, programs like CONTRAM, VISSIM, Aimsun, SIDRA and CUBE are being used by consultant companies in Norway (COWI, 2014; Multiconsult, 2016; Sweco, 2016). Hand calculations using the most recent Highway Capacity Manual and theory and methods described there for evaluating the capacity and level of service of the 2+1 lane road design and the narrow 2+2 lane road design will be used. The calculations are presented in Chapter 4.

### **3.3.1 Uninterrupted-flow Facilities and Interrupted-flow Facilities**

The diversity of transportation facilities and their characteristics are wide, which leads to the need of dividing or somehow classify the facilities according to their features. The Highway Capacity Manual classifies transport facilities into two different categories, uninterrupted-flow facilities and interrupted-flow facilities. For uninterrupted-flow facilities “traffic has no fixed causes of delay or interruption beyond the traffic stream”(Transportation Research Board, 2010 p. 3-13). There are no external factors like traffic signals that could disturb the traffic flow. For interrupted-flow facilities, “traffic control such as traffic signals and STOP signs introduce delay into the traffic stream”(Transportation Research Board, 2010 p. 3-13). In the tradeoff analysis the narrow 2+2 lane road fall under the category of uninterrupted-flow facilities, since it is intended to operate in rural areas with no traffic lights and with grade separated intersections. The classification of 2+1 lane roads depends on the annual average daily traffic values. For annual average daily traffic values between 6 000 and 8 000 2+1 lane roads could be built with T-intersections or roundabouts instead of grade separated intersections (Statens vegvesen, 2014b), and therefore be classified as an interrupted-flow facility if that should be the case. In this tradeoff analysis when looking at capacity and level of service, calculations will be done for annual average daily traffic values of 6 000, 12 000 and 20 000. To make the calculations more comparable it is assumed grade separated intersections also for annual average daily traffic of 6 000, putting the 2+1 lane road in the uninterrupted-flow facility category.

### **3.3.2 Capacity**

When looking at the capacity it is “the maximum sustainable hourly flow rate at which persons or vehicles reasonably can be expected to traverse a point or a uniform section of a lane or roadway during a given time period under prevailing roadway, environmental, traffic, and control conditions” (Transportation Research Board, 2010 p. 4-17). When doing a capacity analysis you estimate the traffic-carrying ability of the facility under different operational conditions. “A principal objective of capacity analysis is to estimate the maximum number of persons or vehicles that a facility can accommodate with reasonable safety during specified time period” (Transportation Research Board, 2000 p. 2-1). Facilities are seldom planned to operate at or near the capacity, since when the traffic are at such levels the

facilities perform poorly. Capacity analyses are therefore also used to calculate the amount of traffic that a facility can accommodate and still operate at a given level of operation. The different levels of operation and operational criteria are defined by establishing the concept of level of service.(Transportation Research Board, 2000)

### **3.3.3 Quality of Service and Level of Service**

In order to determine the performance quality of a transportation facility the Highway Capacity Manual(Transportation Research Board, 2010) introduces the terms quality of service and level of service. “Quality of service describes how well a transportation facility or service operates from the traveler’s perspective”(Transportation Research Board, 2010 p. 5-1). The Highway Capacity Manual lists a number of factors, but particularly focusing on travel time, speed delay, maneuverability and comfort, as the factors influencing the traveler perceived quality of service. Then level of service is defined as “a quantitative stratification of a performance measure or measures that represent quality of service,” which is described using letters A to F, where A represent the best conditions and F the worst (Transportation Research Board, 2010 p.5-1). The service measures that are evaluated for determining the level of service of a transportation facility depend on the transport mode and type of facility. For automobile modes density is used as the service measure for freeways and multilane highways and for two-lane-highways percent time-spent-following, average travel speed and percent free-flow speed are the service measures used. (Transportation Research Board, 2010) Other transport modes and facilities, and their service measures are also mentioned in the Highway Capacity Manual, but not included here because of lack of relevance to the tradeoff analysis.

### **3.3.4 Freeway Facilities**

A Freeway provides uninterrupted flow and is defined as “separated highways with full control of access and two or more lanes in each direction dedicated to the exclusive use of traffic” (Transportation Research Board, 2010 p. V2-i). The Highway Capacity Manual provides different methodologies for evaluating the capacity and level of service of a freeway dependent on if you want to analyze the whole facility as a unit or divide it into three types of segments: basic freeway segments, merge and diverge segments, and weaving segments, and

look at the segments separately. Based on the definition given of a weaving segment in the Highway Capacity Manual (Transportation Research Board, 2010) weaving segments would not or rarely occur for the 2+1 lane road design or the narrow 2+2 lane road design as the two road designs are defined in this tradeoff analysis. The merge and diverge segments will be found in relation to ramps, which will also not be evaluated further. The ramps are standard (Statens vegvesen, 2014b) for both designs and will not contribute to differentiate the 2+1 lane road design and the narrow 2+2 lane road design. It is recommended that the merge and diverge segments have the same lane width and shoulder width as the road (Statens vegvesen, 2014b), so the merge and diverge segments will be a little bit different when looking at the one-lane-direction of the 2+1 lane road and the narrow 2+2 lane road. The lane width will be 0,25 meter less and the shoulder width 0,75 meter less for the narrow 2+2 lane road. The two-lane direction of the 2+1 lane road has the same lane width and shoulder width as the narrow 2+2 lane road, so there it will be no difference. The effect of these small differences in lane and shoulder width for one of the direction is found negligible for the overall performance of the road, so no further evaluations will be performed. Only the method for a basic freeway segment will be used to evaluate the level of service of the narrow 2+2 lane road, and then the two-lane highway method will be used for the 2+1 lane road.

#### **3.3.4.1 Basic Freeway Segments**

A basic freeway segment is not influenced by the ramps or weaving areas,(Transportation Research Board, 2010) see Figure 10. To give an indication of how well the basic freeway segment is accommodating the traffic flow, three performance measures are used. These three measures are density in terms of passenger cars per kilometer per lane, speed in kilometer per hour and the ratio of demand flow rate to capacity. (Transportation Research Board, 2010) When looking at a freeway segment factors like lane width and lateral clearance, driver population, ramp density and amount of heavy vehicles are conditions that affects the LOS and capacity of the basic freeway segment, and could be adjusted for if they are not in accordance to the base conditions. (Transportation Research Board, 2010) Horizontal and vertical alignment, posted speed limits, level of speed enforcement, lightning conditions and weather conditions are other factors that are likely to affect the free flow speed and therefore also the LOS and capacity, but they are hard to quantify and therefore not adjusted for in the

calculations. (Transportation Research Board, 2010) Lane width, lateral clearance, and number of lanes are the most applicable factors within the case study.

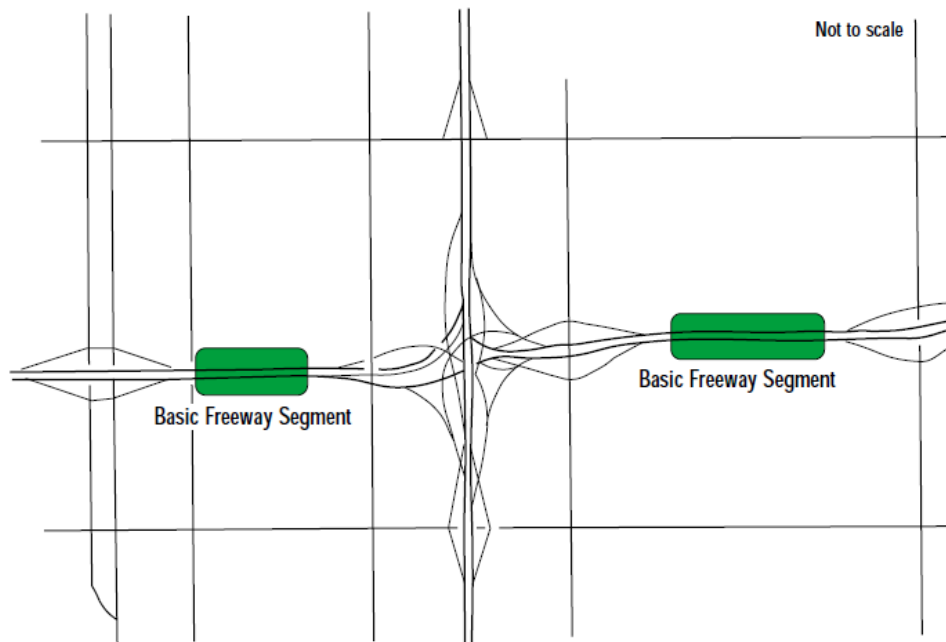

*Figure 10: Basic freeway segment. The picture is retrieved from (Transportation Research Board, 2000 p. 13-2)*

### Lane Width and Lateral Clearance

If the lane width is smaller than 3,65 meters the drivers have to drive closer to one another laterally than they prefer, and to compensate for this they reduce their speed. The same effect occur when the lateral clearance to the median barrier or an obstacle along the road side is less than 0,61 meter for the median lane and less than 1,83 meter for the lane closest to the shoulder. There are no adjustments available for clearance to the median barrier smaller than 0,61 meter. (Transportation Research Board, 2000 p. 13-5 ; 2010 p. 11-12)

### Number of Lanes

An increasing number of lanes increase the free flow speed. With more lanes available the drivers have better opportunities to overtake slower vehicles and therefore maintain a higher speed. (Transportation Research Board, 2000) Number of lanes also affects the adjustment to free flow speed for smaller right-side lateral clearance than the above-mentioned base value of 1,83 meter. Little right-side lateral clearance tends to make vehicles in the right lane to move

a little bit to the left, which affects the vehicle in the next lane. When the number of lane increases this effect is reduced. (Transportation Research Board, 2010)

## Ramp Density

A high density of ramps reduces the free flow speed, because of the merging and diverging vehicles. So freeways in rural areas with less interchanges seem to operate with a higher free flow speed than freeways in urban areas. (Transportation Research Board, 2000 p. 13-6; 2010 p. 11-12) “Total ramp density is defined as the number of ramps (on and off, one direction) located between 3 mi upstream and 3 mi downstream of the midpoint of the basic freeway segment under study, divided by 6 mi.” (Transportation Research Board, 2010 p. 11-12)

## Heavy Vehicles

The amount of heavy vehicles like trucks, busses and motorhomes affects the traffic condition. They take up more space in the lane and their speed is often limited. (Transportation Research Board, 2000) Besides the amount of heavy vehicle, the terrain and grade condition have big influence on the effect the heavy vehicles have on the traffic flow. The Highway Capacity Manual (Transportation Research Board, 2010) makes use of three categories of terrain:

1. Level Terrain: Short slopes with a gradient of no more than 2%, allowing the heavy vehicles to keep up the same speed as the passenger cars.
2. Rolling Terrain: The heavy vehicles have to lower their speed compared to the passenger cars, because of the horizontal and vertical alignment is too extreme for them. The need for going down to crawl speed could occur occasionally for short distances.
3. Mountainous Terrain: The heavy vehicle will have to operate at crawl speed for longer distances, because of steep slopes or sharp curvature.

(Transportation Research Board, 2010 p. 11-14, 11-15)

## Driver Population

The driver population also seems to affect the traffic conditions. If the traffic consists of drivers that are on a leisure trip the capacity seems to decrease compared to a traffic that consists of commuters. The adjustment factor ranges from 0,85 to 1,00, but in general a value of 1,00 should be used if there is no clear indication of anything else. (Transportation Research Board, 2010)

## Level of Service - Basic Freeway Segment

Based on different ranges in the variables speed, density and flow rate characteristics for LOS A to F is described in the Highway Capacity Manual (Transportation Research Board, 2010) for a basic freeway segment.

LOS A, Figure 11, describes free-flow operations. FFS prevails on the freeway, and vehicles are almost completely unimpeded in their ability to maneuver within the traffic stream. The effects of incidents or point breakdowns are easily absorbed. (Transportation Research Board, 2010 p. 11-6)



*Figure 11: LOS A. The picture is retrieved from (Transportation Research Board, 2010 p. 11-5)*

LOS B, Figure 12, represents reasonably free-flow operations, and FFS on the freeway is maintained. The ability to maneuver within the traffic stream is only slightly restricted, and the general level of physical and psychological comfort provided to drivers is still high. The effects of minor incidents and point breakdowns are still easily absorbed. (Transportation Research Board, 2010 p. 11-6)





*Figure 12: LOS B. The picture is retrieved from (Transportation Research Board, 2010 p. 11-5)*

LOS C, Figure 13, provides for flow with speeds near the FFS of the freeway. Freedom to maneuver within the traffic stream is noticeably restricted, and lane changes require more care and vigilance on the part of the driver. Minor incidents may still be absorbed, but the local deterioration in service quality will be significant. Queues may be expected to form behind any significant blockages. (Transportation Research Board, 2010 p. 11-6)



*Figure 13: LOS C. The picture is retrieved from (Transportation Research Board, 2010 p. 11-5)*

LOS D, Figure 14, is the level at which speeds begin to decline with increasing flows, with density increasing more quickly. Freedom to maneuver within the traffic stream is seriously limited and drivers experience reduced physical and psychological comfort levels. Even minor incidents can be expected to create queuing, because the traffic stream has little space to absorb disruptions. (Transportation Research Board, 2010 p. 11-6)



*Figure 14: LOS D. The picture is retrieved from (Transportation Research Board, 2010 p. 11-5)*

LOS E, Figure 15, describes operation at capacity. Operations on the freeway at this level are highly volatile because there are virtually no usable gaps within the traffic stream, leaving little room to maneuver within the traffic stream. Any disruption to the traffic stream, such as vehicles entering from a ramp or a vehicle changing lanes, can establish a disruption wave that propagates throughout the upstream traffic flow. At capacity, the traffic stream has no ability to dissipate even the most minor disruption, and any incident can be expected to produce a serious breakdown and substantial queuing. The physical and psychological comfort afforded to drivers is poor. (Transportation Research Board, 2010 p. 11-6)



*Figure 15: LOS E. The picture is retrieved from (Transportation Research Board, 2010 p. 11-5)*

LOS F, Figure 16, describes breakdown, or unstable flow. Such conditions exist within queues forming behind bottlenecks. Breakdowns occur for a number of reasons:

- Traffic incidents can temporarily reduce the capacity of a short segment, so that the number of vehicles arriving at a point is greater than the number of vehicles that can move through it.
- Points of recurring congestion, such as merge or weaving segments and lane drops, experience very high demand in which the number of vehicles arriving is greater than the number of vehicles that can be discharged.
- In analyses using forecast volumes, the projected flow rate can exceed the estimated capacity of a given location.

In all cases, breakdown occurs when the ratio of existing demand to actual capacity, or of forecast demand to estimated capacity, exceeds 1.00. Operations immediately downstream of, or even at, such a point, however, are generally at or near LOS E, and downstream operations improve (assuming that there are no additional downstream bottlenecks) as discharging vehicles move away from the bottleneck. (Transportation Research Board, 2010 p. 11-6)

LOS F operations within a queue are the result of a breakdown or bottleneck at a downstream point. In practical terms, the point of the breakdown has a  $v/c$  ratio greater than 1.00, and is also labeled LOS F, although actual operations at the breakdown point and immediately downstream may actually reflect LOS E conditions. Whenever queues due to a breakdown exist, they have the potential to extend upstream for considerable distances. (Transportation Research Board, 2010 p. 11-7)



*Figure 16: LOS F. The picture is retrieved from (Transportation Research Board, 2010 p. 11-5)*

### **3.3.5 Two-lane Highways**

The 2+1 lane road design is not mentioned in the Highway Capacity Manual (Transportation Research Board, 2010), so there are no theory or specified methodology for evaluating the level of service of such design. Among those methodologies available the one for two-lane highways seems to be the most suitable and fitting, with some adaptations and considerations regarding the difference in design between those two road classes. Therefore in the following section an overview of the characteristics of two-lane highways and the factors taken into account for evaluating the level of service, from the Highway Capacity Manual (Transportation Research Board, 2010), will be given.

Two-lane highways have a wide specter of functions depending on geographical location and the intended traffic demand they are supposed to serve. The Highway Capacity Manual (Transportation Research Board, 2010) mention functions as efficient mobility, provide accessibility to remote or sparsely populated areas, serve scenic and recreational areas, and serve small towns and communities. Based on the function of the road, three classes of two-lane highways are established. Class I are highways which serves longer trips and relatively high speeds are expected. Class II is highways which in general serves shorter trips or goes through rough terrain where sightseeing could be a part of the trip. Travelling at high speeds is therefore not necessarily expected. Class III are highways typically passing through small towns or rural populated areas, which gives mix of local and through traffic and a high amount of access points along the road. (Transportation Research Board, 2010) The 2+1 lane road design fits best into class I.

#### **3.3.5.1 Level of Service - Two-lane Highways**

To determine the level of service of two-lane highways, the Highway Capacity Manual (Transportation Research Board, 2010) defines three measures:

##### **1. Average travel speed**

ATS reflects mobility on a two-lane highway. It is defined as the highway segment length divided by the average travel time taken by vehicles to traverse it during a designated time interval. (Transportation Research Board, 2010 p. 15-7)

## 2. Percent time-spent-following

PTSF represents the freedom to maneuver and the comfort and convenience of travel. It is the average percentage of time that vehicles must travel in platoons behind slower vehicles due to the inability to pass. Because this characteristic is difficult to measure in the field, a surrogate measure is the percentage of vehicles traveling at headways of less than 3.0 s at a representative location within the highway segment. PTSF also represents the approximate percentage of vehicles traveling in platoons. (Transportation Research Board, 2010 p. 15-7)

## 3. Percent of free-flow speed

Percent of free-flow speed (PFFS) represents the ability of vehicles to travel at or near the posted speed limit. (Transportation Research Board, 2010 p. 15-7)

Depending on the highway class one or two of these measures are used to define LOS, Figure 17.

LOS	Class I Highways		Class II Highways	Class III Highways
	ATS (mi/h)	PTSF (%)	PTSF (%)	PFFS (%)
A	>55	≤35	≤40	>91.7
B	>50-55	>35-50	>40-55	>83.3-91.7
C	>45-50	>50-65	>55-70	>75.0-83.3
D	>40-45	>65-80	>70-85	>66.7-75.0
E	≤40	>80	>85	≤66.7

Figure 17: LOS Criteria for two-lane highways. The picture is retrieved from (Transportation Research Board, 2010 p. 15-7)

One of the major things that differentiate the two-lane highway from the 2+1 lane road design is how the passing capacity for the two-lane highway is limited by the amount of traffic in the opposing direction (Transportation Research Board, 2010). Because of separated driving directions and the alternating additional lane for overtaking the passing capacity of the 2+1 lane road is not limited by the oncoming traffic. The problem of how the volume of the opposing flow is affecting one of the main service measures, percent time spent following, when the driving directions are divided by a median barrier and the oncoming traffic does not affect the passing behavior, is discussed by Catbagan and Nakamura (2006). In the article “Evaluation of Performance Measures for Two-Lane Expressways in Japan” (Catbagan & Nakamura, 2006) Catbagan and Nakamura are looking at “possible performance measures

*that would best describe the traffic operational characteristics of two-lane expressways”* (Catbagan & Nakamura, 2006 p.111) in Japan. The most promising one was follower density.

### 3.3.6 Results from Other Research

An introduction of other studies and their results regarding capacity, free-flow speed and levels of service, that are found interesting for this tradeoff analysis, will be given in this section.

In the article “Tradeoffs among free-flow speed, capacity, cost, and environmental footprint in highway design” (Ng & Small, 2012) Ng and Small make a comparison of expressways with regular and narrow design. The total width of the roadway is the same for both cases and the extra lane for the narrow design are obtained by reducing the shoulder and lane width. (Ng & Small, 2012) The regular and narrow design can be seen in Figure 18.

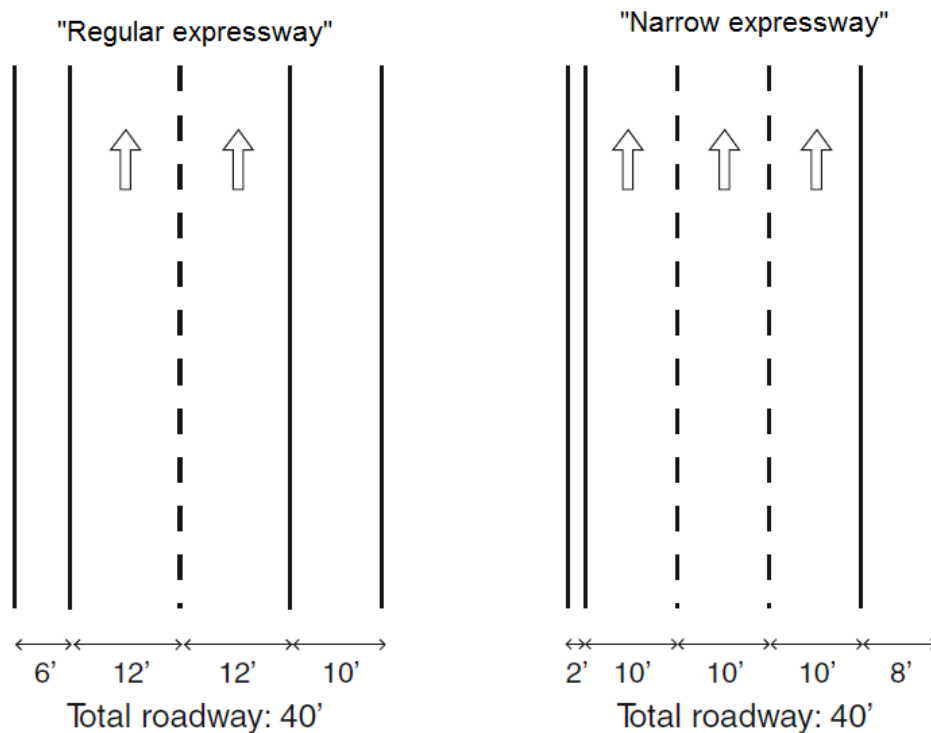

Figure 18: Regular and narrow design. The picture is retrieved from (Ng & Small, 2012 p. 1266)

Regarding the capacity and the free-flow speed Ng and Small (2012) conclude with:

We observe that the “narrow” design is strongly favored under all conditions in which there is appreciable queuing. Most strikingly, the advantage of the “narrow” design increases extremely rapidly with traffic. By contrast, the advantage of the “regular” design for light traffic volumes is very modest and increases very slowly as traffic decreases. This is because the “narrow” design’s advantage depends on queuing, whereas the “regular” design’s advantage depends on the difference in free-flow speeds, which is quite small. (Ng & Small, 2012 p. 1268)

This means that by reducing the lane and shoulder width to create an extra lane inside the same roadway width, gives huge payoffs in form of reduced travel time when the highway capacity is exceeded during peak periods. While the payoff from reduced travel time for the design with wider lanes and shoulders, and its higher off-peak speeds is more modest.

In the “Research Results Digest, Application of European 2+1 Roadway Designs” (Potts & Harwood, 2003) an analysis of the traffic operational performance of the 2+1 design were performed. The objective of this analysis was “to determine how passing lanes that alternate continuously between the two directions of travel perform (i.e., what level of service can be achieved) under U.S. conditions in contrast to passing lanes provided in intervals, as is the most common practice in the United States” (Potts & Harwood, 2003 p. 20). The level of service results can be seen in Figure 19.

Two-way volume (veh/h)	Level of service by passing lane frequency			
	None	Minimal	Intermediate	Continuously alternating (2+1)
<b>50/50 Directional Split</b>				
400	B	A	A	A
800	C	C	B	B
1,200	D	C	C	B
1,600	D	D	C	B
2,000	E	D	D	C
2,400	E	D	D	C
2,800	E	E	D	C
<b>60/40 Directional Split</b>				
400	B	A	A	A
800	C	B	B	B
1,200	D	C	C	B
1,600	D	D	C	B
2,000	E	D	D	C
2,400	E	D	D	C
2,800 <sup>a</sup>	—	—	—	—
<b>70/30 Directional Split</b>				
400	B	A	A	A
800	C	B	B	B
1,200	D	C	C	B
1,600	D	D	C	C
2,000	E	D	D	C
2,400	—	—	—	—
2,800 <sup>a</sup>	—	—	—	—

<sup>a</sup> Combination of two-way volume and directional split exceeds the capacity of a two-lane highway.

*Figure 19: Comparison of level of service analysis results. The picture is retrieved from (Potts & Harwood, 2003 p. 26)*

Potts and Harwood (2003) found the 2+1 roadway to perform at the highest overall level of service. It was able to provide traffic operations at level of service C for all the different traffic volumes and directional splits considered, that did not exceed the capacity of a two-lane roadway. For four-lane highways the level of service would be at level A or a high level of service B in all cases, for comparable traffic volumes (Potts & Harwood, 2003). 2+1 roads do not increase the capacity of a normal two-lane highway. They have only the potential to improve the level of service (Potts & Harwood, 2003). The recommendation given by Potts and Harwood (2003) is that 2+1 roads should not be considered for flow rates exceeding 1 200 veh/h in one direction of travel. Then a four-lane roadway is more appropriate.

According to Carlsson (2009) the average travel speed for cars has increased 2 km/h for 90 km/h and is unchanged for 110 km/h, when converting the 13 meter wide 1+1 lane roads into 2+1 lane roads. The capacity is found to be 1 600 - 1 650 veh/h during a 15 minutes period for



one direction, which is approximately 300 veh/h lower than for an ordinary 13 meter 1+1 lane road. It is the transition between 2 to 1 lane which is the bottleneck. (Carlsson, 2009)

A multilane highway could have a capacity of 2 000 veh/h per lane, while the maximum capacity of a two-lane road is assumed to be 2 800 veh/h. A 50/50 directional distribution will give a capacity of 1 400 veh/h in each direction (Statens vegvesen, 2014h).

### 3.4 Non-monetized Impacts

An impact assessment involves an evaluation of the monetized impacts, non-monetized impacts, and if it is found relevant an evaluation of the local and regional impacts, impacts of the distribution of benefits and net ripple effect are conducted (Statens vegvesen, 2014g). An overview of what are included in the impact assessment is shown in Figure 20.

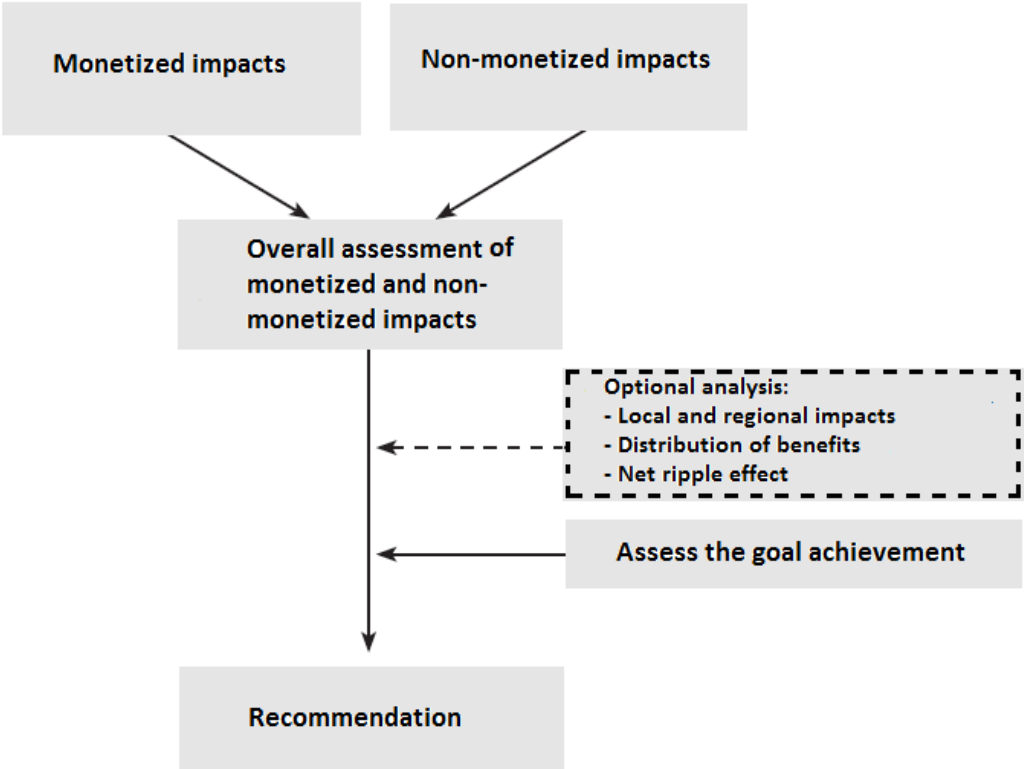

Figure 20: Impact assessment. Adapted from (Statens vegvesen, 2014g p. 51)

The non-monetized impacts are hard to put a price tag on and not necessarily measurable in money, but nevertheless important factors to take into consideration in transportation projects.

The Norwegian standard for impact assessment (Statens vegvesen, 2014g) categorize the non-monetized impacts into five subjects: landscape, local surroundings and outdoor activities, biodiversity, cultural environment and natural resources. They are all evaluated on a nine-point scale which goes from very big positive consequence to very big negative consequence, and is a part of the impact assessment.

## Landscape

The landscape is defined as the visual characteristic of the area and how it is perceived in a spatial way. In addition the travel experience and how the surroundings are perceived from the road are assessed. (Statens vegvesen, 2014g)

## Local Surroundings and Outdoor Activities

Local surroundings are the areas close to where people live and they use every day for walking or cycling trips. Outdoor activities involve leisure time activities in open air and include areas like parks, sport facilities and natural areas of a certain size close to the residential areas. (Statens vegvesen, 2014g)

## Biodiversity

Biodiversity includes biological diversity for land, fresh water and saline water. It is important to preserve the biological diversity for this generation and future generations. (Statens vegvesen, 2014g)

## Cultural Environment

Cultural monuments are traces of human activities in our physical environment, including locations connected to historical events, belief or traditions. Cultural environment is an area where the cultural heritages are a part of a larger context. (Statens vegvesen, 2014g)

## Natural Resources

Natural resources are resources from earth, forest and water, and water and geological resources. It is important to manage them in a sustainable way, so the need of the present is met without compromising the ability of future generations to meet their needs. (Statens vegvesen, 2014g)

### 3.4.1 What Factors Seems to Influence the Non-monetized Impacts?

The underlying topics of the non-monetized impacts appear to be more dependent on the location of the road and the route choice, rather than the design of the road. This seemed also to be the perception of the Norwegian Public Road Administration's impact assessment for the Kløfta-Kongsvinger project (Statens vegvesen, 2007). Their results regarding the evaluation of the non-monetized impacts can be found in Figure 21.

Fagtema	Alt 0 Dagens veg	Alt 1 Fire felt 19 m bredde	Alt 2 Fire felt 16,5 m bredde	Alt 3 to/tre felt 12, 5 m brede	
Nærmiljø	0	+	+	+	
Friluftsliv	0	--	--	--	
Naturmiljø	0	---	---	---	
Kulturminner og kulturmiljø	0	--	--	--	
Landskapsbilde	0	---	---	--	
Landbruk	0	--	--	--	
Lokalt utbyggingsmønster	0	+	+	+	
Virkninger for næringslivet	0	++	+	+	
Transportkvalitet	0	+	+	+	
Kollektivtransport	0	+	+	+	
Gående og syklende	0	+	+	+	

Figure 21: Compilation of the non-monetized impacts. The picture is retrieved from (Statens vegvesen, 2007 p. 53)

They conclude that there are minor differences between the three different road widths of 19, 16,5 and 12,5 meter, but in general the negative effect for landscape, cultural environment, biodiversity and natural resources tend to be larger the wider the design, and that the surroundings and route choice is more important than the cross section width.

So the impression is that with less than two meters separating the width of the 2+1 lane road design and the narrow 2+2 lane road configuration, it will be minor differences concerning the non-monetized impacts. Design features like building T-intersections and roundabouts instead of grade separated intersections will most likely affect the non-monetized impacts in a positive way, because of less space required, but for this trade-off analysis both designs are intended to be built with grade separated intersections.

### **3.5 Monetized Impacts**

A more thorough analysis of monetized impacts associated with the case study will be discussed in Chapter 5. A very rough estimate for the increased cost between a 16, 19 and 22 meter wide four-lane road, based on the general experience of road building, would be an increase of 15% when building 19 meter instead of 16 meter wide road and an additional increase of 15% when building 22 meter instead of 19 meter wide road (Prop. 104 S, 2010-2011). These numbers are based on general cost estimates for road construction provided by experience with road building and not based upon any specific calculations. The estimates are an answer to the question about the cost difference of building the road between Kongsvinger and Slomarka as a 19 meter or 22 meter wide road instead of 16,5 meter wide.

## 4 Calculations and Findings

### 4.1 Traffic Safety

#### 4.1.1 Lane and Shoulder Width

In the article “Operational and Safety Tradeoffs -- Reducing Freeway Lane and Shoulder Width to Permit an Additional Lane” (Dixon et al., 2015) Dixon, Fitzpatrick and Avelar came up with different scenarios showing how to estimate the expected change in crashes when changing the lane and shoulder width. The study uses speed and crash data from urban freeway facilities in Dallas, Houston and San Antonio, Texas for the estimation of the expected change in crashes. No such data basis or similar research regarding norwegian road conditions and driving behavior was identified, but it would be interesting to use their results to compare different norwegian road designs. The use of Equation 1, taken from Dixon et al. (2015), and calculations shown in the scenarios would therefore not be precise enough to use in the paper, but out of interest in doing the calculations and see the result, a similar calculation has been completed to consider the results.

Dixon et al. (2015) are talking about KAB crashes. The Highway Safety Manual (AASHTO, 2010) say that the KABCO scale is often used to classify the crash severity. The K stands for fatal injury, A for incapacitating injury, B for non-incapacitating evident injury, C for possible injury and O for no injury/property damage only, thus a KAB crash is one that results in a fatality or known injury.

$$CiC = e^{[(-2,53*10^{-2})*(NTLW-OTLW)+(-9,56*10^{-2})*(NRSW-ORSW)+(-5,47*10^{-2})*(NLSW-OLSW)]}$$

*Equation 1*

<i>CiC</i>	=	<i>Change in Crashes [%]</i>
<i>NTLW</i>	=	<i>New Total Lane Width [ft]</i>
<i>OTLW</i>	=	<i>Old Total Lane Width [ft]</i>

*NRSW* = *New Right Shoulder Width [ft]*

*ORSW* = *Old Right Shoulder Width [ft]*

*NLSW* = *New Left Shoulder Width [ft]*

*OLSW* = *Old Left Shoulder Width [ft]*

(Dixon et al., 2015, p. 15)

The results from the calculation using the alternatives considered in this research by using Equation 1 are shown in Table 3. The result shows that converting the wider four-lane designs and the 2+1 lane road design into a narrow 2+2 lane road design would lead to an increase in number of KAB crashes.

*Table 3: The expected change in KAB crashes when rebuilding different road designs into a narrow 2+2 lane road.*

<b>Converting:</b>	<b>Change in KAB crashes</b>
23 meter wide four-lane road, Figure 9, into narrow 2+2 lane road (16,5 meter wide), Figure 4.	111%
20 meter wide four-lane road, Figure 8, into narrow 2+2 lane road (16,5 meter wide), Figure 4.	32%
2+1 lane road, direction with 2 lanes, Figure 1 into narrow 2+2 lane road (16,5 meter wide), Figure 4.	5%
2+1 lane road, direction with 1 lane, Figure 1 into narrow 2+2 lane road (16,5 meter wide), Figure 4.	3%

When converting the 23 meter wide four-lane road into a 16,5 meter wide four-lane road the calculations shows an increase of 111% in KAB crashes based on the changes in lane and shoulder width. This comparison is not completely valid or applicable, since the difference in width between the two designs is so large and the intended use, AADT, horizontal and vertical parameters, and speed limit is not the same. In the scenario of converting the 20 meter

wide four-lane road into the 16,5 meter four-lane road the calculations shows and expected increase in KAB crashes of 32% based on the changes in lane and shoulder width. This is more reasonable, but the intended AADT, horizontal and vertical alignment, and speed limit are not the same for the two designs, so the comparison is not completely valid.

The comparison between the 2+1 lane road and the 16,5 meter wide four-lane road is more fitting. The difference in total cross section width is not more than 1,75 meter in favor of the narrow four-lane road. The two designs are also intended to operate under the same AADT and speed limit, and have the same criteria for horizontal and vertical alignment. The results show an increase in KAB crashes of 5% for the narrow 2+2 lane road in comparison with the 2 lane direction of the 2+1 lane road, and an increase of 3% compared to the 1 lane direction of the 2+1 lane road. The 2 lane direction of the 2+1 lane road have a wider left shoulder than the narrow 2+2 lane road, which the 2+1 lane road benefits from. Even though the narrow 2+2 lane road have one extra lane compared to the 1 lane direction of the 2+1 lane, the benefit of larger shoulders are bigger than the extra lane. As the article (Dixon et al., 2015) point out the negative effect of reducing the shoulder width is larger than the positive effect of increasing the total width of the travel lanes with an equal amount. Even an increase of 1,75 meter in the total cross section width is not enough for the narrow 2+2 lane road to compensate for its narrower shoulder widths compared to the 2+1 lane road.

Other literature (Høye et al., 2011) also points out that the accident risk is reduced for an increase in shoulder width. An increase in the shoulder width of 0,3 meter leads to a reduction in all accidents (fatal, seriously injured and less injured) of 5% (Høye et al., 2011).

When comparing the 2+1 lane road to the narrow 2+2 lane road there are only difference in the shoulder width for the one lane direction of the 2+1 lane road. The one-lane direction of the 2+1 lane road have a shoulder width of 1,5 meter compared to the shoulder width of 0,75 meter for the two-lane direction and the narrow 2+2 lane road. This gives the advantage of 0,75 meter extra shoulder width for the one lane direction of the 2+1 lane road, and could potentially lead to a 12,5% reduction in accidents if both directions have a 1,5 meter wide right shoulder. Since only the one-lane direction, 50% of the road has the benefit of a wider shoulder it would be a benefit of 6% reduction in accidents for the 2+1 lane road compared to the narrow 2+2 lane road. This is not so far from the results in Table 3.

## **4.2 Capacity and Level of Service**

### **4.2.1 An Analysis of the Level of Service of a Narrow 2+2 Lane Road Design**

Considering the capacity and evaluation of the level of service of a narrow 2+2 lane road design, only the basic freeway segment will be included, as opposed to the whole facility, since weaving segments rarely occur in Norway for this design and the ramp segments are found insignificant. The following evaluation of the level of service of the narrow 2+2 lane road design is based on the steps in the Highway Capacity Manual (Transportation Research Board, 2010) for a basic freeway segment. Standard base conditions, as described in the Highway Capacity Manual (Transportation Research Board, 2000 p. 23-1), are assumed. Figure 22 illustrated the methodology used, which is then further described and implemented in the following sections.



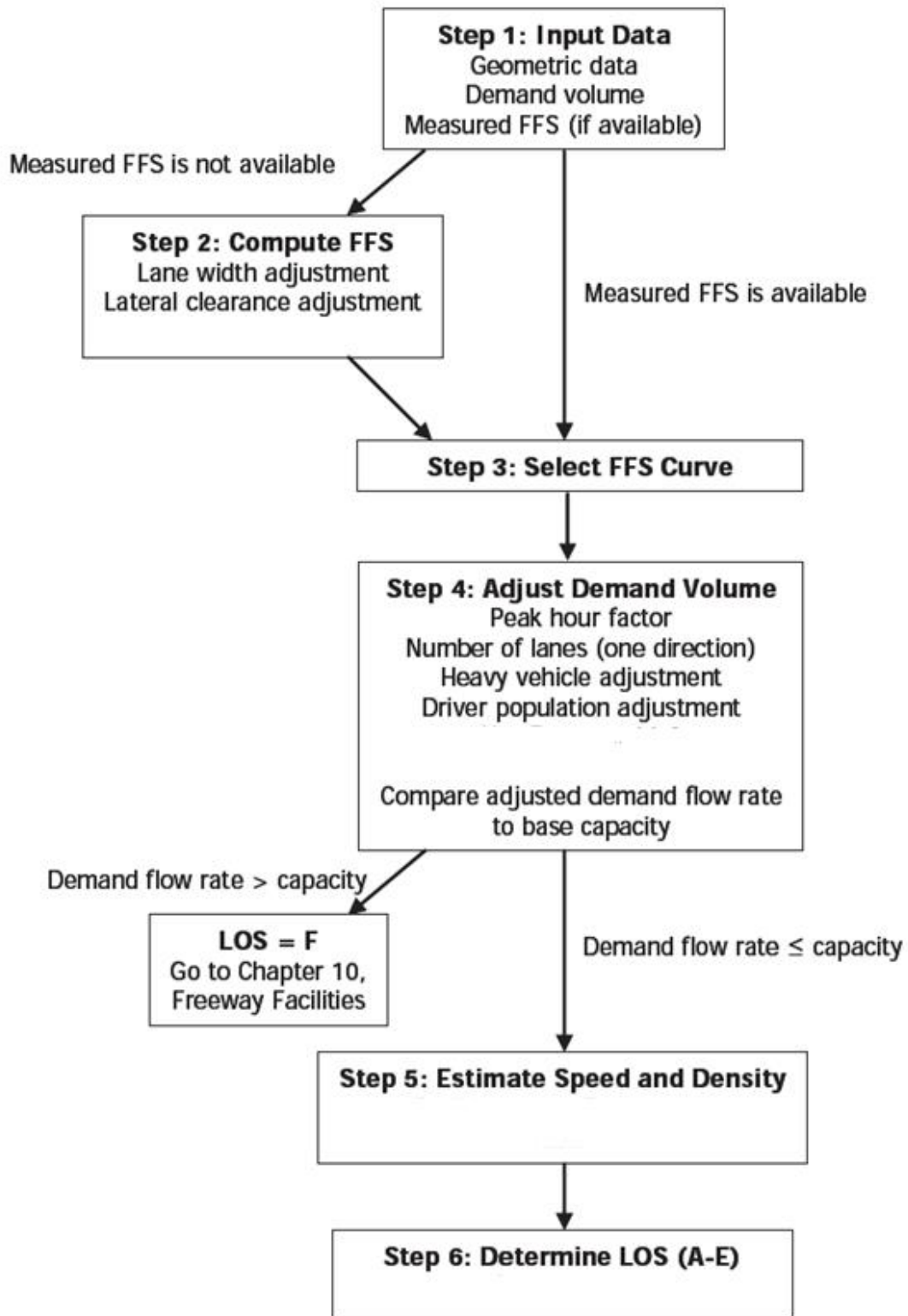
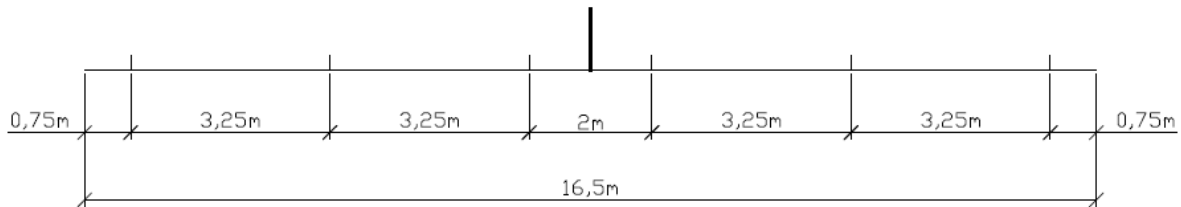

Figure 22: Methodology for calculating LOS for a basic freeway segment. Adjusted from (Transportation Research Board, 2010 p. 11-10)

#### 4.2.1.1 Step 1: Input Data

**Design:** The cross section design of the narrow 2+2 lane road can be seen in

Figure 23.



*Figure 23: Cross section of the narrow 2+2 lane road.*

**Speed limit:** 90 km/h (Statens vegvesen, 2016c)

**Heavy vehicles:** The percentage of heavy vehicles is assumed to be around 10-15%. (Statens vegvesen, 2007)

**Ramp density:** The minimum distance between intersections varies from 1-3 kilometers, when looking at corresponding designs in the Norwegian standard for road and street design (Statens vegvesen, 2014b), but 4-8 km seems to be more typical in practice. This gives a ramp density of 0,25-2 ramps per km, when assuming diamond interchange and distance between the interchanges ranging from 1 km to 8 km.

**Terrain:** It is assumed rolling terrain. Similar designs in the Norwegian standard for road and street design (Statens vegvesen, 2014b) have max gradient of 6 %. In general the topography of Norway is also quite hilly and adaptations to the landscape are often necessary for avoiding too big intervention in the nature.

**Driver population factor:** Since there are no data available it will be set to 1 as discussed earlier in the theory chapter.

**Peak-hour factor:** The peak-hour factor ranges from 0,85 to 0,98 depending on the variation in traffic flow within an hour. The peak-hour factor is typically high for urban and suburban roadways and lower for more rural conditions. (Transportation Research Board, 2010)

#### **4.2.1.2 Step 2: Compute Free-Flow Speed**

There are no field measurements available for determining the free-flow speed of the narrow 2+2 lane road. Instead Equation 2, given in the Highway Capacity Manual (Transportation Research Board, 2010) will be used to estimate a value for the free-flow speed. Note that the equations use U.S. customary units, thus the metric values have been converted in line with the suggestions from HCM 2010 Metric Analysis Guidelines (User Liaison subcommittee, 2012). Table 4 shows the input data in metric values and U.S. customary units, and the corresponding FFS adjustment factors.

$$FFS = 75,4 - f_{LW} - f_{LC} - 3,22TRD^{0,84}$$

*Equation 2*

*FFS = Free-flow speed of basic freeway segment (mi/h)*

*f<sub>LW</sub> = adjustment for lane width (mi/h)*

*f<sub>LC</sub> = adjustment for right-side lateral clearance (mi/h)*

*TRD = total ramp density (ramps/mi)*

(Transportation Research Board, 2010 p. 11-11)

Table 4: Input data in metric values and U.S. customary units, and the corresponding FFS adjustment factors.

	<b>Study values (Metric)</b>	<b>Converted values (U.S. Cust.) Soft and hard conversion</b>	<b>FFS adjustment</b>
<b>Right shoulder width</b>	0,75 m	Soft: 2,46 ft Hard: 2 ft	$f_{LC} = 2,4$ mi/h (HMC, Exhibit 11-9)
<b>Left shoulder width</b>	0,50 m	Soft: 1,64 ft Hard: 2 ft	
<b>Lane width</b>	3,25 m	Soft: 10,66 ft Hard: 11 ft	$f_{LW} = 6,6$ mi/h (HCM, Exhibit 11-8)
<b>Speed limit</b>	90 km/h	Soft: 55,94 mi/h Hard: 55 mi/h	
<b>Ramp density</b>	0,25-2,0 ramps/km	0,4-3,2 ramps/mi	TRD = 0,4-3,2

To use 75,4 mi/h, equivalent to 121,3 km/h, as the base free-flow speed seems like a high base value when the posted speed limit is 90 km/h. To take the posted speed limit into consideration, when calculating the FFS, Equation 3 presented by Wang and Huegy (2013) is used, together with Equation 2. The calculated y-value is added to the FFS achieved by Equation 2, giving the final values for FFS.

$$y = 0,0086x^3 + 0,051x^2 + 0,5223x$$

Equation 3

“Where,  $y$  is the additive term to reflect the impact of posted speeds on free-flow speeds; and  $x$  is the posted speed minus 65 mph, and  $x$  should not be greater than 5 mph or smaller than -10 mph.” (Wang & Huegy, 2013 p. 12)

By using Equation 2 and Equation 3 the free-flow speed was found to be ranging from 50,9 to 58,0 mi/h, depending on the ramp density, which is equivalent to 81,9 to 93,3 km/h.

#### 4.2.1.3 Step 3: Select FFS Curve

When selecting free-flow curve, see Figure 24, the calculated free-flow speed should be rounded to the nearest 5 mi/h according to the guidelines given in the Highway Capacity Manual (Transportation Research Board, 2010).

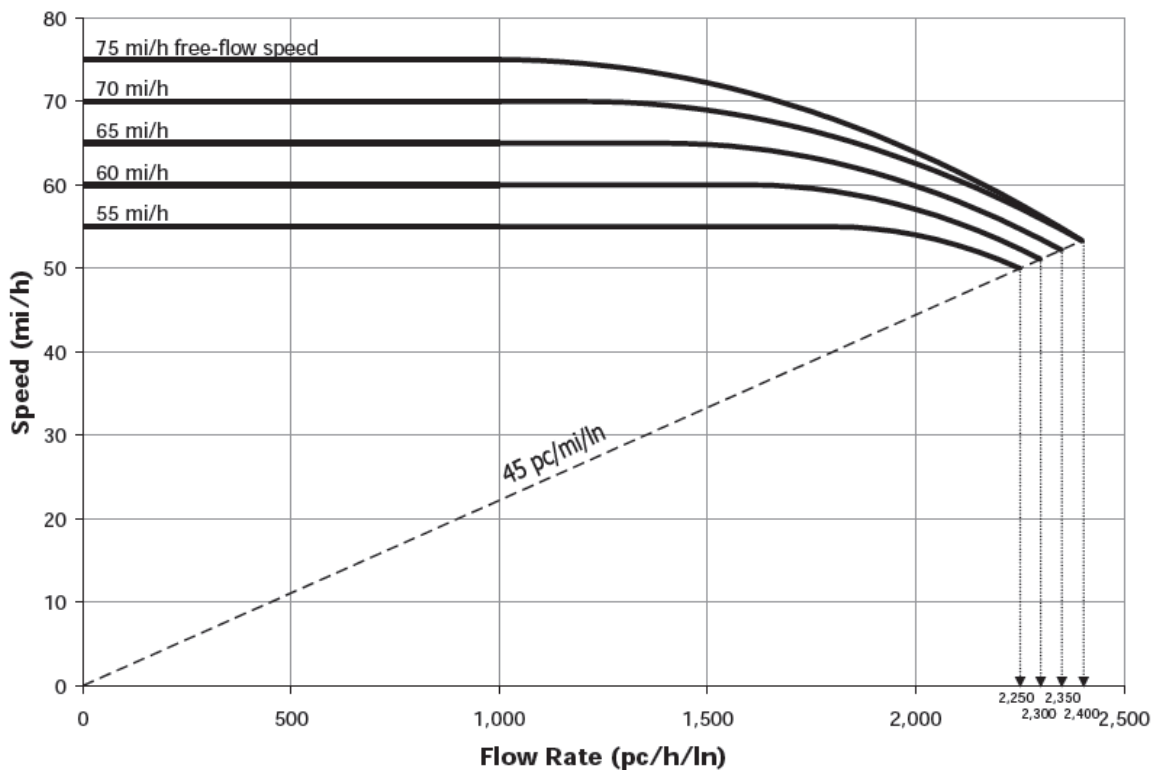

Figure 24: Speed flow curves for basic freeway segments under base conditions. The picture is retrieved from (Transportation Research Board, 2010 p. 11-3)

Based on the calculation of free-flow speeds in step 2, the 60 mi/h curve was chosen for the free-flow speed of 58,0 mi/h. The free-flow speed of 50,9 mi/h is too low to fit to any of the curves in Figure 24. By changing the highest ramp density from 3,2 ramps/mi to 1,6 ramps/mi, equal a distance of 2 km between the interchanges, leads to free-flow speed of 54,7 mi/h and the corresponding 55 mi/h curve. 54,7 mi/h equals 88,0 km/h. A scenario with interchanges every km in a rural area is unlikely, but was chosen at first because of the minimum values that was found. So reducing the density of interchanges from 3,2 to 1,6 ramps/mi, wouldn't influence the practical use of the results too much.

An average ramp density value could have been used instead of calculating two different free-flow speeds, but out of interest in looking at the ramp density's effect on the level of service of the roadway, a lower and upper value for ramp density is used.

#### **4.2.1.4 Step 4: Adjust Demand Volume**

$$v_p = \frac{V}{PHF * N * f_{HV} * f_p}$$

*Equation 4*

*v<sub>p</sub> = demand flow rate under equivalent base conditions (pc/h/ln)*

*V = demand volume under prevailing conditions (veh/h)*

*PHF = peak-hour factor*

*N = number of lanes in analysis direction*

*f<sub>HV</sub> = adjustment factor for presence of heavy vehicles in traffic stream*

*f<sub>p</sub> = adjustment factor for unfamiliar driver population*

(Transportation Research Board, 2010 p. 11-13)

## Demand Volume

The demand volume ( $V$ ) of the road facility is often given as annual average daily traffic (AADT), which is also used in the Norwegian standard for road street design (Statens vegvesen, 2014b) as one of the criteria when choosing the design of the road. In order to get the demand volume in veh/h and thereby be able to use it in Equation 4, the AADT value needs to be converted. One way to do this is using Equation 5 given in the Highway Capacity Manual (Transportation Research Board, 2010).

$$V = DDHV = AADT * K * D$$

*Equation 5*

*$V$  = demand volume (veh/h)*

*$DDHV$  = directional peak-hour demand volume*

*$AADT$  = annual average daily traffic*

*$K$  = the proportion of AADT occurring during the peak hour*

*On urban freeways  $K$  is typically between 0,08 to 0,10, and between 0,09 to 0,13 on rural freeways.*

*$D$  = the proportion of peak-hour volume traveling in the peak direction*

*The  $D$ -factor is typically 0,55 for both rural and urban freeways.*

(Transportation Research Board, 2010 p. 11-24)

In addition to the values found in the Highway Capacity Manual (Transportation Research Board, 2010) the Norwegian standard providing guidance for traffic calculations (Statens vegvesen, 2014h) are also mentioning typical values for  $K$  and  $D$ . The standard (Statens vegvesen, 2014h) says that a  $K$ -value of 12% could be used outside urban areas and the directional distribution should be assumed to be 67/33 if there are no field observations available.

Since it is in the interest of the tradeoff analysis to examine the two road designs based on Norwegian conditions the values for K and D will be set according to the recommended values in the Norwegian standard (Statens vegvesen, 2014h). This gives  $K = 12\%$  and  $D = 67\%$ . Also calculations with  $D = 55\%$ , which is given as a typical value in the Highway Capacity Manual (Transportation Research Board, 2010) will be done.

In the Norwegian Standard for road and street design (Statens vegvesen, 2014b) the AADT values is ranging from 6 000 - 12 000 for road class H5, see Figure 1, which is the standard design for 2/3-lane roads, to 20 000 for road class H8, see Figure 8. So there will be done evaluation of the LOS for the narrow 2+2 lane road (as well as the 2+1 lane road) for the AADT values 6 000, 12 000 and 20 000. The corresponding demand volumes calculated with Equation 5 are found in Table 5.

*Table 5: The calculated demand volumes for AADT 6 000, 12 000 and 20 000.*

	AADT = 6 000	AADT = 12 000	AADT = 20 000
Demand volume (V) [veh/h] for D = 67%	482	965	1608
Demand volume (V) [veh/h] for D = 55 %	396	792	1320

### Peak Hour Factor

“The peak-hour factor represents the variation in traffic flow within an hour. Observations of traffic flow consistently indicate that the flow rates found in the peak 15 min within an hour are not sustained throughout the entire hour” (Transportation Research Board, 2010 p. 11-13). To account for this phenomenon the peak-hour factor is used in Equation 4. The peak-hour factor is ranging from 0,85, for lower traffic volume conditions, to 0,98 for more typical urban peak-hour conditions. (Transportation Research Board, 2010)

Since there is no field data to develop a peak-hour factor for typical Norwegian conditions the demand flow rate under equivalent base conditions ( $v_p$ ) was calculated for both the lower,  $PHF_1 = 0,85$ , and the upper value,  $PHF_2 = 0,98$ . The road designs that are compared here in this tradeoff analysis are common in rural areas, so a PHF value close to  $PHF_1$  would be more appropriate for those surroundings.



## Heavy Vehicles

To account for the presence of the heavy vehicles in the traffic stream the heavy-vehicle adjustment factor is calculated as in Equation 6. The Highway Capacity Manual (Transportation Research Board, 2010) defines a heavy vehicle as “any vehicle with more than four wheels on the ground during normal operation” (Transportation Research Board, 2010 p. 11-13). Generally the heavy vehicles can be categorized as trucks, buses or recreational vehicles.

$$f_{HV} = \frac{1}{1 + P_T(E_T - 1) + P_R(E_R - 1)}$$

*Equation 6*

*f<sub>HV</sub> = heavy-vehicle adjustment factor*

*P<sub>T</sub> = proportion of trucks and buses in traffic stream*

*P<sub>R</sub> = proportion of recreational vehicles in traffic stream*

*E<sub>T</sub> = passenger-car equivalent of one truck or bus in traffic stream*

*E<sub>R</sub> = passenger-car equivalent of one recreational vehicle in traffic stream*

(Transportation Research Board, 2010 p. 11-13)

For rolling terrain the value for E<sub>T</sub> is found to be 2,5 and the value for E<sub>R</sub> is 2,0 by using Exhibit 11-10. (Transportation Research Board, 2010 p. 11-15) The effect of heavy vehicles in the traffic stream could be more specific determined by evaluating the sections of the freeway with steep grades and certain lengths as separate segments. Values for E<sub>T</sub> and E<sub>R</sub> depending on the grade and length are given in the Highway Capacity Manual (Transportation Research Board, 2010 ).

The proportion of recreational vehicles in the traffic stream is assumed to be so low that it is set to 0%, when calculating the heavy-vehicle adjustment factor. The  $f_{HV1}$  is calculated for 10% heavy vehicles and  $f_{HV2}$  is calculated for 15% heavy vehicles, to see how a change in the proportion of heavy vehicles affects the demand flow rate ( $v_p$ ). The results can be seen in Table 6.

*Table 6: The calculated heavy-vehicle adjustment factor for 10% and 15% heavy vehicles.*

Amount of heavy vehicles [%]	$f_{HV(1/2)}$
10	0,87
15	0,82

### Driver Population

The effect of the driver population is reflected by the adjustment factor  $f_p$ . The adjustment factor ranges from 0,85 to 1,00 dependent on the characteristic of the driver population. Commuters use the freeways more efficiently than recreational drivers and unfamiliar users of the freeway, and the adjustment factor is set to 1,00 to reflect those regular users. A value of 1,00 should be used unless there is sufficient evidence indicating that a lower value should be used (Transportation Research Board, 2010). Since the tradeoff analysis should provide guidance on a more overall plan, there are no reason to assume unfamiliar users of the freeway, so the value is set to 1,00.

After clarifying the background of all the factors needed to calculate the demand flow rate ( $v_p$ ) and deciding their values, the demand flow rate can now be found by using Equation 4. The results for different values of the factors can be found in Table 7 and Table 8.

Table 7: Values for demand flow rate ( $v_p$ ) varying depending of the input factors. The values for  $v_p$  are achieved by using Equation 4. The proportion of the peak-hour volume travelling in the peak direction is assumed to be 67%.

V1 [veh/h]	V2 [veh/h]	V3 [veh/h]	$f_{HV1}$	$f_{HV2}$	PHF1	PHF2	$f_p$	N [ln]	$v_p$ [pc/h/ln]
482			0,87		0,85		1	2	326
482			0,87			0,98	1	2	283
482				0,82	0,85		1	2	348
482				0,82		0,98	1	2	302
	965		0,87		0,85		1	2	653
	965		0,87			0,98	1	2	566
	965			0,82	0,85		1	2	695
	965			0,82		0,98	1	2	603
		1608	0,87		0,85		1	2	1088
		1608	0,87			0,98	1	2	943
		1608		0,82	0,85		1	2	1159
		1608		0,82		0,98	1	2	1005

Table 8: Values for demand flow rate ( $v_p$ ) varying depending of the input factors. The values for  $v_p$  are achieved by using Equation 4. The proportion of the peak-hour volume travelling in the peak direction is assumed to be 55%.

V1 [veh/h]	V2 [veh/h]	V3 [veh/h]	$f_{HV1}$	$f_{HV2}$	PHF1	PHF2	$f_p$	N [ln]	$v_p$ [pc/h/ln]
396			0,87		0,85		1	2	268
396			0,87			0,98	1	2	232
396				0,82	0,85		1	2	285
396				0,82		0,98	1	2	248
	792		0,87		0,85		1	2	536
	792		0,87			0,98	1	2	465
	792			0,82	0,85		1	2	571
	792			0,82		0,98	1	2	495
		1320	0,87		0,85		1	2	893
		1320	0,87			0,98	1	2	774
		1320		0,82	0,85		1	2	951
		1320		0,82		0,98	1	2	825

The combination of  $f_{HV1}$  and PHF2 produces the lowest  $v_p$  value, while  $f_{HV2}$  and PHF1 gives you the highest. For V1, V2, and V3, the difference between the highest and lowest  $v_p$  values are 65, 129, and 215, respectively for a 67/33 split, and 53, 106, and 177, respectively for a 55/45 split.

In this step, step 4, the different assumed demand volumes: AADT = 6 000, AADT = 12 000 and AADT = 20 000 have been converted to demand flow rates ( $v_p$ ) under equivalent base conditions. Now it is necessary to check if these demand flow rates exceed the base capacity of a basic freeway segment. If the demand exceeds the capacity, the segment has level of service F, and if not further calculations needs to be done for determining the level of service. (Transportation Research Board, 2010 ) The capacity of a basic freeway segment is dependent on the free-flow speed, see Table 9. For this situation the free-flow speed is 55 mi/h or 60 mi/h dependent on the assumed ramp density. The highest values for  $v_p$  [pc/h/ln], when  $D=67\%$ , is 348, 695 and 1159 for AADT 6 000, 12 000 and 20 000 respectively. While the highest value for  $v_p$  [pc/h/ln], when  $D=55\%$ , is 285, 571 and 951 for AADT 6 000, 12 000 and

20 000 respectively. This means that the capacity is not exceeded and level of service F does not exist for any of the AADT values. Following evaluations will classify the service levels more precisely.

*Table 9: The relationship between capacity of a basic freeway segment and the free-flow speed. (Transportation Research Board, 2010 p. 11-18)*

	FFS = 75 mi/h	FFS = 70 mi/h	FFS = 65 mi/h	FFS = 60 mi/h	FFS = 55 mi/h
Capacity [pc/h/ln]	2 400	2 400	2 350	2 300	2 250

#### **4.2.1.5 Step 5: Estimate Speed and Density**

To estimate the density of the traffic stream Equation 7 is used. The highest demand flow rate values are used in the further calculations in order to calculate for the worst case scenario and also because the factors that give the highest demand flow values seem to be most suited for the conditions the narrow 2+2 lane road would operate under, high heavy vehicle volumes and rural surroundings.

$$D = \frac{v_p}{S}$$

*Equation 7*

*D = density [pc/mi/ln]*

*v<sub>p</sub> = demand flow rate [pc/h/ln]*

*S = speed [mi/h]*

(Transportation Research Board, 2010 p. 11-30)

In earlier steps values for free-flow speed have been calculated and the corresponding free-flow curves, Figure 24, chosen. By using the chosen free-flow curves, the calculated values for demand flow rate and Figure 24, the speeds are found, Table 10 and Table 11. In both cases, the volumes are low enough to remain on the flat section of the free flow curve. These speeds are then used to calculate density Table 12 and Table 13.

Table 10: Values for the speed( $S$ ) depending on the FFS curve and the demand flow rate ( $v_p$ ).  
 $D = 67\%$ .

<b>Speed [mi/h]</b>	FFS curve 55 mi/h	FFS curve 60 mi/h
$v_p = 348$ pc/h/ln	55	60
$v_p = 695$ pc/h/ln	55	60
$v_p = 1159$ pc/h/ln	55	60

Table 11: Values for the speed ( $S$ ) depending on the FFS curve and the demand flow rate ( $v_p$ ).  
 $D = 55\%$ .

<b>Speed [mi/h]</b>	FFS curve 55 mi/h	FFS curve 60 mi/h
$v_p = 285$ pc/h/ln	55	60
$v_p = 571$ pc/h/ln	55	60
$v_p = 951$ pc/h/ln	55	60

Table 12: Density values for different demand flow rates and speeds.  $D=67\%$ .

<b>Density [pc/mi/ln]</b>	$S = 55$ mi/h	$S = 60$ mi/h
$v_p = 348$ pc/h/ln	6,3	5,8
$v_p = 695$ pc/h/ln	12,6	11,6
$v_p = 1159$ pc/h/ln	21,1	19,3

Table 13: Density values for different demand flow rates and speeds.  $D=55\%$ .

<b>Density [pc/mi/ln]</b>	$S = 55$ mi/h	$S = 60$ mi/h
$v_p = 285$ pc/h/ln	5,2	4,8
$v_p = 571$ pc/h/ln	10,4	9,5
$v_p = 951$ pc/h/ln	17,3	15,9

By comparing the density values in Table 12 and Table 13 with Figure 25, the level of service can be decided for the different options, see Table 14 and Table 15. The difference in ramp density reflected by the speed is not enough to differentiate between two service levels. The density values for  $S = 55$  mi/h and  $S = 60$  mi/h are very close to each other, but for  $S = 60$  mi/h the density is a little bit lower. In Table 14 and Table 15 it can be seen that service level is dropping for increasing demand flow rate as one would expect.

<b>LOS</b>	<b>Density (pc/mi/ln)</b>
A	$\leq 11$
B	$> 11-18$
C	$> 18-26$
D	$> 26-35$
E	$> 35-45$
F	Demand exceeds capacity $> 45$

Figure 25: LOS criteria for basic freeway segments. The picture is retrieved from (Transportation Research Board, 2010 p. 11-7)

Table 14: Level of service for different speeds and demand flow rate.  $D = 67\%$

<b>LOS</b>	S = 55 mi/h	S = 60 mi/h
vp = 375 pc/h/ln	A	A
vp = 750 pc/h/ln	B	B
vp = 1250 pc/h/ln	C	C

Table 15: Level of service for different speeds and demand flow rate.  $D = 55\%$

<b>LOS</b>	S = 55 mi/h	S = 60 mi/h
vp = 285 pc/h/ln	A	A
vp = 571 pc/h/ln	A	A
vp = 951 pc/h/ln	B	B

The conclusion is that a narrow 2+2 lane road accommodates the traffic with a LOS A for AADT= 6 000, LOS B for AADT = 12 000 and LOS C for AADT = 20 000, Table 14, if the

proportion of the peak-hour volume travelling in the peak direction (D) is assumed to be 67%. If the proportion of the peak-hour volume travelling in the peak direction (D) is assumed to be 55%, the LOS are A, A and B for AADT 6 000, 12 000 and 20 000 respectively, Table 15. The speed is dependent on the ramp density. High ramp density is reflected by lower speed, S. The other base conditions assumed in the calculations providing the service levels in Table 14 and Table 15 are 15% heavy vehicles in rolling terrain (no recreational vehicles), the lower peak hour factor of 0,85 which is the most suited for rural areas, and a driver population factor of 1 indicating that the users are familiar with the freeway facility.

#### 4.2.2 An Analysis of the Level of Service of a 2+1 Lane Road Design

To analyze the level of service of a 2+1 lane road the methodology for two-lane highways in the Highway Capacity Manual (Transportation Research Board, 2010) will be used. Some differences regarding the performance measures have already been discussed, and in the following steps assumptions and deviation from the methodology will be reasoned.

The lane and shoulder width for the 2+1 lane road is different for the direction with one lane and the direction with two lanes. Normally the evaluation of level of service is done directional and then since the road is usually symmetric about the midpoint assumed equal for both driving directions of the road. Due to lack of a separate method for evaluating the level of service of the 2+1 lane road it will be evaluated by calculating the level of service for a normal two-lane highway, Figure 26, and then look at the improvement when adding a passing lane. Figure 27 illustrates the methodology used, which is then further described and implemented in the following sections.

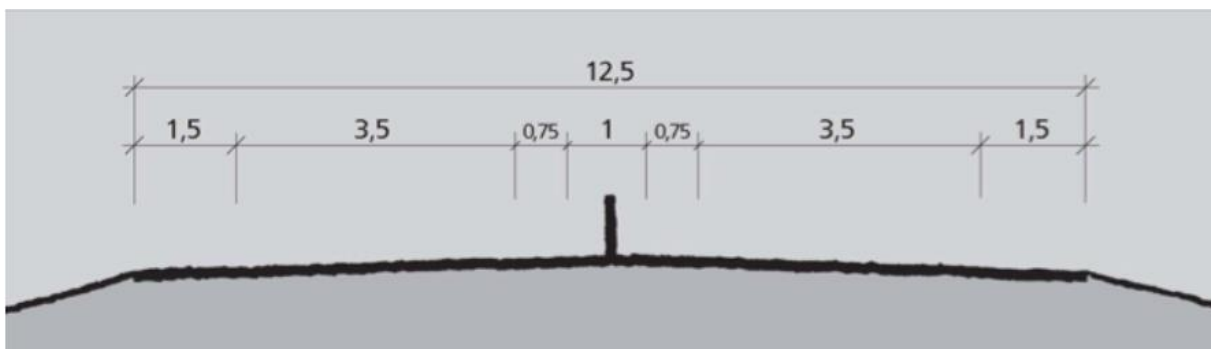

Figure 26: Road class H5, National main roads and other main roads, AADT 6 000 - 12 000 and speed limit 90 km/h. The picture is retrieved from (Statens vegvesen, 2014b p. 47).



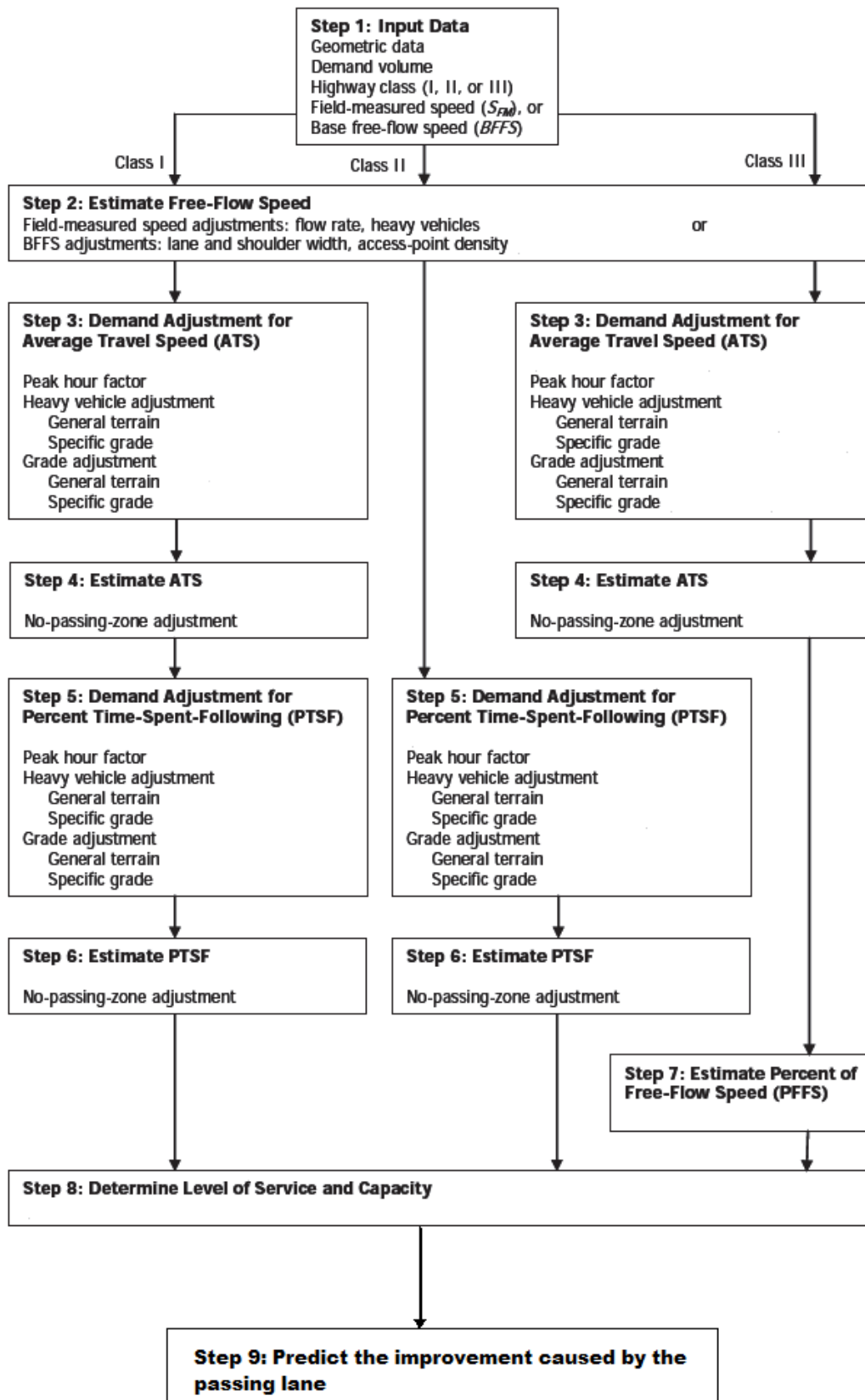

Figure 27: Methodology for calculating LOS for a two-lane highway with passing lane. Adjusted from (Transportation Research Board, 2010 p. 15-13)

#### 4.2.2.1 Step 1: Input Data

Except from the difference in cross section design between the 2+1 lane road and the narrow 2+2 lane road the input data will be the same, as far as possible. This is because of the two designs are meant to accommodate the same type of traffic under same geographical conditions. They are both designs intended to fill the gap between two-lane roads and four-lane roads, when the traffic volumes are too high for a two-lane road, but not enough to spend the amount of resources needed to build a four-lane road. The cross section of the 2+1 lane road design can be seen in Figure 28, and the input data, which are closer described in chapter 4.2.1, are as follows:

**Speed limit:** 90 km/h

**Heavy vehicles:** 10-15%

**Ramp density:** 0,25-2 ramps/km

**Terrain:** Rolling

**Driver population factor:** 1

**Peak-hour factor:** 0,85

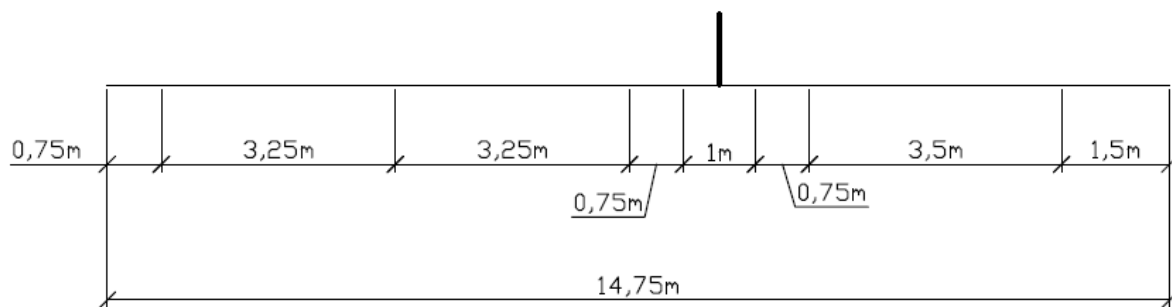

Figure 28: Cross section of 2+1 lane road.

#### 4.2.2.2 Step 2: Estimate the Free-Flow Speed

To decide the free-flow speed field measurements is the best way when looking at a specific section. Since this evaluation is more on an overall plan and no field data is available, Equation 8 is used to estimate the free-flow speed.

$$FFS = BFFS - f_{LS} - f_A$$

*Equation 8*

*FFS = free-flow speed (mi/h)*

*BFFS = base free-flow speed (mi/h)*

*f<sub>LS</sub> = adjustment for lane and shoulder width (mi/h)*

*f<sub>A</sub> = adjustment for access-point density (mi/h)*

(Transportation Research Board, 2010 p. 15-15)

For an estimation of the BFFS the Highway Capacity Manual proposes to use the design speed or the posted speed limit plus 10 mi/h, equal 16 km/h. 90 km/h is both the design speed and the posted speed limit for the 2+1 lane road, making 106 km/h a high BFFS. According to (Elvik, 2012; Ryeng, 2012) speeding is a common in Norway. Assumptions made regarding the base free-flow speed in Norway for roads with a posted speed limit of 90 km/h is 95 km/h, equals 59,04 mi/h). This is not what's suggested in Highway Capacity Manual (Transportation Research Board, 2010), but assumed more fitting for the Norwegian conditions. The values needed for Equation 8 for calculating the free-flow speed are shown in Table 16.

Table 16: Values for the 1 lane direction.

	<b>Study values (Metric)</b>	<b>Converted values (U.S. Cust.) Soft and hard conversion</b>	<b>FFS adjustment</b>
<b>Right shoulder</b>	1,5 m	Soft: 4,92 ft Hard: 4 ft	$f_{LS} = 1,7$ mi/h (HCM, Exhibit 15-7)
<b>Left shoulder</b>	0,75 m	Soft: 2,46 ft Hard: 2 ft	
<b>Lane width</b>	3,5 m	Soft: 11,48 ft Hard: 12 ft	
<b>Speed limit</b>	90 km/h	Soft: 55,94 mi/h Hard: 55 mi/h	
<b>Access-point density</b>	0*	0*	$f_A = 0$

\*The access-point density is set to zero, because it is assumed grade separated intersections for accessing the road.

By using Equation 8 the free flow speed is found to be 57,34 mi/h, which is equivalent to 92,3 km/h.

As for the narrow 2+2 lane road the demand volumes: AADT = 6 000, AADT = 12 000 and AADT = 20 000 will be evaluated.

### 4.2.2.3 Step 3: Demand Adjustment for ATS

To calculate the demand flow rate for average travel speed (ATS) estimation, Equation 9 is used. Flow rates for both directions need to be calculated.

$$v_{i,ATS} = \frac{V_i}{PHF * f_{g,ATS} * f_{HV,ATS}}$$

Equation 9

$v_{i,ATS}$  = demand flow rate  $i$  for ATS estimation (pc/h)

$i$  = "d" (analysis direction) or "o" (opposing direction)

$V_i$  = demand volume for direction  $i$  (veh/h)

PHF = peak-hour factor

$f_{g,ATS}$  = grade adjustment factor

$f_{HV,ATS}$  = heavy vehicle adjustment factor

(Transportation Research Board, 2010 p. 15-16)

### Demand Volume

As for the narrow 2+2 lane road there will be done evaluation of the LOS for AADT 6 000, 12 000 and 20 000. The demand volumes are calculated by using Equation 5 and the same input parameters used for the narrow 2+2 lane road,  $K = 12\%$  and  $D = 67\%$  and  $55\%$ . In addition to the demand volumes for the analysis direction ( $V_d$ ), the demand volumes for the opposing direction ( $V_o$ ) is also calculated, since they are needed in the following steps. The demand volumes for the analysis direction and the opposing direction can be found in Table 17.

Table 17: Demand volumes for analysis direction and opposing direction for different AADT values.

	AADT = 6 000	AADT = 12 000	AADT = 20 000
V <sub>d</sub> [veh/h] for D = 67%	482	965	1608
V <sub>o</sub> [veh/h] for D = 67%	238	475	792
V <sub>d</sub> [veh/h] for D = 55%	396	792	1320
V <sub>o</sub> [veh/h] for D = 55%	324	648	1080

### Peak-hour Factor

The peak-hour factor is set to 0,85, which was found most suitable in the calculations for the narrow 2+2 lane road design.

### Grade Adjustment Factor for Average Travel Speed

To be able to find the grade adjustment factor for average travel speed ( $f_{g, ATS}$ ) the demand volumes need to be adjusted according to Equation 10. The  $v_{vph}$  values are then used to find the corresponding grade adjustment factor for average travel speed ( $f_{g, ATS}$ ).

$$v_{vph} = \frac{V}{PHF}$$

Equation 10

$v_{vph}$  = one-direction demand flow rate (veh/h)

PHF = peak hour factor

V = demand volume (veh/h)

(Transportation Research Board, 2010 p. 15-17)

By using Equation 10 the one-direction demand flow rate ( $v_{vph}$ ) is found for both the analysis direction and the opposing direction, for AADT 6 000, 12 000 and 20 000, and the 67/33 and 55/45 traffic split, see Table 18.

Then the values for  $v_{vph}$  together with Exhibit 15-9 in the Highway Capacity Manual are used to find the grade adjustment factor for average travel speed ( $f_{g, ATS}$ ). The results can be seen in Table 19.

*Table 18: Values for one-direction demand flow rate for different AADT values.*

	AADT = 6 000	AADT = 12 000	AADT = 20 000
$v_{vph, d}$ [veh/h] for D = 67%	568	1135	1892
$v_{vph, o}$ [veh/h] for D = 67%	280	559	932
$v_{vph, d}$ [veh/h] for D = 55%	466	932	1553
$v_{vph, o}$ [veh/h] for D = 55%	381	762	1271

*Table 19: Grade adjustment factors for average travel speed.*

	AADT = 6 000	AADT = 12 000	AADT = 20 000
$f_{g, ATS, d}$ for D = 67%	0,96	1,00	1,00
$f_{g, ATS, o}$ for D = 67%	0,81	0,97	1,00
$f_{g, ATS, d}$ for D = 55%	0,93	1,00	1,00
$f_{g, ATS, o}$ for D = 55%	0,89	0,99	1,00

## Heavy Vehicle Adjustment Factor for Average Travel Speed

To find the heavy vehicle adjustment factor for average travel speed ( $f_{HV,ATS}$ ) Equation 11 is used.

$$f_{HV,ATS} = \frac{1}{1 + P_T(E_T - 1) + P_R(E_R - 1)}$$

Equation 11

$f_{HV,ATS}$  = heavy vehicle adjustment factor for ATS estimation

$P_T$  = proportion of trucks in the traffic stream

$P_R$  = proportion of recreational vehicles in the traffic stream

$E_T$  = passenger car equivalent for trucks

$E_R$  = passenger car equivalent for recreational vehicles

(Transportation Research Board, 2010 p. 15-19)

By using the values for  $v_{vph,d}$  and  $v_{vph,o}$ , found in Table 18, and Exhibit 15-11 in Highway Capacity Manual, the corresponding  $E_{T,d}$  and  $E_{T,o}$  are found and presented in Table 20.

Table 20:  $E_{T,d}$  and  $E_{T,o}$  for the different AADT values.

	AADT = 6 000	AADT = 12 000	AADT = 20 000
$E_{T,d}$ for D = 67%	1,7	1,3	1,3
$E_{T,o}$ for D = 67%	2,1	1,7	1,3
$E_{T,d}$ for D = 55%	1,9	1,3	1,3
$E_{T,o}$ for D = 55%	2,0	1,5	1,3

As for narrow 2+2 lane road the proportion of trucks in the traffic stream is set to 15% and assuming 0% recreational vehicles. The heavy vehicle adjustment factor for average travel



speed is calculated by using Equation 11, and can be found in Table 21.

*Table 21: Heavy vehicle adjustment factors for average travel speed.*

	AADT = 6 000	AADT = 12 000	AADT = 20 000
$f_{HV, ATS, d}$ for D = 67%	0,90	0,96	0,96
$f_{HV, ATS, o}$ for D = 67%	0,85	0,90	0,96
$f_{HV, ATS, d}$ for D = 55%	0,88	0,96	0,96
$f_{HV, ATS, o}$ for D = 55%	0,87	0,93	0,96

#### Demand Flow Rate for Average Travel Speed Estimation

Then by using Equation 9 the demand flow rate for average travel speed estimation is found for both the analysis direction and the opposing, for traffic splits of 67/33 and 55/45. The results are given in Table 22.

*Table 22: The demand flow rate for average travel speed for both the analysis direction and the opposing direction, for different AADT values.*

	AADT = 6 000	AADT = 12 000	AADT = 20 000
$v_{d, ATS}$ [pc/h] for D = 67%	654	1186	1977
$v_{o, ATS}$ [pc/h] for D = 67%	402	641	974
$v_{d, ATS}$ [pc/h] for D = 55%	564	974	1623
$v_{o, ATS}$ [pc/h] for D = 55%	494	828	1328

#### 4.2.2.4 Step 4: Estimate the Average Travel Speed

To estimate the average travel speed in the analysis direction, Equation 12 is used.

$$ATS_d = FFS - 0,00776(v_{d,ATS} + v_{o,ATS}) - f_{np,ATS}$$

Equation 12

$ATS_d$  = average travel speed in the analysis direction (mi/h)

$FFS$  = free-flow speed (mi/h)

$v_{d,ATS}$  = demand flow rate for ATS determination in the analysis direction (pc/h)

$v_{o,ATS}$  = demand flow rate for ATS determination in the opposing direction (pc/h)

$f_{np,ATS}$  = adjustment factor for ATS determination for the percentage of no-passing zones in the analysis direction

(Transportation Research Board, 2010 p. 15-21)

By using the  $v_{o,ATS}$  values in Table 22 and Exhibit 15-15 in Highway Capacity Manual, the average travel speed adjustment factors for 100% no-passing zones and free-flow speed of 60 mi/h are found and presented in Table 23.

Table 23: The values for  $f_{np,ATS}$  when the  $FFS = 60$  mi/h and there are 100% no passing zones.

	AADT = 6 000	AADT = 12 000	AADT = 20 000
$f_{np,ATS}$ for D = 67%	3,9	1,9	1,2
$f_{np,ATS}$ for D = 55%	3,0	1,4	1,0

By using Equation 12 the average travel speed for the analysis direction where found for different AADT values and splits. The results are showed in Table 24.

Table 24: The average travel speed (mi/h) for AADT values 6 000, 12 000 and 20 000.

	AADT=6 000	AADT=12 000	AADT=20 000
ATS <sub>d</sub> [mi/h] for D = 67%	45,2	41,3	33,2
ATS <sub>d</sub> [mi/h] for D = 55%	46,1	42,0	33,5

#### 4.2.2.5 Step 5: Demand Adjustment for Percent Time-spent-following

To calculate the demand flow rate for determination of the percent time-spent-following (PTSF), Equation 13 is used.

$$v_{i,PTSF} = \frac{V_i}{PHF * f_{g,PTSF} * f_{HV,PTSF}}$$

Equation 13

$v_{i,PTSF}$  = demand flow rate  $i$  for determination of PTSF (pc/h)

$i$  = "d" (analysis direction) or "o" (opposing direction)

$f_{g,PTSF}$  = grade adjustment factor for PTSF determination

$f_{HV,PTSF}$  = heavy vehicle adjustment factor for PTSF determination

PHF = peak hour factor

$V_i$  = demand volume for direction  $i$  (veh/h)

(Transportation Research Board, 2010 p. 15-23)

## Peak Hour Factor for Estimation of Percent Time-spent-following

The peak hour factor (PHF) is set to 0,85 as for the calculations of average travel speed.

## Grade Adjustment Factor for Estimating Percent Time-spent following

All the  $v_{vph}$  values needed to find the grade adjustment factors ( $f_{g, PTSF}$ ) from Exhibit 15-16 in Highway Capacity Manual for estimation of percent time-spent-following are calculated in previous steps and can be found in Table 18 . The  $f_{g, PTSF}$  values for rolling terrain and corresponding directional demand flow rate ( $v_{vph}$ ) are presented in Table 25.

Table 25: Grade adjustment factor,  $f_{g, PTSF}$

	AADT=6 000	AADT=12 000	AADT=20 000
$f_{g, PTSF, d}$ for D = 67%	0,97	1,00	1,00
$f_{g, PTSF, o}$ for D = 67%	0,84	0,97	1,00
$f_{g, PTSF, d}$ for D = 55%	0,94	1,00	1,00
$f_{g, PTSF, o}$ for D = 55%	0,89	1,00	1,00

## Heavy Vehicle Adjustment Factor for Estimation of Percent Time-spent-following

To calculate the heavy vehicle adjustment factor for percent time-spent following ( $f_{HV, PTSF}$ ) Equation 14 is used.

$$f_{HV, PTSF} = \frac{1}{1 + P_T(E_T - 1) + P_R(E_R - 1)}$$

Equation 14

$f_{HV, PTSF}$  = heavy vehicle adjustment factor for PTSF estimation

$P_T$  = proportion of trucks in the traffic stream

$P_R$  = proportion of recreational vehicles in the traffic stream

$E_T$  = passenger car equivalent for trucks

$E_R$  = passenger car equivalent for recreational vehicles

(Transportation Research Board, 2010 p. 15-23)

By using Exhibit 15-18 in Highway Capacity Manual and values for directional demand flow rate ( $v_{vph}$ ) found in Table 18, the percent time-spent following passenger car equivalents for trucks ( $E_T$ ) are found. The values for  $E_T$  can be seen in Table 26.

Table 26: Passenger car equivalent for trucks. Rolling terrain.

	AADT=6 000	AADT=12 000	AADT=20 000
$E_{T,d}$ for D = 67%	1,2	1,0	1,0
$E_{T,o}$ for D = 67%	1,7	1,2	1,0
$E_{T,d}$ for D = 55%	1,4	1,0	1,0
$E_{T,o}$ for D = 55%	1,6	1,0	1,0

As previous, the proportion of trucks in the traffic stream ( $P_T$ ) is 15% and the proportion of recreational vehicles in the traffic stream ( $P_R$ ) is 0%. By using the values for  $E_T$  in Table 26 and Equation 14, the heavy vehicle adjustment factors for PTSF are found and presented in Table 27.

Table 27: Heavy vehicle adjustment factors for PTSF.

	AADT=6 000	AADT=12 000	AADT=20 000
$f_{HV, PTSF, d}$ for D = 67%	0,97	1,00	1,00
$f_{HV, PTSF, o}$ for D = 67%	0,90	0,97	1,00
$f_{HV, PTSF, d}$ for D = 55%	0,94	1,00	1,00
$f_{HV, PTSF, o}$ for D = 55%	0,92	1,00	1,00

## Demand Flow Rate for Determination of Percent Time-spent-following

By using Equation 13, PHF = 0,85, and grade adjustment factors and heavy vehicle adjustment factors found in Table 25 and Table 27, the demand flow rate for determination of PTSF was calculated for the different demand volumes in Table 17. The results can be seen in Table 28.

Table 28: The demand flow rate for determination of PTSF (pc/h).

	AADT=6 000	AADT=12 000	AADT=20 000
$v_{d, PTSF}$ for D = 67%	602	1135	1892
$v_{o, PTSF}$ for D = 67%	368	593	932
$v_{d, PTSF}$ for D = 55%	526	932	1553
$v_{o, PTSF}$ for D = 55%	467	765	1271

### 4.2.2.6 Step 6: Estimate the PTSF

To estimate the percent time-spent-following Equation 15 and Equation 16 are needed.

$$PTSF_d = BPTSF_d + f_{np, PTSF} \left( \frac{v_{d, PTSF}}{v_{d, PTSF} + v_{o, PTSF}} \right)$$

Equation 15

$PTSF_d$  = percent time-spent-following in the analysis direction

$BPTSF_d$  = base percent time-spent-following in the analysis direction

$f_{np, PTSF}$  = adjustment to PTSF for the percentage of no-passing zones in the analysis segment

$v_{d, PTSF}$  = demand flow rate in the analysis direction for estimation of PTSF (pc/h)

$v_{o, PTSF}$  = demand flow rate in the opposing direction for estimation of PTSF (pc/h)

(Transportation Research Board, 2010 p. 15-25)

$$BPTSF_d = 100[1 - \exp(av_d^b)]$$

Equation 16

$BTSF_d$  = base percent time-spent-following in the analysis direction

$v_{d, PTSF}$  = demand flow rate in the analysis direction for estimation of PTSF (pc/h)

$a$  = constant

$b$  = constant

(Transportation Research Board, 2010 p. 15-26)

By using Exhibit 15-20 in Highway Capacity Manual and former calculated values for opposing demand flow rate ( $v_{o, PTSF}$ ), Table 28, values for  $a$  and  $b$  is found and presented in Table 29.

Table 29: Values for the coefficients  $a$  and  $b$ .

	AADT = 6 000	AADT = 12 000	AADT = 20 000
a for D = 67%	-0,0021	-0,0033	-0,0048
b for D = 67%	0,931	0,872	0,830
a for D = 55%	-0,0026	-0,0043	-0,0055
b for D = 55%	0,905	0,839	0,824

Then by using Equation 16, values for demand flow rate in the analysis direction ( $v_{d, PTSF}$ ) found in Table 28, and the  $a$  and  $b$  values in Table 29, values for  $BPTSF_d$  are calculated and showed in Table 30.

Table 30: Values for base percent time-spent-following in the analysis direction ( $BPTSF_d$ ).

	AADT = 6 000	AADT = 12 000	AADT = 20 000
$BPTSF_d$ for D = 67%	55,2	77,8	91,8
$BPTSF_d$ for D = 55%	52,6	73,7	90,5

For deciding the no-passing-zone adjustment factor ( $f_{np, PTSF}$ ) for determination of percent time-spent-following, the total two-way flow rate ( $v_d + v_o$ ) is used together with Exhibit 15-21 in Highway Capacity Manual. There is assumed 100% no-passing zones, since the mid-barrier is preventing any take over actions, and a directional split of 67/33 and 55/45. The corresponding  $f_{np, PTSF}$  factors are found and presented in Table 31.

Table 31: Adjustment factor for no-passing-zone.

	AADT = 6 000	AADT = 12 000	AADT = 20 000
$f_{np, PTSF}$ for D = 67%	33,4	19,2	-*
$f_{np, PTSF}$ for D = 55%	39,1	22,8	8,7**

\*The two-way flow rate is too high for finding any value for  $f_{np, PTSF}$  for this directional split.

\*\*The value for a directional split of 50/50 is used since there is none available for such high two-way flow rate for a directional split of 60/40, which could be used to interpolation.

Then by using Equation 15 and values found in Table 28, Table 30 and Table 31, percent time-spent-following is estimated and presented in Table 32.

Table 32: Values for percent time-spent-following ( $PTSF_d$ ).

	AADT = 6 000	AADT = 12 000	AADT = 20 000
$PTSF_d$ [%] for D = 67%	75,9	90,3	-
$PTSF_d$ [%] for D = 55%	73,3	86,2	95,3



#### 4.2.2.7 Step 7: Determine Level of Service

The estimated average travel speed and percent time-spent-following calculated in the previous steps are summarized in Table 33.

*Table 33: Average travel speed (mi/h) and percent time-spent-following (%) in the analyze direction for AADT values 6 000, 12 000 and 20 000.*

	AADT = 6 000	AADT = 12 000	AADT = 20 000
ATS <sub>d</sub> [mi/h] for D = 67%	45,2	41,3	33,2
PTSF <sub>d</sub> [%] for D = 67%	75,9	90,3	-
ATS <sub>d</sub> [mi/h] for D = 55%	46,1	42,0	33,5
PTSF <sub>d</sub> [%] for D = 55%	73,3	86,2	95,3

The level of service criteria can be found in Figure 17. Since both the average travel speed and the percent time-spent-following are applied to find the level of service (LOS), the worse of the two LOS that is obtained, is deciding for the level of service assigned to the roadway (Transportation Research Board, 2010). Using the estimated values for average travel speed and percent time-spent following in Table 33 and the criteria for level of service in Figure 17, the LOS values are found and presented in Table 34.

*Table 34: Level of service for a two-lane highway with no passing lane.*

	AADT = 6 000	AADT = 12 000	AADT = 20 000
LOS for D = 67%	D	E	-
LOS for D = 55%	D	E	-

The capacity of a two-lane highway is 1 700 pc/h in one direction and 3 200 pc/h for the two directions together (Transportation Research Board, 2010). This means that the combination

of directional split of 67/33 and AADT 20 000 exceeds the capacity of a two-lane highway. The combination of directional split of 55/45 and AADT 20 000 is so close to the capacity limit that the capacity is also considered to be exceeded for this combination.

**4.2.2.8 Step 8: Adding a Passing Lane**

The calculations in previous steps, 1-7, were done for a two-lane highway with median barrier. Now the effect of a passing lane will be accounted for to give an indication of the level of service for 2+1 lane roads. Since the 2+1 lane road design does not increase the roadway capacity of a two-lane highway (Potts & Harwood, 2003), and the capacity was considered to be exceed for AADT 20 000 for both the directional split of 67/33 and 55/45, no further calculations are done for these combinations.

The passing lane affects the percent time-spent-following downstream of the passing lane in a positive way, as can be seen in Figure 29. There are also positive affects for the average travel speed, downstream of the passing lane, but that is limited to 1,7 miles (Transportation Research Board, 2010).

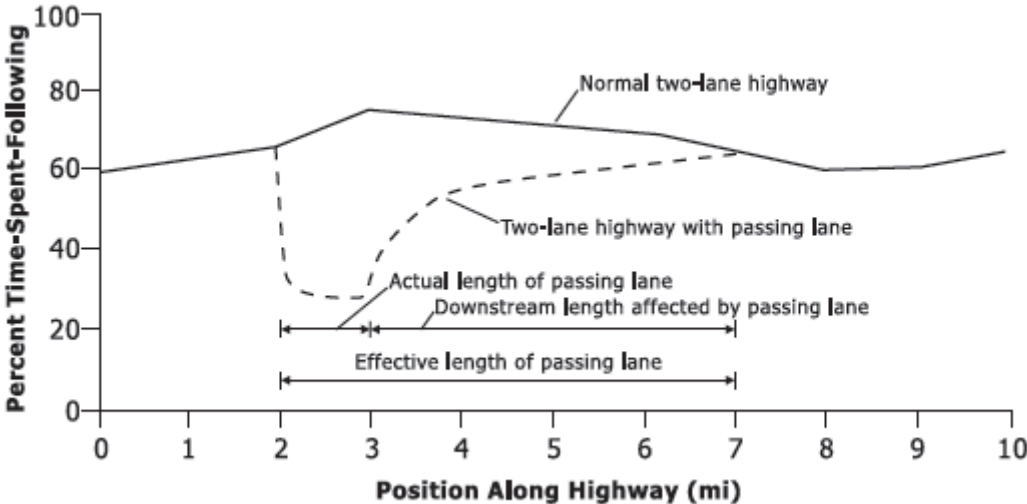

Figure 29: The effect of a passing lane on percent time-spent following. The picture is retrieved from (Transportation Research Board, 2010 p. 15-29).

By using the  $v_d$  values from previous steps, summarized in Table 35, and Exhibit 15-23 in the Highway Capacity Manual, the downstream lengths of the roadway affected by the passing

lane ( $L_{de}$ ) are found. The results are presented in Table 36.

*Table 35: The directional demand flow rate,  $v_d$  (pc/h) for different AADT values.*

	AADT = 6 000	AADT = 12 000	AADT = 20 000
$v_{d, PTSF}$ for D = 67%	602	1135	1892
$v_{d, ATS}$ for D = 67%	654	1186	1977
$v_{d, PTSF}$ for D = 55%	526	932	1553
$v_{d, ATS}$ for D = 55%	564	974	1623

*Table 36: The effected downstream length of the road way in miles for different AADT values*

	AADT = 6 000	AADT = 12 000	AADT = 20 000
$L_{de, PTSF}$ for D = 67%	6,5	3,6	-
$L_{de, ATS}$ for D = 67%	1,7	1,7	-
$L_{de, PTSF}$ for D = 55%	6,8	3,8	-
$L_{de, ATS}$ for D = 55%	1,7	1,7	-

### Step 8.1: Divide the Segment into Regions

The analysis segment can be divided into four parts:

1. Length upstream of the passing lane  $L_u$ ,
2. Length of the passing lane  $L_{pl}$ ,
3. Length downstream of the passing lane within its effective length  $L_{de}$ , and
4. Length downstream of the passing lane beyond its effective length  $L_d$ .

(Transportation Research Board, 2010 p.15-30)

The length of the passing lane ( $L_{pl}$ ) needs to be a part of the analysis. It is also strongly recommended to include the length downstream of the passing lane within its effective length

( $L_{de}$ ). Part 1 and 4 can be skipped based on the judgement of the analyst. (Transportation Research Board, 2010)

With the design specified in chapter 3.1 Design the lengths will be:

1.  $L_u$  will not exist since the length upstream of the passing is the  $L_{de}$  for the previous passing lane.
2.  $L_{pl} = 1,5$  km which equals 0,93 mi
3.  $L_{de}$  depends on AADT and PTSF or ATS

The length available before a new passing lane is coming up will be the limiting factor. With continuously alternating passing lanes, the available length downstream of the passing lane is 1,5 km equal to 0,93 mi, which is shorter than the lengths in Table 36.

4.  $L_d$  will not apply in this scenario since the effective length is longer than the length available

The design of the 2+1 lane road results in the existence of only part 2 and 3, passing lane and affected downstream length. Part 1 and 4 will therefore be excluded in the analysis. The total length of the analysis segment ( $L_t$ ) is therefore  $L_{pl}+L_{de} = 3$  km, equal to 1,86 mi.

#### Step 8.2: Determine the Percent Time-spent-following (PTSF)

Generally the PTSF is equal to 58-62% of it upstream value within the passing lane length ( $L_{pl}$ ). Then within the effective length downstream of the passing lane the PTSF is assumed to increase linearly up to its upstream value. (Transportation Research Board, 2010) This is illustrated in Figure 30.

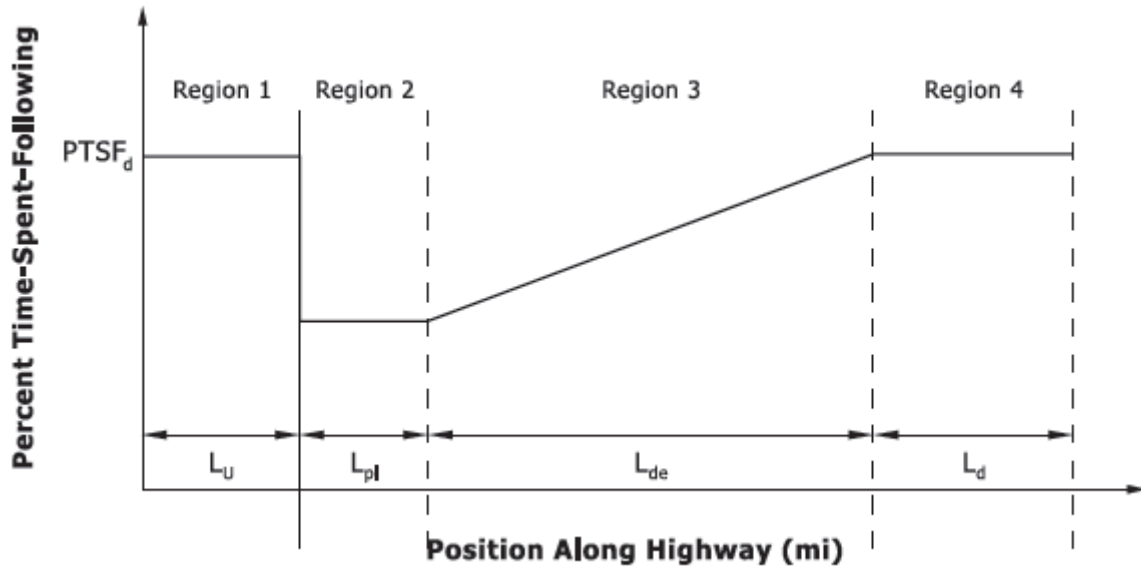

Figure 30: The effect on PTSF from the passing lane. The picture is retrieved from (Transportation Research Board, 2010 p.15-31)

The formula for deciding the percent time-spent-following for a segment affected by the presence of passing lane, in a situation where the available downstream length is less than the value of  $L_{de}$  that is found in Table 36, is given by Equation 17.

$$PTSF_{pl} = \frac{PTSF_d [L_u + f_{pl,PTSF} L_{pl} + f_{pl,PTSF} L'_{de} + \left( \frac{1 - f_{pl,PTSF}}{2} \right) \left( \frac{L'_{de}}{L_{de}} \right)^2]}{L_t}$$

Equation 17

$PTSF_{pl}$  = percent time-spent-following for segment as affected by the presence of a passing lane (%)

$f_{pl,PTSF}$  = adjustment factor for the impact of a passing lane on percent time-spent-following

$L_{de}$  = the effected length downstream of the passing lane, if not the length was limited by the next passing lane coming up.

$L_{de'}$  = the actual length downstream of the passing lane which is effected

$L_u$  = length upstream of the passing lane

$L_t$  = the total length of the analysis segment.

(Transportation Research Board, 2010 p. 15-32)

By using the values for  $v_{d, PTSF}$  in Table 35 and Exhibit 15-26 in Highway Capacity Manual values for  $f_{pl, PTSF}$  are found and presented in Table 37.

Table 37: Values of  $f_{pl, PTSF}$  for different AADT values.

	AADT = 6 000	AADT = 12 000	AADT = 20 000
$f_{pl, PTSF}$ for D = 67%	0,61	0,62	-
$f_{pl, PTSF}$ for D = 55%	0,61	0,62	-

Then by using Equation 17, the  $PTSF_{pl}$  is found for AADT 6 000 and 12 000. The results are given in Table 38.

Table 38: Values for percent time-spent-following for segment as affected by the presence of a passing lane.

	AADT = 6 000	AADT = 12 000	AADT = 20 000
$PTSF_{pl}$ for D = 67%	47,4	58,2	-
$PTSF_{pl}$ for D = 55%	45,7	55,5	-

When the effect of the passing lane is taken into consideration the PTSF is quite significantly reduced, from 75,9% to 47,4% for AADT 6 000 and from 90,3% to 58,2% for AADT 12 000, for the directional split of 67/33. For the directional split of 55/45 the PTSF is reduced from 73,3% to 45,7% and 86,2% to 55,5% for AADT 6 000 and 12 000 respectively.

### Step 8.3: Determine Average Travel Speed (ATS)

The average travel speed is generally 8-11% higher within the passing lane than the average travel speed that would exist without the passing lane, for then linearly decreasing back to the

normal value, within the effective downstream length. (Transportation Research Board, 2010)  
 The relationship between how average travel speed is varying according to the different part of the analysis segment is showed in Figure 31.

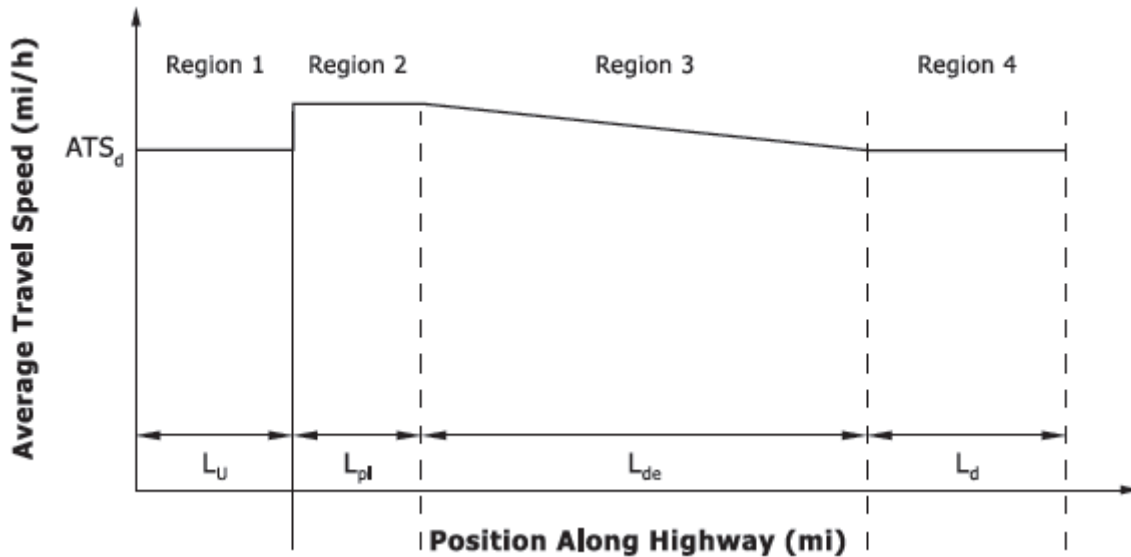

Figure 31: The impact of a passing lane on average travel speed. The picture is retrieved from (Transportation Research Board, 2010 p. 15-32)

As for the PTSF calculations the available length downstream of the passing lane is less than the effected length downstream ( $L_{de}$ ) which can be found in Table 36. Therefore is Equation 18 used to find the new average travel speed.

$$ATS_{pl} = \frac{ATS_d L_t}{L_u + \frac{L_{pl}}{f_{pl,ATS}} + \frac{2L'_{de}}{[1 + f_{pl,ATS} + (f_{pl,ATS} - 1) \left( \frac{L_{de} - L'_{de}}{L_{de}} \right)]}}$$

Equation 18

$ATS_{pl}$  = average travel speed in the analysis segment as affected by a passing lane (mi/h)

$f_{pl,ATS}$  = adjustment factor for the effect of a passing lane on ATS

$L_{de}$  = the effected length downstream of the passing lane, if not the length was limited by the next passing lane coming up (mi)

$L_{de}'$  = the actual length downstream of the passing lane which is effected (mi)

$L_u$  = length upstream of the passing lane (mi)

$L_t$  = the total length of the analysis segment (mi)

(Transportation Research Board, 2010 p. 15-33)

By using values for  $v_{d, ATS}$  in Table 35 and Exhibit 15-28 in Highway Capacity Manual, values for  $f_{pl, ATS}$  are found and presented in Table 39.

Table 39: Values  $f_{pl, ATS}$  for different AADT values.

	AADT = 6000	AADT = 12 000	AADT = 20 000
$f_{pl, ATS}$ for D = 67%	1,11	1,11	-
$f_{pl, ATS}$ for D = 55%	1,11	1,11	-

Then by using Equation 18 new values for the average travel speed when including a passing lane ( $ATS_{pl}$ ) is calculated and presented in Table 40.

Table 40: Values for  $ATS_{pl}$ .

	AADT = 6000	AADT = 12 000	AADT = 20 000
$ATS_{pl}$ for D = 67%	49,5	45,2	-
$ATS_{pl}$ for D = 55%	50,5	46,0	-

The passing lane increases the ATS from 45,2 mi/h to 49,5 mi/h and from 41,3 mi/h to 45,2 mi/h, for AADT 6 000 and 12 000 respectively, for the directional split of 67/33. For the directional split of 55/45 the ATS are increased from 46,1 mi/h to 50,5 mi/h and 42,0 mi/h to 46,0 mi/h, for AADT 6 000 and 12 000 respectively.



**4.2.2.9 Step 9: Determine the Level of Service, when the Effect of the Passing Lane is taken into Consideration.**

The new service levels can be seen in Table 41. The new levels of service are found by using the values for percent time-spent following and average travel speed achieved when taking the passing lane into account, Table 38 and Table 40 , and the criteria in Figure 17.

*Table 41: Service levels for a 2+1 lane road.*

	AADT = 6 000	AADT = 12 000	AADT = 20 000
LOS for D = 67%	C	C	-
LOS for D = 55%	B	C	-

The level of service values which can be seen in Table 41 are a significantly improved compared to those found for a two-lane highway with no possibility for overtaking, Table 34. The main reason for the improvement is that the high values for percent time-spent following are reduced, because the passing lane provides the opportunity to take over other vehicles. With a passing lane the average travel speeds have also increased, and the 2+1 lane road operates now at acceptable level of service for AADT = 6 000 and AADT = 12 000. For AADT 20 000 the capacity is considered breached for the directional split of 67/33 and 55/45.

**4.2.3 Comparing the Narrow 2+2 Lane Road and the 2+1 Lane Road Results**

The level of service for the narrow 2+2 lane road was calculated with the method for freeways, and for the 2+1 lane road the method for two-lane highway with passing lane was used. The results can be seen in Table 42.

*Table 42: Level of service for narrow 2+2 lane road and 2+1 lane road for different AADT values and directional splits.*

	AADT = 6 000	AADT = 12 000	AADT = 20 000
Narrow 2+2 lane road for D = 67 %	A	B	C
2+1 lane road For D = 67%	C	C	-
Narrow 2+2 lane road for D = 55%	A	A	B
2+1 lane road for D = 55%	B	C	-

From the results in Table 42 it can be seen that the narrow 2+2 lane road accommodate the traffic at a higher level of service than the 2+1 lane road. It can also handle an AADT of 20 000 at LOS C or better, where the capacity of the 2+1 lane road is assumed breached. These results matches quite good with the expectations, since in Norway, four-lane roads are normally built when the AADT > 12 000 (Statens vegvesen, 2014b). In countries like Sweden, Germany and Finland the 2+1 lane roads operate at AADT values as high as 20 000, and the maximum value in Germany is set to AADT of 30 000 (Potts & Harwood, 2003). There are many different designs of 2+1 lane roads varying from country to country together with different driver characteristics and topography. It is therefore reasonable that the AADT the road could accommodate would vary. The assumed directional split is also affecting the level of service.

### **4.3 Operation, Maintenance and Rutting**

Operation and maintenance are important parts when it comes to roads and other infrastructure. Each year the Norwegian Public Roads Administration is spending a lot of money on keeping the roads in a good condition. The results from the survey “What is the Cost of Eliminating the Maintenance Backlog on National Roads?” (Sund, 2012), shows that it will cost 25-40 billion NOK to get rid of the maintenance backlog on the national road network. Around 25 percent is related to pavements, including road fundament and drainage.

Narrow driving lanes seem to be one factor causing the need for more maintenance related to pavements. The narrower the driving lane, the less space available for the traffic to move laterally, and thereby making the wear from tires more concentrated, and causing more rutting than what would have been the case for a road with wider lanes. By using the “Slitagemodell” (Swedish Association for Test Methods of Road Materials and Pavements, 2015) developed by VTI (Swedish National Road and Transport Research Institute), some rough indications regarding the rutting caused by wear from studded tires related to different lane widths are established.

Only changes to the values regarding type of road, speed, AADT for the different driving lanes, percentage of studded tires and allowed rut depth is made. Input parameters concerning the characteristics of the material in the pavement and costs of material are kept as the standard values. The intention is to see the effect on rutting when changing the road design. The choice of design affects the cars side-distribution, and how bounded they are to drive in the same tracks. (Jacobson & Wågberg, 2007) The input data and results from the “Slitagemodell” can be seen in Table 43. The values for AADT and results in ( ) are an attempt to take into account that the amount of vehicles in the right side lane will be a bit less for the narrow four-lane road, since it has two lanes in each direction, the amount of vehicles per lane will be reduced.

Table 43: Input data and results from the «Slitagemodell».

	<b>Extreme narrow driving lanes</b>	<b>2+1 lane road (1 lane direction)</b>	<b>2+1 lane road (2 lane direction)</b>
<b>Input values</b>			
Speed limit [km/h]	90	90	90
AADT per driving lane	4 000 (3 500)	4 000	4 000
Wear period [days]	180	180	180
Percentage studded tires [%]	40	40	40
Salted roads [yes/no]	Yes	Yes	Yes
Allowed rutting depth [mm]	20	20	20
Rutting not related to studded tires [mm]	4	4	4
Available wear depth [mm]	16	16	16
<b>Results</b>			
Wear depth per year [mm]	0,62 (0,55)	0,50	0,56
Lifetime before allowed rutting depth is reached [years]	20 (20)	20	20

Since everything is kept the same except from the design of the road, it can be assumed that the design affects the rutting. The percentage of studded tires are based on information from the Norwegian Public Roads Administration's web page (Statens vegvesen, 2015a), while the allowed rutting depth is found in the Norwegian standard for operation and maintenance of national roads (Statens vegvesen, 2014e). For wear period and rutting not related to studded tires, the base values found in the model is used.

## 5 Case Study

### 5.1 E16 Kløfta-Kongsvinger

The project is located in Norway north-east for Oslo between Kløfta and Kongsvinger, Figure 32. The project is divided into four sections Kløfta-Nybakk, Nybakk-Herbergåsen, Herbergåsen-Slomarka and Slomarka-Kongsvinger. The first section of 10,5 km was finished and opened for traffic in Oktober 2007 and the last section of 16,5 km in November 2014. (Statens vegvesen, 2016a) These sections are marked with green in Figure 32. The two remaining sections of 33,0 km, in red, see Figure 32, is still under planning. Because of geotechnical difficulties regarding quick clay, the costs for the two remaining sections have increased significantly and there are now uncertainties related to the further work. The future of the remaining sections will be decided in the next National Transportation Plan.(Statens vegvesen, 2016b)

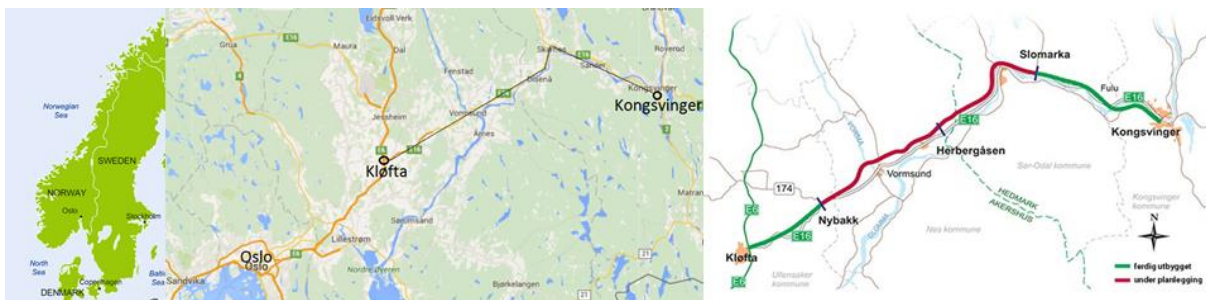

*Figure 32: The location of the E16 project between Kløfta and Kongsvinger. The picture is adjusted from ("E16 Kløfta–Kongsvinger [Picture]," 2016; "google.maps [Picture]," 2016; "Northern Europe [Picture]," 2016)*

The planning of the project started early in the 1990s and the alternatives for different road stretches that was discussed was for a two-lane road. Then as a consequence of the new road normal (for “stamveger”) in 2002, four-lane road became relevant. (Statens vegvesen, 2007) So as a supplement to the first impact assessment for a new two-lane road between Kløfta and Kongsvinger a new impact assessment was compiled, evaluating different road widths. (Larsgård, 2010) This new impact assessment was the «Rv. 2 – Nybakk – Kongsvinger Konsekvensutredning av alternative vegstandarder» (Statens vegvesen, 2007) evaluating the three different road alternatives:

1. Four-lane road with minimum road width of 19 meter
2. Four-lane road with road width 16,5 meter
3. 12,5 meter wide two-lane road with median barrier and at least three passing lanes per 10 kilometer in each direction with a minimum length of one kilometer.

(Statens vegvesen, 2007)

The third alternative is almost a 2+1 lane road, or as Potts and Harwood (2003) describe it, a two-lane roadway with intermediate passing lane frequency. See Figure 33 to look at the difference in passing lane frequency.

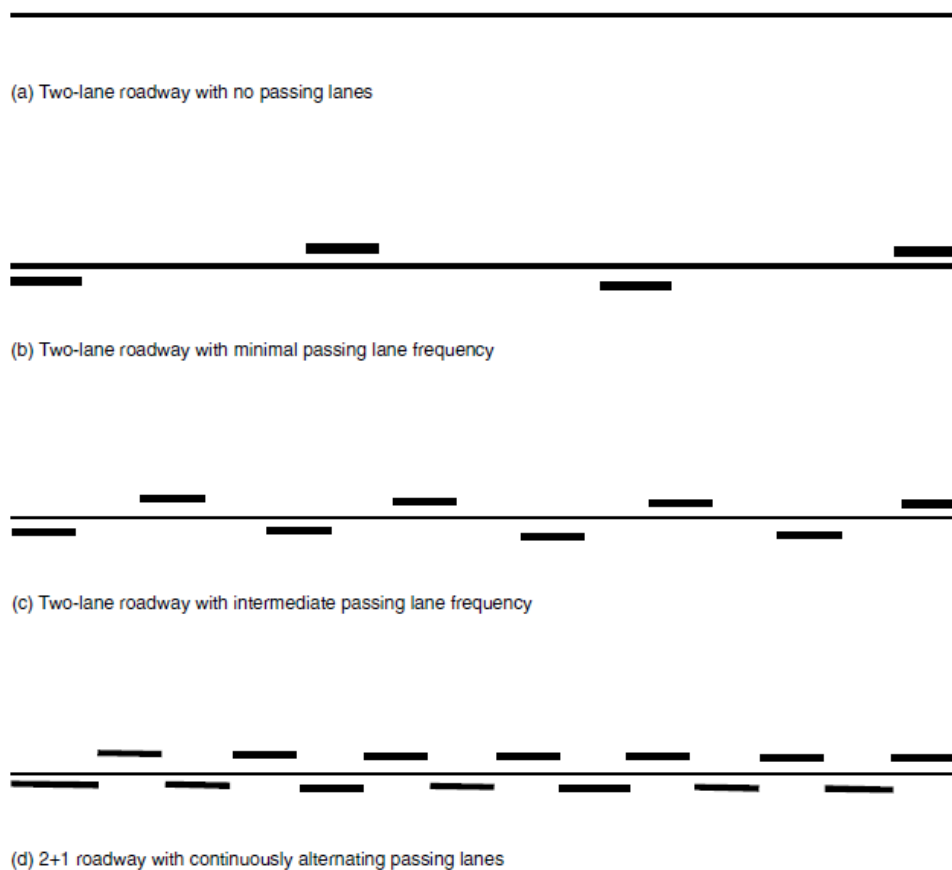

*Figure 33: Two-lane roadways with different passing lane frequency. The picture is retrieved from (Potts & Harwood, 2003, p. 21)*

The old rv.2 had AADT values varying between 7 000 to 14 000 along the approximately 60 km long road. The road was not limited access with many houses and exit roads along the stretch and a lack of pedestrian and bicycle paths. This resulted in reduced speed for about 55% of the 60 km long stretch and a high number of accidents. (Prop. 104 S, 2010-2011)

Between 1996 and 2005 there was in average around 20 accidents each year, with 9 people killed in the accidents and 35 people seriously injured or very seriously injured. (Statens vegvesen, 2007)

The conclusion of the report (Statens vegvesen, 2007) was to continue to build a narrow four-lane road for the stretch between Nybakk and Kongsvinger, similar to what was built and almost finished between Kløfta and Nybakk at the time the report was written. The road width was increased with 0,5 m from 16,0 m which had been built between Kløfta and Nybakk to provide better space for traffic signs in the median. The old two-lane road, rv. 2, should still exist as a local road besides the new E16.

The finished sections consists of 16,0 and 16,5 meter wide four-lane road with median barrier of steel, grade separated intersections and posted speed limit of 90 km/h. See Figure 34.

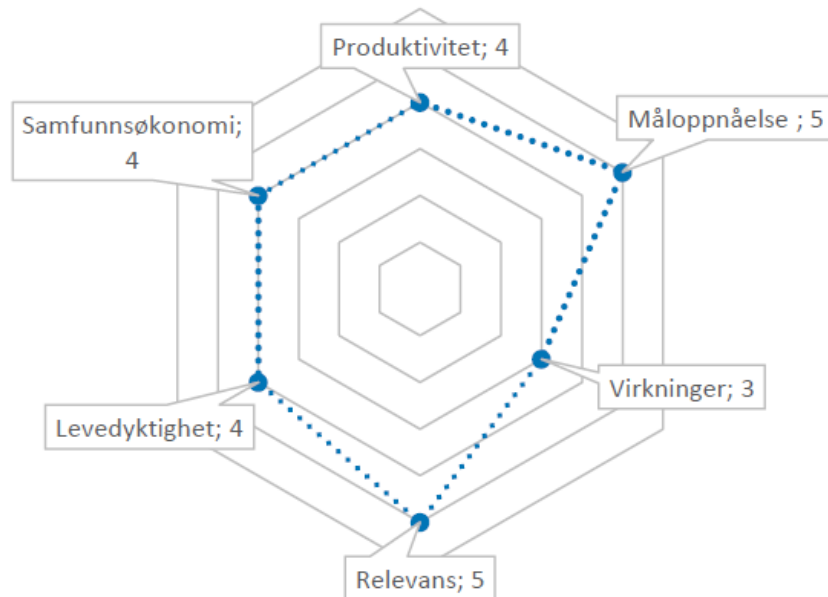

*Figure 34: A picture of E16 between Kløfta and Nybakk. The picture is retrieved from ("google.maps [Picture]," 2016)*

The report (Statens vegvesen, 2007) evaluating the three different road alternatives does not consider a 2+1 lane road although the two lane-road alternative with intermediate passing lane frequency is pretty close regarding the design. Calculations regarding the monetized impacts with focus on tradeoffs between the 2+1 lane road design and the narrow 2+2 lane road design are therefore needed. The evaluation of the monetized impacts will be done in the program called EFFEKT.

In the report “Etterevaluering av E16 Kløfta-Nybakk” (Solli & Betanzo, 2015) the stretch between Kløfta and Nybakk have been evaluated in the light of the whole project Kløfta-Kongsvinger. The evaluation is standardized, so it is possible to compare different projects

with each other. The goal is to be able to learn from the projects. The evaluation criteria are productivity, how well the goals are achieved, effect, relevance and viability. The social economic benefit of the project is also evaluated. (Solli & Betanzo, 2015) The project score for Kløfta-Nybakk can be seen in Figure 35.



*Figure 35: Evaluation of the project Kløfta-Nybakk, seen in the light of the whole project Kløfta-Kongsvinger. The picture is retrieved from (Solli & Betanzo, 2015 p. vii)*

The project performs slightly over average. It scores only 3 points on effects, because the positive effects are dependent on the realization of the whole project. The unfinished sections between Nybakk and Slomarka need to be finished to trigger the positive effects. Still the completion of the road is no guarantee for that the positive effects will be achieved. (Solli & Betanzo, 2015)

The report (Solli & Betanzo, 2015) is evaluating the whole project and the process around it and not mainly the narrow four-lane road design. In the following section I have filtered out the conclusions and results that are more directly related to the design of the road.

When looking into time, costs and quality, the conclusion says that the project was built in time, and the change from the originally plan of building a 2/3-lane road (two-lane roadway with intermediate passing lane frequency) did not delay the progress. (Solli & Betanzo, 2015) The cost of the project Kløfta-Nybakk was 690 million NOK in 2007-kroner. Converted to



2008-kroner it is 747 million NOK. This is only 3,3% higher than the *styringsramme*<sup>1</sup> given for the 2/3-lane road of 723 million NOK in 2008-kroner, and below the value that was set as *kostnadsramme*<sup>2</sup> for the narrow four-lane road. (Solli & Betanzo, 2015) The small difference in cost between the 2/3-lane road option and the narrow four-lane road is partly because in the plan for the 2/3-lane road they had taken into account that the road at a later stage could have the need to be upgraded to a four-lane road. So the bridges were already designed with enough space for a narrow four-lane road. (Solli & Betanzo, 2015) The average cost per meter of road for Kløfta-Nybakk was approximately 68 000 NOK in 2007-kroner (Statens vegvesen sited in Solli and Betanzo, 2015 p. 24). Compared to the average cost per meter for similar road classes, Figure 36, it seems to be a fair price. Of course these numbers are heavily affected by factors like the standard of the road, ground conditions, and number of bridges and tunnels, but it gives some impression of the cost compared to other projects.

	Kostnad per lm 2007-kr
Vegklasse IB (16-22 meter)	Ca 120.000
Vegklasse IIA (11-16 meter)	Ca 70.000
Kløfta-Nybakk	Ca 68.000

*Figure 36: Comparison of the cost per meter for Kløfta-Nybakk with the average cost per meter for other road classes. The picture is retrieved from (Solli & Betanzo, 2015 p. 24)*

After interviewing the Directorate of Public Roads, Solli and Betanzo (2015) listed the most substantial arguments for and against the narrow 2+2 lane road solution, Table 44, which was obtained from the interview. The arguments are translated from Norwegian to English.

<sup>1</sup> Styringsramme is set to P50, probability 50 percent. It is a 50% probability that the costs will be higher or lower than the styringsramme. It means that half of the projects are expected to have a lower cost than the styringsramme and the other half is expected to have a higher cost. (Regjeringen.no, 2014)

<sup>2</sup> Kostnadsramme is set to P85, probability 85 percent. It is then calculated that there is 85% probability that the costs don't exceed the kostnadsramme that is set. The kostnadsramme is what is seen as the acceptable cost. (Regjeringen.no, 2014)

Table 44: Arguments for and against the narrow 2+2 lane road configuration (Solli & Betanzo, 2015 p. 28).

Arguments against:	Arguments for.
<ul style="list-style-type: none"> <li>- The road could be perceived as a freeway even though the speed limit, curvature and design of the road are not designed according to the criteria for a freeway.</li> <li>- If an accident should occur lanes will be blocked because the road doesn't have wide enough shoulders.</li> <li>- The new narrow four-lane road standard could lead to construction of more four-lane roads and thereby more intervention in the nature and the landscape.</li> <li>- Other roads where there is a need for an ordinary four-lane road could be inappropriately scaled down to narrow four-lane road to save money.</li> </ul>	<ul style="list-style-type: none"> <li>- Better traffic flow at traffic peaks.</li> <li>- Better possibility to pass by accidents or situations compared to a road with one lane in each direction.</li> </ul>

Some additional comments are that the bus company which operates at the road seems to be satisfied with the new road, and hasn't experienced any difficulties with the road width. (Solli & Betanzo, 2015) There have been some problems with frost heave on the stretch, but the superstructure has been built in accordance to the Norwegian standard for road constructions (Statens vegvesen, 2014c). The problems are due to underestimation of the difficult soil conditions. (Solli & Betanzo, 2015)

The new road has reduced the travel time, and accidents with person injuries are most likely reduced, but hard to conclude since the available data is limited. Less people are bothered by noise, because of reduced traffic on the old road. (Solli & Betanzo, 2015) From this it seems like the narrow 2+2 lane road provides good mobility and traffic safety for the road users, and serves its intended purpose in a satisfying way. The arguments in Table 44 are concerns about the design in general. Especially the arguments against the narrow 2+2 lane road design seems to be assumption and worries about misuse of the design and not actual design flaws.

## 5.2 EFFEKT

The program called EFFEKT is used to look at the monetized impacts of building a road between Kløfta and Nybakk. EFFEKT is a program that performs benefit-cost analyses for road and transportation projects, and it is based on the principles and methods found in the Norwegian Public Roads Administration's standard for impact assessments (Statens vegvesen, 2014g; Straume & Bertelsen, 2015). The results are used in the planning stage of the project together with an evaluation of the non-monetized impacts and other relevant information to evaluate different solutions or alternatives. (Straume & Bertelsen, 2015)

This case study is focusing on the first part of the E16 Kløfta-Kongsvinger project, the stretch between Kløfta and Nybakk. In Figure 37 the old road is marked with blue and the new road is marked in green. In the benefit-cost analysis the old road will be referred to as alternative 0, the new narrow 2+2 lane road as alternative 1 and a hypothetical 2+1 lane road solution as alternative 2. Alternative 2 will have the same alignment as alternative 1, the green line.

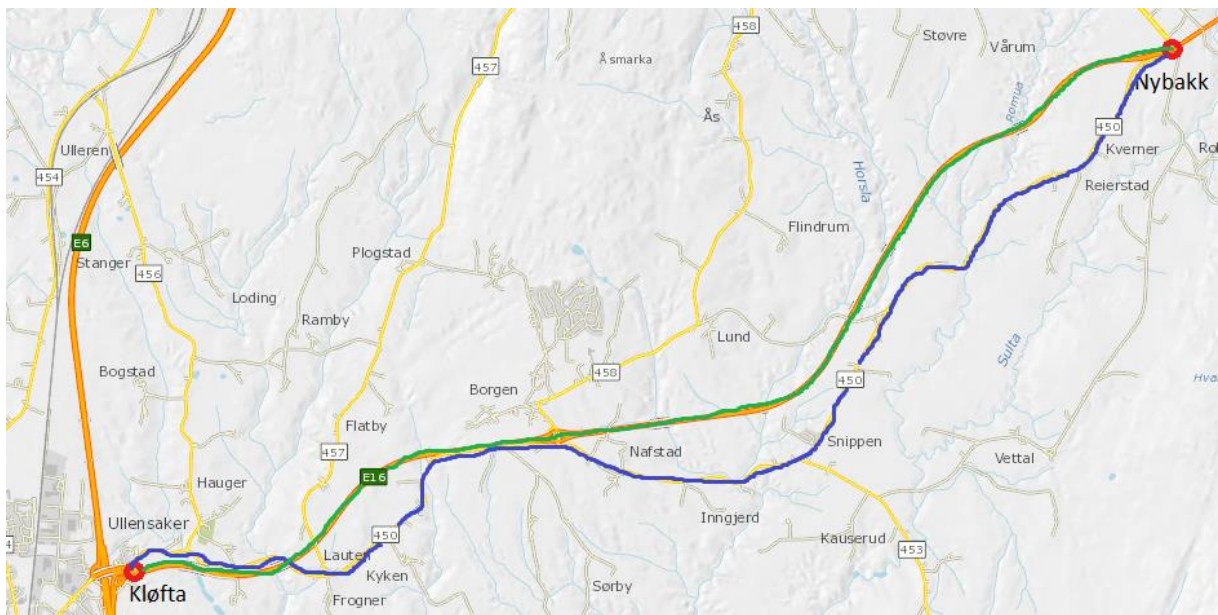

*Figure 37: The old road (blue) and the new road (green) between Kløfta and Nybakk. The picture is adjusted from Vegkart (Statens vegvesen, 2016d).*

In EFFEKT the road system have been simplified by only creating two boundary points. The simplified road system can be seen in Figure 38. This means that there are no traffic generated or lost between Kløfta and Nybakk. The horizontal curvature and height data, for the old (blue) road and the new (green) road is found by using Vegkart (Statens vegvesen, 2016d),

and then typed into EFFEKT. As can be seen in Figure 37 the new road is approximately one kilometer shorter and has an improved geometry compared to the old road.

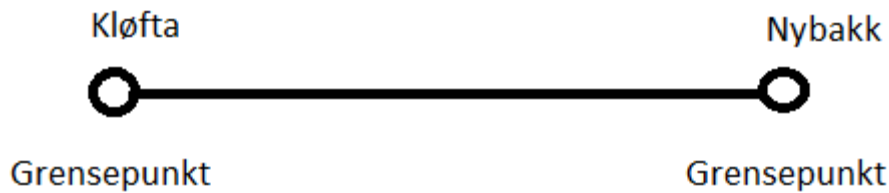

*Figure 38: Simplified road system used in EFFEKT.*

### **5.2.1 Project Data**

After defining the road system, project data which is common for all the road networks created inside the same project is given in. Project data includes basic data as location of the project, analysis period, the project's life time, and interest and value added tax levels. Standard values for the costs of accidents based on severity type, and value of time can be found here and changed if necessary. Data about traffic volumes, composition and percentage growth in the future is also given in under project data, so the traffic will be the same for all the different alternatives. Unless other things are specified the standard values given in EFFEKT is applied.

For this project the AADT is set to 9750 in 2007 and 12% heavy vehicles. Then the increase in traffic will be 1% from 2007 including 2011, 0,7% until 2021 and then 0,6% after that (Statens vegvesen, 2005b). The traffic variation is set to M2: Area with mix of work trips and through traffic.

## 5.2.2 Road Network Data

### 5.2.2.1 Alternative 0: The Existing Situation, the Old Rv2.

The cross section design of the existing road can be seen in Figure 39, and the speed limit is set to 80 km/h. No changes are done to the standard maintenance or environmental data in the program. Data regarding accidents on the stretch can be seen in Figure 40.

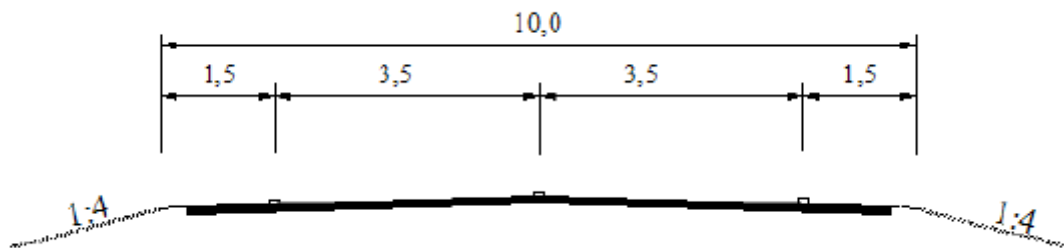

Figure 39: The design of the road that is Alternative 0. The picture is retrieved from (Statens vegvesen, 2007 p. 15)

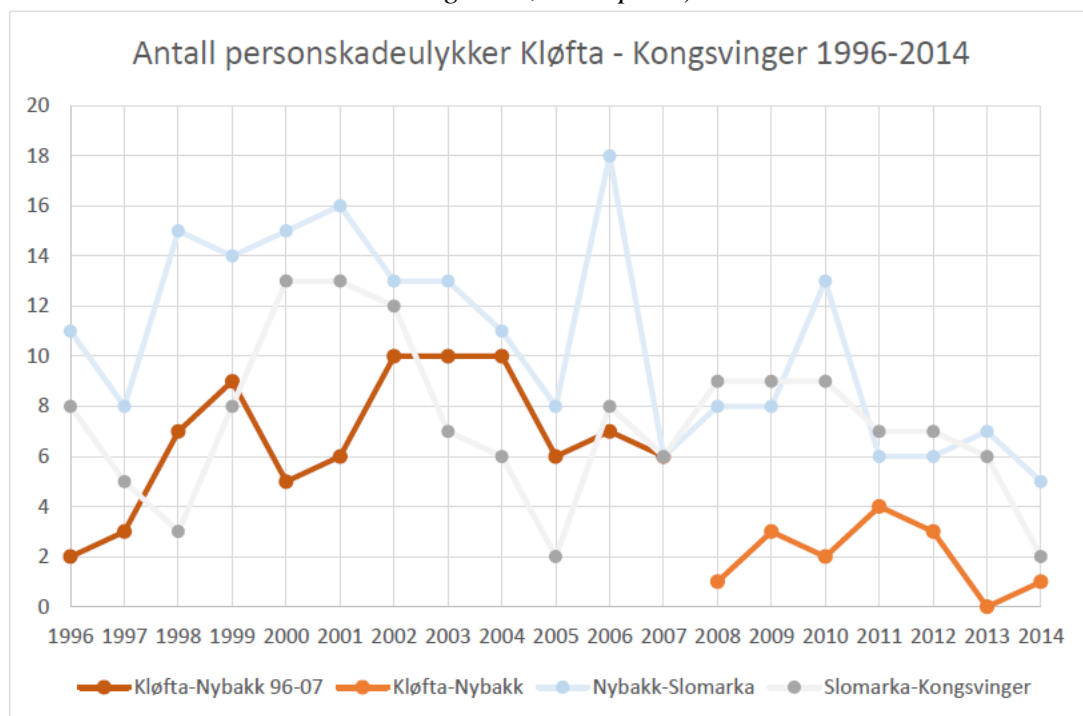

Figure 40: Number of accidents with person injuries for the stretch between Kløfta and Kongsvinger from 1996 to 2014. The picture is retrieved from (Solli & Betanzo, 2015 p. 36) Summing up the accidents in Figure 40 from 1996-2007 for the stretch Kløfta-Nybakk gives 81 accidents with person injuries. In most of the accidents the severity was lighter person

injuries (Solli & Betanzo, 2015). From Vegkart (Statens vegvesen, 2016d) it was found that there had been four fatal accidents in the same period. The fatal accidents consisted of two head-on collisions, one run-off-road accident and one accident related to an intersection. So the data basis for traffic accidents was given as 77 accidents with lighter injuries and 4 fatal accidents as described. The average AADT for the period was assumed to be 9000. These data formed the basis for the accident data for the existing situation, alternative 0.

### 5.2.2.2 Alternative 1: Narrow 2+2 Lane Road

Alternative 1 is the narrow 2+2 lane road design that was actually built when they finished the construction of this stretch in 2007. The design can be seen in Figure 41. The speed limit is 90 km/h and no changes are done to the standard maintenance or environmental data in the program. The construction cost is 690 million NOK in 2007-kroner. The construction period is set to 3 years and 60% of the construction costs will be covered by toll taxes on the road (Statens vegvesen, 2005b).

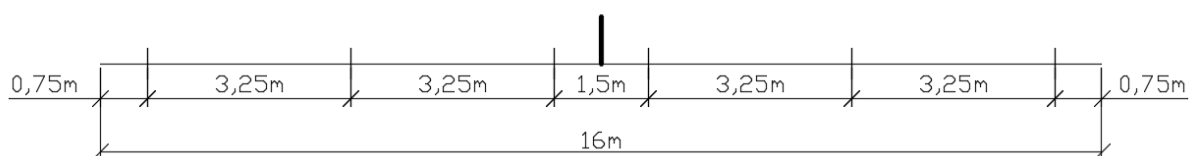

Figure 41: The cross section design of Alternative 1.

Assumptions regarding how the narrow 2+2 lane road would affect the accidents were based upon the literature and findings discussed earlier under the traffic safety section. The narrow 2+2 lane road design's assumed impacts on the accidents are presented in Table 45.

Table 45: The assumed effects from the narrow 2+2 lane road design on accidents.

Accident types that are affected	Killed	Seriously injured	Lighter injured	Number of accidents
All	-75%	-45%	25%	25%

### 5.2.2.3 Alternative 2: 2+1 lane road

The background data is the same as for alternative 1, except from the construction cost, the design of the cross section and the 2+1 lane road's affect on accidents.

#### Construction Costs

At the Norwegian Public Roads Administration's web page (Statens vegvesen, 2014j) the cost in NOK per meter for different road designs were found. For 2/3-lane roads with median barrier the cost is 110 000 - 150 000 NOK/meter and 120 000 - 170 000 NOK/meter for 16 meter wide four lane road. These values are normal values that could be expected, but there are big variations for different projects depending on ground conditions, number of bridges and tunnels, local surroundings etc.

To find an estimate for the cost of building a 2+1 lane road on the same stretch as the narrow 2+2 lane road between Kløfta and Nybakk, the numbers above were used to roughly estimate that a 2+1 lane road would be around 90% of the cost of a narrow 2+2 lane road. The construction costs for a 2+1 lane road between Kløfta and Nybakk would therefore be 621 000 000 NOK. As for alternative 1, toll taxes will cover 60% of the construction costs and the construction period is set to 3 years.

#### Design, Traffic Safety and Performance Measures

The 2+1 lane road design is not a standard road design in EFFEKT, so it is not possible to give in the values as they are defined in Figure 42. Adjustments to the input parameters have to be made so the substitute design, created in EFFEKT, is performing as closely as possible to the 2+1 lane road design.

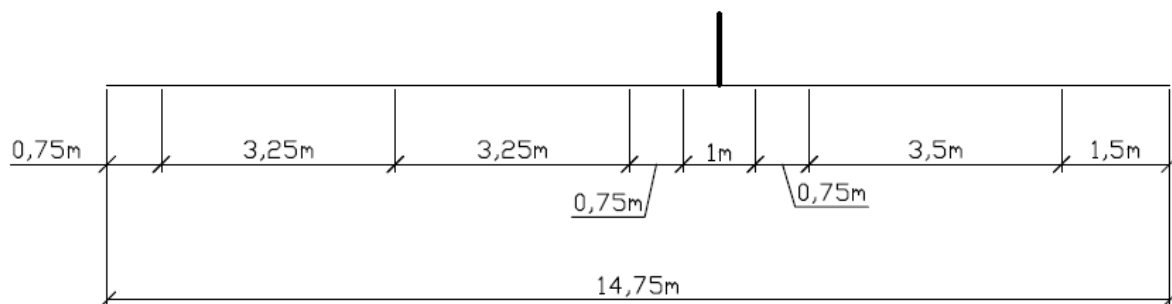

Figure 42: 2+1 lane road design.

Because of the impossibility of giving in the proper values to describe the 2+1 lane road following values were used: 2 lanes, 14,75 meter road width, 1,5 meter shoulder width and 100 percent overtaking sight. Compared to a two-lane road the 2+1 lane road design is primarily offering better level of service and traffic safety. Therefore small modifications had to be made to the substitute design, so it reflects the performance of the 2+1 lane road on these two main features.

To take into account the improvement of the traffic safety it is easy to choose built in measures in the program. It is also possible to create your own measure if you don't find any appropriate measure in the standard list. A standard measure, median barrier on existing 2/3-lane road, was chosen to reflect the 2+1 lane road impact on the traffic safety. The effects of the measure can be seen in Table 46.

*Table 46: The assumed effects from the narrow 2+1 lane road design on accidents.*

Accident types that are affected	Killed	Seriously injured	Lighter injured	Number of accidents
All	-76%	-47%	13%	13%

To determine the level of service of the 2+1 lane road, percent time-spent-following and average travel speed were used. Since it is not possible to obtain values for percent time-spent-following from EFFEKT, the average travel speed on the link will be used as an indicator to evaluate if the operational performance of the substitute design is similar to what could be expected from a 2+1 lane road.

After experimenting with different values for lane width, shoulder width, AADT, horizontal and vertical curvature, and speed limit, it seems to be the posted speed limit, curvature and number of lanes that have the largest impact on the average travel speed. Making changes to the curvature is considered inconvenient, and therefore ruled out as measure to affect the average travel speed. Then changing the number of lanes or the posted speed limit are the two options left, where making adjustment to the speed limit is considered as the best option to influence the average travel speed.

From the calculations in chapter 4.2 Capacity and Level of Service the average travel speed for the 2+1 lane road was found to be approximately 81 km/h and 74 km/h for AADT 6 000



and 12 000 respectively and traffic split of 55/45, performing one to two service levels beneath the narrow 2+2 lane road design. The average travel speed was not calculated for the narrow 2+2 lane road design, but the free flow speed was found to be around 88-93 km/h. Since the level of service for the narrow 2+2 lane road design was B or better for AADT 6 000, 12 000 and 20 000, when the split was 55/45, the free flow speed is an acceptable indicator for the travel speed.

When looking at the average speed data generated in EFFEKT for the stretch Kløfta-Nybakk, the average speed is ranging from 84-89 km/h for the 2+1 lane road design and 92-94 km/h for the narrow 2+2 lane road design, for passenger cars. The traffic split is 50/50 and AADT is around 10 000. Compared to the average travel speeds values found when deciding the level of service for 2+1-road, the average speed in EFFEKT seems a bit high. The average speed in EFFEKT for the narrow 2+2 lane road is also a bit higher than what is expected, but not as much as for the 2+1 lane road. If the speed limit for the 2+1 lane road is set to 85 km/h the average speed for passenger cars is ranging from 78-82 km/h, which fits more to the speed levels found when calculating the level of service.

### **5.2.3 Results**

To get an overview of how variations in the average travel speed and traffic safety affects the results generated in EFFEKT, there are done several calculations. A summary of the results are given in Table 47, Table 48 and Table 49. More detailed results can be found in attachment 5. The calculations are based upon the input data as described for each alternative and the standard values in EFFEKT when nothing else is specified. An interest of 4% and 40 year analysis period is used.

### 5.2.3.1 Scenario 1

Speed limit is 90 km/h for both the 2+1 lane road and the narrow 2+2 lane road. The two designs affect on traffic accidents are given in Table 45 and Table 46.

*Table 47: Scenario 1, summary of the results from EFFEKT.*

Components	Alt. 1 (2+2)	Alt. 2 (2+1)
Investment cost [NOK]	821 288 000 (-)	739 159 000 (-)
Change in time cost [NOK]	1 033 775 000 (+)	873 290 000 (+)
Change in Accident costs [NOK]	394 703 000 (+)	416 022 000 (+)
Remaining change in costs and benefits [NOK]	174 000 (-)	100 915 000 (+)
Net present value [NOK]	607 016 000 (+)	651 069 000 (+)
Benefit-cost ratio per budget kroner [ ]	1,65	1,82

### 5.2.3.2 Scenario 2

The speed limit is set to 85 km/h for the 2+1 lane road and 90 km/h for the narrow 2+2 lane road. The two designs effect on traffic accidents are given in Table 45 and Table 46.

*Table 48: Scenario 2, summary of the results from EFFEKT.*

Components	Alt. 1 (2+2)	Alt. 2 (2+1)
Investment cost [NOK]	821 288 000 (-)	739 159 000 (-)
Change in time cost [NOK]	1 033 775 000	658 631 000
Change in Accident costs [NOK]	394 703 000 (+)	416 022 000 (+)
Remaining change in costs and benefits [NOK]	174 000 (-)	160 448 000 (+)
Net present value [NOK]	607 016 000 (+)	495 942 000 (+)
Benefit-cost ratio per budget kroner [ ]	1,65	1,28

### 5.2.3.3 Scenario 3

The speed limit is 90 km/h for both the 2+1 lane road and the narrow 2+2 lane road. The narrow 2+2 lane road design's effect on accidents are assumed to be equal the 2+1 lane roads effect, which is given in Table 46.

Table 49: Scenario 3, summary of the results from EFFEKT.

Components	Alt. 1 (2+2)	Alt. 2 (2+1)
Investment cost [NOK]	821 288 000 (-)	739 159 000 (-)
Change in time cost [NOK]	1 033 775 000 (+)	873 290 000 (+)
Change in Accident costs [NOK]	416 028 000 (+)	416 022 000 (+)
Remaining change in costs and benefits [NOK]	174 000 (-)	100 915 000 (+)
Net present value [NOK]	628 341 000 (+)	651 069 000 (+)
Benefit-cost ratio per budget kroner [ ]	1,71	1,82

### 5.2.3.4 Summing up the Results from the Three Scenarios

The benefits of alternative 1 and 2 are mainly coming from time savings and reduced accident costs. In scenario 1, building the 2+1 lane road will give the highest benefit-cost ratio per budget kroner. The lower construction costs and larger savings on accidents are enough to outweigh the narrow 2+2 lane road's savings on time cost. In addition the remaining benefits for the 2+1 lane road, which are mainly coming from reduced vehicle costs, less direct costs (toll taxes), and less air and noise pollution costs is contributing to the 2+1 lane roads advantage. In scenario 2, where the only change is that the speed for the 2+1 lane road is reduced, the narrow 2+2 lane road is the design with highest benefit-cost ratio per budget kroner even though the remaining benefits for the 2+1 lane also increases, mostly because of

reduced vehicle costs from the lower speed. The larger gap in time savings compared to the 2+1 lane road makes it more profitable to build the narrow 2+2 lane road. In scenario 3, the speed is the same for both designs as in scenario 1, but the narrow 2+2 lane road is assumed to have the same effect on accidents as the 2+1 lane road. While this scenario improved the narrow 2+2 lane road, the 2+1 lane road is a little bit better with a benefit-cost ratio per budget kroner of 1,82 compared to 1,71 for the narrow 2+2 lane road. The lower construction cost, vehicle costs, direct costs (toll taxes) and air and noise pollution costs are making the 2+1 lane road the more beneficial alternative in this scenario.

In all the scenarios the results for the narrow 2+2-road and the 2+1-road is pretty close. The 2+1-road was more economical beneficial in 2 of 3 scenarios, while the narrow 2+2 road was the better alternative for one of the scenarios. The biggest difference where achieved when reducing the average speed for the 2+1-road, giving the narrow 2+2-road the advantage.

There is another cost- benefit calculation performed by COWI (sited in Solli and Betanzo, 2015), which found the net benefit to be -397 million NOK and the benefit-cost ratio per budget kroner to be -0,38, for the narrow 2+2 lane road. In this analysis an interest of 8% and analysis period of 25 years is used and financing from toll taxes are not included. If the same values for interest, analysis period and toll taxes are used for scenario 1 for the narrow 2+2 lane road, the net benefit is -158 million NOK and the benefit-cost ratio per budget kroner is -0,17. The results are not similar, but assumed so close that the difference could come from differences in the input parameters and not a major mistake in the setup of the project in EFFEKT.



## 6 Discussion and Conclusion

This thesis looks at the tradeoffs between a 2+1 lane road configuration and a narrow 2+2 lane road design through a literature review, level of service calculations based on the Highway Capacity Manual 2010, and a case study of the E16 Kløfta-Kongsvinger project using the program EFFEKT. In this chapter the findings regarding the topics design, traffic safety, capacity and level of service, monetized impacts and non-monetized impacts will be discussed and conclusions drawn. Some thoughts about the use of the 2+1 lane road design and the narrow 2+2 lane design will also be given.

### 6.1 Traffic Safety

The 2+1 lane road and the narrow 2+2 lane road design are both equipped with a median barrier to prevent head-on collisions which are one of the accident types that are highest represented among fatal accidents. Assuming that the same type of barrier is used for both designs, the reduction in head-on collisions should be roughly equal, and results in the same positive effect regarding traffic safety for both designs. At the same time, there are concerns about the emergency vehicles mobility in the 2+1 design. For sections with one lane, emergency vehicles could be trapped behind the traffic without the possibility to use the middle of the road to overtake the traffic due to the median barrier. The narrow 2+2 lane road provides two lanes in each direction continuously, allowing for better emergency vehicles mobility.

In addition to head-on collisions, run-off-road crashes result in severe outcomes and are relevant to the discussion comparing the road designs. A widely held view is that wider lanes and shoulders provide more space for the driver to correct mistakes that could have developed into accidents, and hence road designs with wider lanes and shoulders are safer than narrower designs. Alternatively, the comfort of the wider lanes and shoulders leads to increased speed which results in increased accident severity, thus potentially canceling out the positive safety effects of the wider lanes and shoulders. Also related to speed, while the posted speed limit (90km/h) is the same for the 2+1 lane road design and the narrow 2+2 lane road design, the 2+2 design provides the opportunity to take over “slow” vehicles at almost any time, compared to the 2+1 lane road design where the possibilities are limited. The ability to pass

vehicles at will could give the drivers the perception of that the road is designed for a higher speed than 90 km/h and therefore drive faster than the speed limit, again resulting in an increased negative safety effect.

Given the lack of accident data available for this research, the arguments and conclusions related to speed are quite vague and not directly related to the designs in question. Based on the literature examined, it seems like wider lanes and shoulders provide a positive safety effect, and that the shoulder width affects the safety to a greater extent than the lane width. With narrow lanes and shoulders there is also the concern of increased rutting and pavement edge damages. This could affect the safety in a negative way, and also reduce the lifetime of the pavement and leads to the need for more maintenance, which increases the costs. While there are not very big differences between the designs, the 2+1 lane design has wider widths for the cross section elements, it is reasonable to assume that it will be more favorable than the 2+2 lane road design with respect to traffic safety.

## **6.2 Capacity and Level of Service**

The differences between the 2+1 and 2+2 designs also impact capacity and level of service. Intuitively adding more lanes provides better capacity and makes the road able to accommodate higher traffic volumes. On the basis on what was found in the literature, the narrow 2+2 lane road should have a higher capacity than the 2+1 lane road, which do not increase the capacity of a two-lane highway, but have only the potential to improve the level of service. The level of service calculations carried out in this study supports this. The narrow 2+2 lane road design accommodated traffic volumes of AADT 6 000 and 12 000 at a higher level of service than the 2+1 lane road, and the narrow 2+2 lane road design was also able to handle an AADT of 20 000, where the capacity of the 2+1-road was assumed to be exceeded at this volume. Larger savings from reduced travel time could therefore be expected for the narrow 2+2 lane road design, and this advantage would be expected to increase as the traffic volumes increase.

The case study results from EFFEKT show that the benefit from reduced travel time is higher for the narrow 2+2 lane road design. These results are expected due to modifications made within the program to simulate the 2+1, which is not a standard design in EFFEKT. The alternative design used a two-lane road as a basis and then adjustments were made so the



average travel speed was similar to what could be expected from the literature review and level of service calculations. Even with the slightly lower average travel speed expected with the 2+1 lane road, this road design resulted in the highest net present value and benefit-cost ratio per budget kroner for the specific case, Kløfta-Nybakk, in two of three scenarios. Only for the scenario when the average travel speed for the 2+1 lane road is assumed to be significantly lower than the average travel speed of the narrow 2+2 lane road design, the narrow 2+2 lane road design became the most beneficial alternative. For lower traffic volumes the narrow 2+2 lane road design benefit from assumed higher travel speed and hence larger time savings is not able to outweigh the 2+1 lane road design's benefit from lower construction cost. It seems to be clear that the narrow 2+2 lane road design has a higher capacity and provides better level of service than the 2+1 lane road design, but whether it is economically beneficial with higher capacity and better level of service depends on the amount of traffic.

Besides the monetized-impacts the non-monetized impacts were also briefly discussed, but no separate analysis was conducted. The negative impacts are mostly related to the decision of building a new road, the location and surroundings and the route choice. In general the negative effects on landscape, biodiversity and land-use tend to be larger the wider the cross section, but with less than two meters separating the designs the non-monetized impacts could be assumed equal or maybe a slight advantage to the 2+1 lane road design.

### **6.3 Recommendations**

Based on the points discussed above and the findings presented in this thesis the 2+1 lane road design is recommended for projects where the expected traffic volumes are approximately less than an AADT of 12 000 and there is a relatively equal directional distribution of the traffic. While the safety benefits still remain high, at higher volumes, the 2+1 lane road design does not perform as well as the 2+2 road.

The narrow 2+2 lane road design is recommended for projects with higher capacity demands but not the resources or space for a standard 20 meter wide four-lane road. This road design appears to serve its purpose as an intermediate design between the two-lane road and normal four-lane road in an acceptable way, but is only preferable over the 2+1 lane road design for higher traffic volumes.

As mentioned previously, lack of accident data for the two road designs prevents a more detailed safety analysis. If there is continued interest in the 2+2 narrow lane design and if more narrow 2+2 lane roads were constructed in the future, there would be possibilities for further study. Obtaining enough accident data for the two road designs would allow for a more detailed study including determining if there is a statistical significant difference in traffic safety between the 2+1 lane road design and the narrow 2+2 lane road design. While the gathering of this data is not likely to occur in the near future, it may be possible to look at the impact of lane and shoulder width with respect to safety, but this is not likely to yield results which are different than the previous studies discussed (Bauer et al., 2004; Dixon et al., 2015; Karlaftis & Golias, 2002; Sakshaug et al., 2004; Stamatiadis et al., 2009).

## **6.4 Conclusion**

Operational and safety tradeoffs between a 2+1 road design and a narrow 2+2 road design were considered in order to make conclusions about the use of such road types within the Norwegian road network. This research attempted to determine whether you can achieve the same positive effect regarding traffic safety, while also increasing the capacity and level of service of the road by building a narrow 2+2 lane road instead of a 2+1 lane road, with minimal increase in construction costs. While it is hard to answer this question conclusively, generally speaking, the 2+1 road design option is more preferable than the 2+2 configuration. Given that cost is related to, among other things, width of roadway, both alternatives will be less costly than a standard four-lane road.

The results of this research indicate that when considering safety alone, the 2+1 lane road design has a slight advantage over the narrow 2+2 lane road design regarding traffic safety because of wider lanes and shoulders, assumed lower mean speed and possibly less rutting. The size of the presumed safety advantage is not possible to quantify from the content of this thesis.

Focusing on capacity and level of service, the narrow 2+2 lane road design provides higher capacity than what the 2+1 lane road design can offer. Whether the higher capacity and level of service make the narrow 2+2 lane road design more economical beneficial (as part of a benefit cost analysis) than the 2+1 lane road design depend on the expected amount of traffic. As long as the average travel speed, which is dependent on volume, for the 2+1 lane road was

not significantly lower than for the narrow 2+2 lane road design, the 2+1 lane road design resulted in the highest benefit-cost ratio for the case scenarios. When it comes to the non-monetized impacts, there are such small differences between the two designs that there is no basis to distinguish them. Other elements like location of the road and route alignment are more likely to have a bigger impact when less than two meters separates the cross section widths.

This research provides a basis for road authorities in Norway and elsewhere to consider whether use of a narrow 2+2 roadway design is appropriate. While it is difficult to make a conclusive decision, results from this study, which utilizes previous research results and several different analysis methods, indicates that it is not likely for the narrow 2+2 road design to meet the needs within the Norwegian context considered here.

## Bibliography

- Aarts, L., & Schagen, I. v. (2006). Driving speed and the risk of road crashes: A review. *Accident Analysis & Prevention*, 38(2), 215-224.
- AASHTO. (2010). *Highway Safety Manual: American Association of State Highway and Transportation Officials* (AASHTO).
- AASHTO. (2013). *Policy on Geometric Design of Highways and Streets (6th Edition) with 2012 and 2013 Errata: American Association of State Highway and Transportation Officials* (AASHTO).
- Aksnes, J., Hoff, I., & Mork, H. (2002). *Measurement of edge effects on pavements with thin asphalt surfacing*. Paper presented at the Ninth International Conference on Asphalt Pavements, Copenhagen, Denmark.
- Bagdade, J., Nabors, D., McGee, H., Miller, R., & Retting, R. (2012). *Speed Management: A Manual for Local Rural Road Owners* (FHWA-SA-12-027). Retrieved from <http://safety.fhwa.dot.gov/>
- Bauer, K. M., Harwood, D. W., Hughes, W. E., & Richard, K. R. (2004). Safety Effects of Narrow Lanes and Shoulder-Use Lanes to Increase Capacity of Urban Freeways. *Transportation Research Record*, 1897(1897), 71-80. doi:10.3141/1897-10
- Carlsson, A. (2009). *Evaluation of 2+1-roads with cable barriers: final report* (VTI rapport 636A). Retrieved from VTI: [www.vti.se/publications](http://www.vti.se/publications)
- Catbagan, J. L., & Nakamura, H. (2006). Evaluation of Performance Measures for Two-Lane Expressways in Japan. *Transportation Research Record: Journal of the Transportation Research Board*, Volume 1988, 111-118. doi:<http://dx.doi.org/10.3141/1988-16>
- Christensen, P., & Ragnøy, A. (2006). *The condition of the road surface and safety - The importance of rut depth, roughness (IRI) and changes in cross-slope for road safety* (TØI report 840/2006). Retrieved from Institute of Transport Economics:
- COWI. (2014). Transportmodeller og trafikksimulering. Retrieved from <http://www.cowi.no/menu/Tjenester/samfunnsplanlegging/trafikkoganalyse/transportmodeller/Pages/default.aspx>
- Dixon, K., Fitzpatrick, K., & Avelar, R. (2015). Operational and Safety Tradeoffs -- Reducing Freeway Lane and Shoulder Width to Permit an Additional Lane.
- E16 Kløfta–Kongsvinger [Picture]. (2016). Retrieved from <http://www.vegvesen.no/Europaveg/e16kloftakongsvinger>
- Elvik, R. (2010). Why some road safety problems are more difficult to solve than others. *Accident Analysis and Prevention* 42, 1089–1096.
- Elvik, R. (2012). Actual and Perceived Risks of Apprehension for Speeding in Norway. *Transportation Research Record: Journal of the Transportation Research Board*(Issue 2281), 26-31.
- Elvik, R. (2013). A re-parameterisation of the Power Model of the relationship between the speed of traffic and the number of accidents and accident victims. *Accident Analysis and Prevention*, 50, 854-860.
- Elvik, R. (2014). *Speed and road safety - new models* (TØI report 1296/2014). Retrieved from Institute of Transport Economics:
- Elvik, R., Christensen, P., & Amundsen, A. (2004). *Speed and road accidents. An evaluation of the Power Model* (TØI report 740/2004). Retrieved from Institute of Transport Economics:
- Frost, U., & Morrall, J. (1998). *A comparison and evaluation of the geometric design practices with passing lanes, wide-paved shoulders and extra-wide two-lane highways in canada and germany*. Paper presented at the International Symposium on Highway Geometric Design Practices, Boston, Massachusetts.
- google.maps [Picture]. (2016). Retrieved from <https://www.google.no/maps>
- Haldorsen, I. (2015). *In-Depth Analyses of Fatal Road Accidents in the year 2014* (396). Retrieved from Statens vegvesen: <http://www.vegvesen.no/fag/Publikasjoner/Publikasjoner>

- Hauer, E. (2009). Speed and Safety. *Transportation Research Record: Journal of the Transportation Research Board*, No. 2103, 10-17.
- Høye, A., Elvik, R., & Sørensen, M. W. J. (2011). *Trafikksikkerhetsvirkninger av tiltak* (TØI rapport 1157/2011). Retrieved from Transportøkonomisk institutt:
- Høye, A., Elvik, R., Sørensen, M. W. J., & Vaa, T. (2014). *Trafikksikkerhetshåndboken*. Retrieved from <http://tsh.toi.no/index.html?21836>
- Jacobsen, H. B. (2015). Vil bygge bredere veier for å spare penger. Retrieved from <http://www.tv2.no/a/7767676/>
- Jacobson, T., & Wågberg, L.-G. (2007). *Utveckling och uppgradering av prognosmodell för beläggningsslitage från dubbade däck samt en kunskapsöversikt över inverkan av faktorer. Version 3.2.03* (VTI notat 7). Retrieved from VTI: [www.vti.se/publikationer](http://www.vti.se/publikationer)
- Karlaftis, M. G., & Golias, I. (2002). Effects of road geometry and traffic volumes on rural roadway accident rates. *Accident Analysis and Prevention*, 34(3), 357-365.
- Larsgård, L. P. (2010). *Ny rv. 2 gjennom Sør-Odal* (119891-1). Retrieved from Multiconsult:
- Lee, J., & Mannering, F. (2002). Impact of roadside features on the frequency and severity of run-off-roadway accidents: an empirical analysis. *Accident Analysis and Prevention*, 34(2), 149-161.
- Løtveit, S. (2012). *Zero fatalities and zero severe injuries - From vision towards reality* (119). Retrieved from Norwegian Public Roads Administration: <http://www.vegvesen.no/fag/Publikasjoner/Publikasjoner>
- Multiconsult. (2016). *Trafikk og Transport*. Retrieved from <http://www.multiconsult.no/tjenester/trafikk-og-transport/>
- Ng, C. F., & Small, K. A. (2012). Tradeoffs among free-flow speed, capacity, cost, and environmental footprint in highway design. *Transportation*, 39, 1259-1280.
- Northern Europe [Picture]. (2016). Retrieved from [https://upload.wikimedia.org/wikipedia/commons/3/33/Northern\\_europe\\_november\\_1939.png](https://upload.wikimedia.org/wikipedia/commons/3/33/Northern_europe_november_1939.png)
- Potts, I., & Harwood, D. W. (2003). *Application of European 2+1 Roadway Designs*. Retrieved from Transportation Research Board: <http://www.trb.org/Publications/Blurbs/152630.aspx>
- Prop. 104 S. (2010-2011). *Innstilling fra transport- og kommunikasjonskomiteen om finansiering og utbygging av rv. 2 Kongsvinger (Kurusand)–Slomarka i Hedmark*. stortinget.no: transport- og kommunikasjonskomiteen Retrieved from <https://www.stortinget.no/no/>.
- Ragnøy, A. (2004). *Endring av fartsgrenser. Effekt på kjørefart og ulykker* (TØI rapport 729/2004). Retrieved from Transportøkonomisk institutt:
- Regjeringen.no. (2014). Hva er KS-ordningen? Retrieved from <https://www.regjeringen.no/no/aktuelt/Hva-er-KS-ordningen/id2001422/>
- Ryeng, E. O. (2012). The effect of sanctions and police enforcement on drivers' choice of speed. *Accident Analysis and Prevention*, Volume 45, 446-454.
- Sakshaug, K., Lervåg, L.-E., & Giæver, T. (2004). *Grunnlag for revisjon av håndbok 017 "Veg- og gateutforming": Skulder- og kjørebanebreddens betydning for trafikksikkerheten* (STF22 A04311). Retrieved from SINTEF:
- Solli, H., & Betanzo, M. (2015). *Ettrevaluering av E16 Kløfta-Nybakk* (UA-rapport 71/2015). Retrieved from Urbanet Analyse: <http://www.urbanet.no/document-manager/ettrevaluering-av-e16-klfta-nybakk>
- Stamatiadis, N., Pigman, J., Sacksteder, J., Ruff, W., & Lord, D. (2009). *NCHRP report 633, Impact of Shoulder Width and Median Width on Safety*. Retrieved from Transportation Research Board: [www.TRB.org](http://www.TRB.org)
- Statens vegvesen. (1990). *Håndbok 159 Kapasitet på vegstreknings*
- Statens vegvesen. (2005a). 16 m firefelts veg. Retrieved from <http://www.vegvesen.no/fag/Publikasjoner/Handboker/nyheter/16-m-firefelts-veg>
- Statens vegvesen. (2005b). *Supplerende planbeskrivelse ny reguleringsplan rv2 Borgen-Nybakk som firefelts veg. Tillegsutredning for utvidelse av rv2 til 4-felts veg Kløfta-Nybakk*. Retrieved from Statens vegvesen:
- Statens vegvesen. (2007). *Rv. 2 – Nybakk – Kongsvinger Konsekvensutredning av alternative vegstandarder*. Retrieved from Statens vegvesen:
- Statens vegvesen. (2010). Nullvisjonen. Retrieved from <http://www.vegvesen.no/fag/Fokusomrader/Trafikksikkerhet/Nullvisjonen>

- Statens vegvesen. (2011). Midtrekkverk. Retrieved from <http://www.vegvesen.no/fag/Publikasjoner/Handboker/nyheter/midtrekkverk>
- Statens vegvesen. (2014a). Hvilken side av fartsgrensen er du på? Retrieved from <http://www.vegvesen.no/trafikkinformasjon/Trafikksikkerhet/Kampanjer/Fart/Hvilken+side+a+v+fartsgrensen+er+du+p%C3%A5>
- Statens vegvesen. (2014b). *Håndbok N100 Veg- og gateutforming*
- Statens vegvesen. (2014c). *Håndbok N200, Vegbygging*
- Statens vegvesen. (2014d). *Håndbok N 101 Rekkverk og vegens sideområder.*
- Statens vegvesen. (2014e). *Håndbok R610 Standard for drift og vedlikehold av riksveger*
- Statens vegvesen. (2014f). *Håndbok V120 Premisser for geomterisk utforming av veger*
- Statens vegvesen. (2014g). *Håndbok V712 Konsekvensanalyser*
- Statens vegvesen. (2014h). *Håndbok V713 Trafikkberegninger.*
- Statens vegvesen. (2014i). Kløfta-Nybakk. Retrieved from <http://www.vegvesen.no/Europaveg/e16kloftakongsvinger/Delstrekninger/KloftaNybakk>
- Statens vegvesen. (2014j). Så mye koster det å bygge en meter vei. Retrieved from <http://www.vegvesen.no/om+statens+vegvesen/presse/nyheter/Nasjonalt/s%C3%A5-mye-koster-det-%C3%A5-bygge-en-meter-vei>
- Statens vegvesen. (2015a). Flere pigger av. Retrieved from <http://www.vegvesen.no/om+statens+vegvesen/presse/nyheter/Nasjonalt/flere-pigger-av--855182>
- Statens vegvesen. (2015b). Håndbøker som er utgått. Retrieved from <http://www.vegvesen.no/fag/Publikasjoner/Handboker/om-handbokene/gamle-nye-nummer/utgatt>
- Statens vegvesen. (2015c). Vegkart. Retrieved from <https://www.vegvesen.no/vegkart>
- Statens vegvesen. (2016a). E16 Kløfta–Kongsvinger. Retrieved from <http://www.vegvesen.no/Europaveg/e16kloftakongsvinger>
- Statens vegvesen. (2016b). Etappe 3: Nybakk–Slomarka. Retrieved from <http://www.vegvesen.no/Europaveg/e16kloftakongsvinger/Delstrekninger/NybakkSlomarka>
- Statens vegvesen. (2016c). Fakta. Retrieved from <http://www.vegvesen.no/Europaveg/e16kloftakongsvinger/Fakta>
- Statens vegvesen. (2016d). Vegkart. Retrieved from <https://www.vegvesen.no/vegkart/vegkart/#kartlag:geodata/hva:%28~%29/hvor:%28%29/@60000,7225000,3>
- Straume, A., & Bertelsen, D. (2015). *Brukerveiledning EFFEKT 6.6 (356)*. Retrieved from Statens vegvesen: <http://www.vegvesen.no/fag/Publikasjoner/Publikasjoner>
- Sund, E. K. (2012). *Hva vil det koste å fjerne forfallet på riksvegnettet? Resultat av kartlegging (75)*. Retrieved from Statens vegvesen: <http://www.vegvesen.no/fag/Publikasjoner/Publikasjoner>
- Sweco. (2016). Trafikkmodeller. Retrieved from <http://www.sweco.no/no/norway/Tjenester/Samferdselsteknikk/Trafikkmodeller/>
- Swedish Association for Test Methods of Road Materials and Pavements. (2015). VTIS Slitagemodell. Retrieved from <http://www.metodgruppen.nu/web/page.aspx?refid=81>
- Transportation Research Board. (2000). *Highway Capacity Manual 2000*.
- Transportation Research Board. (2010). *Highway Capacity Manual 2010*
- User Liaison subcommittee. (2012). *HCM 2010 Metric Analysis Guidelines*. Retrieved from
- Wang, C., & Huegy, J. B. (2013). *Determining the Free-Flow Speeds in a Regional Travel Demand Model Based on the Highway Capacity Manual*. Retrieved from Transportation Research Board: [www.TRB.org](http://www.TRB.org)

**PART 2**

**SCIENTIFIC PAPER**





# TRADEOFFS BETWEEN A 2+1 LANE ROAD DESIGN AND A NARROW 2+2 LANE ROAD DESIGN

Lars Hissingby Trandem  
and

Kelly Pitera

The Norwegian University of Science and Technology,  
Department of Civil and Transport Engineering

## 1. INTRODUCTION

In Norway, a new and alternative road design consisting of a 16,5 meter wide cross-section in a 2+2 configuration is being considered to see if it could be an acceptable and feasible solution compared to the more commonly used 2+1 lane road design configuration, specifically in situations where the traffic volume is not high enough to justify the costs of building a standard four-lane road (typically 20 meters in width).

The cross section of the 2+1 lane road design consists of in total three lanes, two lanes in one direction and one lane in the opposite direction, divided by a mid-barrier, Figure 1. The direction of the middle lane is alternating giving both directions, at regular intervals, the advantage of a passing lane, Figure 2. This design is normally used in rural areas with mid-range traffic volumes to prevent head-on accidents and thereby increase the safety of a standard two-lane road.

This paper examines whether you can achieve the same positive effect regarding traffic safety, while also increasing the capacity and level of service of the road by building a narrow 2+2 lane road instead of a 2+1 lane road, with minimal increase in construction costs. While the safety, costs and traffic operations aspects of the different road designs are the most important to evaluate, the non-monetized impacts like landscape, local surroundings and outdoor activities, biodiversity, cultural heritage and natural resources are also considered, as is standard in Norwegian consequence analysis methodology.

An extensive literature review was carried out for evaluating different aspects of the 2+1 lane road and 2+2 lane road design regarding design, traffic safety, capacity and level of service, monetized impacts and non-monetized impacts. In addition, the methods in Highway Capacity Manual (Transportation Research Board, 2010) are applied for calculation and evaluation of the level of service, and the program EFFEKT (Straume & Bertelsen, 2015) is used to estimate the monetized impacts, in connection with a case study of a project in Norway where a narrow 2+2 lane road configuration has been used.

## 2. DESIGNS

### 2.1 2+1 lane road design

The 2+1 road design, as shown in Figure 1, is currently used in Norway. Experience with three-lane highways in Canada and Germany has shown that they cost effectively increase the quality of service and safety for two-lane highways when the requirements for building a four-lane road are not met, or there are other concerns like costs and environmental issues that prevent the four-lane road as an option (Frost & Morrall, 1998). Variations of the 2+1 lane road design is also used in Sweden and Finland (Potts & Harwood, 2003).

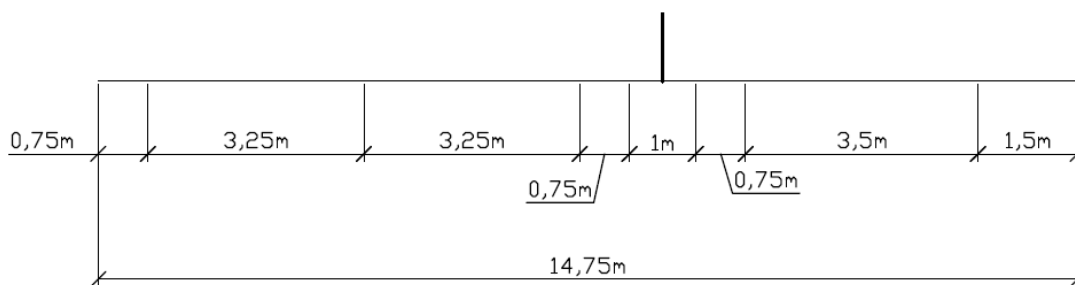

Figure 1: One possible cross-section design of a 2+1 lane road.

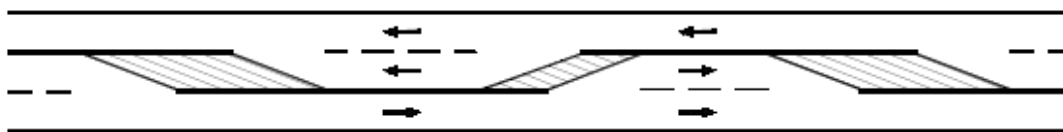

Figure 2: Alternating middle lane. The picture is retrieved from (Potts & Harwood, 2003 p. 3).

The length of the passing lane varies between 1-2 km, dependent on the amount of traffic, and the width of the cross-section ranges from 11-15 meter with some countries using median barriers and others not. Such cross sections are typical used with speed limits between 90-110 km/h and annual average daily traffic volumes between 4 000 and 22 000. The estimated capacity of this design is 1 500-1 700 vehicles per hour per direction (Potts & Harwood, 2003).

### 2.2 Narrow 2+2 lane road design

The narrow 2+2 lane road design is a four-lane road, but with narrower lanes and shoulders than what is currently the standard for four-lane roads in Norway (Statens vegvesen, 2014a). The cross-section of the narrow 2+2 lane road design, Figure 3, is in total 16,5 meter wide with 3,25 meter wide lanes, 0,75 meter wide right shoulders, and 2 meter available for the median barrier and the left shoulders. These dimensions are comparable with the previously described 2+1 design. The standard four-lane road design in Norway is 20 meter wide (or wider), with 3,5 meter wide lanes and 1,5 meter wide right shoulders.

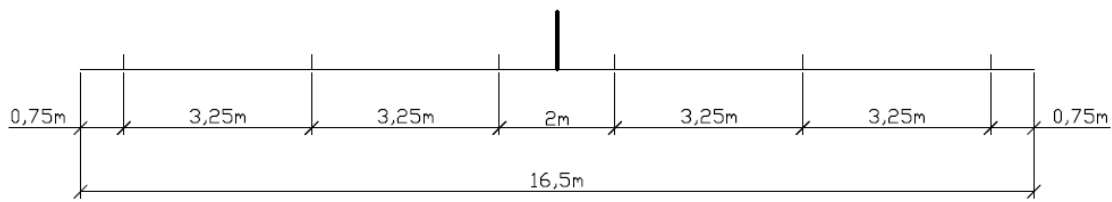

Figure 3: Cross-section of the narrow 2+2 lane road.

Like the 2+1 road, the narrow four-lane road is intended to serve annual average traffic of 8 000-12 000 and have a posted speed limit of 90 km/h. Additionally, as with the 2+1 lane road, it is meant to be a cost effective alternative for improving the traffic safety and increasing the quality of service for two-lane highways when the requirements for building ordinary standard four-lane road are not met.

### 3. TRAFFIC SAFETY

The traffic safety work is important both from an ethical aspect and from an economical aspect. The traffic safety work can be divided into two parts. Part one is to prevent unwanted actions that create accidents, and part two is to create barriers so the consequence of an accident is reduced if it first were to occur (Løtveit, 2012). When evaluating the two designs, the focus will be on barriers reducing the consequence.

In the period 2005-2014, 40% of the people killed in traffic in Norway are killed in head-on collisions, and 33% in run-off-road crashes (Haldorsen, 2015). The different factors contributing to the fatal accidents can be grouped in factors concerning the road user, the vehicle, the road and the road environment, and the weather- and driving conditions (Haldorsen, 2015). It is mainly the road and road environment that will be affected by the road design. During the period from 2005-2014 the conditions regarding the road and road environment is assessed to have been a contributing factor in 27% of the fatal accidents (Haldorsen, 2015). Things like the route alignment, sight obstacle, untidy road environment and insufficient road marking and signs are the most common causes (Haldorsen, 2015). They are rarely the direct cause of the accident, but one of the underlying factors that contribute to that an accident develops into a fatal accident (Haldorsen, 2015). Within this analysis and case study both these accident types are relevant and the type of median barrier, lane and shoulder width, and number of lanes.

#### 3.1 Median Barrier and Head-on Collisions

The purpose of a mid-barrier is to prevent vehicles from entering the opposite driving direction, and thereby reduce the number of head-on collisions. In Sweden they have great experience with the 2+1 road design and its capability of reducing the number of fatalities. The results show that compared to the 13 meter wide 1+1-roads the 2+1-roads have reduced the fatalities with 76% (Carlsson, 2009). For a smaller amount of 16 meter wide 2+2-roads the reduction in fatalities are 75% (Carlsson, 2009). The reduction in fatalities is not necessarily single-handed from the mid-barrier, but could also come from the effect of an extra lane or other inequalities.

### 3.2 Run-off-road Crashes

A sufficient clear zone free from hazards adjacent to the road results in less severe run-off road crashes. To provide this sufficient clear zone and reduce the severity of run-off-road accidents measures like removing the dangerous roadside elements, mitigating the dangerous elements, or replacing dangerous elements with less dangerous constructions is preferable rather than building side barriers to prevent serious accidents (Statens vegvesen, 2014b).

Different studies (Karlaftis & Golias, 2002; Lee & Mannering, 2002) have looked into the impacts different factors have on the frequency and severity of rural roadway accidents. Lee and Mannering (2002) found that by avoiding cut side slopes, decreasing the distance from outside shoulder to guardrail, decreasing the number of isolated trees along the road, and increasing the distance from outside shoulder edge to light poles can reduce the frequency of run-off-road crashes while the severity is dependent on the complex interaction of roadside features. Karlaftis and Golias (2002) found median width and access control to be the most important factors regarding crash rates for rural multilane roads followed by friction and lane width, when the effect of annual average daily traffic was cancelled out.

Both the 2+1 road and the 2+2 road are designed and constructed with same base rules when it comes to keeping a sufficient clear zone free from hazards adjacent to the road to reduce the severity if a vehicle should run off the road. Since the environment adjacent to the road is assumed equal, an important factor is the shoulder width, which varies for the 2+1-road and the narrow 2+2-road, and could make one of the designs more preferable than the other because it increases the clear zone.

It is hard to separate the safety effect from lane width and shoulder width from each other and also from factors like speed, traffic volume, and horizontal and vertical alignment, since they are in a certain degree related to the choice of road standard. Roads with wide lanes and shoulders are typically designed for high speed and traffic volumes, and have a high standard alignment, while smaller roads designed for lower speeds and traffic volumes, have smaller lane and shoulder widths, and varying standards regarding the alignment.

The safety effects of wider lanes are uncertain. Wider lanes provide more space, which may give the driver a better opportunity to correct mistakes and hence avoid crashes. Although the wider lanes could also make the driver more comfortable and lead to increased speed, and thus offset the safety effect from wider lanes. (Stamatiadis et al., 2009) The relationship between speed and traffic safety are discussed in different studies (Aarts & Schagen, 2006; Elvik, 2013, 2014; Elvik et al., 2004; Hauer, 2009; Ragnøy, 2004). It is generally concluded that accidents severity increases as mean speeds increases, although whether the probability of getting involved in a crash increases for higher speeds or deviation from the mean speed or both is more uncertain.

Two studies (Bauer et al., 2004; Dixon et al., 2015) looked at the safety effect of reducing lane width and shoulder widths. Bauer et al. (2004) found that by widening the number of lanes of an urban freeway in one direction of travel from 4 to 5, by

reducing lane and shoulder width, resulted in increases of 10% to 11% in accident frequency. When converting an urban freeway from 5 to 6 lanes smaller increases in accident frequency were found, but these were not statistically significant. Dixon et al. (2015) developed a model that can be used to estimate the predicted amount of crashes related to changes in total lane width, right shoulder width and left shoulder width. There were safety improvements associated with increased lane width, additional lanes, increased left shoulder and increased right shoulder. It is pointed out in one of the scenarios of the study that the adverse safety effects of reduced shoulder widths are larger than the positive safety effects of adding an equal amount to the total lane width.

Calculations with accident data from Norway shows that an increase in number of travel lanes leads to a higher number of accidents per million vehicle kilometers, but lower accident costs. Number of accidents are approximately 25% higher per vehicle kilometers for four-lane roads compared to two-lane roads, but the accident costs are approximately 25% lower for the four-lane roads (Høye et al., 2011). Høye et al. (2011) points out that the lower accident costs could be explained by the in general higher standard on four-lane roads reduces the risk of meeting accidents and run-off-road crashes.

A narrow driving lane gives the drivers less space to move laterally in the lane, which leads to concentration of the pavement wear and creation of rutting. Increased rutting will affect the maintenance costs, and could also have negative impact on the traffic safety. A study (Christensen & Ragnøy, 2006) found that increased rut depth increases the accident risk, but the relationship was not linear. The relationship between roughness (IRI) and accident risk were found to be negative linear, where an increase in IRI entails a reduced accident risk. It was pointed out that the reduced accident risk could be explained with that the drivers reduce their speed when the IRI increase, and then the reduction in speed is what leads to the reduction in accident risk (Christensen & Ragnøy, 2006).

Based on the information above, the 2+1 lane road's overall wider shoulder and lane widths are assumed to be more favorable than the narrow 2+2 lane road design with respect to traffic safety. However, how much better the 2+1 lane road is compared to the 2+2 lane road design, cannot be predicted with certainty from the data available and presented in this paper.

## **4. CAPACITY AND LEVEL OF SERVICE**

### **4.1 Literature review**

The Transportation Research Board's fifth edition of the Highway Capacity Manual (Transportation Research Board, 2010) defines capacity as "the maximum sustainable hourly flow rate at which persons or vehicles reasonably can be expected to traverse a point or a uniform section of a lane or roadway during a given time period under prevailing roadway, environmental, traffic, and control conditions" (Transportation Research Board, 2010 p. 4-17). Facilities are seldom planned to operate at or near the capacity, since at such traffic levels the facilities perform poorly. Capacity analyses are therefore often used to calculate the amount of traffic that a facility can accommodate and still operate at a given service

level.(Transportation Research Board, 2000 p. 2-1) In order to determine the performance quality of a transportation facility the Highway Capacity Manual(Transportation Research Board, 2010) introduces the terms quality of service and level of service. “Quality of service describes how well a transportation facility or service operates from the traveler’s perspective”(Transportation Research Board, 2010 p. 5-1). The Highway Capacity Manual lists a number of factors, but particularly focusing on travel time, speed delay, maneuverability and comfort, as the factors influencing the traveler perceived quality of service.(Transportation Research Board, 2010 p. 5-2) Then level of service is defined as “a quantitative stratification of a performance measure or measures that represent quality of service,” which is described using letters A to F, where A represent the best conditions and F the worst. (Transportation Research Board, 2010 p.5-1)

An analysis (Potts & Harwood, 2003) of the traffic operational performance of the 2+1 design was performed. Looking at different directional splits and passing lane frequencies from a 1+1 road with no passing lanes, to a continuously alternating 2+1- road. Potts and Harwood (2003) found the 2+1 roadway was able to provide traffic operations at level of service C for all the different traffic volumes and directional splits considered which didn’t exceeded the capacity of a two-lane roadway.

The recommendation given by Potts and Harwood (2003) is that 2+1-roads should only be considered for flow rates below 1 200 veh/h in one direction of travel. For greater flow rates, a four-lane roadway is more appropriate. According to Carlsson (2009) the capacity of the 2+1-road is found to be 1 600 - 1 650 veh/h during a 15 minutes period for one direction, which is approximately 300 veh/h lower than for an ordinary 13 meter 1+1 lane road. The bottleneck at the transition from two to one lane is the cause of the reduction of flow rate. These flow rates are significantly lower than the capacity of a multilane highway segments, which range from 1 900-2 200 personal cars per hour per lane, dependent on the free-flow speed (Transportation Research Board, 2010).

Intuitively adding more lanes increases the capacity of the road, but also the width of the cross-section unless the lane and shoulder width is decreased. Ng and Small (2012) observed that by reducing the lane and shoulder width to create an extra lane inside the same roadway width, results in large savings in travel time when the highway capacity is exceeded during peak periods. Saving in travel time costs for the design with wider lanes and shoulders, and higher off-peak speeds are more modest.

## **4.2 Level of Service Calculations**

Level of service calculations were performed using the most recent Highway Capacity Manual (Transportation Research Board, 2010) and theory and methods described there for both the 2+1 lane road and the narrow 2+2 lane road design. Due to the operational difference of these designs, the narrow 2+2 lane road design will be evaluated using the methodology for basic freeway segments, while the 2+1 lane road design will use the two-lane highway method, both from the HCM.

For both the narrow 2+2 lane road and the 2+1 lane road calculations are done for annual average daily traffic values of 6 000, 12 000 and 20 000, since these values cover the volume range from where two-lane and four-lane roads are typically

utilized. The directional splits of 67/33 and 55/45 are used as advised by the Norwegian Public Roads Administration’s guidance for traffic calculations (Statens vegvesen, 2014d) and Highway Capacity Manual (Transportation Research Board, 2010). To convert between metric units, which are the study values, and the United States customary units, the “HCM 2010 Metric Analysis Guidelines” (User Liaison subcommittee, 2012) is used as a guidance. In addition to the Highway Capacity Manual (Transportation Research Board, 2010), the methodology from Wang and Huegy (2013) was used to take into account the effect of the posted speed limit in the estimation of the free-flow speed for the narrow 2+2 lane road design, since the initial values that were found for the free-flow speed were higher than expected.

Both level of service calculation methods convert the AADT into demand volumes,  $V$  (veh/h). The demand volumes are adjusted for heavy vehicles, peak-hour factor, driver population and number of lanes, assuming rolling terrain.

For the narrow 2+2 lane design, the density values were calculated for different speeds and used to determine the level of service for the narrow 2+2 lane road design for different directional splits and traffic volumes. The lower speed of 55 mi/h reflects a ramp density of 1,6 ramps per mile and the higher speed of 60 mi/h reflects a ramp density of 0,4 ramps per mile. The adjusted demand volume,  $v_p$  (pc/h/ln), and associated density and LOS can be seen in Table 1. The results indicate that the travel speeds used as a proxy for ramp density do not affect the LOS rating.

Table 1: Level of service values calculated for the narrow 2+2 lane road design.

Level of Service, Narrow 2+2 Lane Road						
Directional split	AADT	$v_p$ [pc/h/ln]	Density [pc/mi/ln] for speed = 55 mi/h	LOS for speed = 55 mi/h	Density [pc/mi/ln] for speed = 60 mi/h	LOS for speed = 60 mi/h
67/33	6 000	348	6,3	A	5,8	A
	12 000	695	12,6	B	11,6	B
	20 000	1088	21,1	C	19,3	C
55/45	6 000	285	5,2	A	4,8	A
	12 000	571	10,4	A	9,5	A
	20 000	951	17,3	B	15,9	B

For the 2+1 road, the average travel speed and percent time-spent-following are calculated and used to decide the LOS. To adapt the calculations for a 2+1 road, the average travel speed and percent time-spent-following were first calculated for a regular two-lane highway and then once again, after adding a passing lane. The adjusted demand volumes, average travel speed, percent time-spent-following and level of service for the 2+1 lane road design can be seen in Table 2.

Table 2: Level of service values calculated for the 2+1 lane road design.

Level of Service, Narrow 2+1 Lane Road								
Directional split	AADT	Average Travel Speed			Percent Time-Spent-Following			LOS
		$V_{d, ATS}$ [pc/h]	$V_{o, ATS}$ [pc/h]	$ATS_d$	$V_{d, PTSF}$ [pc/h]	$V_{o, PTSF}$ [pc/h]	$PTSF_d$	
67/33	6 000	654	402	49,5	602	368	47,4	C
	12 000	1186	641	45,2	1135	593	58,2	C
	20 000	1977	974	-	1892	932	-	-
55/45	6 000	564	494	50,5	526	467	45,7	B
	12 000	974	828	46,0	932	765	55,5	C
	20 000	1623	1328	-	1553	1271	-	-

From the results in Table 1 and Table 2, it can be seen that the narrow 2+2 lane road accommodates the traffic at a higher level of service than the 2+1 lane road. It can also handle an AADT of 20 000 at LOS C or better, where the capacity of the 2+1 lane road is assumed to be exceeded.

## 5. Case Study from Norway

In addition to comparing the two roadway types in a general sense, a case study was also examined to have a more quantifiable basis for comparison. The case, where a narrow 2+2 lane road configuration has been constructed as a trial project, is located in Norway, north-east of Oslo between Kløfta and Kongsvinger, see Figure 4. The project is divided into four sections Kløfta-Nybakk, Nybakk-Herbergåsen, Herbergåsen-Slomarka and Slomarka-Kongsvinger. The first section of 10,5 km was finished and opened for traffic in Oktober 2007 and the fourth section of 16,5 km in November 2014 (Statens vegvesen, 2016a). These sections are marked with green in Figure 4. The two remaining sections of 33,0 km, in red, see Figure 4, is still in the planning phase. Because of geotechnical difficulties, the costs for the two remaining sections have increased significantly and there are now uncertainties related the further work on the project. (Statens vegvesen, 2016b)



Figure 4: Shows the location of the E16 project between Kløfta and Kongsvinger. ("E16 Kløfta–Kongsvinger [Picture]," 2016; "google.maps [Picture]," 2016; "Northern Europe [Picture]," 2016)

The old roadway along this corridor had AADT values varying between 7 000 to 14 000 along the approximately 60 km long road. The road was not limited access with many houses and exit roads along the stretch and a lack of pedestrian and bicycle paths. This resulted in reduced speed for about 55% of the 60 km long stretch



and a high number of accidents. (Prop. 104 S, 2010-2011) Between 1996 and 2005 there was in average around 20 accidents each year, with 9 people killed in the accidents and 35 people seriously injured or very seriously injured. (Statens vegvesen, 2007)

The finished sections consists of 16,0 and 16,5 meter wide four-lane road with median barrier of steel, and have a speed limit of 90 km/h. See Figure 5. The road width was increased from 16,0 meter, which had been built between Kløfta and Nybakk, to 16,5 meter to provide better space for traffic signs in the median (Solli & Betanzo, 2015). The cross-section of the road is similar to that seen in Figure 3 previously.



Figure 5: A picture of E16 between Kløfta and Nybakk. ("google.maps [Picture]," 2016)

As a response to this trail project, an evaluation of narrow 2+2 roads was conducted by Solli and Betanzo (2015). The opinions of those interviewed at the Directorate of Public Roads, indicated that the use of such lanes were not recommended due to issues with that the road could be perceived as a freeway even though it is not designed according to the criteria for a freeway, lead to construction of more four-lane roads and thereby more intervention in the nature and the landscape, and that other roads where the need for an ordinary four-lane road could be inappropriately scaled down to narrow four-lane road to save money.

## 5.1 Impact Assessment

Impact assessment involves an evaluation of the monetized impacts, non-monetized impacts, and if it is found relevant an evaluation of the local and regional impacts, impacts of the distribution of benefits and net ripple effect are conducted. An overview of what is included in the impact assessment is shown in Figure 6.

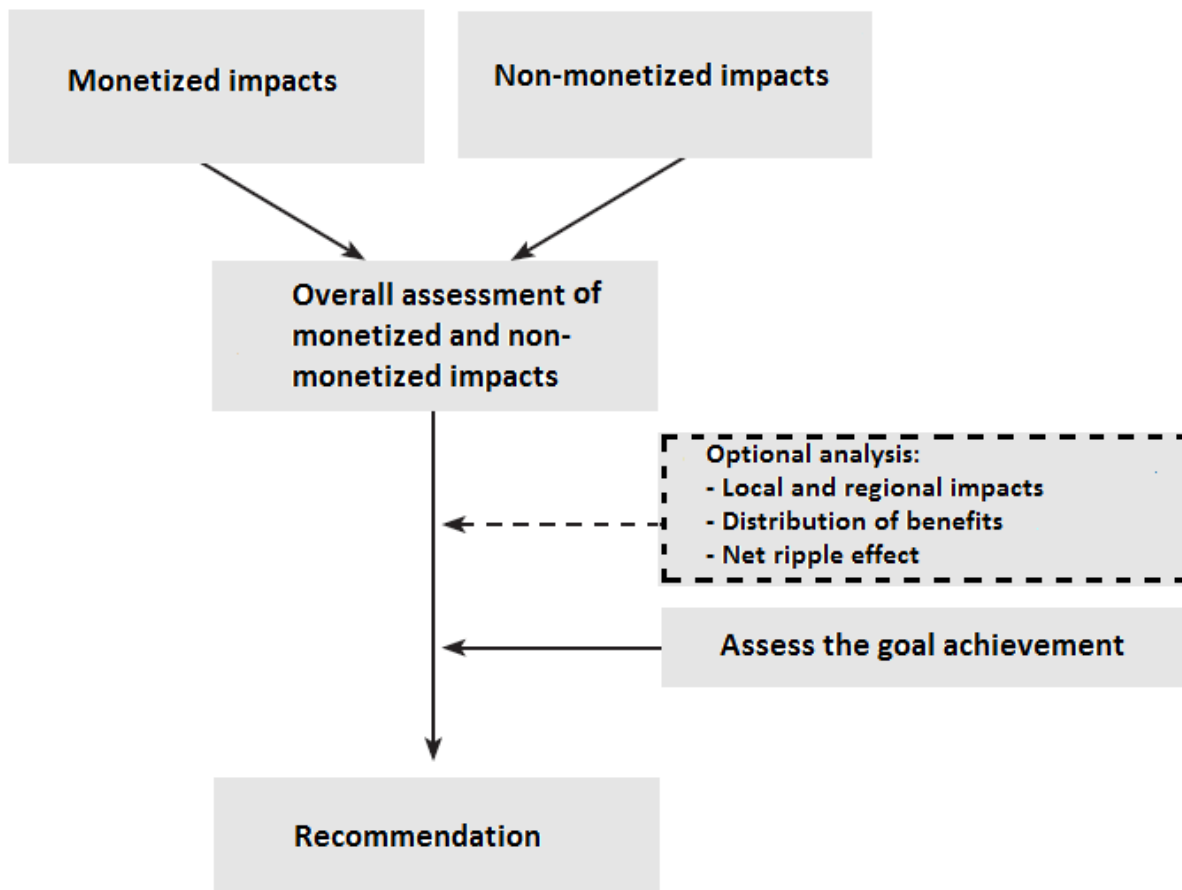

Figure 6: Impact assessment. Adapted from (Statens vegvesen, 2014c p. 51)

### Non-monetized Impacts

The non-monetized impacts are hard to put a price tag on and not necessarily measurable in money, but nevertheless important factors to take into consideration in transportation projects. The Norwegian standard for impact assessment (Statens vegvesen, 2014c) categorize the non-monetized impacts into five subjects: landscape, local surroundings and outdoor activities, biodiversity, cultural environment and natural resources. They are all evaluated on a nine-point scale which goes from very big positive consequence to very big negative consequence, and is a part of the impact assessment.

In an impact assessment (Statens vegvesen, 2014c) concerning the trial project of the narrow 2+2 lane road configuration the Norwegian Public Roads Administration found that it is the road project that triggers the most important impacts regarding the non-monetized impacts, and not the width of the road. There are minor differences between the three different road widths of 19, 16,5 and 12,5 meter, but in general the negative effect for landscape, cultural environment, biodiversity and natural resources tend to be larger the wider the design (Statens vegvesen, 2014c). The non-monetized impacts seem to be more dependent on the location of the road and the route choice, rather than the design of the road.

## Monetized Impacts

The program called EFFEKT is used to look at the monetized impacts of building a road between Kløfta and Nybakk. EFFEKT is a program that performs benefit-cost analyses for road and transportation projects, and it is based on the principles and methods found in the Norwegian Public Roads Administration standard for impact assessment (Statens vegvesen, 2014c; Straume & Bertelsen, 2015). The results are used in the project's planning stage together with an evaluation of the non-monetized impacts and other relevant information to evaluate different solutions or alternatives. (Straume & Bertelsen, 2015)

By using information gained through the literature review and additional information (Larsgård, 2010; Statens vegvesen, 2005, 2014e, 2015) regarding the E16 Kløfta-Kongsvinger project, an evaluation of the monetized impacts for the 2+1-road and the narrow 2+2-road were performed by using EFFEKT.

The calculations are done based on alternative 0: the old existing 1+1-road, alternative 1: the narrow 2+2 lane road, and alternative 2: the 2+1 lane road. To get an overview of how variations in the average travel speed and traffic safety affects the results generated in EFFEKT, several different scenarios are considered as described below. As a starting assumption, the two designs affect on traffic accidents, compared to alternative 0 are given in Table 3.

Table 3: The two road designs assumed effects on accidents.

Road design	Accident types that are affected	Killed	Seriously injured	Lighter injured	Number of accidents
2+1-road	All	-76%	-47%	13%	13%
Narrow 2+2-road	All	-75%	-45%	25%	25%

The assumed effects on accidents are for the 2+1 lane road design based on standard measure given in EFFEKT. For the narrow 2+2 lane road the assumed effects on accidents are based on the findings in the literature review.

### Scenario 1

The speed limit, an input value in EFFEKT that affects the average travel speed, is set to 90 km/h for both the 2+1 lane road and the narrow 2+2 lane road, as suggested by the Norwegian Public Road Administration on these road types. The accident effects are as assumed in Table 3.

### Scenario 2

The speed limit is set to 85 km/h for the 2+1 lane road to make the average travel speed more similar what could be expected based on the earlier level of service calculations, and kept at 90 km/h for the narrow 2+2 lane road. The 2+1 lane road design is not standard in EFFEKT so changes to the speed limit are made to make the operational performance of the modelled design in EFFEKT more similar to what could be expected for a 2+1 lane road design. The accident effects are as assumed in Table 3.

### Scenario 3

The speed limit is 90 km/h for both the 2+1 lane road and the narrow 2+2 lane road. The narrow 2+2 lane road designs effect on accidents are assumed to be that of the 2+1 lane roads as given in Table 3.

### EFFEKT Calculations

Selected results of the EFFEKT calculations are presented in Table 4. The presumed investment cost for the narrow 2+2 lane road is based upon the actual cost for the case project, while the 2+1 lane road cost is based upon average values from the Norwegian Public Roads Administration's home page (Statens vegvesen, 2014e). Additionally, results concerning time savings, changes in accident costs, and other remaining costs and benefits like vehicle costs, direct costs (toll taxes), and noise and air pollution costs are presented, along with the net present value and benefit-cost ratio per budget kroner. The change in costs, net present value and benefit-cost ratio per budget kroner is calculated with respect to alternative 0, the old 1+1-road between Kløfta and Nybakk.

Table 4: Selected results from the EFFEKT calculations.

Components	Scenario 1		Scenario 2		Scenario 3	
	Alt. 1 (2+2)	Alt. 2 (2+1)	Alt. 1 (2+2)	Alt. 2 (2+1)	Alt.1 (2+2)	Alt.2 (2+1)
Investment cost [ 1000 NOK]	821 288 (-)	739 159 (-)	821 288 (-)	739 159 (-)	821 288 (-)	739 159 (-)
Change in time cost [1000 NOK]	1 033 775 (+)	873 290 (+)	1 033 775 (+)	658 631 (+)	1 033 775 (+)	873 290 (+)
Change in Accident costs [1000 NOK]	394 703 (+)	416 022 (+)	394 703 (+)	416 022 (+)	416 028 (+)	416 022 (+)
Remaining change in costs and benefits [1000 NOK]	174 (-)	100 915 (+)	174 (-)	160 448 (+)	174 (-)	100 915 (+)
Net present value [1000 NOK]	607 016 (+)	651 069 (+)	607 016 (+)	495 942 (+)	628 341 (+)	651 069 (+)
Benefit-cost ratio per budget kroner [ ]	1,65	1,82	1,65	1,28	1,71	1,82

In the case study, the focus is on the benefits associated with time savings (operations-related) and reduced accident costs. In scenario 1, building the 2+1 lane road will give the highest benefit-cost ratio per budget kroner. The lower construction costs and larger savings on accidents are enough to outweigh the narrow 2+2 lane road's savings on time cost. In addition the remaining benefits for the 2+1 lane road, which are mainly coming from reduced vehicle costs, less direct costs (toll taxes), and air and noise pollution costs are contributing to the 2+1 lane roads advantage. In

scenario 2, where the only change is that the speed for the 2+1 lane road is reduced, the narrow 2+2 lane road is the design with highest benefit-cost ratio per budget kroner even though the remaining benefits for the 2+1 lane also increases, mostly because of reduced vehicle costs from the lower speed. The larger gap in time savings compared to the 2+1 lane road makes it more profitable to build the narrow 2+2 lane road. In scenario 3, the speed is the same for both designs as in scenario 1, but the narrow 2+2 lane road is assumed to have the same effect on accidents as the 2+1 lane road. While this scenario improved the narrow 2+2 lane road, the 2+1 lane road is a little bit better with a benefit-cost ratio per budget kroner of 1,82 compared to 1,71 for the narrow 2+2 lane road. The lower construction cost, vehicle costs, direct costs (toll taxes) and air and noise pollution costs are making the 2+1 lane road the more beneficial alternative in this scenario.

In all the scenarios the EFFEKT results for the narrow 2+2-road and the 2+1-road are similar. The 2+1-road was more economical beneficial in 2 of 3 scenarios, while the narrow 2+2-road was the better alternative for one of the scenarios. The biggest difference was achieved when reducing the average speed for the 2+1-road compared to the narrow 2+2-road, which is likely a valid assumption

## **6. DISCUSSION**

This thesis looks at the tradeoffs between a 2+1 lane road configuration and a narrow 2+2 lane road design through a literature review, level of service calculations based on the Highway Capacity Manual 2010, and a case study of the E16 Kløfta-Kongsvinger project using the program EFFEKT.

### **6.1 Traffic Safety**

The 2+1 lane road and the narrow 2+2 lane road design are both equipped with a median barrier to prevent head-on collisions which are one of the accident types that are highest represented among fatal accidents. Assuming that the same type of barrier is used for both designs, the reduction in head-on collisions should be roughly equal, results in the same positive effect regarding traffic safety for both designs. At the same time, there are concerns about the emergency vehicles mobility in the 2+1 design. For sections with one lane, emergency vehicles could be trapped behind the traffic without the possibility to use the middle of the road to overtake the traffic due to the median barrier. The narrow 2+2 lane road provides two lanes in each direction continuously, allowing for better emergency vehicles mobility.

In addition to head-on collisions, run-off-road crashes result in severe outcomes and are relevant to the discussion comparing the road designs. A widely held view is that wider lanes and shoulders provide more space for the driver to correct mistakes that could have developed into accidents, and hence road designs with wider lanes and shoulders are safer than narrower designs. Alternatively, the comfort of the wider lanes and shoulders leads to increased speed which results in increased accident severity, thus potentially canceling out the positive safety effects of the wider lanes and shoulders. Also related to speed, while the posted speed limit (90km/h) is the same for the 2+1 lane road design and the narrow 2+2 lane road design, the 2+2 design provides the opportunity to take over "slow" vehicles at almost any time, compared to the 2+1 lane road design where the possibilities are limited. The ability

to pass vehicles at will could give the drivers the perception of that the road is designed for a higher speed than 90 km/h and therefore drive faster than the speed limit, again resulting in an increased negative safety effect.

Given the lack of accident data available for this research, the arguments and conclusions related to speed are quite vague and not directly related to the designs in question. Based on the literature examined, it seems like wider lanes and shoulders provide a positive safety effect, and that the shoulder width affects the safety to a greater extent than the lane width. With narrow lanes and shoulders there is also the concern of increased rutting and pavement edge damages. This could affect the safety in a negative way, and also reduce the lifetime of the pavement and leads to the need for more maintenance, which increases the costs (Aksnes et al., 2002). While there are not very big differences between the designs, the 2+1 lane design has wider widths for the cross section elements, it is reasonable to assume that it will be more favorable than the 2+2 lane road design with respect to traffic safety.

## **6.2 Capacity and Level of Service**

The differences between the 2+1 and 2+2 designs also impact capacity and level of service. Intuitively adding more lanes provides better capacity and makes the road able to accommodate higher traffic volumes. On the basis on what was found in the literature, the narrow 2+2 lane road should have a higher capacity than the 2+1 lane road, which do not increase the capacity of a two-lane highway, but have only the potential to improve the level of service. The level of service calculations carried out in this study supports this. The narrow 2+2 lane road design accommodated traffic volumes of AADT 6 000 and 12 000 at a higher level of service than the 2+1 lane road, and the narrow 2+2 lane road design was also able to handle an AADT of 20 000, where the capacity of the 2+1-road was assumed to be exceeded at this volume. Larger savings from reduced travel time could therefore be expected for the narrow 2+2 lane road design, and this advantage would be expected to increase as the traffic volumes increase.

The case study results from EFFEKT show that the benefit from reduced travel time is higher for the narrow 2+2 lane road design. These results are expected due to modifications made within the program to simulate the 2+1, which is not a standard design in EFFEKT. The alternative design used a two-lane road as a basis and then adjustments were made so the average travel speed was similar to what could be expected from the literature review and level of service calculations. Even with the slightly lower average travel speed expected with the 2+1 lane road, this road design resulted in the highest net present value and benefit-cost ratio per budget kroner for the specific case, Kløfta-Nybakk, in two of three scenarios. Only for the scenario when the average travel speed for the 2+1 lane road is assumed to be significantly lower than the average travel speed of the narrow 2+2 lane road design, the narrow 2+2 lane road design became the most beneficial alternative. For lower traffic volumes the narrow 2+2 lane road design benefit from assumed higher travel speed and hence larger time savings is not able to outweigh the 2+1 lane road design's benefit from lower construction cost. It seems to be clear that the narrow 2+2 lane road design has a higher capacity and provides better level of service than the 2+1

lane road design, but whether it is economically beneficial with higher capacity and better level of service depends on the amount of traffic.

### **6.3 Recommendations**

Based on the points discussed above and the findings presented in this thesis the 2+1 lane road design is recommended for projects where the expected traffic volumes are approximately less than an AADT of 12 000 and there is a relatively equal directional distribution of the traffic. While the safety benefits still remain high, at higher volumes, the 2+1 lane road design does not perform as well as the 2+2 road.

The narrow 2+2 lane road design is recommended for projects with higher capacity demands but not the resources or space for a standard 20 meter wide four-lane road. This road design appears to serve its purpose as an intermediate design between the two-lane road and normal four-lane road in an acceptable way, but is only preferable over the 2+1 lane road design for higher traffic volumes.

As mentioned previously, lack of accident data for the two road designs prevents a more detailed safety analysis. If there is continued interest in the 2+2 narrow lane design and if more narrow 2+2 lane roads were constructed in the future, there would be possibilities for further study. Obtaining enough accident data for the two road designs would allow for a more detailed study including determining if there is a statistically significant difference in traffic safety between the 2+1 lane road design and the narrow 2+2 lane road design. While the gathering of this data is not likely to occur in the near future, it may be possible to look at the impact of lane and shoulder width with respect to safety, but this is not likely to yield results which are different than the previous studies discussed (Bauer et al., 2004; Dixon et al., 2015; Karlaftis & Golias, 2002; Stamatiadis et al., 2009)

## **7. CONCLUSION**

Operational and safety tradeoffs between a 2+1 road design and a narrow 2+2 road design were considered in order to make conclusions about the use of such road types within the Norwegian road network. This research attempted to determine whether you can achieve the same positive effect regarding traffic safety, while also increasing the capacity and level of service of the road by building a narrow 2+2 lane road instead of a 2+1 lane road, with minimal increase in construction costs. While it is hard to answer this question conclusively, generally speaking, the 2+1 road design option is more preferable than the 2+2 configuration. Given that cost is related to, among other things, width of roadway, both alternatives will be less costly than a standard four-lane road.

The results of this research indicate that when considering safety alone, the 2+1 lane road design has a slight advantage over the narrow 2+2 lane road design regarding traffic safety because of wider lanes and shoulders, assumed lower mean speed and possibly less rutting. The size of the presumed safety advantage is not possible to quantify from the content of this thesis.

Focusing on capacity and level of service, the narrow 2+2 lane road design provides higher capacity than what the 2+1 lane road design can offer. Whether the higher

capacity and level of service make the narrow 2+2 lane road design more economical beneficial (as part of a benefit cost analysis) than the 2+1 lane road design depend on the expected amount of traffic. As long as the average travel speed, which is dependent on volume, for the 2+1 lane road was not significantly lower than for the narrow 2+2 lane road design, the 2+1 lane road design resulted in the highest benefit-cost ratio for the case scenarios. When it comes to the non-monetized impacts, there are such small differences between the two designs that there is no basis to distinguish them. Other elements like location of the road and route alignment are more likely to have a bigger impact when less than two meters separates the cross section widths.

This research provides a basis for road authorities in Norway and elsewhere to consider whether use of a narrow 2+2 roadway design is appropriate. While it is difficult to make a conclusive decision, results from this study, which utilizes previous research results and several different analysis methods, indicates that it is not likely for the narrow 2+2 road design to meet the needs within the Norwegian context considered here.



## BIBLIOGRAPHY

- Aarts, L., & Schagen, I. v. (2006). Driving speed and the risk of road crashes: A review. *Accident Analysis & Prevention*, 38(2), 215-224.
- Aksnes, J., Hoff, I., & Mork, H. (2002). *Measurement of edge effects on pavements with thin asphalt surfacing*. Paper presented at the Ninth International Conference on Asphalt Pavements, Copenhagen, Denmark.
- Bauer, K. M., Harwood, D. W., Hughes, W. E., & Richard, K. R. (2004). Safety Effects of Narrow Lanes and Shoulder-Use Lanes to Increase Capacity of Urban Freeways. *Transportation Research Record*, 1897(1897), 71-80. doi:10.3141/1897-10
- Carlsson, A. (2009). *Evaluation of 2+1-roads with cable barriers: final report* (VTI rapport 636A). Retrieved from VTI: [www.vti.se/publications](http://www.vti.se/publications)
- Christensen, P., & Ragnøy, A. (2006). *The condition of the road surface and safety - The importance of rut depth, roughness (IRI) and changes in cross-slope for road safety* (TØI report 840/2006). Retrieved from Institute of Transport Economics:
- Dixon, K., Fitzpatrick, K., & Avelar, R. (2015). Operational and Safety Tradeoffs -- Reducing Freeway Lane and Shoulder Width to Permit an Additional Lane.
- E16 Kløfta–Kongsvinger [Picture]. (2016). Retrieved from <http://www.vegvesen.no/Europaveg/e16kloftakongsvinger>
- Elvik, R. (2013). A re-parameterisation of the Power Model of the relationship between the speed of traffic and the number of accidents and accident victims. *Accident Analysis and Prevention*, 50, 854-860.
- Elvik, R. (2014). *Speed and road safety - new models* (TØI report 1296/2014). Retrieved from Institute of Transport Economics:
- Elvik, R., Christensen, P., & Amundsen, A. (2004). *Speed and road accidents. An evaluation of the Power Model* (TØI report 740/2004). Retrieved from Institute of Transport Economics:
- Frost, U., & Morrall, J. (1998). *A comparison and evaluation of the geometric design practices with passing lanes, wide-paved shoulders and extra-wide two-lane highways in canada and germany*. Paper presented at the International Symposium on Highway Geometric Design Practices, Boston, Massachusetts.
- google.maps [Picture]. (2016). Retrieved from <https://www.google.no/maps>
- Haldorsen, I. (2015). *In-Depth Analyses of Fatal Road Accidents in the year 2014* (396). Retrieved from Statens vegvesen: <http://www.vegvesen.no/fag/Publikasjoner/Publikasjoner>
- Hauer, E. (2009). Speed and Safety. *Transportation Research Record: Journal of the Transportation Research Board*, No. 2103, 10-17.
- Høy, A., Elvik, R., & Sørensen, M. W. J. (2011). *Trafikksikkerhetsvirkninger av tiltak* (TØI rapport 1157/2011). Retrieved from Transportøkonomisk institutt:
- Karlaftis, M. G., & Golias, I. (2002). Effects of road geometry and traffic volumes on rural roadway accident rates. *Accident Analysis and Prevention*, 34(3), 357-365.
- Larsgård, L. P. (2010). *Ny rv. 2 gjennom Sør-Odal* (119891-1). Retrieved from Multiconsult:
- Lee, J., & Mannering, F. (2002). Impact of roadside features on the frequency and severity of run-off-roadway accidents: an empirical analysis. *Accident Analysis and Prevention*, 34(2), 149-161.
- Løtveit, S. (2012). *Zero fatalities and zero severe injuries - From vision towards reality* (119). Retrieved from Norwegian Public Roads Administration: <http://www.vegvesen.no/fag/Publikasjoner/Publikasjoner>
- Ng, C. F., & Small, K. A. (2012). Tradeoffs among free-flow speed, capacity, cost, and environmental footprint in highway design. *Transportation*, 39, 1259-1280.
- Northern Europe [Picture]. (2016). Retrieved from [https://upload.wikimedia.org/wikipedia/commons/3/33/Northern\\_europe\\_november\\_1939.png](https://upload.wikimedia.org/wikipedia/commons/3/33/Northern_europe_november_1939.png)
- Potts, I., & Harwood, D. W. (2003). *Application of European 2+1 Roadway Designs*. Retrieved from Transportation Research Board: <http://www.trb.org/Publications/Blurbs/152630.aspx>
- Prop. 104 S. (2010-2011). *Innstilling fra transport- og kommunikasjonskomiteen om finansiering og utbygging av rv. 2 Kongsvinger (Kurusand)–Slomarka i Hedmark*. stortinget.no: transport- og kommunikasjonskomiteen Retrieved from <https://www.stortinget.no/no/>.

- Ragnøy, A. (2004). *Endring av fartsgrenser. Effekt på kjørefart og ulykker* (TØI rapport 729/2004). Retrieved from Transportøkonomisk institutt:
- Solli, H., & Betanzo, M. (2015). *Etterevaluering av E16 Kløfta-Nybakk* (UA-rapport 71/2015). Retrieved from Urbanet Analyse: <http://www.urbanet.no/document-manager/etterevaluering-av-e16-klfta-nybakk>
- Stamatiadis, N., Pigman, J., Sacksteder, J., Ruff, W., & Lord, D. (2009). *NCHRP report 633, Impact of Shoulder Width and Median Width on Safety*. Retrieved from Transportation Research Board: [www.TRB.org](http://www.TRB.org)
- Statens vegvesen. (2005). *Supplerende planbeskrivelse ny reguleringsplan rv2 Borgen-Nybakk som firefelts veg. Tillegsutredning for utvidelse av rv2 til 4-felts veg Kløfta-Nybakk*. Retrieved from Statens vegvesen:
- Statens vegvesen. (2007). *Rv. 2 – Nybakk – Kongsvinger Konsekvensutredning av alternative vegstandarder*. Retrieved from Statens vegvesen:
- Statens vegvesen. (2014a). *Håndbok N100 Veg- og gateutforming*
- Statens vegvesen. (2014b). *Håndbok N 101 Rekkverk og vegens sideområder*.
- Statens vegvesen. (2014c). *Håndbok V712 Konsekvensanalyser*
- Statens vegvesen. (2014d). *Håndbok V713 Trafikkberegninger*.
- Statens vegvesen. (2014e). Så mye koster det å bygge en meter vei. Retrieved from <http://www.vegvesen.no/om+statens+vegvesen/presse/nyheter/Nasjonalt/s%C3%A5-mye-koster-det-%C3%A5-bygge-en-meter-vei>
- Statens vegvesen. (2015). Vegkart. Retrieved from <https://www.vegvesen.no/vegkart>
- Statens vegvesen. (2016a). E16 Kløfta–Kongsvinger. Retrieved from <http://www.vegvesen.no/Europaveg/e16kloftakongsvinger>
- Statens vegvesen. (2016b). Etappe 3: Nybakk–Slomarka. Retrieved from <http://www.vegvesen.no/Europaveg/e16kloftakongsvinger/Delstrekninger/NybakkSlomarka>
- Straume, A., & Bertelsen, D. (2015). *Brukerveiledning EFFEKT 6.6* (356). Retrieved from Statens vegvesen: <http://www.vegvesen.no/fag/Publikasjoner/Publikasjoner>
- Transportation Research Board. (2000). *Highway Capacity Manual 2000*.
- Transportation Research Board. (2010). *Highway Capacity Manual 2010*
- User Liaison subcommittee. (2012). *HCM 2010 Metric Analysis Guidelines*. Retrieved from
- Wang, C., & Huegy, J. B. (2013). *Determining the Free-Flow Speeds in a Regional Travel Demand Model Based on the Highway Capacity Manual*. Retrieved from Transportation Research Board: [www.TRB.org](http://www.TRB.org)

**PART 3**  
**APPENDIXES**

Appendix 1	Task Description
Appendix 2	Alternative Cross Section Designs
Appendix 3	KAB Crashes Calculations
Appendix 4	Level of Service Calculations
Appendix 5	Results from EFFEKT
Appendix 6	Abstract Submitted for the European Transport Conference 2016



Fakultet for ingeniørvitenskap og teknologi  
Institutt for bygg, anlegg og transport

---

## **MASTEROPPGAVE**

(TBA4940 Veg, masteroppgave)

VÅREN 2016

for

**Lars Hissingby Trandem**

### Tradeoffs between a 2+1 lane road design and a narrow 2+2 lane road design

#### **BAKGRUNN**

In Norway, a new, alternative road design incorporating 16-16,5 meter wide lanes in a 2+2 configuration is being considered to see if it could be an acceptable and feasible solution compared to the common 2+1 lane road design configuration. Currently the narrow 2+2 lane road is in a trial phase in Norway, and not a part of the Norwegian Road Administration's standards for road and street design.

The cross section of the 2+1 lane road design consists of in total three lanes, two lanes in one direction and one lane in the opposite direction divided by a median barrier. The direction of the middle lane is alternating giving both directions at regular intervals the advantage of a passing lane. This design is normally used in rural areas to prevent head-on accidents and thereby increase the safety of a normal two-lane road.

There is interest in finding out if you can achieve the same positive effect regarding traffic safety, and increase the capacity and level of service of the road by building a narrow 2+2 lane road to a small increase in the construction costs. The annual average daily traffic of a road section is often not high enough to justify the costs of building a normal four-lane road, and the costs of upgrading the 2+1 lane road into a four-lane road at a later stage if the capacity of the road is exceeded would be more expensive than if you built a narrow 2+2 lane road in the first place.

Not only the safety, costs and traffic condition aspects of the different road designs are of interest, but also the non-monetized impacts like landscape, local surroundings and outdoor activities, biodiversity, cultural heritage and natural resources. The expectations regarding the non-monetized impacts are that there will be minor differences between the 2+1 lane road design and the narrow 2+2 lane road. The non-monetized impacts seem to be more dependent on the local surroundings and the actual construction of the road, rather than the difference in road design when the variation in the cross sections is so small. These aspects will be discussed in the trade-off analysis and give information to the decision makers for future road projects.



Fakultet for ingeniørvitenskap og teknologi  
Institutt for bygg, anlegg og transport

---

## **OPPGAVE**

### **Beskrivelse av oppgaven**

This thesis will look at the tradeoffs between a 2+1 lane road design and a narrow 2+2 lane road design, taking into account elements like design, traffic safety, capacity and level of service, costs and non-monetized impacts. The tradeoffs will be discussed through a literature review and a case study examining a narrow 2+2 road configuration built within Norway.

### **Målsetting og hensikt**

The goal is to be able to give recommendations for the use of a 2+1 lane road design and a narrow 2+2 lane road design, thus give information to the decision makers for future road projects.

### **Deloppgaver og forskningsspørsmål**

1. Perform a trade-off analysis between a 2+1 lane road design and a narrow 2+2 lane road design by taking into account elements like:
  - Design
  - Traffic safety
  - Capacity and level of service
  - Non-monetized impacts
2. Perform a case study of the E16 Kløfta-Kongsvinger by using the program called EFFEKT for evaluating the monetized impacts.



Fakultet for ingeniørvitenskap og teknologi  
Institutt for bygg, anlegg og transport

---

## GENERELT

Oppgaveteksten er ment som en ramme for kandidatens arbeid. Justeringer vil kunne skje underveis, når en ser hvordan arbeidet går. Eventuelle justeringer må skje i samråd med faglærer ved instituttet.

Ved bedømmelsen legges det vekt på grundighet i bearbeidningen og selvstendigheten i vurderinger og konklusjoner, samt at framstillingen er velredigert, klar, entydig og ryddig uten å være unødige voluminøs.

Besvarelsen skal inneholde

- standard rapportforside (automatisk fra DAIM, <http://daim.idi.ntnu.no/>)
- tittelside med ekstrakt og stikkord (mal finnes på siden <http://www.ntnu.no/bat/skjemabank>)
- sammendrag på norsk og engelsk (studenter som skriver sin masteroppgave på et ikke-skandinavisk språk og som ikke behersker et skandinavisk språk, trenger ikke å skrive sammendrag av masteroppgaven på norsk)
- hovedteksten
- oppgaveteksten (denne teksten signert av faglærer) legges ved som Vedlegg 1.

Besvarelsen kan evt. utformes som en vitenskapelig artikkel for internasjonal publisering. Besvarelsen inneholder da de samme punktene som beskrevet over, men der hovedteksten omfatter en vitenskapelig artikkel og en prosessrapport.

Instituttets råd og retningslinjer for rapportskriving ved prosjektarbeid og masteroppgave befinner seg på <http://www.ntnu.no/bat/studier/oppgaver>.

### Hva skal innleveres?

Rutiner knyttet til innlevering av masteroppgaven er nærmere beskrevet på <http://daim.idi.ntnu.no/>.

Trykking av masteroppgaven bestilles via DAIM direkte til Skipnes Trykkeri som leverer den trykte oppgaven til instituttkontoret 2-4 dager senere. Instituttet betaler for 3 eksemplarer, hvorav instituttet beholder 2 eksemplarer. Ekstra eksemplarer må bekostes av kandidaten/ ekstern samarbeidspartner.

Ved innlevering av oppgaven skal kandidaten levere en CD med besvarelsen i digital form i pdf- og word-versjon med underliggende materiale (for eksempel datainnsamling) i digital form (f. eks. excel). Videre skal kandidaten levere innleveringsskjemaet (fra DAIM) hvor både Ark-Bibl i SBI og Fellestjenester (Byggsikring) i SB II har signert på skjemaet. Innleveringsskjema med de aktuelle signaturene underskrives av instituttkontoret før skjemaet leveres Fakultetskontoret.

Dokumentasjon som med instituttets støtte er samlet inn under arbeidet med oppgaven skal leveres inn sammen med besvarelsen.

Besvarelsen er etter gjeldende reglement NTNUs eiendom. Eventuell benyttelse av materialet kan bare skje etter godkjenning fra NTNU (og ekstern samarbeidspartner der dette er aktuelt). Instituttet har rett til å bruke resultatene av arbeidet til undervisnings- og forskningsformål som om det var utført av en ansatt. Ved bruk ut over dette, som utgivelse og annen økonomisk utnyttelse, må det inngås særskilt avtale mellom NTNU og kandidaten.



Fakultet for ingeniørvitenskap og teknologi  
Institutt for bygg, anlegg og transport

---

**(Evt) Avtaler om ekstern veiledning, gjennomføring utenfor NTNU, økonomisk støtte m.v.**

Beskrives her når dette er aktuelt. Se <http://www.ntnu.no/bat/skjemabank> for avtaleskjema.

**Helse, miljø og sikkerhet (HMS):**

NTNU legger stor vekt på sikkerheten til den enkelte arbeidstaker og student. Den enkeltes sikkerhet skal komme i første rekke og ingen skal ta unødige sjanser for å få gjennomført arbeidet. Studenten skal derfor ved uttak av masteroppgaven få utdelt brosjyren "Helse, miljø og sikkerhet ved feltarbeid m.m. ved NTNU".

Dersom studenten i arbeidet med masteroppgaven skal delta i feltarbeid, tokt, befarings, feltkurs eller ekskursjoner, skal studenten sette seg inn i "Retningslinje ved feltarbeid m.m.". Dersom studenten i arbeidet med oppgaven skal delta i laboratorie- eller verkstedarbeid skal studenten sette seg inn i og følge reglene i "Laboratorie- og verkstedhåndbok". Disse dokumentene finnes på fakultetets HMS-sider på nettet, se <http://www.ntnu.no/ivt/adm/hms/>. Alle studenter som skal gjennomføre laboratoriearbeid i forbindelse med prosjekt- og masteroppgave skal gjennomføre et web-basert TRAINOR HMS-kurs. Påmelding på kurset skjer til [sonja.hammer@ntnu.no](mailto:sonja.hammer@ntnu.no)

Studenter har ikke full forsikringsdekning gjennom sitt forhold til NTNU. Dersom en student ønsker samme forsikringsdekning som tilsatte ved universitetet, anbefales det at han/hun tegner reiseforsikring og personskadeforsikring. Mer om forsikringsordninger for studenter finnes under samme lenke som ovenfor.

**Oppstart og innleveringsfrist:**

Oppstart og innleveringsfrist er i henhold til informasjon i DAIM.

**Faglærer ved instituttet:** Kelly Pitera

**Veileder (eller kontaktperson) hos ekstern samarbeidspartner:**

Institutt for bygg, anlegg og transport, NTNU

Dato: 4/2/2016, (evt. revidert: 9/6/2016)

Underskrift

  
Faglærer



Appendix 2 - Alternative Cross Section Designs

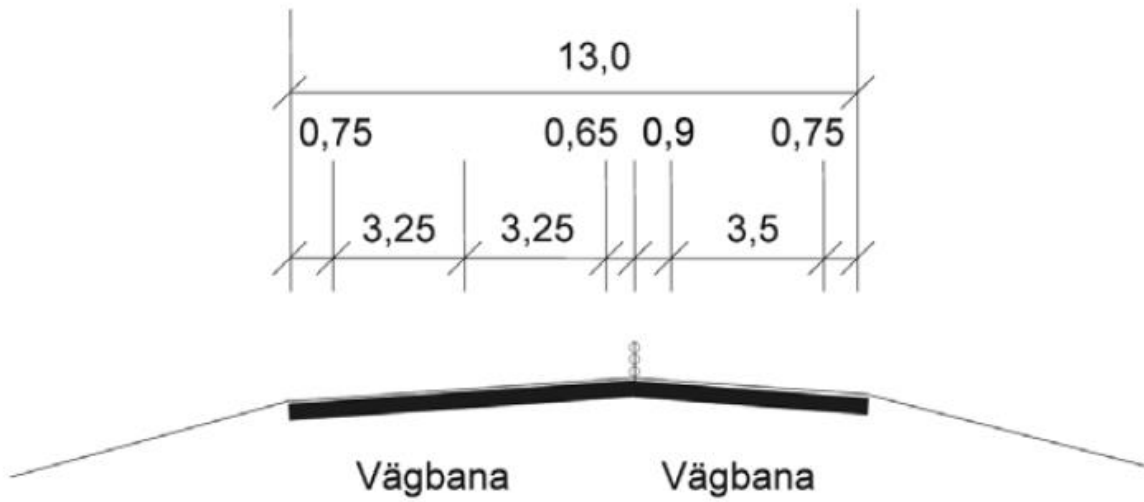

Figure A2.1: Cross section of a 2+1-road with walking and cycling, when rebuilding an old 13 m road. (Sektion Utformning av vägar och gator, 2004 p.24)

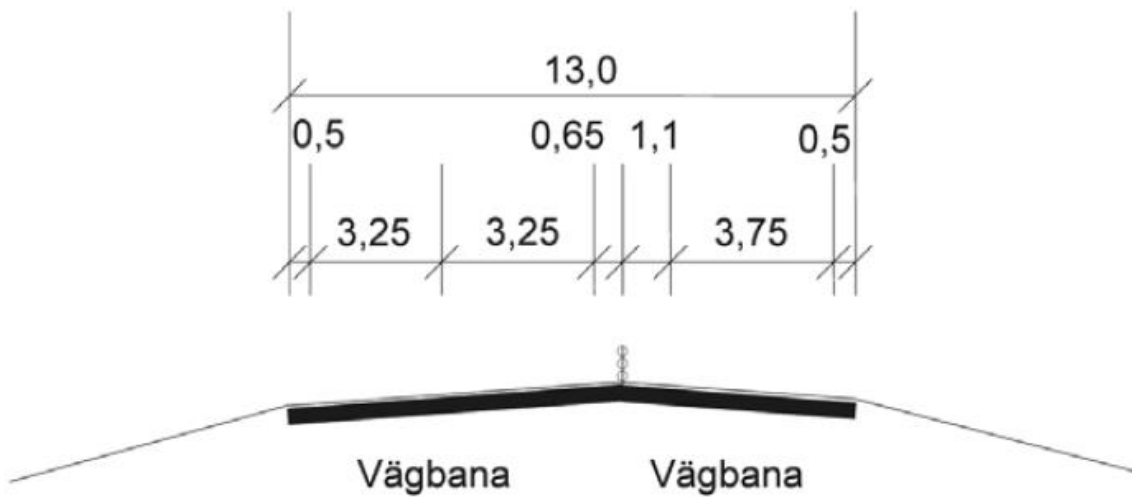

Figure A2.2: Cross section of a 2+1-road without walking and cycling, when rebuilding an old 13 m road. (Sektion Utformning av vägar och gator, 2004 p.25)

Appendix 2 - Alternative Cross Section Designs

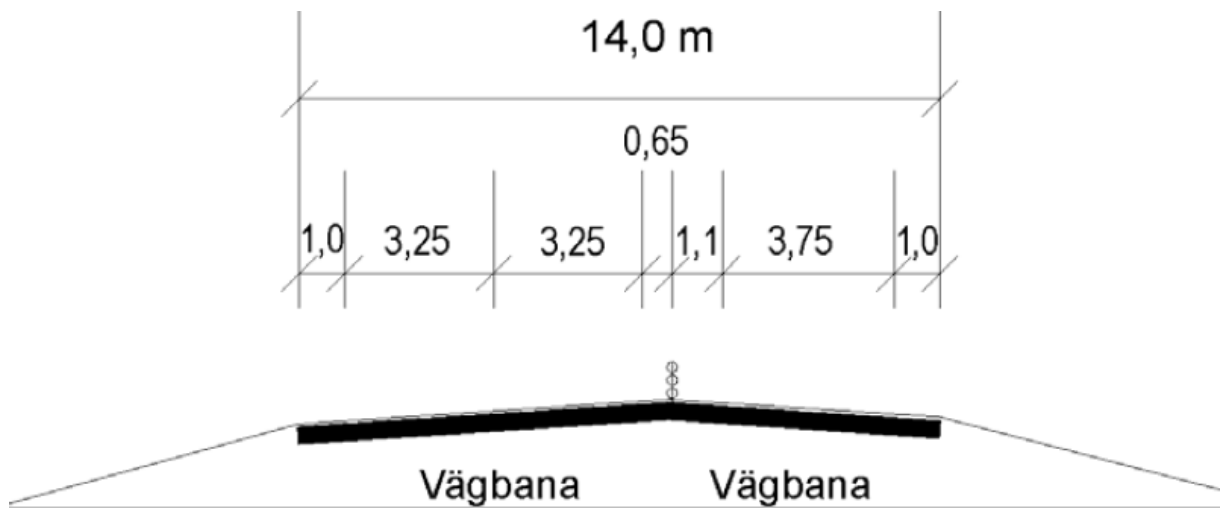

Figure A2.3: Cross section of a 2+1-road when building a new road. (Sektion Utforming av vägar och gator, 2004 p.26)

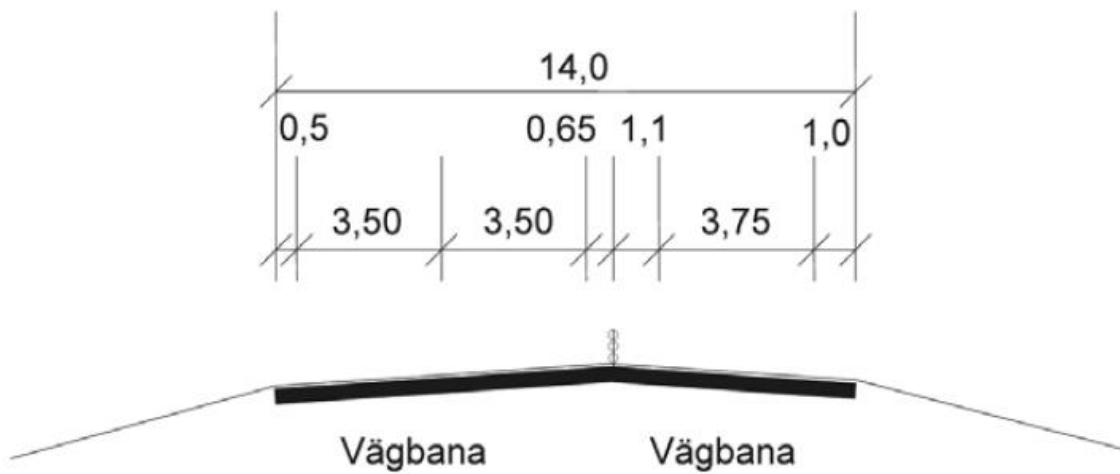

Figure A2.4: Cross section of a 2+1-road when building a new road. (Sektion Utforming av vägar och gator, 2004 p.26)

## Appendix 2 - Alternative Cross Section Designs

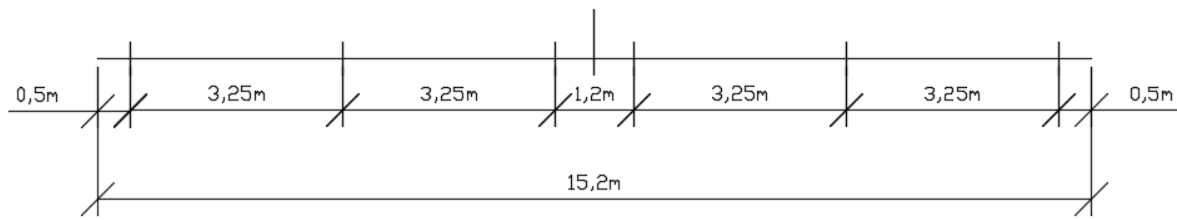

Figure A2.5: Alternative cross section design for a narrow 2+2-road. The drawing is based upon descriptions found in "Vägar och gatorsutformning. Sektion landsbygd – vägrum". (Sektion Utformning av vägar och gator, 2004 p.27)

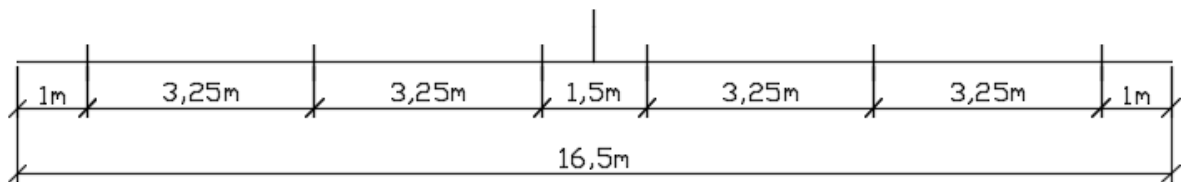

Figure A2.6: Alternative cross section design for a narrow 2+2-road. The drawing is based upon descriptions found in "Vägar och gatorsutformning. Sektion landsbygd – vägrum". (Sektion Utformning av vägar och gator, 2004 p.27)

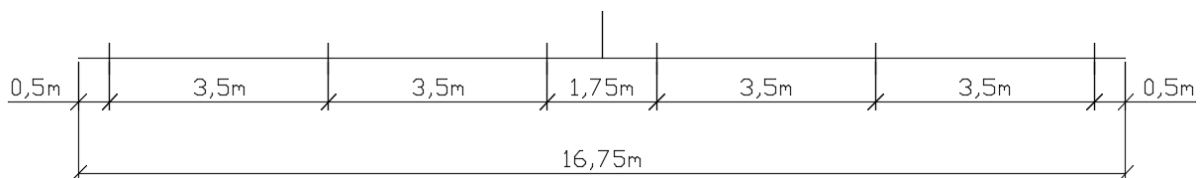

Figure A2.7: Alternative cross section design for a narrow 2+2-road. The drawing is based upon descriptions found in "Vägar och gatorsutformning. Sektion landsbygd – vägrum". (Sektion Utformning av vägar och gator, 2004 p.27)

## Bibliography

Sektion Utformning av vägar och gator. (2004). *Vägar och gatorsutformning. Sektion landsbygd – vägrum*

## **Short Description of Where to Find the Calculations**

The calculations are performed in Excel and can be found in its entirety among the Excel files handed in together with this document. The name of the file is “KAB Crashes” and the calculations are done based on the equation and scenarios found in the article “Operational and Safety Tradeoffs -- Reducing Freeway Lane and Shoulder Width to Permit an Additional Lane” by Dixon, Fitzpatrick and Avelar, 2015. The results from the calculations are presented in Chapter 4 Calculations and Findings under Traffic Safety.

## **Short Description of Where to Find the Calculations**

The level of service calculations for the 2+1 lane road design and the narrow 2+2 lane road design were performed in Excel and can be found in its entirety among the Excel files handed in together with this document. The names of the files are “LOS\_2+1 Lane Road” and “LOS\_Narrow 2+2 Lane Road”. The results from the calculations are presented in Chapter 4 under Capacity and Level of Service.

## Appendix 5 - Results from EFFEKT

Results for the 2+1 lane road design, scenario 1.

<b>EFFEKT</b>	6.60	<b>Prissatte konsekvenser</b>	Side :	1
Akershus		<b>Totale kostnader</b>	Dato :	23.05.2016

Prosjekt : 24 Klofta-Nybakk\_test 3

Kalkulasjonsrente: 4,0 / 3,0 / 2,0 %	Felles prisnivå : 2016	Analyseperiode : 40 år
Mva for investering : 22,0 %	Sammenligningsår : 2007	Levetid : 40 år
Mva for drift/vedl.hold : 22,0 %	Skattefaktor : 1,20	
Melloml./lange reiser: 1 / 1 %		

UTBYGGINGSPLAN : 2 Ny veg\_2+1

	Vegnett	Anleggskostnad i gitt prisnivå	Åpn- år	Anleggs- periode	Anleggskostnad (1000 kr)	
3	Alt. 2_2+1 veg	621000	2007	2007	3,0 år	849 816
4	2+1 veg uten bompenger	0	0	2014	0,0 år	0
					Sum, ikke diskontert (inkl mva)	849 816
					Sum, diskontert (inkl mva)	901 774
					Sum, diskontert (ekskl mva)	739 159

Aktører	Komponenter	KOSTNADER I PERIODEN		
		Planlagt	2007 - 2046 (1000 kr diskontert)	Endring
Trafikanter og transportbrukere	Kjøretøystkostnader	-3 177 939	-3 469 792	291 853
	Direkteutgifter	-511 475	0	-511 475
	Tidskostnader	-2 787 437	-3 660 726	873 290
	Nytte av nyskapt trafikk	0	0	0
	Ulempekostnader ferje/vegstengning	0	0	0
	Helsevirkninger for GS-trafikk	0	0	0
	Utrygghetskostnader for GS-trafikk	0	0	0
	<b>SUM</b>		<b>-6 476 850</b>	<b>-7 130 518</b>
Operatorer	Kostnader	-58 158	0	-58 158
	Inntekter	511 475	0	511 475
	Overføringer	-453 317	0	-453 317
	<b>SUM</b>		<b>0</b>	<b>0</b>
Det offentlige	Investeringer	-739 159		-739 159
	Drift og vedlikehold	-99 613	-83 942	-15 672
	Overføringer	371 571	0	371 571
	Skatte- og avgiftsinntekter	854 367	827 990	26 376
	<b>SUM</b>		<b>387 166</b>	<b>744 049</b>
Samfunnet forøvrig	Ulykker	-359 193	-775 214	416 022
	Støy og luftforurensning	-214 533	-224 172	9 639
	Andre kostnader	0	0	0
	Restverdi	0		0
	Skatteskostnad	77 433	148 810	-71 377
	<b>SUM</b>		<b>-496 292</b>	<b>-850 577</b>
<b>SUM</b>		<b>-6 585 977</b>	<b>-7 237 046</b>	<b>651 069</b>

Netto nytte	NN = 651 069	Netto nytte pr budsjettkrone	NNB = 1,82	Budsjettkostnad	-356 883
		Interrente	%	Forste års forrentning	6,2 %

## Appendix 5 - Results from EFFEKT

Results for the narrow 2+2 lane road design, scenario 1.

<b>EFFEKT</b>	6.60	<b>Prissatte konsekvenser</b>	Side :	1
Akershus		<b>Totale kostnader</b>	Dato :	23.05.2016

Prosjekt : 24 Klofta-Nybakk\_test 3

Kalkulasjonsrente: 4,0 / 3,0 / 2,0 %	Felles prisnivå : 2016	Analyseperiode : 40 år
Mva for investering : 22,0 %	Sammenligningsår : 2007	Levetid : 40 år
Mva for drift/vedl.hold : 22,0 %	Skattefaktor : 1,20	
Melloml./lange reiser: 1 / 1 %		

UTBYGGINGSPLAN : 1 Ny veg\_small firefelt

Vegnett	Anleggskostnad i gitt prisnivå	Åpn- år	Anleggs- periode	Anleggskostnad (1000 kr)	
1 Alt. 1_Smal firefelt	690000	2007	2007	3,0 år	944 240
2 smal firefelt uten bompenger	0	0	2015	0,0 år	0
				Sum, ikke diskontert (inkl mva)	944 240
				Sum, diskontert (inkl mva)	1 001 971
				Sum, diskontert (ekskl mva)	821 288

Aktører	Komponenter	KOSTNADER I PERIODEN		
		Planlagt	2007 - 2046 (1000 kr diskontert)	
			Alternativ 0	Endring
Trafikanter og transportbrukere	Kjøretøystkostnader	-3 267 809	-3 469 792	201 983
	Direkteutgifter	-575 858	0	-575 858
	Tidskostnader	-2 626 951	-3 660 726	1 033 775
	Nytte av nyskapt trafikk	0	0	0
	Ulempeskostnader ferje/vegstengning	0	0	0
	Helsevirkninger for GS-trafikk	0	0	0
	Utrygghetskostnader for GS-trafikk	0	0	0
	<b>SUM</b>	<b>-6 470 619</b>	<b>-7 130 518</b>	<b>659 900</b>
Operatører	Kostnader	-65 238	0	-65 238
	Inntekter	575 858	0	575 858
	Overføringer	-510 620	0	-510 620
	<b>SUM</b>	<b>0</b>	<b>0</b>	<b>0</b>
Det offentlige	Investeringer	-821 288		-821 288
	Drift og vedlikehold	-121 270	-83 942	-37 329
	Overføringer	418 541	0	418 541
	Skatte- og avgiftsinntekter	900 155	827 990	72 165
	<b>SUM</b>	<b>376 138</b>	<b>744 049</b>	<b>-367 911</b>
Samfunnet forøvrig	Ulykker	-380 511	-775 214	394 703
	Støy og luftforurensning	-230 267	-224 172	-6 094
	Andre kostnader	0	0	0
	Restverdi	0		0
	Skattekostnad	75 228	148 810	-73 582
	<b>SUM</b>	<b>-535 550</b>	<b>-850 577</b>	<b>315 027</b>
<b>SUM</b>		<b>-6 630 030</b>	<b>-7 237 046</b>	<b>607 016</b>

Netto nytte	NN = 607 016	Netto nytte pr budsjettkrone	NNB = 1,65	Budsjettkostnad	-367 911
		Interrente	%	Første års forrentning	5,7 %

## Appendix 5 - Results from EFFEKT

Results for the 2+1 lane road design, scenario 2.

<b>EFFEKT</b>	6.60	<b>Prissatte konsekvenser</b>	Side :	1
<b>Akershus</b>		<b>Totale kostnader</b>	Dato :	23.05.2016

Prosjekt : 24 Klofta-Nybakk\_test 3

Kalkulasjonsrente: 4,0 / 3,0 / 2,0 %	Felles prisnivå : 2016	Analyseperiode : 40 år
Mva for investering : 22,0 %	Sammenligningsår : 2007	Levetid : 40 år
Mva for drift/vedl.hold : 22,0 %	Skattefaktor : 1,20	
Melloml./lange reiser: 1 / 1 %		

UTBYGGINGSPLAN : 2 Ny veg\_2+1

Vegnett		Anleggskostnad i gitt prisnivå	Åpn- år	Anleggs- periode	Anleggskostnad (1000 kr)	
3	Alt 2_2+1 veg	621000	2007	2007	3,0 år	849 816
4	2+1 veg uten bompenger	0	0	2014	0,0 år	0
					Sum, ikke diskontert (inkl mva)	849 816
					Sum, diskontert (inkl mva)	901 774
					Sum, diskontert (ekskl mva)	739 159

Aktører	Komponenter	KOSTNADER I PERIODEN		
		Planlagt	2007 - 2046 (1000 kr diskontert)	Endring
<b>Trafikanter og transportbrukere</b>	Kjoretøykostnader	-3 093 406	-3 469 792	376 386
	Direkteutgifter	-511 475	0	-511 475
	Tidskostnader	-3 002 095	-3 660 726	658 631
	Nytte av nyskapt trafikk	0	0	0
	Ulempekostnader ferje/vegstengning	0	0	0
	Helsevirkninger for GS-trafikk	0	0	0
	Utrygghetskostnader for GS-trafikk	0	0	0
	<b>SUM</b>		-6 606 976	-7 130 518
<b>Operatører</b>	Kostnader	-58 158	0	-58 158
	Inntekter	511 475	0	511 475
	Overføringer	-453 317	0	-453 317
	<b>SUM</b>		0	0
<b>Det offentlige</b>	Investeringer	-739 159		-739 159
	Drift og vedlikehold	-99 619	-83 942	-15 677
	Overføringer	371 571	0	371 571
	Skatte- og avgiftsinntekter	822 325	827 990	-5 665
	<b>SUM</b>		355 119	744 049
<b>Samfunnet forøvrig</b>	Ulykker	-359 193	-775 214	416 022
	Støy og luftforurensning	-201 078	-224 172	23 094
	Andre kostnader	0	0	0
	Restverdi	0		0
	Skattekostnad	71 024	148 810	-77 786
	<b>SUM</b>		-489 247	-850 577
<b>SUM</b>		-6 741 104	-7 237 046	495 942

Netto nytte	NN = 495 942	Netto nytte pr budsjettkrone	NNB = 1,28	Budsjettkostnad	-388 930
		Interrenter	%	Første års forrentning	5,6 %



## Appendix 5 - Results from EFFEKT

Results for the narrow 2+2 lane road design, scenario 3.

<b>EFFEKT</b> 6.60	<b>Prissatte konsekvenser</b>	Side :	1
Akershus	<b>Totale kostnader</b>	Dato :	23.05.2016

Prosjekt : 24 Klofta-Nybakk\_test 3

Kalkulasjonsrente: 4,0 / 3,0 / 2,0 %	Felles prisnivå : 2016	Analyseperiode : 40 år
Mva for investering : 22,0 %	Sammenligningsår : 2007	Levetid : 40 år
Mva for drift/vedl.hold : 22,0 %	Skattefaktor : 1,20	
Melloml./lange reiser: 1 / 1 %		

UTBYGGINGSPLAN : 1 Ny veg\_small firefelt

Vegnett	Anleggskostnad i gitt prisnivå	Åp-år	Anleggsperiode	Anleggskostnad (1000 kr)	
1 Alt 1_Smal firefelt	690000	2007	2007	3,0 år	944 240
2 smal firefelt_uten bompenger	0	0	2015	0,0 år	0
					Sum, ikke diskontert (inkl mva) 944 240
					Sum, diskontert (inkl mva) 1 001 971
					Sum, diskontert (ekskl mva) 821 288

Aktører	Komponenter	KOSTNADER I PERIODEN		
		Planlagt	2007 - 2046 (1000 kr diskontert)	Endring
<b>Trafikanter og transportbrukere</b>	Kjøretøykostnader	-3 267 809	-3 469 792	201 983
	Direkteutgifter	-575 858	0	-575 858
	Tidskostnader	-2 626 951	-3 660 726	1 033 775
	Nytte av nyskapt trafikk	0	0	0
	Ulempekostnader ferje/vegstengning	0	0	0
	Helsevirkninger for GS-trafikk	0	0	0
	Utrygghetskostnader for GS-trafikk	0	0	0
	<b>SUM</b>	<b>-6 470 619</b>	<b>-7 130 518</b>	<b>659 900</b>
<b>Operatører</b>	Kostnader	-65 238	0	-65 238
	Inntekter	575 858	0	575 858
	Overføringer	-510 620	0	-510 620
	<b>SUM</b>	<b>0</b>	<b>0</b>	<b>0</b>
<b>Det offentlige</b>	Investeringer	-821 288		-821 288
	Drift og vedlikehold	-121 270	-83 942	-37 329
	Overføringer	418 541	0	418 541
	Skatte- og avgiftsinntekter	900 155	827 990	72 165
	<b>SUM</b>	<b>376 138</b>	<b>744 049</b>	<b>-367 911</b>
<b>Samfunnet forøvrig</b>	Ulykker	-359 186	-775 214	416 028
	Støy og luftforurensning	-230 267	-224 172	-6 094
	Andre kostnader	0	0	0
	Restverdi	0		0
	Skattekostnad	75 228	148 810	-73 582
<b>SUM</b>	<b>-514 225</b>	<b>-850 577</b>	<b>336 352</b>	
<b>SUM</b>		<b>-6 608 705</b>	<b>-7 237 046</b>	<b>628 341</b>

Netto nytte NN =	628 341	Netto nytte pr budsjettkrone	NNB =	1,71	Budsjettkostnad	-367 911
		Interrente %			Første års forrentning	5,8 %

## **Abstract - European Transport Conference 2016**

**Title:** Tradeoffs between a 2+1 lane road design and a narrow 2+2 lane road design

**Short summary of the abstract:** This paper will look at the tradeoffs between a 2+1 lane road design and a narrow 2+2 lane road design, considering traffic safety, capacity and level of service, costs, and non-monetized impacts. Additionally, a case study examining a 2+2 road configuration within Norway will be discussed.

**Abstract:**

*Background*

In Norway, a new, alternative road design consisting of a 16 to 16,5 meter wide cross-section in a 2+2 configuration is being considered to see if it could be an acceptable and feasible solution compared to the more common 2+1 lane road design configuration. Currently the narrow 2+2 lane road is in a trial phase in Norway and not a part of the Norwegian Road Administration's standards for road and street design.

The cross section of the 2+1 lane road design consists of in total three lanes, two lanes in one direction and one lane in the opposite direction, divided by a median barrier. The direction of the middle lane is alternating giving both directions, at regular intervals, the advantage of a passing lane. This design is normally used in rural areas with mid-range traffic volumes to prevent head-on accidents and thereby increase the safety of a standard two-lane road.

There is interest in examining if you can achieve the same positive effect regarding traffic safety, and also increase the capacity and level of service of the road by building a narrow 2+2 lane road, with minimal increase in construction costs. This solution is suggested for road sections where the annual average daily traffic is not high enough to justify the costs of building a normal four-lane road. It is assumed that the costs of upgrading the 2+1 lane road into a four-lane road at a later stage, when a greater capacity is required, would be more expensive than building a narrow 2+2 lane road in the first place. Thus, the narrow 2+2 lane road is a compromise between a 2+1 lane road and a standard width four-lane road and it is important to explore further the tradeoffs between such cross-section designs.

In addition to the safety, costs and traffic operations aspects of the different road designs, the non-monetized impacts like landscape, local surroundings and outdoor activities, biodiversity, cultural heritage and natural resources should also be considered, as is standard in Norwegian

consequence analysis methodology. The expectations regarding the non-monetized impacts are that there will be minor differences between the 2+1 lane road design and the narrow 2+2 lane road. The non-monetized impacts seem to be more dependent on the local surroundings and the actual construction of the road, rather than the difference in road design when the variation in the cross sections is so small. These aspects will be discussed in the trade-off analysis and can provide information to the decision makers for future road projects.

#### *Purpose*

The aim of this paper will be to look at the tradeoffs between the narrow 2+2 lane road design and the 2+1 lane road design, by looking into characteristics like design, traffic safety, capacity and level of service, costs, and non-monetized impacts.

#### *Methodology*

The study will be done by examining existing research and literature for comparative roadway designs regarding traffic safety, capacity and level of service, costs, and non-monetized impacts. This literature study will be used to conduct a trade-off analysis, highlighting positive and negative aspects for both design solutions. A case study of a project in Norway where a narrow 2+2 lane road configuration has been used will also be examined using current Norwegian alternative assessment tools.

#### *Results*

This research will be done during the spring 2016. Based on the study the tradeoffs between the narrow 2+2 lane road and the 2+1 lane road, recommendations for the use of such road configurations will be given. The results of the Norwegian case study will also be presented, and the two parts will be linked together and discussed to draw conclusions on the use of a narrow 2+2 lane road design.