



**NTNU – Trondheim**  
Norwegian University of  
Science and Technology

# Analysis of Steroidal Compounds in Environmental Samples by Comprehensive Two-dimensional Gas Chromatography Time-of-flight Mass Spectrometry

**Eivind Rykkje Hopland**

Master of Science

Submission date: June 2015

Supervisor: Rudolf Schmid, IKJ

Co-supervisor: Øyvind Mikkelsen, MATH  
Matias Kopperi, University of Helsinki  
Marja-Liisa Riekola, University of Helsinki

Norwegian University of Science and Technology  
Department of Chemistry



## ABSTRACT

---

Steroidal compounds, especially human estrogens, have been shown to have an impact on aquatic ecosystems. Investigations at the Viikinmäki wastewater treatment plant in Helsinki revealed presence of these compounds in effluent waters (Kopperi et al. 2013)(88). The ability of steroids to adsorb on suspended wastewater particles during the treatment process can present a pathway into the environment and thus requires detailed research. In this study, there has been an evaluation and optimization of several aspects in the analytical methodology developed by Kopperi. These aspects were as follows: Evaluation of a different type of solid-phase extraction specified for whole-water analysis, optimization of an eluent of a normal phase solid-phase extraction, evaluation of different injector port liners in the GCxGC-TOFMS and the optimization of three different solid particulates extraction methods. The improved method was used on three different types of environmental samples; sewage sludge, garden soil and lawn soil.

The Speedisk which was evaluated for the solid-phase extraction for whole-water analysis was not applicable due to clogging when loading effluent wastewater samples. The normal phase solid-phase extraction eluent was optimized to have 15 % acetone content in opposite to its original 5 % (88). The ultra-inert liners had no significant effect on the sensitivity on steroid species compared to normal liners. The most effective solid extraction method was the pressurized hot water extraction with about 20 times higher relative peak values for androsterone and about 4 times higher for estrone compared to the other extraction methods. The extraction method with highest through-put was the ultrasound-assisted extraction whilst the focused ultrasound-assisted extraction was performing inadequate in both through-put and extraction ability.

The environmental samples that were analyzed in this study were taken from dried sewage sludge and commercially available soil products produced by Metsäpirtin Multa which is run by the Helsinki Region Environmental Service Authority (HSY). The product contains soil elements from wastewater treatment plants and using the optimized method the measured concentrations of some estrogens in these samples were considered high compared to the predicted no-effect concentration for estrogens in soil.

## FOREWORD AND ACKNOWLEDGEMENTS

---

This work has been an adventures journey starting at Helsinki University and ending up here in Trondheim at the Norwegian University of Science and Technology. The numerous discussion and good support from my friends at the exchange program in Helsinki are many and I sincerely thank everyone I have interacted and who has influenced on furthering my insight of this study. I would like to thank the Laboratory of Analytical Chemistry for showing me the practical use of every instrument used in this study. Special thanks to Matias Kopperi for being a good supervisor, an important discussion partner and sample collector. I would also like to thank Keith Biggart for the instructions for using the hot pressurized water extraction instrument, and his opinions around it.

My attendance to the Norwegian Seminar of Mass Spectrometry would not have been possible for both Matias and me if not for Rudolf Schmid associate professor at NTNU. I would like to thank Rudolf for additional and necessary comments on the work in these final days.

My study in Finland would not be the same if it was not for Aino Ukkonen. I would like to give gratitude for her persistence and her caring thoughts throughout this year.

As the foreword comes to an end, as my attendance to NTNU, I would to express my appreciation of the support and good words from my family I have received throughout my entire study at NTNU. Especially to my sister Ann-Helen Rykkje Hopland for being supportive and repairing some of my written English in this work.

Eivind Rykkje Hopland

Trondheim, June 27<sup>th</sup> 2015

## ABBREVIATIONS

---

17 $\alpha$ -Ethinylestradiol	EE2
17 $\beta$ -Estradiol	E2
Analysis of variance	ANOVA
Atmospheric pressure chemical ionization	APCI
Atmospheric Pressure photoionization	APPI
Comprehensive Gas Chromatography with Time of flight Mass Spectrometer	GC $\times$ GC-TOFMS
Dichloromethane	DCM
Diode array detector	DAD
Electron ionization	EI
Electron spray ionization	ESI
Emerging organic contaminants	EOC
Endocrine disruptive compound	EDC
Enzyme-linked immunosorbent assay	ELISA
Estriol	E3
Estrogen responsive chemically activated luciferase expression	ER-CA <sub>lux</sub>
Estrone	E1
European chemicals agency	ECHA
The European commission	EC
European Union	EU
Fluorescence detector	FLD
Focused ultrasound-assisted extraction	FUAE
Gas chromatography	GC
Health, Safety and Environmental	HSE
Helsinki Region Environmental Service Authority	HSY (HRESA)
High performance liquid chromatography coupled to tandem mass spectrometry	HPLC-MS/MS
High temperature high performance liquid chromatography	HT-HPLC
Hydrophilic-lipohilic balance	HLB
Liquid chromatography	LC
Mass spectrometry	MS

Molecularly imprinted polymers	MIP
N,O-bis(trimethyl) trifluoroacetamide	BSTFA
National Institute of Standards and Technology	NIST
Normal phase	NP
Predicted No-Effect Concentration	PNEC
Pressurized hot water extraction	PHWE
Quadrupole ion trap	3D-IT
Quadrupole linear ion trap	QqLIT
Registration, evaluation, authorization and restriction of chemicals	REACH
Reversed phase	RP
Solid-phase extraction	SPE
Tandem mass spectrometry	MS/MS
Trimethylchlorosilane	TMCS
Ultra high performance liquid chromatography	UHPLC
Ultrasound-assisted extraction	UAE
Wastewater Treatment Plant	WWTP
Yeast estrogen screen	YES

# CONTENTS

<b>Abstract</b> .....	<b>I</b>
<b>Foreword and acknowledgements</b> .....	<b>II</b>
<b>Abbreviations</b> .....	<b>III</b>
<b>1 LITERATURE PART I - Background</b> .....	<b>7</b>
<b>1.1 The chemical structure and function of steroids</b> .....	<b>7</b>
<b>1.2 Possible threats towards humans and the environment</b> .....	<b>8</b>
<b>1.3 Governmental view on endocrine disruptive compounds</b> .....	<b>11</b>
<b>1.4 Sources of steroid species</b> .....	<b>12</b>
<b>1.5 The role of wastewater treatment plants</b> .....	<b>14</b>
1.5.1 Partitioning considerations during wastewater treatment.....	14
1.5.2 Preliminary treatment .....	16
1.5.3 Primary treatment .....	16
1.5.4 Secondary treatment - substantial removal of estrogens .....	16
1.5.5 Tertiary treatment .....	16
<b>1.6 Sludge stabilization</b> .....	<b>17</b>
<b>2 LITERATURE PART II – Analytical Methodology</b> .....	<b>19</b>
<b>2.1 Theoretical review on analytical methodology</b> .....	<b>19</b>
<b>2.2 Sampling</b> .....	<b>20</b>
<b>2.3 Sample extraction</b> .....	<b>20</b>
2.3.1 Ultrasound-assisted extraction and focused ultrasound-assisted extraction .....	20
2.3.2 Pressurized hot water extraction.....	21
<b>2.4 Sample clean-up</b> .....	<b>23</b>
2.4.1 Solid-phase extraction .....	23
2.4.2 Practice of solid-phase extraction technology related to wastewater .....	24
2.4.3 Trends in sample preparation of waste water .....	25
<b>2.5 Separation and identification analysis</b> .....	<b>27</b>
<b>2.6 Comprehensive gas chromatography coupled to time-of-flight-spectrometer</b> .....	<b>28</b>
2.6.1 Principle.....	28
2.6.2 Analyte range.....	29
2.6.3 Disadvantage – derivatization .....	29
2.6.4 Capacity .....	31
2.6.5 Ionization source and detector.....	31
2.6.6 Detection limit, analysis time and cost.....	31
<b>2.7 High performance liquid chromatography coupled to tandem mass spectrometry</b> .....	<b>32</b>
2.7.1 Principle.....	32
2.7.2 Analyte range.....	32
2.7.3 Disadvantage - Influence of matrix effect .....	32
2.7.4 Capacity .....	33
2.7.5 Ionization source and detector.....	33
2.7.6 Detection limit, analysis time and cost.....	33
<b>2.8 Summarized comparison of the two methods</b> .....	<b>33</b>
<b>2.9 Focus points in this report</b> .....	<b>34</b>

<b>3</b>	<b>EXPERIMENTAL PART - Introduction.....</b>	<b>35</b>
3.1	The aim of the study .....	35
3.2	Motivation for the optimization .....	35
3.3	Chemicals .....	36
3.4	Sampling.....	37
3.5	Method for analyzing multiple steroids in solid matrices.....	37
3.5.1	Solid-liquid extraction: Ultrasound-assisted extraction.....	38
3.5.2	Solid-liquid extraction: Pressurized hot water extraction.....	39
3.5.3	Solid phase extraction with reversed phase .....	39
3.5.4	Solid phase extraction with normal phase .....	40
3.5.5	Derivatization method - Silylation .....	40
3.5.6	Setup used in analysis with GCxGC-TOFMS .....	40
3.5.7	Injection method.....	40
3.5.8	Data processing .....	41
3.5.9	Internal standard and relative peak area .....	41
3.6	Steroid standards.....	42
3.7	Calibration curves .....	43
3.8	Non-target analysis – Identification of steroid species in sludge and soil samples .....	44
<b>4</b>	<b>Results.....</b>	<b>45</b>
4.1	Speedisk evaluation .....	45
4.2	Florisil method optimization.....	45
4.3	Injection port liner optimization .....	46
4.4	Solid extraction evaluation - A comparison of three methods.....	48
4.4.1	Ultrasound-assisted extraction.....	48
4.4.2	Focused ultrasound-assisted extraction .....	48
4.4.3	Pressurized hot water extraction.....	49
4.4.4	Comparison of the three extraction methods – UAE, FUAЕ and PHWE .....	50
4.5	Environmental sample analysis.....	51
<b>5</b>	<b>Discussion .....</b>	<b>52</b>
5.2	Conclusion.....	55
<b>6</b>	<b>References.....</b>	<b>56</b>
<b>7</b>	<b>Appendix.....</b>	<b>64</b>



# 1 LITERATURE PART I - BACKGROUND

---

The first part of this study is a literature review on steroid species. It covers the effect of steroids on humans and wildlife and highlights the paths and sources of steroid discharges. In light of environmental effect and the sample character of these compounds the analytical methodology is discussed regarding sampling, extraction techniques, sample preparation, separation technique and economical cost. The second part of the study describes the practical work and the accompanying results. The results are discussed in view of the literature part and a conclusion is made on basis of the discussion.

## 1.1 The chemical structure and function of steroids

Steroidal compounds have a variety of functions within the animal body. Steroids are everything from membrane components in the cell regulating its fluidity, to signaling compounds that effect the cell production. They can be characterized into three common categories. **Sex hormones** are steroids that function as hormones that influence the gender difference and support reproduction. These steroids are classified into *androgens*, *estrogens* and *progestogens*. The second category **corticosteroids** are subdivided into *glucocorticoids* and *mineralocorticoids*. These compounds are linked to the metabolism, immune function, blood volume and renal excretion of electrolytes (1). The last category of steroids is the **anabolic steroids**, which interact with androgen receptors to increase bone and muscle production (2)(3). Steroid hormones are different from other hormones. While other hormones often consist of long peptide chains, these hormones are small and built in a fused ring structure with three hexane rings and one pentane ring. Their higher lipophilicity and smaller size enables these steroids to have access through the lipophilic membrane of the cell exposing the nucleus to these compounds. The skeleton structure of a steroid is shown in fig 1.

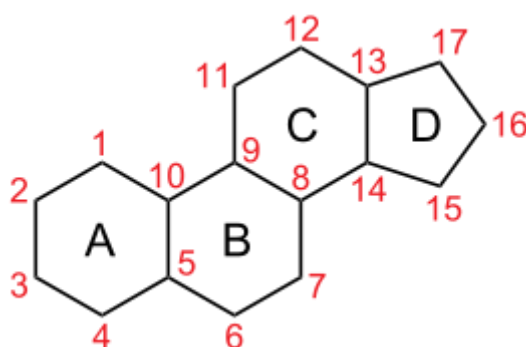

**Figure 1: Gonane - Steroid skeleton and numbering**

Steroids have commonly substituents at the 3<sup>rd</sup>, 16<sup>th</sup> and/or 17<sup>th</sup> carbon atom in the skeleton structure and have different conformations at the 5<sup>th</sup> and 17<sup>th</sup> carbon resulting in a 5 $\alpha$  or 5 $\beta$  or a 17 $\alpha$  or 17 $\beta$  conformation. These two aspects decide the function and biochemical ability of the steroid. Substituents in the steroid structure are

ketones or hydroxyl groups at the 3<sup>rd</sup>, 16<sup>th</sup> or 17<sup>th</sup> carbon while the 10<sup>th</sup> and 13<sup>th</sup> carbon commonly have methyl groups. The structures that are reviewed in this study are the sex hormones estrogen, androgens and progestogens. The A-ring, as shown in figure 1, in estrogens is an aromatic ring and the substituents are mostly hydroxyl groups and in some cases ketone groups. For androgens the A-ring is a normal cyclohexane ring and the substituents are hydroxyl- or cyclic ketone groups. The progestogens have a similar structure as the androgens but have a branched ketone group on the 17<sup>th</sup> carbon instead of a cyclic ketone. The polarity of free steroids derives from its substituents either being the hydrogen bonding hydroxyl group or the polar binding ketone group. Steroids can also exist in conjugated forms with either a sulfate group or a glucose molecule formed through a bond from any of the hydroxyl groups. The conjugate form makes the moderately hydrophobic free steroid more soluble in water, which in turn increases its transportation ability in the body and generally in polar solvents.

## 1.2 Possible threats towards humans and the environment

The groups of steroids that are presently interesting in an environmental context are the sex hormones. Estrogens have been shown to have effect on the reproductive system in certain fish species in aquatic systems (4)(5). They also have been linked to elevated risk of prostate cancer at relatively small concentrations for aged male humans (6). This defines them as known or possible endocrine disruptive compounds (7). An endocrine disruptive compound (EDC) is a compound that alters an organism's reproductive system in some way. The National Institute of Environmental Health Sciences under National Institutes of Health – U.S Department of Health and Human Services, defines endocrine disruptive compounds as:

*“... chemicals that may interfere with the body's endocrine system and produce adverse developmental, reproductive, neurological, and immune effects in both humans and wildlife.”* (8)

Areas with pollution from EDCs have been studied and other animals such as birds, reptiles and mammals have had endocrine reproductive system alterations similar to the changes found for the fish in the aquatic systems (9). Possible pathways to benthivores and further secondary poisoning of predators have also been identified through the bioaccumulation of ethinyl estradiol, an important constituent of many contraceptive pills, in fresh water worms (10). These facts makes sex hormone discharges an environmental issue. An EDC can block or mimic natural hormones in the human or animal body and take its place in the chain of cellular response resulting in either blocked, increased or decreased response of a particular production. It is important to point out that normal hormones are considered endocrine disruptive at certain concentration levels as they too can increase or decrease cellular response.

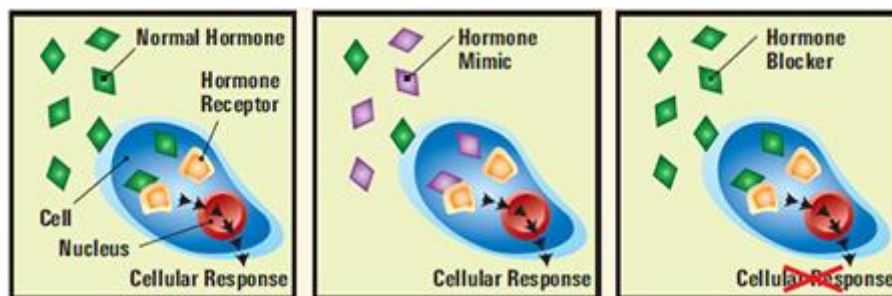

**Figure 2: Visualization of possible effects of endocrine disruptive compounds (8)**

The term estrogenicity has been constructed to measure the difference between compounds in binding to estrogen receptors and can act as a measurement of endocrine disruption potency. In table 1 a sorted selection of steroidal sex hormones and their properties are shown. Estrogenicity applies for the estrogens estrone (E1), 17 $\beta$ -estradiol (E2), 17 $\alpha$ -ethinylestradiol (EE2) and estriol (E3). At the bottom of table 1 two examples of steroid conjugates are shown. The relative estrogen activity is measured by a yeast estrogen screen (YES) bio assay. This method is based on modified yeast cells, which contain the gene for human estrogen receptor coupled to a reporter gene. The estrogenically active compound then binds to the receptor and an enzyme ( $\beta$ -galactosidase) changes color of a specific substrate. After 3-4 days the concentration of the substrate is then determined colorimetrically (11). As shown in table 1 the estrogenicity of E1 and E2 are the strongest of the natural compounds, while the most active one overall is the synthetic EE2. When it comes to androgens there has been evidence of endocrine disruptive potency, however progestogens and androgens have not been studied as much as estrogens (12). As a result of a clear focus on estrogens in the literature in general, the attention will also in this work focus more on these compounds than androgens and progestogens. Lipophilicity is determined by the  $K_{ow}$  values, which are defined as the partitioning of the relevant compound in octanol and water. The mathematical term is showed in equation (1.1).

$$K_{ow} = \frac{C_{Octanol}}{C_{Water}} \quad (1.1)$$

Where  $C_{octanol}$  is the concentration of the compound in *n*-octanol and the  $C_{water}$  is the concentration of the compound in water under equilibrium conditions. The values for  $K_{ow}$  in table 1 are not empirically determined but are estimates from statistical models (13). The values may differ from other empirical values in the literature but the model incorporates a larger set of data. It is also used for all the compounds in table 1 because it makes them more comparable. Regarding the conjugates only  $K_{ow}$  predicted values were found (15). As you can see from this table the free forms have a substantially higher  $K_{ow}$  ranging from 2.5-3.81 compared to the conjugates ranging from 0.16-1.8. This makes the free steroids relatively hydrophobic and they are likely to be found in non-polar surroundings rather than polar surroundings. The conjugates on the other hand have very low  $K_{ow}$  making them more likely to dissolve in water. This is also reflected in the in the examples of conjugate estrogens in table 1 in terms of water solubility, which is 0.35 g/l for glucuronides and 3.6 g/l and for sulphate conjugates.

**Table 1: Selected sex hormones and their relevant properties such as molecular weight, lipohilicity, relative estrogenicity and water solubility for androsterone, androstenedione, testosterone, progesterone, estrone, estradiol, estriol and ethinyl estradiol.**

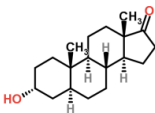
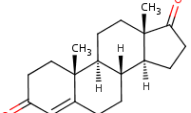
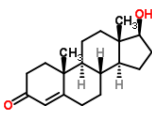
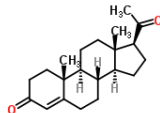
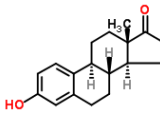
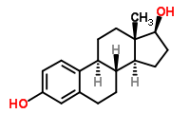
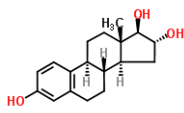
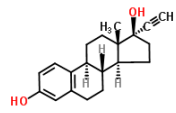
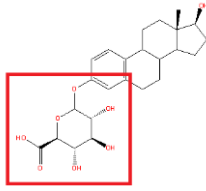
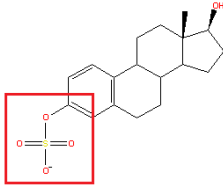
Class of steroids	Androgens			Progestogens
Steroid name	Androsterone	Androstenedione	Testosterone	Progesterone
Steroid structure				
# Carbons	19	19	19	21
Molecular weight (g/mol)	290.440	286.4	288.42	314.46
Potentially endocrine disruptive (yes/no) <sup>a</sup>	Yes	Yes	Yes	-
Lipohilicity (K <sub>ow</sub> ) <sup>b</sup>	3.43	3.06	3.25	3.81
Water solubility <sup>c</sup> (g/l at 23 °C)	0.012	0.0578	0.0234	0.00881
Class of steroids	Estrogens			
Steroid name	Estrone (E1)	Estradiol (E2)	Estriol (E3)	Ethinyl Estradiol (EE2)
Steroid structure				
# Carbons	18	18	18	20
Molecular weight (g/mol)	270.366	272.38	288.39	296.403
Potentially endocrine disruptive (yes/no)	Yes	Yes	Yes	Yes
Relative Estrogenicity <sup>d</sup>	0.20	1.0	0.01	1.32
Lipohilicity (K <sub>ow</sub> ) <sup>b</sup>	3.24	3.43	2.51	3.66
Water solubility <sup>c</sup> (g/l at 23 °C)	0.03	0.0036	0.12	0.0068
Examples of estrogen conjugates				
Estradiol-3-Glucuronide			Estradiol-3-sulfate	
				
	Water solubility: 0.35 g/l <sup>c</sup>		Water solubility: 3.6 g/l <sup>c</sup>	
	Molecular weight added by glucunoride: 194.14 g/mol		Molecular weight added by sulfate: 96.06 g/mol	
	Lipohilicity (K <sub>ow</sub> predicted) 1.8 <sup>c</sup>		Lipohilicity (K <sub>ow</sub> predicted) 0.16 <sup>c</sup>	

<sup>a</sup>(13) <sup>b</sup>(14) <sup>c</sup>(15) <sup>d</sup>(16)

### 1.3 Governmental view on endocrine disruptive compounds

The motivation for detecting EDCs is further strengthened through laws and regulations. In 2006 The European Union engaged a system devoted to the registration, evaluation, authorization and restriction of chemicals known as REACH. The aim of REACH is to make sure necessary Health, Safety and Environmental (HSE) precautions are being made when using chemicals, in general. These guidelines also apply for EDCs. If a company, university or another institution is planning on using chemicals that are not registered, the guidelines require that the institutions provide a detailed description of the compound in use. Safety information and handling is especially important. The European Chemical Agency (ECHA) has since 2011 required that all compounds must be registered in their internal database. ECHA has set out proofing standards to all companies. Companies are now required to verify to the agency that the necessary testing and documentation has been performed on the chemical in use. A *priority list*, made by ECHA, highlights the EDCs that are in need of further reviewing or regulation. This list is continuously revised and compounds can be placed on the list and removed if the necessary valid scientific documentation is provided. The hormones E1 and E3 in addition to the androgens and progestogens are not currently on the priority list of EDCs. The EE2 and E2 were reviewed and were determined endocrine disruptive towards fish at concentration levels 1-5 ng/l (17). Even though most of other hormones are not currently on the priority list of EDCs, the awareness towards the effect of these compounds is present (18) and is being noticed to a certain degree in the EU. Combining the scientific arguments with an EU law on control of naturally occurring EDCs such as estrogens and androgens will result in even more motivation and demands for removal and control of these EDC sources. There are already studies funded on monitoring possible emerging organic contaminants (EOC) and micropollutants, which include the steroid sex hormones, especially estrogens. These studies conducted in EU countries (19), U.S. (7) and across the globe (20) are the basis of the evaluation that will lead to a possible legislation regarding these compounds. Monitoring EDCs has come further in the U.S than in the EU (21), which might put further pressure on EU to conduct and complete legislation regarding this type of environmental pollution. An overview of selected EDCs that are either under regulation or non-regulated in the EU is presented in (21) and shown in figure 3.

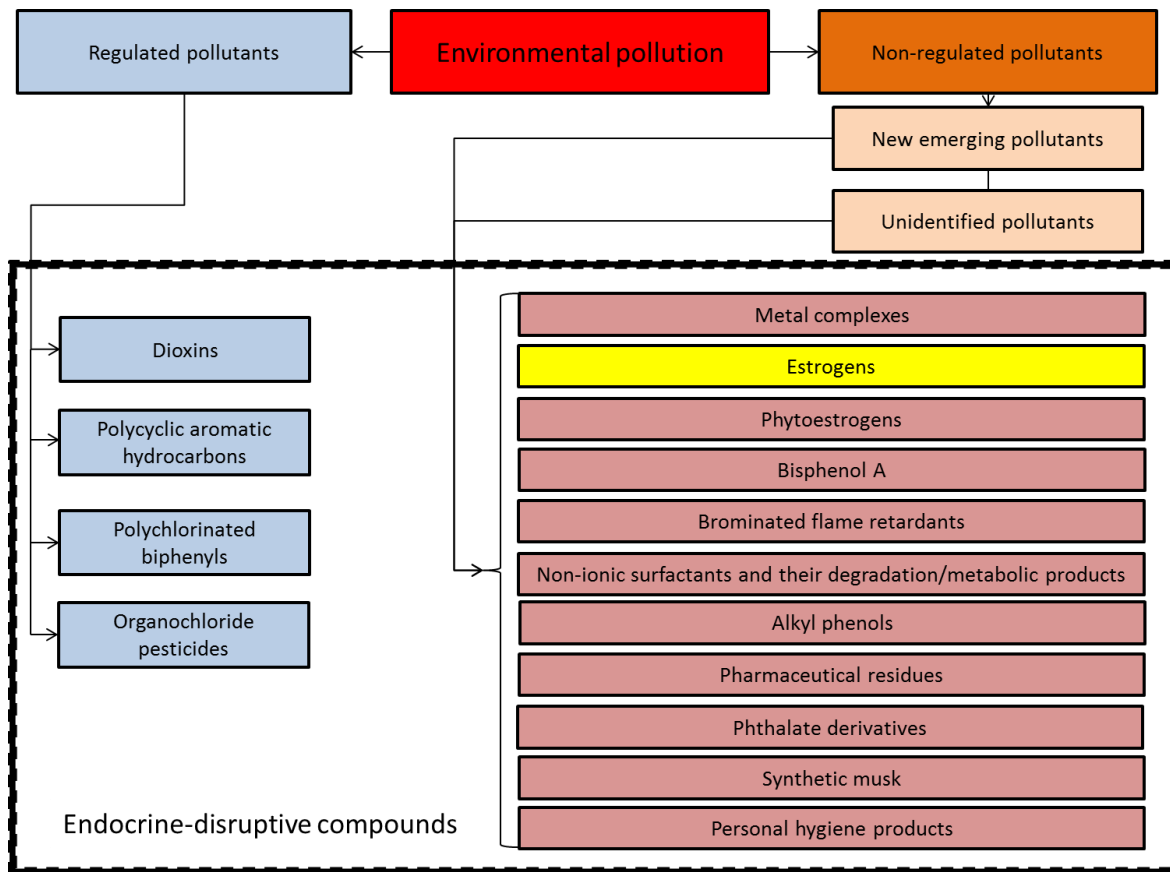

**Figure 3: EU regulation, or the absence of regulation, on a variety of endocrine-disruptive compounds modified from (21)**

### 1.4 Sources of steroid species

Numerous studies have been done on wastewater samples and the biggest anthropogenic sources of steroids are human and animal waste collected at wastewater treatment plants (WWTP) (22). In figure 4 an overview of potential sources is shown.

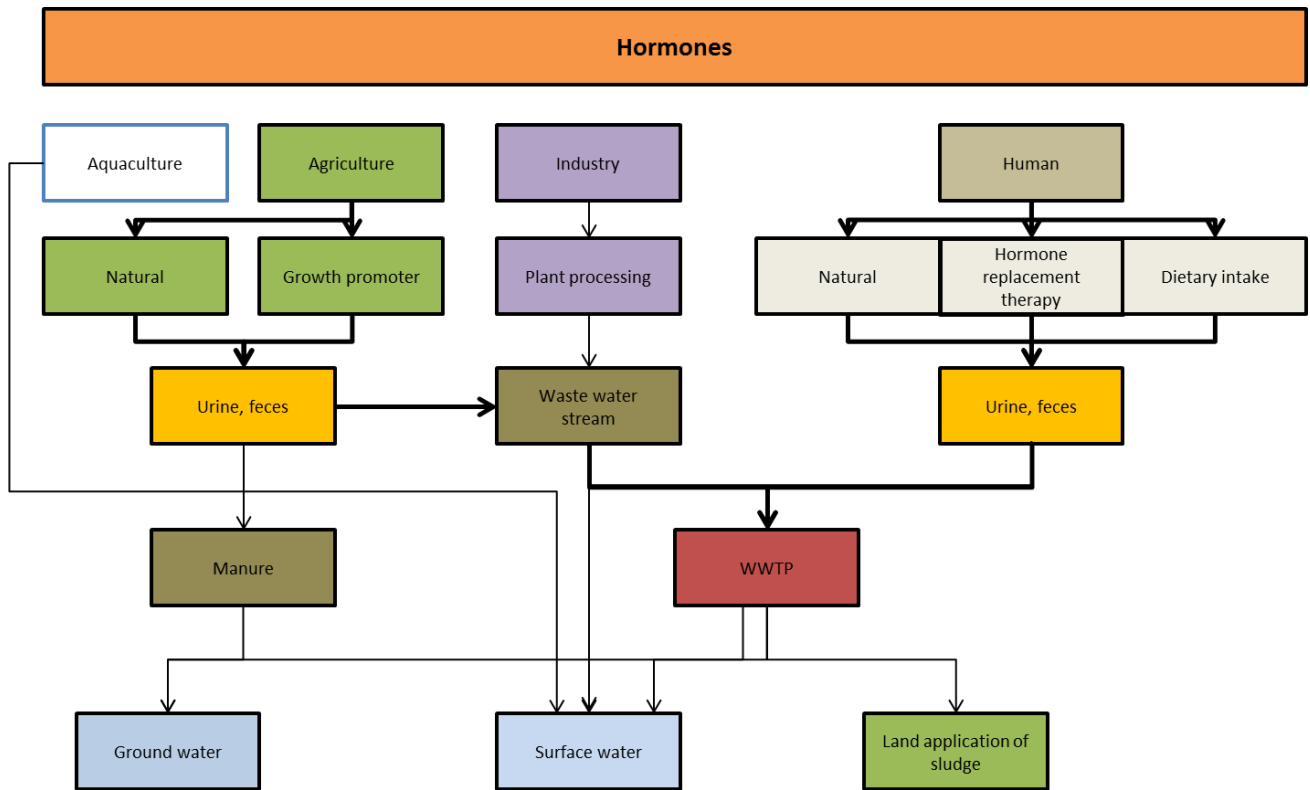

**Figure 4: Flow chart of different sources of steroid pollution where the largest contributors are human and animal waste from livestock, modified from (22)**

The WWTP gathers waste from many institutions where a major source of steroids in general often comes from the population. Metabolites in contraceptives are a source of estrogens coming from the population contributing to EDCs in the environment through wastewater according to (21). The study (21) also points out that it is actually residues from older contraceptives that play an important role in the addition of estrogens and especially EE2 to the environment. The plant industry supplements the steroid discharge by bioethanol and biodiesel production, leaving a waste containing phytoestrogens (23). Phytoestrogens are plant-derived steroids not generated by any endocrine system and are also considered as ECDs according to (21). The agriculture contribution from livestock is mainly from three animal species, namely cattle, poultry and swine, who contribute with E1, E2 and E3 through excretion. Agriculture waste has reported concentrations of estrogens comparable with concentrations found in effluents of wastewater treatment plants (24). Total estrogenicity coming from livestock has been reported in the UK to account for 15 % of all estrogens in surface waters in the country (25). E1 and E2 are the main representatives (98 %) of total estrogenicity of wastewater plant effluents (26)(27)(28). These compounds also have larger estrogenic potencies compared to other ECDs found in the effluents according to studies (26)(29)(30). Even though E1's potency is about one fifth of E2, its quantity in wastewater effluents has been reported ten times higher than E2. E1 is therefore considered a very important ECD according to (14)(31)(32). As mentioned in section 1. "The chemical structure and function of steroids" the form of steroids in general can either be free or conjugated. In a study on estrogen fate in WWTPs (31) showed that it is mostly the sulfate conjugate and not the glucuronide

conjugate that represents the conjugate steroids in wastewater plant influents. When it comes to natural and synthetic estrogens most of them are excreted as inactive polar conjugates according to (28). The conjugated species are less active than the free form and do not pose a direct threat to the environment. They can on the other hand act as a reservoir of possible free steroids through bacterial consumption and release free steroids (33). There are indications that other sources contribute as well, and aquaculture and spawning fish systems have been studied in (24) as a steroid discharge source. In that study (24) the concentrations of testosterone, androstenedione and estrone in fish hatcheries in Canada and the U.S were measured to 0.1-0.8 ng/L which is quite low compared to the other main sources. However, the fact that they have direct effluent to receiving waters makes this source an uncontrolled one in comparison to agriculture and pathogenic sources which are more treatable through waste water treatment plants. Countries that are exposed to this additional steroid source from aquaculture are primarily China, India, Vietnam, Indonesia, Bangladesh, Thailand and Norway which were the biggest fish farming nations in the world in 2010. (34)

## 1.5 The role of wastewater treatment plants

Wastewater treatment plants are installations where controlled removal of contaminants is possible. WWTP have already a set of removal strategies, whose aim is to remove contaminants in the wastewater before the water is discharged into surface waters and the solid wastes used, e.g., as landfill in land applications or fertilizer.

### 1.5.1 Partitioning considerations during wastewater treatment

According to a wastewater study (28) sorption behavior is usually described by the specific sorption coefficient  $K_D$  (l/kg) of total suspended solids. This term explains the ratio between the total suspended solids onto sorbent  $C_{\text{sorbent}}$  (sludge) and aqueous phase  $C_{\text{aqueous}}$ . See equation (1.2):

$$K_D(TSS) = \frac{C_{\text{Sorbent}}}{C_{\text{Aqueous}}} * 1\ 000 \quad (1.6)$$

Sorption is negligible for values less than 2 but is considered extensive when the value is above 4 (35). The estrogens E1, E2 and EE2 are all, according to (28), between 2.0-2.84. This makes sludge a probable surface for steroids to attach to. Note that binding energies for E1, E2 and E3 are considered weak thermodynamically (36)(37). This makes physical sorption dominant over chemical sorption and the adsorbed compounds are therefore reversibly sorbed and can desorb from the sludge as well.

Common WWTPs have treatment steps categorized as preliminary, primary, secondary and tertiary as shown in figure 6. Each step has been affiliated to the overall removal of contaminants, but especially the secondary treatment does contribute to removal of estrogens.



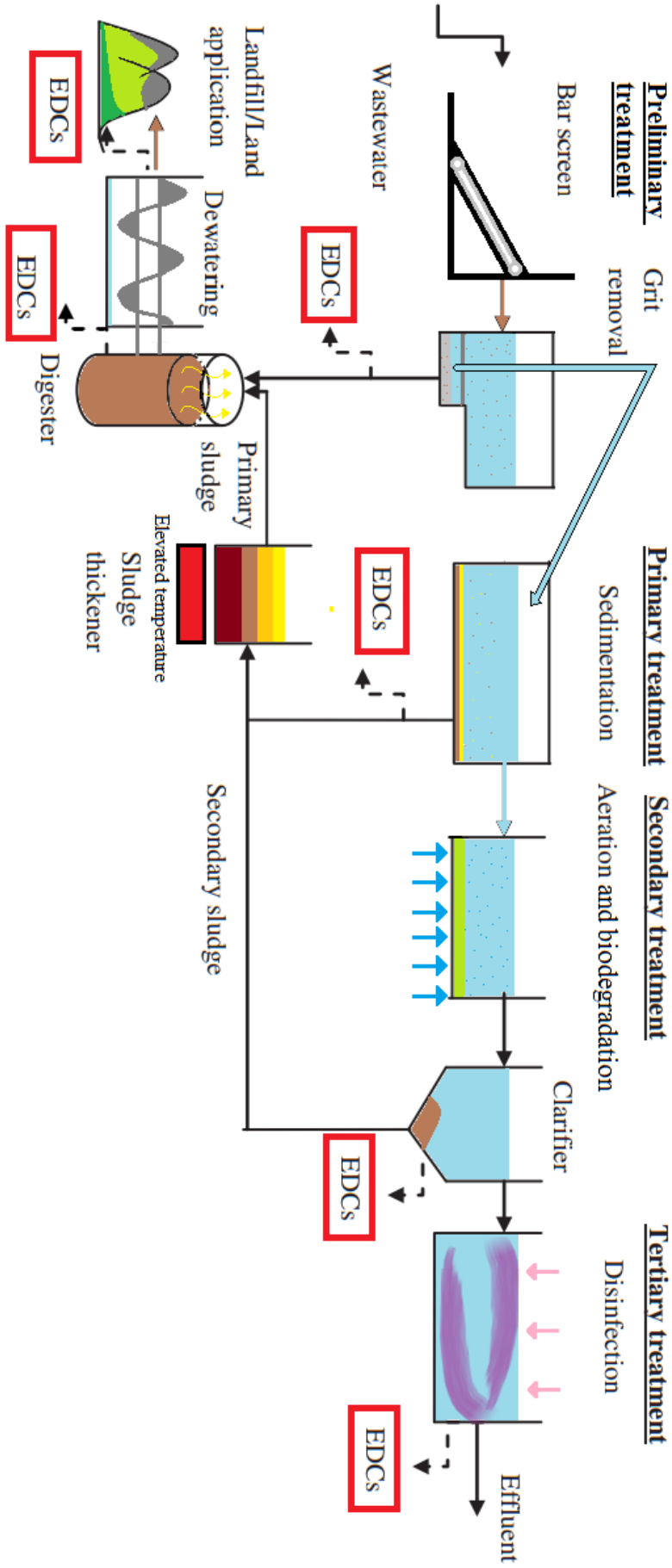

Figure 6: General setup of a WWTP consisting of preliminary treatment, primary treatment, tertiary treatment and sludge treatment creating multiple pathways for steroid species, modified from (22)

### **1.5.2 Preliminary treatment**

This is the first mechanical treatment of wastewater where larger objects are removed from a bar screen and/or a grit removal. This step is unlikely to have a significant effect on organics removal, but the large objects removed can work as a surface where steroid sorption might take place. There is no recorded significant removal of estrogens in this step, according to several studies (38) (39).

### **1.5.3 Primary treatment**

The primary treatment consists commonly of sedimentation, which to a much larger degree affects the steroids than the preliminary treatment. In a study on fate of estrogens (38) they created a model of estrogen sorption onto sludge and sediment. According to this model there are three main parameters that decide the estrogen sorption. The three parameters are hydraulic retention time, mass of primary sludge and partition coefficient. According to this model 10 % of estrogenic compounds are removed at this stage. Precautions should be made, as this model does not take into account the matrix of the aqueous solution, which can affect the partitioning. According to (22) the conjugate form of steroids does not change into the free form in this part of the treatment and there is reason to believe that also during primary treatment the conjugates follow the aqueous path rather than being adsorbed to the sludge.

### **1.5.4 Secondary treatment - substantial removal of estrogens**

The secondary treatment is the introduction to biological treatment where steroid species can be adsorbed onto sludge and is through the sorption accessible for microbial consumption. Conjugates are here, to a large degree, converted to free steroids, as this is a known bacterial ability (31)(40). The population dynamic and growth of the bacteria in this treatment have large effects on biodegradation (22) and therefore estrogens. In this secondary treatment a large portion of the steroids are completely removed, not just converted to free steroids. The biologically influenced sludge in this treatment step is called *activated sludge*. In the most common activated sludge treatment air and a biological floc, which contains bacteria and protozoa, is added to the wastewater and sludge material. The floc largely consists of saprotrophic bacteria whose function is to reduce the organic content. It has been shown that estrogens have been reduced by this method, with removal of E2, EE2 and E3 to up to 85 %. E1 removal however seemed to be more variable and less removed according to (20). The same study (20) point out that the conversion of E2 to E1 can occur during activated sludge treatment. Conventional nitrifying biomass is another common secondary treatment (22), which removes ammonium biologically with ammonia oxidizing bacteria. This treatment has been reported especially effective for the degradation of EE2 (41).

### **1.5.5 Tertiary treatment**

The previous removal techniques are the conventional methods, which are already applied in many WWTP. However, as mentioned in section 1.2 “Possible threats against humans and the environment” there are concentrations of estrogens high enough to argue further removal of estrogens. This could be applied as tertiary treatment and according to (28) some possible removal techniques are chemical removal, chlorination, ozonation and ultraviolet irradiation.

**Chemical removal** refers to colloidal removal of contaminants which easily are adsorbed by colloids. The addition of salts, e.g. aluminum sulfate or ferric chloride, creates negatively charged colloids, which attracts coagulants such as estrogens. Aggregation of these colloids eventually creates large flocs, which are later removed from the sewage solution. **Chlorination** is a technique where chlorine is added, which in the case of estrogens can substitute hydrogens on the phenolic ring, and in this way increase the chance of oxidative rupture of the ring. Chlorinated organic intermediates can however pose as an environmental risk (28). **Ozonation** is the addition of ozone to the mixture, to either oxidize the organic compounds directly or via hydroxyl radicals. In the direct oxidation the ozone reacts with amines, phenols and double bonds in aliphatic compounds. The indirect oxidizing effect via hydroxyl radicals is about nine orders of magnitude faster than the direct way. The indirect radicals are, in addition to this, not as selective as ozone. Estrogens have successively been removed with ozonation with 90-99 %, although the addition of hydrogen peroxide is needed to make this technique effective (28). **Ultraviolet irradiation** is the degradation of compounds by the exposure of UV radiation. For estrogens the phenolic ring is affected by this exposure, and the aromatic ring breaks via photo induced degradation. It can also be indirectly degraded via radicalization of oxygenated radicals which in turn degrade other compounds as well. The efficient wavelengths recorded for the degradation of EE2 are 254 nm for monochromatic radiation and above 290 nm for polychromatic radiation (28). UV treatment alone is not economically sustainable but in a combination with H<sub>2</sub>O<sub>2</sub> or TiO<sub>2</sub> and Fe (III) the method can remove over 98 % of E1, E2 and EE2 according to (28). It is worth mentioning that a substantial part of other known EDCs comes from hospital waste (20). This could in the future need special removal treatment of hospital effluents.

## 1.6 Sludge stabilization

The digester treatment, as shown in figure 5, is where the sludge stabilization happens. This is another treatment that can contribute to estrogen removal. The stabilization techniques are described in a study on sludge stabilization (42) and out of the aerobic digestion, anaerobic digestion and the lime treatment, **aerobic digestion** seemed most effective for removal of both synthetic estrogens and natural ones. The treatment that is conducted after digestion is dewatering and composting. **Composting** is a technique that is based on further biodegradation of the digested sludge to produce stable humus. The process principle is based on increased microbial activity over a longer period of time (minimum 15 days) (43). This is commonly the last step of treatment before the composted sludge is applied as landfill. To assess any concentrations that might affect the environment through soil recycling, there have been constructed predicted no-effect concentration values for EDCs. These values are determined from experimental data from multiple aquatic species and correspond to a certain percentage of the species that had no adverse effects at the actual concentration (44). As a result of few studies conducted on the Predicted No-Effect Concentration (PNEC) values for soil, the soil value is derived from the PNEC values in water. This relationship is shown in equation (1.6.1) and is recommended by the EU commission (44).

## Literature part I - Background

$$PNEC_{solid} = PNEC_{water} * K_D \quad (1.6.1)$$

Where  $K_D$  is the partitioning coefficient of the relevant compound between soil and water. This is not to be confused with the partitioning coefficient of the compound in sludge and water. The predicted no-effect concentration (PNEC) for estrogens in soil has been estimated to be in the range of 1-2  $\mu\text{g}/\text{kg}$  (45). Treated sewage sludge stands for 40 % of fertilizer used in Europe (46).

## **2 LITERATURE PART II – ANALYTICAL METHODOLOGY**

---

The concentrations of steroids are very low in WWTP effluent, and steroid hormones are found in the ng/l range (47). The wastewater effluents and sludge samples are complex samples containing substantial information about what the population and the industry is consuming. Monitoring, both qualitatively and quantitatively, the vast variety of dangerous compounds released into the environment ranging from persistent organic pollutants to illicit drugs to endocrine disruptive compounds, sets high criteria for the general quality of the analytical method. In order to achieve a full overview of the sample, the separation method and the detector needs to paint a clear and complete picture of the whole sample. In addition to these screening abilities, the analytical method needs to be selective and able to do target-analysis. Pollution needs to be monitored and the methods need therefore to be efficient with respect to use of analysis time. Combining screening processes of complex samples with quick analysis methods is a formidable challenge and often results in a technical compromise between resolution and analysis time. In addition, the cost of each analysis and initial set up is a crucial part of getting the method implemented for monitoring. This is based on the fact that environmental monitoring, in general, is commonly funded by only one economical source. (48)

### **2.1 Theoretical review on analytical methodology**

The next paragraphs contain a review on some of the aspects of the methodology needed for wastewater and sewage sludge analysis. The main focus will be on sewage sludge as sample material, but wastewater or sediment samples are discussed if literature on sludge samples is not available. The analytical segments being evaluated is in correspondence to the method used in the experimental part of this work and in the light of the currently available and suggested extraction- and analytical methods. There are four points to consider when choosing an analytical method:

- **Sampling**
- **Sample extraction**
- **Sample clean-up**
- **Separation and identification analysis**

## 2.2 Sampling

Aqueous samples, rather than solid samples, are mostly analyzed in environmental research concerning EDCs as it poses a more immediate threat to the surrounding surface waters and aquatic wildlife than steroids in the sewage sludge. For aqueous samples taken at a WWTP there can be huge difference in certain compound concentrations in samples taken in a very short span of time because of the difference in flow and wastewater pulses for each sampling moment (49). Heterogeneity in sampling is the number one reason for poor quality data, no matter how accurate an analytical method is (49). Taking sludge samples is simpler as the particles accumulate, and represent more of an averaged concentration level. Sewage sludge is to a much higher degree stored in the WWTP than aqueous sample material. Few studies have been conducted on the heterogeneity of sludge samples. There is a study, however, on sampling of suspended particles in sewage pipes located before a WWTP. In this study there was some variation between layers of suspended particles during different weather and rain conditions (50). One can therefore assume at least some heterogeneity of the sewage sludge that is present within the WWTP. In (22) the author points out the need of preservation of sludge samples, as estrogenic degradation occur when samples are collected and stored. Appropriate counter-measurements are freeze-drying, autoclaving or addition of formaldehyde.

## 2.3 Sample extraction

The most common extraction methods utilized on sewage sludge samples are soxhlet/soxtec extraction, ultrasound-assisted extraction (UAE), focused ultrasound-assisted extraction (FUAE), pressurized liquid extraction, pressurized hot water extraction (PHWE), microwave-assisted extraction, supercritical fluid extraction and matrix solid-phase dispersion (46). The extraction methods that will be more thoroughly described here, as they are important constituents of the experimental part of the thesis, are UAE, FUAE and PHWE.

### 2.3.1 Ultrasound-assisted extraction and focused ultrasound-assisted extraction

The principle in this extraction method is based on imploding bubbles that rupture the solid matrices and dissolve whatever compounds might be bound to the surface of the solid. The bubbles are generated by ultrasound and they are created by the ultrasonic effect that periodically generates compressions and depressions within the sonication substance. In most laboratory use, as in this project, the sonicated substance is tap water. These high frequency sound waves are typically in the range of kilohertz. The bubbles are created for each decompression phase and they implode for each compression phase. This is called the “cavitation effect”. Measurements have shown that the cavitation effect produces pressure of up to hundreds of bars of shear force and temperatures of up to several thousand kelvin locally (51)(52). In practice the solid samples are suspended in a liquid, which has a high dissolution constant for the analyte. The generation of bubbles therefore needs to occur not only in medium in which the test tubes are immersed, but also in the solvent used within the test tube. In general the ultrasound-assisted extraction provides the necessary force needed to

overcome van-der-Waal forces to free the analyte of interest and moving the extraction liquid to the contact surface.

The main difference between UAE and FUAE are the set-ups. In the normal UAE set-up the test tubes are fitted in a bath device, as shown in figure 6. The waves are then generated at the bottom of the bath producing high frequency bubbles. The sound waves in the bath are reflected throughout the sonication substance's vicinity hitting the test tubes from numerous angles. The FUAE set-up is done with focusing the sound source closer to the test tubes and at higher output power. This can be done by taping test tubes along the edge of a beaker and filling it with the sonication substance. The sonication device is then dipped into the sonication substance. In this case the sound waves are generated at the tip closer to the test tubes. The device also provides manual mobility of the sound source. This is shown to the right in figure 6:

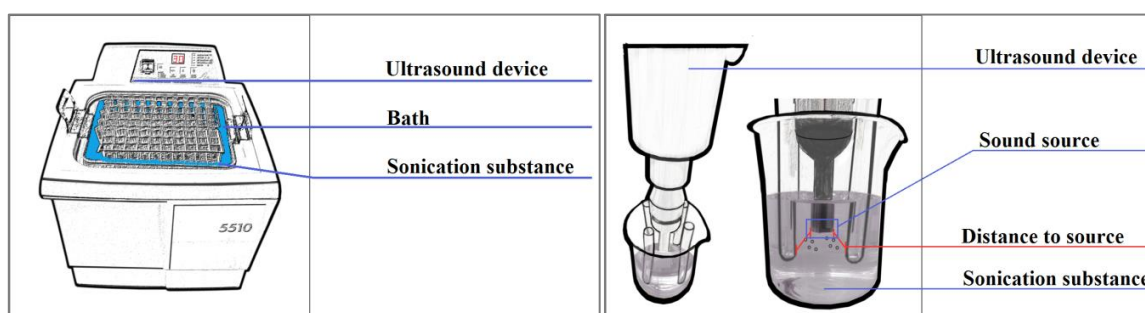
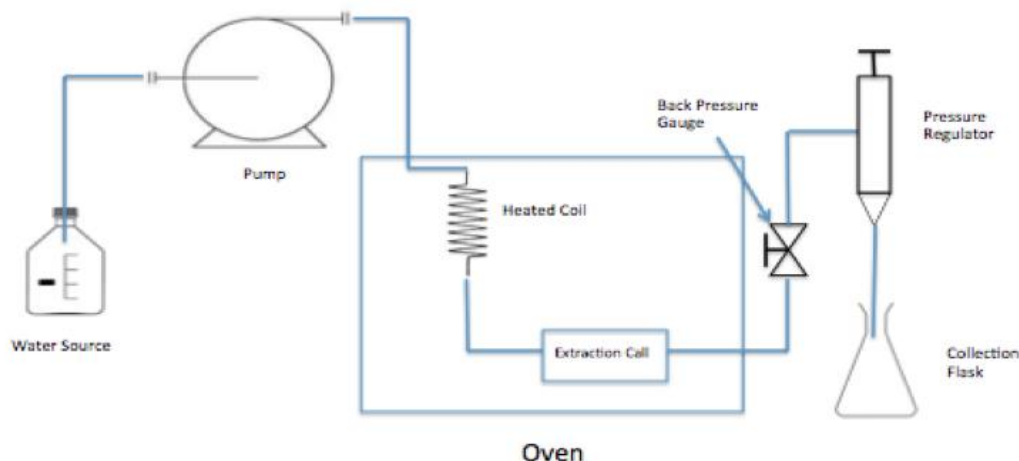

**Figure 5: Ultrasound assisted extraction using a bath device (left) and focused ultrasound assisted extraction where a sonication source is directed towards the samples manually (right)**

The focused ultrasonic-assisted extraction is known for its low cost and rapid analysis time (53). The general benefits of ultrasound-assisted extraction are the decreased extraction time and low solvent consumption compared to other methods (e.g. soxhlet).

### 2.3.2 Pressurized hot water extraction

Pressurized hot water extraction (PHWE) is an extraction method based on sub-critical water as extraction solvent. Pressure and heat is applied to an extraction cell containing the solid matrix of interest and water is then pumped through the cell also being subjected to same heat and pressure. The water is then slowly eluted from the extraction cell resulting in an extract in water phase. In figure 7 a schematic of the method is shown.



**Figure 6: Pressurized hot water extraction instrument in dynamic mode with a pump introducing the water, an oven supplying temperature, an extraction cell mad out of stainless steel, a back pressure gauge, a manual pressure regulator and a collection flask**

The sub-critical range for water is 100-374 °C under the accompanied pressure 15-85 bars (54). In this state water is still a liquid but is considered sub-critical. In this state, water has different properties than in the normal state. Its dielectric constant decreases when increasing the temperature above 100 °C and therefore its ionic product increases. This in turn makes its dipole weaker which alters the solubility with polar analytes.

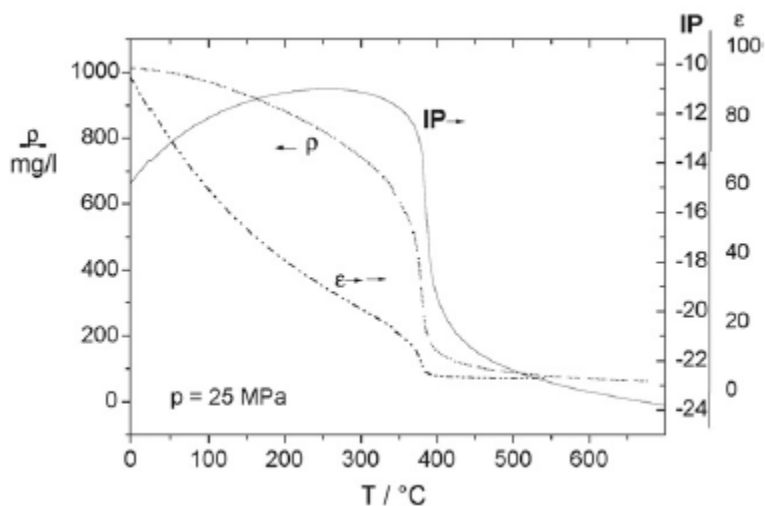

**Figure 7: Water properties at increased temperature [0-600 °C] and constant high pressure [25 MPa] where  $\epsilon$  is the dielectric constant,  $\rho$  is the density of the water and IP is the ionic product, replicated from (55)**

Increasing the temperature under 25 MPa (250 bars), as shown in figure 8, decreases the dielectric constant ( $\epsilon$ ) and simultaneously increases the ionic product (IP). The density ( $\rho$ ) values on the y-axis (mg/l) also decreases to more gas-like properties. In addition to the properties shown in figure 8, the viscosity of a liquid decreases



with increasing temperatures. This makes sub-critical water a liquid-like solvent with gas-like diffusivity. The solvent properties of water at even higher temperatures (200 °C) are similar to methanol, which makes water in the sub-critical state a solvent for less polar compounds (54) such as steroids, which have good solvability in methanol. The most important parameters affecting the extraction are temperature and time (54), while pressure has little effect. Extraction time and whether the extraction is carried out in dynamic or static mode are the main parameters that affect the extraction efficiency in this method. In dynamic mode the solvent is refreshed constantly, so the flow rate and temperature are important parameters. This increases the recovery (54) as the partition rate between sorbent and solvent never reaches equilibrium. This maximizes the rate of the analytes moving from the solid matrix to the solvent. A disadvantage with this mode is that it requires constant flow rates and a functioning pump. In static mode the solvent remains unchanged throughout the extraction period, which saturates the ratio of analyte being transferred from the sorbent to the solvent. On the other hand, the static mode is not dependent on any tubing or pump that can malfunction, which can easily occur at these conditions. Increasing temperature and pressure is a popular technique to enhance extraction efficiencies not only in PHWE (56). Another important aspect is that the method is dependent on thermally robust analytes as the thermal stress is high and there are possibilities for hydrolytic attacks during the extraction. The dangers of altering compounds in biosolids under similar conditions as in PHWE through hydrolysis, dehydration, decarboxylation, aromatization, and condensation polymerization have been studied and discussed (57). One of the possibilities for alterations related to steroids might be the aromatization which is favorable due to the more stable nature of the aromatic structure.

## 2.4 Sample clean-up

Common clean-up procedures in sewage sludge analysis are solid-phase extraction (SPE) with both reversed (RP) - and normal phase (NP), in sequence or alternatively, using polar and nonpolar solvents respectively (46). The elaborate clean-up is often a result of high amount of organics present in the solid extracts. The SPE also effective when there is a need for solvent change. In the next paragraphs there will be presented a brief background in RP and NP SPE utilization together with common usage and future trend in wastewater and sewage sludge SPE clean-up procedures.

### 2.4.1 Solid-phase extraction

*“Solid-phase extraction refers to the non-equilibrium, exhaustive removal of chemical constituents from a flowing liquid sample via retention on a contained solid sorbent and subsequent recovery of selected constituents by elution from the sorbent”*

- Mitra, Somenath, ed. *Sample preparation techniques in analytical chemistry*. Vol. 237. John Wiley & Sons, 2004, 79. (58)

In other words, solid-phase extraction (SPE) is a type of preparative chromatography designed to have as strong retention as possible for a class of compounds. The distribution coefficient is therefore maximized for

the volume and particle size that is available for the sorbent material. The different steps in practical use of SPE are activating, conditioning, loading, washing and eluting as shown in figure 9.

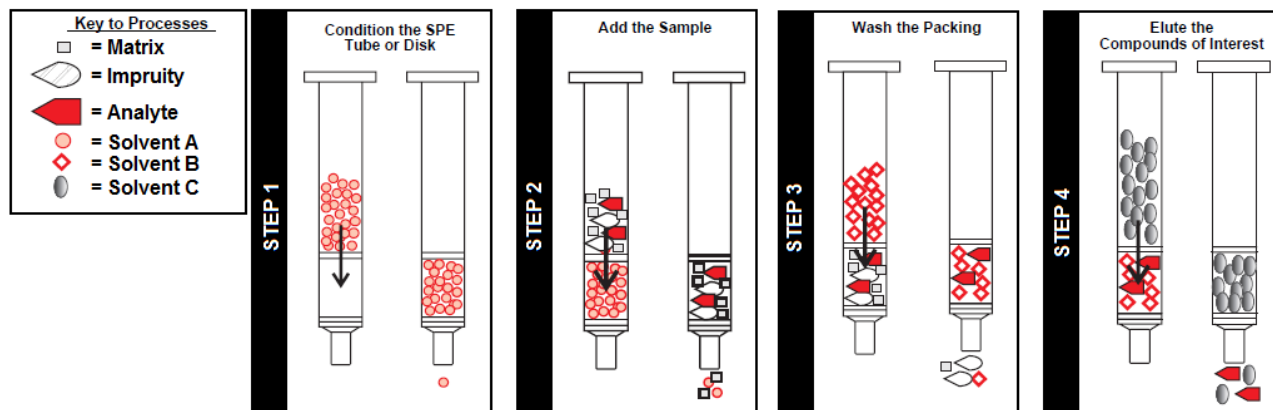

**Figure 8: The main steps of Solid-phase Extraction by removal of impurities through the four steps 1: Conditioning 2: Loading 3: Washing and 4: Eluting, modified from (59)**

The conditioning step refers to making the sorbent ready for the analyte. If this step is not accomplished, analytes might be lost through the cartridge and to waste in the beginning of the loading step. The loading is the step where the sample is introduced to the sorbent. Washing the cartridge with the loading solvent or a similar mixture is necessary due to semi sorbent-interactive impurities that are stuck in the cartridge. Finally, the elution refers to the drainage of the targeted analytes from the sorbent via a low-speed flow of a solvent, which needs to have a highly favorable dissociation constant for the analyte. Strongly adsorbed impurities to the sorbent are in this step retained in the cartridge.

#### 2.4.2 Practice of solid-phase extraction technology related to wastewater

The aim of the solid phase extraction is to transfer the analyte of interest to an adsorbent and simultaneously remove matrix compounds. In wastewater analysis there has been extended use of reversed phase (RP) adsorbents when it comes to extraction of organic pollutants (46). In RP SPE the adsorption is based on non-polar interaction by van der Waals forces. The sample solvent is usually very polar and typically water. The hydrophilic-lipophilic balance (HLB) cartridge from Oasis has been employed with success on estrogenic compounds (60)(61)(62). From table 1 in section 1.2, all of the compounds, except the estrogen sulphate conjugate, have  $K_{ow}$  (lipophilicity) values ranging from 1.8-4.0, which classify them as slightly polar organics having the possibility of non-polar interaction with a hydrophobic material. Other cartridges such as  $C_{18}$  (63) have also been used, but are vulnerable of being dried and losing their function in the washing step (64). The most common elution solvents for RP SPE in wastewater and sewage sludge analysis are ethyl acetate, methanol, acetonitrile or a mixture of these (46).

The normal phase SPE materials most common in wastewater analysis, and especially for steroid analysis are silica ( $SiO_x$ ) (65)(66)(67)(68), alumina ( $Al_2O_3$ ) (69) or magnesium silicate ( $MgSiO_3$ )(70). The last material is also known as Florisil. In normal phase the roles are reversed so that the adsorbent is polar and the solvents

are more non-polar. Percolating your sample through this type of sorbent makes polar molecules adsorb on the material and the strictly hydrophobic material go straight through. The most common elution solvents for normal phase SPE in wastewater and sewage sludge analysis are non-polar and polar aprotic organic solvents e.g. cyclohexane, ethyl acetate, DCM, n-pentane, acetone and n-hexane (46).

In many cases of wastewater analysis there has been a combined use of normal phase SPE and reversed phase SPE, as the samples from wastewaters need a solvent change from water and a thorough clean-up because of the dirty character of the sample. For sludge samples it is not always necessary to use both RP and NP as clean-up. It seems that the most promising reversed phase SPE sorbents used in steroid analysis have been the Oasis HLB, which consists of a copolymer of divinylbenzene and vinylpyrrolidone. The more used normal phase SPEs are some form of normal phase silica, often Florisil (46).

### **2.4.3 Trends in sample preparation of waste water**

As can be seen from the previous paragraph there is a clear potential of time reduction in clean-up steps in wastewater analysis. This in turn could lead to an increase in monitoring ability resulting in a reduced cost of each analysis. Molecularly imprinted polymers are being applied to wastewater and sludge analysis (46). This method is based on imprinting a template into a polymer adsorbent, an adsorbent that is similar to conventional SPE. When the polymer is formed and has solidified, the template is removed and small cavities in the exact shape of the template analyte are made. These distinct forms in the polymer are highly selective towards the template analyte. This is because of the exact electrostatic and non-polar locations made in the polymer. Visualization is shown in figure 10 where the monomer is methacrylic acid and the cross-linking agent is ethylene glycol dimethacrylate, which have been used successfully as monomers for making MIPs (71).

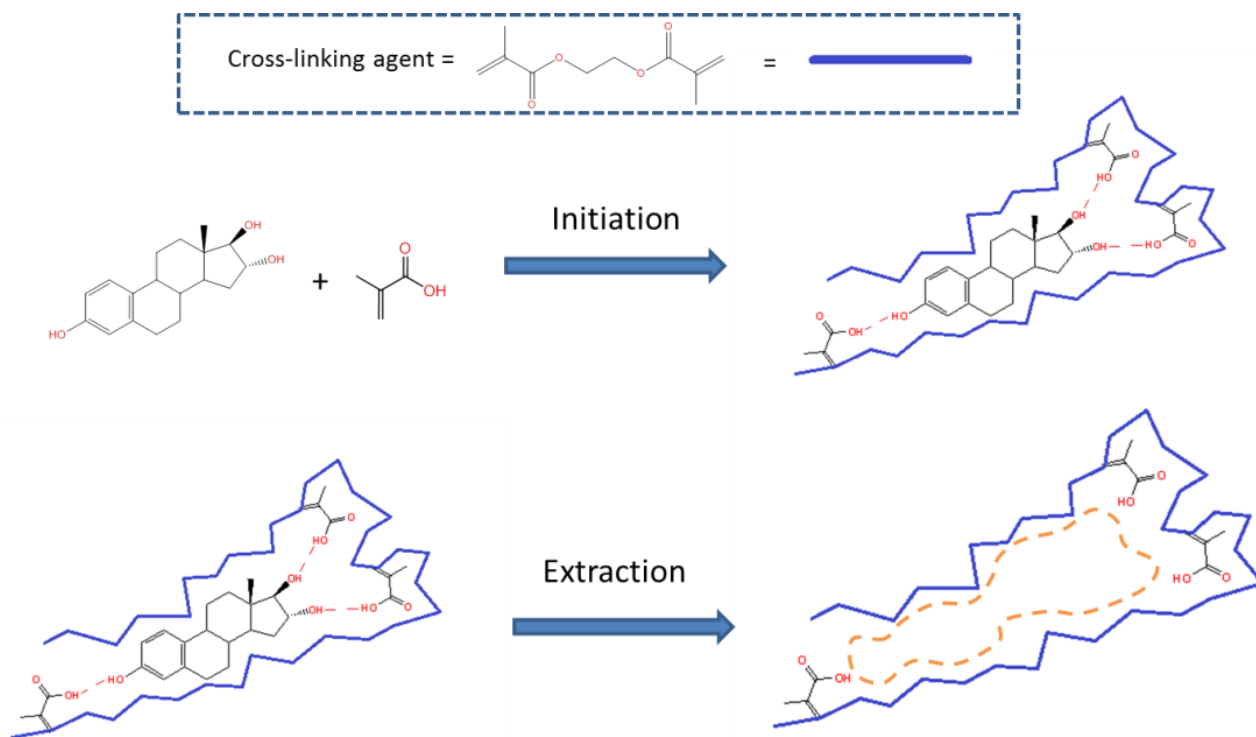

**Figure 9: Principle of molecularly imprinted polymer (MIP) where the cross-linking agent and the monomer creates a cavity for the relevant analyte to selectively attach to**

This technique has been reported very effective both in terms of analysis time, which was 10 minutes faster than with normal SPE, and recovery (72). In (72), the estradiol template worked satisfactory for other, similar steroids such as cis-androsterone, 17-estradiol (E2), [2H3]-17-estradiol ([2H3]-E2), testosterone and 19-norethisterone.

## 2.5 Separation and identification analysis

Choice of analytical method to analyze wastewater samples is widely documented and there are two methods that stand out. The first one is gas chromatography and the other is liquid chromatography. A study (21) summarizes the most applicable analytical methods for estrogen analysis in wastewater including both chromatographic methods and bioanalytical methods. An overview of these methods is shown in table 2, where the advantages and disadvantages are pointed out

**Table 2: Analytical and bioanalytical techniques and their ability to analyse estrogens from different matrices such as blood, urine, sperm and wastewater, replicated from (21)**

Requirements	Techniques		
	Bioanalytical	Chromatographic	
	E-screen <sup>a</sup> , ER-CALux <sup>b</sup> , YES <sup>c</sup> , ELISA <sup>d</sup>	Gas	Liquid
Application	Determines estrogenic activity	Qualitative and quantitative analysis	Qualitative and quantitative analysis
Sample type	Biological materials (blood, urine, sperm)	Water, waste water	Water, waste water
Sample volume capacity (ml)	1-20	200 – 20 000	150 – 5 000
Detection method	Colorimetric fluorescence, luminescence	MS, MS-MS	DAD, FLD, MS-MS
Limits of detection (ng/l)	From 0.14	From 0.05	From 0.06
Ability to determine analyte derivatives (metabolites, conjugates)	No	No	Yes
Suitability for routine application in wastewater analysis	No	Yes	Yes

a = Estrogen screening, b = Estrogen responsive chemically activated luciferase expression, c = Yeast estrogen screening, d = Enzyme-linked immunosorbent assay

The overview in table 2 takes aqueous samples into consideration, but not sludge samples. The nature of sludge samples is different in terms of concentrations and how complex they are. A need for increased peak capacity and universal detection is the primary concern when choosing among GC and LC methods for these kinds of samples. Diode array detector (DAD) and fluorescence detector (FLD) are specific detectors that require a chromophore in order to detect the analyte. Estrogens have a naturally chromophore and would be suitable DAD or FLD but the androgens and progestogens would need to be derivatized in order to be detected. These UV-detectors would be an interesting choice in target analysis, but are not well suited for screening processes. The mass spectrometry detector is a popular detector since it has the ability to screen for compounds and do target-analysis. The most encouraged methods to use for analyzing sewage sludge are comprehensive gas chromatography coupled to mass spectrometry and liquid chromatography coupled to tandem mass spectrometry (46).

## **2.6 Comprehensive gas chromatography coupled to time-of-flight-spectrometer**

### **2.6.1 Principle**

Comprehensive gas chromatography is a technique that is based on the same separation technique as conventional GC. The main difference is that there are two capillaries coupled in series, instead of just one capillary. The two capillaries may have different temperature gradients, separated by a secondary oven as shown in figure 11. The separation principle of the two columns should in theory be different enough to be called orthogonal. (73) Orthogonal means that the retention tendency of the two mechanisms should not significantly correlate. A low-correlation between the two is accepted as orthogonal in analytical chemistry, even though the mathematical definition demands zero correlation (74). Commonly the first separation is a non-polar capillary and the second capillary is a semi-polar one. The first obvious issue coupling two different capillaries in series is the fact that the second dimension will in many cases mix analytes back together again. However, sending small fractions of the sample through a short secondary capillary usually resolves the issue of mixing. This depends on the fragments and if they are small enough.

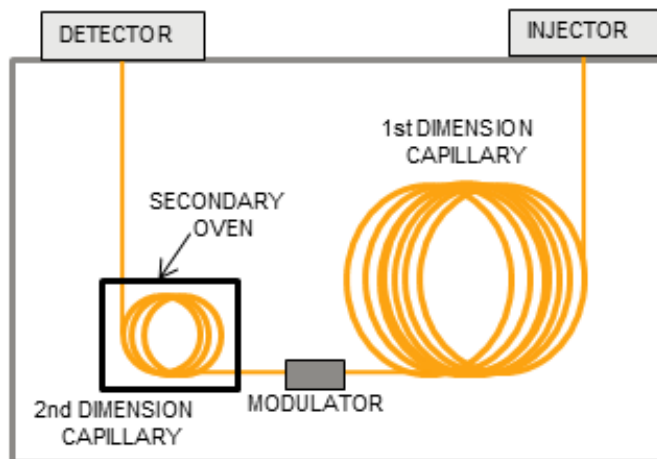

**Figure 10: Comprehensive gas chromatography, where two different separation capillaries are connected via modulator which focuses the compounds coming from the 1<sup>st</sup> dimension capillary and sends them through the short 2<sup>nd</sup> dimension capillary**

The modulator, as shown in figure 11, is a component that is needed between the two different capillaries to maintain the achieved resolution from the first capillary. The device traps and focuses the analytes in fractions at the end of the first column. After the focusing they are sent quickly through the next column. Each fragment time is very short, trapping only for a few seconds. The most common focusing technique is the cryogenic modulation.

The cryogenic technique is based on focusing sample fractions by cooling between the two columns. The analytes from the first column are focused together because of the rapid cooling and are subsequently heated up again, at the same fast rate as the cooling. The heating is controlled to a desired temperature, re-mobilising and sending the fraction into and through the second column. The cryogenic technique is the most effective and therefore the most utilized technique. However, there is a desire to replace this method since it is dependent on expensive cooling gas.

### 2.6.2 Analyte range

The analyte range of a GC is decided by how much of the sample that can be volatilized, since the main separation principle is based on retention resulting from gas to liquid. Polarity in general as well as molecular size of the analyte limits this analytical technique. The polarity of a molecule however can be changed through derivatization of the analyte.

### 2.6.3 Disadvantage – derivatization

Derivatization is a necessity in GC when it comes to analysis of polar molecules. Since the low vapor pressure of polar molecules often would require column-temperatures that neither the GC column nor the analyte could withstand, the analyte is often derivatized by silylation. Silylation is a substitution reaction with, typically,

trimethylchlorosilane (TMCS) where the analyte exchange its active hydrogen with a TMS group as shown in figure 12.

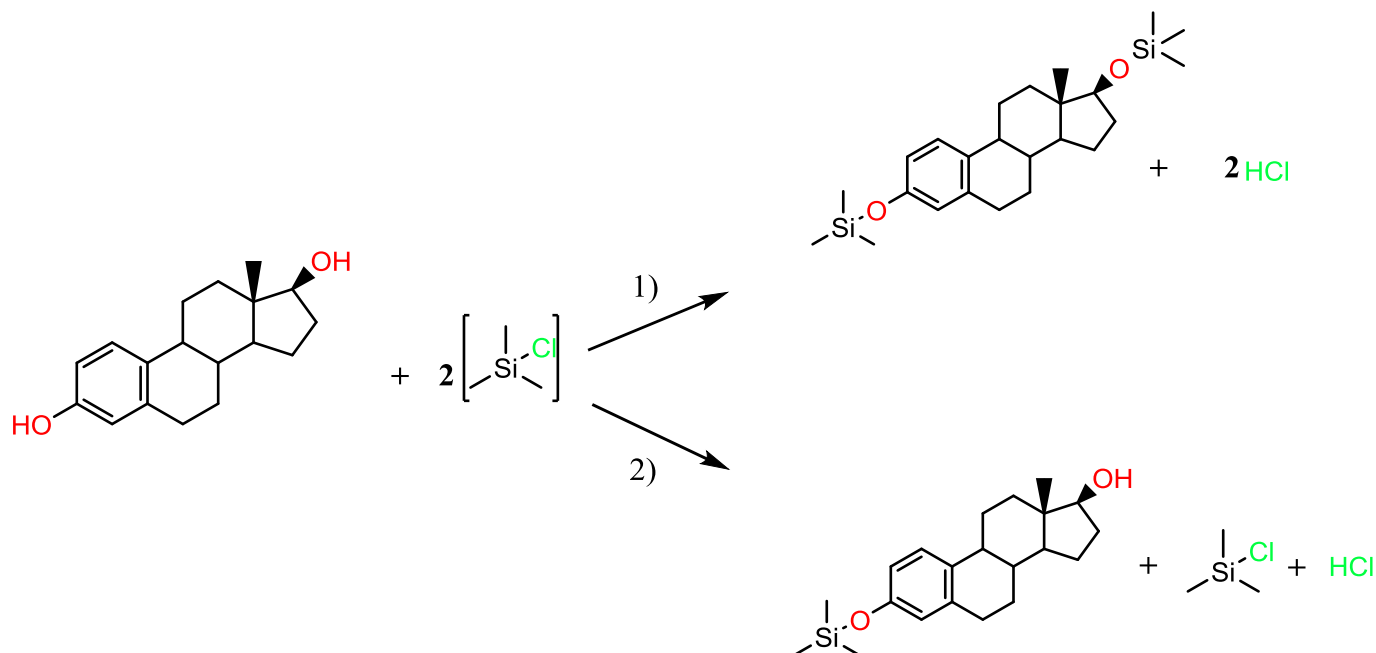

**Figure 11: Silylation principle with estradiol, where the trimethylchlorosilane (TMCS) binds to the active hydrogen either at the 3<sup>rd</sup> or 17<sup>th</sup> carbon or at both places on the estradiol (E2) creating a mono- and a di-derivative. Notice that hydrochloric acid is produced in the reaction.**

The replacement of one, two or three substitutes is adding to the molecule weight and increasing its vapor pressure and increasing its thermal stability. There is a possibility when using silylation agents in the analysis of estrogens that multiple silylated versions of the analyte can occur, as shown in figure 12. The silylation reagent N,O-bis(trimethyl) trifluoroacetamide (BSTFA) is often used in silylation with steroids and there has been cases where multiple trimethyl derivatives occur instead of the desired mono derivative. This can be a source of misidentification (75), but with addition of 1% trimethylchlorosilane (TMCS) and pyridine it sufficiently prevents the generation of multiple derivatives. The proton acceptor pyridine is used to dangerously acidic conditions generated by the hydrochloric acid which can influence analytes in the silylation solution. It has also been noted that in addition to being an acid scavenger, pyridine as a solvent can act as a catalyst making the hydroxyl group more accessible in the silylation process (76). Silylation is also sensitive to water and must be kept free from moisture during and after the reaction, especially phenolic TMS ethers (such as in figure 12). (77)



### 2.6.4 Capacity

The main advantage of the comprehensive GC technique is its peak capacity, which makes it suited to analyze matrices with large numbers of compounds, e.g. wastewater samples. The difference in comprehensive GC towards normal GC can also be described through peak capacity  $n$  for completely orthogonal columns as shown in equation 2.6.4.3:

$$n_{c,2D,orth} = n_{c1} * n_{c2} \quad (2.6.4.1)$$

Here  $n_{c1}$  is the peak capacity of the first column and  $n_{c2}$  is the peak capacity in the second column. The capacity of the technique is increased with  $n_{c2}$  - times which is a considerable increase from just  $n_{c1}$  from normal columns (74). This capacity is however limited as the length of the second column cannot be too long as it will lose its already achieved resolution. The main limitation however is that the modulation can only focus optimally for a certain time and the fragments must be fully eluted and analyzed before the next fragment. Because of this, the second column is often just a few meters long and has just a few seconds in retention time.

### 2.6.5 Ionization source and detector

The ion source in GC coupled with the mass spectrometer is almost exclusively based on electron ionization (EI). EI is often used because of its high fragmentation ability giving mass spectra high compound specificity, and its compatible property with the gas characteristics of analytes from the GC. The reproducibility of the spectra generated by the EI makes it applicable for intra- and inter-laboratory comparisons. This greatly enhances its identification ability. The identification, or detection, of analyte peaks today is often done by a time of flight mass spectrometer (TOFMS). Time-of-flight is the spectrometer of choice since it has the ability to continuously detect at high frequencies full-scan spectra of compounds eluting from the chromatograph, which in turn allows detection of continuous data to construct a valid peak. This is in contrast to the quadrupole in full scan mode that does not have the acquisition rate required to create sufficient data points when constructing a peak (74).

### 2.6.6 Detection limit, analysis time and cost

Detection limits from analyses of estrogens in sewage sludge done by comprehensive GC are not reported at this point. There have been studies on sediments however, which is not as complex as sewage sludge but similar in matrix constitution. The reported detection limit was 0.4 - 2.5 ng/g (78) in sediments and 0.2-0.9 ng/l in wastewater influent (79). The cost of each individual sample is relatively low as the consumption of reagents are small and the capillary can easily be cleaned by cutting parts of the retention gap. The MS cost is high compared to quadrupole systems as e.g. there is a higher demand on the vacuum conditions in TOF-MS systems, related to the requirements of mean free path, which is crucial in TOF. There is no available price list on the initial cost of a comprehensive GC-TOFMS-system.

## 2.7 High performance liquid chromatography coupled to tandem mass spectrometry

### 2.7.1 Principle

Liquid chromatography (LC) is based on liquid-solid adsorption and is most used with the reversed phase system, where non-polar interactions such as London dispersion forces dominate the interaction with the solid phase. The column packing material is usually octadecyl silane, also known as C18. In sewage sludge analysis the trend in LC are the utilization of short narrow bore columns, high mobile phase flow-rates and ultra-high pressures (80).

### 2.7.2 Analyte range

Since reversed phase LC is based on the phase interaction between liquid and solid, the analytes have to be in aqueous solution during separation. This is a big advantage since many compounds of environmental interest, and most other organic compounds are stable at room temperature in aqueous. RP-LC can analyze relatively small polar analytes and simultaneously bigger polar and nonpolar analytes. HPLC-MS is known for its many applications ranging from trace analysis in environmental chemistry, analysis in clinical laboratories, preparative applications in organic chemistry, analysis in proteomics and chiral separations (81)(82)(83)(84).

### 2.7.3 Disadvantage - Influence of matrix effect

Closely related to the high number of compounds available for analysis with this technique is that there is an increased influence of the other compounds on the analyte detection. Matrix effects are caused by co-eluting compounds that either increases or decreases the signal of your analyte, and in the case of MS the matrix effect is related to the ionization interference of these co-eluting compounds. This effect increases depending on the complexity of your sample. According to a study on LC-MS/MS trends (80), wastewater analysis is particularly complex and is therefore prone to matrix effects during the analysis. Extractions from sewage sludge can be even more complex than from wastewater, resulting in enhanced possibility of these effects. Important validation parameters that will be affected by this are limit of detection, linearity, accuracy and precision.

The LC study (80) points out that the counter-measures for the effects can be use of isotopically labeled (deuteration, C<sub>13</sub>) reference materials that can correct inaccurate measurements. The author (80) also mentions that the matrix effects increases the need of good clean-up procedures. SPE or multi-residue hydrophilic-lipophilic balance (HLB) methods are often used in these situations. There is an increasing trend in use of molecularly imprinted polymers (MIP) as pre concentrators and clean up measures in wastewater analysis. The MIPs are popular, especially with LC-MS analysis, since they efficiently remove matrix components and simultaneously proved good recoveries. In one study the method limit detection was lowered by a factor of 7 when compared to a multi-residue HLB method. (85)

#### **2.7.4 Capacity**

The usual plate number for HPLC with 2.5  $\mu\text{m}$  particles is around 10.000 – 20.000, and the technique has a peak capacity smaller than GCxGC-TOFMS. A drawback with decreasing particle size to increase peak capacity is the resulting increased backpressure. This can be compensated for with high-temperature LC where the backpressure is reduced by increasing temperature resulting in change in viscosity in the solvent. It is however affected by two major flaws namely analyte degradation and thermally unstable packing material in the column according to (85). A more common way to increase efficiency is to use sub-2 $\mu\text{m}$  particles in the column, also known as UHPLC. The study (85) also points out that to maintain the same analysis speed the packing material, and the instrument in general, needs to withstand pressures up to 700 -1000 bar. Another alternative could be the use of core-shell particle technology for RP-LC or the application of supercritical fluid chromatography.

#### **2.7.5 Ionization source and detector**

The most common ionization source in LC/MS is electro spray ionization (ESI) which is a soft ionization technique. Other relatively popular LC/MS ionization techniques are atmospheric pressure chemical ionization (APCI) and atmospheric pressure photoionization (APPI) (85). ESI is, however, most commonly used, as it is applicable to ionize a wider range of analytes compared to the two other techniques. The mass spectrometer in LC-systems is often a spectrometer with trapping ability. Common mass spectrometers are quadrupole ion trap (3D-IT), quadrupole linear ion trap (QqLIT or QqQ) or the more expensive and effective orbitrap analyzer. The need for tandem mass spectrometer is based on the ionization source. Soft ionization sources often create no, or little, fragmentation, which in turn gives little help for interpretation of mass spectra, as is so common for EI in GC/MS. Trapping these non-fragmented primary adduct ions and fragmenting them in a second step generates a number of fragment ions from the precursor, and ensures a higher degree of correct identification, or specificity. The mode of the MS is often at selected reaction monitoring. Recent regulations have stated that 4 points of identification should be achieved in terms of ensuring quality data. (86) Based on its higher degree of quality data, tandem MS is the present trend in MS application with LC.

#### **2.7.6 Detection limit, analysis time and cost**

The detection limits found on sewage sludge analysis of estrogens and progestogens done with LC-MS/MS are as low as 0.03-0.85 ng/l (87). The separation time is typically around 10-20 minutes. The actual prizes per sample run are difficult to estimate regarding the different solvents and columns in HPLC, but there is considerable cost in solvent consumption per run, man-power and cost of equipment.

### **2.8 Summarized comparison of the two methods**

Comprehensive GC has its advantages in peak capacity, dealing with dirty samples and the lower cost per run. The intra- and inter-laboratory ability of the ionization mode in the GC is also a big advantage. It has its

limitations with the need of derivatization and that it is not able to analyze conjugates. The LC system transfers more of the sample to the analytical LC column than the hot vaporizing injector transfers to the capillary in GC. This can be considered an advantage as it reveals more about the sample. The drawback of the huge amount of compounds introduced to the LC column is the possibility of matrix-effects in the ionization, which can result in overestimates of compounds. Solvent consumption, man-power, maintenance and initial cost are also bigger for LC systems than for GC systems, which may make it the expensive choice of the two. The GCxGC-TOFMS have on the other hand an expensive element in the need of cooling gas for the cryogenic modulator. The identification in MS/MS is not comparable with other spectra from other laboratories because of the reproducibility of the ionization technique (ESI). The identification then needs to be calibrated from time to time and individually for each laboratory. The detection limits are about the same, ranging from 0.03-0.85 ng/l for the LC-system and 0.2-0.9 ng/L for the GC-system, which is adequate for wastewater analysis. LC has the ability to analyse conjugates as well as free steroids, and do this without the need of derivatization. Therefore the sample preparation is often faster for LC than for GC. Lastly, LC does not suffer from the possibility of thermal alteration of the molecule and is considered a soft analyte-preservable technique using less time per analysis.

## **2.9 Focus points in this report**

The following experimental part focuses mainly on extraction methods, sample preparation optimization, liner evaluation and the measurement of certain steroids in sewage sludge and soil samples.

## 3 EXPERIMENTAL PART - INTRODUCTION

---

### 3.1 The aim of the study

The experimental part of this thesis was carried out in the Laboratory of Analytical Chemistry at University of Helsinki and consists of further optimization of an already established method developed by M. Kopperi (88). Emerging organic contaminants (EOC's), such as different types of steroids, being released into ecological systems have been proven harmful for the reproductive ability of certain fish species (89)(90). In effluent waters of Viikinmäki wastewater treatment plant in Helsinki the presence of these compounds has been demonstrated (88). The motivation of this project was to examine and quantify types of steroids in sewage sludge and wastewater particles to get an estimate of steroid concentrations and its fate during the wastewater treatment process.

The aim of this study was to optimize the already developed method, focusing mainly on different types of extractions of steroids from solid matrices. The extraction methods that were evaluated in this project were ultrasound assisted extraction with bath (UAE) and probe (FUAE), and pressurized hot water extraction (PHWE). In addition to this an optimization of the sample preparation regarding normal phase extraction and whole water analysis was conducted. An instrumental optimization, regarding different types of liners in the GC-injector, was also performed. The adapted methodology was subsequently applied to environmental samples in order to quantify some steroidal compounds in commercially available soil from Metsäpirtin multa (HSY). (91)

### 3.2 Motivation for the optimization

Extraction from solid matrices had already been evaluated with dynamic ultrasound-assisted extraction (88). This however was the only method tested for solid extraction and left a room for improvement both in time- and extraction efficiency. The motivation of the sample preparation optimization was the desire to minimize the loss of steroid species during clean up, whilst also maintaining the cleanness of the sample. The sample preparation was also evaluated on the basis of analysis time, and was tested with an advertised quicker method for whole water analysis (92). Moreover, the desire for better sensitivity led to an investigation GC injector liners used in the gas chromatograph.

### 3.3 Chemicals

**Table 3: Chemicals used in the experimental part**

<b>Compound name</b>	<b>CAS- number</b>	<b>Company name</b>	<b>Country</b>	<b>Purity</b>
Acetone	67-64-1	Sigma-Aldrich	United States	HPLC grade
Acetonitrile	75-05-8	VWR BDH Prolabo Chemicals	Northern Ireland	HPLC grade
Androstenedione	63-05-8	Fluka	Switzerland	≥ 99,1 %
<i>trans</i> -androsterone	481-29-8	Fluka	Switzerland	≥ 98 %
<i>1,1</i> -Binaphtalene	604-53-5	Acros Organics	United States	
Dichloromethane	75-09-2	Fisher Chemical	United Kingdom	HPLC grade
Estradiol	50-28-2	Fluka	Switzerland	≥ 98 %
Estriol	50-27-1	Fluka	Switzerland	≥ 97 %
Estrone	53-16-7	Fluka	Switzerland	≥ 99 %
<i>17</i> -Ethinylestradiol	57-63-6	Fluka	Switzerland	≥ 98 %
<i>n</i> -Hexane	110-54-3	SupraSolv® Merck KGaA	Germany	HPLC grade
Methanol	67-56-1	VWR prolabo (BDH) Chemicals	Northern Ireland	HPLC grade
N,O-bis(trimethyl) trifluoroacetamide + 1% trimethylchlorosilane	25561-30-2	Fluka	Switzerland	-
Progesterone	57-83-0	Merck	Germany	≥ 97 %
Pyridine	110-86-1	Sigma-Aldrich	United States	-

### 3.4 Sampling

The solid samples were taken from Viikinmäki wastewater treatment plant (WWTP) in Helsinki and consisted of 500-600 g of sewage sludge. These samples were grab samples and were taken at the end of the process after dewatering, see figure 13.

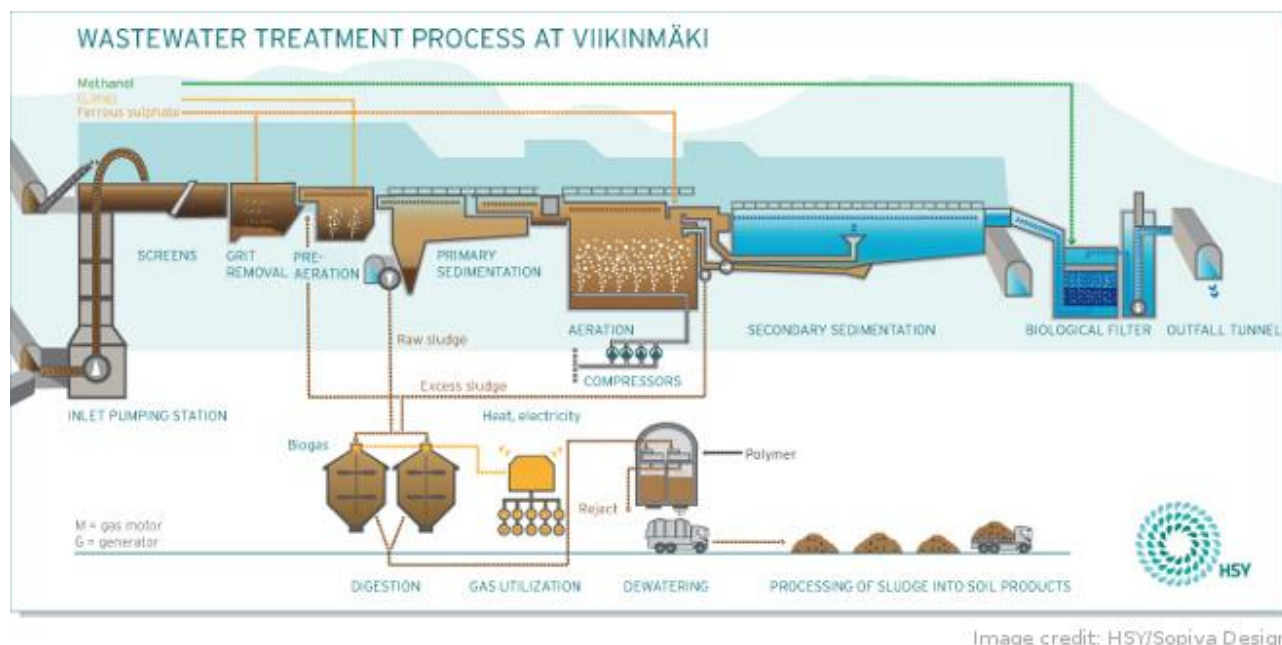
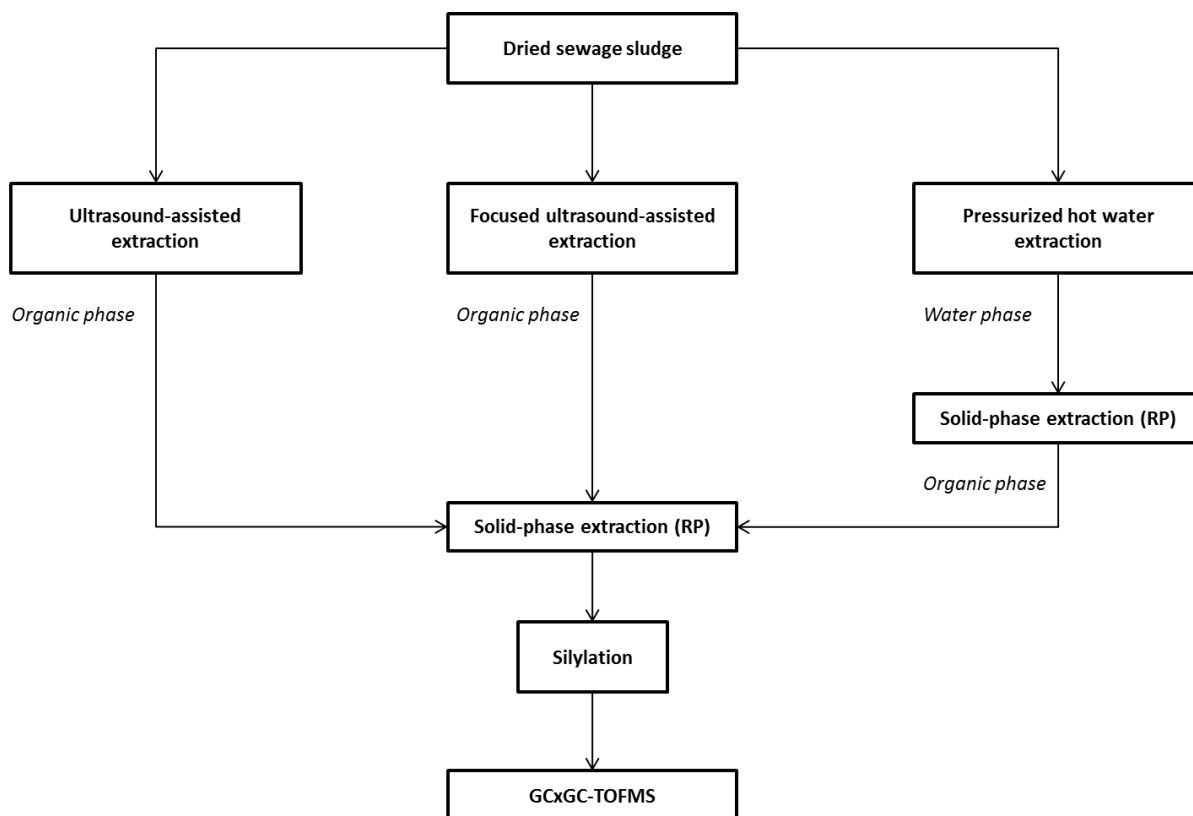

**Figure 12: Viikinmäki wastewater treatment plant (WWTP), which is located north-east of Helsinki and have the common preliminary treatment, primary treatment, secondary treatment and sludge treatment of influent wastewater (4)**

In addition to the dewatered sewage sludge there was collected an equivalent amount of soil samples produced at Metsäpirtin multa (HSY). This soil consisted of composted sewage sludge from Viikinmäki WWTP and other soil elements. The composting step is according to HSY conducted by mixing sludge with turf and then composting it for a minimum of 6 months. After a bioprocess in the composting field the soil is mixed with two additives (sand and biotite powder). The treated soil is labeled as “lawn soil” and “garden soil”. In addition to turf and sewage sludge, horse manure is added to the “garden soil” before the composting stage.

### 3.5 Method for analyzing multiple steroids in solid matrices

The method used for analysis of steroidal compounds was developed by M. Kopperi (88) and the *solid particle analysis* consists of the following steps: Sampling, solid-liquid extraction, solid-phase extraction (reversed phase extraction and/or normal phase extraction), derivatization and analysis by GCxGC-TOFMS. An adapted method, similar to the already developed one, was applied in this project. The next paragraphs describe the new adapted method for analysis of solid matrices.



**Figure 13: Flow chart of the study, showing the procedure of the different extraction methods, the clean-up procedures and silylation in sequential order**

In figure 14 the method plan for this project is visualized and as it shows there are three different extraction methods evaluated in this project. The main objective of this experimental work was to compare these three extraction methods and evaluate their differences.

### 3.5.1 Solid-liquid extraction: Ultrasound-assisted extraction

#### 3.5.1.1 Ultrasound-assisted extraction

Solids collected from the wastewater treatment plant were dried before they were weighed with a Sartorius BP 301S (min 10mg, max 303g, std dev =0.1 mg), to approximately 50 mg, into test tubes containing 4 ml of acetonitrile and vortexed for 1 min. The test tubes were then immersed into a 5510 Branson ultrasound bath (29, 21cm x 24cm, 13cm x 15, 24cm) which applied sound waves (40 kHz) to the sound medium substance (tap water). The waves were generated with 135 W. After the extraction time in the bath most of the extraction solvent was pipetted to a new test tube. The remaining solids were washed again with acetonitrile (1-2 ml) and the tubes were centrifuged in a Centrifuge Mistral 1000 for 2 minutes at 3000 rpm to acquire the rest of the liquid. The two extracts were combined. Four different extraction times were tested; 30 min, 60 min, 90 min and 120 min.



### 3.5.1.2 Focused ultrasound-assisted extraction

The samples (50 mg) were placed in test tubes and taped to the inside of a 400 ml beaker, which was filled with tap water (250 ml). The extraction solvent was 4 ml of acetonitrile. The ultrasound probe was a Branson Sonifier® 250 (Emerson Automation Ferguson, United States) and produced sound waves with 20 kHz frequency with an output power of 200 W. The duty cycle was 0.8/1 seconds, and the test tubes were 2-3 cm from the macro tip (Standard Disruptor Horn). Samples were sonicated with this device for 15 min, 30 min, 45 min and 60 min.

### 3.5.2 Solid-liquid extraction: Pressurized hot water extraction

The PHWE was carried out in a GC-oven (Hewlet Packard 5890A) in an extraction cell dimensions made of stainless steel and equipped with a with a ceramic filter at the inlet of the cell. The distilled water was pumped through the extraction cell with a pump (JASCO PU-980 Intelligent HPLC Pump) operating with the flow rate 1 ml min<sup>-1</sup>. The schematic for the whole instrument is presented in section 2.3.2 in figure 7. The packing of the sample, as shown in figure 15, was done with acid treated and calcined sand from Riedel-de Haën, Germany.

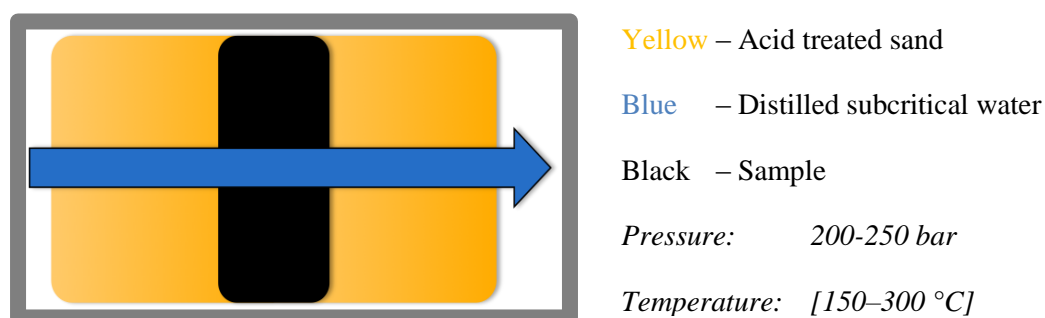

**Figure 14: Packing procedure of the extraction cell where the acid treated sand prevents clogging of the outlet when the sub-critical water is led through the cell**

The samples were weighed manually to about 50 mg. The pressure in these extractions was at 200-250 bars, which was controlled with a manual pressure regulator. The temperatures for each extraction was 150 °C, 175 °C, 200 °C, 225 °C, 250 °C, 275 °C and 300 °C, respectively, and the time was kept constant at 30 minutes for all sample extractions, leaving a sample volume of 30 ml.

### 3.5.3 Solid phase extraction with reversed phase

The extracts from the pressurized hot water extraction had to change solvent to be analyzed in the GCxGC-TOFMS. The extracts were therefore cleaned with a solid phase extraction with reverse phase. Solid phase extraction (SPE) was done with polymeric reversed phase Phenomenex (U.S.A.) Strata-x (500 mg/6 mL) cartridges. They were activated with methanol and conditioned with ultrapure water (Direct-Q® Ultrapure Water System, Merck Millipore, United States) before the liquid sample (30 ml) carefully was percolated

through the cartridge. The manifold that was used for the elution was a Manifold vacuum Pump (max 20 torr, Sweden). The same type of methanol was used for the elution (5 ml) as for the activation. The samples were then collected in test tubes, evaporated to dryness and prepared for the normal phase extraction.

#### **3.5.4 Solid phase extraction with normal phase**

Extracts from all extraction methods were prepared by solid phase extraction with normal phase. The Agilent Bond Elute Florisil cartridges (100 mg, 1 mL) were activated with a hexane/dichloromethane (DCM) (3:1, V:V) solution and conditioned with pure hexane. The samples were loaded onto the cartridges with the solution hexane/DCM (3:1, V:V) and the elution was done carefully with a DCM/acetone (4 ml, 15:85, V:V) mixture. The samples were then ready for evaporation and silylation.

#### **3.5.5 Derivatization method - Silylation**

Samples were prepared, one set at a time (max 8 vials), for the GCxGC-TOFMS analysis. The evaporation was done using a N<sub>2</sub>-assisted Reacti-vap (I #TS-18825) with AGA pressure relief until about 100 µl. The samples were then transferred to a GC-vial (250 µL) and evaporated completely after washing the test tubes with DCM/acetone (95:5, V:V). 10 µL of N,O-bis(trimethyl) trifluoroacetamide (BSTFA) with 1 % trimethylchlorosilane (TMCS) and 2 µL of pyridine were added to the vials and the vials were set to heating (60-65 °C) for 30 minutes. An internal standard 1,1'-Binaphthalene (38 µl, 1 µg/mL) was added after the heating process and the vials were ready for GCxGC injection.

#### **3.5.6 Setup used in analysis with GCxGC-TOFMS**

The gas chromatographic analysis was performed with a LECO Pegasus 4D GCxGC-TOFMS system with a gas chromatograph (7890A) and an autosampler (7683B) from Agilent Technologies (Santa Clara, CA, USA). The first column was a non-polar column (BGB-5MS, 30 m × 0.25 mm i.d., film thickness 0.25 µm; BGB-Analytik AG Boeckten, Switzerland) and was connected via a press-fit to a semi-polar second column (DB-17, 1 m × 0.1 mm i.d., film thickness 0.10 µm; Agilent Technologies, Santa Clara, CA, USA). The entrance to the first column was connected to a 2.5 m × 0.53 mm i.d. deactivated retention cap (Agilent Technologies, Santa Clara, CA, USA). The carrier gas was helium (Oy Aga Ab, Espoo, Finland, purity 99,996 %) and was in constant flow mode, 1,3 ml/min, with head pressure at 170 kPa and temperature at 60 °C. The GC oven for column 1 was programmed as follows: 30°C (1 min) then 10 °C min<sup>-1</sup> to 250 °C and finally 5 °C min<sup>-1</sup> to 285 °C (6 minutes). The whole program was in total 36 minutes. The GC-to-MS transfer line and ion source were held at 290 °C and 200 °C, respectively. The electron ionization energy was set to -70 eV.

#### **3.5.7 Injection method**

The samples were introduced to the GCxGC with a volume of 1µL by splitless injection and they were injected three times from each vial. Each bulk of the three successive injections was followed by an injection with only DCM which represented the zero-samples. Any compounds that had carryovers into the zero-samples were ignored.

### 3.5.8 Data processing

The data processing was carried out by a method described by (88). The ChromaTOF software processed the data, comparing the peaks to the NIST2005 database and it assigned retention indices on the basis of previously analyzed alkane series. Guineu metabolomic data analysis software was then used to align peak areas of successive injections. Compounds were further identified by comparison of retention indices and the mass spectra of Golm database. The data were manually checked with removal of compounds with mass spectra that had similarity values below 700. The last manual check was of the two retention times compared to the steroid calibration standards.

### 3.5.9 Internal standard and relative peak area

All the peak areas were divided by the peak area of the internal standard that was added and found in each sample. The new calculated area is referred to as the relative peak area. The internal standard is 1,1'-binaphthalene and has a structure similar to steroids as shown in figure 5.

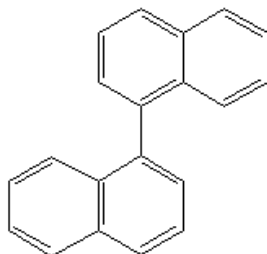
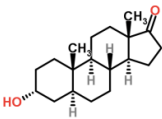
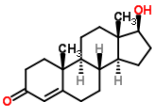
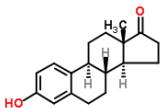
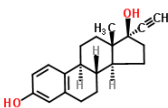
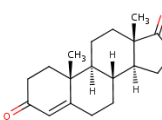
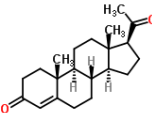
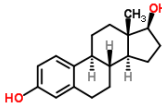
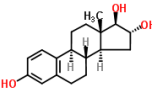

**Figure 15: Structure of the internal standard 1,1'-binaphthalene which is similar to the steroid structure**

### 3.6 Steroid standards

A mixture of the steroids was used in optimizing the liners and the normal phase extraction. The mixture was also used for calibration curves. The compounds in the mixture are listed in table 5.

**Table 4: Steroid components and their structures in the steroid mixture, containing a wide range of steroids. The mixture contains androsterone, testosterone, estrone, ethinyl estradiol, androstenedione, progesterone, estradiol and estriol**

Steroid name	Steroid structure	Steroid name	Steroid structure
Androsterone		Testosterone	
Estrone		Ethinyl Estradiol	
Androstenedione		Progesterone	
Estradiol		Estriol	

### 3.7 Calibration curves

To create calibration curves for quantitation, blank samples were spiked with 0.1 µg/ml, 0.5 µg/ml, 1 µg/ml, 5 µg/ml and 10 µg/ml and injected twice into the GCxGC-TOFMS. They were used in a five-point calibration for quantitation of four marker compounds. The calibration curves are shown in figure 16.

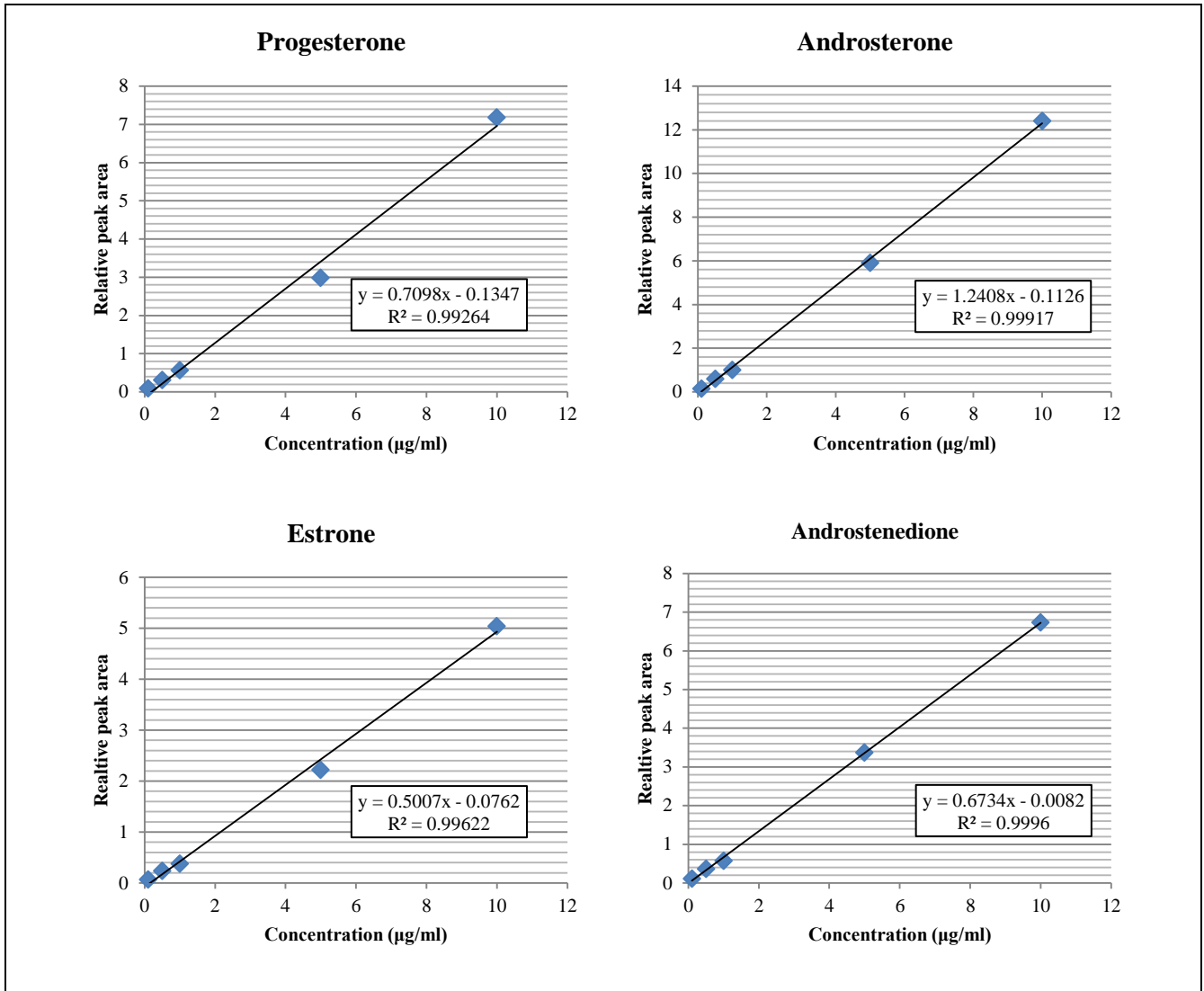

Figure 16: Calibration curves for quantitation of four marker steroids progesterone, androsterone, estrone and androstenedione

### **3.8 Non-target analysis – Identification of steroid species in sludge and soil samples**

For the non-target analysis the data processing was done as described in section 3.5.8 in the experimental part. After aligning the peaks a manual removal of peaks with similarity values below 700 was done as well as removal of compounds found in the zero samples. Subsequently, a manual search in the dataset was done for estrogens, androgens, progestogens and cholestanes and the number of each of the mentioned species were counted in the sludge, garden and lawn samples.

## 4 RESULTS

### 4.1 Speedisk evaluation

The solid-phase extraction used in the already developed method consists of extracting steroids from both solids and liquid samples in two different procedures. Speedisk (Bakerbond Speedisk® Octadecyl C-18, 6 ml/200 mg) was tested to investigate the possibilities to apply this as a whole water analysis in one extraction step. The cartridges were tested with 300 ml 600 ml and 900 ml of effluent samples to test its volume capacity. The cartridges were unsuitable for this whole water analysis as they were clogged after loading 250 mL of the sample.

### 4.2 Florisil method optimization

The solid-phase extraction using Florisil cartridges was evaluated regarding its eluent. A mixture of acetone and dichloromethane (5:95) was used as eluent in the already developed method by M. Kopperi (88). The ratio of acetone was increased in an attempt to increase the recovery of steroids, while keeping the sample clean enough, avoiding fatty acids and other interfering lipophilic compounds. The result of recovered steroids is shown in figure 17, and all the samples were spiked with 5 µg/ml of the steroid mixture.

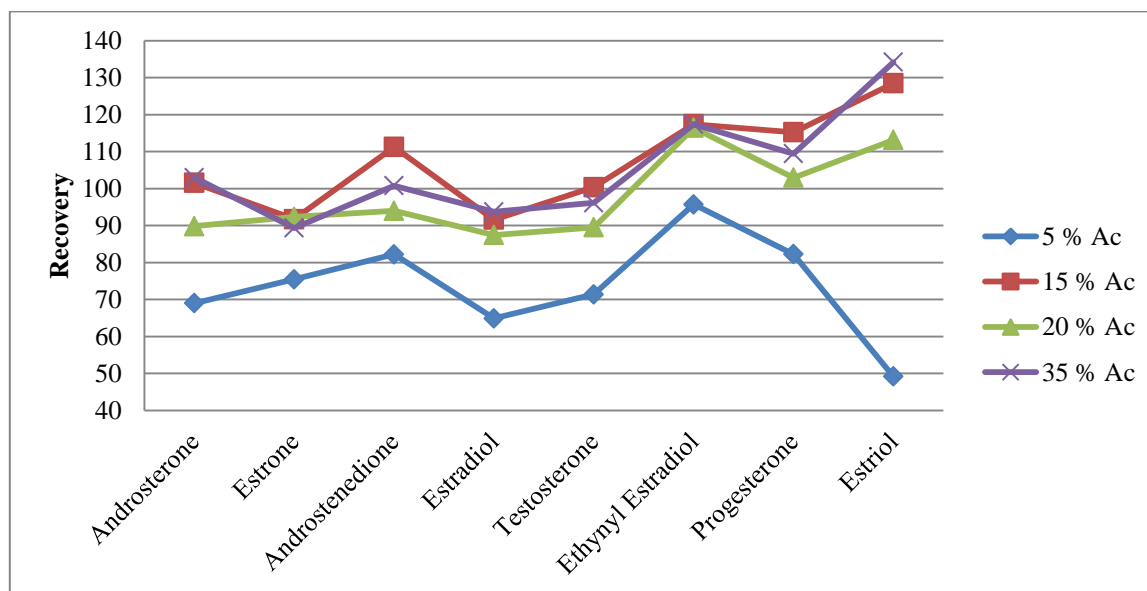

**Figure 17: Florisil optimization, where the recovery is the relative peak area found from the spiked samples divided by the relative peak area from an analysis of the steroid mixture directly with no preparation**

### 4.3 Injection port liner optimization

An instrumental optimization was also done, and the object of investigation was the injection port liner. Five different liner features were tested keeping all other parameters constant. Concentrations used of the steroid mixture were 0.5 µg/ml, 2 µg/ml and 5 µg/ml. The liners that were tested were the current liner (Agilent Liner, splitless, single taper, glass wool, deactivated, 5183-4693), and a new liner (Agilent Ultra Inert Liner, splitless, single taper, glass wool, 5190-2293). The different states of the liners were as follows:

1. Normal liner with the current glass wool available at the laboratory
  - Current glass wool: Silane treated from Supelco
2. Normal liner without glass wool
3. Ultra inert liner with the accompanying glass wool from Agilent
4. Ultra inert liner without glass wool

The results are summed up in figure 18. The values are a sum of all the responses of the compounds in the steroid mixture (table 4) measured in relative peak area. The individual response of each steroid is the average of three injections and the error bars are the sum from each individual steroid standard deviation.

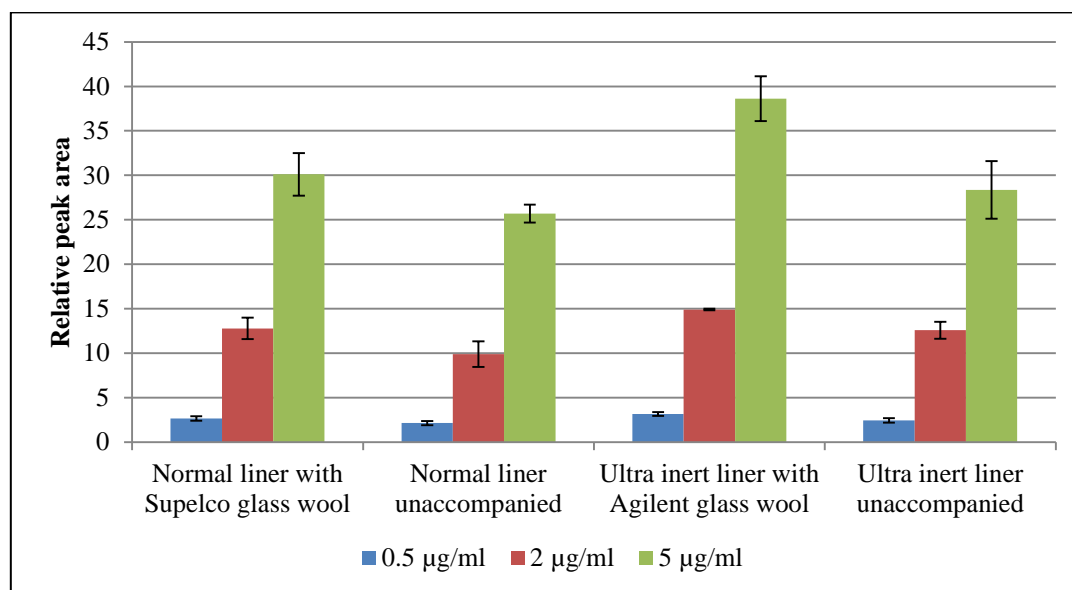

**Figure 18: Shows the results from injection port liner optimization. Showing the sum of the relative peak areas of the steroid mixture and error bars are from the standard deviation from three injections**

The sum of the averages and the sum of the standard deviations for figure 18 are listed in the appendix in table A5. The individual measurement for each compound in the steroid mixture, which include an average of three successive injections measured in relative peak area together with standard deviations and relative standard deviations, are listed in table 6-9 in the appendix. The individual variation for each steroid compound is also listed in figure A1 and A2 in the appendix.



A paired t-test was done to check if the sum of the response of the steroid mixture differed for two different liner features. The values are taken from table A12, and the results are shown in figure 19. The features that were tested were as follows:

1. Normal liner with the current glass wool available at the laboratory (silane treated glass wool from Supelco)
2. Ultra inert liner with the accompanying glass wool from Agilent after 3 weeks of usage

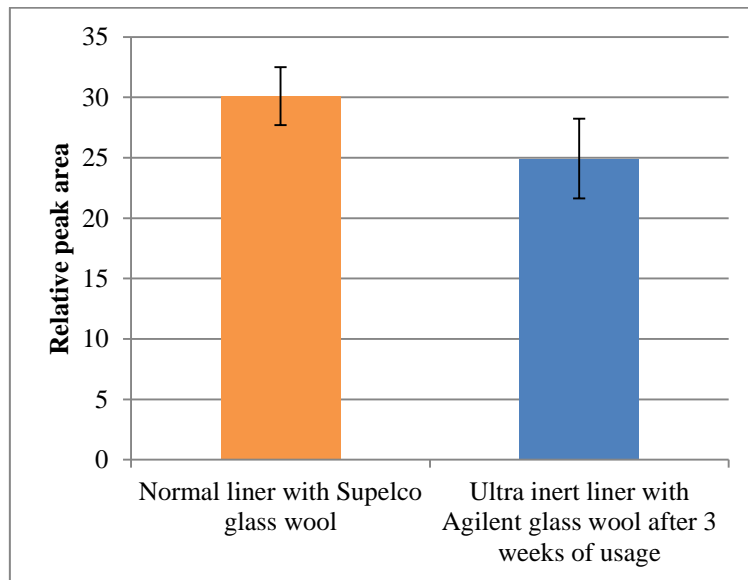

**Figure 19: Injector port liner comparison between the normal liner and ultra inert liner after 3 weeks of usage. Described by the sum of the relative peak areas of the steroid mixture and error bars are from the standard deviation from the three injections.**

This test was done only with the 5 µg/ml concentrations and the observed p-value was 0,14 which is bigger than 0.05. Since  $p_{\text{observed}}$  is bigger than  $p_{\text{critical}}$  there is no significant difference between the means of the two features at a 95, 0% confidence level.

## 4.4 Solid extraction evaluation - A comparison of three methods

### 4.4.1 Ultrasound-assisted extraction

The values in figure 20 are average relative peak areas of three injections, and the samples were done in parallel. The extraction times tested were 30, 60, 90 and 120 minutes.

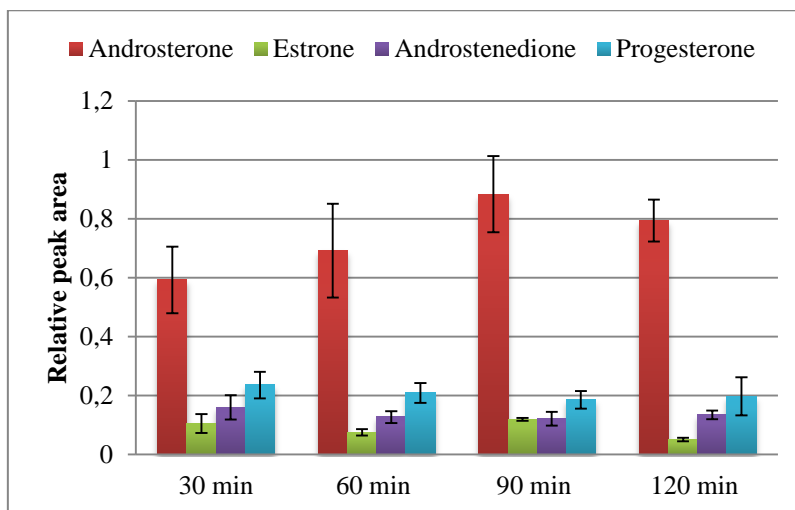

**Figure 20: Relative peak areas of selected steroids androsterone, androstenedione, estrone and progesterone from dried sewage sludge after ultrasound-assisted extraction (UAE)**

### 4.4.2 Focused ultrasound-assisted extraction

The results that are shown in figure 21 are average relative peak areas of three injections and the samples were done in parallel. The extraction times tested were 30, 60, 90 and 120 minutes.

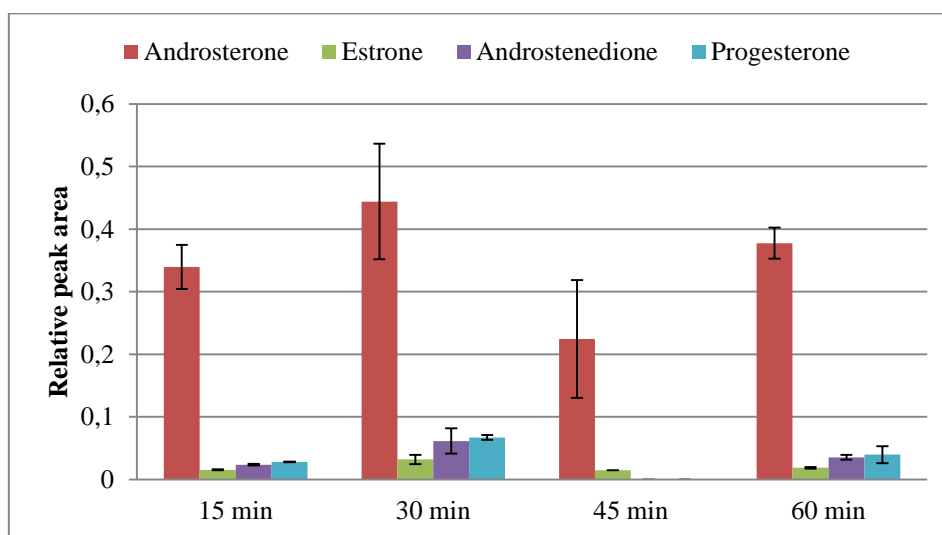

**Figure 21: Relative peak areas of selected steroids androsterone, androstenedione, estrone and progesterone from dried sewage sludge after focused ultrasound-assisted extraction (FUAE)**

#### 4.4.3 Pressurized hot water extraction

The values that are shown in figure 22 are the averages from three injections measured in relative peak areas. The extraction temperatures were 150, 200, 225, 250, 275 and 300 °C.

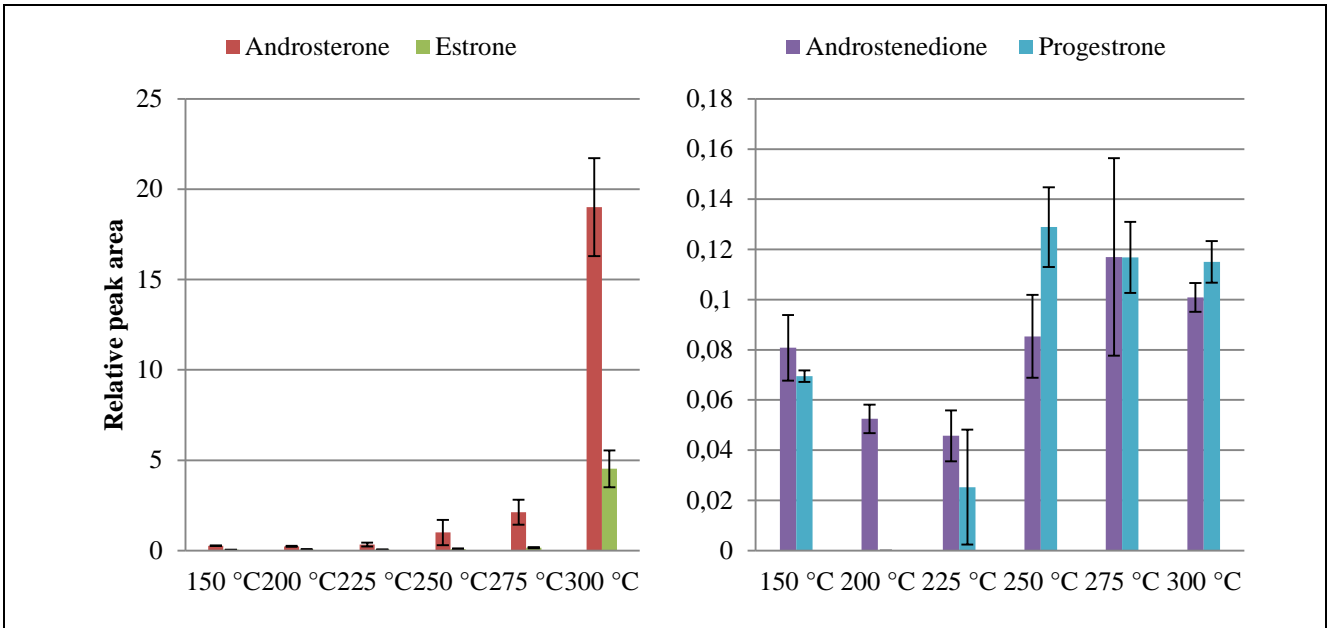

**Figure 22: Relative peak areas of selected androsterone, androstenedione, estrone and progesterone from dried sewage sludge after pressurized hot water extraction (PHWE)**

#### 4.4.4 Comparison of the three extraction methods – UAE, FUAE and PHWE

The three different extraction methods are compared in figure 23, and the reference is also shown (vortexing). The reference sample was 50 mg of dried sewage sludge and it was simply vortexed in 4 ml acetonitrile for 3 minutes and then analyzed.

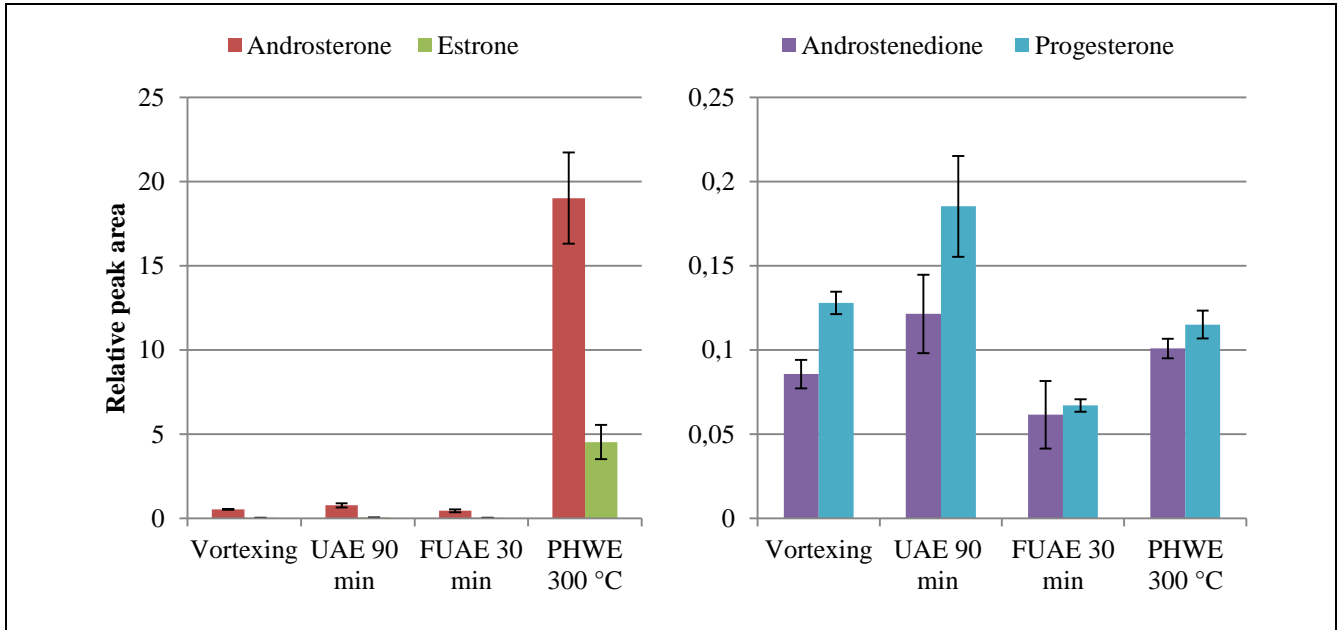

**Figure 23: Comparisons of the three extraction methods at the most efficient extraction times and temperature, which was 90 minutes for the ultrasound-assisted extraction, 30 minutes for the focused ultrasound assisted extraction and at 300 °C for the pressurized hot water extraction (cfr, figures 21-23)**

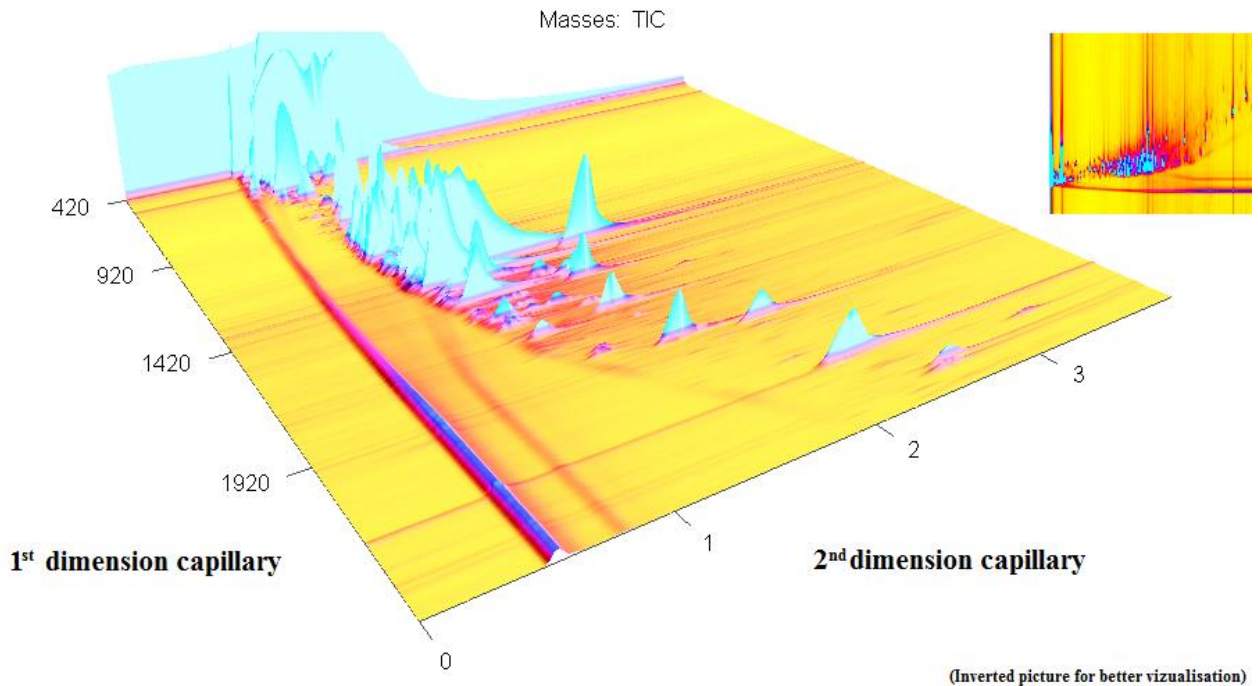

**Figure 24: Total ion chromatogram from analysis with comprehensive gas chromatography coupled to time-of-flight mass spectrometer of the extract from 250 °C pressurized hot water extraction**

## 4.5 Environmental sample analysis

The commercially available soil samples “garden soil” and “lawn soil” were analyzed using ultrasound-assisted extraction for 30 minutes. The four marker compounds progesterone, androsterone, estrone and androstenedione were quantified in these samples using calibration curves shown in figure 16. In addition to concentration analysis, the number of different identifiable steroidal species present in the sample was also determined. The results are shown in table 6 and the concentration is given in micrograms of steroids in grams of soil.

**Table 5: Concentrations ( $\mu\text{g/g}$ ) and their variations of target steroids androsterone, estrone, androstenedione and progesterone in the dried sludge and soil products**

Compound name	Sewage sludge ( $\mu\text{g/g}$ )		Garden soil ( $\mu\text{g/g}$ )		Lawn soil ( $\mu\text{g/g}$ )	
	Average	Standard deviation	Average	Standard deviation	Average	Standard deviation
<b>Androsterone</b>	69.4	-	2.0	1.3	-	-
<b>Estrone</b>	11.9	-	-	-	3.7	1.3
<b>Androstenedione</b>	3.0	-	-	-	-	-
<b>Progesterone</b>	13.6	-	-	-	-	-

The environmental samples were analyzed as described in section 3.8, and the non-target analysis of the number of steroid species found in the sewage sludge, garden and soil samples are listed in table 7.

**Table 6: Number of different steroidal species found in the non-target analysis of the sludge, garden and lawn samples**

Steroid species	Dried sludge	Garden soil	Lawn soil
<b>Androgens</b>	5	2	1
<b>Estrogens</b>	1	-	1
<b>Progestogens</b>	6	1	2
<b>Cholestanes</b>	7	9	12

## 5 DISCUSSION

---

### 5.1.1.1 Speedisk evaluation

The Speedisk-series from J.T Baker offers an extraction disk with a larger filtration area (92) compared to the extraction column that was used in this evaluation. These disks are larger in diameter and they are intended for bigger sample volumes and for water samples that may contain particles. The disks have a 5 cm diameter in comparison to the 1 cm wide columns used in this project, increasing the filtration area by a factor of 25. The bigger disks, however, are about 50 % more expensive than the Speedisk columns. The Speedisk investigation suggested that wider cartridges should be used for these kinds of samples and volumes. The cartridges tested were clogged after loading 250 mL of the sample and they were not considered suitable for this whole water analysis, where larger sample volumes (1 L) are sampled.

Another possibility to decrease clean-up time could be the introduction of MIPs. These sorbents can be specially made for steroids and significantly decrease sample preparation time. These have been shown to be very specific, relatively low-priced and reusable.

### 5.1.1.2 Florisil extraction optimization

The eluent mixture consisting of dichloromethane and acetone was proven more efficient in steroid recoveries at higher concentrations of acetone. However the increase of acetone concentration also elutes more dirty extracts, which is undesirable when it comes to analysis with GCxGC-TOFMS. The acetone concentration increase from 5 % to 15 % suggests a higher recovery of steroids while not having too dirty extracts eluting from the cartridges. The increase of acetone concentration beyond 15 % yields just a slightly better recovery and much dirtier extracts. The results suggest that for further improvement of the eluent the interval between 5-15 % of acetone in the mixture should be investigated. Ethyl acetate is commonly used according to the literature as normal phase SPE solvent for sewage sludge samples. It could increase the recovery of more hydrophobic steroids. However the acetone have suitable elution properties towards steroids and there seems to be little to improve from changing the elution mixture. For reversed phase, the SPE cartridges Oasis HLB are commonly used in sludge analysis and in this part of the clean-up there could be potential for improvement.

### 5.1.1.3 Injector liner optimization

The liner optimization suggests that ultra-inert liners offers better sensitivity in general considering the sum of average peak areas for all of the steroids in the standard mixture. It seems that glass wool has a positive effect on the sensitivity since it increases the signal for both the normal and the ultra-inert liner for the concentrations 2 and 5 µg/ml.

Testing the response of an ultra-inert liner with Agilent glass wool after 3 weeks of usage against the normal liner with available glass wool does not show a significant difference. This means that even though it looks like the normal liner feature have overall higher response than the ultra-inert liner there is no statistical assurance for it. However, the sensitivity of the ultra-inert liner quickly decays after 3 weeks of usage and further investigations regarding durability of the ultra-inert liners is recommended. Further improvement of the durability of the inertness of liners in would be to test the SilcoTek® (93) deactivation.

### 5.1.1.4 Solids extraction evaluation

The extraction technique that seemed most efficient was the pressurized hot water extraction, with relative peak area about 20 times higher for androsterone and about 4 times higher for estrone. An explanation for these high amounts could be that the PHWE breaks up steroid conjugates and also penetrates the matrix more efficiently. However the conjugates, mostly sulphate conjugates, have a high solubility in water and a considerable amount of these conjugates will rather be in aqueous solvent and not adsorbed on the surface of the sludge and suspended particles that are the nature of these samples. Chemical conversion, via high temperature and pressure, from one steroid to another could be an explanation for the increased values of estrone and androsterone. None of the target steroids analyzed decreased as much as androsterone and estrone increased at the different temperatures. There could be other steroid species converting into either estrone or androsterone but it is probably not any of the other target steroids analyzed here (androstenedione, progesterone). As one can see from table 7 there are a number of cholestanes, progestogens and androgens in the sewage sludge that might have a conversion effect. The estrone increase can be explained by the possible aromatization, which can occur, as discussed in section 2.3.2, under the conditions in PHWE and is favored because of the stable structure that the aromatic ring provides. There is also a small possibility that the extraction efficiency is substantially better compared to the other methods, and that more species of androsterone and especially estrone are actually present in the sludge samples. This could have a serious impact on the validity of other extraction methods previously used in sludge extraction, especially are the standard methods UAE and FUAЕ vulnerable. The next step in evaluating these high relative peak areas is to acquire reference material of steroids in soil, or isotope labeled references, and check the recovery and how the behavior changes. These kinds of reference materials are scarce and expensive, especially the isotope labeled ones. In addition to this, the spiking is an issue, as the integration of steroids in the sewage sludge matrix is difficult to imitate. The extract of PHWE is in water and needs a solvent change to methanol through reverse phase SPE. There is a possibility with PHWE to use methanol directly as the extraction solvent instead

of water, which might present an ability to reduce clean-up steps using PHWE going directly to normal-phase SPE, see figure 14, as one can do for the two other extraction methods.

When sample throughput is considered, the ultrasound-assisted extraction bath would be the method of choice due to its capability to extract numerous samples (60 pcs) simultaneously, whereas PHWE only could extract from one sample at a time with dynamic mode set-up. Static mode in PHWE would increase the sample throughput as you can stack up to 20-40 extraction cells in the oven. The dynamic mode is however the preferred extraction as it offers, according to the literature, better extraction efficiencies. The number of extracts in dynamic mode in PHWE could be increased with further modification to the instrument, although it would probably not reach the 60-sample capability of the UAE. The FUAE was poor in both sample throughput and extraction ability, even though the method has worked satisfactory in terms of extraction abilities in other studies.

The relative standard deviations of the extracts were for PHWE at 300 °C 14-22 %, for UAE 90 minute extraction 9-19 % and for FUAE 60 minute extraction 7-34 %. The natural variation of the reference sample was 4-10 %. From these values UAE have the lowest variation. This makes the UAE stand out in terms of repeatability and would be the choice for a validation study. PHWE has acceptable variations but needs more evaluation when it comes to possible alteration of analytes. The FUAE have the biggest variation and need further evaluation to be applied to sewage sludge matrices. The natural variations of the vortexed reference are relatively low. This shows that the extraction method is an important source of variation when evaluating the whole method. More measurements are needed to ensure the quality of this data.

### 5.1.1.5 Environmental sample analysis

Several steroidal compounds were found in the sewage sludge and also in the soil samples. The concentration levels of the garden and lawn samples were reduced 70-100% during the composting process. Even though measures to prevent biodegradation of estrogens when stored (freeze drying, autoclaving or addition of formaldehyde) were not used in this study, still  $\mu\text{g/g}$  - concentrations remained in the soil samples. These concentrations are high considering predicted no-effect concentrations (PNEC) for estrogens in soil has been estimated to be in the range of 0.001 - 0.002  $\mu\text{g/g}$ . The values found for estrogen in this study are between 2.4 and - 5.0  $\mu\text{g/g}$  which are 3 orders of magnitude above the PNEC value. This soil is commercially available and is being used in Helsinki. This soil acts as a potential source of natural sex hormone discharge into the environment. Even though calculation of with these values is based on the effect of concentrations in water and the  $\text{PNEC}_{\text{soil}}$  is just an adjusted value determined by the partitioning constant found in the literature, these values are very high. More work is needed to verify these data, at the present dataset consists of 2 parallels with 2 injections. The data found here also suggests that large parts of the steroids coming from different sources to the WWTP ends up in the sludge, due to their water-octanol partitioning coefficient  $K_{ow}$ , partitioning coefficient in sludge  $K_{\text{sludge}}$  and their low water solubilities. This high concentration could be generated from released free steroids coming from bacterial degradation of conjugates in the WWTP at both



sludge stabilization and secondary treatment, even though the already applied biodegradation efficiently removes a significant part of free estrogens. Several new removal techniques such as chemical removal, chlorination, ozonation and ultraviolet irradiation have been reported effective on removal of estrogens. These methods should be adapted to remove hormone active compounds from sludge as well and not just from the aqueous phases. There is a chance that conjugate steroids are present also in these sludge samples and the next step in relation to GCxGC-TOFMS measurement of conjugates would be acidic hydrolysis or enzyme-based hydrolysis to check whether there are conjugates present in the sludge samples. Another way to check for conjugates is to apply LC-MS/MS as the analytical method. As pointed out in section 2.7.2 the analyte range is substantially wider with this method. The LC-system might simultaneously analyze conjugates and free steroids in the same run and be more compatible with fully automated SPE solutions, which is crucial in terms of analysis time and further the monitoring possibilities for wastewater and sewage sludge.

The trend for using MIPs is more compatible with LC-systems than GC-systems. For GC the derivatization is a complicating drawback and is also time consuming. The challenge with a LC analysis would be the lower resolution and possible matrix-effects. Several measures can be taken to meet the resolution demands, and those discussed earlier here are UHPLC or HT-HPLC. These methods could meet the efficiency demands as their particle size is smaller and therefore the resolution is significantly better than with normal HPLC. They also offer the same analysis time as HPLC. Another, so far untested, option would be the use of SFC, which can in principle achieve higher resolution than HPLC and UPLC.

## 5.2 Conclusion

The Speedisk columns were not applicable for whole water analysis due to amount of suspended solids in the sample and the volume required. The normal phase extraction eluent for the Florisil solid-phase extraction was optimized to have 15 % acetone content rather than the 5 % content in the original paper (88). The most effective extraction method was the PHWE with over 20 times higher relative peak values for androsterone and 4 times higher for estrone as compared to the other extraction methods. There remains some open questions with respect to the origins of the surprisingly much higher levels of these steroids compared to the other steroids analysed here, and not at all increasing extraction yields are increasing equivalently. The most reliable, flexible and time efficient extraction method was, however, the UAE bath. Quantification was done for estrone and androsterone in commercialized soil improvement products for lawn and garden, respectively. The quantities are considered to be in the range of 2.4-5 µg/g for estrone and 0.7-3.3 µg/g for androsterone.

## 6 REFERENCES

---

1. Grant, P. (2008). Coumarin Anticoagulants and Endocrine Interactions. *Coumarin Anticoagulant Research Progress*, 11.
2. Kasperk, C. H., Wergedal, J. E., Farley, J. R., Linkhart, T. A., Turner, R. T., & Baylink. (1989). Androgens directly stimulate proliferation of bone cells in vitro. *Endocrinology*, 124(3), 1576-1578.
3. Hartgens, F., & Kuipers, H. (2004). Effects of androgenic-anabolic steroids in athletes. *Sports Medicine*, 34(8), 513-554.
4. Pelley, J. (2003). Estrogen knocks out fish in whole-lake experiment. *Environmental science & technology*, 37(17), 313A-314A.
5. Jobling, S., Williams, R., Johnson, A., Taylor, A., Gross-Sorokin, M., Nolan, M., Tyler, C R., Aerle, R., Santos, E. & Brighty, G. (2005). Predicted exposures to steroid estrogens in UK rivers correlate with widespread sexual disruption in wild fish populations.
6. Modugno, F., Weissfeld, J. L., Trump, D. L., Zmuda, J. M., Shea, P., Cauley, J. A., & Ferrell, R. E. (2001). Allelic variants of aromatase and the androgen and estrogen receptors toward a multigenic model of prostate cancer risk. *Clinical Cancer Research*, 7(10), 3092-3096.
7. Benotti, M. J., Trenholm, R. A., Vanderford, B. J., Holady, J. C., Stanford, B. D., & Snyder, S. A. (2008). Pharmaceuticals and endocrine disrupting compounds in US drinking water. *Environmental Science & Technology*, 43(3), 597-603.
8. Preziosi, P. (1998). Endocrine disrupters as environmental signallers: an introduction. *Pure Appl. Chem*, 70(9), 1617-1631.
9. Liebig, M., Egeler, P., Oehlmann, J., & Knacker, T. (2005). Bioaccumulation of 14 C-17 $\alpha$ -ethinylestradiol by the aquatic oligochaete *Lumbriculus variegatus* in spiked artificial sediment. *Chemosphere*, 59(2), 271-280.
10. The National Institute of Environmental Health Sciences  
  
<http://www.niehs.nih.gov/health/topics/agents/endocrine/>  
  
Uploaded: 23.06.2015 12:17
11. Routledge, E. J., & Sumpter, J. P. (1996). Estrogenic activity of surfactants and some of their degradation products assessed using a recombinant yeast screen. *Environmental toxicology and chemistry*, 15(3), 241-248.
12. Thomas, K. V., Hurst, M. R., Matthiessen, P., McHugh, M., Smith, A., & Waldock, M. J. (2002). An assessment of in vitro androgenic activity and the identification of environmental androgens in United Kingdom estuaries. *Environmental Toxicology and Chemistry*, 21(7), 1456-1461.

## References

13. Falconer, I. R., Chapman, H. F., Moore, M. R., & Ranmuthugala, G. (2006). Endocrine-disrupting compounds: a review of their challenge to sustainable and safe water supply and water reuse. *Environmental toxicology*, 21(2), 181-191.
14. Irwin, J. J., Sterling, T., Mysinger, M. M., Bolstad, E. S., & Coleman, R. G. (2012). ZINC: a free tool to discover chemistry for biology. *Journal of chemical information and modeling*, 52(7), 1757-1768.
15. Wishart, D. S., Jewison T., Guo A C., Wilson M., Knox C., Liu Y., Djoumbou Y., Mandal R., Aziat F., Dong E., Bouatra S., Sinelnikov I., Arndt D., Xia J., Liu P., Yallou F., Bjorn Dahl T., Perez-Pineiro R., Eisner R., Allen F., Neveu V., Greiner R. & Scalbert A. (2012). HMDB 3.0—the human metabolome database in 2013. *Nucleic acids research*, gks1065.
16. Conroy, O., Sáez, A. E., Quanrud, D., Ela, W., & Arnold, R. G. (2007). Changes in estrogen/anti-estrogen activities in ponded secondary effluent. *Science of the total environment*, 382(2), 311-323.
17. EC, 2006. Regulatory framework for the management of chemicals (REACH) EUR 1907. European Chemicals Agency.
18. Basile, T., Petrella, A., Petrella, M., Boghetich, G., Petruzzelli, V., Colasuonno, S., & Petruzzelli, D. (2011). Review of endocrine-disrupting-compound removal technologies in water and wastewater treatment plants: an EU perspective. *Industrial & Engineering Chemistry Research*, 50(14), 8389-8401.
19. Loosa, R., Carvalho, R., António, D C., Comeroa, S., Locoroa, G., Tavazzi, S., Paracchini, B., Ghiani, M., Lettieri, T., Blahab, L., Jarosova, B., Voorspoels, S., Servaes, K., Haglund, P., Fick, J., Lindberg RH., Schwesig, D. & Gawlika, B M. (2013). EU-wide monitoring survey on emerging polar organic contaminants in wastewater treatment plant effluents. *Water research*, 47(17), 6475-6487.
20. Luo, Y., Guo, W., Ngo, H. H., Nghiem, L. D., Hai, F. I., Zhang, J., Liang, S. & Wang, X. C. (2014). A review on the occurrence of micropollutants in the aquatic environment and their fate and removal during wastewater treatment. *Science of the Total Environment*, 473, 619-641.
21. Kozłowska-Tylingo, K., Namieśnik, J., & Górecki, T. (2010). Determination of estrogenic endocrine disruptors in environmental samples—a review of chromatographic methods. *Critical Reviews in Analytical Chemistry*, 40(3), 194-201.
22. Hamid, H., & Eskicioglu, C. (2012). Fate of estrogenic hormones in wastewater and sludge treatment: A review of properties and analytical detection techniques in sludge matrix. *Water Research*, 46(18), 5813-5833.
23. Lundgren, M. S., & Novak, P. J. (2009). Quantification of phytoestrogens in industrial waste streams. *Environmental Toxicology and Chemistry*, 28(11), 2318-2323.
24. Kolodziej, E. P., Harter, T., & Sedlak, D. L. (2004). Dairy wastewater, aquaculture, and spawning fish as sources of steroid hormones in the aquatic environment. *Environmental science & technology*, 38(23), 6377-6384.
25. Johnson, A. C., Williams, R. J., & Matthiessen, P. (2006). The potential steroid hormone contribution of farm animals to freshwaters, the United Kingdom as a case study. *Science of the Total Environment*, 362(1), 166-178.

## References

26. Nakada, N., Nyunoya, H., Nakamura, M., Hara, A., Iguchi, T., & Takada, H. (2004). Identification of estrogenic compounds in wastewater effluent. *Environmental Toxicology and Chemistry*, 23(12), 2807-2815.
27. Nelson, J., Bishay, F., Van Roodselaar, A., Ikonomou, M., & Law, F. C. (2007). The use of in vitro bioassays to quantify endocrine disrupting chemicals in municipal wastewater treatment plant effluents. *Science of the Total Environment*, 374(1), 80-90.
28. Racz, L., & Goel, R. K. (2010). Fate and removal of estrogens in municipal wastewater. *Journal of Environmental Monitoring*, 12(1), 58-70.
29. Desbrow, C. E. J. R., Routledge, E. J., Brighty, G. C., Sumpter, J. P., & Waldock, M. (1998). Identification of estrogenic chemicals in STW effluent. 1. Chemical fractionation and in vitro biological screening. *Environmental Science & Technology*, 32(11), 1549-1558.
30. Tanaka, H., Yakou, Y., Takahashi, A., Higashitani, T., & Komori, K. (2001). Comparison between estrogenicities estimated from DNA recombinant yeast assay and from chemical analyses of endocrine disruptors during sewage treatment. *Water Science & Technology*, 43(2), 125-132.
31. D'ascenzo, G., Di Corcia, A., Gentili, A., Mancini, R., Mastropasqua, R., Nazzari, M., & Samperi, R. (2003). Fate of natural estrogen conjugates in municipal sewage transport and treatment facilities. *Science of the Total Environment*, 302(1), 199-209.
32. Kimura, A., Taguchi, M., Ohtani, Y., Shimada, Y., Hiratsuka, H., & Kojima, T. (2007). Treatment of wastewater having estrogen activity by ionizing radiation. *Radiation Physics and Chemistry*, 76(4), 699-706.
33. Ying, G. G., Kookana, R. S., & Ru, Y. J. (2002). Occurrence and fate of hormone steroids in the environment. *Environment international*, 28(6), 545-551.
34. FAO. 2012. The State of World Fisheries and Aquaculture 2012. Rome. 209 pp, 29
35. Clara, M., Strenn, B., Saracevic, E., & Kreuzinger, N. (2004). Adsorption of bisphenol-A, 17 $\beta$ -estradiol and 17 $\alpha$ -ethinylestradiol to sewage sludge. *Chemosphere*, 56(9), 843-851.
36. Ren, Y. X., Nakano, K., Nomura, M., Chiba, N., & Nishimura, O. (2007). A thermodynamic analysis on adsorption of estrogens in activated sludge process. *Water research*, 41(11), 2341-2348.
37. Xu, K., Harper, W. F., & Zhao, D. (2008). 17 $\alpha$ -Ethinylestradiol sorption to activated sludge biomass: thermodynamic properties and reaction mechanisms. *Water research*, 42(12), 3146-3152.
38. Khanal, S. K., Xie, B., Thompson, M. L., Sung, S., Ong, S. K., & Van Leeuwen, J. (2006). Fate, transport, and biodegradation of natural estrogens in the environment and engineered systems. *Environmental science & technology*, 40(21), 6537-6546.
39. Teske, S. S., & Arnold, R. G. (2008). Removal of natural and xeno-estrogens during conventional wastewater treatment. *Reviews in Environmental Science and Bio/Technology*, 7(2), 107-124.
40. Ternes, T. A., Kreckel, P., & Mueller, J. (1999). Behaviour and occurrence of estrogens in municipal sewage treatment plants—II. Aerobic batch experiments with activated sludge. *Science of the Total Environment*, 225(1), 91-99.

## References

41. Shi, J., Fujisawa, S., Nakai, S., & Hosomi, M. (2004). Biodegradation of natural and synthetic estrogens by nitrifying activated sludge and ammonia-oxidizing bacterium *Nitrosomonas europaea*. *Water Research*, 38(9), 2323-2330.
42. Furlong, E. T., Quanrud, D., & Stinson, B. M. (2010). *Fate of estrogenic compounds during municipal sludge stabilization and dewatering* (p. 176). London: Water Environment Research Foundation.
43. United States Environmental Protection Agency (2002). *Biosolids Technology Fact Sheet: Use of Composting for Biosolids Management*. 1-10.  
  
[http://water.epa.gov/scitech/wastetech/upload/2002\\_10\\_15\\_mtb\\_combioman.pdf](http://water.epa.gov/scitech/wastetech/upload/2002_10_15_mtb_combioman.pdf)  
  
Uploaded: 24.06.2015 11:56
44. EC, 2003. Technical Guidance Document on Risk Assessment, Part II. EUR 20418 EN/2. European Commission, Joint Research Centre.
45. Martín, J., Camacho-Muñoz, M. D., Santos, J. L., Aparicio, I., & Alonso, E. (2012). Distribution and temporal evolution of pharmaceutically active compounds alongside sewage sludge treatment. Risk assessment of sludge application onto soils. *Journal of environmental management*, 102, 18-25.
46. Zuloaga, O., Navarro, P., Bizkarguenaga, E., Iparraguirre, A., Vallejo, A., Olivares, M., & Prieto, A. (2012). Overview of extraction, clean-up and detection techniques for the determination of organic pollutants in sewage sludge: a review. *Analytica chimica acta*, 736, 7-29.
47. Johnson, A. C., & Williams, R. J. (2004). A model to estimate influent and effluent concentrations of estradiol, estrone, and ethinylestradiol at sewage treatment works. *Environmental science & technology*, 38(13), 3649-3658.
48. United States Environmental Protection Agency, National Directory of Volunteer Environmental Monitoring Programs (1998)  
  
<http://water.epa.gov/type/watersheds/monitoring/dir.cfm>  
  
Uploaded: 15.06.15 13:19
49. Ort, C., Lawrence, M. G., Rieckermann, J., & Joss, A. (2010). Sampling for pharmaceuticals and personal care products (PPCPs) and illicit drugs in wastewater systems: are your conclusions valid? A critical review. *Environmental science & technology*, 44(16), 6024-6035.
50. Larrarte, F. (2008). Suspended solids within sewers: an experimental study. *Environmental Fluid Mechanics*, 8(3), 249-261.
51. Capote, F. P., & de Castro, M. L. (2007). *Analytical applications of ultrasound*(Vol. 26). Elsevier, 171.
52. Shah, Y. T., Pandit, A. B., & Moholkar, V. S. (1999). Gas-Liquid Cavitation Chemistry. In *Cavitation Reaction Engineering* (pp. 85-153). Springer US.
53. Navarro, P., Etxebarria, N., & Arana, G. (2009). Development of a focused ultrasonic-assisted extraction of polycyclic aromatic hydrocarbons in marine sediment and mussel samples. *Analytica chimica acta*, 648(2), 178-182.

## References

54. Teo, C. C., Tan, S. N., Yong, J. W. H., Hew, C. S., & Ong, E. S. (2010). Pressurized hot water extraction (PHWE). *Journal of Chromatography A*, 1217(16), 2484-2494.
55. Kruse, A., & Dinjus, E. (2007). Hot compressed water as reaction medium and reactant: properties and synthesis reactions. *The Journal of Supercritical Fluids*, 39(3), 362-380.
56. Camel, V. (2001). Recent extraction techniques for solid matrices—supercritical fluid extraction, pressurized fluid extraction and microwave-assisted extraction: their potential and pitfalls. *Analyst*, 126(7), 1182-1193.
57. Funke, A., & Ziegler, F. (2010). Hydrothermal carbonization of biomass: a summary and discussion of chemical mechanisms for process engineering. *Biofuels Bioproducts and Biorefining*, (4), 160-177.
58. Mitra, S. (Ed.). (2004). *Sample preparation techniques in analytical chemistry* (Vol. 237). John Wiley & Sons, 79.
59. Supelco (1998) *Bulletin 910: Guide to Solid Phase Extraction*  
  
<http://webcache.googleusercontent.com/search?q=cache:ZCvWBdk6MLQJ:www.researchgate.net/publications/PublicPostFileLoader.html%3Fid%3D54bce6d7cf57d71e078b4650%26key%3D507585a4-940d-4d8a-9e44-934021dfda77+&cd=1&hl=nn&ct=clnk>  
  
Uploaded: 25.06.15 18:16
60. Yu, Y., Huang, Q., Cui, J., Zhang, K., Tang, C., & Peng, X. (2011). Determination of pharmaceuticals, steroid hormones, and endocrine-disrupting personal care products in sewage sludge by ultra-high-performance liquid chromatography–tandem mass spectrometry. *Analytical and bioanalytical chemistry*, 399(2), 891-902.
61. Lillenberg, M., Yurchenko, S., Kipper, K., Herodes, K., Pihl, V., Sepp, K., Löhmus, R. & Nei, L. (2009). Simultaneous determination of fluoroquinolones, sulfonamides and tetracyclines in sewage sludge by pressurized liquid extraction and liquid chromatography electrospray ionization-mass spectrometry. *Journal of Chromatography A*, 1216(32), 5949-5954.
62. Gatidou, G., Thomaidis, N. S., Stasinakis, A. S., & Lekkas, T. D. (2007). Simultaneous determination of the endocrine disrupting compounds nonylphenol, nonylphenol ethoxylates, triclosan and bisphenol A in wastewater and sewage sludge by gas chromatography–mass spectrometry. *Journal of Chromatography A*, 1138(1), 32-41.
63. Ternes, T. A., Andersen, H., Gilberg, D., & Bonerz, M. (2002). Determination of estrogens in sludge and sediments by liquid extraction and GC/MS/MS. *Analytical Chemistry*, 74(14), 3498-3504.
64. Trass, T., Layne, J. & Koerner, P. (2012) Rapid LC/MS/MS Analysis of Digoxin and Digitoxin in Plasma using Strata™-X SPE Cartridges and Kinetex® 2.6 µm C8 Core-Shell HPLC/UHPLC Columns, *Phenomenex*  
  
[http://phx.phenomenex.com/lib/tn94120412\\_W.pdf](http://phx.phenomenex.com/lib/tn94120412_W.pdf)  
  
Uploaded: 27.06.2014
65. Chiu, T. Y., Koh, Y. K. K., Paterakis, N., Boobis, A. R., Cartmell, E., Richards, K. H., Lester, J. N. & Scrimshaw, M. D. (2009). The significance of sample mass in the analysis of steroid estrogens in

## References

- sewage sludges and the derivation of partition coefficients in wastewaters. *Journal of Chromatography A*, 1216(24), 4923-4926.
66. Nie, Y., Qiang, Z., Zhang, H., & Adams, C. (2009). Determination of endocrine-disrupting chemicals in the liquid and solid phases of activated sludge by solid phase extraction and gas chromatography–mass spectrometry. *Journal of Chromatography A*, 1216(42), 7071-7080.
67. Combalbert, S., Pype, M. L., Bernet, N., & Hernandez-Raquet, G. (2010). Enhanced methods for conditioning, storage, and extraction of liquid and solid samples of manure for determination of steroid hormones by solid-phase extraction and gas chromatography–mass spectrometry. *Analytical and bioanalytical chemistry*, 398(2), 973-984.
68. Bevacqua, C. E., Rice, C. P., Torrents, A., & Ramirez, M. (2011). Steroid hormones in biosolids and poultry litter: A comparison of potential environmental inputs. *science of the total environment*, 409(11), 2120-2126.
69. Fernandez, M. P., Noguerol, T. N., Lacorte, S., Buchanan, I., & Piña, B. (2009). Toxicity identification fractionation of environmental estrogens in waste water and sludge using gas and liquid chromatography coupled to mass spectrometry and recombinant yeast assay. *Analytical and bioanalytical chemistry*, 393(3), 957-968.
70. Citulski, J. A., & Farahbakhsh, K. (2010). Fate of endocrine-active compounds during municipal biosolids treatment: a review. *Environmental science & technology*, 44(22), 8367-8376.
71. Santos, M. G., Tavares, I. M. C., Boralli, V. B., & Figueiredo, E. C. (2015). Direct doping analysis of beta-blocker drugs from urinary samples by on-line molecularly imprinted solid-phase extraction coupled to liquid chromatography/mass spectrometry. *Analyst*, 140(8), 2696-2703.
72. Prieto, A., Vallejo, A., Zuloaga, O., Paschke, A., Sellergen, B., Schillinger, E., Schrader, S. & Möder, M. (2011). Selective determination of estrogenic compounds in water by microextraction by packed sorbents and a molecularly imprinted polymer coupled with large volume injection-in-port-derivatization gas chromatography–mass spectrometry. *Analytica chimica acta*, 703(1), 41-51.
73. Schoenmakers, P., Marriott, P., & Beens, J. (2003). Nomenclature and conventions in comprehensive multidimensional chromatography. *LCGC Europe*, 25(5), 1-4.
74. Ramos, L. (Ed.). (2009). *Comprehensive two dimensional gas chromatography* (Vol. 55). Elsevier, 1-34.
75. Zhou, Y. Q., Wang, Z. J., & Ning, J. I. A. (2007). Formation of multiple trimethylsilyl derivatives in the derivatization of 17 $\alpha$ -ethinylestradiol with BSTFA or MSTFA followed by gas chromatography-mass spectrometry determination. *Journal of Environmental Sciences*, 19(7), 879-884.
76. Zhang, K., & Zuo, Y. (2005). Pitfalls and solution for simultaneous determination of estrone and 17 $\alpha$ -ethinylestradiol by gas chromatography–mass spectrometry after derivatization with N, O-bis (trimethylsilyl) trifluoroacetamide. *Analytica chimica acta*, 554(1), 190-196.
77. Sigma-Aldrich Co.LLC

[https://www.sigmaaldrich.com/content/dam/sigmaaldrich/docs/Supelco/Product\\_Information\\_Sheet/4747.pdf](https://www.sigmaaldrich.com/content/dam/sigmaaldrich/docs/Supelco/Product_Information_Sheet/4747.pdf)

Uploaded: 24.06.2015 14:08

## References

78. Hájková, K., Pulkrabová, J., Schůrek, J., Hajšlová, J., Poustka, J., Nápravníková, M., & Kocourek, V. (2007). Novel approaches to the analysis of steroid estrogens in river sediments. *Analytical and bioanalytical chemistry*, 387(4), 1351-1363.
79. Baronti, C., Curini, R., D'Ascenzo, G., Di Corcia, A., Gentili, A., & Samperi, R. (2000). Monitoring natural and synthetic estrogens at activated sludge sewage treatment plants and in a receiving river water. *Environmental Science & Technology*, 34(24), 5059-5066.
80. Petrovic, M., Farré, M., De Alda, M. L., Perez, S., Postigo, C., Köck, M., Radjenovic, J., Gros, M. & Barcelo, D. (2010). Recent trends in the liquid chromatography–mass spectrometry analysis of organic contaminants in environmental samples. *Journal of Chromatography A*, 1217(25), 4004-4017.
81. Vogeser, M., & Seger, C. (2008). A decade of HPLC–MS/MS in the routine clinical laboratory—goals for further developments. *Clinical biochemistry*, 41(9), 649-662.
82. Searle, P. A., Glass, K. A., & Hochlowski, J. E. (2004). Comparison of preparative HPLC/MS and preparative SFC techniques for the high-throughput purification of compound libraries. *Journal of combinatorial chemistry*, 6(2), 175-180.
83. Bodnar, W. M., Blackburn, R. K., Krise, J. M., & Moseley, M. A. (2003). Exploiting the complementary nature of LC/MALDI/MS/MS and LC/ESI/MS/MS for increased proteome coverage. *Journal of the American Society for Mass Spectrometry*, 14(9), 971-979.
84. Norton, D., Crow, B., Bishop, M., Kovalcik, K., George, J., & Bralley, J. A. (2007). High performance liquid chromatography–tandem mass spectrometry (HPLC/MS/MS) assay for chiral separation of lactic acid enantiomers in urine using a teicoplanin based stationary phase. *Journal of Chromatography B*, 850(1), 190-198.
85. Farré, M., Kantiani, L., Petrovic, M., Pérez, S., & Barceló, D. (2012). Achievements and future trends in the analysis of emerging organic contaminants in environmental samples by mass spectrometry and bioanalytical techniques. *Journal of chromatography A*, 1259, 86-99.
86. EC, 2002. Concerning the performance of analytical methods and the interpretations of results. EUR 657. European Commission Guidelines
87. Kuster, M., de Alda, M. J. L., Hernando, M. D., Petrovic, M., Martín-Alonso, J., & Barceló, D. (2008). Analysis and occurrence of pharmaceuticals, estrogens, progestogens and polar pesticides in sewage treatment plant effluents, river water and drinking water in the Llobregat river basin (Barcelona, Spain). *Journal of Hydrology*, 358(1), 112-123.
88. Kopperi, M., Ruiz-Jiménez, J., Hukkinen, J. I., & Riekkola, M. L. (2013). New way to quantify multiple steroidal compounds in wastewater by comprehensive two-dimensional gas chromatography–time-of-flight mass spectrometry. *Analytica chimica acta*, 761, 217-226.
89. Jobling, S., Nolan, M., Tyler, C. R., Brighty, G., & Sumpter, J. P. (1998). Widespread sexual disruption in wild fish. *Environmental science & technology*, 32(17), 2498-2506.
90. Vajda, A. M., Barber, L. B., Gray, J. L., Lopez, E. M., Bolden, A. M., Schoenfuss, H. L., & Norris, D. O. (2011). Demasculinization of male fish by wastewater treatment plant effluent. *Aquatic Toxicology*, 103(3), 213-221.



## References

91. Helsinki Region Environmental Service Authority HSY

<https://www.hsy.fi/en/residents/pages/default.aspx>

Uploaded: 03.03.15 15:40

92. Duratec Analysentechnik GmbH

[http://www.duratec.info/index.php?option=com\\_docman&task=doc\\_details&gid=124&Itemid=10&lang=en](http://www.duratec.info/index.php?option=com_docman&task=doc_details&gid=124&Itemid=10&lang=en)

Uploaded: 02.06.15 11:48

93. SilcoTek®

<http://www.silcotek.com/>

Uploaded: 02.04.15 14:18

## 7 APPENDIX

---

**Table A1: Shows the values from the injection port liner optimization. Showing the sum of the relative peak areas of the steroid mixture and the standard deviation from three injections**

<b>Average of three injections sum steroid mixture response</b>			
<b>Concentration</b>	<b>0.5 µg/ml</b>	<b>2 µg/ml</b>	<b>5 µg/ml</b>
<b>Normal liner with Supelco glass wool</b>	2,664053	12,79024	30,10991
<b>Normal liner unaccompanied</b>	2,150038	9,904541	25,7033
<b>Ultra inert liner with Agilent glass wool</b>	3,162584	14,90485	38,60078
<b>Ultra inert liner unaccompanied</b>	2,452448	12,57637	28,35636
<b>Standard deviation of the sums from the three injections</b>			
<b>Concentrations</b>	<b>0.5 µg/ml</b>	<b>2 µg/ml</b>	<b>5 µg/ml</b>
<b>Normal liner with Supelco* glass wool</b>	0,256082	1,206352	2,400183
<b>Normal liner unaccompanied</b>	0,233422	1,445139	1,005919
<b>Ultra inert liner with Agilent glass wool</b>	0,22076	0,092899	2,521372
<b>Ultra inert liner unaccompanied</b>	0,257479	0,958147	3,254472

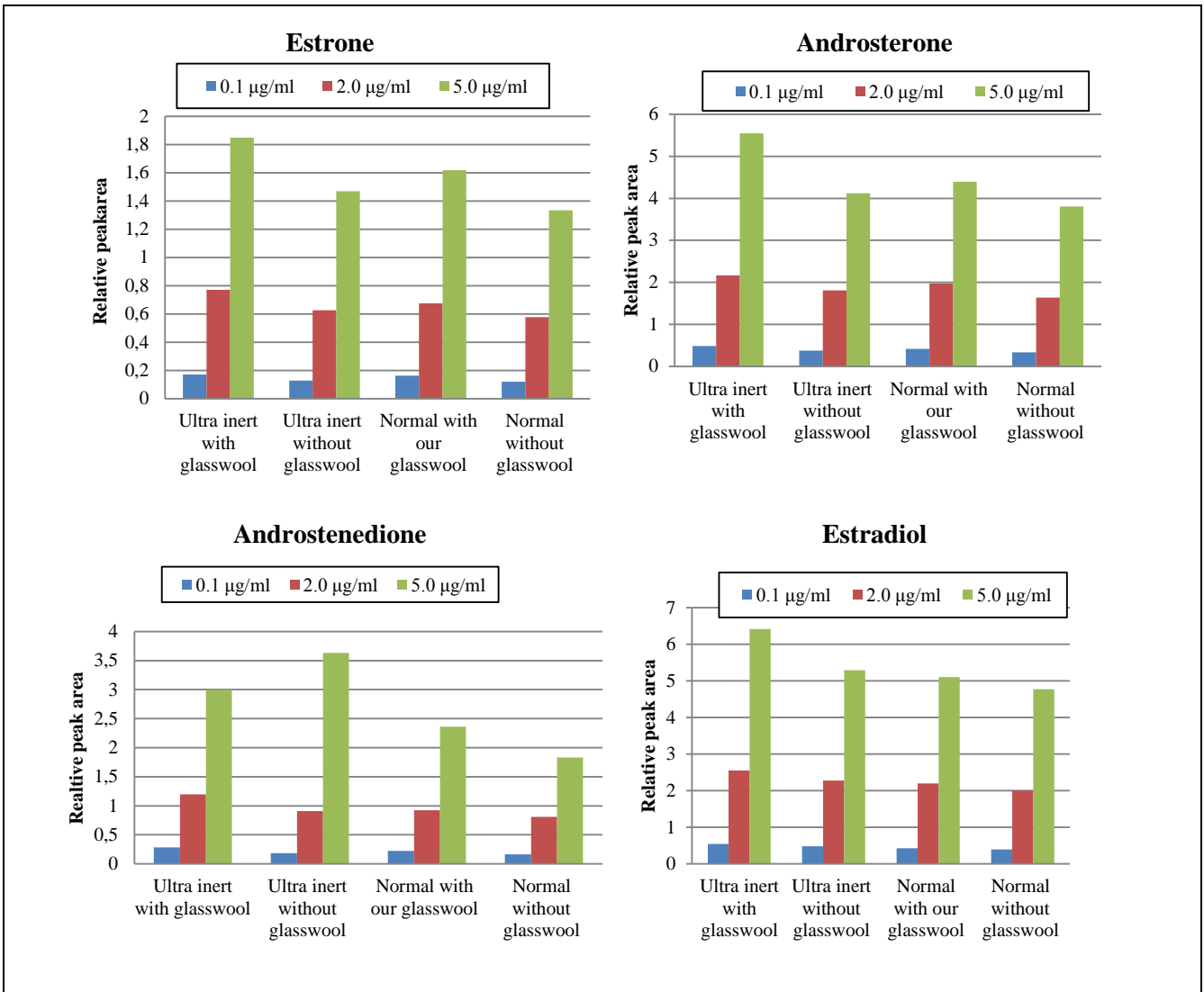

Figure A1 Part I of the trend for the individual steroids in the steroid mixture for estrone, androsterone, androstenedione and estradiol from the liner optimization

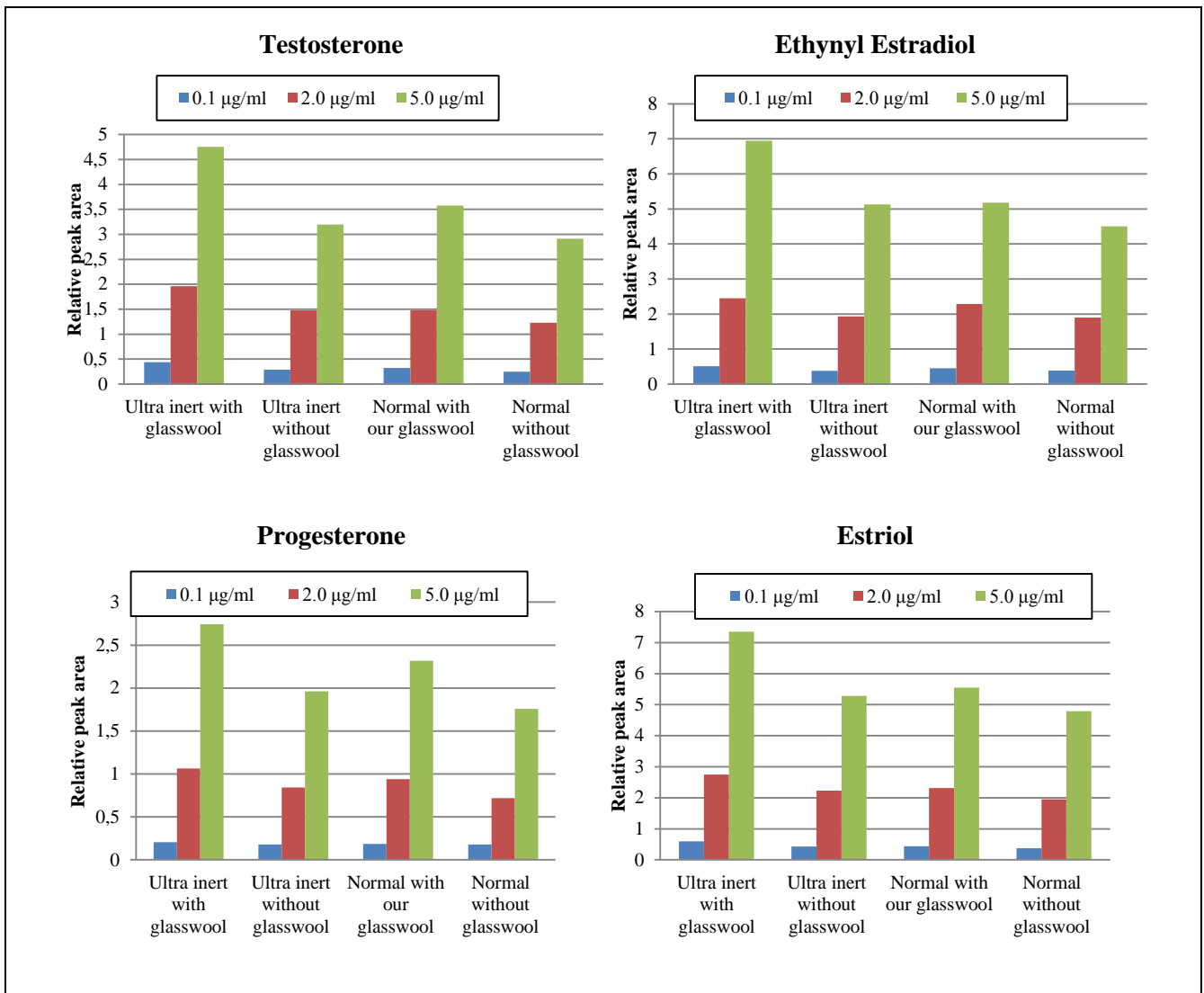

Figure A2 Part II of the trend for the individual steroids in the steroid mixture for testosterone, ethynyl estradiol, progesterone and estriol from the liner optimization

Appendix

**Table A2:**

**Relative peak area and relative standard deviations from the individual steroids in the steroid mixture (androsterone, estrone, androstenedione, estradiol, testosterone, ethinyl estradiol, progesterone and estriol) – For the feature: Ultra inert liner with Agilent glass wool**

Compound	0.5 µg/ml		2 µg/ml		5 µg/ml	
	Avg	RSD(%)	Avg	RSD(%)	Avg	RSD(%)
Androsterone	0,485462	6	2,163676	5	5,54696	6
Estrone	0,144818*	13*	0,770515	7	1,848019	7
Androstenedione	0,283223	4	1,19762	7	2,994506	11
Estradiol	0,544741	18	2,551142	5	6,415412	5
Testosterone	0,437983	11	1,962792	2	4,75522	5
Ethinyl Estradiol	0,51421	17	2,448812	5	6,942602	7
Progesterone	0,205755	14	1,062717	3	2,743529	7
Estriol	0,594664	3	2,74757	1	7,354536	7

\* Only 2 injections

**Table A3:**

**Relative peak area and relative standard deviations from the individual steroids in the steroid mixture (androsterone, estrone, androstenedione, estradiol, testosterone, ethinyl estradiol, progesterone and estriol) – For the feature: Ultra inert liner without any glass wool (unaccompanied)**

Compound	0.5 µg/ml		2 µg/ml		5 µg/ml	
	Avg	RSD(%)	Avg	RSD(%)	Avg	RSD(%)
Androsterone	0,375017	11	1,810608	10	4,123571	2
Estrone	0,127846	9	0,625535	8	1,470019	2
Androstenedione	0,186442	15	0,90787	9	3,630641	1
Estradiol	0,48026	15	2,530062	7	5,289299*	2*
Testosterone	0,290965	12	1,479986	10	3,197699	2
Ethinyl Estradiol	0,379855	13	2,115991	8	5,127039	2
Progesterone	0,180145	1	0,841914	11	1,962188	2
Estriol	0,43192	7	2,264406	9	5,319005	3

\* Only 2 injections

Appendix

**Table A4:**

**Relative peak area and relative standard deviations from the individual steroids in the steroid mixture (androsterone, estrone, androstenedione, estradiol, testosterone, ethinyl estradiol, progesterone and estriol) – For the feature: Normal liner with Supelco silane treated glass wool**

Compound	0,5 µg/ml		2 µg/ml		5 µg/ml	
	Avg	RSD(%)	Avg	RSD(%)	Avg	RSD(%)
Androsterone	0,413888166	6	1,973056	6	4,396003	6
Estrone	0,16150628	17	0,674508	5	1,617405	10
Androstenedione	0,222179727	15	0,924789*	9*	2,360168	9
Estradiol	0,429229877	8	2,199647	15	5,106263	8
Testosterone	0,322621136	12	1,480635	9	3,577813	8
Ethinyl Estradiol	0,450810103	11	2,282646	5	5,182126	6
Progesterone	0,185649078*	16*	0,939066	14	2,316868	14
Estriol	0,443099842	3	2,31589*	15*	5,553269	9

\* Only 2 injections

**Table A5:**

**Relative peak area and relative standard deviations from the individual steroids in the steroid mixture (androsterone, estrone, androstenedione, estradiol, testosterone, ethinyl estradiol, progesterone and estriol) – For the feature: Normal liner without any glass wool (unaccompanied)**

Compound	0,5 µg/ml		2 µg/ml		5 µg/ml	
	Avg	RSD(%)	Avg	RSD(%)	Avg	RSD(%)
Androsterone	0,330623	14	1,637216	3	3,805098	2
Estrone	0,120414	10	0,577848	3	1,334521	7
Androstenedione	0,166778	6	0,810817	0	1,833672	5
Estradiol	0,399218	11	2,001974	1	4,771433	4
Testosterone	0,248881	8	1,227066	4	2,910586	4
Ethinyl Estradiol	0,390514	4	1,900679	4	4,502291	4
Progesterone	0,177342*	5*	0,717851	5	1,757776	8
Estriol	0,375381	6	1,952043*	5*	4,787919	5

\* Only 2 injections

**Table A6: Weight and relative peak area values for the environmental sample analysis from 3 parallels and 2 injections of the garden and lawn soil (used in relation with table 5)**

Environmental sample weights and relative peak area from garden and lawn samples			
Type of solid	Weight - Parallel 1	Weight - Parallel 2	Weight - Parallel 3
Garden soil	74.9 mg	525.4 mg	2005.1 mg
Lawn soil	53.3 mg	514.3 mg	2092.0 mg
Relative peak area	Peak area - Parallel 1	Peak area - Parallel 2	Peak area - Parallel 3
Garden soil	0*	7.976	155.870
	0*	15.154	159.909
Lawn soil	0*	25.551	70.812
	0*	22.992	44.750

*\*Not taken into account in RSD and standard deviations calculations*

**Table A7: Weight and relative peak area for one parallel from the sludge sample used with the garden and lawn sample (used in relation with table 5)**

Environmental sample relative peak area from the sludge samples – Weight 50.1 mg			
Compound	Peak area - Injection 1	Peak area - Injection 2	Peak area - Injection 3
Androsterone	258.697	92.660	82.859
Estrone	32.564	8.983	7.310
Androstenedione	20.023	1.375	2.738
Progesterone	21.289	10.589	8.863

**Table A8: Variation of the extraction times 30, 60, 90 and 120 minutes described by relative standard deviations from the samples for the ultrasound-assisted extraction (UAE)**

Relative standard deviations from UAE (%)				
Steroid	30 min	60 min	90 min	120 min
Androsterone	19	23	17	9
Estrone	31	14	9	12
Androstenedione	26	16	19	11
Progesterone	19	16	16	33

**Table A9: Variation of the extraction times 15, 30, 45 and 60 minutes described by relative standard deviation for the focused ultrasound-assisted extraction (FUAE)**

Relative standard deviations from FUAE (%)				
Steroid	15 min	30 min	45 min	60 min
Androsterone	10	21	42	7
Estrone	4	23	-	7
Androstenedione	5	33	-	11
Progesterone	1	6	-	34

**Table A10: Variation of the extraction temperatures 150, 200, 225, 250, 275 and 300 °C described by relative standard deviations from the samples for the pressurized hot water extraction**

Relative standard deviations from PHWE (%)						
Steroid	150 °C	200 °C	225 °C	250 °C	275 °C	300 °C
Androsterone	3	13	32	10	33	14
Estrone	10	61	58	12	21	22
Androstenedione	16	11	22	9	34	6
Progesterone	3	-	91	10	12	7



**Table A11: Variation of the extraction described by relative standard deviations of the reference sample which was simply vortexed**

Relative standard deviations from reference (vortexing) (%)	
Steroid	RSD
Androsterone	4
Estrone	10
Androstenedione	10
Progesterone	5

**Table A12:**

Values used in the student t-test measuring if there is a difference from the two liner features:

- 1.) Normal liner with Supelco silane treated glass wool
- 2.) Ultra inert liner with Agilent glass wool after 3 weeks of usage

The values are a sum of the relative peak areas of the steroid mixture and the standard deviations are from the three injections.

Relative peak area of the two features tested with a t-test					
Feature	Injetion 1	Injetion 2	Injection 3	Average	Standard deviation
Normal liner with Supelco silane treated glass wool	32,5341	27,73448	30,06116	30,1099	2,4002
Ultra inert liner with Agilent glass wool after 3 weeks of usage	27,37009	26,22816	21,17087	24,9230	3,2992
<b>p-value</b>	<b>0,135</b>				